

POPULAR MECHANICS MAGAZINE

WRITTEN SO YOU CAN UNDERSTAND IT

REG. TRADE MARK GREAT BRITAIN No. 40428

REG. U.S. PAT. OFF.

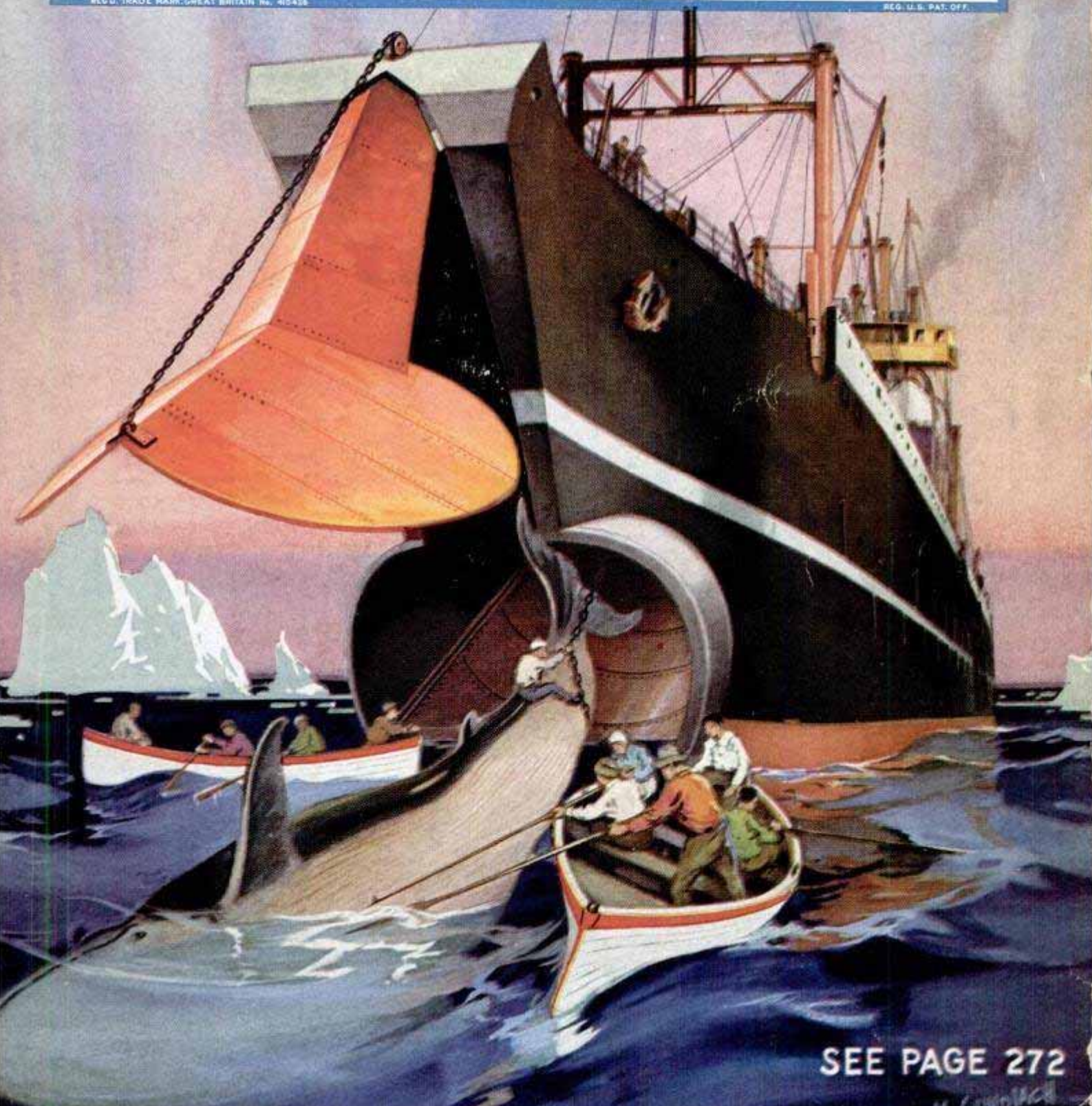

SEE PAGE 272

ATKINS

METAL CUTTING SAWS

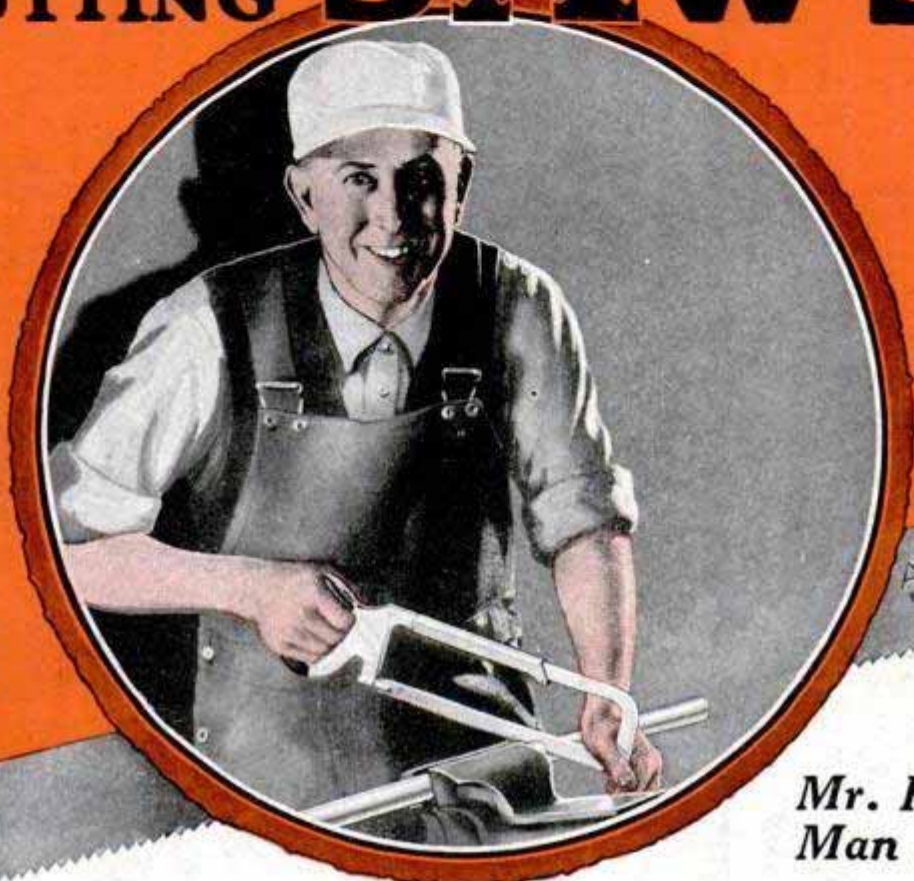

ATKINS - SILVER
MADE IN U.S.A. - STEEL

*Mr. Happy
Man Says:*

“SILVER STEEL Hack Saw Blades Last Six Times as Long”

TESTS show that the new ATKINS “Silver Steel” Hack Saw Blades for hand use will cut *twice* as fast, and last at least *six times* as long, as any other hack saw blade you ever used.

Think what a saving of time, money and effort this means to you on all your hack saw work. What it means to do a metal-cutting job in *half* the usual time—to have a hack saw blade that will outlast *six* ordinary blades! “Silver Steel” blades keep their teeth and will not snap.

You should be using these wonderful new blades NOW. Ask your hardware dealer to show you these new and better blades. If he cannot supply you, write us and tell us what kind of metal you are cutting, enclosing 25c, and we will send you a sample “SILVER STEEL” blade.

E. C. ATKINS & CO., Est. 1857
426 S. Illinois St., INDIANAPOLIS, IND.

*Leading Manufacturers of Saws,
Saw Tools, Saw Specialties
and Machine Knives*

ATKINS - SILVER
MADE IN U.S.A. - STEEL

Exclusive Mechanical Features

MAKE CONN'S MUSICALLY SUPERIOR



The Conn Victor Cornet is hailed by artists as "the world's best."



Conn Saxophones embody many exclusive, easy-playing features.



Many models of Conn Trombones fill every playing need.

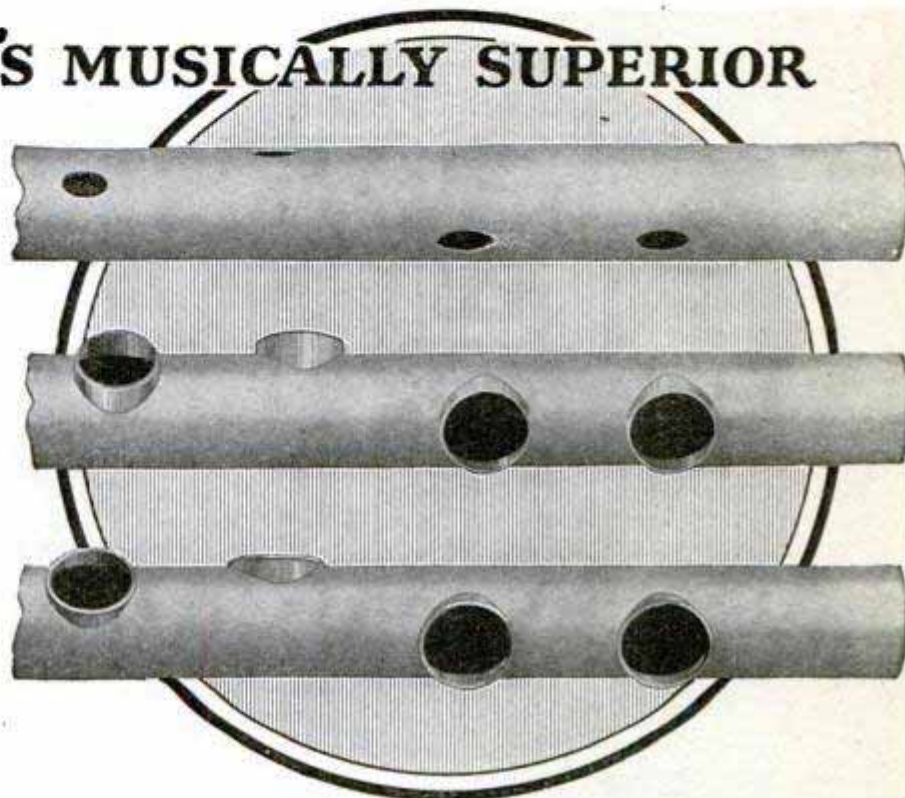

INTEGRAL sockets, drawn from the body of the instrument, are a vital feature of all Conn metal keyed instruments, of which the saxophone is chief. The illustration at the top shows the tone holes, accurately placed to the thousandth of an inch. The middle picture shows the drawn socket. Below you see the rolled edge of the socket, which saves pads and insures tight closing. *There is absolutely no chance for air leakage by this Conn process!*

This is but one of many mechanical superiorities which make Conns easier to play, perfect in scale, beautiful in tone, the choice of the world's foremost professionals.

START NOW TO CULTIVATE YOUR MUSICAL "BUMP." Be popular, welcome everywhere, entertain yourself and friends; enter a fascinating professional career if you choose. With an easy-playing Conn you make rapid progress, play popular tunes in a short while.

FREE TRIAL, EASY PAYMENTS on any Conn for Band or Orchestra. Choose any instrument, cornet, trumpet, trombone, saxophone, flute, clarinet, oboe, drum, etc. *With all their exclusive features Conns cost no more!* Send coupon now for free literature and details of free trial offer.

Mail Coupon

C. G. CONN, *Inc.*, 231 Conn Bldg., Elkhart, Ind.
Please send free literature and details of trial offer on

(Instrument) _____

Name _____

St. or R. F. D. _____

City, State _____

County _____

CONN

BAND
INSTRUMENTS
WORLD'S LARGEST MANUFACTURERS

CULTIVATE YOUR MUSICAL "BUMP"





Next in line — yet never chosen — perhaps it's *comedones*

FOR three years he had been next in line. They had given the Department Manager's job, with its high salary and prestige, to another. He never suspected that *comedones* kept him always "next in line."

* * *

It is a misfortune to suffer from comedones—the scientific name for blackheads. What's more, you may not even be conscious of them, though others notice them. Comedones often interfere with business success, for you can't be clean cut and attractive when they are present. Do *you* wonder why

you don't get ahead? Perhaps it's *comedones*.

Pompeian Massage Cream helps you overcome *comedones*. It gets in where comedones form, rolls out all the dirt and oily secretions.

It stimulates a healthy circulation, keeps the pores open, and gives you a clean, ruddy complexion.

Try this treatment: After you shave, spread Pompeian Massage Cream generously over your face—and rub. Continue to rub until the cream rolls out. Note how dark the cream looks. That's the dirt that was in your pores.

Don't let comedones form. Use Pompeian Massage Cream every day—especially when engagements demand that you look your best. To get the full benefit, use Pompeian Massage Cream regularly at home after shaving. Your face will feel and look like a million dollars. 60c jars at all drug stores.



Use at Home after Shaving

TEAR OFF NOW! YOU MAY FORGET

THE POMPEIAN LABORATORIES
Dept. 45, Cleveland, Ohio

Gentlemen: I enclose 10c (a dime, coin preferred) for a special trial tube of Pompeian Massage Cream.

Name

Street Address

City..... State.....

SEND FOR
10-DAY TRIAL
TUBE

For 10c we will send a special trial tube containing sufficient cream for many delightful massages. Positively only one trial tube to a family on this exceptional offer. Use this coupon now.



For Men!

Popular Mechanics Magazine

200 E. Ontario Street, Chicago, U. S. A.

H. H. WINDSOR, Founder

H. H. WINDSOR, Jr., Editor and Publisher

London: Hachette & Cie.,
16-17 King William Street, Charing Cross, W. C. 2

Paris: Hachette & Cie.,
111 Rue Reaumur

Melbourne: Gordon & Gotch
509-513 Little Collins St.

ISSUED MONTHLY

SUBSCRIPTION

SINGLE COPY, 25 CENTS

In United States and its possessions, also Canada, Cuba, and Mexico, per year, postpaid - \$2.50

To all other countries in the Postal Union - 3.00

All subscriptions are discontinued at expiration. Please examine the date printed on your wrapper.

Entered as Second Class Matter Sept. 15, 1903, at the Post Office at Chicago, Illinois, under Act of March 3rd, 1879.

Entered as Second Class Matter at the Post Office Department, Canada.

Published monthly by POPULAR MECHANICS CO.

Copyright, 1927 by Popular Mechanics Co.

Copyright in Australia. Copyright in France

Vol. 47

Contents for February, 1927

No. 2

Advertising—hoist lighted world as shipping sign	218	Fuel—coal dust mixed with clay proves good	257
Aerial Postal Service—racing death in icy clouds	213	Games—bull's-eye tennis on liners	255
Aerial Warfare—test main tunnel for air-raid shelter	183	Garages—steel roofs made for war serve as	192
Agriculture		Garden—in form of U. S. map in park	198
electricity grows crops without fertilizer	258	Glue—spreader tip on tube	199
hot-air fan for drying crops	280	Golf	
Airplane—can be silenced	222	game played indoors	181
Airship		scorer on watch strap	225
big barrel serves as, at amusement resort	201	Greenhouse—move hothouse twelve miles without	
planes launched by airship make safe landing	247	breaking glass	252
Alligator—man defeats live, in underwater battle	278	Hair—waver heated by water	226
Astronomy		Head Hunters—and their weird rites	234
find two comets in one day	257	Heater	
fly wings measure heat in stars	225	faucet water heater	231
Automobile—Racing—course has five tracks	266	portable kerosene fire box	279
Automobiles—Accelerator—that rolls	223	House	
Automobiles—Design		lasts hundred years figures show	182
auto run by compressed air	278	model home on hotel canopy shows city's growth	199
front drive for low car	251	House Plans	352
Automobiles—Equipment and Supplies—bumper has		Household Devices	286
net on chains	183	Icebergs—fighting, with fire	248
Automobiles—Fuel—motor fuel from coal tar	246	Ironwork—artists express ideas in	233
Aviation—battle of wings for air honors	283	Island—big floating, captured	212
Baby Carriage—that folds up carried as handbag	256	Jack—safety repair lift for auto	201
Bearings—self adjusting	256	Life Saving Apparatus—life bag and stretcher in one	181
Billiard—detachable cue tip	211	Lifeboat—aerial, proposed for channel rescues	191
Blasting—one of world's largest rocks	289	Light	
Boats and Boating—light canopy on carnival gondola	193	lamps in senate chamber	225
Botany—glass traps for sunbeams aid plant growth	216	measuring speed of, to aid surveys	250
Bridge		Loading and Unloading—haul trailers on flat cars to	
footbridge over Paris avenue	282	speed shipments	239
of hope rivals "bridge of sighs"	189	Lungs—strength of, tested blowing up tube	233
Building—"ship" as real estate office	288	Magic—with money	227
Building Material		Map—greatest relief	200
blocks in cathedral column each weigh eight tons	232	Mask	
steel tile for bathrooms	265	ancient Indian comic ridicules boaster	246
Buoys—phone, for submarines	267	grade pupils make, for school exhibit	206
Cables—underground power insulated in oil	296	Meter—sheepskin "lungs" in gas	288
Cakes—decorating taught in school	281	Model—tower built of newspapers	296
Chair		Monument	
has rack for umbrella and shelf for hat	251	making of	207
mended with brace set	262	to mail carrier	282
Chemical Warfare—sham battle tests latest chemical		Motor Sled—replaces dog teams on mining sled	179
weapons	190	Motor Truck—high-lift truck body	275
Chromium—wonder metal and what it does	185	Motorcycle—armored sidecar with radio for police	
Clock—repair men turn acrobats fixing	272	work	211
Comb—full size that folds	222	Moving Picture Projector—helps sales	191
Cowboy—elk round-up in New England	245	Mower—comb teeth on, help remove weeds	182
Crown—famed Russian	294	Music—blocks teach children	212
Decoration and Ornament—china cat and bird on wall		Musical Instrument—horn connected to violin	197
of house	273	Navigation—"skip" waves give radio direction and	
Disease—oxygen chamber aids pneumonia victims	295	secrecy	180
Electric Light		Organ—single pipe for big	237
bath cabinet	261	Paint—electric burner for paint	241
transformer in light socket runs small bulbs	246	Parachutes—with pockets	267
Electric Light Bulb—filaments of rare metal to im-		Petroleum	
prove lights	199	oil one ton of soft coal yields	226
Explosion—man-made blasts to show way to mine safety	285	oil wells do not run straight	211
Eyes—pocket exerciser for	280	Phonograph—disk record bent double	295
Fact—things you know that aren't true	259	Photography	
Fire Apparatus		camera for action photos	219
fire signal has loud speaker	289	camera to solve old temple mysteries	198
"smoke eater" latest aid in fighting fires	224	Pipe (Tobacco)—pipe carver reveals skill in meer-	
Fire Engine		schaum figures	258
like limousine	212	Pipe—rifled inside for better flow of oil	254
sidecar on cycle fire engine	252	Pirates—fighting	194
Fish—builds nest of weeds	258	Plating—gold in vacuum without acid bath	275

[Continued on Page 4]

Patent Board 265

Ants, Building Codes to fight 192

Signal 237

Islands admits ultra-violet rays

Special Trailer 240

Playground Apparatus—spiral slide	226	Warship—Great Britain's warships show their strength	263
Postal Service—aid to mail delivery	296	Watch—wrist, as alarm clock	256
Rabbit—steel wire serves as ferret	224	Water	
Radio		liners carry forty gallons of water per passenger	224
city has radio phones	258	treating, on railways, saves millions yearly	282
set in diver's cage	223	Water Sport	
Radio Aerial		float propelled by feet	250
aerial adapter for P.M. superhet	306	jockeys ride in tub for race	182
flag and weather-vane top aerial mast	308	Water Tower—of steel, and tank moved	222
Radio Antenna—antenna of unusual design	308	Weather	
Radio Apparatus—facts and fads for fans	307	English climate slows U. S.-made timepieces	212
Radio Battery		fewer storms in November records show	242
filter eliminates A-battery	300	Windmill—electricity from the sky supplied by	257
storage B-battery has built-in charger unit	309	Window—cleaned with curved stick	296
Radio Cabinet—console front is cone speaker	309		
Radio Condenser—vernier dial fits all condensers	300		
Radio Construction			
battery cable simplifies wiring	310		
new unit brings old set up to date	299		
potentiometer for R.F. control	309		
Radio Eliminator—twelve dollar eliminator	301		
Radio Ground—ground disk retains moisture	308		
Radio Jack—for inter-room connections	318		
Radio Loop—direction finder for loop	299		
Radio Receiver—crystal set for boy builder	297		
Radio Repairing			
filling holes in radio panels	300		
loose connections frequent cause of trouble	308		
Railroad			
bringing Europe nearer by rail	253		
world's fastest train	202		
Rays			
invisible, will guide planes in fog	242		
violet, bring happiness to animals in zoo	226		
Razor—repeater with blades in handle	267		
Rubber—new process of vulcanizing to cut tire bills	273		
Safety Devices and Measures—reflectors in belts guard street cleaners	288		
Sand			
meter tells moisture of	261		
self-propelling loader	193		
Sea—exploring sea bottom	177		
Seasickness—wave force harnessed to prevent	238		
Ship			
has big door in prow for loading whales	272		
turning them into autos	276		
Shipwreck—big steamer broken in two by storm	217		
Shoes—emergency overshoes fit vanity case	209		
Signs and Signboards			
special signs guide tourists	239		
three-armed signpost has face of man	240		
light and vibrator bring sleep in eight minutes	242		
loss of, aids brain but fatigues body	238		
Sling Shot—drill for cadets	206		
Snakes—fishing in desert for lizards and	264		
Sound—high-frequency waves destroy life	241		
Spectacles—light on spectacle frame saves doctors' eyes	183		
Sport—rodeo imitated by wall exerciser	179		
tennis and football table game	262		
Stadium—built on mountain for Easter services	241		
Stage Mechanism—electrical "plot" for opera	252		
Statue—shines in clouds over searchlight	209		
Street Traffic Regulation			
auto stop and turn signal	237		
footprints show pedestrian where to cross street	217		
Sun—sun's rays to heat buildings expert predicts	189		
Superstition			
eyes painted on Chinese ship to prevent wrecks	192		
how evil spirits are banished in Orient	210		
Surveying—flyers map Alaskan mountains	221		
Table—folding, and chair set	294		
Temperature—eight miles up	232		
Ticket—bus ride tickets printed as fare is paid	255		
Tire			
reclaimed for canvas and rubber	198		
valve has built-in pressure gauge	232		
Totems—reveal picture of vanishing race	243		
Toys—rack of, for baby's crib	219		
Trailer—car for motorcycle holds kitchen and beds	242		
Transportation			
historic views show change from trail to rail	274		
motor truck auto train cuts cost of delivery	240		
Trees—write diaries with growth recorder	193		
Turbine—water wheel carved centuries ago	275		
Typewriter—skill at typewriting revealed by mind tests	208		
United States—prosperity is speeded by industrial saving	285		
United States Navy—giant picture of fleet given to President Coolidge	231		
Vacuum Cleaner—big wheeled	265		
Vanity Case—on auto wheel serves as horn button	191		
Vegetation—gives off light during decay	237		
		Archery—substitute for child's bow	331
		Automobiles—Horn—changing tone of auto	332
		Automobiles—Repairing—vulcanizing small holes in auto tops	331
		Birds—feeding stations for	311
		Book—rubber band replaces book end	329
		Brake—buzzer prevents running with emergency on	316
		Can Opener—dollar and dime	319
		Clips—testing contact of charging	315
		Drawers—several locked with one bolt	329
		Electric Wiring	
		running lampcord through metal molding	328
		sealing extension cord plug	331
		Gutter—improving the rain spout	314
		Heater—exhaust, for coffee pot	318
		Heating Plant—vacuum cleaner helps heat second floor	330
		Legging—tape on child's	332
		Level—tin cup used as	332
		Life Saving Apparatus—preserver for skating pond	316
		Model—build your own ship model	321
		Motorcycle—runners for	320
		Music—increasing jazz effects of drum	319
		Painting—spray pump for painting springs	330
		Paper—pulp makes good fuel	329
		Photography—dark-room light pirates	328
		Radiator—shield keeps auto engine warm	320
		Skates	
		ice kickmobile	331
		lads make own ice skates	315
		Soot—for furnace covering	330
		Stair—non-slipping carpet rods	316
		Tire	
		emergency chain	328
		holding valves open	327
		Tool—tap wrench holds countersink	318
		Tool Chest—for auto	315
		Toy—whirling clown	317
		Trap—setting mousetrap	329
		SHOP NOTES	
		Advertising—rotating advertisement on auto	342
		Asbestos—cement for	351
		Automobiles—Repairing	
		fitting wristpins in pistons	346
		twine holds crankcase gaskets	342
		Brushes—for cleaning parts with gasoline	343
		Coal—cutting down fuel bill	345
		Concrete—runway and bins for mixing	343
		Drill—portable stand	351
		Garage—sloping floor for	344
		Gasoline Lighting—how to take care of gasoline lamps	338
		Gauge—combination T-square and	347
		Lathe—expanding arbor	348
		Lead—precautions to observe in melting	344
		Locks and Keys—what you should know about locks	333
		Motor Truck—heating delivery truck	351
		Nail—list for shop	350
		Painting—paint pot hook	337
		Pencil Sharpener—improved for draftsmen	348
		Plows—how to adjust coulter for best work	348
		Poultry—portable chicken fence	349
		Printing—handy case for printers	348
		Radiator—protecting tractor	341
		Safety Devices and Measures	
		for electric switch	348
		shield stops flying rivets	347
		Solder and Soldering—holder for iron	342
		Steel—straightened with spike maul	346
		Tar—cutting machine	337
		Vise—large, holds small one	349
		Water—device for detecting leaks	344
		Wheels—reinforcing weak wagon	347
		Wrenches—easily made socket	342

Declaimed 1928

273

Vulcanizing
273
thing you know
259

209
60 million dollar lead pipe

179

F. J. ...

DRAKE'S PRACTICAL MECHANICAL BOOKS

THEY WILL RAISE YOUR PAY—

ORDER ON 5-DAY TRIAL

The books listed below will perfect you in your chosen trade—pave the way to the big positions. Written in non-technical language—easy to read and understand. *Every book covers its subject completely. An entire course of instruction condensed into one volume.* Your choice sent postpaid—you benefit 5 days—money refunded in full if not entirely satisfactory. Order direct from this page.

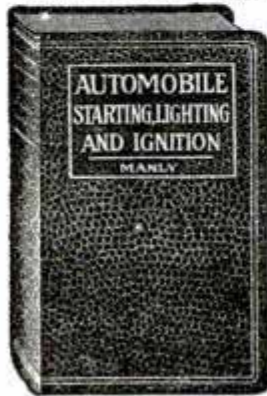

Automobile Books

Automobile Starting, Lighting and Ignition, by Manly... 700 pp. \$3.00
Brookes' Automobile Handbook. \$2.00
Ford Motor Car, Truck and Tractor, by Manly... Cloth \$1.50
Automobile Battery, Care and Repair, by Manly... Leatherette \$2.00
Motorcycle Handbook, by Manly \$1.50

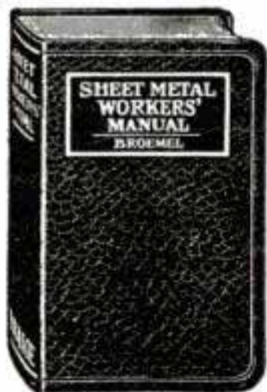

Shop Practice Books

Sheet Metal Workers' Manual... \$2.00
Oxy-Acetylene Welding and Cutting... Cloth \$1.25
Slide Rule and Logarithmic Tables. \$2.00
Handbook for Millwrights... Cloth \$2.00
Machine Shop Practice... Cloth \$2.00
Mechanical Drawing and Machine Design... Cloth \$2.00

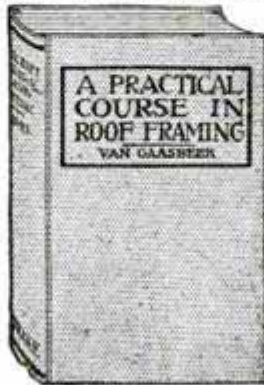

Carpentry Books

Cloth Binding
Modern Carpentry, 2 vols. \$3.00
The Steel Square, 2 vols. \$3.00
Modern Estimator. \$1.50
Timber Framing. \$2.00
Builder's Architectural Drawing... \$2.00
Concretes. \$1.50
Practical Bungalows. \$1.00
Roof Framing, by Van Gasbeek... \$1.50

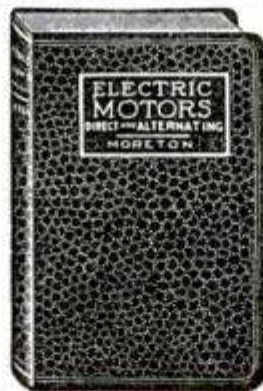

Electrical Books

Telephony, Including Automatic Switching, by Smith, 450 pp. Leatherette \$2.50
Practical Applied Electricity. \$2.00
Wiring Diagrams and Descriptions. \$1.50
Armature and Magnet Winding... \$1.50
Electric Motors, D. & A. \$1.50



Painting and Decorating

Ross Crane Book of Home Furnishing and Decoration... Cloth \$3.00
House Painting Methods with the Brush and Spray Gun, by Vanderwalker, Cloth... \$2.00
Interior Wall Decoration, by Vanderwalker... Leatherette \$4.00
The Mixing of Colors and Paints, by Vanderwalker... Cloth \$2.00
A Show at Sho' Cards... Cloth \$4.00
Sign Painting, by Atkinson... Cloth \$4.00
Strong's Book of Designs, Leatherette \$4.00
Modern Painter's Cyclopedia, Cloth \$2.00
Automobile Painting... Cloth \$1.50
New Hardwood Finishing... Cloth \$1.50
Wood Finishing, Plain and Decorative... Cloth \$2.00
Owen's Paint Guide... Cloth \$1.00

Steam Engineering

Swingle's Handbook for Steam Engineers and Electricians, Leatherette... \$4.00
Examination Questions and Answers for Marine and Stationary Engineers, Leatherette... \$2.00
Steam Boilers... Leatherette \$2.00
Swingle's Catechism of Steam, Gas and Electrical Engineering, Leatherette \$1.50

Modern Languages

By Prof. P. S. Allen, U. of Chicago
French without a Teacher... Cloth \$1.25
Spanish without a Teacher... Cloth \$1.25
German without a Teacher... Cloth \$1.25
Everyday French... \$1.25
Everyday Spanish... \$1.25

ORDER DIRECT FROM THIS PAGE—ON OUR MONEY-BACK PLAN

The books listed above are only a few of the many in our catalogue, which you will receive promptly after filing out and mailing us the attached coupon. For quick action order direct from this page—cross name of each book wanted and send in with price quoted. We prepay postage and send the books on our money-back plan.

FREDERICK J. DRAKE & CO.
PUBLISHERS

1008 Michigan Ave., Chicago

Drake Books Are For Sale at All Book Stores

FREDERICK J. DRAKE & CO.
1008 Michigan Avenue
Chicago, Ill.

GENTLEMEN:—Please send me free, postage paid, your illustrated catalogue which lists and describes 200 Practical Mechanical Books for Home Study.

My name is

and my address

Mail Coupon For Free Catalogue
Your Guide to Home Study

What
could
you do
with a
tooth-brush
and
thirty-five
dollars
?

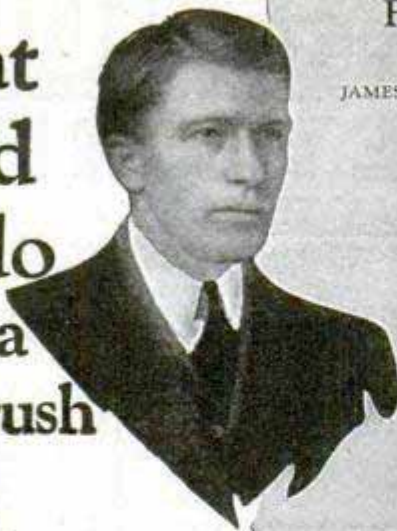

GEO. C. LARSEN, Pres. C. F. STANLEY, V.-Pres. GEO. YUNG, Sec.-Treas.
Farmers' Union Creamery Company
Dealers in
DAIRY PRODUCTS
JAMES C. NORGAARD, Manager Superior, Neb.

LaSalle Extension University,
Chicago, Illinois.

Gentlemen:

When I arrived in New York, in 1914, I had a toothbrush, \$35 in cash, a lot of pep, and not an English word in my vocabulary.

My first job, in a Wisconsin creamery, paid me \$10 a month and board. At night school, in Green Bay, I learned English.

In the winter of 1919 I took my first course with LaSalle—in Traffic Management. From 1919 to 1921 I pursued LaSalle training in Business Management, and to this course I attribute most of the progress I have since made.

Naturally I am enthusiastic about LaSalle Training, and do not hesitate to say that any man who is eager to get ahead in business will find it the most profitable investment he ever made.

Very truly yours,

James C. Norgaard
Manager.

DO YOU feel that Fate has handicapped you by a lack of opportunity? If you don't believe that all a man needs is determination to *make* opportunity—to start right where he is and land 'way higher up the ladder—consider James Norgaard.

As he stood on a New York dock ten years ago, he didn't understand a word of English. His equipment for success was \$35.00—and a tooth-brush.

Today he's an officer of the grain exchange, director in the building and loan association, president of an ice cream company, and general manager of one of the largest co-operative creameries in the world.

The really interesting thing is that there's nothing unusual or startling or extraordinary in the plan Mr. Norgaard followed.

Thousands of other men find the same help in LaSalle home-study business training. It's available any and every day, to any and every man of aggressiveness and determination.

See LaSalle clearly. View it simply as a proved short cut to increased earning ability—to money and position and opportunity. It's here for you and as near to you as the mails.

These Free Books Show How

You are eager to get ahead—you will find it of vital importance to learn more of the success-methods James Norgaard and thousands of others have employed so profitably. We have therefore prepared a special 64-page booklet which outlines these methods in detail. It also points out the big opportunities in the field you are in or wish to enter—shows you how you can fit yourself to get them.

The coupon brings this booklet to you without cost or obligation—also a copy of "Ten Years' Promotion in One." A pencil—an envelope—a postage stamp! Get these two books now—and make your start TODAY!

Find Yourself Thru LaSalle!

LA SALLE EXTENSION UNIVERSITY, Dept. 264-R CHICAGO

I shall be glad to have your 64-page booklet about the business field I have checked below. Also a copy of "Ten Years' Promotion in One," all without obligation.

- | | |
|---|--|
| <input type="checkbox"/> Business Management | <input type="checkbox"/> Traffic Management—Foreign and Domestic |
| <input type="checkbox"/> Higher Accountancy | <input type="checkbox"/> Railway Station Management |
| <input type="checkbox"/> Modern Salesmanship | <input type="checkbox"/> Banking and Finance |
| <input type="checkbox"/> Law; Degree of LL. B. | <input type="checkbox"/> Personnel Management |
| <input type="checkbox"/> Commercial Law | <input type="checkbox"/> Modern Business Correspondence and Practice |
| <input type="checkbox"/> C. P. A. Coaching for Advanced Accountants | <input type="checkbox"/> Expert Bookkeeping |
| <input type="checkbox"/> Effective Speaking | <input type="checkbox"/> Business English |
| <input type="checkbox"/> Modern Foremanship | <input type="checkbox"/> Commercial Spanish |
| <input type="checkbox"/> Industrial Management | |

Name Present Position

Street City State



these books free

BUILDERS

TRADE GUIDES

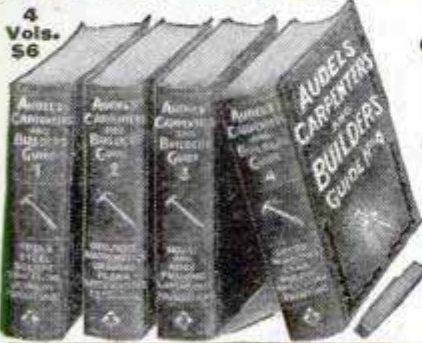

4 Vols. \$6

AUDELS CARPENTERS AND BUILDERS GUIDES—4 VOLS. \$6

Inside Information for Carpenters, Builders, Joiners, Building Mechanics—all Woodworkers. **1600 pages; 3700 diagrams; flexible; pocket size.** Short-cut instructions, new methods, ideas, solutions, plans, systems—money saving suggestions. An easy progressive course for the apprentice. A practical daily helper and Quick Reference for the master worker. A Helping Hand to Easier and Better Work and Better Pay. To get this aid for yourself, simply fill in and mail the FREE COUPON below.

INSIDE TRADE INFORMATION ON:

How to use steel square; How to file and set saws; How to build furniture; How to use mitre box; How to use chalk line; How to use rules; How to make joints; Carpenters' arithmetic; Mensuration problems; Estimating strength of timbers; How to set girders and sills; How to frame houses and roofs; How to estimate costs; How to build houses, barns, garages, bungalows, etc.; How to read and draw plans; Drawing up specifications; How to excavate; How to use settings 12, 13 and 17 on the steel square; How to build hoists and scaffolds—skylights; How to build stairs; How to put on interior trim; How to hang doors; How to lath—lay floors; How to paint.

"Audels Guides worth four times their price—handy too as I carry them in pocket for reference." W. J. Bates, Knoxville, Pa.



4 Vols. \$6

AUDELS PLUMBERS AND STEAMFITTERS GUIDES—4 VOLS. \$6

A new set—just out! A practical, illustrated, Reference Library and Study-Course for Master Plumbers, Journeymen and Apprentice Steamfitters, Gas Fitters and Helpers, Sheet Metal Workers, Draughtsmen, Master Builders, Engineers and all Building Trade Students. **1670 pages; 3642 diagrams; flexible; pocket size.** Guides explain all the principles, advances and short cuts of the Plumbing and Heating trade. Contains instructions on how to figure and estimate jobs. Use FREE COUPON below to examine, without obligation, this valuable work.

INSIDE TRADE INFORMATION ON:

Soldering, tinning. Joint wiping, bending, beating. Pipe—iron—steel, threading. Mathematics, tables, physics. Materials—iron, steel, copper, brass, lead, tin, antimony. Sheet metal—galvanized—plate. Sanitation, syphonage, tanks. Drainage, sewage, purification. Fixtures—bath—kitchen. Pipe fittings, soil pipe, tools. Laying out work. Roughing. Screwed fittings, flanges, joints. Pipe bending, examples. Elbows. Heating, ventilation, refrigeration. Water supply, mains, wells, tanks. Gas-fittings. Underwriters. Sheet metal work, problems, methods, brazing, heating, lead burning. Welding, various welds, methods. Blacksmithing, forges, tools.

"Audels Guides are practical, easy to understand, reliable. Cover the field in plain language." W. F. Arming, Annapolis, Md.

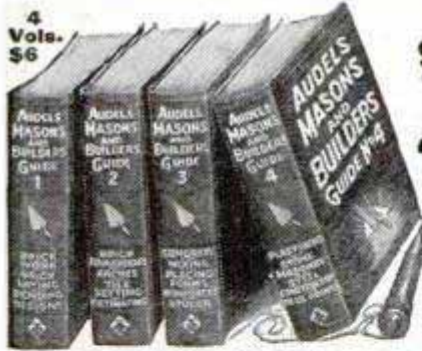

4 Vols. \$6

AUDELS MASONS AND BUILDERS GUIDES—4 VOLS. \$6

A new, complete, illustrated trade reference library, for Bricklayers, Cement Workers, Plasterers, Tile Setters and Stone Masons, including a practical outline of Steel Construction. **1100 pages; 2057 diagrams; flexible; pocket size.** A practical Trade Assistant explaining modern methods of masonry construction. Easy to understand and apply. A reliable and authentic reference work and study-course for Master Journeyman and Young Mechanic. Use FREE COUPON below and find out for yourself, without obligation, whether this set will benefit you.

INSIDE TRADE INFORMATION ON:

Bricklaying, tools, materials; Brick designs, patterns, bonds; Setting frames and foundations; Mortars, scaffolds, estimating; Mortars and mortar mixing; Tile setting, mosaic, hollow tile; Straight edge test, troweling; How to figure brick work; Safe loads, piers, chimneys; Boiler settings, anchors, fire stops; Labor 'ables; Concrete, forms; How to figure concrete work; Stucco—on old and new buildings; Plastering—wood lath—metal; Plasterers agreement; Plastering on various surfaces; Stonemasonry; Cutting, finishing, estimating stone; Derricks, rigging; Stee construction; Fire proof; How to read blue prints.

"Audels Masons Guides are the best books on the subject. Have laid brick 12 years and am able to judge." H. A. Sonnet, Corlies, Pa.

PRACTICAL ELECTRICITY — 1 VOL. \$4

Audels Handy Book of Practical Electricity is a simplified Ready Reference and Study Course in one pocket size, leather bound volume—for Engineers, Professional Electricians and Students. **1040 pages; 2600 diagrams; flexible red leather bound.** A reliable authority and handy helper for every electrical worker. Contains important and valuable wiring diagrams, calculations, machine sketches, helps on maintenance and repair. Use this FREE COUPON today and find out, without obligation, how this handy book will help you in your daily work.

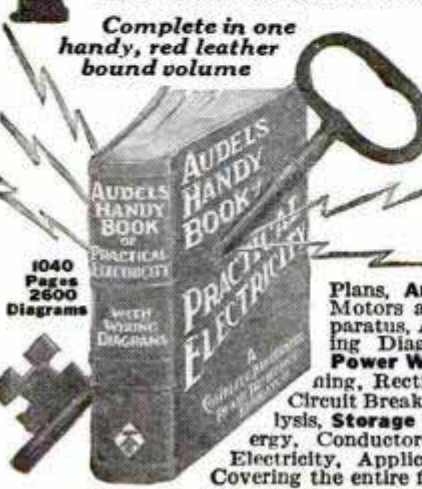

\$1 PER MO.

Complete in one handy, red leather bound volume

1040 Pages 2600 Diagrams

INSIDE TRADE INFORMATION ON:

Electro-Therapeutics, X-Rays, Shocks, Welding, Brazing, Radio Hook-ups, Motion Pictures, Telephone, Telegraph, Cranes, Bells, Elevators, Pumps, Tools, Ship Drive, Railways, Vehicles, Automobile Electric Systems, Ignition, Generation, Lighting, Plant Management, Power Plans, Armature Winding, Repairing, A. C. Motors and Apparatus, D. C. Motors and Apparatus, Alternator Construction, Dynamos, Wiring Diagrams, Sign Flashers, Cable Splicing, Power Wiring, Outside Wiring, Switches, Lighting, Rectifiers, Converters, Transformers, Fuses, Circuit Breakers, Rheostats, Electro Plating, Electrolysis, Storage Batteries, Magnetism, Electrical Energy, Conductors, Insulators, Static, Dynamic, Radio Electricity, Applications, Ready Reference and Index Covering the entire field of Modern Electricity.

Learn More and You Will Earn More!

Know your job and you'll never be without one. The skilled man is always in demand. Knowledge is power. Learn your trade thoroughly by easy reading. This coupon is your opportunity for advancement and better pay. You risk nothing in sending for Audels Guides for free examination. Send it NOW!

FREE EXAMINATION COUPON

THEO. AUDEL & CO.,
65 W. 23 ST., NEW YORK CITY

Please mail me for free examination the books marked (x) below. If I find them satisfactory, I agree to mail \$1 in 7 days, on each set ordered, and to further mail \$1 monthly until each set until I have paid the purchase price.

4 CARPENTERS GUIDES \$6 4 PLUMBERS GUIDES \$6

4 MASONS GUIDES \$6 1 ELECTRICIANS HANDY BOOK \$4

NAME

ADDRESS

OCCUPATION

EMPLOYED BY.....2T30

NOW FREE



B. W. COOKE
Directing
Engineer



CLIP COUPON
4
OUTFITS
Free
OF EXTRA COST

EARN
up to

\$150 a Week!

If you're earning a cent less than \$60 a week, *clip coupon now*. Get the **PROOF** that you can be on your way to **BIG PAY** as an Auto Expert **QUICK!** See for yourself how fascinating this training is—how easily you can master Auto Work right in your own home—and how quickly you can get in line for the big Auto Jobs that pay up to \$150 a week and more—or a Money-Making Auto Business of your own! Remember these Lessons and Job Tickets come to you **ABSOLUTELY FREE** and without obligation. Clip coupon now.

I'll train you AT HOME
Get these free Lessons and Job Tickets now. See how thorough, how complete "JOB-WAY" Training is—includes all Electrical work—Ignition, Starting, Lighting—all Mechanical, also Welding, Brazing, Vulcanizing—also Business Course, Salesmanship, Advertising—How to keep simple Books—also Students' Magazine, also 4 working Outfits. Nowhere else can you get this original genuine, copyrighted B. W. Cooke "JOB-WAY" Training.

This Big Auto Book Also FREE Coupon brings this startling, revolutionary Auto Book, too, absolutely Free! Shows how hundreds of men have reached Big Pay in amazingly quick time! Shows what you can do. Send for it now!



SEND ME LESSONS and BOOK FREE

B. W. COOKE, 1916 Sunnyside Ave., Dept. 216, Chicago
Send me absolutely FREE and without any obligation on my part, 3 JOB-WAY Auto Lessons and 3 JOB-WAY Tickets. Also your Auto Book FREE and full particulars of your 4 Outfits Offer.
Name
Address
Town State

TO PROVE

that "JOB-WAY" is "PAY-RAISE" Training

Clip coupon now. I'll send you absolutely **FREE OF CHARGE**—with positively no obligation on your part—3 **JOB-WAY** Auto Lessons and 3 **JOB-WAY** Tickets! and my big book. I want you to *SEE for yourself* just why "JOB-WAY" Training is bringing so many men **Big Money** in such remarkably quick time. I want you to see how men *without a day's previous auto experience*—and only common schooling become Garage Owners, Superintendents, Managers, and earn up to **\$150 a week** and more! I want you to see why Hundreds of men have found "JOB-WAY" Training to be such interesting, most practical money-making training!

That's why I make you this unusual offer—with absolutely no strings on it and not a single penny's charge. Clip coupon now and I'll rush your Lessons and Job Tickets to you *absolutely Free!*

Be An Electrical-Mechanical Auto Expert

The World's Biggest Business Needs You!

There are so many tremendous Opportunities in this gigantic Auto Industry that I want every ambitious man *who really wants to make more money, to have these Lessons and Job Tickets just to see how easily and quickly I can boost his pay*

way up. Just think! Seven thousand Millions of Dollars are paid to Auto men every year for *upkeep alone*—Nineteen Million Dollars a day! Think what that means to you—the Big Pay Opportunities open to you as an auto expert! It's the one field for the man who wants a **BIG** pay check! Learn all about it now!

Act Quick!

Don't delay a minute. Send coupon right now while I can still make you this special offer of 3 **JOB-WAY** Auto Lessons and 3 **JOB-WAY** Tickets absolutely free—as well as my Big Auto Book, free too! Act now!

B. W. COOKE Directing Engineer
Chicago Motor Training Corporation
1916 Sunnyside Ave. Dept. 216 CHICAGO, ILL.

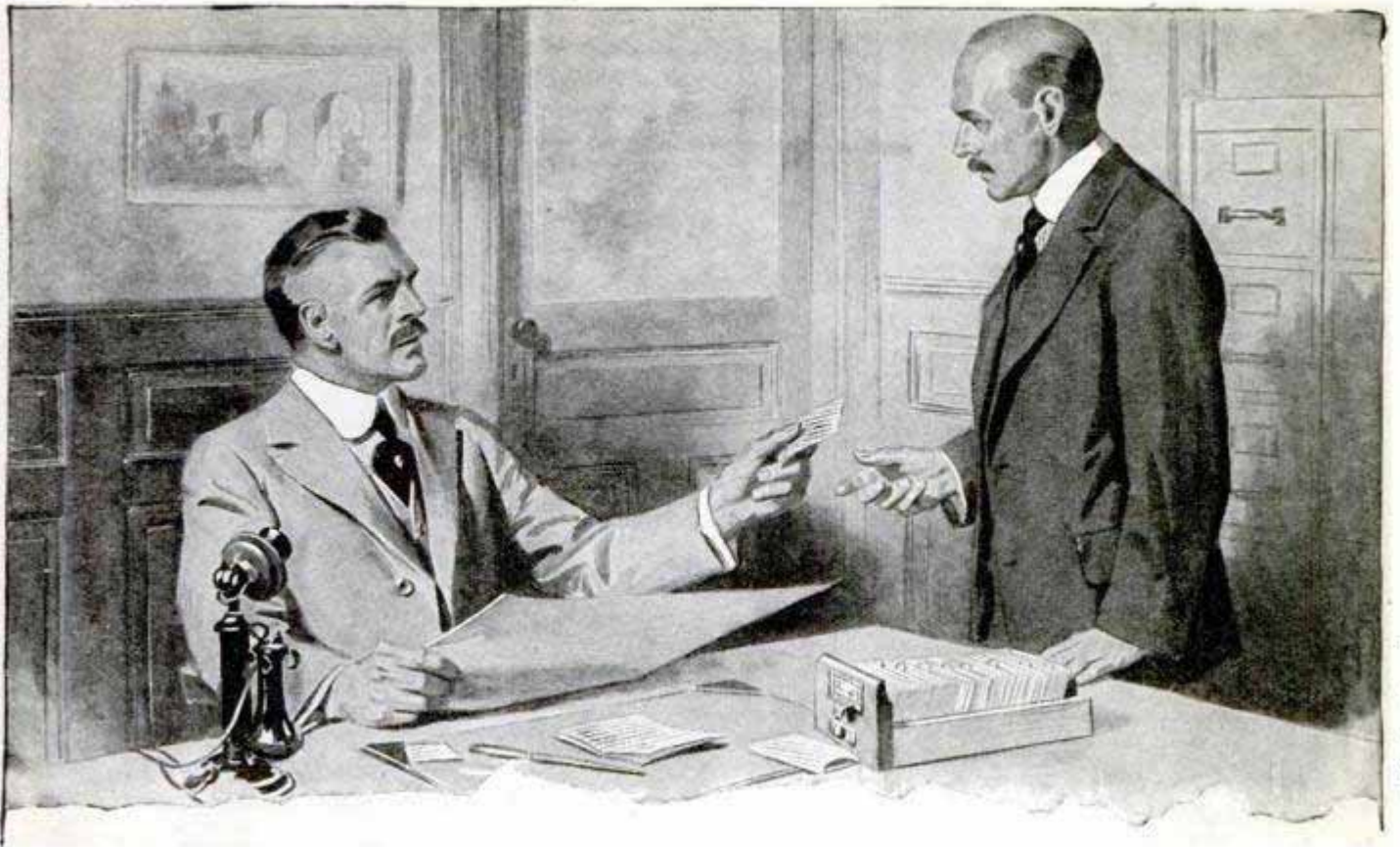

“Put Wagner on the Job!”

“I’ve been planning to promote him at the first opportunity. And now it’s here. Watson hasn’t been showing the interest in this business that I hoped he would and he’s got to step down. Wagner, on the other hand, has been studying in spare time, with the International Correspondence Schools. They’ve been sending me his reports and I want to tell you he’s doing fine. I’ve been watching him and he’s ready. Put him in Watson’s place and give him full charge of the department. And tell the cashier to see me about his salary.”

Great news for Wagner. Too bad about Watson. But what can you expect?

When an executive hires a man or when he promotes a man, he can’t afford to take chances. It’s to his advantage to stand back of the man he feels sure will make good.

Suppose he has to choose between two men—one who is studying in his spare time and one who is not?

Isn’t it natural to suppose that the ambitious man will be given the preference? It surely is! Recent events have proved it.

Our investigations show that the I. C. S. man is the first to be put on and the last to be discharged. Indeed, the thing that held the jobs of many men during the business depression was the fact that they were studying with the I. C. S.

For 35 years, the International Correspondence Schools have been helping men to win promotion and more money—to have happy, prosperous homes—to know the joy of getting ahead in business and in life.

No matter where you live, the I. C. S. will come to you. No matter what your handicaps or how small

your means, we have a plan to meet your circumstances. No matter how limited your previous education, the simple, practical, wonderfully-illustrated I. C. S. lessons make it easy for you to learn.

All that we ask is this:—

Just mark and mail the coupon printed below, and without obligation or a penny of cost, let us send you the story of what the International Correspondence Schools can do for you.

INTERNATIONAL CORRESPONDENCE SCHOOLS Box 5627-E, Scranton, Penna.

Without cost or obligation, please send me one of your booklets and tell me how I can qualify for the position or in the subject before which I have marked an X:

BUSINESS TRAINING COURSES

- | | |
|--|---|
| <input type="checkbox"/> Business Management | <input type="checkbox"/> Salesmanship |
| <input type="checkbox"/> Industrial Management | <input type="checkbox"/> Advertising |
| <input type="checkbox"/> Personnel Organization | <input type="checkbox"/> Better Letters |
| <input type="checkbox"/> Traffic Management | <input type="checkbox"/> Show Card Lettering |
| <input type="checkbox"/> Business Law | <input type="checkbox"/> Stenography and Typing |
| <input type="checkbox"/> Banking and Banking Law | <input type="checkbox"/> Business English |
| <input type="checkbox"/> Accountancy (including C.P.A.) | <input type="checkbox"/> Civil Service |
| <input type="checkbox"/> Nicholson Cost Accounting | <input type="checkbox"/> Railway Mail Clerk |
| <input type="checkbox"/> Bookkeeping | <input type="checkbox"/> Common School Subjects |
| <input type="checkbox"/> Private Secretary | <input type="checkbox"/> High School Subjects |
| <input type="checkbox"/> Spanish <input type="checkbox"/> French | <input type="checkbox"/> Illustrating <input type="checkbox"/> Cartooning |

TECHNICAL AND INDUSTRIAL COURSES

- | | |
|---|--|
| <input type="checkbox"/> Electrical Engineering | <input type="checkbox"/> Architect |
| <input type="checkbox"/> Electric Lighting | <input type="checkbox"/> Architects’ Blueprints |
| <input type="checkbox"/> Mechanical Engineer | <input type="checkbox"/> Contractor and Builder |
| <input type="checkbox"/> Mechanical Draftsman | <input type="checkbox"/> Architectural Draftsman |
| <input type="checkbox"/> Machine Shop Practice | <input type="checkbox"/> Concrete Builder |
| <input type="checkbox"/> Railroad Positions | <input type="checkbox"/> Structural Engineer |
| <input type="checkbox"/> Gas Engine Operating | <input type="checkbox"/> Chemistry <input type="checkbox"/> Pharmacy |
| <input type="checkbox"/> Civil Engineer | <input type="checkbox"/> Automobile Work |
| <input type="checkbox"/> Surveying and Mapping | <input type="checkbox"/> Airplane Engines |
| <input type="checkbox"/> Metallurgy <input type="checkbox"/> Mining | <input type="checkbox"/> Agriculture <input type="checkbox"/> Navigation |
| <input type="checkbox"/> Steam Engineering | <input type="checkbox"/> Mathematics <input type="checkbox"/> Radio |

Name.....
Street.....
Address.....

City..... State.....

Occupation.....

Persons residing in Canada should send this coupon to the International Correspondence Schools Canadian, Limited, Montreal, Canada.

Are You Hungry For... Adventure... Popularity... Big Pay?



THEN CHOOSE AVIATION!

Are you eager for a life of constant thrills, constant excitement and fascinating events? Do you crave adventure, popularity, admiration, and the applause of great crowds? Then why not get into the Aviation Industry—the greatest adventure since time began—the greatest thrill ever offered to man?

Think what Aviation offers you. Thrills such as you never had before! The praise and plaudits of the multitude. Ordinary salaries from \$75 to better than \$400 a week! And a chance to get in on the ground floor where rewards will be unlimited!

Aviation is growing so swiftly that one can hardly keep track of all the astonishing new developments. Air-mail routes have just been extended to form a vast aerial network over the entire U. S. Airlines and airplane factories are springing up all over the country. Men like Henry Ford are investing Millions in the future of commercial Aeronautics in America! The possibilities are so tremendous that they stagger imagination!

Everything is set for the greatest boom in history. The fortunes that came out of the automobile industry and out of motion pictures will be nothing compared to the fortunes that will come out of Aviation! There is just one thing holding it up:—lack of trained men! Even in the beginning thousands will be needed—and generously paid. The opportunities open to them cannot be over-estimated. Those who qualify quickly will find themselves on the road to undreamed of money—success—popularity—and prominence!

ARE you a red-blooded, daring he-man?

Easy to Become an Aviation Expert

\$50 to \$100 a Week

Get into this thrilling profession at once while the field is new and uncrowded. Now—by a unique new plan—you can quickly secure the basic training for one of these wonderful high salaried jobs, at home, in spare time. Experts will teach you the secrets—give you all the inside facts that are essential to your success. And, the study of Aviation is almost as fascinating as the actual work itself. Every Lesson is chock-full of interest—and so absorbing that you actually forget you are studying. But best of all are the ultimate rewards you are fitting yourself to gain!

Fascinating—Daring—Big Paying

Prepare Now for One of These Positions

- Aeronautical Instructor \$60 to \$150 per week
- Aeronautical Engineer \$100 to \$300 per week
- Aeronautical Contractor Enormous Profits
- Aeroplane Repairman \$60 to \$75 per week
- Aeroplane Mechanician \$40 to \$60 per week
- Aeroplane Inspector \$50 to \$75 per week
- Aeroplane Salesman \$5000 per year and up
- Aeroplane Assembler \$40 to \$65 per week
- Aeroplane Builder \$75 to \$200 per week

Send for FREE Book

Send the coupon for our new, free book, just out—"Opportunities in the Airplane Industry".



It is vitally interesting, reads like a romance and tells you things about this astonishing profession you never even dreamed of. This book is so fascinating it could easily sell for a dollar. We offer a limited number FREE. Write for yours today.

American School of Aviation
Dept. 1352, 3601 Michigan Ave., Chicago, Ill.

AMERICAN SCHOOL OF AVIATION,
Dept. 1352, 3601 Michigan Ave., Chicago, Ill.

Without any obligation please send me FREE book "Opportunities in the Airplane Industry." Also information about your course in Practical Aeronautics.

Age.....

Name.....

Address.....

City..... State.....



None of This!

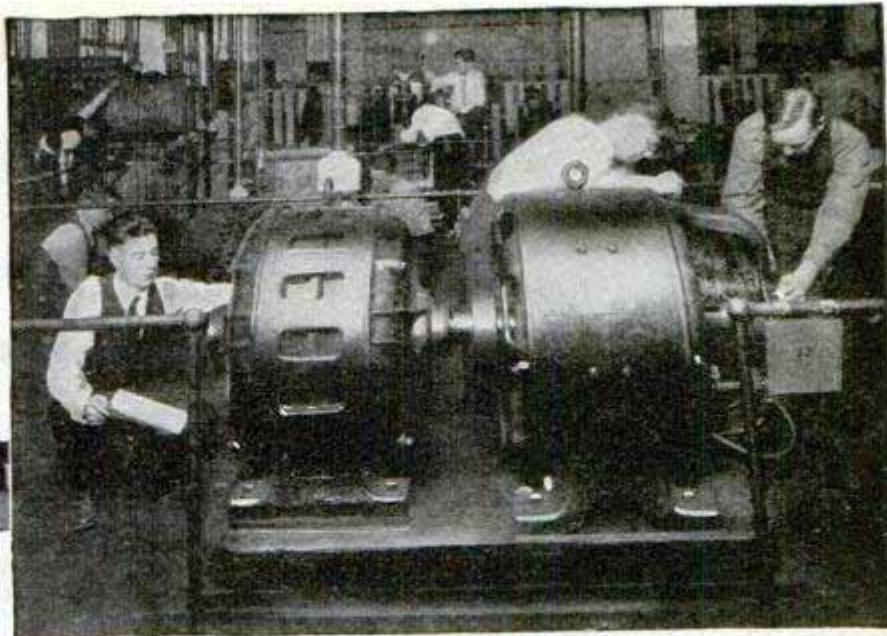

ELECTRICITY Becomes Amazingly Easy When Taught Without Books or Lessons **IN 90 DAYS**

WHY work at dull, uninteresting jobs that will never pay you more than \$35, \$40 or perhaps \$50 a week? Make up your mind **now** to become a master of electricity! Train in 12 easy weeks to hold down the kind of a job that pays \$50 and up to \$200 a week, and which creates a constant demand for your services nearly any place in the world!

No Books—No Classes

Electricity, as taught in the Great Shops of Coyne, is surprisingly easy to grasp. That's because we use no books or dry lessons. You learn by doing actual, practical experimenting on big, electrical machinery—finest outlay in the country. You learn by **doing**—and you learn from the ground up.

Not a Correspondence School

Experts work right along with you every step of the way. You get personal attention—it's not a bit like trying to figure out a lot of correspondence school pamphlets and diagrams all by yourself. The Coyne Way gives you real, **sound** knowledge that fits you to do **practical** electrical work in all its branches.

COYNE ELECTRICAL SCHOOL

Dept. 27-72

H. C. Lewis, Pres. 1300-10 W. Harrison St., Chicago, Ill.

No Experience or Advanced Education Needed

You don't need one day's previous electrical experience or any advanced education to master electricity the Coyne way. Some of our most successful graduates never went farther than the 8th grade.

Earn While You Learn

By our special arrangement, our employment department will help you locate part-time work, if you want to earn while you learn. And after graduation we give you the benefit of our **FREE EMPLOYMENT Service** for life. Every week we secure as many as 40 positions for Coyne men.

Get FREE Book

Write today for my big book on electricity with over 150 photographs. Learn what great opportunity Coyne Training opens up for you. Also get full details of my Big-3 Special offer. No obligation. Mail the coupon now.

FREE If You Act Now

1 R. R. Fare will be refunded upon enrollment from any point in the U. S. to Chicago.

2 Radio course given absolutely without any extra charge. Covers new developments in this fascinating field.

3 Auto course, covering truck and tractor electricity. Especially valuable if you ever want to start electrical business of your own. See coupon!

FREE BOOK Coupon

H. C. Lewis, Pres.
Coyne Electrical School, Dept. 27-72
1300-10 W. Harrison St.
Chicago, Illinois

Please send me your free catalog on electricity and details of your 3 special offers. No obligation on my part.

Name.....

Address.....

City..... State.....

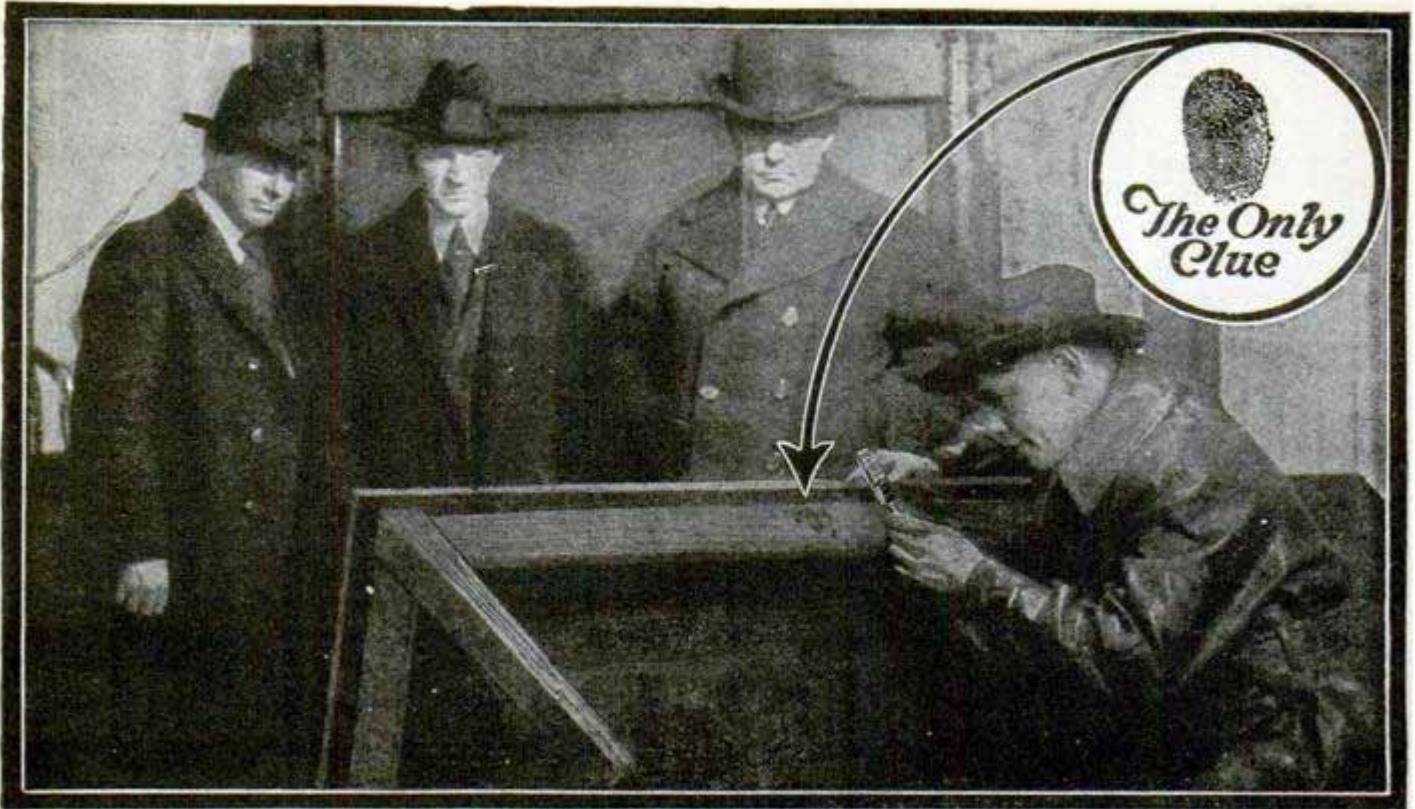

\$500 REWARD for TWO HOURS WORK

WARREN BIGELOW, the Finger Print Detective, was making his usual review in the morning newspapers. He had just finished reading the press reports of the daring robbery of the offices of the T—O—Company when the telephone on his desk rang. Central Office was calling, asking him to come immediately to the scene of the robbery. Although he drove his high powered roadster rapidly and arrived very shortly at his destination, he had plenty of time to consider the main features of the case as reported by the press. The job had undoubtedly been done by skilled cracksmen and robbers of uncommon nerve. Sixty-five hundred dollars in currency—the company pay-roll—were gone. Not a single, apparent clew had been found by the police.

Finger Print Expert Solves Mystery

On his arrival, Bigelow was greeted by Nick Austin, Chief of Detectives, who had gone over the ground thoroughly.

"Hello, Warren. Here's a job that has us stumped. I hope you can unravel it for us."

By this time, the district officers and the operatives from Central Office had almost given up the investigation. After hours of fruitless efforts, their work was at a standstill. They were completely baffled.

With lively interest and a feeling of relief they stepped back to await the results of the Finger Print Detective's findings. They were plainly awed at his quiet, assured manner. The

adroit old Chief himself was manifestly impressed at the quick, sure way in which Bigelow made his investigation.

Almost immediately Bigelow turned his attention to a heavy table which had been tipped up on its side. Examination of the glossy mahogany showed an excellent set of finger prints. The thief might just as well have left his calling card.

To make a long story short, his prints were photographed and taken to Central Office, where they were matched with those of "Big Joe" Moran, a safe blower well known to the police. Moran was subsequently caught and convicted on Bigelow's testimony and finger-print proof. Most of the money was recovered. In the meantime the T—O—Company had offered a \$500.00 reward, which was given to Bigelow—his pay for two hours' work.

Learn at Home in Spare Time

Could you imagine more fascinating work than this? Often life and death depend upon decisions of finger-print evidence—and big rewards go to the Expert. Thousands of trained men are now needed in this great field. The finger-print work of governments, corporations, police departments, detective agencies and individuals has created a new profession. Many experts regularly

earn from \$3,000 to \$10,000 a year in this fascinating game. And now you can easily learn the secrets of this new Science in your spare time—at home. Any man with common school education and average ability can become a Finger Print Detective in a surprisingly short time.

Free Course in Secret Service

For a limited time we are making a special offer of a Professional Finger Print Outfit, absolutely Free, and Free Course in Secret Service Intelligence. Mastery of these two kindred professions will open a brilliant career for you.

Write quickly for fully illustrated free book on Finger Prints which explains this wonderful training in detail. Don't wait until this offer has expired—mail the coupon now. You may never see this announcement again! You assume no obligation—you have everything to gain and nothing to lose. Address

UNIVERSITY OF APPLIED SCIENCE
Dept. 13-52, 1920 Sunnyside Avenue, Chicago, Illinois

Why don't You be a Finger Print Expert?

UNIVERSITY of APPLIED SCIENCE, Dept. 13-52, 1920 Sunnyside Av., Chicago

Gentlemen: Without any obligation whatever, send me your new, fully illustrated, FREE book on Finger Prints and your offer of a FREE course in Secret Service Intelligence and the Free Professional Finger Print Outfit.

Name

Address

Age

Sweeney Says You, Too, Can Have Money in Bank, \$5,000 Home, 2 Cars

"E. J." Himself



Listen, man: Do you want money? Do you want independence? Do you want a sure trade that pays \$50 a week up? Do you want to travel and see the world? How would you like a good driving job? Or a place in a repair shop? Or your own service, tire or battery station?

BIG SPECIAL OFFER

Never before have I made such an amazing offer. I now make it possible for you to come to this Sweeney Million Dollar Trade School right now. If you are mechanically inclined—if you are willing to work and make a little sacrifice for a few weeks you can ABSOLUTELY PROMISE YOURSELF to make your dream come true. You don't need experience; you don't need education. I train you in REAL SHOPS—with tools, not books. Here's a million dollar investment to back my GUARANTEE. Over sixty thousand men in all parts of the country will tell you what I say is true. Over 20,000 of my men are in business for themselves.

HERE'S a letter that shows what you can do. \$10,000 CASH says it is true and genuine. Why man—I can show you 500 or a thousand letters just as good. YOU may not have to go broke to pay for your training. But even if you do, what's the odds? See how well it paid Hawkins to go broke.

Dear E. J.:-

All I can say is I was broke when I left Kansas City—had only 25 cents over my ticket to Meridian; came here—went to work in the Dodge Service Station. Then in N. East Service Station—then opened up a service place of my own. Now moved in a larger place—¼ block square. Keeping six mechanics busy. Just built a nice home for over \$5000. Own my own car, and wife has hers—sedan. Owe no one, have good stock on hand and money in the bank. I can honestly say—it was Sweeney's wonderful training that did it. Before I went to Sweeney's I worked in a dry goods store as clerk—drawing one of top salaries, \$22.50 a week. Now the expenses of my three kids in boarding school are more than the \$22.50 a week I used to make.

I am still with you in the air at night—using an eight-tube set, Western Electric amplifier. A. J. Hawkins, Meridian, Miss.

MEN WANTED

Get This FREE Book Today!

Just send me your name and I will send you a 64-page big illustrated book. I have put into this fascinating book a lifetime of mechanical experience. It is full of real pictures—shows how mechanics do all kinds of expert jobs. Lists the opportunities in the business. Tells just what to do—where to go—to make good. Explains step by step how to learn to be a skilled mechanic. Answers every question. Many a mother and father reading this book have been inspired to make sacrifices and help their sons out. Tells all about the world famous Sweeney System—adopted by U. S. GOVT. during the war to intensively train soldier motor mechanics. Shows how easy it will be for you to FIT YOURSELF for a real job, independence and prosperity. I will send this to you free—no cost—no obligation. Write for it today. No colored students accepted. Answer this NOW. Remember I am making the most amazing offer in the history of this school.

E. J. SWEENEY

E. J. SWEENEY,
President

Send-this

NOW

LEARN A TRADE-
Sweeney
AUTOMOTIVE & ELECTRICAL SCHOOL
3431 SWEENEY BLDG. KANSAS CITY, MO.

EMORY J. SWEENEY, President
Dept. 3431 Sweeney Building, Kansas City, Mo.

Send me free, without any obligation on my part, your 64-page catalog and special offer.

NAME.....

GIVE AGE.....

P. O.....

STATE.....

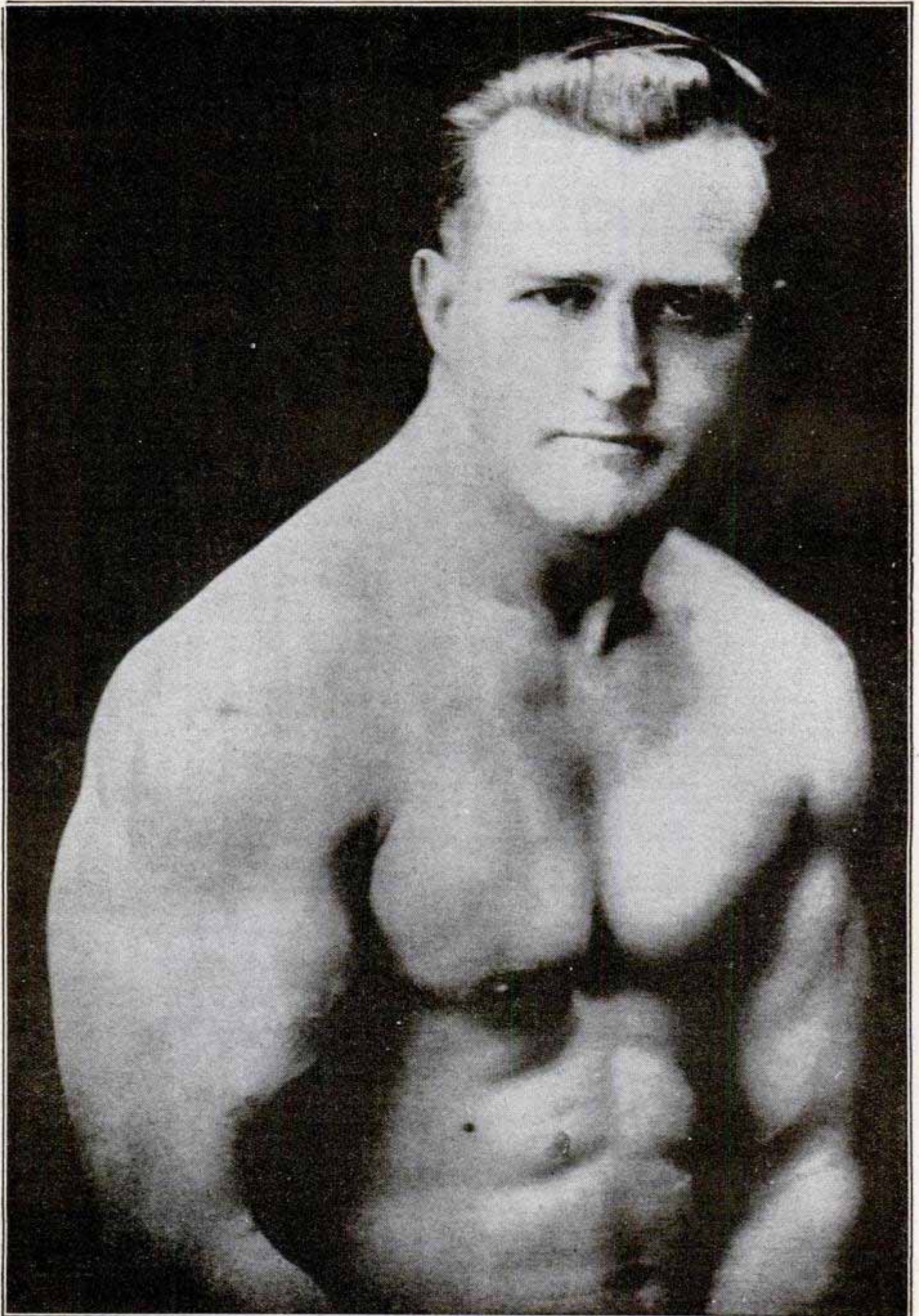

EARLE E. LIEDERMAN, *The Muscle Builder*
Author of "Science of Wrestling," "Muscle Building," "Secrets of Strength," "Here's Health," "Endurance," etc.

Kill This Man!

THERE'S a devil inside of you. He's trying to kill you. Look out for him! He tells you not to work so hard. What's the use? the boss only piles more work on you. He tells you not to bother with your body. If you're weak—you always will be weak. Exercise is just a lot of rot. Do you recognize him? Of course you do. He's in us all. He's a murderer of ambition. He's a liar and a fool. *Kill him!* If you don't, he will kill you.

Saved

Thank your lucky stars you have another man inside of you. He's the human dynamo. He fills you full of pep and ambition. He keeps you alive—on fire. He urges you on in your daily tasks. He makes you strive for bigger and better things to do. He makes you crave for life and strength. He teaches you that the weak fall by the wayside, but the strong succeed. He shows you that exercise builds live tissue—live tissue is muscle—muscle means strength—strength is power. Power brings success! That's what you want, and gosh darn your old hide! you're going to get it.

Which Man Will It Be?

It's up to you. Set your own future. You want to be the Human Dynamo? Fine! Well, let's get busy. That's where I come in. That's my job. Here's what I'll do for you:

In just 30 days I'll increase your arm one full inch with real live, animated muscle. Yes, and I'll add two inches to your chest in the same time. Pretty good, eh? That's nothing. Now come the works. I'll build up your shoulders. I'll deepen your chest. I'll strengthen your whole body. I'll give you arms and legs like pillars. I'll literally pack muscle up your stomach and down your back. Meanwhile I'll work on those inner muscles surrounding your vital organs. You'll feel the thrill of life shooting up your old backbone and throughout your entire system. You'll feel so full of life you will shout to the world, "I'm a man and I can prove it!"

Sounds good, what? But listen! That isn't all. I'm not just promising these things. *I guarantee them!* It's a sure bet. Oh, boy! Let's ride.

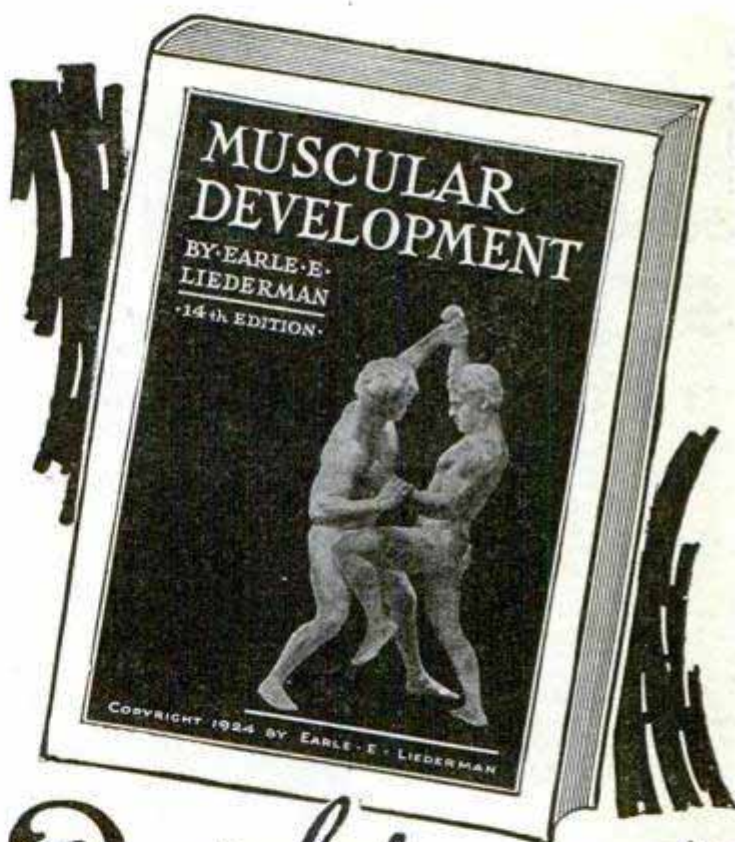

Send For My New
64 Page Book

"Muscular Development"

IT IS FREE

What do you think of that? I don't ask one cent. And it's the peppiest piece of reading you ever laid your eyes on. I swear you'll never blink an eyelash till you've turned the last cover. And there's 48 full-page photos of myself and some of my prize-winning pupils. This is the finest art gallery of strong men ever assembled. And every last one of them is shouting my praises. Look them over. If you don't get a kick out of this book, you had better roll over—you're dead. Come on, then. Take out the old pen or pencil and sign your name and address to the coupon. If you haven't a stamp, a postal will do. But snap into it. Do it *now*. Tomorrow you may forget. Remember, it's something for nothing and no strings attached, no obligation. *Grab it!*

EARLE E. LIEDERMAN

Dept. 2002, 305 Broadway, New York City

**It
Is
F
R
E
E**

**DON'T
SEND ONE
PENNY
—
YOUR
NAME AND
ADDRESS
ON A
POSTAL
WILL DO**

EARLE E. LIEDERMAN
Dept. 2002, 305 Broadway, New York City

Dear Sir: Please send me, absolutely FREE and without any obligation on my part whatever, a copy of your latest book, "Muscular Development."

Name.....

Street.....

City..... State.....

(Please write or print plainly.)

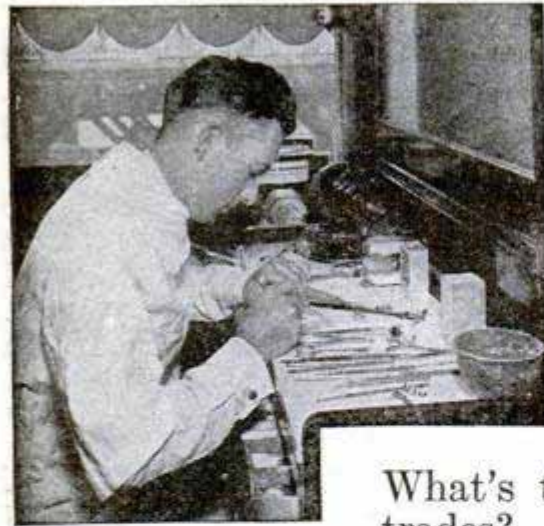

Easiest, pleasantest work you ever saw! Your own boss, money and success yours from the very beginning. You can start with a "shoe-string." We prepare you in a few months to run a business of your own, to do any job. Common schooling, ability to use your fingers **ALL YOU NEED!** Free R. R. Fare to Chicago, Cleveland, Detroit, Boston or Philadelphia for a limited time!



Jobs Up to \$125 a Week!

In a business where there are many times as many jobs as Experts, salaries are high, hours are easy, opportunities are everywhere! Dentists recognize the high-standing of our graduates. No books here—learn with tools and instruments. Start quick—get ready in a few months for your big opportunity! *Mail Coupon today!*

Rubber Plates

Learn to make partial upper or lower plates with soldered, cast or wire clasps, with palatal bars; with lingual bars. McCarrie-trained Students learn to make full rubber plates of every type, including Vulcanite base-plates, butted gums, carved gums, etc.

CROWNS

Here's only a small part of your practical training in Crown-work: Two-piece, seamless, open-face, Richmond, cast-base porcelain, Carmichael, split-pin, carved (swaged) cusp, cast cusp, etc.

BRIDGE WORK

Complete training in both fixed and removable bridgework. Interchangeable teeth, gold dummy, Sanitary porcelain dummy jobs—Roach, Gilmore, Bischoff and all forms of cast-clasp work is taught—not with books but in *actual Laboratory.*

METAL BASE DENTURES

Cast bases of Aluminum, Watt's metal, etc., are included in your training. Both centrifugal and air pressure casting machines are used. Free Book contains complete list of subjects in course.

FREE!
R. R. Fare
TO
Chicago
Cleveland
Detroit
Boston
or
Phila.

This Dental Laboratory Expert earns UP TO \$20 a day!

What's the use of training for the old, overcrowded trades? If you're going to prepare for big-salaried jobs or a profitable business of your own **GET INTO THE FASTEST GROWING PROFESSION—“Laboratory Dentistry.”** Biggest opportunity for success of the century, because there are many more jobs than there are experts to fill them, because there are a dozen cities crying for Laboratories for each **EXPERT** capable of operating one!

64,000 DENTISTS NEED LABORATORY WORK!

Only a few hundred Laboratories in all the U. S.—most of them in the larger cities. Dentists can't afford to do their own mechanical jobs. They can buy the services of a Laboratory Expert at about \$3.00 an hour and sell their own time at \$6 to \$15 an hour. Dentists will encourage you to learn mechanical Dentistry, start a "Lab" of your own, give them quicker service than sending their work to other cities. Dentists can't wait and keep their patients waiting. Ask your Dentist.

WE HELP YOU OPEN A LABORATORY OF YOUR OWN!

Many of my graduates open a Laboratory of their own. To encourage more men to go into this wonderful Mechanical profession, we will help you find a good location for your Laboratory, and help you towards success. Write for complete information on how you can find yourself in a profitable business of your own after you become a Dental Laboratory Expert.

INTERESTING BOOK—FREE!

Right this minute there are openings for 150 Dental Laboratory Experts in locations where they can do a business of \$5,000 to \$20,000 a year. But you can't cash in, take advantage of these OPPORTUNITIES until you're *Trained.* Catalog tells you how quickly and easily you can get ready, how hundreds of others have **SUCCEEDED!** Tells you how you learn in a few months **BY DOING ACTUAL LABORATORY JOBS** in the world's greatest *Dental Laboratory Schools.* Brings you **FREE R. R. Fare** offer and other big inducements. *Write for free Book today!*

EARN while you LEARN!
Day students make all or part cost of course by part-time night work. Night students can find plenty of good jobs "to see them thru."
We'll help you!

McCarrie School of Mechanical Dentistry

1338 S. Michigan Ave.
Dept. 65 Chicago, Ill.

McCarrie School of Mechanical Dentistry
1338 S. Michigan Ave., Dept. 65, Chicago, Ill.

Without obligation, please send me your *Free R. R. fare offer* and free Book with complete information about how I may become a Mechanical Dentist. How you will help me open a Laboratory, how you will help me find a job while I take my training, etc.

Name.....
St. No. or R. F. D.....
City.....State.....



Over \$10,000 a Year
C. V. Champion of Illinois counts it a "red letter day" when he first read this remarkable book — "Modern Salesmanship." He says "It enabled me to learn more, earn more, and BE MORE!" To-day he is president of his company and his earnings exceed \$10,000 a year!



\$1,000 in 30 Days
W. Hartle spent ten lean years in the railway mail service before "Modern Salesmanship" put him on the road to big pay. He has earned more in a week than he formerly earned in a month — averaged over \$1,000 for thirty days!



\$13,500 First Year
A. H. Ward was formerly a Chicago clerk, earning \$25 a week. Within one year he increased his earnings over \$1,000 a month—or to \$13,500 a year! The book—"Modern Salesmanship"—proved the first rung in his ladder to Success!



\$7,286 Last Year
F. G. Walsh was a clerk earning \$1,000 a year, and trying to support a wife and three children. He had to do something. N. S. T. A. training built up his income last year to \$7,286—an increase of over 700 per cent.

-and They Started By Reading This Amazing Book!

Now—For a Limited Time Only—This Remarkable Man-Building, Salary-Raising Volume Is Offered FREE to Every Ambitious Man! If You Ever Aspire to Earn \$10,000 a Year or More, Read It Without Fail.

Where Shall We Send Your Copy FREE?

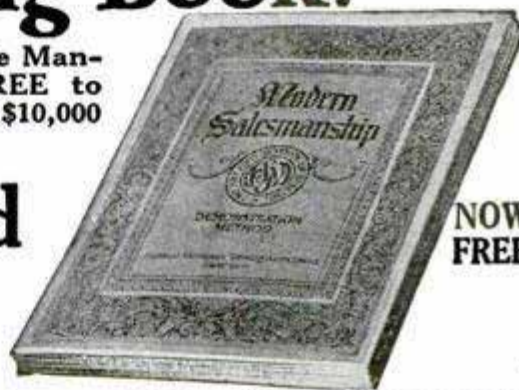

NOW FREE

A BOOK! Just seven ounces of paper and printer's ink—but it contains the most vivid and inspiring message any ambitious man can ever read! It reveals the facts and secrets that have led hundreds of ambitious men to the success beyond their fondest expectations! So powerful and far reaching has been the influence of this little volume, that it is no wonder a famous business genius has called it "The Most Amazing Book Ever Printed."

This vital book—"Modern Salesmanship"—contains hundreds of surprising and little-known facts about the highest paid profession in the world. It reveals the real truth about the art of selling. It blasts dozens of old theories, explains the science of selling in simple terms, and tells exactly how the great sales records of nationally-known star salesmen are achieved. And not only that—it outlines a simple plan that will enable almost any man to master scientific salesmanship without spending years on the road—without losing a day or dollar from his present position.

What This Astonishing Book Has Done!

The achievements of this remarkable book have already won world-wide recognition. The men who have increased their earning capacities as a direct result of reading "Modern Salesmanship" are numbered in the thousands. For example, there is E. E. Williams of California who was struggling along in a minor position at a small salary. "Modern Salesmanship" opened his eyes to things he had never dreamed of—and he cast his lot with the National Salesmen's Training Association. Within a few short months of simple preparation, he was earning \$10,000 a year! Today he receives as much in 30 days as he used to receive in 365!

And then there's J. H. Cash of Atlanta. He, too, read "Modern Salesmanship" and found the answer within its pages. He quickly raised his salary from \$75 to \$500 a month and has every reason to hope for an even more brilliant future. And still they come! W. D. Clenny of Kansas City commenced making as high as \$850 a month. F. M. Harris, a former telegrapher, became sales manager at \$6,000 a year. O. H. Malfroot of Massachusetts became sales manager of his firm at a yearly income of over \$10,000.

A Few Weeks—Then Bigger Pay

There was nothing "different" about these men when they started. Any man of average intelligence can duplicate the success they have achieved—for their experience proves that

salesmen are **made**—not born, as some people have foolishly believed.

Salesmanship is just like any other profession. It has certain fundamental rules and laws—laws that you can master as easily as you learned the alphabet. And through the **National Demonstration Method**—an exclusive feature of the N. S. T. A. system of SALESMANSHIP training—you can acquire the equivalent of actual experience while studying. Hundreds of men who never sold goods in their lives credit a large portion of their success to this remarkable training.

Free to Every Man

If we were asking two or three dollars a copy for "Modern Salesmanship" you might hesitate. But it is now FREE. We cannot urge you too strongly to take advantage of this opportunity to see for yourself what salesmanship has done for others—and what the National Salesmen's Training Association stands ready and willing to do for you. Find out exactly what the underlying principles of salesmanship are—and how you can put them to work for you. No matter what your opinion is now, "Modern Salesmanship" will give you a new insight into this fascinating and highly-paid profession.

Mail the coupon now!



Dept. B-12, N. S. T. A. Building, Chicago, Ill.

National Salesmen's Training Assn.,
Dept. B-12,
N. S. T. A. Building, Chicago, Ill.
Without cost or obligation you may send me your free book, "Modern Salesmanship."

Name.....
Address.....
City..... State.....
Age..... Occupation.....



Automobile Experts in Demand

Study with the same school that helped to train many leading men in the automobile industry

THE best proof of the value of the home-study courses of the International Correspondence Schools is the success of I. C. S. students. This success is especially apparent in the automobile industry.

Jesse G. Vincent, Vice-president of the Packard Motor Car Co., is a former I. C. S. student. So is Walter P. Chrysler, President of the Chrysler Corporation. E. V. ("Eddie") Rickenbacker, Vice-president and Director of Sales of the Rickenbacker Motor Car Co.; Hiram Walker, Chief Engineer of the Chandler Motor Car Co., and John Moore, designer of the famous Ansted Motor, are also former I. C. S. students.

The first step they took was to mark and mail an I. C. S. coupon similar to the one printed below. Make your start the same way and make it right now. We'll gladly send you complete information about the I. C. S. Automobile Courses or any other course in which you are interested.

INTERNATIONAL CORRESPONDENCE SCHOOLS Box 5631-E, Scranton, Penna.

Oldest and largest correspondence schools in the world
Without cost or obligation on my part, please tell me how I can qualify for the position or in the subject before which I have marked an X:

- | | |
|---|--|
| <input type="checkbox"/> Complete Automobile Course | <input type="checkbox"/> Gas Engine Operating |
| <input type="checkbox"/> Automobile Electric Equipment | <input type="checkbox"/> Complete Gas Engine Course |
| <input type="checkbox"/> Electrical Engineering | <input type="checkbox"/> Architect |
| <input type="checkbox"/> Electric Lighting | <input type="checkbox"/> Architects' Blueprints |
| <input type="checkbox"/> Mechanical Engineer | <input type="checkbox"/> Contractor and Builder |
| <input type="checkbox"/> Mechanical Draftsman | <input type="checkbox"/> Architectural Draftsman |
| <input type="checkbox"/> Machine Shop Practice | <input type="checkbox"/> Concrete Builder |
| <input type="checkbox"/> Railroad Positions | <input type="checkbox"/> Structural Engineer |
| <input type="checkbox"/> Civil Engineer | <input type="checkbox"/> Chemistry <input type="checkbox"/> Pharmacy |
| <input type="checkbox"/> Surveying and Mapping | <input type="checkbox"/> Airplane Engines |
| <input type="checkbox"/> Metallurgy <input type="checkbox"/> Mining | <input type="checkbox"/> Agriculture and Poultry |
| <input type="checkbox"/> Steam Engineering <input type="checkbox"/> Radio | <input type="checkbox"/> Mathematics |
-
- #### BUSINESS TRAINING COURSES
- | | |
|--|---|
| <input type="checkbox"/> Business Management | <input type="checkbox"/> Salesmanship |
| <input type="checkbox"/> Industrial Management | <input type="checkbox"/> Advertising |
| <input type="checkbox"/> Personnel Organization | <input type="checkbox"/> Better Letters |
| <input type="checkbox"/> Traffic Management | <input type="checkbox"/> Show Card Lettering |
| <input type="checkbox"/> Business Law | <input type="checkbox"/> Stenography and Typing |
| <input type="checkbox"/> Banking and Banking Law | <input type="checkbox"/> Business English |
| <input type="checkbox"/> Accountancy (Including C.P.A.) | <input type="checkbox"/> Civil Service |
| <input type="checkbox"/> Nicholson Cost Accounting | <input type="checkbox"/> Railway Mail Clerk |
| <input type="checkbox"/> Bookkeeping | <input type="checkbox"/> Common School Subjects |
| <input type="checkbox"/> Private Secretary | <input type="checkbox"/> High School Subjects |
| <input type="checkbox"/> Spanish <input type="checkbox"/> French | <input type="checkbox"/> Illustrating |

Name.....
Street Address.....
City..... State.....

Occupation.....
If you reside in Canada, send this coupon to the International Correspondence Schools Canadian, Limited, Montreal

LAW THIS BOOK FREE!

Study at Home
Become a lawyer. Legally trained men win high positions and big success in business and public life. Greater opportunities now than ever before.

Earn \$5,000 to \$10,000 Annually!

We guide you step by step. Degree of LL.B. LaSalle law graduates practicing in every state. We furnish all text material, including 14-volume Law Library. Low cost. Easy terms. Valuable, interesting 96-page book free. Send for it NOW.

LaSalle Extension University, Dept. 264-L, Chicago



"STAMMERING

Its Cause and Cure"

You can be quickly cured if you stammer. Send 10 cents, coin or stamps, for 238 page cloth bound book on Stammering and Stuttering. It tells how I cured myself after Stammering and Stuttering for 20 years. BENJAMIN N. BOGUE
6940 Bogue Building, 1147 N. Ill. St. Indianapolis

LEARN PHOTOGRAPHY!

Earn \$200 to \$500 monthly. Or start your own business. Photography and Photo-Engraving taught by largest college of its kind in world. Est. 1893. Big demand for graduates.

Write for free book

Illinois College of Photography Box 427 Effingham, Ill.



200 Kinds of IRON, WOOD and WIRE PUZZLES. Leader and Illustrated List 10 cents. Western Puzzle Works, St. Paul, Minn.



Play "JAZZ" on the Saxophone

Become a musician so quickly as to astound everyone. Learn by playing real music—instead of tiresome "exercises." You'll soon become the most popular person in your "set."

New Easy Method

is a revelation. Nothing else like it for thoroughness and rapidity. So simple that young and old find it easy to play with amazing skill. No "trick music"—but actual notes, learned quickly right in your own home.

FREE BOOK and Demonstration Lesson

offer this wonderful musical opportunity. Send for them today before copies are exhausted. You'll be astounded, thrilled, fascinated, at this easy, rapid way to become a veritable master of your favorite instrument. Instruments supplied when needed, cash or credit.

LEARN TO PLAY ANY INSTRUMENT

- | | |
|-----------------------------------|---|
| <input type="checkbox"/> Piano | <input type="checkbox"/> Mandolin |
| <input type="checkbox"/> Organ | <input type="checkbox"/> Drums and Traps |
| <input type="checkbox"/> Violin | <input type="checkbox"/> Harmony and Composition |
| <input type="checkbox"/> Clarinet | <input type="checkbox"/> Sight Singing |
| <input type="checkbox"/> Flute | <input type="checkbox"/> Ukulele |
| <input type="checkbox"/> Harp | <input type="checkbox"/> Piccolo |
| <input type="checkbox"/> Cornet | <input type="checkbox"/> Trombone |
| <input type="checkbox"/> Cello | <input type="checkbox"/> Saxophone |
| <input type="checkbox"/> Guitar | <input type="checkbox"/> Voice and Speech Culture |
| | <input type="checkbox"/> Automatic Finger Control |
| | <input type="checkbox"/> Piano Accordion |
| | <input type="checkbox"/> Banjo (Plectrum, 5-String and Tenor) |

U. S. SCHOOL OF MUSIC, 72-A Brunswick Bldg., New York City
Send me your amazing free book, "Music Lessons in Your Own Home," with introduction by Dr. Frank Crane, also DEMONSTRATION LESSON. This does not put me under any obligation. (Please Write Plainly.)

NAME.....
ADDRESS.....
Name of Course..... Have you this inst.?



I Will Train You At Home To Fill a Big Pay Radio Job



"I give you all this apparatus so you can learn quickly at home the *Practical Way*"

J.E.S.
FREE OF EXTRA COST

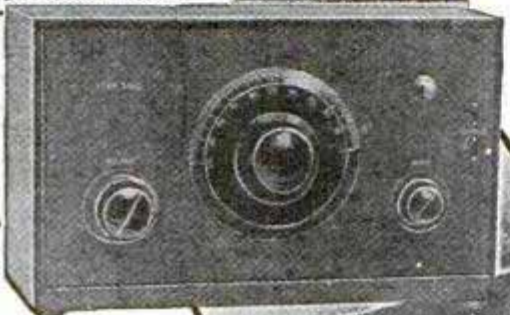

You Get All of This

All instruments shown here and others sent to all my students free of extra cost under short time special offer. Clip coupon now—find out all about this big unequalled offer while you still have time to take advantage of it. This training is intensely practical—these instruments help you do the practical work. You learn workmanship and get added confidence in your ability.



\$70 in one Day for T. M. Wilcox
"In business for myself—RECENTLY MADE \$70 in ONE DAY. I was an electrician of rich experience, occupying a splendid position as telephone superintendent when I enrolled with you, believing it would open up greater opportunities. Estimate Radio worth tens of thousands of dollars to me in next few years." T. M. Wilcox, Belle Island, Newfoundland.

World Famous Training That "Pays for Itself"

My Radio course World-Famous as the training that "pays for itself." Make more money QUICK when you take up this practical course. Work on millions of antennae, receiving sets, offers you big chance to make spare time cash while you're learning. I'll show you how. My students don't wait a year to increase their income—they report QUICK INCREASES as a result of this course—often two or three weeks after starting. Howard Luce, Friedens, Pa., made \$320 in 7 weeks during spare time. D. H. Suitt, Newport, Ark., writes: "While taking the course I earned in spare time work about \$900. These records not unusual—these men a few of hundreds."

Your Satisfaction Guaranteed

We who know the results this practical tested training gets, stand behind it all the way with a signed guarantee bond that we give you when you enroll. Get started today! It's your big chance for one of the bigger Radio jobs—mail coupon NOW for my Big FREE BOOK and proof! No obligation.

If you're earning a penny less than \$50 a week, clip coupon now. Send for AMAZING FREE BOOK, "Rich Rewards in Radio." Why go along at \$25 or \$35 or \$45 a week, when you could earn \$50 to \$250 in the same six days, as a Radio Expert? Hundreds of N. R. I. trained men are doing it—why can't you?

Earn \$50 to \$250 a Week—Radio Experts in Big Demand

Radio needs trained men. Get into this new live-wire profession of quick success. It's the trained men, the Radio Expert, who gets the big jobs of this profession—paying \$75, \$100, \$200 a week and up. Every day N. R. I. trained men are taking good places in the Radio field—men just like you—their only advantage is TRAINING. You can prepare just as they did by new practical methods. Our tested clear training makes it easy for you. Big Free Book contains all the proof.

You Learn Quickly In Spare Time

So sure am I that I can train you successfully for a better future in this new Big-Pay profession that I guarantee your training with a money-back bond. Lack of experience or education won't hold you back—common schooling all you need to start. You can stay home, hold your job, and learn quickly and pleasantly in your spare time. My practical, helpful methods enable you to start RIGHT AWAY toward one of the bigger Radio jobs paying \$50 to \$250 a week. No delay, no losing time from work—no scrimping or scraping to get your training.



Operates WMAQ
"Accepted a position with the Chicago Daily News Station WMAQ. MY INCOME PRACTICALLY DOUBLED. I handle all consultation, also do operating. Your course taught me the theoretical and practical knowledge that makes my work easy." Keith Kimball, Station WMAQ, Chicago, Ill.

Get This FREE BOOK

Most amazing book on Radio ever written—full of facts and pictures—tells all about the great new Radio field, how we prepare you and help you start. You can do what others have done—GET THIS BOOK. Send coupon today—no obligation.
J. E. SMITH, President
NATIONAL RADIO INSTITUTE
Dept. B-85, Washington, D. C.



Employment Service To All Graduates

Originators of Radio Home-Study Training

J. E. Smith, President
NATIONAL RADIO INSTITUTE
Dept. B-85, Washington, D. C.
Dear Mr. Smith—Without obligating me in any way, send me your free book, "Rich Rewards in Radio" and all information about your practical, home-study Radio Course.

Name.....Age.....
Street Address.....
Town.....State.....

Do You Make these Mistakes in ENGLISH?

Free yourself of embarrassing mistakes in speaking and writing. Wonderful new invention automatically finds and corrects your mistakes; gives you a powerful mastery of language in only 15 minutes a day.

Many persons say, "Did you hear from him today?" They should say, "Have you heard from him today?" Some spell calendar "calender" or "calander." Still others say "between you and I," instead of "between you and me." It is astonishing how many persons use "who" for "whom," and mispronounce the simplest words. Few know whether to spell certain words with one or two "c's" or "m's" or "r's," or with "ie" or "ei." Most persons use only common words—colorless, flat, ordinary. Their speech and their letters are lifeless, monotonous, humdrum. Every time they talk or write they show themselves lacking in the essential points of English.



SHERWIN CODY

Every time you talk, every time you write, you show what you are. When you use the wrong word, when you mispronounce a word, when you punctuate incorrectly, when you use flat, ordinary words, you handicap yourself enormously. A striking command of English enables you to present your ideas clearly, forcefully, convincingly. If your language is incorrect it hurts you more than you will ever know, for people are too polite to tell you about your mistakes.

Wonderful New Invention

For many years Mr. Cody studied the problem of creating instinctive habits of using good English. After countless experiments he finally invented a simple method by which you can acquire a better command of the English language in only 15 minutes a day. Now you can stop making the mistakes which have been hurting you. Mr. Cody's students have secured more improvement in five weeks than had previously been obtained by other pupils in two years!

Learn by Habit—Not by Rules

Under old methods rules are memorized, but correct habits are not formed. Finally the rules themselves are forgotten. The new Sherwin Cody method provides for the formation of correct habits by constantly calling attention only to the mistakes you yourself make—and then showing you the right way, without asking you to memorize any rules.

One of the wonderful things about Mr. Cody's course is the speed with which these habit-forming practice drills can be carried out. You can write the answers to fifty questions in 15 minutes and correct your work in 5 minutes more. The drudgery and work of copying have been ended by Mr. Cody! You concentrate always on your own mistakes until it becomes "second nature" to speak and write correctly.

FREE BOOK ON ENGLISH

A command of polished and effective English denotes education and culture. It wins friends and favorably impresses those with whom you come in contact. In business and in social life correct English gives you added advantages and better opportunities, while poor English handicaps you more than you now realize. And now, in only 15 minutes a day—in your own home—you can actually see yourself improve by using the 100% self-correcting method.

A new book explaining Mr. Cody's remarkable method is ready. If you are ever embarrassed by mistakes in grammar, spelling, punctuation, pronunciation, or if you can not instantly command the exact words with which to express your ideas, this new free book, "How to Speak and Write Masterly English," will prove a revelation to you. Send the coupon or a letter or postal card for it now.

SHERWIN CODY SCHOOL OF ENGLISH
52 Searle Building, Rochester, New York

SHERWIN CODY SCHOOL OF ENGLISH,
52 Searle Building, Rochester, N. Y.

Please send me your free book "How to Speak and Write Masterly English."

Name.....

Address.....

City..... State.....



Young outdoor men wanted

Interesting, vigorous outdoor work in a growing organization where merit wins advancement. Good starting wages. Permanent positions and a real future for men who make good. Our present field force of Davey Tree Surgeons cannot meet the increasing demand. So we are selecting now, to enter our employ, a few sturdy, clean young men, thorough Americans, single, between 20 and 30 years old, free to travel, industrious, with good practical education, and able to give good references. Write for qualification blank to serve in place of personal interview.

The Davey Tree Expert Co., Inc.,
640 Federal Bldg., Kent, Ohio.

Do Your Own Paper-Hanging!

"The Expert Paper Hanger," by A. Ashmun Kelly, tells you exactly how to remove old paper, prepare walls, trim, paste and hang all kinds of paper, canvas, burlap, etc. Gives tested recipes for best pastes and sizes for all kinds of walls.

Easy When You Know Methods of Experts

This book shows how to get best results. Explains every detail. No experience needed. You can paper your own home and save money.

Sent on 5 Days' Approval—Send No Money
Over 185 pages of concise, easily-used information. Handy volume, cloth-bound. Pay postman only \$2.50, plus few cents postage. Money refunded if you return within 5 days.

Catalog of Mechanical and Engineering Books FREE
All standard books on House Painting, Interior Decoration, Wood Finishing, Mechanical Drafting, Auto Mechanics, etc. Send for it now.

DAVID McKAY CO., Dept. 22, 604 S. Washington Sq., Philadelphia, Pa.

DAVID McKAY CO., Dept. 22, 604 S. Washington Sq., Philadelphia, Pa.
Send me "The Expert Paper Hanger" by A. Ashmun Kelly, with your Free Catalog. I will pay postman \$2.50 plus postage, you to refund if I return book in 5 days. [] Check here if you wish catalog only.

Name.....

Address.....

City..... State.....



ELECTRICITY

Complete Study Course and Pocket Library \$10

SHIPPED FREE

A set of HAWKINS GUIDES is a true friend to the electrical worker. It tells you how to do any job the right way—without guessing or taking chances.



Hawkins Guides put all the facts about modern electrical engineering at your finger tips. Therefore your chances for advancement in the electrical field are unlimited.

HAWKINS GUIDES DOUBLE YOUR VALUE



Electricity is king! It is the ruling force of today—transportation, communication, light, heat, power—indeed every modern activity is dependent on electricity. Industry is crying for electrical men that know their jobs!

Hawkins Guides teach you all you need to know about electricity in easy, step-by-step lessons. Daily spare time reading of the Guides will greatly increase your value to yourself and your employer in a few weeks. Hundreds of our friends have written us and told us this!

Hawkins Guides put all the facts about modern electrical engineering at your finger tips. Therefore your chances for advancement in the electrical field are unlimited.

READERS OF HAWKINS GUIDES KNOW HOW



"You can't stump him on an electrical job." "He certainly knows his business." "Certainly have to hand it to him for knowing how."—These are the things employers say about our friends who are readers of Hawkins Guides. No matter what question or problem comes up the Ready Reference Index enables you to give an expert answer at once.

HAWKINS STARTS YOU WHERE OTHERS LEFT OFF

Why should you work at low wages when easy reading of HAWKINS GUIDES will give you the money-making knowledge of the expert? Easy daily reading of the Guides will teach you in a few months what it has taken the expert a lifetime to learn!

With HAWKINS GUIDES in hand you have a running start to success in the electrical field. You will actually begin where others left off!

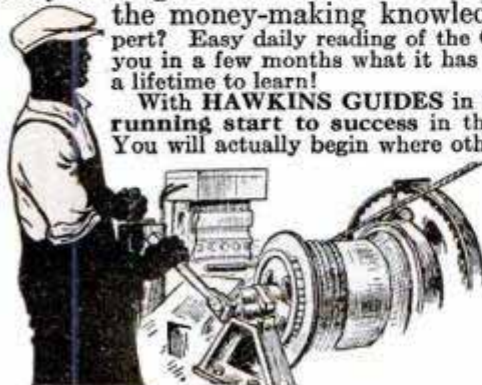

NOW!

This coupon is your golden opportunity. Tear it out—send it now!

FOR EXAMINATION!

REAL ELECTRICAL EDUCATORS

"Hawkins Guides at \$10 is the best investment I have ever made. Am able to take up almost any electrical job and have never gone to an electrical school."—B. Roessler, Oenaville, Texas.

AS EASY AS A. B. C.

"Everything in Hawkins Guides is very plain and anybody can read and understand them as easy as A. B. C."—J. Knight, Tobyhanna, Pa.

OTHER ENTHUSIASTIC READERS SAY

"Worth ten times their price." "Helped me to two raises in four months." "Better than a school of instruction." "Studied them when I was laid up and got further ahead than if I had been on the job."

Hawkins Guides Explain These Points So You Can Easily Understand:—

Magnetism—Induction—Experiments—Dynamoes—Electric Machinery—Motors—Armatures—Armature Windings—Installing of Dynamoes—Electrical Instrument Testing—Practical Management of Dynamoes and Motors—Distribution Systems—Wiring—Wiring Diagrams—Sign Flashers—Storage Batteries—Principles of Alternating Currents and Alternators—Alternating Current Motors—Transformers—Converters—Rectifiers—Alternating Current Systems—Circuit Breakers—Measuring Instruments—Switch Boards—Wiring—Power Stations—Installing—Telephone—Telegraph—Wireless—Bells—Lighting—Railways. Also many Modern Practical Applications of Electricity and Ready Reference Index.

Hawkins Guides—10 POCKET SIZE NUMBERS

Each number easy to carry around and read in spare time. Big type and clear diagrams. Easy to study and learn. Durable, flexible binding—gold edges. 3,500 pages—4,700 illustrations. Shipped free for examination. Pay only \$1 a month if satisfied. Price of set, complete, \$10.



EXAMINE GUIDES FREE!

Let the Guides themselves demonstrate their practical value to you—as a study course, reference work and complete electrical library. You are the judge. Simply send this coupon. No obligation unless you are entirely satisfied. Tear out on dotted line—fill in—mail it NOW!

\$1 PER MO.

FREE EXAMINATION COUPON

Theo. Audel & Co., 65 W. 23rd St., New York City

Please send me (postpaid) for my approval Hawkins Electrical Guides, 10 numbers (price \$1 each). If satisfactory I will mail you \$1 in 7 days and further mail \$1 monthly until purchase price of \$10 is paid.

Name.....
 Address.....
 Occupation.....
 Employed by..... 2T30

\$100 for One Good Commercial Drawing



Become An Artist This Easy Way

Scores who never dreamed they could draw can now easily become artists. You, too—without any previous training—and no matter how little apparent talent you have—can now easily learn Illustrating, Designing and Cartooning, through this amazingly easy method.

You learn at home yet your work receives the personal attention and criticism of successful commercial art instructors. Many students actually sell enough work during their training to pay for it many times over.

Big Money in Commercial Art

Millions of dollars are being spent this year on advertising and story illustrations, commercial designs, and cartoons. And even more will be spent next year. Commercial art is a tremendous field—and a field where very big money is gladly paid anyone who can produce good art work. Advertisers, magazines, newspapers, printing houses, business concerns all need trained artists. Competent artists easily earn from \$50 to far over \$300 a week. And now you can easily prepare to enter this "world's most fascinating, best paid business."

Mail Coupon for Free Book

A new handsomely illustrated book has just been printed, which gives all the most up-to-date information on the scores of wonderful opportunities in Commercial Art and shows how this startling quick method easily enables you to enter this field. It tells about our students—their success—what they say—actual reproductions of their work—how they made big money while studying. This attractive book will be sent without cost or obligation. Send for it. Mail coupon now. Washington School of Art, Room 302-E, 1115-15th St., N. W., Washington, D. C.

WASHINGTON SCHOOL OF ART
Room 302-E, 1115-15th St., N. W., Washington, D. C.

Please send me without cost or obligation your new book on art. "Quick Easy Way to Become an Artist," and details of your attractive offer.

Name.....
Please write plainly Mr., Mrs., or Miss

Address.....

City..... State.....

Here's the Career for YOU



Get into Motion Picture Camera Work, Portrait and Commercial Photography. Learn at home. Big money while learning.

Earn up to \$250 a week

Hundreds of positions pay \$75 to \$250 a week. Or open your own studio. Easy, fascinating work.



CAMERA FREE

to students. Your choice of real Motion Picture Camera using professional film or 5 x 7 View Camera, anastigmat lens.

Write for big Free Book on Professional Photography. Explains amazing opportunities.

NEW YORK INSTITUTE OF PHOTOGRAPHY

12 W. 33d St., New York, N. Y., Dept. 49

Note: If you prefer to come to our studios for instruction, write for Catalog R-49 to nearest address: 10 W. 33d St., New York, or 630 So. Wabash Ave., Chicago.



\$30 A DAY FOR DISTRICT SALESMEN

Responsible man, 30 years old or over, and permanent resident in community, can make \$30.00 a day and up as District Salesman, taking orders for our finest, tailored-to-order clothes at sensational new low price. No investment necessary. We supply everything, give exclusive territory to producers, pay highest cash commission daily and big monthly bonus besides. Write at once to Dept. 771.

GOODWEAR Chicago, Inc.

844 West Adams Street

CHICAGO

Learn to Mount Birds



Learn at home by mail, to mount birds, animals, game heads; tax furs, make rugs and robes. Complete lessons. Easily and quickly learned by men, boys and women.

FREE Write today for Free Taxidermy Book. Tells all about it. Every Sportsman, Hunter, Trapper and Nature lover should know this wonderful fascinating art. Save your trophies. Big profits. Success guaranteed. Our school is 20 years old—100,000 graduates. Investigate today. Write for Free Book.

Northwestern School of Taxidermy

9772 Elwood Bldg., Omaha, Neb.

Welding

Become a Welding Expert! Then earn top wages or go into business for yourself. We train you at Home, in your Shop, or on the Job. "Kerr's Training Course for Welders" is a thorough course in practical experience, covering all metals. It trains you in WHAT TO DO and HOW TO DO IT. Write at once for terms and enrollment card. (State if you have the use of a welding outfit.)

KERR'S WELDING SCHOOL Dept. 2, 752 N. Broadway
LOS ANGELES, CALIF.

Comedies, Dramas, Musical Comedies and Revues, Minstrel Chorus, Songs, Blackface plays. Everything for Burnt Cork Shows and All Amateur Entertainments. Monologs, Dialogs, Speakers. **PLAYS** Vaudeville Acts How to Stage a Play Make-up Goods

CATALOGUE FREE
T. S. DENISON & CO., 623 So. Wabash, Dept. 9, CHICAGO

LEARN WATCH REPAIRING



You can learn by our modern and original system of instruction every part of the Watch Repairing Trade at home as good or better than at a shop. You can earn money while learning and secure a well paying position or start in business after completing our course of instruction. Good watch repairers are always in demand and earn from \$50 to \$75 per week. For particulars apply to the Wisconsin School of Watch Repairing
166 Mason St., MILWAUKEE, WIS.



I Can Teach You to Sing Like This!

—Eugene Feuchtinger

I do *not* mean I can make a Caruso out of every man—
or a Mary Garden out of every woman,—but

*I can teach you in a few short months a basic
secret of voice development which Caruso dis-
covered only after years of persistent effort*

HERE IS THE SECRET! This is a picture of the human throat, showing the all important Hyo-Glossus muscle. Biographers of the great Caruso tell us of his wonderful tongue control. Caruso himself speaks of it in his writings, as the basic secret of vocal power and beauty. But tongue control depends entirely on the development of your Hyo-Glossus muscle.



The Hyo-Glossus muscle in your throat can be strengthened just as surely as you can strengthen the muscles of your arm—by exercise.

Professor Eugene Feuchtinger, noted vocal scientist, famous in Europe before coming to America, was the first man to isolate and teach a method of developing the Hyo-Glossus.

100% Improvement Guaranteed

Thousands of men and women have already received the benefits of the "Physical Voice Culture" method. If you will practice faithfully, your entire satisfaction is guaranteed. In fact, if your voice is not doubled in power and beauty, your money will be refunded. You alone are to be the judge.

If you are ambitious to sing or speak, or merely improve your voice for social or business purposes, here is your opportunity. If you suffer from stammering, stuttering or other vocal defect, here is a sound, scientific method of relief. Under the guidance of Prof. Feuchtinger himself, you can practice these wonderful, silent exercises in the privacy of your own home. For this method of training is ideally adapted to instruction by correspondence.

Free Book Send today for the Professor's book, "Physical Voice Culture." It will open your eyes to the possibilities of your own voice. It will indeed be a revelation to you. Get it without fail. Mail coupon.

Perfect Voice Institute 1922 Sunnyside Ave.
Studio 13-52, Chicago

PERFECT VOICE INSTITUTE
1922 Sunnyside Ave., Studio 13-52, Chicago

Please send me FREE, Professor Feuchtinger's book, "Enter Your World." I have put X opposite the subject that interests me most. I assume no obligations whatever.

Singing Speaking Stammering Weak Voice

Name.....

Address.....

Age.....

23rd Year



Learn to Read Blue Prints In 12 Weeks - New, Easy, Short-Cut Method

BILLIONS are being spent in building. There's a frantic call for men who can read blue print plans and lay out building work. Foremen, superintendents and contractors who can read plans are making \$3,000 to \$15,000 a year—and more. Get in on the ground floor now. 12 weeks of fascinating study and you're on the way to a business of your own and big money.

12 Happy Weeks at Chicago Tech —“The School for Builders”

Come to Chicago. See for yourself the millions being spent here in building. 12 weeks of fascinating study, more like play than work—and you're ready to start for home—trained to enter building. A common schooling is all you need. Practical instructors. Opportunities for part time work. Earn while you learn. Free Employment Bureau. Living accommodations arranged for. Day or Evening Classes. Enter any time. Get full information now. Send no money—just the coupon. Fill it out and mail now . . . today.

In Spare Time At Home

If you can't come to Chicago, you can learn Plan Reading, Estimating, etc., at home. Your spare time is enough. Same short-cut methods. Quick, easy, thorough.

Blue Prints FREE

If interested in home-study we'll send you a set of building plans and our booklet "How to Read Blue Prints." Mark the coupon.

Get the Facts Now - FREE!

Find out about this 23-year old school for builders; about the organization, men behind it, etc. Let us show you what training has done for thousands of our graduates who are now top-notchers in the building field. Send for this information if you want to make more money in the world's big pay field—Building. No obligation; just mail the coupon.

**CHICAGO
TECHNICAL
SCHOOL FOR BUILDERS**
Dept. B-300, 118 E. 26th St., Chicago, Ill.

CHICAGO TECH. SCHOOL FOR BUILDERS
Dept. B-300, 118 E. 26th St., Chicago, Ill.

Please send me without obligation, free and postpaid, full facts and information on how I can learn to read blue prints and become a trained builder in 12 weeks.

Name

Address

Town or City State

Age Occupation

At Chicago Tech. or by Home Study. Mark Choice with an "X"

CLIP and MAIL COUPON - NOW

Learn to Write

I Teach by Mail

I CAN make a good penman of you at your home during spare time, no matter where you live or how poorly you now write. My simplified system has shown thousands of others the way to good penmanship during the past twenty years—it can and will do the same for YOU!

Beautifully Illustrated Book
“How to Become a Good Penman”

It contains general information, with testimonials and beautiful specimens of penmanship showing what others have accomplished by the Tamblin System. (Your name elegantly written on a card if you enclose stamp for postage.) **WRITE TODAY. Address**

F. W. TAMBLIN
418 Ridge Bldg., Kansas City, Mo., U. S. A.

ELECTRICAL

Course for men of ambition and limited time. Over 4000 men trained. Condensed course in Theoretical and Practical Electrical **ENGINEERING** including the closely related subjects of Mathematics and Mechanical Drawing taught by experts. Students construct motors, install wiring, test electrical machinery. Complete course

IN ONE YEAR

Prepare for your profession in the most interesting city in the world. School established 1893. Send for catalog

BLISS ELECTRICAL SCHOOL
432 Takoma Ave. WASHINGTON, D. C.

SPANISH

Learn at home on your phonograph. New Conversational Method. Endorsed by Spanish Embassy. You learn to speak, read and write Spanish as if you were living in Spain.

Write to-day for Free Descriptive Booklet
International Correspondence Schools, Box 5626-E, Scranton, Pa.

Learn to PAINT SIGNS and SHOW CARDS

We quickly teach you by mail, or at school, in spare time. Enormous demand. Big future. Interesting work. Oldest, foremost school.

EARN \$50 TO \$200 WEEKLY

John Vasson, N. Y., gets \$25 for single show card. Crawford, B. C., says: "Earned \$200 while taking course." Send today for free information, samples and guarantee.

DETROIT SCHOOL OF LETTERING
150 Stimson Ave. Est. 1899 Detroit, Mich.

WHY NOT

spend Spring, Summer and Fall gathering butterflies, insects? I buy hundreds of kinds for collections. Some worth \$1 to \$7 each. Simple outdoor work with my instructions, pictures, price-list. Send 10 cents (not stamps) for my illustrated Prospectus before sending butterflies.

MR. SINCLAIR, DEALER IN INSECTS,
Dept. 6. Box 1424. San Diego, Calif.



See How Easy it is to Quickly Become a Powerful Speaker

THERE is no magic, no trick, no mystery about becoming a powerful and convincing public speaker. I will prove that you can quickly become a powerful speaker. By an amazing five minute test I will show you how to discover whether you are one of the 7 men out of every 9 who have this "hidden knack" and do not know it.

Why Powerful Speakers Are Always Leaders

It is the man who can put his ideas into convincing speech—the man who can sway others at his will and dominate one man or a thousand who is sought out and asked to fill big, important high-salaried positions. He is a leader; he stands head and shoulders above the mass. I am going to prove that you can be such a man by simply bringing out your "hidden personality."

What 15 Minutes a Day Will Show You

- How to talk before your club or lodge.
- How to address board meetings.
- How to propose and respond to toasts.
- How to make a political speech.
- How to tell entertaining stories.
- How to make after-dinner speeches.
- How to converse interestingly.
- How to write better letters.
- How to sell more goods.
- How to train your memory.
- How to enlarge your vocabulary.
- How to develop self-confidence.
- How to acquire a winning personality.
- How to strengthen your will-power and ambition.
- How to become a clear, accurate thinker.
- How to develop your power of concentration.
- How to be master of any situation.

It is Amazingly Easy to Quickly Become a Powerful Speaker

You do not need a college education nor any previous voice training to become a powerful speaker. I will show you the secret that causes one man to rise from an obscure position to the head of a great corporation; another from the rank and file of political workers to national prominence; an ordinary trades-union member to the national leadership of great labor unions; a timid and retiring man to change suddenly into a popular and much applauded after-dinner and banquet speaker. Thousands have accomplished just such amazing things due to this simple, easy, yet effective training.

You Become a Good Speaker—Or I Don't Want a Penny

I will make you a powerful, convincing, and easy speaker within a few weeks if you will give me 15 minutes a day in the privacy of your own home. I know what I have done for thousands of others; therefore if I cannot make you a powerful speaker, your training will not cost you a penny.

Amazing Book Free—Mail Coupon

If you will fill in and mail the coupon at once, you will receive a remarkable new book called "How to Work Wonders with Words."

Now Sent Free



This book gives you an amazing test, by which you can determine for yourself in five minutes whether you are one of the seven men out of every nine who possess the "hidden knack" of powerful speech, but do not know it. Decide for yourself if you are going to allow 15 minutes a day to stand between you and success. Thousands have found this to be the biggest step forward in their lives. If it has played such an important part in the lives of many big men, may it not in yours? Then mail the coupon at once.

North American Institute

3601 Michigan Ave., Dept. 1352, Chicago, Ill.

North American Institute,
3601 Michigan Ave., Dept. 1352
Chicago, Ill.

Please send me FREE and without obligation my copy of your famous book, "How to Work Wonders with Words."

Name

Address

City State

BOYS

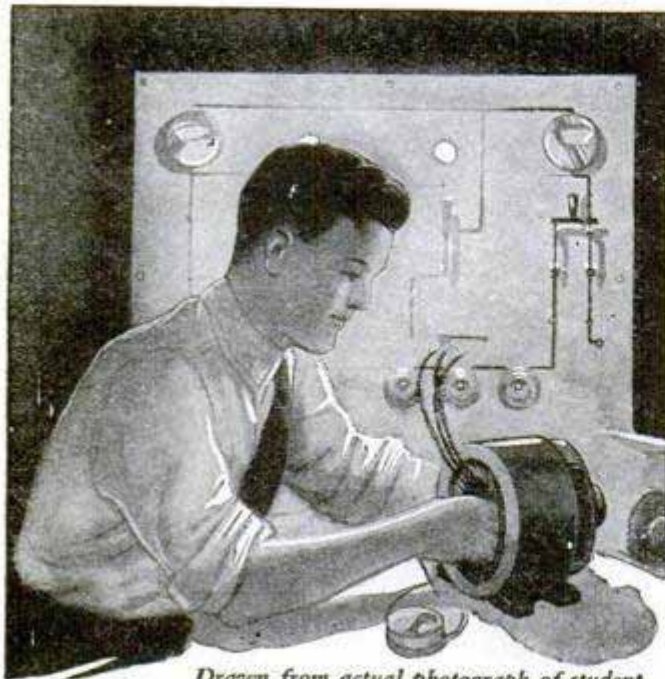

Drawn from actual photograph of student doing spare time electrical work

Learn Electricity Make Big Money

How would you like to earn two or three dollars every evening after school and prepare yourself for a fine big job at the same time? Here's the opportunity of a lifetime for you fellows who like Electricity. Begin right now to prepare yourself for a regular man's size job in this fascinating field. Your chances for a big success are simply wonderful—the pay is big (thousands of men earn \$70 to \$200 a week) and advancement comes swift and sure.

I Will Train You at Home

With my easily earned, spare time Electrical Course I will train you at home like I have trained hundreds of other boys who are now big successful men. It will not interfere with your school work and you can earn more than the small cost of the course doing odd electrical jobs in your spare time. The Course pays for itself. I will show you how to get this work and how to do it. Some of my boy students make \$10 to \$15 a week this way.

Tools, Apparatus and Radio Course—Given Without Extra Charge

Send me the coupon below and I will tell you all about the big outfit of tools, apparatus and instruments and a new Radio Course that I am giving to my students for a limited time. I will send you my big interesting Electrical Book and a sample lesson, too—all Free. You will be tickled with the things I will send you Free. Mail the coupon right now.

L. L. COOKE, Chief Engineer
Chicago Engineering Works
Dept. 012 CHICAGO

Look What This Boy Is Doing

"Although the School term is coming to a close, and I am pretty busy with my examinations, I manage to keep up with my electrical studies and work."

"I guess I forgot to tell you I am now in business for myself. Am doing fine, but owe it all to you. If it had not been for your Course, I, being under age, could not have secured my license in this town. But I got it, and now have all the work I can do, averaging \$20 to \$30 a week, thru spare time work."

"I went out on a job tonight after school, on which I made \$3 and brought home another on which I made \$2.50—\$5.50, for 4 hours' work and no material furnished by me."

ROGERS SMITH,
1212 Chestnut St.
Greenville, N. C.

Use This "FREE BOOK" Coupon

L. L. COOKE, Chief Engineer,
Chicago Engineering Works,
Dept. 012 2150 Lawrence Avenue, Chicago

Send me your Big Outfit Offer, your big Electrical Book, Sample Lesson and particulars of your Electrical Course and Extra Radio Course. This will not obligate me in any way.

Name.....

Address.....
This Coupon only for use of boys 15 years old or more.

\$25⁰⁰ DRAWING \$2⁹⁸ COURSE for

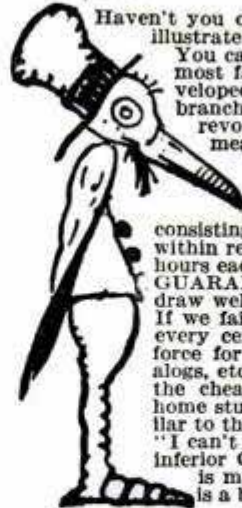

Haven't you often wished that you could draw cartoons, illustrate some idea, sketch some pretty face, etc.? You can do all of these things. One of America's most famous Cartoonists and illustrators has developed a great, simple system for success in all branches of Commercial Art. This system has revolutionized the entire theory of drawing. It means that drawing can be as easy for you as writing—much simpler than learning shorthand, bookkeeping or typewriting.

We are now placing this original system for learning Drawing, Art and Cartooning, consisting of 34 lessons with over 500 illustrations, within reach of every one. If you will devote a few hours each week to the Course WE ABSOLUTELY GUARANTEE that you will learn to draw and draw well before you have half finished the Course. If we fail to make this claim good, we will refund every cent paid us. By eliminating a large office force for answering correspondence, expensive catalogs, etc., we are enabled to make a price of \$2.98, the cheapest price ever known for a high-grade, home study course. Many have sent us letters similar to that of Rob't P. Davis of Detroit, who wrote: "I can't see how you ask so little, when others with inferior Courses get from \$20 to \$60 for theirs. It is more than I expected." Learn to draw. It is a big asset, no matter what field you are in.

Send No Money

Just order the course, and \$2.98 on arrival pay postman \$2.98 plus a few cents postage, payment in full for the entire Course and Free Drawing Outfit. If not entirely satisfied, return within five days and we will REFUND MONEY. Address:

FREE: If you order the course at once, we will include a drawing outfit, consisting of artist's pencils, pens, paper, erasers, thumb tacks, etc., enabling you to go to work without any additional cost.

LEDERER SCHOOL of DRAWING, Dept. 2768-C, Chattanooga, Tenn. Orders from outside the U. S. A. are payable \$3.28 cash with order.

LEARN WATCH REPAIRING

Be a watchmaker—you can learn this profitable trade by correspondence in a few weeks in your own home by the DeSelms Chart System. After you complete the course you will know a watch from A to Z. You will know just what the matter is and how to repair one. When you graduate you will be a practical watchmaker and repairer and competent to fill any position. Positions for our graduates. Ask for our Free Book. It explains our system and terms.

THE DeSELMS WATCH SCHOOL
LOGANSPORT, INDIANA



PIANO JAZZ

By Note or Ear. With or without music. Short Course. Adult beginners taught by mail. No teacher required. Self-instruction Course for Advanced Pianists. Learn 259 styles of Bass, 684 Syncopated Effects, Blue Harmony, Oriental, Chime, Movie and Café Jazz, Trick Endings, Clever Breaks, Space Fillers, Sax Sturs, Triple Bass, Wicked Harmony, Blue Obligato, and 247 other subjects, including Ear Playing. 133 pages of REAL Jazz, 25,000 words. A Postal brings our FREE Special Offer.

Waterman Piano School, 1826 W. Adams St. Los Angeles, Cal.

STAMMER

Write for my free book "Millard's Advanced Natural Corrective Course" and a free copy of my speech magazine. 10,000 cases successfully treated. Est. 24 years. Largest school for stammerers in world. Millard Inst. of Normal Speech, 2317 Millard Bldg., Milwaukee, Wis.

GOV'T. POSITIONS

\$35 TO \$75 WEEKLY

- | | |
|------------------------|----------------------------------|
| () Railway Mail Clerk | () Meat Inspector |
| () P. O. Clerk | () Special Agent (investigator) |
| () Forest Ranger | () Stenographer-Typist |
| () File Clerk | () Immigrant Inspector |
| () Matron | () City Mail Carrier |
| () General Clerk | () U. S. Border Patrol |
| () Chauffeur-Carrier | () Typist |
| () Skilled Laborer | () Seamstress |
| () Watchman | () Steno-Secretary |
| () Postmaster | () Auditor |
| () RFD Carrier | |

Mr. Ozment, Dept. 111, St. Louis, Mo.
Send me particulars about positions marked "X"
—salaries, locations, opportunities, etc.

NAME.....

ADDRESS.....

Magic

Learned Easily
at Home



Dr. Harlan Tarbell, internationally known magician and teacher of some of the world's greatest magicians.

Astonish Your Friends

Gain the magnetic popularity that makes you the center of any crowd. Business and social success is assured the man who can perform mystifying tricks. You can earn big money on the side or as a professional, as well as being the most popular person in your crowd. Why envy others' skill? You can learn Magic yourself, quickly and easily.

**The First
and Only
Course
in Magic**
*ever offered to the
public teaching
Real Professional
MAGIC*



Earn \$250 to \$1000 a Month

even sleight of hand, generally supposed to require long practice, is NOW made simple to learn. For Dr. Harlan Tarbell, one of the really Great Magicians, has finally opened up the secrets of his profession in a completely illustrated course offered at a merely nominal cost. Through the wonderful Tar-

bell system you will be able to mystify and entertain your friends. After that Dr. Harlan Tarbell takes you through the entire maze of sleight of hand, card tricks and elaborate stage diversions. The apparently superhuman doings of the accomplished magician becomes as simple as ABC.

Great Special Offer!

There is a tremendous demand for magic entertainment. Clubs, Lodges, Charity and Social affairs—all will pay high fees to the man who knows Magic. Dr. Harlan Tarbell really gets as high as \$250 for a half hour's work right now. Opportunity everywhere to make money aside from your regular occupation. Salesmen find it a tremendous asset. Find out all about this unprecedented opportunity to learn Magic. Learn about the great Special Price and Easy Payment Offer we are making Now, for a limited time only. The coupon brings full details without any obligation. *Mail it TODAY.*

Tarbell System, Inc.
1920 Sunnyside Ave., Studio 13-52 Chicago, Ill.

Mail This Coupon NOW!

Tarbell System, Inc., Studio 13-52
 1920 Sunnyside Avenue, Chicago, Illinois
 Gentlemen: Without any obligation send me your free literature and information all about your wonderful "Tarbell Course in Magic." Also tell me about your great Special Price Offer and Easy Payment Plan—offered NOW for limited time only.

Name.....
 Address.....
 Age.....

\$3500 to \$5000 a Yr.

Making Crowns, Plates, Bridges, Etc., for Dentists

Some Mechanical Dentists earn even more in this Pleasant, Profitable, Professional Trade

THREE MONTHS TRAINING

will qualify you to enter this most rapidly growing professional trade—Mechanical Dentistry. Best opportunity for men who like to use tools—dignified work, steady income, rapid advancement, no "slack seasons" as in other trades.

LEADING THE FIELD

Bodee training is recognized as best by dentists everywhere, owing to our 34 years' experience at this work—established 1892—the oldest school. Opportunity is in store for Bodee-trained men, and they make good. After only a few years you find them prominent in this profitable trade—on good salaries or conducting their own laboratories. There's room for many more—think it over! We conduct a Placement Bureau to select suitable positions, and, should you desire to open your own laboratory, we assist you in securing a location and equipping your laboratory.

LEARN BY "DOING"

Individual instruction—No classes whatever—Practical work. You use regular standard tools and learn to do exactly the kind of work which will later be required of you by Dentists.

EARN WHILE YOU LEARN

Don't let lack of money stop you. We have plenty of whole or part time jobs on file to help you pay your expenses.

JUST COMPARE!

Compare this trade with what you are now doing, or with the best you can find in any other line! Compare our unrivalled training—step by step—every point thoroughly covered—no time wasted! Compare also the very reasonable cost at the Institute with the cost at any other school.



FREE { FREE R. R. FARE to our nearest school
FREE PARTIAL SCHOLARSHIPS NOW
FREE POST-GRADUATE INSTRUCTION
A \$50 OUTFIT OF STANDARD TOOLS INCLUDED

Send for Catalog No. 2

BODEE DENTAL INSTITUTE

NEW YORK
1755 Broadway

PHILADELPHIA
1306 N. Broad St.

BUFFALO
501 Washington St.

BROOKLYN
86 Court St.



DO YOU LIKE TO DRAW?

It's Easy To Learn When Shown In The Right Way

Some of the cleverest cartoonists and comic artists in America today learned how to draw quickly—by following **CARTOONIST EVANS' SIMPLE AND EASY METHOD**. This school is recommended by foremost cartoonists because they know the students are handled right. If you like to draw, send 6c in stamps for **portfolio of cartoons and full details**. The course is **NOT EXPENSIVE**.

The W. L. Evans School of Cartooning 821 - Leader Building
CLEVELAND, OHIO

AT HOME

LEARN TELEGRAPHY

AT HOME



TEACH YOURSELF

in half usual time, at trifling cost, with the wonderful Automatic Transmitter, **THE OMNIGRAPH**. Sends unlimited Morse or Continental messages, at any speed, just as an expert operator would. Adopted by **U. S. Government, and leading Universities, Colleges and Telegraph Schools**. Catalog 6 cents.

OMNIGRAPH MFG. CO., 13-19 Hudson St., NEW YORK

TRAVEL - for 'UNCLE SAM'

RAILWAY MAIL CLERKS
MAIL CARRIERS—POSTOFFICE CLERKS
MANY FEBRUARY CLERK-CARRIER EXAMINATIONS
\$1700 to \$2700 a Year for Life

No "lay-offs" because of strikes, poor business, etc.—sure pay—rapid advancement. City and country residents stand same chance. Common sense education sufficient—no political influence.

STEADY WORK

Cut coupon and mail it before turning the page.

MEN—BOYS
18 to 45

Use Coupon Before You Lose It

COUPON

FRANKLIN INSTITUTE, Dept. F-177, Rochester, N. Y.
Rush to me, entirely free of charge. (1) A full description of the position checked below; (2) 32-page book, with list of positions obtainable; (3) Free Sample coaching.

Railway Mail Clerk (\$1900 to \$2700) Customs Positions (\$1140 to \$1860)
 Postoffice Clerk (\$1700 to \$2300) Internal Revenue (\$1140 to \$1860)
 City Mail Carrier (\$1700 to \$2100) Rural Mail Carrier (\$2100 to \$3300)

Name

Address

Ouch!
say, Jim, who said
you could dance?



Thirty Days Ago

I Couldn't Dance a Step

— yet almost overnight I became a good dancer

By JAMES BLACKFORD

"OH, how I wish I knew how to dance!" That's what I kept saying to myself the night of the Country Club party. All my friends were there—dancing. I watched them. What fun they were having!

Dozens of smartly clad couples—whirling and gliding over a dance floor smooth as glass. Soft lights—gay laughter—flashing smiles! And what music! It was alive with that thrilling, seductive rhythm that makes you just yearn to dance.

I stood on the sidelines trying to look happy—trying to smile back at my friends. But it was no use. I was too miserable.

I Make a Blunder

Just then Ruth, a girl friend of mine, came up to me. "Why, Jim, why aren't you dancing?" she exclaimed. I started to explain that I couldn't dance, but suddenly I changed my mind. "I was waiting to dance with you, Ruth," I said cheerfully, not realizing the blunder I was making.

What a nightmare that dance was! I thought I could make a bluff at dancing—thought I could imitate the movements of the other dancers. It was impossible. Half a dozen times I stumbled. Half a dozen times I stepped on Ruth's feet. Finally she lost patience with me. I apologized, and we sat out the rest of that dance in silence.

The very next day I resolved to learn to dance. I had heard of Arthur Murray, the famous dancing instructor, and what wonders his learn-at-home method had

IF YOU CAN DO THIS STEP

Arthur Murray will make you a finished dancer in 10 days.

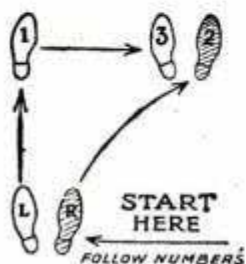

done for others, and so I decided to send for his course.

The course worked marvels for me. In a few short evenings I had learned the simple steps, and within thirty days everyone admitted that I was a finished dancer. I am certainly obliged to Arthur Murray and his wonderful, simplified method of learning to dance in your own home.

This story is typical, and it shows you just the chance you've been looking for—a chance to become an accomplished dancer right in your own home at a small cost.

Learn to Dance at Home

No matter how poorly you dance now—no matter if you've never been on a dance floor in your life—Arthur Murray's new method makes you a finished dancer in ten days or you don't have to pay a penny for the lessons.

Just think! In ten days' time you'll be able to do the Charleston, the French Tango, the Ritz Fox Trot, the Debutante Waltz, and all the other smart new steps.

This method of learning dancing is so simple and easy to understand that you can do any of the latest steps in one evening, right in your own room, without music or partner. And in ten days' time you will be ready to take your place as the best dancer in your set!

Five Lessons Free

To prove that Arthur Murray can make you a finished dancer in ten days' time, he is willing to send you five lessons from his remarkable course—*absolutely free!* Just send the coupon (with 10c to cover the cost of printing and mailing), and these valuable lessons will be forwarded at once. Also a free copy of his new book, "The Short Cut to Popularity."

Don't wait—you owe it to yourself to clip and mail this coupon NOW. Arthur Murray, Studio 703, 7 East 43rd Street New York City.

ARTHUR MURRAY, Studio 703
7 East 43rd Street, New York City.

To prove that I can learn to dance at home in ten days you may send the FIVE FREE LESSONS. I enclose 10c (stamps or coin) to pay for the postage, printing, etc. You are to include free "The Short Cut to Popularity."

Name.....

Address.....

City..... State.....

See how easy it is to learn the Arthur Murray way!

Many Well-Known Men Have Helped To Prepare These ELECTRICAL COURSES

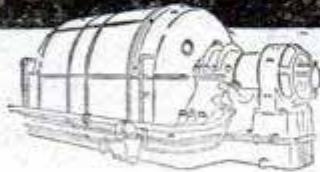

Endorsed
by
THOMAS A.
EDISON

Endorsed
by
CHARLES P.
STEINMETZ

NEARLY \$200,000 has been spent in the preparation of the Electrical Courses of the International Correspondence Schools.

They have helped thousands of men to get good positions in this fascinating profession for two reasons. (1) They are specially designed to meet the needs of the student who studies at home. (2) They are written by *practical men*.

Here are just a few of the men who have contributed to these courses:

EDGAR KNOWLTON — Electrical Engineer, Alternating Current Engineering Department, General Electric Co.

J. LESTER WOODBRIDGE, E.D. and M.E.—Chief Engineer of the Electric Storage Battery Co.

O. J. BUSHNELL—Superintendent of the Meter Department, Commonwealth Edison Co.

S. A. FLETCHER—Electrical Engineer, Superintendent of Service, Alabama Power Co.

H. B. GEAR, A.B., M.E.—Engineer of Distribution, Assistant to Vice-president, Commonwealth Edison Co., Chicago.

C. E. KNOX—Consulting Engineer on the Woolworth Building, New York. Author of "Electric Light Wiring."

G. E. PARHAM, M.E.—Electrical Engineer, General Foreman, the Brooklyn-Manhattan Transit Corporation.

S. H. MORTENSON—Designer of Alternating Current Motors and Generators, Allis-Chalmers Manufacturing Co.

When you read over a list like that, you know why these I. C. S. Electrical Courses have been endorsed by Edison and Steinmetz . . . you can see why we say they will help you.

Just mark and mail the coupon printed below and we'll gladly send you a Free Booklet telling all about these I. C. S. Electrical Courses or any other course in which you are interested.

INTERNATIONAL CORRESPONDENCE SCHOOLS
Box 5628-E, Scranton, Penna.

Without cost or obligation, please send me one of your booklets and tell me how I can qualify for the position or in the subject before which I have marked X:

- | | |
|--|--|
| <input type="checkbox"/> Electrical Engineer | <input type="checkbox"/> Electric Draftsman |
| <input type="checkbox"/> Electrician | <input type="checkbox"/> Electric Car Running |
| <input type="checkbox"/> Electric Wiring | <input type="checkbox"/> Electric Machine Designer |
| <input type="checkbox"/> Electric Lighting | <input type="checkbox"/> Radio |
| <input type="checkbox"/> Telegraph Expert | <input type="checkbox"/> Salesmanship |
| <input type="checkbox"/> Practical Telephony | <input type="checkbox"/> Show Card and Sign |
| <input type="checkbox"/> Mechanical Engineer | <input type="checkbox"/> Painting |
| <input type="checkbox"/> Mechanical Draftsman | <input type="checkbox"/> Railroad Positions |
| <input type="checkbox"/> Toolmaker | <input type="checkbox"/> Illustrator |
| <input type="checkbox"/> Machine Shop Practice | <input type="checkbox"/> Business Management |
| <input type="checkbox"/> Gas Engineer | <input type="checkbox"/> Private Secretary |
| <input type="checkbox"/> Diesel Engineer | <input type="checkbox"/> Business Correspondent |
| <input type="checkbox"/> Civil Engineer | <input type="checkbox"/> Bookkeeper |
| <input type="checkbox"/> Surveying and Mapping | <input type="checkbox"/> Stenographer and Typist |
| <input type="checkbox"/> Reading Architects' Blueprints | <input type="checkbox"/> Accountancy |
| <input type="checkbox"/> Metallurgy | <input type="checkbox"/> Traffic Management |
| <input type="checkbox"/> Architect | <input type="checkbox"/> Commercial Law |
| <input type="checkbox"/> Architectural Draftsman | <input type="checkbox"/> English |
| <input type="checkbox"/> Plumbing and Heating | <input type="checkbox"/> Common School Subjects |
| <input type="checkbox"/> Sheet Metal Worker | <input type="checkbox"/> Civil Service |
| <input type="checkbox"/> Automobiles | <input type="checkbox"/> Railway Mail Clerk |
| <input type="checkbox"/> Chemistry <input type="checkbox"/> Pharmacy | <input type="checkbox"/> Stationary Engineer |
| | <input type="checkbox"/> Mathematics |

Name.....

Address.....

Persons residing in Canada should send this coupon to the International Correspondence Schools Canadian, Limited, Montreal, Canada.



Ladies' Patronage has made BARBERING one of the splendid paying professions of the day. 60,000 MOLER GRADUATES know MODERN BARBERING IS EASY TO LEARN—QUICK TO EARN—CLEAN and FASCINATING. Write for catalog B-2.

Address the Branch

of the MOLER SYSTEM OF COLLEGES nearest you.
(Street address not needed)

- | | | |
|------------------|------------------|---------------------|
| Chicago, Ill. | Detroit, Mich. | Fargo, N. D. |
| New York, N. Y. | Denver, Colo. | Memphis, Tenn. |
| St. Louis, Mo. | New Orleans, La. | Dallas, Tex. |
| Kansas City, Mo. | Omaha, Nebr. | Houston, Tex. |
| Cincinnati, Ohio | Milwaukee, Wis. | San Antonio, Tex. |
| Cleveland, Ohio | Atlanta, Ga. | Toronto, Ont., Can. |

Anyone CAN LEARN

No talent or experience necessary. Fascinating work. Pays big money. Complete instruction book tells about: Alphabets, Colors, How to Mix Paints, Show Cards, Window Board and Wall Signs, Ready made letters, Gilding, Tricks of the Trade, also gives 100 Alphabets and Designs. Book bound in flexible imt. leather-gold edges, and four half bearing Show Card Pens. Sent postpaid \$3.00, (C.O.D.) 10c ex. Ogilvie Pub. Co., 57 Rose St. Dept 20. N. Y. City

\$3

EARN MONEY IMMEDIATELY—
WE FURNISH EQUIPMENT TO START !!

OPPORTUNITIES IN Salesmanship

Become a Salesman

Every phase of business revolves around selling. The trained salesman is in demand—he can fix his own hours, choose his own field, control his own pay. His income depends only upon his results—there is no limit to what he can earn. We train you to sell successfully thru the LaSalle problem method under supervision of expert salesmen. Train in your spare time. Low cost; easy terms. 64-page booklet, "The Modern Salesman, Ambassador of Progress," free. Send for it today.



FREE

LaSalle Extension University, Dept. 264-S, Chicago

They Thought I Was Bluffing



When I Told Them I Learned Music Without a Teacher

You could have heard a pin drop in the room! I had just finished playing Rubinstein's "Melody in F." My friends were actually dumfounded. At last I was the center of attraction instead of a mere onlooker! It was just like a dream come true!

"Why, you didn't know a single thing about music not so long ago, Bob"—"How in the world did you ever do it?" A note of half envy, half admiration crept into their voices. "Yes," said Jim, "what sort of trick have you played on us—I thought you weren't musically inclined." "Oh, he's been taking lessons for years and has kept it a secret"—followed Betty and Sue in rapid-fire succession. "You can't fool us though, you never learned to play that well without a teacher."

They were all wrong though. At first I didn't believe it was possible to learn music by mail. I thought I needed special "talent." But, thanks to a startling new simplified method, I soon discovered my mistake. It was simple as A-B-C, and actual

FUN learning. Each new lesson was better and easier than the last. Everything about them was so simple that a child of eight could understand it. Now I can play any piece of music—classical or jazz—and play real notes! I never have to refuse when I'm called upon to entertain. Now my life is just a joyous round of gay parties and admiring friends.

Play Any Instrument

You, too, can now teach yourself to be an accomplished musician—right at home—in half the usual time through

this startling method, which has already shown almost half a million people how to play their favorite instrument. Forget that old-fashioned idea that you need special "talent." Just read the list of instruments in the panel, decide which one you want to play and the U. S. School will do the rest. And bear in mind no matter which instrument you choose, the cost in each case will be the same—just a few cents a day.

Send for Our Free Booklet and Demonstration Lesson

If you are in earnest about wanting to play your favorite instrument—if you really do want to gain the proficiency in music that will add to your happiness, increase your popularity, and open the way to greater income—ask at once for the free booklet and valuable demonstration lesson. Getting them will cost you nothing and place you under no obligation. Right now we are making a Special Offer to a limited number of new students.

Now—before it's too late to gain its benefits—sign and send the convenient coupon. Instruments supplied when needed. Cash or credit. U. S. School of Music, 72 Brunswick Bldg., New York City.



U. S. SCHOOL OF MUSIC,
72 Brunswick Bldg., New York City

Please send me your free book, "Music Lessons in Your Own Home," with introduction by Dr. Frank Crane, Demonstration Lesson and particulars of your Special Offer. I am interested in the following course:

.....
Have you above instrument?.....
Name.....
(Please write plainly)
Address.....
City..... State.....

Pick Your Instrument!

Piano	Harmony and Composition
Organ	Sight
Violin	Singing
Drums	Ukulele
and Traps	Guitar
Banjo	Hawaiian
(Tenor, Guitar	Steel
Plectrum or 5-String)	Guitar
Mandolin	Harp
Clarinet	Cornet
Flute	Piccolo
Saxophone	Trombone
Cello	
Voice and Speech Culture	
Automatic Finger Control	
Piano Accordion	



IN DRAWING CARTOONS

Why spend your time doing work that is drudgery, and get little money for it when you can enter this well paid profession? You can learn cartooning at home with this amazing easy method, which teaches you to draw cartoons that sell. You can also earn while you learn.

A steady income—\$3,000 to \$15,000 a year—your own boss—easy hours—no off seasons—that's the life of a good cartoonist. Right now you may be earning only a pitifully small salary—but with this training you can easily learn cartooning. There's always a demand for good cartoonists.

Easy to Learn Cartooning At Home in Spare Time

There is a knack about learning cartooning which you can master in your spare time with this simple home study method. It starts you at the very beginning—on simple fundamental principles—then takes you through every branch of humorous and serious cartooning. You will be surprised how quickly you can draw cartoons that will sell. Many earn even while learning.

Send for Free Book

Get this handsomely illustrated booklet which gives the details of this remarkable home study course in Cartooning. Gives thorough outline of the cartooning field and market for cartoons. Shows how to become a cartoonist. No obligation. Send for it today. **Washington School of Cartooning, Room 302-E, 1113—15th St., N. W., Washington, D. C.**

WASHINGTON SCHOOL OF CARTOONING
Room 302-E, 1113—15th St., N. W., Washington, D. C.

Please send me without obligation, your Free Booklet on Cartooning, and full details of your home study method of teaching Cartooning.

Name.....
(Print Name Plainly)

Address.....

City..... State.....
(If under 16 please give age)



**ALL-WOOL \$23.50
Suit Only**

Think of being able to offer a suit or topcoat made of the finest quality of pure Virgin Wool; fit, fabric and fashion guaranteed, at the powerfully attractive price of \$23.50! Can you sell such values? You can, if the experience of 2,500 other salesmen means anything. And you don't have to know anything about selling clothing. We'll take you, train and equip you to go out and make a success of this work if you are honest, ambitious and willing to work. If you are, write us. You'll hear from us promptly with the full facts. Address Dept. 50.

William C. Bartlett, Inc., 850 Adams St., Chicago

Gentlemen: I'm interested in the opportunity you offer. Please send the facts without obligation to me. 50

Name.....

Address.....

Town..... State.....

MUSIC LESSONS FREE

In Your Home



Write today for our **FREE** booklet. It tells how to learn to play Piano, Organ, Violin, Mandolin, Guitar, Banjo, etc. Beginners or advanced players. Your only expense about 2c per day for music and postage used.

American School of Music, 50 Manhattan Bldg., Chicago

LEARN PIANO TUNING AT HOME

Send for **FREE** copy of the 28th ANNIVERSARY EDITION of our book "Winning Independence." Read how students master TUNING with our Tune-A-Phone, and WHY our graduates head the profession in all parts of the world. With Bryant's patented devices, tools, charts, and lessons, one learns quickly and easily. Low tuition, easy terms; Diploma granted. **MONEY-BACK GUARANTY.** \$10 to \$25 a day, exceptional opportunities, and an ideal profession await you. **BRYANT SCHOOL OF TUNING (71) Bryant Bldg., Augusta Michigan**



Wonderful, new device, guides your hand; correct your writing in few days. Big improvement in three hours. No failures. **Complete outline FREE.** Write C. J. Ozment, D-34, St. Louis, Mo.

LAW High-Grade Instruction By Correspondence Prepares You for the Bar—Est. 1892

University Methods. Standard Text-Books. Approved by Bench and Bar. Graduates practicing in every state. Send today for Free Catalog and Rules for Admission to the Bar. **CHICAGO SCHOOL OF LAW, 802 Reaper Block, Chicago, Ill.**



No Joke to STAMMER

Successful. Master perfect speech. Win happiness. Send for full information and special phonograph record. Dime covers postage. 153 Stimson, The Lewis Institute, Detroit



Learn Photography at HOME

Earn \$3,000 to \$10,000 a year. Prepare quickly during spare time. Also earn while you learn. New easy method. Nothing else like it. Send at once for free book, "Opportunities in Modern Photography" and full particulars. Special offer open now. **International Studios, Inc., Dept. 1352, 3601 Michigan Ave., Chicago, U. S. A.**

This Singular Book Wields a Strange Power Over Its Readers

Giving them a MAGNETIC PERSONALITY almost instantly!

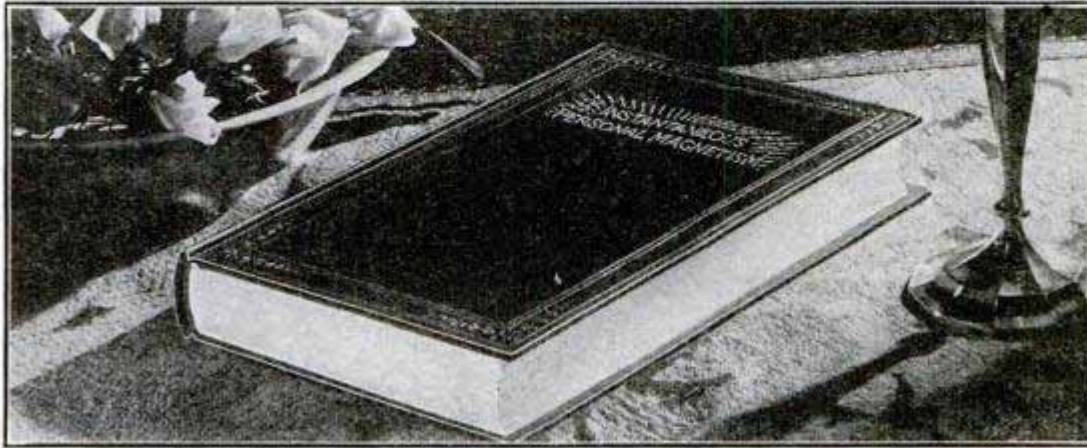

Will You Read It 5 Days FREE—to Prove It Can Multiply *Your* Present Income?

A STRANGE book! A book that seems to cast a spell over every person who turns its pages!

A copy of this book was left lying on a hotel table for a few weeks. Nearly 400 people saw the book—read a few pages—and then SENT FOR A COPY!

In another case a physician placed a copy in his waiting room. More than 200 patients saw the book—read part of it—and then ORDERED COPIES FOR THEMSELVES!

Why are people so profoundly affected by this book?—so anxious to get a copy? The answer is simple. The book reveals to them for the first time how anyone can develop a Magnetic Personality INSTANTLY! It explains how to gain OVERNIGHT the personal charm that attracts countless friends—the self-confidence that insures quick success in any business.

It tells how to draw people to you at once, irresistibly—how to be popular in any society—how to overcome almost at once any timidity you may have—how to be a magnet of human attraction, well-liked wherever you go!

Best of all it tells you how to accomplish these results—INSTANTANEOUSLY!

Whence Comes This Uncanny Volume

Forty years ago, Edmund Shaftesbury, student of the human mind, set out to discover the secret of Personal Magnetism. He applied his discoveries to his friends. Results were astonishing!

His methods seemed to transform people into ENTIRELY NEW BEINGS! Shaftesbury's fame spread. Great men came to him. His students and friends embraced such names as Gladstone, Queen Victoria, Edwin Booth, Henry Ward Beecher and Cardinal Gibbons.

Until recently, Shaftesbury's teachings have been available only to people who could pay \$50 or \$100 each for instruction books. Now, his wonderful teachings have been collected into a single volume, at a price WITHIN THE REACH OF ALL! And furthermore Shaftesbury has consented to reveal hundreds of new discoveries never before put into print.

Strange Effect on Readers

Readers of this book quickly become masters of a singular power to influence men and women around them. Not by force—not by loud argument. But rather by some subtle, insinuating power that sways men's emotions. They are able to play on people's feelings just as a skilled violinist plays upon a violin.

Is it any wonder that thousands of men and women say that they are overjoyed with the results they have received? One enthusiast said of this volume, "Things I have read there I would never have dreamed of." Another wrote, "I would not give up what Shaftesbury has taught me for \$100,000!"

In your everyday life—in social life—you will find this book of immense value. You will learn to

fascinate people you meet—to attract new friends—to gain speedy promotion in business.

Read This Book 5 Days Free

Merely mail coupon below and this remarkable volume, with cover in handsome dark burgundy cloth, gold embossed, will be sent you for free examination. If you aren't stirred and inspired in the 5-day free period, return it and it costs you nothing. Otherwise keep it as your own and remit the Special wholesale Price of only \$3 in full payment. This volume was originally published to sell at \$5—but in order to reach many readers it is being offered at reduced price. You risk nothing—so clip and mail this coupon NOW. Ralston University Press, Dept. 13-B, Meriden, Conn.

RALSTON UNIVERSITY PRESS,
Dept. 13-B, Meriden, Conn.

All right—I'll be the judge. You may send me the volume "Instantaneous Personal Magnetism" for 5 days' FREE EXAMINATION in my home. Within the 5 days I will either remit the special low price of only \$3, in full payment, or return it without cost or obligation.

Name.....

Address.....

City.....State.....

Book Tells You

- How to develop a Magnetic Personality
- How to use certain Oriental Secrets
- How to gain perfect nerve control
- How to read people's feelings by watching their mouths
- How to read people's thoughts by watching their eyes
- How to develop a magnetic eye
- How to make your face appear 20 years younger
- How to control others by a glance
- How to use Magnetic Healing
- How to end awkwardness and timidity
- How to attract the opposite sex
- How to get ahead in your business or profession
- How to make your subconscious mind work wonders
- And dozens of other vital topics

**I will make this Contract
With YOU**

If you are now earning \$40 a week or less
to help you get

I Guarantee

A Job paying at least
50% more than
you earn

today, within 60 days after you
finish, or your money refunded.

Chief Engineer Dunlap



**A Guaranteed
TWIN
Service**

T
Training
Preparing
you for a bet-
ter job and a
raise in pay

E
Employment
—then help-
ing you get it,
or money
refunded!



The American School

Invites you to its 30th
Birthday Celebration!

Chartered in 1897 as an educational institution—NOT FOR PROFIT, the American school pledges you the same standards of instruction and service as in the best resident schools and colleges. Over 200 of the leading Engineers, Executives, and Educators, from America's foremost industries and Universities, prepared the home instruction we offer. Their standing vouches for its quality.

**Training built by 29 Noted
Engineers—Men from:**

- General Electric Co.
- Commonwealth Edison Co.
- Crocker-Wheeler Co.
- Cutler-Hammer Mfg. Co.
- American Telephone & Telegraph Co.
- Western Electric Co.
- Underwriters Laboratories, Inc.
- Massachusetts Institute of Technology
- Westinghouse Electric & Mfg. Co.
- and many others

Instruction—

We have simplified the learning of Electricity so that even men with only common schooling can easily master it at home, in their spare time. My students learn by doing interesting Electrical jobs with standard tools and materials which we supply without extra cost. We use Lessons, Job-Tickets, and Outfits—that's our NEW, RAPID WAY to prepare you for a good, well-paid Electrical position.

—then Jobs!

When you enroll for this Electrical training we give you a written agreement that it will prepare you for a fine Electrical job paying at least a 50% raise in pay, that we will then help you find such a position, or the training will not cost you a penny! So now you know in advance, BEFORE you put your time and money into training, just how it will benefit you. All risk of loss or disappointment is eliminated by my guarantee.

Come into Electricity!

I am looking for more ambitious young fellows to prepare for well paid Electrical jobs. You need not have a high school education to qualify for this opportunity—but you MUST be interested in Electricity and willing to do a little spare time work at home to prepare for a fine Electrical position and a substantial increase in pay. First, I will put you thru a simple, rapid, new method of training. Then I will help you get placed in a permanent, satisfactory job. This offer is limited to men now earning \$40 a week or less, and is backed by a 30 year old, million dollar institution.



Millions of dollars are being spent on Electric Power Lines.



Electrical Experts are needed in every Power plant.



Railroads are turning from steam to Electricity.

Get Ready for a **\$60 to \$125** A WEEK ELECTRICAL JOB!

You can't pick out a better future for yourself than in Electricity—now the biggest and fastest growing industry in the world. Leaders like Edison and Marconi say the opportunities in Electricity today are greater even than for the pioneers 30 years ago. Millions of houses are being wired for Electric light—railroads are turning from steam to Electricity—industries are more and more dependent on electric power. This is the Electrical age, and thousands of men are urgently needed to install Electrical machinery and apparatus, to design and manufacture Electrical equipment, to operate Electrical plants. Come into Electricity! And get set for Big Pay, rapid promotion, and a successful future!

5 Electrical JOB-TICKETS Absolutely **FREE!**

See for yourself how rapid, how simple and easy we have made the learning of Electricity. See how you like the work. Send for FACTS about the great Electrical industry, and the wonderful opportunities you will find there. Remember, this million dollar school guarantees both to train you and to help you get a well-paid job. Coupon brings complete information, without the slightest obligation.

Send absolutely FREE, 5 Electrical Job-Tickets, FACTS about the opportunities I will find in Electricity, and explain your guaranteed TWIN service, training and JOBS to

7 Outfits GIVEN without extra charge to every student.

1. Soldering Furnace and Kit
2. Belt and Alarm Wiring Outfit
3. Electric light and power wiring material
4. Meter and Compass
5. Transformer, etc.
6. Radio Receiving Set (knock-down)
7. \$10 Power Motor (knock-down)



One is this \$10 Power Motor

Same type as the big fellows in a power plant. It's sent knock-down. You wind the field and armature, assemble it, change it over to a generator. That's the way you learn every branch of Electricity here!

CHIEF ENGINEER DUNLAP, Electrical Division

The American School
 Dept. E-274, Drexel Av. & 58th St., CHICAGO

St. No.
 City..... State.....
 Mail immediately to Chief Engineer Dunlap American School, Dept. E-274, Drexel Ave. and 58th Street, Chicago.



Learn By Doing!

Every phase of all branches of

ELECTRICITY

Taught By Actual Practice

In one of America's foremost institutions for trade training.

Established 1902

No Books Used

Individual Instruction. Start Any Day.

A SPECIAL and SEPARATE Course in Ignition, Auto Lighting and STARTER Systems.

Write for FREE 64-Page Catalog

THE NEW YORK ELECTRICAL SCHOOL
44 West 17th Street NEW YORK CITY

\$10 TO \$20 A DAY

Actual Figures Show a Shortage of Over 25,000 Painters in the U. S. That's why this is the **BEST TRADE BY FAR** for you to get into. Thousands of jobs open in every large city for men who can do the work. Specialize in the following work:—

Interior Decorating — House Painting
Paperhanging — Sign Painting
Show Card Writing — Graining and Marbling

YEAR ROUND WORK AT BIG PAY or start a business of your own. A few weeks' training at low cost will put you in the Big Pay Class. Write Today for Special Offer. Mr. Allen, c/o Chicago Painting School, 144 W. Austin Ave., Chicago.

BART SUPPLIES

Quality art materials at lowest prices. Save on everything you need. Convince yourself—send today for catalog.

BART SUPPLIES, 426 East St. Bldg., MINNEAPOLIS, MINN.

RAISE BELGIAN HARES

NEW ZEALAND REDS—Chinchillas—Flemish Giants

MAKE BIG MONEY—We supply stock and pay you following prices for all you raise: Belgian Hares \$2 each—New Zealand \$3 each—Chinchillas \$4 each—Flemish Giants \$5 each. 32-page illustrated book, catalog and contract, also copy of *Fur Farming* magazine, tells how to raise skunk, mink, fox, etc., for big profits, all for 10c. Address

OUTDOOR ENTERPRISE CO., Box 25, Holmes Park, Mo.

HOW A BOY BUILT UP A GREAT SQUAB FARM

Started small in backyard when at school with no money, now has **\$30,000** plant, ships to New York 150 bbls. squabs yearly, receiving **\$75 to \$100** a barrel. You can do the same. Send for this book. Price is fifty cents but we will mail it to you for the names and addresses of four of your friends and your own name and address. Write today to

Plymouth Rock Squab Co., 634 A St., Melrose High., Mass.



Want Some Money?

Here's a wonderful way to get it

Our beautifully illustrated book tells how. It tells all about our new methods of art decoration, art treatment and how anybody can learn without previous training or experience. It contains page after page of handsome color illustrations of what you can make and sell. You can make good money and this book is **FREE**. Our system is amazingly easy to learn and the profits are larger than in almost any other business. You can produce beautiful finished art objects almost from the beginning. You don't have to know how to draw or have any experience. Begin making money now.

All supplies are sent by us with the instructions and many have made \$25 the first week. Some society women have taken up this work for their own amusement.—Either way, pleasure or profit, it's the most delightful home work you can imagine. Write Now for your copy of this valuable book; it's **FREE**.

Fireside Industries

DEPT. 66-B, - ADRIAN, MICH.



Goaway for Strong Men! —Weaklings Stand Aside.

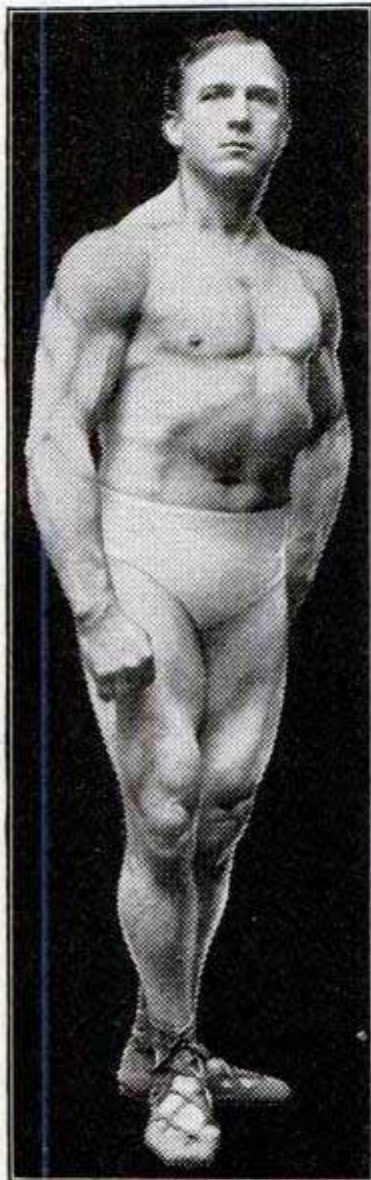

STRONGFORT
Builder of Men

Compare Lionel Strongfort's physique, faithfully pictured here, with that of any of the hundreds published of other athletes and strong men. Compare the lines. See the muscles. Note the fact that Strongfort is not crouching, nor pressing, nor expanding—he stands up straight, naturally, normally—the finest and most perfect specimen of physical and health development the world has known.

weakness to health and strength. It is priceless. I'll send it to you on request—FREE. Write for your copy today.

STRONGFORT INSTITUTE
LIONEL STRONGFORT, DIRECTOR
PHYSICAL AND HEALTH SPECIALIST
DEPT. 295 NEWARK, NEW JERSEY, U.S.A.

Be defiant, courageous, MANLY!

You won't be regarded as a real man if you are a slouching, nervous, fidgeting grouch—slinking along, afraid of your shadow, timid in company; sallow-complexioned, pimply-faced—with shifting, cowardly eyes; round-shouldered, with unsteady step; a cold, clammy grip—lacking pep, punch or personality—you simply won't get anywhere.

Fellows of this type are not wanted. If you are a weakling, nervous and always pessimistic—you will feel your inferiority wherever you go. Men will shun you. Women will not be attracted to you. Even dogs will bark at you!

It is the penalty you pay for weakness!—but you won't have to pay this price if you will face the facts and make up your mind you are going to go to the mat with ill-health and fight to a finish. It's up to you—to you alone. You can overcome weakness.

You Can Be Strong and Healthy

Like thousands of those who have come to me in a pitiable state of physical bankruptcy you can be restored through STRONGFORTISM, the basic science of health and strength. You can be raised from the depths of despair and despondency to the heights of glorious manhood. You can be strong, vigorous, happy and successful if you but give Nature a chance to work through my proven system.

STRONGFORTISM

Creates New Energy and Strength

Through STRONGFORTISM men all over the world have been rejuvenated and restored to health and strength after they have suffered untold mental and physical horrors as the inevitable result of excesses, fast living, and abuse of their physical power.

STRONGFORTISM has a record unparalleled—there is no other system, or method, or course that compares with it in restoring impaired human beings to health and strength.

STRONGFORTISM begins at the source to create new energy and strength by utilizing Nature's forces scientifically. It builds up the internal muscular system first and thus gets rid of constipation, dyspepsia, indigestion, heart ailments, bad blood, catarrhal troubles, rheumatism and other afflictions, increasing your energy and stamina. External muscular development follows quickly and you become a new man inside and out—a fellow to be reckoned with and envied wherever you go.

NO APPARATUS—NO DRUGS

Strongfort's Course does not depend upon artificial means or stimulants—no dope nor drugs. Nature does the work—all you do is give Nature a chance. Only a little of your time, in the privacy of your home, is all that is required. You will be surprised at how easy it all is, how astonishing the results, how speedily you will feel the effects of the new life animating your whole body.

I Want to Send You MY FREE BOOK

This book of many pages and dozens of pictures tells of my wonderful experience

—how I became the outstanding athlete of the world, performing feats others dared not attempt; how I turned the knowledge gained through developing my own body to the benefit of others, and then how STRONGFORTISM was evolved. It tells what I have done for others, what I can do for you. It doesn't mince words. It tells plain truths.

"Promotion and Conservation of Health, Strength and Mental Energy," points the way from disease and

FREE CONSULTATION

Clip and Send this Coupon—Absolutely Confidential

Mr. Lionel Strongfort, Strongfort Institute, Dept. 295, Newark, N. J.—Please send me absolutely free my copy of your book, "PROMOTION AND CONSERVATION OF HEALTH, STRENGTH AND MENTAL ENERGY." I have marked (X) before the subjects in which I am most interested.

- | | | |
|---------------|-----------------|-------------------------|
| .. Colds | .. Weak Eyes | .. Great Strength |
| .. Catarrh | .. Flat Chest | .. Lung Troubles |
| .. Asthma | .. Despondency | .. Poor Circulation |
| .. Headache | .. Emaciation | .. Round Shoulders |
| .. Rupture | .. Rheumatism | .. Skin Troubles |
| .. Thinness | .. Nervousness | .. Stomach Disorders |
| .. Pimples | .. Constipation | .. Increased Height |
| .. Insomnia | .. Short Breath | .. Muscular Development |
| .. Overweight | .. Weak Heart | |
| .. Weak Back | | |

Name.....
Age..... Occupation.....
Street.....
City..... State.....

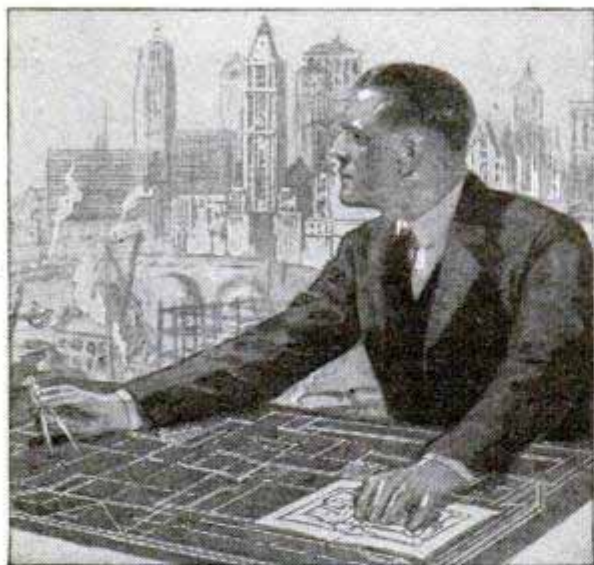

Former Plasterer Now Earning \$12,000 a Year

"When I enrolled with the International Correspondence Schools, I was a plasterer and I didn't know a thing about blueprints. Today I have my own contracting business and I am able to figure the most difficult jobs and execute them to the satisfaction of everyone concerned. My income is between \$12,000 and \$15,000 a year. It certainly was a lucky day for me when I sent in that I. C. S. coupon."

That's a true story of what just one student of the International Correspondence Schools has done. Every mail brings letters from other ambitious men and women telling of promotions and increases in salary due directly to spare-time study.

One hour a day spent with the I. C. S., in the quiet of your own home, will prepare you for success in the work you like best.

Mail Coupon for Free Booklet

INTERNATIONAL CORRESPONDENCE SCHOOLS
BOX 5630-E SCRANTON, PA.

Explain, without obligating me, how I can qualify for the position, or in the subject, before which I mark X.

- | | |
|---|--|
| <ul style="list-style-type: none"> <input type="checkbox"/> ARCHITECT <input type="checkbox"/> Architectural Draftsman <input type="checkbox"/> Contractor and Builder <input type="checkbox"/> Building Foreman <input type="checkbox"/> Concrete Builder <input type="checkbox"/> Structural Engineer <input type="checkbox"/> Structural Draftsman <input type="checkbox"/> Plumber and Steam Fitter <input type="checkbox"/> Heating and Ventilation <input type="checkbox"/> Plumbing Inspector <input type="checkbox"/> Foreman Plumber <input type="checkbox"/> Sheet Metal Worker <input type="checkbox"/> CIVIL ENGINEER <input type="checkbox"/> Surveying and Mapping <input type="checkbox"/> Reading Architects' Blue Prints <input type="checkbox"/> ELECTRICAL ENGINEER <input type="checkbox"/> Electric Lighting and Rys. <input type="checkbox"/> Electric Wiring <input type="checkbox"/> Telegraph Engineer <input type="checkbox"/> Telephone Work <input type="checkbox"/> MECHANICAL ENGINEER <input type="checkbox"/> Mechanical Draftsman <input type="checkbox"/> Toolmaker <input type="checkbox"/> Machine Shop Practice <input type="checkbox"/> CHEMIST <input type="checkbox"/> Pharmacy | <ul style="list-style-type: none"> <input type="checkbox"/> Navigation <input type="checkbox"/> SALESMANSHIP <input type="checkbox"/> ADVERTISING <input type="checkbox"/> Window Trimmer <input type="checkbox"/> Show Card and Sign Painting <input type="checkbox"/> BUSINESS MANAGEMENT <input type="checkbox"/> Private Secretary <input type="checkbox"/> Business Correspondent <input type="checkbox"/> BOOKKEEPER <input type="checkbox"/> Stenographer and Typist <input type="checkbox"/> Higher Accounting <input type="checkbox"/> COMMERCIAL LAW <input type="checkbox"/> Common School Subjects <input type="checkbox"/> Mathematics <input type="checkbox"/> GOOD ENGLISH <input type="checkbox"/> ILLUSTRATING <input type="checkbox"/> Railway Mail Clerk <input type="checkbox"/> CIVIL SERVICE <input type="checkbox"/> Mining Engineer <input type="checkbox"/> Gas Engine Operating <input type="checkbox"/> STATIONARY ENGINEER <input type="checkbox"/> Textile Overseer or Supt. <input type="checkbox"/> TRAFFIC MANAGER <input type="checkbox"/> AUTOMOBILES <input type="checkbox"/> AGRICULTURE <input type="checkbox"/> Poultry Raising <input type="checkbox"/> French <input type="checkbox"/> Spanish <input type="checkbox"/> Banking |
|---|--|

Name _____
 Present Occupation _____ Business Address _____ 3-6-24
 Street _____
 and No. _____

City _____ State _____
 Persons residing in Canada should send this coupon to the International Correspondence Schools Canadian, Limited, Montreal, Canada.

Learn In **10 WEEKS** at Home

Become a
RADIO EXPERT

Earn Big Money
In this Gigantic,
Fascinating Field!

AERO-SYSTEMS, INC.
 Offers You a Remarkably Low Priced High-Grade RADIO COURSE

WE GUARANTEE TO REFUND TUITION IF YOU ARE NOT SATISFIED WHEN YOU COMPLETE THE COURSE

Now you can get a complete RADIO course at a ridiculously low price. Train to become a high-salaried expert or merely to make and understand your own sets. Write for particulars before price goes up.

Aero-Systems, Inc., Dept. 102
 19 South Wells Street, CHICAGO, ILL.

MAIL THIS COUPON NOW!

AERO-SYSTEMS, INC., Dept. 102, 19 S. Wells St., Chicago
 Please send me full particulars of your amazingly low-priced Radio course.

Name.....

Address.....

YOU CAN OIL PAINT

Amazing new method teaches men or women to earn after first lesson. OIL PAINT photos—portraits, landscapes or art subjects. Earn \$18 to \$50 and more a week. OIL PAINT OUT-FIT GIVEN. Send now for free illustrated book. PICTORIAL ART STUDIOS, Inc. Dept. MP, 2731 No. Clark St., Chicago

MINSTRELS Musical Comedies and Revues, with full instructions for staging. You can stage your own show with our books. Full line of plays, stage songs crossfire, monologues, afterpieces, vaudeville acts and make-up.

CATALOGUE FREE
T. S. DENISON & CO., 623 So. Wabash, Dept. 19, CHICAGO.

Be The Life of Any Party!

LEARN TENOR BANJO

Now you can have the joy of being your own musical self—the thrill of popularity—new friends—happier evenings—more money-making opportunities—if you wish. You can be admired and wanted everywhere, counted in on every party, because you are a clever entertainer on America's most popular instrument—the Tenor Banjo.

For the first time in the history of my long playing career—five years with Isham Jones' Recording Orchestra—I am now in position to offer you my famous Home Study Tenor Banjo Course. I call it "The Key to Successful Banjo Playing." It is my Course—compiled after years of study and experience with the tenor banjo—the instrument I helped to develop. I am now using this Course successfully in my school, the Chicago Tenor Banjo Institute, and am training beginners, advance students, and professional artists, to reach new heights of popularity and bigger pay jobs.

Easy to Play the McNeil Way

This course can now be yours. Just as if I were sitting at your elbow teaching you the correct finger positions—melody, chords, harmony, etc., etc. My Course is a personalized "A-to-Z" Course. It includes everything you will ever want to know about Tenor Banjo playing. An added feature to help you is the phonograph record—played by myself, illustrating breaks, jazz strokes, etc., etc.

Be the Life of Any Party!

If you are really eager to learn to play, if you honestly yearn for popularity and increased income, then act now. Write today for free booklet and details.

Charles McNeil, Studio Director,
CHICAGO BANJO INSTITUTE
 Dept. 1352, 3345 N. Lincoln St., Chicago, Ill.

Mr. Charles McNeil, Studio Director,
 Chicago Banjo Institute,
 Dept. 1352, 3345 N. Lincoln St., Chicago.

Dear Sir: I would like to find out more about your Home Study Tenor Banjo Course. Without obligation, please send me literature and full information.

Name.....

Address.....

City..... State.....



B. W. COOKE
Directing
Engineer
CHICAGO

“JOB-WAY”
3 JOB TICKETS AND 3 AUTO LESSONS

NOW
Absolutely
FREE

GET THE FACTS!

About the Tremendous Money-Making Opportunities in the WORLD'S BIGGEST BUSINESS!

Find out how you can get into this gigantic Auto Business! Think of it—7 Thousand Million Dollars paid to Auto men every year for upkeep alone! See why there are so many Tremendous Opportunities for the trained Auto Man to get Big Raises in Pay QUICK!—opportunities waiting for YOU! My Free Book shows why. My Free Lessons show how you can take advantage of these wonderful Opportunities.

Be an Auto Expert

If you want to boost your pay quick, Mail the Coupon now. Be an Auto Expert. It's the one Business for the red-blooded, ambitious man who wants to make real money! I help you do it. Get all the particulars about my lifetime Employment Service and my lifetime Consultation Service—both of which I include Free of Extra Charge.

Send Coupon at ONCE!

Learn how men without a day's previous auto experience, and only common schooling become Garage Owners, Superintendents, Managers and can earn up to \$150 a Week and more! See why hundreds of men have found “JOB-WAY” to be such interesting, practical Training! I stand ready to give you absolute proof. Clip COUPON NOW and I'll rush your Lessons to you Absolutely Free!

B. W. Cooke
Directing Engineer
Chicago Motor Training Corporation
1916 Sunnyside Ave.
Dept. 216A CHICAGO



3 JOB TICKETS also FREE

ACT QUICK!
My Big New Auto Book Also FREE!

Coupon brings this startling, revolutionary, new Auto Book, also absolutely Free! Shows how hundreds of men have reached Big Pay in amazingly QUICK Time! Shows what you can do!

Send for It Now!

Coupon Brings Full Details of my 4 OUTFITS OFFER

Includes Tools, Tool Bag, Electrical Test Bench, Also 303 Wiring Diagram Charts, Also Special Electrical Outfits.

I'LL PROVE

That I Can Put YOU in Line for the BIG PAY JOBS—QUICK!

Clip coupon now! I'll send you absolutely FREE OF CHARGE—with positively no obligation on your part—3 “JOB-WAY” Auto Lessons and 3 Job Tickets and my big, new Auto Book also FREE! I want you to see for yourself—just why B. W. Cooke “JOB-WAY” Training is bringing so many men BIG Money in such remarkably quick time. I want you to see what it can do for you!

Find out how I train You

AT HOME!

Don't sell your time for low pay! You don't need to! Get all the Facts! Find out how you can become a Big Pay Man in amazingly quick time! See how I train you this fascinating, easy, new way—with LESSONS—JOB TICKETS—TOOLS—and ACTUAL AUTO JOBS! These 3 FREE Lessons show you why you can stay home; keep your present job! They prove that you don't have to leave your doorstep—that you can Master every branch of Auto work right in your own home. Send Coupon while I can still offer you these 3 Lessons and 3 Job Tickets absolutely FREE!

See How You Can Earn up to \$150 a Week

If you're earning a cent less than \$60 a week, clip coupon now! Get the proof. See for yourself how easily you can master Auto work right in your own home—and how quickly you can get in line for the big Auto Jobs that pay up to

\$10,000 a year and more—or in a Money-Making Auto Business of your own. Remember—these lessons and Jobs come to you absolutely FREE of charge and without any obligation on your part whatever.

MAIL THIS COUPON NOW!

Send 3 AUTO Lessons and 3 FREE BOOK

B. W. COOKE DIRECTING ENGINEER Dept. 216A CHICAGO MOTOR TRAINING CORPORATION, 1916 Sunnyside Avenue, Chicago, Illinois

Dear Sir: Send me absolutely FREE and without any obligation on my part, 3 “Job-Way” Lessons and Jobs. Also your Auto Book FREE and Full particulars of your 4 Outfits Offer.

Name

Address

Town.....

State.....

From "Puny" to PANTHER-MAN

My FREE Book

tells how you can get a body like I gave this lad. Why delay? The book only costs you a postage stamp and there are no strings to that!

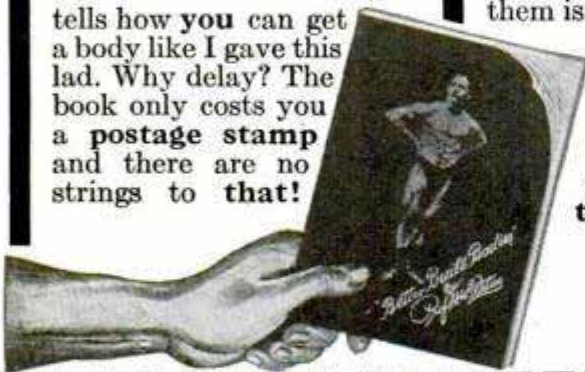

Titus, Dept. P-111
105 E. 13th Street,
New York City.

Dear Sir:

Mail my copy of your big new illustrated book, *Better Built Bodies*, absolutely FREE and without obligation.

Name.....

Address.....

City.....State.....

LOOK at these two pictures! LOOK at them!! Then go peek in your mirror and see which one of them is more like you. Never mind blushing! Don't waste time being ashamed! There's no need of staying that way!
The chap in the picture got next to himself and came to me!

In thirty days I built that man from the sparrow-armed boy in the first picture. I loaded him with muscles. I can do as much—maybe more—for you! If you want a real body mail the coupon before you go to bed TONIGHT!

TITUS Dept. P-111
105 East 13th St., New York City



BEFORE

This lad looked pretty hopeless when he came to me. His arms looked like sparrow wings with the feathers removed. His ribs stood out and his bones tried to poke through his skin all over his body. His chest was hollow, his neck scrawny. He had sluggish blood circulation and jumpy nerves. He couldn't sleep. Then he took my course!



30 DAYS AFTER

What a man! In thirty days I built the fellow you see above. I loaded his bones with muscles! I gave him a body that laughs at hardships and illness. He says: "No other apparatus and instruction can touch yours! When the human body will hold another muscle—Titus will put it there!"

PATENTS

Booklet Free Highest References
Promptness Assured Best Results

Send drawing or model for preliminary examination of Patent Office records.

ALL BUSINESS GIVEN PROMPT AND PROPER ATTENTION

Listed Patent Lawyer in the latest editions of the Rand-McNally Directory of Bankers and Attorneys, of Chicago, Ill.; The Baggott & Ryall Directory of Attorneys, New York City; The Lawyers Guaranteed Directory, Detroit, Michigan; The Lawyers and Bankers Quarterly, published by the Legal Directory Publishing Company of St. Louis, Mo.; the American Lawyers Annual, Cleveland, Ohio.

WATSON E. COLEMAN,
REGISTERED PATENT LAWYER

Victor Building, 724 Ninth Street, N. W.
WASHINGTON, D. C.



— Be a Railway Postal Clerk

Get \$1900 to \$2700 a Year
Easy Work—Long Vacations

Why work hard for small pay? Uncle Sam offers you a fine position as a Railway Postal Clerk. Travel on fast trains sorting mail. Travel expenses paid. \$1900 a year TO START. \$100 RAISE EVERY YEAR until you reach TOP PAY.

FREE Information About This Fine Job

Let Arthur R. Patterson help you qualify for this wonderful position. He trained thousands now in Civil Service. Write for FREE BOOK. Tells how Mr. Patterson coaches you to pass exams. Also read his Money Back Agreement. Mail coupon now.

ARTHUR R. PATTERSON, PRINCIPAL
The PATTERSON SCHOOL, Dept. 82, Wisner Bldg.
Rochester, N. Y.

Arthur R. Patterson, Principal
The Patterson School
Dept. 82, Wisner Bldg.
Rochester, N. Y.

Sir: Send me without charge your catalog describing Railway Mail Clerk and other Civil Service positions.

Name.....Age.....

Address.....City.....State.....

Ford

40 Miles on a Gallon

"We have tried them out. Ford got 40 miles on a gallon."—F. S. Carroll.



Saves 50%

F. A. Cole writes he put one on a Studebaker Special Six. Reports a saving of 50% in gasoline.

Buick

36 Miles On 1 1/4 Gallons

"Yesterday I made a trip of 36 miles and used only 1 1/4 gallons." L. L. Robinson.

CHEVROLET

43 Miles On a Gallon

"We have tried them out. Chevrolet got 43 miles."—F. S. Carroll. Rex Deen, another Chevrolet owner, reports he got 25 miles a gallon. Took the device off and mileage dropped to 19. Put it back and mileage moved up to 25.



Almost Double

J. R. Wood writes he increased mileage on his Oldsmobile from 17 miles a gallon to 30 miles a gallon by actual count on 3,000 miles.

INTERNATIONAL TRUCKS

Saves 41%

"I find it better than you recommend it. On the International Truck we use, we are saving by positive test 41% in gas and our engine uses less oil."—George Bell.

Sworn Affidavit

I, L. G. Stransky, Vice President, J. A. Stransky Mfg. Company, being first duly sworn depose and say that the J. A. Stransky Mfg. Company have in their files thousands of unsolicited testimonials from satisfied users all over the world.

Signed L. G. Stransky
Vice President.

Subscribed and sworn to before me this 29th day of November, 1926.

(Signed) Ernest Henegar
Notary Public.



**With This Amazing Device
I Drove 1300 Miles
Without Buying Gasoline**

No wonder over a million car owners have installed the Stransky Vaporizer! Here's a remarkable instance—one of many that shows how this amazing device has saved gasoline and increased power. J. R. Wood of St. Louis writes that he ran his car 3,000 miles on the same amount of gas that he formerly used on only 1,700 miles. Think of it! 1,300 miles without buying gasoline! Read the inventor's daring no-risk offer to you.

\$75 to \$200 In a Week

SELDOM if ever has such a money-making opportunity been offered distributors—experienced or otherwise—full time or spare time. Think how fast the money rolls in when Foster could make \$137.50 in a week—Fuller, \$104.50 in five days—Cronk \$51 in an hour!

If your present job doesn't pay you \$75 to \$200 in a week, think fast! Full page newspaper ads are being used all over America. Over a million car owners have installed it already—on all makes of cars, trucks and tractors—even on an aeroplane. Thousands of car owners have ordered direct from the factory because they couldn't find a distributor. Jump in quick and get your share of the cream!

How It Works

The Stransky Vaporizer was invented by J. A. Stransky, former candidate for Governor of South Dakota. It is based on a newly-discovered scientific engineering principle that has stood thousands of tests by car owners, dealers, garage mechanics and other authorities. It has no delicate

parts to get out of order. There is nothing complicated about it. You can attach it to your engine in about three minutes and it needs no further attention.

Official tests show that most car owners waste 20 to 30% of their gas by improper combustion. Thousands of car owners say that this amazing device has saved them as much as 50%; that it picks up power more quickly, ENDS spark plug and carbon troubles, and works in all weathers or roads. And so convinced is the inventor that it will prove its story that he makes the following no-risk offer.



J. A. STRANSKY
Former candidate Governor of South Dakota is the inventor of this amazing device now installed by over a million car owners.

Mail Coupon Below

Over one million car owners have installed the Stransky Vaporizer at the inventor's risk. This coupon will bring you full details of our plan to let you test this device on your car in the same way. You will also learn a definite plan that has helped others earn \$75 to \$200 in a week, full or spare time. Your request will not obligate you. Rush the coupon today.



Free Gasoline Offer

J. A. Stransky Mfg. Co.,
Dept. B-10, Pukwana, S. D.

Yes, send me without obligation full details of your no-risk test offer. Also tell me about your distributor's money-making plan.

Name.....

Address.....

City.....State.....

The STRANSKY VAPORIZER
Saves Gasoline

J. A. STRANSKY MFG. CO.
Dept. B-10 Pukwana, S. D.
Resources \$500,000.00



Play Piano Jazz BY EAR

-in 90 days!

YOU can play real tunes from the start. No notes to puzzle you—no tiresome scales to practice.

You need not know a thing about music. Even if you have never touched a piano, if you can hum or whistle a tune, we can teach you to play all popular song hits *by ear* at a very small cost. No need now to spend years practicing under old-time method. My new and original system teaches you easily and quickly. Be a jazz master and make yourself popular everywhere you go. And the best part of it is there is nothing hard about it. Write at once for

FREE BOOKLET To show you how easily it can be done.

This wonderful home course is offered at a ridiculously low cost. A little practice gives amazing results. You can sit down and play any popular jazz piece that you hum.

David M. Suttle, Director
ILLINOIS SCHOOL OF MUSIC
671 Hearst Square, Chicago

Send NOW for FREE Book

Wrestling

Learn at Home

Book 10c



Men, Boys be perfect physically. Learn right in your own home from **WORLD'S CHAMPIONS** how to be an expert **WRESTLER**. Learn secret trick holds, blocks, breaks and pinning holds. Learn how to defend yourself against bigger, stronger men. Learn Jiu-jitsu. Also most wonderful course in **PHYSICAL CULTURE** ever discovered. The world renowned **FARMER BURNS AND FRANK GOTCH** are authors of these splendid lessons. Learn to be a real athlete. You can if you'll try. Have a beautiful attractive body that all will admire. Surprise your friends, and the "bully" with your great ability. Learn to protect yourself, your mother, sister or sweetheart. Have perfect health, ability.

Only 10c Send only 10c coin or stamps, for 32 page book, ILLUSTRATED, giving full particulars. Tells the secrets of the big Champions; gives many tricks, holds and other valuable information. A costly

book which we send for only 10c—the cost of packing and postage. Don't miss it. Don't delay. **SEND TODAY—THIS MOMENT.** State your age.

Farmer Burns School, 1772 Railway Exchange Bldg., Omaha, Neb.

Learn Watchwork, Jewelrywork and Engraving

A fine trade commanding a good salary, and your services always in demand. Address: **Horological, Dept. P, Bradley Institute, PEORIA, ILLINOIS,** for our latest catalog.



"BECOME A LIGHTNING TRICK CARTOONIST"

Send \$1.00 for Laugh Producing Program of 23 Trick Drawings with Instructions. Catalog of Chalk Talk Supplies Free. **BALDA ART SERVICE, Dept. 1, Oshkosh, Wis.**

\$20,000,000 DAILY WAGES
Paid to AUTO MECHANICS

Learn in 8 Weeks

Ten thousand men have

been qualified by my practical, easy-to-learn Shop Method of teaching with real tools on real equipment. I guarantee your money back if I fail. No book study.

I Pay Your Railroad Fare to my training shops and Board You 8 Weeks

My eight weeks' course is complete. No extras to pay for. This offer is limited. Save one-third while it lasts. Act promptly. Mail the coupon today. Remember "Mac" is one of the world's largest operators of Auto and Tractor Training Schools.

Get your name on the payroll of America's biggest industry and be fixed for life. Auto Mechanics "who know their stuff" are in demand everywhere—never so many jobs as right now waiting for trained men to fill them. No apprenticeship. No education required.

Wages \$75 to \$150 Weekly

are paid to thousands of auto experts. Others make more as owners of garages and repair shops. What man of 16 or 60 could ask for a Bigger Opportunity? Write today for my remarkable special reduced tuition offer including your board and railroad fare.

Ask for My Big Book — Tells Everything

MAIL THIS COUPON FOR MY GREAT OFFER

McSWEENEY, Auto, Tractor and Electrical SCHOOLS
Dept. BW-14, Cleveland, Ohio, Cincinnati, Ohio, Chicago, Ill.

Please send your Special Offer and Big FREE Illustrated Book.

Name.....
Address.....
City.....
State.....

McSWEENEY SCHOOLS
Auto, Tractor and Electrical
Dept. BW-14
Cleveland, O. Cincinnati, O. Chicago, Ill.

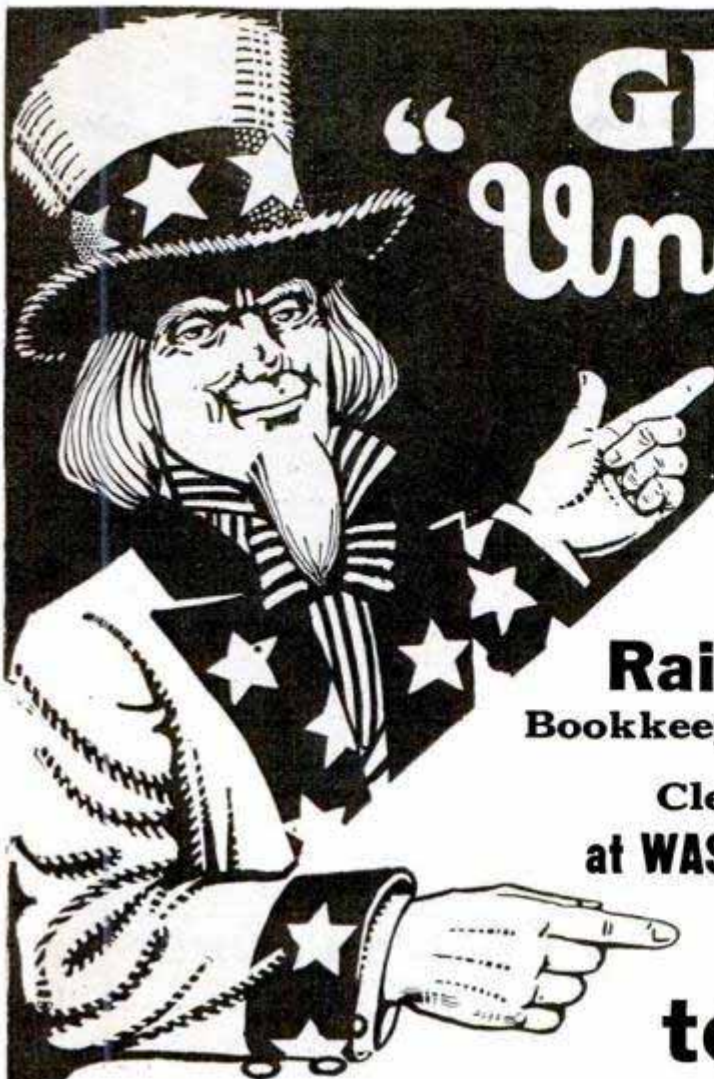

“GET ON” Uncle Sam’s PAYROLL

Post Office Clerks
City Mail Carriers
Rural Mail Carriers
Railway Postal Clerks
Bookkeepers Stenographers
Income Tax Auditors
Clerks in Government Offices
at **WASHINGTON, D. C., and ELSEWHERE**

\$1140⁰⁰
to \$3300⁰⁰ a Year

These are steady positions. Strikes, poor business conditions, lockouts or politics will not affect them. U. S. Government employees get their pay for full twelve months every year. There is no such thing as “HARD TIMES” in the U. S. Government Service.

RAILWAY POSTAL CLERKS

Railway Postal Clerks now get \$1900 the first year, being paid on the first and fifteenth of each month. \$79.16 each pay day. Their pay is quickly increased, \$100 and \$150 a year, the maximum being \$2700 a year. \$112.50 each pay day. They get extra allowance for hotel expenses when away from home.

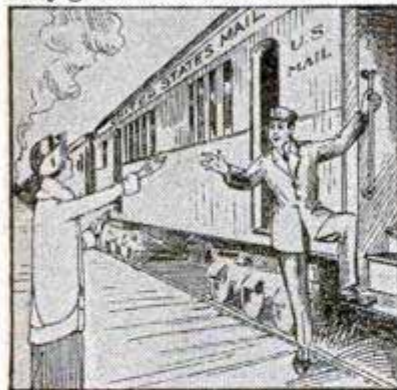

PAID VACATIONS

Railway Postal Clerks, like all Government employees, are given a yearly vacation of 15 working days (about 18 days). On runs they usually work three days and have three days off duty, or in the same proportion. During this off duty and vacation, their pay continues just as though they were working. When they grow old they are retired with a pension. As Railway Postal Clerks are continually traveling, they have an excellent chance to see the country. They are furnished with a railroad pass.

CITY MAIL CARRIERS—POST OFFICE CLERKS

Clerks and Carriers get \$1700 the first year regular, and automatically increase \$100 a year to \$2100 with further increase to \$2300. They also have 15 days vacation. Examinations will be held during February at many large cities. City residence is unnecessary.

GENERAL CLERK

(Open to men or women 18 or over)

Salary \$1140 to \$1860 a year. Pleasant clerical work in the various departments and offices at Washington, D. C., and elsewhere throughout country.

WHAT WILL YOU EARN 5 YEARS FROM NOW?

Compare these conditions with your present or prospective condition, perhaps changing positions frequently, kicking around from post to pillar, no chance in sight for PERMANENT employment; frequently out of a position and the year's average salary very low. DO YOU EARN \$1900 EVERY YEAR? HAVE YOU ANY ASSURANCE THAT A FEW YEARS FROM NOW YOU WILL GET \$2700 OR MORE A YEAR, EVERY YEAR?

GET FREE LIST OF POSITIONS

Fill out the coupon. Tear it off and mail it today—now, at once. DO IT NOW—This investment of two cents for a postage stamp may result in you getting a U. S. Government Job.

**FRANKLIN
INSTITUTE**
Dept. F-174
**ROCHESTER,
N. Y.**

Rush to me, entirely free of charge (1) a full description of the position checked below; (2) Sample coaching; (3) Free copy of 32-page illustrated book, “U. S. Government Positions and How to Get Them,” with list of positions now obtainable.

RAILWAY POSTAL CLERK..... (\$1900-\$2700)
POST OFFICE CLERK..... (\$1700-\$2300)
CITY MAIL CARRIER..... (\$1700-\$2100)
RURAL MAIL CARRIER..... (\$2100-\$3300)
CLERK IN GOVERNMENT OFFICES..... (\$1140-\$1860)
BOOKKEEPER..... (\$1320-\$2040)

Name.....

Address.....

Use This Coupon Before You Mislaid It—Write or Print Plainly

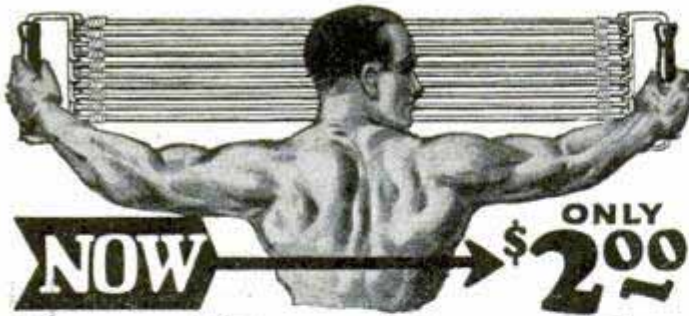

NOW → **ONLY \$2.00**
Giant Chest Expander

and Progressive Exerciser

Be a muscular marvel. Have the muscles of a superman. Become strong for your health's sake or to astound your friends with extraordinary feats which only men of giant strength can do. In a few short weeks you will easily do stunts which now seem difficult—then real muscles and strength will be yours—and yours to keep. If you want exercise to just keep in good shape you can reduce the strength of the Progressive Exerciser by eliminating as many cables as you wish. If you want great resistance so as to build up big solid muscles, then use the full strength.

Send No Money Use This Money Saving Coupon

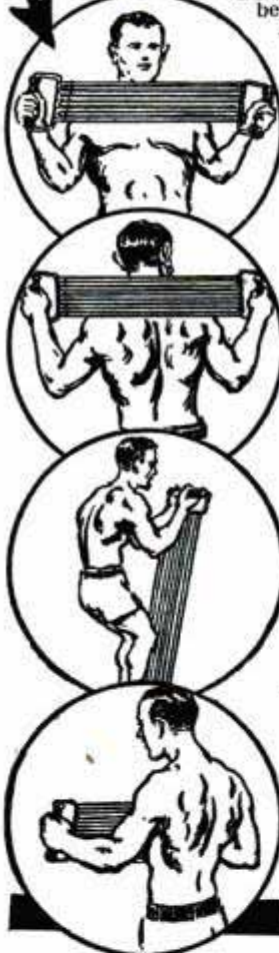

How the Giant Chest Expander and Progressive Exerciser is Made

The Giant Chest Expander and Progressive Exerciser is made with new live, springy rubber so as to give it long wearing and great resisting qualities. Do not pay more for an exerciser that has forty or less rubber strands to each cable. Get the best and most durable. The Giant Progressive Exerciser has 50 strands of the finest rubber procurable to each cable.

Free Instructions

We do not think it enough to send you an exerciser worth double what we ask, but for a limited time, we will also include instructions absolutely free. These instructions are interesting and simple to follow—they show you the short cut to health and strength. Order today before this wonderful offer is withdrawn.

Your Guarantee

The Giant Chest Expander is sold with a guarantee that you will say it is the finest you ever saw or your money back.

5 Cables or double 10 Cables for \$2 **for \$4**

The double strength exerciser has resistance of over 200 lbs.

How to Order—Send No Money
 Sign your name and address to coupon below and get your Giant Exerciser at the present low introductory price by return mail. The price is made low because we want everyone to enjoy muscles and strength at the lowest possible cost. Don't pay more—order from us—get the most for your money. Use coupon now.

PROGRESSIVE EXERCISER CO.,
 4002 Langdon Bldg.,
 Broadway and Duane Street, New York

Please send Your 10 cable Progressive.
 Your 5 cable Exerciser.

Check the Exerciser you want, and it will be sent you by return mail. Pay postman introductory price, plus few cents postage on arrival. It is understood that if you are not entirely satisfied with your exerciser you may return it within 5 days and get your money back.

Name.....
 Street.....
 City..... State.....

If you live outside the United States, send cash with order.

Be a High-Salaried GARMENT DESIGNER

Join this wonderful profession with its amazing opportunities for both sexes. Clean, dignified work.

PARRY PRACTICAL TRAINING qualifies you in a few weeks to hold BIG-PAY positions in America's largest fashion salons and clothing and fur industries.

MEN AND WOMEN EARN \$75 TO \$500 EVERY WEEK

No experience needed. This long-established school is the only one officially recommended and endorsed by Chicago Designers' Association of Women's Apparel. Write for full particulars of special offer. **PARRY GARMENT DESIGNING INSTITUTE**, Dept. 101, 19 S. Wells St., Chicago, Ill.

Mail This Coupon Now

R. H. Parry, Director, PARRY GARMENT DESIGNING INSTITUTE
 Dept. 102, 19 South Wells Street, Chicago, Illinois

You may send FREE particulars of Designing Course checked.

MEN'S GARMENTS WOMEN'S GARMENTS FUR GARMENTS

Name.....
 Address.....

WANT WORK AT HOME?

Earn \$18 to \$60 a week RETOUCHING photos. Men or women. No selling or canvassing. We teach you and furnish WORKING OUTFIT given with each enrollment. Limited offer. Write today. **Artcraft Studios, Dept. 50, 3900 Sheridan Rd., Chicago**

LEARN WATCHMAKING AND ENGRAVING

BY OUR PROFIT-SHARING PLAN OUR GRADUATES SUCCEED

One of our Iowa students started in a very small way—now doing over \$30,000 a year. Another in Wisconsin, over \$10,000 the first year. Day or night classes. Call or write for FREE BOOK
Chicago School of Watchmaking, Dept. 2501, 4844 Lincoln Avenue, CHICAGO

MAKE MUCH MONEY—

Making and selling your own goods. Formulas, manufacturing processes, Trade-Secrets. All kinds. All lines. Catalog, special circulars free.

W. THAXLY CO., Washington, D. C.

A Great Book Free with this pay-raising library

For a short time only we will give every subscriber to the New Library of Machine Shop Practice a copy of French's Engineering Drawing—the greatest book on mechanical drawing ever written. This book makes drawing as plain as day—tells you all about instruments, plans and methods—and prepares you to handle any drawing job you will ever have to do. It comes to you absolutely free with

Machine Shop Practice

9 volumes — 3065 pages — 3608 illustrations
 (A combined home study course and reference library)

The New Machine Shop Library is written for practical men. It gives you the best methods for every kind of machine shop work. It explains machine tools and their operation, drawing and design, tool work, gears and grinding, jigs and fixtures, automatic screw machines and their tools and all of the mathematics you will ever have to use. It is plainly written, completely illustrated—the very best kind of help to the machine-shop man who wants to advance himself.

Sent **FREE** No money down—only 7c a day



FREE EXAMINATION COUPON

McGraw-Hill Book Co., Inc., 370 Seventh Ave., New York

Send me for 10 days' free examination the New Library of Machine Shop Practice. If satisfactory, I will send you \$1.50 in 10 days and \$2.00 monthly until the special price of \$19.50 is paid. If not wanted, I will return the books at your expense.

On receipt of my first payment of \$1.50, it is understood that I am to receive, free of charge, a copy of French's Engineering Drawing.

Signed.....
 Address.....
 City and State.....
 Position.....
 Employer..... P. M. 2-1-27



A New Day IS DAWNING ON ONE GREAT FIELD

ELECTRICITY

\$200⁰⁰ to \$800⁰⁰ a Month

**Are the Incomes That Trained
Electrical Engineers and
Electricians Make**

There is no limit to the earnings or business possibilities for the trained electrical expert. Every factory, every home, every transportation system, automobiles, aeroplanes, etc., are using electricity more and more for power and convenience.

I can prove to any thinking man who is mechanically inclined, that his greatest opportunities—surest future—will come if he learns this profitable and fascinating trade and science.

Electricity Must Be Taught

It is practically impossible for a man to become an expert electrician unless he is taught by a man who not only knows electricity, but knows how to teach it. Practical experience on actual electrical equipment—not books—is the only way this trade can be mastered.

We Teach with Electrical Machinery—Not Books

Every minute of your time in the Coleman Electrical School will be spent on actual equipment, such as used in factories, power-houses, buildings, homes, automotive electricity—such as ignition, starting and lighting systems—electrical refrigeration, telephone and telegraph systems, in fact, the entire field of electricity is covered in a practical way in our school.

No Guess Work About Our System

It's practical and understandable. YOU LEARN BY WORKING on actual equipment, under the supervision of expert electricians. Our School is completely equipped. Hundreds of generators, dynamos and electrical appliances are here for you to work on. Our School is complete.

Earn the Big Money That Electrical Experts Earn

Write today for full information about this opportunity School. I will show you a future that is unlimited in its financial returns and is fascinating as well. My catalogue tells the story of the Coleman Electrical School.

I Have a New Year's Present for You

I offer you until February 10, 1927, an opportunity of attending this School at a tuition rate unheard of before. This special offer includes my complete Scholarship and full privilege of our employment department. Write today for full information about my School. How we teach the business, and the opportunities it holds for you.

**W. H. Coleman, President
Coleman Electrical School**

My Guarantee

I guarantee that my School is one of practical training. We teach by doing. We have all equipment necessary to make you a practical and competent electrically trained man. I have spent more than ten years training men. I know what you must know in order to earn the big money. I will teach you how to get it.

W. H. COLEMAN, President,
Coleman
Electrical
School

W. H. Coleman, President
Coleman Electrical School
1628 Main Street
Kansas City, Mo.

Dear Sir:

I want to learn about your School. Please send me free and postpaid, your illustrated catalogue that will tell me how you can make me an electrically trained man. It must be free and place me under no obligation.

Name.....
Town.....
State.....

O. C.
MILLERDirector
Extension
Work
American
School

The American School

A million Dollar *No-Profit* Educational Institution, now offers men a *double* service—training for a specific job, then help in finding the job. For one small price, on terms of only \$5.00 a month, you are now assured of definite benefits, both in position and salary. Write for complete information—*today!*

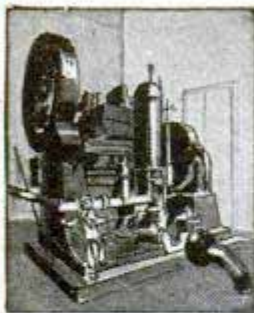

No machine can be built until the Draftsman first builds it on paper. My training prepares you for this work.



Never has the world seen anything like the building boom of today. This has created enormous demand for real Draftsmen.

5 BIG-PAY Branches

The big money in Drafting goes to men who specialize in Machine Design, or Electrical Drafting, or Architectural Drafting, or Structural, or Automotive. It is not enough merely to know *general* Drafting practice. You must know how to calculate and design and plan original work. You need many Engineering subjects to fill the kind of a Drafting position that pays \$60 to \$125 a week. The American School now includes this specialized training in its Drafting course.

Costly Drafting Outfit Given!

Fine, imported instruments like these help you learn Drafting quickly and easily. These standard quality, full size instruments, board, table, triangles, T square, ink, protractor, etc., given to every student without extra cost.

O. C. Miller, Director Extension Work

The American School

3 Drafting

to prove you can

We have invented a new, simplified way to teach Drafting—the first real improvement in Drafting home instruction in history. We want you to see a few of these new Job-lessons, try them, test your own ability to master them—without one penny of cost or obligation. For instance, you will see how we get away from the “copying” methods used in the past, so you develop into a DRAFTSMAN, instead of a “tracer.” See for yourself the ingenious new method which compels you to think, to solve problems, to do actual Drafting-room jobs from the very first lesson!

A New, Rapid, Simplified Training

Copying drafting lessons prepares you to be only a “tracer.” This new “Job-Method” gives you actual drafting-room jobs in a new one-step-at-a-time way. With pictures which you can understand almost without reading the “lessons.” And that is why the American School-trained Draftsmen can qualify for a good job at big pay when they graduate.

Win Success Thru Drafting

Drafting is easy, fascinating work. Short hours. Big pay. And the Draftsman is always in line for promotion to executive positions. This training is complete. It includes high school subjects (if you need them) and all the Engineering and Mathematics Drafting experts require.

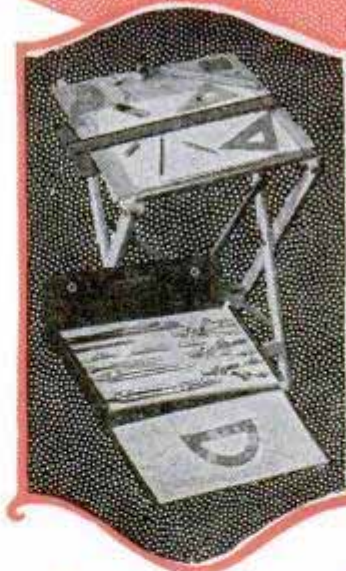

FREE Job Service

The American School now offers its students and graduates, without cost, the services of an efficient employment department keeping in constant touch with employers of Draftsmen all over the U. S. We have placed hundreds of men in good, big-pay Drafting positions. We've made this training so complete, so practical, so easy to master, that our students are bound to make good. And so, because the demand for real Draftsmen continues to exceed the supply and because this training actually prepares men for good Drafting positions we back it with a Free Employment Service.

Dept. D-274
Drexel Avenue and
58th St., CHICAGO

Lessons *Actually* FREE

learn at home in spare time!

Draftsmen Wanted!

\$60 to \$125 a Week!

yourself. Plan your future in Drafting. Even if you have only common schooling, even if you know nothing of Drafting, we guarantee to make you a real Draftsman or to refund your money! Special surprise offer right now to the first 500 men who answer this ad—reduced price, easy terms. Coupon brings complete information.

70,000 fine jobs advertised last year. Get ready to fill one. Get out of the rut. Make something of



Electricity needs Draftsmen who know Electrical principles as well as general Drafting practice. I give you this training.



The demand for Draftsmen experienced in concrete and structural steel work is enormous. Many big-pay positions open.



Every great Auto factory employs Draftsmen who specialize in Automotive work — men who design bodies, plan engines, etc.

I Will Make This Contract With You



American School
—the Million Dollar
Educational Institution



4. or we'll refund every cent of your money.

WHEN you enroll for our home-training in Drafting, we agree to give you:

1. Complete Drafting training, by the new Practice-Method.
2. Professional Drafting Outfit, as illustrated.
3. We will help you get a good Drafting position at a substantial increase in pay,

O. C. Miller
Director Extension Work

Coupon Brings 3 Lessons FREE!

Get them. Test your own ability to learn Drafting and get ready for a fine job and big pay.

Coupon also brings surprise offer, and complete information about your opportunities for success in Drafting. Mail It Today!

Read These Letters!

City of Chicago
Department of Buildings
Gentlemen: The same day I received my diploma I got word that I was one of the two candidates who had successfully passed the examination for Deputy Commissioner of Buildings of the City of Chicago, a position paying \$3600 per year.

There were eight applicants examined besides myself, all men well known to the architectural and engineering profession. Seven of these failed to obtain a passing grade of 70%. My grade was 84.69.

Inasmuch as I failed to pass this same examination three years before, my present success is mainly due to the knowledge gained through your School.

Yours very truly,
ROBERT KNIGHT

Got His Draftsman's Job

"I wanted to let you know how I came out in getting that job at the Brownell Co., Dayton, Ohio. I was to start and have a trial at Drawing, and I am still in the Drawing room. The engineer seems to like the work I make, and also the other draftsmen. I thank the School very much for getting me in at this place, because your letter of recommendation helped me a whole lot to get the job."

BERNARD WEBER,
730 St. Nicholas Ave., Dayton, O.

Liberty High School Bethlehem, Pa.

Dear Sirs:—This is to thank the American School for all that you have done for me since I signed up for the Drafting and Design Course.

In the eight years since then, I have gradually climbed from the position of tracer to that of Head of the Department of Machine Drawing and Design in our magnificent new \$2,000,000 High School here, at many times the salary which I received at that time.

The officials of the Pennsylvania State Department, and Dr. Wm. C. Ash of the University of Pennsylvania, all claim that our course in Drafting and Design is the best now being taught in this state. Every drafting graduate that we have turned out has proved successful, and one is now Chief Draftsman in a local steel concern. Yours sincerely,
J. S. LEAR

Has Charge of Large Jobs

"Even before I had finished my course, I was put in charge of large construction jobs in different cities. I have been doing that ever since, and the jobs are getting larger all the time. I owe my success to the American School because of the knowledge I gained in mathematics and calculations."

ELMER L. LAMB,
1306 Smith St., Peoria, Ill.

3 Drafting Lessons *Actually* FREE

O. C. MILLER, Director Extension Work
AMERICAN SCHOOL

Dept. D-274, Drexel Ave. and 58th St., Chicago.

Rush 3 Free Drafting Lessons. Job and Raise Offer, complete information, money-back guarantee, etc., to prove I can become a real Draftsman at home in spare time.

Name.....

Street*No.....

City..... State.....

**Make
\$10.00
after supper
while learning**

*That's what Wittenberg
did—and now as a
"COOKE" Trained
Electrical Man
he is earning*

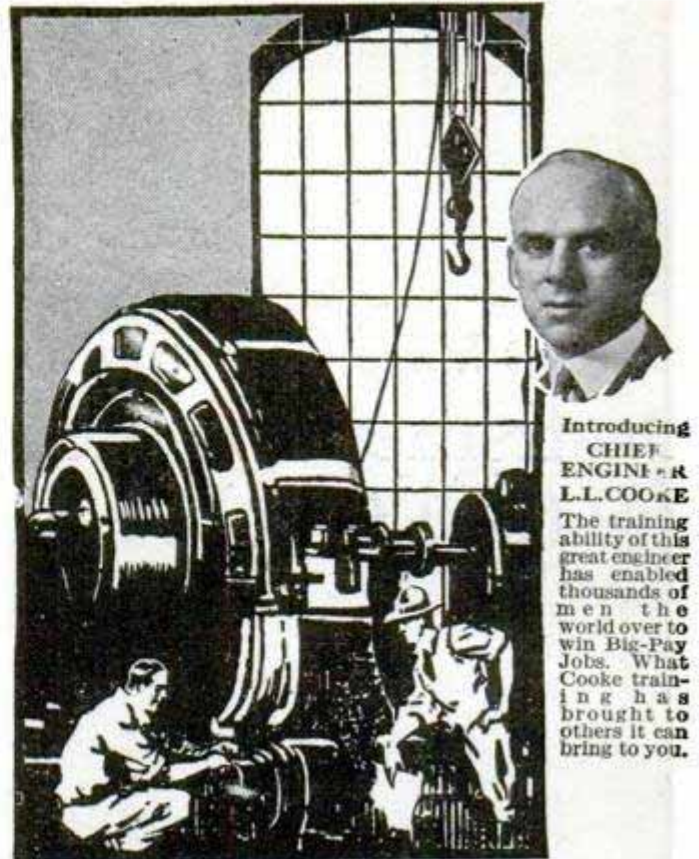

Introducing
**CHIEF
ENGINEER
L.L. COOKE**
The training
ability of this
great engineer
has enabled
thousands of
men the
world over to
win Big-Pay
Jobs. What
Cooke train-
ing has
brought to
others it can
bring to you.

NEVER HAVE SUCH OPPORTUNITIES EXISTED BEFORE. Money! Position! Influence! Success—the electrical industry offers you ALL this. In what other profession could you go out of an evening and earn \$10 while learning?—make \$500 during a season's odd moments?—"knock out" \$25 to \$30 a week doing spare time jobs? Yes, these things ARE being done every day. Hundreds of Cooke trained men are doing them!

**The "COOKE" Way to BIG Pay
Easy—Practical—Sure**

Previous experience not necessary. A half hour a day at home, learning Electricity by the simplified practical "Work Sheet" and "Job Ticket" Method of Chief Engineer Cooke, will make you a Trained Electrical man. He furnishes all necessary tools and apparatus—five big Working Outfits—without extra cost. You have nothing to buy.

And you can make good money while you learn. The Chief shows you how to get spare-time work—how to do it—and tells you what to charge. That's while learning! When you have finished you are ready for a BIG PAY Job. Thousands of Cooke trained men earn \$3,500 to \$10,000 a year. Some even more! It's all a matter of ambition—of getting started right—of placing yourself in the hands of one of America's foremost electrical instructors, Chief Engineer Cooke.

Valuable Book FREE—Send for It

Send now for the big, interesting, 64-page illustrated book that Chief Engineer Cooke has prepared for you—"Secrets of Success in Electricity." It's free. Get it—read it. Learn how Cooke trains men, easily, quickly, thoroughly—how thousands of Cooke trained men have won big-pay jobs—how you, too, can win permanent success in this fascinating, big-pay industry. Do not delay—mail the coupon today!

**Over \$6000.00
a year in
ELECTRICITY**

Read what this Cooke trained man has to say: "I have just bought a 5-passenger sedan and my income now amounts to about \$475 a month—\$118 a week. Before I took your Course I never made over \$50 a month. I only had a 6th grade education and this is the only electrical training I have had. Even while taking your Course I often made an extra ten dollars for an evening's spare time work."—Herman Wittenberg, 1930 Grand Concourse, Bronx, New York. Surely, you can do as well! Tear off, sign and mail the coupon to

L. L. COOKE, Chief Engineer

**L. L. Cooke School
of Electricity**

Owned and Operated by
Chicago Engineering Works
(Incorporated)

Dept. 512
2150 Lawrence Ave.
CHICAGO, ILL.



COUPON

CHIEF ENGINEER COOKE,
Dept. 512, 2150 Lawrence Ave.,
Chicago, Ill.

Please send me your free book, "The Secrets of Success in Electricity" and full particulars of your training that helps men into big pay jobs. This does not obligate me in any way.

Name.....

Address.....

City.....State.....



"Last month I made \$197.00 on spare time wiring jobs. Not bad for a 19-year-old boy. There are fellows in this town who don't make half that much full time. You sure put men in the big pay class." — John Hudec, 223 West 9th Ave., Tarentum, Pa.



"In addition to my regular work I am handling electrical work of all kinds. This is bringing me in from \$300 to \$500 per month, which isn't so bad for spare time work. I am thankful for what you have done for me." —Julius A. Fischer, Wallace, Idaho.

The "Cooke" Trained Man is the "Big Pay" Man

Classified Advertisements

WORLD'S BEST WANT AD MEDIUM

Advertisements in this section, 30 cents per word, each insertion, minimum 10 words, payable in advance. To be inserted under proper classification in March issue, copy should be in our office January 18th.

ADVERTISING AGENCIES

ADVERTISERS—To buy, sell or to secure agents, salesmen, you can place your 24-word ad in the following 15 leading Sunday papers for only \$15; circulation over 2,000,000: Age-Herald, Birmingham; Gazette, Little Rock; Journal, Atlanta; Star, Indianapolis; Register, Des Moines; Courier-Journal, Louisville; Times-Picayune, New Orleans; Star, Kansas City; World-Herald, Omaha; Courier, Buffalo; Enquirer, Cincinnati; Press, Pittsburgh; Commercial-Appeal, Memphis; News, Dallas; Journal, Milwaukee. Proof of Insertion Guaranteed or Money Refunded. 52-page rate book sent free. Frank W. Lenthoff Advertising Agency (established 1897), 600 North Michigan Blvd., Chicago.

A TEN Dollar Ad may put your proposition over. \$10 pays for a 4 line 24 word classified ad one Sunday in 10 of the largest newspapers. Reach over 7 million readers. Minneapolis Tribune. Buffalo Courier. St. Louis Post-Dispatch. Pittsburgh Press. Indianapolis Star. Atlanta Journal. Detroit Free Press. Birmingham News. Cincinnati Enquirer. Little Rock Gazette. Free catalogue showing other lists of newspapers and magazines sent on request. Ankrum Advertising Agency, 22 West Jackson Blvd., Chicago. Largest classified advertising agency in the world.

ADVERTISING Service. Over 25 years' experience building up advertisers. We prepare, plan and place magazine, newspaper and classified advertising. Also write folders, circulars, letters, etc. Describe briefly your proposition. Send your recent advertising matter, proofs of ads, etc. (if any). We will send you "Advertising Simplified," latest book of rates and valuable information. Ask Dun's, Bradstreet or any publication about us. Charles H. Touzalin Agency, 708 Union Trust Bldg., Chicago, Ill.

ADVERTISE in the classified section of newspapers and magazines, to secure help, money, or to sell. 24-word advertisement in nine big Metropolitan papers \$10.00. Nearly two million circulation. Many other bargain lists. Write for Free 58-page Directory No. 26. Brinckerhoff Advertising Agency, 37 W. VanBuren, Chicago.

ADVERTISE in 24 Big Sunday Newspapers, 24 words \$15.00. Excellent for securing Agents, Salesmen, and Business Opportunities. Catalog listing 1,000 leading Dailies, Weeklies, Mail Order Magazines, Everything. Free. Wade Advertising, Baltimore Bldg., Chicago.

WE sell original letter names. Rural mail buyers, agents, ladies. 5,000, \$25.00. Pennell-Standard, Covington, Ky.

ADVERTISE — Newspapers, Magazines, Country papers — classified (Want Ads) — display space. Free catalog. Martin, 37B West 39th, New York.

SIX Word Line—355 rural weeklies \$3.55. Admeyer, 4112-M Hartford, St. Louis.

FOR ADVERTISERS

ADVERTISE in 275 country newspapers, 28 words, \$10. Keator, Hartford Bldg., Chicago.

WE write letters, every description. Ads. that sell. Booklets and Mail-Order Copy with a "pull." Also Addressing, Mailing. Bids given. Write us your wants. A. W. P. Agency, Dept. 0, Manheim, Pa.

CIRCULARS Mailed. First Class Mail, 25c per 100. Israel, Box 169A, GPO, New York City.

75 **MAGAZINES** 5c word, \$3 inch. Information. Porter, 9416 115th St., Richmond Hill, N. Y.

ADVERTISE 30 words 439 Rural Newspapers \$12.65; Inch \$35.12. Thompson Service, 818 Oak St., Cincinnati.

60 **WEEKLIES**, 25 words, \$1.95; 500 blotters, \$2.95. Commercial Adservice, 5 Pleasant, Worcester, Mass.

25 **WORDS** 88 magazines; \$1.00. Thrice \$2.00. Smith's Service, 1194, Wenatchee, Wash.

SALES PROMOTION

SALES Letters, Advertising, Sales Tax Ad Shop, Box 32, Adrian, Mich.

\$50 TO \$50,000 Daily Sales Developed During 28 years for clients by our direct mail plans, copy, campaigns. One product, 1923, an idea; this year \$100,000 orders booked. Fifty year old concern desired 50 national representatives in 1925; we produced 40 in three months. 700 dealers in 10 months at \$3 each, for another. Ten years Sales Promotion Manager Larkin Co. Submit sales problems for Free diagnosis. James C. Johnson, 118A Woodbridge Ave., Buffalo.

AUTOMOBILE SUPPLIES

SAVE 40-80%. New and Used Automotive Parts, 2,000 models. Bankrupt supplies, 5,000 bargains. Sport shields, \$5.00, roadster tops, \$10.00, complete touring, \$15.00. Wheels, radiators, generators. Brightman Auto Exchange, 321 Windsor Ave., Hartford, Conn.

TUNGAR Bulbs—Increase their lives 30% to 100%. Your tools only, will do it in a jiffy. Particulars 35c. Millback, Box 3266, Tampa, Fla.

SELLING OUT—Reliable Battery Chargers, Radio or Automobile. Guaranteed. \$4.50, 5958 Washington, Chicago.

MIRROBS Resilvered at Home. Costs less. 5 cents per square foot; you charge 75 cents. Immense profits plating auto-parts, reflectors, tableware, stoves, refinishing metalware, etc. Outfits furnished. Details Free. Write Sprinkle, Plater, 77, Marion, Ind.

\$1.00 BACK if misrepresented. Guaranteed 40 below zero Radiator Antifreeze, easy to make don't evaporate, much cheaper than alcohol. Formula \$1.00. Forex Laboratories, Station C., Milwaukee.

VACUUM Ventilator, Sedans, Coupes. Brand new. Big Money, 100% profits. Thousands prospects every city. Make \$25 day easy. Salesmen's Double Outfit \$5. Beebe Co., 338P York, New Haven, Conn.

VULCANIZING Auto Tires is a Paying Business. We have Plants near you from \$50 up. Catalog Free. Instruction Book \$1. Equipment Exchange, 108 East 11th, Los Angeles, Calif.

MAGNETOS, Starters, Generators, Ignition systems, spark plugs, part, timing chains, repairing. Meinerd Magneto Co., 1759 E. 21st St., Cleveland, Ohio.

REPAIR Tires with our Vulcanizers and watch business grow. Cost little to own and little to operate. Adams-Barr, Columbus, Ohio.

AUTO Emblems. Any Lodge. Write. North Central Distributors, Dept. J, Ashland, Ohio.

AUTOMOBILES

PATENTS. Time counts in applying for patents. Don't risk delay in protecting your ideas. Send sketch or model for instruction or write for Free book "How to Obtain a Patent" and "Record of Invention" form. No charge for information on how to proceed. Communications strictly confidential. Prompt, careful, efficient service. Clarence A. O'Brien, Registered Patent Attorney, Security Bank Building (directly across street from Patent Office), Washington, D. C. See pages 154 and 155.

620 **VALUABLE** kinks for all who own, drive, repair or care for automobiles, only 98 cents. Write us to send you Popular Mechanics Auto Owner's and Auto Repairman's Handbooks. Fully illustrated. Pay Postman 98 cents and few cents postage. Popular Mechanics Press, Room 902, 200 E. Ontario St., Chicago.

SHOP Notes for 1927. Get your copy now. Only a limited edition. Contains all the articles published in the Shop Notes department of Popular Mechanics Magazine during 1925. Send No Money. Just write a postal and we'll send 1927 Shop Notes and any one of the other following numbers: 1908, 1912, 1913, 1914, 1915, 1916, 1917, 1919, 1920, 1921, 1922, 1923, 1924, 1925, 1926. Pay postman 98 cents and the postage when he hands you the two books. Popular Mechanics Press, 200 E. Ontario St., Room 902, Chicago, Ill.

AUTOMOBILE SERVICE EQUIPMENT

AUTO Repair Shop Lathe 9"x3". Back Geared, Screw Cutting; price, including countershaft and equipment, \$150.00. For truing armatures, refacing valves, finishing pistons, making bushings, thread-cutting, etc. Write for No. 33 Auto Mechanics Hand Book describing this lathe. South Bend Lathe Works, 736 East Madison St., South Bend, Ind.

BIGGEST profits in automotive field from Starting-Lighting-Ignition Service with Low-Priced HB Test Bench. No investment required aside from small initial payment. Pays for itself with handsome net profit besides. Write for free bulletin TB. The H. B. Equipment Co., Box M-272, Troy, Ohio.

KING earns \$300 monthly charging batteries by approved fast method. Does three times the work at half the cost of old methods. Cost him only \$16.50 and paid for itself every month. You can handle it in small space without special experience. Write for Bulletin CP. One Day Charger Co., Box M-273, Troy, Ohio.

75% **INCREASE** in business the first month after Coleman put in dependable air service. Easy monthly payments easily carried by increased business. Highest quality, latest principle, most economical 3/4 HB Automatic Compressor built. Write for Bulletin AC. Automatic Compressor Co., Box M-274, Troy, Ohio.

COMMUTATOR and valve truing lathe. Jefferson Mfg., North 2nd St., Fairfield, Iowa.

FOR FORD OWNERS

FORD Flat Rate Price List; Total Cost of Repair Jobs; Agents big money. Only 50c. H & H, 5778 Rivard, Detroit, Mich.

STARBUCK vaporizer has an electrical attachment that makes starting in cold weather easy. Big gas saver. Soon pays for itself. F. M. Starbuck, 642 D St., Northeast, Washington, D. C.

FORD lamp door opener, postpaid, \$1.25. Peter La-Void, Viroqua, Wis.

UNDERSLUNG with "RKO" Swing L0 Irons. See "Red-1-Kut" ad page 151.

MOTORCYCLES, BICYCLES AND SUPPLIES

OVERSTOCKED Used Motorcycles. 1923 Indian Chief \$95.00. 1923 Harley Davidson \$95.00. 1923 Henderson DeLuxe \$120.00. Two hundred others; write for free list. Myerow Brothers Co., 15 Berkeley St., Boston, Mass.

SEND stamp for Bargain Bulletin. All makes rebuilt motorcycles at lowest prices. Used parts half price. Ash Motor Corporation, Rochester, N. Y.

BEST offer, slightly used Chief and sidecar. Stewart Marshall, Rome, Ga.

MONEY Saving Motorcycle Bargains—Large stock of Used Harley-Davidson—\$50 and up. Send for FREE bargain bulletin—Now! Motorcycle Parts, accessories, repairs for all makes. Knuth's Harley-Davidson Agency, 2525 Fond Du Lac Ave, Milwaukee, Wis.

DON'T buy a Bicycle Motor Attachment until you get our prices. Shaw Mfg. Co., Dent, 27, Galesburg, Kans.

NEW and used Motor Cycle Parts. Tower Cycle Co., 3604 Kingsland Ave., Pine Lawn, Mo.

AUTOMOBILE—Make your own motor car, toy size, operated with motorcycle engine. Any boy can make it. Costs little aside from engine. Full directions with drawings and dimensions in The Boy Mechanic, Book 3. Send No Money. Pay postman postage and \$2. Popular Mechanics Press, Room 902, 200 E. Ontario St., Chicago, Ill.

AVIATION

LEARN flying right. Latest type planes. Large field. Ideal flying climate. Graduates real pilots. Rates reasonable. Address, McMullen Aviation School, Tampa, Fla.

AIRCRAFT Material—Plans and various types of engines—suitable for marine, stationary, and automobile use also. Catalogue on request. Build your own plane (Canuck) from new materials, by our part payment plan. Complete stock of JN and Canuck plane parts, OX-5 motor parts. Cables, all sizes, lengths up to 8", with turnbuckles and clevises—50c. Perfect for sagging doors, gates, radio mast braces, tow ropes, etc. Many other special offers. Monumental Aircraft, Inc., 339 N. St. Paul Place, Baltimore, Md.

PATENTS. Time counts in applying for patents. Don't risk delay in protecting your ideas. Send sketch or model for instruction or write for Free book "How to Obtain a Patent" and "Record of Invention" form. No charge for information on how to proceed. Communications strictly confidential. Prompt, careful, efficient, service. Clarence A. O'Brien, Registered Patent Attorney, Security Bank Building (directly across street from Patent Office), Washington, D. C. See pages 154 and 155.

HEATH propellers, winners in speed and efficiency at the Philadelphia light plane races, are individually designed and when used on airplanes, sleds, boats, etc. they will give real results. Prices surprisingly reasonable. Send 4c for propeller circular. Blueprints of new Heath sport plane now ready. Easy and inexpensive to build, using motorcycle motor. Blueprints \$5.00. Heath Airplane Company, Chicago.

AIRPLANES, motors, supplies; 100 H. P. Gnome Rotary Motors \$75.00 Florida; 28 H. P. Lawrence Motors \$125.00; Curtiss 90 H. P. slightly used \$250. Sheep-lined leather helmets \$5.00; non-shatterable goggles; oval \$2.50, wide-vision \$4.00. Temperature gauges with 12 ft. tubing \$7.50. Leather breeches \$12.00; leather coats \$18.50, or sheep-lined \$23.50. Aerial Camera \$100. Airplane Turnbuckles 15c. Logan Aircraft, 716 W. Superior, Cleveland.

TEN lessons in the air of twenty minutes each will make you a pilot by our advanced method of training. This, together with our five weeks shop course, at \$190.00, makes America's oldest aircraft factory the most popular flying school. Work after class hours guaranteed. Special winter evening course, including shop work, field and flying, \$100.00. Employment furnished during the day, paying \$20.00 to \$40.00 per week. Heath Airplane Company, Chicago, Ill.

AERONAUTICS! Are you keeping pace with the new developments? "Aeroplane Engines in Theory and Practice," by Rathbun describes engines fully. Used as a text in Government Schools and includes all makes. For Mechanician, builder and flyer. Send no money. Just order on a postal. When postman hands you book, pay him \$2.50 and postage charges. Popular Mechanics Press, Room 902, 200 E. Ontario St., Chicago.

COMPLETE Scale Plans, with Building-Flying Instructions for following 3-ft. Model Aeroplanes, 25c each postpaid; Fokker North Pole Monoplane; JN4D-2; DeHavilland; NC4; Blériot; Neuport or Taube Monoplanes; Cecil Peoli Racer. Complete 48 pp. catalog 5c; listing hundreds of parts and supplies for experimenters. Ideal Aeroplane Co., 185½ Spring Street, New York.

AIRPLANE, boat, sled propellers. Build speedy "Aerodrive" sleds, boats from our blueprints of either type, priced at \$1. Fine leather helmets only \$3. Aircraft supplies list 5c. Everything aeronautical! Ostergaard Aircraft, 4269 North Narragansett, Chicago.

THE American School of Aviation announces a new correspondence course in Mechanics of Aviation. A thorough training in Practical Aeronautics. American School of Aviation, Dept. 1861, 3601 Michigan Ave., Chicago, Ill.

28 H. P. 2 cyl. Lawrence airplane motors, New \$75.00; used \$65.00; Remanufactured Curtiss 90 H. P. motors, guaranteed and block tested, \$225.00. Heath Airplane Company, Chicago, Ill.

EARN \$3,500 to \$10,000 a year. Prepare for flying. Complete home study in mechanics of Aviation. Write for free Catalog. Western Airplane Corporation, Desk K-2, Monadnock Block, Chicago.

GET In The Flying Game; Hundreds will be needed. Prepare yourself now. Complete elementary course. Postpaid \$1.00. James Aircraft Company, Box 640, Allentown, Pa.

THREE foot model aeroplane. Price \$1.00. Circulars free. Aero Shop, 3050 Hurlbut Ave., Detroit, Mich.

AIRPLANES. Send for free cuts, and plans of our wonderful two place, companion type, small, high lift wing monoplane, and information how to build this ship, and be sure it will fly, also propeller literature. Crawford Airplane Mfg., 2225 American Ave., Long Beach, Calif.

DICTIONARY of Aviation, \$3.00. Languages Publishing Company, 8 West 40th Street, New York.

WANTS—To learn flying near Newark, New Jersey. Climax, 769 Hunterdon Street.

PREPARE in Your Spare Time to Fly and Build Airplanes. Flying and Evening Shop Course \$150.00. Shop Course only, \$15.00. Wallace Aircraft Co., 4710 Irving Pk. Blvd., Chicago, Ill.

LEARN Aviation at America's Foremost School. Earn your tuition if you lack the cash. Send 25c to Box 502, Peoria, Ill., for full particulars.

THE Age of the Air Is Here. For reliable information on both airplane building and flying we recommend, "Aeroplane Construction and Operation," by Rathbun, a book used in Government Schools. All features of construction treated. Send no money. Pay postman \$2.50 and postage. Popular Mechanics Press, Room 902, 200 E. Ontario St., Chicago, Ill.

BOOKS AND PERIODICALS

PRACTICAL Psychology Teaches Hypnotism, Personal Magnetism, Magnetic Healing, Auto-Suggestion, Cure Habits and Disease. Easy Lessons. Send for Booklet, 4 cents stamps. Fernando, Dept. M, Springfield, Mass.

HYPNOTISM easily learned. Lessons guaranteed. Postpaid \$1.10. Smith Pub. Co., Dept. 3, Springfield, Mass.

FOODS from Twenty Lands. Popular Mechanics new Cook Book made up of recipes sent by our readers from 20 countries. Many delightful foreign dishes, and many American ones, too. Only a few copies for sale. Send No Money. Just order on a postal. When postman hands you book, pay \$1.50 and postage charges. Popular Mechanics Press, Room 902, 200 East Ontario St., Chicago, Ill.

AUTHORS write for circular "Cooperative Book Publishing." Meador Company, 27 Beach, Boston, Mass.

HOW to Make and How to Mend. 1,000 articles telling how to repair almost everything in use or needed about a home or farm. Many illustrations, formulas and trade secrets. Especially for amateur mechanics. Send no money. Just ask for "How to Make and How to Mend." Pay postman postal charges and \$1.00. Popular Mechanics Press, Room 902, 200 East Ontario St., Chicago, Ill.

READ "Macon Moore," real good Detective Story, 250 pages complete, 50c postpaid. List of many other instructive and entertaining books included. J. Rodgers Hoggard, Publisher, Windsor, N. C.

REPAIRS about home easily made with instructions in our new book. Tells exactly how to use tools, sharpen tools and cutlery, repair furniture and cabinets, upholster, work metal, solder, work glass, paint, stain, varnish, hang paper, repair plumbing, repair furnace, repair electrical equipment, repair shoes, repair harness, repair gloves, repair concrete work. Send No Money. Just write a postal and ask for "The Practical Book of Home Repairs." When postman hands you the book, pay him \$2.50 and the postal charges. Popular Mechanics Press, Room 902, 200 East Ontario St., Chicago, Ill.

"COLOR Mixing Guide" \$1.00—Book Stores, Fine Arts Pub. Co., 2633 College, Indianapolis, Ind.

HYPNOTISM wins health, wealth, fame, love. 25 easy lessons and 248 page illustrated reference guide No. 2. Popular Institute, F439, Milwaukee Ave., Chicago.

LEARN Character Reading from Handwriting. Wonderful Book, only 20c. Free catalog. F. & R. Co., Hoboken, N. J.

BOOKS, all kinds 5c. U. Library, H Essex St., Boston, Mass.

CURIOUS Books, Unique Novelties, Stunning Pictures. Samples, 10 cents Prepaid. Linds, 214 W. 34th Street, New York.

DYKE'S Automobile Encyclopedia. Latest 14th edition. Information on repairing and adjusting every part of all motor cars. How to find trouble, and fix it. Send No Money. Pay postman the postage and \$6. Popular Mechanics Press, Room 902, 200 E. Ontario St., Chicago, Ill.

OUTDOOR Opportunities. Instructions for raising and selling rabbits, guinea pigs, milch goats, silver foxes, ferrets, white rats, white mice, dogs, cats, pigeons, pheasants, bantams, canaries, bees, frogs, mushrooms, ginseng, and golden seal. All profitable on town lot. Send No Money. Simply write a postal and say: "Send me Outdoor Opportunities." Pay postman \$1.50 and postal charges. Popular Mechanics Press, Room 902, 200 East Ontario St., Chicago, Ill.

PICTURES AND POSTCARDS

EXCHANGE Postcards! Interesting, educational. Membership and List 25c. Popular Exchange, Windsor, N. C.

TRUE-BLUE friends exchange postcards, stamps. Membership, 25c. Interesting Club Book, 10c. Ericson, Elroy, Wis.

JOIN Live Postcard Club; membership lists, including catalog, 10c. Harvey Teeple, Decatur, Ind.

ART Pictures, Books and Novelties. Catalog 10c. Howard Sales Co., Dept. 15, 1188 Folsom St., San Francisco, Calif.

GAMES, ENTERTAINMENTS AND PLAYS

PLAYS, musical comedies and revues, minstrel music, blackface skits, vaudeville acts, monologs, dialogues, recitations, entertainments, musical readings, stage handbooks, make-up goods. Big catalog free. T. S. Denison & Co., 623 S. Wabash, Dept. 11, Chicago.

VENTRILQUISM taught almost anyone at home. Small cost. Send 2c stamp today for particulars and proof. George W. Smith, Room S-150, 125 N. Jefferson Ave., Peoria, Ill.

100 **LIGHTNING** Chalk Talk Stunts \$2.00. Cartoonist, 2925 Euclid, Kansas City, Mo.

CHALK-TALK your way to popularity. Audiences at your feet if you learn how to entertain with a few simple pictures. Little artistic ability needed. "How to Chalk Talk" tells what to say and what to draw. Profusely illustrated. Make \$10 and more a night. Send No Money. Just order on a postal. Pay postman \$1.00 and postage. Popular Mechanics Press, Room 902, 200 East Ontario St., Chicago, Ill.

NOVELTIES, CURIOS, ETC.

SMOKE Ring Blower is a knockout. Blow rings with your cigar, pipe or cigarette. Introducing at 15c each, or 2 for 25c. Order now. F. Kelly, 3438 Minnesota Ave., St. Louis, Mo.

MAGIC TRICKS, BOOKS AND JOKER NOVELTIES

LOOK Here! All for 15c. We want to introduce our goods all over the country, and accordingly make this great offer: If you will send us 15 cents (silver or stamps) we will mail at once, all the following, complete: Game of Authors, 48 cards with full directions; Complete Set of Dominoes, in compact and handy form; Chess Board, with men; Checker Board, with men; Fox and Geese Board, with men; Nine Men Morris Board, with men; Game of The Spanish Prison—very puzzling; Mystic age table, to tell the age of any person, young or old, married or single; 14 pictures of married life; 10 amusing Parlor Pastimes—enjoyment for the entire family; 16 astounding feats in Parlor Magic; 40 amusing and interesting experiments in Chemistry; The Slipped Card with 14 other, equally good Card Tricks; The Game of Fortune—for ladies and gentlemen; Magic Music, Order of the Whistle, and 5 other good games; 10 amusing readings—alone worth the price of the entire package; 250 Jokes, Conundrums, and Riddles—with answers; 73 Toasts—suitable for every occasion; 7 different methods for Telling Fortunes; 3 long monologues; 5 humorous recitations—enough to make your sides burn; 53 Money Making secrets—some have sold for as high as \$100.00 apiece. We guarantee this package is worth ten times the amount we ask for it. It is the best collection of Games, Magic, etc., ever offered by any firm in America. Just Think! It will amuse and instruct the whole family circle for months. Remember that our price is only 15c for all the above, which are in one package. We will send six packages for 75c. Benedek Supply House, 2300 N. Mason Avenue, Chicago, Illinois.

FOR something different, send 10c for "Fun-Magic-Mystery." New 80-page Book of 500 Tricks. Also contains Catalog largest line Magic Tricks and Supplies in South, at lowest prices. Send 10c today! Lyle Douglas, Station A, Dallas, Texas.

NEW Sensational Wrist Shackle Escape only 85c complete. Wonderful bargains in other tricks and illusions. Catalogs free. Sample trick 10c. F. & R. Co., Dept. F, Hohen, N. J.

MAGIC—Tricks, Books and Supplies. For Amateurs as well as the great professionals. Anyone can learn through our instructions. Feature Acts in Mind-Reading, Spiritualism, Rope Ties, etc. Large illustrated Professional Catalog, 20c. Chicago Magic Co., 140 So. Dearborn St., Dept. B, Chicago, Ill.

MAGIC easily learned with our modern tricks and instructions. Astonish others. Packet of secrets and new illustrated catalog of magic for stage and parlor, 10c. Piedmont Novelty Shop, Box 631, Danville, Va.

FREE—Our puzzle, trick, game, joke, Novelty Catalog. Wright & Son, 601-G Indiana Ave., Peoria, Ill.

MAGICAL mysteries—Entertaining Novelties, tricks, puzzles. Catalogue free. Schembri, Box 1124, Detroit, Mich.

BOOKS, Magic, Mysteries, Magic Tricks, Novelties. Catalog Free. Singer, 555, Hancock, Wis.

ESCAPE King's set 5 magic keys, 50c; Padlock Escape Act included free. Graef, 3310 Herndon, Chicago.

SUITCASE full Magician's Apparatus; 75 tricks, \$5.00; also Magic Library for sale. Gray, 3310 Herndon, Chicago.

MAGIC tricks. Card tricks. Coin tricks. Hypnotism. Ventriloquism. 64 page book. Complete guides, 10c each. Geo. Fenner, 2401 Jefferson, Louisville, Ky.

FIVE card tricks and catalogs 25c. Midwest Novelty Sales, 7609 Drexel, Chicago.

FREE with \$25 order die box. Send 20c for our large catalogue of tricks, wigs, sensational escapes. Oaks Magical Co., Dept. 548, Oshkosh, Wis.

SEVEN Magical Delusions and Catalogs—25c. Glimagico, Morgan Park, Ill.

READ sealed messages in dark; messages retained by audience; burned message appears on blank slate; spirit message appears on slate in sifter's presence; spirit rappings; spirits appear in the dark; answer questions written on folded papers while blindfolded. All this you can do with directions in "Behind the Scenes with the Mediums." 69 best secrets of mediums fully exposed. The best because most baffling, yet all easy to do. Send No Money. Just write a postal. Pay postman \$1.50 and postal charges. Popular Mechanics Press, Room 902, 200 East Ontario Street, Chicago, Ill.

STAMP COLLECTING

JUST What Every Stamp Collector Wants. Free. The new 1927 Scott Price List is just out, brimming full of wonderful bargains. Hundreds of Scott Seal packets, sets, and dime sets of guaranteed genuine stamps. Many attractive new packets and sets that every collector, advanced or beginning, should know about. Prices that make every item a real bargain. Also describes the complete line of Scott Albums, from 60 cents to \$55.00; catalogues, hinges, tongs, magnifying glasses, watermark detectors, millimetre scale and perforation gauge and all other accessories needed by the collector. This big illustrated price list of more than 80 pages is free for the asking. Write for it now. Scott Stamp and Coin Co., 1 West 47th Street, New York, N. Y.

500 DIFFERENT Stamps for 25c! Big Collection 500 Different Stamps from Bosnia-Herzegovina, Crete, Epirus, Hong Kong, Iceland, Kenya and Uganda, Liberia, Malta, Nyassa, Tanganyika, Wallis and Futuna, Zanzibar, and other "hard" countries. Catalogue value \$10.00. Price only 25c to Approval Applicants! Special Bargains: 1,000 different 79c; 15 triangle stamps 49c; 100 Africa 50c; 100 Asia 60c; 100 Balkan States 35c; 100 British Colonies 25c; 100 French Colonies, 30c; 100 Portuguese Colonies 50c; All 8 packets for \$3.00! Illustrated Lists Free. Loma Stamp Co., 2221 Madison Ave., San Diego, Calif.

ANCHERS \$\$\$ Outfit—only 12c! Fine triangle stamp; set German stamps with (pre-war) value forty million dollars (interesting!); perforation gauge, mme. scale; small album; airmail set; scarce stamp from smallest republic on earth; newspaper set; packet good stamps from Travancore, Johore, Dutch Indies, etc. Entire outfit for 12c to approval applicants! (Nice pocket stock book, value 25c, with every order!) Ancher Stamp Co., 148½ Clerk St., Jersey City, N. J.

200 DIFFERENT Stamps Free to Approval Applicants. Wm. Shuford, 400 N. Avenue 64, Los Angeles, Calif.

SNAPS—Offer No. 1—300 Different Foreign, 65 Different U. S. Stamps including \$1 and \$2 values, All For 25c. Offer No. 2—70 different Foreign Stamps from 70 Different Countries, including Africa, Asia, Australia, Europe, West Indies, etc., Only 10c. Offer No. 3—Stamp Album, providing spaces for 2,220 stamps, with 700 illustrations, packet of 500 different stamps, 500 hinges and millimeter measure, all for only 50c, A big bargain. Free with each order, our pamphlet which tells "How To Make a Collection Properly"; also price list of albums—supplies and hundreds of bargains in sets and packets. Queen City Stamp Company, Room 36, 604 Race Street, Cincinnati, Ohio.

"MYSTIC'S 'Queer Country' Packet! Contains scarce stamps from the following strange lands: Alaouites, Antioquia, Corea, Cyprus, Fiji Islands, Gwallor, Hyderabad, Iceland, Jhind, Kenya Uganda, Lebanon, Monaco, North Borneo, Nyassa, St. Thomas Prince, Port. Guinea, Siam, Sierra Leone, Tanganyika, Trinidad Tobago, Ubangi, Upper Volta, Wallis Futuna, Zanzibar. Get this wonderful packet of "freak countries" and make your friends envious! Price only 10c to approval applicants! Write today. Mystic Stamp Company (Dept. 8), Camden, New York.

\$1.00 FREE. Black U. S. Postage. Given Away with each order. Pioneer Stamp Album with 500 illustrations, 150 different stamps from 40 countries, Syria, Lebanon, Hejaz, Liberia, New French Colonies, British, Portuguese Colonies, South Africa, Australia, 500 hinges, 36 page illustrated catalogue. All for 15c. Big Commission to Agents for the Best approval sheets of stamps ever offered. Write for sample outfit. Hussman Stamp Co., Dept. M, 620 Olive St., St. Louis, Mo.

MOST Sensational values; over 140 diff. Algeria, Airplanes, Azerbaijan, Barbadoes, Cameroun, Gabon, Guyane, Irish set, large French Colony packet, largest stamp, 49 year old U. S., gauge, etc., for 10c to approval applicants. List free. 100 diff. U. S. 25c—1,000 hinges 9c—50 Bavaria 7c. Hawkeye Stamp Co., Cedar Rapids, 39, Iowa.

OUR Latest 20-page U. S. and Canadian price list free. Stanley Gibbons, Inc., 37 Ann St., New York City.

BIG Free Offer—Large illustrated list of good stamps and sets at bargain prices; also fine packet 47 different stamps from Camerouns, scarce Costa Rica (cat. 30c), Niger Coast, etc.—all absolutely free. Enclose 4c for postage, etc. Shaw Stamp Co., Bear River, Nova Scotia, Canada.

BEST one-cent approvals in America. F. P. Hand, 1117 So. 60th St., Philadelphia, Pa.

UNION South Africa, Triangles, 2 different, 14c. Splendid British Colonial approvals. Fred Bullham, Lake Avenue, Racine, Wis.

1,000 UNUSED Stamps 75c; 1,000 different, .80; 2,000, \$3.50; 3,000, \$9.00. Fred Onken, 630 79th Street, Brooklyn.

INDIA, Tete-Becce. Kishengarh. Rare pair Cataloging \$2.50 for only 25c to applicants for our Super-Approvals. References. Arthur Barger & Company, 839 Beacon Street, Boston, Mass.

PENNY Approvals that Satisfy. Neil Gronberg, Box 5411, Philadelphia, Pa.

150 GOOD mixed foreign stamps, 3 cents. Stanton, Niantic, Conn.

FINEST one-cent approvals in the United States. Stanton, Niantic, Conn.

BEAUTIFUL Selections on Approval. Dan Reid, 608 Yonge Street, Toronto.

FREE 25 different French Colonials to approval applicants. Prall, Somerville, N. J.

STAMPS—Packets, approvals. Beauty packets 10c each; Mozambique, Togo, Trinidad, Congo, 120 others. Reynolds Stamp Co., Flint, Mich.

500 MIXED U. S. and foreign stamps 15c. Glenwood Stamp Co., 30 Athol Street, Springfield, Mass.

SEND for free packet stamps. J. W. Whittaker, 48 Blake St., Stratford, Ont., Canada.

200 — 200 — 200 — 200 — ALL different stamps; 200 hinges; approval sheet to hold 200 stamps; perforation gauge, millimeter scale and ruler; duplicate stamp container—all for only 15c to approval applicants. Edgewood Stamp Company, Milford, Conn.

NEWFOUNDLAND Stamp Bargains! 38 face different One Dollar; 24 for 25c; 15 for 10c; 80 Scotts varieties \$10. Illustrated Catalogue 10c. Rev. Butler, St. Georges, Newfoundland.

THE Mystery Packet! Stamps from Rinds of Cannibals, sun worshippers, wild savages! including Albania, Bosnia, Chad, Congo, Cochin, Dominican, Guadeloupe, Gold Coast, Kouang-Tcheou, Malay, Togo, Travancore, Ubangi, and other far-off places. Hundred stamps (all different) 5 cents to approval applicants only. 11 illustrated lists free. Write Today! Special 500 all different stamps 30c, 1,000 same 89c; 50 different German Colonies \$1.78; 100 same (fine) \$4.55; 150 same \$9.00. C. D. Reimers, 9 Flatiron Building, Fort Worth, Texas.

SCARCE-BLOCK 4 unused Le Roy pre-cancelled Stamps, 20 cents postpaid. Hurry. Clarke's Stamp Department, Le Roy, N. Y. 108 STAMPS, Chad, etc., album, 4c to approval applicants. Hill, Leonard St., Waltham, Mass.

SERBIA, 1904, Death—ks. 8 Varieties complete. Catalogues \$2.50. Price 50c. Bier, 91—69th Street, Brooklyn, N. Y.

STAMP Collector's Outfit—Fine for beginners—15c. Regular \$1.00 Value. Interstate Company, 1769 East Eldorado, Decatur, Ill.

109 DIFFERENT, Abyssinia, Azerbaijan, Zanzibar, etc. 10c to approval Applicants. Floyd Marsh, 524 Hamilton Ave., Indianapolis, Ind.

103 DIFF. Newfoundland, etc., 3c. Supreme, 2335-7 S. Turner, Chicago.

DANZIG Stamps Free—Interesting packet from Danzig with big catalogues free for 2c. Midland Stamp Company, Toronto, Canada.

UNBEATABLE: 1,050 Different (Cat. \$26) for \$1. McFadden, 9 E. Third, St. Paul, Minn.

UNUSED United States stamps at face value; more than 100 varieties, at Government Philatelic Agency. List and information, 10c. C. E. Nickles, 211 Seaton, N. E., Washington, D. C.

22 DIFFERENT Coins, 50c. 4 different 10c. Otto Oddehon, Kansas City, Mo.

STAMPS at 50% to 90% discount. Fine stock. Mammoth Lists free. Ioor, 802 State Life Building, Indianapolis, Ind.

ROMANIA, No. 154—161. Catalogue Value \$2.73, price 60c! Bargain list free. Setwell, 2317 Cortelyou Road, Brooklyn, N. Y.

FREE—50 Different to Approval Applicants. Carlton Bain, 89 Magazine, Cambridge, Mass.

STAMP Album Free, spaces for 1,200 stamps with purchase of 50 stamps from 50 different countries for 25 cents. B. Nagle, 1101 Marion, Reading, Pa.

10F. DIFFERENT, from 53 countries, 10c. Leufbery, Port Orange, Fla.

FREE, 155-page cloth-bound book entitled "Stamps As An Investment." Write for information. R. D. MacGuffin, Narberth, Pa.

BUY collections without purchasing duplicates. Write Farley Stamp Co., Auburndale, Mass.

\$1.00 U. S. STAMP to Approval Applicants. 2c Postage. Jones, 828 South Williams, Denver, Colo.

STAMPS—1,000, 25c; 500 different, 30c; 1,000, 80c; 2,000, \$3.25. Album holds 2,000 stamps, 60c. Michael, 4444 Clifton, Chicago.

"INTERNATIONAL" Set and Packet Collection! Six sets: "Jubilee," "Charity," "Airstop," "Eagles," "Prisoners," "Pictorialis." Four Packets: British, French, Dutch Colonies; Precancels; Bulgaria; "International" 15c Approvals, Adults, Juniors. Deering, Fairmount, Marlborough, Mass.

200 STAMPS, Bargain List, Magazine 15c. Approvals. Harvey Teeple, Decatur, Ind.

STAMPS on approvals 1/4c up. Free premium, Herbert Keigwin, Middletown, N. Y.

1,000 DIFFERENT Fine Stamps—69 cents. Approvals. Kenilworth Stamp Co., Ridgewood, N. J.

FREE 100 Stamps, postage 2c. Approval applicants. Dennie, 7763 Logan, Detroit, Mich.

MAGNIFICARCIUS Packet Foreign Stamps, Beauties from Distant Lands. (Many Richly Colored unusual designs) free for 2c. Gray Stamp Company, Toronto, Canada.

FINE Stamps on approval at 65% discount. National Stamp Co., Box 417P, New Kensington, Pa.

44 STAMPS from 44 different countries. 4c. Lists free. Harold Shepard, Hyattsville, Md.

EXCHANGE stamps, postcards. Membership, 25c. Interesting Club Book, 10c. Erickson, Elroy, Wis.

NET Approvals. Try these. Reference Please. Premium. Tower Stamp Co., 42 Westville St., Dorchester, Mass.

TRIANGLES! 75% Discount—Special approval sheets with each 5c packet containing set triangles, 2 sets war tax, set airplane, U. S. stamp before 1880, etc.; over 100 different stamps. Murray Stamp Co., 515A Tower Bldg., St. Louis.

500 DIFFERENT Free to approval applicants. G. A. R. A2256 Maypole, Chicago.

110 NEW Europe All Different, a wonderful collection cataloguing several dollars, free to collectors requesting our Net Approvals. Postage 2 cents. Badger Stamp Co., Milwaukee, Wis.

TRIANGLES—Ten different triangle stamps 10 cents to approval applicants. Paul Revere Stamp Co., Box 24, Back Bay, Boston, Mass.

JUNGLE Packet contains stamps from Abyssinia, Congo, Kenya, Nyassa, Mozambique, Ubangui, Tanganyika and other savage lands. Only 10 cents to approval applicants. Fenway Stamp Company, 161 Massachusetts Ave., Boston, Mass.

FREE Hungary Charity No. 565 to 567 and a surprise packet given to those requesting for my 1, 2, and 3c approvals, and also my 50% discount. Chas. W. Schmidt, P. O. Box 4832, Frankford Station, Philadelphia, Pa.

STAMPS, 100 varieties, Africa, Brazil, Peru, Cuba, Mexico, etc., 10c. 50 different U. S. 25c; 1,000 mixed, 40c; 1,000 hinges, 10c. List free. C. Stegman, 5941 Cote Brillant, St. Louis, Mo.

500 DIFFERENT only 25c (regular price 50c), many unused, from British, French, Italian and Portuguese Colonies, Chile, Fiume, Guatemala, Persia, Siam, etc., to all approval applicants. Big bargain lists free. Victoria Stamp Co., London, Can.

BORNEO, Malay, Liberia and 105 other Different Foreign Stamps, Hinges and Lists with Approvals 9c. 55 Different United States, including Commemoratives, 10c. Fennell Stamp Co., Dept. M, St. Louis, Mo.

ELEVEN Wonderful Stamps 10c to 1c, approval applicants. Richard Stolt, 2135 Cleveland Ave., Chicago.

FREE Mammoth Illustrated Price List of wonderful bargains in packets and beautiful sets. 12 scarce Azerbaijan free to approval applicants. Pennsylvania Stamp Co., Greensburg, Pa.

FREE—Canadian \$1.00 stamp to approval applicants. Stanley Munday, 112 Irvine Avenue, Westmount, P. Q., Canada.

STAMPS on approval, many very old ones. Harry S. Humphrey, Jr., "The Maples," Joliet, Ill.

100 DIFFERENT. French and British Colonies, Dutch Indies, Ireland, Japan, Siam, South America, etc. Only 5c to approval applicants. General Stamp Co., Box 2866, Denver, Colorado.

ONE Hundred Stamps from one hundred countries. 30c. Plotz, 476 Clinton Avenue, Albany, New York.

500 DIFFERENT, 24c; 1,000, 59c; 2,000, \$2.39. Price List free. Wineholt Stamp Co., Woodbine, 26, Penna.

ALBANIA—Five Different—12c; One Brunel, 3c; two Nauru, 9c; one Rarotonga, 3c; four Tanganyika, 15c. Free—New Issue Packet to Approval Applicants. Liberty, 3974 Arsenal, St. Louis, Mo.

FREE! Rare stamp to approval applicants. Albert Behnke, Davenport, Iowa.

FREE! Guatemala Set (cataloguing \$1.25) with International Package (1,000 stamps) 35c. Walsh, 1889 Albany Ave., Brooklyn, N. Y.

24 VARIETIES Cuban stamps, 10 cents. List of 6,000 low-priced stamps free. Address Chambers Stamp Co., 111P, Nassau St., New York City, N. Y.

COVERTCO Packet, 250 varieties unused and used stamps 15 cents. Covert Stamp, 39 State, Rochester, N. Y.

1,000 ALL different stamps \$1.00. New price list of all United States stamps free. Voorhees, 7 South Dearborn St., Chicago.

PACKET of 23 stamps, no two countries alike. Packet hinges. Set of \$1 and \$2 U. S. Rev., all for 5c. P. M. Miami Stamp Co., Toledo, Ohio.

FREE! Loose Leaf Postage Stamp Album at rate of 8 pages each month given with subscription to monthly Journal. Send 2c stamp for prospectus. United Stamp Co., Marquette Bldg., Chicago, Ill.

STAMPS, 100 all different. Postage 2c. Lists free. P. M. Quaker Stamp Co., Toledo, Ohio.

TO approval applicants enclosing 10c for our Marvel Packet of 55 different from Gabon, Togo, etc., we will send—absolutely free—a genuine scarce South African triangle stamp! Curhan Stamp Co., Gloucester, Mass.

105 CHINA, etc. 2c. Album (500 illustrations) 3c. Bullard, Sta. A, Boston.

100 DIFFERENT U. S. stamps 40c; no cut squares. Approvals all countries; send reference to M. L. Cook, 527 West 46th Street, Chicago, Ill.

STAMPS sent on approval at 70% discount. Reference required. Emory Renoll, Hanover, Pa.

UNITED STATES—Send on approval. Send me your want list. Ref. Please. M. Hanna, New Kensington, Pa.

1,000 MIXED U. S. and Foreign Stamps 25c. Phil. Lunsted, Cape Cottage, Me.

FREE 40 Czecho Slovakia Stamps to approval applicants. 2c Stamp. Lightdown's, Osborne Rd., Southsea, England.

FREE, 200 different stamps to approval applicants. Auburn Stamp Co., 767 Irving, Syracuse, N. Y.

FINE Approval Selections at 60% discount. 100 stamps free for 3c postage. Write Now. Wineholt Stamp Co., Woodbine, 26, Penna.

FOREIGN Revenues, Telegraphs, Locals, envelopes, rails, etc. pretty, different, cheap. Stamped Marine Policy free to applicants with references. Vanderhoof, 1114 Logan, Denver, Colo.

200 DIFFERENT stamps 10c; 1,000 Hinges 10c. R. H. Carlton, 380 W. So. Temple, Salt Lake, Utah.

110 DIFFERENT Stamps, many unused, high values, free to collectors requesting our Net Approvals. Postage 2 cents. Christensen, Milwaukee, Wis.

SEND \$1.00 for my Approval Sheets of Foreign Stamps. Fine. 200 British Colonies, all different, \$1.25. C. Taylor, 15 Cross St., Newport, R. I.

25 BRITISH Colonies 5c. To approval applicants. Clarence Coleman, Somerville, New Jersey.

RARE COINS

RARE Coin Book 50c: Illustrates all the coins of the United States, Mexico, Central and South America; also the prices we pay for rare U. S. coins. There is no other publication, at even twice the price, that can compare with this book which is entitled "Coins of the Americas." Send for our \$2.00 set comprising fifty-cent piece, twenty-five-cent piece and ten-cent piece (all early dates); also five-cent silver, three-cent pieces, silver and nickel, two-cent piece, large cent, and half cent. Coin Bulletin mailed free to collectors regularly. If interested, write for a sample copy. Guttag Bros., 16 Exchange Place, New York City.

UNITED STATES Commemorative Half Dollars in Uncirculated Condition at Special Prices. Lincoln, \$1.29; Maine, \$1.33; Pilgrim, \$1.29; Monroe, \$1.23; Hugenot, \$1.29; Lexington, \$1.23; Stone Mountain, \$1.23; California, \$1.23; Sequel, \$1.29; Oregon Trail, \$1.29. Flying Eagle Cent and bargain price list 10c. Arcy, Box 483, Muskogee, Oklahoma.

50 WAR coins 50c. 10 Confederate bills 50c. 10 Large foreign bills 30c. Set Handsome Mexican bills 35c. Retail lists free. Nagy, 8 P South 18th, Philadelphia.

CALIFORNIA gold quarter 27c. Half 52c. 1776 Pennsylvania Colonial, 50c; \$100 Confederate 20c. A. Wylie, Wheaton, Ill.

40 OLD coins all different \$1.00; 100 different Germany War-coins, \$2.00; Stone Mountain Half-Dollar Unc, \$1.00; 20 different Broken Bank Bills Fine, \$1.00; 200 different Germany Bill Unc, \$1.00. Claud Denney, Box 315, Dallas, Texas.

OLD Coins, Large Spring Selling catalogue of coins for sale free. Catalogue quoting prices paid for coins, ten cents. William Hesslein, 101A Tremont Street, Boston, Mass.

CALIFORNIA Gold—Quarter Size, 27c; 3/4 size, 53c; 3c Piece and Catalogue, 10c Norman Shultz, Box 746, Salt Lake, Utah.

UNITED STATES and Foreign Money, Medals, Catalogue and Villa Bill 10 cents. Alexis Mengelle, Colorado Springs, Colo.

GET Profit and Pleasure in collecting Old Coins. Send 10c for Large Illustrated Coin Catalogue. You'll be delighted with it. Send for it right now. B. Max Mehl, Numismatist, Mehl Bldg., Dept. P, Fort Worth, Texas. Largest Rare Coin Firm in the U. S.

RARE Coins, Bank Bills, Stocks, Bonds, Bought and Sold. 3 different Bills, 2 Coins and Price List 10c. Geo. Best, Cedar Rapids, Iowa.

UNITED STATES, Large Cent, two-cent bronze, three-cent nickel and Bargain List, 25c. Fifteen dates large cents, \$1.00. George Coffin, Greenwood Mountain, Me.

COINS Wanted, Wholesale. Frank Saco, 735 45th Street, Brooklyn, N. Y.

FOR BOYS

MOVIE Films 175 feet \$1.00. Corona Laboratories, 227 N. Corona Ave., Valley Stream, N. Y.

IDEAS for those who like to tinker with tools, and for professional carpenters. 40 articles on saws and sawing, 17 on benches and bench equipment, 22 on doors and door hanging, 18 on lumber, 13 on mitering, 74 on tools, 22 on shop equipment, and many others—366 in all, and 229 illustrations. Send No Money. Just write a postal. Pay postman postage and \$1.50. Popular Mechanics Press, Room 902, 200 E. Ontario St., Chicago, Ill.

FILMS for Toy Machines, 200 feet \$1.50 Postpaid. Dixie Film Co., Box 2042, Memphis, Tenn.

FUN making things. Four large profusely illustrated books telling how to make almost everything from a sail boat to a toy automobile propelled by a motorcycle engine. Now \$2 per book or \$7 for the four if ordered at once. Send No Money. Just write a postal saying, "Send the Boy Mechanic Library." Pay postman \$7 and postage. For single books, specify either Book 1, Book 2, Book 3, or Book 4. Popular Mechanics Press, Room 902, 200 E. Ontario St., Chicago, Ill.

FAMOUS Bailey Handbook—The book that prepares you to pass the examination for any grade of license for Stationary, Marine and Diesel Engineers, Firemen and Boiler Inspectors in any state of the Union or any province of Canada. Flexible cover. Handy Pocket Size. Pay Postman \$2.00 plus the postage when he hands you the package. Popular Mechanics Press, Room 902, 200 E. Ontario St., Chicago, Ill.

CAMERAS AND PHOTO SUPPLIES

PHOTOGRAPHIC equipment and accessories of every description are listed and illustrated in our 228-page catalogue. It will pay you to secure a copy which is issued free, as our prices are low. We also deal in used goods which are sold under the same guarantee as new goods. Ask for our Bargain Book, Central Camera Co., Dept. E114, 112 S. Wabash Ave., Chicago, Ill.

BEAUTIFUL hand-colored genuine photograph, Niagara Falls, illuminated. Lesson on "Tinting." Both for 25 cents. Phillips, 189 Gamage Avenue, Auburn, Maine.

HAVE you a camera? Pictures on China, glass, leather, watch dials, etc. We show you how to do this from any negative for your pleasure or profit. Write for particulars. Kyograph Photo System, 21 West 17th, New York City.

GERMAN Cameras, Lenses, Bargains. Bartro, 6436 Hotel St., Los Angeles, Calif.

MODERN Photography in all its branches now taught by mail. New Successful Method. Students earning \$300.00 while learning. Big opportunity. Write for particulars and unusual offer open for short time. Dept. 3432, International Studios, Inc., 3601 Michigan Ave., Chicago.

RETOUCHING; Complete Mail-course, \$5.50. Francois (Professeur parisien), Saugatuck, Mich.

KODAK Films—Special trial offer; your next kodak film developed, 5c—prints, 2c each. Moser & Son, 1917 St. James Ave., Cincinnati.

BIG Money Saved on Photographable Lenses and Apparatus—goods exchanged; repairing done. Ralph J. Goisen, 1128 Argyle St., Chicago, Dept. P.

FILMS Developed, Special Trial Offer. Any Size Kodak film developed 5c, prints 3c each. Trial 6x10 Enlargement in handsome folder 40c. Overnight Service. Roanoke Photo Finishing Co., 209 Bell Ave., Roanoke, Va.

HAVE You a Camera? Write for Free sample of our big magazine, showing how to make better pictures and earn money. American Photography, 116 Camera House, Boston, 17, Mass.

KODAK Film—Special Trial Offer—Your next roll developed 5c, prints 3c each. Beautiful 6x10 mounted Enlargement 40c. Sameday Service. Fleet Photo Service, 1210 G., N. W., Washington, D. C.

MOTION PICTURES

FILMS: \$3.00 per reel up. Comedy, Western, Cartoon, Drama, Serial, Educational, Special Features. Best Movie Stars. Free List. Toy Film 200 Feet Postpaid \$1.50. Dixie Film Co., Box 2042, Memphis, Tenn.

NEW and Rebuilt Projectors for Theaters, Schools, Churches, Traveling Shows. Supplies and Complete Theater Equipments. Bargain Prices. Free Catalog. Monarch Theatre Supply Co., Memphis, Tenn.

\$\$\$ FOR Ideas. Photoplay Plots revised, criticized, copyrighted, marketed. Send for free booklet. Universal Scenario Company, 244 Security Bldg., Santa Monica and Western Ave., Hollywood, Calif.

FILMS—Fifty cents up. Absolute bargains. List free. Alton Films, 205 Brush Creek Blvd., Kansas City, Mo.

MOVING Pictures for home use. 1,000 foot rolls, \$3.50, 200 foot rolls, \$1.00. Send remittances with orders. Toy Film Co., 804 So. Wabash Ave., Chicago, Ill.

MOVIE cameras. 200 ft. Universal with pan and tilt tripod. Fine condition. \$225. Used 200 ft. Barker, without tripod, \$45. Thomas D. Baker, 605 W. Mercury St., Butte, Montana.

THEATRE Projector \$80.00. Film \$3.00 per reel. Stewart Marshall, Rome, Ga.

THEATRE and Roadshow Machines. Movie Cameras, Suitcase projectors, Films, Supplies. List Free. Box No. 481, General Post Office, New York.

SEND \$2.00 for startling new Cinometer. Gives exact exposure for all Movie Cameras or lenses. Fits pocket. Free Bargain List of Motion Cameras. Bass Camera Company, 109 North Dearborn Street, Chicago, Ill.

MOVIE Apparatus. New \$150 Spring Motor Movie Camera, leather case, \$37.50. Eastman Standard Negative Film 2 1/2 cents a foot. Motor driven suit case projectors \$50 to \$100. Movie Printer \$25. Movie developing outfit \$20. Air Brush \$5. Ray, 296 5th Ave., New York.

SCENERY TO RENT

WORLD'S Most Beautiful Settings for operas, plays, minstrels. Amelia Grain, Philadelphia.

EDUCATIONAL AND INSTRUCTION

YOU can have a business profession of your own and earn big income in service fees. A new system of foot correction; readily learned by anyone at home in a few weeks. Easy terms for training; openings everywhere with all the trade you can attend to. No capital required or goods to buy, no agency or soliciting. Address Stephenson Laboratory, 1 Back Bay, Boston, Mass.

STORY Ideas Wanted for photoplays and magazines. Big demand. Accepted in any form for revision, development and submission to markets. Send manuscript for free criticism. Booklet mailed on request. Universal Scenario Company, 403 Security Bldg., Santa Monica Blvd. and Western Ave., Hollywood, Calif.

USED Educational Books. Magazines bought, sold, exchanged. Write, Wm. Moorehead, Hagerman, Texas.

RAILWAY Positions. Men, 17-40, wanting positions, office or on trains. \$125-\$400 monthly, free passes, experience unnecessary, write Baker, Supt., 41, St. Louis, Mo.

CARTOONING and commercial art work easily learned with new book. Complete art course beginning with simplest drawings and leading through higher branches of illustration. Profusely illustrated. Send No Money. Just write a postal for "Commercial Art and Cartooning." Pay postman postal charges and \$1.25. Popular Mechanics Press, Room 902, 200 East Ontario St., Chicago, Ill.

WORLD-ROMIC System. Masterkey 5,000 languages. Primers, \$1.98; Arabic, Chinese, French, German, Italian, Japanese, Russian, Spanish. Languages, 8 West 40th, New York.

FIREMEN, Brakemen, Baggage men (white or colored), sleeping car, train porters (colored), \$150-\$250 monthly. Experience unnecessary. 810 Railway Bureau, East St. Louis, Ill.

BE a Laboratory Expert. Earn from \$300 to \$500 Monthly. Study Microbiology Sanitation. Day, Evening classes. Diplomas, Degrees Granted. 71-piece outfit Free to students. Write for Free Prospectus To-Day. International College of Microbiology, 2517 N. 76th Ave., Chicago, Ill.

ARE You Interested in Writing short stories, poems, songs, photoplays, For Profit? Then send for our new edition of actual letters from prominent editors, who want your manuscripts. It's Free if you send for it Now. Address M. Mendelsohn, Editor, Dept. 102, Writer's Digest, 22 E. 12th St., Cincinnati, Ohio.

SPEECHES. No matter where you must speak, here is help. 366 pages of instruction and anecdotes, toasts and complete speeches for the amateur or professional. Send No Money. Simply write a postal for "Speeches, Their Preparation and Delivery." Pay postman postal charges and \$1.25. Popular Mechanics Press, Room 902, 200 East Ontario St., Chicago, Ill.

LIGHTNING trick cartooning. Complete course, \$1.00. Cressman, Washington, N. J.

USED educational matter sold on purchase basis. Also rented and exchanged. Money-back guarantee. Catalog free. (Books, etc. bought.) Lee Mountain, Pisgah, Ala.

POCKET Drawing Board, T-square, triangles, etc., book on mechanical drawing. 35c. Box 256, St. Louis, Mo.

FORGED decorative articles. Andirons, fireplaces, scroll and grille work, lamps, candle sticks, coat hangers, knockers and other hand-forged decorative articles can be made with instructions in new printing of "Hand Forging," by Thomas F. Googerty. Profusely illustrated. Send no money. Write a postal asking for Hand Forging. Pay postman postage and \$2.09. Popular Mechanics Press, Room 902, 200 East Ontario St., Chicago, Illinois.

MEN wanting forest ranger positions. \$1,500-\$2,400. Write for particulars and list Natl. forests. Mokane, A-21, Denver, Colo.

EARN \$25 weekly, spare time, writing for newspapers, magazines. Experience unnecessary. Details Free. Press Syndicate, 981, St. Louis, Mo.

INSTRUCTION books, all kinds. Catalogue free. Wineholt Book Co., Woodbine, 4, Penna.

DOUBLE Entry Bookkeeping mastered in 60 hours with 8 keys; guaranteed; diplomas. International Bookkeeping Institute, Dept. 8, Springfield, Mo.

MAKE a Telescope; Join ranks of enthusiastic group of amateur astronomers. Fascinating subject treated in new book, only one published in America, "Amateur Telescope Making." Pay postman \$2 and few cents postage on delivery. Popular Mechanics Press, Room 902, 200 E. Ontario St., Chicago, Ill.

USED educational matter. Lowest prices; terms. Catalog free. Mention Subject. Fred Goetz, 440-A Sansome, San Francisco.

COMPLETE book on Magic. 563 pages; 318 illustrations. Hundreds of tricks. The standard book for years. Make money giving magic entertainments. Send No Money. Just ask for Prof. Hoffman's "Modern Magic." Pay postman postal charges and \$2.00. Popular Mechanics Press, Room 902, 200 East Ontario St., Chicago, Ill.

RADIO OUTFITS AND SUPPLIES

NO more battery troubles! Wonderful invention eliminates "B" batteries. Costs only \$7.95. Details on page 176. Roll-O Radio Co., Cincinnati, Ohio.

TRANSFORMERS for UX213, Raytheon or chemical "B" Supply, \$4.25; 50H chokes, \$2.00; 30H choke, \$1.75. Write for new list. Radio Parts Sales Co., Box 24, Orange, N. J.

300-MILE "Pocket" Radio, \$2.00. No Tubes nor Batteries required. Useful and practical, loudspeaker volume. Order direct today. Spencer Laboratories, 116 Atlas, Akron, Ohio.

CROSLY, new guaranteed, latest models, bargain prices. Nold, 27 Chestnut St., Schenectady, N. Y.

RADIOS—Five tube sets \$22.50 delivered. Tubes 95c. Literature Free. Agents Wanted. Seminole, 427 East 16th, New York.

ELIMINATORS, Power-Units, Chargers. Reduced prices. G. Simms, Lake, New York.

RADIO Up-to-the-Minute. 1926 edition. Telegraphy, radio reception, vacuum tubes, telephony, how to build receivers, broadcasting, all treated in new book. Send No Money. Pay postman \$1.25 and postage. Just write postal for "Radio Up-to-the-Minute." Popular Mechanics Press, Room 902, 200 East Ontario St., Chicago Ill.

TRADE AND TECHNICAL SCHOOLS

TELEGRAPHY—Both Morse and Wire-less—taught thoroughly and quickly. Tremendous demand. Big salaries. Wonderful opportunities. Expenses low; chance to earn part. School established fifty years. Catalog free. Dodge's Institute, Fern St., Valparaiso, Ind.

BIG Pay Jobs. Learn Sign Painting, Decorating, Paperhanging, Show Card Writing, Graining and Marbling by practical training in a few weeks. Chicago Painting School, 148 West Austin Ave., Chicago.

LEARN Bricklaying at home or in school run by contractors. Catalog free. Associated Building Employers, H400, A. B. E. Building, Grand Rapids, Mich.

VULCANIZING Auto Tires is a paying business. Instruction Book for \$1 Bill. Equipment Co., 106 11th St., Los Angeles, Calif.

BUSINESS OPPORTUNITIES

HIRE yourself as Boss! \$250 a week easily made making these Big-selling Specialties. 300% to 900% Profit. Investment Small. No machinery needed. Let me show you how to make Heetite the New German anti-freeze preparation for Radiators; Fibro-seal Guaranteed Puncture Proof; Para-vulkin, no-ement Instant Weld Patch; Super-Radiolyte, 20-minute Battery charging Liquid, and 30 other big money-makers in the House-hold, Food Beverage and Toilet Specialty lines. Valuable Literature Free! Miller, Chemist, 1706-C Jetton, Tampa, Fla.

READ The Mail Order News—America's Pioneer Mail Trade Journal. Quarter Century Old. Approximately 600 pages yearly of valuable information for beginners an established mail-order houses. Analyzes mail-order business, its opportunities. Practicable mail-order ideas, legitimate money-making schemes, instructive articles. Tells how to start, what to sell. Published monthly. Subscription \$3.00 yearly. Send 25c for sample copy. None free. Mail Order News, 360 Bristol Bldg., New York.

PATENTS. Time counts in applying for patents. Don't risk delay in protecting your ideas. Send sketch or model for instruction or write for Free book "How to Obtain a Patent" and "Record of Invention" form. No charge for information on how to proceed. Communications strictly confidential. Prompt, careful, efficient, service. Clarence A. O'Brien, Registered Patent Attorney, Security Bank Building (directly across street from Patent Office), Washington, D. C. See pages 154 and 155.

ATTENTION! You can have a business of your own. Establish and operate New System Real Estate Business, brokerage and insurance agency in your community. Office at home. Earn \$5,000 year. Representatives wanted everywhere. Send stamp free booklet. Hayes Realty Association, Cincinnati, Ohio.

LEARN To Make Molds for Statuary, Dolls, Vases, Ornaments and hundreds of easily sold articles. Mold from lead, wax, imitation marble, rubber, and 35 other compositions. Commercial Methods. Easily learned. Simple, practical profitable. Free literature. Manufacturer's Bureau, R5, 1129 East 31st, Kansas City, Mo.

MUSHAMOLES: New food specialty. Your own parlor or sell restaurants, fountains, etc. Big opportunities. Particulars free. E. Sprinkle, Paris, Ark.

START a business of your own. Nickel, silver, copper and gold plating. Large profits. Two dollars for full information or twenty cents for samples and particulars. Electro Platers Supply Co., 547 Considine Ave., Cincinnati, Ohio.

TOURIST Cabin Camps—big profits—small investment. Good locations, laws, information, Construction Plans, \$2.00. Camp Spokane, Washington, 915 Lindeke.

SHERIDAN'S Directory. Latest, Largest and Best Buyer's Guide. Wholesale Supply Sources for Thousands of Articles, \$1.00. S. Van Auken, 34 Richton, Detroit, Mich.

MAKE money at home in mail order paint business, with us, no experience or capital required. We furnish everything. Details 10c. Gill Paint Mfg. Co., Wisconsin Rapids, Wisc.

BATTERY charging is profitable. Do it with the Scioto Battery Charger. It costs only \$50 and operates at low expense. Adams-Barr, Columbus, Ohio.

FREE Mail Order Information. Write today enclosing stamp. Mason, 3900 Broadway, Room 5, Chicago.

100 QUICK Profit, Honest, Guaranteed Workable Mail Order Plans and Specifications with complete detailed methods used in every successful mail order business. A high-class complete publication, finished in 1926. Covers all departments of the mail order business. Also teaches you clearly to originate plans of your own and put them into immediate operation. The only work of its kind ever published. Written by fully competent and reliable authority. Mail Order Service, Box 93, Omaha, Nebr.

START manufacturing Insect Powder, Ant Powder, Roach Powder, Fly Killer, Rat Paste, Disinfectants, etc., at home. Big profits. We supply guaranteed formulas. Buy your materials anywhere. Information free. Furman Company, Kerrville, Texas.

OPPORTUNITY—Yu-Chu penny gum vending machines at \$4.50. Possible 1,200% yearly profit. Elkins Display Co., Elkins, W. Va.

BIG Profits Refiltering Crankcase oil, small capital. Pan-Cam Filter Co., Escondido, Calif.

MAKE money silvering mirrors, refinishing auto headlights, tableware, metal plating, bedsteads, chandeliers. Outfits furnished. International Laboratories, Dept. 71, 309 5th Ave., New York.

LEARN to Manufacture—It pays big profits. We teach you how. Start spare time. Few dollars. At home. We show you how to sell. Write for free circular. Heartinger System, 2202 Wyoming, St. Louis, Mo.

YOUR own mail order or local business. Opportunities galore. Free particulars. Fayette Specialty Co., Conneville, Penna.

MIRRORS resilvered at home. Costs less 5 cents per square foot; you charge 75 cents. Immense profits plating like new; brassy worn-off autoparts, reflectors, tableware, stoves, etc. Outfits furnished. Details Free. Sprinkle, Plater, 127, Marion, Ind.

UNUSUAL and very different. We do not sell any merchandise, but if you want to know about thousands of fast sellers and their confidential sources of supply, send us your name and address for free information. State whether Agent, Salesman, etc. International Information Institute, Desk 80, G. P. O. B. 223, New York.

15c PUTS your name on mailing list year. Receive offers, magazines, from wholesale supply houses everywhere. Kentucky Agency, Covington, Ky.

"SCHEMER," Alliance, Ohio, 36 p. monthly, prints Schemes, Tips, Formulas. Subscriber reports \$25,000 from three; another \$10,000 from one. Try it! Year, \$1.00; 3 months, 30c.

NEW Office Business you can handle at home. Make money any time. Send addressed reply envelope. Owen Coe, 129 East 59th St., New York.

ARTIFICIAL marble sanitary flooring instructions, covering wood or cement flooring 1/2 inch thick, fireproof, waterproof, all colors, low cost. Ornamental casting, concrete, plaster, papier-mache decorations, garden furniture, statuary, flexible molds. 17 years instructing the public; particulars and illustrations free. Chris. Mahler, Huntington, N. Y.

ENTER a new business. Earn \$3,000 to \$6,000 yearly in professional fees making and fitting a foot specialty, openings everywhere with all the trade you can attend to; easily learned by anyone at home in a few weeks, at small expense; no further capital required, no goods to buy, job hunting, soliciting or agency. Address Stephenson Laboratories, (1) Back Bay, Boston, Mass.

\$3,000 TO \$5,000 Yearly. Want it? Others are making it. Send check or money order today for our invaluable books "How to Sell Real Estate," \$3.00—and "How to Conduct Real Estate and Insurance Business," \$1.50. Absolute satisfaction guaranteed. Free circulars. Realty Book Co., Dent 52, Cleveland, Ohio.

LOOKING for patented article made from aluminum die castings. Will arrange for manufacture if exclusive sale given. Continental Investment Co., 40 Clinton St., Newark, N. J.

MAKE Much Money—Making and Selling Your Own Goods. Formulas by experts. Manufacturing processes. Trade Secrets. All lines. All kinds. Catalog, Special circulars free. B. Thaxly Co., Washington, D. C.

PATENTS Procured; Trade Marks Registered—A Comprehensive, experienced, prompt service for the protection and development of your ideas. Preliminary advice gladly furnished without charge. Booklet of information and form for disclosing idea free on request. Richard B. Owen, 30-Owen Bldg., Washington, D. C., or 41-R Park Row, New York.

OPERATE Chewing Gum Machines. Large profits. Small Capital. Particulars free. Walter Gum Co., 21 Dodworth St., Brooklyn, N. Y.

NEW Spare Time Money-Making opportunities. Investigate. Osc. Hanson, Mentor, Minn.

\$25 STARTS Clean, Honest, Spare-Time, Home Work, Mail Order Business. Very Easy and Simple. Circular free. B. M. Smith, Box 369, Morristown, N. J.

GOOD Money easily earned at home spare time silvering mirrors, glass embossing, chipping, frosting, gold leafing, etc., Patterson & Co., Brooksville, Ky.

DELAWARE Incorporated. Charters; Fees Small; forms. Chas. G. Guyer, 901 Orange St., Wilmington, Del.

CHEMICAL Expert will furnish Formulas and Trade Secrets. All lines. Lists Free. W. L. Cummings, Ph. D., 228 Gordon Ave., Syracuse, N. Y.

LEARN the collection business. Good income, quick results. Interesting booklet, "Skillful Collecting" free. National Collectors Assn., Long St., Newark, Ohio.

EARN \$10 daily silvering mirrors, plating and refinishing metalware, autos, chandeliers, bedsteads, headlights. Outfits furnished. E. Decie Laboratories, 1133 Broadway, New York.

DON'T gamble in mail order business. Be sure. Free circular puts you wise. MacRae, M40 Oregonian Building, Portland, Ore.

MECHANICS, painters, carpenters, start furniture refinishing, painting, handyman shop on nearly nothing; winning plan brings customers quickly. John Braceland, 1439 So. Ninth, Philadelphia, Pa.

\$750,000,000 MAIL order business in 1925. Many grow rich in this great trade. Sell merchandise, information, patented articles various preparations. Breniser's Famous Mail Order Handbooks tell how. Eleven brochures \$3. One book with complete catalog, 25c; none free. Breniser, (Established 1900), 1607 Sansom, Philadelphia.

START Mail Order Business of your own at home. We supply catalogues with your address on. Wineholt Sales Co., Box 4, Woodbine, Penna.

POSTAL Success. Instructive articles of mail selling. Copy 10c. Porter Publications, 9416a 115th St., Richmond Hill, N. Y.

ESTABLISH big paying business in your home town or travel. Many opportunities offered. V. Santschl, Glenellyn, Ill.

RAISE Money for invention, any business proposition. Inexpensive, reliable method. Interstate Service, Elizabeth, N. J.

RESPONSIBLE manufacturer wants competent men to manage office and salesmen. \$300 to \$1,500 necessary; will allow expenses to Trenton if you qualify. Address Manager, 536 Forst Richey Bldg., Trenton, N. J.

I MADE \$30 a Week Home. French Breadmaking. 15 years' experience; Free Booklet tells. Ashbrook 67, Marengo, Ohio.

UNPATENTED Ideas Can Be Sold. I tell you how and help you make the sale. Free particulars (Copyrighted). Write W. T. Greene, 810 Jenifer Building, Washington, D. C.

SELL Pro-Tex-Chex. A Check Protector. Sample 25c Postpaid. Goldstein Bros., Santa Cruz, Calif.

WE Start You in Business, furnishing everything; men and women, \$30.00 to \$100.00 weekly operating our "New System Specialty Candy Factories" anywhere. Opportunity lifetime; booklet free. W. Hillyer Ragsdale, Drawer 4, East Orange, N. J.

MAKE toys and novelties at home. Big profits. Instructions and illustrations, 25c. Astrolite Company, Sharpsburg, Pa.

NOW that you have read all these offers, send 25c for Detailed Information. (None free.) "How" and "What" to Sell by Mail; through Agents; or Direct; We want 100,000 Representatives! Opportunity is knocking—Answer! Surety Service, Dept. 272, 25 Exchange St., Rochester, N. Y.

TELEGRAPHY

TELEGRAPHY—Both Morse and Wireless—taught thoroughly and quickly. Tremendous demand. Big salaries. Wonderful opportunities. Expenses low; chance to earn part. School established fifty years. Catalog free. Dodge's Institute, H St., Valparaiso, Ind.

CHEMISTRY

EXPERT Chemical Service. Working formula or process prepared for your special purpose, \$5.00. Write me. W. Stedman Richards, Industrial Chemist, Box 2402, Boston, Mass.

EXPERIMENTERS' laboratory apparatus. Chemicals. List 5c. Chemical Apparatus Co., 4402 West End, Chicago.

CHEMICAL Analysis, Processes, Technical Information. Robert Henderson, Laboratory, Madison, Maine.

FORMULAS AND TRADE SECRETS

SPECIAL formulas for Manufacturing and Business purposes. Any one you want, including full manufacturing instructions and where to get all supplies, sent for \$5. Satisfaction guaranteed. Announcements of latest formulas for quick-selling seasonal products sent monthly without charge. Write today. National Information Bureau, 316E Shephard Building, Grand Rapids, Mich.

MAKE and sell latest food specialties, beverages, toilet preparations—super fuel ingredients—puncture sealer. Formulas that really produce the goods. Get next to new products and how to make them. Free literature. Manufacturer's Bureau, R3, 1129 East 31st, Kansas City, Mo.

RELIABLE formulas for all purposes \$5. Let us solve your problems. Chemical Testing Laboratories, Box 2961, Boston.

BEST Formulas at Lowest Prices. Douglas Chemists, 4332 Vanburen, Chicago.

FORMULAS, Guaranteed Best Chemical Science can devise. Stamp brings big bunch valuable literature describing Latest Reliable Processes for Manufacturing All Lines. Don't Buy till you've received these Profitable Propositions. No recipe-book Trash. 29 years giving satisfaction. Miller Chemist, 1706-U Jetton, Tampa, Fla.

MAKE Much Money—Making and Selling Your Own Goods. Formulas by experts. Manufacturing processes. Trade-Secrets. All lines. All kinds. Catalog, Special circulars free. B. Thaxly Co., Washington, D. C.

500 FORMULAS including Luminous Paint—Renewing Dry Batteries—Resilvering Mirrors—Gas Tonic, Puncture Plugger, 25c. Catalog Free. Ideal Book Shop, Park Ridge, Ill.

WOULD you pay \$15.00 for a secret that would put you into \$5,000 to \$10,000 a year business? Manufacture Bestall Chemical Wood Stone for public building, kitchen and bath room flooring. Can be molded into dolls, souvenirs and novelties. Circular free. Maxim Chemical Co., New-castle, Ind.

FORMULAS, Processes and Recipes in every issue of Worthwhile. 25c per year. Sample copy, 5c. Franklin G. Warth, Dept. 2, 130 Cady Street, Rochester, N. Y.

INCREASE your income—"Selected Opportunities" listing 24 business plans, two formula charts, \$1.00. Robert Smeriglio, P207 Stillwater, Stamford, Conn.

TRADE Secrets Exposed; Write Public Correspondence Association, Box 326, 601 E. 36th St., Chicago, Ill.

MONEY-MAKING Formulas, \$1.00. List for stamp. Anything analyzed, \$2.50. Association Chemists, Indianapolis, Ind.

MONEY Making Formulas, \$1.00. List for stamp. Anything Analyzed, \$3.00. Association Chemists, Indianapolis, Ind.

20c—ANY Formula—20c. Dime Information Bureau, Colorado Springs, Colo.

EASY money maker, just like I use myself; why not you? Particulars for red stamp. W. P. Stump, Hemet, Calif.

10,000 FORMULAS. A real Gold Mine of money-making ideas. Tells how to make almost everything under the sun. You can make and sell cosmetics, mucilage, anti-freeze solutions, battery solutions, beverages, cheese, chewing gum, cleaning preparations, extracts, hair preparations, inks, bluing, leather polish, mirrors, perfumes, polishes, typewriter ribbons, carbon paper, washing powders, liquid soap, and hundreds of other profitable articles. Send No Money. Just write a postal for "Hemley's 20th Century Book of Formulas." Pay postman postage and \$4. Popular Mechanics Press, 200 E. Ontario St., Room 902, Chicago, Ill.

15,000 FORMULAS in "Scientific American Cyclopaedia of Formulas." Includes following and many others: accidents and emergencies, agriculture, alloys and amalgams, artists' materials, beverages, cements, glues, pastes, mucilages, bleaches, renovating, coloring metals, dyeing, glass, heat treatment of metals, household formulas, ice cream, confectionery, chewing gum, lapidary work, exterminating vermin, lubricants, paints, varnishes, photography, condiments, canning formulas, rubber, soap, candles, soldering, toilet preparations, perfumes, waterproofing, fireproofing, writing materials. Send No Money. Just write a postal. When postman hands you book, pay \$5.50 and postal charges. Popular Mechanics Press, Room 902, 200 East Ontario St., Chicago, Ill.

AGENTS WANTED

EARN Big Profits Making New Products. We have secured the country for new products that can be easily made in home or shop. In "Specialty Manufacturing" we describe the manufacture of more than 200 worthwhile, saleable Novelties, Toys, Preparations, Auto, Electrical and Household Appliances, Agent's Goods, Toilet Articles, Fancy Goods and clever novelties from Wood, Cloth, Glass, Metal, etc. "Specialty Manufacturing" sent postpaid \$3. C. O. D. if desired. Money back guarantee. Circular Free. Manufacturer's Bureau, R6, 1129 East 31st, Kansas City, Mo.

\$25 TO \$50 a week—\$1 to \$2 an hour spare time in easy, pleasant occupation. Thousands of men and women are making this income with the famous Ho-Ro-Co Soaps, Perfumes, Toilet Articles, Specialties. Over 200 items; quick sales, appeal in every home. La-Em-Strait Hair Dressing, the fastest seller wherever introduced. Write at once for Free Sample Case offer—the best yet. Ho-Ro-Co., 791 Ho-Ro-Co Bldg., St. Louis, Mo.

LANOWA Polishing Cloth-Mitten Duster Combination selling like wildfire. 200% profit. Appoint agents. Free sample and territory. Fraser Products, 305-J 43rd, Kansas City, Mo.

EVERY automobilist, engineer motorman, needs amazing Windshield Cleaner; pocket size yet one rub keeps entire windshield clear for hours; works while you drive; no rubber, paste, cloth, no attachments; guaranteed 2 years; Wright sold 20,000. Security Mfg. Co., Toledo, Ohio.

AGENTS—Best seller; Jem Ruber Repair for tires and tubes; supersedes vulcanization at a saving of over 800 per cent.; put it on cold, it vulcanizes itself in two minutes, and is guaranteed to last the life of the tire or tube; sells to every auto owner and accessory dealer. For particulars how to make big money and free sample, address Amazon Rubber Co., Philadelphia, Pa., Dept. 505.

AGENTS wanted, either sex, full or part time. Unusual medical proposition. Big profits. Thousands successful. Write Dept. E-1, Richards Cooperative Co., Rockport, Maine.

MAKE money silvering mirrors, refinishing auto headlights, tableware, metal plating, bedsteads, chandeliers. Outfits furnished. International Laboratories, Dept. 71, 309 5th Ave., New York.

SELL Show-Cards. New Line. Big Profits. Quick Sales. Particulars Free. Eifko, 525 South Dearborn St., Chicago.

AGENTS—Greater Profits, Year Round Sales; complete guaranteed line dress and work shirts, overalls, coveralls, work pants, playsuits. \$10-\$25 daily easy. We show you. Complete Outfit Free. Nimrod Shirt Co., Dept. 8, 4922 Lincoln Ave., Chicago.

\$100 WEEKLY—Hundreds making it selling marvelous auto invention. You can too. One size—fits all cars. Installed in three minutes. Sells like hot cakes. If not we take them back and refund. Send for free introductory sample. Mae Auto Products Company, Dept. 902, 6355 Broadway, Chicago.

AGENTS, portraits, photo-pillow tops, frames, sheet pictures, medallions, photo-jewelry, guaranteed hose, laundry tablets, food products, toilet requisites, luminous crucifixes. Catalogue 50 specialties free. 30 days' credit. Jas. C. Bailey Co., Dept. C2, Chicago.

SELL Brushes. 100 quick-selling items. 100% profit. Full or part time. Write for proposition. State age, experience and territory desired. Kautenberg Co., Box 255-P, Freeport, Ill.

AGENTS Wanted to sell Men's Hats direct from factory. Send for Catalogue. Model Hat Mfg. Co., Dept. 5, East Orange, N. J.

AGENTS, Salesmen, Crewmen—You'll have the Devil's own time finding a better seller than "Zippo." Splendid profit on snappy 50c "Go-Getter" repeat article that sells on a ten second demonstration. Works while you watch it! Demonstrates value while others waste time making claims. New development! Greatest scientific triumph of the age! It's the berries! Write immediately for complete proposition. Karam-Smith Company, 602 Bozart Street, Fort Wayne, Ind.

LIVE Agents to Sell Shure Clean Hand Soap, the world's best soap for removing grease, paint, inks, etc. Big commission. H. M. Spencer, 4145 N. Kilbourne Ave., Chicago.

NEW fast selling household specialties. County distributors wanted. Write today. Hess Manufacturing Company, Freeport, Ill.

BIG Money-making opportunities; no peddling. Particulars free. Elite, 38 Elizabeth St., New York.

AGENTS. Two Bits Every Two Minutes. Here's 25c profit on new household specialty you can sell in two minutes. The Pantong—something brand new. A red hot seller. Full time or sideline. Write to The Tyler Mfg. Co., Dept. CL-11, Muncie, Ind.

SELL Better Quality All-Wool Made-to-Order Suits at \$31.50. Profitable new field for men who are conscientious and dependable. No experience necessary. Full or part time—\$45 to \$100 weekly and liberal bonus. Commissions paid in advance. We furnish handsome large swatch samples and complete instructions free. Write W. Z. Gibson Inc., 161 W. Harrison St., Dept. B517, Chicago.

\$18 TO \$25 daily. Biggest selling line of 2-piece suits, \$9.95 and \$12.50; 3-piece wool suit, \$17.95 (regular \$28.00 value). All-wool overcoat, \$18.50. Splendid rain-coats, slickers and boys' suits. Biggest commissions. Free outfit. "Jim" Foster, Inc., Dept. 42-C, 2250 S. Spaulding Ave., Chicago, Ill.

STARTLING Invention: New Shock Absorber for Fords retails at \$3.50. Big profits easy. Exclusive distributors wanted. M & M Mfg. Co., 41, Station C, Omaha, Nebr.

MAKE and Sell clever Novelties, Toys—latest fast selling Auto, Toilet and Food Specialties—Mail order and Agent's items. Free list describes reliable plans, patterns, processes, commercial information. Manufacturer's Bureau, R4, 1129 East 31st, Kansas City, Mo.

WANT Distributing Agent for Handslick, powdered hand soap; removes anything from hands; everybody a customer; sample free. Solar Products Co., J-2142 S. Troy, Chicago.

SELL Reversible Semi-Soft Collars made of one piece of cloth with patented neck curve; newest Broadway styles; 30% commission collected the moment you make sale; quick sellers because nationally known. Send 25c for sample collar your size and novel selling kit. Bitrite Collar Co., 926x Broadway, New York City.

\$20 DAILY Easy selling amazing rain-proof caps. Made-to-measure. Finest fabrics and styles. Big advance profits. Free outfit and free cap offer. Taylor Cap Manufacturers, Dept. Y-5, Cincinnati, O.

AGENTS: Made \$500.00 Monthly. Pay daily. No investment. Rhinestones initial buckles and novelties sell easy everywhere. Exclusive territory. Chaton Novelty Co., 606 Blue Island, Chicago.

OH, Hello! Why didn't I see this before. Christy's Iron Rust and Stain Remover sells like blazes. Write for free sample. Christy, Inc., 5067 Lakeway, Newark, New York.

AGENTS, \$240 month and auto to travel in. Bonus besides. Introduce new line guaranteed hosiery for men, women, children. 126 styles, colors. Beats store prices. Guaranteed to wear 7 months or new hose free. Finest line Silk Hosiery you ever saw. High class proposition. New sales plan. No experience needed. Credit given. Spare time satisfactory. Write for samples. Wilkin Hosiery Co., Dept. 1631, Greenfield, Ohio.

AGENTS: Salesmen—Sell New Thermo-static Automatic Carburetor Control Attachment for Fords. Big profit, full or part time. Increases mileage 50-100%. Attached in two minutes. No drilling. Cadillac now using Thermo-static Carburetor Control under Blanche license. Sales guaranteed. \$15.00 a day Guaranteed to Distributors. Write today. Blanche Auto Devices Co., Dept. 805-B.X., 157 E. Erie St., Chicago.

PATENTS. Time counts in applying for patents. Don't risk delay in protecting your ideas. Send sketch or model for instruction or write for Free book "How to Obtain a Patent" and "Record of Invention" form. No charge for information on how to proceed. Communications strictly confidential. Prompt, careful, efficient service. Clarence A. O'Brien, Registered Patent Attorney, Security Bank Building (directly across street from Patent Office), Washington, D. C. See pages 154 and 155.

SELL Pioneer \$23.50 all wool tailoring, full or part time. \$5 an hour selling our famous tailored-to-measure all-wool suits at \$23.50. Commissions paid in advance. Striking leather brief case containing 100 large swatch samples furnished. We train the inexperienced. Pioneer Tailoring Co., 159 W. Harrison St., Dept. B117, Chicago.

\$50,000. PICTURE Man Friedman made canvassing. Beginners can make \$100.00 weekly with my sales talk. Experienced men make more. Free book. "Profits in Portraits" explains. Samples Free. Picture Man Friedman, Dept. 8-D, 541 W. Lake, Chicago.

AGENTS—Make a dollar an hour. Sell new kind of sharpeners. Sharpens all knives and tools quickly. Demonstrating sample free. Premier Mfg. Company, Dept. 64, Detroit, Mich.

JUST Out—Patented Apron Without strings, straps, hooks or buttons. On or off in a jiffy. Over 100% profit. Commissions paid daily. Write for free sample offer. Sta-Put Co., 202 N. 11th St., St. Louis, Mo.

DO you want to be your own boss—Work out in the open—Make \$50 to \$100 a week? Build up business that will pay you this income for life and a business that no one can take from you? McNess products mean just this to you. Write for proof and information. Furst-McNess Co., 506 Sunlight Bldg., Freeport, Ill.

EVERYDAY Greeting Cards easy seller. Sample box 75c. Particulars free. Messenger, Stillwater, N. Y.

AGENTS are cleaning up with National Fibre House Brooms and Auto Mitten Dusters. Send for Free Catalog and Sample Offer. National Fibre Broom Co., St. Louis, Mo.

"MAGNAKLOTH" taking autoists by storm, one rub absorbs dust from the car or furniture, quick sale, big profits. National Service Co., Dept. "P," Pierre, S. Dak.

VANILLA Salesmen—Try our Concentrate. Add water and bottle. Beats them all. Profit biggest. Sample. Trask, Mfg'r, East Vassalboro, Maine.

DO you want good live agents—fellows who can get the business? Ask me how others are doing it. I'll gladly render the necessary assistance without cost to you. Address, M. L. Rund, Mgr. Classified Advertising. Popular Mechanics Magazine, Chicago.

CASH Paid for Butterflies, Insects. See Sinclair Display Advertisement on Page 24.

"RED-HOT" Agents, Mail-Order Men, Beginners, Valuable Inside Information; 300% Profit. Samples Circulars Free. Nite Mail Order Supply Co., 609 27th St., Denver, Colo.

AGENTS—Big profits; easy to sell. For Fords and Chevrolets. Retail 75c. Money back guarantee. American Fixture Co., 232 W. Water St., Milwaukee, Wis.

\$50.00 WEEKLY easy, Applying Gold Initials on Automobiles. No experience needed. \$1.45 profit every \$1.50 job. Free Samples. "Ralco Monograms," 1043 Washington, Boston, Mass.

\$11.50 PROFIT, on 50c outfit complete. Hair Tonic in powder form. Simply add water and bottle. Everything furnished. Casey Company, 1043 Washington, Boston, Mass.

WE have a line of goods for which every man in America is a prospect. Can be handled with tremendous profit by any salesman now selling to men. \$20.00 Outfit Free. Address Dept. 51, William C. Bartlett, Inc., 850 West Adams, Chicago.

POSITIONS open selling three complete lines direct to farms. Auto, truck and tractor oils, barn and house paints, roofing products. Permanent customers. Year around repeat order business. Big income assured. No investment or experience. Everything furnished to start. Write today for proposition. Solar Products Co., 404 Century Bldg., Cleveland, Ohio.

HUSTLERS don't skip this. Money-back guarantee. New patented Ford invention. Money saver. 500 sold by one agent in one day. Sample demonstrator postpaid for \$1.00. Retail price \$2.00. Nu Idea Mfg. Co., Inc., Dallas, Texas.

MIRRORS resilvered at home. Costs less: 5 cents per square foot; you charge 75 cents. Immense profits, plating like new; brassy worn-off autoparts, reflectors, tableware, stoves, etc. Outfits furnished. Details free. Sprinkle, Piater, 128, Marion, Ind.

BE Independent. Make—Sell your own specialties. Immense profits. Catalog dependable formulas, special selected agents' best sellers, free. M. Lustrò, 832 East Pershing, Chicago.

AGENTS write for special offer. \$60 a week and latest model Ford auto. Your pay daily in advance. Extra bonus besides. Introduce finest line guaranteed hosiery. Our silks can't be beat. No experience needed. Samples furnished. We give you extra fine silk hose for your own use absolutely free. Write today. Jennings Hosiery Co., Dept. 2231, Dayton, Ohio.

AGENTS: 90c an hour to advertise and distribute samples to consumers. Write quick for territory and particulars. American Products Company, 9020 Monmouth, Cincinnati, Ohio.

AGENTS—Our new selling plan means quick sales and big profits. Toilet Articles, Perfumes, Household Products. We credit you. Carlisle Co., Dept. PM, Huntington, W. Va.

CAN you sell Ford size tires at \$3.50 each? Write for plan. Details free. American Accessories Co., Station 431, Cincinnati, Ohio.

OUR latest Lingerie, Neckwear, Scarf line is unequalled for making money. Write for details. Public Service Mills, 725-F 5th Street, Union City, N. J.

FREE—List of Automobile and Electrical Supplies. Low Prices. Kelly, 5958 Washington, Chicago.

NEW household invention ends window washing drudgery; abolishes ladders, buckets, sponges, brushes; 75% quicker; keeps hands dry; low price. Lady Jane Mfg. Co., Toledo, Ohio.

ELECTRIC Window Flasher sign with changeable letters \$15.00. Brilliant day and night. Retail only \$15.00. Particulars free. National Display, 124 W. 18th, New York.

AGENTS Wanted: Something New. Every Motorist a Buyer of our Electro-Magnetic-Emergency Wonderlamp; takes only one minute to demonstrate and make a sale; no experience necessary; \$5.00 an hour easily made, either full time or evenings. Wonderlamp Co., 920 Fisk Bldg., Dept. 10-A, New York.

AGENTS—men—women—sell beautiful linens at wholesale prices. Every Home Buys. Big commission. Exclusive Territories. Dept. D. Milton Co., 87 Leonard, New York.

\$25.00 DAILY selling Raincoats and Slickers. \$2.95; Newest colors, red, blue, green, etc. Outfit free. Commissions daily. Elliott Bradley, 241 VanBuren, Dept. 699, Chicago.

SELL Tailor-Made Shoes. Sensational new fitting discovery eliminates foot troubles; makes walking a pleasure. 55 men's and women's styles; 24 leathers. Prices lower than stores. Big commissions. Free outfit. Free samples shoes. Tailor-Made Shoe System, 932 Wrightwood, Dept. OA2, Chicago.

SURE Seller to every merchant—no gamble—big profits—steady repeater—free sample and exclusive territory. Embossed Show Card Co., 9174 Euclid, Cleveland, Ohio.

A WINNING line for 1927. 50 essential household articles. A live wire can easily make \$50 per week. Home Supply Corp., Asbury Park, N. J.

HANZO "Removes the grime—in half the time." Best little coin-roaxer out. Sells anywhere and to everybody. Staple repeat order article, used by millions. Investigate this. Sample and information on request. Hanzo Company, 765-A Waveland, Chicago.

\$25 DAILY selling \$10 slickers for \$2.98; also full selections of other raincoats; Quick deliveries; all colors. Outfit Free. American Waterproof, 724P Roosevelt, Chicago.

SEND three references for Samples. 15 Hosiery Styles; 50 colors. \$10.00 Dinner Set Free to customers. S. Q. S. Desk D., Lexington, Ky.

IF I Send You a Suit made in latest style from finest goods, will you keep it, wear it, and show it to your friends as a sample of my sensational \$19.50 suits guaranteed regular \$40.00 values? Could you use \$3.00 an hour for a little spare time? If so, write me at once for my wonderful new proposition. Just write your name and address on a card and mail to Salesmanager, Peoria and Adams, Dept. 574, Chicago.

BEAUTIFUL radiator covers. Adjustable metal Over-Tops. Beats high-priced covers. Several needed every home, apartment, office, having hot water or steam radiators. Past sales. Hire others. Big profits surprise you. Interior Arts, Inc., 4523 No. Clark, Dept. 50, Chicago.

SELL Surety, the Original, Genuine Powdered Hand Soap and make \$5,000 yearly. We furnish sales plans, advertising and Free Samples. Write quick. Surety Mfg. Co., Dept. 56, 25 W. Washington St., Chicago.

SELLING Like Blazes! Eleven piece toilet goods assortment at \$2.25 with two piece carving set Free to your customers. 100% profit. Davis Products Co., Dept. 56, 1321 Carroll, Chicago.

DISTRICT Agents—Sell \$23.50 All Wool Union Made Suits and Topcoats for large, old established firm. Wonderful values; one price. Liberal commissions in advance; money back guarantee. Expensive 9x13 swatch outfit Free. Protected territory. Write 1-D. Harvey, Box 90, Chicago, Ill.

MYSTERY aeroplane 50c—Comic models 25c. Novelty Supply House, Jamestown, N. Y.

FREE: Large wholesale Specialty Catalog, showing latest best sellers from all parts of the world. Spors Co., Lesueur Center, Minn.

RADA-DIAMONDS. Big flash. Big Profits. Agents coining money selling on installments. Sample kit Free. National Co., Box 1174-PM, Omaha, Nebr.

MAKE Much Money—Making and Selling Your Own Goods. Formulas by experts. Manufacturing processes. Trade Secrets. All lines. All kinds. Catalog. Special circulars free. B. Thaxly Co., Washington, D. C.

AMAZING 30-day Offer! To prove our Mexican Blu-Flash Gem really matches finest genuine Diamond Side-by-side, we'll mail perfect \$5.00 picked sample, alive with rainbow fire, for only \$1, with catalog, proof of our claims, and Free \$5 Jewel case proposition. Sells at sight; enormous profits! Write quick. Mexican Gem Co., Monterey, Calif.

START a shoe business of your own. Exclusive agency for Duo-Flex shoes for men, women and children. Low prices. Big profits, and credit extended to reliable people. Write department D, Dyer-Sawyer Company, Lewiston, Maine.

GET Free Selling Outfit! Earn \$3,000 to \$5,000 a year selling most complete line guaranteed Hosiery and Underwear in America. No experience needed. You can become District Manager and have others working for you—if you act quick! Write today. Malloch Knitting Mills, 572 Grant St., Grand Rapids, Mich.

FREE—Extra Pants with wonderful \$29.75 Suits. Make \$85 weekly. Wonderful \$23.50 line. Big Profits. Free Outfit. Jay Rose, Tailors, 413G, South Wells, Chicago.

AGENTS To Sell The New Waterproof Featherweight All-Purpose Coat. Weights only 26 ounces. Latest styles and colors. Men's \$4.98, Women's \$3.98. Liberal commissions. Write today for sales plan. Featherweight Coat Co., 5713 Euclid, Cleveland, O.

SILVER Mirrors and make \$5 to \$10 a day. Best instructions, \$1.00. Elmer Gutknecht, 445 Idaho St., Milwaukee, Wis.

COMPLETE line of perfumery and toilet goods. Finest quality, lowest price. Big profits for one agent in each town. Indiana Manufacturing Company, Box 102, Evansville, Ind.

AGENTS—Make \$100 weekly selling our auto tire puncture seal. Works instantly, automatically, permanently. Money-back guarantee; exclusive territory. Get free trial offer. Gray Seal Sales Co., 4522 Olive St., St. Louis, Mo.

AGENTS! \$1 an hour selling E. Z. Clean washing compound; sample and particulars free. Real Quality Products Co., Findlay, Ohio.

RITHMETIC KID makes Quick Money. Sample and Wholesale prices 25c. Wholesale Supply Co., Valdosta, Ga.

\$13.80 DAILY in advance (Send for sworn proof) Introducing New Insured Hosiery. 57 styles, 40 colors, guaranteed seven months. No capital or experience required. You simply take orders. We deliver and collect (or you can deliver, suit yourself). Credit given. Pay you daily, monthly bonus besides. Spring line now ready. We furnish samples. Spare time will do. Milton Mathews, Road 5862, Cincinnati, Ohio.

AGENTS—\$13.80 Daily in advance, Introducing New Insured Hosiery for men, women, children. Must wear or replaced free. 57 styles. 39 colors including latest "Silk to the Top" Ladies Hose. Nyland made \$5.95 in one month. Edwards, \$469.60. Mrs. Bone, \$425.45. Why not you? Even spare time should pay you \$3.00 an hour. No experience needed. We furnish samples. Silk hose for your own use Free. New Plan. No matter what you are now doing, write quick. Maccoches Company, Road 2562, Cincinnati, Ohio.

\$14.50 DAILY Easy—Pay in advance, Introducing Chieftain Guaranteed Shirts, 3 for \$4.95. No experience or capital needed. Just write orders. We deliver and collect. Full working outfit free. Cincinnati Shirt Company, Lane 1582, Cincinnati, Ohio.

\$90.00 WEEKLY selling Hosiery and Bed Spreads. Liberty Mills, Dept. 10, Shelby, N. C.

ALL-YEAR-ROUND profitable business selling wonderful new water softener and cleaner. Removes grease, oil, ink and dirt quickly. Every home and business place a live prospect. 100% profit. Big repeat orders. Exclusive territory. Write for free sample. Seacoast Laboratories, Sea Bright, N. J.

NEW Farm Radio—Agent's Set Free. Hear wonderful radio programs from big cities on the Lambert; costs less than any other long distance radio made; no up-keep expense; no electric current, batteries or tubes required; every demonstration sells; just what your friends and neighbors want. Write today. Lambert Radio Co., Wichita, Kansas.

PATENTED—Sanitary Self-cleaning Comb Write for details. Sample 50c. Sanitary Comb Co., 296 Broadway, New York.

AGENTS to introduce new Griddle Greaser. Sample dozen by mail, \$1.00. A. Jensen, R. 6 B. 86, Stockton, Calif.

EVERY Woman Wants a Sewing Set. Home Sewing Sets contain 142 useful sewing articles, \$4 an hour easily made with this 50c seller. Prentice-Lee, 145 East 23rd St., New York.

AGENTS make \$10.00 Daily selling Non-Splash Water Filters on sight. Best canvasser's article on market. Investigate. Write for particulars, Desk 14, Seed Filter Company, 73 Franklin Street, New York.

WE Pay \$50 a Week and Expenses and give Ford Auto to men to introduce poultry and stock compounds. Imperial Co., D23, Parsons, Kan.

AGENTS Wanted to distribute samples, big money, new method, write quick. P. M. Vann, Box 3, Sta. D, New York.

GOLD Leaf Window Letters and Script Signs. No experience; 500% profit. Samples Free. Consolidated, 69-U West Van Buren, Chicago.

DISCOVERED! Diamond Rival—Rajah Gems astound Jewelry world and defy detection. Set in artistic Sterling Silver mountings copies of highest priced platinum designs. Sell like wildfire at popular prices. Salesmen and Agents unique selling plan means enormous profits for you. Write immediately for details. Rajah Company, Dept. X-2, Salisbury, N. C.

NEW Invention—Big Seller—400% profit. Liquid Quick Mend for hosiery and fabrics. Every woman buys. Hundred other fast sellers. J. E. Johnson Co., Dept. 450, 6145 Wentworth Ave., Chicago.

\$75 WEEKLY Man or Woman Wanted with ambition and industry, to distribute Rawleigh's Household Products to steady users. We train and help you so you can make up to \$100 a week or more. No selling experience necessary. Pleasant, profitable, dignified work. Write today. W. T. Rawleigh Co., Dept. IL8253, Freeport, Ill.

AGENTS—Make \$15.00 daily. Opportunity to ride in Chrysler closed car; show samples; distribute teas, coffee, spices, extracts; things people eat. This unusual offer made to first person answering in your locality. Write or wire Health-O Quality Products Company, Dept. 101-B, Cincinnati, Ohio.

POWER Tire Pumps for Fords. Claggett Mfg. Co., Marlboro, Md.

BRAND new plan. Make \$45 a week and up and get your own clothes free. Profits paid in advance. Any man can easily earn this and more, just showing our wonderful outfit and taking orders for our high-grade tailoring. Free suit to each agent. Handsome carrying case outfit of large real cloth samples—everything furnished free. Spencer Mead Company, Sherman and Harrison Sts., Dept. B817, Chicago.

SELL Sozzlem. Amazing New Discovery. Make \$100 weekly. Wonderful Seller. Big Profits. Steady Repeat Year Round. Exclusive Territory. Won't Last Long. Get Yours Quick. Sozzlem, Reading, Mass.

AGENTS—Radio product: Unlimited possibilities! Write, Kimley Electric Co., 2663 Main St., Buffalo, N. Y.

REAL Money selling a great new Health Invention generating Violet Ray, Vibration, Electricity and Ozone. Exclusive Territory now open. Write today. Lindstrom & Co., 30 W. Lake St., Dept. 13-52, Chicago.

AGENTS Wanted—\$45 to \$85 a week selling beautiful shirts. Lowest prices. latest styles, finest tailoring. Henry made \$25 in a day. Free insurance policy wins every sale. Profits in advance—we deliver and collect. Get free outfit quick. Fashion Wear Shirts, Dept. B-942, Cincinnati, Ohio. Old reliable firm.

WOMEN—\$2 an hour spare time; new idea sanitary necessity; sells on sight; every woman buys; new feature never before used; designed by physician; revolutionizes old uncomfortable methods; pay every day; no deliveries, no collections, no experience or capital required. Particulars mailed in plain envelope. Don't delay; Write Mrs. Mary P. Coleman, Meriden, Conn.

WOULD \$100.00 per week interest you? Millions of photos all over the Country just crying to be made into beautiful artistic medallions. We have new plan. Lowest Prices. Speedy service. Experienced agents losing money every day they put off writing us. Art Medallion Co., Department C, Corner Campbell & Jackson, Chicago, Ill.

SELL Radium Water Generators. Entirely New fast seller. Repeat orders sure. Permanent income. Ask Why today. Radium Refinery, 2209 Broadway, Oakland, Calif.

WE pay \$48 a week, furnish auto and expenses to introduce our Soap and Washing Powder. Buss-Beach Company, Dept. A42, Chippewa Falls, Wis.

THANCO Vanilla—Bottle Yourself! Concentrated; add water; free labels. Crushes competition! 500% Profit! Immense seller! Other concentrated products. Write Thomas Manufacturing Company, Indianapolis, Ind.

HERE they are—Fifty fast sellers everybody needs and buys. Fifty Dollars weekly easily made. B. & G. Mfg. Co., Dept. 110, Pittsburgh, Pa.

AGENTS—Try Device Free. Starts Cold Motor Instantly. Saves Gas. Amazing Seller. Write Quick. Elec. SuperStarter, Dept. A-2, Grand Rapids, Mich.

SELL Super-Power, the blue wonder crystals. Latest automobile product. Sells like a flash. Saves gas, increases power and pep, removes carbon while driving. Guaranteed harmless. Just pour into gas tank. Steady repeat article. Your profit 100 to 182%. Particulars free, write today. Cassard Specialty Laboratories, 31A Fountain Street, Grand Rapids, Mich.

WANTED—County Agents and Representatives to market the 3A Garage Door Holder. All owners of private garages are instantly attracted by its Simple, Automatic Action. Write for attractive proposition. Knowlson-Stevenson Co., Ann Arbor, Mich.

99 WOMEN out of 100 want to buy—Biggest seller today. Enormous repeater. Free sample. Budd Products, 1608 East 66th St., Cleveland, Ohio.

YOU can be your own boss with our Key-Check outfit. Good for \$5 a day stamping names on pocket key checks, fobs, etc. Sample check with your name and address. 20 cents. Pease Die Works, Dept. M, Winchester, N. H.

AGENTS: Only Domestic Pea Huller on Market. Sells year round. Weight one pound. Retails \$1.00. Home Pea and Bean Hulling Machine Co., Marietta, Ohio.

GOLD-LEAF Sign Letters; make and sell; 1,000% profits. Particulars. Johnston Co., Quincy, Ill.

GOLD Leaf Window Letters and Script Signs. No experience; 500% profit. Samples free. Consolidated, 69-U West Van Buren, Chicago.

AGENTS: Our gold-eyed Needle Cases are wonderful sellers; immense profits; \$50 to \$300 weekly; proof and particulars free; sample outfit 10c; factory prices. Paty Needle Co., 231 Davis Square, Somerville, Mass.

\$500 MONTHLY proposition. Particulars Free. B. Davis, 1726 Roosevelt Rd., Chicago.

"MAKE And Sell Your Own Goods"—Tremendous Profits; No machinery; No experience; We show you how; Write quick for Free Book. Clover Laboratories, (P) Parkridge, Ill.

REAL money for you. Our combination Aluminum Cooking set easy to sell. No delivering, no collecting. Make \$10 to \$15 daily. Espy-Biddle Co., Dept. 2, 2325 Carson Street, Pittsburgh, Pa.

\$16 A DAY Easy—I start you in auto accessory business; no investment; no experience necessary. Landin, 3433 Montrose Ave., Chicago.

FOR Christmas. Our Luminous Crucifix shines in the dark and makes a wonderful Christmas present. Our agents always clean up with this Crucifix at this time. W. G. Hannan Co., Dept. B, 2539 S. State St., Chicago.

GENUINE Gold Leaf Letters anyone can put on Store windows. Guaranteed to never tarnish. Large Profits. Enormous Demand. Free Samples. Write today. Metallic Letter Co., 438-D North Clark, Chicago.

"LIQUID-LEATHER" Fills Holes in Shoes, Rubbers, Tires. Dries Instantly. Pliable, Waterproof. Just Imported from France. Tube Retail 75c—Cost 35c. Sells Housewives, Sub-Agents. Nullife Leather, Hartford, Conn.

AGENTS—Demonstrators—To sell the Chrisman Ejector Fork—The latest in kitchen utensils—Sample 50c. The Chrisman Manufacturing Co., 301 Anthe Bldg., Covington, Ky.

AGENTS—To sell Catholics—Wonderful Proposition. United Religious Goods Co., 201 United Bldg., Covington, Ky.

NO Dull Times Selling Food. People must eat. Federal distributors make big money; \$3,000 yearly and up. No capital or experience needed; guaranteed sales; unsold goods may be returned. We furnish you with sample case, license and Free Samples for customers—Sure repeat orders. Exclusive territory. Ask now! Federal Pure Food Co., A2307 Archer, Chicago.

BIG Profits. Sell "No-Splash" 4-Strainer Water Filters. Fast sales, lowest prices; send for 8 dozen, \$1.80 postpaid. Jones Mfg. Co., 243E2 Franklin St., Boston, Mass.

LAST Call! Fall in. Here's a Money Maker! Supreme Shirts give 100% satisfaction. Proposition, Kit Free. Supreme Shirt Co., 276-M Fifth Ave., New York.

SELL men's neckwear; wonderful proposition. Astor, 318-M Broadway, New York.

MANUFACTURE Very Latest, Biggest-selling Advertised Specialties yourself—No Machinery; investment small—All lines. Stamp brings Valuable Interesting Literature explaining how others sell your products and big bunch lists Guaranteed Formulas. 500 to 1,200% profit to you. Reliable Information Only. No "Master Formula" trash. Miller, Chemist, 1706-V Jetton, Tampa, Fla.

"AGENTS" Big Money Selling New Household Cleaning Set. Washes and dries windows. Sweeps, scrubs, mops. All complete only \$2.95. Over half profit. Write Harper Brush Works, 132 Third St., Fairfield, Iowa.

AUTO owner tire agent wanted each locality to use and take orders for hand-made Mellinger cord and balloon tires; guarantee bond 15,000 miles; shipped prepaid on approval; get your tires free; no capital or experience required; make \$100 to \$300 weekly. Write for wholesale prices and sample kit. Address Mellinger Tire Co., Dept. 400, Kansas City, Mo., or Dept. 400, Philadelphia, Pa., or Dept. 400, Oakland, Calif.

CALIFORNIA Rosebuds selling like hot cakes. Agents coining money; new stuff. Big profits. Catalog free. Mission Factory PM, 2328 West Pico, Los Angeles, Calif.

A BUSINESS of Your Own—Making Sparkling Glass Name and Number Plates, Checkerboards, Signs. Big Book and Sample Free. E. Palmer, 512 Wooster, Ohio.

AGENTS—New Plan, makes it easy to earn \$50.00 to \$100.00 weekly, selling shirts direct to wearer. No capital or experience needed. Represent a real manufacturer. Write now for Free Samples. Madison Company, 566 Broadway, New York.

GET Our Free Sample Case—Toilet articles, perfumes and specialties. Wonderfully profitable. La Derma Co., Dept. A, St. Louis, Mo.

AGENTS wanted—To sell Ray-O-Lite cigar and gas lighters. Big earnings. Sample 50c. Rapid Mfg. Co., 799-E Broadway, New York.

OVER 100% Profit. Self Lighting Gas and Cigar Lighters; Everybody interested, repeat business. Sell individuals, dealers, subagents. Particulars Free. P. Bernhardt, 127 West 30th St., New York.

MILLIONS stolen. Remarkable new \$5.00 Check Protector stops forgery. Inks, protects two colors. Sensational sales, profits. Write. Safety Devices Corp., Grand Rapids, Mich.

REMNANT Store, Bethel, Ohio. Greatest Dry Goods Bargains on Earth. Agents and Dealers.

WILLIAMS' No-Water Hand Soap, in tubes, has taken Auto owners by storm; washes dirtiest hands perfectly clean without water; easy demonstration makes quick sale. 150% profit. Williams Co., Dept. 265 Montclair, N. J.

\$320 PROFIT First Three Days' Sales for Zindel, Illinois, with Morey Quick Action Auto Rim Tool. Profit \$2 tool. Exclusive territory for hustling agents. Earn \$10 to \$50 cash daily, \$75 to \$300 weekly year round. M. Morey Rim Tool, Blissfield, Mich.

AGENTS—Clever Invention! Inkspoon makes every pen a fountain pen. Fast office seller; big profit, demand increasing everywhere. Exclusive territory offered. Sample free. H. Marul Company, Tribune Bldg., New York, N. Y.

EARN \$10 daily silvering mirrors, plating and refinishing metalware, autos, chandeliers, bedsteads, headlights. Outfits furnished. E. Decle Laboratories, 1133 Broadway, New York.

WANTED: Local and State Representatives for famous ready made Artistic Signs, price tickets, etc. No competition. Full protection. Large profits. For particulars write Artistic Signs, 799B Broadway, New York.

BIG Money and Fast Sales. Every owner buys Gold Initials for his auto. You charge \$1.50; make \$1.35. Ten orders a day easy. Write for particulars and free samples. American Monogram Co., Dept. 40, East Orange, N. J.

AGENTS: 500% profit. "Happy Home Make Shampoo" builds your own big business. Martin of Indiana made \$75.00 in one day. Missouri man made \$750.00 one month. Exclusive territory. Geo. A. Schmidt & Co., Dept. P, 236 W. North Ave., Chicago.

AGENTS, both sexes, we manufacture and control new household article. Fast seller. Big profits. Exclusive territory. Write now. Connolly, 123 Liberty St., New York.

MOCCASIN Manufacturer Wants Agents Everywhere to sell a complete line of moccasins to wearers. Entire new line. No competition, repeat orders. Get details. Daley Moccasin Co., Fort Covington, N. Y.

WE Start You Without a Dollar. Soaps, Extracts, Perfumes, Toilet Goods. Experience unnecessary. Carnation Co., Dept. 2480, St. Louis.

AGENTS—Make a dollar an hour. Sell Mendets, a patent patch for instantly mending leaks in all utensils. Sample package free. Collette Mfg. Co., Dept. 404, Amsterdam, N. Y.

AGENTS—Send for Free Sample "Fret-not" Washday Wonder. Big Profit. You don't have to talk; if she doesn't buy at sight, leave sample. Exclusive territory. Credit given. Empire Specialties Co., 1549 N. Wells, Dept. 101, Chicago.

AGENTS make \$100 week placing advertising Cigar Lighters with glass front. Every dealer wants one. Write for free plan. Drake Mfg. Co., Dept. M, Milwaukee, Wis.

AGENTS—Sell 5c fast selling candy specialties to stores. Big profits. Lorrac Products Co., Albany, N. Y.

MANUFACTURE lamb wool polishers, dusters. Newhall, 358 Broad St., Lynn, Mass.

AGENTS make \$3.00 an hour taking orders for our 40 Fascinating Kitchen Specialties. No competition. Write Quick. General Products Co., Dept. 7-K, Newark, N. J.

AGENTS—Stamping names on Pocket Key Protectors; sample Check with your name and address. 25c. Stamping Outfits, Emblem Checks, Check Fobs, Name Plates, Hart Mfg. Co., Desk 2, 303 Degraw St., Brooklyn, N. Y.

AGENTS—Here's a New One. "Best-ever Powdered Hand Soap." Sells like wildfire. Marvelous Discovery. Removes grease, paint, ink, oil, in fact anything from the hands. Cannot harm skin. 150% Profit. Great Repeater. Agents simply coin money. "Free Samples Get the Business." Write immediately. Bestever Products Co., 1937 E. Irving Park, Chicago.

AGENTS—Steady Income. Large manufacturer of handkerchiefs and dress goods, etc., wishes representative in each locality. Factory to consumer. Big profits, honest goods. Credit given. Send for particulars. Freeport Mfg. Co., 59 Main St., Brooklyn, N. Y.

POLMET—The Wonderful Polishing Cloth that cleans all metals without liquid, paste or powder. Approved by "Good Housekeeping" and "Modern Priscilla"—sells fast at 25c. Sample free. Gale & Co., Inc., 15 Edinboro St., Boston.

MAN in each town to plate auto parts, reflectors, bathroom fixtures, refinish beds, mirrors, chandeliers; by new method. No capital or experience required. Simple plan of manufacturing at home starts you in big money-making business. Outfit furnished. Free particulars and proofs. Gun Metal Co., Ave. H, Decatur, Ill.

REPLATE brass worn-off Automobile parts, Reflectors, Bath Room Fixtures, Worn Spoons, Forks, etc., with pure silver. Looks like new. Use U-Kan-Plate Polish. Positively no mercury. \$1.00 half pints. Post Paid. Satisfaction Guaranteed. Agents wanted. Dept. A, U-Kan-Plate Co., Philadelphia.

AUTOMOBILE Specialties. Guaranteed formulas for all latest money makers. Lowest prices. Write for free lists. Murphy, Chemist, Tujunga, Calif.

PERFUMED Beads from California. Fast Sellers. No Competition. License unnecessary. Big margin. Hire subs. Clean up. Mission, 519PM, 2328w. Pico, Los Angeles, Calif.

AGENTS: Big Money Monogramming by Transfer method. Catalog Showing Over 50 Styles and Particulars Free. Motorists' Accessories Co., Mansfield, Ohio.

FREE Sample. "Rain Shield Wiper." Retail \$1.00—Cost (25 cents). Sold Clear and Rainy Days. No Cloth—No Paste—No Attachment. (1) Rub keeps windshield clear 48 hours. Experience unnecessary. NuLife Corporation, Hartford, Conn.

\$60-\$200 A WEEK. Genuine Gold Letters for store windows. Easily applied. Free samples. Liberal offer to general agents. Metallic Letter Co., 438-B North Clark, Chicago.

GOLD Sign Letters. \$0.75 for Thousand. Non-Tarnishable. Free sample. Catalogue. Atlas Sign Works, 1032 E. 53th St., Chicago.

KLEENZIT Kleening Pencil—Removes spots and stains from men's garments and similar fabrics. Simply mark spot with cleaning crayon and erase with brush-pad moistened with water. Sells readily at 35c to 50c. Big profit. Sample 25c. Argyle Specialty Company, Argyle, Wis.

HIGH-GRADE SALESMEN WANTED

\$100 PER week—Just Show It and Collect. "Sure-Hold," the screw-driver with fingers that hold the screw and start it where human fingers cannot reach. Positively Sells on Sight. Every mechanic is waiting to buy. Millions Will Be Sold. Made in 3 sizes (to handle any screw or bolt). Sell for \$1.00, \$1.10 and \$1.25 each or \$3.35 per set. To Agents only. Upon receipt of \$2.35 (money order or currency) we will send you sample set by parcel post, prepaid, with agents' confidential price list and full particulars, showing you how to make \$100 Per Week. If you prefer, send 50 cents postage and pay postman \$2.00 upon receipt of sample set. Money Back Guarantee. If you are not delighted with our proposition return the "Sure-Holds" and we will immediately return your money. You take no risk. Biggest Money Maker Today. No Competition. We Guarantee the Sale. Automobile Free. Be First. Sure-Hold Screw Driver Company, Jefferson and Third, Desk X, Seattle, Wash.

SALESMEN—Pomeroy Electric Primer has started coldest autos easily for five years. Underwriters' approval. Guaranteed. Sells \$3.75. Whole or part time. Special advertising campaign. No investment. Write immediately. Pep Primer Co., Mfrs., Rochester, N. Y.

SALESMEN—Local and traveling representatives sell "Wine" Grape Juice in kegs and barrels. Port type, Sherry type, Tokay type, Claret type, Muscatel type, Madeira type, Catawba type, Burgundy type, Reisling type, Sauterne type, French Vermouth and Italian Vermouth. Manufactured by the oldest and most responsible winery in America, shipped from our own vineyards. Be independent, work for yourself, no investment required. Established since 1879 with a high rating in Dun's and Bradstreet's. Call on our established trade for new business, who will also recommend others. The Taylor Wine Company, 152 West 42nd St., New York City.

WONDERFUL Opportunity for reliable man as representative of \$4,000,000.00 firm showing nationally advertised line of staple merchandise to business men. Basic necessity—steady repeater. Underselling competition 30%—Earnings start big, grow larger. Our men earn \$50.00, \$100.00 and more weekly—full or spare time. No experience needed. A few exclusive territories are open. Write for full information—Free. J. B. Simpson, Dept. 1316, 843 Adams St., Chicago.

WANTED—Tailoring Salesmen, make \$60 to \$125 per week. We are the largest made-to-measure tailoring house in the country, furnishing elaborate sample equipment. Over 150 all wool fabrics sell at \$23.50, \$29.50, \$34.50 and \$43.50 which includes commissions of \$3.50 to \$8.50 and bonus. Guaranteed absolute satisfaction, perfect fit, best workmanship, or no sale. We maintain an absolute 6-day delivery schedule. Write for our line and all accessories to be sent free. Tell us all about yourself. Edward E. Strauss & Co., Inc., Dept. 101, 402 So. Market St., Chicago.

SALESMEN: Galacite, the most successful patented puncture-proofing compound for auto tires, is making \$5,000 to \$10,000 a year for our hundreds of authorized representatives. Sells to car owners and dealers in big quantities. Seals any puncture instantly and makes tire puncture-proof for life. Positively guaranteed. Backed by a large, well financed corporation of long standing. Complete elaborate outfit and extensive advertising co-operation ready to back you in your community. The best money-making proposition ever offered you. Write at once to C. F. Johnson & Co., 19 West Jackson Blvd., Dept. 453, Chicago.

\$30.00 A DAY for District Salesmen. Responsible man, 30 years old or over, and permanent resident in community, can make \$30.00 a day and up as District Salesman, taking orders for our finest, tailored-to-order clothes at sensational new low price. No investment necessary. We supply everything, give exclusive territory to producers, pay highest cash commission daily and big monthly bonus besides. Write at once to Dept. 772, Goodwear Chicago, Inc., 844 West Adams, Chicago.

SALESMEN—Distributors, sell marvelous smokers, pocket lighters, gas lighters; every smoker, every home buys immediately; earn large profits; send for self-selling plans. Masterlite Corp., 110-C East 23rd, New York.

TIP-TOP Salesmen to handle our line of Tip-Top Luggage on Commission basis. Line established for 15 years. Petersburg Traveling Goods Co., Petersburg, Va.

WANTED—High-Class Salesmen calling on Plants and Industrials to sell The Klay Universal Gear, Pulley and Wheel Pullers. No competition, Quick Sales, Large Commissions. The Scott & Ewing Co., Bluffton, Ohio.

SALESMEN calling on mills and factories can add to their income \$25 to \$50 a week without increasing their expenses. Write for particulars. Redcone Company, Inc., 1400 Broadway, Room 334, New York City.

MR. BRUSH Salesmen—Old Established New York Brush Manufacturers require services of men in all territories to sell their extensive line of Sanitary Twisted in Wire Brushes. We pay larger commission than any other Brush House in the country. Write immediately for proposition. Wire Grip Sanitary Brush Corporation, 15 Mercer Street, New York.

MEN—Sell dependable shrubbery, fruit trees, etc. Steady demand. Complete co-operation. Commissions paid weekly. Write Perry Nurseries, Dept. R-2, Rochester, N. Y.

75c PROFIT on \$1.00 sale. Auto furniture and glass cleaner. Your name on label. Exclusive rights—free sample. Mfg. E, 213 Griswold, Detroit, Mich.

LADIES' full fashion hosiery mill a wonderful opportunity for men now calling on department store and dry goods trade. Side line if desired. Commission basis to start. In first letter state territory desired and detail your experience. All replies strictly confidential. Toewear Hosiery, Inc., Norristown, Penna.

SELL real \$40 suits for \$23.75—All wool Tailored to order. Write for big sample outfit of 120 All-Wool smart new fabrics. \$4 for you on every sale. A proposition good for \$5,400 to \$7,200 in 1927. Grab it! State age, territory, references, experience if any. Fairbanks Tailoring Co., Dept. C-105, Oakley at Wabansia, Chicago.

SIDE-LINE Salesmen to connect us with Agents to sell our Auto Mitten Dusters. No money needed. No goods to sell. Pay weekly commissions on all orders received from men you appoint. National Fibre Broom Works, St. Louis, Mo.

COLLECTS Money from the Dead-Beats. Retail \$5.00—Cost \$1.00—Profit \$4.00. "New Method." Every Storekeeper, Doctor buys quickly. Wonderful Money Getter. Federal Association, Hartford, Conn.

IF You Think in Terms of \$6,000 The First Year Write Me Now. Strong line for retail stores. Nationally advertised. Established concern. Best season now starting. Liberal weekly advance to producer. Geo. R. Williams, Mgr., 1317 Liberty Bldg., Cleveland.

\$10 To \$20 daily selling Ver-I-Ezy Comfort Shoes to men and boys. Big seller for years. Easy sales. Low priced; Cash Commission. Full or part time. Write, Easywear Shoe Company, Dept. 229, Indianapolis.

SALESMEN! Big season just ahead. Show our line of advertising pencils. Established 15 years. Complete selling outfit. Naco, 126 So. Clinton, Dept. B50, Chicago.

MILLIONS of car owners must have tires. Sell quality cord tires direct from factory. Low prices. Liberal commissions. Hadi Rubber Company, Sandusky, Ohio.

OFFICE Specialty salesmen for sensational seller. Desk name plate Sample 75c. World Signs, H108 North Dearborn, Chicago.

WANTED men or women to sell Furman's full line of guaranteed insecticides, such as Roach Powder, Fly Killer, Rat Bon Bons. Exclusive territory, 60% profit. Furman Company, Kerrville, Texas.

SALESMEN—Try Device Free. Starts Cold Motor Instantly. Saves Gas. Amazing Seller. Write quick. Elec. Super-Starter, Dept. S-2, Grand Rapids, Mich.

BECOME Your Home Town's Leading Business Man. Big money. Easy work. Selling groceries, coffee, canned goods, auto oils, direct to consumer. Undersell competition. Free gifts. Commission Advanced. Liberal Credit Plan. No Experience or capital necessary. Loverin & Browne, 1615 So. State, Chicago.

GOLD Leaf Window Letters and Script Signs. No experience; 500% profit. Samples Free. Consolidated, 69-V West Van Buren, Chicago.

ANTIFREEZE prevents radiators freezing. No evaporation, cheaper, better than alcohol. Greatest winter seller to filling stations, garages. Gallon free. Antifreeze Co., St. Paul, Minn.

WALKER made \$165 first day selling Collection System. Pays ten for one. We show you how. Adjustment Bureau, Mobile, Ala.

SALESMEN ribbons any territory side line 10% commission. Augusta Company, 333-341 Fourth Ave., New York City.

SALESMEN—Are You Making Enough Money? Let us show you how to make Big Profits with Jiffy Washing Tablets. No experience required. Write for Free Sample and Plans. Jiffy Soap Products Co., Dept. A, Dayton, Ohio.

SALESMEN—Become Independent. Own Your business, experience unnecessary selling our \$7,500.00 Accidental Death; \$50 Accident; \$25 Sick Weekly Benefits—\$12.50 Yearly. Other Amounts proportionate. Guaranteed steady income from renewals. \$250,000 Deposited Insurance Department. Universal Policy, Dept. A, 30 Clinton St., Newark, N. J.

TAKE orders for coffee, sugar, flour, meats, canned goods, staple groceries also paints, radio sets, tires, auto and tractor oils. No capital or bond required. We deliver and collect. Permanent business. Rig pay. Write at once. Hitchcock-Hill Co., Dept. 50, Chicago.

TRAVELING Salesmen Calling on Retail Stores wanted by large manufacturer of fast-selling specialties entirely different from the average. Year-round sales, main or sideline. Big commission paid immediately on original and repeat business. Opportunity for well paid and permanent connection with old-established firm. If not making \$150 weekly, write today. Union Specialty Works, Dept. 222, Boonville, N. Y.

MAGIC Moving Window Salesman. It's Real changeable letter system has actually boosted users' sales 200% to 400%. None but dead dealers indifferent. If you can spot a winner, get the facts and begin pocketing \$100 weekly. Display Products Company, P. O. Box A5123, Gateway Station, Kansas City, Mo.

FREE Adding Machine to "Live-Wires" accepting our Dollar-a-Minute Agency. Improved 2-lb. Calculator. Adds, Subtracts, Multiplies, Divides. Work equals \$300.00 machines. Retail \$15.00. Big demand; large profits. Write quick for protected territory. Lightning Calculator Co., Dept. F, Grand Rapids, Mich.

\$60-\$200 A WEEK. Genuine Gold Letters for store windows. Easily applied. Free samples. Liberal offer to general agents. Metallic Letter Co., 438-A North Clark, Chicago.

CALIFORNIA Rosebuds selling like hot cakes. Agents coinng money. Absolutely new. Big profits. Catalog free. Mission Factory SP, 2328 West Pico, Los Angeles, Calif.

FOUR \$7.50 sales to merchants net you \$20.00 daily. Sayers Systems, 2803 Sheffield Ave., Chicago, Ill.

ANY Salesmen Can Sell Them! Merchants everywhere use punchboards. Someone sells them, why not you? Collect big commissions daily. Newest, largest, elaborate catalog sent upon request. Lincoln Sales Co., 9 So. Clinton, Chicago, Dept. D.

SELL Corn Remover Display Easels to stores. Tyrrell Products Co., Martins Ferry, Ohio.

HELP WANTED

\$95.00 TO \$225.00 Month. Men-women 18 up. Get U. S. Government Jobs. Railway Postal Clerks—Mail Carriers—Postoffice Clerks and Clerical Positions. Steady. Life Positions. Paid vacation. Common education sufficient. 32-page book with sample examination coaching and full particulars free. Write today sure. Franklin Institute, Dept. F3, Rochester, N. Y.

BIG Demand in Uncrowded Field—\$3.50 to \$5 per hour for trained Automatic Machine Repairmen. We help you earn while learning. Light, clean, fascinating work. Write St. Clair Technical Inst., St. Clair Bldg., 156 E. Erie, Chicago, Ill.

\$15.00 DAILY (In Advance) Introducing latest Guaranteed Hosiery for Men—Women—Children. Just write orders. We deliver and collect. Capital—Experience unnecessary. Samples furnished. Milton Mathews, Road 2602, Cincinnati, Ohio.

RAILWAY Mail Clerks. \$1,900 first year. Men 18-35. Common education sufficient. Steady work. Specimen examination questions—Free. Write immediately. Franklin Institute, Dept. F16, Rochester, N. Y.

MAKE money silvering mirrors, refinishing auto headlights, tableware, metal plating, bedsteads, chandeliers. Outfits furnished. International Laboratories, Dept. 71, 309 5th Ave., New York.

CASH paid for butterflies, insects. See Sinclair Display Advertisement on Page 24.

MEN to train for locomotive firemen on railroads nearest their homes—everywhere; beginners \$150-\$250 monthly; promoted, locomotive engineer, \$3,000-\$4,000 yearly. Best paying positions on railroads. Railway Association, Desk M1, Brooklyn, N. Y.

RAILWAY Mail Clerks. \$1,900 year. Men 18-35. Sample coaching free. Write immediately. Franklin Institute, Dept. F16, Rochester, N. Y.

MIRRORS Resilvered at Home. Costs Less 5 cents per square foot; you charge 75 cents. Immense profits plating auto-parts, reflectors, tableware, stoves, Refinishing metalware, etc. Outfits furnished. Details free. Write Sprinkle, Plater, 287, Marion, Ind.

DON'T prepare for any Civil Service Examination without seeing our catalogue. Free Columbian Correspondence College, Washington, D. C.

U. S. GOVERNMENT wants men. \$1,700—\$1,900 and up at start. Railway Mail clerk examination coming. Let our expert (former Government examiner) prepare you for this and also Rural Carrier, Post Office, Customs, Internal Revenue, and other branches. Write today for free booklet. Dept. 8, Patterson Civil Service School, Rochester, N. Y.

OBTAIN Employment! 70 Jobs were offered one person, using plan. Send postal now. "Service," Box 39, Station K, New York.

WANTED—Boys—Men. Learn Auto Repairing. \$25.00 week. Sample lessons free. Franklin Institute, Dept. F400, Rochester, N. Y.

MEN wanting to prepare for forest ranger or railway mail clerk examinations Write Mokane, A-23, Denver, Colo.

GOVERNMENT positions pay \$35 to \$75 weekly. We help you get them. Big List Free. Write, Mr. Oament, 101, St. Louis, Mo.

EARN \$10 daily silvering mirrors, plating and refinishing metalware, auto, chandeliers, bedsteads, headlights. Outfits furnished. E. Decie Laboratories, 1133 Broadway, New York.

MEN Wanted—prepare as firemen, brakemen, colored train or sleeping car porters, wire for application blank; experience unnecessary; first class roads, no strike. Name position wanted. Railway Institute, Dept. 35, Indianapolis, Ind.

BECOME a Landscape Architect. Uncrowded profession of wonderful opportunity for money-making. Easily mastered by mail. Earn while you learn. Write for book. American Landscape School, 56-E, Newark, N. Y.

SILVERING Mirrors, French Plate. Easily learned; immense profits. Plans free. Wear Mirror Works, Excelsior Springs, Mo.

WE Start You in Business, furnishing everything. Men and women, opportunity to earn \$35 to \$100 weekly operating Ragsdale's original "New System Specialty Candy Factories" anywhere; wholesale or retail. Big commercial candy book free. W. Hillier Ragsdale, Drawer 350, East Orange, N. J.

TYPEWRITERS AND SUPPLIES

100 TYPEWRITERS Free. Overstocked. Rent Rebuilt Underwood or Remington \$3.00 month. If you pay its value in rental, we give machine free. Particulars free. Pittsburgh Typewriter Exchange, 945 Hersch Bldg., Pittsburgh, Pa.

UNDERWOOD Typewriters—only \$3.00 down. Easy monthly payments. Low prices at less than manufacturers. 10 days' free trial. Rebuilt, all worn parts replaced. Just like a new machine. 5-year guarantee. Write for a big free catalogue B-151. Shipman-Ward Mfg. Co., 1512 Shipman Bldg., Chicago, Ill.

TYPEWRITERS, all standard makes, thoroughly re-manufactured by the famous "Young Process" and shipped direct from factory to you on 10 days' trial. Guaranteed 5 years. Easy monthly payments. Write today for free catalog. Young Typewriter Company, Dept. 5742, 654 W. Randolph St., Chicago.

TYPEWRITERS—all makes; real values; guaranteed. Typewriter Bargain House, Ada, Okla.

TYPEWRITERS, all standard makes. \$10 up. Fully guaranteed. Free trial. Write for complete illustrated lists. Northwestern Typewriter Exchange, 121 N. Francisco Ave., Chicago.

TYPEWRITERS \$5-\$35. All kinds. Send cash. Knights, 1512 Locust, St. Louis, Mo.

PRINTING, ENGRAVING AND MULTIGRAPHING

5,000 20-POUND bond letter heads or envelopes \$11.50, 10,000 \$22.00. First class work. Cash with order. Phillips Printery, 1235 Kings Highway, Dallas, Texas.

QUALITY printing. Lowest prices. Special prices on Letterheads, Envelopes. We print anything. Large or small orders. "Q" Shop, Roaring Spring, Penna.

\$3.00 DELIVERED. 500 Watermarked Bond Letterheads 8½x11, 250 envelopes. Money with order. Lowest prices all printing. National Printing, Goshen, Ind.

PLEASING Quality Envelopes, Letterheads or Cards; 250 \$1.10, 500 \$2.00, 1,000 \$2.90 Postpaid. Artistically printed. Elwood Ericson, Kennedy, N. Y.

250 HOWARD bond Letterheads or Envelopes. \$1.75; 500, \$2.75; 1,000, \$4.00. Wilco Press, 1110 Capitol Bldg., Dept. C, Chicago, Ill.

COMMERCIAL Art, Illustrating, Letterheads, Cut Service. Fred Sipe, Harrisonburg, Va.

"NEARGRAVURE" Process Printed Stationery—Exclusive—Distinctive. Samples Prices. Solldays, Knox, Ind.

PRINTING—Lowest Prices in America. Samples free. Pitts, Amana, Iowa.

FOLDERS—1,000 3½x6, 900 words, \$4.00. Drewton, Box 1051, Fargo, N. D.

PUBLISH Your Own Magazine or House Organ. Our standardized service at one-fifth ordinary prices. Samples and particulars free. Evans Printing Company, Grand Rapids, Mich.

TRY to beat these prices: 5,000 letter heads, 20 lb. Hammermill Bond, \$11.25, 5,000 3X envelopes, \$8.75. Other prices and samples on request. The Low Cost Printers, 123 W. 21st, New York.

LADIES' and Gents' Personal Cards printed 50 for 50c. Midget Cards, 100 for 50c. Card Case free. Liberty Press, Liberty, Ky.

EVERYTHING Printed! Samples Free! Franklin Press, B-32, Milford, N. H.

GUMMED Labels, 500 name and address. 2 lines 35c. 3 lines 55c. Catalogue. Eastern Label Co., B, Clintonville, Conn.

250 EACH Hammermill Bond Letterheads. Envelopes, \$3.00. Samples. Midland Press, 543 West Hickory, Kankakee, Ill.

100 BOND Letterheads and 100 envelopes printed, 98c. Kalata Printing Company, Ironwood, Mich.

250 LETTERHEADS, 250 white envelopes printed and mailed \$3.00. Samples printing free. Sunco, Mohawk, N. Y.

MAKE your own cuts. New simplified method, cheap. Complete illustrated instructions, \$1. F. Record, 247 So. Broadway, Room 10, Los Angeles, Calif.

MULTIGRAPH typewriting business correspondence, two dollars thousand. Hammermill Bond letterheads four dollars. Mayera Corporation, Monmouth, Ill.

BUSINESS Cards, \$3 per 1,000. P. A. Lavin, Coshocton, Ohio.

250 BOND Letterheads, Envelopes, Billheads, Cards, \$1.35 Each. Economic Press, Leonia, N. J.

SUPERIOR quality printing; attractive samples free. Kay Press, 546 Thurston, Rochester, N. Y.

GUMMED Labels, with name, Business and address, 500—30c; 1,000—50c. P. Wetzel, Valhalla, N. Y.

DISTINCTIVE—Artistic Business Stationery that Creates Confidence. 1,000 Letterheads or Envelopes \$3.00. Samples. Moulton Printing Company, 1410-P East 8th, Kansas City, Mo.

WE print Stationery, Booklets, Catalogs, Circulars. Samples. Commercial Press, Batavia, Ohio.

QUALITY Printing! Reasonable Prices! Send for Free Standardized samples and prices. Folders, Circulars. Catalogs our specialty. Ernest Fantus, 525 South Dearborn, Chicago.

PRINTING, OUTFITS AND SUPPLIES

PRINTING Outfits—Presses, type supplies, type novelties. Send stamp for catalogue. Model Press, York, Penna.

USED presses, type, supplies. C. L. Whitfield, Ballentine, Norfolk, Va.

COMPLETE printing outfits, presses, type, ink, paper, supplies. Write for Catalogue. Kelsey Company, G-11, Meriden, Conn.

PRINTING Presses—Type—Supplies. List for 2c stamp. (Bargains.) Foster, 4342 North Robey, Chicago.

DUPLICATORS AND DEVICES

YOU can make 50 to 100 copies of a letter, notice, etc., at a cost of three cents on a Hoyer Quality Duplicator. Write for free trial offer. The Hoyer Duplicator Co., 14 S. Wells St., Chicago, Ill.

"STENCIL-DUPLICATOR" 8 x 11, \$10. Copies like mimeograph. F. Gerwin, Dale, Okla.

RUBBER STAMPS

YOUR Name and address on two line rubber stamp 25c. Brush & Co., Auburn, Nebr.

ADDING MACHINES

NEW \$3.50 Automatic Adding Machine. Adds, Subtracts, Multiplies. Absolutely accurate. Capacity \$999,999.99. Fully guaranteed. 75,000 pleased users. Makes adding easy, positive, quick. Eliminates Mistakes. Saves Time. Postpaid \$3.50. Bassett Co., 1458 D Hollywood Ave., Chicago.

FREE trial. Marvelous Calculator. Adds, Subtracts, Multiplies, Divides automatically. Work equals \$300.00 machines. Five year guarantee. Price only \$15.00. Write today for free trial offer. Special: \$3.00 Pocket Calculator, only \$2.00 cash. Lightning Calculator Co., Dept. E, Grand Rapids, Mich.

MAILING LISTS

1,000 NAMES \$2.00. 500 Farmers' Names, \$1.50. F. E. Gilbert, Box 91, Elyria, Ohio.

1,000 NAMES, \$1.00. Mention Classification. Wineholt Sales Co., 4, Woodbine, Penna.

FOR SMOKERS

SEND \$1.25 Box finest quality mild cigarettes. Sample package 10c silver or stamps. Pocket tin Special Pipe Tobacco 10c. Direct-to-smoker. French Tobacco Co., Dept. 11, Statesville, N. C.

LOOK! Five pounds good mellow smoking tobacco, \$1.00. Five pounds chewing, \$1.25. Quality and satisfaction guaranteed. Farmers' Club, 57, Hazel, Ky.

HOMESPUN Tobacco—Chewing, 10 lbs. \$2.00; smoking, 5 lbs. \$1.00; 10, \$1.75. Aged in bulk, mellow and sweet. Satisfaction guaranteed. Farmers' Union, Mayfield, Ky.

LEAF Tobacco to Consumer. Satisfaction Guaranteed. Best Chewing 20c lb. Smoking 10c; you pay postage 10 lbs. up. Collier Tobacco Pool, Martin, Tenn.

TOBACCO: Kentucky Sweet Leaf. Mellow with age. Fine flavor. Smoking, 15 lb. \$1.50. Chewing, \$2.25. Pay when received. Ernest Choate, Wingo, Ky.

FOR MEN

FURNITURE. Make Furniture at Home. Popular Mechanics books tell how to make all pieces. "Mission Furniture and How to Make It, Book 1, Book 2, Book 3." Send No Money. Just write a postal. Pay postman postage and \$3. Popular Mechanics Press, Room 902, 200 East Ontario St., Chicago, Ill.

DRAFTING. Learn Mechanical Drawing. Big demand for men. Pocket-size. Start at beginning and learn by a series of simple lessons. Send No Money. Just write postal for "A Practical Course in Mechanical Drawing." Pay postman postage and \$1. Popular Mechanics Press, Room 902, 200 E. Ontario St., Chicago, Ill.

BOATS AND LAUNCHES

BOATMEN: Parts to convert Ford Motors, lightweight base—Watercooled manifold. Coupling-Bearstarters. Write for circulars. Standard Mfg. Co., 230 Hawley St., Rochester, N. Y.

USED motor boat equipment, bought, sold, exchanged. Also repair parts. Wm. H. Baker, Pond St., Quincy, Mass.

HUBBELL Marine Coolers convert Ford engines into marine motors. Booklet free. Ford speedboat, easily built, blueprint and directions, sixty cents. C. C. Hubbell, 118 Cottage St., East Norwalk, Conn.

COMPLETE plans and specifications for building clipper ships in bottles, \$1.00. Rojahn, 519 DeKalb Ave., Brooklyn, N. Y.

NEW Boat Book telling how to make 21 kinds of boats. Also many other helpful ideas on boating. Profusely illustrated. With this we include the big book, "Outdoor Sports the Year Round." Directions for making all sorts of devices for outdoor recreation. Send no money. Simply pay the postman \$1.98 plus postage when books are delivered. Popular Mechanics Press, Room 902, Popular Mechanics Building, Chicago, Ill.

BOAT Building Plans for amateurs. Rowing, sailing, speed, cruising. Free catalog. Rudder Publishing Company, 9 Murray Street, New York.

BUILD your own boat for this season's use using Brooks Knock-Down parts or patterns. 55 Models, 9' to 40'; send 25c for complete catalog. Brooks Boat Co., Inc., Rust Ave., Saginaw West Side, Mich.

SHIP Models—Worth-while—Easy to make. Decorative ships. Picturesque Barbary Pirate Felucca and Beautiful Spanish Treasure Galleon (both 17th century). Instructions so simplified that any handy person can make these models with a few household tools almost without expense. No personal knowledge of ships or naval architecture required. New book only one of its kind. Pay postman \$2.50 plus postage when book is delivered. Popular Mechanics Press, Room 902, 200 East Ontario St., Chicago, Ill.

RAZORS AND BLADES

FIVE Gillette Style blades, 20c. "Bureau," 215M Las Animas, Colorado Springs, Colo.

FOR THE HOME

MEN! Women! Earn \$1 an Hour at Home, Weaving Colonial Bags, genuine fluff rugs, fancy fabrics, from new and other materials. Home weavers always busy. You learn in 30 minutes. We guarantee it. Looms now at reduced prices. Liberal Pay-As-You-Weave terms. Solve Your more-money problem by writing for Free Loom Book today. Union Loom Works, 480 Factory St., Booneville, N. Y.

GRANDFATHER'S Clock Works, \$5.00. Build your own case; Instructions free; make good profits selling your friends. Clock works with chimes for old or new cases. Write for full particulars. Clock Co., Ruffner St., Philadelphia.

REFRIGERATING Machine, Homemade. Operates successfully. Gives better service than ice. This and 328 other practical articles in our book "Home Mechanics." Just ask for this and "Handbook for Women" containing 394 valuable household helps and pay postman 98 cents and postage for the two books. Popular Mechanics Press, Room 902, 200 East Ontario St., Chicago, Ill.

NEW Crop Table Rice. Fresh and sweet 100 pounds beautiful white rice double sacked, \$4.50. J. Ed. Cabaniss, Box 22, Katy, Texas.

CEDAR chests only \$11.65—"Red-I-Kut" complete with rich copper trim—you assemble and save half—send for pictures. Kumpel Furniture Company, Guttenberg, Iowa.

DECORATIVE work. Directions for decorating with pressed leaves, antique painting, preserving plants, bouquets of colored grass, tree cone decoration, fungi decoration, decalcomania, crystalized grasses, Grecian painting, copper impressions of leaves, skeleton leaves, leather work, modeling in clay, moss work, paper flowers, pearl work, ornamenting with shells, etching shells, transparencies. All this and much more in "Youman's Household Guide." Send No Money. Just order on postal. Pay postman \$2 and postal charges. Popular Mechanics Press, Room 902, 200 East Ontario St., Chicago, Ill.

WATCH REPAIRING

ALL makes of Watches repaired by experts. Write International Watch Service, Box 5P, Fordham Station, New York.

ANTIQUES, WAR RELICS AND INDIAN GOODS

FOR Dem. European battlefields' relics; also medals. Illustrated catalogue and sample war photographs, 25c. Welsh, 1889 Albany Ave., Brooklyn, N. Y.

SEND 5c for fine new list Indian relics, antique bronzes. F. E. Ellis, Webster Groves, Mo.

PHONOGRAPHS AND RECORDS

PORTABLE Phonograph, eight records, \$17! Phonograph Bulletin free! Myers Music Co., 1112 Angelrod, St. Louis, Mo.

BUILD your own phonograph. We furnish everything. Catalog sent free. American Phonograph Co., 4116 West 24th Place, Chicago.

MUSIC AND MUSICAL INSTRUMENTS

PIANO Jazz: Teaches Ear Piano Playing as played by Red-Hot Musicians. May I send you circulars? Write "Piano Bill," 207 Ossington, Toronto, 3, Ontario.

SELL Latest Song Hits. Big Profits. Big Demand. Write Frank Music Publishing Co., Helena, Ark.

SONG lyrics solicited—A different proposition. Richard Broughton, Sioux Falls, S. Dak.

JAZZ: For Piano—How to Play Popular Music, Ragtime, Jazz and Blues, Breaks and Endings. How to Rag and Jazz on the Sax, Tenor Banjo, Play Melody on the Uke. All 75c each. Circulars mailed. Winn School of Popular Music, 44 West 34th Street, New York.

SONG Poem Writers—Address Ray Hibeler, D1, 2194 N. Keystone Av., Chicago.

I BUY, Sell, Publish Songs. Chester Escher, 455 Wayne St., Jersey City, N. J.

VIOLINS—Genuine handmade masterpieces. Get Details. John Lehto, 935 14th, San Pedro, Calif.

DOLLARS to Cornetists—Trombonists! High notes, attack, tonguing made easier. Full instruction \$1.00. Paul D. Placido, 628 East 29th St., Baltimore, Md.

LEARN Tenor Banjo Playing. Little method. Complete instructors (3 books) \$1.00. Quincke, 430 So. Broadway, Los Angeles, Calif.

SHARPS and Flats—Free. Very interesting. Send for it Today. Harry L. Alford, 192 No. State St., Chicago, Ill.

VIOLINS. Deep, Mellow, Soulful—on credit. Easy terms for wonderful instrument. Get details today. Gustav F. Henning, 2424 Gaylord St., Denver, Colo.

"**MUSIC** Composed" to words. Bauer Bros., (formerly of Sousa's Band), Oshkosh, Wis.

WRITE Songs. Big money and reputation. Write for information. J. Gordon Pub. Co., 201 N. Hoyne Ave., Chicago.

I WANT Song Poems. Casper Nathan, 3544 N. Racine, Chicago.

SONG Poem Writers—Stamp brings "Song Writers' Guide." Wm. Van Beaver, B1-1239 Elm St., Green Bay, Wis.

PATENT ATTORNEYS

PATENTS. Time counts in applying for patents. Don't risk delay in protecting your ideas. Send sketch or model for instruction or write for Free book "How to Obtain a Patent" and "Record of Invention" form. No charge for information on how to proceed. Communications strictly confidential. Prompt, careful, efficient service. Clarence A. O'Brien, Registered Patent Attorney, Security Bank Building (directly across street from Patent office), Washington, D. C. See pages 151 and 155.

LACEY'S Patent Sense. Valuable book free. See ad page 160.

PATENTS—Write for our Guide Books and "Record of Invention Blank" before disclosing inventions. Send model or sketch of your invention for Free Inspection and Instructions. Terms Reasonable. See advertisements on pages 156 and 157. Victor J. Evans & Co., 934 Ninth, Washington, D. C.

PATENTS Procured. Prompt Service. Personal, careful and efficient service. Highest references. Moderate fees. Send sketch or model for actual search and advice. George P. Kimmel, Master of Patent Law, 54-D Legal Bldg., Washington, D. C.

PRACTICAL, useful inventions wanted for live patent buyers. Send particulars promptly. American Patents Corporation, Barrister Building, Washington, D. C.

PERCY S. WEBSTER, 203 Saving and Loan Building, Stockton, California. Long established organization. Patent booklet free.

PATENTS, Trade Marks, Copyright procured. Very easy terms. H. Sanders, Registered Patent Attorney, 7 Rand McNally Building, Chicago.

PATENT and Trade Mark Lawyers, Mason, Fenwick & Lawrence, Washington, D. C. Established sixty-five years. Best references. Other offices, New York and Chicago. Write us.

PATENTS. Booklet free. Highest references. Best results. Promptness assured. Send model or drawing for preliminary examination. Watson E. Coleman, Patent Lawyer, 724 Ninth St., Washington, D. C.

INVENTORS—My Book Inventor's Manual, telling what every inventor should know, sent free upon request. Hartwell Balcom, Registered Patent Lawyer, Barrister Building, Washington, D. C.

PATENTS—Send for form "Evidence of Conception" to be signed and witnessed. Form, fee schedule, information free. Lancaster and Allwine, Registered Patent Attorneys in United States and Canada, 221-Ouray Bldg., Washington, D. C.

"**INVENTOR'S** Advisor," the valuable Patent book with 139 mechanical movements and illustrations, sent free upon request. M.M. Labiner, Patent Attorney, 3 Parkrow, New York.

INVENTORS—Write for our Guide Book, "How to Get Your Patent" and Evidence of Invention Blank. Send model or sketch of your invention for our prompt examination and instructions free. Randolph & Co., Dept. 430, Washington, D. C.

PATENTS, Trade-Marks, Designs. This firm has 27 years' experience and gives expert personal service at reasonable rates. We properly protect your invention. Write for free information and exact cost of procuring patent before proceeding. John B. Thomas & Co., 902 F St., N. W., Washington, D. C.

UNPATENTED Ideas Can Be Sold. I tell you how and help you make the sale. Free particulars (Copyrighted). Write W. T. Greene, 807 Jenifer Building, Washington, D. C.

PATENTS Procured: Trade Marks Registered—A comprehensive, experienced, prompt service for the protection and development of your ideas. Preliminary advice gladly furnished without charge. Booklet of information and form for disclosing idea free on request. Richard B. Owen, 30-Owen Bldg., Washington, D. C., or 41-R Park Row, New York.

"INVENTORS' Guide" sent free on request; this book contains illustrations of patented inventions and gives valuable information and advice for all who have original ideas or improvements. Frank Ledermann, Registered Attorney and Engineer, Woolworth Bldg., 1712, New York.

INVENTORS: Send sketch or model for advice and exact cost of patent. Ask for our Free book: "How to Obtain a Patent." Tells what every inventor should know. Established twenty-eight years. Highest references. Prompt service. Reasonable charges. Chandler & Chandler, 474 Seventh, Washington, D. C.

MILLIONS spent annually for ideas! Hundreds now wanted! Patent yours and profit! Write today for free book—tells how to protect yourself, how to invent, ideas wanted, how we help you sell, etc. American Industries, Inc., 500-Victor Bldg., Washington, D. C.

INVENTORS having ideas to patent: Write for Booklet explaining Co-operative Plan for handling your applications. Tells how to sell and safeguard your inventions at lowest cost. Ralph Burch, Patent Lawyer, Jenifer Bldg., Washington, D. C.

MONROE E. MILLER, Ouray Bldg., Washington, D. C. Patent Lawyer; Mechanical, Electrical Expert. Booklet and Priority Record blank gratis.

RICHARD E. BABCOCK, Patent Lawyer, Washington Loan & Trust Bldg., Washington, D. C., Booklet.

ESTABLISHED 1864. Milo D. Stevens Company. Free Booklet, Patents, Trade-Marks, Copyrights. Offices, Monadnock Block, Chicago; Barrister Building, Washington, D. C.

INVENTORS Universal Educator—contains 900 mechanical movements; 50 perpetual motions. Tells how to obtain and sell patents. Suggests new ideas. Explains how to select your attorney and avoid patent sharks. Special Price, \$1.00 post-paid. Albert E. Dieterich, 621B Ouray Bldg., Washington, D. C.

FOR INVENTORS

PATENTS. If you have an invention which you wish to patent you can write fully and freely to Munn & Co., for advice in regard to the best way of obtaining protection. Please send sketches, or a model of your invention and a description of the device, explaining its operation. All communications are strictly confidential. Our Hand-Book on Patents is sent free on request. This explains our methods, terms, etc., in regard to Patents, Trade Marks, Foreign Patents, etc. "Scientific American" contains Patent Office Notes, Decisions of interest to inventors and particulars of recently patented inventions. Munn & Company, Solicitors of Patents, 1523 Scientific American Building, 24 W. 40th St., New York City; 524 Scientific American Bldg., Washington, D. C.; 1313 Tower Bldg., Chicago, Ill.; 666 Hobart Bldg., San Francisco, Calif.; 521 Van Nuys Bldg., Los Angeles, Calif.

PATENTS. Time counts in applying for patents. Don't risk delay in protecting your ideas. Send sketch or model for instructions or write for Free book "How to Obtain a Patent" and "Record of Invention" form. No charge for information on how to proceed. Communications strictly confidential. Prompt, careful, efficient service. Clarence A. O'Brien, Registered Patent Attorney, Security Bank Building (directly across street from Patent Office), Washington, D. C. See pages 154 and 155.

INVENTORS—Write for our Guide Books and "Record of Invention Blank" before disclosing inventions. Send model or sketch of your inventions for our free inspection and instructions. Terms reasonable. See advertisements on pages 156 and 157. Victor J. Evans & Co., 157 Ninth, Washington, D. C.

PATENTS Procured: Trade Marks Registered—A comprehensive, experienced, prompt service for the protection and development of your ideas. Preliminary advice gladly furnished without charge. Booklet of information and form for disclosing idea free on request. Richard B. Owen, 30-Owen Bldg., Washington, D. C., or 41-R Park Row, New York.

INVENTORS Universal Educator—contains 900 mechanical movements; 50 perpetual motions. Tells how to obtain and sell patents. Suggests new ideas. Explains how to select your attorney and avoid patent sharks. Price (revised edition) \$1.00 post-paid. Albert E. Dieterich, 621-Ouray Bldg., Washington, D. C.

IF you have a practical, useful invention to sell, send particulars promptly. American Patents Corporation, Barrister Building, Washington, D. C.

INVENTIONS Perfected, Ideas Developed, Models, Tools, Dies, Experiment. John Zoltan, 833 Lyman Ave., Oak Park, Ill.

PATENTS wanted, by manufacturers. Send description, Box 126, Dowagiac, Mich.

I SELL Patents. Established in 1900. The Service you will ultimately employ if you have a valuable patent to sell. Charles A. Scott, 773PM Garson Avenue, Rochester, N. Y.

REDESIGNING, Selling and Promoting Patents, High grade Model making and Drafting service at reasonable rates. All our work is strictly confidential and guaranteed. L. C. Johnson Engineering Works, 3405 North Clark St., Chicago, Ill.

UNPATENTED Ideas Can Be Sold. I tell you how and help you make the sale. Free particulars (Copyrighted). Write W. T. Greene, 806 Jenifer Building, Washington, D. C.

I AM in touch with hundreds of moneyed men and manufacturers who wish to buy good inventions. Write Hartley, 38 Court St., Bangor, Me.

WE assist selling patent when obtained through us. Patents Bureau, Times Bldg., St. Louis, Mo.

INVENTOR wants financial aid. Fred E. E. Petterson, General Delivery, Dothan, Ala.

LACEY'S Patent Sense. Valuable book free. See ad page 160.

GET your own patents. Legal blanks, complete instructions \$1. Cutting Sons, Campbell, Calif.

PATENTS FOR SALE

OUTRIGHT—Successful patented Conductor's change carrier Strap. Owner unable to exploit. Protects clothes from tearing or becoming soiled, reduces weight. Max Kisselhoff, 1050 Tiffany St., New York City.

FOR Sale—new anti-skid device, patented, no chains. Outright, royalty. Daresod, 324 E. 60th St., New York.

GLASSBLOWERS manufacture my Patent glass and wood, 75% profit. I buy all you make. Patent copy and particulars 50c. Will sell same invention in Canada. John Baukus, 2821 So. Jefferson, Saginaw, Mich.

"OUTRIGHT," Individual (Dry) Tea Dispenser. Portions Checked. Hygienic, Economy. For Hotels, Restaurants and Ships. Patent pending. John Hardy, 21 Cambridge Street, East Orange, N. J.

OUTRIGHT—Internal Grinder; operates with 1, 2, and 3 spindles. Best offer takes it. Henry Kosmos, 2546 W. Monroe Street, Chicago, Ill.

OUTRIGHT—Combination Telephone stand market for six millions; sell for \$5.00, cost \$1.00. Henry Kosmos, 2546 W. Monroe St., Chicago, Ill.

OUTRIGHT or Royalty. Adjustable screen door brace. Prevents sagging, dragging. E. V. Morreau, 803, Marshall, Texas.

JUST out—Patent on Game Apparatus. A game of skill, fun for young and old. Outright or royalty. Edwin J. Scarseth, Galesville, Wis. Route 2.

OUTRIGHT or Royalty. Automatic headlight dimming devices. For automobiles. Edwin Helmssoth, Arlington Heights, Ill., c/o Wm. Hugo.

FOR Sale—Patented pedal scooter with speed of bicycle. Stetson, Box 2243, Sta. B. San Francisco, Calif.

METAL Heel Plate effectively prevents slipping on ice, snow, sleet; quickly attached, detached. Outright, royalty, reasonable. Charles Heinemann, 186 Paterson Ave., East Rutherford, N. J.

FOR Sale—Patent, Improved Flour Sifter, outright or Royalty Basis. Harry Nakagawa, Tanana, Alaska.

CORNER Glareshields; protects the eyes of the driver from glare of the sun; new and practical; nothing like it. Outright or royalty. G. E. Phillips, Imola, Calif.

OUTRIGHT preferred. Smoke ring blower. Big profit for novelty manufacturer. E. F. Kelly, 3438 Minnesota Ave., St. Louis, Mo.

FOR Sale or Royalty. My new improved Split Sewing Machine Needle is easily threaded. A needle that can be threaded by a person with very poor eye-sight. If interested, will send sample. Address: John T. Raper, Route 2, Lucama, N. C.

THE Sovereign Wind Concentrator is the greatest power on earth. Patent for sale. Address L. G. Sovereign, Rt. 2, Milford, Nebr.

OUTRIGHT—Patent number 1,559,398—Bathroom Fixture. Must sell at a bargain. Hans Anderson, 325 Center St., Chicago, Ill.

PATENTS for U. S., Canada and France on a Valve Lifter. Write to G. J. White, Ranch House, Oceanside, Calif.

CLOTH Pin which does away with the hardships of hanging out clothes in cold weather. Box 437, Forston, Minn.

SPOKE extender puts in new spokes in place or whole rim. Shrinks tire without smith or shop. N. C. Watson, Wade, Fla.

DANDY Camp Patent. On market. Sells well. Earl Sanders, Pawnee, Ill.

WHY let your patents lie idle? Tell our two million five hundred thousand readers about it! The majority of our readers are especially interested in new ideas and inventions. Ask me to tell you how other inventors successfully sold their patents. M. L. Rund, Mgr., Classified Advertising, Popular Mechanics Magazine, Chicago.

ENGINEERING

ENGINEERING Data: Pocket loose-leaf Transformers, and distribution diagrams. Send for circular. C. Homan, 193 Berkeley Place, Brooklyn, N. Y.

ELECTRICAL

FORD Electrical Equipment Troubles—Locate and remedy them easily yourself with the aid of our book "Ford Standard Electrical Equipment." Why pay big garage bills? Battery, Ignition, Starting and Lighting covered. Order to-day. When postman hands you the package pay him \$1.98 and the postage. Popular Mechanics Press, Room 902, 200 E. Ontario St., Chicago, Ill.

ELECTRICAL Kinks on all phases of practical electricity. 47 ideas on wiring, 45 on making electrical devices, 19 on lighting, 5 on transformers, 5 on motors, 8 on generators, 11 on switches, 22 on testing, 12 on repairing, 11 on battery manufacture and repair, 5 on telephones, and 9 on electricians' tools. 214 articles, 162 pictures. Send no money. Just write postal for "Electrical Kinks." Pay postman postage, and \$1.50. Popular Mechanics Press, Room 902, 200 E. Ontario St., Chicago, Ill.

SURVEYING INSTRUMENTS

LARGEST stock of new and used surveying instruments in the country direct from factory. Satisfaction guaranteed or money refunded. Wissler, 619 N. Broadway, St. Louis, Mo.

MODELS AND MODEL SUPPLIES

PATENTS. Time counts in applying for patents. Don't risk delay in protecting your ideas. Send sketch or model for instruction or write for Free book "How to Obtain a Patent" and "Record of Invention" form. No charge for information on how to proceed. Communications strictly confidential. Prompt, careful, efficient service. Clarence A. O'Brien, Registered Patent Attorney, Security Bank Building (directly across street from Patent Office), Washington, D. C. See pages 154 and 155.

SHIP Model Fittings. List, send dime. Roy Hancock, 323 Douglas Ave., Portsmouth, Va.

LET our experience be your guide. Models that are models; Tools and equipment for economic manf. Patterns of all types; manufacturing in all branches. Satisfaction guaranteed. United Machinery Company, Cincinnati, U. S. A.

BLUEPRINTS—60 different Models, steam, gasoline engines, small boilers. List for stamps. United Engineering Works, 3407 W. 66th Place, Chicago.

WE have in Stock all kinds of Hard and Soft Woods. For Model, Inlaying and Scroll Work. Write us your requirements. Geo. Wild, 510 East 11th St., New York.

INVENTORS, we build high-grade demonstration models. Write us. Nortwed Model Machine Shop, Ethan, S. Dak.

MODEL steam engines and boilers. Boat and boiler fittings. Send 10c stamp for catalog. Refunded with first order. Model Machine Shop, P. O. Box 5, Station Y, New York City.

SPECIAL machine builders, tool and die makers, inventor's models, production work of all kinds. Dept. L. Quality Hardware & Machine Co., Ravenswood and Thorndale Avenues, Chicago, Ill.

MODELS, Experimental Work, Light Manufacturing, and Stamping. Frosthalm Bros., Syracuse, N. Y.

MODELS, Tools and Dies, and General Manufacturing, new invention, our specialty. Logan Machine & Manufacturing Co., 126 S. Clinton St., Chicago, Ill.

HULIT & Co., General Model Makers, 625 W. Jackson, Chicago, Ill. Specializing in high-grade model work on inventions of merit. Complete Equipment, Experienced Workmen.

We make working models for inventors and do experimental work and carry a complete stock of brass gears and model supplies. Send for catalogue. The Pierce Model Works, Tinley Park, Ill.

MANUFACTURING

INVENTIONS developed and manufactured. Any material. Models, instruments, tools. Lowest prices. Established twenty years. Swanberg, 5124 N. Kildare Ave., Chicago.

MODEL and experimental work. Dies, stampings, tools, production, engineering. Sterling Tool & Mfg. Co., 1335 30th St., Milwaukee, Wis.

SPECIAL Machinery or parts, dies, tools, metal specialties, models, special gears, stock gears and model supplies. Send for Catalogue. The Pierce Model Works, Tinley Park, Ill.

PATTERNS, wood and metal. Models, tools and dies. Brass, bronze, aluminum and iron castings. Screw machine work, production work of all kinds. Write Modern Machine & Pattern Co., Terre Haute, Ind.

MANUFACTURING Models, Dies, Stampings, Brass Work, one or thousands. Baum's Metal Specialties, Kansas City, Mo.

WIRE goods made to order. Cooley Mfg. Co., 539 N. Western Ave., Chicago.

FOR MANUFACTURERS

MODEL, Experimental and Light Machine work. Accurate; prompt service. Lowest prices. Southern Instrument Works, 1210 Dallas Ave., Houston, Texas.

MACHINERY, TOOLS AND SUPPLIES

PIPE second hand, guaranteed suitable for all practical purposes with new threads and couplings, sixteen feet and over; cut to your requirements, also Boiler Tubes, New Fittings. Pfaff & Kendall, 102 Waydell St., Newark, N. J.

16" SMITH and Mills Crank shaper, \$500.00; 20"x10" Bradford engine lathe, \$375.00; 10" Drill press with chuck, new, \$19.25; No. 60 Heald auto cylinder grinder, \$750.00; Geared chain hoists, one ton, \$27.50; 1/4 H. P. New motors \$15. Write for complete machinery and supply catalog. Cincinnati Machinery Supply Co., 218 E. Pearl St., Cincinnati, Ohio.

KEENEDGE and Universal Skate Grinding Holders have no equal for sharpening skates, \$3.50 and \$5.00 each. Will grind all makes of skates and save time in sharpening Tubes and Hockey skates. Fero-dowill Mfg. Co., West Indiana Ave., St. Paul, Minn.

CONCRETE Building Block Machines and Molds. Catalogue free. Concrete Machine Co., 5 N. Main St., St. Louis, Mo.

OTHERS have successfully sold their machinery through our columns—so can you. Ask me for proof. M. L. Rund, Manager, Classified Advertising, Popular Mechanics Magazine, Chicago.

LATHES 9 in. Backgeared. 1" hole in spindle. Mechanical Lathe Co., 546 Washington, Chicago.

BENCH-SAWS, Band-Saw, Jointers, Scroll-Saws, Lathes & Motors at factory prices. Write for catalogue. E. A. Pophal Mfg. Co., Wausau, Wis.

FOR Sale—Four Spindle Drill and patterns to build same. Arthur D. Allen, Mt. Morris, N. Y.

BOLTS, nuts, rivets, specialties. O. L. Dickey, Bayonne, N. J.

USED Machine Tools—Lathes, Milling Machines, Grinders, etc. Send for List. Cincinnati Automatic Machine Co., Cincinnati, Ohio.

ENGINES, MOTORS AND DYNAMOS

ALTERNATING Current Motor Bargain, 1/2 Holtzer-Cabot—\$7.50. Many other specials. Send for new list or tell us your needs. Hyre Electric Company, 615 MX South Dearborn St., Chicago.

NEW full 1/4 HP, 110 volts, AC, 60 cycle grinder and buffer, equipped with 6" wheels, enclosed motor \$15.75 each. New 1/4 HP, 110 volt, AC motors, 60 cycle, with pulley \$10.00 each. Prompt shipments. Westinghouse new 1,000 Watt, 32 volt, light and power generators, ready to run, while they last \$48.00 each. General Distributing Co., Security Bldg., Duluth, Minn.

1/4 HORSE Alternating and direct current used motors \$6.50. 1/2 H. P. 110 V. Universal motors \$2.75 each. Gas and gasoline engines slightly used sizes five to twenty horse. Also other bargains. Queen City Electric Co., 1736 Grand Ave., Chicago, Ill.

FOR Sale—Several hundred small Belt Driven Air Compressors, 1 1/2" Bore, 1 1/2" Stroke. Air cooled, well built, and never used. Left over from a large order. Will ship them for \$1.50 each, post paid on receipt of price. Here is a bargain for anyone interested. York Electric & Machine Co., 30 N. Penn St., York, Pa.

DIESEL Engines—Marine, Locomotive, Stationary. Growing importance of the Diesel Engine cannot be overestimated. This new book should be in the hands of every student of mechanical engineering. 500 pages, 280 illus. Pay postman \$5 and postage when he delivers book. Popular Mechanics Press, Room 902, 200 E. Ontario St., Chicago.

MOTORS—New GE 110 or 220 volt 60 cycle Single Phase 1/4 HP, \$11.90; 1/2 HP, \$28.50; 1 HP, \$38.50. Mail \$3 check or money order. We will ship COD anywhere. Motor Specialties Co., Crafton, Penna.

ELECTROPLATING. New printing of popular book by H. C. Reetz. Complete instructions for plating with all kinds of metals. Send no money. Just write a postal asking for "Electroplating." Pay postman the postage and \$1.00. Popular Mechanics Press, Room 902, 200 East Ontario St., Chicago, Ill.

BLACKSMITHS

BE a Master Mechanic Blacksmith and Expert Tool Maker and Dresser with colored tempering charts. Price \$1.00. Valuable samples free. W. M. Toy, Sidney, Ohio.

BENDING MACHINES

THE famous Hossfeld Wrenchless Universal Bender is the last word in bending machines; bends metal, cold or hot, into most any conceivable shape, including Eye-bolts and Automobile Spring Eyes. Bends up to 1" bars or 1 1/4" Pipe cold. Used by the largest corporations, yet so inexpensive that even a farm shop need not be without one. Send for Circular. Hossfeld Mfg. Co., Box 344, Winona, Minn.

FOR SALE—MISCELLANEOUS

MAGNIFIERS and Pocket Microscopes. Highest Grade. Free Catalog. Optix Company, Pershing Square Building, New York.

500 **HOROSCOPES**. Big Astrological Wheel, \$15. Delisle, 810 Hyde Park Blvd., Chicago, Ill.

BUY—Exchange—Sell! Many of our readers have for sale or exchange the article you are looking for—and lots of them are looking for the very items you want to turn into cash. Get together! Let our two million five hundred thousand readers know your wishes—they'll help you! Send your ad today to M. L. Rund, Manager Classified Advertising, Popular Mechanics Magazine, Chicago.

ADDRESSOGRAPHS, Letter Folders, Multigraphs, Envelope Sealers, Duplicators, less than half price. Guaranteed. Pruitt Co., 117 No. Market, Chicago.

WANTED—MISCELLANEOUS

MAIL us your discarded Jewelry, Gold, Crowns and Bridges, Watches, Diamonds, Silver, Platinum, and old False Teeth. Money promptly mailed. Goods returned if offer refused. United States Smelting Works, (The Old Reliable), Dept. 71, Chicago.

REAL ESTATE, FARM AND ORCHARD LANDS

135 ACRES, 4 Horses, 10 Cattle. Income over \$88 weekly. 520 Fruit Trees; 120 acres fields, stream-watered; excellent stone residence, 9 rooms; good 90-ft. basement barn, other numerous bldgs.; near motor bus, convenient city. Only \$8,500 and 4 horses, 8 cows, 2 bulls, 6 hogs, 250 poultry, crops, modern machinery included. Part cash. Details pg. 37 big illus. Catalog. Copy free. Strout Farm Agency, 255-P, 4th Ave., New York City.

SEIZED and sold for taxes. 2 acres on Georgian Bay, \$40.50. 12 1/2 acres, Muskoka, \$43.20. 50 acres hunting camp, \$63.90. 50 acres, lake front, \$142.20. 100 acres, hunting and trapping, \$94.50. 200 acres, fine sporting property, \$250.00. These prices are not first payments, or price per acre, but the total amount asked. Also beautifully situated hunting and fishing camps for moose, deer, caribou, ducks, partridge, trout, whitelish, bass, etc.; best in North America. Summer cottage sites, farms, heavily wooded tracts, acreages large and small, for pleasure and investment; all offered at ten cents on the dollar of their value, and on easy monthly payments of \$5 and upwards. Illustrated list describing the above and hundreds of other properties seized and sold for taxes, mailed free on request. Send no money. Send for a list at once, so you will have first choice. Tax Sale Service, Room 617, 72 Queen Street, West, Toronto, 2, Ontario, Canada.

CASH paid through your Bank or Attorney for nearby New York, Brooklyn, Long Island, New Jersey lots. Send description and price. Horace Stripe, 18 West 34th, New York.

FLORIDA'S Finest Orange Land near fast growing city. Only \$1.50 acre monthly. Hurd, B-591, Klamath Falls, Ore.

\$10 IS all I ask down on 20 acres in Mich. Potato Belt. Very easy terms. Near markets, lakes and streams. Write for particulars now. G. W. Swigart, 1276 First Natl. Bank Bldg., Chicago.

ATTENTION—"Get acquainted." Cash for your property. Farm, Hotel or Retail Store, no matter where located; confidential service. Hayes' Business Agency, Cincinnati, Ohio.

OZARKS—10 acres near White River and proposed power dam, \$100, \$5 monthly. Alvin Zimmerman, 1802 N. 5th, Kansas City, Kans.

SELL your property quickly for cash, no matter where located. Don't pay big commission. Particulars free. Real Estate Salesmen Co., Desk B, Lincoln, Neb.

PECAN-Orange-Fig Groves "On the Gulf" Monthly payments. Guaranteed care. Big, quick returns. Suburban Orchards, Dept. M, Biloxi, Miss.

OREGON Homesteads (late opening) and lands offer exceptional opportunities. Map and details \$1.00. Frank Thompson, Sheridan, Ore.

POULTRY

No. 1 LOW Booking Terms; Super-Test accredited chicks. All kinds. Our low prices and good service get the orders. Three color catalog free. Missouri State Hatchery, Dept. 711, Butler, Mo.

KEEP Chickens? Tell us the breed and how many and we'll send you free a copy of the most interesting poultry journal ever published. Poultry Item, Box 71, Sellersville, Pa.

OUR Baby Chicks are from high-egg bred, inspected flocks. Big—sturdy. Grow like weeds! Sent postpaid, safe delivery guaranteed. Plymouth Rocks, Rhode Island Reds, Leghorns, White Wyandottes, Minorcas, Buff Orpingtons, Anconas. Quality chicks. Low Prices. Catalog Free. Mary Maude Farms, Box 122, Portland, Ind.

ROOTS AND HERBS

HERB Doctor Book—10 cents. 250 receipts for making herb medicine. Hazzard Company, Box 1, Vanderveer Park, Brooklyn, N. Y.

DOGS AND PETS

RAISE guinea pigs. Pay better than poultry or rabbits; easy to raise; little space required. Particulars and booklet how to raise free. Cavies Distributing Co., 3102 Grand Ave., Kansas City, Mo.

FOXES, raccoons, muskrats, skunk, ferrets, rabbits, squirrels, mink, opossums. B. Timman, Caledonia, Minn.

RABBIT Sale—Pedigreed. \$2.00 up. Illustrated book, 10c. Malkranz Rabbitry, New Bethlehem, Pa.

PERSONAL

INGROWING Nails may be successfully treated at home without pain; results guaranteed. Copyrighted instructions \$1.00. Eugene S. Eaton, Box C-553, Bandon, Ore.

FREE: Valuable book telling the uses of Roots and Herbs. Box 23, Station L, New York.

SEND 25c coin and your date of birth for forecast of your vibrations for 1927. Aryel Synclare, Numerologist, Box 25, Patton, Calif.

TOBACCO or Snuff Habit Cured or no pay. \$1.50 if cured. Remedy sent on trial. Superba Co., N3, Baltimore, Md.

WONDERFUL health book for only 10c (publisher's price \$1.00). Appreciated by every reader, sick or well. Teaches health the natural way, also suggest reliable self treatment of disease. Address, Author, Box 437, Seattle, Wash.

MISCELLANEOUS

TYPEN, Fountain Pen Typewriter, \$10. Wt. 1 oz. Wonderful new speed printer. With pocket case and ink. Kaiqlex, folding vest pocket adder; —, X, +, \$6., 6 places with book, new logs and tables; new speedy methods. Accurate to any No. of Figs. \$1 a dial. Best in its class. Surpasses slide rule. Illustrated booklets on new things, on request, free. Every customer satisfied or money back, 1 wk. Dr. H. E. W.'s Specials, Audubon, Pa., U. S. A.

BANNERS, signs, cartoons, drawings. T. R. Goodwin, Gen. Del., Kansas City, Mo.

POWERFUL Meyers xray. Will sell or trade for Arizona, Kansas or Georgia property. Box 24, Coshoccon, Ohio.

ELIMINATE cold floor drafts with pipe-less heaters. Plans 50c. Bachman, 1064, Fullerton, Pa.

MIRRORS resilvered at home. Costs less 5 cents per square foot; you charge 75 cents. Immense profits plating autoparts, reflectors, tabeware, stoves, refinishing metalware, etc. Outfits furnished. Details free. Write Sprinkler, Plater, 288, Marion, Ind.

CAN You Draw? Make money at home. Something new. Sample and particulars 10c. "Straley," 1017 W. Mulberry, Springfield, Ohio.

ANSWERS to mathematical problems of office, store, shop, bank, farm, or factory. Explains and simplifies every principle of arithmetic, mechanics and mensuration. Send No Money. Just ask for Ropp's Calculator." Pay postman \$1.00 and postage. Popular Mechanics Press, 200 E. Ontario St., Room 902, Chicago, Ill.

MEXICAN-MADE pistol holsters, cartridge belts, lariats; hand-carved belts and holsters; horse-hair belts, hat bands, fobs; rattlesnake belts, fobs. Ingersoll Leather Co., 307 Fannin, Houston, Texas.

ARTIFICIAL Eyes. Booklet free. Denver Optic, 559 Quincy, Denver, Colo.

TATTOOING Supplies Direct from Manufacturer. "Waters," 965 Puttnam, Detroit.

FORTUNES in Mines and Minerals. Ore specimen free. Minerals for sale. Buskett, Joplin, Mo.

WOLF and Coyote Exterminator Capsules —With formula and instructions; got 9 coyotes one night, brought \$121.50; free circular. George Edwards, Livingston, Mont.

CASH paid for butterflies, insects. See Sinclair Display Advertisement on Page 24.

DO you want good live agents—fellows who can get the business? Ask me how others are doing it. I'll gladly render the necessary assistance without cost to you. Address, M. L. Rund, Mgr. Classified Advertising, Popular Mechanics Magazine, Chicago.

I CATCH from 45 to 50 foxes in from 4 to 5 weeks' time. Can teach any reader of this magazine how to get them. Write for particulars. W. A. Hadley, Stanstead, Quebec.

CUTS anybody can make. Simple, cheap process. \$1. Specimens, particulars. 2c stamp. M. Day, Windfall, Ind.

HOMEOPATHIC and Biochemic preparations sent postpaid to all parts of the world. Manual and booklets free. Halsey Bros. Co., 645 St. Clair St., Chicago, Ill. Established 1855.

AMATEUR Cartoonists: Make money in spare time with new cartoon selling plan. Write Smith's Service, PM1194, Wenatchee, Wash.

WEEDS—Cut them with cutter bar on Shaw Garden Tractor. Also plows, cultivates and runs belt machinery. Low prices. Immediate delivery. Shaw Manufacturing Company, Department C, Galesburg, Kans.

BARGAIN Offer. Act Quickly. Genuine Part Wool Indian Style Blankets. Size 66x80. Fast woven colors. Special \$3.00 each guaranteed. Double value. Benz, 432 East 156 Street, New York City, New York.

SHORTCUTS in figures. The quickest ways of working all problems. Instructions for drilling yourself to become rapid with figures. Complete, yet simplicity itself. Send No Money. Just write a postal for "Shortcuts in Figures." Pay postman \$1.25 and postage. Popular Mechanics Press, Room 902, 200 East Ontario Street, Chicago, Ill.

"BLUEPRINT Reading" is a compact book telling how to read Machine blueprints. Send No Money. Just pay postman postal charges and \$1. Popular Mechanics Press, Room 902, 200 E. Ontario St., Chicago, Ill.

KINKS on Metal Work. 419 discoveries for anyone who works with metal. For mechanic, machinist, or the man who tinkers at home. 287 illustrations. Send No Money. Just write a postal asking for "Machinist's Kinks." When postman hands you book, pay postage and price of book, \$1.50. Popular Mechanics Press, Room 902, 200 E. Ontario St., Chicago, Ill.

LOCKSMITHING. 500 tricks of the trade; how to make keys; how to open locks and safes; safe drilling; how to set combinations; key-cutting tables; umbrella work; everything you should know to become a lock expert. Copiously illustrated. Only complete book on subject sold at reasonable price. Send No Money. Just write a postal for "Locksmithing." When postman hands you book, pay \$1.50 and postal charges. Popular Mechanics Press, 200 East Ontario St., Room 902, Chicago, Ill.

ESCAPE from Sacks, Rope Ties and Chains. Easy with these complete instructions. Give an entire evening's entertainment and mystify the "wise ones." Let them tie you hand and foot, place you in a bag and seal the bag. In a minute you are out. Complete instructions in "33 Rope Ties" and "Sack Escapes." Send No Money. Pay postman \$1.50 and postal charges for these two books. Popular Mechanics Press, Room 902, 200 East Ontario St., Chicago, Ill.

It takes only 8 weeks to get a big job



Geo. Smith owns an agency and repair shop in West Alexandria, Ohio. He makes \$200 a week.



C. E. Gillespie has charge of a fleet of trucks and tractors with the State Highway Commission, due to McSweeney training.

In the Auto, Tractor and Electrical Business

Read what these men are doing—here is your big chance to get "on easy street." Come to these great shops on the biggest SPECIAL offer ever made. Big firms need trained men. The Auto and Tractor Business is on the boom. Thousands of trained men will be needed during the next few months. I get calls every day from Garages, Battery Stations, Auto Repair, and other successful concerns for McSweeney men. When the big fellows need high grade men they know where to come for them. They want McSweeney trained men. My training is unusual. Scientific tool training—that's the secret. You do things here according to the latest engineering standards. Thousands of dollars have been spent in modern tools and equipment. You'll know a motor like a brother. That's why my men are at home with the biggest shops in the country. If you want to succeed the way Smith, Collins and the rest have—qualify by the same method.



D. M. Collins, Williamsville, West Virginia, writes, "After finishing McSweeney training, I started in as manager of a garage at \$300 per month."

I'LL PAY YOUR RAILROAD FARE AND BOARD YOU!

In order to fill the openings that now exist, I am making this unusual offer including your railroad fare and board without ANY extra charge whatever. But even that is not all. I'll tell you about the rest in my letter.



McSweeney Auto, Tractor and Electrical Training Shops, Dept. BR-14, (Address shops nearest you) Cincinnati, O., Cleveland, O., Chicago, Ill.

Without any obligation send me your big free book on Autos. Also information regarding Special Reduced Price Tuition temporary offer.

Name.....
 Street.....
 City.....State.....

Send for FREE BOOK

My big illustrated training book tells how others are succeeding. It tells many things you ought to know about Autos and Tractors. Write for it and my short time Reduced Price Tuition offer NOW. It soon expires.

MC SWEENEY
AUTO, TRACTOR
and ELECTRICAL SCHOOLS

Cincinnati, Ohio Dept. BR-14, Cleveland, Ohio Chicago, Ill.

Big Money for You as an Automobile Mechanic

These four practical books, written by five well known teachers of automobile practice, will teach you right in your own home during your leisure time just what you need to know about automobile troubles and repair. They will teach you automobile construction, maintenance and repair as experts know them and will help you to earn an expert's pay.

Practical Automobile Library: Four Books—\$1.50 in 10 days and \$2 monthly for 6 months—only \$13.50 in all!

Hundreds of question-answering diagrams—hundreds of clearly-marked illustrations—make the books plain and readily understandable. All the explanations and descriptions are clear, simple, direct. Every chapter is packed with definite, step-by-step, how-to-do-it information. Here is your opportunity to enter a big-pay field.

Sent FREE

Send No Money
Mail the Coupon

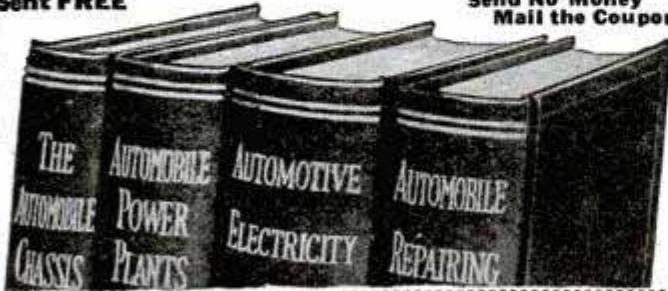

FREE EXAMINATION COUPON

McGraw-Hill Book Co., Inc., 370 Seventh Ave., New York

Send me for 10 days' free examination the New Practical Automobile Library. If satisfactory I will send you \$1.50 in 10 days and \$2.00 monthly until the special price of \$13.50 is paid. If not wanted, I will return the books at your expense.

Signed

Address

City and State

Position

Employer P. M. 2-1-27

MAGIC LEARN OVERNIGHT TO MYSTIFY YOUR FRIENDS

THURSTON
World's Greatest Magician
Will Teach YOU
MAGIC by MAIL



Now you can learn magic OVERNIGHT! Think of receiving instruction from the Great THURSTON—the man who has mystified Presidents, Kings, Emperors and famous scientists! Think of the fun and the thrill when you can amaze your friends with the baffling mysteries of Thurston's magic!

SUCCESS GUARANTEED

Everyone cannot become a great artist or musician or genius. But anyone can learn magic when instructed by THURSTON, the Master Magician. Tricks which seem absolutely incomprehensible become simple as A B C when explained and illustrated the new THURSTON way. Yet they become more mystifying each time you perform them. THURSTON guarantees that without any previous experience you can learn and perform every trick in his course almost immediately!

Complete Course—Nothing Else to Buy

Contains the 25 most entertaining tricks from THURSTON'S great collection. Most mystifying because performed without apparatus. Absolutely nothing else to buy—all tricks

performed with ordinary articles such as cards, coins, handkerchiefs, etc. Do not confuse Thurston's Course in Magic-by-Mail with cheap book magic and mechanical tricks that everyone has seen.

SEND NO MONEY

Pay nothing till postman delivers Course—then only \$5 plus a few cents postage for complete course, (or send \$5 in advance and we pay postage). You can return the Thurston Course within 5 days and get your money back if you are

not satisfied that this is the best investment you ever made in your life. Don't wait. Don't delay. Order now and in a few days you will be able to perform real magic that will amaze everyone!

THURSTON, the MAGICIAN & ASSOCIATES, Inc.
16 West 46th Street Room 506 NEW YORK, N. Y.

Popular Mechanics Library of Newest Books

This library consists of the eight books listed below, which have been published by Popular Mechanics Press in recent months:

- | | |
|------------------------------|--------------------------------|
| Lathe Handbook | Home Mechanics |
| Handbook for Women | Handbook for Farmers |
| Concrete Handbook | Boat Tourist |
| Auto Owner's Handbook | Auto Tourist's Handbook |

The regular price of these books when bought separately is \$4.50. To those who order the complete Library of Newest Books at one time, the special price of \$4 will be allowed. **SEND NO MONEY**—Simply write a postal asking that the library be sent G.O.D. When the postman delivers the books at your door, hand him the \$4 and the few cents postage.

POPULAR MECHANICS PRESS, Popular Mechanics Building, Room 711, CHICAGO

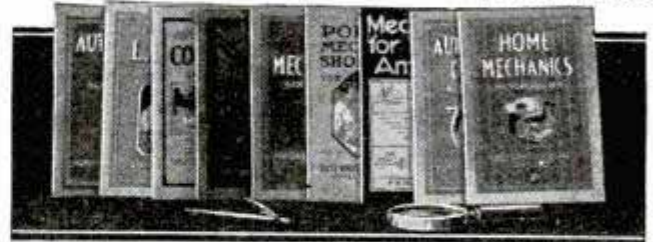

FREE—WRITE TODAY!

Quisenberry's BIG BOOK
Poultry secrets and his new way revealed. 35 years experience from all over the country. Money-making ideas from well known experts. You can put them into cash at once. **Less losses—More Eggs** from less feed—guaranteed. All this in big FREE Book. Just send name, address and kind of poultry you like. **EXTRA!**—Free Bulletin tells what to do each month. Don't fail to send for these today. Absolutely Free!

AMERICAN POULTRY SCHOOL
Dept. 70 Kansas City, Missouri

NEED A BETTER GRIP ON MATHEMATICS?



SEND for a copy of "Mathematics for the Practical Man," only \$1.50. By common sense methods it removes the mystery and difficulties so that algebra and even calculus are made simple.

Assuming your knowledge is limited to arithmetic you quickly and easily gain a working knowledge of Algebra, Geometry, Trigonometry and Calculus. Simply pay postman when he hands you the package.

Popular Mechanics Press
Room 102,
200 E. Ontario Street, Chicago

EVERYBODY'S HANDBOOK of Electrical Kinks

This is a brand new book similar to Popular Mechanics other "kink" books. It is made up of 214 ideas and short cuts for doing electrical work of all kinds. It is a book for amateurs as well as professional electricians. If you are interested in wiring, electric lighting, the making of electrical devices, experimenting, repair work, battery manufacture and repair, or telephones, you will find many helpful articles in this book. If you are interested in radio, you should have this book to learn some of the short cuts used by electricians in wiring and making apparatus.

THE BOOK CONTAINS

- | | |
|--|--|
| 47 ideas on wiring | 11 ideas on switches |
| 45 ideas for making electrical devices | 6 ideas on installation |
| 19 ideas on electric light'g | 22 ideas on testing |
| 5 ideas on transformers | 12 ideas on repairing |
| 5 ideas on motors | 11 ideas on battery manufacture and repair |
| 8 ideas on generators | 5 ideas on telephones |

There are 162 Pictures to make the ideas clear. Boys can follow the directions as well as men. If you understand the simple fundamental principles of electricity, this book will be a wonderful help to you.

Send No Money Just write your name and address on a postal card and say that you want the New book of Electrical Kinks. When the postman hands you the book, hand him \$1.50 and the few cents postage. If you live outside the U. S. or do not expect to be at home when the postman calls, send the \$1.50 with your order. Address
POPULAR MECHANICS PRESS Room 702 Popular Mechanics Bldg. 200 E. Ontario St., Chicago

Wanted: Men--Women!

Make \$5,000 to \$15,000 a year as Real Estate Specialists. I made \$100,000 in less than 5 years. Learn the secret of my success. Use my scientific system. Start at home in your spare time. No capital or experience needed. Write for free book and positive proof of big success.

MEN--Women--listen!
No matter who you are, where you are or what your daily task may be, here is a money-making business opportunity meriting your immediate attention.

It is an opportunity to get started in one of the biggest profit-making professions there is. And you can start right at home—in your spare time—without capital or previous experience—and build up a permanent, independent business of your own. Real estate is a business of wonderful possibilities. It is a business in which

up-and-doing men and women are making \$5,000—\$10,000—\$15,000—a year.

I started in the real estate business with no experience and less than \$5 capital, and in less than five years I made over one hundred thousand dollars.

And I have started others in the business—men and women—from 19 to 65—taught them my successful system—gave them my counsel and advice—helped them make money my way.

And what I have done for others, I will do for you—provided you are in

earnest in your desire to get ahead. To learn just how I began—to learn the secret of my success—to learn how I started others—to break away from the rut of routine work and establish yourself in a high-class business—sign and mail the Coupon at the bottom of this page. You will then receive—without cost or obligation—my new, illustrated book, "How to Become a Real Estate Specialist," which contains my history and your opportunity. American Business Builders, Inc., Dept. 44-BB, 18 East 18 St., New York.

Get Your Share of These Big Profits

\$200 A WEEK



"Working on a salary of \$35 a week, my savings were few and my worries many. Now in less than seven weeks from the day I opened my office, I have made in excess of \$1,200. To no other agency do I owe the ability to carry on this business other than your system. Without it I would still be making my \$35 per week instead of around \$200 as a starter."

E. K. McLendon, Oregon.



"In May, 1925, I was simply a housekeeper and stenographer. Reading your advertisement I learned for the first time of your System. Have I succeeded? This is the answer: I have sold a good many thousand dollars' worth of real estate. Have deals pending that will go beyond the \$300,000 mark. I owe all my success to your comprehensive System."

Mrs. Carrie Marshall, Mississippi.

\$300,000 IN DEALS



SUCCESS WITHOUT CAPITAL

"I have been helped a great deal with your System. I have now a new car, two new typewriters, a stenographer, and a dandy office, and money in the bank, all through my own efforts and without any capital to start with."

Alice Moore, Connecticut.



"Your System opened my eyes to the possibilities in Real Estate. Since starting eight months ago, I have specialized in selling vacant lots and have earned four thousand dollars."

W. H. Robinson, Illinois.

\$500 A MONTH

No Other Business Offers You Such Rich Rewards

NO other business in the world, that you have ever heard of, offers you all the advantages and opportunities that real estate does. Here are a few of them:

(1) Real estate is the biggest thing there is. More than half the wealth of the nation is invested in it.

(2) It is an easy business to learn. It does not take years of study like medicine, law, dentistry, pharmacy, architecture, engineering, etc.

(3) You can get started with little or no capital. I started with less than

five dollars. Others have started with small sums and made big money.

(4) The real estate business is as permanent as the earth itself. It is not affected by changes in style, by human whims or caprices.

(5) Real estate is a pleasant business. No hard, laborious work requiring unusual health or strength.

(6) It is a business open to young and old of both sexes.

(7) It pays bigger money than anything else I know of. Experienced men sometimes make \$1,000—\$5,000—

in single deals—more than the average man makes in a year of hard work.

(8) There is practically no limit to the business. It is said that there are at least ten million properties for sale or exchange at all times.

(9) It is a great small-town business. One user of my system said he made more than \$1,000 a month last year in a town of only 3,000 people.

If you want to get into a business having all these advantages and opportunities, write at once for my free book, "How to Become a Real Estate Specialist."

**This Free Book
Opens Wide the
Door to Real
Estate Success**



Mail This Coupon Today

AMERICAN BUSINESS BUILDERS, Inc.

(Authorized Capital \$500,000.)

Dept. 44-BB, 18 East 18 St., New York.



Send me—without cost or obligation—your new, free, illustrated book, "How to Become a Real Estate Specialist."

Name

Address

Advertising

**PAYS MANY
\$5,000 to \$50,000
A YEAR**

You Can Earn Big Money In This Easy-To-Learn PROFESSION

There is nothing complicated—nothing mysterious about this great money-making work. All you need to make a big success in this field is a common school education and the determination to get ahead. No other trade or profession is so easily and quickly learned, at home, as Advertising—no other offers such quick and extraordinary returns in cold cash. This

Old Established School Has Trained Thousands

Page-Davis graduates, men and women alike, are acknowledged leaders in the Advertising world. That is because they learned the fundamentals of advertising from masters of the profession. You have that same opportunity offered you now. What others have done—what you can do—is fully told in

This Amazing Book FREE



—it tells the
whole story

Send for it today. Read of wonderful successes made by those who were, like you—seeking the road to big money and a respected place in the business world. Read how easy it is to prepare yourself for such a position. Before you do another thing write for this book—the "Stepping Stone" to a happy successful life.

PAGE-DAVIS SCHOOL OF ADVERTISING
Dept. 1352 3601 S. Michigan Ave. Chicago

I WANT YOUR BOOK

PAGE-DAVIS SCHOOL of ADVERTISING
Dept. 1352 3601 S. Michigan Av., Chicago, U. S. A.

Gentlemen:— Please send me your Book which tells how I can become a proficient advertising executive with big pay. Also tell me all about your Money-back Guarantee. Of course, I assume no obligation in asking for your Book and this information.

Name

St. No. or R. F. D.

City State

PAGE-DAVIS
School of Advertising



Your Choice \$20⁰⁰ Musical Instruments **FREE** TO OUR STUDENTS

Your choice of a Violin, Tenor Banjo, Hawaiian Guitar, Banjo, Cornet, Ukulele, Banjo Ukulele, Guitar, Mandolin or Banjo Mandolin. You will be proud to own any one of these instruments and you can have one absolutely free. A few cents a day for lessons is your only expense. Our system of teaching is so easy that you can play several pieces by note with the first four lessons. We guarantee success or no charge. Instrument and lessons sent on one week's free trial. Write for booklet today, no obligation.

CHICAGO CORRESPONDENCE SCHOOL OF MUSIC
1632 N. Halsted St. - Dept. 221 - Chicago, Illinois



If you write poor and with difficulty, I can show you how to steady your nerve and write with ease as plain-as-print. Send for FREE BOOK, "How To Become an Expert Penman," which explains my Method of Teaching Penmanship by Mail and what students have done by taking my courses. Your name will be elegantly written on a card if you enclose stamp to pay postage. SEND TODAY before you forget it!
T. M. TEVIS, BOX 25X, CHILLICOTHE, MO., U. S. A.

LEARN WATCHMAKING

and become independent. We help you secure a position.
Easy to learn. Send for FREE CATALOG.
ST. LOUIS WATCHMAKING SCHOOL, Dept. 5, ST. LOUIS, MO.



Get into the electric wiring field— big money for you

Great demand in wiring field. These books prepare you. **KINKS**; helps; short cuts; practical, on-the-job electrical data, written particularly to help wiremen, trouble shooters, maintenance men, armature winders, electrical contractors and students. The whole wiring field covered; concrete and usable details about new and better ways for doing the kind of work you have to do.

American Electricians' Library
6 volumes, 2000 pages, illustrated, \$16.00 payable
\$2.00 in ten days and \$2.00 a month

The books tell you all you must know about conduit wiring, armature winding, wiring for lighting circuits and switches, wiring for machinery, circuit troubles, circuit testing, or electrical machinery erection. Through a study of this great set you can push yourself into a big-pay job for life.

See it FREE — Send no money — ACT

FREE EXAMINATION COUPON

McGRAW-HILL BOOK CO., Inc.
370 Seventh Avenue, New York

Send me the American Electricians' Library for 10 days' free examination. If satisfactory, I will send you \$2 in 10 days and \$2 monthly until the full price, \$16, is paid. If not wanted, I will return the books at your expense.

Name

Address

Position

Company P.M. 2-1-27



FREE BLUE PRINTS

AND FREE BOOK "HOW TO READ BLUE PRINTS"
SHOW YOU THE WAY TO

9 BIG PAY JOBS

- | | |
|--|---|
| 1 Building Superintendent—\$5,000 to \$12,000 | 6 Building Estimator—\$6,000 to \$10,000 |
| 2 Building Inspector—\$4,800 to \$8,000 | 7 Real Estate Expert—\$5,500 to \$12,000 |
| 3 Appraiser—\$6,000 to \$10,000 | 8 Construction Foreman—\$4,500 to \$8,500 |
| 4 Material Buyer—\$5,000 to \$7,500 | 9 CONTRACTOR AND BUILDER IN A BUSINESS OF YOUR OWN—\$5,000 to \$12,000 |
| 5 Material Salesman—\$5,000 to \$12,000 | |

FIND OUT HOW
Easy it is to Make
\$4,500 to \$12,000 A Year

[Learn to read Blue Prints this amazing new way! Get into the world's richest industry—Building! See how quickly and easily you can train to make \$4,500 to \$12,000 a year! My FREE Book "How To Read Blue Prints" discloses all the so-called "mysteries" of Blue Print Reading—also gives some startling facts about the nine best jobs in America. Don't send one penny—just mail the coupon!

NO longer need you spend years trying to pick up the "mysteries" of Blue Print Plan Reading. For now a quick, sure practical method has been perfected that has made thousands of men Blue Print Experts in a surprisingly short time.

This is no ordinary "school course." It is practical from start to finish. It is based on many sets of real Blue Prints—plans that would cost thousands of dollars if purchased from architects. Twenty famous experts in all lines of construction work talk over these Blue Prints with you in plain simple language. Show you every detail. Explain every short cut. Tell you the "secrets" of quick, accurate estimating. Explain Superintending. Give you for the first time many inside facts and money-making methods used by the "Giants" of the Building Industry.

This is the kind of training that quickly puts men into \$5,000 to \$12,000 a year jobs—or into profitable contracting businesses of their own. Yet now you get it right at home in only 2 or 3 months. It requires no extensive education. If you can read and understand what is written here you can easily master it. See what this training has done for others: Bartholomew, Calif., became a contractor at an in-

crease of over 300% his first year; Blair, Okla., stepped up to Superintendent at 100% increase; Dickerson, R. I., increased his salary 700% in 12 months; Marchand, La., says "My income has increased 200% and I now have more contracting work than I can do."

Over seven billion dollars will be spent this year in new construction! No wonder, then, such tremendous opportunities are open to you when you have this "head-work" training in Blue Prints.

If you want more money—real big money! Then choose a "Blue Print" job in Building, Clerk or Salesman, Carpenter or Bricklayer, here is the one field where there are unlimited opportunities for advancement.

So accept my FREE gift of a complete set of real working Blue Prints, and my fascinating Book "How To Read Blue Prints" that tells all the interesting and instructive facts about Blue Print Plans. Don't send one penny—pay no C. O. D.—it's all FREE. Just fill out and mail the coupon today—NOW!

TWO BOOKS
also

FREE



IF YOU LIVE NEARBY

Visit our big day or evening school attended by over 500 Builders. You can get the same training at home by mail—same plans, lessons and instructor. Your spare time is enough.

Chicago Technical School for Builders
Dept. B-140, Chicago Tech.
Building, 118 East 26th Street, Chicago, Ill.

Please send me your free book "How To Read Blue Prints," and complete set of real Blue Prints. I understand these are mine to keep without obligation. It is also understood that no salesman will call on me.

Name.....
Address.....
City.....State.....
Age.....Occupation.....

Chicago Technical
SCHOOL for BUILDERS

Dept. B-140, 118 East 26th St., Chicago, Ill.



Make That Dream Come True!

Haven't you often pictured yourself playing the Hawaiian Guitar, a happy crowd around you, everybody enjoying and admiring your playing? Now you can reach your goal—and play all the latest hits just as the Hawaiians do!



You can play the **HAWAIIAN GUITAR** just like the Hawaiians!

\$15
HAWAIIAN GUITAR
with Genuine Seal Grain
Fabrikoid Cover
FREE
when you enroll

Complete Conservatory Course

52 complete lessons. Pictures explain every move. Our method is simple, practical and interesting—only 4 motions to learn. No tiresome scales and exercises—you play a real piece your very first lesson.

Expert Instruction by Native Hawaiians

Get the advantage of expert instruction by Kolomoku, Kafaluki, Ferera and Seville—every one famous as both player and teacher. Even if you never touched a musical instrument in your life, under their direction you make rapid headway—you will be astonished when you see how easy it is!

This Sweet Toned Hawaiian Guitar

in genuine Fabrikoid Case—and complete playing outfit including picks, steel playing bar, etc. sent you free when you enroll. Retailers ask \$15 or more for a similar outfit without the case. Remember, there are no extras—we furnish everything with the course.

Learn In Spare Time

Pick up your guitar at any time and play. Your lessons are always handy—you can always refer to them. You are never hurried or forced. And no waiting for a class to form—start now—go ahead as fast as you like.

Pay as You Play Small first payment starts you. And the entire 52-lesson course comes to just a few cents a lesson! Begin now.

We Guarantee in writing to teach you. And after graduation we coach and advise you without charge. Over 45,000 successful graduates.

Tenor Banjo and other courses—Violin, Tiple, Tenor Guitar, Banjo Ukulele, Ukulele—under well-known instructors. Write for information.

FIRST HAWAIIAN CONSERVATORY OF MUSIC, INC.
9th Fl., Woolworth Bldg., Dept. 348, New York, N. Y.

Approved as a Correspondence School Under the Laws of the State of New York

SEND THIS COUPON FOR LIBERAL OFFER!

First Hawaiian Conservatory of Music, Inc.
9th Fl., Woolworth Bldg., Dept. 348, New York, N. Y.
Please mail full information about your 52-lesson Hawaiian Guitar Course. I am not obliged to enroll unless I want to.
Name _____
Address _____
City _____ State _____



Don't Envy The Plumber BE ONE!

\$11.00-\$16.00 PER DAY and work **EVERY** day, is the Plumber's wage.

Every skilled workman will tell you that Plumbers have the best of it. WINTER and SUMMER the Plumber is busy at top wages. No skilled Plumber is ever out of a job—compare his opportunities with any trade, plus the opportunities of having your own shop.

We teach you Plumbing with **TOOLS** (not books) under Licensed Master **PLUMBERS** in one of the finest equipped schools in America. We make you a Plumber, every branch is taught thoroughly—Lead Work—Blue Print for plan reading—all other tricks.

LEARN IN 8 to 12 WEEKS without previous experience.

If you are making less than \$60.00 a week you owe it to yourself to investigate. Get **FREE** catalog that tells in pictures and words how we teach this trade. Special rates now.

UNIVERSAL PLUMBING SCHOOL
2030 Troost Ave. KANSAS CITY, MO.

LEARN TO DRAW!

Remarkable book just off the press—"COMMERCIAL ART AND CARTOONING." Explains how to make illustrations for Books, Advertisements, etc. Also tells how to become a successful Cartoonist. **NO CORRESPONDENCE COURSE—Everything complete in this book—14 chapters, over 125 illustrations.** Tells about Elementary Drawing; Still Life; Pen, Ink, Charcoal and Crayon Work; Wash and Figure Drawing; Cartooning; Bound Flexible, Imitation Leather—Gold top. Worth \$5.00. Sent postpaid for **\$2.00** (C. O. D. 17c extra). **OGILVIE PUB. CO., 57 Rose St., New York, Dept. 133.**

POST PAID \$2.00

Book on Law Free

Write today for this new book. It tells you how a law training will shorten your road to success. It also carries a vital and inspiring message to every ambitious man! Find out about the opportunities that await the law trained man. Find out how you can learn law right in your own home. No obligations. The book is absolutely **FREE**. Write Today—now while we are making a special reduced tuition offer.

American Correspondence School of Law
3601 Michigan Ave. Dept. 1352 Chicago, Illinois

Hotels Start You With Salaries up to \$3,500 a Year — with your living

HOTELS, restaurants, clubs, apartments, everywhere need trained men and women—salaries to start up to \$3,500 a year with your living usually included. Over 70,000 high-class positions paying \$2,500 to \$10,000 a year are open every year in the hotels of the United States. Today, this is the 4th **INDUSTRY IN AMERICA** with over \$1,000,000,000 in new hotels and clubs being built in 1927. These new hotels, clubs, restaurants, etc., will need nearly 200,000 trained men and women. You can have one of these high-class big-pay positions, fascinating work with meals and luxurious apartment usually furnished **FREE!** No previous experience necessary. The Lewis Schools guarantee to give you the valuable knowledge that it has taken some of the most successful hotel men years to obtain—men who are now making \$5,000 to \$50,000 a year. We train you by mail in your spare time at home with the Lewis Simplified Study Plan and put you in touch with big opportunities. Our students employed, our methods endorsed by leading hotel men everywhere.

Send today for Free Book, Your Big Opportunity, Insuring You a Better Job and details about our Money-Back Agreement.

LEWIS HOTEL TRAINING SCHOOLS

Room AC-388 Washington, D. C.

FREE BOOK COUPON

LEWIS HOTEL TRAINING SCHOOLS, Room AC-388, WASHINGTON, D. C.
Send without obligation the Free Book, Your Big Opportunity, etc.

Name.....
Address.....
City..... State.....

I'll Pay Your Railroad Fare to Chicago Without Extra Cost

Learn ELECTRICITY!

**-In the great
GREER
SHOPS**

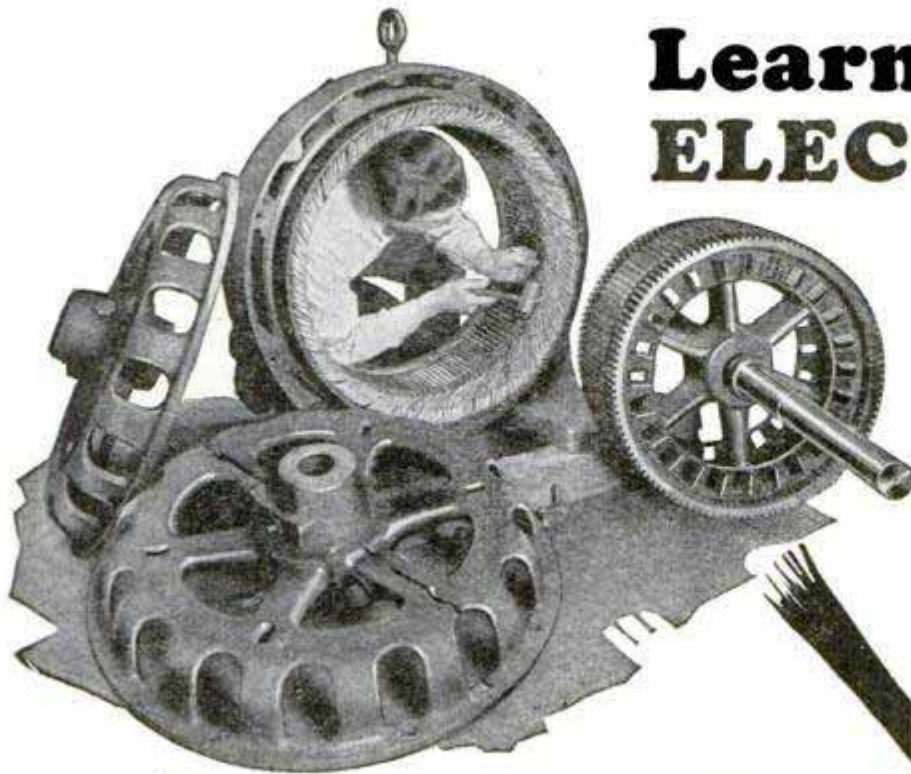

Repairing a 50 Horsepower Motor in the Greer Shops

**We have started
many a man
toward finan-
cial independ-
ence in the
electrical
and auto-
motive
trades.**

**MAIL
THIS
COUPON**

Men If you had the positive assurance that a few seconds' time, a snip of the scissors and a postage stamp would start you on your way to financial independence you wouldn't hesitate, would you? Then mail the coupon. It's the big opportunity of your life, looking right at you.

Earn \$1.00 per Hour to \$25,000.00 per Year

THESE are the wages paid to men who know how to handle that funny and fascinating juice called ELECTRICITY. Electricity is as tame as a kitten. It follows little wires—or big ones—wherever you want it to go. Just learn how to hook up those wires and the tame kitten becomes the greatest force in the world. It turns the wheels in thousands of factories. And you can be paid the **biggest money you've ever earned** for knowing how to make electricity work.

Wouldn't you like such a fascinating job? Twelve short weeks in our training shops will teach you all the tricks. Your parents, wife or relatives will gladly spare you from home for that short time. Because it will mean more money for you and for them—for life.

The Greer Shops have trained nearly 60,000 men for better jobs. Our equipment and instructors are the best that money can buy. When you are Greer-trained you are thoroughly trained by actual shop experience. Thousands will tell you so.

Automobiles Too!

While you are learning electricity here you can learn about automobiles too! Learn two big pay trades at the same time, at amazingly low combination price. You save 37½% by taking both courses. Actual shop training on everything connected with autos. 75 to 100 real cars of all makes to work on.

Here you are, pretty close to the coupon that brings you our big FREE BOOK telling all about it and how little it costs. Mail this coupon before you do another thing.

Greer College of Electrical Engineering
Dept. 103 CHICAGO, ILLINOIS

FREE Employment Service

Our employment department is ready to help you—while in training and for life. Day and evening classes. Low cost. Easy terms.



Using the "Weaver Crane" in the Automobile repair department. Here you learn about all up-to-date auto equipment—by actually using it. Real experience on all makes of cars, under supervision of an expert.

ERWIN GREER, President, Greer College—
Dept. 103, 2024 S. Wabash Ave., CHICAGO.
Please send me your FREE BOOK and offer for Electrical course
It is understood I am not obligated in any way Automotive course

Name

Address





"All that I am I owe to her"

"Two years ago I was so blue and discouraged that I didn't know which way to turn.

"Everything seemed to be going wrong. Bills were piling up and my small salary scarcely lasted from week to week. Worst of all, there wasn't any prospect of my getting more money.

"Then one night I sat down and tried to find a way out. But I seemed to be up against a blank wall. 'It's no use,' I said to myself, 'I'm a failure now and I guess I'll always be a failure.'

"Mary saw what I was thinking and she came up and quietly put her hand on my shoulder.

"Don't give up, Bob," she said. "For my sake, please don't give up. You're just as smart as other men, but you haven't the training they have. Why don't you take up the same kind of a course that Tom Barnett did? You know how it helped him!"

"I saw that Mary was right, so I enrolled for a course with the International Correspondence Schools. I thought it would be hard, but it wasn't. The lessons really fascinated me, because I could see how they were helping me in my work.

"In six months I got my first raise in salary, and I've been going up since then. We wouldn't have this house and the car and money in the bank if Mary hadn't urged me to enroll with the I. C. S."

Why don't you study some one thing and get ready for a real job, at a salary that will give your wife and children the things you would like them to have? You can do it if you really try.

Just mark and mail the coupon and at least find out what the I. C. S. can do for you. It doesn't cost you a penny or obligate you in any way to do this, but it may be the means of changing your entire life. Do it now!

INTERNATIONAL CORRESPONDENCE SCHOOLS Box 5632-E, Scranton, Penna.

Without cost or obligation, please send me one of your booklets and tell me how I can qualify for the position or in the subject before which I have marked an X:

BUSINESS TRAINING COURSES

- | | |
|--|---|
| <input type="checkbox"/> Business Management | <input type="checkbox"/> Salesmanship |
| <input type="checkbox"/> Industrial Management | <input type="checkbox"/> Advertising |
| <input type="checkbox"/> Personnel Organization | <input type="checkbox"/> Better Letters |
| <input type="checkbox"/> Traffic Management | <input type="checkbox"/> Show Card Lettering |
| <input type="checkbox"/> Business Law | <input type="checkbox"/> Stenography and Typing |
| <input type="checkbox"/> Banking and Banking Law | <input type="checkbox"/> Business English |
| <input type="checkbox"/> Accountancy (Including C.P.A.) | <input type="checkbox"/> Civil Service |
| <input type="checkbox"/> Nicholson Cost Accounting | <input type="checkbox"/> Railway Mail Clerk |
| <input type="checkbox"/> Bookkeeping | <input type="checkbox"/> Common School Subjects |
| <input type="checkbox"/> Private Secretary | <input type="checkbox"/> High School Subjects |
| <input type="checkbox"/> Spanish <input type="checkbox"/> French | <input type="checkbox"/> Illustrating <input type="checkbox"/> Cartooning |

TECHNICAL AND INDUSTRIAL COURSES

- | | |
|---|--|
| <input type="checkbox"/> Electrical Engineering | <input type="checkbox"/> Architect |
| <input type="checkbox"/> Electric Lighting | <input type="checkbox"/> Architects' Blueprints |
| <input type="checkbox"/> Mechanical Engineer | <input type="checkbox"/> Contractor and Builder |
| <input type="checkbox"/> Mechanical Draftsman | <input type="checkbox"/> Architectural Draftsman |
| <input type="checkbox"/> Machine Shop Practice | <input type="checkbox"/> Concrete Builder |
| <input type="checkbox"/> Railroad Positions | <input type="checkbox"/> Structural Engineer |
| <input type="checkbox"/> Gas Engine Operating | <input type="checkbox"/> Chemistry <input type="checkbox"/> Pharmacy |
| <input type="checkbox"/> Civil Engineer | <input type="checkbox"/> Automobile Work |
| <input type="checkbox"/> Surveying and Mapping | <input type="checkbox"/> Airplane Engines |
| <input type="checkbox"/> Metallurgy <input type="checkbox"/> Mining | <input type="checkbox"/> Agriculture <input type="checkbox"/> Navigation |
| <input type="checkbox"/> Steam Engineering | <input type="checkbox"/> Mathematics <input type="checkbox"/> Radio |

Name.....
 Street.....
 Address.....
 City..... State.....
 Occupation.....

Persons residing in Canada should send this coupon to the International Correspondence Schools Canadian, Limited, Montreal, Canada.

How Much Do You Know

DO YOU KNOW how to figure interest, obtain a divorce, measure potatoes, make a will, endorse checks, write letters, conduct meetings? The Business Guide answers these and 10,000 other questions correctly.

544 PAGES—over 500 subjects, fully illustrated with forms, charts and tables. Commercial laws, 120 legal forms, interest tables, how to advertise, make investments, draw contracts, measure grain, lumber, wall paper, etc. Covers all puzzling daily problems.

USED EVERYWHERE—Thousands—merchants, lawyers, farmers, teachers, mechanics, clerks, housewives—own this book and write they wouldn't part with it at any price. Should be in every home and office.

SPECIAL—Regular \$5.00 edition, heavy Law Buckram binding, at reduced price. Order today. Pay postman \$2.97 plus few pennies postage. (\$2.85 if cash with order). Money back guarantee of satisfaction.

J. L. NICHOLS & CO.
Dept. 7, NAPERVILLE, ILL.

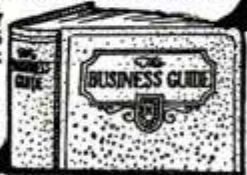

Drum Lessons With the Outfit



With each genuine Ludwig Trap Drum Outfit we furnish an instruction method. Ludwig drum sets from \$32.50 up. Call on your music dealer or write us for full particulars. Send for free catalog.

World's Largest Makers of Drums and Banjos

LUDWIG & LUDWIG
1611 N. Lincoln St. Chicago, Ill.



"Learning to Fly"



Get in on the thrills of aviation! *Learning to Fly* is a simple, direct course in aviation logic, written by Murphy McHenry, recognized, licensed pilot—costs but \$1 complete—includes description of actual experiences in an airplane.

Send dollar bill today for *Learning to Fly*. If you are planning on taking actual air lessons you will find the fundamental information in this course invaluable. Prepare now for large developments soon to come in civil aviation.

This course is non-technical, logical, direct, authoritative.

Send complete (all lessons) for \$1. **AIRWAY SCHOOL**
Dept. 7, San Mateo, Calif.
Gentlemen: Enclosed find One Dollar for which please send me, postpaid, Murphy McHenry's course in aviation logic, complete.

Name.....
 Street, Number.....
 City..... State.....

Can you fix it

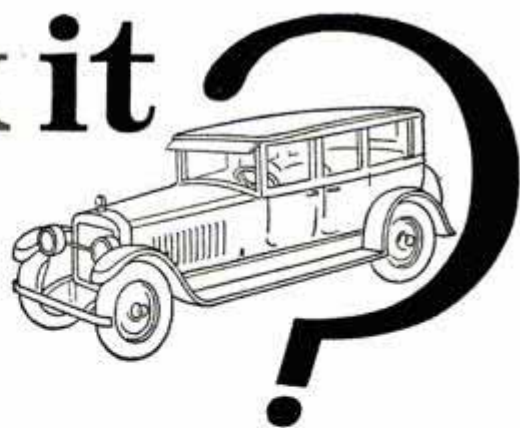
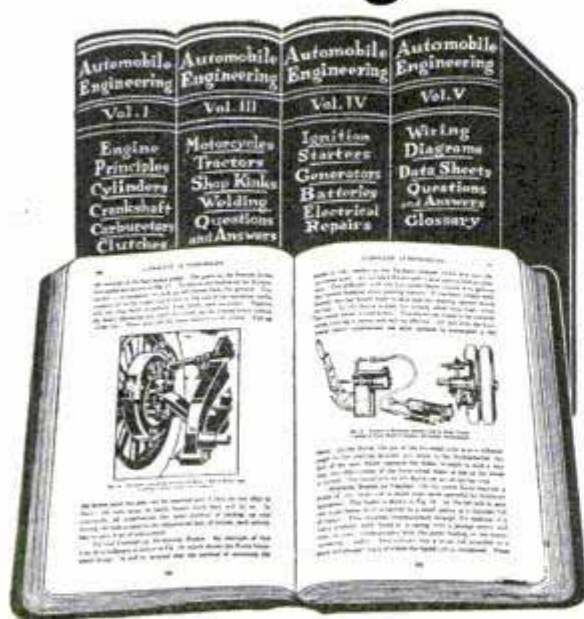

New books have "jiffy index," making all facts instantly available. You find anything you want to know in a moment, in this brand new 1926 edition.

These books tell how

HERE are the most interesting, the most practical books we have ever published on automobile construction, operation and repairs. Brimful of facts, photographs and explanations so easy to understand that anyone can learn how in almost no time.

Over 2000 pages, with diagrams, blueprints and everything else needed to make anyone an authority on automobiles.

Whether you want to qualify as garage owner, auto repair expert or merely wish to know how to keep your own car 100% efficient, you will welcome these books, especially on our

No Money Offer

This plan brings this valuable information within the reach of everyone. You don't send us a single penny. You don't have to pay us anything—just send your name and address and we'll send you the complete set of 5 volumes, specially bound in Flexo covers.

Read them carefully; keep them 10 days; find out anything you want to know, and then if you want to keep them, send only \$2.00 then and \$3.00 per month until the special low price of \$24.80 is paid. There is no further obligation.

American Technical Society Membership Free

This is a great organization for the publishing and spreading of specialized knowledge—we have over a million dollars of resources, enabling us to get the cooperation of the largest automobile manufacturers and dealers, who have furnished us plans and photographs. If you send NOW for this new edition of Automobile Engineering, we will include a Consultation Membership in this great organization.

Eighteen automobile experts will be ready to help you at all times. You can write or wire any time for special information. Answers will be sent to you promptly—without cost.

Don't Hesitate

There are no strings to this offer—it means just what it says. Send name and address on the coupon and ALL of the five books—the complete set—will be sent to you for examination.

Remember one fact only which you can find in these books may save you an expensive repair or help you to a better job.

Learn All About Autos

Get these five big books on this liberal offer and learn all the things you want to know about autos.

Carburetors, engines, springs and spring suspension, brakes, 4-wheel drives, lubrication systems—all are fully covered.

These complete and comprehensive auto books are yours if you want them on this easy plan. Send for a set NOW; there's nothing to pay.



EMPLOYMENT SERVICE FREE

In addition to all this, those who send now will be entitled to the services of our EMPLOYMENT DEPARTMENT without charge. We are in daily contact with firms all over the country who need good men and are willing to pay big. This service costs you nothing. Don't miss this special offer. Send now.

You don't have to read the books through; the index enables you to put your finger on the information wanted in a jiffy.

For Free Offer, Use Coupon

American Technical Society,
Spec. Dept. A-219, Chicago, Ill.
I would like to look at the 5 Auto Books described above. Send them on your FREE offer. I will examine them carefully and return them in 10 days unless I like them; in which case I will send you \$2.00 then and \$3.00 per month until the total price of only \$24.80 is paid. You are to also send me Free Consulting Membership Certificate in the American Technical Society and I am entitled to the services of your employment department without charge.

Name.....
Street.....
City..... State.....
Reference.....



DRAWING *is a way* to FORTUNE

Ali Hafed, a Persian farmer, sold his acres to go out and seek his fortune. He who bought the farm found it contained a diamond mine which made him fabulously rich. Ali Hafed overlooked the great opportunity at his door to go far afield in search of wealth—which illustrates a great truth.

DO YOU LIKE TO DRAW?

If you do it is almost a certain indication that you have talent, a talent which few possess. Then don't follow Ali Hafed's example and look farther for fortune. Develop your talent—your fortune lies in your hand!

Earn \$200.00 to \$500.00 a Month and More

Present opportunities for both men and women to illustrate magazines, newspapers, etc., have never been excelled. Thousands of publishers buy millions of dollars' worth of illustrations every year. Illustrating is the highest type of art—pleasant work, yielding a large income.

THE FEDERAL COURSE IS A PROVEN RESULT GETTER

It is the only Home Study Course which has been built by over fifty nationally known artists—Sid Smith, Neysa McMein, Norman Rockwell, Clare Briggs, Charles Livingston Bull and Fontaine Fox among them.

FREE—"A ROAD TO BIGGER THINGS"

If you like to draw you should read this free book before deciding on your life's work. It tells about illustrating as a highly paid, fascinating profession and about the famous artists who have helped build the Federal Course. Just tear out this ad, write your name, age, occupation and address in the margin, mail it to us and we will send you your copy of the book and the sample lesson free. Do it right now while you are thinking about it.

Federal School of Illustrating

2137 Federal School Bldg. Minneapolis, Minn.

Please Mention Popular Mechanics

\$100 Per Hour

We are training men evenings to earn \$1.00 per hour and more at skilled trades, including bricklaying, plastering, auto body repairing, electricity. We help men to get jobs to earn their way while learning. If you want to come to Detroit write us.

TRADES BUREAU
544 Woodward Ave.
Detroit, Michigan

MUSIC LESSONS FREE



Write today for our FREE booklet. It tells how to learn to play Piano, Organ, Violin, Mandolin, Guitar, Banjo, etc. Beginners or advanced players. Your only expense about 2c per day for music and postage used. **American School of Music, 51 Manhattan Bldg., Chicago**

Men Are Men Who EARN What They Get
Get into the automobile business. It's your one best opportunity. But you must know from A to Z automotive construction and operation to reach your fullest ambitions.

That Get Biggest Pay
Get your education where your training will be practical, thorough and scientific and where your diploma will be worth many times more than its cost. Write for our FREE catalogue and complete story of our highly successful institution—established 17 years ago. Address

Stewart Automobile School, 227-F West 57th St., NEW YORK CITY

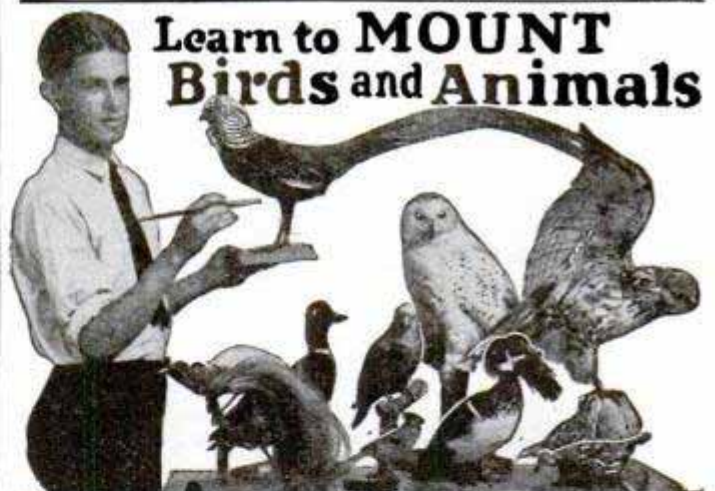

Learn to MOUNT Birds and Animals

Learn at Home by Mail

Be a taxidermist. Learn to mount BIRDS, ANIMALS, GAME HEADS, FISH. Wonderful fascinating new art. All secrets revealed. Easily, quickly learned by men, women and boys. Decorate home and den with nature's finest art. SPORTSMEN save your trophies. BIG PROFITS for spare time. Sell your mounted specimens and mount for others. Have a business of your own. Big demand, high prices. Learn from old reliable school, 20 years' experience.

FREE! Beautiful illustrated book, "How to Learn to Mount Game," with dozens of photos of mounted specimens. Yours for the asking—FREE—Write Today. Taxidermy is a NECESSITY for sportsmen and nature lovers—INVESTIGATE. Get this wonderful FREE BOOK NOW—no obligations. Send Coupon Today!

Northwestern School of Taxidermy
1772 Elwood Bldg. Omaha, Neb.

Send me your free illustrated book "How to Mount Game." Also tell me how I may learn this fascinating art easily and quickly by mail. No obligation.

FREE BOOK COUPON

Name

Address



HOMER H. MCKEE
President
Detroit Fidelity & Surety Co.



RALPH J. DALY
Secretary-Treasurer
Detroit Fidelity & Surety Co.



Home Office
Detroit Fidelity
& Surety Co.

LaSalle Training Helps College Man to C. P. A. Degree

Ralph J. Daly was an engineer, and an excellent one. Graduated from the University of Michigan, he joined the engineering staff of the Central Union Telephone Co.—then for three years he taught engineering at the University of Pennsylvania.

But business attracted him—and he gave up teaching to enter the Detroit Trust Company. Here, however, he found himself a little more than marking time.

Mr. Daly saw that he needed a grasp of business principles and methods which his college training had not supplied. He recognized the ability of LaSalle to help him—as evidenced by the fact that LaSalle has trained more executive accountants, including Certified Public Accountants, than any other business training institution. He enrolled with LaSalle for home-study training in Higher Accountancy.

With the completion of his training, Mr. Daly obtained the C. P. A. degree—and thus at once identified himself

as a man fitted to do unusual things in business, and to do them well.

His progress, since his enrollment with LaSalle, has been marked—and rapid. Today he is Secretary-Treasurer of the Detroit Fidelity & Surety Company—a position which he credits largely to the practical training he got from LaSalle. "I feel that it was the one great factor," he writes, "which enabled me to find myself in the business world."

Send for Free Book "Accountancy, the Profession That Pays"

The man who has caught the vision of what Accountancy means in the business world—who would seriously fit himself for a high-salaried position—will not turn the page until he has clipped and mailed the coupon for complete information.

For men of this character LaSalle has prepared a 64-page book entitled "Accountancy, the Profession that Pays." It will pay you well to read it. —And LaSalle will send it to you free.

Balance the two minutes that it takes to fill out the coupon against the rewards of a successful career—then clip and mail the coupon—NOW.

A Valuable Service—Both to Employer and Employee

"In our business of guaranteeing the fidelity of trusted employees I am always favorably impressed with the man whose application shows his ambition to better equip himself by home study.

"Any educational institution designed to afford a practical business training and broaden the mental horizon is of immeasurable value. LaSalle Extension University, in offering such educational facilities, is performing a valuable service alike to the individual and his employer."

(Signed) Homer H. McKee, Pres.
Detroit Fidelity & Surety Co.

LaSalle Training Yields Big Returns

"It is indeed a pleasure to recommend your Higher Accountancy course of study to young men and women entering business or to those desiring to obtain the degree of Certified Public Accountant.

"From my own experience and progress, as the result of your training, I feel I can assure any student who will faithfully pursue the course, that his returns for the expense and effort involved, will be many fold."

(Signed) Ralph J. Daly, C.P.A.
Secretary-Treasurer
Detroit Fidelity & Surety Co.

LASALLE EXTENSION UNIVERSITY

THE WORLD'S LARGEST BUSINESS TRAINING INSTITUTION

—FIND YOURSELF THRU LASALLE!—

LASALLE EXTENSION UNIVERSITY

Other LaSalle Opportunities: LaSalle opens the way to success in every important field of business.

If more interested in one of the fields indicated below, check here:

- Business Management: Training for Official, Managerial, Sales and Departmental Executive positions.
- Modern Foremanship and Production Methods.
- Personnel and Employment Management.
- Modern Salesmanship.
- Railway Station Management
- Commercial Law.
- Traffic Management—Foreign and Domestic.
- Expert Bookkeeping.
- Business English.
- Industrial Management.
- Commercial Spanish.
- Law: Training for Bar; LL. B. Degree.
- Effective Speaking.
- Modern Business Correspondence and Practice.
- C. P. A. Coaching for Advanced Accountants.
- Banking and Finance.

Dept. 264-HR

CHICAGO

Opportunities in Accountancy—Check below and we will send you a copy of "Accountancy, the Profession that Pays," also copy of "Ten Years' Promotion in One," all without obligation.

Higher Accountancy:

Leading to position as Auditor, Comptroller, Certified Public Accountant, Cost Accountant, etc.

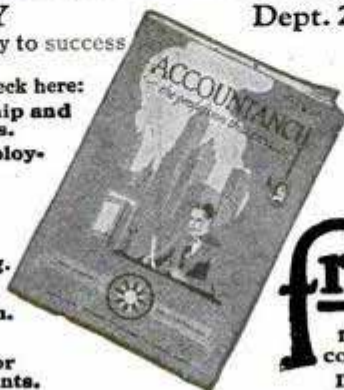

free!
mail coupon NOW

Name.....
Age..... Present Position.....
Street.....
City or Town.....



Learn to Play **JAZZ** by Ear in 90 Days

Be a master of jazz, syncopation, melody. It is easy to learn at home in your spare time. Wonderful Niagara Method shows you how.

By R. C. JAMES

How I used to wish that I could sit down at the piano and pour out the golden syncopation of American melody, like the jazz piano players I had heard. How I used to wish that I could be the popular one in every crowd.

But I could not play a note. I did not know a thing about music.

Niagara Method Shows The Way

Then somewhere—just as you are reading this—I read of the Niagara Method which makes piano playing wonderfully simple. I sent for Director Wright's book "The Niagara Secret." I read the book, and I knew it was right.

I followed Director Wright's principles, and in no time I had caught on to his ideas.

Simple—Easy—Delightful

And the best part of it all is that there is nothing hard about the Niagara Method. In a short time, by following Director Wright's principles and by devoting a part of my spare time to the practical application of his course, I soon learned to play.

No tiresome scales—no arpeggios to learn—no weary hours of practice—no do-re-mi—no meaningless exercises. If you know the Niagara Method, you can sit down and reel off any popular song which the high-priced orchestra leaders play in the cabarets, clubs, hotels, dance halls, or theaters.

Decide to Begin Now

If you have never played a note, or if you do play—no matter how well—you too may become a master of jazz and melody by learning the simple, wonderful Niagara Method.

FREE BOOK

Don't wait another day. Send the coupon now for the "Niagara Secret." This book is yours absolutely FREE. If 10c (coin or stamps) is enclosed you also receive wonderful booklet "How to Entertain at Piano."

Ronald G. Wright, Director
Niagara School of Music,
113 Niagara School Building, Niagara Falls, N. Y.



CLIP THIS COUPON NOW!

NIAGARA SCHOOL OF MUSIC, 113 Niagara School Building,
NIAGARA FALLS, N. Y.

Without obligation mail me your book "The Niagara Secret." I enclose 10c for book "How to Entertain at Piano."

Name _____

Street _____

City _____ State _____

PREPARE FOR AN **ART CAREER**

—thru the only school operated as a department of a large art organization. Commercial Artists trained the "Meyer Both Way" earn as high as \$10,000 per year. We today have hundreds of students who had previously studied art elsewhere. Why? Because your instruction is based upon our everyday experience in meeting the art needs of leading advertisers. Home study instruction. Write for illustrated book telling of the success of our students.

MEYER BOTH COMPANY

Michigan Ave. at 20th St., Dept. 16, Chicago, Ill.

ELECTRICITY LEARN IN 12 WEEKS

Finlay method of practical Electrical instruction (now in 24th successful year) prepares you for big paying position in 12 short weeks. Learn by doing actual electrical work. **Double and Triple your Income.** Send at once for free Finlay catalog and full details regarding this wonderful business. Enroll any time. Completely equipped shops and laboratories. Faculty of highly trained experts. Certificates awarded. Students assisted to positions. Success can be yours. Write today and get the facts. Ask about One and Two-Year Courses.

FINLAY ENGINEERING COLLEGE
116 Finlay Building KANSAS CITY, MO.

TELEGRAPHY

(Morse and Wireless) and RAILWAY ACCOUNTING taught thoroughly. Big salaries; great opportunities. Oldest, largest school. Endorsed by Telegraph, Railway, Radio, and Government officials. Expenses low—opportunities to earn large portion. Catalog free. **DODGE'S INSTITUTE, Jones St., Valparaiso, Ind.**

ENCYCLOPEDIA BRITANNICA

in the New Form—at a saving of 40 per cent

Write for full details. Address Dept. PM3

THE ENCYCLOPEDIA BRITANNICA, INC.
342 Madison Ave., New York City

FOREST RANGERS

Men wanting forest ranger, mail clerk, or other government positions, write for particulars.

MOKANE, 236, DENVER, COLO.

Health Food Directory —

How to select the proper foods for gaining weight; reducing; building vitality; disease resistance; constipation; building muscle, etc. Rates and tabulates standard branded foods. No other book like it. 150 pages of valuable information. Special price 25c, postpaid. Limited edition.

Macfadden Publications, Inc., Dept. P. M. 2, 1926 B'way, N. Y. City



Work for "Uncle Sam"

\$141.67 to \$275 MONTH

ON REGULAR
MAIL CARRIERS
(City or Rural)

Steady—common education sufficient. Big chance for men, 18 up.

Mail
Coupon
Today
Sure

**FRANKLIN
INSTITUTE**
Dept. F 311

Rochester, New York

Rush to me, WITHOUT CHARGE 32-page book with full particulars telling how to become a mail carrier or Post Office Clerk. Send sample coaching.

Name.....

Address.....

LEARN **Y M C A** **WITH**
AUTO **BROOKLYN, N. Y.** **"PRIVILEGED"**
MECHANICS **STUDENTS**
IN BROOKLYN—THE HEART OF NEW YORK CITY

Come to New York for your technical schooling, the metropolitan heart of the nation. The concentration of the biggest and best products of American ambition. First in business; pleasure; opportunity. New York is the home of America's largest repair shops, the finest service stations. Students of Brooklyn Engineering Institute, operated by Bedford Y. M. C. A., have access to them, and their managers endorse our courses. All students get practice as well as theory.

BETTER TRAINING; LOWER COSTS

Brooklyn Engineering Institute is completely equipped; the course is thorough in every respect. Yet the complete cost per week is extremely low. While you learn, you save. The Institute offers small classes (12 students per instructor) which insures individual attention and rapid advancement.

The time payment plan puts the course within the reach of any ambitious young man; and the efficient placement bureau simplifies the problem of getting a desirable job.

SPECIAL ADVANTAGES

Students at Brooklyn Engineering Institute count it a privilege to enjoy such congenial surroundings. Dormitories in the building have club facilities equal to some of the finest in America. Swimming pool, gymnasium, library, sports—recreations of all kinds at the disposal of our students. Unexcelled anywhere for training combined with recreation.

ENROLL NOW

Come to New York. Classes from 12 to 17 weeks, at your option. Enjoy the privileges of this institute. Meet prominent men interested in Bedford Y. M. C. A.; the home of Dr. Cadman's radio talks.

Develop physically in our gymnasium; professionally in our school; culturally in our city with its points of historic interest.

If unable to enroll at once, mail the coupon for catalog.



WHAT YOU LEARN



Welding Students At Work



Corner Of Machine Shop



Rebuilding Auto Electrical Equipment



One End Of Overhauling Shop

PRIVILEGES YOU ENJOY



Students Private Sleeping Quarters



Swim Here, After School Sessions



Take Part In Exercises Sports And Games



Billiards And Bowling Under Wholesome Conditions

Brooklyn Engineering Institute,
 1115-25 Bedford Avenue, Brooklyn, N. Y.

Gentlemen:—Please mail information about the Auto Mechanic's Course and special privileges it confers.

Name _____
 Street Address _____
 City and State _____

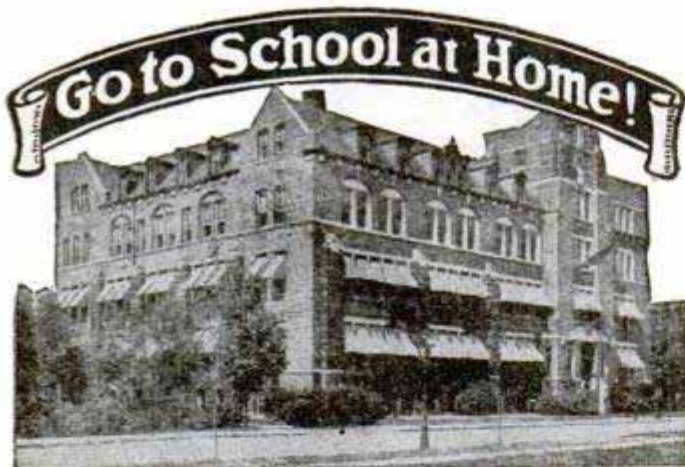

High School Course in Two Years!

You Want to Earn Big Money!

And you will not be satisfied unless you earn steady promotion. But are you prepared for the job ahead of you? Do you measure up to the standard that insures success? For a more responsible position a fairly good education is necessary. To write a sensible business letter, to prepare estimates, to figure cost and to compute interest, you must have a certain amount of preparation. All this you must be able to do before you will earn promotion. Many business houses hire no men whose general knowledge is not equal to a high school course. Why? Because big business refuses to burden itself with men who are barred from promotion by the lack of elementary education.

Can You Qualify for a Better Position

We have a plan whereby you can. We can give you a complete but simplified high school course in two years, giving you all the essentials that form the foundation of practical business. It will prepare you to hold your own where competition is keen and exacting. Do not doubt your ability, but make up your mind to it and you will soon have the requirements that will bring you success and big money. **YOU CAN DO IT.**

Let us show you how to get on the road to success. It will not cost you a single working hour. Write today. It costs you nothing but a stamp.

American School

Dept. H-274, Drexel Ave. and 58th St., Chicago

American School

Dept. H-274, Drexel Ave. and 58th St., Chicago

Send me full information on the subject checked and how you will help me win success.

- | | |
|-----------------------------|---------------------------|
|Architect |Business Law |
|Building Contractor |Lawyer |
|Automobile Engineer |Machine Shop Practice |
|Automobile Repairman |Mechanical Engineer |
|Civil Engineer |Shop Superintendent |
|Structural Engineer |Employment Manager |
|Business Manager |Steam Engineer |
|Cert. Public Accountant |Foremanship |
|Accountant and Auditor |Sanitary Engineer |
|Bookkeeper |Surveyor (& Mapping) |
|Draftsman and Designer |Telephone Engineer |
|Electrical Engineer |Telegraph Engineer |
|Electric Light & Power |High School Graduate |
|General Education |Wireless Radio |
|Vocational Guidance |Undecided |

Name.....

Address.....

OPPORTUNITIES IN Traffic Management

Become a Traffic Expert

The opportunities in traffic management are limited only by the boundaries of the business world. The trained traffic man is in demand by transportation systems and by industrial organizations.

Three Detroit Firms Pay Their Traffic Managers Over \$20,000 a Year

Prepare for this growing, profitable profession at home in your spare time under supervision of traffic experts. Low cost; easy terms. Thru the LaSalle Problem Method you learn by doing. Valuable 64-page booklet free.



This Book FREE!

Send for it NOW.

LaSalle Extension University, Dept. 264-T Chicago

LAW Free Book

Write today for FREE 128-page book, "THE LAW TRAINED MAN," which shows how to learn law in your spare time and earn more money. Qualify for a high salaried executive position or prepare to enter the practice of law. Study at home through the Blackstone Course prepared by 80 prominent legal authorities including CHIEF JUSTICE WILLIAM HOWARD TAFT. Blackstone graduates practicing law everywhere. LL. B. degree conferred. Magnificent 25 volume law library furnished immediately upon enrollment. Moderate tuition fee. Low monthly terms. Money Back Guarantee. Write for book today.

Blackstone Institute, Inc., 4752 Grand Blvd. Dept. 52 Chicago
America's Foremost Non-Resident Law School



Learn Watchwork, Jewelrywork and Engraving

A fine trade commanding a good salary, and your services always in demand. Address **Horological**, Dept. P, Bradley Institute, PEORIA, ILLINOIS, for our latest catalog.

Test Your Art Ability FREE



If you like to draw, test your natural sense of design, proportion, color, perspective, etc., with our Art Ability Questionnaire. Learn if your talent is worth developing, and how much training you will need. You will be frankly told what your score is.

Many Federal Students are making \$3,500, \$4,000, \$5,000 and \$6,000 yearly. The Federal course is recognized everywhere by art employers and buyers of commercial art. Learn at home in spare time, without previous training. *Personal, individual criticisms on your work.* Get this free test—send now for your Questionnaire.

Federal School of Commercial Designing
625 Federal Schools Bldg. Minneapolis, Minn.

Send me your free Questionnaire

Name.....

Address.....

Tools FREE

of ANY Extra Charge

Also a Drafting Table
Act NOW!



This is NOT a "Student's" Outfit but an Imported Set of Professional Drafting Instruments, a Chief's Drafting Table, and Standard Supplies.

Yours for the Asking!

No Extra Cost Whatever. No Conditions except to Reply Promptly. This offer Open

to All who Speak Up NOW!

Scores of Firms are in need of Draftsmen now—and I need you. Many offer to take BEGINNERS, at \$50 a WEEK. Graduates can start at \$90 and \$100! GET BUSY!

Every industry in this country is using draftsmen in droves! In twenty-five years, I've never been harder pushed to turn out enough new men. In fact, it's the shortage that brings you this wide-open offer of all instruments—a real drafting table—full working outfit—complete, standard supplies—even paper and pencils and ink! No extra charge for any of them. That's how I hope to get the required men in record time.

Drafting is the field for any man who wants to get somewhere. For men who want to be heard from. Want work that counts, and pay that makes working worth while and life worth living.

I'll teach you draftsmanship by practical methods that make a man easily and quickly finish the whole course. I use modern methods; I employ every short-cut; but I leave nothing out that you have to know to earn \$3500 to \$10,000 a year as a practical draftsman.

LEARN AT HOME but on the same kind of actual drafting room jobs we assign you from our own drafting rooms. It isn't hard to do. Drafting isn't "drawing." You don't need "talent." If you are interested and can read and write, I give you the training to become a good draftsman. (Dobe-trained men are draftsmen and chiefs in big concerns all over the country—and many have made good abroad.)

This Opportunity Doesn't Call for Cash, so Don't Pass It Up for Lack of Ready Money

Please don't beat yourself by thinking of your finances at this time! It isn't money I want now—it's men. You, if you mean business. What I am after is your application. Once I get that, you'll get action. I'll have you ready to draft for important pay—in any engineering or industrial line you like—before you know it. So get my proposition in front of you this week! Then, if you do enroll, you're in line for my free outfit offer.

WELL PAID JOBS are soon sighted by men under Dobe training! They get offers before they're through. Are often spoken for months ahead of graduation. And I have students from 17 years of age to 51 at present time! So: first of all, and right now, send this coupon for my new free book Successful Draftsmanship; fully illustrated; explains everything.



YES!

That's Chief Draftsman Dobe's answer to "Can I Succeed in Drafting?"

YES!

Does Dobe really turn out practical draftsmen in a few months?

YES!

Is there always such a big call for men who can draft as Want Ads in the newspapers show at the present time?

YES!

Do I actually get all instruments and supplies without one dollar's extra cost?

YES!

FREE TOOLS COUPON

CHIEF DRAFTSMAN DOBE

1951 Lawrence Ave., Div. 13-52, Chicago

Send me free and postpaid Successful Draftsmanship Book and material telling all about your home course, terms, etc.

Name..... Age.....

Address.....

Now Only
4.98
For This Big 10 Cable Exerciser

SAVE
\$20.02

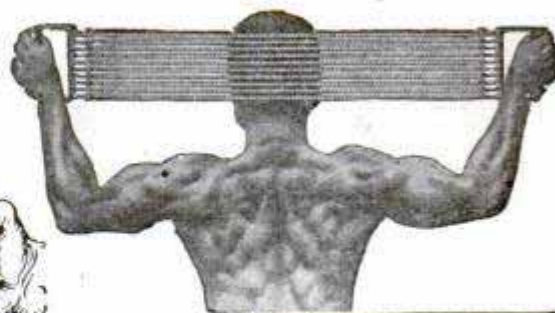
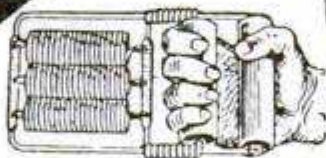

Victor Master Grip

HEY, fellows! Put that twenty-dollar bill back in your **hown pocket!** You don't have to spend all that money for an apparatus. You can get the very best Muscle Building Outfit on the market today for **one-fifth of the regular price!**

You get a Complete scientific course of instruction in **BODY BUILDING—Worth \$10.00.**

HENRY VICTOR, Dept. M-106
109 East 13th Street
New York City

Gentlemen:

Send me your complete outfit and the two **FREE** books. I enclose the bargain price of only \$4.98. If I am not satisfied, I will return the outfit immediately and my money will be refunded in full.

You get the famous Victor Master Grip which will increase your forearm and wrist muscles to an unbelievable development. It is progressive and can be used with (1) mild;

(2) medium; (3) strong springs. It is also a grip tester, registering from 1 to 100 per cent. Professional strong men and athletes everywhere praise it. No training apparatus is complete without one. Worth at least \$5.00.

And you get this **High Tension 10-Cable Exerciser**, the Champion Muscle Builder of the World! Made with steel reinforced handles—the strongest made. It is progressive and can be used with any number of cables from one to ten. Everlasting quality throughout! When used with my Scientific Course of instruction you will almost see your muscles grow. Your chest expansion will increase, your heart and lungs will have more room. Every muscle and organ in your body will feel like new. Worth \$10.00. That's a \$25.00 outfit if there ever was one! And you get it complete for only \$4.98.

FREE!



If I get your order while my supply of these books holds out—I'll include both of them **FREE** with your apparatus. "Boxing," an illustrated book by James J. Corbett, and "Wrestling," by Frank Gotch. Both books are filled with inside dope on boxing and wrestling. I have only a few copies of each left. Get yours by mailing the coupon now. **TONIGHT—**before you go to bed.

RUSH THE COUPON

Put your order in the mail now! If you aren't satisfied with the outfit when you get it—ship it back at once—and I'll return your money in full. Don't wait. Get your order going now!

HENRY VICTOR, Dept. M-106
109 East 13th Street NEW YORK CITY

Name.....
 Address.....
 City.....State.....

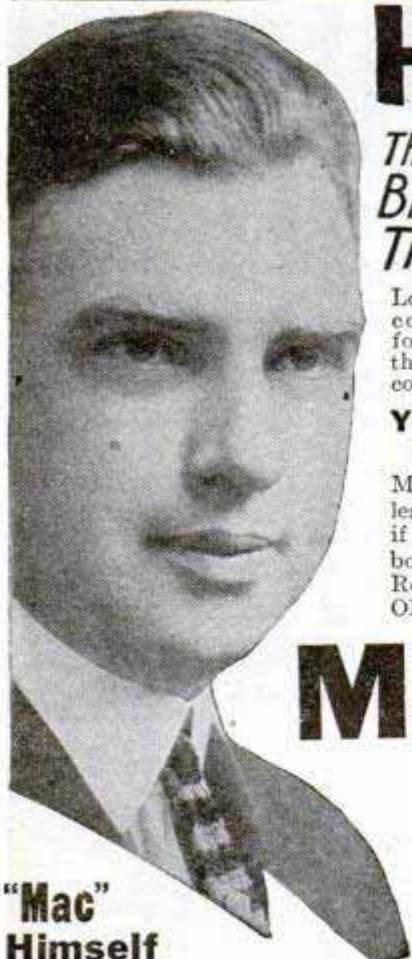

"Mac" Himself

One of America's Foremost Trainers of Auto and Tractor Mechanics.

HELP! HELP! HELP!
 Thousands of **BIG PAY JOBS CRYING FOR TRAINED AUTO MECHANICS**

Louder and louder comes the call for more expert auto and tractor mechanics for Big Pay jobs. Millions of jobs and only a few thousand men properly prepared to fill them. If my great schools were twenty times as big I could not turn out mechanics fast enough to meet the demand for trained men.

You Learn 8 WEEKS in Only \$85 to \$125 Weekly WAGES

My practical training is complete and is easily learned in 8 short weeks. Your money back if not satisfied. No extras to pay for. No book study; very little schooling required. Read below my special **LIMITED FREE OFFER.**

Work at home or see the world. Or open your own repair shop and earn up to \$10,000 yearly profits. Men who know how to repair American made cars are needed in every foreign country. Thousands more shops are needed, here and everywhere. Send the coupon **TODAY** sure.

McSWEENEY AUTO, TRACTOR AND ELECTRICAL SCHOOLS

Dept. BX-14 Cincinnati, Ohio
 Cleveland, Ohio
 Chicago, Ill.

HURRY! I pay your board and R. R. fare to my school. Send for big book—

FREE

McSweeney Auto, Tractor and Electrical Training Shops, Dept. BX-14, (Address shops nearest you) Cincinnati, O., Cleveland, O., Chicago, Ill.

Without any obligation send me your big free book on Autos. Also information regarding Special Reduced Price Tuition temporary offer.

Name.....
 Street.....
 City.....State.....

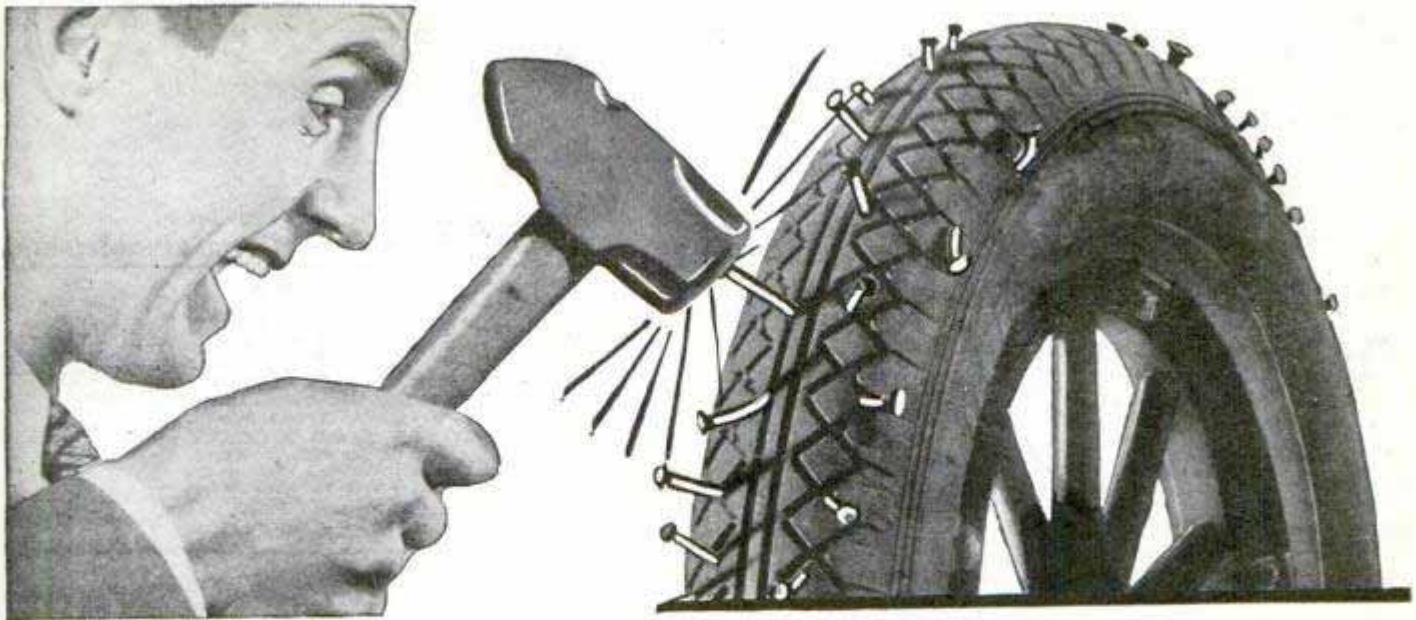

Amazing Tire Fluid Banishes Punctures Forever!

Startling New Discovery Heals Punctures While You Drive!
Seals Nail Holes, Slow Leaks, Valve Leaks, Porous Tubes, Etc.
No Fuss or Bother! No More Taking Tires Off Wheel! Aer-Pruf Is Self-Acting! See Generous TRIAL OFFER Below!

HERE is an amazing new invention that makes any tire puncture proof—and adds 100% to the joy of motoring. This wonderful, new, scientific discovery—the work of O. S. Nelson, of South Dakota—is called Aer-Pruf. Under test, it held air into an old tire punctured with 857 nails—without a single leak! It seals punctures the instant they happen—so that you go spinning along without even knowing you have a puncture! It does away with changing tires and patching tubes, either in the garage or on hot, dusty roads—in blazing sun, in drenching rains, on dark nights, in freezing snow storms! No wonder it appeals to every motorist, without exception.

Punctures Sealed While You Drive

Aer-Pruf will seal punctures as large as a twenty-penny spike or as small as a tack! Heals troublesome slow leaks, valve leaks and porous tubes, too. Greatly increases tire mileage. Has no injurious effect on tire, tube or valve. Not affected by extreme heat nor zero weather. You ride on light, buoyant air just as before—but with absolute protection!

AER-PRUF MFG. CO.

B-3187 Logan Bldg.,

Mitchell, So. Dak.

An Over-Night Sensation!

When Aer-Pruf accomplishes such marvelous results—is it any wonder that agents and spare-time workers everywhere are piling up big, liberal commissions for just a few hours' work? Every auto owner is vitally interested—for he detests the bother and delay of changing tires and tubes!

All you have to do to make money with Aer-Pruf is drive nails in an old tire in front of big, interested crowds. A two-minute demonstration suffices to convince any intelligent motorist when he sees tires punctured again and again without a single leak! You don't need a car to demonstrate Aer-Pruf, either. Many agents make \$15 to \$25 a day with just an old rim and discarded casing! It's really surprising!

SAMPLE OFFER

Now, to introduce his new invention, Mr. Nelson will send you samples at his own risk. But that's not all. He offers to pay you for testing Aer-Pruf if you are not amazed and delighted with results! This surprisingly generous offer is limited—so take advantage of it without delay. No obligation. Clip the coupon at once. Mail it today!

Aer-Pruf Mfg. Co.,
B-3187 Logan Bldg., Mitchell, South Dakota.

Please send me full details of your FREE sample offer and your offer to pay me for my time in testing sample if I am not amazed and delighted with it. Give me full particulars of your generous agents' proposition, too.

Name.....

Address.....

City..... State.....



AGENTS!

Aer-Pruf is one of the most surprising money-makers EVER introduced. Men who demonstrate it are making all the way up to \$85 and \$150 a week. Spare-time workers, \$25 to \$35 evenings and Saturday afternoons. Why not get your share?

\$14 an Hour

"I started out this morning and the first man I demonstrated to took an order. And in about two hours I had made over \$20—or \$14 an hour."
J. O. Bright, Georgia.

"I demonstrate Aer-Pruf at fairs and on main streets. Made as high as \$57 one evening." Frank Ryman.

PAIN and DISEASE

Quickly Conquered by
VIOLET RAY



Let us tell you how thousands of men and women suffering from rheumatism, neuritis, paralysis, nervousness, skin diseases, headaches, constipation, sprains, prostate trouble, goitre and many other ailments, even hay fever and asthma, have found quick relief—new health and vitality with this marvelous, scientific invention. Pains vanish almost instantly.

Violetta

Ten Days FREE Trial
For Health—Beauty—Vigor

Endorsed and used by hospitals, sanitariums and physicians. Every home can now have one. Saves hours, days, months of suffering. No medicine. Painless, pleasant treatment. Only the violet ray can penetrate to every nerve affected. Simple, safe, painless—anyone can use VIOLETTA. Why suffer pain and poor health when you can try VIOLETTA 10 days FREE.

This Book FREE

Tells all about violet rays—how this marvelous discovery by Nikola Tesla, the electrical wizard, now brings this mysterious curative power to all. Contains many astounding testimonials from our thousands of satisfied users. Send for the facts and our liberal trial offer today. Mail the coupon now.



VI-REX CO., 2304 Warren Ave., Dept. 231 Chicago

Please send me your free book on Violet Rays and details of your 10 days' free trial offer.

Name.....

Address.....

City.....State.....

Ailment.....

The Lincoln Sport Plane

Build and fly it yourself
100 miles per hr.
30 h. p. motor

Blue Prints and material now ready for builders. Send 25c for illustrated book. It tells you how. New flying school opens March 1st. Earn while you learn.

LINCOLN AIRCRAFT COMPANY, Dept. 2, LINCOLN, NEB.

Learn to PAINT SIGNS and SHOW CARDS

We quickly teach you by mail, or at school, in spare time. Enormous demand. Big future. Interesting work. Oldest, foremost school.

EARN \$50 TO \$200 WEEKLY

John Vassos, N. Y., gets \$25 for single show card. Crawford, B. C., says: 'Earned \$200 while taking course'. Send today for free information, samples and guarantee.

DETROIT SCHOOL OF LETTERING
154 Stimson Ave. Est. 1899 Detroit, Mich.



9 Big Books covering all subjects fully:

- Surveying
- Map Making
- Roads
- Bridges
- Culverts
- Railroad Engineering
- Estimating for Steel Buildings
- Masonry
- Water Supply
- Water Power
- Cost Systems

Want to make more money?
Be a Civil Engineer

Here is an easy way to learn. You hold your future in your own hands. If you have a grammar school education, and want the advantages of knowledge usually gained in college, you will welcome this new system of reading at home. No long hours of grinding study; just the meat of every subject told in such a simple way that anybody can understand.

These books were prepared by men who were experts, they are full of boiled down facts and easily learned methods which save time and study.

Civil Engineers are more important than ever; steel buildings, bridges, highways, railroads and harbor projects make Engineering more important than almost any other profession.

If you want to get ahead—try this easy way
We Ship Nine Books FREE

This is a "straight-from-the-shoulder" offer to men who want a big future. If you could hear half the stories of success we receive, you would not hesitate a minute. Send for the books now; just your name and address; and we'll ship the entire set of nine volumes. Keep them ten days, then if you realize how valuable they are to you, send only \$2.00, and after that only \$3.00 per month until the small total of only \$29.80 is paid. A free membership in the American Technical Society will be included if you send NOW. This entitles you to full consultation privileges with 18 engineering experts.

The special jiffy index puts facts at your finger tips

AMERICAN TECHNICAL SOCIETY, Dept. C-219, Chicago
You may send me, for Free examination, your nine new books on Civil Engineering. Unless I return them in ten days I will send you \$2.00 as first payment, then \$3.00 per month until the special price of only \$29.80 is paid. Include membership in the American Technical Society FREE.

Name.....

Address.....

City.....State.....

Reference.....

LEARN *to* FLY

1000 Ambitious Young Men
WANTED

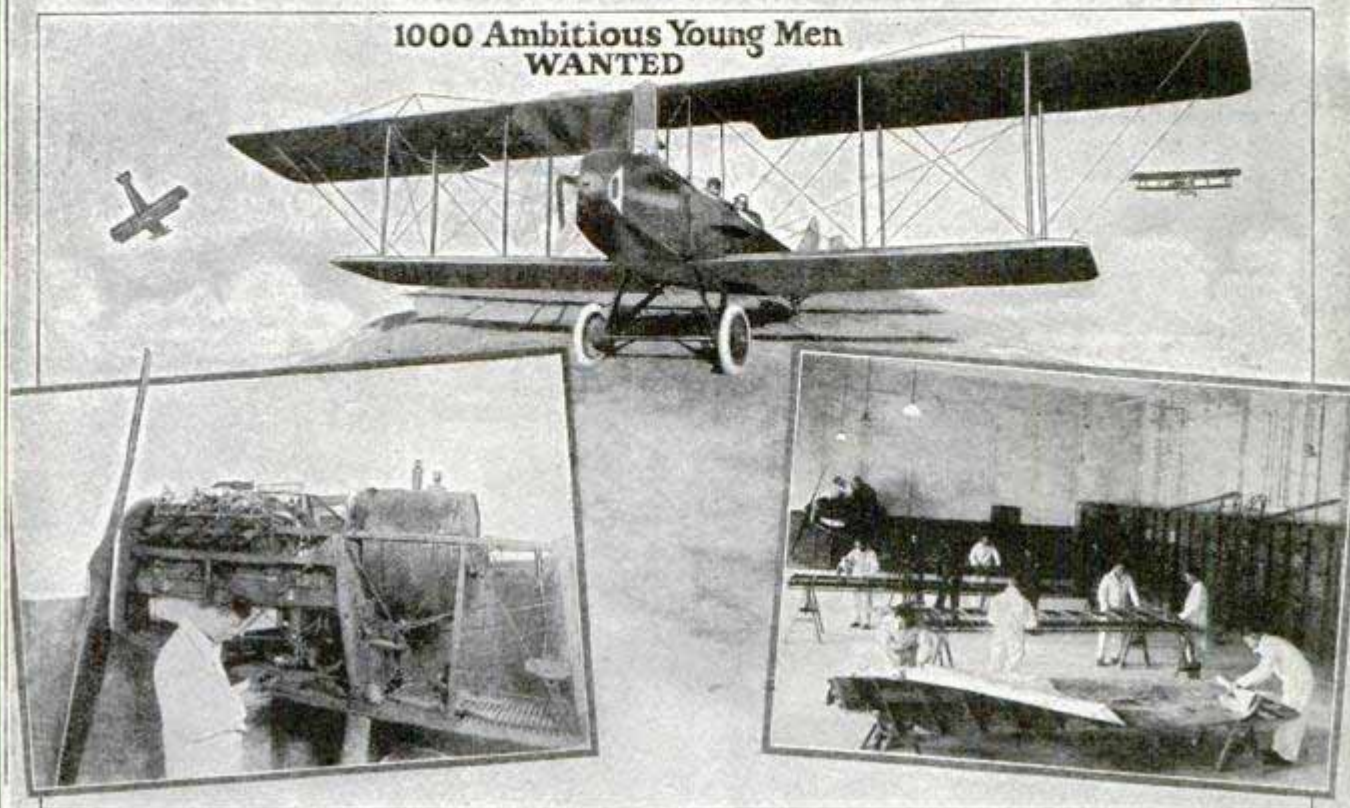

Sweeney System of Practical Airplane Mechanics

These photographs show how Sweeney students are trained by DOING. After thorough ground school work, under skilled instructors in the construction and repair of planes, recovering wings, tuning motor, etc., learning everything about the mechanical work by actual practice, the student then, if he wishes, goes into the air and qualifies as a pilot under safe and experienced pilots, with double controls for actual flying. Here's the great business of the future. The National Air Transport alone has invested \$700,000 on the Kansas City air route. They are spending \$1000 a day to operate an over-night service to New York City. Ambitious men are wanted as pilots and ground mechanics. At the great SWEENEY SCHOOL you learn not only by doing, but you get personal instruction.

THE SWEENEY SYSTEM

is divided into two parts. **FIRST:** You are thoroughly taught in the ground school. This fits you as an aviation mechanic. You can build your own plane and do anything required in aviation mechanics and construction and repairing when you have finished this work. You are thoroughly taught motors, etc., and work with thousands of dollars' worth of new material, including all types of engines—**SECONDLY:** After completing this work, if you want to be a

pilot, you take all the actual flying necessary to make you a competent pilot. Now when you understand that two to seven hours is all the average man needs to learn expert flying you will appreciate what this ample experience in the air under skilled men will do for you. Aviation is no longer a mystery—no longer a hazard; no, it is a business growing greater and more important. This has been wonderfully demonstrated in the successful flights

over the North Pole and also in the big part Aviation is now playing in commercial activities. Progress is rapid. More men are needed every day. You can qualify as a mechanic, or an engineer, or repair man, or builder; five men on the ground are needed for one man in the air, but if you want to become a pilot you easily master the work and can go into postal, government, or commercial work. Flyers are in demand, earning big money at fairs, taking up passengers, etc., \$5 for a 10 minute flight is pretty fine pay!

Opportunities in FLYING

Aviation Mechanics—
\$50-\$125 Week
Riggers—\$50-\$75 Week
Flyers—\$125-\$225 Week
Taxi Service—\$100-\$300
Week
Aerial Photo Pilot—\$200-
\$250 Week
Special Messenger Service—
\$125-\$200 Week
Aerial Advertising—\$225
\$500 Week
Crop Dusting—\$125-\$200
Week
Crop Survey—\$125-225
Week

SEND NAME TODAY for full details of this aviation mechanical course and photographs of planes and equipment actually used; also full information as to the commercial end of flying and opportunities for young men.

---SEND THIS NOW---

EMORY J. SWEENEY, President
3406 Sweeney Bldg., KANSAS CITY, MO.

Please send me full information about your Aviation Course.

Name.....Age.....

Address.....

Town.....State.....

SWEENEY SCHOOL OF AVIATION

LEARN TO FLY BY FLYING

Sweeney
SCHOOL of AVIATION
3406 SWEENEY BLDG, KANSAS CITY, MO.

LEARN TO DRAW
CARTOONS

To Show You How Quickly and Easily You Can Do So

I'LL TEACH YOU

to draw comic faces like these in 15 minutes. Send me your name and address, and let me mail you a Test Lesson Chart which will teach you how to draw comic faces. Whether you think you have talent or not, make this interesting test.



FRECKLES

Mere words cannot express my appreciation of the course of lessons I received from the Landon School.
Merrill Blosser.



BRANNER

WINNIE WINKLE

When I consider the small investment I made in taking your course and the enormous profits I am making now I feel like a profiteer.
M. M. Branner.



REG'LAR FELLERS

I attribute my success to the thorough and highly competent course I received from you.
Gene Byrnes.

I want to show you that with the aid of my PICTURE CHART METHOD of teaching original drawing you can learn to draw as easily as you learned to write. Every step in producing original heads, figures, animals, and all details of original cartoon drawing are PICTURED in an extensive series of Charts, and the text with each lesson shows how to apply the various steps in producing original drawings of your own. This plan is today recognized as the most effective method of teaching drawing ever devised.

RESULTS TELL THE STORY

Here are three of the famous characters created by Landon students who have attained national reputations as Comic Strip Cartoonists. Hundreds of former students of this School are producing cartoons on political and national affairs, sports, comic strips, etc., for leading newspapers and syndicates all over the United States and Canada. Many newspapers now employ from two to five students of this School; one big newspaper employs nine. Many successful students who prefer to work at home are selling their drawings by mail. The record of results produced by this school is evidenced in the increasing demand by newspaper Editors for Landon graduates.

Send NOW for complete information and sample Picture Chart to test your ability. Please state your age, and enclose 6c in stamps for postage.

C. N. LANDON, Director.

The Landon School
1238 National Bldg., CLEVELAND, OHIO



I'll Teach You to Play a Saw in 24 Hours!

C. J. MUSSEHL, Pioneer Artist on the Musical Saw, has taught thousands to become Experts, Vaudeville Stars and High-Priced Entertainers.

I'll Loan You the SAW 5 Days Free

Be Popular—Play for Money or Fun



JUST to prove how quick and easy you can learn to play a saw, I'll send you a genuine, specially tempered Musical Saw for 5 days' trial. I guarantee that in 24 hours you can play tunes like "Old Black Joe" and "Home Sweet Home." Then you quickly learn latest jazz and song hits, operatic and classical music. Amazingly simple—no notes to read, no dreary practice. You don't need to know a thing about music.

Success Positively Guaranteed

I have taught thousands to play the Musical Saw. Just three short simple lessons reveal every secret of my twelve years' success as a professional saw musician. Scores have won fame and fortune. Let me prove that you, too, can quickly play like a professional. The Musical Saw's only rival is the violin for sweetness and expression. Tone effects are positively startling and so unexpected that nothing compares to it in winning instant popularity or becoming a salaried entertainer.

Phonograph Record

FREE!



Double-disc, demonstration-size phonograph record of beautiful Saw solo and duet, sent with full particulars of my free trial offer. You'll wonder that a saw can produce such marvelous music. But the record proves it. Enclose 10 cents (stamps or coin) to cover record handling and postage. Or if you do not want the record, just ask for my big **FREE TRIAL OFFER**, sent postpaid.

MUSSEHL & WESTPHAL
259-B W. Water Street, Fort Atkinson, Wis.

BRICK LAYING 	ELECTRICITY 	AUTO PAINTING 	STRIPING 	PLUMBING 
\$14.00 A DAY	\$75.00 A WEEK	\$50 TO \$125 A WEEK	\$2.00 AN HOUR	\$300 A MONTH

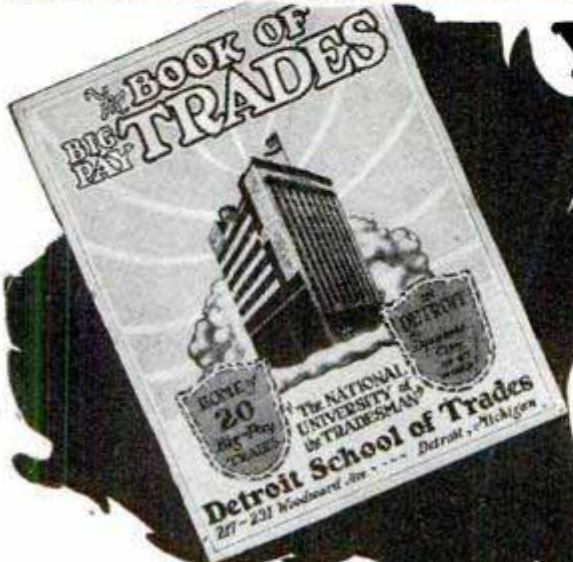

YOUR OPPORTUNITY

Learn One of these

BIG PAY TRADES

QUICK

Don't spend months in school or digging through dry books. Here you learn by doing with tools on actual jobs—you learn right—and you learn quick. Before you know it you're ready for big pay right here in Detroit.

DON'T Work At a Hard Low-Pay Job Another Day!

Get out of the grease—leave the rut forever—say "Good bye" to low pay. Take your choice of the clean, big pay jobs and start earning \$50 to \$100 a week right from the start in a real trade.

Get This New Big Pay Book

The Most Amazing Door to Quick Big Money You've ever seen. Twenty trades. Pick the one you are best suited for. Work at a job you like. Learn your trade, quick. This book is free.

Steady Work in Detroit's Big Plants

Scores of Big plants, body plants, auto plants, wheel makers, tool makers, designers, finishers, strippers—hundreds of real estate developments and new buildings—plenty of work inside or outside—at big pay. Steady work the year around for men who know their trades.

BIG PAY JOBS GALORE Not Enough Men

The Detroit School of Trades teaches 20 big pay trades. It is called the "National University of the Tradesman". You don't have to learn some old, low-pay, worn-out business. Send for the book, look through, pick the money you want in the trade you want to learn. Then come here, we'll teach you how and help you get a job. Over three hundred of our men now working in one body plant. Hundreds of others in other plants. Hundreds more needed.

Think of These Facts

Hansen made \$183 for one week's work in bricklaying. Brooks jumped from \$35 a week to \$65.85 the first week he left school. Augustine was making \$6.00 a day—learned plastering and makes \$12 a day. Hundreds double their pay. You can do as well. Remember it doesn't cost you a penny for this book. Risk one postage stamp now on what may be the opportunity of a lifetime. Read it, be convinced. Come and see. Succeed for yourself. Send coupon at once. Don't delay. The National University of Trades can do big things for you.

DETROIT SCHOOL OF TRADES
DEPT. 12 DETROIT, MICHIGAN

Come and Work In Dynamic DETROIT

A great city—big—throbbing with life—growing—filled with opportunity—crying for men to take big pay for doing the jobs that need doing. Building trades booming. Automotive trades—real trades—always good—get into the spirit of a big city, fastest growing most dynamic in America—do big things with big men—succeed with successes in this City of Wonderful Opportunity

THE STATE OF MICHIGAN

protects you. The great Detroit School of Trades is licensed by the Michigan State Board for vocational education and conforms in every respect to the standards and requirements laid down by this organization, just the same as a State University or Endowed College.

CHOOSE

In This Great School We Teach These Big-Pay Trades

Bricklaying--\$1.50 to \$1.65 per hour
Plastering--\$1.50 per hour
Plumbing--\$1.25 to \$1.75 per hour
Carpentry -- \$90.00 to \$125.00 per week
Electrical--\$10.00 to \$14.00 per day
Sign Painting--\$1.00 to \$2.00 per hour
Paper Hanging--\$10.00 and up per day
Interior Decorating--\$10.00 to \$14.00 per day
Plan Reading and Estimating--\$70.00 to as high as \$250 a week
Auto Mechanics--\$1.00 to \$2.00 per hour
Auto Painting--\$9.00 to \$12.00 per day
Auto Trimming--\$9.00 to \$14.00 per day
Metal Finishing--\$10.00 per day
Acetyline Welding--\$1.00 to \$2.00 per hour
Tool Making--\$76.00 to \$200.00 per week

DETROIT SCHOOL OF TRADES, DEPT. 12 DETROIT, MICH.

Send me Free and without obligation your big new book of BIG PAY TRADES. I am interested in

the _____ trade

Name _____

Address _____

City _____ State _____

FREE Send Coupon **10-DAY**

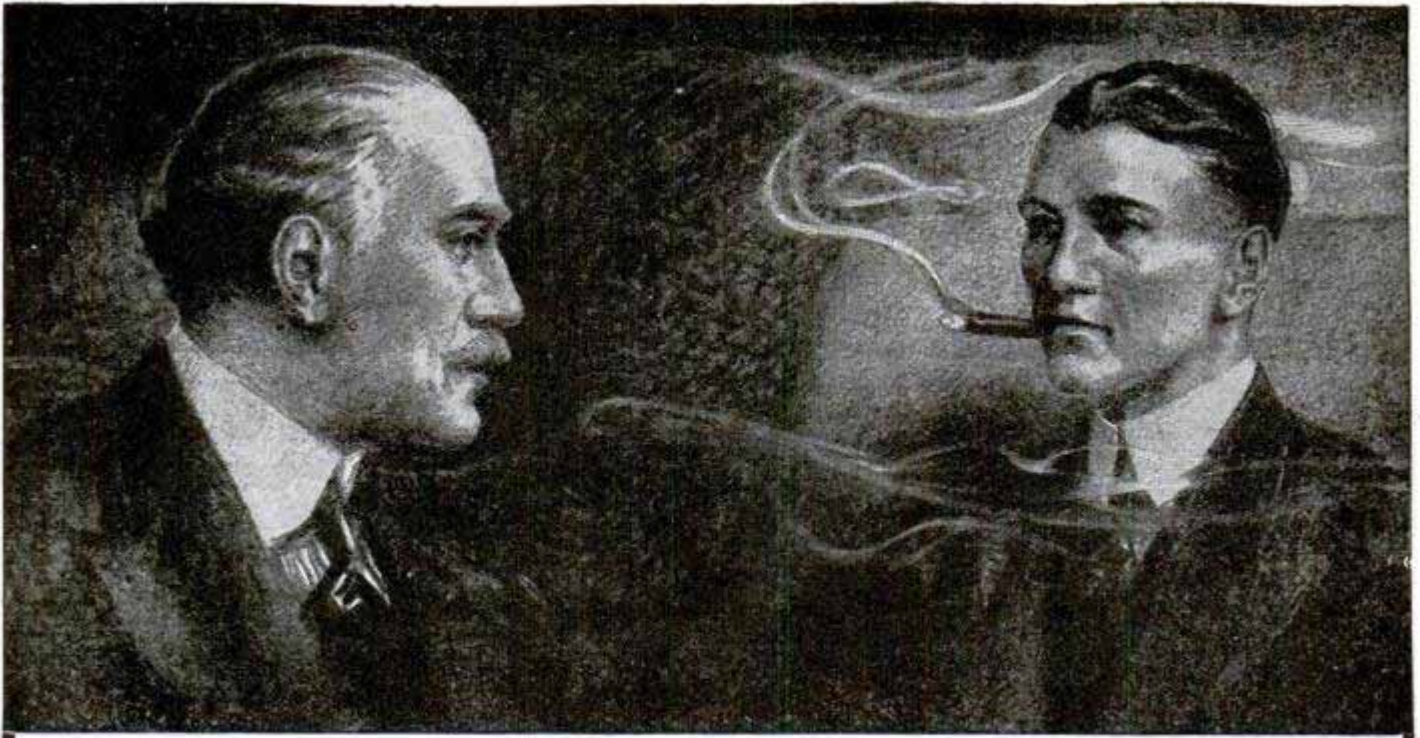

Tobacco Is Hurting You

Look at the facts square in the face, Mr. Tobacco User. You may think tobacco is not hurting you.

That is because you haven't as yet, perhaps, felt the effects of the nicotine poison in YOUR system. For you know that nicotine, as absorbed into the system through smoking and chewing tobacco, is a slow working poison. Slow, yes—but sure.

Tobacco is lowering your efficiency. It slows a man down. Makes it harder for you to concentrate your mind on your work. You haven't near the amount of "pep" and energy you would have if you stopped using it. There's many a man twice as old as you in years who's twice as young in energy, simply because he lets tobacco alone.

Some day you will realize to what an alarming extent tobacco has undermined your system.

When your hands begin to tremble—
and your appetite begins to fail—
and your heart seems to "skip a beat" now and then—
and slight exertion makes you short of breath—
then you have a right to suspect that
TOBACCO is getting the upper hand.

Any well-informed doctor will tell you that these are only a few of many symptoms of tobacco poisoning.

And YOU know that the use of tobacco in any form is an expensive, utterly useless habit. You know you ought to quit.

Tobacco Habit Banished Let Us Help You

It doesn't make a particle of difference whether you've been a user of tobacco for a single month or 50 years, or how much you use, or in what form you use it—whether you smoke cigars, cigarettes, pipe, chew plug or fine cut or use snuff—**Tobacco Redeemer** will positively remove all craving for tobacco in any form in a very few days. Not the slightest shock to the nervous system. Your tobacco craving will usually begin to decrease after the very first dose—there's no long waiting for results.

Tobacco Redeemer contains no habit-forming drugs of any kind and is marvelously quick, scientific and thoroughly reliable.

It is in no sense a substitute for tobacco. After finishing the treatment you have absolutely no desire to use tobacco again or to continue the use of the remedy. It helps to quiet the nerves and make you feel better in every way.

Results Guaranteed A single trial will convince you. Our legal-binding, money-back guarantee goes with each full treatment. We will refund every cent you pay for the treatment if after taking it according to the easy-to-follow directions, it should fail to banish the tobacco habit completely.

SEND Coupon for Free Proof Let us send you our free booklet on the deadly effects of tobacco, together with testimonial letters from men all over the country telling how they have been absolutely freed from the tobacco habit by this simple home treatment. You could not ask for stronger proof that **Tobacco Redeemer** will free you from the habit than the evidence we will gladly send on request. Just mail the coupon—or a postal will do.

NEWELL PHARMACAL CO.

Dept. 300 Clayton Station St. Louis, Mo.



Free Book Coupon

NEWELL PHARMACAL CO.

Dept. 300 Clayton Station St. Louis, Mo.

Please send, without obligating me in any way, your free booklet regarding the tobacco habit and proof that **Tobacco Redeemer** will positively free me from the tobacco habit or my money will be refunded

Name

Street and No.

Town..... State.....

An underpaid bank clerk a year ago Today~ a high-salaried ELECTRICAL EXPERT

... Here is an inspiring true story of success. If you're ambitious—if you're making less than \$40 a week—you'll discover in this story an opportunity to get out of the rut and into the big money class.



Can you imagine a man who, a few months ago, knew nothing about electricity, installing this big power plant and complicated equipment? It proves that National-trained men are real Electrical Experts.

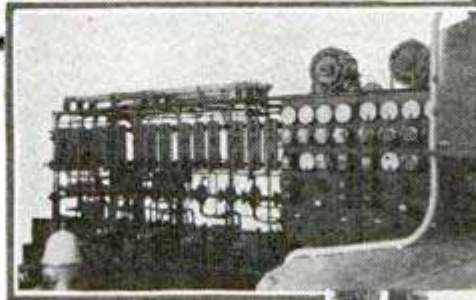

W. A. Roben—high paid Electrical Expert for the big Utilities Power & Light Corp.—who credits National training for his success.

After a few months of National Electrical School training—Roben installed this complete Wisconsin Electrical Power Plant

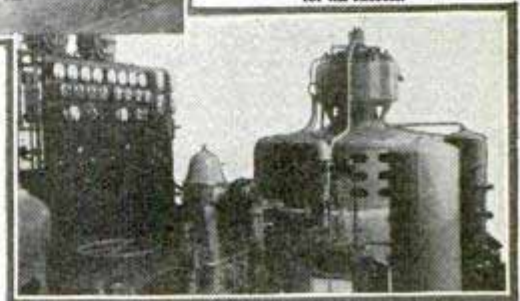

"I wasn't making enough money to live on, a year ago," writes W. A. Roben now. He realized he'd never get anywhere as a bank clerk—and after investigating other fields, he decided that the fast-growing Electrical Industry offered more opportunities to make big money.

Lack of Experience Didn't Hold Him Back

But he knew nothing about Electricity. How could he hope to win success against men who had grown up in the industry?

A magazine advertisement like this showed him the way. He sent for the National Electrical School's free book of opportunities. What he read there



Established 1905

caused him to quit his job and enroll for National training.

In this big school of shops, master instructors showed him exactly how to do wiring jobs—to construct radios and operate broadcasting stations—to build motors—operate Electrical control boards and instruments. They helped him do practical work on over a half-million dollars worth of new electrical equipment.

He Learned in Months Instead of Years

"When I left National," he writes, "I was hired immediately with no other recommendation or experience than my National training. I was given top pay and sent to Gays Mills, Wis., where I supervised the installation of a complete power plant. It went into operation without an error. I am next to have charge of a bigger job in Iowa."

Many National Graduates Earning \$200 a Week

Employers are eager to get men who know the things that National teaches you. Big electrical projects are developing so fast that there is a serious shortage of trained men. There's no limit to the pay a real Electrical Expert can command.

Do you want one of these jobs—paying \$50 to \$200 a week and then up—up—up! National can train you—just as it has trained Roben and 16,000 other men for success and big pay. This school has won a world-wide reputation for thorough, **quality** training. National-trained men are in demand everywhere. Send now for the big free book that gave W. A. Roben his start and read how National will help you train for a big-pay job.

Mail Coupon for FREE ELECTRICAL BOOK

National Electrical School,
Dept. 503, 4006 So. Figueroa St.,
Los Angeles, California.

I want a big-pay Electrical Job. Send me your free book telling how to get one.

Name.....

Address.....

City.....State.....

NATIONAL ELECTRICAL SCHOOL - - LOS ANGELES, CALIFORNIA

10 DAYS' TRIAL
SEND NO
MONEY



NO
NEED
FOR A
NEW
PHONOGRAPH

New PHONIC Reproducer

makes an up-
to-the-minute **\$3⁸⁵**
Phonograph out
of your old one! **Direct
from
Factory**

Now at last you can say goodbye to the squeaky, nasal, rasping, metallic tone of your phonograph. Now you can have the beautiful, natural, full-rounded tone of the expensive new machines which are startling the world. Yet you need not buy a new phonograph if you have an old one. The reproducer is the HEART of any phonograph—and the New PHONIC reproducer makes your old phonograph like an entirely new one. Based on the new PHONIC principle. Makes you think the orchestra or artist is in the same room.

Gives the New Tone and Volume of Latest New Phonographs

Tones never before heard are clearly distinguished when the new PHONIC reproducer is used. Test it on an old record. Hear the difference yourself. Listen to the deep low notes and the delicate high notes. Hear how plainly and clearly the voice sounds. Note the natural tone of the violin and the piano, and the absence of "tinny" music. You'll be amazed. The new PHONIC reproducer is ideal for dancing or for home entertainments. Its volume is almost double that of the ordinary reproducer.

10 Days' Trial — Send No Money

You cannot realize how wonderful the New PHONIC is until you hear it. That is why we want to send it to you on 10 days' trial. Send no money now—just the coupon. Pay the postman only \$3.85 plus a few pennies postage when the New PHONIC arrives. Then if you are not delighted, send it back within 10 days and your money will be refunded. If sold in stores the price would be at least \$7.50. Our price only \$3.85. Over 350,000 people have dealt with us by mail. You take no risk. Mail the coupon now for 10 days' trial. **BE SURE TO STATE THE NAME OF PHONOGRAPH YOU OWN.**

NATIONAL MUSIC LOVERS, Inc., Dept. 582,
327 West 36th Street, New York

Please send me a New PHONIC reproducer for.....
.....I will pay the postman \$3.85
(give name of Phonograph) plus few cents postage. If I
am not satisfied after trial, I will return your reproducer within
10 days and you guarantee to refund my money.

Name.....

Address.....

City.....State.....

Outside U. S. \$4.10, cash with order.

\$75 A WEEK BUILDING RADIO SETS

now being made

Join the Radio Association of America. Let it train you to build and repair sets, to be the "radio doctor" of your community. \$3.00 an hour easily made in spare time.



\$500 Earned in Spare Hours

Lyle Folliek, Lansing, Mich., writes: "Have already made over \$500 in spare time." He is just one of many. Our members are starting radio stores, securing better positions, passing radio operator examinations, qualifying as big-pay Radio Experts, as well as making money spare time.

Join the Association Now! By our Special Plan your membership need not cost you a cent. Number of these memberships limited. Write for details NOW!

RADIO ASSOCIATION OF AMERICA, 4513 Ravenswood Ave., Dept. PM-2, Chicago, Ill.

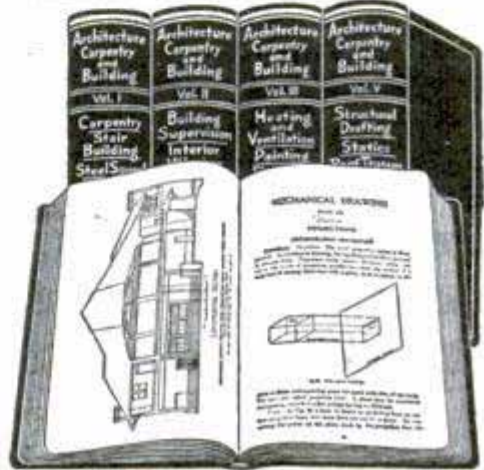

Brain Tools

For Architects, Draftsmen, Carpenters, Contractors,
Builders and all who expect to build

Men who work with their hands know that headwork gets them more money.

Brain tools make the tools in your tool box at least twice as effective, and the best brain tools you can get are good books—not just any books, but books which tell you the things you want to know, and do it instantly. Carpenters make themselves contractors by learning how to estimate correctly. Contractors are able to handle bigger and more profitable jobs by learning how the big fellows do it, and architects and those who want to enter this highly paid profession earn more money by having facts and figures at their finger tips. This brand new set of five handsomely bound books, covering all phases of architecture, carpentry and building, enables you to get authoritative, specialized information in a moment. No tedious long hours of reading—no hard grinding study, but instant reference to the vital facts. You don't waste a minute—the new jiffy index puts before your eyes, without wasted time, the things you want to know.

The most complete work of its kind we have ever published; nothing has been overlooked. Use of tools—building construction, heating, lighting, plumbing, architectural drawing, blueprint reading; in short, the most comprehensive and easily understood work of its kind.

These Books Sent FREE

Yes, this is true. We ship them to you without a penny of down payment. When you get them, look them over carefully—note how easy it is to find what you want to know—test the index in any way you want to, and then, if after 10 days you agree that you have at hand a veritable mine of invaluable information, send only \$2.00 and keep the books. After that send us only \$3.00 per month until the small total of \$24.80 is paid. For a short time we will include with each set a complete portfolio of the five basic orders of Architecture. These 58 beautifully illustrated plates are drawn to scale and carefully figured. Size of each 11x15 inches. You'll thank the day you sent for your set.

Learning Means Earning

and here you have at hand information gathered from hundreds of experts, all for so small a sum you'll never miss the money. Use these books as others have done and you'll get many times their price in a few months. One job alone may repay you several fold. Send for your set today.

FREE EXAMINATION COUPON AMERICAN TECHNICAL SOCIETY

Dept. G-219, Chicago, Ill.
You may send me, entirely without obligation, this handsome set of 5 volumes—Architecture, Carpentry and Building. I am to have full ten days in which to look them over and decide if I want to keep them. After which I will either send them back or send \$2.00 down and \$3.00 per month until the special price of only \$24.80 has been paid. Please include FREE the portfolio of 58 handsome plates.

Name.....

City.....State.....

Reference.....

Free Membership

Send now and we will include with these money-making books a membership in the American Technical Society which entitles you to free consultation privileges with twenty highly paid experts. This alone is invaluable. In addition to all this you are entitled to the services of our Employment Department FREE when seeking a better job.

To Men Getting Bald I Say!



No matter how fast your hair is falling out—no matter how much of it is already gone—I make this amazing guarantee! I'll end dandruff—stop falling hair—grow new hair in 30 days—or you don't pay me a cent! No strings attached! No "Ifs," "Ands" or "Maybes"! New hair or no pay! And you are the sole judge!

By ALOIS MERKE

Founder of the Merke Institute, 5th Avenue, New York

SAVE yourself from baldness! Stop falling hair! Grasp this "no risk" offer to grow new healthy hair in 30 days!

Here's My Contract!

If your hair is rapidly falling out—if your appearance is spoiled by approaching baldness—if you have tried countless expensive hair treatments unsuccessfully—it makes no difference. My contract stands! I'll grow new hair in thirty days—or the trial costs you NOTHING.

Here's My Secret

Years of training and research and day after day experience in treating thousands of cases of loss of hair at the famous Merke Institute, Fifth Avenue, N. Y., have taught me many valuable facts about the hair—and this, the most amazing of all—that in most cases of baldness the hair roots are not dead, but merely dormant—asleep!

You're wasting your time—you're throwing away money—when you try to reach these dormant roots with ordinary hair tonics, oils, massages and salves. For such measures treat only the surface skin and never even get to the roots, the real source of trouble. How could they ever possibly grow new hair?

My Method Reaches the Roots

It's no use trying to make a tree grow by rubbing "growing fluid" on the bark. You must get to the roots! And that's just why my scientific treatment is so tremendously beneficial! It penetrates below the surface of the scalp. It quickly reaches the cause of the trouble—the dormant, starving hair roots. It awakens them. Hair begins to sprout again. It takes on new life and color. It becomes

stronger and thicker. And in a surprisingly short time—sooner than you ever imagined possible—you have a new healthy growth of hair—OR I PAY ALL COSTS OF THE TREATMENT MYSELF.

And best of all, my system is so simple that it can be used in any home where there is electricity without the slightest discomfort—and for just a few cents a day!

New Hair or No Cost!

Thousands claim seeming miracles for my treatment. I don't. I admit some cases of loss of hair are hopeless. Only remember this—these cases are so very rare and so many hundreds of others have regained luxuriant hair through my method, that I am willing to let you try it for 30 days—AT MY RISK!

Then if you are not absolutely delighted—say so. And I'll mail you a check immediately—refunding every cent of your money—and the treatment will have cost you NOTHING!

Free Booklet Tells All

The very fact that you have read this announcement shows that you are anxious about the condition of your hair. So why not investigate? Find out for yourself. If you will merely fill in and mail the coupon I will gladly send you without cost or obligation a wonderfully interesting booklet which describes in detail my successful system, which is growing new hair for thousands all over the country. In addition it tells all about my iron-clad guarantee, which enables you to take my treatment without a penny's risk. Clip and mail the coupon today. Allied Merke Institutes, Inc., Dept. 162, 512 Fifth Ave., New York.

Allied Merke Institutes, Inc.
Dept. 162, 512 Fifth Avenue,
New York City.

Please send without cost or obligation a copy of your book, "The New Way to Grow Hair," describing the Merke System.

Name.....

Address.....

City.....State.....

EVIDENCE!

Hair Coming Back

"Having used your Thermocap Treatment for 30 days, I find a new growth of hair coming back on bald spot. It is growing in very fine. The Thermocap is a Treatment that everyone who is losing his hair should buy."

G. H. P., Portland, Me.

Dandruff Leaves Entirely

"I want to tell you how wonderful your treatment is. The first week my dandruff left entirely, and by the third week a new growth of hair could be seen all over my head."

Mrs. H. S.,
Port Angeles, Wash.

Partly Bald for 10 Years

"I have been partly bald for the last 10 years and have used your treatment only four weeks to date, but I can already see a new crop of hair coming in."

J. A. K.,
Anderson, Ind.

See the World FREE!



Taste Romance and Adventure In the Far Lands of the Earth

How often you've longed to see for yourself the awe of Egypt's pyramids—the beauties of the gorgeous Mediterranean sunset—the squalor of China's ancient cities!

Spend a few years, or the rest of your life, tasting high adventure on the seven seas and in all the world's great ports—roving the earth's highways and byways! You can do it FREE—all your expenses paid—and earn a good salary besides!

Only one profession will carry you around the world at will, traveling like a gentleman, but that's the most interesting and pleasant work there is—Radio Operating! Easily and quickly learned, there's no other profession like it for the man who wants the experiences and pleasures of world-travel. Radio operators are needed—all sea-going ships like the one shown here must carry from one to half a dozen or more.



Take a Look Beyond the Skyline Without a Penny's Expense

Radio operators aboard ocean liners live luxuriously—they rank as officers of the ship. Meals, a private cabin, all other living needs are furnished free, and besides the operator draws a good salary. You can learn quickly and easily at home in your spare time to be a Radio operator through our practical training methods. Take a look at the FREE BOOK which tells how—mail coupon below.

This U. S. Government-recognized school has been training successful operators since 1914. Our graduates are all over the world. We maintain an Employment Department to put you on your own ship. The world-famous NATROMETER, our own patented invention, obtainable only by students of this Institute, is recognized as the best and easiest way to learn the Radio code. A few short months, with the aid of the famous Natrometer and our quick home training, and you too can be a fully qualified Radio operator, sitting in your cabin like the one shown above, bound out for Liverpool or Nagasaki!

Read the Free Book that tells all about this fascinating profession and our practical Government-recognized methods of training you for it. Send coupon TODAY—no obligation. Special tuition offer now on for limited time includes world-famous Natrometer free of extra cost with your course! Act at once.

**NATIONAL RADIO INSTITUTE
WASHINGTON, D. C.**

SPECIAL OFFER COUPON

National Radio Institute,
Dept. BB-85, Washington, D. C.

Gentlemen: Without obligating me in any way send me your free book and information about your special limited Natrometer offer.

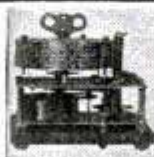

World-Famous Natrometer

Name.....

Address.....

Learn How to BOX

JIMMY DeFOREST BOXING COURSE

Has Developed Champions by Mail

Hundreds of DeForest Trained-By-Mail Boxers Are Making Good in the ring today!

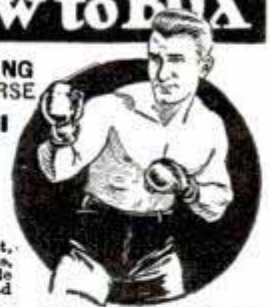

In 20 weeks under the System of Jimmy DeForest, World's Greatest Trainer and Maker of Champions, you will master the priceless knowledge that has made champions, and started hundreds of boys on the road to Fame and Fortune.

Promising pupils are brought to the front at once. With the co-operation of an Advisory Board of prominent promoters who are enthusiastic about this plan, thirty boys are selected from all weight classes every six months and recommended to leading promoters for engagements.

Champions Give DeForest Course Sole Credit for Success

Champions and other students who are making good in the squared circle, publicly proclaim that the DeForest Course is responsible for their achievements. Read in the "Golden Age of Boxing" the amazing and almost unbelievable stories of John Nemis, welterweight champion of Maritime Provinces, Jimmy Robe, George Tasker, Buell C. Murphy, and other stars. Boys who were rank amateurs are today earning big money. Novices are developed into topnotchers.

Greatest Physical Training System in the World

The DeForest Course is the greatest physical training system in the world. Weaklings have been made strong and men physically rebuilt, energy, strength and courage developed. Prominent men and leaders in all walks of life, including Prof. T. W. Seeley, famous Physical Culturist, box regularly to keep themselves fit.

Read This Gripping Book

Send today for the new famous book, "The Golden Age of Boxing," greatest book of its kind ever written, full of valuable information, photos of great boxers and pupils who became successes overnight. Full outline of the DeForest Course. This book will thrill you. Write now.

JIMMY DeFOREST BOXING COURSE 347 Madison Ave., Box 614, NEW YORK CITY

MEN WANTED

TO LEARN

Motion Picture Projection

\$2,000 to \$4,000 a Year

Quickly learned. Short hours, big pay. Best equipped school in Michigan. Projectionists for Movie Houses and Road Shows.

MOVIE OPERATORS SCHOOL

61 Sproat Street,

DETROIT, MICHIGAN

NEW PRACTICAL

DIESEL ENGINE BOOK

The importance of the Diesel engine in its various applications to Marine, Locomotive, and Stationary operation can scarcely be overestimated. Every progressive engineer and student of mechanical engineering will realize the necessity of extending his knowledge into this field.

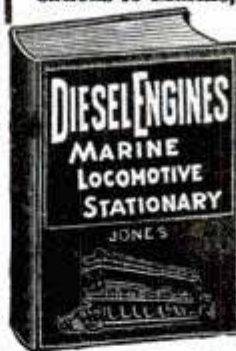

This up-to-the-minute book by D. L. Jones, Chief Machinist, U. S. Navy, is extremely practical, complete and in simplified language. Deals thoroughly with installation, operation and maintenance.

565 pages (6x9)—340 Illustrations.

Pay postman \$5.00 on delivery.

**Popular Mechanics Press
200 E. Ontario St. CHICAGO**

Helpful IDEAS for Home Owners

In these two practical books, you will get 502 ideas that will be helpful in making your home a better place to live in—a home to be proud of. The ideas are for the making, improving and repairing of the devices needed about and in the home. The books are:

1. Home Mechanic's Handbook No. 1
2. Concrete Handbook No. 1

These books tell how to make most everything, from door stops to a refrigerator, and from a concrete sidewalk to a lawn fountain.

Send No Money Simply write a postal and ask that Popular Mechanics two Homeowner's books be sent C.O.D. When the postman delivers the books to you, hand him \$1.00 plus the few cents postage.

POPULAR MECHANICS PRESS

Popular Mechanics Bldg. Room 611 Chicago, Ill.

**\$1
TWO BOOKS FOR**

TRUSS VICTIMS!



Magic Dot, a tiny device weighing less than 1-25 of an ounce makes possible an entirely new system for supporting and often healing rupture.

Magic Dot Brings Magic Relief

—And Hernia Often Disappears!

Magic Dot not only offers you amazing new comfort from the very first day, but something of far greater importance—the possibility of ultimate FREEDOM!! The New Science System is even more than a feather-light, pressureless support. Its big purpose is to cause a disappearance of the protrusion and eventually free you from the necessity of any kind of support. This is because its inventor has found proof that Nature will often heal if given a certain kind of aid, which is now made available in 100% practical form for the first time! A record of amazing results in numerous cases, together with common sense diagrammatic explanation has just been published in book form—a copy of which will be sent you on request without obligation.

Clever Sample FREE!

Write at once for a sample of remarkable washable, air-breathing Airtex! It will be sent you absolutely without charge, together with our "See it First" offer on the complete New Science System and a book describing exactly how this new rupture relief works. It is one of the biggest things that has ever been offered to those afflicted with hernia, or rupture—and will open your eyes to the dawn of a new day of freedom from the rigorous limitations your trouble has saddled upon you! Don't delay! This generous offer is limited to 30 days. Mail the coupon at once!

NEW SCIENCE INSTITUTE

2133 Clay Street STEUBENVILLE, OHIO

New Science Institute,
2133 Clay Street, Steubenville, Ohio.

Without obligation send me a no-cost Airtex sample with illustrated explanation of Magic Dot and full details of the New Science System of rupture and hernia relief.

Name

Address

City State

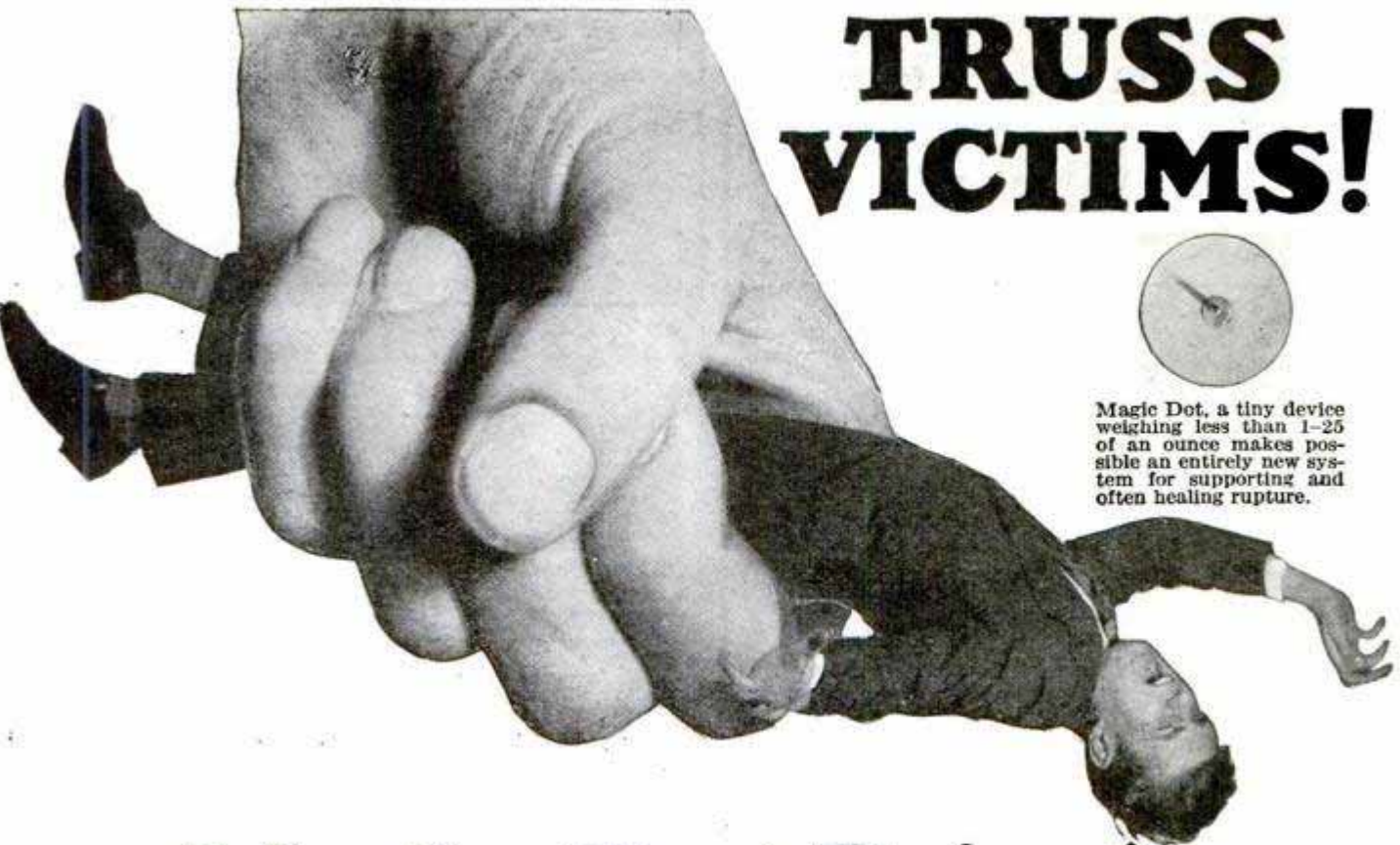

NOW—a great scientific achievement revolutionizes rupture treatment. No longer are ruptured men and women doomed to the eternal torture and discomfort or harnesslike trusses with their gouging knobs, steel springs and unsanitary leg straps! An astonishing simple little device that weighs only 1/25 of an ounce offers you glorious new freedom—freedom such as you never dreamed would ever be yours again!

This surprising invention has won the praise of physicians, and rupture sufferers from coast to coast. It is such a radical departure from the old-fashioned, painful, dangerous appliances it renders obsolete that one cannot help but wonder why scientists have never stumbled upon its secret before! It is simplicity itself—but the results it accomplishes are little short of remarkable! Only when you have tested its feather-lightness by holding it in the palm of your own hand, can you realize how startling it really is!

Weighs Less Than a Penny!

A remarkable little circle called Magic Dot anchors and makes possible the lightest, flesh soft padlet you can imagine. Composed of a newly-discovered substance (named Airtex) it is honey-combed with tiny cells that actually breathe air with every movement of your body. It expands and contracts as easily as your own flesh. When you walk, run, bend or exercise it squeezes itself—not the tender part of the body it rests against.

The Airtex-Magic Dot combination is so little and light that the wearer hardly knows he has it on. Its myriad air-cells keep it air-cooled at all times—so that it does not produce that "hot spot" feeling that is so uncomfortable. Besides this, the padlet can be washed out sweet and clean in a jiffy. Just dip it into clear water and squeeze with your hand. Every bit of perspiration odor is easily removed in an instant—leaving it as fresh and sanitary as new!

Absolutely Dependable and Safe!

And yet with all its yielding softness, Airtex holds the rupture securely in place at all times—whether you are standing, sitting, lying or exercising and moving about. No slipping or skidding; no constant readjusting, no danger of strangulation or "coming down."

The Right Way to Play THE TENOR BANJO

—by Chords



The chord method of playing the Tenor Banjo is the correct way for the student who aspires to produce real music. In the Martell Home Study Course the objective is a high proficiency in playing by chords. We do not feel that our task is finished when the pupil has learned to pick out single string melodies. This is merely preliminary instruction for the real art of Tenor Banjo playing.

Our system was originated and prepared exclusively for us by the famous John Martell, one of the best known masters of the Tenor Banjo. It consists of twelve easy lessons, leading the student step by step from the rudiments to the full accomplishment of Tenor Banjo playing.

The satisfaction and pleasure that accompany the ability to play well are ample rewards for the effort spent in studying and practicing the lessons. As a source of profit, too, the Tenor Banjo ranks high. It has become the most popular orchestra instrument. Players are in constant demand for stage, radio and orchestra.

Complete Martell Course Only \$7.00—Easy Terms

The price for the entire course is only \$7.00. We offer no banjo in connection with our system of instruction because we realize that many already possess an instrument. If you have no tenor banjo, we believe you would prefer to purchase one separately from the course in order to know what each costs you. We have made arrangements with one of the leading manufacturers to supply Tenor Banjos at an exceptionally low price to those of our students who desire it. These instruments are sold at this special price to our enrolled pupils only (further information on request).

As an aid to students who desire it, we offer this system on easy terms. Just send us \$2.00 and we will send you the lessons in successive weekly mailings. The balance is payable in five weekly payments, \$1.00 each. A 10% discount is allowed to those who make full payment in advance, making the full price, \$6.30 for cash.

Fill Out and Mail This Coupon NOW
Tomorrow It May Be Forgotten

NEW YORK INSTITUTE OF MUSIC
Dept. 102—143 East 34th St., New York, N. Y.

- Check One
- Enclosed find cash, check or money order for \$6.30 (list price less 10%) in full payment for course.
 - Enclosed find cash or money order for \$2.00 for which please enroll me for the Martell Home Banjo Course. Balance will be paid in 5 weekly installments of \$1 each.
 - Please send further information.

NAME.....
ADDRESS.....
CITY.....STATE.....

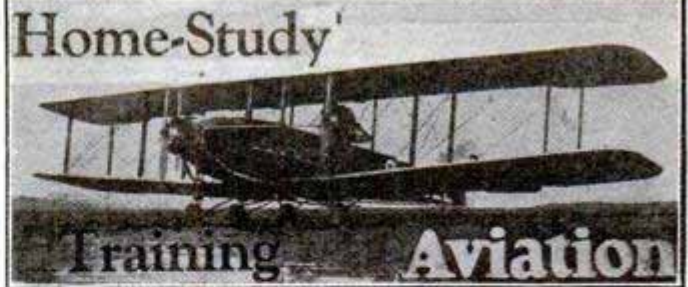

Be an airplane expert!

Aviation is new! It is the field of wonderful opportunities today! It is not crowded. It offers every man of average ability a chance to become an Airplane Expert. We are looking for ambitious, daring, red-blooded fellows who want to make Big Pay in a clean, fascinating field. Airplane Experts can find steady employment—anywhere, any time.

PAYS BIG MONEY—QUICK!
Ask for Details and Big Airplane Catalog
WESTERN AIRPLANE CORPORATION
Aeronautical Training Division Dept. M-2
Suite 402-3-4-5 Monadnock Block Chicago, Ill.



Earn Money at Home

Large, successful firm wants ambitious men in every county. Build your own business, in spare time by mail and locally, right from your home. No stock to carry. We furnish everything. Free instructions. No canvassing. Write to

MR. WM. BADESCH, Business Extension Mgr.
131 Duane Street Dept. 3 New York

Better Handwriting

Easily learned, on wonderful new patented device. Children like it, adults pleased. Agents wanted. Sample 98c. Write for information today. VIC. HANSEN, WALLACE, IDAHO



Counting returns on election night

HOW TO BE A Newspaper Reporter

Get the thrills of this adventurous life. Adventure, excitement, thrills, romance and unbounded opportunities await the trained reporter.

It's he alone who is admitted when others are barred. When Governors, Statesmen, World Champions and celebrities of stage and screen come to town, it's the reporter who talks with them on a friendly footing. It's the reporter who passes inside the fire lines and gets the first tip on exciting police stories.

Above all, this fascinating profession is full of boundless opportunities and often leads to power and wealth in politics, business and professional life. A notable example of early success is that of Horace Wade, the "Boy Reporter" who today is the intimate friend and associate of the world's greatest men. Not yet twenty years of age he has achieved the ambition of most men of fifty and that without college education or other special training, except such as Press Writers' Headquarters is prepared to give you.

Experts Now Ready to Help You

You can now prepare to enter this chosen field. You can do so without leaving your present job. You can train at home and find it fun doing so. Press Writers' Headquarters has a staff of experts, men who are themselves successful and can tell you the things you need to know in a simple, easy way. The cost is nominal, not more than what you should earn in a few days, after qualifying. With over 17,000 newspapers, with 36 million copies daily, in the United States you can see what tremendous opportunities are open to you.

FULL DETAILS FREE

We will send you our complete plan without obligation if you'll write for it. The story of a hundred successes and a complete outline of the experience of Horace Wade, the most astounding example of a young man's success in the world has ever known. There is no cost and no obligation. Send the coupon now.

PRESS WRITERS' HEADQUARTERS, Dept. 22
630 S. Wabash Ave., Chicago, Ill.
You may send me complete details of your plan and the story of Horace Wade's success without any obligation of any kind.

Name.....
Address.....

THE CHICAGO DAILY NEWS School and College Bureau

Offers You Its Specialized Services in Choosing a School

Last year the School and College Bureau of The Chicago Daily News saved many busy parents and questioning boys and girls both time and worry by sending them prompt, reliable information about just the kind of school they wanted—personal requirements as to location and tuition charges being considered in each individual case.

Again this year many young people will be perplexed by the problem of finding the right school. Why not let us help you?

The Chicago Daily News maintains this service absolutely free of charge to you. No need to hurriedly select a school on mere hearsay when expert advice can be obtained by telephoning, writing or calling for a personal interview at

THE CHICAGO DAILY NEWS
School and College Bureau
Dept. K, 15 N. Wells St., Chicago, Illinois

Keynote To Popularity

Popularity is yours. Everyone will seek your company, if you play tenor banjo. Enroll for our course. We start you with an \$18 professional gift tenor banjo. Prof. Six was director of Glee and Instrumental Clubs at N. Y. University. His picture, diagram and phonograph record method is so simple you play immediately.

Don't Send a Single Cent
Write for particulars about our course and we will reserve an \$18 gift tenor banjo for you. Write now for book and free first lesson. **New York Academy of Music, Studio 102, 100 Fifth Ave., N. Y. C.**



Become an OIL PAINTER

Earn while you learn. Experience not necessary. An inexpensive practical course of Home Study of real Oil Painting on canvas. Materials included. No extras.

HOME ART STUDIO, 5220 Lakewood Ave., CHICAGO



TELEGRAPH-RADIO

\$18 to \$35 a week while training for Radio and Telegraph Operator jobs at \$150 to \$300 per month. Write for particulars.

CHICAGO TELEGRAPH INSTITUTE
Dept. 1-2-7 1338 S. Michigan Avenue, CHICAGO

861 IDEAS for Farmers

The experiences of 417 farmers and farmers' wives have been combined in "The Most Remarkable Book Ever Published for Farmers." There are 138 ideas for the farm shop, 35 on fencing, 98 on auto, truck and tractor, 61 on farm buildings, 36 on field machines, 48 on concrete work, 22 on orchard work, 23 on painting, 15 on live stock, 34 on poultry, 54 on garden work, 25 on electrical work, 22 on farm tools, 16 on hunting, fishing and trapping, 140 household helps, and many others.

SEND NO MONEY—Simply write a postal asking that Popular Mechanics Handbook for Farmers be mailed to you. When the postman delivers the book, simply hand him \$1 plus the few cents postage.

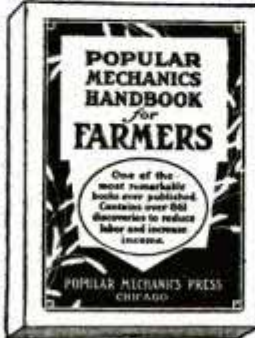

POPULAR MECHANICS PRESS
Popular Mechanics Bldg. Room 717 Chicago, Illinois

A Quick, Sure Way to a Big Income is to RAISE POULTRY



Easy to make \$1000
a Year Spare Time -
\$5000 and up Full Time



Let the Other Fellow Pay YOU the Fancy Prices

When you go into a store and pay 75c to \$1.00 for a dozen eggs, did it ever occur to you that YOU might be getting the 75c to \$1.00 instead of the other fellow? Did it ever occur that a small back yard or vacant-lot flock of poultry would pay enormous profits, if properly managed, and require very little of your time? In this country, where 85% of the people live in cities, and live right, want the best of everything—they will pay and pay well for fresh eggs and poultry meat. There will be a QUICK, sure demand for every egg or bird you produce. Poultry raising offers a golden opportunity. Is there any good reason why YOU shouldn't take advantage of it?

Start Small, Grow Fast, Sure Methods Bring Quick Success

Start small, if you like, just as hundreds thousands of others have started. Then, by following the sure, tried, proved, money-making method which we will give you, you can grow as fast as you wish. Many of our students who began with the idea of having the BEST for their own tables and cutting living expenses, too, soon found in this fascinating, healthful, profitable business, the quick road to a large, steady, full-time income. You can get into a business of your own—one that will make you YOUR OWN BOSS with an income of \$5,000 a year and UP—or you can make \$1.00 to \$3.00 for EVERY hour of your spare time. Let us show you HOW!

Surprise Yourself—Let This FREE Book Open Your Eyes

All I ask is a chance to PROVE that you can CASH-IN on my forty years experience as Commercial Poultryman and former Senior Poultryman in the U. S. Dept. of Agriculture. A chance to prove that the poultry business DOES have big opportunities for you—and that regardless of your location, whether in a city, a town or on the farm—I and the staff of experts associated with me—can show you the way to real SUCCESS and independence, just as we have already shown thousands of others. My new FREE book on "How to Raise Poultry for Profit," will be an eye-opener. Clip the coupon and send for it today. Do it now—this minute. You have everything to gain by—quick action!

READ! What Others Are Doing

"The results I am getting from your methods speak for themselves. In a flock of 65 fowls, I have gotten 888 eggs from the first of the month up to date (the 23rd). BRADY CHANCE, Dewey, Okla.

"Your course on poultry raising is the most practical and complete in the country. You have opened up a pleasant and profitable way for me to gain an independent living." S. ANDERSON, Barrington, R. I.

"The information contained in your course has been of such great help to me that I would not take \$1,000 for what I have gained." L. M. WRIGHT, Federalsburg, Md.

"I consider my enrollment with the National Poultry Institute the best investment I ever made." Mrs. J. W. CHAWLEY, Farmville, Va.

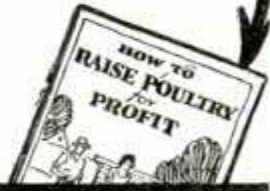

FREE BOOK TELLS HOW

NATIONAL POULTRY INSTITUTE,
Dept. 411-F, Washington, D. C.

Gentlemen: I want to know more about the opportunities for me in the poultry business and about your plan for helping me make \$1,000 to \$5,000 a year and up. Send FREE book.

Name

Address

Get out of the Rut!

This FREE Book Shows You How → Ornamental Iron Draftsmen start at \$65.00 a week. Experienced men earn up to \$500 a month or more.



This free book gives you proof of the big demand for Ornamental Iron Draftsmen and the opportunities they have to advance into big-paying positions as estimators, salesmen, partners, etc. It shows letters like this from big companies: "Forward names of your graduates that are located in Chicago. We are always on the lookout for ornamental draftsmen who can qualify," and "We will be pleased to know whether you have any ornamental iron draftsmen you can send us, as we are in need of some at the present time." There is a good paying position waiting for you in this profession!



Easy for You to Qualify

This free book shows how easily you can establish yourself in this growing and highly paid profession that has become a big factor in modern building construction. You don't have to study text

books, or have any previous experience in drafting, or know higher mathematics.

FREE Employment Service

You will be interested in seeing how you will be personally recommended for a position the minute you can qualify. We have the names of many concerns now that want ornamental iron draftsmen.

Get This Free Book

It will show you how to get out of the rut and start to a position that will bring you the pleasures that make life worth while. Don't wait—mail the coupon now!

FREE
Mail the Coupon
NOW

American Institute of Ornamental Iron & Bronze
3015 Hennepin Ave., Minneapolis, Minn.
Please send the FREE Book, "KNOWLEDGE, Your Greatest Asset."
Occupation.....Age.....
Name.....
Write your address plainly in margin

YUDOU CUZANUN RAREEADUD TUTHASHISUS
You can learn this secret language in a few minutes. Use it for secret conversation and correspondence. Price 25c (2 copies). No stamps. Your money refunded if you are not satisfied.
E. H. ARBUCKLE, P. O. Box 2182, Sta. H, Cleveland, O.

Big Money at Home

Men and women—Learn wonderful *surcraft*. Quick, sure profits at home. Have a business of your own. No investment. Volume unlimited. Send Now—Free Book
N. W. Fur Co., 1772 Sutherland Bldg., Omaha, Neb.



DRAW CARTONS

TURN YOUR TALENT INTO MONEY

Cartoonists earn from \$50 to \$300 per week—some even more. Remarkable new Circle System of Drawing teaches you in half the usual time. Send for booklet and sample lesson plate explaining full details of the Course.

The National School of Cartooning, 623 Penton Bldg., Cleveland, Ohio



GOV'T. POSITIONS

ABOUT 50,000 OPEN YEARLY

MAKE \$35 to \$75 WEEKLY YEAR ROUND

Men and Women, 18 to 55 wanting to qualify for a good healthy permanent Government Position, inside or outside work, in your locality or elsewhere local or traveling, write us immediately for full particulars, etc. No obligations whatever.

Mail this coupon to-day and get full particulars FREE

Ozment's Service Bureau, St. Louis, Mo. (152)

Send me full particulars about positions marked "X", salary, location, home instructions, etc. without obligations to me.

- | | | |
|------------------------|----------------------------------|-------------------------|
| () Railway Mail Clerk | () Watchman | () Immigrant Inspector |
| () P. O. Clerk | () Postmaster | () City Mail Carrier |
| () Forest Ranger | () RFD Carrier | () U. S. Border Patrol |
| () File Clerk | () Meat Inspector | () Seamstress |
| () Matron | () Special Agent (Investigator) | () Steno-Secretary |
| () General Clerk | () Stenographer | () Auditor |
| () Chauffeur-Carrier | () Typist | |
| () Skilled Laborer | () Typist | |

NAME.....
ADDRESS.....

NEW Kind of Belt Reduces Waistline - *Easily!*

Instantly makes you look inches thinner and years younger and actually massages away fat every second while you wear it!

HERE'S a new easy way to get rid of that bulky, useless, disfiguring fat without any effort on your part! A new kind of belt has been perfected which actually takes off fat in an easy, gentle way—just like an expert masseur! The moment you put on this new self-massaging belt your waist is instantly reduced from 2 to 4 inches! Your stomach disorders, constipation, backaches and shortness of breath generally disappear as the sagging internal organs are put back in normal place. You are filled with a wonderful new energy, and will probably look and feel 10 to 15 years younger!

Reduce the Way Athletes Do

The Weil Reducing Belt is made of specially prepared and scientifically fitted rubber. It is so constructed that, as you wear it, every breath you take and every move you make imparts a constant gentle automatic massage to every inch of the abdomen. It works for you every second, day and night, and reduces much more rapidly than ordinary massage.

The Weil Belt is made of the same kind of scientifically treated rubber that is used by hundreds of professional athletes and jockeys, because it not only reduces quickly but at the same time preserves their strength. It is highly indorsed for its healthful principles by physicians everywhere. Satisfaction guaranteed or your money instantly refunded without question.

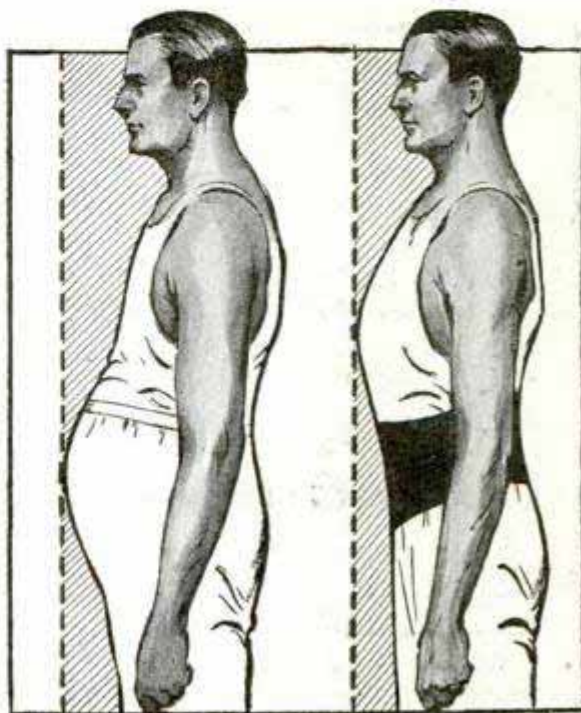

SPECIAL TRIAL OFFER

Write at once for full description and details of the Special 10-day Trial Offer being made to The Weil Company, 92 Hill Street, New Haven, Conn.

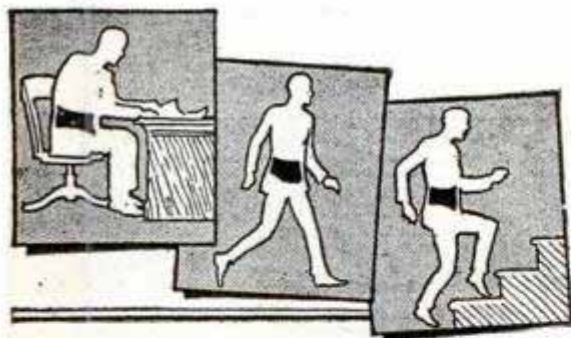

As illustrated at the left, every move of your body, walking, climbing stairs—merely breathing as you sit—causes the Weil Belt to massage your abdomen. It is working for you every second.

THE WEIL COMPANY
92 Hill Street, New Haven, Conn.

Gentlemen: Please send me without obligation complete description of the Weil Scientific Reducing Belt and also your special 10-day Trial Offer.

Name

Address

City State.....

POPULAR MECHANICS

LATHE
HANDBOOK No. 1



POPULAR MECHANICS PRESS
CHICAGO

259 Discoveries For Lathe Operators

This book contains the experiences of 106 successful operators in the U. S. and in the principal foreign manufacturing countries. 83 articles tell how to make special lathe tools and attachments. 33 on gauges and indicators. 23 on special devices for holding work. 9 special lathe centers. 29 on how to do unusual jobs. 28 on boring and drilling. 11 on thread cutting.

212 Illustrations The pictures make it easy for a beginner. Every article is written so anyone can understand it, and every kink has been thoroughly tested.

Send No Money Just write a postal. Popular Mechanics Lathe Handbook and Drilling and Thread Cutting Handbook will be sent C. O. D. Pay postage and 98c for the 2 books.

POPULAR MECHANICS PRESS
Room 22, Popular Mechanics Building, Chicago, Ill.

Interior Decorating LEARN AT HOME

\$3,500 to \$10,000 a Year

Tremendous new interest in Interior Decorating. Big demand for trained men. Get into a big salaried position or start a business of your own. Student B. C. L. writes, "Am designer and drapery buyer in department store. Salary doubled." Prominent decorators teach you at home. Write for Free Booklet.



National School of Interior Decoration Dept. 762, 2 W. 47th St., NEW YORK CITY

YOU CAN EARN UP TO \$250 per month salary and expenses



AS A RAILWAY TRAFFIC INSPECTOR

I have many openings for ambitious chaps in this interesting and dignified profession, where pay is good and opportunities excellent. A Traffic Inspector, sometimes called Traffic Observer, is practically his own boss, sees new faces and sights each minute of the day, and reports only to high officials who reward good work with promotion. Hours are regular—and work is healthful.



RAYMOND A. McCUR

writes: "A little more than six months ago you sent me to a position with a guarantee that it would pay not less than \$120 a month to start. I started at \$120 a month—and am now earning \$180 a month. I am an inspector no longer, but still working for the same system in a strictly confidential line, and am daily in touch with the officials and inspection department."

No Experience Required

I have trained hundreds of inexperienced men in Traffic Inspection and placed them in good positions upon graduation. I teach you in three months' spare time home study, and upon completion, I'll assist you to a position paying at least \$120 per month salary and expenses to start, or refund your money. (You will notice I said "salary"—and there are no ifs about it.)

Traffic Inspection appeals to live men—it gives variety, independence and opportunity—where you are away from the monotonous desk or dirty shop—where you've an opportunity to "be somebody."

I have hundreds of letters from men I have helped to better themselves. Let me show you some.

Mail coupon today for full information. There's no obligation.

James T. Jarrell, Pres.

Standard Business Training Inst. Division 2—Buffalo, N. Y.

"Upon graduation we assist you in securing a position."

Standard Business Training Institute Division 2—Buffalo, N. Y.

Yes, I'd like to know something about Traffic Inspection. Send me your free booklet, "A Profession of Protection."

Name.....
 Address.....
 City or Town.....

IF DEAF LEARN TO READ LIPS

You can make your eyes a substitute for your ears by modern scientific lip reading. Don't be left out of good times. Don't handicap your business success. We can teach you during spare time to read lips, by our home-study course. Write today for details.

NATIONAL SCHOOL OF LIP READING 401 Euclid Bldg., Minneapolis, Minn.

BE AN OFFICER in the U. S. Coast Guard

\$1700 Up to \$7,500 Yearly

\$780 yearly at the U. S. Academy while training. You rank Ensign to Captain in service. Age requirements 18 to 24. Write Dept. F for information.

COAST GUARD PREPARATORY SCHOOL
 4000 Ga. Ave. N. W. Washington, D. C.

Four Big Volumes Shipped FREE No Deposit

A General Reference Work Covering
 Electrical Principles, Direct Current Dynamos, Direct Current Motors, Storage Cells, Armature Winding, Design of Small Motors, Transformers, Motor Testing, Magnet Design, Controllers, Limiters, Signaling Power Stations, Switchboards, Station Management, Welding, etc.

Illustrated with over one thousand engravings
 Black Flexible Fabricoid Binding, Stamped in Gold

This Secret Helps Make Money

Know how to find what you need to know, easily and quickly, when you need to know it. That's the Secret. No need for long, tedious hours poring over "lessons" at home or in the classroom. Men who know this Secret get any job done, while others are wondering how to do it! How simple and easy this is, is here explained for every ambitious man who will take advantage of this Extra Special Offer to become an Electrical Expert.

SCANT SCHOOLING NO BAR TO SUCCESS

Costly technical education, years of study not necessary. Steinmetz, of General Electric, was a poor, uneducated immigrant. Benjamin Franklin, who first drew electricity from the clouds, went to school only 2 years. Edison was a railway clerk. Volta, Faraday—ALL THESE WERE MEN OF SCANTY SCHOOLING. They had none of the advantages now offered you to help you become an expert in electricity.

INCREASE YOUR EARNINGS

Benefit by the knowledge and experience gained by hundreds of electrical experts. All the important facts are in these 4 compact volumes—everything that you will need to know about electricity. With these books you should INCREASE YOUR EARNINGS far beyond what you can EVER make if you go on in your present job. Clearly and simply written, anyone can understand. Dynamos, motors, lighting, signals, wiring, radio—with these books you can design, build or repair them all. Whatever you need, it's there, instantly available.

The Secret—JIFFY INDEX shows at a glance any subject you need, everything about it, completely told, diagrammed and illustrated, without reading pages and pages. Now offered at the lowest price and on the easiest terms we ever made.

SEND NO MONEY Only name and address—then when the books arrive show them to your friends. No lessons, no examination papers, no studying required. JIFFY INDEX shows anything you want in less than a minute. If convinced, send only \$2.00 in ten days, then only \$3.00 monthly until you have paid the special low price of only \$19.80 for all.

Membership FREE. If you send now, we will make you a member of the American Technical Society, giving you all the privileges of consulting our experts any time without cost. This alone is a priceless advantage. Our Employment Department is also at your disposal. Keep the application blank we send with the books to be used if you decide to look for a better job. So send TODAY!

AMERICAN TECHNICAL SOCIETY, ELECTRICAL DIVISION, E-219, CHICAGO, ILLINOIS.
 You may send me your new complete Electrical Engineering library. (1926 edition), 4 big volumes, bound in flexible covers, for ten days' Free Examination. If satisfied, I will send you \$2.00 then and \$3.00 per month until the special low price of only \$19.80 is paid, otherwise I will return them and owe you nothing.

Name.....
 Address.....
 City..... State.....
 Reference.....

17-Year old Boy owns big Garage

National Automotive Training Pays him \$350 to \$450 a Month

STEVE KOSNIK earned the money to build his own garage in two years as auto repairman. Now he and two assistants can't handle all the work—so he's going to hire some more National Automotive School men. Steve is a success at seventeen. How much money are you making now?

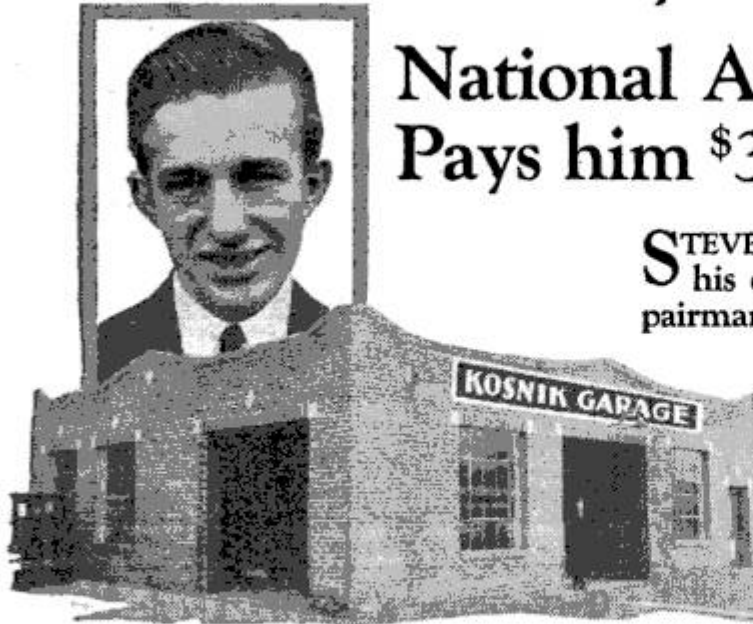

—and here's the book that started him
and 16,000 others toward Success
NOW FREE TO YOU!

You don't need experience—you don't need a high-school education—you don't need anything but *ambition* to make big money in the auto business!

Learn Autos the Right Way

That's the wonderful thing about National shop training. You learn by *doing!* In a few months of practical work with expert instructors you learn to repair every make of car.

Then you have the TRAINING that qualifies you to hold a big-pay job—\$50 to \$200 a week—because every employer is eager to get *trained* men. You should be able to get steady work—frequent raises—and soon own a garage of your own.

Plenty of Jobs for Trained Men

Will you be content to plod along at underpaid jobs—when the fast-growing auto industry offers you *real* money? There is a crying need for properly trained men

to service the millions of automobiles. Right now half-trained, amateur mechanics are "getting by" because employers can't get well-trained men. Men with National training stand out in the crowd—they get good jobs—the highest pay.

How 16,000 Men Have Increased Their Pay

For 22 years National has trained men *right*. Over 16,000 successful graduates will tell you National training increased their pay. Men and boys come from all over the world to get the famous thorough *quality* training in National's million dollar school of shops where you do actual repair jobs on newest engines, cars, airplanes, tractors. In a few months at National you learn more than you would in years as an apprentice.

Free Employment Service

National teaches you everything you need know to be an Auto Expert—and then makes every effort to get you a good job. Ideal training conditions in Los Angeles—thousands of big-pay jobs open in California alone. National may be able to get you a part-time job to pay your expenses while training. Send right now for your free copy of National's big Auto Book.

Learn
Autos in
Los
Angeles

This
BIG FREE BOOK
Starts You on the
Way to Big Pay!

Read about the opportunities for you in the auto industry—how other men have won top salaries—how National trains you—and how you can soon be in a better job. Mail coupon Now!



National Automotive School,
Dept. 667,
4006 Figueroa St., Los Angeles,
Calif.

Send me your free illustrated
Auto Book.

Name.....

Address.....

City..... State.....

National Automotive

and ELECTRICAL SCHOOL

Dept. 667, 4006 Figueroa Street

LOS ANGELES, CALIFORNIA



SHOW CARD LETTERING

Learn at Home

HERE is the very course you need if you want to get a good paying position as a Show Card Letterer or Sign Letterer, or have a business of your own. This course is complete and practical and especially arranged to meet the needs of the student who studies at home. It was written by E. L. Koller, Principal of the School of Art of the International Correspondence Schools, member of the American Federation of Arts, and The National Society of Craftsmen.

Mr. Koller has had twenty years' teaching experience, and his success in helping other men and women is an indication of what he can do for you.

H. L. Wood, a clerk, made more than \$700 "on the side" before he had completed his course and also won \$125 in prizes. Harry William Lord writes that he has more than doubled his salary as a result of studying this I. C. S. course in spare time. William Whitman, a former wagon builder, now has a sign painting business of his own and is earning nearly three times as much as he did before enrolling with the International Correspondence Schools.

There is no doubt that Show Card Lettering and Sign Lettering offer a real opportunity to ambitious men and women. Just mark and mail the coupon and we'll gladly send you a booklet telling all about the I. C. S. course in Show Card Lettering, or any other subject in which you are interested.

INTERNATIONAL CORRESPONDENCE SCHOOLS

Box 5629-E, Scranton, Penna.

The oldest and largest correspondence schools in the world

Without cost or obligation on my part, please tell me how I can qualify for the position or in the subject before which I have marked an X:

SHOW CARD LETTERING

- | | |
|---|--|
| <input type="checkbox"/> ILLUSTRATING | <input type="checkbox"/> CARTOONING |
| <input type="checkbox"/> Business Management | <input type="checkbox"/> Advertising |
| <input type="checkbox"/> Traffic Management | <input type="checkbox"/> Better Letters |
| <input type="checkbox"/> Business Law | <input type="checkbox"/> French <input type="checkbox"/> Spanish |
| <input type="checkbox"/> Banking and Banking Law | <input type="checkbox"/> Stenography and Typing |
| <input type="checkbox"/> Accountancy (Including C.P.A.) | <input type="checkbox"/> Business English |
| <input type="checkbox"/> Nicholson Cost Accounting | <input type="checkbox"/> Civil Service |
| <input type="checkbox"/> Bookkeeping | <input type="checkbox"/> Railway Mail Clerk |
| <input type="checkbox"/> Private Secretary | <input type="checkbox"/> Common School Subjects |
| <input type="checkbox"/> Salesmanship | <input type="checkbox"/> High School Subjects |

TECHNICAL AND INDUSTRIAL COURSES

- | | |
|---|--|
| <input type="checkbox"/> Electrical Engineering | <input type="checkbox"/> Steam Engineering |
| <input type="checkbox"/> Electric Lighting | <input type="checkbox"/> Architect |
| <input type="checkbox"/> Mechanical Engineer | <input type="checkbox"/> Architects' Blueprints |
| <input type="checkbox"/> Mechanical Draftsman | <input type="checkbox"/> Contractor and Builder |
| <input type="checkbox"/> Machine Shop Practice | <input type="checkbox"/> Architectural Draftsman |
| <input type="checkbox"/> Railroad Positions | <input type="checkbox"/> Structural Engineer |
| <input type="checkbox"/> Gas Engine Operating | <input type="checkbox"/> Chemistry <input type="checkbox"/> Pharmacy |
| <input type="checkbox"/> Civil Engineer | <input type="checkbox"/> Automobiles |
| <input type="checkbox"/> Surveying and Mapping | <input type="checkbox"/> Mathematics <input type="checkbox"/> Radio |

Name.....

Street Address.....

City..... State.....

Electricity

A Practical Training

in this great profession will make your successful future a certainty.

The School of Engineering of Milwaukee has specialized for 23 years in training young men for

ELECTRICAL ENGINEERING

With a B. S. Degree in 3 years

Junior Electrical Engineering—12 months to 30 months, depending upon previous education. Graduates are technically trained electrical experts. **Commercial Electrical Engineering**—1 year for high school graduates. **Automotive Electricity**—a 3 to 6 months' course will make you a highly paid specialist on all types of starting, lighting and ignition systems. **Armature Winding**—and **Motor Generator Repair**—thorough 3 months' course. **Practical Electricity**—6 to 12 months' course to become a Master Electrician.

We will Aid You Earn Your Way Partly through College, through our practical plan of co-operative industrial employment. Board and room at cost. Student activities, orchestra, daily broadcasting WSOE. **NEW TERM NOW ORGANIZING.** Write NOW for latest catalog and full details. Mention age, education and course of interest.



SCHOOL of ENGINEERING

of Milwaukee

P.M. 227-163 Oneida Street Milwaukee, Wisconsin

Skin Troubles

Cleared up—often in 24 hours. To prove you can be rid of Pimples, Blackheads, Acne Eruptions on the face or body, Barbers' Itch, Eczema, Enlarged Pores, Oily or Shiny Skin, simply send me your name and address today—no cost—no obligation. **CLEAR-TONE** tried and tested in over 100,000 cases—used like toilet water—is simply magical in prompt results. You can repay the favor by telling your friends; if not, the loss is mine. **WRITE TODAY.** E. S. GIVENS, 428 Chemical Bldg., Kansas City, Mo.



Don't Let Anybody

BULLY YOU

Learn Scientific Tricks of Physical Mastery

By a few simple tricks you can have any assailant at your mercy quick as a flash. The astounding secrets of self-defense, used by the New York Police, are revealed in the marvelous, officially recognized system—

Captain Wallander's Course

All Complete In

Physical Training Manual

By Capt. A. W. Wallander

Commander Physical Training, New York Police

A complete course in physical culture. Scores of gripping action photos showing just how to throw a bigger man and overpower him—disarm a hold-up thug—build up muscle—keep in fighting trim. Hundreds of health hints, too: care of the feet, prevention of colds, correct posture, walk without fatigue. This is the genuine book used by the New York Police, now available TO YOU. **Easy to Learn** Let Capt. Wallander give you his great secrets and detective tricks. You'll hardly believe that such valuable knowledge could be learned so easily.

ALL YOURS IN WORLD'S MOST AMAZING COURSE

In Physical Culture and Police circles this volume is world famous. Send immediately for your copy. **DON'T SEND MONEY NOW.** Send coupon today. When volume arrives, pay the postman \$1.97, plus few cents postage. If you are not satisfied return volume and get money back. **\$1.97**

SIEBEL PRESS, 34-D W. 20th St., New York.

Send me Capt. Wallander's Physical Mastery Course as contained in the "Physical Training Manual."

Name.....

Address.....

City..... State.....

(\$2.25 U. S. Cash with order outside the U. S. A.)

A Million Dollar Can Opening Machine

BRAND NEW INVENTION BRINGS FORTUNES TO AGENTS!

Here's Something Brand New! An Amazingly Simple Invention—Yet, Absolutely Revolutionary! For Now, At One Sweep, Millions Of Old Style Can Openers Are Doomed To The Scrap Heap! Think Of It, Men! A Tremendous New Opportunity For Quick Profits In Every Home In America! No Wonder Agents Are Making Astonishing, Almost Incredible Sums—\$75, \$100, \$150 A Week Easily Right Along. So Mail The Coupon For All The Facts And Full Details Of My Remarkable FREE TEST OFFER!

ABOUT once in a "Blue moon" some genius pops up with a new invention that everyone has been waiting for. Then, presto! Almost like magic, agents' profits go soaring overnight to tremendous heights! And now the cold, hard-boiled facts about this amazing new can opener bear convincing proof!

More Than a Can Opener

This queer new device doesn't just cut a ragged hole around the edge of the can. It lifts the entire top completely out, clean as a whistle! The machine grips the can—holds it—opens it—flips up the lid so you can grab it—and gives you back the can without a drop spilled, without any jagged edges to hack your fingers—all in a couple of seconds! You just put the can in the machine—turn the handle—and almost instantly the job is done! Built to do the job better than anything ever devised! Will last a lifetime! It's far more than just a can opener, it's a real can-opening machine!

The Secret of Big Money

Women hate the old style can opener—and with good reason, too. It's the last relic of barbarism in the modern kitchen. Yet every day millions of women have to open cans the dangerous, laborious old-fashioned way. Food is spilled and wasted. Fingers are cut and torn—often followed by infections and blood poisoning that result in expensive doctor bills. Opening cans the old way is a job nasty enough to make most any man swear—this amazing new way—it's so easy a ten year old child can do it with perfect safety! No wonder women—and men too—simply go wild over it!

A Spectacular New Sales Plan

I want you to see this surprising new invention with your own eyes. I want you to know why everyone man or woman, falls for it the instant they see it. Whether you are an experienced salesman, or never sold a penny's worth of anything in your life—I want to tell you about a remarkable new sales plan that wins you a profit on every call you make. This plan is made possible by another spectacular money maker in the Speedo line and guarantees you a steady income of up to \$150 a week!



Free Trial—Act Quickly!

If you are ambitious—if a new, but tested and proved opportunity to make \$75 to \$150 a week interests you—act at once before some other live wire beats you to this lifetime opportunity. Without obligation, learn about these amazing new patented inventions, and get my FREE TRIAL OFFER. Just mail the coupon today—NOW!

SPEEDO

PATENTED HOUSEHOLD SPECIALTIES

CENTRAL STATES MFG. CO.

4500 Mary Ave. Dept. B-700 St. Louis, Mo.

Central States Mfg. Co.,
4500 Mary Ave., Dept. B-700,
St. Louis, Mo.

Yes, rush me the facts and details of your FREE OFFER.

Name

Address

City State



AVERAGES \$16.53
A DAY!

R. A. Stewart writes, "Made 20 sales in 23 calls. Between the 13th and 28th this month I have made \$248. Speedo has them all beat for real money."

\$72 HIS FIRST WEEK

J. F. Riley says, "I made \$72 my first week only working 4 1/2 days. Since then my commissions have been bigger each week."

12 SALES IN 2 HOURS

J. C. Reister wires, "Rush 96 Speedos to me via express. Sold my trial order of 12 in 2 hours spare time."

**FIND OUT
WHY**

The **COOKE** Trained Man is the **BIG PAY** Man in **ELECTRICITY**

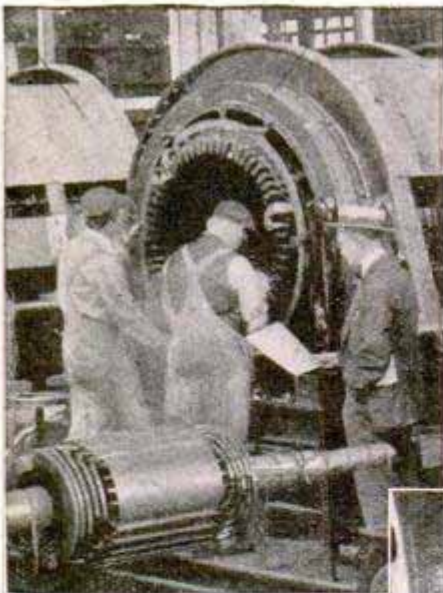

These Men are Making Big Money!

Triples Pay— Now Power Plant Superintendent

"I'll never regret the day I enrolled with you, Mr. Cooke. A year ago I was a garage mechanic at small pay. Through your wonderful training I am now Superintendent of the Canton Electric Power Plant at three times my former pay. I shall always be a booster for your Course."
W. J. Moore, Supt., Canton, Oklahoma.

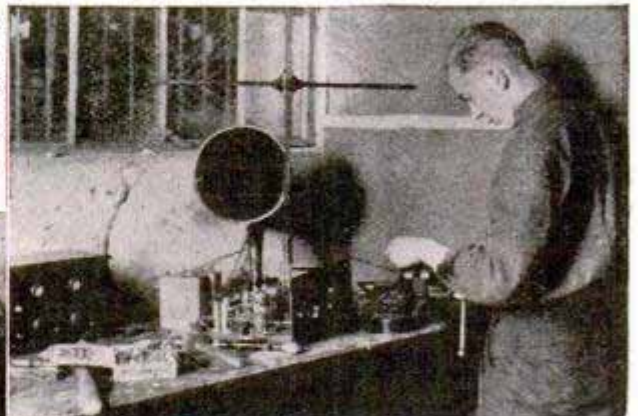

\$200 a Month for Spare Time Work

"I am now making \$200 a month doing electrical jobs in my spare time, in addition to my regular pay. Not bad for a 19 year old boy, is it, Mr. Cooke? There are fellows in this town who don't make half that much full time. You have surely put me in the Big-Pay Class."

John Hudec, 223 W. 9th Ave.
Tarentum, Pa.

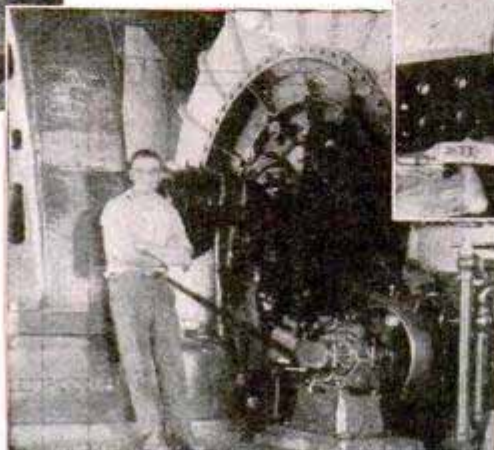

Pay Goes Up from \$3.00 a Day to \$26 a Day

"Last year I was getting only \$3 a day in the fields. Then I enrolled for Cooke Training and today I make \$26 a day and more, in my own Radio and Battery Shop. I have all the work I can handle. My success is entirely due to your Course, for I knew nothing about Electricity when I enrolled."

E. A. Lehmann, 1521 Market St.,
Oakland, Calif.

Thousands of Cooke Trained Men Earn \$3500 to \$10,000 a year

Be a "Cooke" Trained Man Yourself!

You want to make big money! You want to earn more than a mere \$20 or \$30 a week! Of course you do. Then get into Electricity, the field of big pay and bigger opportunities. I'll train you at home—in your spare time. You work just as you are working now—at your same old job. But you learn Electricity every day,

in an easy,
simple,unfor-
gettable way
—by doing.

And—

5 BIG OUTFITS to work with

NOT TOYS, BUT
REAL HONEST-TO-
PETE TOOLS &
APPARATUS.
NOT A PENNY
EXTRA FOR
ALL THESE!



1 TOOLS & EXPERIMENTAL
OUTFIT

2 BELL & ALARM
OUTFIT

3 ELECTRIC LIGHTING
OUTFIT

4 ELECTRIC
POWER
OUTFIT

5 TRANSFORMER
OUTFIT

Every "Cooke" student will tell you he doesn't see how I can possibly afford to give so many wonderful and big outfits.

You Earn as You Learn!

That's the way I teach Electricity—so that you can make extra money as you go along. That's why my Course is Practical. That's why my students are successful. That's why the "Cooke trained man is the Big-Pay Man," everywhere, and always. \$40 a week is just an ordinary salary in Electricity. \$70 to \$200 a week is what thousands of Cooke Trained Men are earning.

Money Back if Not Satisfied

That's what I'll agree to do in writing. And you're to be the judge and jury, all in one. If you're not satisfied you get your money back—every cent of it. And back of me stands the Chicago Engineering Works, a \$2,000,000 Illinois Corporation.

Nothing Like "Cooke" Training

Don't confuse other Courses with mine. Don't be satisfied with anything but "Cooke" Training, the course with 10,000 boosters. There is nothing like it anywhere. It stands by itself—alone in this field. This is the Training that Electrical men are praising—the training that big Electrical companies select for their employees—the training that has put thousands of men into big-pay jobs.

Before you select any Course, find out about "Cooke" Training with its 16 guaranteed features and its long record of proven success.

If You Are Earning Less Than \$70 a Week—Mail Coupon TODAY!

Don't wait a minute! Find out today why "The Cooke Trained Man is the Big-Pay Man" everywhere! Find out how Cooke Training will help you boost your pay! Mail the Coupon for my big book of proof, pictures and Pay-Raising FACTS. Do it NOW!

L. L. COOKE, CHIEF ENGINEER

L. L. Cooke School of Electricity

Owned and Operated by

Chicago Engineering Works, Inc.

Dept. 12 2150 Lawrence Ave., Chicago, Ill.

FREE BOOK COUPON

L. L. Cooke, Chief Engineer,
Dept. 12
2150 Lawrence Avenue
Chicago, Illinois

Mr. Cooke:

I want to know why the "Cooke" trained man is the "Big Pay" man in Electricity. Send me your big FREE Book with other information. This does not obligate me in any way.

Name.....

Address.....

City..... State.....



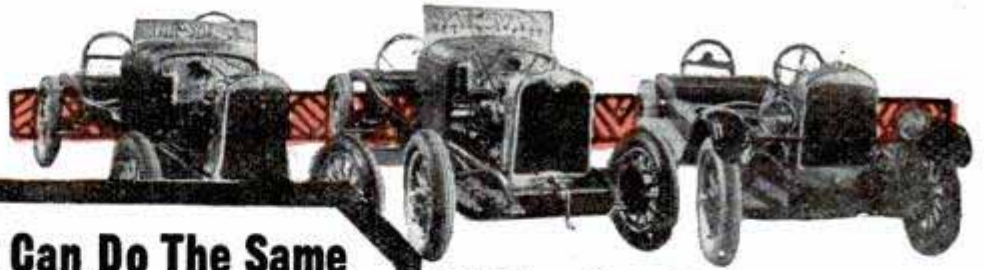

**You Can Do The Same
With M. S. A. S. Training**

I just went thru several hundred letters recently received from M. S. A. S. graduates. Every one is a message of success. One man now has the largest Motor Truck Agency in Central Louisiana. Another says his pay has increased \$75 a month. Another states the Foreman of his Garage has advanced him over men years his senior. The letter reproduced below is a typical example of M. S. A. S. Success Training. **Every one of these men started by doing the same thing you're doing this very minute!** Fill out, tear out and mail the Coupon right now and I'll send you the greatest Success Opportunity Plan of the present age! **Don't delay—do it now.**

R. S. Jeller
Pres.

I'll Give You These Detroit-Made Cars, Latest Models, To Work On

Oldsmobile, Oakland, Jewett, Essex, Hudson, Reo, Packard, Buick, etc.—just some of the new Chassis recently received for you to practice on. All latest model cars. Our location in Detroit, the Automobile center of the world, and our contact with automobile manufacturers, brings us close co-operation and endorsement. This means much to you. Always the latest and most up-to-date equipment and continually being improved.

OLSON GARAGE

General Auto Repairing
OILS - ACCESSORIES - SUPPLIES
MEADOWLANDS, MINN.
June 23, 1926

Michigan State Auto School,
3729 Woodward Avenue,
Detroit, Mich.

Dear Sirs:-

Have been making good money since I left your school and am in business for myself. All the tools I had at the time I left was the tool kit which I purchased at school. Now I have a garage, a good supply of tools and repair equipment; also carry a supply of Ford and Chevrolet repair parts, tires and accessories. Have the agency for the Chevrolet car.

For the last three years I have been kept busy all the time, both winter and summer, when otherwise work used to be rather slack in winter on account of the heavy snow.

I am glad to see that the school is just as much if not more interested in us graduates after we leave school as at the time we attend it. Wishing the school the best of success, I remain,

Harold Olson

MICHIGAN

STATE



Win Quick Success in this Fascinating Business ~

LEARN AUTOS WHERE 19,784 ARE MADE EVERY DAY!

Are you mechanically inclined? If so, then read every word of my message. Right this minute I am placing an opportunity before you to win rapid promotion and a future success which you can make just as big as you want to. 100,000 more trained auto men are needed at once. It's a wonderfully

big paying field. It's the biggest business in the world! It is growing so fast that at present there are 269 cars to every repair shop. It is your marvelous opportunity. Come to Detroit now and learn this business right. Within a short time I will send you out on the road to big money.

DETROIT TRAINED MEN GET THE GOOD PAYING JOBS

Three-quarters of all the cars are made right here. Wherever autos are used—Detroit trained men get the good jobs, highest pay. Study autos where they are made. Learn at the famous Michigan State Automobile School—unanimously endorsed by the auto industry. This school knows how to train you right, and that is what you want and need to make the most money in this fascinating business. Come at once. If necessary, we'll assist you in securing part-time work to earn money each week. Students who enroll in our evening courses are assisted to full-time day jobs. (Ask for details, and when writing please explain your circumstances fully.) We help place many of our graduates directly. This employment service is absolutely free.

**NEW AUTO BOOK
FREE**

Work With Detroit Standard Auto Shop Tools— and Learn to Use Them Right! You learn, with tools, from real practice, how cars are made and how to repair them. You have head training as well as hand training. The man whose hands only are trained fails when he hits the hard jobs. There are no hard jobs for Michigan State trained men, for they have the knowledge in their heads to guide the skill in their hands.

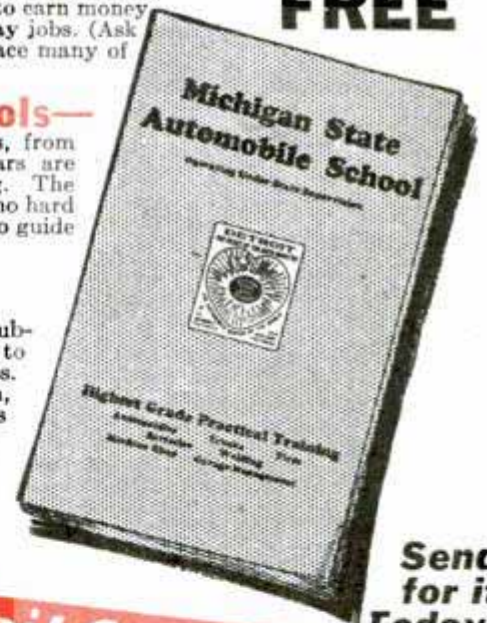

Send for it Today!

The Auto Business Needs You NOW

Auto Electricians, Garage Foremen, Service Managers, Repair Shop Owners, Sub-Dealers in autos, General Distributors—all these big paying positions are calling to you. What a chance for the trained man! Car owners search for reliable repair shops. Garage owners advertise for competent mechanics. They don't want green men, but the skilled auto man always has a job. There is a dire need for good garages and battery shops, tire shops, welding shops and electric service stations. Open a shop any place, right at home where your friends are or in some other town or at country cross roads. There is a fortune in this business for you.

FREE Business Course

The former Service Manager of the Packard Motor Car Company trains our students in the business end of running a garage. This business training is worth over a hundred dollars alone, but it costs you nothing extra, another one of the big advantages of Michigan State training. All students get this business course without extra charge.

Send the Coupon NOW

Get all the interesting facts. Mail the coupon at once for big FREE Catalog and for full information concerning your future. It's illustrated with photos of school equipment, factory production and other interesting matter. It contains hundreds of letters from our successful graduates. It tells you how you, too, can get a good paying job—how you can go into business for yourself with little capital. Mail the coupon or send us a postal card today. Write now. (We do not enroll colored students, except for our Home Study Course.)

Michigan State Automobile School
302 Auto Building, 3729 Woodward Ave.
Detroit, Michigan

Home Study Course

For those who cannot come to Detroit now for their training, we have a special Home Study Course. This course covers the same subjects in detail as our regular course. The knowledge you gain in the first week or two in the Home Study Course should enable you to get a job in a garage right away.

52 Starts You

New Plan Starts you on the first two lessons of your Home Study training for \$2.00. Act at once. Sign coupon and mail TODAY.

Mail Coupon To Day

Michigan State Automobile School
302 Auto Building, Detroit, Michigan

Send me free and without obligation full information about Detroit training to make the most money. Also send me FREE your big new illustrated Catalog and Automobile Training Book.

Name.....

Street Number or R. F. D.....

City..... State.....

I am interested in
 12 weeks' Auto Course
 30 weeks' Master Course.
 Home Study Course.

AUTOMOBILE SCHOOL

Easy For YOU To Have a Profitable Business



Learn to Make Clever Show Cards

MANY EARN \$25 a week in spare time, \$50 to \$75 a week for full time. Steady profits right from the start. Pleasurable work—own your own business.

Now you, too, can build a prosperous, well-paying business! No capital or previous training needed. Wonderfully thorough professional method correctly trains you in clever show card making—right! at home—and quickly prepares you for an uncrowded, fascinating field of really surprising money-making possibilities.

Now is the time to start! Retailers, wholesalers and merchants all around you constantly need distinctive display material. Never before were opportunities as varied, profits as inviting as *right now*. And this practical course is so simple—instruction is so expert—progress is so amazingly rapid—you are creating original, salable show cards almost from the very beginning—and cashing in on the ever-ready demand for your services!

Act NOW! Stores in your own locality form an eager market for sales-boosting show cards. Students even earn while they study—*so can you!*

Coupon Brings Free Book

Send at once for FREE illustrated, descriptive booklet outlining this whole attractive business, telling exactly how to start and conduct your business and giving full details of our practical home study course. Don't delay. Be independent. Earn a good income. Own your own business. Mail coupon NOW!

WASHINGTON SHOW CARD SCHOOL

Room 302-E, 1117-15th St., N. W., Washington, D. C.

Washington Show Card School, Room 302-E,
1117-15th St., N. W., Washington, D. C.

Please send me FREE and without obligation, a copy of your new book, "Quick Success in Show Card Making."

Name.....
(State whether Mr., Miss, or Mrs.)

Address.....

City..... State.....

Something for Nothing THIS MAGAZINE IS FREE

The Milo Publishing Company is giving you a copy of "STRENGTH" FREE. In order to get this free copy, there is nothing you have to pay—nothing to buy—nothing to do except fill in the coupon below and send it in to us. This big, interesting magazine will then be mailed to you free of charge and postage cost. We are not even going to ask you to look it over or read it, for we know that when you get it in your hands you will be interested and eager to see its contents.

"STRENGTH" Is Wonderfully Illustrated

There are pictures of beautifully formed women muscular men, athletes, strong men, and those who have found health and happiness in its pages.

"STRENGTH'S" Reading Matter Is Interesting, Healthful and Written by Experts.

There are articles on the cause and cure of all diseases and ailments. These articles will make your life happier and healthier. There are articles for women as well as men—articles for amateur athletes, future strong men, acrobats, and physical perfection seekers.



One of the many illustrations

Get Your FREE Copy Now

You will spend many an enjoyable and profitable hour with it. You'll be benefited in a great number of ways, and be thankful that we acquainted you with this great magazine. Don't turn this page without first clipping the coupon and mailing it to us. Then within a few days your "STRENGTH" Magazine will be delivered to your door, and you will be extremely glad to receive it.

SEND NO MONEY and Don't hesitate to send the coupon, for there is positively no catch in it.

SEND IN THIS COUPON NOW



THE MILO PUBLISHING CO., P.M. 2-27
2747 N. Palethorp St., Philadelphia, Pa.

Gentlemen: Please send me immediately, and without any obligation on my part, a FREE COPY of your great magazine "STRENGTH."

Name.....

Address.....

City..... State.....

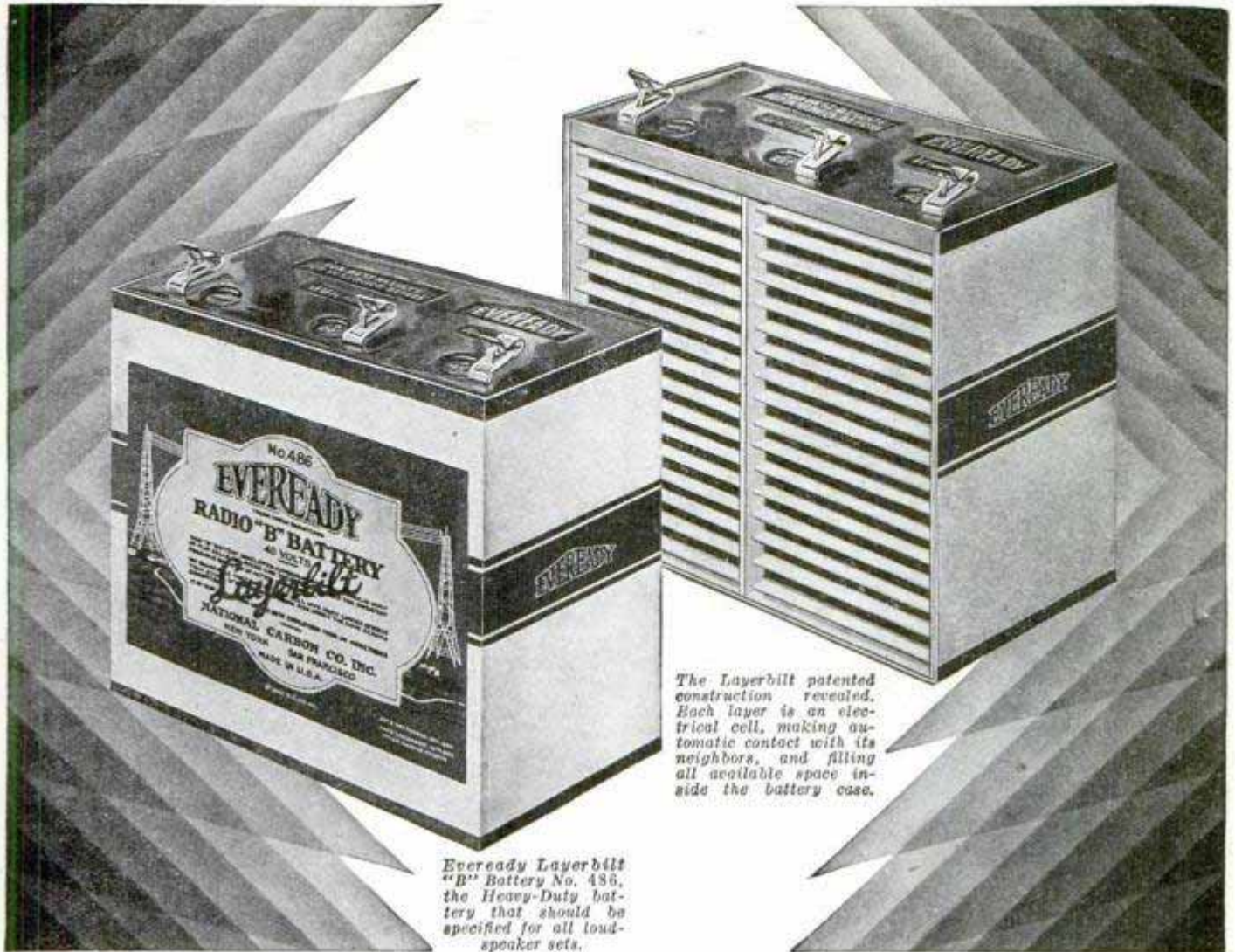

Eveready Layerbilt "B" Battery No. 486, the Heavy-Duty battery that should be specified for all loud-speaker sets.

This is the Heavy-Duty Battery in which the new Layerbilt construction provides greater economy

THERE'S an important discovery in radio economy awaiting all users of loud-speaker sets who have been buying the smaller Light-Duty "B" batteries instead of the large Heavy-Duty size required by such sets. Because the Light-Duties cost somewhat less to buy they seem like an economy, but the surprising fact is that the Eveready Layerbilt No. 486 lasts more than twice as long though it does not cost anywhere near twice as much. It is, therefore, much more economical—we believe it to be the most economical "B" battery ever built.

Eveready Layerbilt's remarkable life is due to its unique construction. All other dry cell "B" batteries are assembled of cylindrical cells, with much waste space between them, and many soldered connections bridging the gaps.

The Eveready Layerbilt, however, is built in layers of flat current-producing elements, making automatic connection with each other. Every available inch inside the battery is occupied usefully. You get more battery for your money, and that battery is more efficient.

Remember this about "B" batteries: All loud-speaker sets require Heavy-Duty batteries, and the Eveready Layerbilt has proved time and again to be the longest lasting and most economical Heavy-Duty "B" battery.

Manufactured and guaranteed by
NATIONAL CARBON CO., Inc.
 New York San Francisco
 Canadian National Carbon Co., Limited
 Toronto, Ontario

Tuesday night is Eveready Hour Night—9 P. M., Eastern Standard Time, through the following stations:

WEAF—New York	WTAM—Cleveland
WJAR—Providence	WWJ—Detroit
WEEI—Boston	WGN—Chicago
WTAG—Worcester	WOC—Davenport
WFI—Philadelphia	WCCO { Minneapolis
WGR—Buffalo	{ St. Paul
WCAE—Pittsburgh	ESD—St. Louis
WSAI—Cincinnati	WRC—Washington

758.

Marine Salvage Co.
Portland, Oregon.

DIVING BALL'S ELECTRIC HANDS TO GRIP WRECKS

Cmt. Carlton Street, 406 Laughlin St.
The Halls, Ore

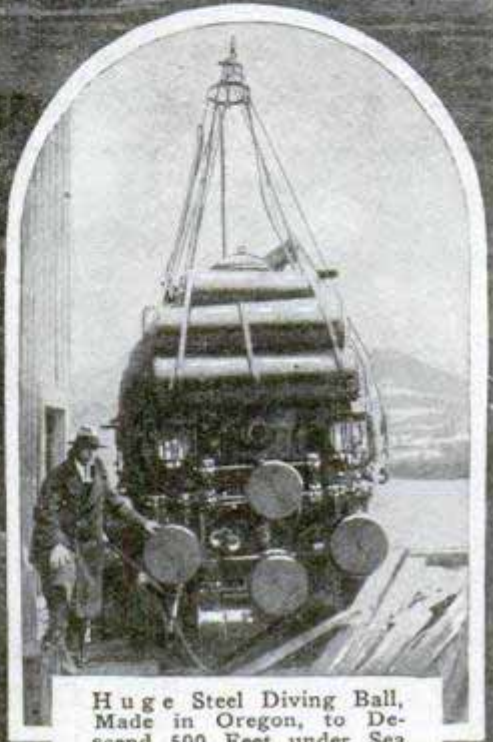
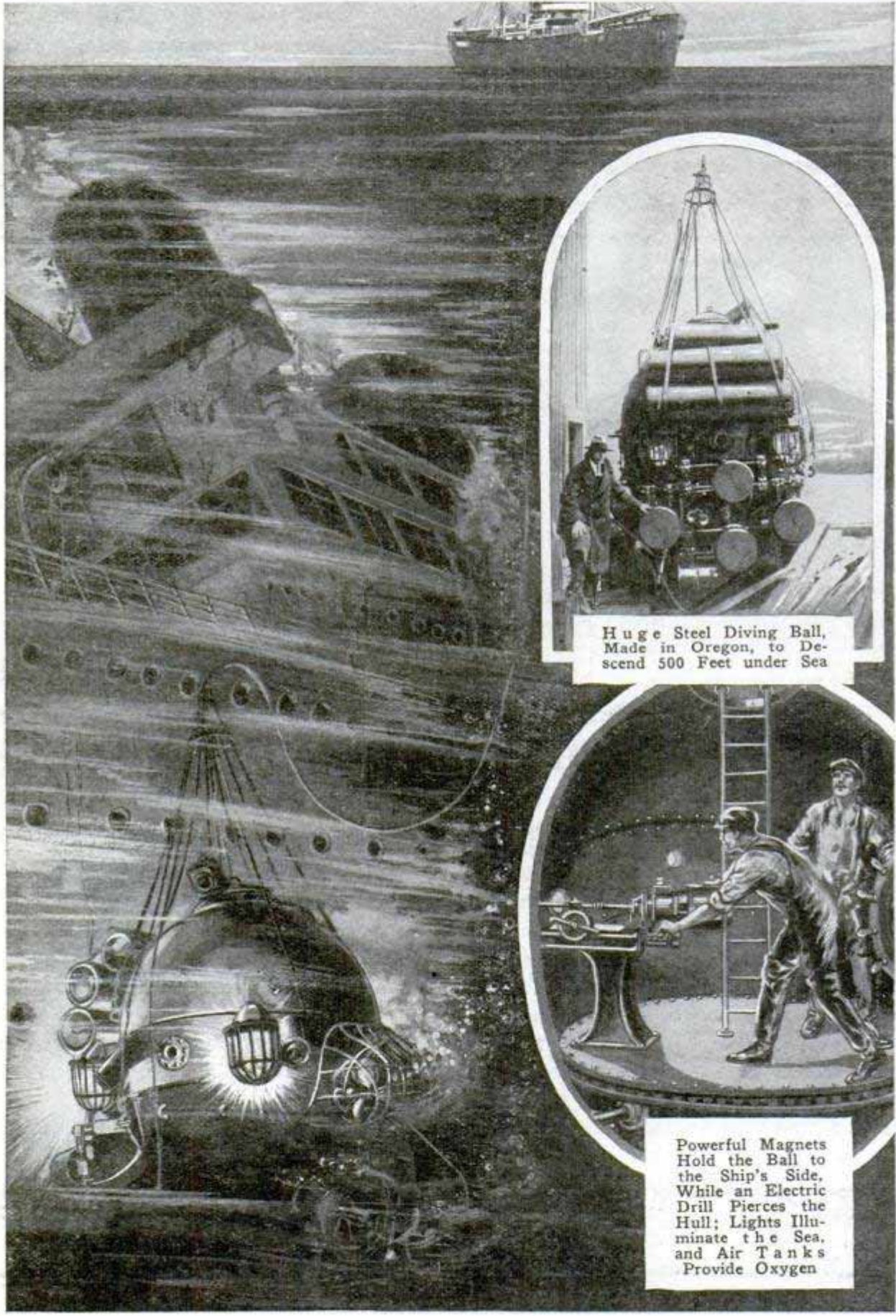

Huge Steel Diving Ball, Made in Oregon, to Descend 500 Feet under Sea

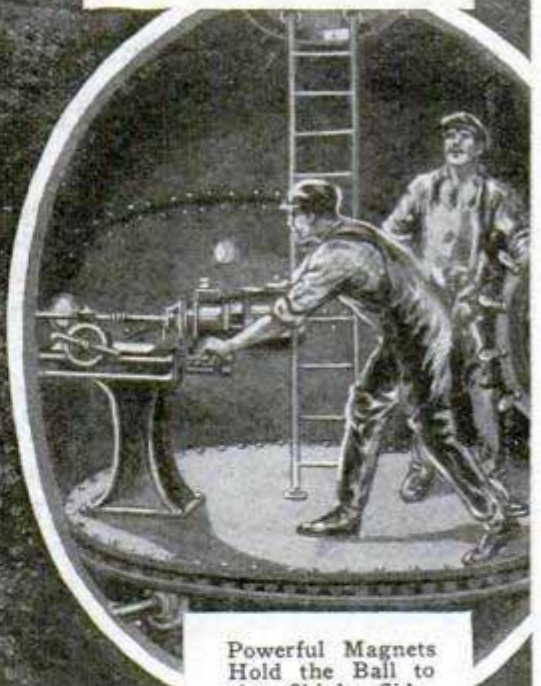

Powerful Magnets Hold the Ball to the Ship's Side, While an Electric Drill Pierces the Hull; Lights Illuminate the Sea, and Air Tanks Provide Oxygen

Popular Mechanics Magazine

REGISTERED IN U. S. PATENT OFFICE

WRITTEN SO YOU CAN UNDERSTAND IT

Vol. 47

FEBRUARY, 1927

No. 2

To Explore Sea Bottom a Mile under Water

Naturalist Plans to Break All Diving-Bell Records in Search of New Life amid Tropical Coral Far Beneath the Waves

PLANS to explore the bottom of the sea a mile beneath the surface have been completed by Dr. William Beebe, director of tropical research of the New York Zoological society, who a year ago explored the mythical mysteries of the Sargasso sea. He is planning a special steel cylinder with a small glass window, both capable of withstanding the enormous pressure at a depth of 5,000 feet. Oxygen apparatus, carried inside the cylinder, will eliminate the air line used by divers, and reduce the connection with the surface ship to a single steel cable, which also will carry a telephone line.

"No human being has ever visited the deepest part of the ocean," Dr. Beebe says. "It is perfectly simple, however. You have a tight cylinder, with a screwed-on top which cannot possibly work loose with a pressure of a ton to the square inch at 5,000 feet below the surface. You make your own oxygen inside the cylinder as you need it. Physicists assure me the thing is entirely practical. The only reason no one has ever attempted a descent to these depths before, is that there is no financial advantage to be gained from such a trip."

"What do you expect to find?" he was asked.

"If I knew, I wouldn't go down," the naturalist retorted. "It will be perfectly brilliant down there under the sea, for most of the deep-sea fishes carry their own lighting plants. Usually they die when brought to the surface, but I managed to keep one alive for a few moments on the Sargasso expedition, and when it was carried to the dark room, it became suffused with a most exquisite pale-green light."

Dr. Beebe has used ordinary diving equipment on several of his expeditions and become an experienced diver. He sailed shortly before Christmas to spend four months in the coast waters of Hayti, and took with him a hand motion-picture camera, completely inclosed in a water-

tight steel case, to take movies of the fish among the brilliant coral reefs of the tropics. He also took a stenographer along so that he could dictate, from the bottom, by means of his divers' telephone, an exact description of everything he saw.

"When I have been down heretofore I had to come up every ten minutes or so and dictate my observations," Dr. Beebe said, "and even then

Marie Poland Fish, the Young Biologist Who Hatched the Eel's Eggs Discovered by William Beebe's 1925 Expedition, Thereby Solving a 2,000-Year-Old Mystery

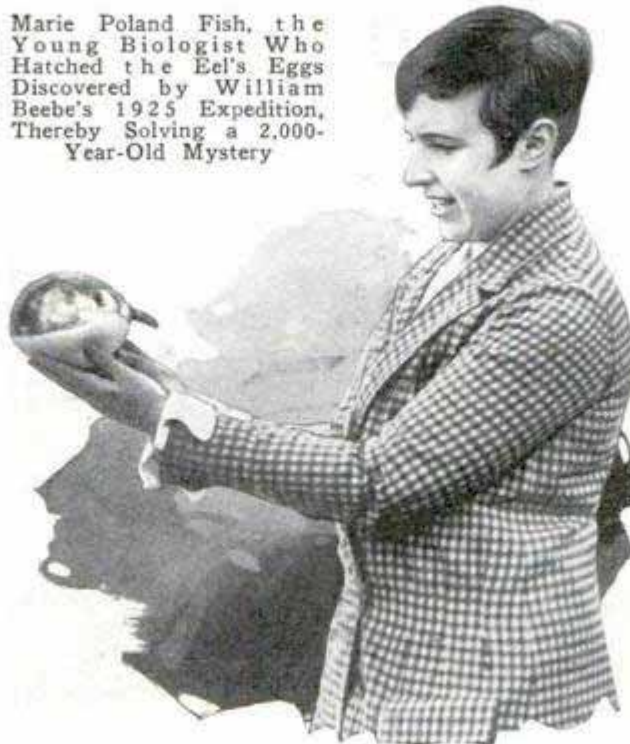

the written record was limited to what I could remember and describe. It was like describing the circus after you reached home. With the telephone at hand I can describe everything just as it happens."

A three-masted schooner, with several tents on deck to supplement its living quarters, provided a home for this winter's expedition. Next year, however, when he plans to make the attempt to explore mile-deep water, the "Arcturus," the steamer used in the Sargasso expedition, will be outfitted again. Starting from New York, he plans to make his first descent off the New Jersey coast, going down over the edge of a deep-sea cliff known as the "Continental Shelf."

The importance of the work done by Dr. Beebe's expeditions was emphasized recently when it was announced that microscopic eggs, brought up by a deep-sea dredge from the edge of Challenger Bank, a shoal ten miles southwest of Bermuda, had been hatched out and proved to be eels. The discovery, made by Mrs. Ma-

rie Poland Fish, biologist of the United States bureau of fisheries, solved a mystery that has perplexed men since long before the Christian era. The ancient Greeks, unable to find any trace of the origin of eels, attributed their paternity to Jupiter.

Many years ago, however, scientists discovered that the common eels of both America and Europe journeyed to the deep and warm waters around the West Indies to spawn; that the old eels died there and never came back, but that eventually the young ones went unerringly back to the streams from which their parents had come. Tiny larvæ, barely one-fifth of an inch long, were brought up from depths of 600 to 1,000 feet, but until the discovery by Mrs. Fish no one had ever seen an eel's egg. To reach the spawning ground, the eels of Europe make journeys

of 2,000 miles or more. The young eels take three years to return from the sea, spend five or six years growing to full length in fresh-water streams and then go back to sea.



Venus Flower Basket, a Flinty Deep-Sea Sponge Found near the Philippines

Pictures from "The New Natural History," by Prof. J. Arthur Thompson. Courtesy G. P. Putnam's Sons
Sea Horses, So-Called from Their Peculiar Heads, at Left; They Use the Tail to Anchor Themselves to Sea-weed; at Right, a Giant Lizard Caught by Professor Beebe on Galapagos Island

GAS MOTOR REPLACES DOG TEAMS ON MINING SLED *Canada*

For Winter Travel over Northern Snows; the Motor Sled with Its Caterpillar Drive and Big Front Steering Wheel; Sheltered Cabin in Rear Supports Searchlight

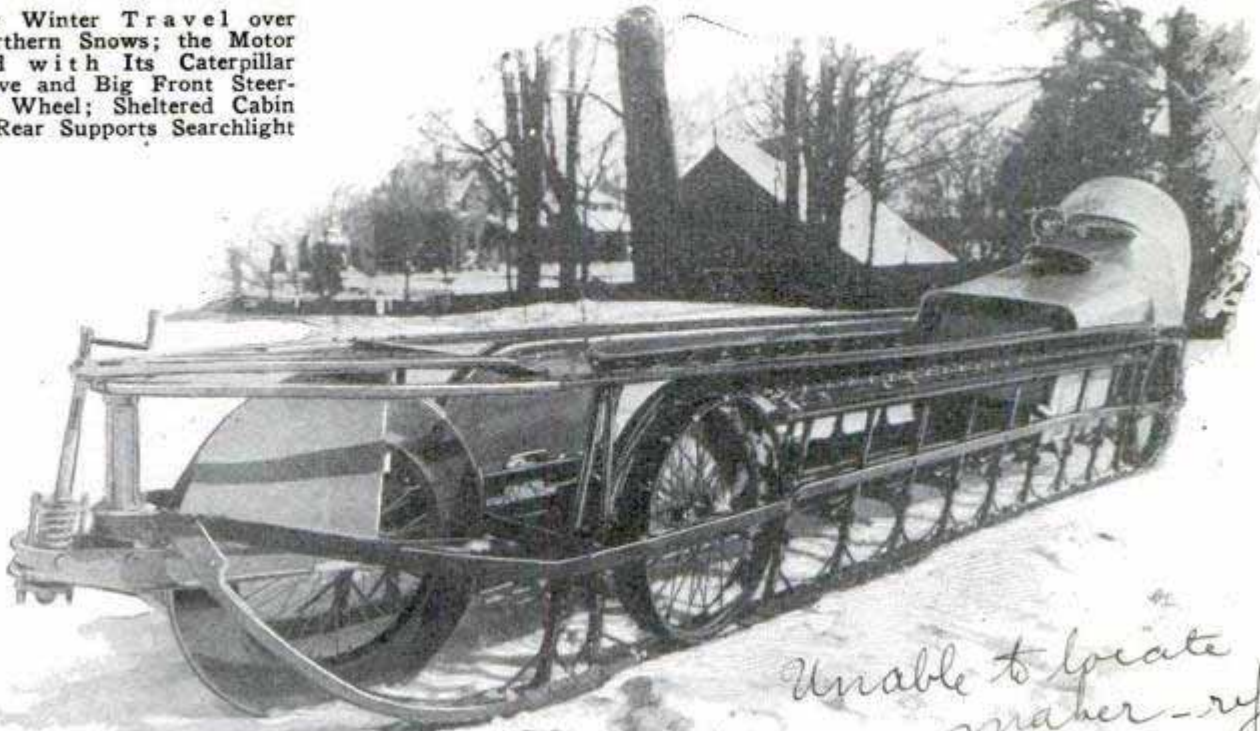

Unable to locate maker - refer to Wide World.

Motor sleds propelled somewhat like a caterpillar tractor have been adopted in the mining fields of northern Ontario and Quebec for travel and hauling goods between the small towns. They are steered by a single front wheel and can pass over drifts, as the chains that push it along keep the sled from sinking. A searchlight is attached to the front of the operator's cab at the rear for night travel.

er. On the same ship were four pheasants in a cardboard box between the vessel's side and a berth. The Oriental merchants often will pay \$10 a pair for them. The trappers were fast depleting the stocks of birds when the government intervened.

SMUGGLING BIRDS TO ORIENT
LATEST TRICK OF THE SEA

Following an embargo on shipments of song birds from Australia, a ring of smugglers has been active capturing the songsters and hiding them aboard ship in efforts to evade the custom officers. Not long ago, a number of love birds were found hidden under the stokehold plates in one steam-

RODEO SPORT IS IMITATED
BY WALL EXERCISER 1015

Attached to the wall of the gymnasium or private room, a muscle developer is based on the principle of the bull-dogging contests at the rodeo. It has two handles which represent the animal's horns.

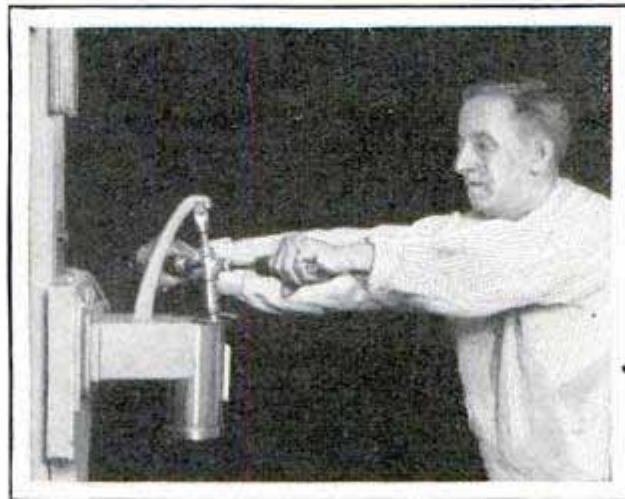

Carrying the Rodeo to the Gymnasium; Trying to Throw the "Bull" by Forcing Plate into Socket

The user grips these and endeavors to force a movable plate into a socket. This plate is pivoted against a strong spring at the bottom and the tension may be increased or diminished by turning a collar at the base, to represent the strength of a bull.

Kansas City Star

11/23/26

Chas M. Postly

3/12

11/23/26

"SKIP" WAVES GIVE RADIO DIRECTION AND SECRECY

power the wave needs to batter its way through the ether and atmosphere in the daytime or the summer is much greater than the power required for similar transmission at night or in the winter. The

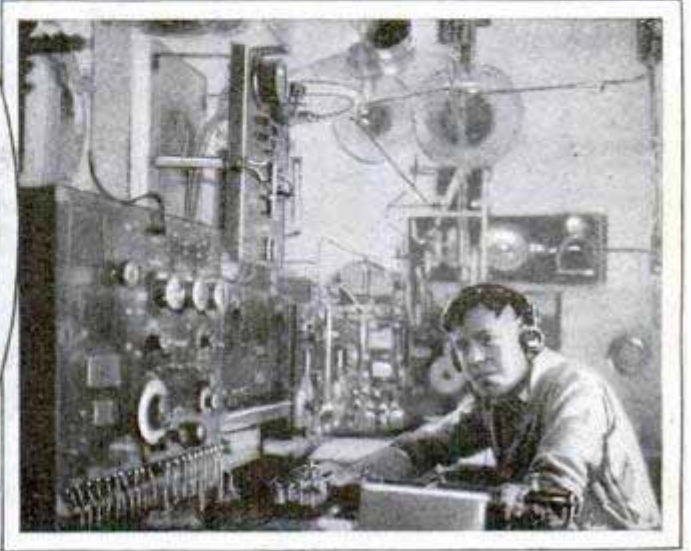

Short - Wave Radio Apparatus on Airplane, a Receiving Station, and Drawing Comparing "Skip" Radio to Skipping Stone

10/3
Radio Officer at North Island, Calif.

The discovery of a radio wave, directional and possessing qualities which open a new field for development, has been announced by Maj. Francis E. Pierce, of the marine aviation expeditionary force. This wave "jumps" over any intermediate receiving station as desired by the operator, so that it is absolutely unaware that radio transmission is in progress. In a test between vessels of the United States fleet, one ship sent radio signals to another while a vessel which steamed between the two was unable to pick up the vestige of it. The exact distance of "skip" can be computed, so that naval vessels can make radio signals jump over enemy ships.

The length of the jump varies with the day and night and the seasons, because the

discoveries of Maj. Pierce are the result of a lifetime of research. Under his direction signals have been sent on forty-three meters from the west coast, from an aircraft, to Washington. To further bring the use of short waves to practical utility, the navy dispatched short-wave apparatus with the Lieut. Ben Wyatt mapping expedition to Alaska last summer, and his planes constantly communicated from Alaska with the fleet in southern California waters. Maj. Pierce is now pursuing experiments aimed to harness what is known as freak radio transmission. He believes that the long distances often attained by comparatively low-powered sets can be reduced from a freak to a common performance.

Chicago Daily News 11/10/26

SPEED OF BIRDS

Tests of bird speed in calm air, made by a German investigator, show that the flyers have a wide range of rapidity and few equal the rate of a moderately fast train. Of those observed, the starling had the greatest speed, slightly more than forty-six miles an hour. Jackdaws made 38.22 miles an hour, the parrot finch, thirty-seven miles, rooks 32.58 miles and hooded crows and gray gulls, 31.05 miles. The sparrow hawk had the slowest speed of all the birds whose flights were measured, making but 25.70 miles an hour.



Teeing Off for the Slanting Target; the Ball Is to Be Sent through One of the Holes, Affording Excellent Putting Practice

Aug. 26

GOLF GAMES PLAYED INDOORS IMPROVE PUTTING SKILL

Two interesting golf games can be played on an indoor outfit that gives helpful practice in putting and develops other fine points of the outdoor game. Regular balls and clubs are used, and there is no limit to the number of players. A tee is set up, ten feet or more from a slanting target containing five holes of different sizes. In one game, the score is determined by the number of points won for putting the ball through the holes, the smaller holes counting more points than the larger. In the other game, the score is kept as in an outdoor game, by counting the strokes required for holing out.

LIFE BAG AND STRETCHER AIDS IN FIRE RESCUES

To prevent injury to persons being taken from burning buildings, a combination bag and stretcher has straps to hold the victim securely while being lowered. The bands are fastened under the armpits and around the legs, whereupon the occupant is folded in the bag to give him further protection.

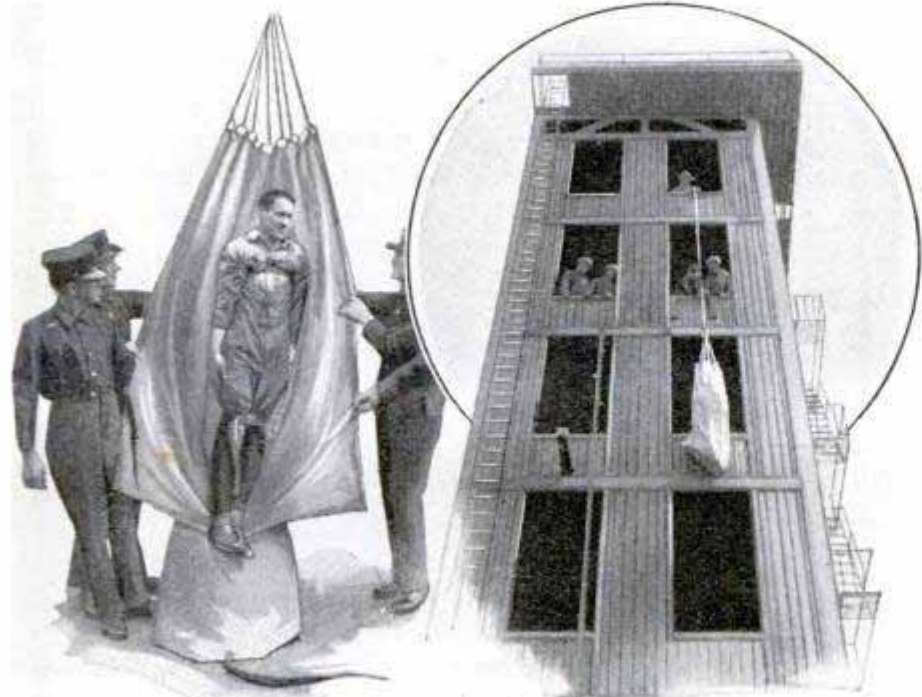

Demonstrating the Life Bag; "Victim" Securely Strapped inside the Covering, and Lowering Him from Tower

E. J. Breckman Corp. 20 N. Michigan Ave. Chicago

1027
Largely due to activities in the radio field, an epidemic of invention appears to be sweeping the country, according to Thomas F. Robertson, commissioner of patents, his report showing that more than 110,000 applications for patents and trade-marks were submitted in the year ended June 30, 1926.

Dr. W. H. Blake
Fire Rescue Squad No. 1

916



Off to a Spirited Dash for the Finish; the Tub Racers Warming into Their Rowing While Their "Mounts" Apparently Share the Excitement of the Event and Stretch toward the Tape

**WATER JOCKEYS RIDE IN TUBS
IN NOVEL OAR RACE**

Thrills of the turf were humorously reproduced on the water at a Berlin carnival when oarsmen, dressed as jockeys, climbed into tubs bearing figures of horses' heads and brushes for tails. The race itself was a contest in paddling for the round tubs tended to spin about. The straining necks of the "horses" gave the effect of speed in spite of the actually slow rate of progress.

**HOUSE LASTS HUNDRED YEARS
AVERAGE FIGURES SHOW**

According to a survey by engineers of the lumber manufacturers' association, the average life of a house is about 100 years. It was found that individual dwellings may last much longer but, on the average, structural depreciation sufficient to make the house unfit for further use occurs after a century. It also was discovered, according to one of the engineers, that frame dwellings depreciate in value only a little more than those of brick or

masonry. It was pointed out that one of the commonest reasons for abandoning houses is that the neighborhood about them becomes undesirable for residence purposes, and the inmates move away although the dwellings may still be good.

**COMB TEETH ON LAWN MOWER
HELPS REMOVE WEEDS**

Attached behind the cutting blades of the lawn mower, a comb arrangement is designed to remove weeds and other coarse growths from the grass. The teeth

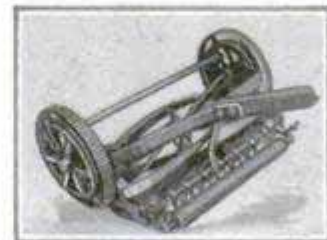

point backward and, on a reverse pull of the mower, cut or drag out the big weeds or raise them so that the mower knives may cut them.

The comb is adjusted to the proper angle by means of thumbscrews, is easily regulated for rough ground, and the teeth are self-cleaning. Single ones may be removed and they may be sharpened as one blade or separately.

national transportation
Olds
Washington, D.C.

Chicago Tribune 4/28/26

Dr. W. John Robertson
55 Eureka St
San Francisco Calif

1/17/26

SOLDIERS TEST MAIL TUNNEL FOR AIR-RAID SHELTER 950

Sixty guardsmen offered to run the risk of possible suffocation recently in testing a post-office tunnel in London to determine if it could safely be used as a refuge in time of air raids. The men remained in the passage several hours and when it was noticed that they were becoming faint, as a result of the impure air, fresh supplies were pumped in to revive them. The experiments were conducted by government experts and their details were shrouded in secrecy.

BUMPER HAS NET OF CHAINS TO PREVENT INJURIES 1002

Controlled by the emergency brake, a three-in-one bumper devised by a western inventor is intended to prevent serious injury to a person struck by the car. When not in use, it resembles an ordinary three-plated guard. When the hand brake is thrown in, one member of the bumper falls to within an inch of the ground and another rises above the center piece. A net of chains, hidden in a narrow trough back of the guards when the bumper is not in operation, connects the three parts, making a web to shield the person struck. At the base of the lower bumper is a heavy strip of rubber to prevent hands or clothing from being torn or the victim being dragged under the wheels. The action is achieved by a cable connected to the brake. This may be unhooked when the brake is used in parking and at other times when it might be in the way.

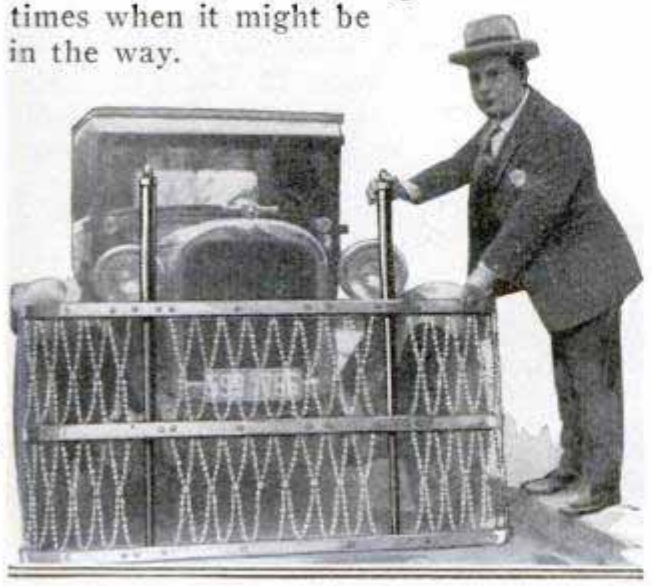

Bumper Extended, Showing the Elevated Section and the Net of Chains between the Guards

Dr. Giuseppe Isaglis



Using Light on Spectacle Frame to Inspect Teeth; Drawing Illustrates Position of the Lens

LIGHT ON SPECTACLE FRAME SAVES DOCTORS' EYES

Attached to a spectacle frame where it can direct the rays from between the eyes, a powerful little searchlight is an aid to physicians and dentists in making examinations, as it relieves eye strain and projects an effective illumination on the area under scrutiny. Current is supplied from a dry battery and the spectacles may be had without lenses or worn over the regular glasses. A feature of the light is that it can be turned off simply by tipping it back. The current goes on when the lamp is brought back to normal position.

FIFTY SEVEN HUNDRED PLANTS GROWN IN MEXICO 1019

Some 5,700 known kinds of plants and trees that grow in Mexico have been listed by Paul C. Standley of the Smithsonian Institution after several years of research. Among these are woods from which fine cabinets are made, rubber and drug producers, the cocoa tree, oil-yielding palms and many fruits. A description of the plants includes their local names and their most important uses.

Empress Oscillator Corp. 14 3rd St. New York 1775

945

\$6 - \$10.00

The Chromium Co. of America
26 Broadway, New York

Wonder Metal and

What It Is

- ¶ A metal the color of platinum.
- ¶ Harder than the hardest tool steel.
- ¶ Can be plated on iron, steel, copper, brass, etc.
- ¶ Impervious to salt spray and all but two acids.
- ¶ Practically unscratchable; so hard it cuts glass.
- ¶ Melting at 3,000 degrees, it resists high temperatures.

AUTOMOBILE radiators and lamps that will neither tarnish, rust nor corrode are being plated in a Detroit automobile factory. In New York, ships' brass work is receiving the same plating to render it impervious to salt spray. In Chicago, exactly the same treatment is being given some 1,500 different articles to render them acid and tarnish-proof, to make them resist heat and terrific wear, and to protect cutting edges by making them harder than the hardest tool steel.

The material of this novel electroplating process is chromium—by no means a new metal, but one which up to three years ago had resisted all efforts to utilize it in practical plating processes. Within the past few years, however, a half dozen investigators, working independently, have perfected chromium-plating processes and brought one of the wonder metals of the world into everyday use.

Chromium belongs to the same general family from which comes the tungsten for electric-light globes; and it is the presence of its salts that gives

the emerald its beautiful color. As a plating material it can be produced with a brighter gloss than nickel, something of the blue-white color of platinum and a wearing ability that the finest steel cannot equal and only the diamond surpass. For years it has gone into chrome steel for armor plate, and when the late Elwood Haynes, the famous automobile inventor, produced steelite, a tool steel harder than any made up to that time, he used chromium and cobalt in his alloy.

The bureau of standards, assigning the diamond an arbitrary hardness value of ten, rates chromium at nine and steelite, its nearest competitor, at eight. Like the diamond, anything coated with chromium will scratch glass and also the hardest steel plate.

Automobile valves plated with it can not be pitted by carbon and, at the end of 10,000 miles, show no visible sign of wear. One manufacturer is preparing to bring out a car in which the cylinder walls, pistons, valves and valve seats, crankshaft and wristpins—in fact, all the bearing surfaces—are plated with chromium. Machinery shafts and bearings plated with it have been in use for two or three years in several plants, and because of its great hardness show no wear.

Greaseless Frying Pans, Non-Stick Pie Tins and Samples of Untarnishable Table and Kitchen Ware. All Plated with Chromium



Capeland branch
 General Motors
 Vacuum Car Co.
 25 S. Haynes, Chicago
 (See process.)

Processed by
 Metals Protection Co. Bld

What It Means to You

Files that have been plated with a coat so thin as not to interfere with the cutting edges have lasted three times as long as the best unplated steel files. Drills and other cutting tools show correspondingly increased life.

Plate a frying pan or pie tin with it, and you require no grease or lard, for the food will not stick. Coat the bottom of an electric iron and starch will not adhere, with the result that faster and better ironing can be done.

Those things have been done in the laboratory, though such plated products are not yet in general use. The reason is that chromium costs more than nickel, and in many lines manufacturers are moving cautiously toward adopting it. It costs about twenty-five cents to plate an average-size file in the plant of the Vacuum Can company, Chicago, where thousands of files and drills have been plated. They wear three times as long as an unplated file, so the cost of the steel file and the purpose for which it is to be used are the determining factors. It would cost as much to put a very thin coat on a five-cent tin pie pan or a ten-cent frying pan. As yet there is no demand for plated cooking utensils at those prices.

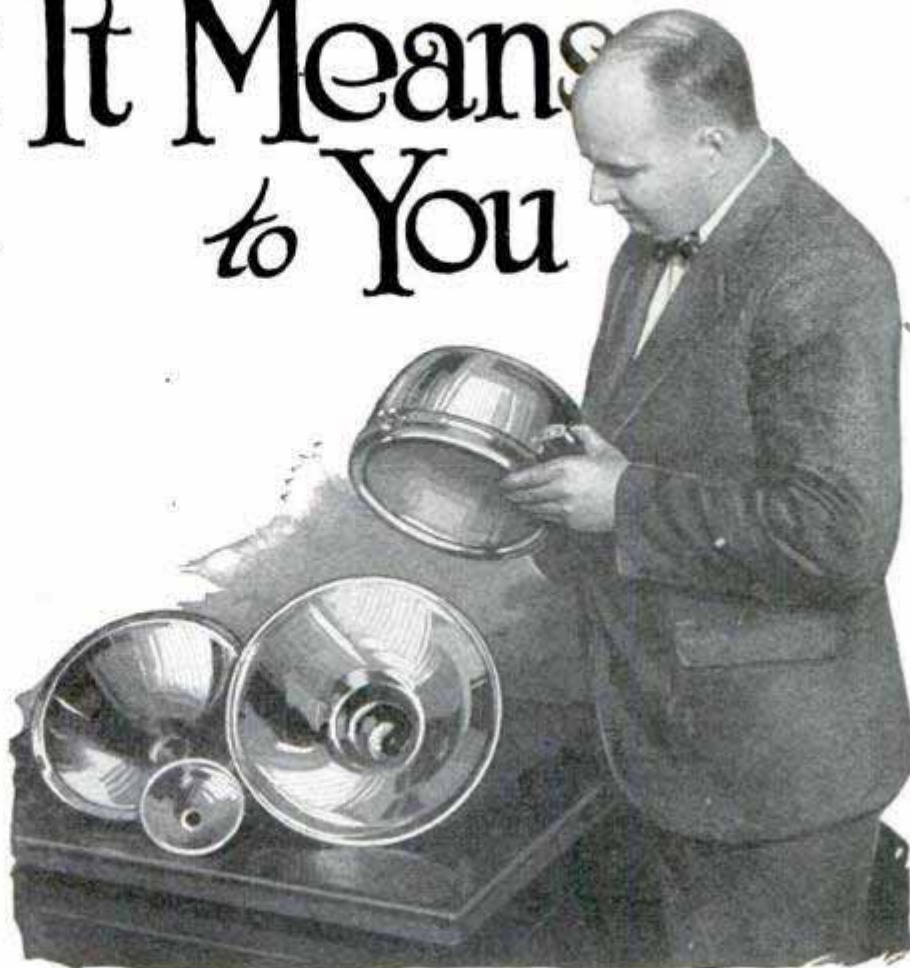

Auto Lamps and Reflectors Plated by the New Process Never Corrode or Tarnish and Remain Bright for the Life of the Car

"Chromium," says B. O. Smith, president of the Vacuum Can company, "is a marvelous metal, but not a cure-all. It has a multitude of uses in which it gives marvelous results, but it requires a tremendously high amperage of electricity to get a good deposit, so, for the present at least, its use should be confined to articles where the cost of this electricity and the plating material and labor is not out of proportion to the price of the article.

"If we plate a fine surgical instrument for seventy-five cents, the plating cost is only a fraction of the value of the tool, and the advantage of a rust and tarnish-proof material which requires no drying

25 & Hoynes. Are

What It Means

Cooking utensils

- ¶ Greaseless and stainless frying pans.
- ¶ Electric irons that will not stick to starch.
- ¶ Files and drills that last three times longer.
- ¶ Auto, boat and plumbing parts that never tarnish.
- ¶ Auto valves that will not "pit."
- ¶ Table and kitchen ware that need not be wiped dry.

And resulting enamel for sinks, bathroom, sink and laundry fittings with chromium finish. Standard

El-An. Inc

Crusader Ware

Wardhewer, My C. Woodhouse, My C. 1909 year Salance

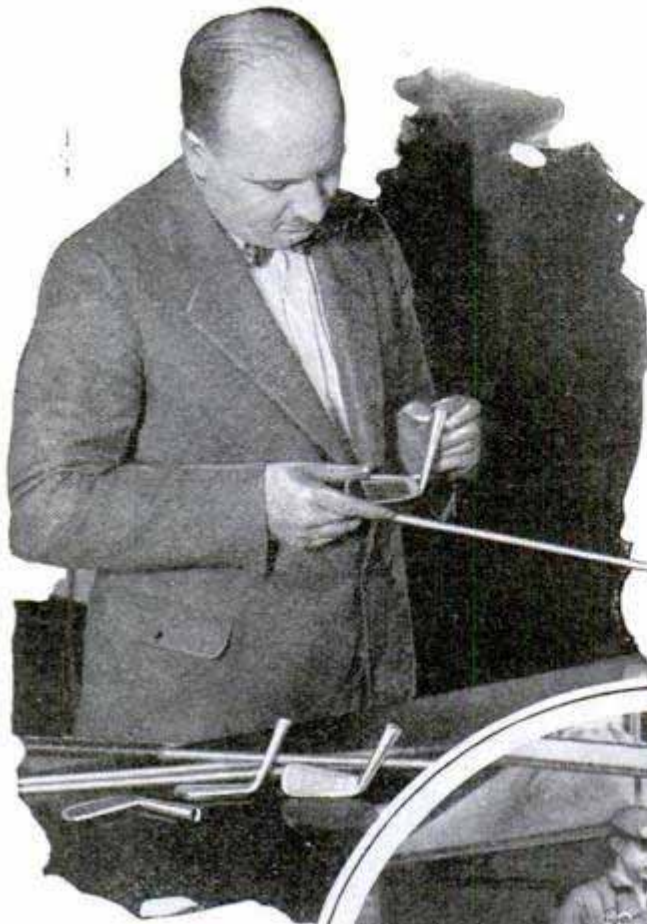

more than offsets it. But a kitchen knife or table cutlery, even though they require no drying after washing, do not justify the added expense and won't until a general demand arises.

Because of its hardness and its heat-resisting qualities—chromium melts at nearly 3,500 degrees—it is opening up an entirely new plating field in industry. Plated engine insides already are in use, along with plated shafting and tools. One of the big oil companies has had thousands of small copper tubes, used in its refining processes, plated to resist heat. The chromium coating raised the melting point of the copper tubing 700 degrees, and in tests it was found that even at that point the copper would melt out from beneath the shell and leave the chro-

mium coat, only a few ten-thousandths of an inch in thickness, standing unharmed.

Plating for heat resisting, for rust and corrosion resistance, and for highly polished ornamental parts, such as automobile radiators, headlamps and reflectors, involves three different processes. The metal can be deposited, by variations in the plating process, either as a highly polished coat, a satin-finish effect, or in a dull, murky gray of almost the same shade as a warship's battle paint. The dull-gray coat has the highest heat resistance.

The control over the plating while it is being deposited in the tank is so accurate that, in experiments, safety-razor blades were coated with chromium without dulling their edge, while in use they lasted for

many times the usual number of shaves, because of the hardness of the metal. Gauges used in machine shops are being built up to size after long wear by chromium plating, and one manufacturer is salvaging \$30 hobs in which the shaft hole



Courtesy Iron Age
Golf Clubs and Metal Shafts Can Be Plated Either in a Bright or Satin Finish; Center Picture Shows Auto Radiators Being Plated; at Right, Scratching a Glass Plate with Pure Chromium

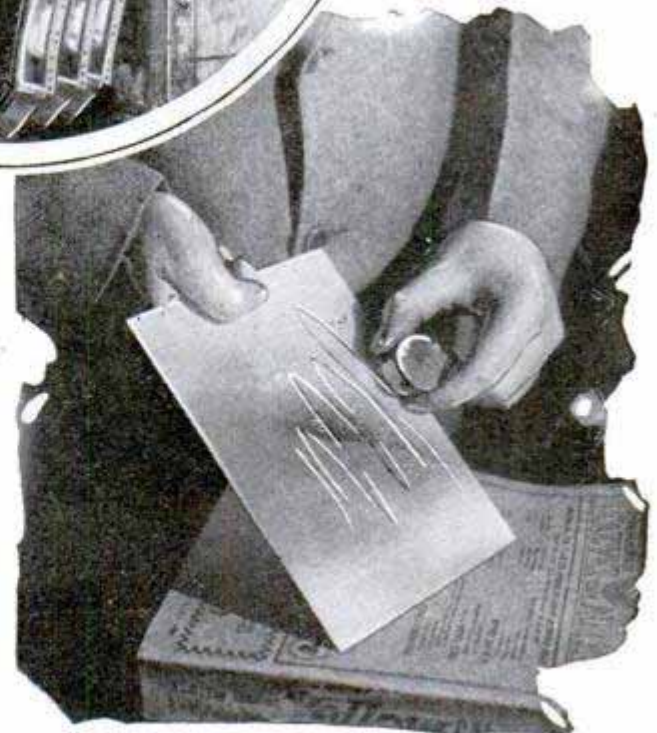

*Used by ...
26 Broadway, New York.
120*

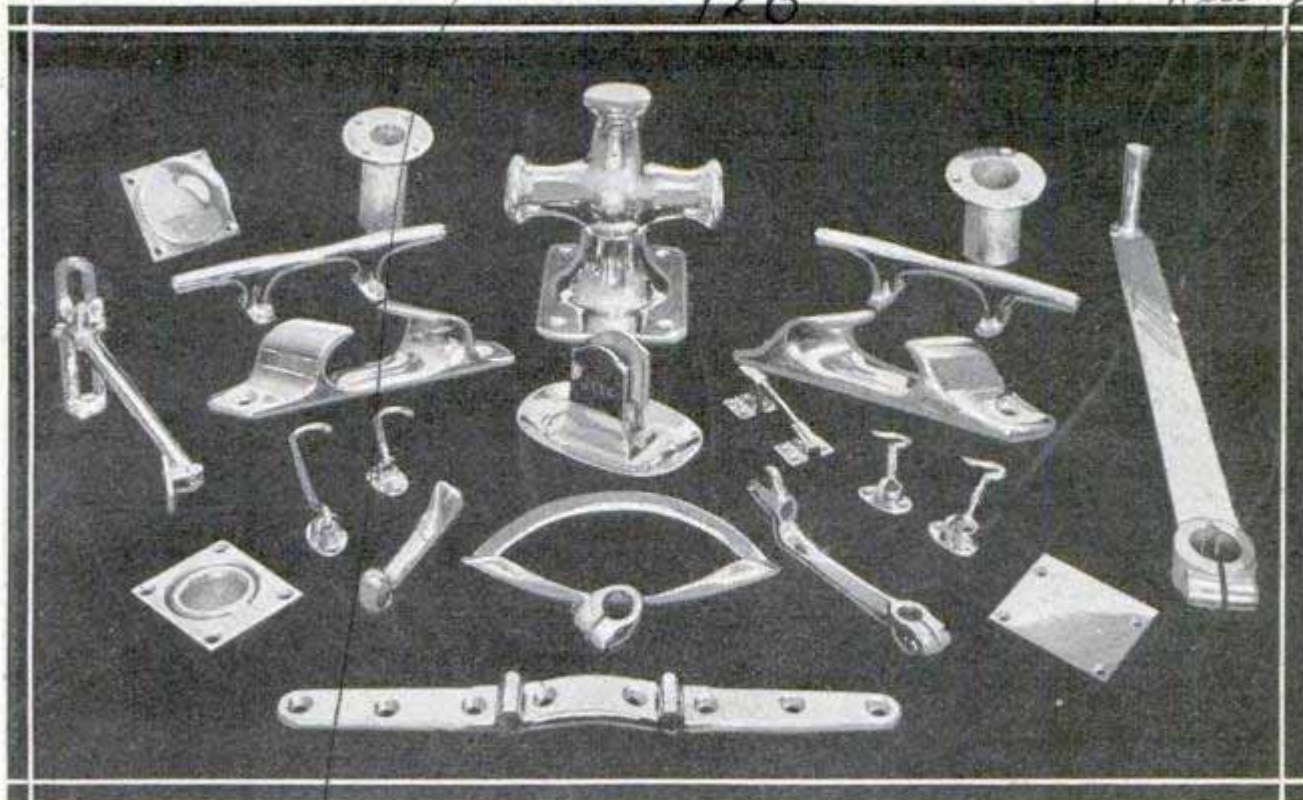

Samples of Chromium Plating for Motorboat Parts, Designed to Resist Salt Spray; the Material Is Finding a Wide Use at Sea and Eliminates the Incessant Polishing of Brasswork

was slightly oversized by having them built up to dimensions by plating.

Colin G. Fink, of Columbia University, and associates, who developed one of the chromium-plating processes, has found a wide field of application in plating fine plumbing fixtures and such decorative ship parts as binnacles, bells and other brass fittings, which are constantly exposed to the corroding effects of salt spray.

One of the General Motors subsidiaries, which has been using chromium plating on radiator shells and some other parts for a year, subjected a radiator to a constant bath of salt spray for more hours than would occur in the normal life of a car in a seaside town, without any trace of corrosion.

Chromium is impervious to all acids but two—hydrofluoric, the acid which even eats through glass, and nitric.

Besides its many other uses, chromium is at work printing money and postage stamps for Uncle Sam. Deposited on the case-hardened steel engravings used in the bureau of printing and engraving, chromium has run for more than 150,000 impressions without showing any appreciable sign of wear, whereas the case-hardened steel alone wore out after 50,000 prints had been made. Chromium-plated

electrotypes used for such purposes as printing paper cartons, tags, cards, etc., have run for a considerably greater number of impressions without damage, than can be obtained from the ordinary nickel-plated electro. In New England textile mills chromium-plated steel is replacing other materials for printing delicate fabrics, giving longer life and finer work.

This wonder metal also will protect iron, steel and copper from scale. Several thousand electric-soldering-iron tips have been plated to prevent the breakdown which occurs near the base of the tip after constant heating. Even boiler tubes have been plated on the inside to prevent scale. The plating process differs with different plants. In an automobile factory the radiator shells are first plated with copper to fill the big pores, then with nickel to fill the copper pores, and finally with a "flash" or thin coat of chromium to fill the nickel pores. At the Vacuum Can plant the chromium is plated directly on steel, iron, both forged and cast, copper, brass and other metals. Surgical and dental instruments plated directly on steel show no difference from the same instruments plated over a nickel base, except that sometimes the nickel coat scales and affects the chromium.

Casehardened

*Dr. Colin G. Fink,
Professor of Electrochemistry at Columbia*

*Mr. Chance Bros. & Co. Ltd, Smeethwick, Birmingham
Staffordshire, England*

NEW GLASS LETS HEALTH RAYS THROUGH WINDOW

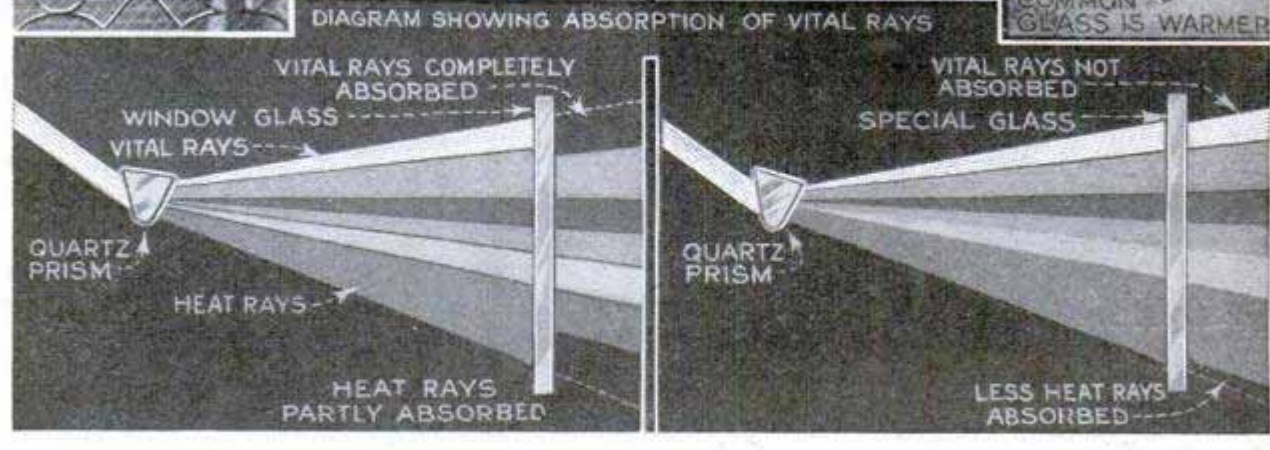
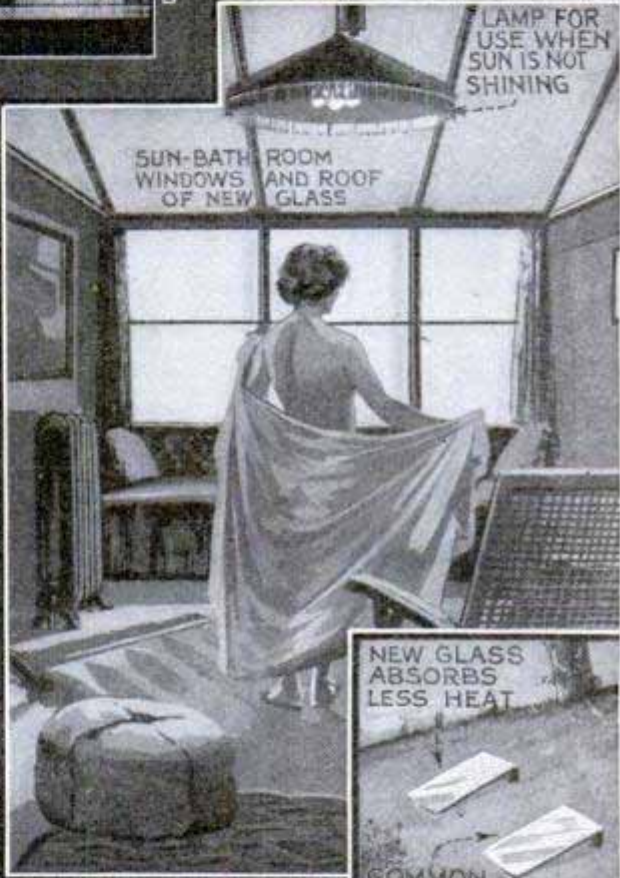
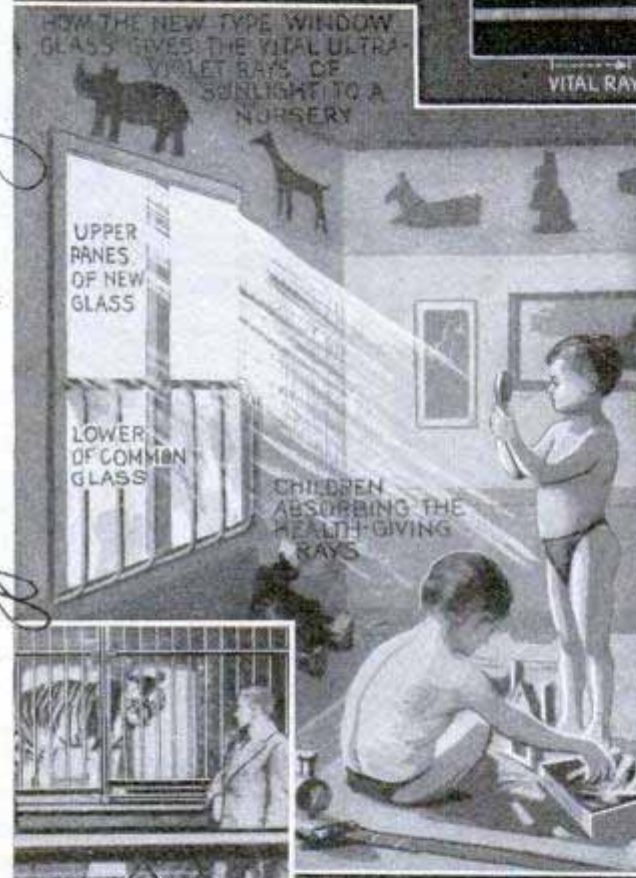
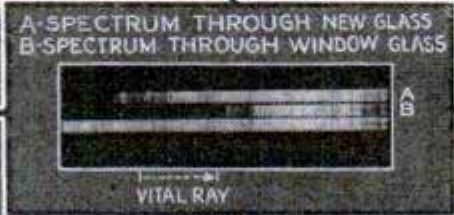
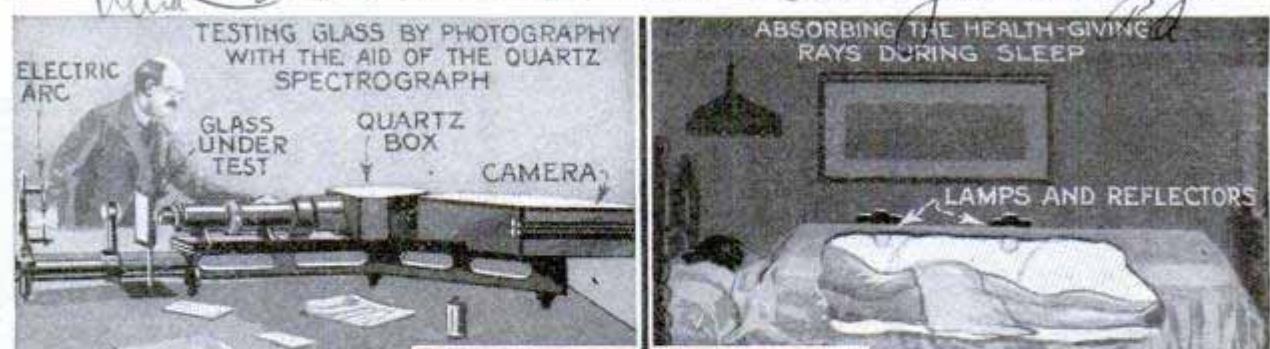

*Quartz-Lite - Ultra-Violet Ray Glass -
American Window Glass Co. Farmers Bank
5040 100th.*

Copyright, The London Illustrated News

Passing Not Only the Health-Giving Ultraviolet Rays, But More of the Sun's Heat Too, a New Glass Produced in England Is Being Used Both in Homes and at the London Zoo

188

*Vitaglass - Vitaglass Corp -
50 E. 42nd St. N.Y.*

*Nov 6, 1926
P. 881*

(similar to - Corning)

Christian Science Monitor 11/9/26

SUN'S RAYS TO HEAT BUILDINGS
EXPERT PREDICTS

Heat from the sun's rays, harnessed by special equipment on the roofs, may warm big buildings in the future, in the opinion of Col. John R. Kilpatrick, war-time construction chief. He points out that modern structures are being built to last many years and that they lend themselves to the adaptation of such a system.

INSECTS HELP RECLAIM LAND
BY KILLING PRICKLY PEAR

Farmers in Australia are looking to a lowly scale insect and a species of moth to help them save 25,000,000 acres of land from the prickly pear. More than \$40,000 and five years have been spent by experts in finding these natural enemies to the pest plant, which has been spreading at the rate of 1,000,000 acres a year. Care had to be taken that the bugs were not injurious to desirable vegetation and that none of the enemies of the insects themselves would be introduced with them. After many experiments, three strains of the insect and the moth have been liberated to work their worst on the prickly pear, and hope is expressed that they will be victors.



Upper Photo Shows the "Bridge of Hope" to District Attorney's Office; Inset, the "Bridge of Sighs" to the Tombs

"BRIDGE OF HOPE" RIVALS
"BRIDGE OF SIGHS"

As a counterpart to the famous "Bridge of Sighs" in New York city, the passage leading across the street from the criminal-court building to the Tombs, a "Bridge of Hope" now presents a brighter side of the picture. It connects the court building and the district attorney's office where a fate much less depressing than a long prison sentence may await the culprit. Both bridges are similar in construction and design.

LICENSE TAGS FOR AIRPLANES
LATEST U. S. RULING

Airplanes will be tagged and numbered like automobiles, according to a department of commerce ruling under the new aviation laws. A census showed that there were about 5,000 planes in operation over the country late last year. By the new regulations, no airplane can be flown until it has been licensed and tagged.

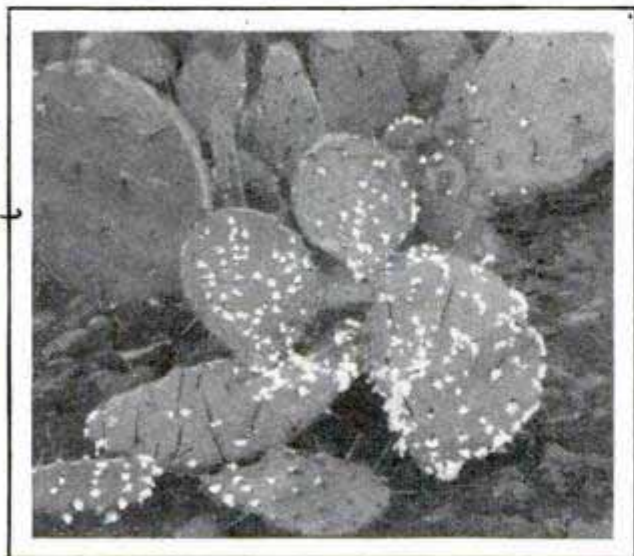

Prickly-Pear Plant with Evidence of Ravages Worked by Insects Bred to Destroy It

Australian Institute of Science and Technology

Photo by E. R. Sarreger U. S. Federal Horticultural Board

Cmd. Chas. F. Cushing, 138 W. 65th St. New York

W. J. Idevald 11/7/26

989

SHAM BATTLE TESTS LATEST CHEMICAL WEAPONS



Brilliant Night-Time Displays of Liquid Fire Featured Recent Sham Battle Maneuvers of Regulars at the Army's Great Gas Factory at Edgewood Arsenal; Phosphorus Bombs, Shot from Mortars, Trailed Long Streamers of Fire across the Sky as They Plunged Down on "Enemy" Trenches; the Soldiers Went to the Front in Style, Riding Narrow-Gauge Trains through the Arsenal Woods

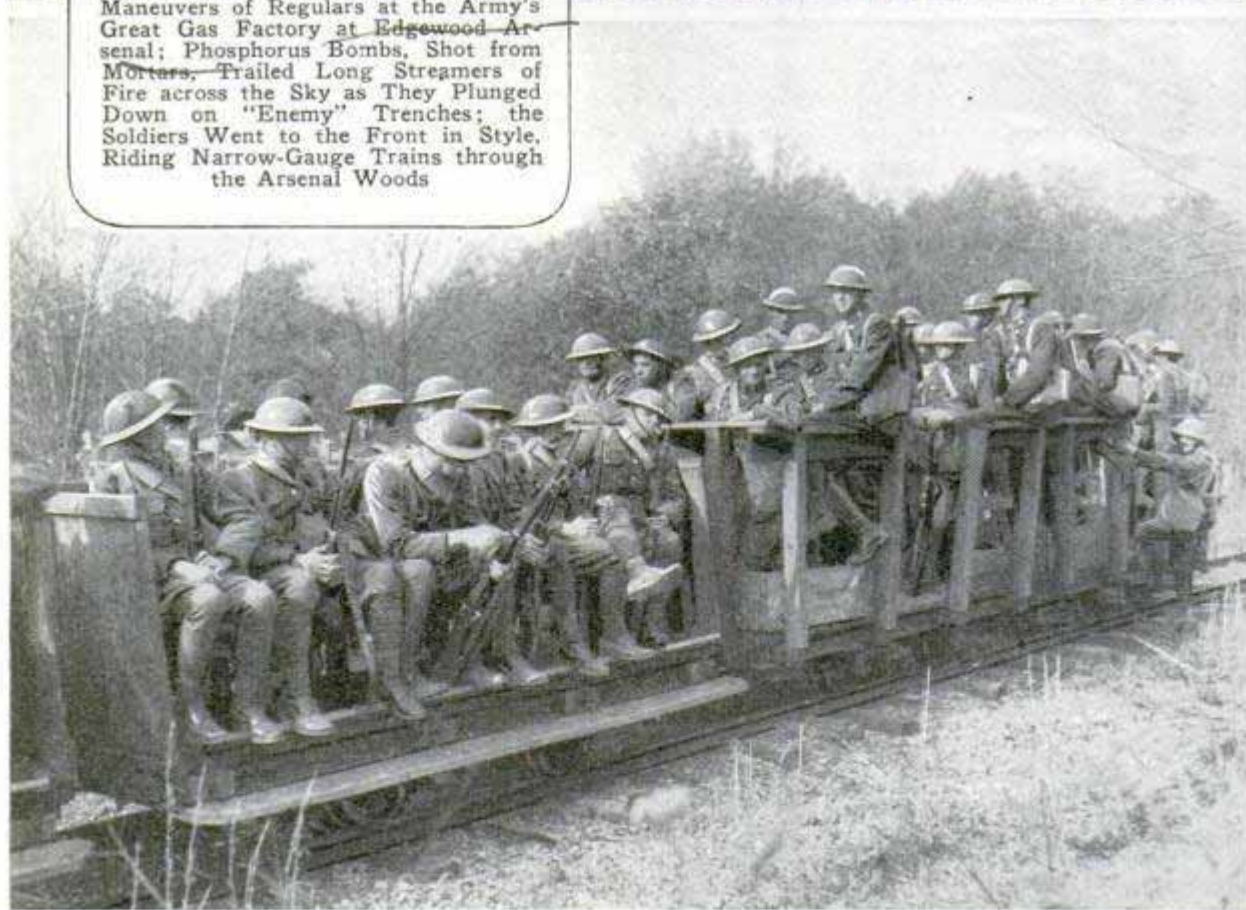

25 5

BAY HORSE THE ONLY SURVIVOR OF CUSTER BATTLE

Details of the Custer battle with the Sioux Indians at the Little Big Horn were reviewed recently when a question arose as to the color of the horse that was the only survivor of the massacre. For several years, the mounted hide of "Comanche," a big bay, has stood in a glass case in the Dyche museum at the University of Kansas, as that of the steed ridden by Capt. Myles W. Keogh whose horse was the only living thing found on the battlefield. In a recent story of the fight, Capt. Keogh's mount was referred to as a "big, powerful gray." Museum records were consulted, with the result that the authenticity of its possession seems to be established and there is little doubt that "Comanche" was a bay. The best evidence is seen in a history of the horse sent to the museum by John C. Lockwood, adjutant of the national Indian war veterans, and one of the two men who found "Comanche" on the battlefield after the Custer massacre. Lockwood describes how he and James Severs carried water in their hats to revive the horse, which was removed, suffering from several wounds, out of a pile of bodies. It died of old age several years later, at Ft. Riley, the historian states, and its hide was mounted and placed on exhibition in the museum at the University of Kansas.

AERIAL LIFEBOAT IS PROPOSED FOR CHANNEL RESCUES

To go to the aid of victims of airplane accidents in crossing the English channel, a swift seaplane equipped with life-saving apparatus has been planned. It would be stationed on the English side of the passage and communication by wireless would be maintained with planes in flight. It is pointed out that the aerial lifeboat could arrive at the scene of disaster much quicker than a steamer.

Answers 1/13/26



Demonstrating the Combination Powder Box and Horn Button; the Lid Snaps Tightly Shut

VANITY CASE ON AUTO WHEEL SERVES AS HORN BUTTON

For the woman auto driver, a powder box with puff is fixed to the top of the steering wheel. When closed it serves as a button to sound the horn.

MAGIC LANTERN FOR SALESMEN HELPS SELL PRODUCT

For the special use of salesmen in displaying their goods, a lantern projector operated from a light socket, shows pictures, charts and diagrams for the inspection of prospective customers. A plain wall or piece of paper may be used as the screen and an ordinary electric bulb supplies the light for projection.

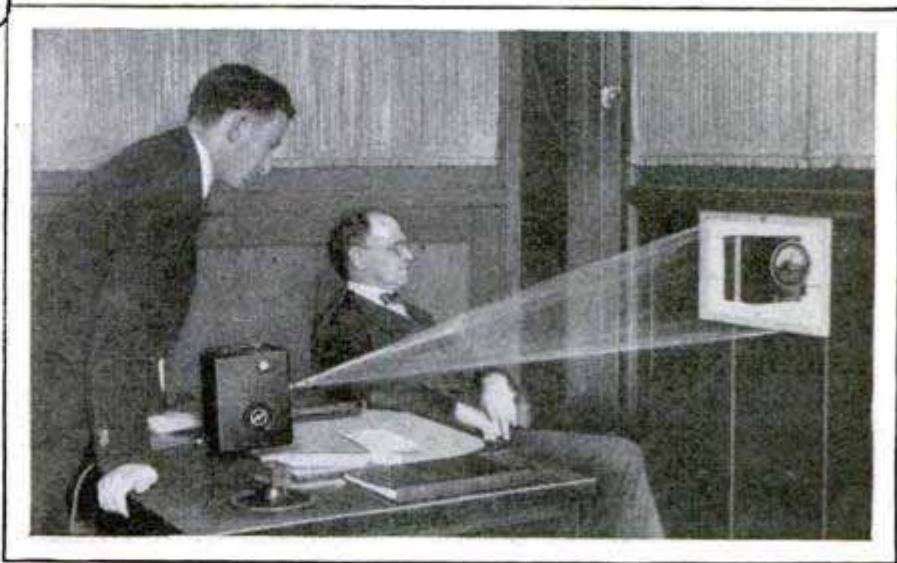

Salesman Displaying Pictures of Goods from Projection Lantern, Which Saves Carrying Catalog and Emphasizes Good Points of Merchandise

Bausch + Lomb Optical Co Rochester

Century News
11/23/26

9/8

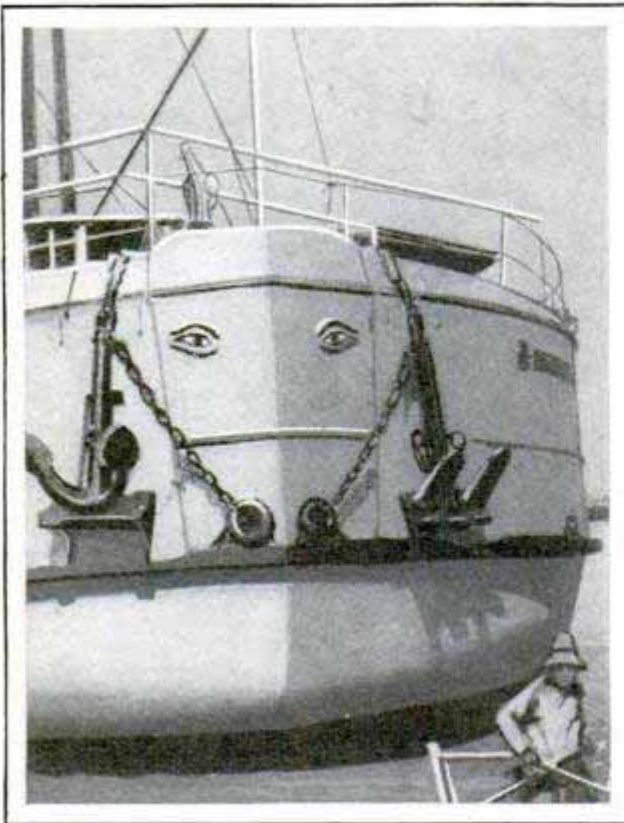

To Protect the Ship from Evil Spirits; Eyes on Prow of Chinese Vessel

EYES PAINTED ON CHINESE SHIP TO PREVENT WRECKS

According to a Chinese superstition, a vessel must see in order to avoid wrecks, consequently eyes were painted on the prow of the ship shown here, producing an odd effect. The belief is in line with the feeling that prompted the early adoption of figureheads. They were supposed

to be guardians of safety, capable of pacifying the angry gods of the seas and averting danger from other malicious spirits.

COAST CITIES TO FIGHT ANTS BY BUILDING CODES

10/8

Ravages of white ants in some cities of the Pacific coast have led to proposals for provisions in the building codes to combat the insects. One clause specifies insulation of all untreated woodwork from contact with the ground and application of proper chemicals to other timbers. The report from one city that fifty per cent of its business buildings had been seriously damaged by ants during the last year emphasizes the seriousness of the situation.

STEEL ROOFS MADE FOR WAR

10/3

SERVE AS GARAGES

Hoods of half-inch steel, made to resist shell fire, have been adapted to peace-time service as garages at the government plant-testing farm in Virginia. They are easily erected, keep out storms and cold and are of convenient size for one car. At the farm, experiments are conducted with new plants, flowers, soils and fertilizers. Road materials are also tested, and an interesting side issue is the search, made in co-operation with golf experts, for turf and grasses that will provide the best greens for the courses.

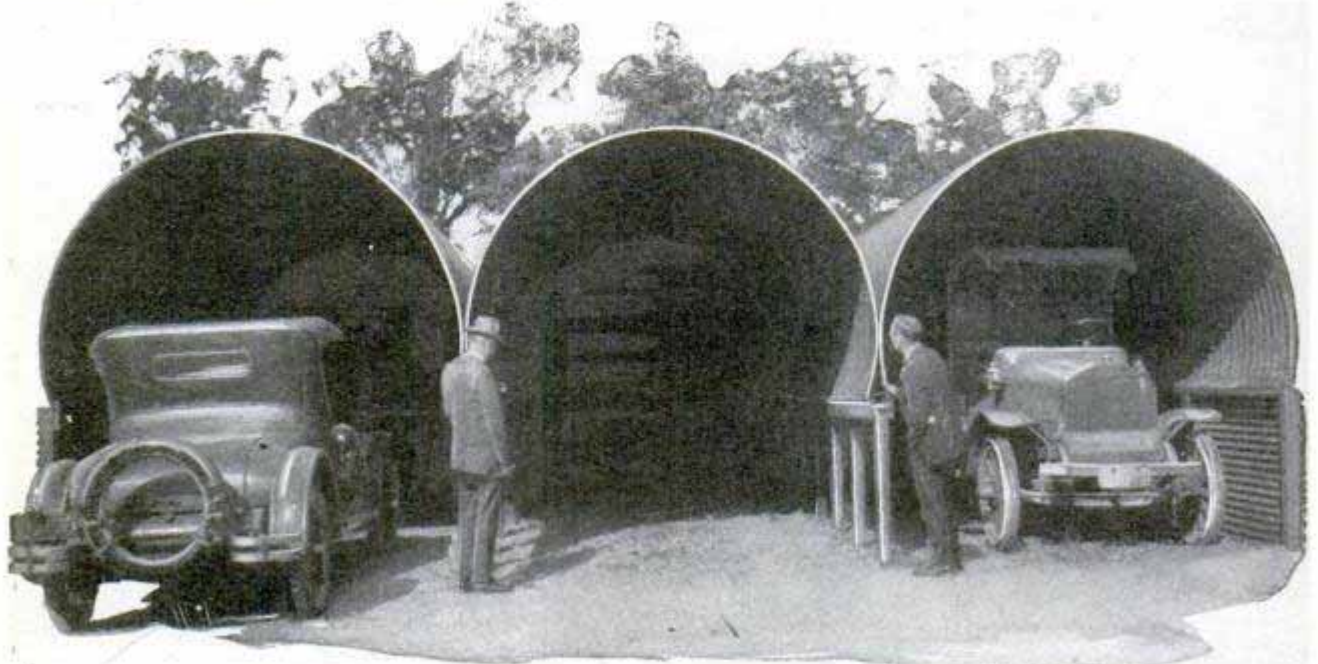

Intended for Bomb-Proof Shelters but Adapted to Garages for Government Automobiles; Steel Roofs Arranged to Harbor Cars at the Plant-Testing Farm in Virginia

Arlington Farm
Wa.

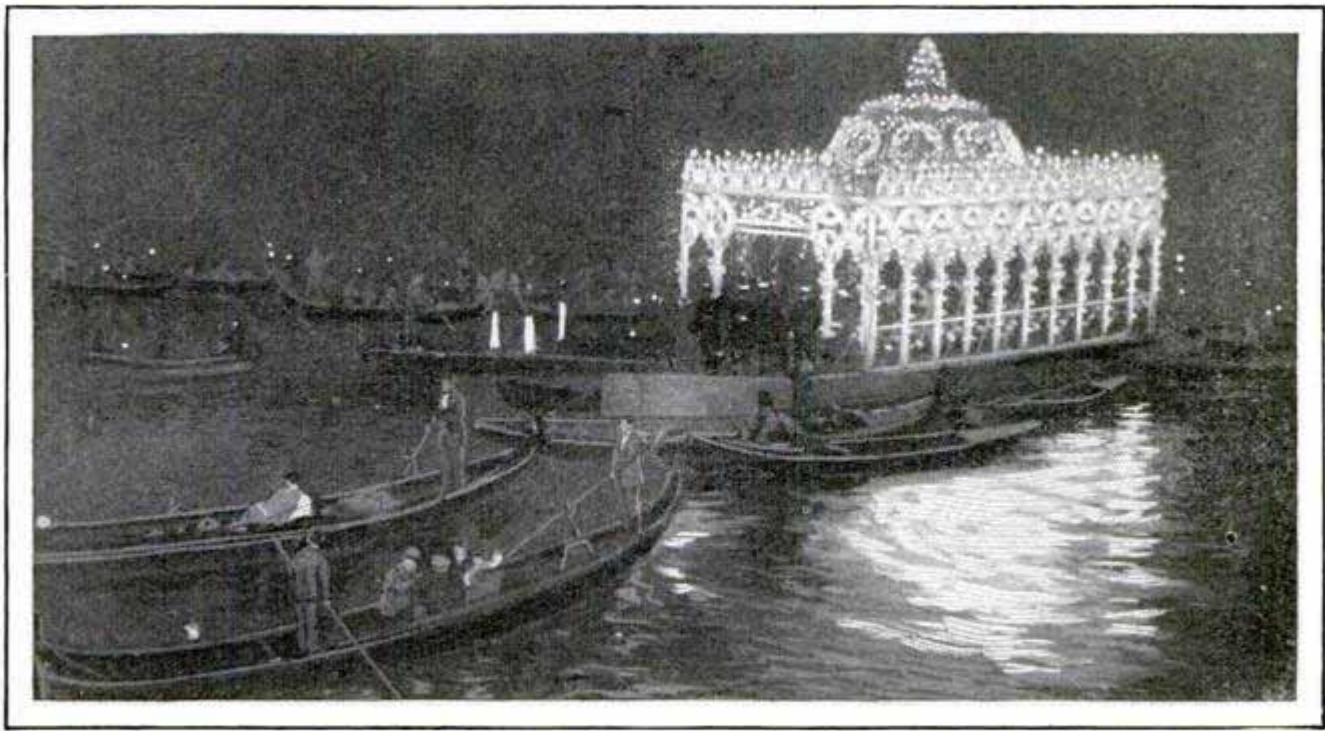

Electric Lights Lend Glamor to a Water Fete in Venice; the Glowing Gondola Palace Outlined in Brilliant Colors for the Parade

**LIGHTED CANOPY ON GONDOLA
FEATURE OF CARNIVAL**

One of the high lights in a recent water carnival in Venice was a brilliantly illuminated gondola in a parade along the canals. An arched canopy and dome studded with many electric lights gave the effect of a moving palace.

each year." The dendrograph, as the instrument is called, is said to measure variations in diameter with greater precision than any other practical apparatus, and makes a continuous record.

**SELF-PROPELLING SAND LOADER
SAVES HAND LABOR**

Run by a twenty-horsepower motor, an endless-chain loader for sand, or other loose materials, can be moved about on its own treads. It can thus be easily set for the most efficient loading and does the work of several men in less time.

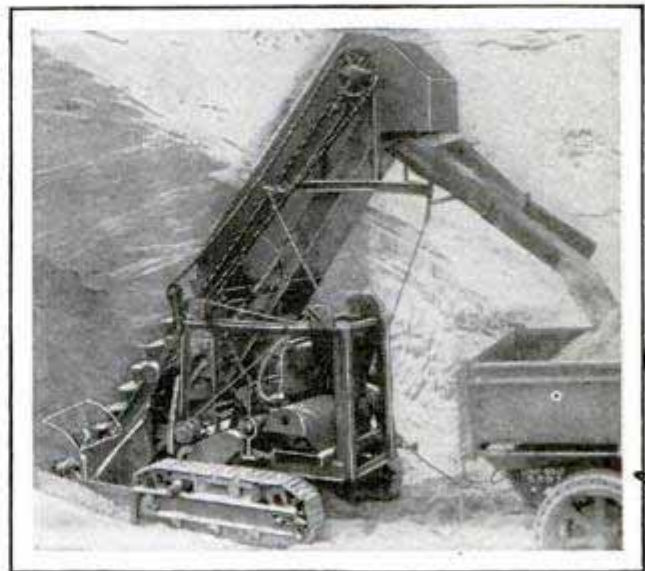

Sand Loader in Action; It Can Be Moved to New Position by Its Own Power

**TREES WRITE THEIR DIARIES
WITH GROWTH RECORDER**

A score or more of trees in the United States today have their pens in hand, so to speak, and are writing their own diaries with an accuracy that leaves nothing to memory. This is the interesting revelation of Dr. D. T. MacDougal, who explains that the "pen" consists of an instrument which records the growth behavior of a tree in relation to changes in the outside world. "With this writing equipment," Dr. MacDougal says, "a tree is able to tell us how its life is affected by rainfall, a series of humid days, a period of drought, or by seasonal conditions of any kind. Many trees of great interest and importance put on yearly layers of wood no thicker than a tenth of an inch, and some, after the first two or three centuries of their existence, add not much more than half of this amount to the wood

The American Association of Washington

993

Wachy 1026

*Senk - Bell Co. Michigan Ave
910 S. Michigan
Chicago 90*

*in her issue -
American Forests,*

Fighting Pirates

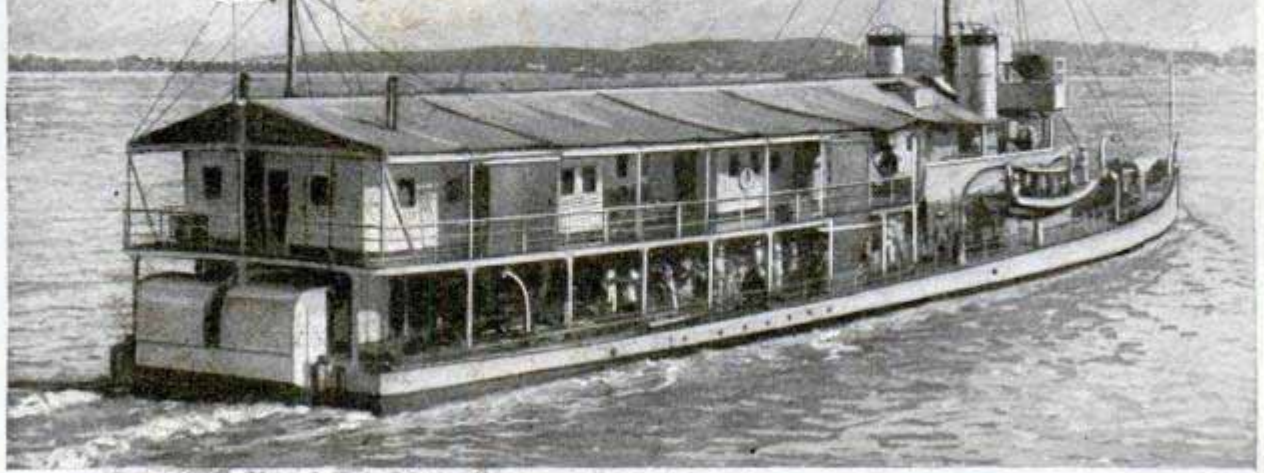

River Gunboat on the Yangtze-Kiang; These Queer Craft, Built in China for Their Special Work, Have All Quarters above Deck Because of the Shallow Draft Necessary

Army, Navy and Marines in Far East Continually Engaged with Rebels, Bandits and Pirate Ships of the Yellow Sea

FIGHTING pirates and bandits is the regular job of picked army and navy units in the Far East—the only spot where enlisted men are sure of getting almost continuous action. Pirates swarm on the rivers of China and in the Yellow sea, while their land-going brothers, the native bandits, work up to the very walls of the biggest cities. To protect American lives and commerce, the American government, like all the principal powers, maintains large forces in China, where, under special treaties, they have power granted nowhere else in the world.

Piracy, as practiced in the Far East, has become modernized since the advent of steamships. In the old days, the pirate junks overtook the slow-sailing ships, boarded them, killed the crews in bloody fights and transferred the cargoes to the native vessels. But a sailing junk can't overhaul a fast steamer, so, nowadays, the pirates take passage as ordinary coolies, and at a favorable moment seize the ship. Then the junks come alongside to transfer the loot.

But the attack isn't always a success. Recently forty pirates seized a British

steamer only eighty miles from Hong-kong, the great British concession, but during the night two of the captured ship's officers got loose, obtained revolvers, and without help killed twelve pirates, drowned another and captured nine, the rest fleeing in the ship's lifeboats.

About the same time American and British gunboats were attacked a thousand miles up the Yangtze by Chinese rebel armies, virtually bandits. The rebels had seized several British and American ships, and when the gunboats went to the rescue attacked them, too, killing a half dozen English sailors.

The naval forces, however, shelled a few rebel camps and succeeded in recovering the captured ships.

Since long before the Boxer rebellion, the army, navy and marine corps have maintained forces in China, engaged in the triple task of guarding the legation at Peking—a marine-corps assignment—protecting American settlements in Tientsin and other cities, keeping the Peking-Mukden railroad open to traffic—a job for the army—and guarding commerce on the Yangtze-kiang, a task which the navy

in CHINA

handles with a fleet of seven specially built gunboats. In addition, the Asiatic squadron at sea patrols the ocean highways to guard against pirate attacks.

It was one of the seven river gunboats that was attacked when it joined the British fleet in freeing the captured steamers on the Yangtze. The gunboat navies maintained by all the leading powers on this river are specially designed craft for shallow-river work. With their powerful engines they can invade the famous gorge—a cleft which in places has walls 13,000 feet high—and force their way upstream against the ten-knot current. The path of the river through the gorge is so steep that boats going upstream actually climb 500 feet in 350 miles, and that without a single lock.

Because of their shallow draft, the gunboats are useless at sea, and hence must

be built in China. The seven American craft are the only vessels in the navy built outside American yards, and they also have the distinction of being the only

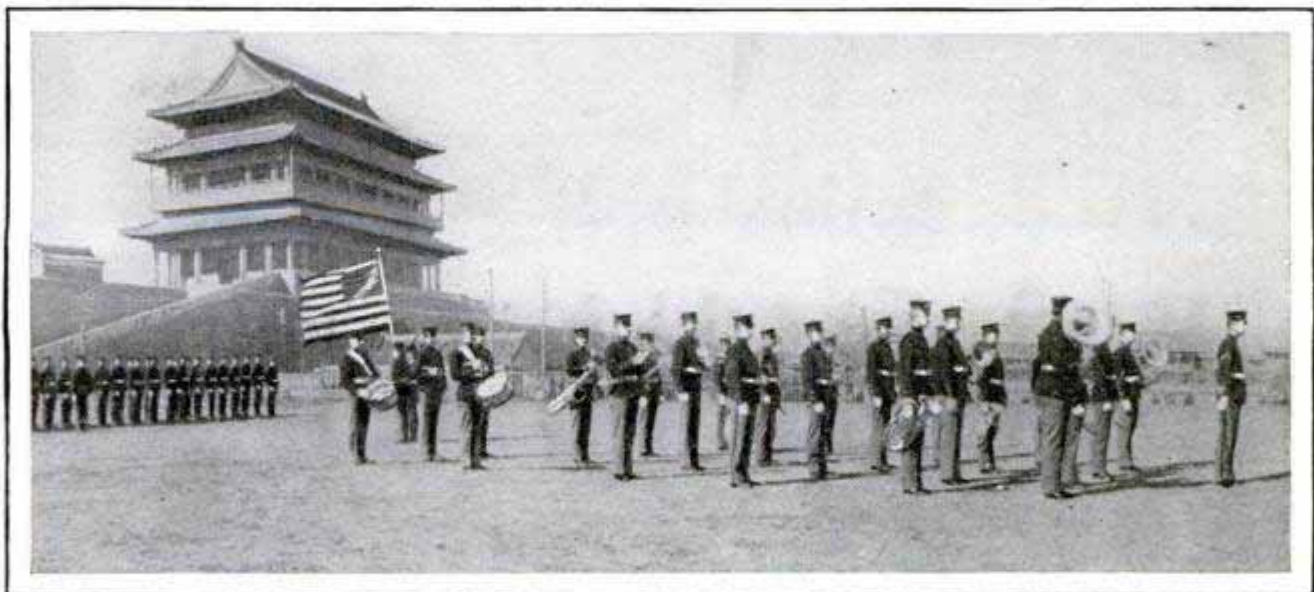
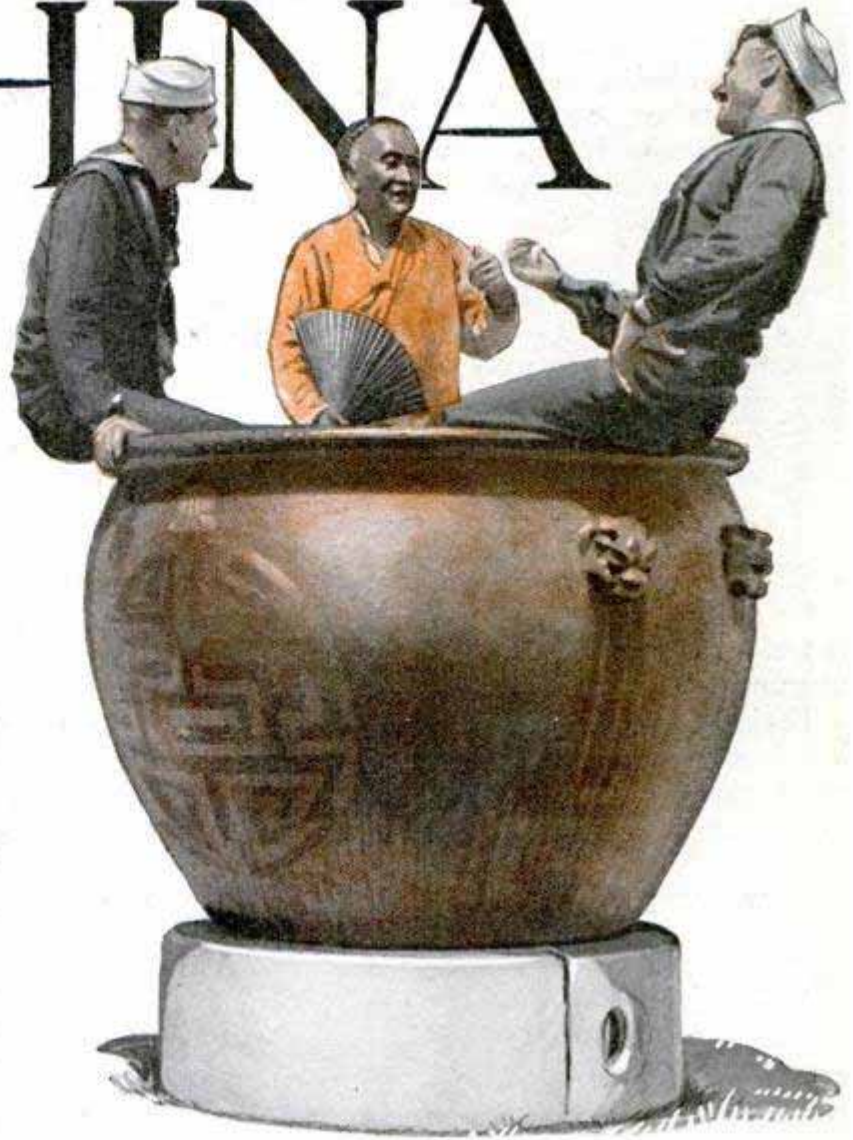

Marines of the Peking Legation Guard Drilling Beside the Great Wall of the City; the Legation Guard Stood Off the Boxers for Months While Awaiting Relief from Outside

ships carrying their name plates painted in a foreign language, Chinese picture characters being used.

The territory covered by the river fleets stretches from Hankow, 640 miles above the river mouth, upstream for several hundred miles. Below Hankow, the river is navigable for ocean ships, and this stretch is patrolled by destroyers, cruisers and a battleship or two, part of the Asiatic fleet. They also sweep the coast line on constant watch for the pirates of Formosa, who miss no chance to attack and loot both native and foreign vessels. The pirates, who formerly operated from their unwieldy junks, with slatting sails of bamboo and matting, have modernized their methods and now operate with all the efficiency and organization of a band of gunmen.

Their favorite method in recent years has been to take passage on a coasting steamer as ordinary travelers, and, when safely out at sea, seize the ship, loot passengers and crew, transfer any valuables from the cargo to waiting junks, and then disappear, occasionally carrying off a few passengers to be held for ransom.

Assignment to the Asiatic station, either of the navy or in the marine corps and army detachments ashore, is eagerly sought, not only because of the promise of active service, but for several other reasons. An army recruiting officer, describing the Chinese service, says:

"Think of soldiering where every dollar is worth two, where all fatigue duty is done by proxy, and where every fighting man has a valet to care for him and his equipment! From the four million men who wore the olive-drab uniform of the United States army eight years ago, such a statement would call forth scornful laughter and soul-felt sentiment given in no uncertain terms.

"Yet, far from being the idle imaginings of some idealistic-minded soldier, this condition actually exists. In Tientsin, at the gates of the mysterious Orient, two full battalions of the Fifteenth Infantry are stationed, and the 700 men of the American forces in China consider themselves as near paradise as any soldier can reasonably expect to get.

"Nor is this all. In China one never hears tales of hardtack, corn-willies or goldfish—those delicacies so familiar to the A.E.F. Instead, the China contingent finds the mess tables loaded with chicken and steak, turkey and venison, and numerous other luxuries. In one month Company I of the Fifteenth Infantry, consumed, exclusive of Sunday and holiday meals, 5,500 eggs and 500 pounds of chicken. Another company claims its men ate an even thousand eggs one morning for breakfast, in addition to other dishes! And beans are practically unknown."

The Fifteenth first went to China in 1900 to help put down the Boxer rebellion, and

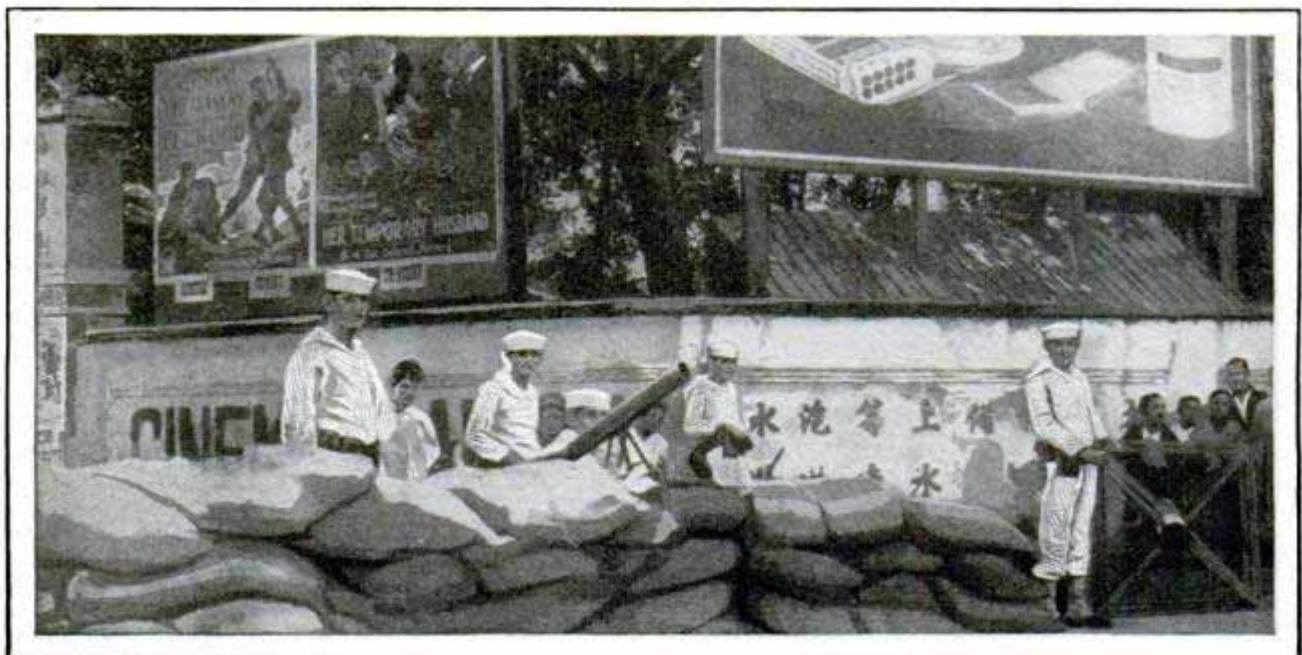

American Sailors in a Machine-Gun Nest Guarding the American Section at Hankow; the Man on the Right Is Holding the Loop Aerial of a Portable Wireless Set



Japanese Soldiers Watching the American Rifle Team Win the International Championship of China, One of the Features in Which All the Foreign Troops Engage

was ordered back in 1912, when bandits again threatened foreign lives. It has been there ever since, with the exception of one battalion maintained in the Philippines. No soldier does any fatigue duty, for he can hire a native to do it for him at a salary of seventy-five cents a month. About all the troopers have left to do is drill and target practice, to which the mornings are devoted, while, following the universal custom of the white man in the Orient, the afternoons are given to rest and recreation.

With troops of several countries stationed in Tientsin, there is keen international rivalry, both in drills and on the target range. In the last international match, the team from the American regiment defeated the picked marksmen of the Japanese, British and French Garrisons, winning high praise from Lieut. Gen. Takada, of the Imperial Japanese army, under whose auspices the match was held.

The life of the marine guards at the American legation in Peking is much the same. All the forces maintain baseball, football and basketball teams, while polo is popular with the officers, who play teams from the other foreign detachments.

TOOTH MILLION YEARS OLD FOUND IN COAL MINE 847

That man appeared early in the age of mammals is indicated by the discovery of a fossil human tooth in a coal mine, near

By Mr. J. C. Siegfried

Billings, Mont. From the character of the deposits in which it was found, it apparently had been laid down more than 1,000,000 years ago. Dentists declared that the tooth had been the second lower molar of a human being.

HORN IS CONNECTED TO VIOLIN TO AMPLIFY TONE 1048

Fitted with an amplifying horn, a violin is said to be equal to five ordinary instruments in an orchestra. Besides increasing the volume, the attachment is reported to develop the quality and beauty of the tones. The horn is supported over the



To Increase the Power of the Violin's Voice; Amplifying Horn Connected to Instrument at Rear Rests on the Player's Shoulder

player's right shoulder and does not interfere with the use of the bow.

Access maker rubber room

Violin horn

Whole World Vincent Lopez

for University of Iowa.

*J. Schumann
Works at Tottenham
England.*

*James H. Roast
University of Chicago*

986

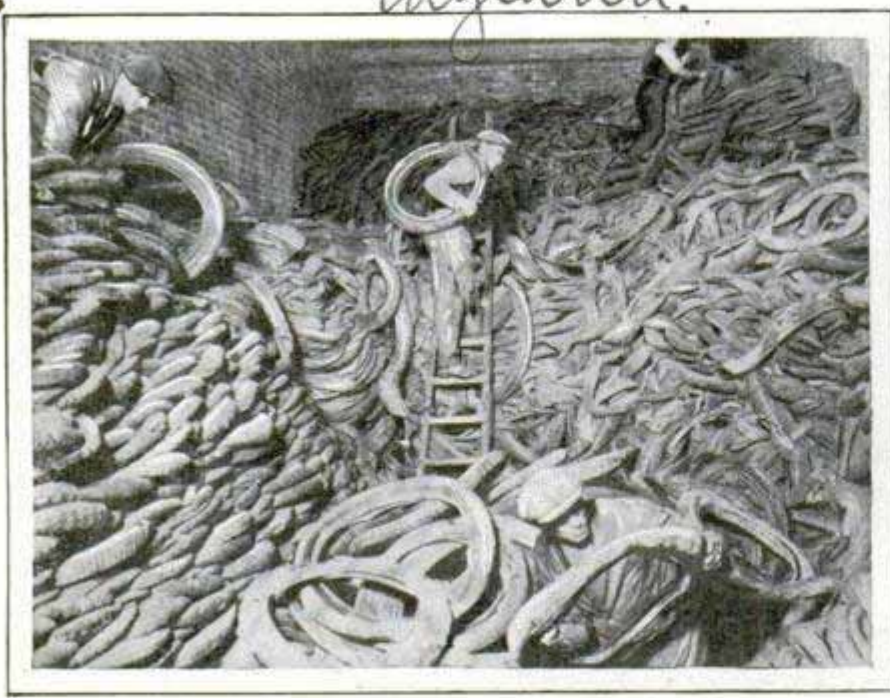

Picking Out a Few of the Best Ones from a Mammoth Salvage Pile of Old Automobile Tires in London

RECLAIM CAST-OFF AUTO TIRES FOR CANVAS AND RUBBER

Useless for further road service, many discarded automobile tires yield marketable rubber and canvas to the junk men. Some handle little else but worn tires and tubes. The salvaged product appears in the form of mats, packing, shoe soles and other materials. Much of it is used in roofing. Tire-reclaiming is a considerable industry in England, where millions of tubes and casings are junked annually.

CAMERA TO SOLVE MYSTERIES OF OLD TEMPLE

How the camera is being used to save for posterity the records of some of the most interesting chapters in human history, is illustrated in the "inscription salvage" being done on the walls of ancient temples along the Nile. From the original pictures and symbols on the crumbling stones, the photographer makes small negatives, section by section. Enlargements and tracings from the negatives are then taken to the

temple and, while the worker balances himself on ladder or scaffold, he "proofreads" the copy directly from the original. It is estimated that two or three more years will be needed to complete and publish the records from the Medinet Habu temple, at Luxor, alone.

GARDEN IN FORM OF U. S. MAP NOVEL PARK FEATURE

Flowers and shrubs were sent from forty-nine cities throughout the country

937



The United States Map Garden in Miami, Fla., Park; It Is Planted with Flowers and Shrubs Sent from Forty-Nine Cities

Bay Front Park

969

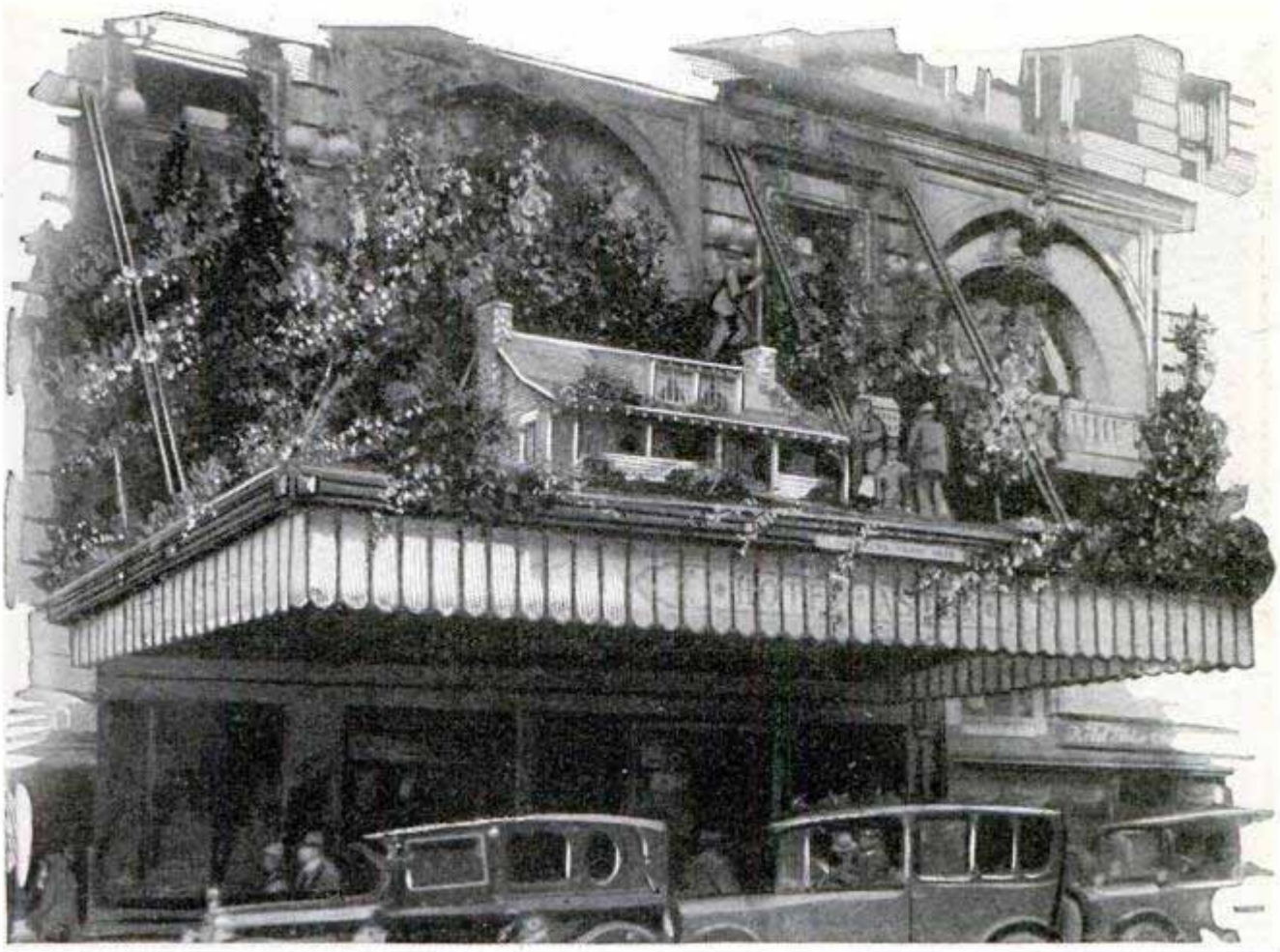

A City Pauses for a Backward Glance; Replica of a Dutch Farmhouse on the Canopy of the Hotel Astor, New York, Erected for Broadway Anniversary Observances

for planting in a unique garden in a Miami, Fla., park. The plot is lined out to represent the states of the Union and, when in blossom, will constitute a flowering map of the nation. The plants were set by former residents of the states represented.

MODEL HOME ON HOTEL CANOPY SHOWS CITY'S GROWTH

One of the features of the anniversary celebration in commemoration of the beginnings of Broadway, was the display of a model house on the canopy of the Hotel Astor. It was a replica of Heinrick Eden's Dutch home that stood on the site of the hotel in the early days, when he owned a large block of property near by. The contrast between the modest dwelling and the huge hotel, forcibly illustrated the city's growth of a century.

SPREADER TIP ON GLUE TUBE PROTECTS FINGERS 964

Glue is easily applied from a tube, without soiling the fingers, through a spreader tip of rubber. It is shaped to simplify even distribution of the adhesive which is forced through a small hole in the cap. The aperture is self-sealing so that it is not necessary to screw on an extra top. Squeezing the tube opens the hole when the glue is to be used again.



FILAMENTS OF RARE METAL TO IMPROVE LIGHTS 956

Not content with the improvement in the incandescent electric lamp through using drawn wire filaments of tungsten instead of carbon, investigators are experimenting with molybdenum for this purpose. The metal withstands extremely high temperatures, is malleable, and can be forged while hot and worked into rods.

Chicago - 431 R. Wells.

Russia Cement Co.

Edwin Jarvis
The Paragon, Washington, D.C.

954

An Oration at the Annual Convocation
Wellesley Hills, Mass

GREATEST RELIEF MAP IS SIXTY-THREE FEET WIDE

E. L. Nicholas, Geographical
Illustrator

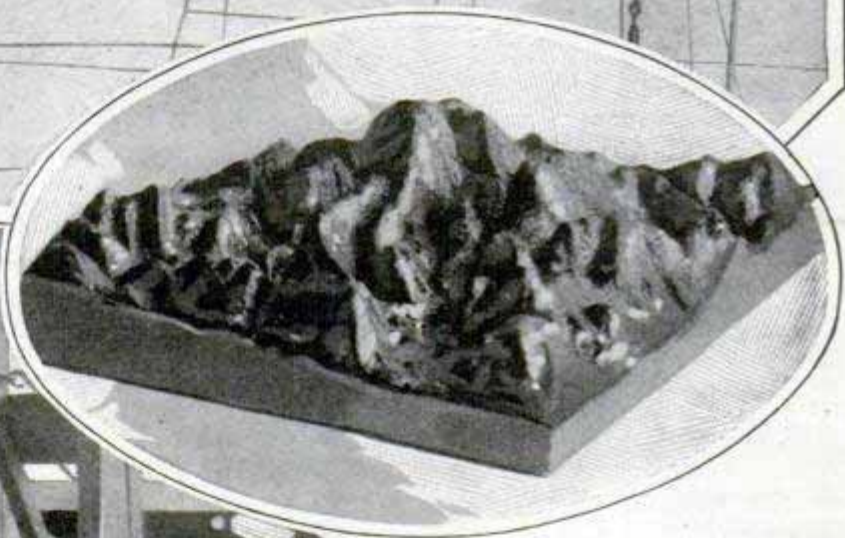
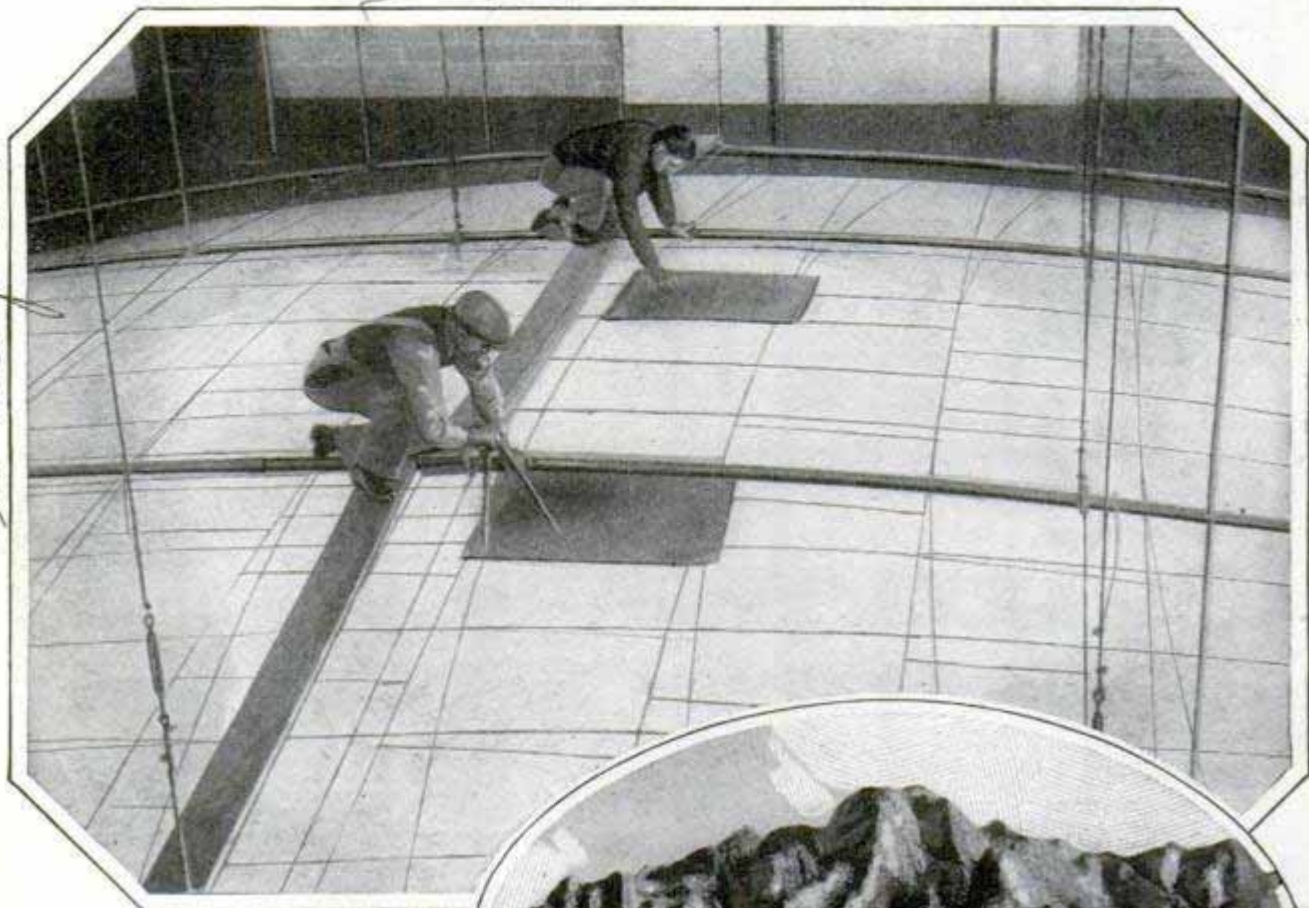

At Work on Section of Map of U. S. and Canada; It Is Curved to Conform to Shape of the Earth and the Plots Are Molded Separately; Right, a Block of Mountainous Territory Showing Detailed Modeling; the Finished Map Will Cover 3,000 Square Feet, at a Scale of About Four Inches to the Mile

Cutting Block on Jigsaw; More Than Twenty Men Are Working on Map

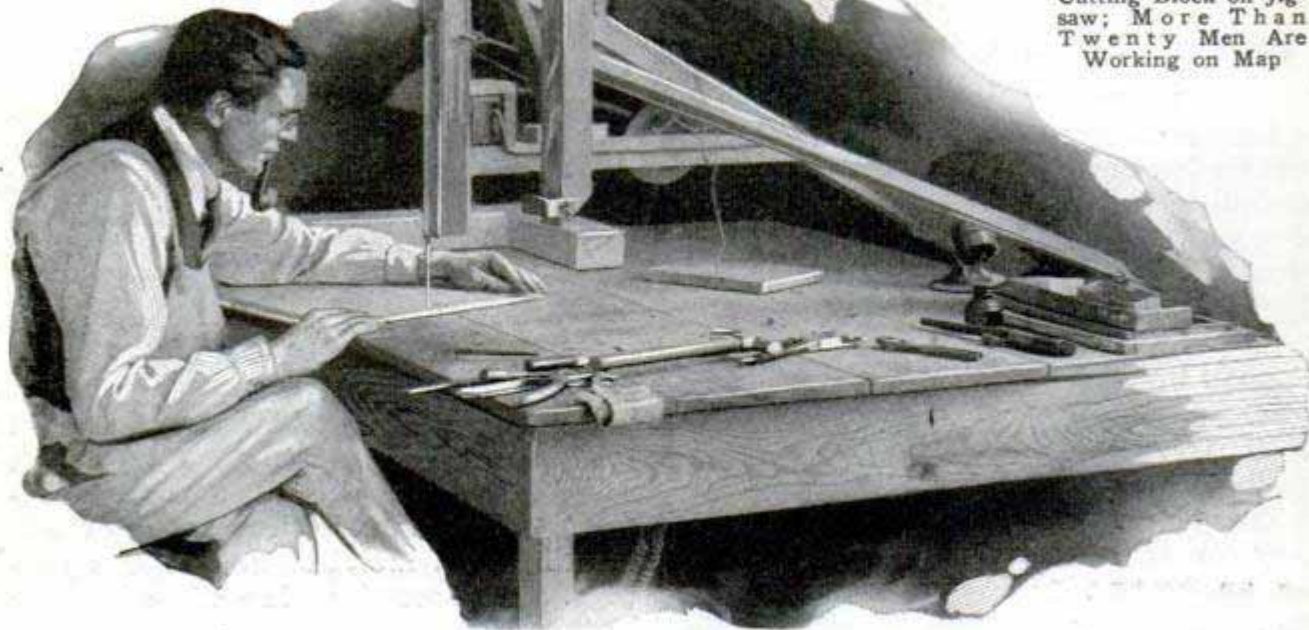

ms 9.2 13

1717 St. Paul St.
Baltimore, Md

HOUSES WITH FEWER PIECES TO CUT COSTS 958

By reducing the number of pieces needed in building a residence, research workers see a way to bring down the costs of construction. Sample houses of concrete blocks already have been built with the units reduced to 100 instead of the 75,000 that are used in the ordinary brick dwelling, when all the units of supplementary materials are counted. The New York tenement-house committee points out that sixty-three per cent of the cost of a house goes into putting the parts together. The hope of cheaper housing is, therefore, believed to lie mainly in cutting down the labor thus expended. It is thought that this can be accomplished, in a great measure, by using larger and standard-sized units. Some officials of the committee hold that it is possible to build concrete houses of these large units in three days, using but 100 pieces for a six-room structure. Representatives of the national lumber manufacturers' association have expressed the belief that frame houses can be planned with even fewer than 100 pieces to the house.

SAFETY REPAIR LIFT FOR AUTO SAVES ROOM 963

For use inside or outside the service station, an automobile lift requires less space than the usual rack and eliminates the task of driving the car up an incline and climbing down. It functions by oil pressure in a heavy cylinder, a motor-driven pump affording the power, and the car is elevated by the front and rear axles, leaving the wheels free. Space under the auto is unobstructed, allowing the mechanic access to all parts. An additional feature is that installation expense is saved. The lifting and lowering operations are smooth, steady and rapid, the manufacturers claim, and it is impossible to drop the car accidentally.

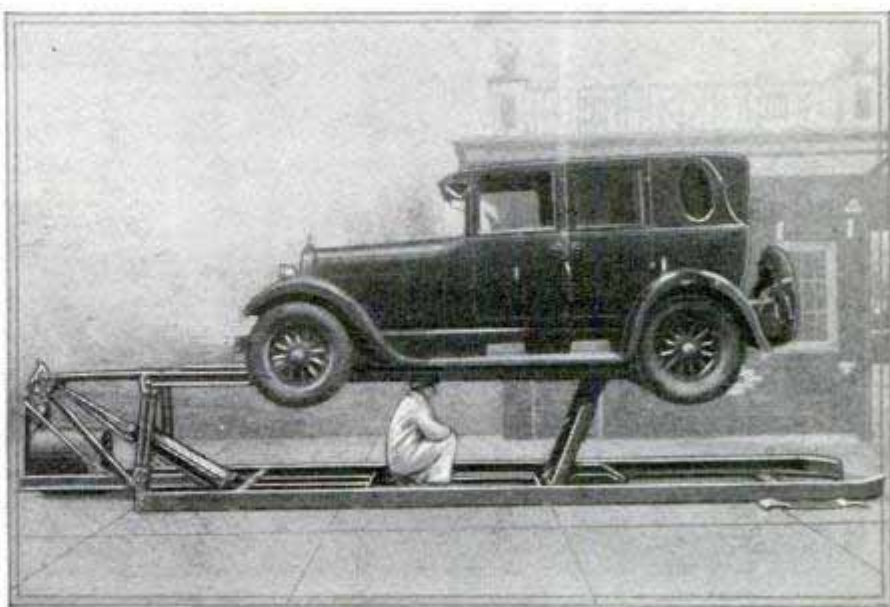

Repair Lift Raised, Showing How Wheels Are Left Free and Worker Has Unobstructed Space Underneath



A Sight-Seeing Ride in the Aerial Barrel: It Is Elevated by a Crane

BIG BARREL SERVES AS AIRSHIP AT AMUSEMENT RESORT

Visitors at an amusement park in Basel, Switzerland, are able to get a bird's-eye view of the grounds and surrounding country while riding in a big barrel that is lifted and swung about on a crane. The upper part of the cask's staves have been cut away so that the occupants can look out and a door permits entrance or exit.

Internal Power and Transportation Exhibits

Weaver Manufacturing Co. Ltd. Canada

Weaver Mfg Co., Springfield, Ill.

621

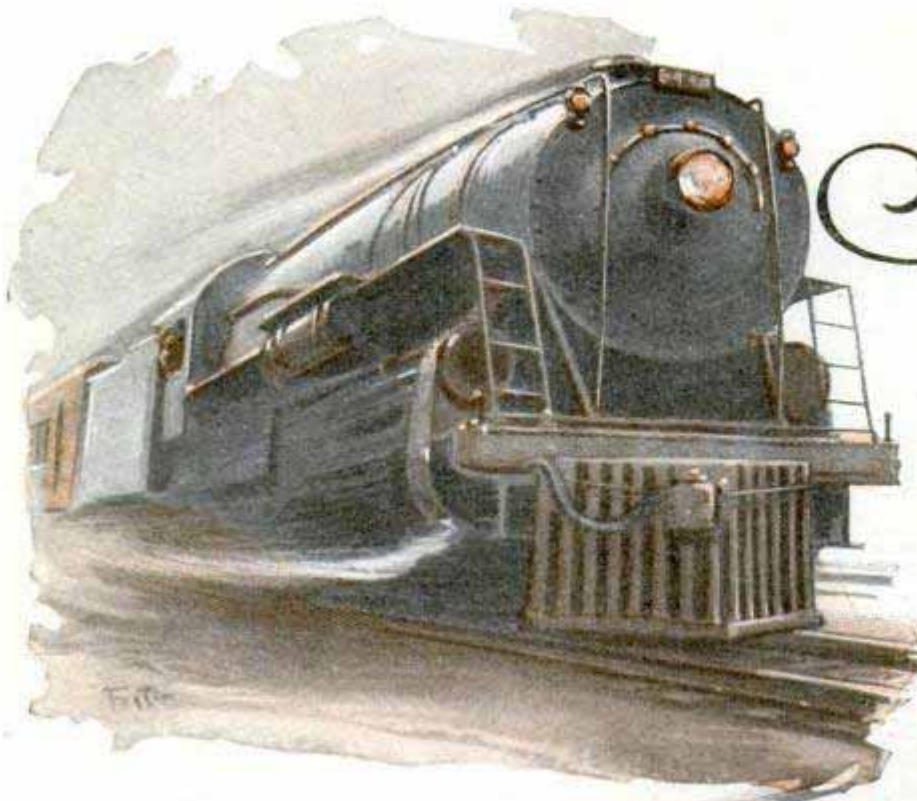

The

By JOHN

run in the world is made on the Great Western railway in England, from Swinton to Paddington station, London, seventy-seven and a quarter miles in seventy-five minutes at the rate of 61.8 miles an hour. Another train on the same road, the Cornish Riviera express, makes the 226 miles to Plymouth at the rate of 54.8 miles

The Twentieth Century Limited, Running between New York and Chicago, Is the World's Fastest Long-Distance Train, Covering 976 Miles

RIDING on one of the world's fastest trains is no easy job, if you are up in front in the locomotive, because you cannot sit down for a minute.

Although American railways are known for their efficiency, the fastest passenger

an hour. This is a non-stop run, during which sections of the train are cut off while it is going at full speed—a thrilling operation.

America, however, holds the honor of having the fastest long-distance train in

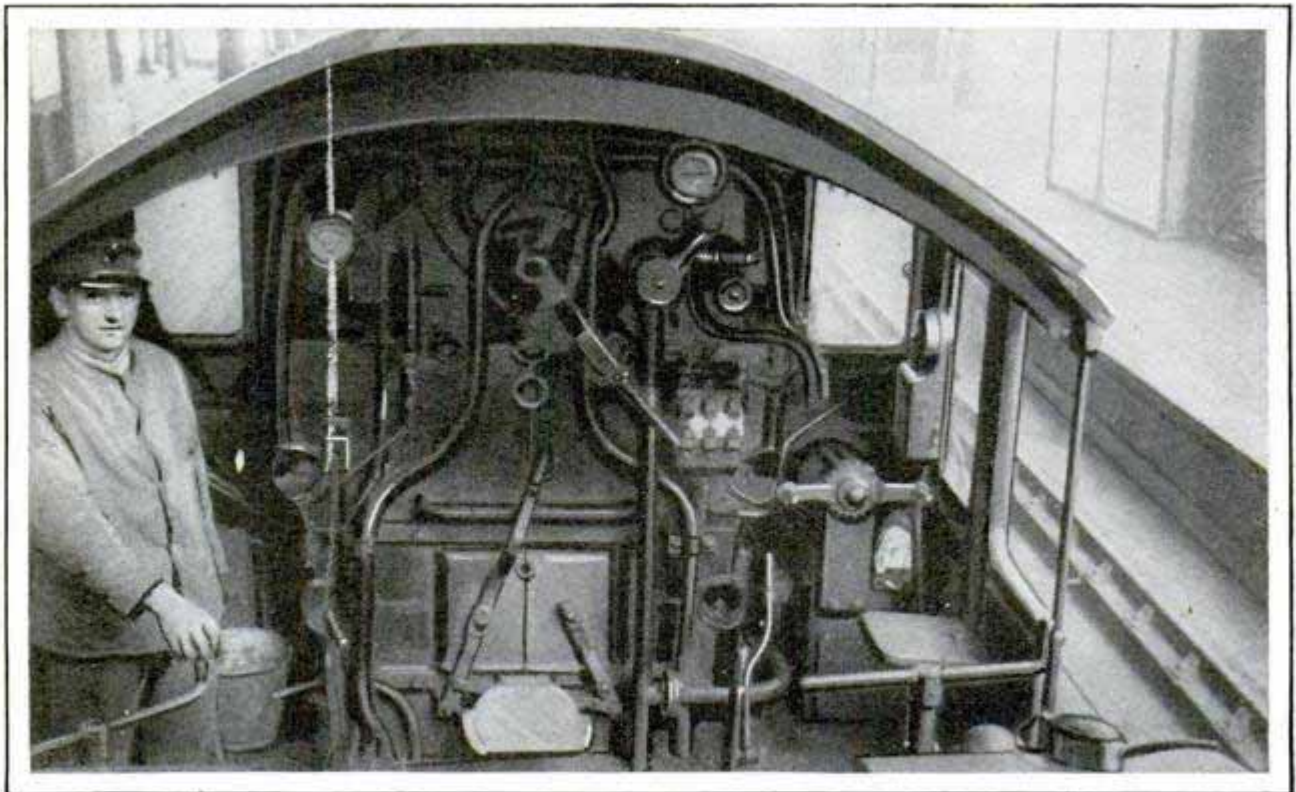

Interior of the Engine Cab of the "Lord Nelson," Which Hauls One of England's Fastest Trains, the Atlantic Express, Running from Waterloo Station to Devonshire

World's Fastest Train

A. FORD
205 Artistic
League Club
Los Angeles
Calif.

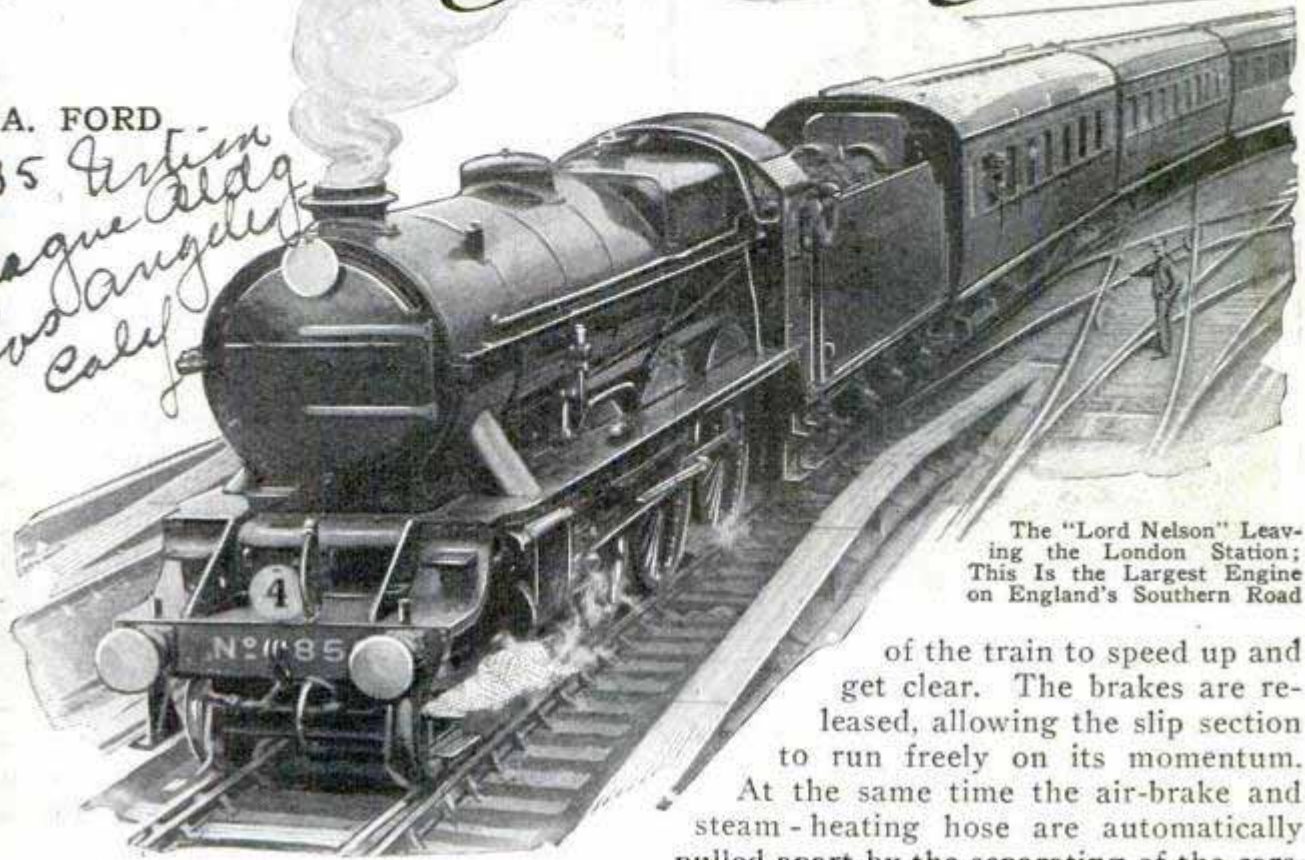

The "Lord Nelson" Leaving the London Station; This Is the Largest Engine on England's Southern Road

the world, the Twentieth Century Limited, which makes the run of 976 miles between New York and Chicago, in twenty hours at the rate of 48.8 miles an hour.

The fastest mile ever made on any railway, at any time, was recorded by the famous locomotive No. 999 of the New York Central on May 10, 1893. On a tangent, slightly downgrade, the speed was 112.5 miles an hour.

The Cornish Riviera express cuts off, or "slips," cars at three stations. In each case the "slipping" is done while traveling at high speed. The moment the engineer signals with his whistle and slackens the train, the guard in the section to be cut off pulls a lever which opens the coupling device, slips the car or cars and sets the air brakes. It only remains for the front part

of the train to speed up and get clear. The brakes are released, allowing the slip section to run freely on its momentum.

At the same time the air-brake and steam-heating hose are automatically pulled apart by the separating of the cars. Both are provided with valves which automatically close the exposed ends when the connections have been severed.

On the day I made a trip on this train two cars were to be slipped at Westbury, ninety-five miles from London, while the train was moving at a speed of about eighty miles an hour. Exactly on the dot, the express, composed of half a dozen coaches, started so noiselessly and so smoothly that I would not have known we were moving had I not been looking out of the window. But if the beginning was smooth and noiseless, the rate of acceleration was swift. The lightness of the English trains is a big factor in their quick get-away. Only a few rods outside the station we were moving at more than thirty miles an hour. As we approached

SOME OF AMERICA'S FASTEST TRAINS

			Miles	Speed
Number 1181.....	Penn.	Philadelphia-Atlantic City.....	60	55.4
Number 17.....	Reading	Philadelphia-Atlantic City.....	60	55.4
Twentieth Century Limited.....	N. Y. C.	Chicago-New York.....	976	48.8
Broadway Limited.....	Penn.	New York-Chicago.....	908	45.4
Southwestern Limited.....	N. Y. C.-Big Four	New York-St. Louis.....	1,157	44.1
Washingtonian.....	B. & O.	Philadelphia-Washington.....	133	43.6

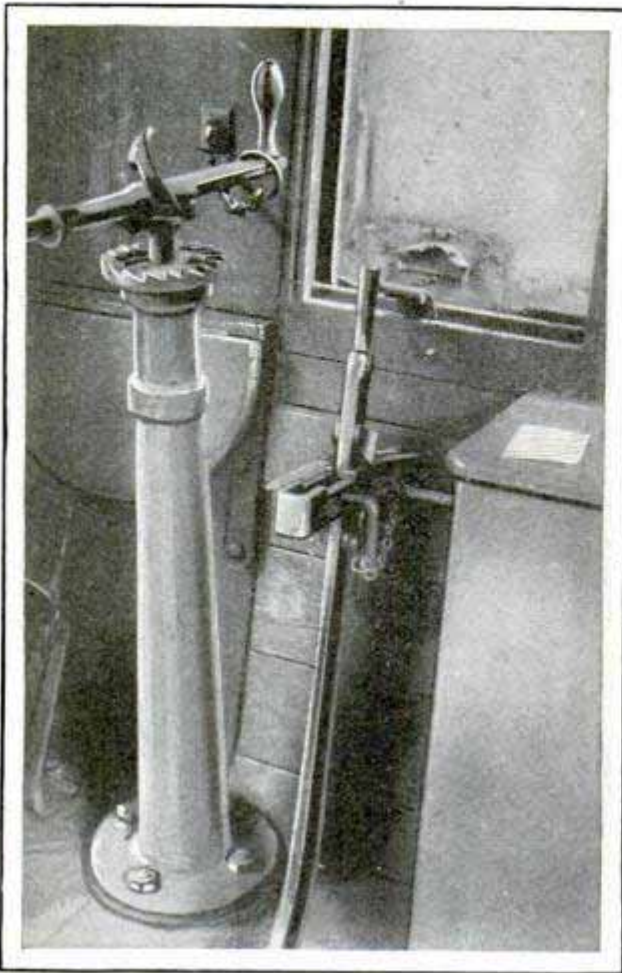

Vertical Lever, Right, in Guard's Compartment, Disconnects the Car and Drops It Off at Its Station

Westbury, the engine gave a shrill whistle and I felt the train slacken for an instant. Then the coach slowed up while the train disappeared from view around a bend ahead. Our speed gradually slackened and we rolled into Westbury as smoothly and quietly as if we had been riding on pneumatic tires. Riding back to London in the cab of the world's fastest train was different.

"Better stand over there by the fireman's window," the driver said when I showed him my special pass. I obeyed and began to get acquainted with the details of a speed monster different from any I had ever seen.

"Charlie," said the driver glancing at his watch, "better take a drink of this tea while you have time. You won't get another chance." And with that he held out to the fireman a steaming cup which had been resting on the vibrating iron shelf just above the fire door.

Charlie dropped his shovel for an instant and took the white cup in his blackened hand. The engineer looked back toward the station and I heard the guard's "go ahead" whistle. The brawny hand of the driver was on the "regulator handle" gradually giving the monster steam. Imperceptibly we began to move. Notch by notch he opened it wider until the whole frame of the speed machine swayed from side to side. To avoid getting in the way of the fireman, whose shoveling was almost continuous for the next hour and fifteen minutes, and to prevent being thrown against hot steam pipes, I kept hold of a brass pipe and spread my feet apart.

The rumble and roar of the engine and train was incessant now that we were under full steam. The engineer's face was a fascinating study. He scorned the folding seat beside him and much of the time leaned clear out of the cab watching the right of way ahead intently. From years of service—later he told me he had been a driver for fourteen years—his face had taken on the same squint that one sees in Bill Hart's eyes. There was something almost fierce in that penetrating look. With but

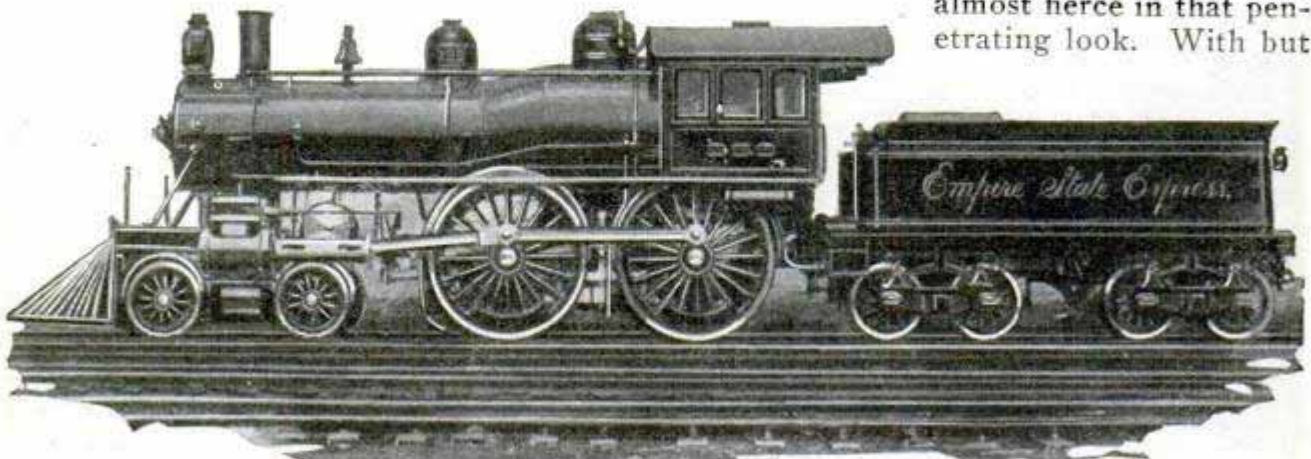

The Fastest Locomotive That Ever Traveled, the New York Central's Famous Number 999, Hauled the Empire State Express May 10, 1893, at a Speed of 112.5 Miles an Hour

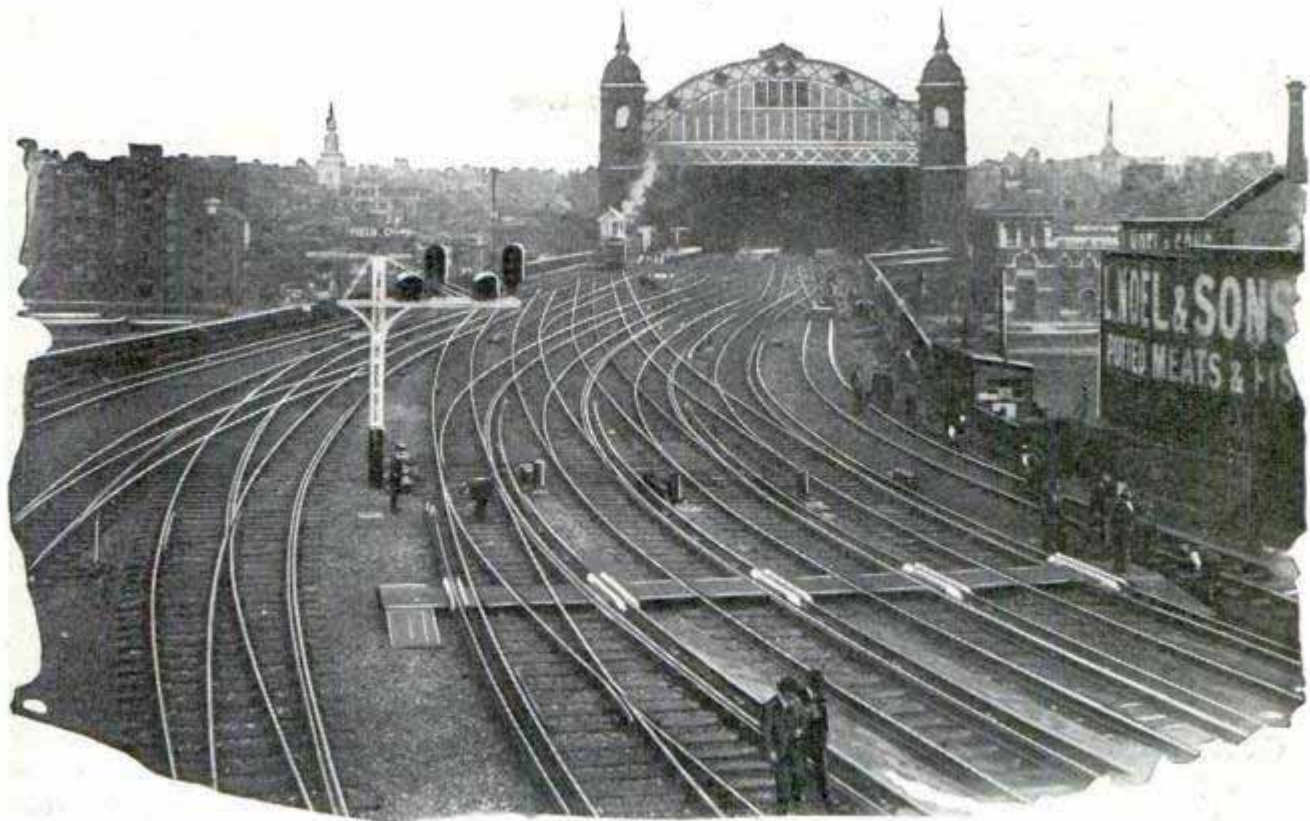

Cannon Street Depot, in London, Which Has Been Electrified, Handles So Many Suburban Trains That, during Rush Hours, One Leaves the Station Every Half Minute

two or three exceptions his hand never left the regulator handle. With a grimy cap pulled well down on his forehead and with his head thrust slightly forward, he forced his locomotive at well-nigh top speed through town and countryside. Now and again he would glance at the steam gauge whose needle quivered incessantly at the red line marked "225." Once or twice in the long wild run he turned to see if Charlie was feeding the iron monster all it could hold.

The towns lie close together in England, especially within a radius of seventy-five miles of London, and they are towns with manufacturing plants, fine railway stations and many other things which mean intricate rail systems. Had I not been prepared for it, the speed with which we roared through these places would have taken my breath away. Gazing at the maze of tracks into which we plunged again and again without slackening speed so much as a hair, I half wondered if we would go crashing into buildings or rolling stock. But always the signals spelt safety and always the vibrating iron horse found a clear path without a second's hesitation.

As the minutes passed and I stood watching the shining rails ahead, I came

to understand more fully one great advantage which British trainmen have over American crews. The American engineer is tortured with the haunting fear that he is going to kill some one. In England that possibility is almost wholly removed. The rights of way are without trespassers, and with but few exceptions there are no grade crossings. The highways in England go over or under the railway tracks. In the few instances where there were grade crossings, high gates were provided. These gates always stand across the highways except when traffic is passing, and when the gates are opened for motor cars or wagons, they are swung across the railway. In England trespassing on railway property is an offense that is quite apt to land one in jail.

At last we were in the outskirts of London, and the buildings became more numerous, yards and gardens grew smaller and less frequent, and street traffic grew more dense. But our driver never slowed up except on one or two occasions. Then the big lever was moved from its position only for a few seconds, after which the shrill whistle was sounded more frequently, often beginning 200 yards before we reached a depot and continuing until we had entirely passed the station platform.

*Mr. ...
A. 525, Union Station
Chicago*

995



Exhibiting Grotesque Mask Molded for Unique Crafts Display in Los Angeles School

GRADE PUPILS MODEL MASKS FOR SCHOOL EXHIBIT

Grammar-school pupils of Los Angeles recently demonstrated their skill as stage craftsmen in an exhibit of miniature scenic sets, masks and other theater equipment. Models of animals from the nursery rhymes, and small boats were also shown.

SLING-SHOT DRILL FOR CADETS IMPROVES MARKSMANSHIP

Cadets at a British military school utilize the lowly sling shot to train their eyes and steady their nerves that marksmanship with guns may be improved. Shooting from difficult positions is often necessary and training is afforded by firing the "rubber guns" while lying on the back.

917



Sling-Shot Drill at British Military School

INQUEST OVER BROKEN RAILS KEEPS RAILROADS SAFE

1036

Every time a steel rail breaks in-service an elaborate investigation is instituted to fix the cause and the blame. The history of every length of rail in thousands of miles of service is kept on file, and if five per cent—from five to seven rails—break in any one batch of rails made from the same "heat" at the mill, all the rest are hunted down, removed from main-line service and relegated to switches, side-tracks and little used branches. The precautions used on the vast mileage of the Pennsylvania railroad system are typical of those common on all American roads. When a break is found, the foreman of the section gang fills out a report covering the complete history of the rail, and on printed outline drawings fills in three views of the break. The fifty-six questions which he must answer cover not only the name of the maker, the heat number and the date the rail was installed, but the hour of the break, whether a train had just passed or not, whether the break interrupted the electrical-signal system and set the stop signal to protect trains, the condition of cross ties, joint bars, ballast and even the kind of drainage near by. All that information passes through several inspectors' hands, and, if the facts warrant, the broken rail is shipped to the experimental laboratory at Altoona, Pa., for chemical, physical and microscopic tests. Modern 130-pound to the yard rails are expected to stand up under the passage of 200,000,000 gross tons before they are removed from main lines to less heavy duty. The ends are then cut off to remove the sections where the greatest wear has occurred, and the shortened rail is used for lighter traffic.

Blind persons in an Iowa city carry canes with a red glass disk at the top and when they want help in crossing a street, hold the stick horizontally to signal for aid; the plan has proved entirely successful.

1062

Dubuque

97

Spanish War Memorial

MAKING OF A MONUMENT—FROM MODEL TO BRONZE

for San Juan Hill in Cuba

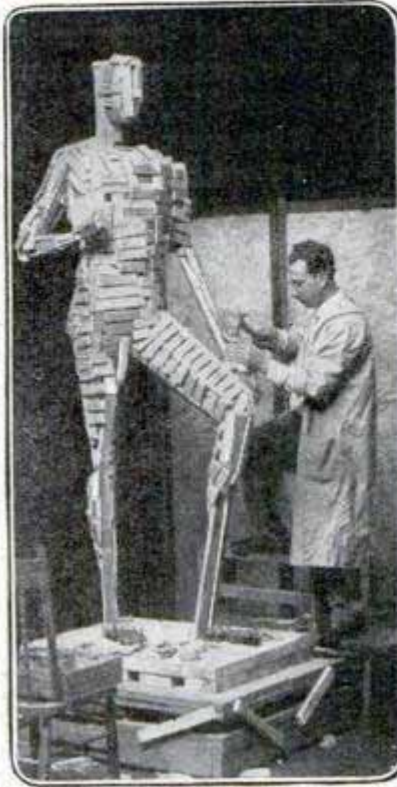

First Step after Completing Small Working Model; the Wood and Steel Framework



Shellac Is Next Applied; Then the "Armature" or Base Is Covered with Clay



Upon Rough Clay Figure True Points of Small Model Are Made with Pantograph



Clay Is Then Covered with Plaster Which Is Strengthened with Iron Pipe



When Plaster Has Set, It Is Broken Off in Sections and Reassembled



The Bronze Is Made from the Plaster Model, and Is Then Smoothed and Polished

Herbert Photos

SKILL AT TYPEWRITING IS REVEALED BY MIND TESTS

783



sure exerted on the keys. There are tests for optical concentration under a strong light and of visual power. To show whether both hands work well together, pearls are threaded as rapidly as possible on a needle. To test concentration and speed, candidates are required to call out and locate in proper sequence let-

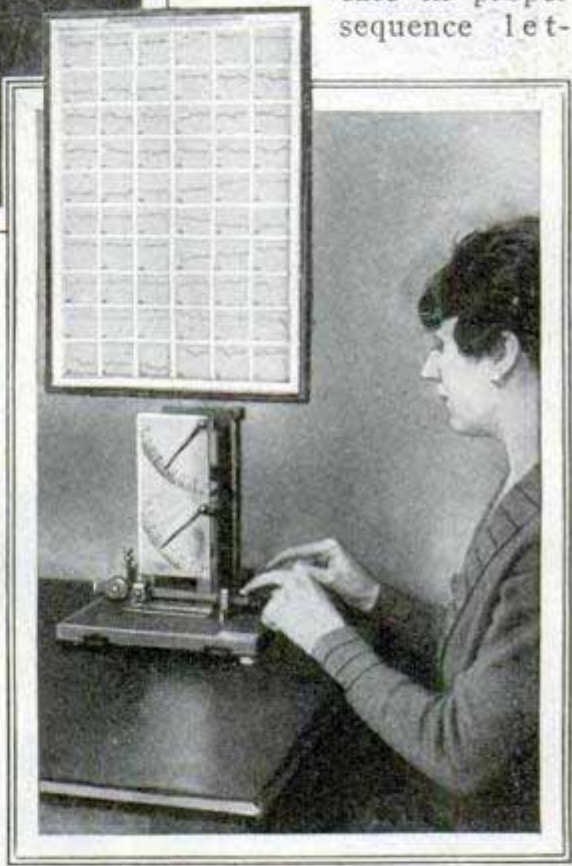
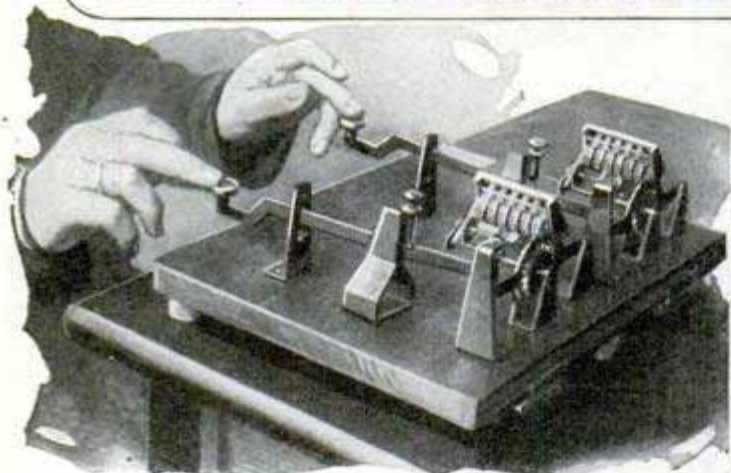

Some of the Tests Given to Typists; Above, Reading Copy Lines, and Finger Tests for Speed and Strength

Tests to determine the qualifications of typists have been worked out in Berlin. First a reaction machine tests speed of finger movement. Two levers, like typewriter keys, are pressed as often as possible for one minute. An indicator counts the strokes and a balance records the pres-

ters which have been disarranged on a calendar. Skill in hand work is shown by a test in taking out screws from a block of wood, using various-sized screwdrivers.

STUDY OF SHORE LINES TO TELL IF EARTH IS SINKING

83 national research
Investigators have started a task that may take twenty-five years to finish, a careful measure of the shore lines along the Atlantic coast to determine if the North American continent is sinking. Some geologists believe that it is subsiding at the rate of one or two feet a cen-

tury, and to find if this is true, hundreds of measurements are to be made with tide gauges in Jamaica Bay, Eastport, Me., and at St. John, N. B. The United States coast and geodetic surveys, New York city dock department and the Canadian government are expected to co-operate in the work. Plans have also been made for measuring the shore lines on the Pacific coast for the same purpose.

Kansas City Journal 6:00 pm. 14, 1926
no further information

**FIFTY-MILLION-DOLLAR LOOT
BURIED ON PIRATE ISLE**

There's fifty million dollars in doubloons, pieces of eight and treasure of the Spanish main waiting on a desolate island off the coast of Brazil for the person who can find them. This is the word of George Finlay Simmons, curator of the Cleveland museum of natural history, who spent two years in the south seas as commander of the steamer "Blossom," visiting three continents and bringing back a number of specimens for the museum's collection. The treasure is believed to lie where it was buried a century ago by two pirates who took it from the Inca Indians. One of the hoards, valued at \$40,000,000, was captured by a Spanish rover, Jose Santos. It was taken from a ship loaded with gold and silver bars, altar vestments and candelabras from the churches of Peru. More than \$8,000,000 additional was buried on the same island by an English pirate who called himself "Zulmiro." Records of the prize were kept and were in the possession of the Russian quartermaster of the ship until he died in the far east. Between 1800 and 1892, eight expeditions were made in search of the treasure. Some of them did not even reach the island. Those who did were foiled in their hunt when they found that landmarks on their maps had been obliterated by a slide.

**EMERGENCY OVERSHOES
FIT VANITY CASE**

So small they fit into a box about the size of a vanity case, emergency overshoes are being made of light, transparent rubber. They roll on and off the shoe in a jiffy without bothering as to size or shape. The rubber is about the thickness of that in surgeons' gloves and bathing caps, does not damage the leather and may be worn inside the shoe as an additional protection for the feet against dampness. At present the rubbers are made in the natural color only, but later they will be supplied in various shades to match those of ladies' slippers.



Slipping On the Rubbers, and How They Look on the Shoes

dr. Harry J. Powers,
310 S. Michigan Ave

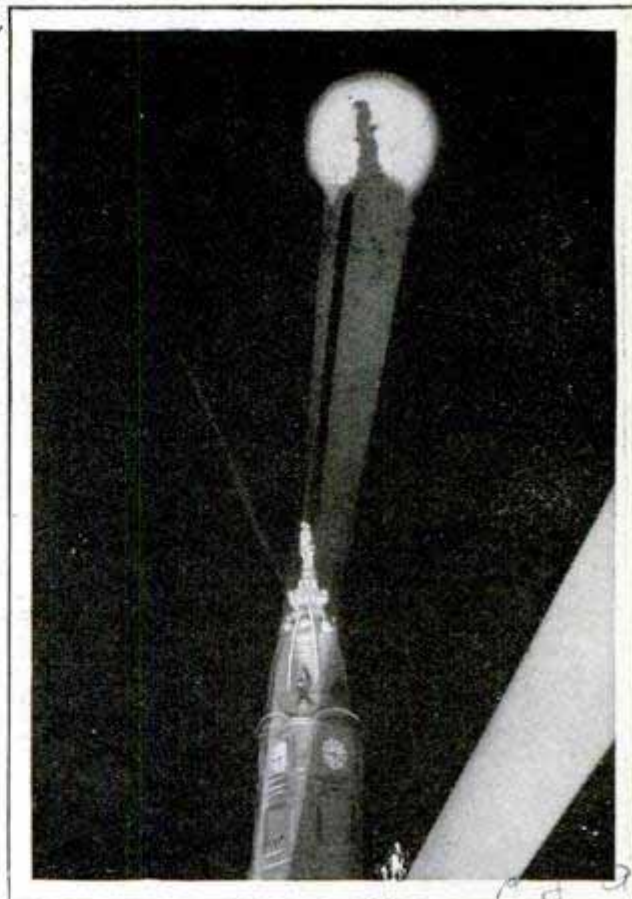

Shadow of Penn Statue Cast on Low-Hanging Clouds by Powerful Searchlight

**STATUE SHINES ON THE CLOUDS
OVER SEARCHLIGHT**

During the illumination of the William Penn statue on the tower of the city hall in Philadelphia, a weird effect was noticed when the shadow of the figure was seen on a bank of low-hanging clouds, giving the impression of a "spirit" or double view. Such occurrences are not particularly rare, but generally the light is not sufficiently strong to cast a shadow that can be photographed. In this case the powerful searchlight, shining from below, caused an unusually clear-cut shadow.

☐ Cable insulation and hard-rubber compounds are being prepared from synthetic rubber that lacks elasticity.

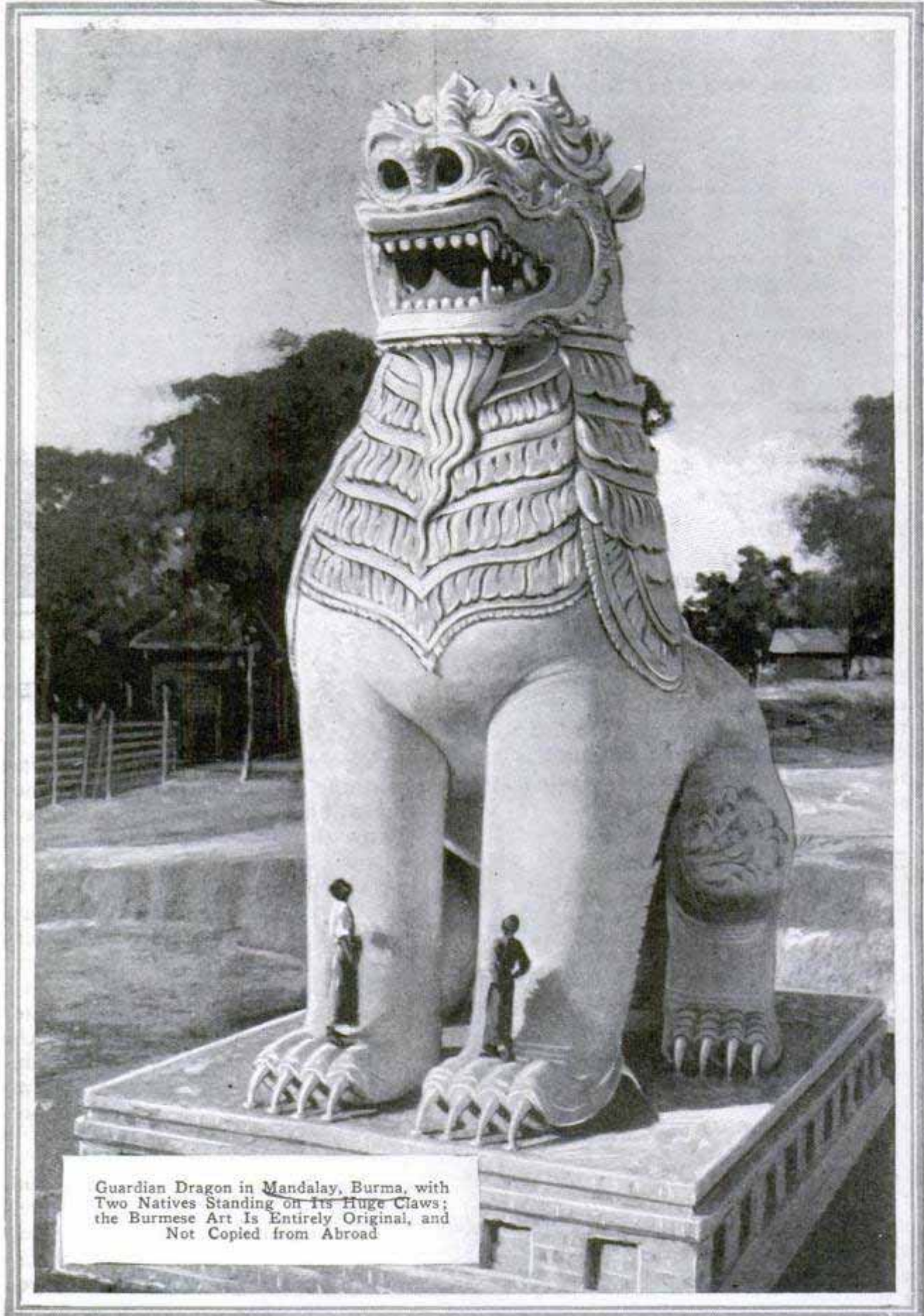

Guardian Dragon in Mandalay, Burma, with Two Natives Standing on Its Huge Claws; the Burmese Art is Entirely Original, and Not Copied from Abroad

211
inventor surveying apparatus
OIL WELLS DO NOT RUN STRAIGHT

Deep oil wells generally are not straight, but abound in twists and turns, the deflections in some cases running to hundreds of feet. A survey of a well in California showed that at a depth of 6,000 feet it was 517 feet out of plumb. A chart of some wells, it is said, would look more like a corkscrew than a straight line. Strata of different hardness and tilted layers, which make drills slide off at an angle instead of cutting straight down, are among the chief causes for these twists in the wells. A well may be started in the middle of a tract of land and end at the bottom under a different tract. Wells sometimes wander into each other with consequent damage and the possible ruination of a producer. Two wells started together may often vary widely instead of following parallel courses, thus complicating the task of drilling.

FISH KILLED TO SAVE SARDINES START NEW INDUSTRY *981*

Hunting the tuna fish was formerly done to protect the sardines, which they devour in large numbers, but since the tuna is now popular for food, it is the basis of an important phase of the fishing industry. In the Mediterranean, the tuna are detected by watchmen who sit in chairs on high extension steel ladders on the coast and relay word by telephone when a school of the fish is sighted. By means of sardine bait, the fish are lured into a bay, called the "death chamber." This chamber is a square inclosure of heavy netting which is closed at the entrance when a number of fish have been caught in it. Then the men, working from a float around the net, kill the tunnies with spears.

*Herald Examiner
11/21/26*

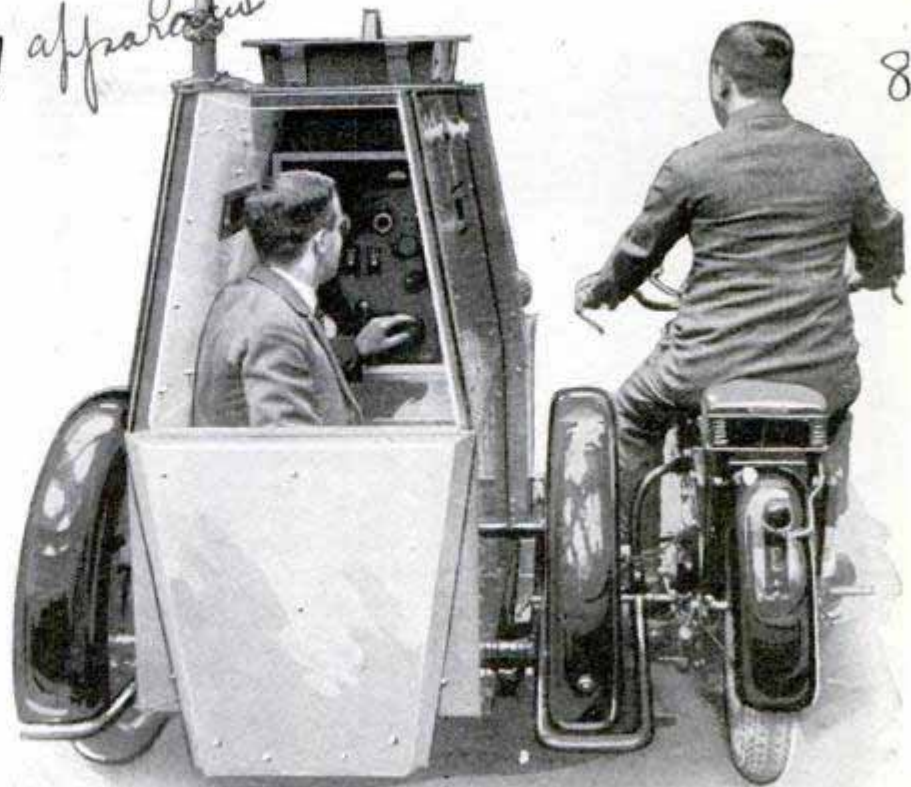

Radio Sidecar for Police Work in Berlin; It Can Be Disconnected and Run on Own Power

ARMORED SIDECAR WITH RADIO AIDS IN POLICE WORK

Besides having a radio receiver, an armored motorcycle sidecar, introduced in Berlin, can be detached and run on its own power. The protected top of the car is built high enough to afford room for the operator inside and slants abruptly in order to deflect bullets.

DETACHABLE BILLIARD-CUE TIP AIDS ACCURATE PLAYING *960*

Caps for billiard cues are made detachable by means of a threaded-sleeve device

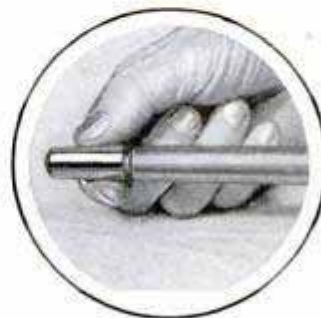

a western inventor has introduced, so that they may be removed and laid away where they will not be damaged after the game. The tip is held securely to the threaded section by gripping jaws so that there is little danger of its becoming loose while a game is being played.

*J. Krstich,
Smith Omaha*

W.C. London, England

844

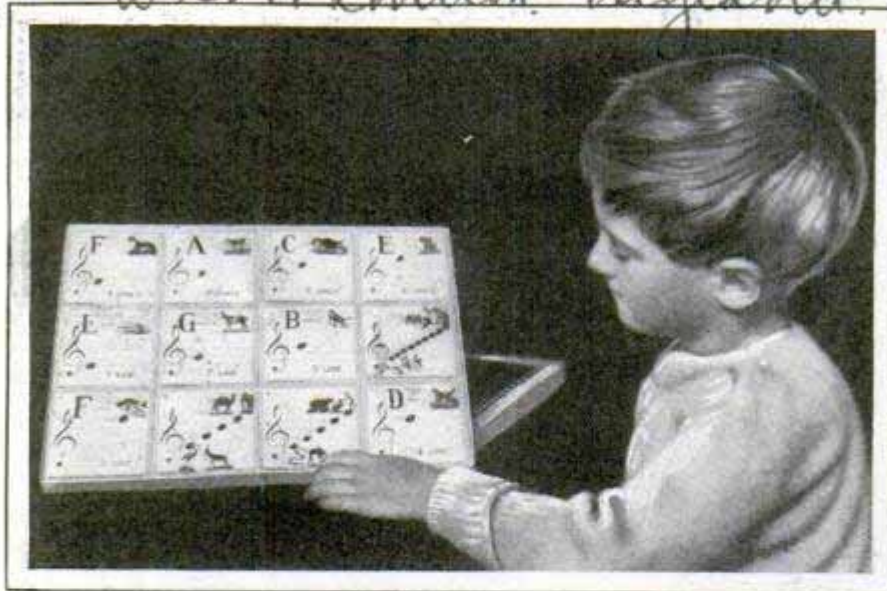

To Make the Music Lessons Easier; These Blocks Are Printed with Notes and Scales as Well as Animal Pictures

BLOCKS TEACH CHILDREN MUSIC AND NATURAL HISTORY

To familiarize young children with the rudiments of music, blocks have been prepared that have notes and parts of the scale printed on them. The spaces of different notes are designated not only by diagram but by a picture of an animal as "cat" for the note "c."

BIG FLOATING ISLAND CAPTURED TO PREVENT INJURING DAM

Floating islands have been discovered in various parts of the world but few of them caused any trouble. However, when a block of land, estimated to contain eight or ten acres, broke away from the banks and floated down the Racket river, in New York, toward a power-plant dam, men and trucks were hastily assembled to capture it. The island was stopped and lashed to the shore with cables, but broke away again. It was finally made fast by towing it into a bay and building cribs of logs filled with stone about it

882
Hogley Falls, near Potosi, N.Y.

to prevent further journeying. The Racket river is a swift-flowing stream and carries a great volume of water.

ENGLISH CLIMATE SLOWS U.S.-MADE TIMEPIECES

American visitors to England have found that they must set their watches ahead three minutes or so to counteract the effect of the climate upon the works, and some travelers have had to adjust their timepieces

at least twice a week. One manufacturer attributes the slowing to the damp climate. Many watchmakers declare that a change of altitude is more likely to affect the works than change of temperature.

FIRE ENGINE LIKE LIMOUSINE PROTECTS THE CREW

Firemen of a Paris company are shielded from unpleasant weather and water when answering calls or combating flames as their engine has an inclosed limousine-like body. The unit is provided with heavy tires, wire-glass doors, and several lines of hose can be attached to it at one time. A coupling hook at the rear permits using the outfit for towing.

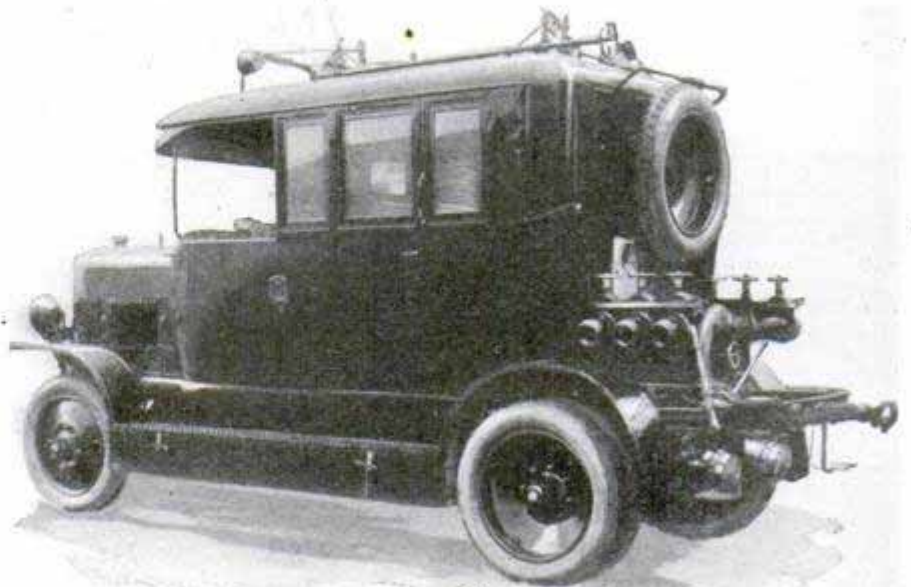

Luxury for the Firemen; the Limousine Engine of a Paris Company Shields Occupants from Wind and Water

Chicago Daily News 11/10/26



Pilot Wesley Smith, of the Air Mail, Dressed in Fur-Lined Clothes and Ready to Hop Off on a Night Flight across the Mountains, Where Storms Are a Constant Menace to Flyers

LABORING along in a sea of cloud and fog, a night air-mail plane not long ago fell victim to one of the last of the great unconquered enemies of flying—ice—and was brought down at an emergency field in the heart of the Alleghenies. You have seen pictures of great transatlantic liners staggering into port with bows loaded under tons of frozen seas, but few, outside aviation circles, know that the same danger faces the airman thousands of feet above the earth.

When the cold, wet clouds hang low over the mountain tops and the craft are forced to climb through them to gain sufficient altitude to clear the peaks, the trouble begins. The moisture collecting on wings and propeller turns to ice. Great balls of it accumulate along the front edge of the wings and break up the air streams so badly that, even though the added weight may not suffice to bring the ship down, the loss of lift through interrupted air streams does the trick. When that happens, there is nothing to do but hunt an emergency landing field, and trust to luck that it will be good enough to fly out of again without waiting for dawn.

With such fields located every seventeen miles, the danger of a forced landing does not appear great, but actually it is enormous. Many of the fields are bad, since they are only meadows leased from

farmers; few of them are safe to fly into at night and still harder to fly out of. Added to a naturally difficult landing ground is the fact that the load of ice makes the landing speed of the ship from twenty to thirty miles an hour higher than normal—a condition that would be serious on even the best of fields.

"Bad weather," says Wesley L. Smith, one of the pilots who fly the night mail over the Alleghenies, "is our worst problem. And on this stretch we have more varieties of it than on any mail route in the country. I have flown over the Rockies, where altitudes are two and three times as great as they are here, but found them far easier to pass. In summer, the west seldom has thunderstorms, while we have them here almost daily. In the winter, in the Rockies it is either too bad to start out or else good enough to get through without difficulty. Here it is usually possible to start and often so bad at the finish that you wish you had stayed at home."

The summer rainstorms do not cause great trouble in themselves, for rain does not interfere seriously with visibility, but they usually are accompanied by low clouds and fogs, which come within 200 feet of the ground in flat country, and envelop all mountains, often rising to heights of 5,000 to 10,000 feet. At those

altitudes there are strong westerly winds, a decided help to the east-bound pilot, but ruinous for the west-bound plane, since gasoline is soon exhausted fighting them.

A St. Louis-Chicago plane last fall had an experience with fog on a bright moonlit night. When the pilot arrived over Chicago, he found 4,000 feet of fog and, because of the bright moon, could not see the powerful landing lights on the Maywood field. He circled around for two hours, hoping that a cloud might blot out the moon or the fog thin. Finally, with gasoline almost exhausted, he flew to the west for thirty miles to be clear of the city, shut off his engine to save the mail bags from possible fire, and stepped over the side with his parachute, thus making a safe landing.

"We can start," Smith says, "in any fog, and land through it if the landing lights are visible. I did this one night at Bellefonte. The mountain near the field rose above the fog and guided me until I could see the landing lights straight down through the mist. I circled off and came back for the landing, only to find I had lost the lights. I made three trials, and on the third got in safely, though the visibility was less than 500 feet.

"Winter brings its own problems, not only of ice, but of snow. The clouds usu-

ally are higher in snowstorms, touching only the mountain tops, but visibility is poor; usually straight down is the only direction in which you can see. I flew through such a storm for an hour east of Cleveland one night, seeing only the towns and beacons as I passed. I was not in the clouds, for my landing lights on the wing tips did not flare into huge balls of luminous vapor as they do when flying in clouds."

Snow is a great help in flying, for even on the darkest night it is possible to see the ground. But, on the other hand, deep snow on an emergency landing field prevents its use, for the unlucky man who lands there must await a thaw, or the arrival of skis to replace the wheels on the ship before he can take off. The main terminals are rolled to pack the snow and planes can land and start easily with the wheels.

"When forced to land in winter on an emergency field," Smith said, "we always keep the engine running because it is too hard to turn over the propeller and start it again without assistance. An engine can be idled for several hours with very low gas and oil consumption, and the flight resumed when the weather clears. If the engine must be stopped, it usually is necessary to send out two experienced mechanics from the nearest terminal to help get it started again."

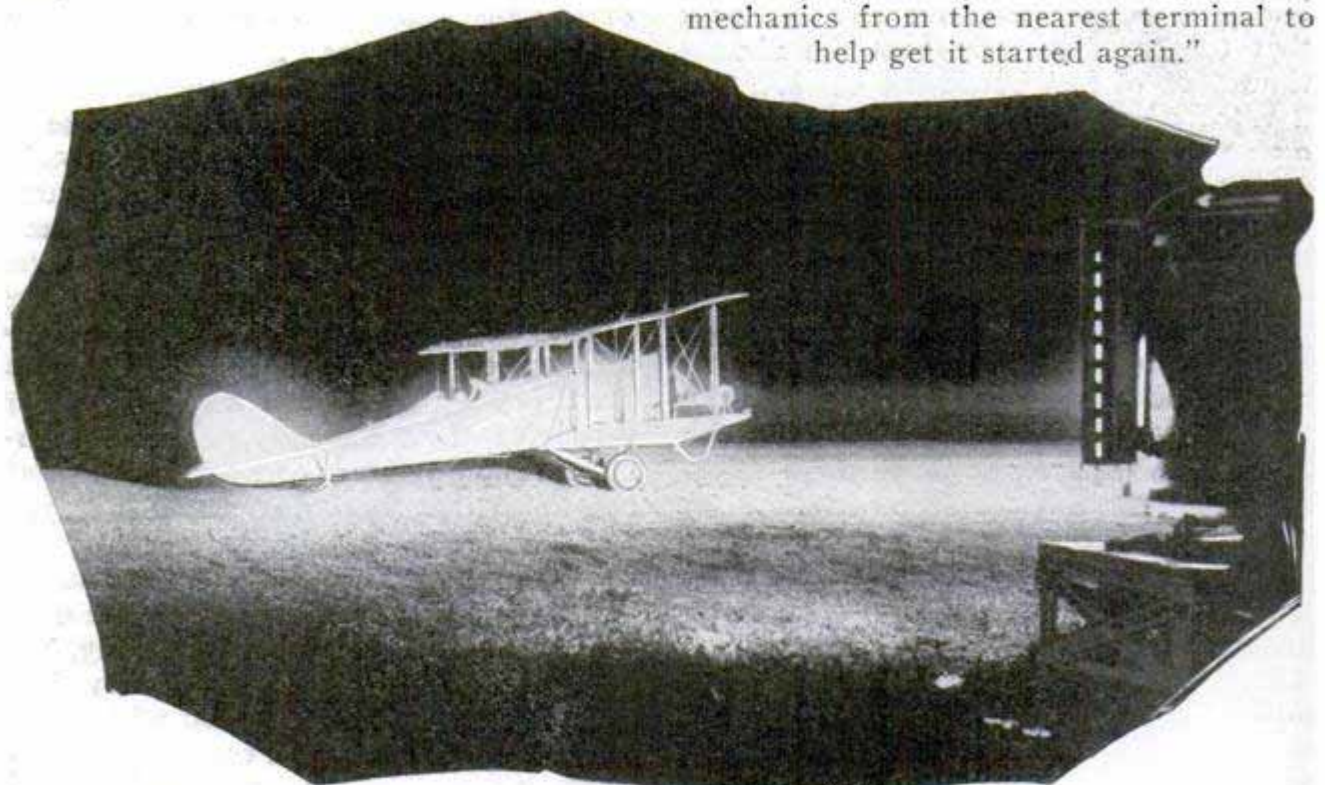

Powerful Floodlights on Landing Fields Are Designed to Throw a Low, Widespread Beam, the Top of Which Will Be below the Eye Level of the Pilot, to Prevent Glare

Flying isn't so bad, even in the coldest weather, in the new Douglas planes, which are replacing the old DeHavilands used for so many years. The cockpit is deep and the pilot is well protected, while a heater provides more hot air than really is needed. One of the exhaust stacks is surrounded by a jacket which delivers hot air in front of the flyer's feet. The outlet usually has to be turned away, however, because the air is so hot that it almost will burn the feet.

The pilot sits so low in the new craft that an arrangement had to be provided to hoist him up when he wanted to look over the side. The seat is equipped with powerful coil springs. Normally, his weight holds the seat down, but to get a

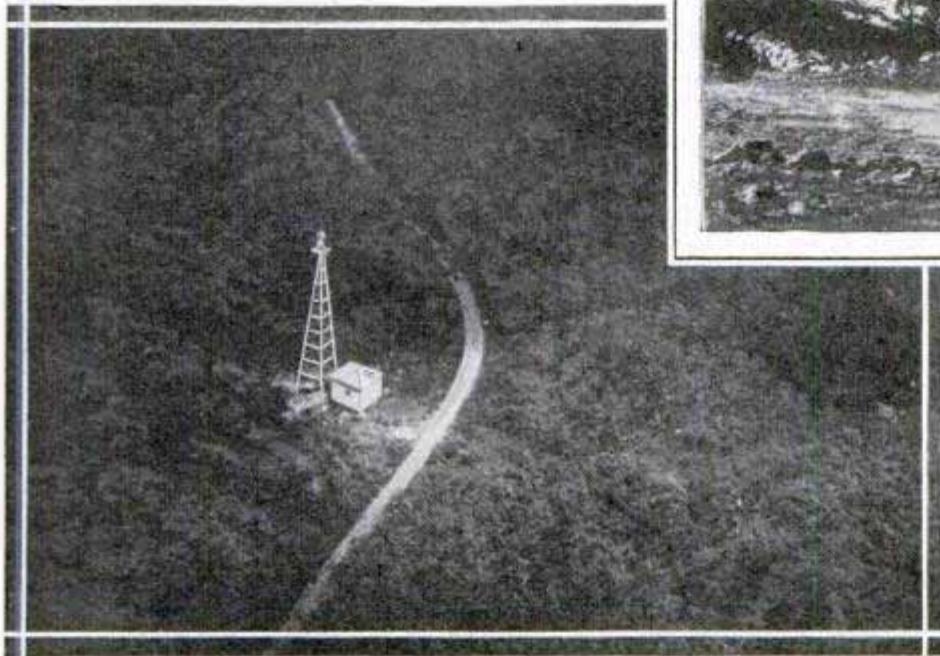

Beacon on a Wooded Mountain Top in the Alleghenies, Showing the Lack of Landing Fields; Above, a Beacon on a Wind-Swept Height



look over the side he has only to ease his weight and it shoots up like a jack-in-the-box. To go down again, he presses a button and the seat sinks under him.

The new planes also have reduced the ice danger. Their wings are of the thick type, less inclined to pick up ice balls than the thin wings of the older type; the braided-cable stay wires have been replaced with streamlined steel braces, and the aileron controls are concealed inside the wings. The old craft had the aileron cables stretched along the front edge of the wing, exposed to ice and with unprotected pulleys. It was necessary to work the ailerons on the wing tips constantly in bad weather to keep the pulleys from freezing tight.

whether the pilot is flying straight; a bank indicator to show whether the ship is going into a side slip; the fore-and-aft level, and the usual air-speed, engine-speed, gas, oil, water and electrical indicators. The bank indicator, built by one of the air-mail mechanics, is simply a slightly curved tube, filled with alcohol and containing a large steel ball, with very little clearance between the ball and the tube. If the ship banks, one wing dipping, the movement of the ball indicates the fact.

Besides watching all these instruments, the air-mail flyers have many other accessories to deal with. There are three navigating lights, red and green on the wing tips and white on the tail, and two landing lights, also on the wing tips. In addition



Hangars Are Covered with Lights to Warn the Pilots to Steer Clear in Making a Night Landing; the Dispatcher's Office Is in the Corner, and Back of It, the Pilots' Clubroom

Major Chase, Abbey Road, Chertsey, England.

to the latter, two big landing flares, attached to parachutes, are carried in a special compartment, from which either or both can be discharged by pulling a lever. Another lever pulls out pins which release the gasoline tanks, so that they may be dropped into space to remove any danger of fire in event of a crash. The tanks, which are built into the wings, are held in place by fabric strips passing be-

neath them, while connection to the gas pump line is made by a butt joint, kept tight by springs against the gaskets. All of the tapes are controlled by wedges, and when the release lever is pulled, the wedge slips out, freeing the tapes.

Despite the load of extra equipment for night flying—the lights and electrical system alone weigh 250 pounds—the new mail planes can carry 1,000 pounds of mail.

**GLASS TRAPS FOR SUNBEAMS
AID PLANT GROWTH**

2265

As a substitute for permanent hothouse or garden frames, small tent-shaped glass units held in place by anchor wires have been used successfully in England. Set together along a row, they form a practically shadowless covering for the plants, retaining the sun's warmth, deflecting rains toward the roots and protecting the leaves from soot. The ease with which the "traps" can be moved is considered a desirable feature.



© The Fleet Agency
Little Glass Tents for Garden Plants to Aid Growth

Major Chase, Abbey Road, Chertsey, England.

Los Angeles 1819 E. 25th St. Los Angeles Calif
POPULAR MECHANICS
1032

MONEY FROM CITY RUBBISH

Instead of paying to get rid of its rubbish, Los Angeles sells it to concerns which convert it into marketable materials. Garbage is sold for sixty cents a ton for hog food and a by-products company pays \$500 a month for the city's junk. About eighty truckloads are received and sorted daily. Scrap metal is burned free of wood, paint and other foreign substances, pressed into bales and sold to a copper concern for about a cent a pound. Old automobile bodies are pounded into compact form for shipping by a huge pile-driver press. Tin cans, about 700 pounds to a load of rubbish, 100,000 unbroken bottles a month, paper and rags, radio batteries and electric appliances are among the things salvaged. Broken glass is shipped to China, where it is made into beads and lamp chimneys.

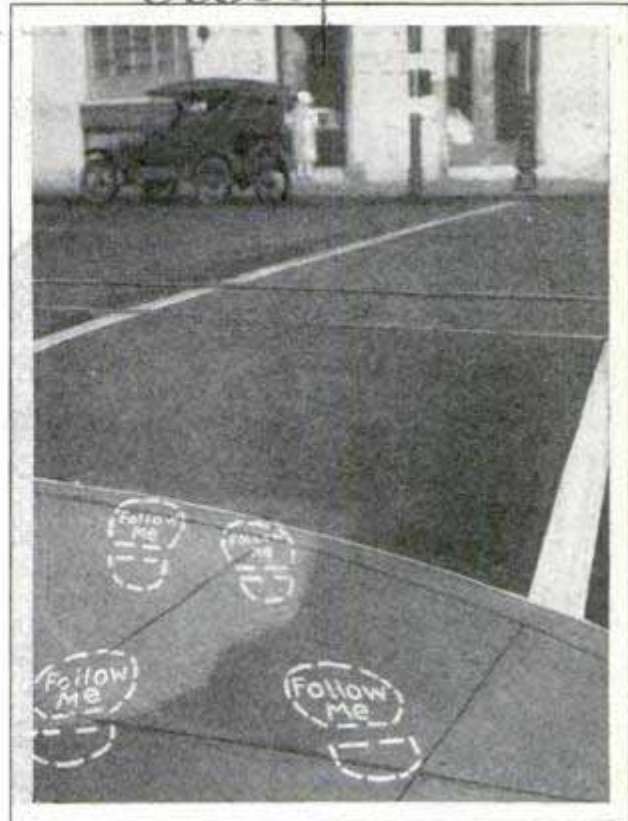

Leading to the Safe Path across the Street; Stenciled Footprints to Guide Pedestrians

BIG STEAMER BROKEN IN TWO BY FORCE OF STORM

Waves pounding against the stranded steamer "Valsesia," off Bary island, near the English coast, finally broke it in two. Before further damage could be done, salvagers towed the wreck to safer waters. The boat was carrying a cargo of coal and, at low tide, persons living near took the opportunity to gather up pieces that had been scattered about by the waves.

FOOTPRINTS SHOW PEDESTRIAN WHERE TO CROSS STREET

The trail of safety for pedestrians is plainly marked at intersections in Berkeley, Calif. In addition to the usual lines indicating the lane to follow, footprints, stenciled on the sidewalks and bearing the legend "Follow Me," point to the guarded passage as the only safe one to take.

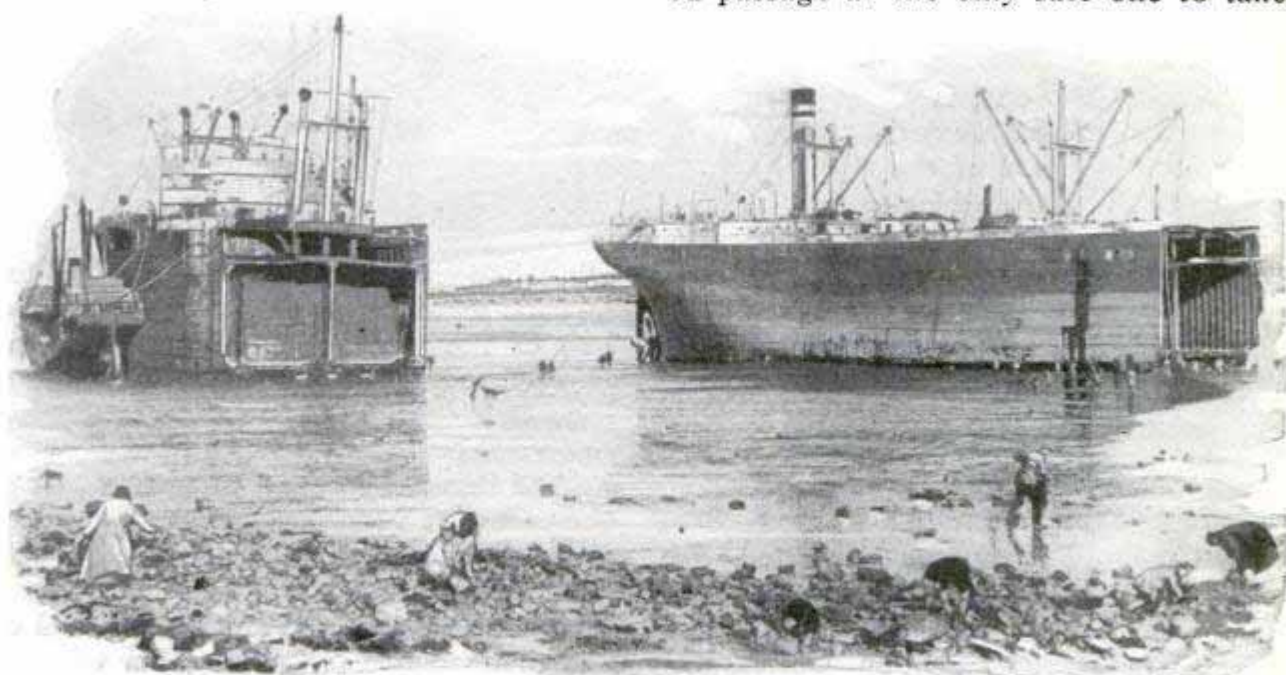

Broken in Two after a Severe Storm, the Steamer "Valsesia" Stranded near the English Coast; in the Foreground Are Villagers, Picking Up Pieces of Coal from the Cargo

the valsesia steamer

LIGHTED WORLD HOISTED AS SHIPPING SIGN

829

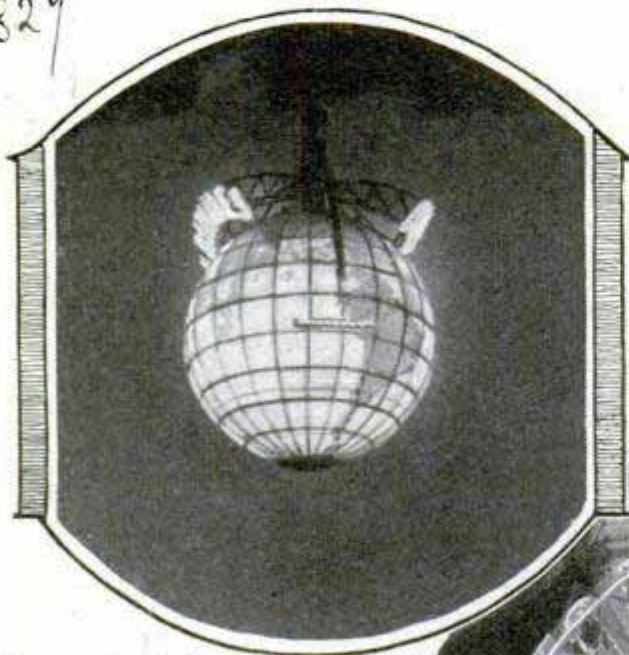

Sign as It Appears When in Position at Night with the Replica Ship Moving about the Globe, and Closer View in Day-time Quarters; It Is Lifted into Place with a Derrick

With the continents outlined in electric bulbs and a tiny ship moving across the "oceans," a miniature world is raised on top of a shipping office in Paris each night as an advertising display. The piece is hoisted with a large derrick and, during the day, is lowered to a sheltered alcove in the roof of the building. The large blazing letters around the top of the sphere spell the words "Messageries Maritimes"—the name of the concern.

Paris, France

CHANCE DISCOVERY OF MINES AIDED BY ANIMALS

Oil was recently discovered on an island off the coast of Honduras by the aid of a land crab. The region is infested with these creatures, which burrow into the soil like rabbits. One of them dug into a marsh under a cottage and the next day the occupant of the house detected the odor of petroleum. He had been seeking

oil for years without success but the crab's burrow directed him to a high-grade flow. A western pioneer discovered a valuable quarry of sandstone in Idaho by a fragment in a badger's digging, and a crow aided indirectly in the discovery of the rich gold fields of Pilbarra in western Australia. A small boy picked up a rock to throw at the crow and, noticing glittering particles in the piece, took it to a farmer who recognized the flecks as gold. In his excitement, he telegraphed the governor of the colony, "Boy picked up stone to throw at a crow," and forgot to mention the gold. The governor wired back, "Yes;

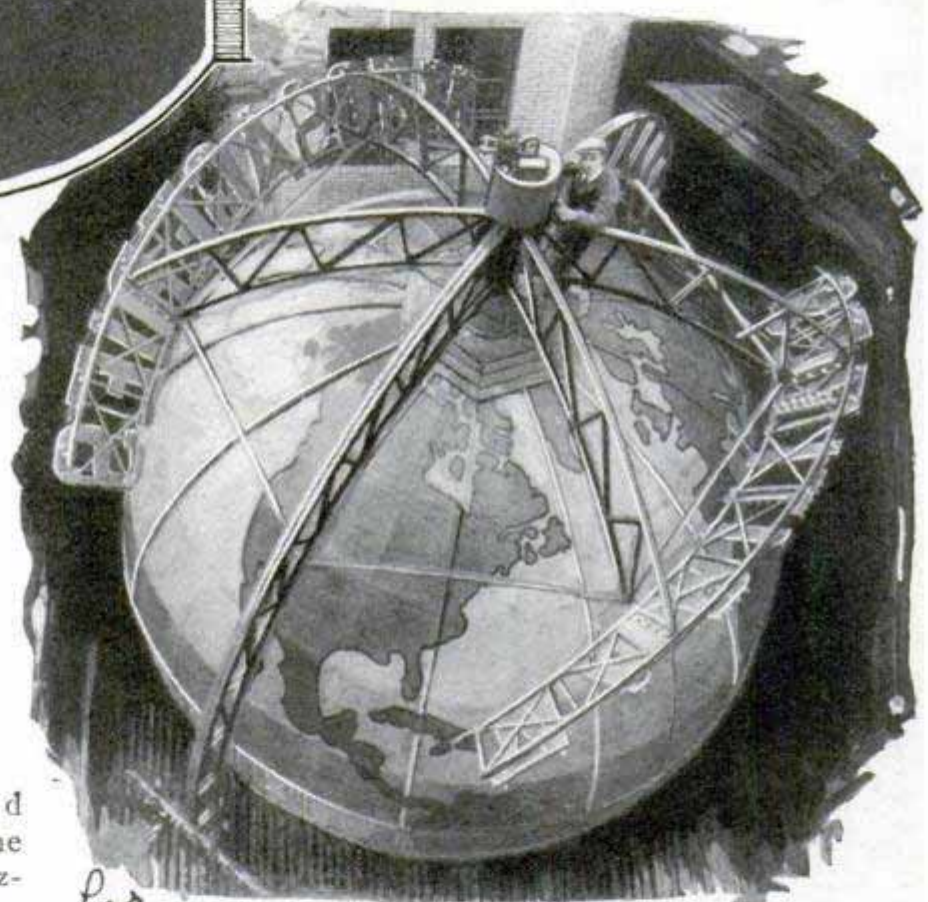

what happened to the crow?" The humorous incident marked the discovery of one of the world's richest gold regions. Camp fires have been instrumental in leading men to ore deposits. A Mexican Indian, upon awakening from sleep beside the fire he had lighted, found a piece of silver in the ashes. The chance discovery revealed that he had camped on ground worth thousands of dollars in rich ore. For a long time, settlers in Australia walked on soil that would have made them wealthy, without believing that the rock contained gold. In 1830, a convict was punished

630 21st Ave
New York City

after finding a piece of the precious metal. He was accused of melting a stolen watch, but the gold had come from a camp fire. A South African farmer, attracted by some bright stones in the clay on which his house was built, chipped them out and to his amazement found that they were diamonds. He traced the clay back to the pit from which it had been dug and so discovered one of the first South African mines that since have become world-famous. One of the diamond deposits in Kimberley was discovered by a child who found a "pretty stone" while she was playing on the banks of the river. She took it to her mother, who showed it to a merchant. Everyone laughed when he pronounced it a diamond. He wrote his name on glass with the stone, but the others were still unconvinced. He purchased the diamond for a trifle and sold it for \$2,500.

RACK OF TOYS FOR BABY'S CRIB SAVES NURSE'S TIME

Six or more toys are suspended from a bow-shaped support which is clamped to the baby's crib, preventing loss of the articles and saving the nurse the trouble of hunting for the things or picking them up. The toys are always within the infant's reach and their variety is intended to afford the baby added amusement.



Toy Rack Attached to Crib: Pieces Are within Reach of the Baby and Cannot Get Lost

Shown at the
B. J. Merkerhaus

845
"Double" Camera for Action Views: Top Part Is a Finder without Curtain to Interrupt the Operator



CAMERA FOR ACTION PHOTOS HAS CONSTANT FINDER

One of the difficulties in taking pictures of animals or other moving objects is that there often is a considerable change in the subject's position between the last look at the finder and the instant the exposure is made. To overcome this difficulty, a photographer, who has made a specialty of animal pictures, has devised what appears to be a large double camera. In reality, it is a single instrument, but the upper part is essentially a duplicate of the lower except that it contains no film or plates and projects a constant image of the subject upon a finder at the top up to the very instant the picture is taken. This eliminates the interruption of a "curtain" and makes certain that what the operator last saw in the finder before opening the shutter will appear on the negative properly focused.

☐ In winter, the snowshoe rabbit changes its coat from brown to white.

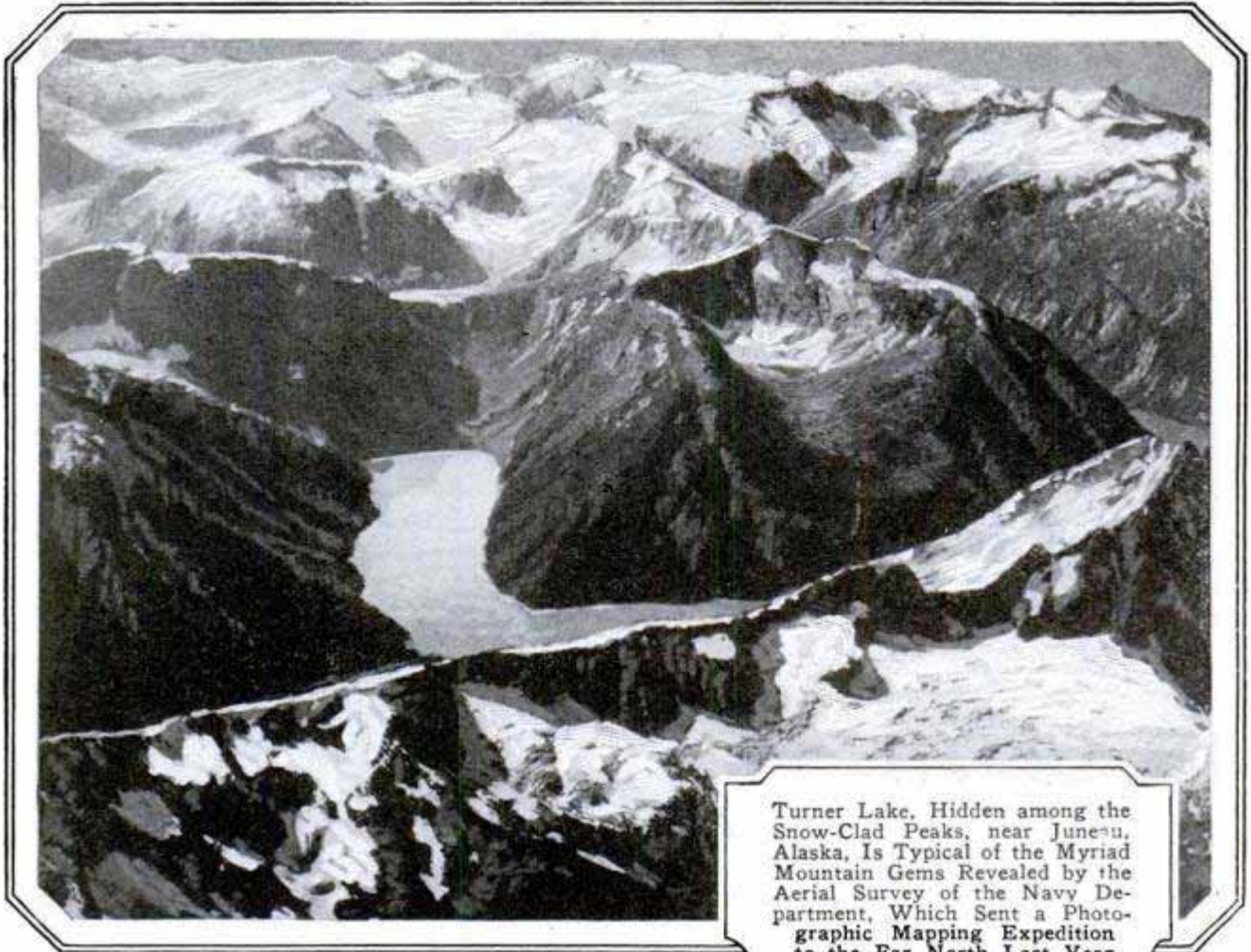

Turner Lake, Hidden among the Snow-Clad Peaks, near Juneau, Alaska, Is Typical of the Myriad Mountain Gems Revealed by the Aerial Survey of the Navy Department, Which Sent a Photographic Mapping Expedition to the Far North Last Year

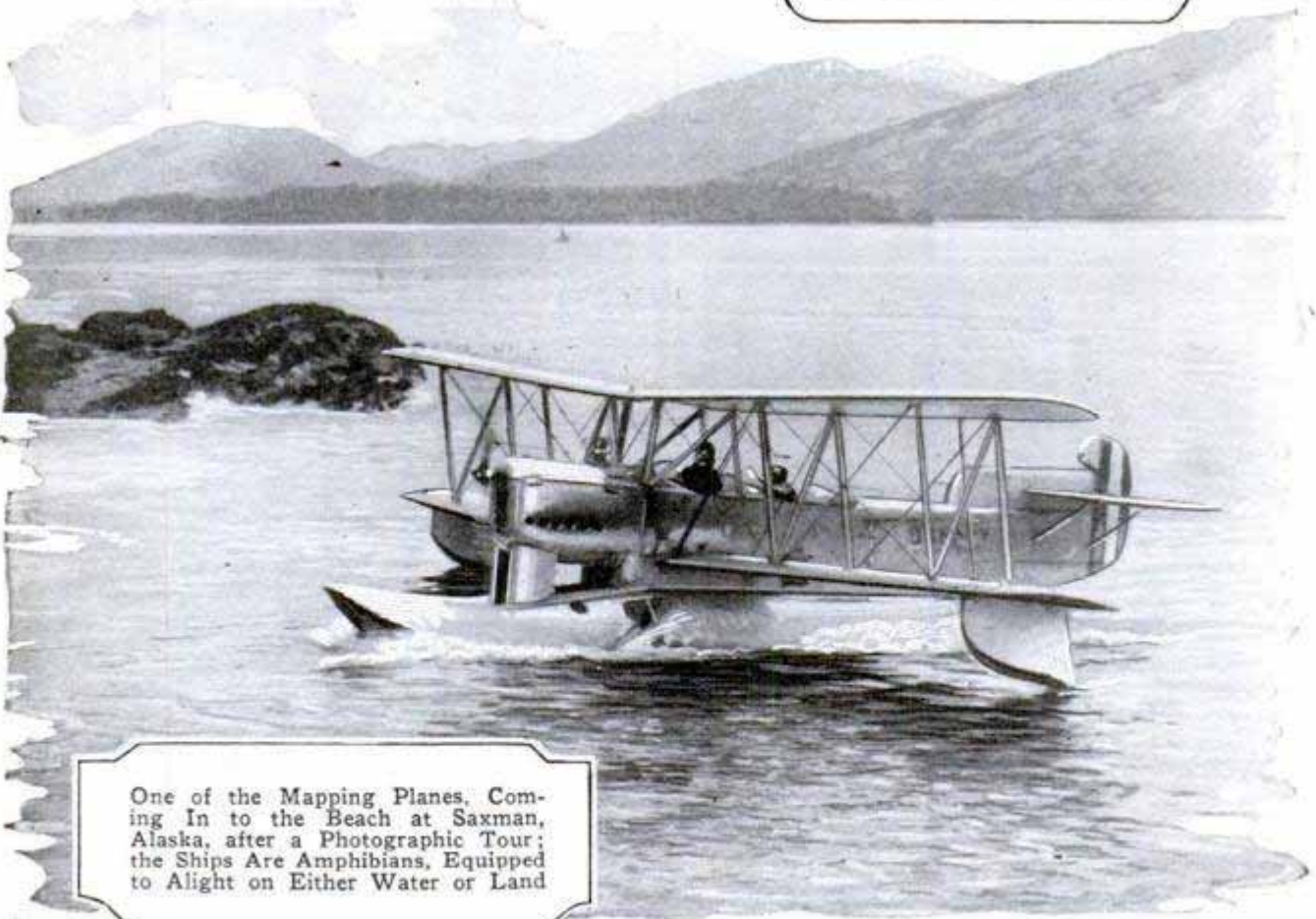

One of the Mapping Planes, Coming In to the Beach at Saxman, Alaska, after a Photographic Tour; the Ships Are Amphibians, Equipped to Alight on Either Water or Land

514 Woodward Bldg.
Washington, D.C.



Flying over Burrough's Bay, Alaska, One of the Amphibian Planes Used in Mapping the Mountain Fastness Is Photographed by the Flyers in Its Companion Ship

Flyers Map Alaskan Mountain Ranges

Navy Planes Cover Fifteen Thousand Square Miles and Bring Back Pictorial Record of Impassable Snow-Clad Heights

SUCCESSFULLY mapping some 15,000 square miles of largely unexplored territory on Admiralty and Douglas islands, two of the long chain of American-owned Aleutian islands, navy flyers last summer set a new record for surveying in the Far North. Much of the country covered was so wild that it is questionable whether it could have been surveyed on foot. Over it the planes swept at ninety miles an hour, with cameras clicking automatically every few seconds, and covered in a single hour a greater area than an ordinary surveying party could have traversed in weeks.

In addition to the mapping, in which pictures were taken with camera pointed straight down, hundreds of "obliques" were shot of snow-clad mountain tops, hidden lakes, deeply shadowed coves and canyons and other natural features which will be invaluable in the work of the forestry, agriculture and fish commissions.

The camera disclosed immense forests, hitherto unknown, containing millions of feet of lumber. Mountain lakes, well stocked with fish, were revealed for the sportsman, and aerial views of great mountain heights, snapped at close hand, will prove of interest to climbers who wish to explore them.

The surveying party was equipped with amphibian planes capable of alighting on either land or water. Because of the isolated region in which they operated most of the time the surveying party had to transport complete equipment and supplies from the States. A mine sweeper furnished quarters for the officers and crew, while a large sea-going barge, fitted with a big deck house, provided a machine shop, photographic laboratory and rooms for the equipment and other supplies.

At some places the facilities of the salmon canneries were utilized, and, at the main base, huts were erected on shore.

11/3/26

877

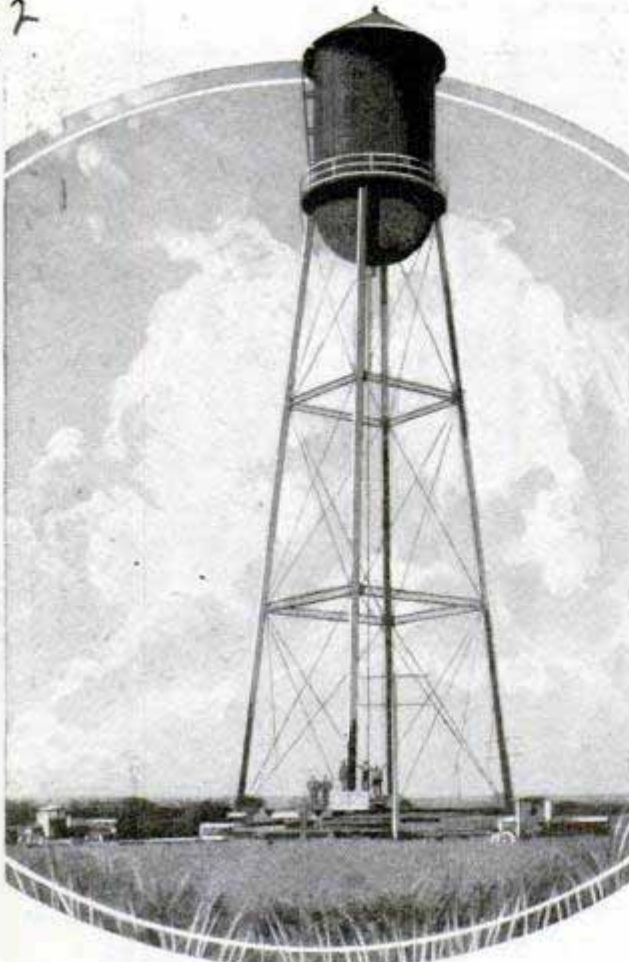

Pulling the Tower across the Prairie; after a 630-Foot Journey, It Was Only One Inch Out of Plumb

STEEL WATER TOWER AND TANK MOVED SIX HUNDRED FEET

Moving a steel water tower, 150 feet high and surmounted by a large bowl, with a combined weight of more than 150 tons, seems a difficult engineering task, but the problem was solved by a Texas firm. So evenly balanced was the weight, on steel rails laid across the prairie, that one man was able to pull the tank with the aid of the tackle outfit. The first step was to build a framework of heavy timbers about the base of the tower, then tie the four corner posts together so that they could not spread. Rails were then laid and the tower was moved along them by means of steel rollers.

*C. Hansen & Son
Dallas, Texas*

greater distance than any other sound. It may be that vibration of the engine contributes to the noise of the airplane, but this is uncertain. It is possible that means might be found to silence the hum, but little would be gained if the roar could not be stifled also.

ONLY FEW OCCUPATIONS LEFT TO MEN EXCLUSIVELY

836

Women have established themselves in all but thirty-seven of the occupations followed by man, it was shown at a recent exposition in Cleveland, Ohio. Mining, electrical engineering and driving locomotives are among the fields that have not yet been entered by women, but they have patented a number of electrical appliances and several are engaged in the merchandising and managing phases of engineering as well as in many other branches of this field of endeavor.

FULL-SIZE COMB THAT FOLDS 644 FITS IN SMALL CASE

One of the common objections to pocket combs is that they are too small to be fully effective. This limitation is overcome in a full-size article that folds into a tiny case for the pocket or traveling bag. It has three sections which lock together, making the comb rigid when opened.

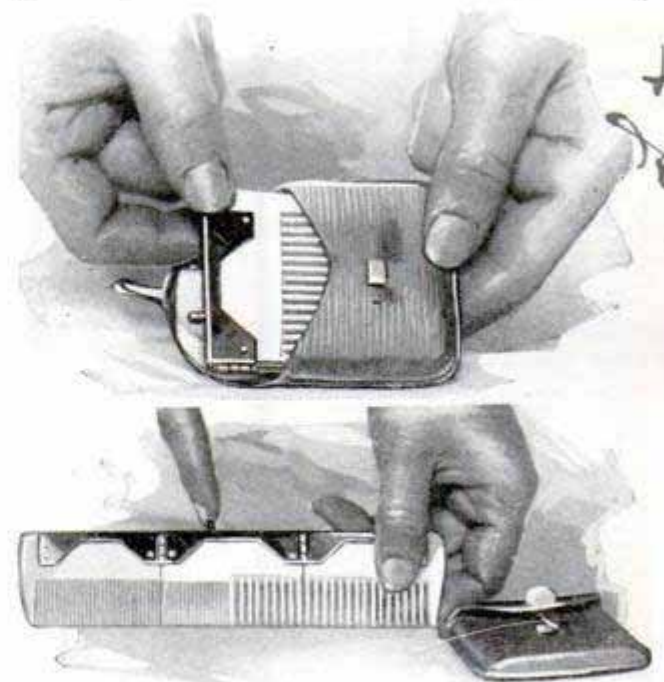

Folding Comb and Its Small Case; the Hinges Lock When the Comb Is Extended

*1133 Broadway
New York City*

853 CAN AIRPLANES BE SILENCED?

Is it possible to silence the airplane? Recent tests in England proved that the noise consists of two parts, a musical hum caused by the exhaust of the engine and a roar from the propeller. The stays of the aircraft have an æolian song of their own, which occasionally is heard at a

*Com. Edwin Tarrise
The Harrop.*

Tom. J.C.

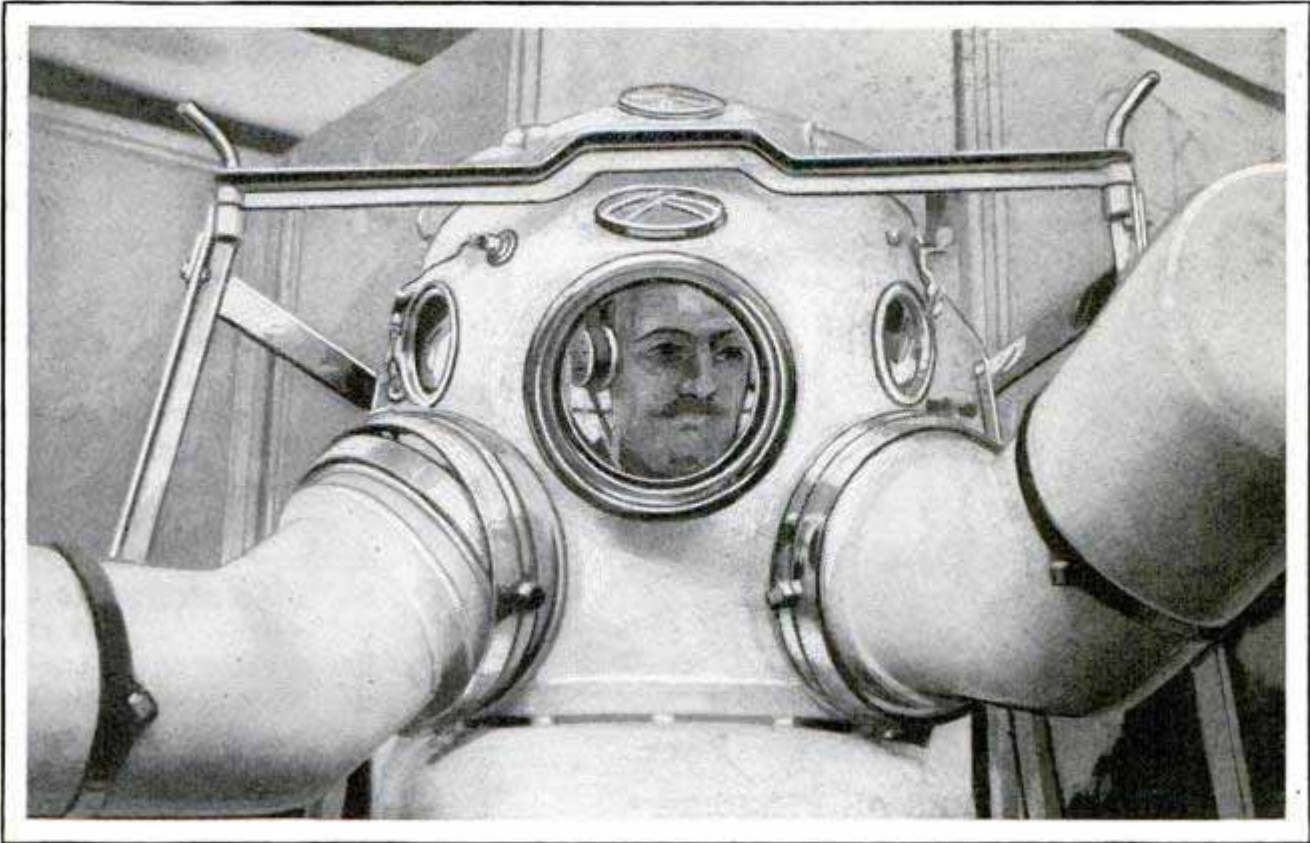

Copyright, Keystone View Co.

Radio Now Serves the Diver; Headphones on Occupant of Cage, through Which He Can Listen to Signals and Speech Broadcast from Tender Crew at Surface

WIRELESS SET IN DIVER'S CAGE REDUCES WORKER'S DANGER

One of the latest types of diving apparatus, exhibited in Berlin, contained radio headphones and connections to a small broadcasting set carried by the tenders at the surface, so that the worker within the cage could keep in touch with the men above. In this way, he could make certain that his signals were received and correctly interpreted.

BREAKAGE OF LINER'S GLASS INCREASED BY SALT AIR

Ten thousand dollars a year may seem a large amount to set off against the mysterious breakage of table glass on an ocean liner, but an English expert explains it partly on the ground that the action of the salt air causes a "disease" in the glass which results in extreme brittleness and consequent early breakage. Glass, he declares, is highly variable in strength and its resistance cannot be determined as easily as that of some other materials. The strongest glass, as a rule, breaks into the greatest number of pieces. On ocean lin-

ers, glass decay, due to atmospheric influences, is manifested by minute holes appearing in the substance and these deepen so rapidly that breakage is sometimes occasioned by merely touching the glass with the fingers.

ROLLING AUTO ACCELERATOR MAKES DRIVING SMOOTHER

Safer and smoother driving is said to be realized from a roll type of accelerator

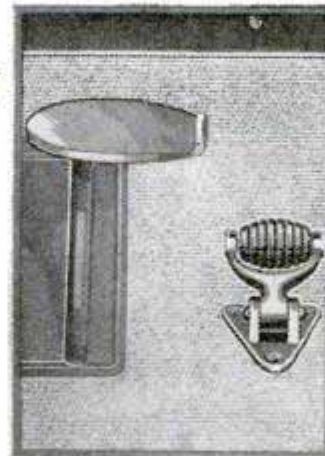

pedal for small cars. It is installed at the right of the other pedals and is easily distinguished from them by its shape and color, so that accidents are not likely to happen through use of the wrong pedal. When pressed, it swings and rolls forward smoothly and without jerks so that a perfectly even, and immediate, response is noticed.

Roller Pedal 32.00

87 77

*Cont. George H. Holder, Esq
Keystone View, 1400 Main Road*

*Williams Brothers, 250 S. Francisco, Calif.
Universal Corp.*

*Franklin Square
L. C., New York*



Forcing Rabbit from Its Burrow with the Steel-Wire Ferret

Screw-Dug
STEEL WIRE SERVES AS FERRET IN HUNTING RABBITS

To drive rabbits from their holes, a western inventor has devised a wire arrangement that takes the place of a ferret. It is twenty-seven feet long when extended, weighs less than two pounds and is easily carried. Made of special steel, it does not break when thrust and prodded in a hole.

LINERS CARRY FORTY GALLONS OF WATER PER PASSENGER

To insure a plentiful supply of water for drinking and other purposes during ocean voyages, the large steamers are equipped with huge tanks with a capacity of thousands of gallons. Estimates fix the daily consumption of fresh water by a first-class passenger on the "Majestic" at forty gallons. The average for the entire ship is approximately twenty-five gallons. The steamer takes on 1,424,000 gallons of fresh water at New York for every voyage. Of this, 804,000 gallons are for the boil-

ers. On a round trip, the "Majestic" uses more than 3,000,000 gallons. The "Olympic" consumes 680,000 gallons, the "Homeric" 860,000 gallons and the "Belgenland," 537,600. Almost all the large steamers are equipped with filtering plants and, although the water is pure when taken into the tanks, it is usually given three filterings before it is piped to the drinking supplies and two before it goes to the bathrooms. In the earlier days of ocean travel, the amount of fresh water each passenger could have was limited. Third-

class passengers received only three pints a day against about fifteen gallons now.

"SMOKE EATER" IS LATEST AID IN FIGHTING FIRES

Operating on the same principle as a vacuum cleaner, a smoke pump is intended to withdraw fumes and polluted air from building interiors, during a fire, for the protection of the men. A huge hose, about fifteen inches in diameter, is passed into the room to be pumped out and air can be withdrawn at the rate of 10,000 cubic feet per minute. The pump already has been tested and is expected to be of special service in combating basement fires where accumulated smoke often overcomes the firemen.

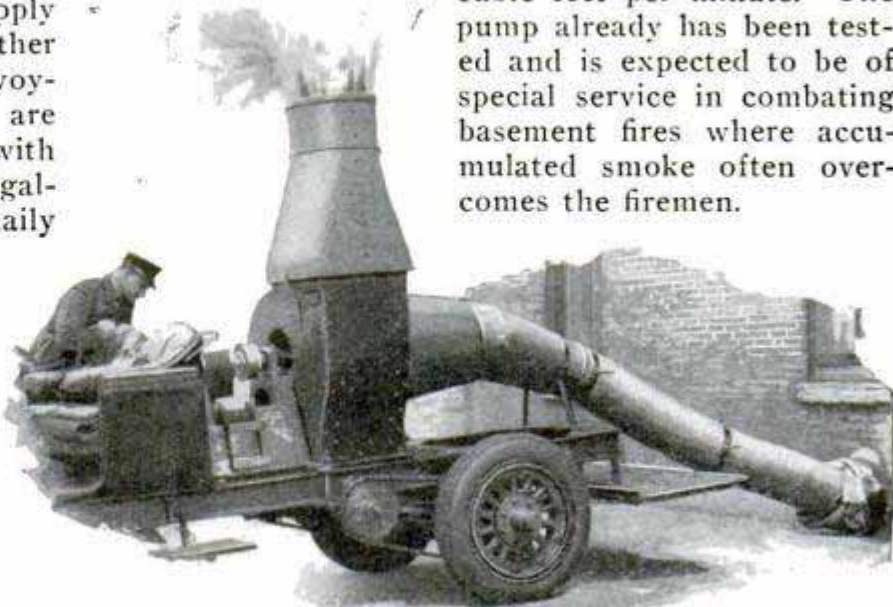

Drawing Smoke from Basement with the Suction Pump

*Wm. Charles King
Fire Chief*

\$4.00 by mail only.

*Ocean Service
New York, 1916*

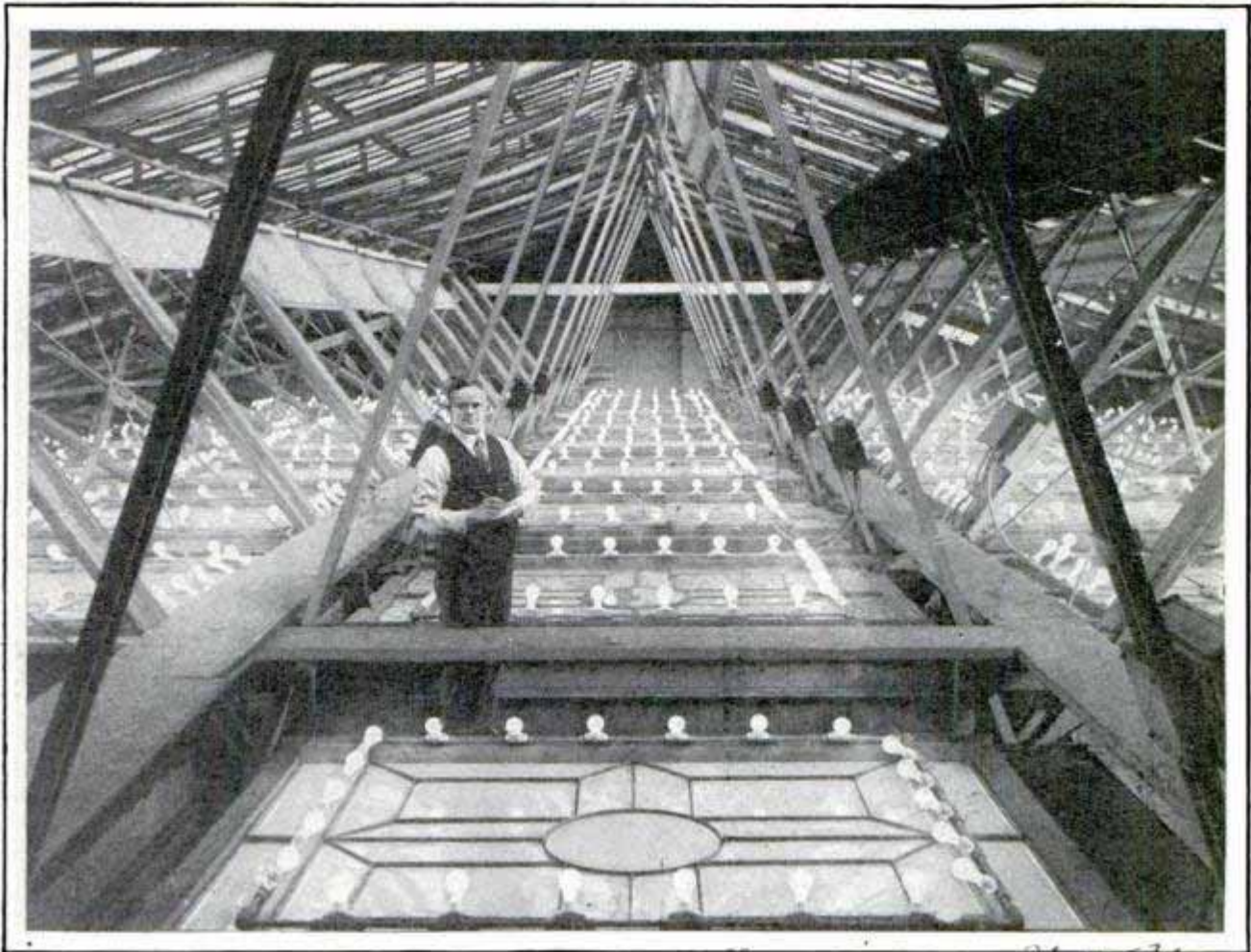

"Above the Scenes" in the U. S. Senate Chamber; View of the "Garden" of Lights Placed Back of the Ceiling Glass to Illuminate the Room's Interior

HUNDREDS OF HIDDEN LAMPS LIGHT SENATE CHAMBER

To provide sufficient illumination for the United States senate chamber, more than 1,100 electric lights have been installed back of the glass in the ceiling. There are 550 fifty-watt lamps, 460 of 100 watts and 178 seventy-five-watt globes. All are arranged in such a way as to produce an even and effective glow.

FLY WINGS MEASURE HEAT IN DISTANT STARS 862

Parts of an instrument being constructed at the Smithsonian Institution for measuring the heat in the fainter stars are made of fly wings, so delicate are the units for the apparatus. It is the work of Andrew Kramer, "wizard craftsman," who has astonished his fellows by similar contrivances of almost unbelievable accuracy. For instance, he has shaved down a brass tube to such thinness that it crumpled un-

der its own weight like paper. One of the parts in a device for standardizing measurements of the sun's heat received on the face of the earth is a screw thread cut in a piece of ivory so thin as to be almost transparent.

GOLF SCORER ON WATCH STRAP AIDS ACCURATE GAME 824



Attached to the same strap that holds the wrist watch, a dial recorder for keeping track of the number of golf strokes, eliminates the use of a pencil and pad. It may be removed from the strap when the game is

finished so that the timepiece can be worn alone.

*George H. Fuller +
S. J. Co. Madison*

852

Adding a New Twist to the Playground Slide, the Spiral That Gives a Longer Coast

Murphy

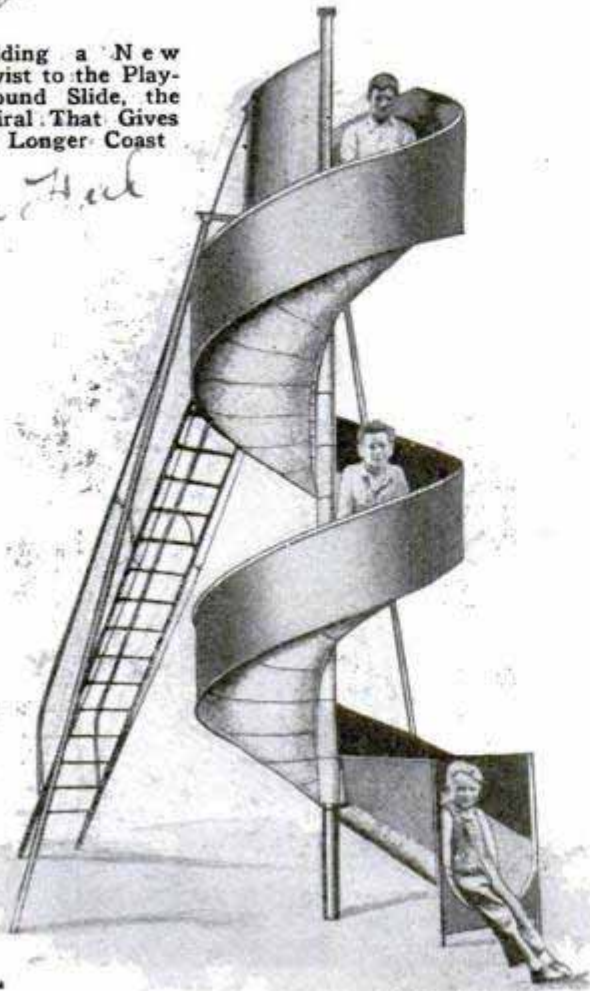

SPIRAL SLIDE FOR PLAYGROUND INSURES CHILD'S SAFETY

The principle of the winding slide fire escape has been adapted to a playground unit in a chute with high sides to prevent the child from falling, and a safe ladder for reaching the top. An additional feature of the equipment is that it provides a longer slide than the straight type and does not take up so much room.

HAIR WAYER HEATED BY WATER PREVENTS BURNING

Heated by water instead of by flame or electricity, a hair wayer introduced in England eliminates the danger of burning. Boiling water is poured into a plated container which forms the upper part of the wayer. It cannot spill al-

W. H. Sargent



Hair Wayer, Showing the Chamber for Hot Water at the Top; Long Applications Are Possible

© C. A. Oldroyd

though the steam is allowed to escape. The temperature of the heating element is kept below the boiling point, and since there is little risk of damaging the hair, the wayer may be kept in one position for a longer time, producing more permanent results.

VIOLET RAYS BRING HAPPINESS TO ANIMALS IN ZOO

To improve the health and disposition of animals in the London zoo, authorities have decided to adopt a kind of glass that admits the ultraviolet rays from the sun instead of the ordinary material which excludes the beneficial beams. The effect of the new glass, as compared with the old, was illustrated in the case of "Murphy," a young orang-utan. The animal had been cross and finicky about its feed and was bald in spots, but since the installation of the special glass, "Murphy" has been cheerful, willing to eat almost anything and has a new coat of hair. Like results were observed upon a family of small monkeys, and lizards, which moped and died during the winter months, are being kept in good health with the aid of ultraviolet rays. Zoo keepers in other parts of the world are studying the new glass with a view to using it in animal houses.

ONE TON OF SOFT COAL YIELDS MANY GALLONS OF OIL

Lubricating and fuel oils, and aromatic compounds suitable for "no-knock" motor fuels, to a total amount of 140 gallons can be derived from a single ton of soft coal, according to Dr. Friedrich Bergius of Heidelberg, Germany. He is credited with the invention of a process for liquefying coal into oils by treatment with hydrogen under great pressures. The net yield, after deducting the coal consumed in the operation, is 104 gallons to the ton. Dr. Bergius says that all problems touching the practical and economical application of the process have been solved.

9 + 10 Charing Cross, London S.W.1

10/6 post free - duty England by customer

884

Chicago Tribune 11/16/26

Douglas Jimmy & Co. Ltd. Gloucester England

5-6-7

Magic with Money

By W. B. GIBSON

MANY of the best and cleverest tricks are performed with coins. Those explained in this article are intended for the reader who is not skilled at sleight-of-hand; and they can be learned by anyone with very little practice.

The "Coin from the Elbow" is an interesting trick. You show both hands empty, and deliberately drop a penny down your left sleeve. Then you place the fingers of your right hand against the left elbow, and mysteriously draw the coin through the cloth of the sleeve. Two coins are used. One is set between the buttons of the left sleeve, near the wrist. The front of the left hand is kept toward the people watching the trick, so they do not see the hidden coin. The first is dropped in the left sleeve. Then you



Discovery of the Missing Coin in an Apple or Orange Is a Simple Trick That Always Mystifies the Onlooker

place the tips of your right fingers behind the left sleeve, and slide the right hand down to the left elbow. Your fingers pick up the hidden coin on the way, and carry it down to the left elbow, where it is drawn into view, apparently through the sleeve.

Here is a quick and surprising method of making a coin disappear. Hold the coin in your right hand and slap it into the left palm, two or three times, making a downward sweep with the right hand. As you finish the last sweep, you can show both hands empty. This is accomplished by keeping your eyes on the left hand, so that everyone watches that spot. The right hand, in its last upward sweep,



Here Is How It Is Done, with a Bit of Wax Holding the Coin; in Actual Performance the Finger Hides the Penny

it, tear the box to pieces, to show that the coin is not there. This will prevent discovery of the opening in the end.

A coin may also be made to vanish with the aid of a small piece of paper, about the size of a playing card. Lay the coin in the center of the paper, and fold in the sides, then fold in the outer end of the paper, holding this in your left hand. As you tilt the outer end upward, the coin will slide into your left hand. Then you must fold up the inner end of the paper with your right hand, and lay the paper on the table with the right hand. When the paper is later unfolded, or torn to pieces, the coin will be gone. Either of the preceding tricks may be performed with a borrowed coin, which has been marked. As the coin is in your possession, while the observers think it is in the box or the paper, you can cause it to reappear in



Top Row, Start of Eight-Coin Puzzle, Second Row, the Finish, and the Others, the Four Successive Moves of Two Coins Each

simply drops the coin on the brim of your hat, in front. The coin remains there, while the hands are shown empty. If you are not wearing a hat, you can drop the coin in your hair, but, in this case, a small coin must be used for the trick.

Any coin may be made to disappear with the aid of a match box. First, prepare the box by cutting a slit in one end of the drawer, at the bottom. Place the coin in the box, close the drawer, and shake the box sideways, so that the coin rattles. Then tilt the box and the coin will slide through the slit into your hand. The box is then laid aside, and when it is opened later on, it is empty. If anyone still thinks that the coin is in the box, and wants to examine



The Coin Is Dropped Up the Sleeve, While a Duplicate Is Concealed between the Coat Buttons for Later Production; at Right Is an Easy Way to Make a Coin Disappear



a most mysterious fashion. You need a table knife, with a broad blade and an apple or an orange. They are lying near by. You bring the fruit forward, showing that it is entirely unprepared. Then you cut it in half, and the coin is found in the core.

On the side of the knife blade, rather close to the handle, you must previously affix a dab of soft wax. In getting the knife, press the coin against the wax, bring on the knife with the orange, but hold the knife so that the coin is out of sight.

Cut the examined fruit with the blade, and push the knife forward so that the coin goes into the orange. Press the latter firmly and withdraw the knife. The coin will remain in the orange, and you may let anyone separate the two hemispheres and find the coin between them.

Another method of recovering the missing coin requires nothing more than a piece of cardboard, a little larger than a playing card, or a small pin tray, if one is available. You place the cardboard on your left hand, so that it



How Many Pennies Piled Up Equal One on Edge? Try It and See; at Left Is a Simple Method by Which an Extra Coin Can Be Added to Those Placed on the Cardboard

hides the coin that is resting there. Then you ask different people to lay coins on the cardboard. When you have collected several coins, let them

slide into the hands of the person who lent you the missing coin.

At the same time release the coin from beneath the tray, and when he counts the coins that have been deposited in his hands, he will be surprised to find his coin among them.

There are two very interesting "stunts" with coins that are not really tricks; but they are worthy of mention, because they never fail to create surprise. Suppose a one-cent piece is stood on edge. How many pennies, stacked in a pile, would be required to reach the same height? Most persons will say that five, six, or seven are sufficient. But the correct answer is thirteen. When you state that fact, nine out of ten people will not believe you until

A Slit in the End of a Pocket Match Box Provides an Opportunity to Make a Coin Disappear from the Box at Will or to Reappear



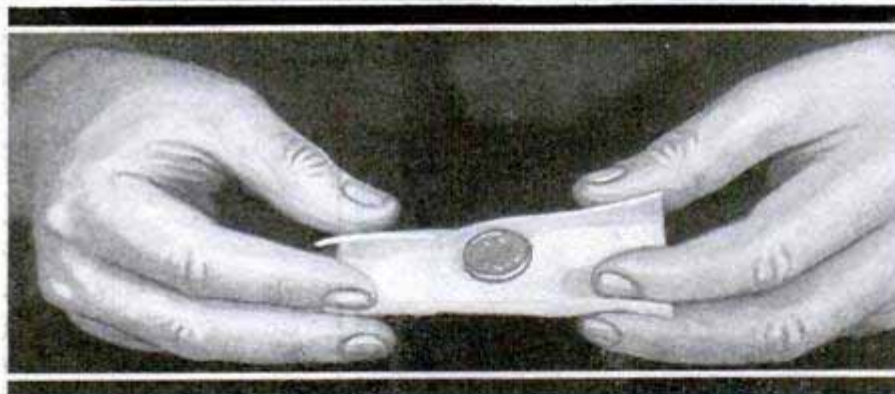

Another Easy Method of Making a Coin Disappear from a Folded Paper, Which Can Then Be Torn in Bits

you have actually demonstrated it with the coins themselves.

The other perplexity is this: "How many pennies can you lay on a silver dollar without allowing any of them to extend over the edge?" The pennies, of course, cannot be stacked, but must be laid side by side on the larger coin. Nearly everyone will say that three, four, or more pennies can be thus placed; but as a matter of fact, one is the correct answer. The second penny will go over the edge of the silver dollar. This is another fact that people won't believe until they see it.

A good little trick may be performed with a nickel and a small cylindrical box, of the type which contains a roll of half-

inch adhesive tape. First you drop the coin in the box, put on the cover, and give the box a shake to show how easily the coin turns over inside. The coin is put in head up; after the shake the tail side is up. Then you drop the coin in again, clamp on the lid, and shake the box vigorously for ten or fifteen seconds. Looking at the top of the box, you say: "The coin is now lying head up." When the cover is removed, there is the coin, head up! This trick may be repeated several times; but you will be right every time.

The secret lies in the fact that the box is not quite as high as the diameter of the coin. As previously mentioned, people invariably underestimate the diameter of a coin; and the coin looks very small and insignificant, when dropped in the box.

So when you place the coin in the box, simply note which side of the coin is up. Then you may put the cover on, and shake the box a great many times; but the coin will not turn over.

But before you began the trick, you showed that the coin did turn in the box. This was accomplished by putting the cover on very lightly. The thumb and forefinger hold the cover in place, while you give the box a few revolving shakes, to make the coin turn over. The slight gain in the height of the box thus obtained allowed the coin to turn. Some of these boxes are not quite so deep as others. If you happen to have a shallower box, use a penny instead of a nickel. You can easily discover what kind of a coin to use by standing the different coins on edge in the box. The coin that just barely projects above the rim is the one to use.

There is a very puzzling trick with eight pennies. Lay the coins in a row so that

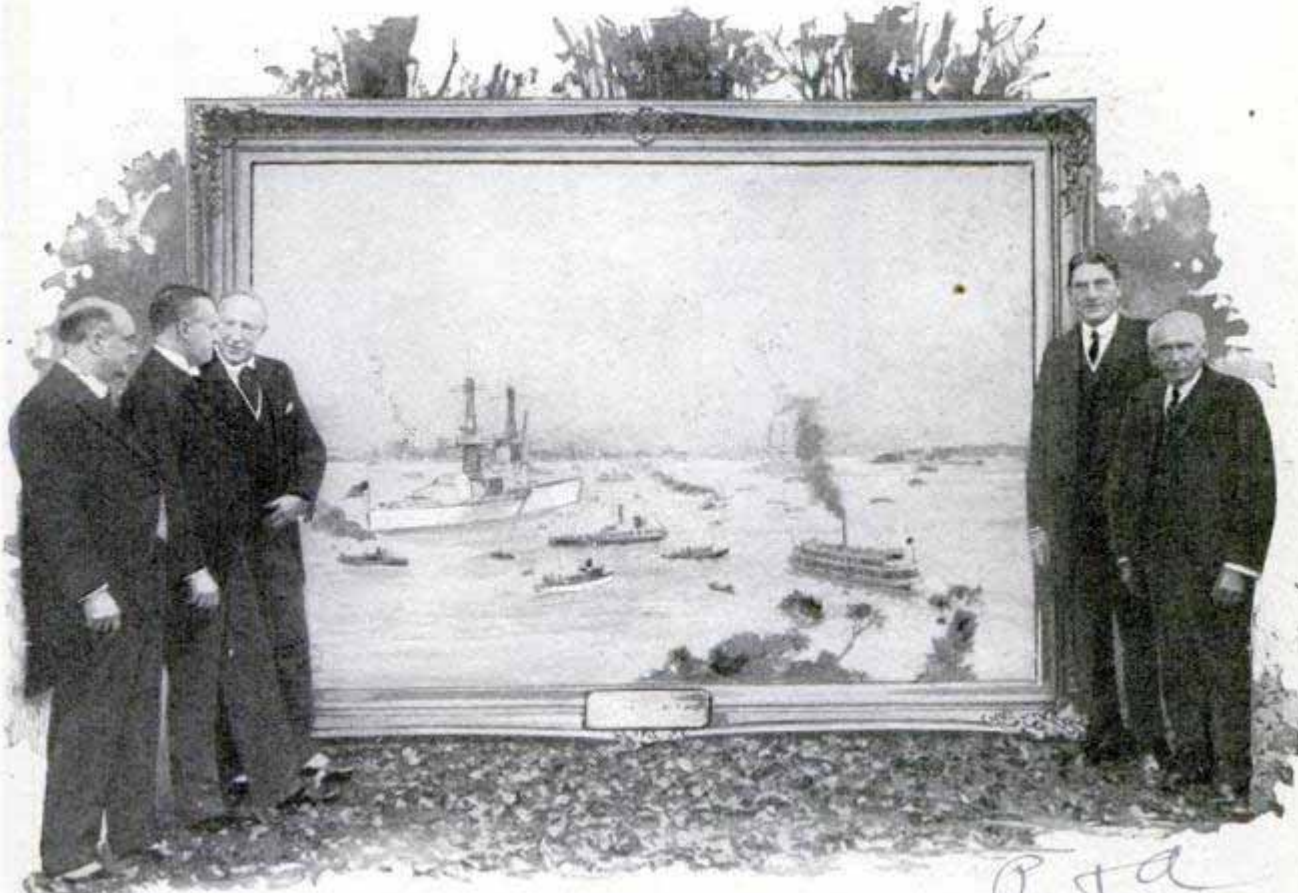

Left to Right, J. J. Rouse of Sydney, President Coolidge, Sir Hugh Denison, Australian Commissioner, Secretary of Navy Wilbur and Secretary of State Kellogg beside Painting of Fleet

they alternate heads and tails. You must then move the coins two at a time to other positions, so that in four moves all the heads and tails will be together, observing the rule that the two coins moved each time must be side by side.

The diagram explains how the four moves are made, and you should practice them until you can perform them quite rapidly. You can then make the moves yourself, and the average person will be unable to follow them.

A juggling trick, which requires a little practice but is a very entertaining feat once the knack has been acquired, consists in laying a dime or a penny on your wrist, the palm of the hand being held upward, and making the coin turn over without touching it.

Simply snap your thumb and second finger. The wrist action of the muscles will make the coin turn a neat somersault. Find the right spot on the wrist, and it will work very easily.

☐ Lighthouses on the Atlantic coast have been painted with large arrows pointing north to help guide aviators.

GIANT PICTURE OF FLEET GIVEN TO PRESIDENT COOLIDGE

In commemoration of the visit of the United States fleet to Australia, Charles Bryant, of New South Wales, painted a picture showing some of the battleships at anchor in the harbor at Sydney. The painting was presented to President Coolidge and is to hang in the national art gallery at Washington.

FAUCET WATER HEATER RUNS FROM LIGHTING SOCKET 826.

Running hot water is quickly available from a portable electric heater that is attached to the faucet and supplied with current from a light socket. A flexible nozzle leads the stream through a jacket in which is a special heating coil.



\$12.50.

The hot water comes out of a spout on this housing.

*H. L. Es Mfg Co,
1301 W. 29th St.
Chicago, Illinois*

**BLOCKS IN CATHEDRAL COLUMN
EACH WEIGH EIGHT TONS**

879.

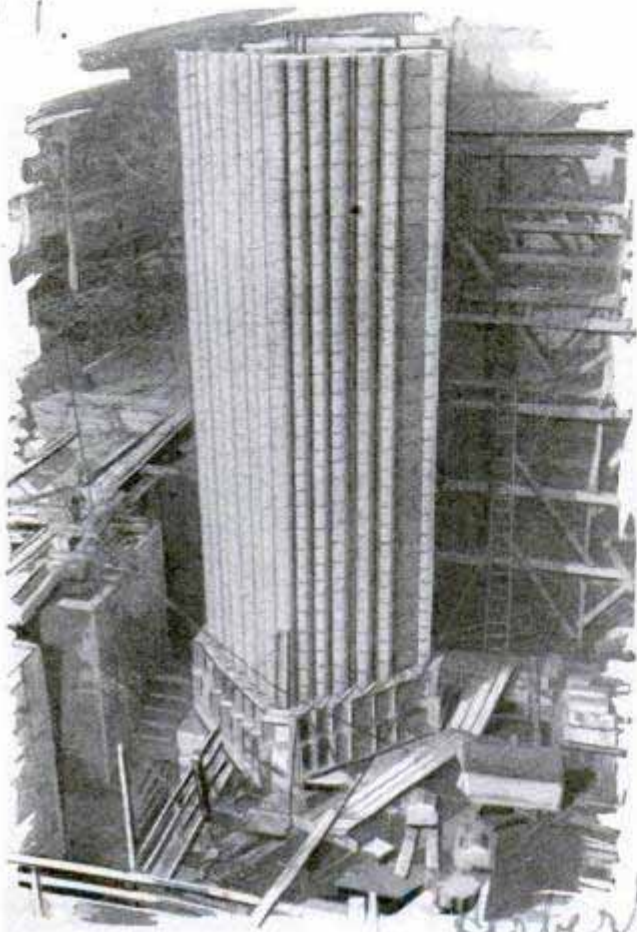

Pillar of the Nave for the Cathedral of St. John the Divine under Construction

Under the expert hands of master craftsmen, the Cathedral of St. John the Divine, in New York city, is slowly taking form. The enormity of the task is emphasized in such details as erecting the huge supporting columns for the nave. The pillars are composed of layers of four great blocks of limestone, each weighing eight tons. The column illustrated here, not yet finished, weighs more than 1,200 tons. Accurate fitting and careful joining are necessary to give the unit its strength and evenness.

909.

**TEMPERATURE EIGHT MILES UP
NINETY-SIX BELOW ZERO**

A United States weather balloon encountered a temperature of ninety-six degrees below zero Fahrenheit at an altitude of a little more than eight miles during a recent "sounding" of the upper air. This represented a drop of more than 166 degrees from that prevailing at the surface near Royal Center, Ind., where the

U.S. Weather Bureau

balloons were started. In all, forty-four flights were made, either singly or in groups. Recording instruments and a self-opening parachute were attached to each. Thirty-seven of the cases were found and returned to the weather bureau after flights that, in some cases, extended over 200 miles. Some of the balloons reached altitudes never attained by any human being. The highest went about ten and one-third miles. At this point, a slightly higher temperature was found than at the eight-mile level. This relatively warmer area is known as the stratosphere. It has several peculiarities, being warmer than the air below, free from clouds, and the winds are less severe than in the layers just beneath it. The bottom of the stratosphere varies in altitude, the instruments showed. Its height is not known. Balloons have ascended nineteen miles without going past it. The balloons used for this service are about forty inches across when inflated and they expand to a bursting point in the rarefied air. The instruments with their parachute and wicker case, which serves to take up the shock when the outfit reaches the earth, weigh less than a pound.

**TIRE VALVE HAS BUILT-IN
PRESSURE GAUGE**

885

An automobile tube now on the market is equipped with a valve which has a built-in air-pressure gauge, visible under a transparent cap, so that each tire shows its condition at a glance. The main valve

Viscometer



stem has a piston, held down by a spring, and the piston wall is engraved and marked for various pressures. The piston is hollow and the usual filler cap screws in the top of it, the valve parts being inside the piston. The dust cap is replaced by one with non-

breakable transparent sides, so that the reading can be made readily.

*The Viscometer Corp
30842 nd st*

Chicago, Ill. U.S.A.

10/4/26

HOW SKYSCRAPER GOT ITS START

The constantly increasing height of modern buildings is made possible by two inventions—the passenger elevator and the steel frame, which not only supports itself but carries the weight of the confining walls. When the first Equitable building was built in New York, in 1869, rising to seven stories, with a passenger elevator with a speed of 100 feet a minute, it was considered a daring departure, but quickly justified itself. It took eighteen years, however, from that date before the first steel skyscraper, twelve stories high, was built in Chicago. That was the Tacoma building. Others followed quickly.

902

ARTISTS TURN TO IRONWORK TO EXPRESS IDEAS

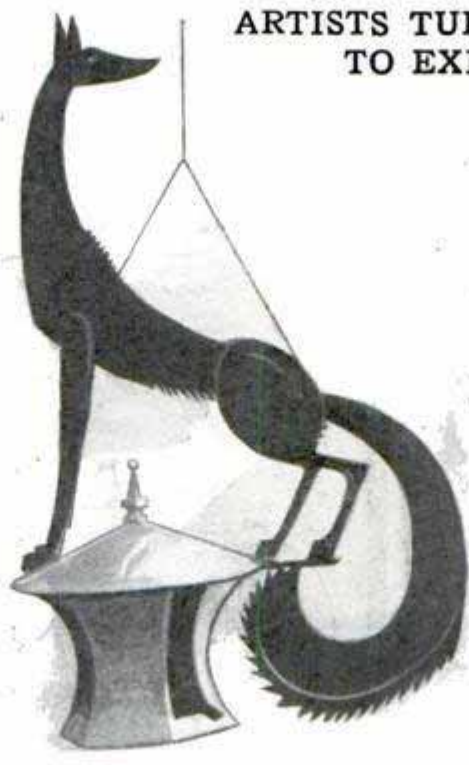

Chimney Pot with Wolfhound Vane Done by American Artist in Wrought Iron



Hunt Liederich American Artist in Paris

Handwrought ironwork, including chimney pots, weather vanes, fire screens and lanterns are being produced by members of the American art colony in Paris who have given up paints and the sculptor's chisel for forge and anvil. Their work has attracted so much attention that recently a number of American artists deserted the annual salon and organized a purely American exhibition. Some of the work, such as the combination of wolfhound weather vane with a revolving chimney pot, showed unusual originality.

STRENGTH OF LUNGS TESTED BLOWING UP TUBE

928

The blowing championship of Nebraska was awarded to a young farmer of that state after he had inflated an inner tube to a length of twenty feet and a circumference of fifty-six inches wholly by his lungs. Shortly after, the tube burst. It took eighty minutes of puffing to fill the tube.

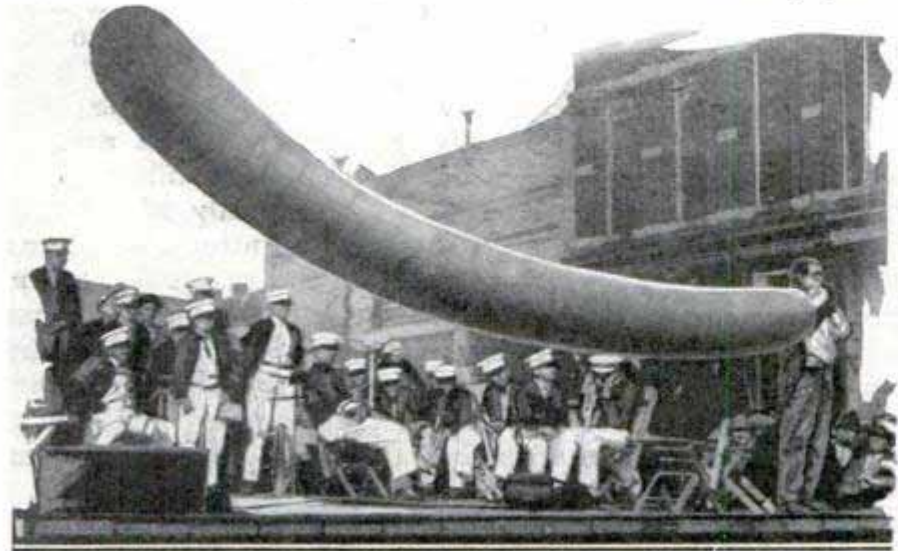

Just Before It Burst; the Inflated Inner Tube After the Champion Had Puffed at It for Eighty Minutes

USES OF SHELLAC

910

Used in hundreds of industries, shellac is an important commodity in scores of articles where it is not commonly known to play a part. For instance, shellac and not wax is the basis of sealing wax; it is used by the ton in making varnish. Hatmakers employ it to stiffen brims and it is utilized in large quantities in the motion-picture film industry.

Tom 'Wanda' Brown Contest at Wood. here

Kansas City 1/20 1916

Head Hunters

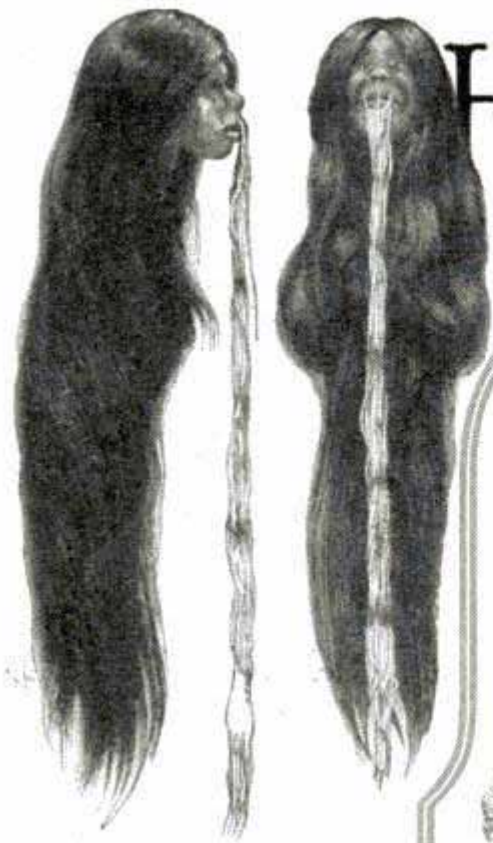

Pair of Shrunken Head Fetishes of the Jivaro Indians in the Field Museum, and an Indian Warrior's Gala Dress

BELIEVING that possession of an enemy's head makes the spirit of the dead warrior a slave to his vanquisher, the Jivaros of South America are the possessors of a sacrificial rite that is unique among savage tribes. Although standing very low in the scale of intelligence, they long ago evolved a process of shrinking the captured head to the size of a baseball bat, without destroying the features or their natural proportions.

How it was done remained a mystery long after the first of the peculiar trophies had been brought out of the interior around the headwaters of the Amazon tributaries. At first the heads were passed on from tribe to tribe until they reached the outposts of civilization, far up the Amazon, and fell into the hands of white traders and explorers from museums. Not until recent years have white men succeeded in

penetrating the upper reaches of the Pastaza and Morona, the two principal rivers along which the Jivaros dwell, to learn first-hand the methods used in the process.

Head hunters were known before—there are still some left in the South Sea islands—but the ability to not only cure the skin but actually shrink it to a fraction of its former size without destroying its lifelike qualities was as amazing to the museum explorers as the discovery of the first embalmed body of a long dead Pharaoh.

The Jivaros, though only 25,000 strong, are also unique in that they remain as independent today as when the first Spaniard set foot in America, having always succeeded in resisting conquest. Until quite recently their only weapon in battle was the spear and shield, though now they have begun to acquire firearms. They used the blowpipe, too, with poisoned arrows, but only for killing game.

Practically all of the head-hunting expeditions are the result of one or more members of a tribe having died from natural causes, which the friends of the dead ascribe to sorcery from another tribe, whereupon they take the war path, armed and with several smooth round rocks for each warrior.

The rocks are the chief requirement for curing the heads they hope to take. After

and their Weird Rites

the enemy is slain and the head severed, a slit is made up the back of the neck and the skull and flesh removed. The slit is then sewed up, and the head boiled in water with some antiseptic herbs. Next a fairly large round stone, warmed in the fire, is inserted through the neck opening, and with another warm round stone the warrior proceeds to "iron" the skin until it gradually shrinks to nearly the size of the interior rock. This is then removed and a

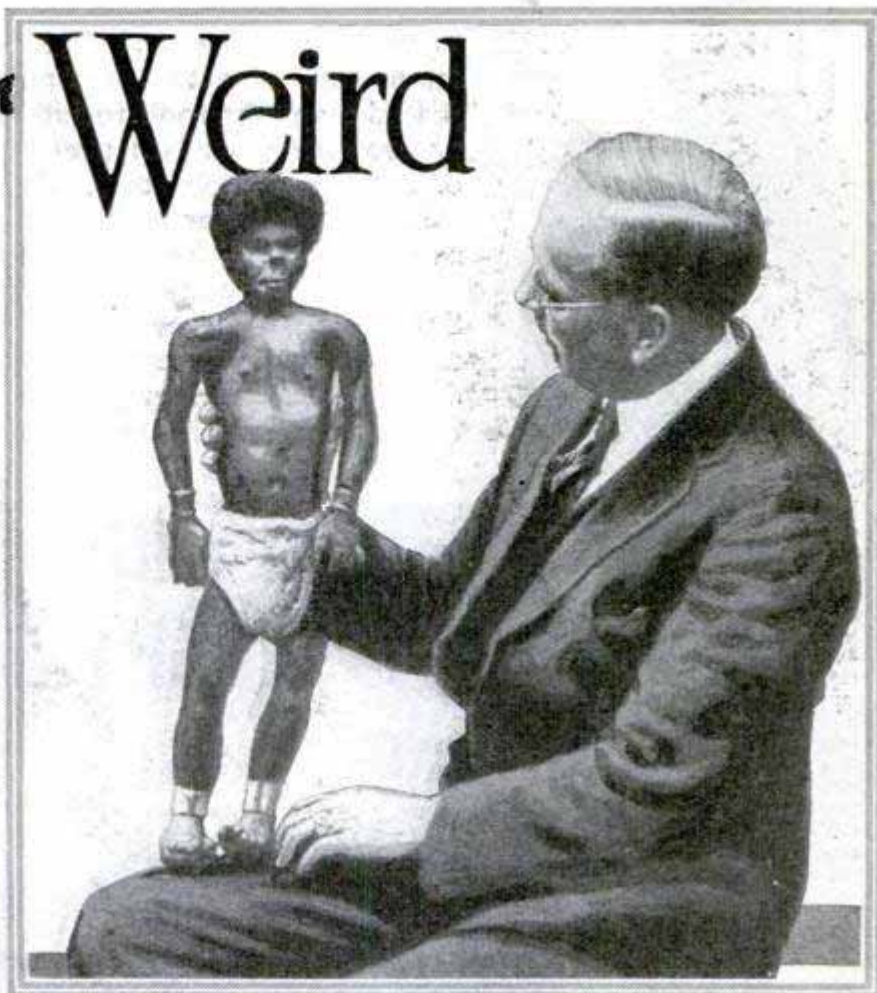

Entire Body Shrunk by the Jivaro Process; Two Such Are in the Hayes Foundation Collection, but Their Genuineness Is Doubtful; Below, Jivaro Warrior in Costume Worn When Listening for Spirit Voices in the Forest



smaller stone substituted, the process being repeated until the head is reduced to the desired size. The whole preparation is completed in a day.

Following the shrinking, a slit is made in the crown and a long cord inserted to suspend the trophy, while streamers of colored cotton yarn are attached to perforations made in the lips.

When the war party returns, a tribal celebration is held, in which the trophy, suspended from a pole, is the principal feature. The victor for several days has to observe rigid regulations and taboos, without which it is believed great harm would befall him. Eventually, after he is deemed to have mastered the slain man's spirit and made it his slave, the head is removed to his hut as an individual trophy.

The Jivaros are not afraid of open fighting, but usually prefer to attack at night, timing the assault to come just before dawn. Their huts, in which several related families live, stand singly and alone in a clearing of the jungle. The house is



Jivaro Woman; a Fetish Head from the Milwaukee Museum, and a Jivaro Wearing Part of His Ceremonial Ornaments for the Curious Rites That Attend the Enslaving of a New Spirit

built of poles, with a thatched roof, and sometimes is surrounded by an outer stockade. Each man able to carry arms has a separate berth, arranged around the outer wall, with slits through which he can ward off attack. In the narrow jungle paths leading to the clearing skillfully concealed traps

are planted, usually a pit containing a sharpened stake on which anyone stumbling into the trap will be impaled.

Their bravery in battle is almost entirely due to the belief that they have enslaved the spirits of their dead foes, and likewise will receive aid from their departed forefathers. The latter appear to them in dreams induced by drugs made from narcotic plants that grow wild in the forest. Under the influence of the dope they wander through the jungle, listening, they believe, to the spirits of the dead, who give aid and advice.

The heads used as trophies must have come from a member of a rival tribe, as those of one's own tribe are supposed

to be without power. The demand for trophies for museums and collectors became so great recently, however, that the natives took to killing people of their own tribe, or even stray white travelers, in order to earn the price offered by the collectors. As a result, the governments of Peru and Ecuador now forbid exportation of the trophies, as one means of keeping the rite confined to tribal battles.

The Jivaro country is similar in many ways to the South Sea islands, even though it lies more than a thousand miles from salt water. Like the islanders, the Jivaros have developed as a water-going race, since the only means of communication through the tropical jungle is the myriad

creeks. The district, in the main, is quite flat and swampy, all the streams that pour into the Amazon being unable to carry off promptly the tremendous rainfall of the tropics. The nearest approach in North America to the swampy jungle was the interior of the Everglades. The main difference is that the tropical vegetation is even thicker in the Jivaros' land, spanning the streams so thickly that often only tiny tunnels are open



under the hanging vines for the passing canoes. Because of the jungle and the maze of streams, the natives have been able to resist not only other natives but likewise white invasion. Fruit, nuts and some rubber are the chief products in their domain, and they have not sufficed to tempt many traders into the interior.

VEGETATION GIVES OFF LIGHT DURING PROCESS OF DECAY

At a certain time in the fall of the year, beech and oak leaves give off a faint glow when they begin decaying. The glow occurs in tiny fibers interwoven in the leaf which are essential to its health although they do not start glowing until the leaves are dead or dying. Examination of the underside of a beech leaf reveals small yellow spots, the centers of the fibers. If these are disturbed with the point of a pin, they will shine more brightly for a few moments. Glow has been recorded at various times from grasses, the lily, a species of poppy and the common nasturtium, but special apparatus is needed to detect these faint lights. There is a kind of luminous moss which may be seen in crevices among large stones and rocks by the roadside, and the roots of the tormentil give off light when the soil is removed.

AUTO STOP-AND-TURN SIGNAL PROMOTES SAFETY

Signals for right or left turns and stops are given from a compact accessory attached to the rear of the auto and operated by two switches. The one that controls the stoplight, in the center, is manipulated automatically by the car brake. The direction indicators, consisting of an arrow for left turns and a pointer of slightly different shape for right, are illuminated by throwing a switch on the steering column near the wheel. The separate operation of the lights is intended to reduce confusion and make each signal more clearly visible.

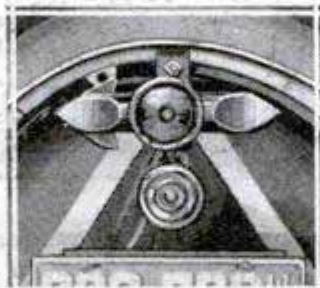

Heise Electric Shop
125 St. B roadways

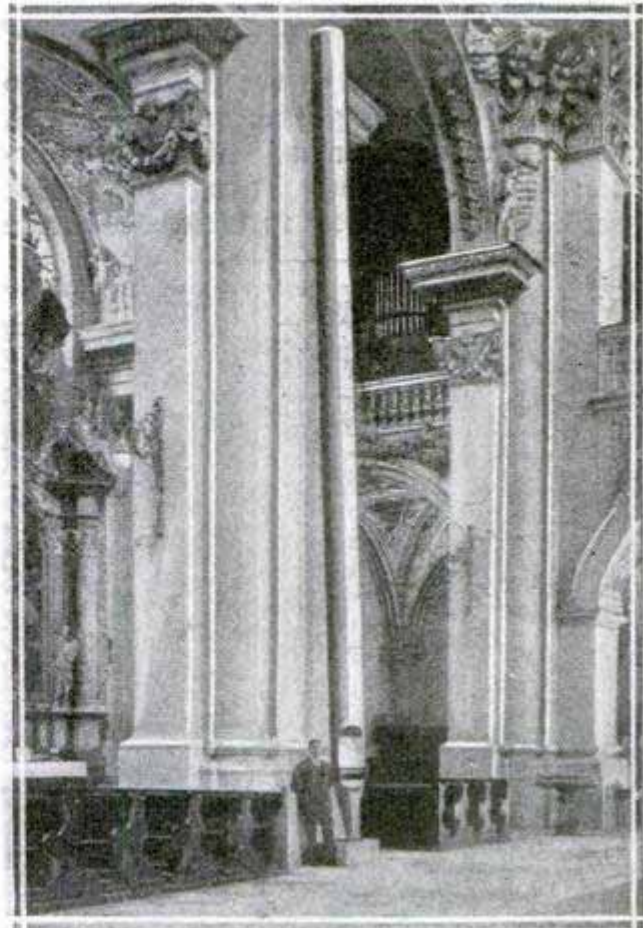

Huge Pipe for Organ in German Cathedral Compared with Height of Archway

SINGLE PIPE FOR BIG ORGAN THIRTY-SEVEN FEET HIGH

Weighing nearly 650 pounds, one of the large metal pipes for a huge organ now in course of construction in the cathedral at Passau, Germany, is thirty-seven feet high. The organ takes its place as one of the largest instruments of its kind in the world.

MAKE COAL FLOW LIKE LIQUID BY HEATING PROCESS

Pulverized soft coal can be made to run and seek its own level like a liquid by application of heat, according to an eastern expert. He explains that the warming causes the liberation of vapors or gases, which form tiny bubbles about each fine particle of coal, reducing friction and causing the mass to flow. The condition lasts as long as the vapors are issuing from the particles. It is pointed out that a general application of this principle would result in great changes in mining and combustion methods as well as in the transportation of the commodity.

Illustration Germany
See page 930

New York

Walter E. Trent, Pres.
Trent & Co.
55 E. 16 St.

839

new Winterfelder 24
Berlin W. 30 Germany

WAVE FORCE HARNESSSED TO PREVENT SEASICKNESS

Using the power of the waves to keep the ship from rolling is accomplished with a system of tanks installed in a new German liner, the "New York," to prevent seasickness. Bulges formed along the

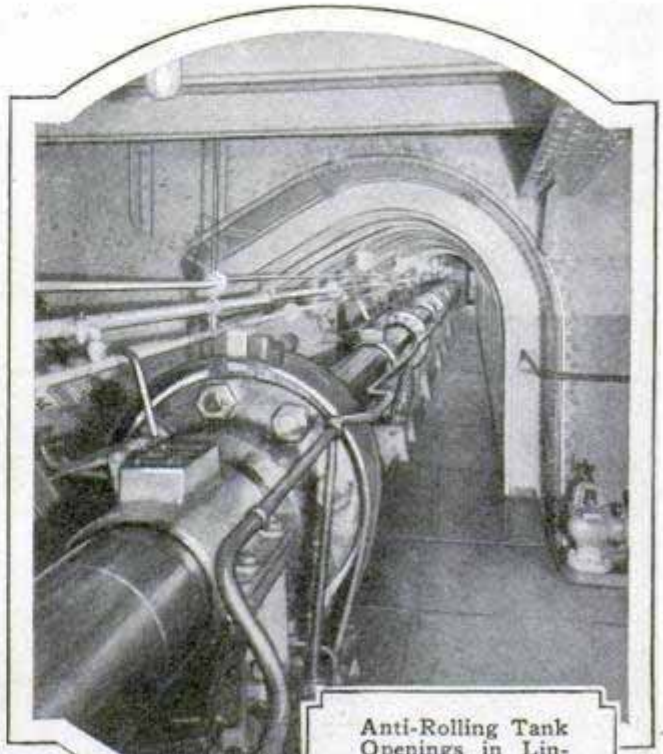
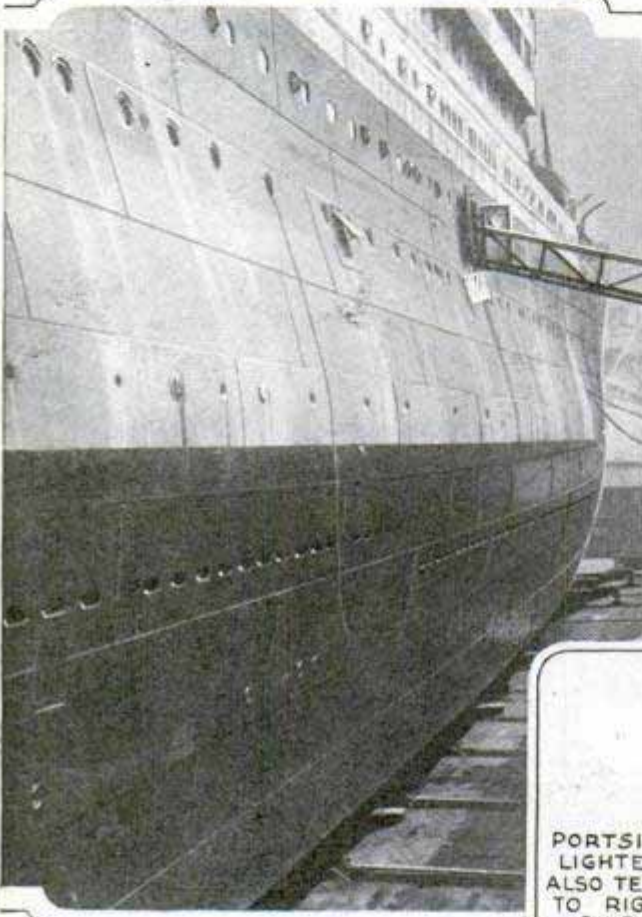

Anti-Rolling Tank Openings in Liner's Hull, Sketch of Operation, and View of the Propeller-Shaft Alley

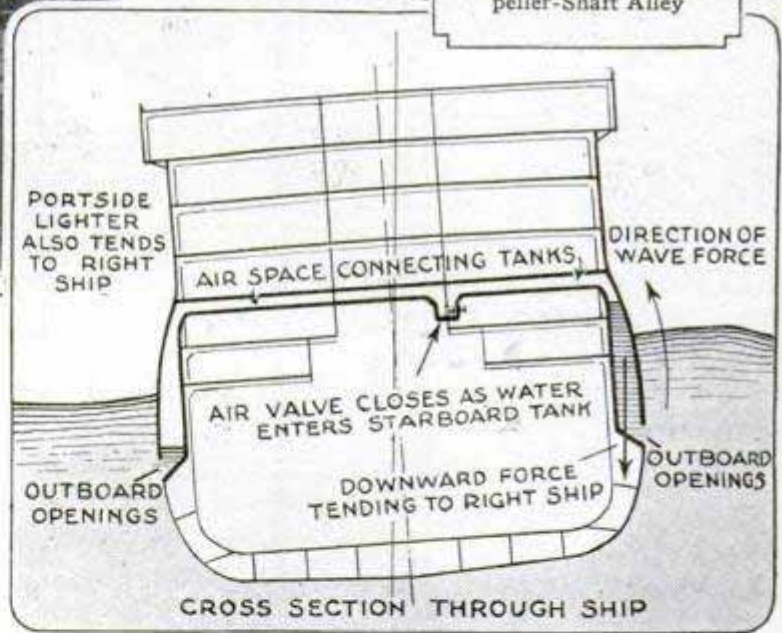

sides of the ship provide a space between the main hull and outer skin. Rows of rectangular openings admit the sea in this space, the bulges being connected at the top with an air pipe across the ship. When a wave strikes one side of the ship and starts it to rolling the pressure of the sea drives water up in the tank, raising its level and increasing the weight on that side. The air forced out by the incoming sea passes through the connecting pipe and drives water out on the other side, lightening it, so that the ship has a tendency to go back to an even keel. The connecting pipe is fitted with an air intake valve to admit air into the tanks from above, but the valve closes under pressure from within and prevents air escaping. The ships are fitted with propeller-shaft

tunnels of a new design so that the full length of the driving shaft is easily accessible for oiling and inspection.

LOSS OF SLEEP AIDS BRAIN BUT FATIGUES BODY 863

Cutting off two hours of sleep each night, makes the brain more alert but is a considerable drain on the body, tests at Colgate university have shown. The

*Psychology by College
Univ. School of Psychology*

867

experiments were conducted with three young men. Materials used included alarm clocks, a stop watch and an apparatus to measure the consumption of oxygen. To arrive at a working basis for the investigation, the subjects were drilled for weeks in mental multiplication. Fifteen problems were solved each day at a single sitting, while the time required and the errors made were recorded. When a "performance level" had been reached, a point beyond which there seemed to be little likelihood of improvement, the subjects were placed on a strict sleep allowance of eight hours nightly and the results of their problem working again recorded. Then they were tested with but six hours of sleep. With this amount of time devoted to slumber, all showed an improvement in their mental work, but the amount of energy expended when doing the problems increased enormously as compared to that spent when eight hours of sleep were allowed.

SPECIAL SIGNS GUIDE TOURISTS TO CITY'S HISTORIC SPOTS

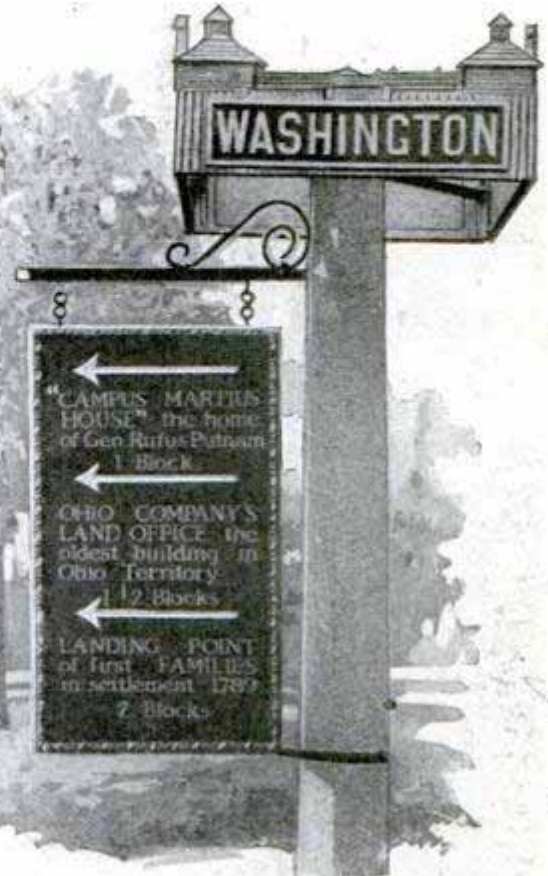

E. M. Haines, Marietta, Ohio

Telling the Motorist What to See; Handsome Signs Erected at Street Intersections to Guide Tourists

More than forty decorative signs, lettered on both sides and easily legible from a distance of sixty to seventy-five feet, have been erected at street intersections in Marietta, Ohio, to direct visitors to interesting places in the city. They are of the finish of antique bronze and the metal characters are faced with gold leaf. Arrows point in the direction of the place described, and the distance is given in blocks. The signs are of uniform pattern and are placed on substantial concrete posts, which also bear the name of the street in clear letters.

HAUL TRAILERS ON FLAT CARS TO SPEED SHIPMENTS

Saving in time and expense by reducing the handling of less than carload shipments to a minimum is expected from an innovation in traffic introduced on a mid-western electric line. Auto trailers, loaded for city distributing, are sent on flat cars without taking off the wheels so that they can be quickly removed at their destination and hauled about the town with their load already arranged for delivery to the purchasers. A central station where the trailers are filled further expedites matters.

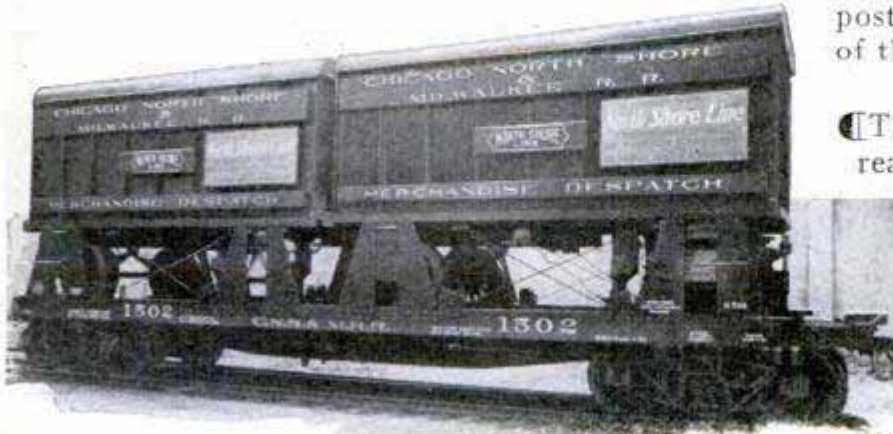

Trailers on Board Flat Car for Electric-Railroad Journey; at Destination They Are Hooked to Truck

*Chicago North Shore
Insurance*

The Popular Mechanics Bureau of Information offers its free service to all readers of this magazine. Names and addresses of manufacturers and dealers in articles described, and any other details in our possession, will be promptly furnished by addressing the bureau.

933



Aiding Travelers at a Forest Crossroads in Germany; the Guide-Post Sentinel

NOVEL THREE-ARMED SIGNPOST HAS FACE OF MAN

Travelers through one of the forests in Germany are directed on the proper way by an odd signpost representing a man. Its outstretched arms bear legends giving the destinations and distances.

MOTOR-TRUCK AUTO TRAIN CUTS COST OF CAR DELIVERY

Freight-car loading and unloading costs are eliminated by a motor-truck and trailer outfit which hauls four completely

assembled automobiles directly from the factory to the dealer. This method insures the delivery of an absolutely unused car, is said to reduce transportation time, and, as one man can drive the "train," operating costs are not high.

OLD PAINTINGS ARE RESTORED BY FEATS OF EXPERTS

Almost unbelievable feats are performed by men who restore old paintings. One of the first things the worker does in repairing a picture with a canvas torn, cracked or rotted with age, is to purchase a new canvas. A sheet of Manila paper is glued to the painted side and the old canvas is then carefully scraped away. When all the fabric is off, the grounds upon which the paint lies are removed by solvents or gentle scraping until nothing remains of the original but the fragile shell or pigment adhering to the paper. The new canvas is then covered with the strongest fish glue obtainable and pressed firmly down upon this shell. As soon as the painting is attached securely to its new foundation, the only step remaining is to take off the paper. This can be done with hot water. Haquin, a French artist, was, it is thought, the first to successfully transfer a painting on wood to canvas. He glued a sheet of paper over the surface of the painting and afterward upon this a layer of muslin. When the glue was dry, he planed down the panel until it was as thin as matchwood. Then he scraped off the rest with a long, flexible knife. This done, the mere skin of color held together by the paper and muslin was left. It was a comparatively easy task to glue this to a canvas and remove the paper and muslin. If an old picture lacks a portion of its pigment, this may be replaced with fresh colors.

Cont. Edwige Farragut, Washington, D.C.

827

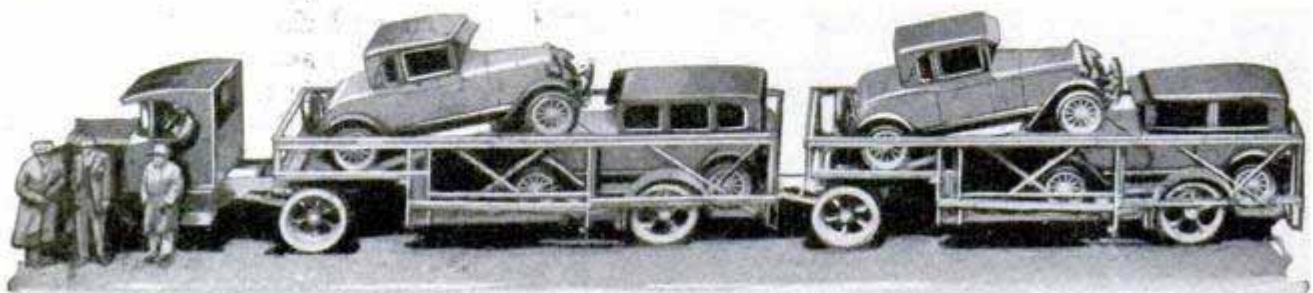

How Autos Are Hauled Directly from Factory to Dealer by Motor-Truck Train; the Conveyance and Special Trailers with Load of Four Cars

See also Motor Vehicle Co., 447 Cass Ave. Detroit, Mich



Cross-Capped Stadium on Mt. Helix, near San Diego, Calif., Where Outdoor Easter Services Are Observed with Impressive Rites; There Are Seats for About 2,000 Persons

STADIUM BUILT ON MOUNTAIN FOR EASTER SERVICES

Near San Diego, Calif., a permanent stadium has been constructed on top of Mt. Helix, 1,380 feet above sea level, for the observance of special outdoor Easter services. Although it is used but once a year, it has been carefully built with seats of stone and steps of concrete. It will hold about 2,000 persons. A smooth dirt road leads to the top of the mountain.

HIGH-FREQUENCY SOUND WAVES DESTROY LIFE

That sound waves of extremely high frequency are capable of destroying life and cutting down the number of red blood corpuscles, has been demonstrated in experiments performed by Prof. Robert W. Woods, of Johns Hopkins university. He reported that a minnow was killed after two minutes' exposure to sound vibrations at a frequency of 300,000 cycles and, in fifteen minutes, the blood corpuscles in a mouse were reduced sixty-five per cent. The vibrations were produced in oil and passed through a quartz plate, striped with tin foil, into the receptacles which held the subjects. The experimenter does not believe that the sound-wave method will be used by sportsmen

as a substitute for guns, as it cost \$6,000 to kill the minnow and \$45,000 to weaken the mouse. It is thought that the tests may shed some light on the effects of pernicious anæmia.

ELECTRIC BURNER FOR PAINT REDUCES FIRE RISK

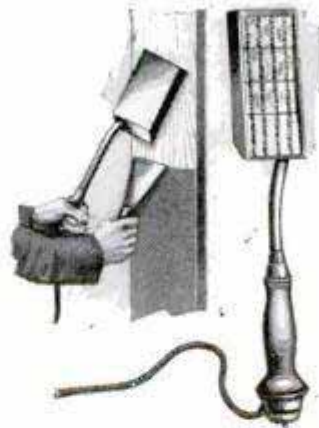

As a substitute for the painter's blowtorch, an electrically heated unit, that may be operated from the lighting circuit, is said to be safer and more easily handled. A scraper can be attached to the frame so that

there will be no need of using more than one tool to remove the coating.

HOW MUCH BLOOD?

If the weight of the body of a healthy man is divided by twenty, the result will be the approximate weight of the blood, according to the results of recent experiments. It is not known whether this formula applies as accurately to women.

English Mechanic 10/1/26

Curran 823

New York World 10/31/26

2638 Leroy Ave

911 Oberway, Ill.

952

INVISIBLE RAY WILL GUIDE TRAINS AND PLANES IN FOG

Greater safety for aviators in fogs and less likelihood of train collisions are promised through the application of rays of light invisible to the eye yet capable of actuating signals miles away from their source. According to an electrical research worker, these rays could be projected thirty miles into space and controlled as to direction. Their function in guiding the planes would be to register signals on a photoelectric cell mounted on the pilot's instrument board. For the purpose of this signaling, the inventor is said to have devised a special tube which

becomes fluorescent in response to the controlled rays. Adapted to railroad use, the cell would show light only at the close approach of another train.

951

TRAILER CAR FOR MOTORCYCLE HOLDS KITCHEN AND BEDS

Space for two beds, cooking and other equipment is provided in a trailer attached to a motorcycle. Designed especially for short camping expeditions, it has sturdy wheels for travel over rough roads, and is so connected to the cycle that it does not jolt any more than the ordinary trailer.

11/10/26

Motorcycling

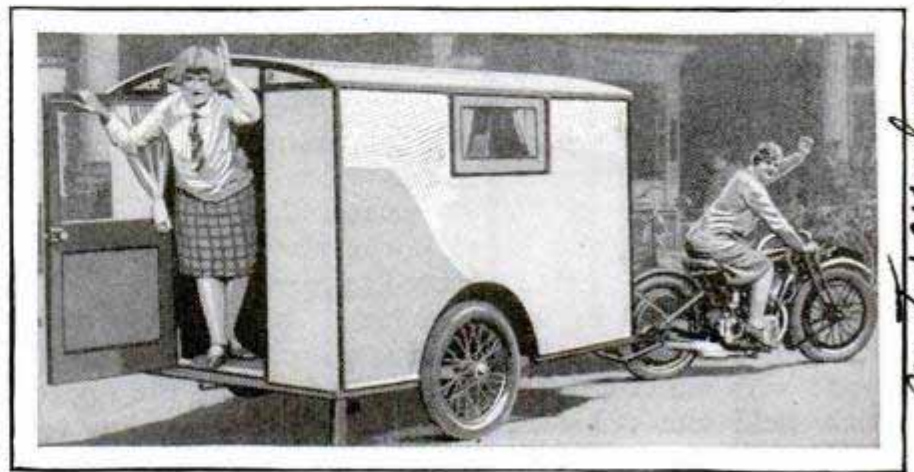

The Trailer Bungalow Hauled by Motorcycle

Shown at Olympia Cycle



Demonstrating the Sleep-Inducing Outfit; under the Black Band Are a Vibrator and Blue Light

LIGHT AND VIBRATOR BRING SLEEP IN EIGHT MINUTES

A French electrical engineer has devised an apparatus that is said to put a person to sleep in eight minutes. It consists of a black band containing a blue light which is placed over the eyes of the subject. Combined with this is a small vibrator. The effect of the illumination and the vibrations brought on sleep.

FEWER STORMS IN NOVEMBER WEATHER RECORDS SHOW

In the last forty years, only three tropical storms of true hurricane nature have been observed after the first of November. Since 1886, nearly 250 storms of the hurricane type have occurred, although, of this number, only 128 have attained true hurricane force. About eighty-eight per cent of the winds occur in the months of August, September and October.

H. E. Leitchamoin Paris France

Wide World

904

New York Sun

Totems Reveal Vivid Picture of Vanishing Race

LIKE the vanishing race whose rare skill at carving has made them possible, the totem poles of the Alaskan Indians are rapidly disappearing through neglect and decay, and even outright destruction, and science seems unable to prevent it. This is the

Houses Grow Ears to Grace Their Highly Decorated Fronts in the Kwakiutl Indian Villages of Alert Bay, Vancouver Island, British Columbia; Totem Art Is Carried to Its Highest Peak in Some of These Decorations

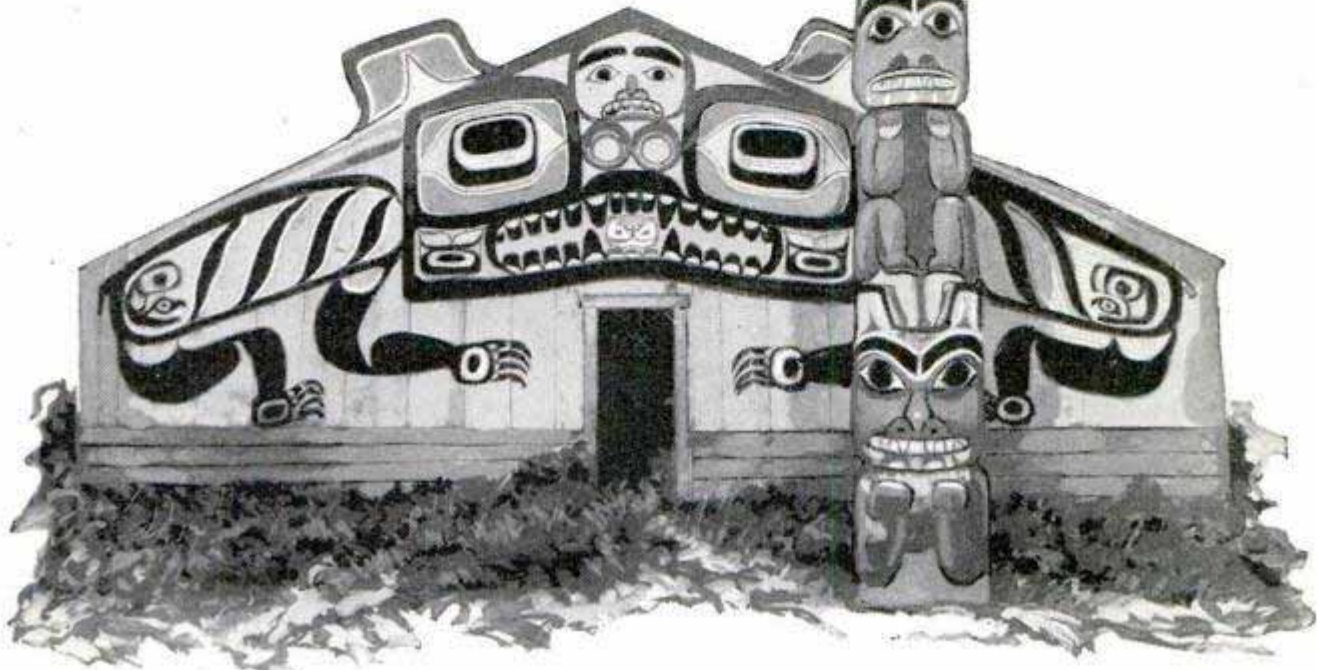

disclosure made by Dr. Herbert W. Krieger, of the Smithsonian Institution, in a lengthy report prepared for the government on the results of his efforts last summer to preserve some of the rarest products of totemic art in the southeastern parts of Alaska.

Dr. Krieger states that many of the villages are no longer occupied by their former inhabitants, while others show evidences of neglect because of the absence of their owners, who are working in the Alaskan canneries or are imitating the white man's ways and are living in new houses of sawed boards, leaving their ancestral homes, which represent the highest skill of the northwest coast Indian, to fall into decay. The wood carver's art of these tribes, Dr. Krieger says, has aroused wonder and admiration from the time of their discovery by the Russian explorer Behring, who first landed at what is now known as Sitka, Alaska, in 1741. Nowhere else in the world may one find a similar type of art, representing for the most part carved figures. The images are

usually of well-known animals, such as the beaver, bear, killer whale, shark, hawk, eagle and raven, but there are also mythical creatures, such as the thunder bird, which is reputed to make lightning by the flash of its eyes and thunder by the clapping of its wings.

These carved figures find expression on the tall wooden totem poles chiefly, although house posts, dugout canoes and many other objects of daily use form subjects for carvings. The most striking bits of artistic efforts of the natives are on the tall columns of cedar wood, which are really memorials erected in honor of the male relative whose property the builder had inherited. These totem poles, some giantlike in height, generally occupy the place of honor at the center of the gable end of the owner's house.

Among the Tlingit and certain other of the coast tribes the totem pole has a hollowed cavity in the rear in which are placed the cremated remains of the one in whose honor the memorial was erected. Nearly all the poles standing at the pres-

887



This, Alaska's Most Elaborate Totem Pole, Stands in the Memorial Park at Sitka; It Came from the Village of Kasaan

ent time have such cavities. Among the Tlingit the name for totem pole is the word meaning "coffin"; its use and significance would make it, according to our notions, the equivalent for tombstone or memorial column.

Dr. Krieger found that the totem pole which once stood proudly before the house of a family or clan, and showed by its carvings the lineage and personal achievements of the residents, is fast succumbing to decay and ill use. Since the coming of white men, the Indians have lost their pride in tradition. One native cut down some finely carved poles to make a sidewalk. On the west coast of Prince of Wales island is the village of Kowkan, with fifty good totems intact, but this is far from the course of white men's travels and is uninhabited. Tongass village also has some unique totems. Three of these have the carved emblem declared by natives to represent Captain Cook, the first white man seen by their ancestors. One pole has a very fair likeness of Abraham Lincoln carved among its bears and eagles and ravens. The natives think probably that the chief who made it had seen a white man, an event worthy of preservation in native history, and had acquired a picture of Lincoln which he copied on his totem. It is also possible that the carver sought to record the purchase of Alaska by the United States, since one earlier totem has been found with what was probably a portrait of the Czar of Russia.

Any unusual experience in the life of the individual may be incorporated in the carvings on the totem pole. One has the carved figure of a ship under full sail, Dr. Krieger said. This pole belonged to a woman who was the first of her village to see such a vessel and the white men who landed at Sitka. A carved figure on another pole represents the experience of an Indian at Tongass village who once acted as host to a former secretary of the interior on his visit to Alaska. The secretary was asked to sit on a pile of fine furs in the Indian's house. At the close of the interview he was told that he was forgetting his furs. "It is the custom of our people," said the Indian, "that what a visitor sits upon is his."

When the totem pole was erected later by his nephew, the former secretary of the

941

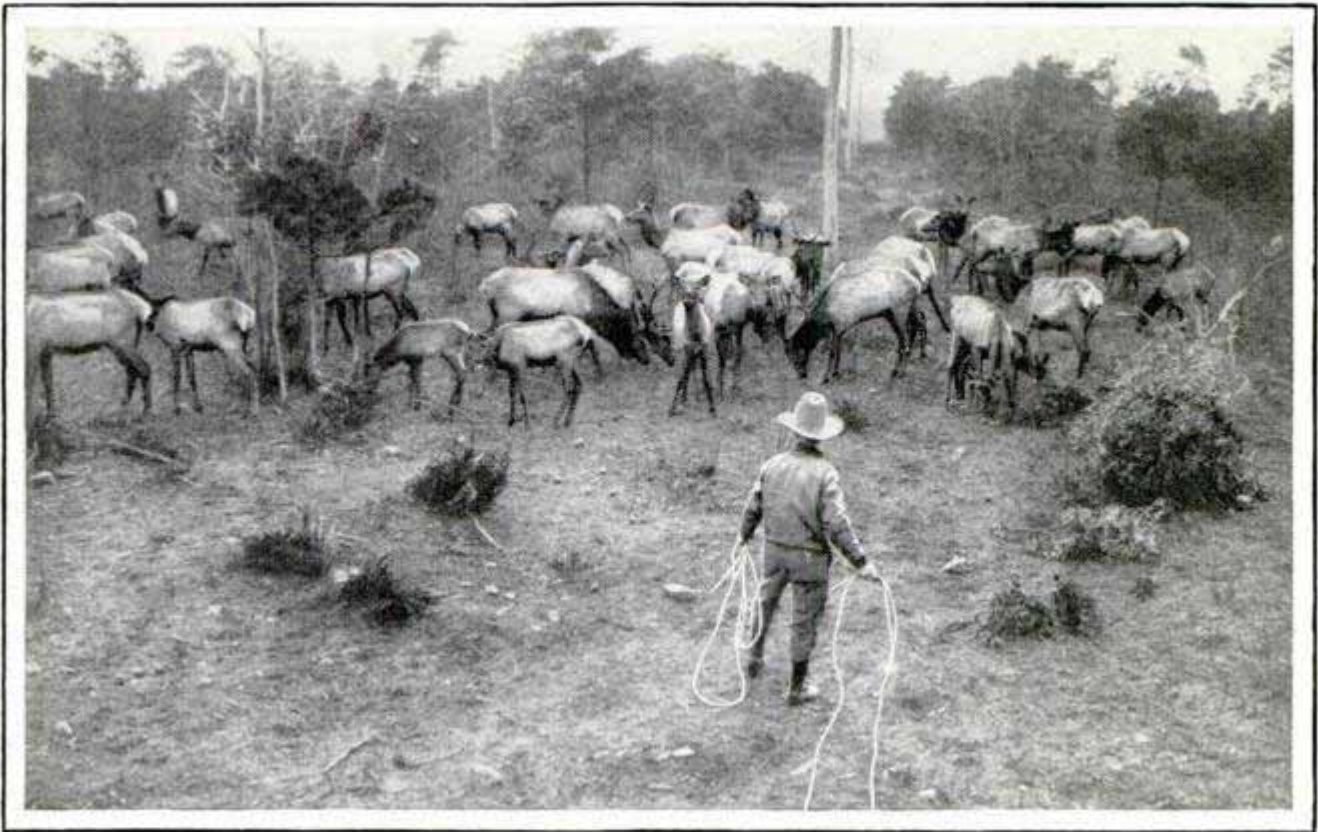

At the Annual Elk Round-Up on a Massachusetts Farm; the Young Animals Are Being Roped and Separated from the Others to Be Put in Special Winter Pasture

interior was represented on it dressed in a frock coat, silk hat and checked trousers.

"Totem pole art," Dr. Krieger says, "is largely a representation of animals. These usually refer to the role played by certain animals as actors in native myths. The curved beak of the hawk is invariably represented as touching the mouth on the underside, while the thunder bird, which wears a cloud hat, has a larger beak. The raven has a long straight beak, while that of the eagle is short and curved. Birds, even when they take human form, are to be recognized by a beak added to an otherwise human face. The beaver usually is biting a stick, which it holds between its paws. Certain mythical water monsters may take on a variety of forms. Animal representations have erect ears placed above the eyes, but are otherwise hard to distinguish from human figures.

"The most important thing in the life of the Indian is his crest or totem. Representations of this animal crest are placed on every conceivable object of daily use; they are even tattooed on his arms and body and are painted on his face. The inheritance of a proper kind of crest determines an individual's chances of success and standing in his community."

ELK ROUND-UP IN NEW ENGLAND — SHOWS ROPER'S SKILL

Capturing elk with a lasso suggests a picture of the wild west in one of its wildest phases but the reality is found in Middleboro, Mass., and the lariat thrower is a Yankee "cowboy." The scene is on an elk farm where, once a year, the animals are separated from the rest of the herd, as winter approaches, and placed on a special range. They are also given a specially selected diet which consists chiefly of milk.

ARCTIC COAL TO BE SENT BY AIR AVIATOR PREDICTS 899

Coal will be shipped to the United States from the Arctic by airplanes within the next forty years, Lieut. Comm. Richard E. Byrd, first aviator to fly over the North Pole, believes. He bases his prediction on the opinion that flying machines of sufficient safety and power for heavy commercial use will soon be produced. Incomplete surveys have revealed that there are millions of tons of coal in Alaska and huge fields of the fuel in other parts of the Arctic.

N.Y. Times 11/14/26

9/26/26

**ANCIENT INDIAN COMIC MASK
RIDICULES BOASTER**

584



The Braggart Was Disliked Even in Early Times; Comic Indian Mask Ridiculing Boasters

Suggesting the cartoon of today, a grotesque mask was made by an Indian tribe to symbolize the boastful warrior, who, on returning from an expedition, tired his auditors with repeated tales of his own prowess. The image, made of wood, delivers its message by the emphasis of a single feature—a huge mouth. The mask has been exhibited in the Museum of the American Indian in New York city.

**MOTOR FUEL FROM COAL TAR
MADE BY NEW PROCESS**

955

Soft-coal deposits in the United States can supply the world's need for motor fuel for the next 800 years, an oil expert declares. He reports the development of a "cracking" process by which tar from bituminous coal is converted into motor fuel of high anti-knocking properties. He

Mr. Isustave Iglofi
Technical Director
Products Co.

estimates that there are 1,600,000,000,000 tons of soft coal in the United States. From this 800,000,000,000 barrels of tar could be produced, sufficient to yield 240,000,000,000 barrels of fuel.

**SIDE SEATS IN STREET CAR
STONE-AGE HERITAGE**

903

Side seats in street cars are popular because of an ingrained preference that comes down from stone-age days, according to Dr. Edwin B. Twitmyer, psychologist of the university of Pennsylvania, who has made a study of the habits of car riders. William James advanced the theory that men prefer to sit with their backs to the wall because their ancestors placed their backs against a rock or tree so that they could not be attacked from the rear. For the same reason, Dr. Twitmyer says, people put their beds near the wall, and make the headboard higher than the footboard. Car riders prefer seats near the door because of the added sense of security or, in some cases, because they want to efface themselves from notice as quickly as possible.

**TRANSFORMER IN LIGHT SOCKET
RUNS SMALL BULBS**

946

Tiny electric bulbs such as are used in physicians' and dentists' equipment can be lighted from the house circuit through a transformer that is connected directly to the light socket. It reduces a 110-volt current to two and one-half volts and is said not to heat up, even if used continuously. A small bulb can be operated for thirty-six hours at a cost of a cent or so, the manufacturers assert. Tips on the transformer make it easy to connect the cords to the small lamp unit.



Speciallight Corp New York
Compress Oscillator
775 E. 143 St. N.Y.C.

PLANES LAUNCHED BY AIRSHIP MAKE SAFE LANDING

Speaking of the air expresses of the future, an airship pilot remarked: "Flying is simple enough, but landing at the intermediate air stations will cost time and

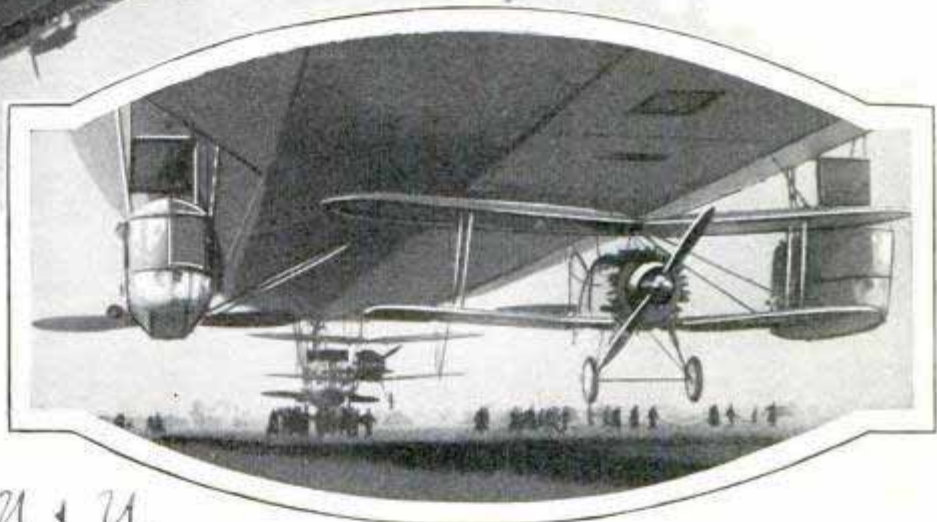
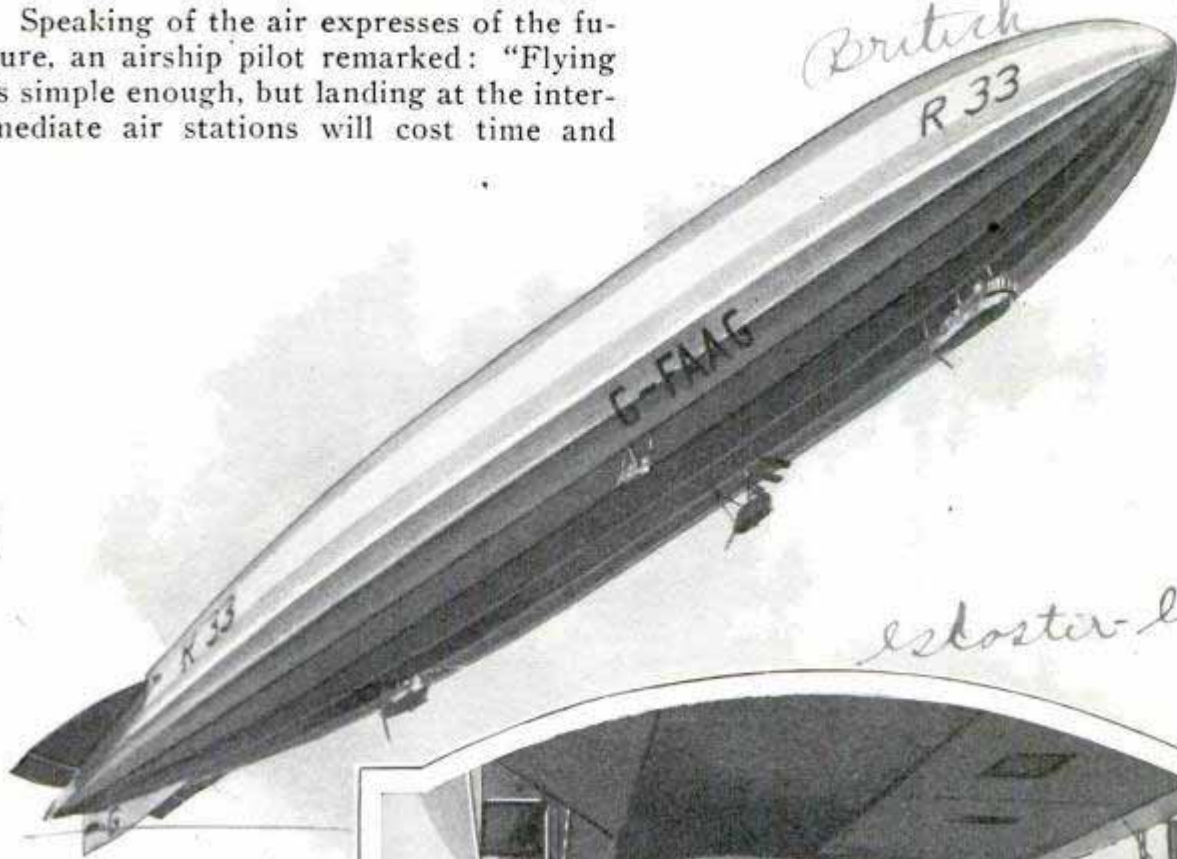

For Intermediate Landings from Dirigibles; Airplanes Carried by the Big Bag Descend with Passengers, Allowing the Ship to Proceed without Making a Stop

U & U.

money." Speed is the most valuable feature of air-borne passenger and mail traffic, and every landing means a considerable delay. To solve this problem, the British air ministry recently made some spectacular experiments.

Under the hull of an airship two airplanes, weighing over a ton each, were suspended. The ship took the air, and when an altitude of about 2,000 feet had been reached, the pilots of the planes entered them by means of short rope ladders. The engines of the planes were started, a pull on the control lever freed them from the slip hook from which they hung and in a steep dive the machines parted from the mother ship. In a few moments, the planes straightened out and made a perfect landing.

In wartime, fighting machines can be

released from the airship to protect it from attacking enemy craft. Peaceful aviation also benefits largely by such experiments, for they seem to have proved that it is possible to land safely from an airship proceeding at full speed.

TINY FLAGS PROTECT GARDENS OF JAPAN FROM BIRDS

To keep marauding birds from seeds and young plants, Japanese gardeners use an effective adaptation of the familiar scarecrow. They stake off the field with lath and common wrapping cord into squares about twenty feet wide, and on the strings they attach small strips of cloth or paper. These tiny pennants flutter in the breeze and the continual motion keeps the birds from the patch.

998
 Comd. Lee McCrae
 147 07 N. Hill Ave
 Pasadena, Calif

638

Reaction of the Thermite Charge

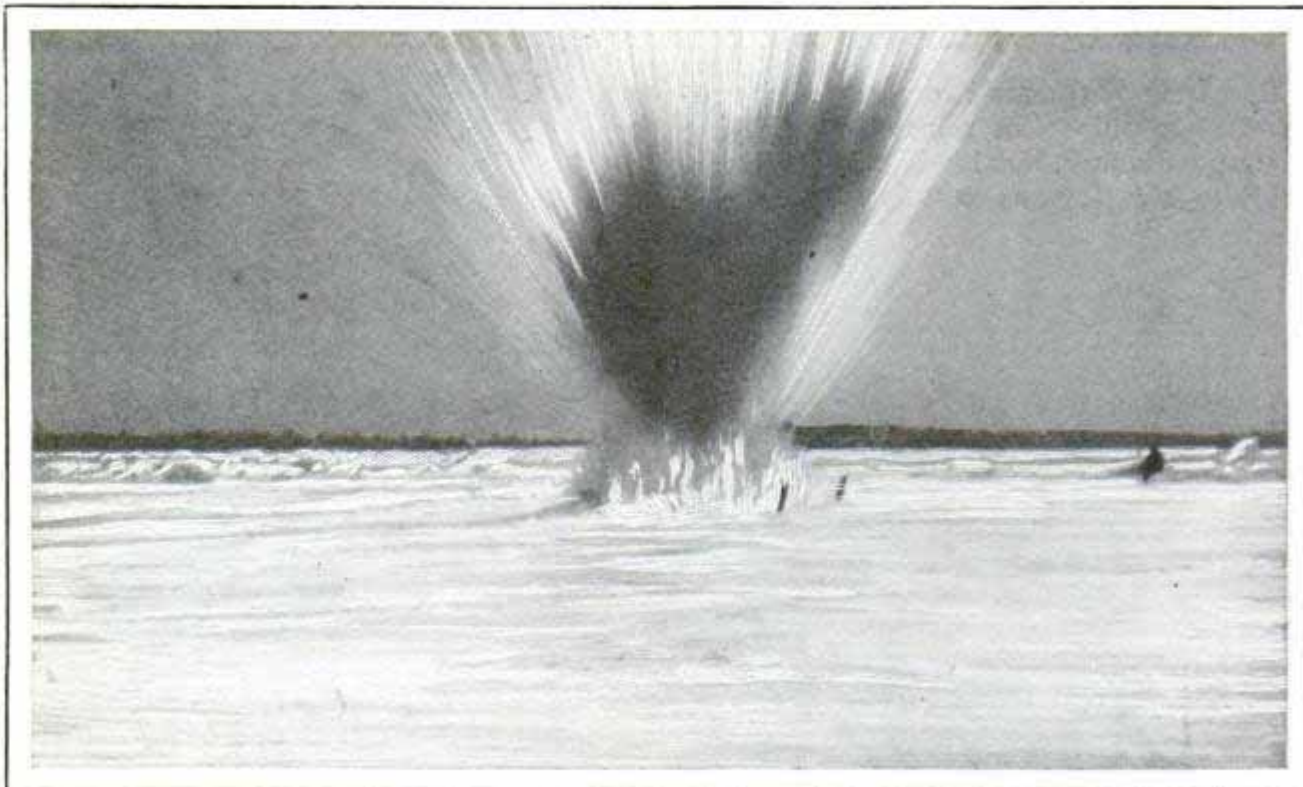

The Shot Which Dislodged the Chimney Island Ice Jam in the St. Lawrence River, March 13, 1925; Reaction of a Ninety-Pound Thermite Charge Moved 1,000,000 Pounds of Ice

Fighting Icebergs with Fire

Charges of Substance Producing Intense, Quick Heat Shatter Frozen Masses That Menace Ships

SEVERAL popular ideas about icebergs have been upset and an effective way to destroy the huge wanderers for the protection of shipping has been demonstrated by Dr. Howard T. Barnes, of McGill university, who has made seven expeditions in northern waters in the interests of science and navigation.

Tests with sensitive thermometers disclosed that often the surface water near a berg is warmer than that farther away. The ice mass acts as a sort of pump, sinking the surrounding sea water by cooling and drawing to itself the warmer surface water, thus contributing to its own destruction. This rise in temperature was noticed as far as five miles from a berg.

Other measurements showed that from one-sixth to one-tenth of the volume of an iceberg consists of air, hence the density is such as to make it float out of the water much more than ordinary hard ice. According to Dr. Barnes, the common statement that nine-tenths of an iceberg is under water is not always true, for

sometimes as much as one-half of the mass may be above the surface.

Chunks of icebergs placed in hot water, hissed like frying bacon owing to escaping air. Samples of the air were analyzed and found similar to the atmosphere today, indicating that there has been no change in the air over the earth since the snowflakes fell on the Greenland ice cap, possibly 5,000 years ago. Where the air bubbles predominate, the color of the berg is white, while blue veins in it are due to the absence of air.

A material that would give a high temperature in the shortest time was found in thermite, a combination of aluminum and iron oxide, widely used for welding and other purposes where great heat is desired. The effectiveness of this substance was demonstrated in the winter of 1924-25, when Dr. Barnes used it to blow out an ice gorge in the Allegheny river. An expedition last summer succeeded in destroying two icebergs with thermite and further tests are planned.

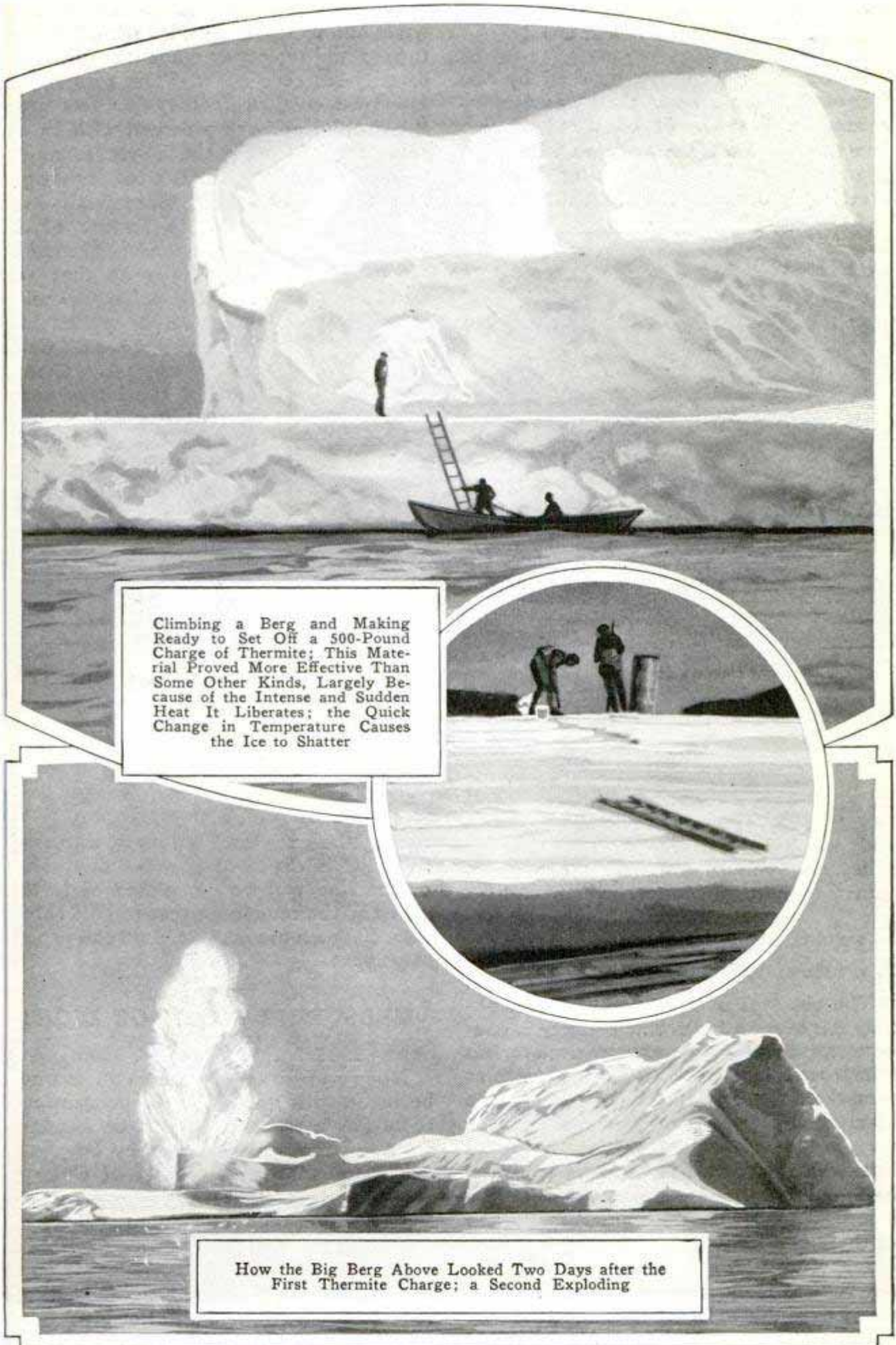

Demmer
the Seine in Paris
France
Swimming
841

**FLOATS PROPELLED BY FEET
AT SIX MILES AN HOUR**

Driven by a propeller worked by the feet of the user, a novel craft was demonstrated in France. It consisted of two floats fitted to a framework on which the operator rests in a swimming position. Steering is done by the front float and a

sist of fifty-four aluminum and seven steel wires and will be suspended from 826 steel towers and twenty-one anchor towers set seventy-six rods apart. The former will hold the conductors fifty-five feet from the ground and are provided with extensions for increasing the height to ninety feet. Each of the smaller towers weighs five tons, and the anchor units ten

tons. A feature of the line is the special method of splicing so that sections of cable five miles long can be pulled into place at one time. Ordinarily, not more than a mile of the heavy wires can be handled at once without risk of breaking. A ten-ton tractor furnishes the power for un-

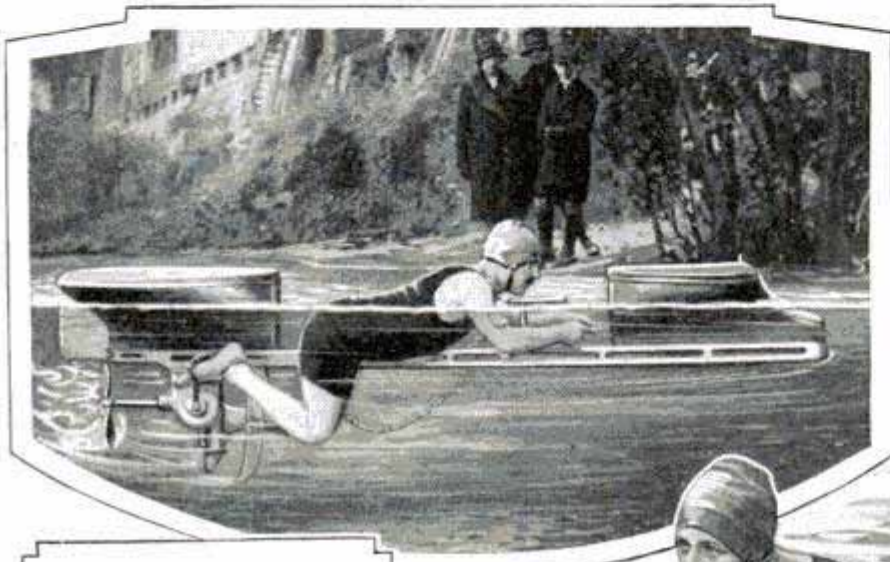

Photo - Diagram of the Foot-Propelled Float in Action, and View of Its Appearance on Surface



© Keystone View Co.

rudder. A speed of slightly more than six miles an hour is said to have been attained without difficulty.

**POWER-LINE BUILDING RIVALS
ROMANCE OF RAILWAY**

The big days of railroad building probably are over so far as this country is concerned, transportation experts declare, but construction projects, in some respects as remarkable as any that characterized the blazing of the railroad trails, are under way in the growing network of power lines and their rows of high steel towers. Such an undertaking is the 223-mile line being strung from the snowy fastnesses of the high Sierras into Los Angeles. Unlike the railway, it is being built through the roughest and most mountainous territory available in order to reduce the cost of the right of way. The cable will con-

reeling the cable and pulling it into position. It is expected that the south half of the line will be completed early this year and the remaining part in 1928. More than 500 men are employed on the project at present.

**MEASURING SPEED OF LIGHT
TO AID SURVEYS**

Maps and surveys of the earth can now be made with greater accuracy than ever before as a result of the latest measurements of the speed of light by Dr. A. A. Michelson of the University of Chicago. He points out that by determining the time it would take for light to travel from one point to another, it is now possible to measure a distance of 100 miles or so in two weeks where the old methods would require two years and still not give as accurate results. By flashing light rays from

Southern California Edison Co
843

848

One more Oct. 19, 1926

revolving mirrors between Mount Wilson and Mount San Antonio in California, a distance of twenty-two miles, Dr. Michelson computed that the speed of light is approximately 299,796 kilometers (186,284

FRONT DRIVE GIVES SOLUTION FOR LOW RAKISH CAR

Success of front-wheel drive on several racing cars during the last two years of-



An English Idea for a Streamlined Body on a Front-Wheel-Drive Car; Notice How the Elimination of the Rear Axle Helps Bring the Body Down for a Low Center of Gravity

miles) a second. This rate is slower by some miles than previously had been believed. Five sets of mirrors were used to reduce the chances of error. They gave equivalent results. By repeating the measuring experiment over a greater distance, the scientist expects to achieve an even more accurate figure.

732

CHAIR HAS RACK FOR UMBRELLA AND SHELF FOR HAT

Theater patrons have individual "check rooms" in a chair fitted with a rack on the back that holds a coat, a bracket at the side for the umbrella and shelf space underneath for the hat or for parcels. The coat holder projects but a short distance from the back of the seat and is arranged to prevent the garment from becoming mussed up by the occupant of the seat behind.



The Wardrobe Chair, Showing How the Various Articles Are Stored

fers a solution of the problem of a low-hung car which will cling to the road, the elimination of steps and the necessity of climbing up to a seat, and removes the difficulties in the way of real streamlining, with true "tear-drop" bodies. Continental designers are already working on custom-built cars in which all of these problems have been met. The propeller shaft running from the engine to the back axle was the one big obstacle in the way of low-slung cars, with the center of gravity below the center of the wheels. The front

drive has no propeller shaft, and therefore needs no back axle, the wheels being capable of side suspension.

A section view of such a car, designed in England, shows how the tear-drop body can be carried back with smooth lines in a tail that incloses gas tank, spare tire and luggage compartments, the latter two being reached through a trapdoor in the car roof, which at this

point is as low as the rumble seat of a roadster. This type of car could take turns at very high speed, and even in a sharp skid would have little tendency to turn over.

Names and addresses of manufacturers and dealers in articles described in Popular Mechanics, and any other details, will be promptly furnished by our Bureau of Information.

Shown at International Exhibition of Inventors

7, Parkersburg Ave. London E.C. England.

892

For Quick Answers to Fire Alarms; German Motorcycle Outfit with Sidecar That Has Separate Motor

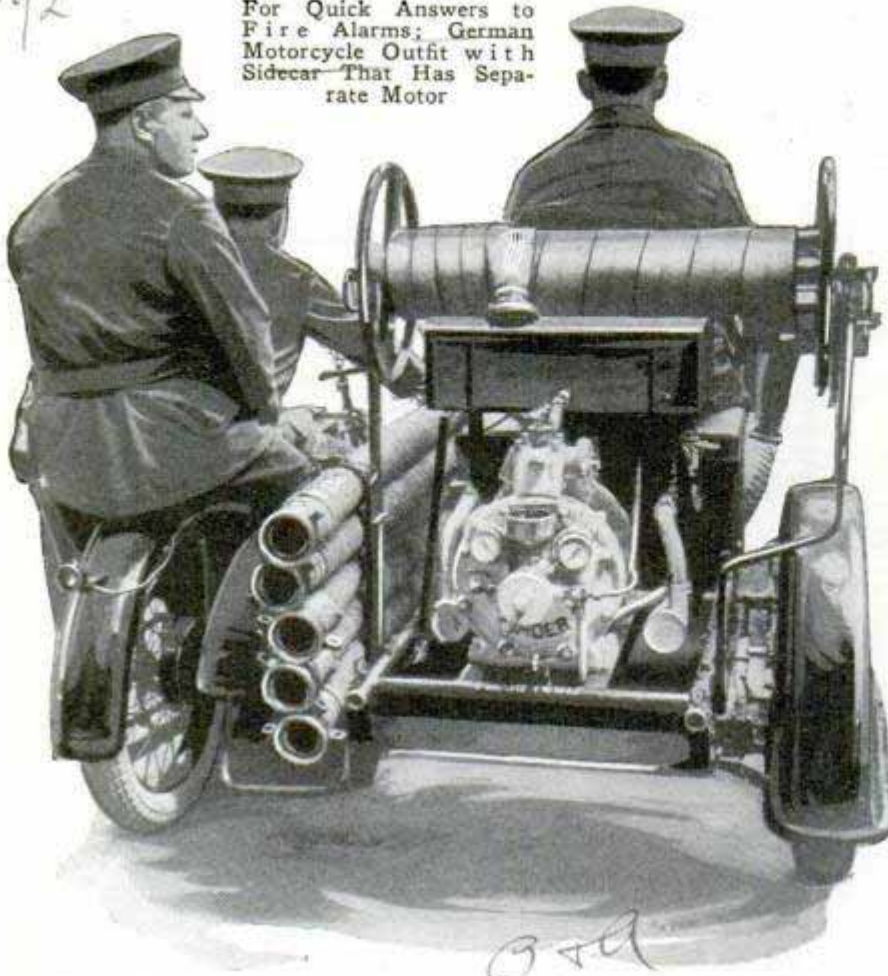

SIDECAR ON CYCLE FIRE ENGINE RUNS ON OWN POWER

For fighting fires, a special motorcycle, exhibited in Berlin, is really two vehicles in one, as the sidecar, containing the apparatus, can be detached from the cycle and made to run by its own motor. Additional wheels enable this operation.

ELECTRICAL "PLOT" FOR OPERA CAREFULLY PREPARED

Besides the theme which the singers develop on the opera stage, there is another plot that the public witnesses through the work of hidden actors who are sometimes almost as essential to the success of the scenes as the principals. This is the plan of electrical lighting to accompany the music, which indicates just when certain buttons or switches are to be pulled for the special electrical

effects. The chief electrician is in charge of this inner play. When a cue is reached, he presses a button and a light or buzzer signal relays word to a helper at some far part of the stage that it is time for him to operate a spotlight, raise or lower a curtain or perform some other task. At the Metropolitan Opera house in New York, a man sits in the cellar with his head through a hole in the stage but out of sight of the audience. When he receives his cue, he signals through a speaking tube to an electrician at his feet who operates the lighting switches for the stage. During rehearsal, the chief electrician, stage manager and scenic artist watch the effects from

the rear of the house. They communicate with the stage by means of telephones.

MOVE HOTHOUSE MANY MILES WITHOUT BREAKING GLASS

Movers achieved another triumph recently when they rolled an eighty-foot greenhouse in Los Angeles to a new locality, twelve miles distant, without breaking a single glass in the structure. The roof and sides were carefully braced.

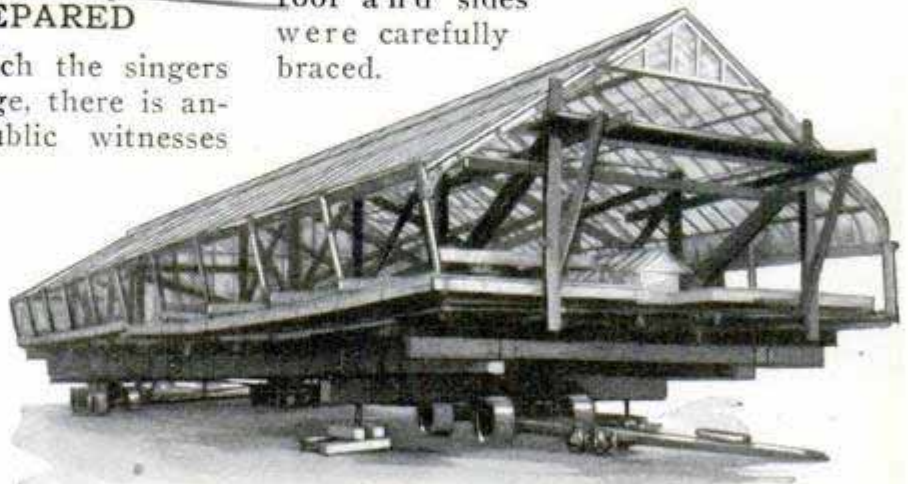

Greenhouse on Wheels Showing Bracing That Saves Glass

Chicago Daily News
11/22/26

Kress House Moving Co.



Bridge and Artificial Island Built in Hudson Bay, at Port Nelson, to Furnish Protection for the Harbor; Steel and Concrete Piers Resist the Ice and Break Up Jams

Bringing Europe a Thousand Miles Nearer to America by Rail

By EARLE W. GAGE *Richville, N.Y.*

ADVENTUROUS engineers are pushing a pair of steel ribbons through the wilderness of the northland which will bring Europe 1,000 miles nearer America, cut off more than 3,000 miles on the journey from Europe to the Far East, and unlock billions of wealth, hidden behind the barrier of waste stretching between Hudson Bay and civilization.

The great transcontinental railroads of the past generation opened vast empires to development, resulting in the settlement of the American continent, but the new Hudson Bay railroad is destined to transform the travel between two hemispheres, vitally affecting the millions of Asia and Europe who look to the vast central American plain for food and clothing.

This 425-mile link that is being forged onto the great American railroad chain will connect more than 20,000 miles of trunk lines with the shortest possible route to Europe, besides tapping the Great Lakes waterways and connecting them with foreign markets. Although it will cost more than \$20,000,000 to push this road from the end of existing steel to Hudson Bay, and more than \$6,000,000 to construct the harbor, docks and warehouses at the mouth of the Nelson river, engi-

neers estimate that the original investment will be returned to the Canadian government at the end of ten years, due to elimination of the long haul halfway across the continent, in order to reach transatlantic steamers.

Canada's great inland sea, Hudson Bay, gives the vast interior region a central outlet to the Atlantic and to world markets. Although this region is often associated with arctic conditions, no part of it comes within the polar circle, and a report says with assurance, "that ships may enter and leave Port Nelson all the year around." The northern part of the bay is in about the same latitude as the highlands of Scotland, while Moose Factory, on the southern shore, is only a trifle north of London. The temperature of the water of the bay is several degrees higher than that of Lake Superior, and it has a mitigating influence on the climate of the vast territory which immediately surrounds it.

Though Hudson Bay remains open, Hudson strait freezes over. Thus, transportation will be possible for only four months of the year, but the saving in cost and time from the freight traffic in the summer will justify the construction of the railroad. During the closed season,

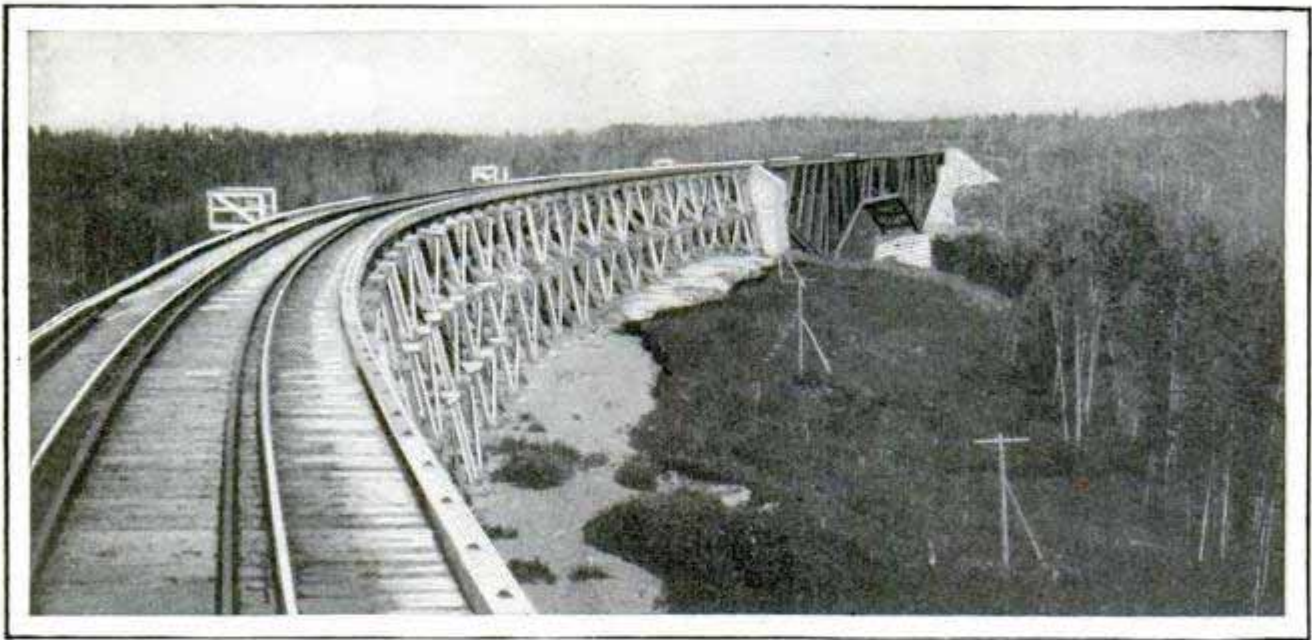

Hundreds of Miles of Virgin Wilderness, or "Bush" as the Canadians Call the Forests of the North, Is Penetrated by the New Railroad in Its Long Run to Hudson Bay

the enormous resources of the region, including farm crops, timber, paper-pulp stock, minerals, and the large wealth of fur, will provide freight business.

Now the bulk of the wheat sent from central America to European markets must pass through the bottle neck at the head of the Great Lakes, or over the more expensive long-haul freight route to the seaboard, when lake ports are locked by ice. This season of relief is only slightly longer than that provided by Hudson Bay's open water, and since the bay route offers ample facilities for seagoing vessels as far as Port Nelson, much larger cargoes can be transported in a shorter time.

The Hudson Bay district constitutes an area of 3,000,000 square miles, including every variety of soil and climate known to the temperate zone. The bay itself is 1,000 miles long, 600 miles wide at the widest part, and is the third largest inland sea in the world. It yields the northern whale, a single adult specimen of which is valued at from \$10,000 to \$20,000, and thirty kinds of edible fish. The large fur companies expend from \$5,000,000 to \$6,000,000 a year in the purchase of furs alone in this area.

To the south lie the fertile farming districts, to the west the grain belt, and, just beyond, the vast cattle-range country. Forests cover millions of acres.

Only recently a man discovered the Belcher islands and also found them veritable iron mines. A geologist estimates

the iron resources of these islands to be not less than 200,000,000 tons and even more ore is in sight in the Nastapoka islands.

Since these islands lie but a few miles from shore, where water power is available and harbor facilities are provided by nature, their value is great, and many claims have already been staked in anticipation of the day when mills will start.

From Winnipeg, metropolis of western Canada, via Hudson Bay to Liverpool, is 3,620 miles, and via Montreal, 4,228 miles; Duluth, via Hudson Bay to Liverpool, 3,728 miles, and via New York, 4,201 miles. Such interior grain-storage points as Brandon, Regina, Calgary, Prince Albert, Edmonton and Saskatoon will be brought from 1,061 to 1,296 miles nearer to Europe's markets with the opening of the Hudson Bay route. On the other hand, Port Nelson is 2,925 miles from London, while Montreal, via Belle Isle, is 2,761 miles, and via Cape Race, 2,927 miles. However, the Hudson Bay route effects an average reduction of 1,000 miles to tide-water, without increasing the ocean distance to world markets.

CRUDE-OIL PIPES RIFLED INSIDE 86 FOR BETTER FLOW

The principle of the rifled gun is sometimes applied to pipes for pumping oil when the fluid is extremely thick. Heat cannot successfully be applied to a long

The Harraqub
Washington, D.C.

conduit, and mixing with too much water results in an emulsion from which the oil cannot be readily separated. Flowing through a rifled pipe, the oil, to which is added a quantity of water, is caused to whirl rapidly. The water, being heavier, seeks the outside and forms a thin film between the oil and the inner side of the pipe. Friction is thus reduced, and with this system, the oil and water issue separately at the end.

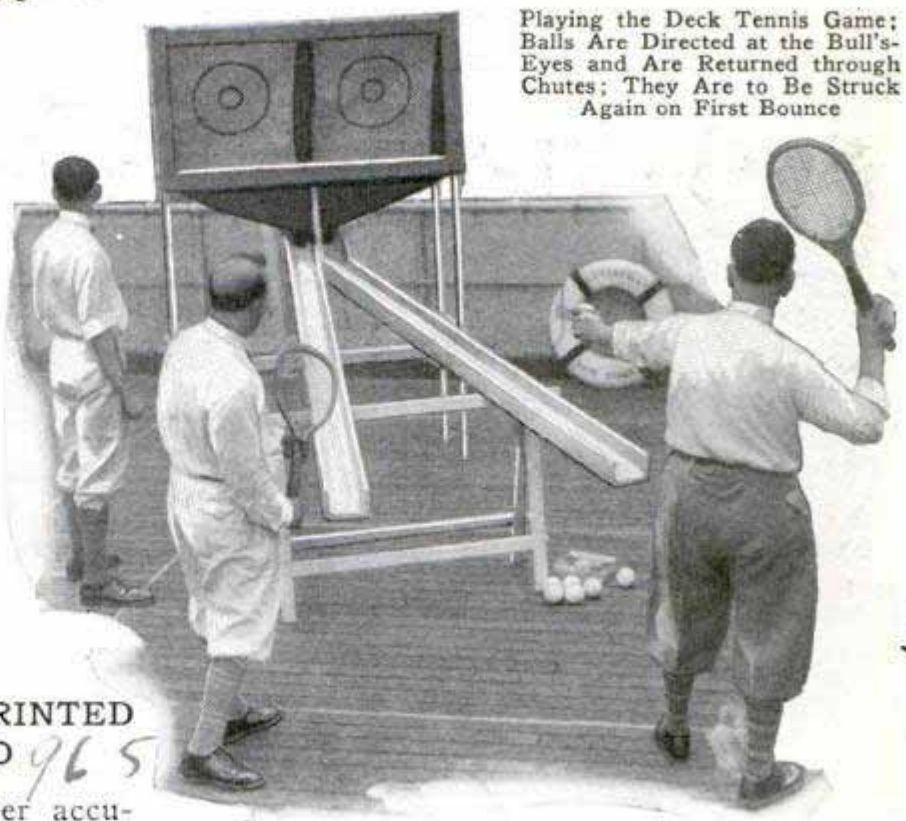

Playing the Deck Tennis Game; Balls Are Directed at the Bull's-Eyes and Are Returned through Chutes; They Are to Be Struck Again on First Bounce

BUS-RIDE TICKETS PRINTED AS FARE IS PAID 965

To make possible greater accuracy in the collection and counting of fares on motor-bus and inter-urban-car lines, a register issues tickets and keeps a record of them for checking with the receipts. As passengers enter, they are given a ticket from the machine which stamps the slip to show the date, class of fare, amount paid, number of station and other data. The ticket is handed back to the operator when the passenger leaves so that it can be compared with the record which has been left in the register. Furthermore, the attendant also is enabled to tell by the ticket if the per-

do not print tickets only.



Issuing a Ticket from Register; Machine Keeps a Record of the Fare for Future Auditing

son has ridden beyond the point to which he originally paid his fare and thus collect any balance due.

BULL'S-EYE TENNIS ON LINERS
LATEST MARINE SPORT

For the amusement of ships' passengers, a modified tennis game has become popular and is considered practical, too, as it affords an effective means for players to keep in training while on long voyages. Instead of a net, a target-and-chute apparatus is used. The balls are aimed at bull's-eyes in a frame, fall back through the runway and are to be struck again toward the target on the first bounce. Score is kept by a system of points based on the accuracy of the shots and successful returns without touching the ball with the hands.

COUNT INSECTS ON FRUIT TREES
WITH STICKY PAPER TRAPS 968

Sticky fly paper serves government experts in the war on insect pests that menace fruit and other trees. Placed in screen boxes, it is held under the branches of a tree and the limbs shaken. The insects caught on the paper are counted, so that the investigators can determine accurately at what time of year the bugs are most plentiful. The traps have been used for two seasons in studies of insects that attack orange and lemon trees.

Chicago - 2728 S Michigan Blvd

Levathan

liner

U.S. Bureau of Entomology

Chmer Fare Register Co,

**BABY CART THAT FOLDS UP
CARRIED AS HANDBAG**

Gocart, Unfolded and Col-
lapsed, Showing How It
Can Be Carried as a
Handbag

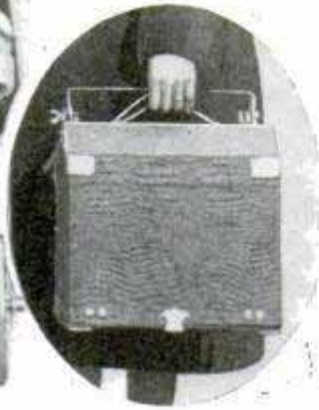

Weighing only fourteen pounds, a col-
lapsible cart for the baby is folded up in
the form of a handbag for carrying. Sav-
ing of storage space and ease in going up
and down stairs are among the advantages
claimed for it, while comfort and safety
are assured the infant when the carriage
is in use.

**SELF-ADJUSTING AUTO BEARING
INVENTED BY PRISONERS**

A self-adjusting connecting-rod bear-
ing that automatically takes up its own
slack has been patented by two prisoners
in the Utah state penitentiary. The bear-
ing is springless, working on a cam prin-
ciple. The two inventors worked out the
idea in the prison machine shop and ap-
plied it to all the cars and trucks used at
the penitentiary, as a practical test before
getting their patent. Previous to that,

however, it had been run for thirty hours
in a shop test with no lubricating facilities
save what could be supplied occasionally
from an oilcan. Despite this grueling test,
the bearing is said to have shown no ap-
preciable wear. Because of its nature,
the bearing does not require burning or
scraping in, and as it takes up the wear
and adjusts itself, a car with a new bear-
ing can be closed and driven away at once.

**SUGAR AIDS MUSCULAR ENERGY
CLIMBING TESTS SHOW**

Mountain climbers often experience an
increased desire for sweets and some, who
never touch such things at home, con-
sume large quantities when they are on
tours. A test was performed not long ago
to determine what effect sugar had on a
climber's muscular energy. The subject
was ignorant that an experiment was be-
ing made. On one day, he was given liq-
uid sweetened with sugar and, on the next,
a similar liquid sweetened with saccharine
to make it taste like the other. It was
found that a greater amount of work could
be accomplished on the days when the
sugar was given. Workers in the sugar-
cane regions depend to a large extent up-
on the juice of the cane for nourishment.
One investigator found that eight and
three-fourths ounces of sugar a day in-
creased his work capacity from twenty-
two to thirty-six per cent.

**WRIST WATCH AS ALARM CLOCK
SERVES AS REMINDER**

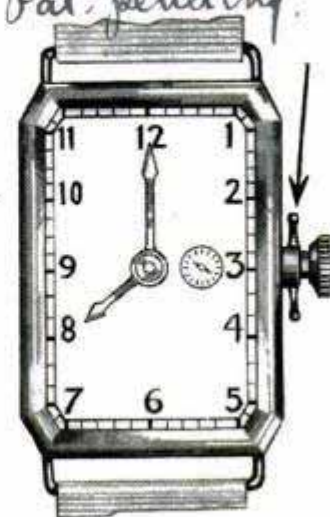

Attachable to the
ordinary wrist
watch with but lit-
tle change of the
mechanism, a re-
volving unit with
protruding points
that touch the skin
when they turn,
calls the attention
of the wearer to a
pending engage-
ment or may awak-
en him, as the case
may be. The equip-
ment includes a timing apparatus by which
the points are set to revolve at any hour.

Central Hall, London, Eng.

Kansas City, Mo. 11/8/26

*Somewhat similar. Handy Kab.
Jacobs + Karsler, 9 E. 14th St. New York*

*R. D. McCoy and
Archie Sulcos*

*Utah Deputy Warden
Richard H. Wooten*

Pat. pending
Colonado Hotel
St. Louis, Mo.
Dr. Jacob Neuman

11/14/26

Corp?

88/

Elkhart, Ind

FIND TWO COMETS IN ONE DAY ONE OLD, OTHER NEW 90 91

Finding a new comet on the same day as the rediscovery of an old one by the man who originally found it, was reported as an astronomical record recently. The new comet was observed by Dr. J. Comas-Sola, director of the Fabra observatory in Barcelona, Spain, and, following the practice of astronomers it will be given his name. It was seen early in the morning in the southeastern sky. As it is of the twelfth magnitude, it cannot be observed without a good telescope. About the same time, Dr. G. Neujman, at the observatory at Simeis, Russia, was picking up a comet he had discovered in 1916. He had calculated that it would come back every five and one-half years.

COAL DUST MIXED WITH CLAY PROVES GOOD FUEL 895

During the miners' strike, Englishmen learned new lessons in fuel economy. Coal dust, ordinarily considered too fine for furnaces, was rolled into balls with clay, to hold it together, and a coating of sawdust added to promote combustion and prevent the material from becoming sticky. The balls burned a long time and without forming clinkers, it is said.



Molding the Coal-Dust Balls; They Are Coated with Sawdust to Prevent Stickiness.

International



Propeller Windmill and Air-Mail Light, Which Is Supplied with Current from the Mill

ELECTRICITY FROM THE SKY SUPPLIED BY WINDMILL

In place of the familiar wheel with its many blades, an improved type of windmill consists of a propeller, similar to that used on aircraft, and special gearing for driving an electric generator or for pumping water. The outfit is said to have much greater efficiency than the old apparatus, and, once installed, the wheel requires little attention other than two oilings a year. The electric generating plants are of a thirty-two and 110-volt type. One of the reasons that the propeller is so efficient, as compared with the ordinary wheel, is that the two working blades cut the air with the least possible resistance and deliver more power to the dynamo. The propeller is so controlled by the vane that it is deflected out of extremely high winds, automatically protecting the plant and equipment.

Popular Mechanics Magazine does not publish the name of the maker or seller of any device described in its pages, but this information is kept on file and will be furnished, free, by addressing our Bureau of Information.

795



A Fish That Apes the Birds; Nest-Building in Its Home; This Species Also Changes Its Color

FISH BUILDS NEST OF WEEDS AND GUARDS EGGS

Among the peculiar kinds of fish is one that builds a nest of seaweeds and shore grasses around a stick or other anchored object. The eggs are laid in this shelter and are carefully guarded. The fish has the additional faculty of changing color like a chameleon to evade its enemies.

PIPE CARVER REVEALS SKILL IN MEERSCHAUM FIGURES

838

Vienna long has been the center of the meerschaum-carving industry but with the arrival in this country of one of a famous family of pipe makers, persons here have been able to see some of the cutting and finishing processes. The meerschaum is usually soft when first extracted from the diggings, most of which are in Asia Minor, but it hardens on exposure to warmth. After carving, the material usually is smoothed, heated in wax and given a high polish.



Otto Loder Cutting a Claw Design in Meerschaum Pipe Bowl; Several Tools Required for Delicate Carving

Atto Loder, Los Angeles, Calif.

CITY HAS RADIO PHONES

854

Commercial wireless telephoning is already in use at The Hague, where a municipal system with more than 1,000 subscribers has been opened. The service is said to be successful. Tests have shown that radio-phone messages can be sent between New York and London, and regular operation is expected as soon as a tariff has been fixed. Experiments in transatlantic wireless telephoning have been conducted for more than three years.

813

ELECTRO-CULTURE MAY REPLACE FERTILIZER

Will electricity be used as a substitute for fertilizers in raising crops? Striking results, that seem to indicate the possibility of such an innovation in agriculture, are reported from Germany where the electrical treatment was used to grow oats, rye, barley, wheat, potatoes and other crops on an unpromising piece of land without any other fertilizers, natural or artificial. For comparison, precisely the same crops were sowed in an adjacent field and were not given the "electro-culture." They showed strikingly inferior results. A number of masts, some fifteen feet high, fitted with simple electrical apparatus were set up at various points on the lot. From a bar magnet placed across the top of each mast, a zinc-coated iron

wire led over insulators into the earth and was continued underground parallel to the surface in the direction of the magnetic pole. Energy drawn from the air apparently stimulated the growth of the plants near the wires, the effect being noticeable from three to five feet on either side of the charged strand.

Alth. Berlinische near Berlin
Christian Science Monitor 10/18/26
Laurence J. Fogelbach
Berlin

569

Things You Know—That Aren't True

Commonly Accepted Beliefs Prove That "the Exception" Does Not Prove the Rule

By J. EARLE MILLER

WHEN you discover that something you have always known isn't really so, you may think that "that's the exception that proves the rule"—but that familiar old proverb happens to be one of the well-known "facts" that aren't so.



The idea that the exception does prove the rule goes clear back to the days when an old Latin proverb was translated into English. "Probat" was translated into "proves"—

which it may mean—but it likewise means "test," and that is the sense in which the Romans used it, so the proverb really is that "the exception tests the rule." The word is still used in English with the same sense, as for example the "proving grounds" at which cannon are tested. So what the exception really does is test the rule and prove thereby that it was not a true rule.

The commonly accepted beliefs that aren't true are almost numberless. Take the story that James Watt as a boy watched the



steam lift the lid of his mother's tea-kettle, and so conceived the idea for the steam engine. Somebody executed an elaborate engraving picturing young James watching the tea-kettle bubble, and thereupon most



everybody believed the story. What actually happened was that Hero of Alexandria, as far back as 130 B.C., had produced motion from steam and many men had invented crude steam engines, including Newcomen, whose devices were being used in mines be-



fore Watt's time. But they were all quite crude, and Watt, who was an instrument maker, being employed to repair a model of Newcomen's engine, conceived the idea of improving it—and built the condensing engine.

Another well-known "fact" that doesn't stand analysis, is the oft-quoted remark that most great discoveries are the result of accident. Watt's own discovery was really the result of a wide experience as an instrument maker and repairer for Glasgow university, plus close application to the problem of improving the Newcomen engine. Isaac Newton made some of his greatest discoveries by means of a child's toy—soap bubbles—but people who are amazed at the "accidental way" in which he made important discoveries playing with such a device, forget the years of deep study which enabled him to draw important conclusions from such apparently trivial phenomena. Many of his "discoveries" relating to light were painstakingly worked

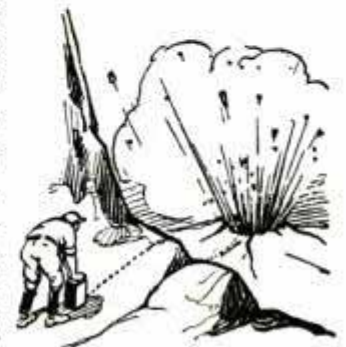

out through involved mathematical deductions, and then verified with bubbles.

The attraction of gravitation, according to the popular idea, was suggested to him



by the fall of an apple; Galileo, according to the same belief, got his idea of the pendulum from watching a swaying chandelier in a cathedral; and Madame Galvani, an invalid

for whom frog soup had been prescribed, noticed the dead animals twitching, called her husband's attention to it, and so he made his great electrical discovery.

The actual facts are that what Newton really discovered was that the same force which causes things to fall to earth retains the moon in its orbit—and it was his

years of mathematical study that made it possible for him to connect the two phenomena. Galileo had been studying falling bodies for years and had proved the absolute regularity of their movements long before he suggested the pendulum as a time measurer; and as for the Galvani story, it is a proven fact that he had been using frogs' legs for electroscopes for eleven years before his wife's health failed. It likewise is known that the pretty story of the invalid and her observations was fabricated by Alibert, an Italian writer.

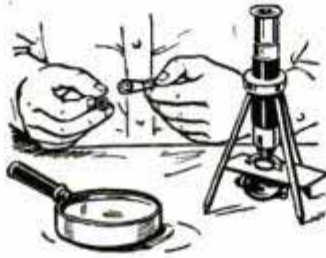

The idea that whetstones are oiled to reduce the friction of the metal being sharpened on them is another of the well-known, but untrue, facts. The oil actually increases the friction. The reason is that the tiny parts of metal rubbed off the blade being sharpened would be rubbed into an unoiled stone and burrished smooth, lessening its cutting powers, so oil is used to keep the metal parts in suspension and saves the stone.

That lightning never strikes twice in the same place has been repeated so often that many people believe it implicitly. Yet the Washington monument was

struck several times before it was equipped with lightning rods; the steeple of St. Mark's in Venice was struck frequently before it was supplied with conductors; and there is hardly a city in America but what has a tall smokestack or two that has been hit more than once.

Another belief which is general, particularly among people handling explosives, is that the force of dynamite is always exerted downward. Soon after the invention of the explosive, it was found that a stick laid on the ground would tear a deep hole beneath it, or if laid on a slab of stone would shatter the stone, instead of expending its force upward where, apparently, there was no resistance. In neither case, however, was there anything above the stick on which it could have wrought damage! If the stone had been raised on pillars and the stick of dynamite placed under it, the slab would have been shattered as easily. The explanation for the apparently downward action of dynamite is simple. Its destructive power is due to the tremendously fast expansion of the gases generated by the explosion. On a stone slab, three feet square, there rests a column of air weighing nearly nine tons. If moved slowly this air does not offer much resistance, but when the dynamite is exploded and the gases try to move nine tons of air at their own speed the resistance is nearly as great as that of solid matter, so the force is expended downward, as the stone slab breaks more easily than the air will move.

Every few months the newspapers announce that some obscure mechanic has rediscovered the "lost art" of hardening copper and has been offered a million or two million dollars for his "discovery." As a matter of fact, that ancient art of hardening copper is not lost



and there never has been a time when we could not produce copper tools as hard as any the ancient Egyptians made. But copper is more expensive than iron and a copper tool is not nearly so efficient as a steel one, so nobody cares to harden it.

Practically everybody believes that he can see steam—yet this is just another of those well-known facts that aren't facts at all. What you see coming out of the engine exhaust as a white cloud is simply minute particles of water. If they were in the state of steam you couldn't see them at all.

Another commonly accepted fallacy is that large lenses are more powerful than small ones. The power of a lens, meaning the extent to which it magnifies an object, is directly dependent upon the curvature of the surfaces, so it is easy to see that the smaller the lens the greater the curvature, and hence the greater the magnification.

Natural history, as represented by the common beliefs and superstitions, is full of similar errors. For example, there is the belief that when a turtle bites you, it won't let go until it hears thunder, and that small houseflies are the young of large flies. As for the latter, it is not generally known that flies, bees, wasps, butterflies, moths, etc., are as large at the time they emerge from the cocoon or cell as they ever are afterward.

An untruth that bobs up persistently is the theory that a ship sunk in the deeper parts of the ocean never reaches the bottom, but continues to float around in the depths forever. The proof of the mistake lies in the fact that it is impossible to compress water beyond a minute quantity, hence four miles down it has very little greater specific gravity than above. The ship still weighs more than the water it displaces, and so goes to the bottom.

ELECTRIC LIGHT-BATH CABINET TREATS ENTIRE BODY

796 Rays are projected upon the body from below as well as from above in a combi-

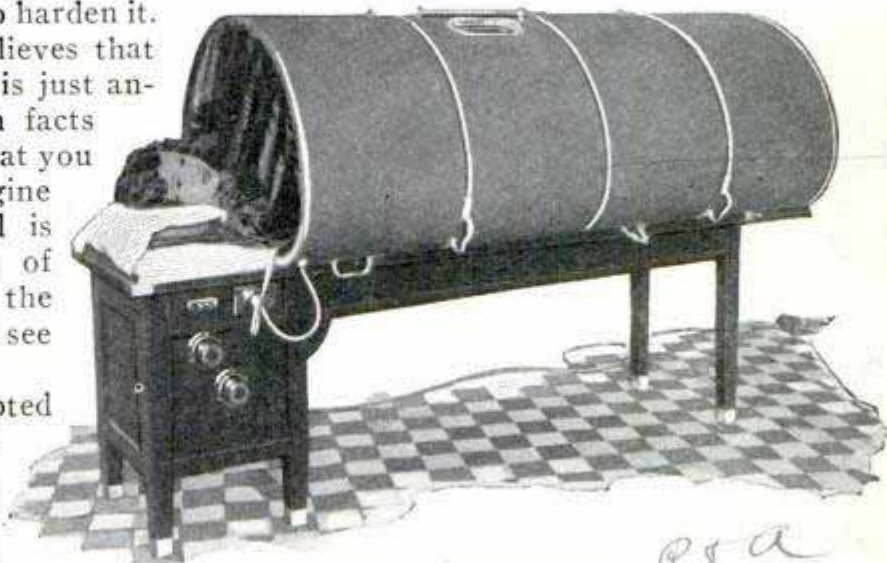

Taking Treatment in "Sunlight" Cabinet Which Projects Rays from Below as Well as from the Top

nation electric cabinet for administering light treatments. Lamps are arranged in the table part of the outfit and in the canopy which covers the patient. The heat and light can be accurately regulated.

METER TELLS SAND MOISTURE AIDING FOUNDRY WORK

761 To eliminate guesswork in estimating the amount of moisture in sand for foundry purposes, an electrical meter has been devised. It operates on the principle of the varying conductivity of the material according to its degree of moistness. The gauge, which resembles a cane, and contains flashlight dry-battery cells to furnish the current, is simply thrust into a pile of sand and the reading is instantly shown on a dial at the top. A standard chart of moisture-content figures is furnished from which to determine the wetness of the particular sample being tested. This instrument is intended to promote greater accuracy, saves the time and expense of laboratory tests and is simple to use.



Moisture Meter in Use; End of Stick Is Stuck in Sand Pile and Reading Taken from Handle

A. W. McDevaney & Co.,
53 W. Jackson Blvd.
Chicago

74 New Montgomery St. San Francisco Calif
Hot 2 mag

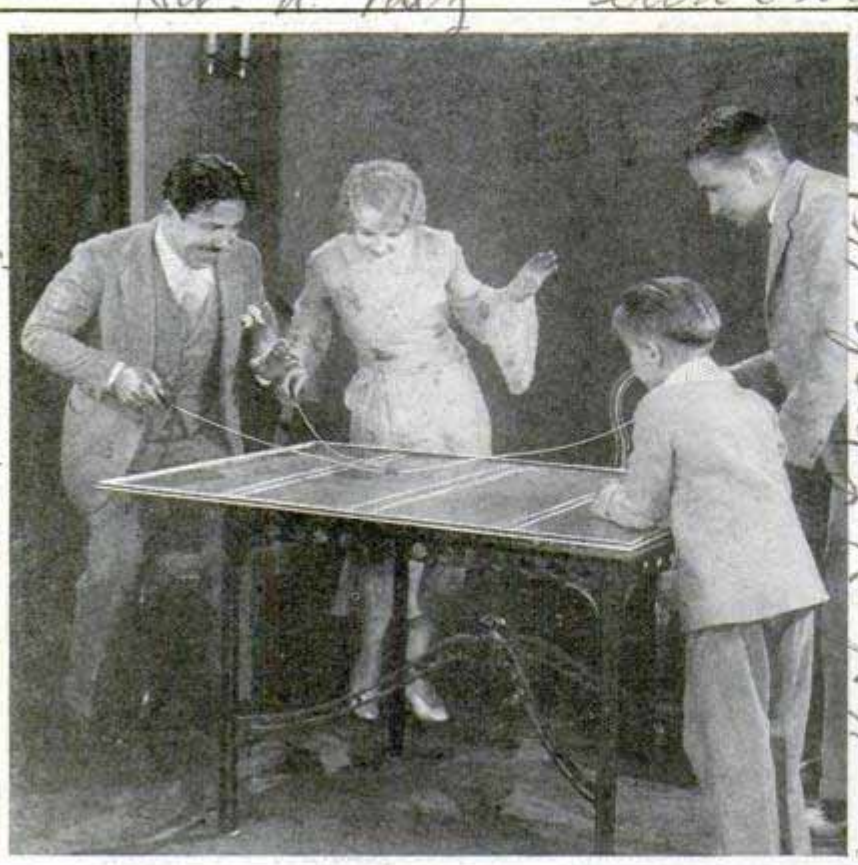

Monte Banks and Pauline Garon Pushing the Disk against a Single Rival; the Game Is a Steady Battle of Skill

TENNIS AND FOOTBALL THRILLS IN LATEST TABLE GAME

Skill and determination are required in playing a table game that has some of the principles of football and tennis. Two or more persons can play at one time. A wooden disk, started at a line in the middle of the folding field, is to be shot with flexible wire pushers into a goal at the opposite side of the board. All players tackle the disk at once so that the contest is a steady battle until a score is made. A foul line is drawn around the field and pushing the disk out of bounds penalizes the offending player or side one point.

MOUNTAIN LIONS ARE COWARDS HUNTERS DECLARE

Mountain lions rarely show fight unless wounded; even a mother will desert her young when dogs draw near, and, though the lions can run with express-train speed for 100 yards or so, they are soon winded and forced to take to a tree. According to M. E. Musgrave, of the United States biological survey, the mountain lion is probably the least courageous of the

larger wild animals. Its cowardice seems hard to reconcile with the facts that it usually weighs 150 pounds or more when grown and is so strong that it can kill horses weighing 800 or 900 pounds and drag them thirty feet into the bushes. It has been known to carry away deer and big calves without any evidence of dragging. The animals are phenomenal jumpers. A leap of twelve or fifteen feet into a tree from the ground is not uncommon, and they have been known to jump down fifty or sixty feet from a branch without injury. Like the cat, they have the ability to land on their feet. Mr. Musgrave reports that he has

climbed out on a limb and taken pictures of a lion while sitting within six feet of it. The animal hissed and growled, but showed no other signs of fight. After a short chase, the lion soon becomes nearly exhausted and sticks to its tree even though punched with a stick.

OLD CHAIRS QUICKLY MENDED WITH SIMPLE BRACE SET



Without extensive overhauling, old chairs that have become loose can be strengthened for further service by attaching a patented set of clamps and wire braces. The device is fastened to the chair bottom and affords a support for each leg. The clamp may be tightened by means of a threaded bar located in the center.

All railroads in Europe with the exception of those in England, are to adopt twenty-four-hour time tables.

Chicago. R. G. Harlan. Morrison Hotel. Probable info. Transp. 21 W. Huron

New York N.Y. 1001

Joseph B. Wash
Joseph B. Wash
Joseph B. Wash

Report to appear in Journal of Mammalogy

849 J. B. ...

GREAT BRITAIN'S WARSHIPS SHOW THEIR STRENGTH

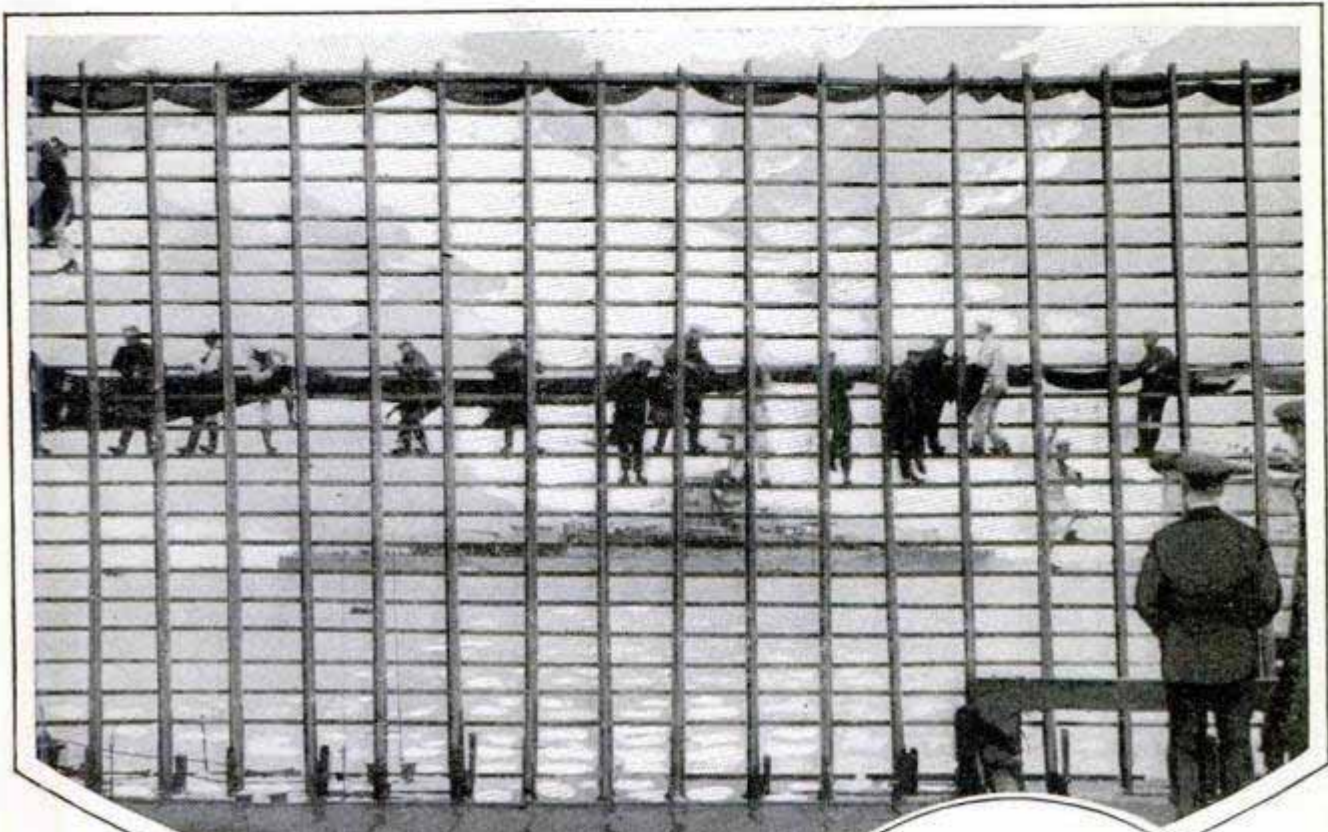

British Sailors Repairing a Big-Gun Target, While H.M.S. "Revenge" Lies in the Background Waiting to Resume Firing; Below Is Part of the English Atlantic Fleet Plowing through the Seas in Close Formation on the Way to the Annual Battle Maneuvers

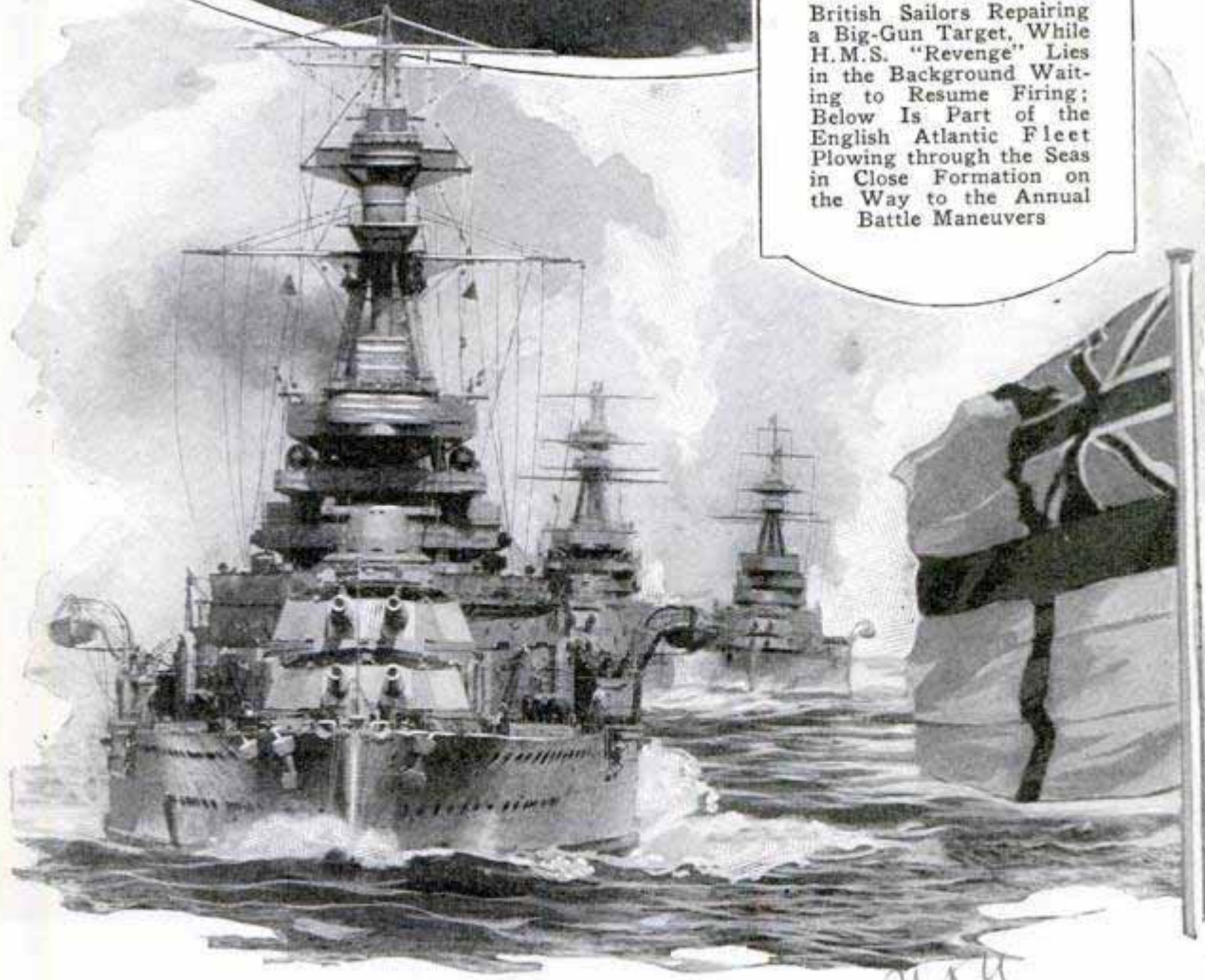

FISHING IN THE DESERT FOR SNAKES AND LIZARDS

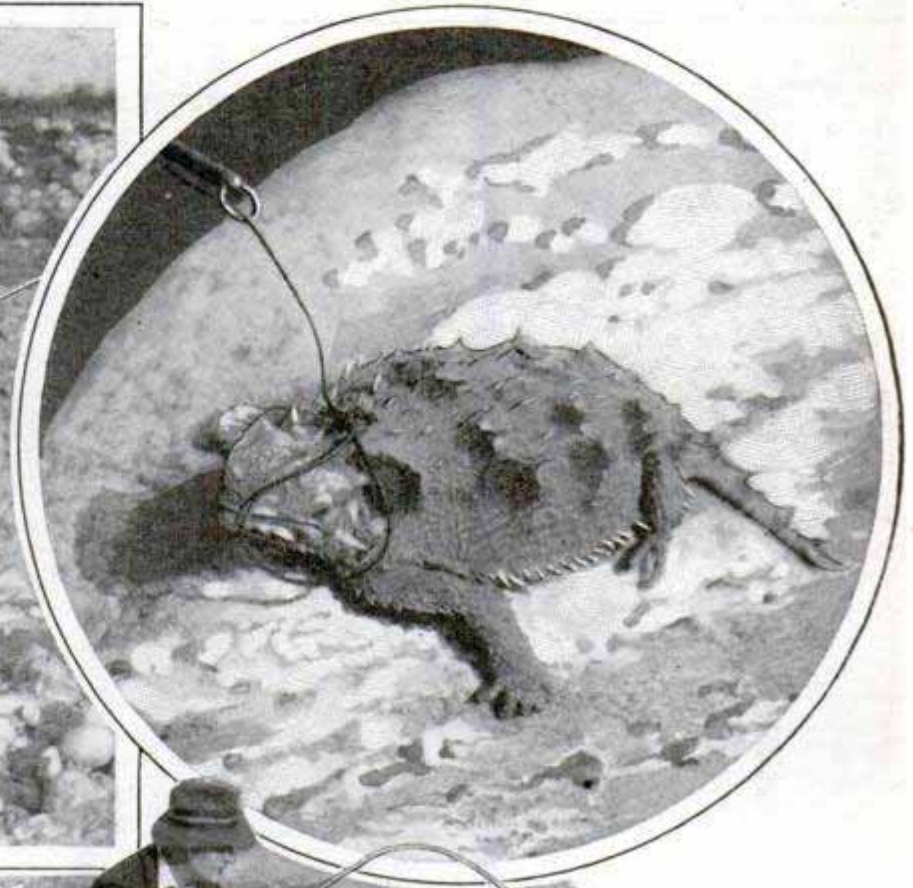

Mr. Rowe at His "Dry Land Fishing," and Two Specimens; the Noose in the Line Easily Slips over Reptile's Head



If you motor across one of the deserts of the southwest and see a man in the costume of a trout fisherman, carrying a creel and "fishing" in the sage brush and cactus with a rod and reel, his name is Willis A. Rowe, whose specialty in natural history research is snakes and lizards. He catches his live specimens for study with a trout rod and reel, and carries them to his home at San Fernando, Calif., in an ordinary creel. Mr. Rowe, who has been studying snakes for twenty years, has tried "snake sticks" and all the other known methods of catching reptiles alive. The trout-fishing outfit, however, which he devised for his own use, is said to be much safer and more efficient. It is safer because it allows him to work at a distance and is more efficient because a snake or lizard, once ensnared by the trout line, has never been known to get away. No hooks are used for catching snakes. The

scientist merely makes a slip noose on the end of the line, which is then allowed to dangle from the casting rod. When he finds a reptile that he desires for study, the creature is easily approached at a safe distance. The slip noose is then dropped over the head of the snake or lizard, and the reptile is lifted off the ground. It is then easy to gain a handhold upon the reptile's neck just back of the head to avoid any possibility of being bitten.

FIRST COPPER WAS SMELTED WITH PETROLEUM? 830

That the most ancient copper used by man may have been smelted by heat from petroleum, one of the most modern of

*in article to British pub
nature*

666

fuels, is the theory advanced by an eastern scientist. The process, if followed, was probably the result of an accident, nature, rather than man, arranging the primitive procedure. The belief is based upon the similarity of the region along the Iora and Kura rivers in the Caucasus, the home of the early Egyptians, to the description of the Egyptian paradise outlined in the "Book of the Dead." In this area, petroleum, seeping out, has formed small lakes and pools in close proximity to copper ore. The theory is that the oil became ignited accidentally so that when the copper was discovered later, it was in metallic form. The most widely held supposition is that primitive man became a metallurgist when the family campfire had been made where copper ore happened to be present.

**BIG-WHEEL VACUUM CLEANER
ELIMINATES LIFTING**

726

Easily taken up or down stairs, a large vacuum cleaner with a blower attachment can be moved around by one person without lifting. It weighs 100 pounds and the blower is said to be effective in removing dust from difficult places, as from electric motors and other apparatus and behind radiators.



*portable
No. 500*

To Make Housework Still Easier; Big Vacuum Cleaner on Rubber-Tired Wheels Saves Lifting

It is built for use in office and apartment buildings and homes.

*Allen + Billmyre Co. Inc.
512 Grand Central Palace*

Chicago - 118 W. Ellis

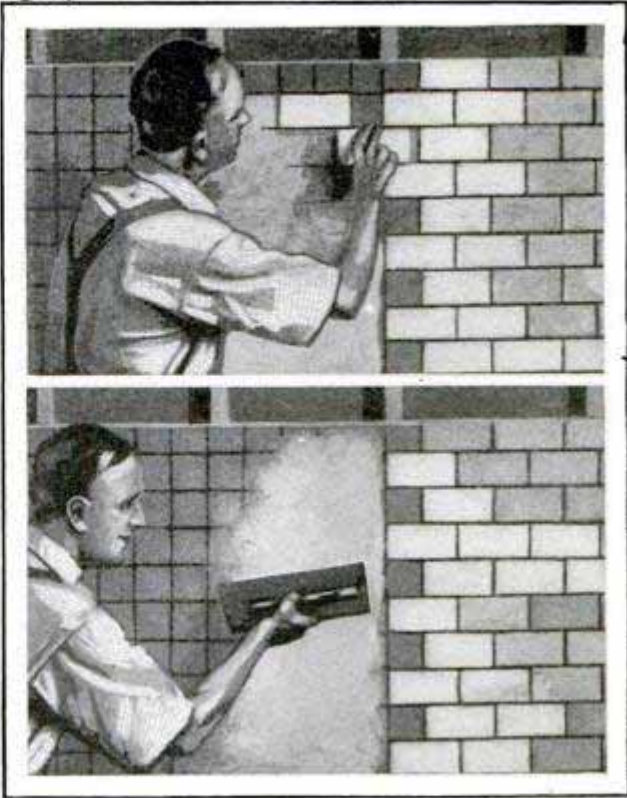

Building Wall of the Steel Tile; It Is Laid against a Special Cement and Insulating Material

**STEEL TILE FOR BATHROOMS
CUTS COST OF WALLS**

Tile of the same material as is used in tubs is now furnished for the bathroom walls. It consists of porcelain enamel fused on steel. The pieces form a smooth, durable surface which is easily cleaned and resists corrosion. An insulated base and special cement, against which the tile is laid, help keep out heat and cold.

**BOARD FOR AVIATION PATENTS
TO AID INVENTORS**

A board to consider aviation patents and designs has been organized by act of congress and is now in operation at Washington. It is composed of the assistant secretaries of the army and navy for aviation, and the assistant secretary of commerce. The purpose of the board is to give thorough scientific and practical consideration to all designs, inventions and improvements relating to aircraft that may be submitted by any individual or corporation, and it is authorized to pay not to exceed \$75,000 for any design, improvement or invention it may consider of value to the government. Payments so made, vest the ownership of such inventions in the government.

*Knapp - Harris Co. & Co. 55 St. Louis and
14th St. Excelsior. & Co.
Aeronautical Patents
and Design Board
navy Bldg. Washington D.C.*

1012

Mr. ... 537 S. Dearborn Chicago

UNIQUE AUTO RACE COURSE HAS FIVE TRACKS IN ONE



TWISTING and Turning through the Rolling Hills of the Eifel District in Germany, the Nuerburg Ring Motor-Race Course Will Be Practically Five Tracks in One, as It Will Contain Four Smaller Courses within the Largest. The Main Road Will Be Nearly Twenty Miles Long, and Extend over a Section of Territory Six Miles Wide; Stands to Accommodate More than 10,000 Persons Are Being Constructed at the Starting and Finishing Points, Where Garages, Repair Shops and Other Service Facilities Will Be Provided. Above Is Shown a Model Diagram of the Entire Course, the Main Track Being Outlined by the Heavy White Line and the Smaller Rings in Lighter Tracing; Practically the Only Straight Section of the Entire Circuit Is Back of the Lofty Observation Post in the Upper Center. To the Right of the Peak May Be Seen the Starting Point. Below Is a Model of the Grandstand Pavilion, Garages and Parking Spaces at the Start. Races Will Afford Opportunities for Testing Brakes as Well as Speed

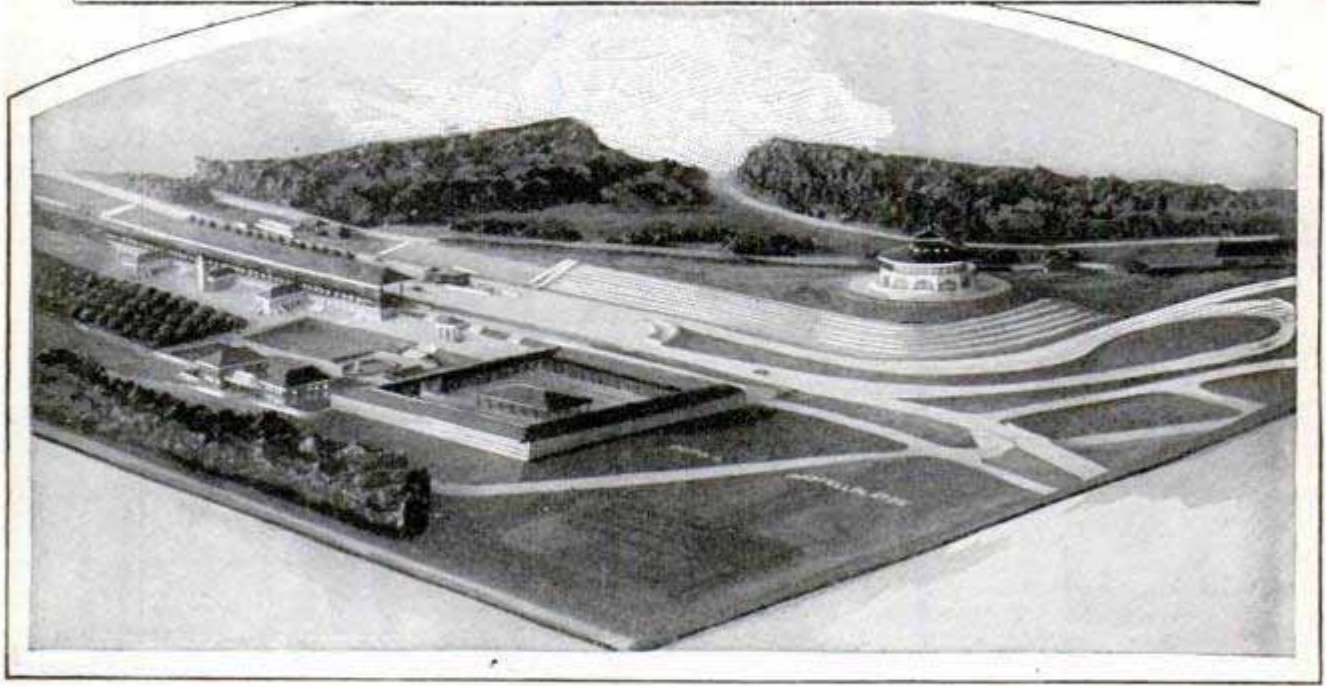

PHONE BUOY FOR SUBMARINES TO AID IN RESCUES 894

As a means of locating and communicating with submarines that are unable to rise to the surface, a special buoy has been devised and has been considered by the British admiralty. It is to be carried alongside the conning tower, and if the craft is unable to emerge, the buoy, filled with compressed air, on being released, rises to the surface. It is attached to the submarine with a cable and contains a telephone with connection to the crew below so that rescuers could communicate with the men. The buoy is also equipped with rockets, a lighting apparatus and signal bell in order to attract the attention of passing ships.

REPEATER RAZOR SAVES TIME IN CHANGING BLADES 893

Twenty blades are held in the handle of a magazine safety razor now on the market, and a new one is adjusted simply by tilting the top or head of the razor, pulling out a plunger and pushing it back. The old steel falls out and the fresh one drops into place. The blade can be adjusted by moving the razor head to the best angle for shaving. The used pieces are put back into the "magazine" and when all twenty have been employed, they are thrown away in a package. New blades are furnished in a clip which is easily in-

cannot consider foreign business at present. 4/1/24



Photo Diagram of the Magazine Razor, Showing How the Blades Are Renewed

serted. The entire outfit, when closed, is little larger than a fountain pen.

Magazine Repeating Razor Co.
285 Madison Ave. N.Y.C.



Testing the Parachute with Dummy; the Pockets on Sides Serve as Supplementary Supports

NEW PARACHUTE WITH POCKETS TO EASE DESCENTS

With a row of air pockets about the lower edge, a balloon-shaped parachute devised by an Italian inventor, is intended to make descents more slow and hence ease the shock of landing. The pockets act as small parachutes in themselves and the depth of the main bag as compared with the shallow interior of the usual type of support is a prominent feature. The pockets are also arranged to help open the parachute when the wearer releases it.

The color sense is not developed in children until they reach the age of about two years.

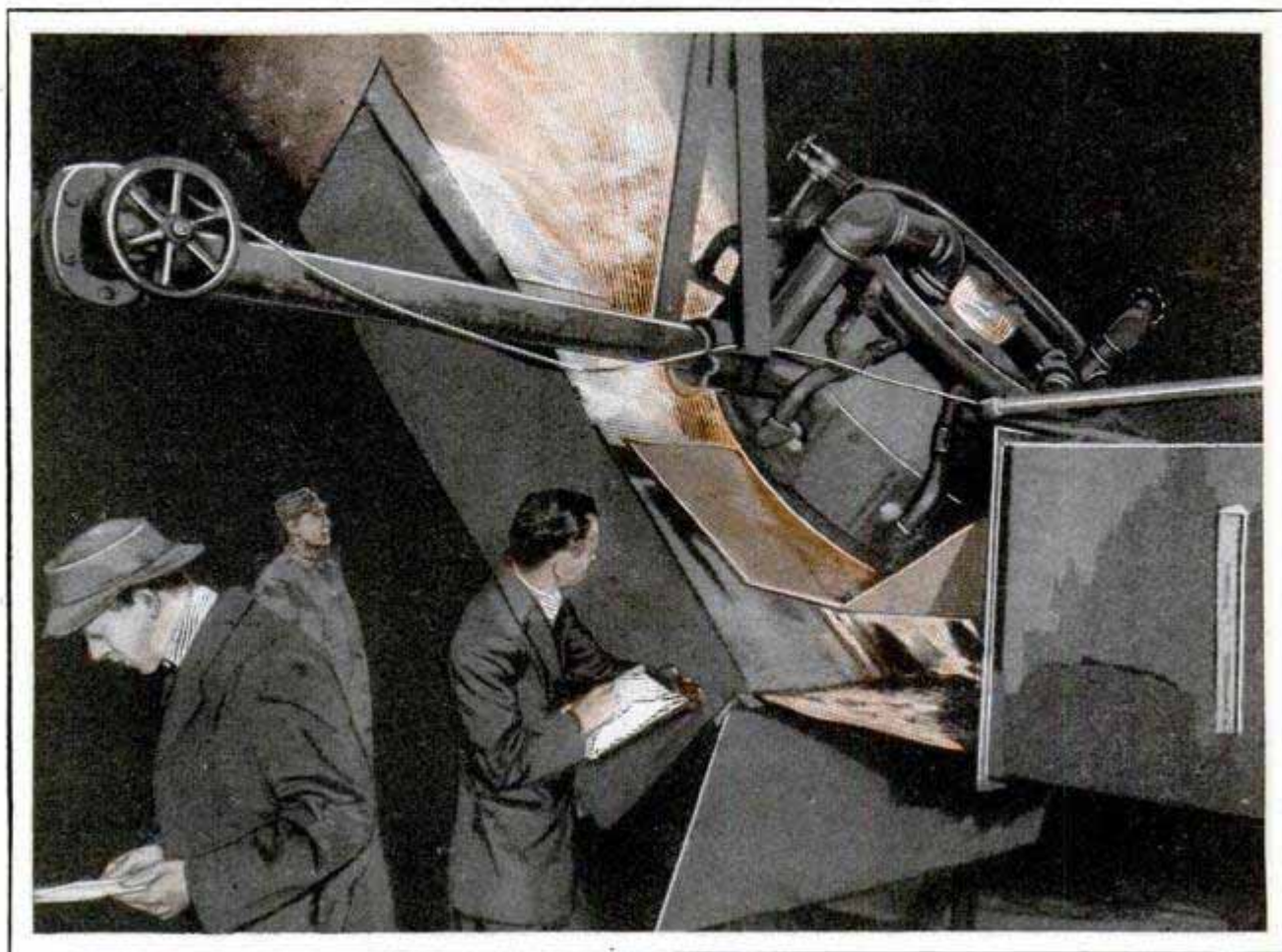

Testing Your Fireproof Roofing with Huge Gas Burner, and Wind Tunnel to Provide the Gale That Blows the Flames Up the Slanting Roof and under the Overlapping Edges

Unseen Firemen Who Guard Your Life

Potential Dangers Located Before They Can Arise by Scientists Who Battle Blazes in War to Protect Your Home and Business

A SHEET of flame from an immense gas burner is being driven against a section of fire-resisting roof material by an air blower.

Firemen, without rubber boots, hats and coats, who never rode a swaying motor truck are standing by. Instead of hose and water they hold loose-leaf clips filled with charts. One watches a clock and another the electrical controls of delicate thermometers which are measuring the heat on top and underneath the section of roof.

They are fighting the fire that may menace your home next year or ten years from now, fighting before it ever happens, and doing it silently, efficiently and out of sight, with never a red-painted hose wag-on to attract the public's eye.

The scene is in the laboratories of the

fire underwriters, a huge plant where scores of trained scientists spend their lives trying to wreck and destroy the cherished inventions of other men, in order that the unsafe and the dangerous may be eliminated and only the things that make life safe get out to you.

The flames shooting up the model section of roofing will be kept at a fixed temperature for a certain period, and then the damage, or lack of damage, will be carefully measured, and the manufacturer will be told either that his product is safe or that it is unsafe. If it is approved as standard, every insurance agent will be prepared to give you a reduction in your premium rate if you use that roofing.

Fire testing is only a small part—though one of the most important—of the work of the laboratories. They reach out into

every branch of fire, safety and burglary protection covered by insurance. Every piece of fire hose manufactured in the United States must pass one of their inspectors, on duty in the factory; out of every dozen or so lengths a small piece is

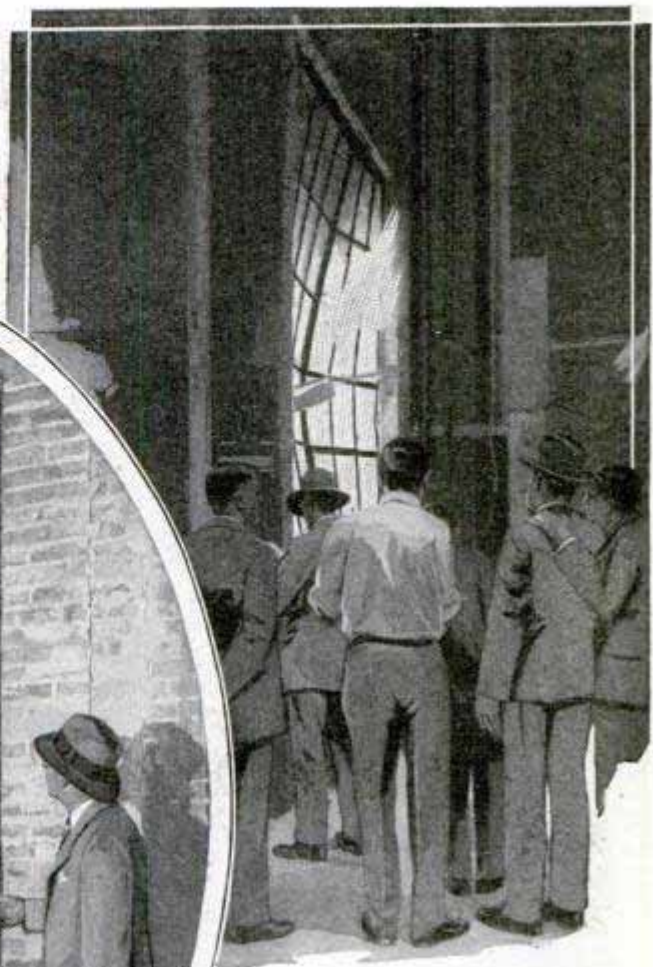
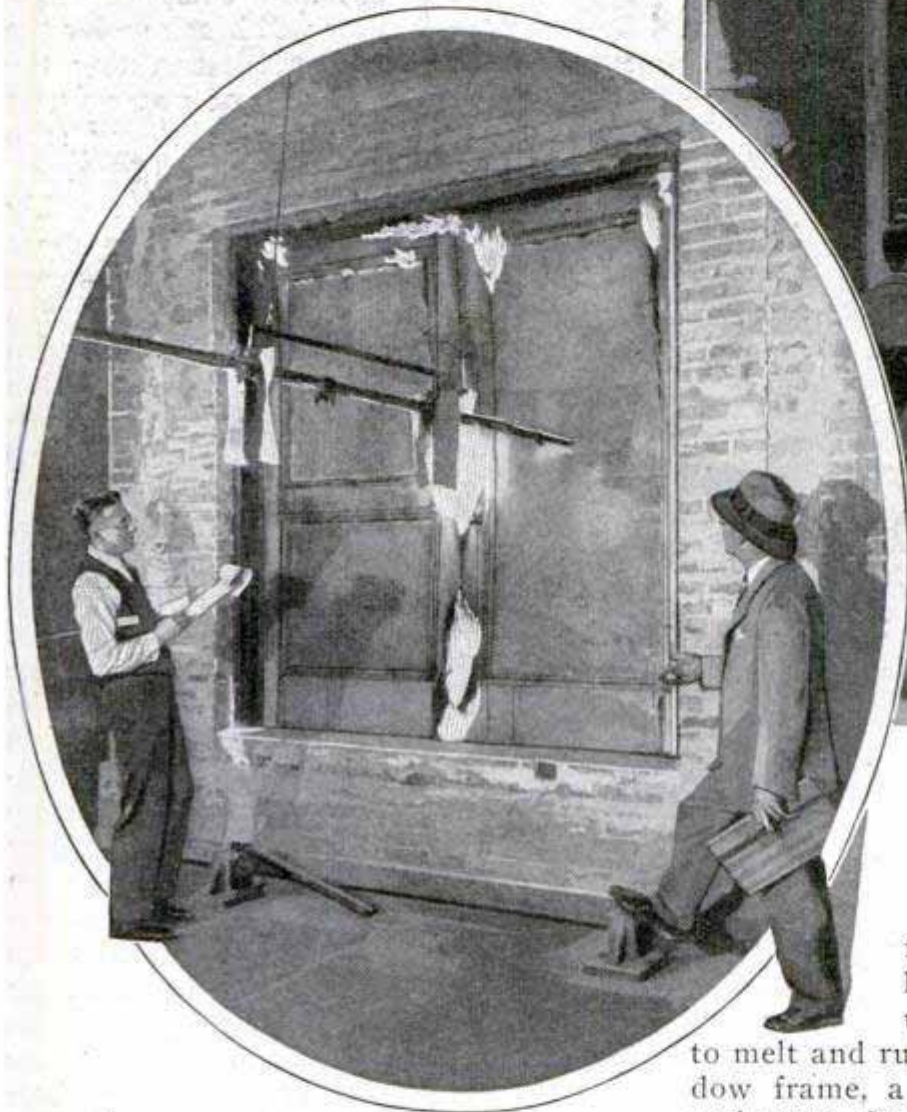

Expanding on the Side Next to the Fire First, a Huge Steel and Wire-Glass Window Slowly Bends In to the Flame; Left, Metal-Covered Fire Doors Flicker with Wood-Gas Flames as the Interior Carbonizes

clipped from one and sent in for testing at the laboratory, and from every few hundred an entire length is taken.

In the laboratory itself fires are raging nearly every weekday of the year, burning up roofing and fire doors and windows, and even huge steel safes and office files. Several hundred thousand dollars has been invested in vast gas furnaces in which material can be submitted to tests more severe than any encountered in an ordinary fire.

One of these is equipped with enormous steel front frames, suspended from a track above, in which solid brick walls, twenty feet square and with doors or windows built in place, can be assembled, rolled in

front of the gas burners, locked in place, and burned until the very bricks begin to melt and run. Picture a big steel window frame, a dozen or more feet wide and more than that in height, built into an eight-inch brick wall, and with frames filled with wired glass. The fires are lit, and with thermometers checking the temperature, the heat is gradually brought up to an enormous height and held there until an hour has passed. Long before that time, the glass has cracked in a million places, but the wire binding holds it in place. As the minutes pass, some of the glass begins to run, and little holes appear, with an occasional tongue of flame licking through.

The steel frame itself expands under the tremendous heat and, being hottest on the side next the blaze, begins to bend in toward the flames. The putty next begins to give way, and whole panes of glass will

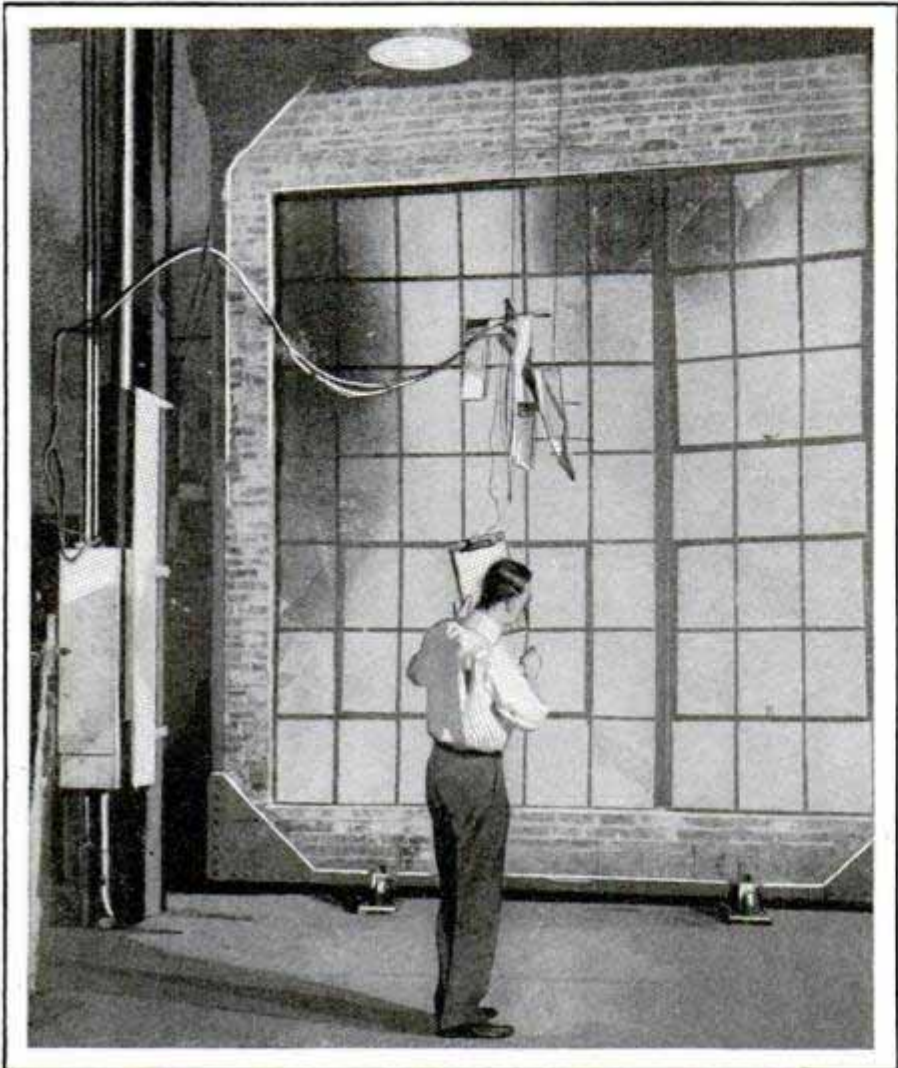

Heat, So Intense It Will Melt the Wired Glass, Is Raging behind This Big Fire Window during the Test

and, at the call of time, shut off the gas and roll the red-hot brick wall and window to one side. Instantly a two-inch fire hose is played over it to see how badly the window will break under the impact, determining the quantity of water that might pass through to damage stock inside.

The testing of a big steel safe is even more thrilling. The insurance covers valuable papers and records, and losses through the interruption of business, so the underwriters are interested in seeing that they are kept safe. Because of its weight, a safe not only is subjected to damage by fire, but also to that suffered when floors give way and it drops into the basement, possibly from the heights of a tall building. So the manufacturer sends a brand-new safe. It is loaded with old record books, newspapers and loose sheets covered with writing, and put in a big furnace, after holes have been drilled to carry the leads of electrical thermometers placed in the interior and a tube for air samples. The furnace is sealed and the fire started, to burn for hours.

slowly sway out from the top and bend downward. Taut wires are stretched across the furnace front and the distance from them to the face of the glass has been carefully measured at a dozen places before the fires were started. Now the attendants dash into the intense heat at intervals, raise a long steel yardstick and measure the distances again to determine the amount by which the steel frame has been warped.

Suspended in front of the furnace is a long pipe carrying a series of thermometers, to record the temperature at varying distances in front of the window, a check that shows how far inflammable material should be kept away to prevent communication of a fire from an adjoining building. As the last five-minute period of the hour begins, the timer starts calling off the minutes, and on the final one the seconds. Men at the furnace release the chocks holding the framework

papers and loose sheets covered with writing, and put in a big furnace, after holes have been drilled to carry the leads of electrical thermometers placed in the interior and a tube for air samples. The furnace is sealed and the fire started, to burn for hours.

The thermometers inside the safe record the temperature, and show whether it has reached the point where the papers will begin to char, while the air tube enables the observers to take samples from inside the safe and test them for dangerous gases. The latter is important, as the gas pressure may blow the strong box open.

After hours of heating, the red-hot safe is hauled out of the furnace, lifted by a crane and swung thirty feet up a huge brick stack, then dropped to a ten-foot thick concrete floor below. Back into the furnace it goes for more hours of heating, then it is opened and the condition of the contents noted.

660



Banks of Foot-Square Pans Are Used to Catch and Measure the Water from an Automatic Sprinkler Head



Cauldrons of Blazing Gasoline Provide a Chance to Try Out Foam Extinguishers; Below, Firemen Are Watching a Test of Hose and Couplings; Every Piece of Fire Hose Used in This Country Is Carefully Tested at the Factory While Being Made

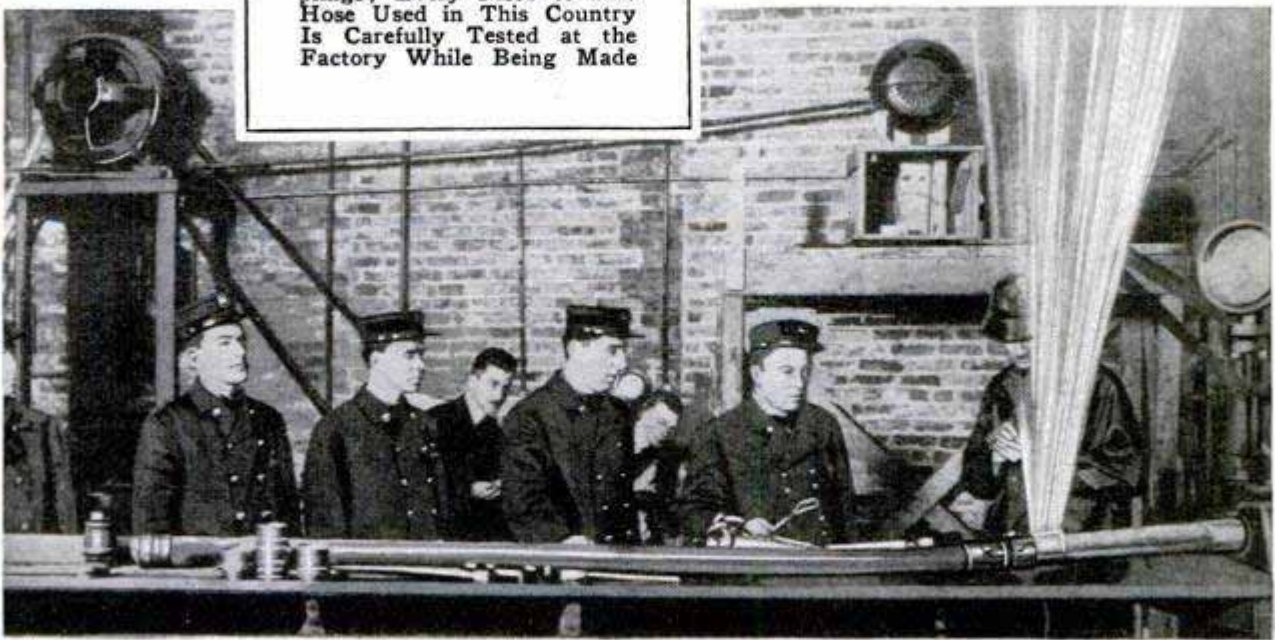

750

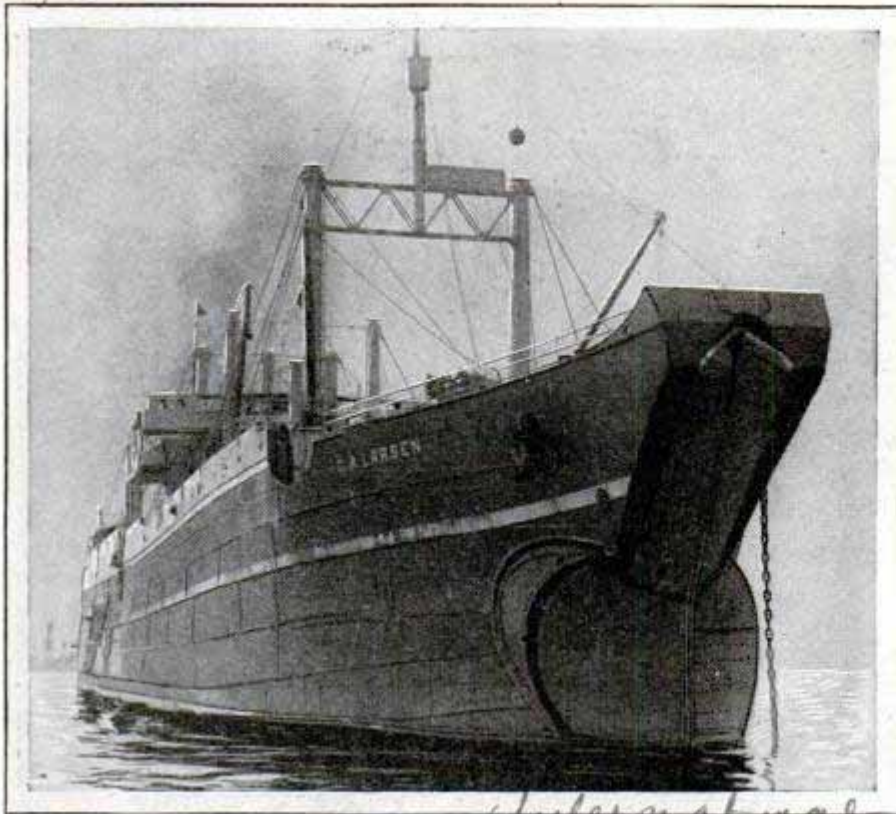

Steamer "C. A. Larsen," Showing the Blunt Prow Which Opens to Permit Dragging Whales Aboard

SHIP HAS BIG DOOR IN PROW FOR LOADING WHALES

So that whales can be dragged into the hold, the steamship "C. A. Larsen," flying the Norwegian flag, has a water-tight door in its blunt prow just above the water line. This eliminates the necessity of towing the catch back to shore before working out the oil and preparing the other marketable substances.

WHY DO WE LAUGH?

Many explanations have been given as to the cause of laughter. Herbert Spencer believed that laughing was an overflow of excessive nervous energy. Henri Bergson, the French philosopher, concluded that laughter was evolved by the race as a means of discipline. Prof. William McDougal, of Harvard university, believes that nature has developed laughter in order to protect us against the excessive working of the instinct of sympathy, first because, when we laugh, the rate of breathing is increased and the circulation of the blood

stimulated, and, secondly, the trend of thought is broken up so that the mind is carried away from a situation that otherwise might tend to cause depression.

REPAIR MEN TURN ACROBATS FIXING TOWER CLOCK

Workmen called to repair the tallest tower clock in Berlin demonstrated their agility as well as their technical knowl-

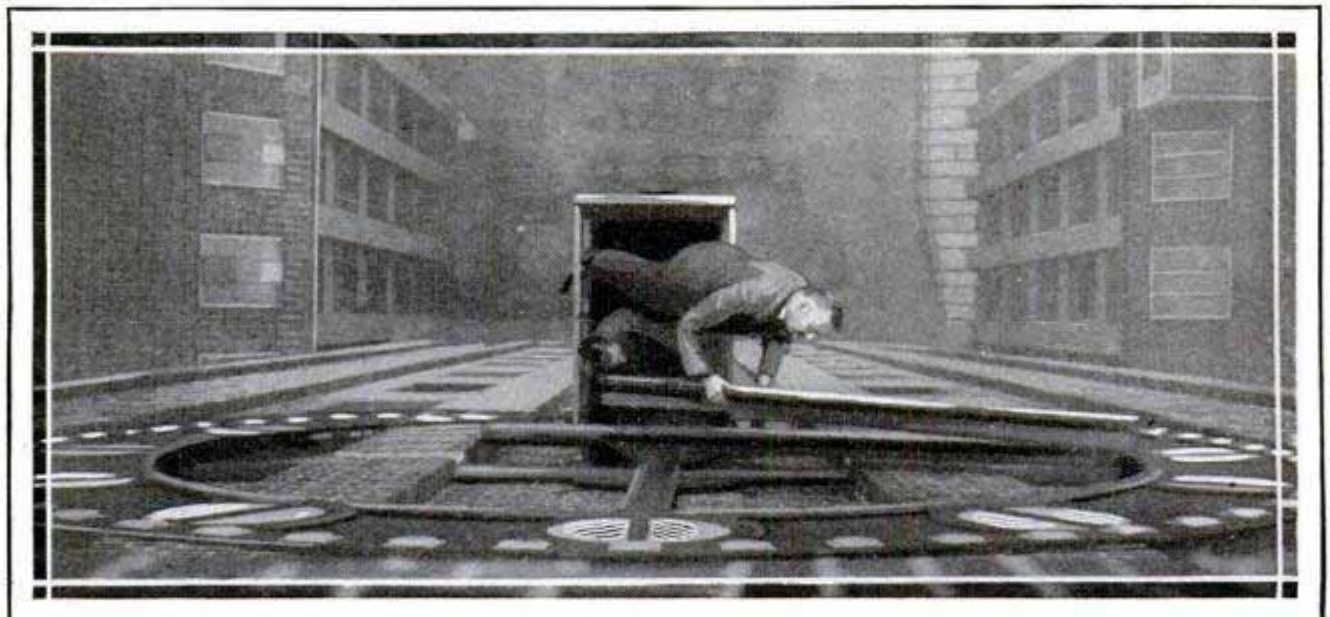

Looking Down on the Workmen during Repairing of the Tower Clock; the Moving Hands Increased the Hazards of the Task

891
June 11/14/26
N.Y.

869

Key tone

:-
e is
a
aced
le
e
e
The
essi
e ne
id th

edge during the job. Confined to a small platform erected just beneath the middle of the dial, they were limited to close quarters and the moving hands, tending to cause a grip on them to slip, presented an additional hazard.

WHERE ONE DIVE INTO THE SEA MAY BRING A FORTUNE

Divers in the south seas flirt with fortune daily, for there is always a chance that the shell they pick up may contain a valuable pearl. A greenish one of twenty-six carats was sold in New York for \$16,000 and although the finder probably did not get more than \$500, the sum was sufficient to make him independent for life. The divers gather shells for making buttons. This brings from \$80 to \$100 a ton. A rule is that the finder keeps the pearls. As they open the shells, the divers' gambling instinct is keenly alive, for their fingers may dislodge a pearl valued at hundreds of dollars. In the shallower waters, clusters of mussels are found which occasionally yield yellow pearls, not so valuable as the pink and white ones but prized for their oddity. No diving apparatus is used and the natives are able to remain submerged as long as two and a quarter minutes. They place the shells in a weighted net at the bottom, which is then drawn up with a cord.

CHINA CAT AND BIRD ON WALL UNIQUE HOUSE DECORATION

China figures of a cat and a bird on the front wall of a house in England attract attention from passers - by. The cat is posed as though chasing the bird and both are realistically modeled. They are held by hidden brackets.



China Figures of Cat and Bird Attached to Front Wall of House

Household Patent 2908
Harrisburg, Pa.

in South Kensington, England
Direct Agency

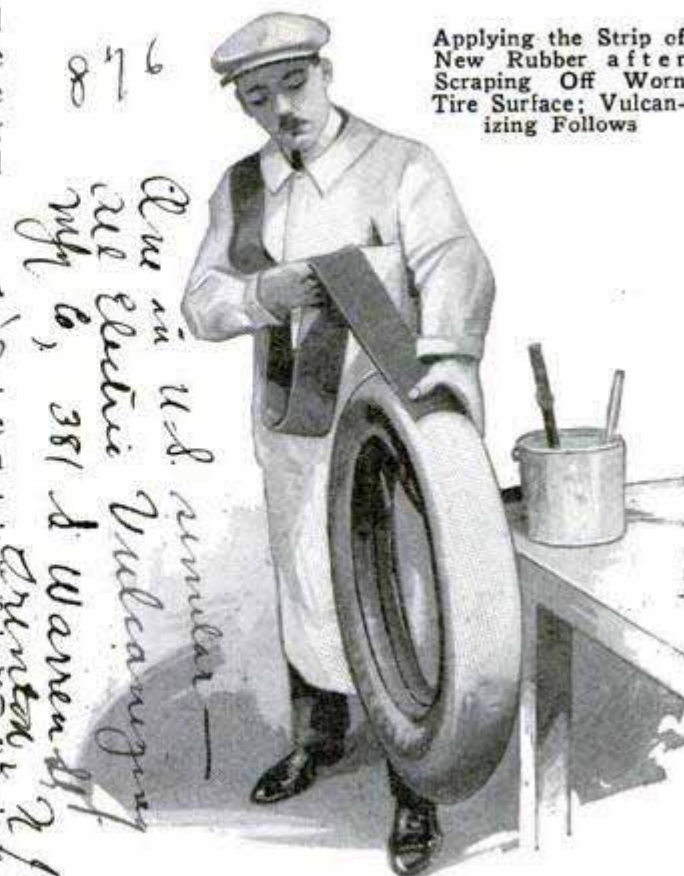

Applying the Strip of New Rubber after Scraping Off Worn Tire Surface; Vulcanizing Follows

876
978
905
New in U.S. number
all electric Vulcanizing
Mfr. Co., 381 S. Warren St.
Philadelphia, Pa.

NEW PROCESS OF VULCANIZING TO CUT TIRE BILLS

Old auto tires are said to be reconditioned to such a degree that they will give service equivalent to seventy-five per cent of that of new ones, by a special vulcanizing process developed in France. The worn surface is first removed, then covered with a secret gumlike material. Over this is placed a new rubber strip, then the tire is treated in the machine, which not only vulcanizes the rubber but stamps

it with impressions similar to those on new tires. A feature of the machine is that it can be made to fit any tire.

Write our Bureau of Information if you wish to know who makes or sells any article described in this magazine.

Mfr. Societe Anonyme de Procédés "Trik"
26 me d'arr. Jacques, à Grenoble, (France) France

988

Transcontinental

HISTORIC VIEWS SHOW CHANGE FROM TRAIL TO RAIL

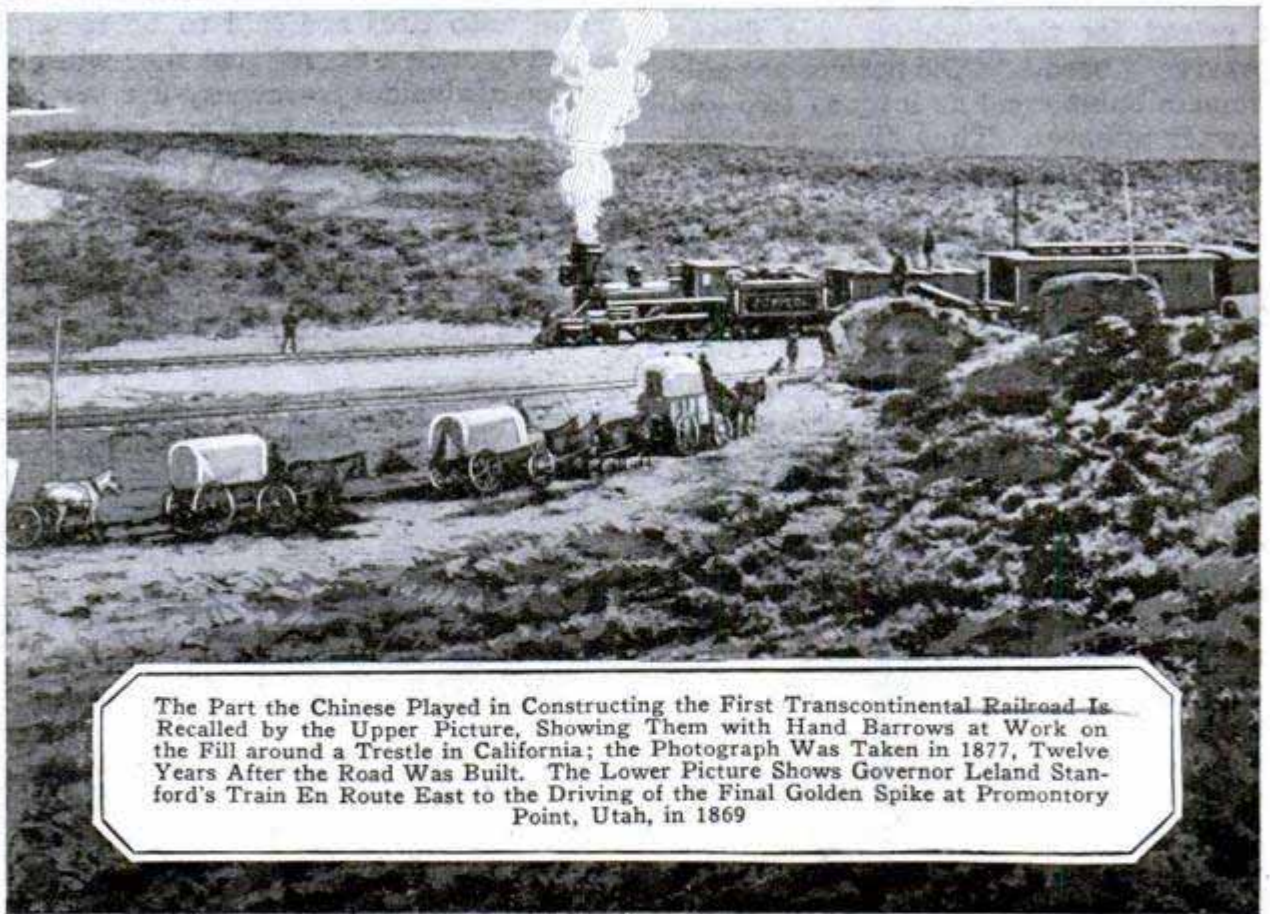
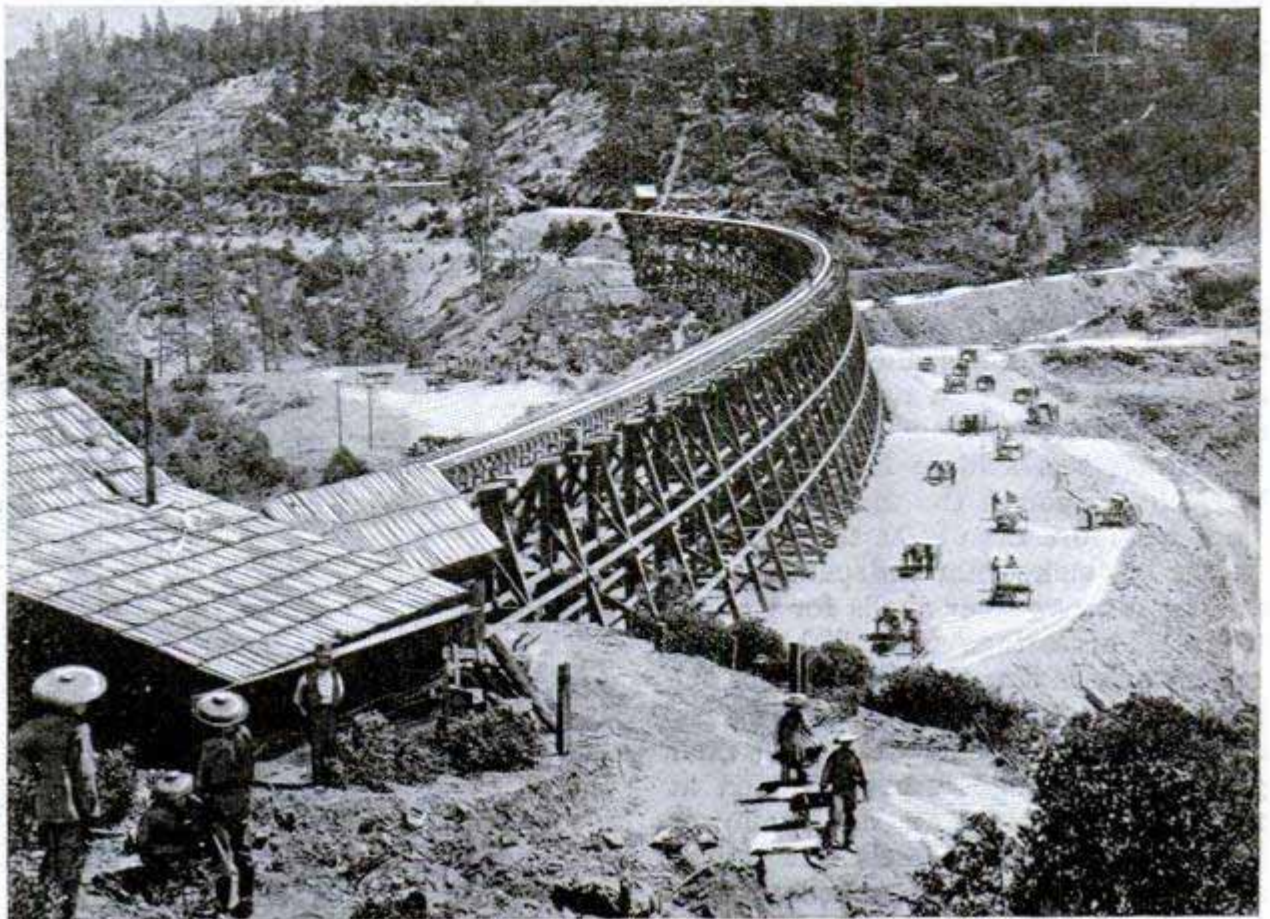

The Part the Chinese Played in Constructing the First Transcontinental Railroad Is Recalled by the Upper Picture, Showing Them with Hand Barrows at Work on the Fill around a Trestle in California; the Photograph Was Taken in 1877, Twelve Years After the Road Was Built. The Lower Picture Shows Governor Leland Stanford's Train En Route East to the Driving of the Final Golden Spike at Promontory Point, Utah, in 1869

d interational

1926

GOLDPLATING DONE WITHOUT ACID IN VACUUM

Textiles, laces and other materials can be goldplated successfully by a new process developed in Germany, according to reports—a method which requires no acids and has other economical features. The metal is deposited upon the object by means of electricity aided by a vacuum container and is dry and in molecular form. No polishing is necessary after the plating, as polished articles do not lose their luster, it is said. On sheet and wire, an even coating is applied but on irregular articles the parts closest to the electrodes receive a heavier layer. This, however, is considered an advantage as they are the areas subjected to the greatest wear. The action of the electric current within the vacuum tends to drive the tiny particles of gold along so fast that they collide with enormous force against anything standing in their way and become attached to it. The process also is said to give a more durable plating.

HIGH-LIFT TRUCK BODY DUMPS AT SIDE, TOP OR BOTTOM

Loads can be dumped easily over obstacles from a lift truck body that is raised on four steel screws to the height of eight and one-half feet. It is so designed that it can be emptied from the top, from either side or from the bottom. The special feature by which it will operate without binding even when the truck is on an incline, is of particular value, the manufacturers assert.

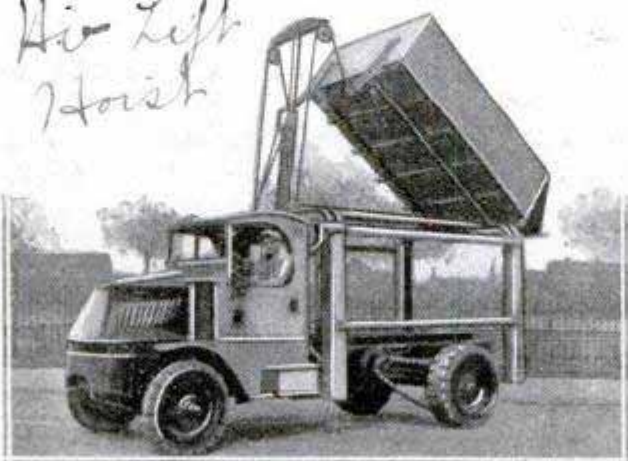

Body Elevated for High Dumping from End; It Also Empties from Sides or Bottom

*Jones Isear Co.
Boston Harbor*

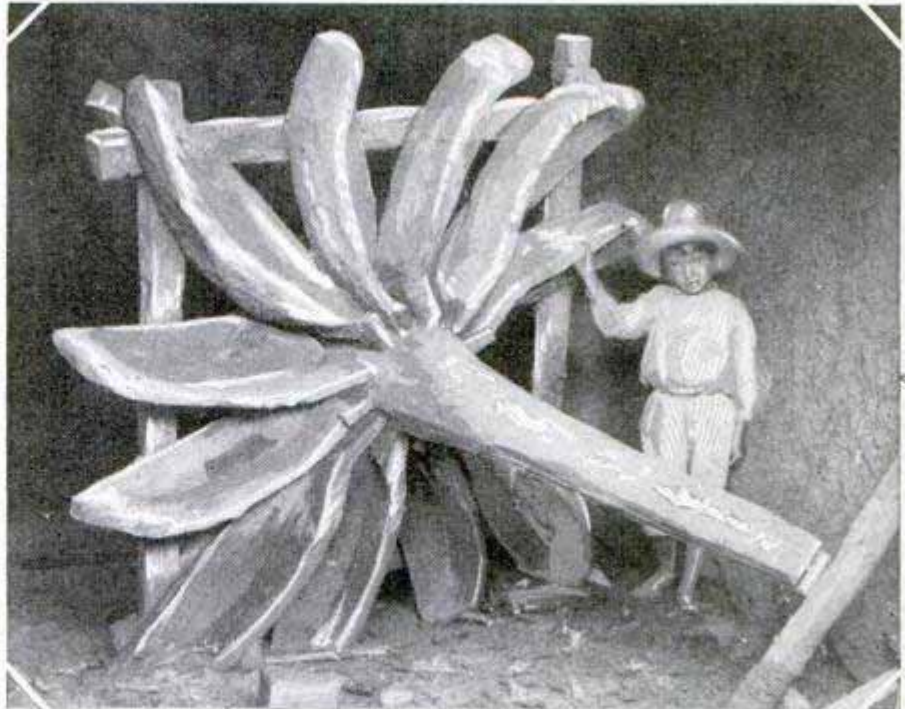

Turbine Water Wheel, Cut from Wood Nearly Four Centuries Ago for Mill in Mexico; It Still Operates

TURBINE WATER WHEEL CARVED CENTURIES AGO

Turbines are generally associated with modern power plants, but from Mexico comes proof that this form of wheel was known to Spanish engineers more than 380 years ago. The wheel was carved by hand from hard wood and belongs to a mill in the state of Chiapas. Although built in 1540, the mill still runs and the original wheel is in service. The turbine was adapted so that the fullest efficiency might be realized from the small water power available on the site. A reservoir was constructed to store up water at night so that additional supplies could be used the next day. The turbine was placed deep under the level of the ground to increase the fall. Two wheels of this type were made for the mill. They make from seventy to 100 revolutions per minute. The present owner of the installation intends to use it to generate electricity for lighting and power purposes.

*At El Rosario Molino
Chiapas, Mexico
Traveler's Journal
Apr 1926
J. I. Jones*

608

Kansas City

10/3/26
Salvage

Turning Ships Into Autos

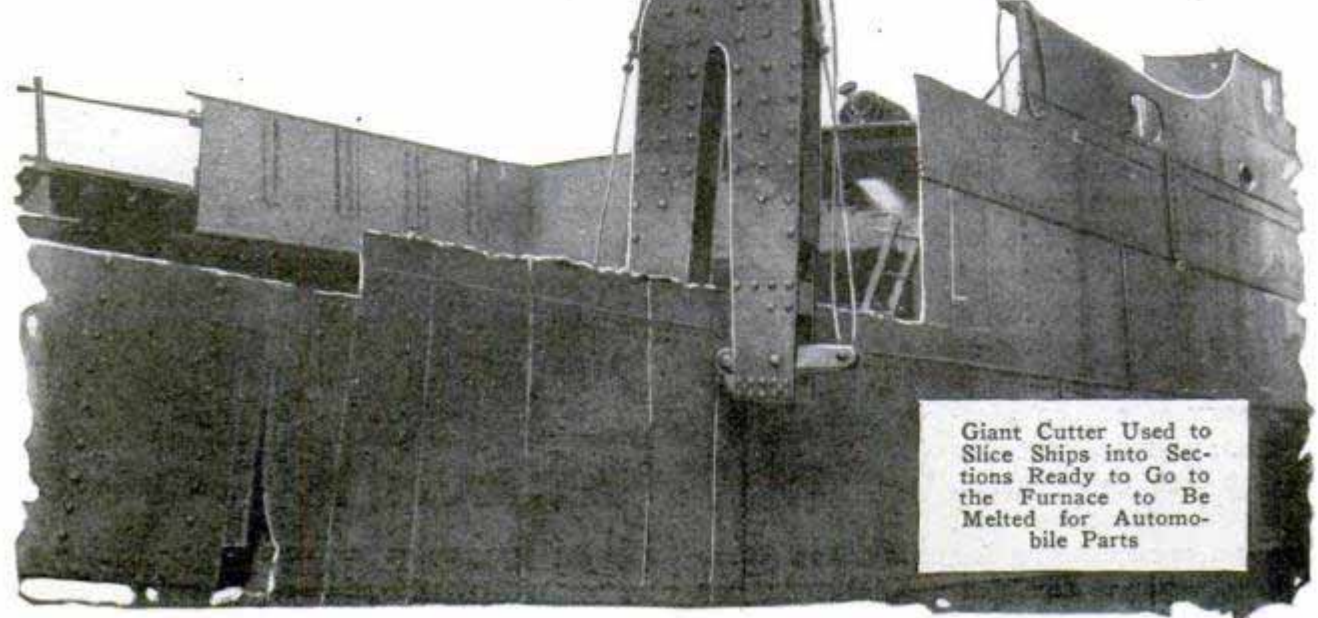

Giant Cutter Used to Slice Ships into Sections Ready to Go to the Furnace to Be Melted for Automobile Parts

WITH a special plant built to cut up 199 war-time steel ships and convert the scrap into automobiles, Henry Ford is demonstrating new ideas in salvage work. Like the packing plants that "save everything but the squeal," the ship workers are using everything but the coating of barnacles and rust the vessels brought up from the sea.

The salvage wharf provides docking space for twelve ships at a time, and the first ship in the line disappears every second day, while a new one moves in at the other end. A different operation is carried out in each berth, the remains moving on to the next place for the following step, until in the last stage, having been wrecked to the water line, a floating drydock slips under what is left and raises it to the surface for the final cutting.

Alongside the dock, one railway line is equipped with a series of wrecking cranes, and beyond that, three other tracks provide for trains to haul the salvage away. Of these, one takes steel scrap to the furnaces to be melted up at the rate of 300 tons a day for auto axles and tractor parts. A second hauls the woodwork to the wood plant, and a third carries away the salvaged parts, boilers, refrigerating plants,

electrical installations, searchlights, life preservers, and myriads of other fittings.

Some of the searchlights are shipped to Ford airplane fields to be used as guides for night planes. Two of the boilers, generating 1,500 horsepower, have been set up at the company's locomotive works to furnish additional power. Other boilers have been shipped to branches in this country, Paris and other foreign posts. Of the electric light and refrigeration plants a number have been installed at company mines and timber camps. The life preservers are emptied of their cork and this is used for refrigeration packing. Deck cabins, lifted off bodily, have been turned into tool houses and small offices and distributed among the various plants.

The 199 ships cost the government \$100,000,000 to build, and were sold as scrap for \$1,697,470. Despite the low price, however, the scrap sent to the furnaces is costing, including labor and other charges, about \$13, whereas similar scrap can be bought in the open market for around \$11 a ton. The company will break even, or even make a profit, on the value of the salvaged parts for which a use can be found. Under the terms of the sale, none of the material can be sold.

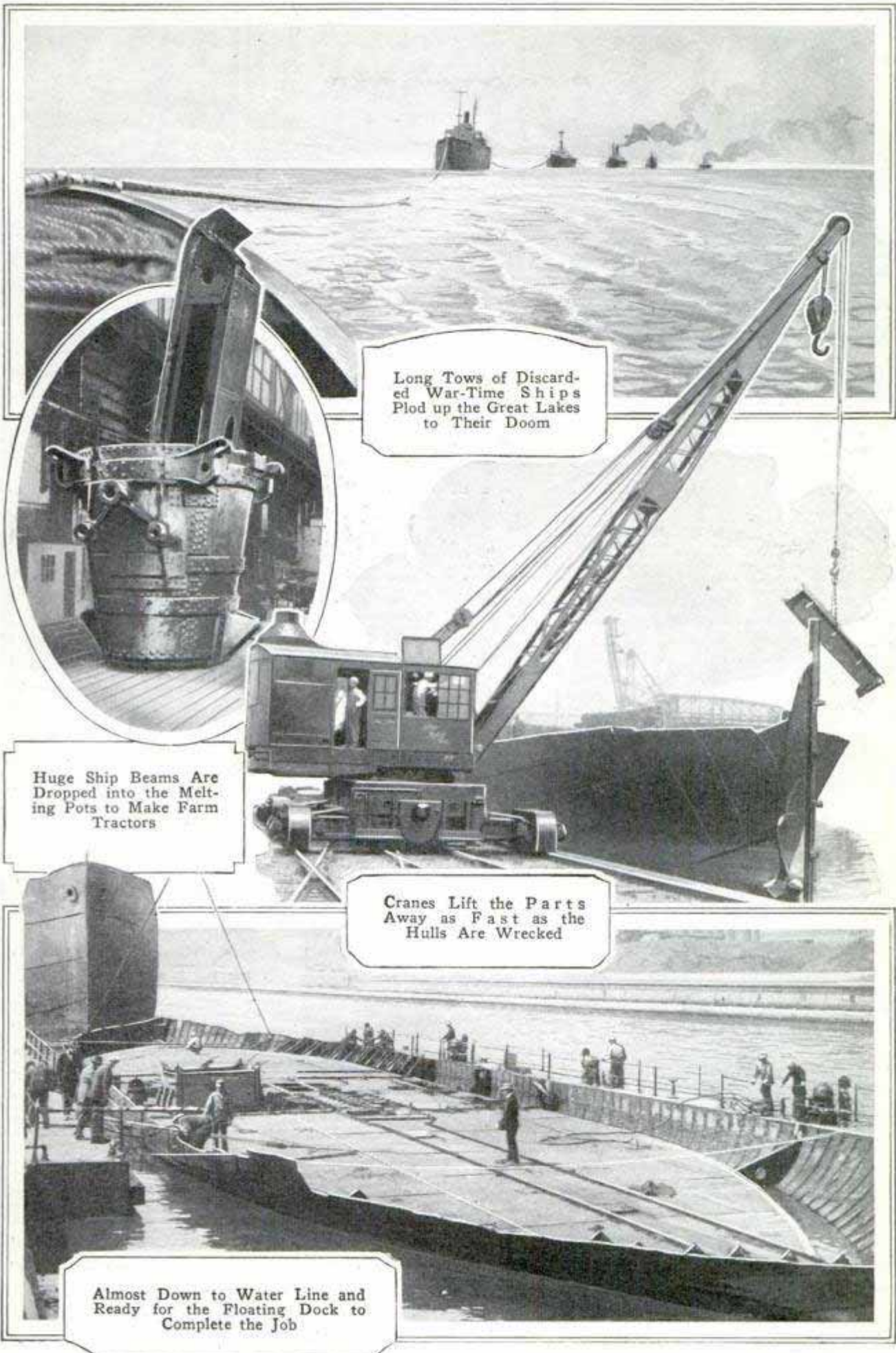

Long Tows of Discarded War-Time Ships Plod up the Great Lakes to Their Doom

Huge Ship Beams Are Dropped into the Melting Pots to Make Farm Tractors

Cranes Lift the Parts Away as Fast as the Hulls Are Wrecked

Almost Down to Water Line and Ready for the Floating Dock to Complete the Job

9/14 MAN DEFEATS LIVE ALLIGATOR IN UNDERWATER BATTLE

at a motion-picture studio, while photographers recorded the results. For eighteen minutes, the struggle lasted with but two short rest intervals. The trainer's bathing suit was torn, but he suffered no injuries. He manages to hold their jaws to-



George Link in Wrestling Bout with Live Alligator; the Photos Were Taken in Moving Picture Studio



gether while wrestling with them and can walk barefooted among them without mishap.

CHICAGO POWER LIGHTS LAMPS IN BOSTON 9/19

Switches were closed, electric current from a Chicago generating station sped along interlaced wires and lights in Boston, 1,000 miles away, flashed in response. Another engineering dream had been realized. The demon-

Wrestling with live alligators under water is the strenuous pastime of a western man who has devoted several years to the study and raising of the creatures. To demonstrate his skill and show that he hadn't trained one especially for exhibition purposes, he allowed visitors to pick out any one of the alligators for him to fight. The bout was staged in a glass tank

stration was proof of the power web that has been woven between the east and the mid-west, a vast connecting scheme for the exchange of electric current between stations. It promises, engineers say, economy, greater efficiency and lower rates. It will reduce the need for expensive reserves of power at individual stations, the distribution of peak loads at different hours

Edison Co.

Chicago daily news 9/12/26

London, W.C. 2, England.

in different regions can be done with lower equipment cost, for one station can draw from another instead of buying more generating machinery, and it will reduce the loss of letting equipment lie idle part of the time. The hook-up does not mean that it is yet practical to light Boston from Chicago. Some 500,000 volts would be required for the economical operation of so long a line and that is too much to handle, at present, engineers declare. On the Pacific coast, there is a similar system of interconnecting lines, a 1,800-mile hook-up, with 300 miles the longest transmission, for which 220,000 volts are required. The next step planned is to bridge the Rockies, linking the coasts together.

AUTO RUN BY COMPRESSED AIR CUTS FUEL EXPENSE *972*

Possibilities of compressed air as power for the automobile have been tested by a western inventor in a special car he has devised. It is said to run an average of thirteen miles on one filling of air at 400 pounds' pressure and, at 150-pound pressure, develops thirty horsepower. Fuel expense is reduced to almost nothing, as the operator can refill the tanks at a service station and the pumps on the car are arranged in such a way that the momentum in going downhill helps keep up the pressure in them. On one auto, a motorcycle engine is used to drive the compressor and, on another, an electric motor supplied with current from a storage battery. The inventor recently made a journey of 192 miles in the air-propelled car, using only one and one-half gallons of gasoline for the auxiliary pump engine.

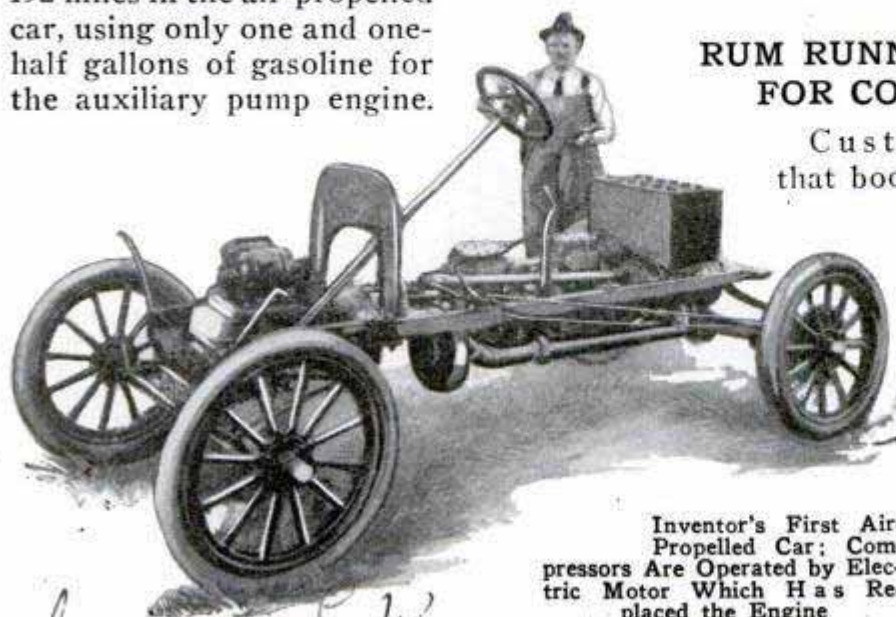

Inventor's First Air-Propelled Car; Compressors Are Operated by Electric Motor Which Has Replaced the Engine

*Edw. J. Kenney
117 S. Myrtle Ave.
Portland*



Kerosene Fire in Grate; the Box Is Filled with Absorbent Wool and Is Easily Removed

PORTABLE KEROSENE FIRE BOX HELPS SAVE COAL

To take the chill off the room, an aluminum box with a handled lid is filled with asbestos wool soaked in kerosene and ignited after placing it in an open grate. One filling is said to afford a hot fire for an hour. If less is desired, the blaze may be extinguished at any time simply by putting on the lid.

RUM RUNNERS USE SUBMARINE FOR CONTRABAND CARGO *996*

Custom authorities discovered that bootleggers had adapted up-to-date naval equipment when they captured an odd-looking craft in Lake Champlain, loaded with 4,800 bottles of ale. It was a submarine that could be towed behind a launch and submerged. Three such submarines were found following a successful escape of the first one, which was being towed.

No U.S. agent known

1932 W. 6th St.

Los Angeles
Calif.

934



20.00

Eye Exerciser in Use; Levers in Front Permit Movements to Relax Muscles

POCKET EXERCISER FOR EYES TO HELP VISION

To relieve eye strain and rest the muscles of the optic organs, an exercising device that can be carried in the pocket or handbag, is intended to be of aid to persons of nearly every age and occupation. It consists essentially of two cup-shaped sockets, one for each eye. By means of small levers at the bottom of the exerciser,

these cups can be rotated inward or outward. This action, combined with gentle pressure, is calculated to give the tired muscles of the eyes necessary relaxation and stretching to help relieve the tension and remove poisons that accumulate with fatigue through overuse. The treatment is said to bring helpful results and it can be used while at motion-picture shows, during automobile trips or other activities that demand unusual effort from the eyes.

ODD PLANT FORETELLS QUAKE; ANOTHER ACTS AS COMPASS

Leaves of the compass plant found in various parts of the Mississippi valley, keep their faces toward the rising and setting sun so that they sometimes serve as guides to persons who have lost their way. In Cuba is a flowerless plant that is said to enable scientists to predict earthquakes and volcanic eruptions. It is highly sensitive to electric and magnetic influences and makes certain movements as a result, by which the trained observer can foretell great convulsions in nature.

1020
Jed - Oct 11/20/26

HOT-AIR FAN FOR DRYING CROPS TO CUT FARM LOSSES

To make the farmer less dependent on the weather and reduce losses are objectives sought in a portable crop drier developed at Purdue university. It consists chiefly of a blower with a capacity of 7,000 cubic feet of air per minute drawn around and through an oil-fired unit and delivered to the stack, which is built over a conical frame, through a ditch eighteen inches square. For drying hay, a temperature of 165 degrees is used. For grain, the heat should not exceed 140 degrees. The burner unit consumes between five and six gallons of fuel per hour. The outfit has been used successfully with soy beans and alfalfa.

1001
Lafayette Ind.

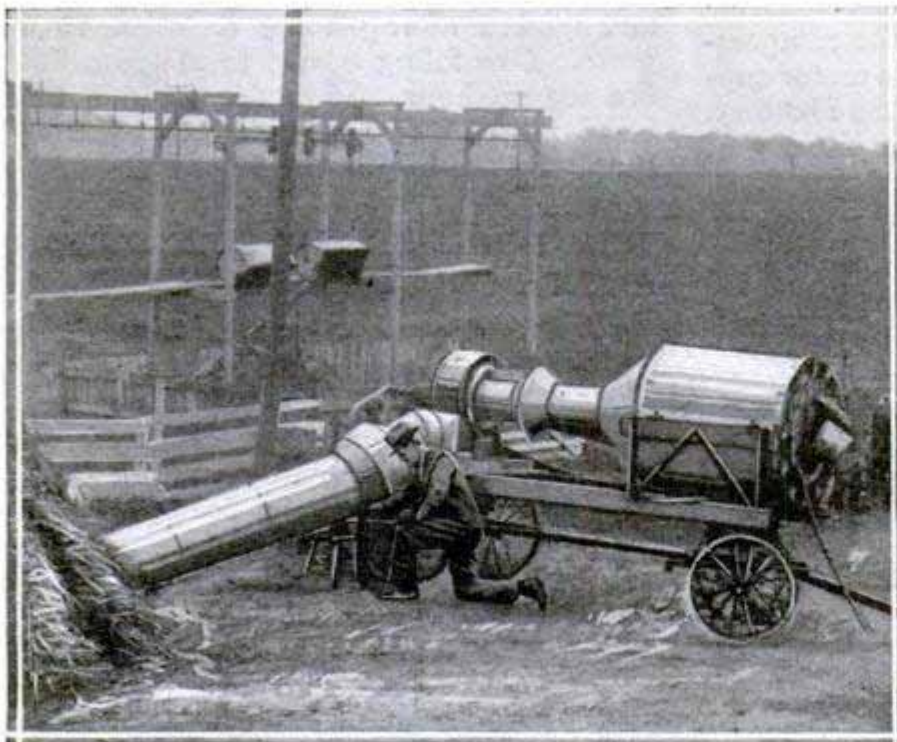

Curing Hay with Blasts of Hot Air from Motor-Driven Blower; the Air Current Is Heated by a Kerosene Burner

Agricultural Experiment Station

Ornamentation 3206 S. Grand
 DECORATING CAKES IS TAUGHT IN UNIQUE SCHOOL
 Ave Los Angeles

Calif.

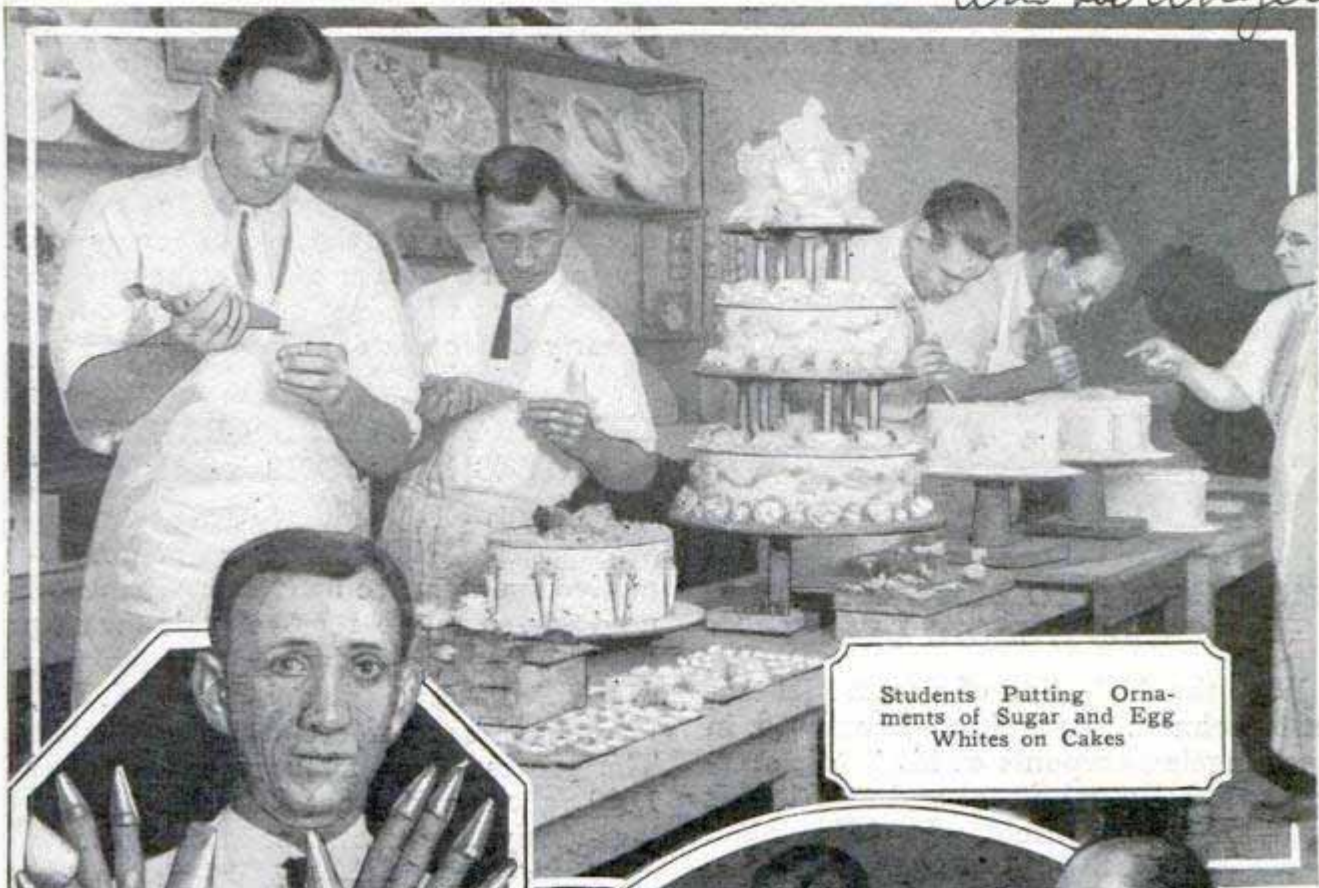

Students Putting Ornaments of Sugar and Egg Whites on Cakes



John F. Parruch

Instructor with a Few of the Cone-Shaped Tubes through Which Frosting Is Forced, to Form Different Effects and Designs



Applying the Coating to Cake Before the Figures Are Molded, and Close View of Student Making Fancy Flower Decorations; the Frosting Is Squeezed Out of the Cone Held in His Right Hand



985

Honor to a California Hero, the Tablet to "Snowshoe" Thompson Dedicated in Los Angeles



MONUMENT TO MAIL CARRIER RECALLS HEROIC DEEDS

With the dedication of a memorial tablet to John A. "Snowshoe" Thompson, in Los Angeles, accounts of his heroic services to the United States and the pioneer west are being retold. In 1856, when heavy snows had blocked the Sierras, Thompson volunteered to take the mail bags on his back between Placerville and Carson Valley, a distance of ninety miles. He made a crude pair of skis from oak. They were ten feet long and weighed twenty-five pounds. The mail sacks were heavy, from sixty-five to 100 pounds, and the secret of doping the skis with preparations, to make them run more smoothly,

had not been learned then. The snow stuck to Thompson's runners, there were no houses between the towns, drifts, from thirty to fifty feet deep, had to be crossed and no trail had been blazed. For twenty winters, "Snowshoe" carried the mails and without remuneration from the government. He died at the age of forty-nine, known as the pioneer of the stage and the locomotive and as one of the bravest men of early California days.

TREATING WATER ON RAILWAYS SAVES MILLIONS YEARLY

Railroads of the country are saving approximately \$11,000,000 a year in locomotive maintenance by treating the water used for steam to remove scale-forming solids, an expert declares. This figure is considered especially significant since only fifteen per cent of the water is treated. The process costs about four cents per 1,000 gallons and about 50,000,000,000 gallons receive the treatment in one year.

(Time and soda ash)

FOOT BRIDGE OVER AVENUE REDUCES TRAFFIC DELAY

Bridges of the type illustrated here have been proposed for heavily trafficked streets in Paris so that pedestrians may cross in safety and without halting automobiles. The arch slopes gradually so that the steps are easy to climb.

919

Water, Chairman, American Railway Service Committee, Engineering Association



Bridge for Pedestrians over Busy Automobile Street Is Expected to Reduce Traffic Delays as Well as Help Save Lives; Absence of a Supporting Column Leaves Way Unobstructed

Mach 95
800 hp.
Antonio Lococo

Italian Monoplane Which Took Virtually the Same Lines as the American Speed Ships, Eliminated the Upper Wing and Won the World's Championship for Seaplanes

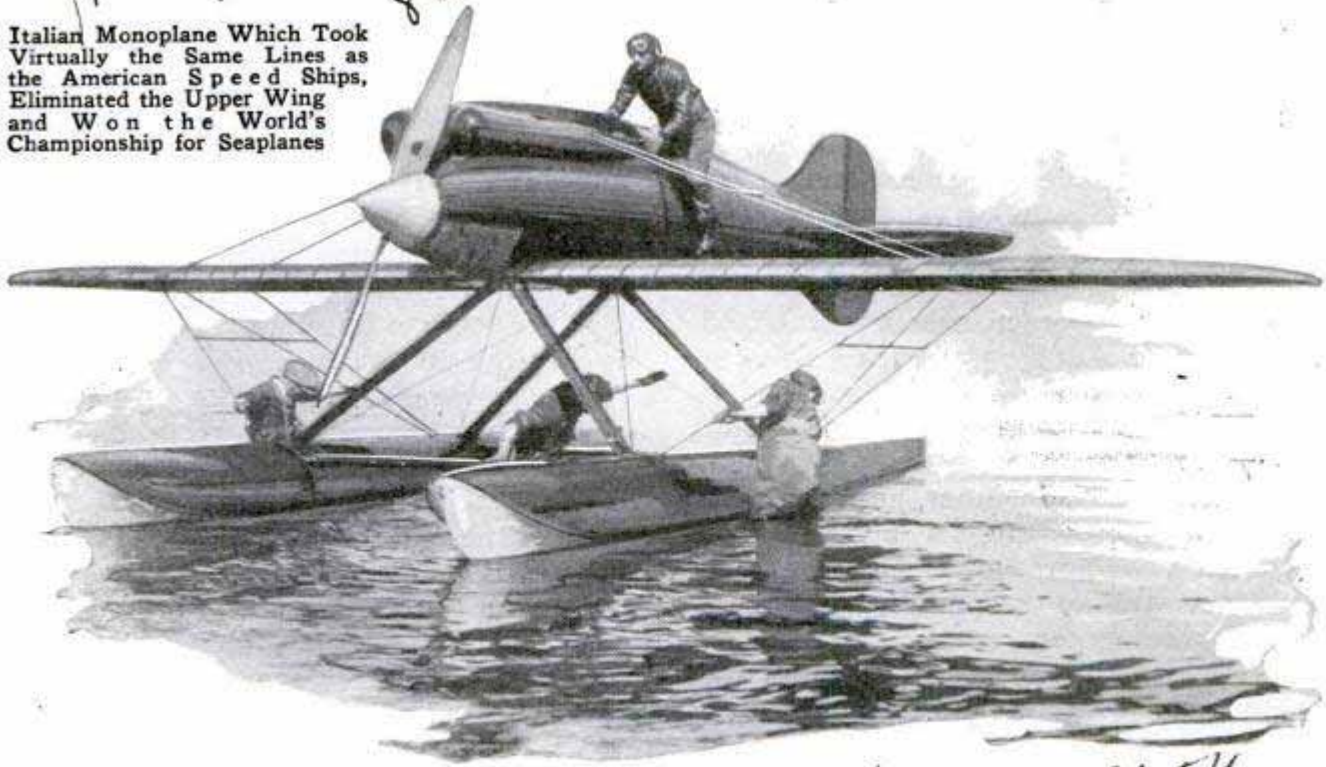

The Battle of Wings for Air Honors *USA*

U. S. Strives to Retake Records Lost When Italy's Monoplanes Proved Single-Wing Superiority

WITH the last of America's great air records carried away to Italy by Maj. Mario de Bernardi, victor in the Schneider cup race, airplane designers already are at work on new craft to represent this country in the 1928 races in Italy. Before going home Maj. Bernardi set four new world's records, and took away the last of the leading air honors won by Americans in the years following the war. His marks include all of the high-speed records for seaplanes, while French flyers had previously lifted the land-plane speed title, as well as the altitude record.

The defeat of the American flyers, representing both the navy and marine corps, was largely due to the cycle in which airplane building moves. A record-breaking type is developed, and then raced year after year until somebody comes along with a faster ship. The Curtis planes lifted the Schneider cup from Italy in 1923, and proved so fast that nobody came over to race for it the following year. In 1925, both Italian and British ships were sent over, and badly beaten. The Italians went home and built better craft, which in many respects closely resembled the

American ships but had vastly more powerful engines. Racing them in 1926 against the American ships of the year before, they won by many miles an hour.

American flyers, however, still have a chance to gain permanent possession of the Schneider trophy if they win the 1928 race. Under the terms of the gift from Jacques Schneider, the seaplane trophy was to become the property of the nation winning it three times in five years. Having won in both 1923 and 1925, another victory would give the United States the cup, even though the 1928 race falls outside the five-year period begun with our first victory in 1923. The reason is that the international aeronautical federation, which controls the race, decided before last year's event that, if Italy won, races thereafter would be held every other year instead of yearly, so that the cup terms will specify three victories out of five consecutive races, instead of three wins in five years. It is even possible that it may be decided, should the United States lose in 1928, that it will have another chance to win permanent possession of the cup in 1930, as that will be the fifth consecutive

race, since none was held in 1924, owing to the fact that no foreign nation sent challengers at that time.

The American team was not only handicapped by smaller engines and older planes, but also had lost one of its best pilots and best ships before the 1926 race. Lieut. F. H. Conant, who was killed a few weeks before the race, when a standard ship which he was flying struck a fishing-net stake while landing, had attained a speed of 251.5 miles per hour with one of the racers.

That left the 1925 winner, powered with a 700-horsepower engine, and another ship with a 600-horsepower motor. They faced the Italian seaplanes, with 800-horsepower engines.

Italy's victory was also a triumph for monoplanes over biplanes. The little Macchi racer, which Maj. Bernardi piloted to victory at 246.4 miles an hour, had much the same fuselage lines as the American ships, but its single wing had sufficiently high lift, without the added resistance of the American double wings. Following the race, the same ship took the high-speed record away from the American army by covering a measured course at an average speed of 258.873 miles an hour. The previous record, made by Lieut. Doolittle, was 245.713 miles.

Flying at such tremendous speeds presents unusual difficulties. Pilots become momentarily unconscious while rounding the pylons at the corners of the triangular course, and, as they fly over the water, are always in danger of plunging into the sea. The racers are so small and fast that it is very hard to correct any minor deviation from the course without "overcontrolling," as the pilots say, and going too far in the opposite direction. The Curtis racers corrected this fault by gearing the control levers, giving a sort of vernier control like that on a radio dial.

One of the oddities of high-speed flight, however, is that a stalled motor, even at very low altitudes, does not offer any particular danger. Flying at better than three miles a minute, the pilot can pull the stick back and zoom a thousand feet in the air if necessary, and there jump out and make a safe descent by parachute. The great speed is sufficient to hurl the plane, even with a dead engine, that high.

**STREET CARS MADE VISIBLE
AT NIGHT 821**

For greater safety, some of the street cars in San Francisco have been painted white at both ends. At night, reflecting lights shine against the surfaces so that the car is visible to a person driving an automobile several blocks away.

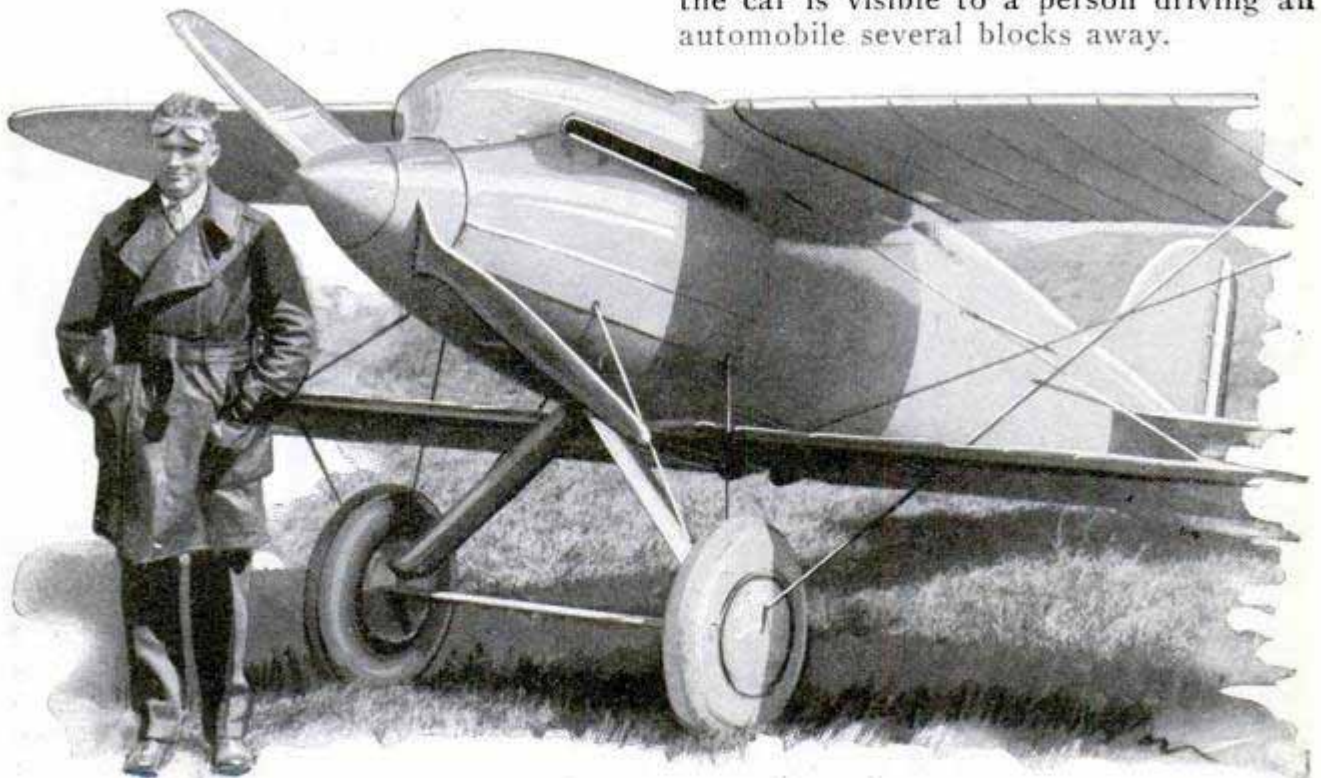

One of the Curtis Ships Fitted with Wheels and Landing Gear as Used in the Pulitzer Race, When They Set the World's Speed Mark, Now Lost; the Pontoons Are Interchangeable with the Wheels

234-195 m JH 615 hp

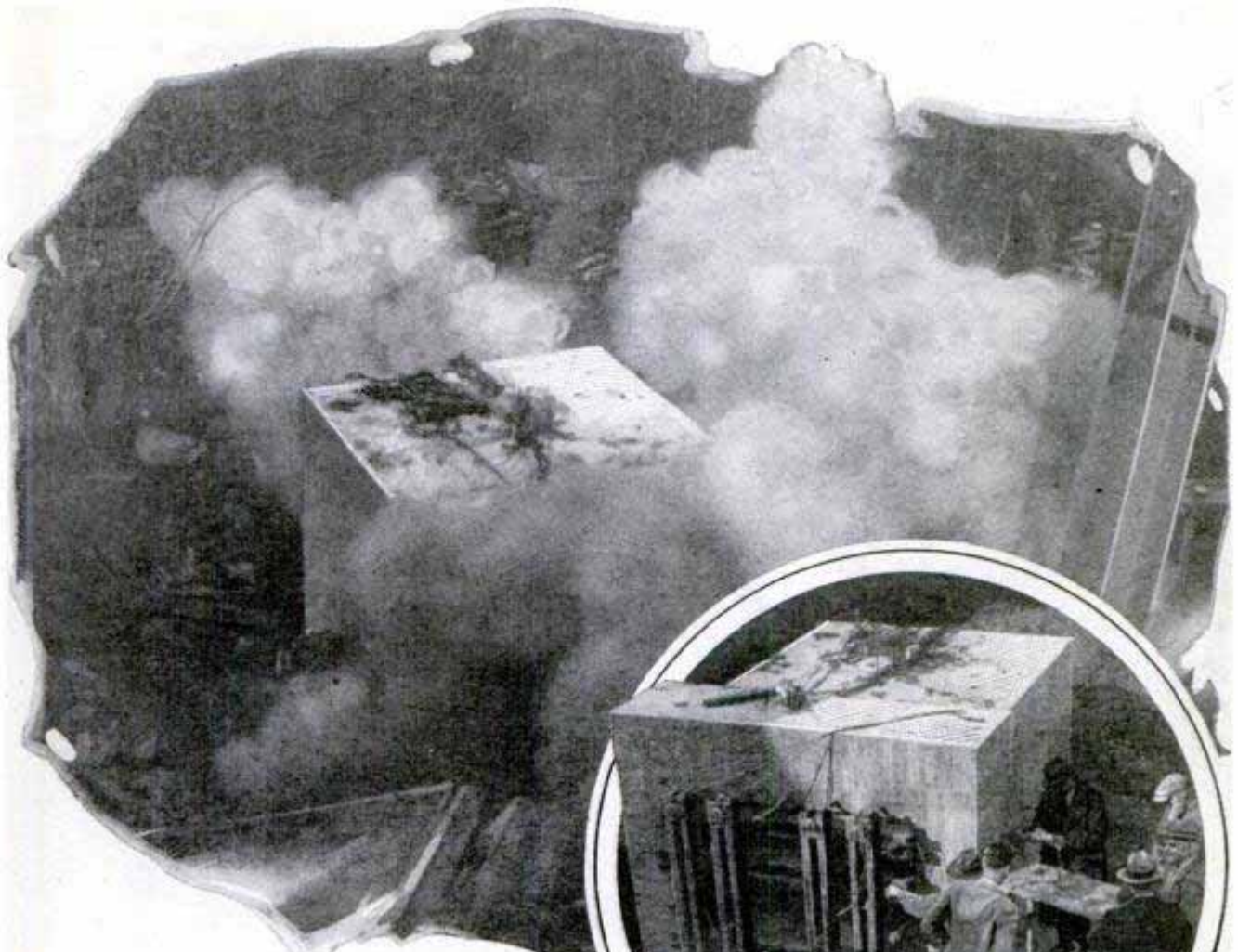

Photograph of the Explosion and Preparing the Charge; the Results Are Carefully Checked

MAN-MADE BLASTS TO SHOW WAY TO MINE SAFETY

To determine what type of bulkheads will afford the best protection for miners, the bureau of standards has been conducting a series of explosion tests in a special chamber. The results of the blasts are carefully studied as to their effect on various kinds of materials and the explosions are arranged with great ingenuity in order to duplicate as nearly as possible those that occur in mines.

1043

U. S. PROSPERITY IS SPEEDED BY INDUSTRIAL SAVING

British observers, sent to America in search of the secret of our prosperity, discovered two facts that surprised them. One was that we have increased the electrical output of steam-generating stations sixty-seven per cent in five years with only fifteen per cent increase in the quantity of coal consumed. The other was that railroad freight rates have been reduced and

ton-miles of freight handled per employe increased, while the number of workers has been cut by nearly 100,000 men. The results attained in fuel conservation through extension of the use of electricity were even more surprising to the observers. They found seventy per cent of all power used in American factories is delivered to the machines through electrical wires, and the number of homes using electricity increased from 5,700,000 to 15,000,000. There was a forty-three per cent increase in water power—hydroelectric stations providing 8,300,000 of the total of 23,840,000 kilowatts generated in the United States. At the same time the improvement in efficiency of the coal-burning plants engaged in producing electric power cut the fuel consumption from three pounds per kilowatt-hour to two pounds.

The Times Trade and Engineering Supplement 11/20/26

410. Includes.

To Save Work



Closely Resembling Linen, a Manufactured Product Is Made Up into Fancy Table Doilies That Can Be Scrubbed with a Brush

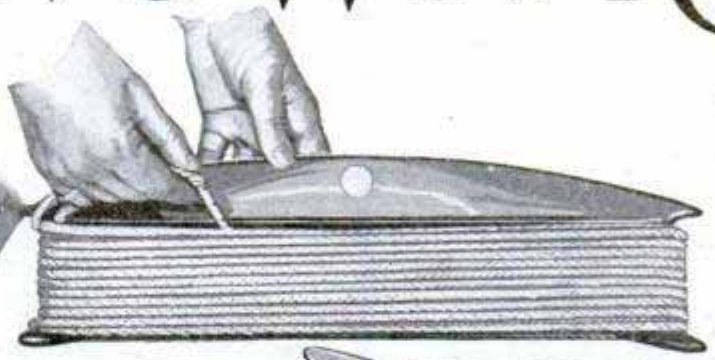

Clothesline on Metal Reel to Prevent Snarling, and, at Right, Combined Tongs and Bottle Cleaner

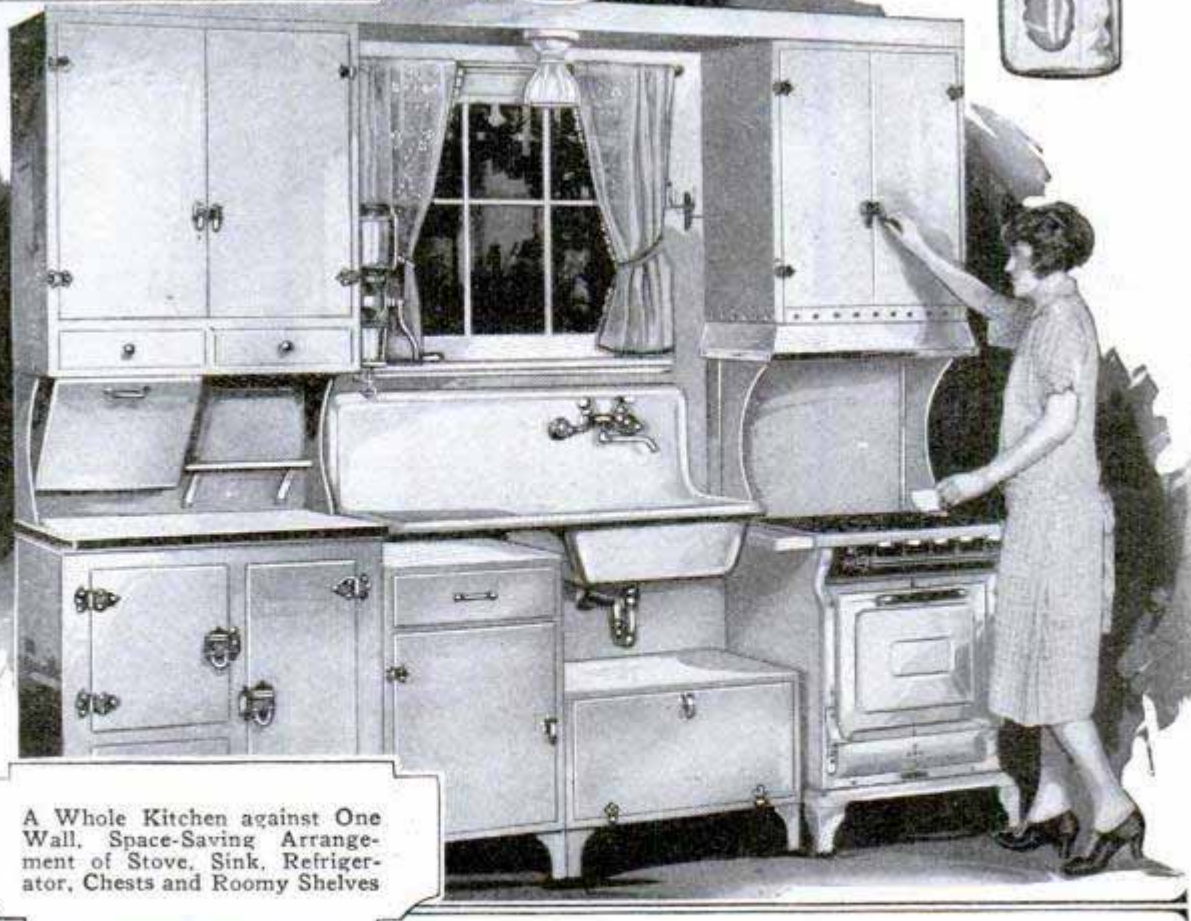

A Whole Kitchen against One Wall. Space-Saving Arrangement of Stove, Sink, Refrigerator, Chests and Roomy Shelves

Anyone wishing further information on devices described in the editorial pages can

in Your Home

W
H
E
E
R
C
O
E
D
C
C
45
C
I
C
O
C
o
M
f
S
t
S
t
S
c
634
L
e
&

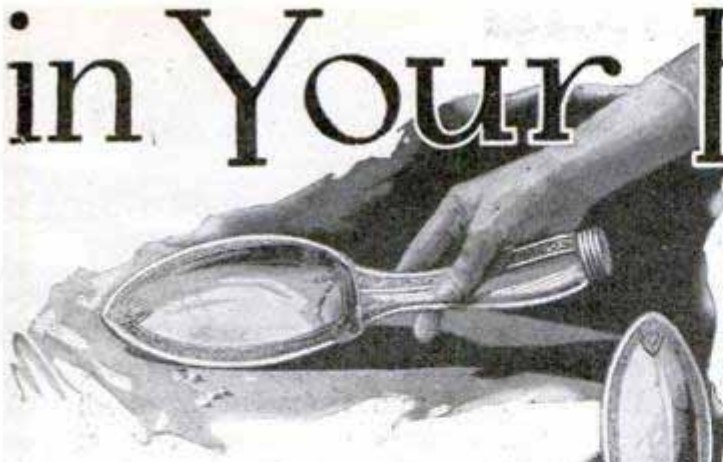

Table Scraper Is Emptied through the Handle and Prevents Scattering of Crumbs



Electric Heater for Rooms Operates from Light Socket and Is Arranged to Afford Ample Circulation for the Warmed Air



Combination Stool and Hamper for Soiled Clothes Fits in Small Corner of Bathroom; It Has Slits for Ventilating



To Relieve Floor Scrubbing of Its Drudgery, a Rest on Casters Protects Knees and Clothing



Lemon Squeezer and Strainer in One Simple Implement with a Hole for Hanging on Hook

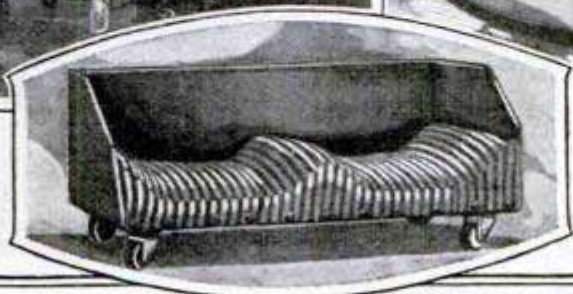

obtain it by addressing Bureau of Information, Popular Mechanics Magazine, Chicago

Monitor 4/13/26

880



For the Safety of Street Sweepers: Belts with Red Glass Reflectors to Warn Motorists

REFLECTORS IN SAFETY BELTS GUARD STREET CLEANERS

Red-glass reflectors attached to the safety belts worn by street sweepers in Portland, Oreg., are intended to attract the attention of automobile drivers at night and thus help prevent accidents to the cleaners who work after sundown. It has been suggested that similar belts be worn by pedestrians abroad at night. There are two glasses in front and two in the back. Reflecting the light of street and other lamps, they are said to be visible at a considerable distance.

SHEEPSKIN "LUNGS" IN METERS PASS RIGID TESTS

Diaphragms used in gas meters are made of sheepskin, as this material has been found most suitable to the demands of accuracy and prolonged performance. In selecting the skins, about six are discarded for one taken, as they must be in excellent condition. Insect bites, scratches and other blemishes make them unfit for service. The skin is soaked in a heavy oil for ninety days to make it proof

against the corrosive elements in the gas; then it is cut and attached to a tin-coated steel ring and is ready for its years of duty.

SECRETS OF EARLY MUSIC HELD IN MYSTERIOUS CURIO

In custody of the Boston symphony orchestra is a nameless musical instrument of dark-grained wood, shaped somewhat like a sword and threaded from end to end with strings set about two inches apart. It is part of a collection of ancient pieces and there is but one clue to its identity, a yellowed bit of parchment inscribed with tiny Chinese characters that have not been deciphered. It is thought that the instrument may have belonged to a period early in the history of music, when Chinese prisoners gave secrets of their ways of music making in exchange for their liberty.

"SHIP" AS REAL ESTATE OFFICE HELPS ADVERTISE LOTS

In keeping with the nautical name of a subdivision near Atlantic City, a real-estate office was built in the form of a ship. Erected on a wide expanse of open land, it was fitted to provide ample space for salesmen and customers.



Real-Estate Office Built in Form of a Ship to Advertise Subdivision

Neptune Gardens

*Ent. Richard J. Bond
1861 6
St. Louis*

888

New England News 11/15/26

24 Mich St.

770

BLASTING OUT ONE OF THE WORLD'S LARGEST ROCKS

One of the largest single rocks ever quarried was blasted from Stone Mountain, Ga., to be used in making columns for the capitol building in Cuba. The huge

church weighs nine and one-fourth tons and the smallest fifteen pounds. The sets contain from twenty-three to fifty-three

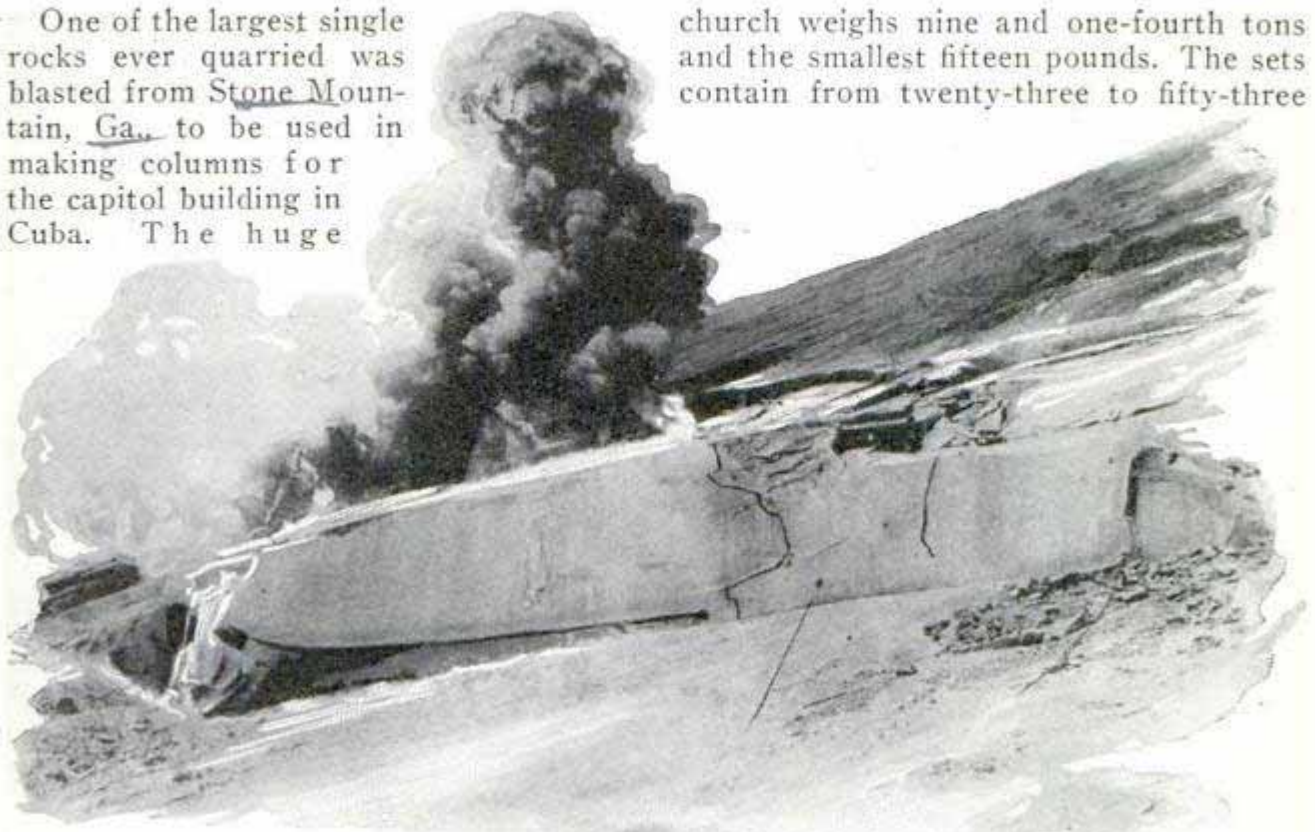

Blasting Huge Fragment from Stone Mountain, Ga., for Cuban Capitol Pillars

"chip" was more than fifty feet high and contained 250,000 cubic feet, enough to fill 650 freight cars. Big as the piece was, it represented but a small part of the mountain itself, which is a granite boulder rising to a height of more than 1,600 feet from a flat plain near Atlanta.

bells. They are tuned to semi-tone intervals and are played with a set of levers arranged like the keys on a piano.

TEACHING BELLS TO SING

Carillons cost from \$10,000 to \$100,000, depending upon the number and quality of the bells, and casting them is a task requiring great skill. Some of the secrets of the old Flemish masters of the art are said to have been rediscovered so that the tones of a carillon of today compare favorably with those of bells made centuries ago. To achieve the exact tone desired, a few shavings may be removed from the interior of the casting with a fine tool. The bell then is given a dull gloss by means of a sand blast. No paint is used, as that would deaden the sound. The sound waves from some of the large bells are sufficiently powerful to shatter a wine glass a yard away. The heaviest bell in the carillon ordered for a New York

FIRE SIGNAL HAS LOUD SPEAKER TO SPEED ALARMS

The person turning in the fire alarm can speak to the men at the engine house and receive a reply, preventing mistakes in locations and other delays, in a signal box that has an amplifying unit for the voice. A loud speaker relays the fire call distinctly, so that



the men at the fire station are called to attention, and the reply can be heard twelve or fourteen feet from the box. This feature is expected to discourage attempts to turn in a false call. Access to the signal is gained by breaking a glass panel as in the ordinary fire box.

Mess. Lillibet & Johnson, Croydon, England

in Birmingham

511

It's easy to dodge Electric Shocks (if you know how)

By PAUL PADDOCK

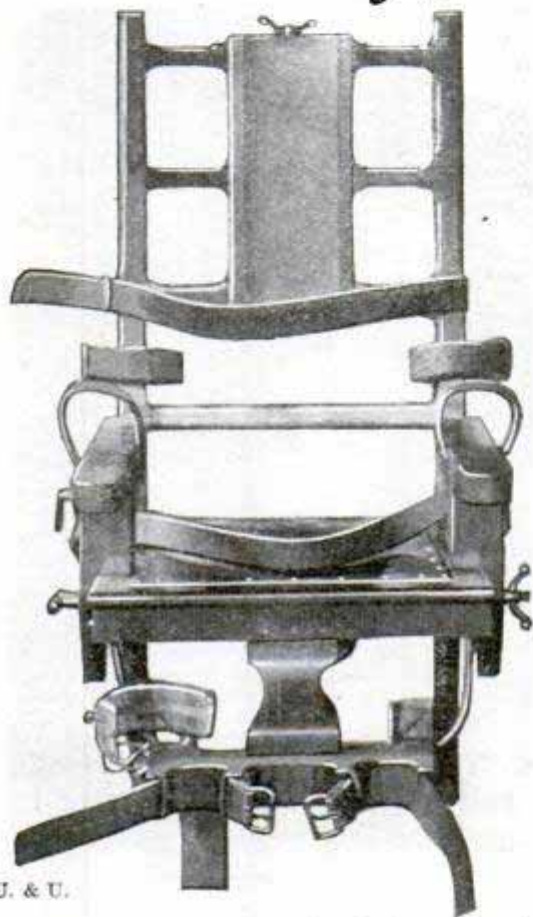

© U. & U.

The Electric Chair at Sing Sing Prison, Showing the Helmet and Straps for Hands and Feet

WHILE electricity is still much of a mystery, it may be employed as safely as a stream of water from a hose—if you know how. Spray from an atomizer under many pounds' pressure would hardly cause more than a tingling sensation to the skin because the amount of the liquid is so small, but a stream from a fire hose under the same pressure might result in serious or even fatal injuries.

And so with electricity; its safe handling depends not only on the pressure, but on its amount. With water, the quantity is expressed in pints or gallons, and

in electricity it is measured in "amperes." The pressure of water is told in pounds while in electricity the same force is counted in volts.

This explains why, although 2,000 volts and about seven amperes are used to kill criminals in the electric chair and shocks from the ordinary 110-volt, ten to thirty-ampere lighting circuit have often proved fatal, no more than a bad jolt results from coming in contact with the 10,000 volts used at the spark plug of an automobile. In the latter case the amount of current, or amperage, is too small to cause any or at least not serious harm.

Like water seeking the lowest level, electricity always takes the easiest route back to its starting point. It works its way through obstacles, lighting lamps and running motors, as a stream surmounts a paddle wheel which has been erected in its course to turn mill machinery. The path in which the current moves is called a circuit and, unless it is complete so it can return to its starting point, it can do no work and cause no damage.

The danger only comes when the current can make a circuit through the body in returning to its starting point. Thus, a repairman standing on an insulated platform through which electricity cannot

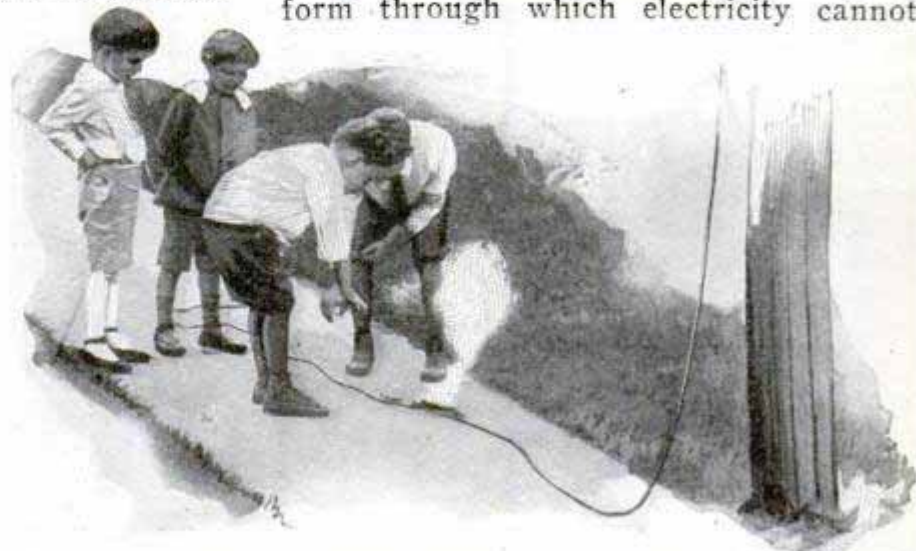

A Live Wire Generally Looks as Innocent as a Harmless One; Teach Children to Leave All of Them Alone

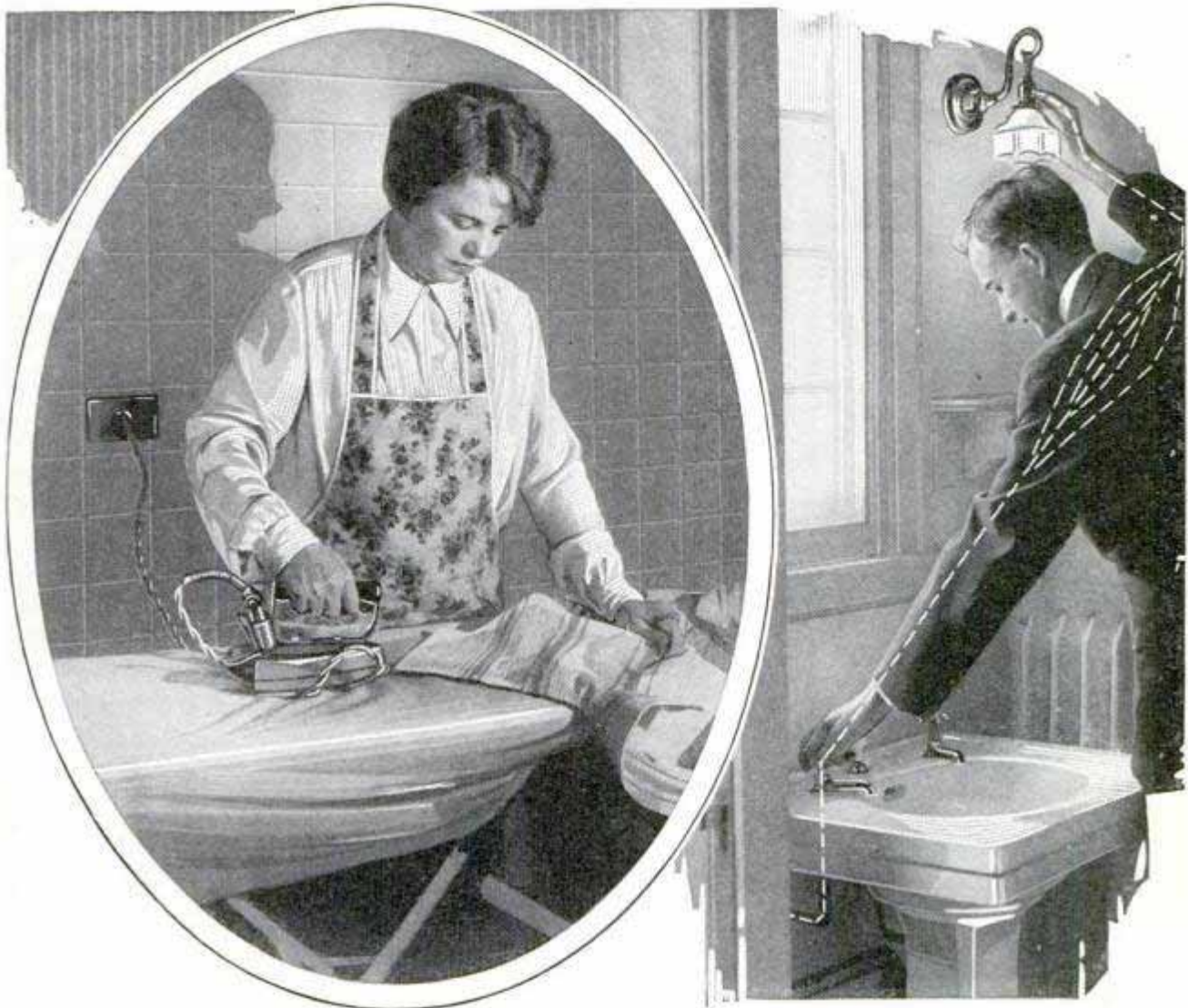

How Many Electric-Iron Cords Are Ruined, Leading to Shocks and Fires; Right, Diagrammatic Photo Tracing Path of Current from Faulty Light through Body to Water Pipe

pass, may handle a wire carrying 600 volts in perfect safety, whereas he probably would be instantly killed if he did the same thing while standing on the ground so that the electricity could make a circuit through his body.

When going through the body, electricity works just as it does when lighting lamps or running motors. Its disastrous effect on the human system is to contract the heart and lungs, stopping their operation, if there is enough current, and if the application is continued, the nerves are injured, chemical changes are caused in the blood and serious burns result. A person who has suffered an electric shock is in the same condition as one who has been asphyxiated, and artificial respiration should be applied for an hour or more before giving up hope.

Throwing strings, sticks or wires or flying kites over electric wires, and climbing poles that carry circuits are common haz-

ards that children often take with disastrous results. If the kite string contains tinsel, as it often does, the danger is vastly increased. In the household, the electric iron has been found to be one of the chief trouble makers when not used carefully. If the current is not turned off, a fire may result. Care must be exercised, in handling the cord, not to kink or bend it. That ruins the insulation and may break the small wires inside allowing the electricity to escape just as water leaks out of a defective pipe. All appliances run with cord attachments should be handled with equal care. Exposed wires in connections to floor lamps are a common source of shocks and fires.

Makeshift fuse plugs often cause serious damage. The fuse is simply a protective device to safeguard against overloading the circuits in the home. It is the weakest link in the "chain." If the load becomes too heavy, that is, if too much

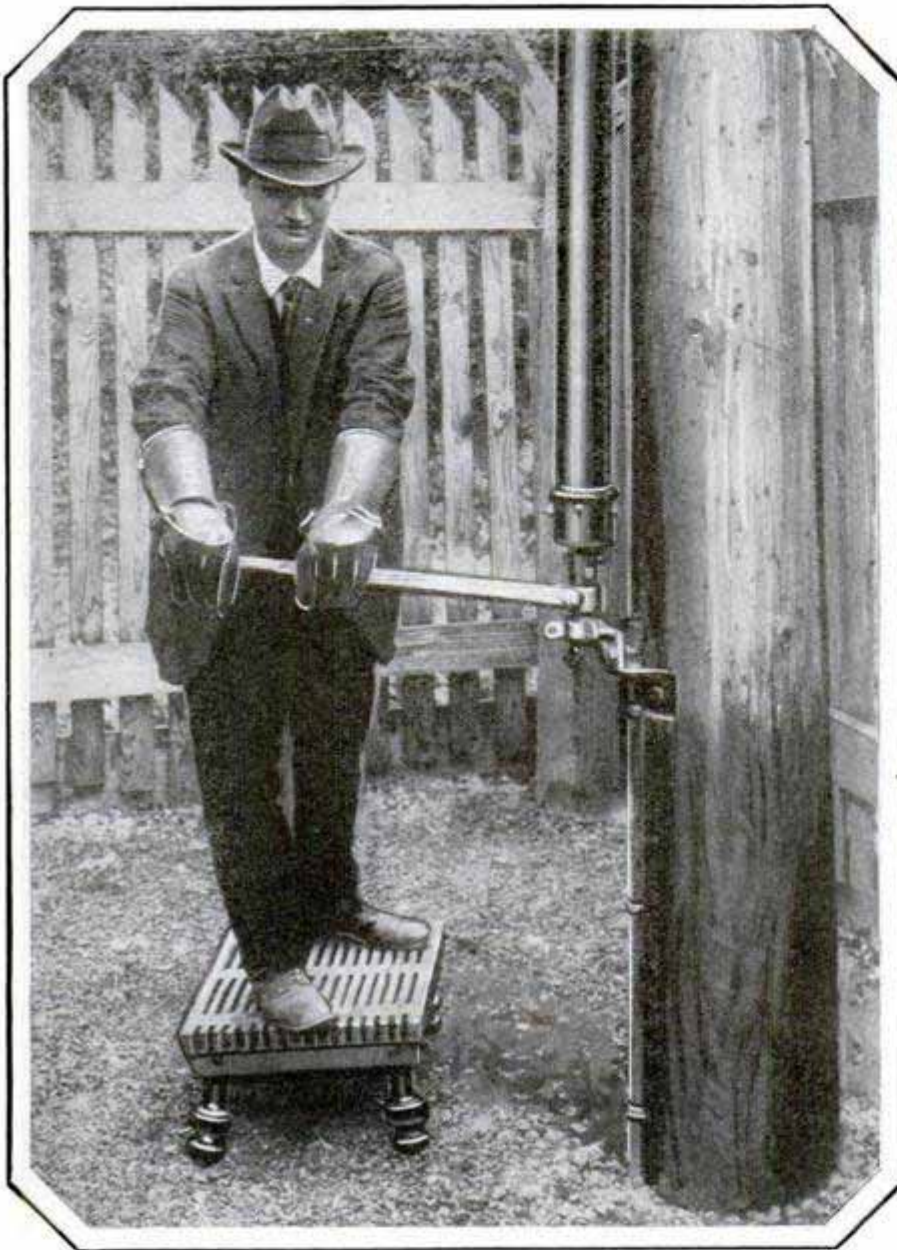

Guarding against Injury in Manipulating a Grounding Switch by Standing on Insulated Platform and Using Gloves

electricity flows into the wires, the fuse blows out. That shuts off the supply to the circuit, removing the danger of increased overloading. Putting coins, wires or other articles into the box in place of a blown fuse is hazardous, for more electricity than the wiring can safely accommodate is likely to flow in. The heating elements of toasters and percolators are likely to be melted and wires in the walls may become red-hot, causing fires.

When using the telephone, avoid touching radiators or other metal objects. In laundries, bathrooms or other damp places, never touch metal parts of lamp sockets, fixtures or other electrical devices that may be "alive." The hazard is greatly increased if the person is bathing in a

tub, for more of the body is exposed to the water, which, being a good conductor, tends to draw off the full amount of current.

Radio dry batteries need not be feared, but even a six-volt storage battery may be the cause of a fire if the terminals leading from it become crossed. As battery eliminators are used in connection with the house-lighting circuit and develop high voltages, they afford a possible source of shocks. The metal parts of these units should never be touched when the current is turned on. Knobs, and other parts that need to be adjusted when the set is running, are properly insulated to prevent injury. In purchasing electrical equipment of all kinds, it is advisable to look for labels which show that the pieces have been properly tested before being placed on the market.

Never touch a person who has been shocked while he is still in contact with the live wire. Try to summon someone who knows how to do this, but if assistance cannot be obtained, use a long dry board, a dry wooden-handled rake or broom to draw the person away or remove the wire. Keep out of water and never use a moist object. In taking hold of a live wire, use only one hand and never touch a wet pole that is carrying electric wires.

Shocks through the upper part of the body are likely to be more dangerous as they may pass through the heart and other vital organs. Always be wary of fallen wires on the streets, especially after storms where there is danger that the strands may be part of an electrical circuit or in contact with live wires. Don't touch

the worn spots on insulation, have cords and wiring inspected by competent persons, never try to take electrical shocks just to experiment and keep furniture away from interior wiring.

The effect of an electrical shock, if the current is of the alternating or interrupted type, is partly muscular, alternately contracting and loosening the muscles. That is why the current from an ordinary "shocking" coil seems to jerk the hands when you grasp the electrodes.

Most of the house-lighting current, outside certain business and factory districts in some cities, is of the alternating type, reversing its direction sixty times a second. Under ordinary circumstances it is not particularly dangerous, causing only a mild shock when you come in contact with the wire. If you grasped both wires, though, you would receive the full capacity passed by the house fuses, usually twenty to thirty amperes, which might be an exceedingly dangerous or even

Don't Crumple the Electric Heating Pad; Fine Wires May Break, Causing Fires; Keep Hands Away from Water When Using Electric Curling Iron

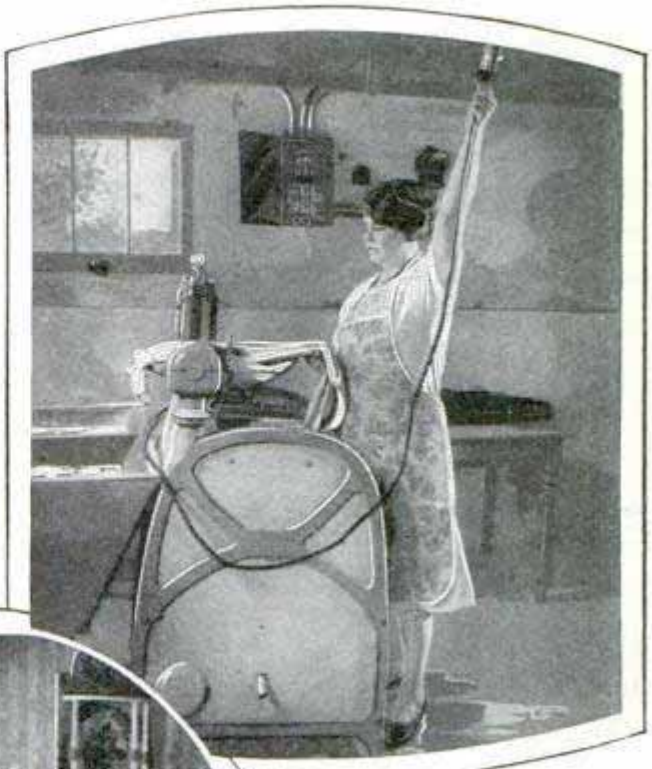

A Too Frequent Cause of Shocks; Thoughtlessly Touching a Defective Wire While Standing on Wet Floor with Electric Washer Running



fatal amount. When you touch only one wire, the amount of the current which can pass through your body is limited by the material between you and the ground—your shoe soles, the carpet, floors and walls. Usually they insulate you so effectively

that the amount of flow is small and the shock light. Occasionally you may read of some one being killed in his own home by the electric-light current. More often than not the victim is a woman, and the circumstances of death much the same. Usually the newspapers recite that, while taking a bath, the victim attempted to use an electric vibrator or curling iron, a circuit was established through the water and the water pipes to the ground, and a heavy enough current passed to cause death.

The water in the bathtub or washbasin makes a perfect ground for the same reason that you select a water pipe to ground your radio aerial.



915



Jewel-Studded Crown Which Was Worn by Catherine the Great of Russia and Is Now for Sale at Huge Price

FAMOUS RUSS CROWN VALUED AT FIFTY-TWO MILLION

Containing 1,520 diamonds and surmounted by a cross of huge jewels, the historic crown that was worn by Catherine the Great of Russia is valued at \$52,000,000. It is included among the Russian crown jewels purchased from the Soviets. Another famous item is a large jewel given her by the Swedish king, in 1777.

FOLDING TABLE-AND-CHAIR SET FITS IN SINGLE BOX

735

Folding chairs and a table to match are provided for card parties, clubs and hotels in a compact set of five pieces that fit into a single small carton when not in use. The chairs, for instance, stack evenly and a dozen of them occupy a space only eighteen inches wide, three

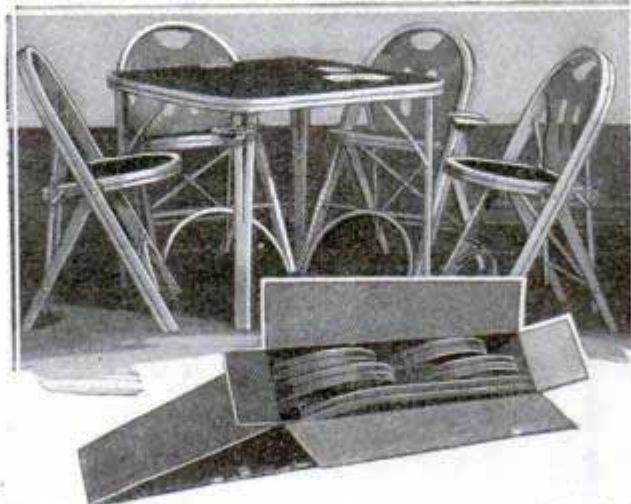

Table and Chairs Set Up and Packed in Box; Note Ash Tray on Front Table Leg

Louis Mastetter & Co. and Wayne, et al.

feet long and two feet deep. An additional feature is an ash tray that slips into a slot in any of the four legs.

FISH SURVIVE FREEZING TESTS

831

That many creatures can survive extreme cold is common knowledge, but a European scientist has made some interesting experiments showing that some species can endure even lower temperatures than is generally believed. A number of fresh-water fish were kept in a block of ice at a temperature of twenty degrees Centigrade below zero. When the ice was carefully thawed out, the apparently

dead fish revived and swam in the melted water. Lower temperatures proved fatal to the fish, but frogs withstood colds of twenty-eight degrees, a water salamander, fifty degrees, and some species of snails endured 120 degrees.

HUNDRED-STORY BUILDINGS FOR STORES AND HOMES

825

Skyscrapers, 100 stories high and containing both offices and residences, will appear in large cities within the next fifty years, an eastern architect predicts. As

he pictures the structures, fifteen floors would be devoted to business and the rest, set back in pyramid fashion at intervals of every three stories or so to admit light, would afford living quarters. Sidewalks at the various levels, with space for small stores, lunchrooms and other conces-

Chicago, Ill. Post 4/3/26

Chicago - 1517 S Wabash

Prof. Pictet, Geneva, Switzerland

Alfred C. Dyson, Eastern Architect

Alvan L. Barach

New York Pneumonia

**OXYGEN HOOD AND CHAMBER
AID PNEUMONIA VICTIMS**

is reported

sions, plots for grass, trees and playgrounds, would be practical under such an arrangement, he declares. Skyscrapers of this type would occupy an enormous base and would be erected at intervals of one block, so that there would be relatively little obstruction to the view from any window of the upper floors.

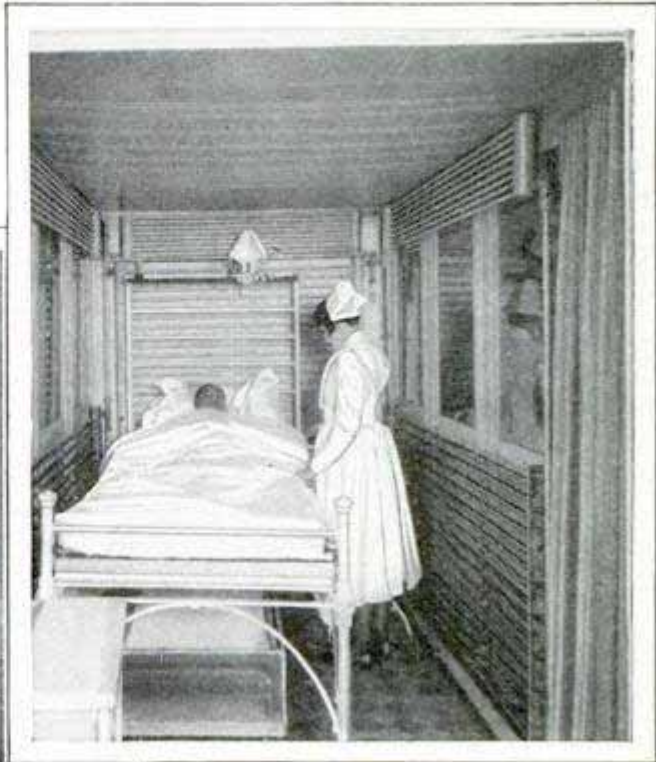
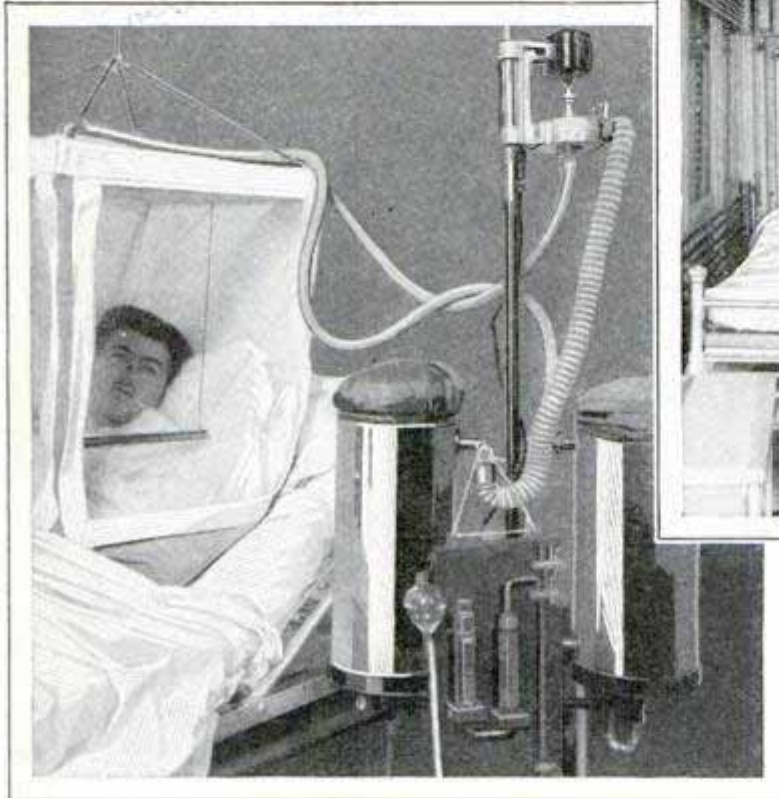

Oxygen Cabinet and, at Left, the Hood for Use at Cot

Electrical heat would eliminate smoke and chimneys. The plan suggests new standards of health and efficiency in densely crowded cities, the architect believes.

**DISK RECORD BENT DOUBLE
WITHOUT DAMAGE** *842*

Flexible phonograph records have appeared in England and are said to be so elastic that they can be bent double, thrown to the floor and otherwise mistreated without injury. After one of the records had been bent, it was placed on the machine and listeners declared they were unable to detect any impairment in the reproduction. *British*



© Keystone View Co.

ing of oxygen. They are said to be improvements over the old funnel method in many ways, particularly because from forty to sixty per cent oxygen can be given the patient while he rests in any position and for any length of time, whereas but twenty-two to twenty-four per cent oxygen could be administered through the funnel. The hood incloses the head and chest and is suspended from a standard which is mounted on a wheeled base. Celluloid windows on two sides and another in the roof admit light. Air entering the hood is filtered through soda lime to remove the carbon dioxide and is dried by passage over an ice cylinder. In the chamber, the flow of oxygen is regulated by a valve.

☐ We want all our readers to write us freely and often whenever they wish additional information on articles published in this magazine. Address Bureau of Information, Popular Mechanics, Chicago.

Unable to locate maker

similar made by -
Perfect Window Washer & Mop
Amsterdam, N.Y.



To Simplify the Window Washer's Task; Outside Surface Cleaned from Interior with Curved Mop

CLEAN WINDOWS FROM INSIDE WITH CURVED STICK

Washing the outside of windows can be done from the interior with a special scrubber attached to a cane-shaped stick. The article, developed in England, is intended to serve as a substitute for ladders and to eliminate the necessity of standing or leaning in hazardous positions while washing outer surfaces. The cleaning unit can be easily changed.

SAILOR INVENTS AID TO MAIL DELIVERY

Mail delivery to moving steamers in the Detroit river from the floating post office there has been facilitated by the application of a sailor's invention. The letters and packages are carried by a small launch and although the boats cut their speed to half as the mail craft comes alongside, the line, thrown around the timberhead of the larger vessel, frequently has broken by suddenly coming up taut. The mail boat drifted away and no delivery could be made. This difficulty has been solved by the installation of special snubbing posts devised by the second

Electrical Review 10/26/26



Blocks in This Model Tower Are Made of Old Newspapers, Pressed into Shape after Soaking

mate of one of the large lake vessels. They are placed abreast of hatch No. 3 on loaded boats and amidships when the freighters are light. The importance of this device is realized when it is known that, during the season of navigation, the floating post office delivers 1,500,000 pieces of mail and approximately 9,000 telegrams and special-delivery letters.

UNDERGROUND POWER CABLES

INSULATED IN OIL
Installation of two huge power cables carrying current from 132,000-volt generators recently installed in New York and Chicago raised a problem in insulation that was finally solved by filling the underground conduit with transformer oil, under pressure. The New York line is eleven miles long, and, as it supplies current for the high-pressure pumps of the fire-fighting system, the city requires the company to pay a forfeit of \$400 for every minute the line is out of commission. The Chicago power line is six miles in length. Pressure on the insulating oil of the latter is maintained through connections with large oil tanks on top of buildings at several points along the route. The power company built the buildings merely to get the use of the roofs for the tanks, and then leased the lower floors as garages.

MODEL TOWER IS BUILT OF OLD NEWSPAPERS

Old newspapers have been adapted to a novel and ingenious use by a western craftsman. He soaks them in water until they are pulpy then pounds them into blocks with which he builds various models. The six-foot tower shown here has a small elevator inside which is run by a tiny motor. Several cigar boxes, some wooden crocheting needles and more than 300 copies of a daily newspaper were required to complete the model.

Telegraph Works
Clerk in Postland
J. H. Schmeider

A Crystal Set for the Boy Builder

By WILL H. BATES

THIS little set is recommended for the boy builder, although the grown-ups also will enjoy it. Exclusive of the phones, the cost should not exceed \$1. Surprising volume is obtained on the local stations, and the set is more selective than the average receiver of this type.

Very few parts are required. The wood base may be made of scrap material found around the home. The other items can be bought at the 10-cent store, with the exception of the crystal holder. For this, an upright type, as illustrated, should be

coat of mahogany or walnut stain. Drill it for the four binding posts, which are located as shown in the illustration of the under side of the base. A $\frac{1}{2}$ -in. bit is used to countersink these holes halfway through the board from below.

The spiderweb coil is wound on the form shown in the diagram; this form may be cut from fiber or cardboard, and the dimensions should be followed. The thirteen spokes are $1\frac{1}{4}$ in. long, leaving an uncut center $2\frac{1}{2}$ in. in diameter. Wind the turns of No. 24 d.c.c. magnet wire alter-

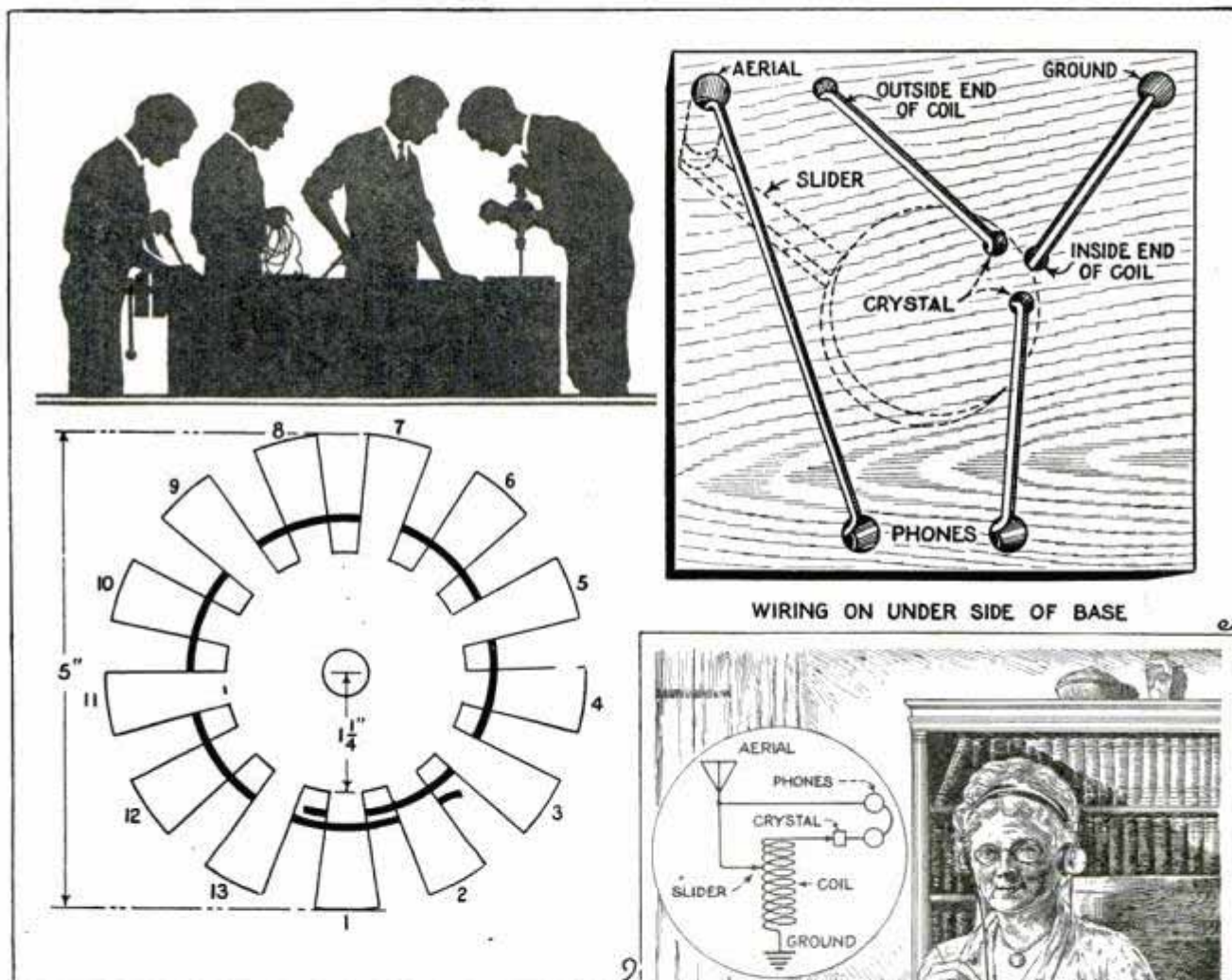

Left, Construction Details of Coil Form; Black Line Shows Method of Winding; Insert at Right, Schematic Circuit Diagram

selected, and may be obtained for about 25 cents. A good pair of 2,000-ohm phones should be used and these are available for about \$2.50.

The base may be beveled on the top edges, sanded down, and then given a

nately over and under the spokes, as indicated by the heavy line. When doing this keep count of the turns by marking one spoke and counting one each time this is passed. Fifty turns are required. Leave

the base, and on the under side, cut a groove in a straight line from this hole to the ground binding post. Run the inside end of the wire down through this hole and along the groove to the ground

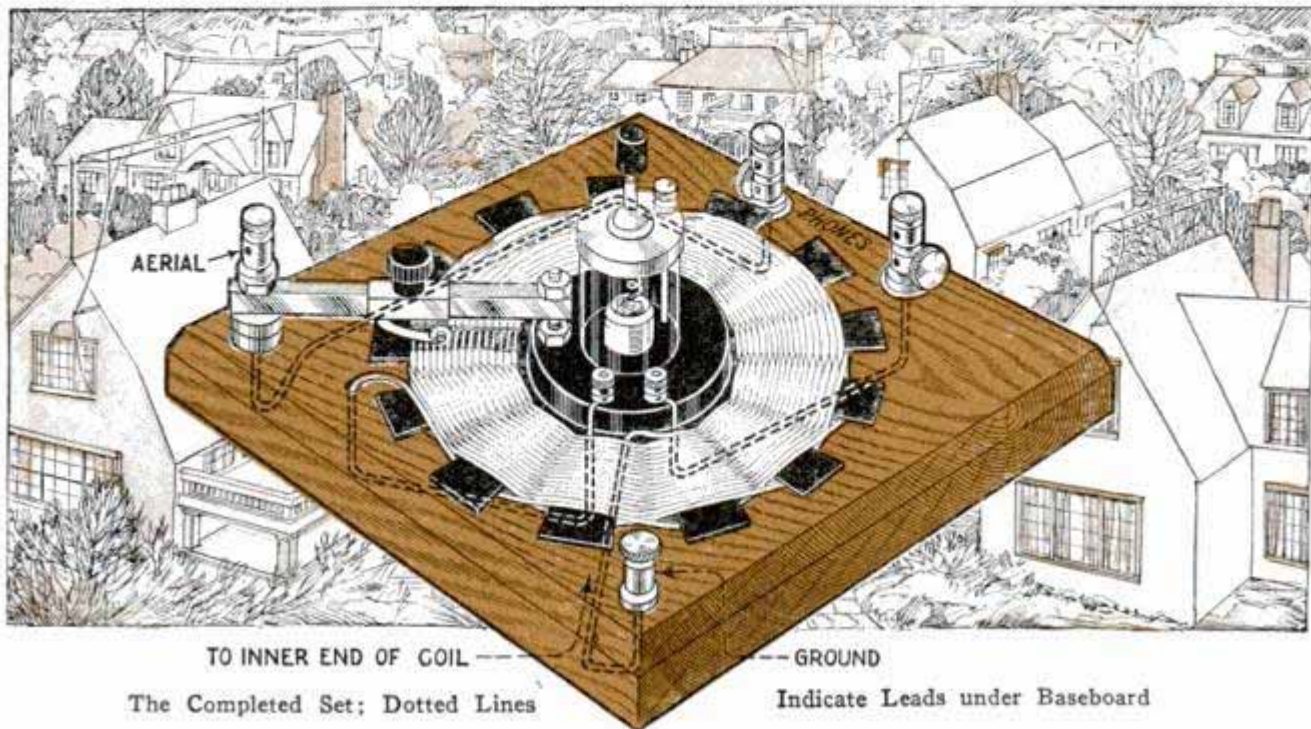

The Completed Set; Dotted Lines

Indicate Leads under Baseboard

about 6 in. of wire at the start and finish of the coil, to make the necessary connections to the binding posts. When the coil is completed, scrape off the insulation from the wires on one of the spokes for a space about $\frac{1}{4}$ in. wide, running straight down the spoke toward the center. Put the spiderweb form on the center of the baseboard with the scraped section of the wire pointing to the aerial post. Then place the crystal holder in the exact center of the spiderweb coil, with one of the screw holes for mounting the crystal holder in direct line with the scraped wire and the aerial post. Fasten down the holder to the base with a wood screw through the mounting hole on the opposite side of the crystal holder.

At the starting, or inside, end of the coil, drill a small hole straight down through

post. Also drill a small hole at the outside end of the coil, and another just in front of one of the binding posts on the crystal holder. Join these two holes with a groove, and bring the outer end of the coil down through the base, along the groove and up to the post on the crystal holder. Drill another small hole just in front of the other binding post on the crystal holder, and run a wire down from this side of the crystal, through a groove along the bottom to one of the phone posts. The other phone post is then connected with the bottom of the aerial binding post in the same manner.

With a hacksaw, cut off a section of the square slider bar, long enough to bridge the space between the base of the crystal holder and the aerial post. Measure the distance from the screw hole in the flange of the crystal-holder base to the aerial post, and drill holes in the slider bar accordingly. A 6-32 brass machine screw, $1\frac{1}{2}$ in. long, is brought up through the baseboard, and through the opening in the flange. This hole is drilled down through the flange, using the hole in the crystal holder as a template. The hole on the under side of the base is countersunk for the head of this screw, which is

MATERIAL LIST

- 1 wood base, $\frac{3}{4}$ by 6 by 6 in.
- 4 binding posts.
- 1 spiderweb form.
- 1 small spool No. 24 d.c.c. magnet wire.
- 1 slider bar, 3 in. long, with slider.
- 2 6-32 brass machine screws, $1\frac{1}{2}$ in. long.
- 1 wood screw, 1 in. long.
- 1 crystal and holder, upright type.
- Washers and extra nuts.

not shown in the illustration as no circuit wires go to it. A nut is fitted on the end of the screw protruding through the holder flange above, and the slider bar slipped down on the nut, where it is held by another nut. At the aerial post, a brass machine screw of the same size is passed up through the baseboard, the lead from the phone post first being securely fastened to the head of the screw on the under side. Washers or a bushing should be used to level the bar. Put the slider on the bar and mount on the screw. The aerial binding post is then screwed down, and the set is ready for use.

To operate the receiver, use a one-wire aerial, about 75 or 80 ft. long, and connect a lead from the ground post to a clamp attached to a cold-water pipe. Then insert the phone-cord terminals in their posts. Tune by moving the slider along the bar until a station is heard at maximum volume and adjust the crystal to the spot where best results are obtained.

1143- R.
New Unit Brings Old Set Up to Date

A new power-amplifier unit that may be used to modernize the old set has lately made its appearance on the market. It consists of three specially designed stages of a.f. amplification in a compact assembly, which can either be placed inside the cabinet, if there is room, or used as shown in the illustration. The cable leads from the unit are merely clipped to the regular batteries of the set. The a.f. tubes are shifted to the unit and one tube is added. A special lead in the cable is provided for connection to the detector tube.

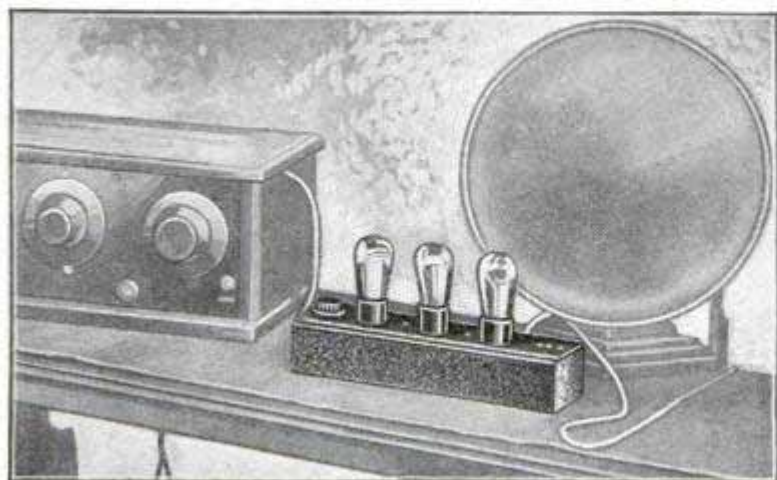

Power-Amplifier Unit Connected to the Old Set, Improves Tone, and Provides Increased Volume

*Alden Mfg Co
 15 ... field Mass.*

*Howe Mfg. Co.
 30 Euclid Avenue
 1136 R. Eddy Cleveland Ohio*

Direction Finder for Loop

A handy device for pointing the loop exactly toward the location of a distant

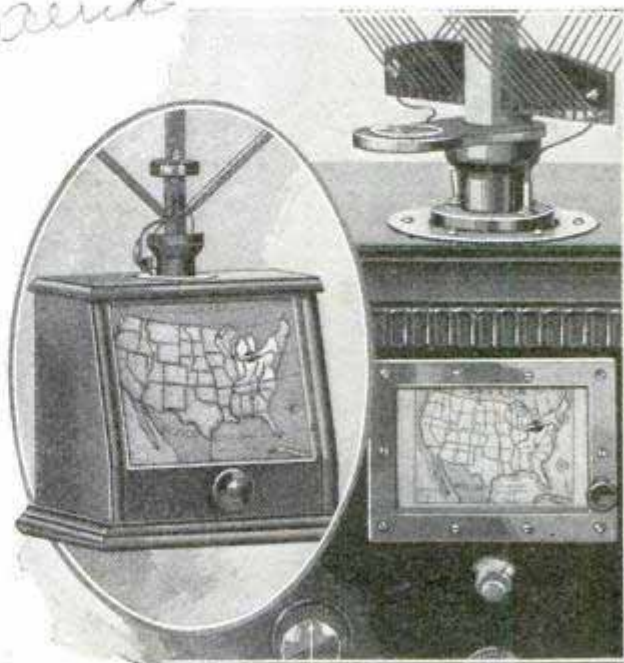

Insert, Loop Direction Finder as a Separate Unit; Right, Built-In Type for the Set Builder

broadcasting station was exhibited at the recent Chicago radio show, and is now on the market. It is offered as a separate unit, or may be obtained in knocked-down form suitable for mounting in any set. The finder consists of a properly projected map of the United States, under glass, on which is mounted an arrow indicator. There are two control knobs on the instrument, a small one on the side, and a large one at the front. The first controls the arrow only; the second controls both loop and arrow. The first step in using the device is to swing the loop, by hand, until it points due north, as determined by the compass mounted near its base. Then, by means of the small knob, the arrow is also set to point due north on the map. Now, if the larger knob is turned so that the arrow points to the location of the station desired, the loop, swinging with it, will also point to the station, permitting the operator to tune it in at maximum strength.

Ⓢ Do not use small B-batteries on large sets, nor large B-batteries on small ones.

300
 1134-2

Filter Eliminates A-Battery

Eliminating the A-battery, a new filter unit is attached to the output of a tungar charger, where it will perform enough

Above, A-Battery Eliminator: Insert, View of Top Showing the Connection to the Set and Charger

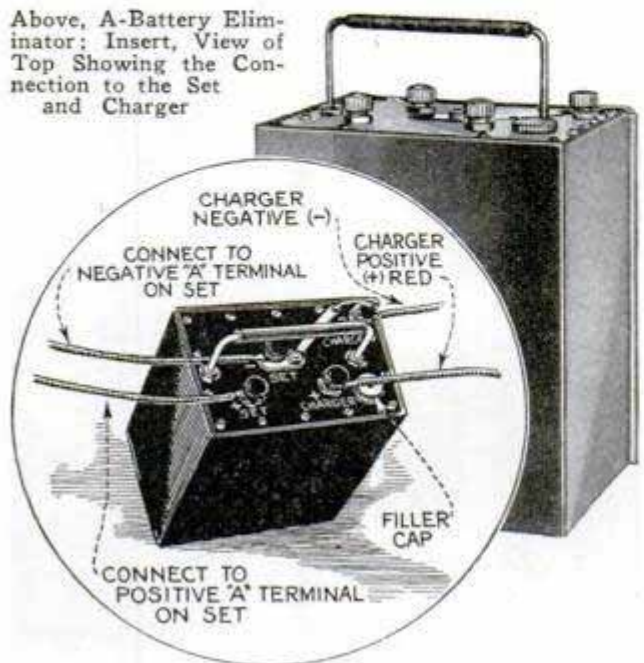

“smoothing” and filtering to permit the use of anything from a one to a ten-tube set. For sets employing from one to six tubes of the 201-A type, or equal load, a 2½-amp. charger is recommended and a 5-amp. for those using more than six similar tubes. Vibrator-type chargers are not recommended for use with the unit. As the device supplies no power, its output is limited by the capacity of the charger. The connections are very simple. Based upon an electro-chemical action, the new unit permits the set to draw its A-power direct from a light socket, without alternating-current hum.

Filling Holes in Radio Panels

The radio experimenter often wishes to try out new circuits that call for a change in dials and other equipment on the panel. These changes leave a number of unsightly holes that must be filled up if the same panel is used. Countersink the holes on both sides with a “rose-head” countersink after the panel has been stripped of all instruments. Get some black pitch or compound such as is used for sealing storage-battery cells, or for covering dry cells and melt it in a can over a flame. Lay the panel flat on a sheet of paper on the table, and pour the compound into the holes,

leaving a slight surplus above the surface. In about 30 minutes it dries hard and may be rubbed down to the panel surface with fine sandpaper. To put a good finish on the panel, which may be covered with scratches, use powdered pumice and water, and rub with a block of felt, always rubbing the full length of the panel, never across it. Go over the entire surface and wipe clean with either a damp cloth or one containing a slight amount of oil. The filling compound will stay in place as the countersunk holes serve to dovetail and hold it. If any irregular spots are left, apply some of the compound to them, smoothing such places off with a hot soldering iron, and rub down as before.—Harold P. Strand, Malden, Mass.

New Universal Vernier Dial

949-2 Fits All Condensers

A universal vernier dial designed for all types of variable condensers is now offered to the radio builder. This dial may be used for either right or left-hand and for 180° or 360° condensers. A numbered disk is fastened to each side of the rotating plate; to reverse the reading, the plate is simply turned around, making practically four dials in one. Directly under the degree number on the dial there is a logging window with plenty of room for writing in the station call letters, permitting the listener to tune in the station he wants without reference to wavelength charts. There is also a designating window below in which can be placed any of the various

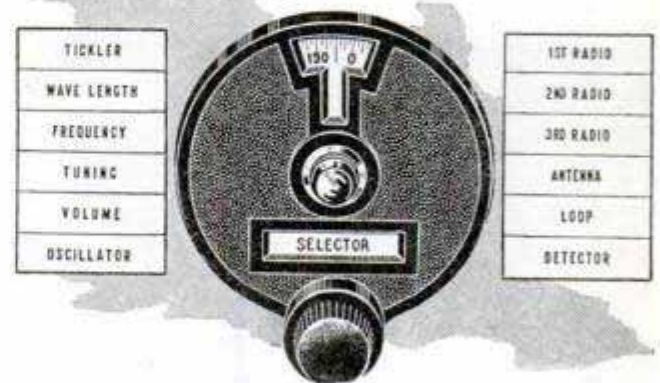

Universal Vernier Dial Really Is Four Dials in One; List of Titles Available for Lower Window

titles shown at right and left of the dial in the illustration. A full set of these is included with each dial.

Imperial Molded Products Corp.

Twelve Dollars Builds This B-Eliminator

By ARTHUR KENNEDY

TWELVE dollars is indeed a low cost for a really efficient B-battery eliminator, capable of supplying upward of 135 volts at 20 milliamp. An eliminator of the usual design is expensive to build, specially constructed high-voltage transformers, rectifier tubes, filter chokes and condensers being required. This B-eliminator, without any step-transformer, makes use of a well-known principle whereby it is possible to obtain d.c. voltages almost double that of the 110-volt 60-cycle a.c. input. Electrolytic, or "colloid," rectifiers and condensers take the place of rectifier tubes and dry-pack condensers in this unit. They have several advantages; first high resistance to electrical breakdown, and second, extremely high capacity per unit of electrode area, making a simple and compact, as well as an economical, source of B-battery voltage. Many of the parts can be found in the average home, materially reducing the cost of making the apparatus.

Before beginning the construction of the instrument read the whole article attentively, so as to understand each step thoroughly, have all the materials on hand and follow the instructions explicitly. The general construction details appear in the illustrations and, in a measure, are self-explanatory. For mounting the eliminator in one compact unit, the author used two $\frac{7}{8}$ -in. pine boards, 8 by 15 in. To

the upper one, seven wooden disks, cut from similar material and just large enough to fit snugly inside the tops of the Mason jars, were nailed, or screwed, in the manner shown in the photo on this page. The disks were arranged in two rows, one of three and the other of four, the space left in the former being reserved for mounting the filter choke coil on the baseboard. The seventh jar contains

the two by-pass condensers of the voltage divider, as will be noted on the simplified wiring diagram. The section diagram on page 303 gives the reader a detailed view of the top assembly. It will be noted that vent holes are drilled through the disks and top; these holes should be at least $\frac{1}{4}$ in. in diameter. The brass machine screws to which the aluminum and lead elec-

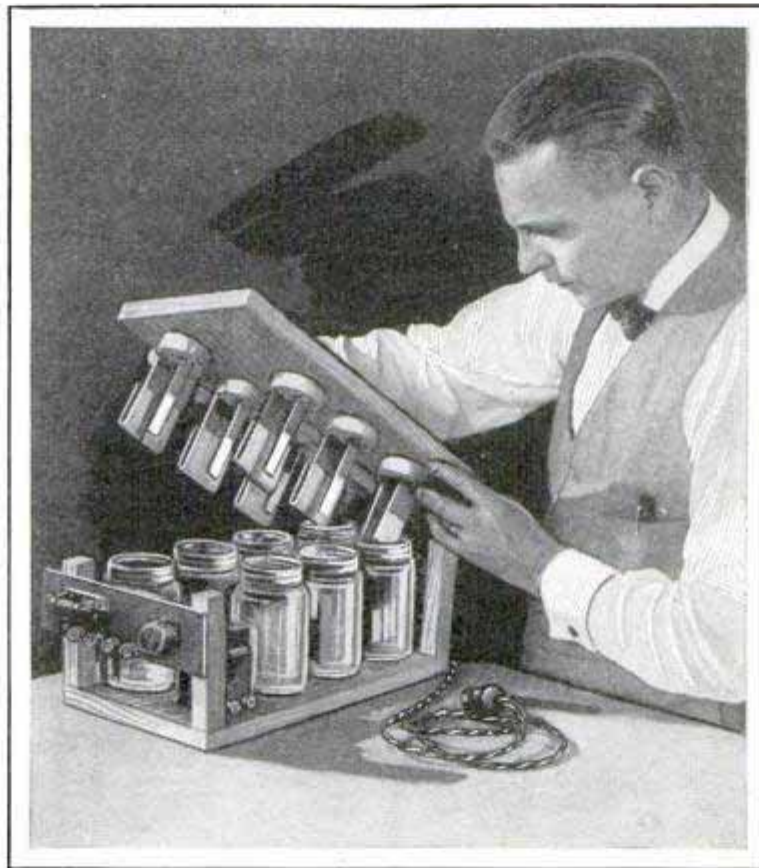

Parts Assembled Ready for Cell-Forming Process

trodes are fastened may be longer, so as to eliminate counterboring, if desired. A long soldering lug, of the round-hole type, is placed under the head of each screw for the circuit connections. After the wood disks are in place arrange seven pint screw-top fruit jars in position on the baseboard and put on the top. Four 1 by 1-in. wood uprights are then cut for supports at the corners; they should be of such length as to allow the wood disks to enter to their full thickness into the jars when the instrument is assembled.

The holes for the electrodes are then drilled $1\frac{1}{2}$ in. apart, and the various lead



Above, Mounting Aluminum Condenser Plates; Center, Schematic Diagram of Circuit; Below, Pointing Out Taped or Insulated Portions of the Electrodes

and aluminum electrodes are cut and mounted in their respective positions on the underside of the disks. Note that the electrodes are placed so as to be $\frac{3}{4}$ in. apart. The first two jars from the rear of the unit are for the rectifier cells. Each cell has one lead and one aluminum electrode, 1 in. wide, $4\frac{3}{8}$ in. long, and about $\frac{1}{16}$ in. thick, the actual thickness being of little importance, just so that it is not too thin. These strips should be thoroughly cleaned with emery or sandpaper before using, and this applies to all aluminum and lead strips in the unit. The electrodes are bent over about $\frac{1}{2}$ in. at the top and trimmed so as to fit the disk. They are then drilled and mounted on the disks, as shown in the upper photo on this page, by means of the brass machine screws and

held in place with a brass nut. The rectifier electrodes are then rubber-taped, or coated for $1\frac{1}{2}$ in. from the top with PBX paint. This is done to prevent surface sparking, which would cause pitting of the aluminum plates. This method of insulating is carried out on all the electrodes as pointed out in the lower photo.

The solution for both the rectifiers and condensers of this eliminator is the same. One gallon of distilled water is necessary and it is very important that it be distilled. If in doubt, drop a few crystals of nitrate of silver in a small sample of the water. If the water turns milky, do not use it. To the gallon of distilled water add about 1 lb. of good borax or ammonium phosphate to make a saturated solution, which is obtained when the water will absorb no more of the solid. Under

no circumstances use a metal container for making the electrolyte; mix the solution in a glass vessel and stir with a glass rod, to aid the water to dissolve the solid. Fill each rectifier jar with the saturated solution to a point where it covers about a third of the area of the

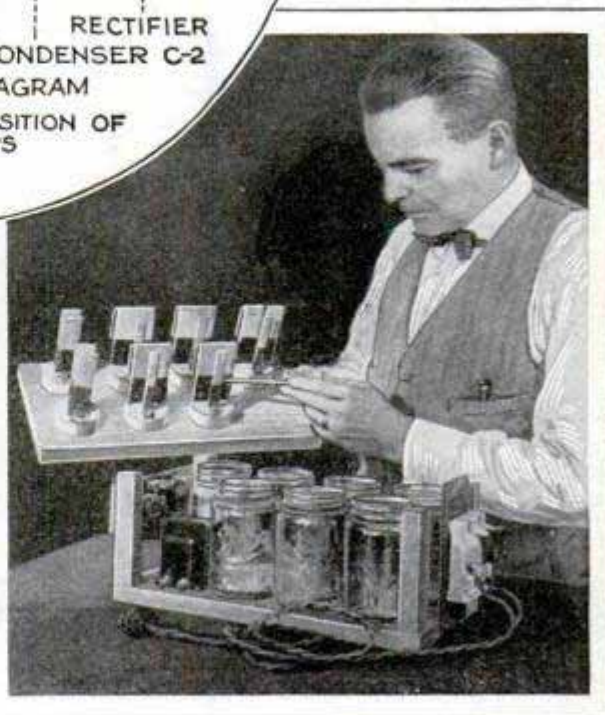
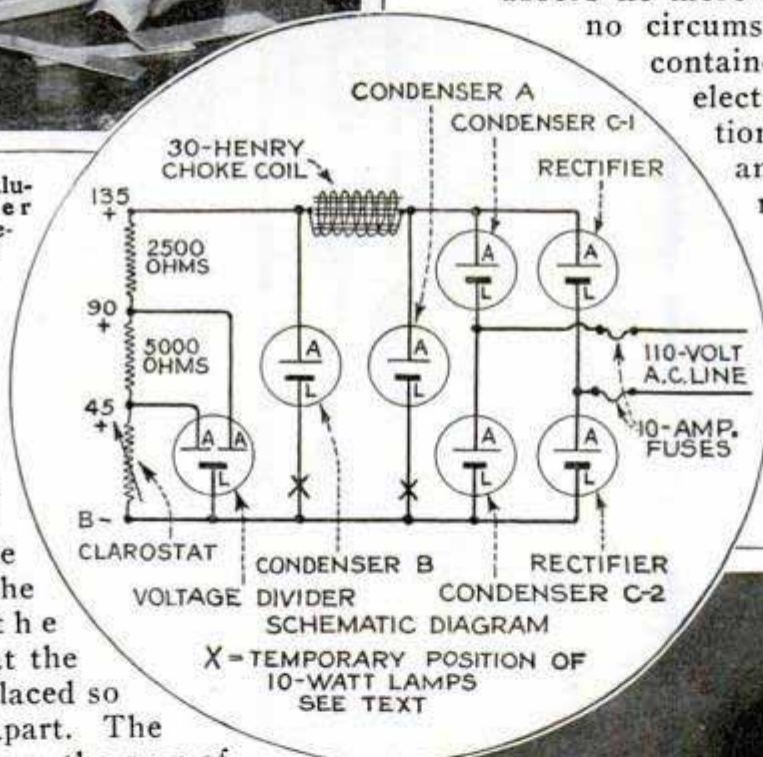

taped portion of the plates. We are now ready to form the two rectifier cells; up to this point these cells will not rectify a.c. current.

Taking each cell separately, make temporary connections to the lugs on the top, with lamp cord, so as to place the cell across the 110-volt a.c. line and connect a 25-watt lamp in one side of this line in series with the cell. Turn on the current and let it flow for a few hours. This is the forming process and changes the nature of the cells, which previously would have passed current in either direction, so that they will pass current in one direction only. As the cells form, the aluminum plate will turn a very light gray, where it is exposed to the action of the solution. This aluminum-oxide coating insulates the lead from the aluminum plate when the current attempts to pass from the latter to the former, but acts as a conductor when the current passes in a reversed direction. If a rectifier cell refuses to form, the aluminum plate will turn a dark sludgy-looking gray. If, after three hours of forming, the aluminum has not turned to a light gray, but instead is dark and dirty-looking, it is an indication that directions have not been followed closely enough. The cause is either un-

clean electrodes, impure water or low-grade aluminum. The aluminum plate must be pure and free from grease and foreign matter before it is placed in the solution. If a cell does not form properly, take the electrodes from the solution, dry them and go over them again thoroughly with emery cloth. Put them back in the solution and repeat the forming process. If after doing this the cell refuses to form and if you are sure that the water used is really distilled, the trouble is due to impure aluminum. Chemically pure sheet aluminum cannot be obtained in the open market, but commercial sheet aluminum of a good grade is pure enough for our purpose and can be bought in any hardware or plumbers' supply house.

If your cells have refused to form and you have been using borax in the solution, try changing to ammonium phosphate; it is a little more difficult to obtain but your druggist can procure it for you through his wholesale house. In a few cases the author found that the borax

was at fault, a possibility that seems quite remote. After the rectifier cells have both been formed, take the electrodes out of their jars, dry them and coat the taped or painted section of each electrode with vaseline. Also

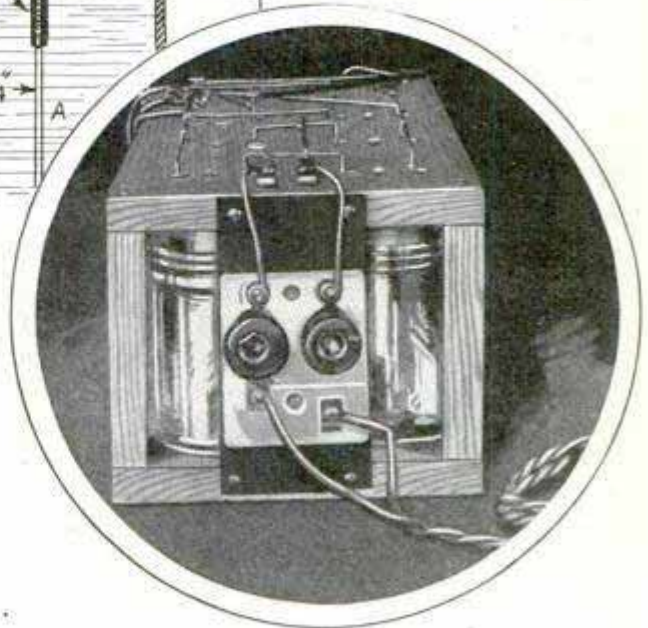
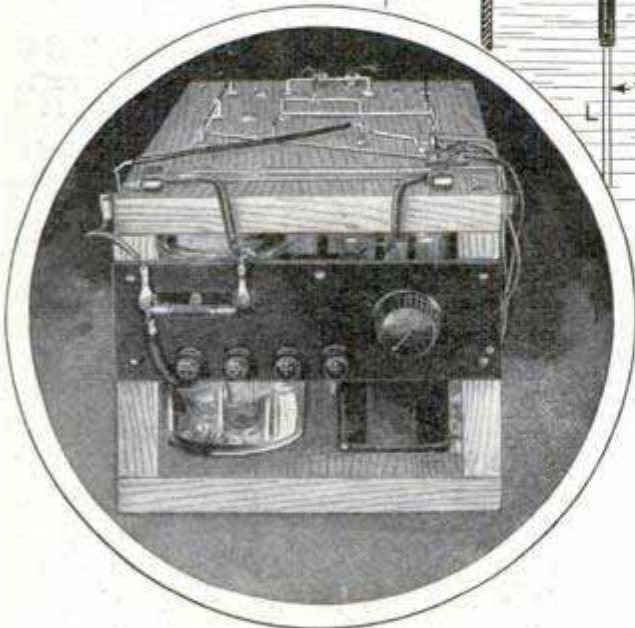
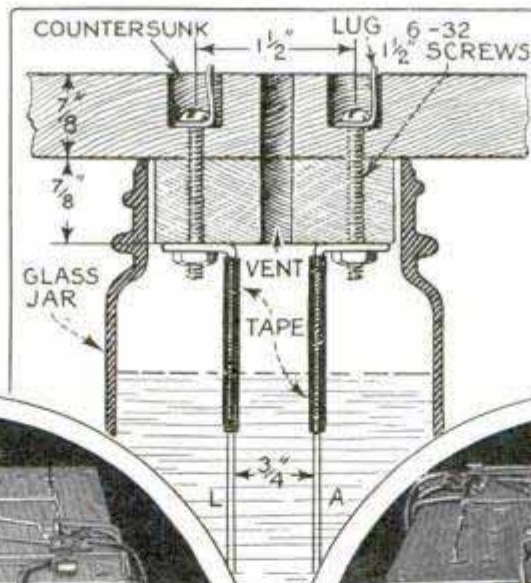

Above, Section Diagram Showing Method of Mounting the Electrodes; Left, Front View of Completed Eliminator; Right, Rear View Showing Fuse Block in Position

coat the bottom of the wooden disks and the inside of the jar, for $\frac{1}{2}$ in. down from the top, with vaseline. This will prevent the borax or ammonium phosphate from creeping. Replace the electrodes in the jars and through the vent hole drop a little kerosene, just enough to cover the surface of the solution. This is done to prevent too rapid evaporation of the electrolyte.

Next comes the preparation of the electrolytic condensers, of which five will be needed. The tank condensers, C-1 and C-2, are arranged as shown in the schematic diagram on page 302. They are 8 mfd. each. At a forming voltage of 110 volts, exactly 8 sq. in. of the aluminum plate must be exposed to the solution; no variation is permissible here. The condensers are constructed and formed in exactly the same way as were the rectifier cells.

The aluminum plates are 2 by 6 in., and

tion of the lead electrode goes below the surface of the solution, otherwise there will be very pronounced surface arcking. In forming the tank condensers, connect each one to one of your already formed rectifier cells. Connect each individual unit in series with a 10-watt lamp to the 110-volt a.c. line. That is, connect the lead electrode of each rectifier cell to one side of the line, and the aluminum electrode of the rectifier cell to the lead electrode of the condenser to be formed. The other terminal of the condenser is connected through two 10-watt lamps to the other side of the line. Each forming unit should be made separately, so that any error in preparing one cell for forming will not affect another that has been carefully prepared.

After the tank condensers have been properly formed, vaseline the electrodes, the bottom of the wood cover, and the inside of the jar from the top as with the

MATERIAL LIST

- | | |
|---|---|
| 7 pint Mason jars. | 2 10-amp. fuse plugs. |
| 1 gal. distilled water. | 4 binding posts. |
| 1 lb. borax, good grade. | 1 piece bakelite, 3-16 by 3 by $6\frac{1}{2}$ in. |
| 1 sheet aluminum, 6 by 14 by 1-16 in. | 1 piece bakelite, 3-16 by $2\frac{1}{2}$ by 8 in. |
| 1 sheet lead, 6 by 6 by 1-16 in. | 2 pieces of wood, $\frac{7}{8}$ by 8 by 15 in. |
| 1 Clarostat. | 4 wood uprights, 1 by 1 by $5\frac{1}{8}$ in. |
| 1 fixed resistor, 2,500 ohms, with mounting. | 2 porcelain-base sockets, for lamps used in forming process. |
| 1 fixed resistor, 5,000 ohms, with mounting. | 6 ft. lampcord with plug. |
| 1 Thordarson, or similar type, 30-henry filter choke. | 15 6-32 round-head brass machine screws, $1\frac{1}{2}$ in. long. |
| 6 Fahnestock clips. | Wood screws, rubber tape, soldering lugs, busbar wire, etc. |
| 1 porcelain fuse block. | |

are bent over $\frac{1}{2}$ in. at the top for fastening to the wood disk, leaving $5\frac{1}{2}$ in. free, of which $1\frac{1}{2}$ in. is taped or painted as with the rectifier cells. Bend back the ends of the aluminum plates so that they will not strike the bottom of the jars, but do not let the two surfaces touch each other. The aluminum plate goes to the positive side of the line in all cases.

The filter condensers, A and B, shown next after the tank, or C-1 and C-2, condensers on the wiring diagram on page 305, have the same aluminum plate area of 8 sq. in. exposed, as the tank condensers, but, being formed at a high voltage, they will have just half the capacity of the tank condensers.

The lead electrode of all condensers, tank, filter and voltage divider, is $\frac{1}{2}$ by 4 in. long. Make sure that the taped por-

rectifier cells. Then wire the eliminator as far as the filter choke coil; connect an unformed A or B filter condenser in series with two 10-watt lamps, at points marked X in the schematic diagram. Follow the diagram closely and be sure to connect the lamps in series, as there is 220 volts d.c. across the filter condenser at this point. Place the fuse block in the a.c. line, turn on the current and form as before. After forming, replace the formed A or B filter condenser with the other unformed filter condenser, and form it. As the filter condensers form, the 10-watt lamps in series with them will gradually grow less brilliant and finally go out. At this point, short one of them out of the circuit and continue forming. Connect the eliminator right through to the voltage divider, just as soon as both the filter

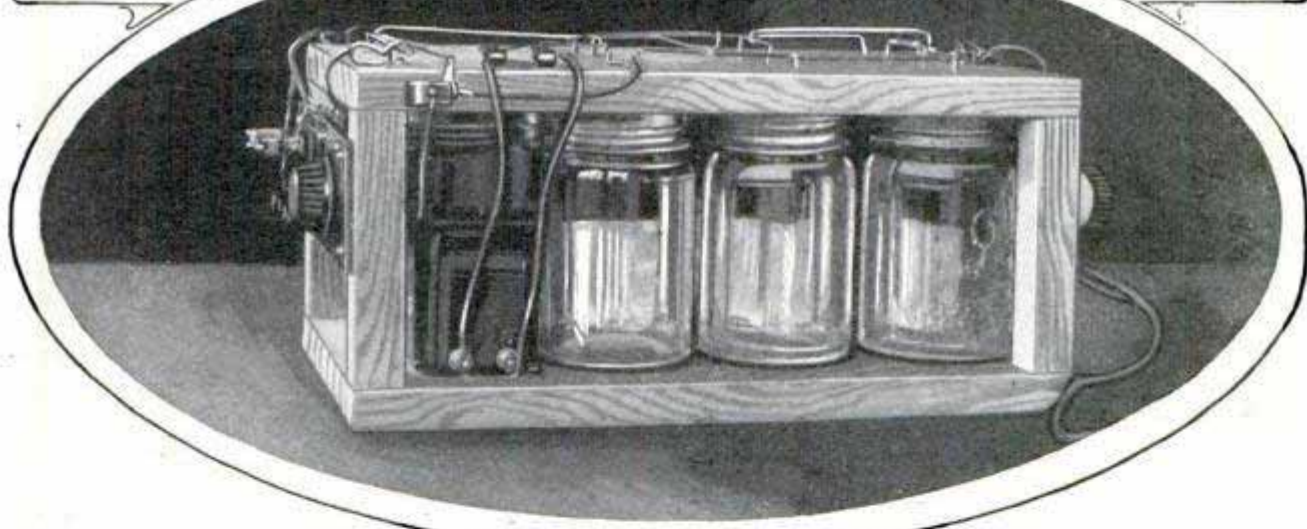
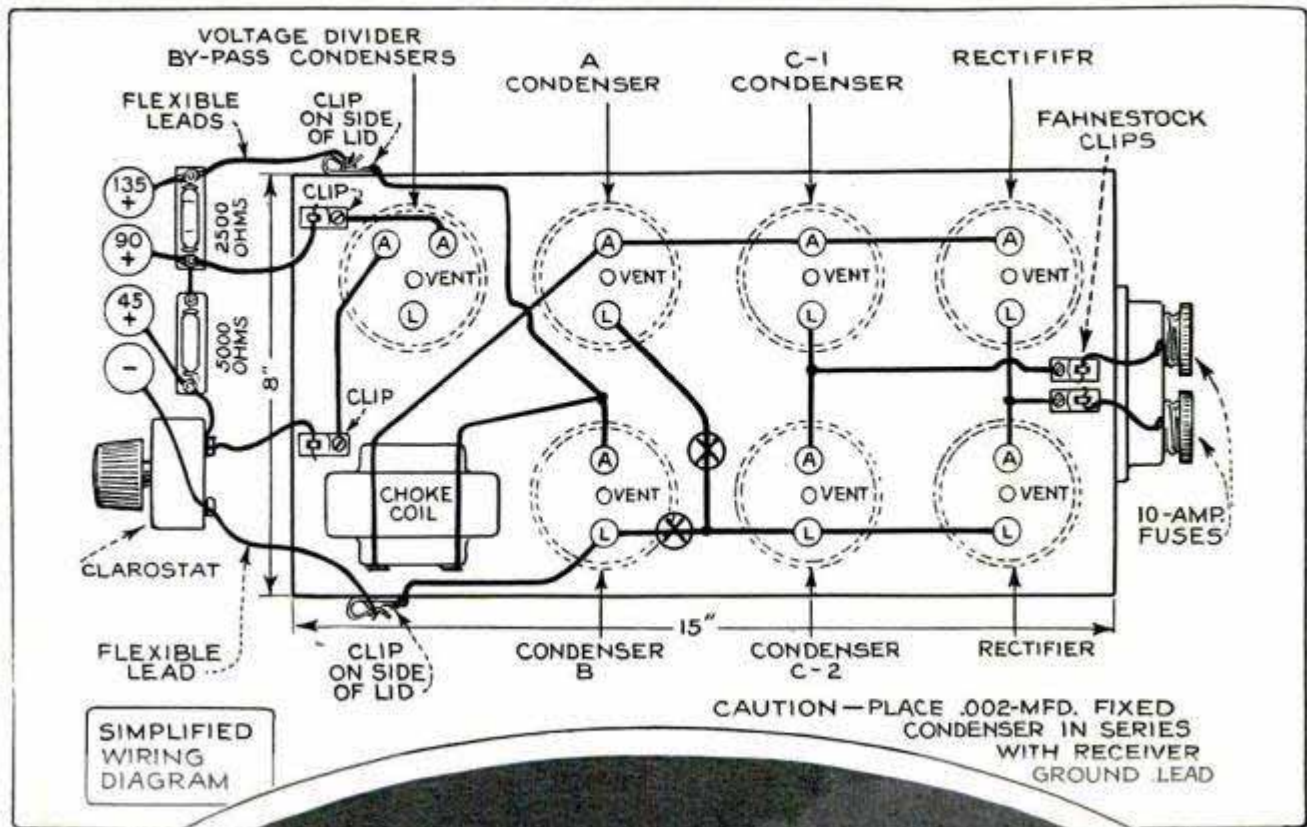

Above, Simplified Wiring Diagram; Below, Completed Eliminator Ready for Use

condensers have been completely formed.

The fixed resistors of the voltage divider are mounted on a strip of bakelite screwed to the front uprights of the unit, as shown in the left-hand photo on page 303. The 2,500-ohm resistor is mounted on the front at left, and the 5,000-ohm at the center on the back of strip. Shunted directly across the detector-voltage terminals is a "clarostat," which is mounted on the strip at right. This variable resistance is to form an artificial load, so that, regardless of the number of tubes in the set, the voltages at the terminals will always remain the same. Even if your re-

ceiver does not require 135 volts, do not omit the 135-volt binding post and its resistor. Build it just as it is and use the 90-volt terminal for your set; you may need the 135 volts at a later date or on some other set. The by-pass voltage-divider condensers are built in the same jar. The two positive aluminum electrodes are 1 by 6 in. and the lead electrode is $\frac{1}{2}$ by 4 in. Prepare the plates as before, bending back and mounting the aluminum plates, side by side and $\frac{1}{8}$ in. apart. To form, first tie the two aluminum plates together, and place the cell, in series with a 25-watt lamp, across the 110-volt a.c. line. Form-

ing is complete when the aluminum plates have turned a light gray. Connect in the voltage divider and condensers and run the various voltage leads to the binding posts arranged along the lower edge of the bakelite strip at front.

It will be noted that six Fahnestock clips are mounted on the top and edge of the lid, to take flexible leads from points below, so as to facilitate removing the top. These flexible leads and clips are clearly shown in the simplified diagram.

A large blueprint of the circuit diagrams and various forming steps outlined in the text has been prepared and may be obtained from Popular Mechanics Magazine Radio department, 200 E. Ontario st., Chicago, for 15 cents, to cover postage and packing. Specify blueprint No. 117.

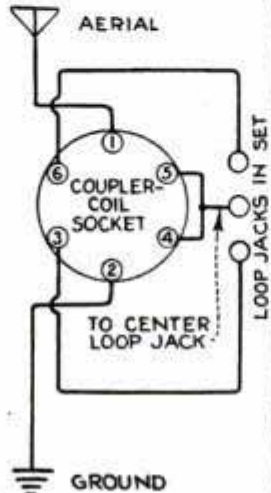

Left, Diagram of Connections, Showing the Numbered Posts on the Coil Socket; Right, Plug-In Coil

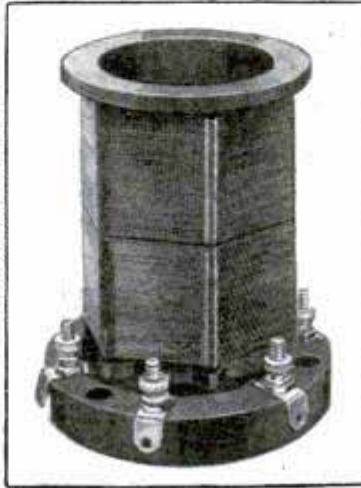

points of the compass come in with equal volume. It is made of copper in the shape of an 8 by 10-in. cylinder and is mounted on an insulated pole.

Aerial Adapter for P.M. Superhet

Numerous requests for information regarding the use of an outdoor aerial with

the new Popular Mechanics superheterodyne, described in the October, 1926, issue, are answered by the simple device shown in the diagram. The set is designed for a loop of the three-tap type, and should not be used on an outside aerial, except for extreme long-range experiments, as, over ordinary ranges, the set would tune too

broadly on an outdoor aerial. The plug-in coupler is the S-M type 110-A, with S-M universal socket and is shown in the photo. The binding posts on the socket are numbered as indicated on the diagram, and should be connected as shown. This aerial-coupler device should not be mounted in the set; it can be assembled on a small wood base and placed near the set when required.

This superheterodyne gives excellent results on the loop, and there is no reason for the use of an outside aerial except for experimental purposes. Any superheterodyne used on an outdoor aerial will re-radiate, causing interference.

Non-Directional Aerial

A new type of non-directional aerial does away with long unsightly wires and guys, is compact and can be installed in crowded localities where it would not be practical to use an aerial of the usual type. Being non-directional, stations from all

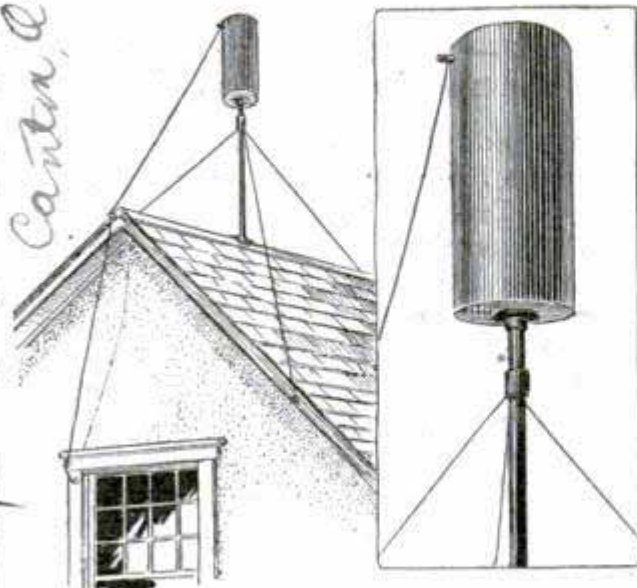

Non-Directional Aerial Consisting of Copper Cylinder Mounted on Insulated Pole

Denatured Alcohol Cleans Hydrometer

After continued use, the hydrometer becomes difficult to read due to a deposit of fine particles in the acid on the inside of the glass barrel. This deposit may be removed with wood alcohol. Provide a special bottle for the alcohol as it can be used over and over. Draw up the alcohol in the barrel of the instrument and squirt it back into the bottle; this simple method keeps the glass clean, so that graduations on the float stem can be easily read.

Letter filed 6/28/27
1009-R
Brayley Electric Co
329 Des Moines St. E
Centon, Okla

247 Park Ave. *New York.* 1148 R.
Facts and Fads for Radio Fans

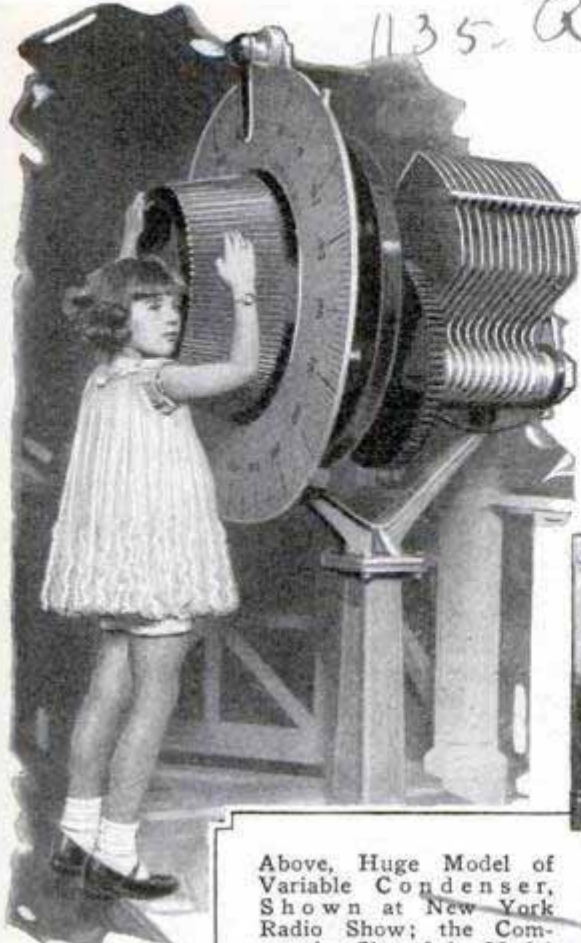

Above, Huge Model of Variable Condenser, Shown at New York Radio Show; the Comparative Size of the Model Is Indicated by Little Miss Betty Sargent Who Is Trying to Operate It

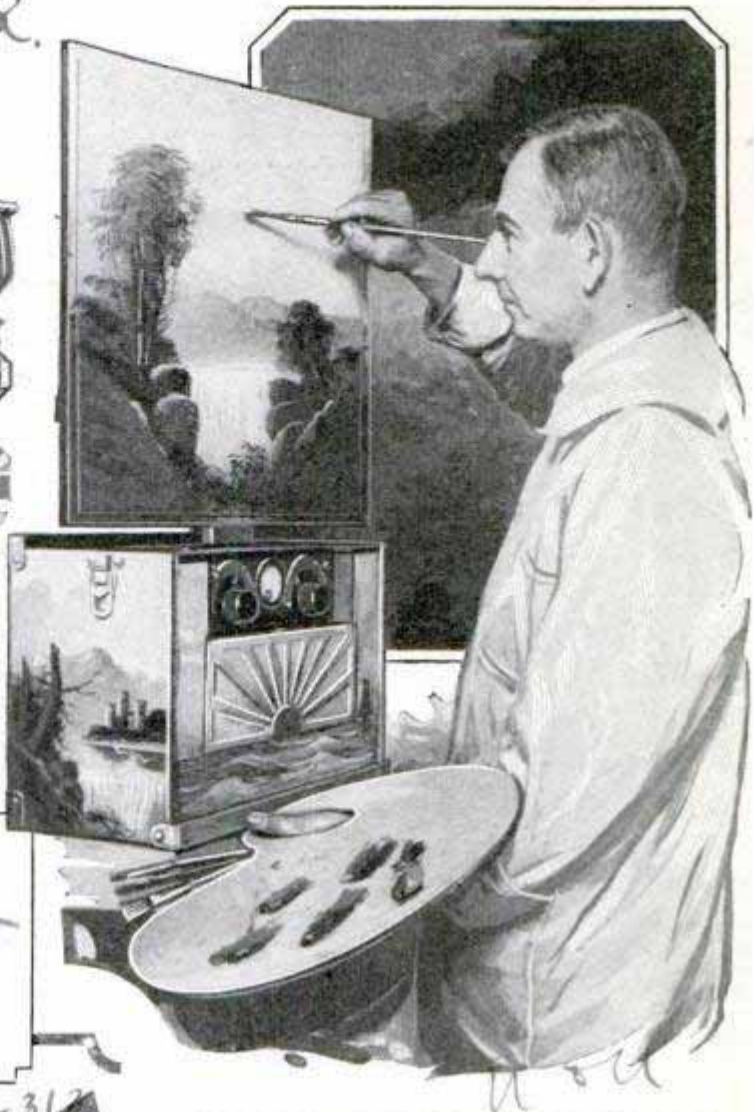

Henry P. Englehardt, a Chicago Artist, Putting the Finishing Touches on an Elaborately Decorated Portable Set; Below, S. S. Kirby, of the U. S. Bureau of Standards, Is Shown Conducting a Test to Determine the Cause of Fading Signals 1034 R.

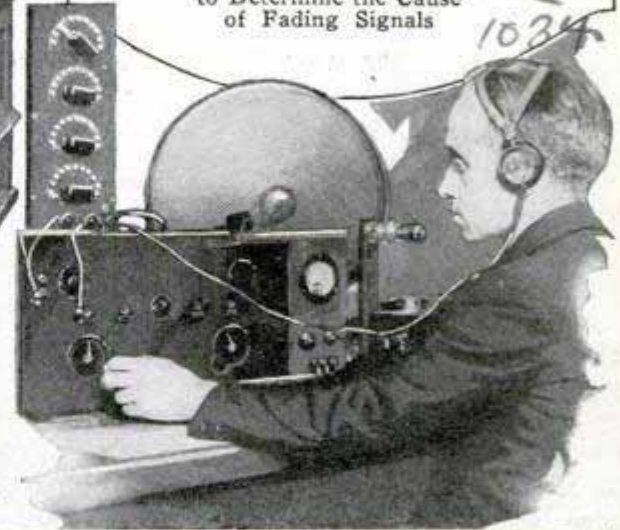

Left, Six-Tube Radio Set, Built in a Baby-Grand Style; It Fits into a Corner and Attracted Favorable Comment at Radio Show in Chicago

1129 - R *dia*

Flag and Vane Top Aerial Mast

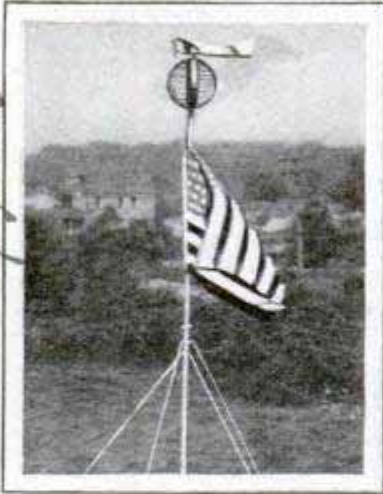

The usually plain aerial mast may be improved in appearance by utilizing it as a flagpole, and also as a support for a weather vane if desired. A pulley should be arranged for raising and lowering

the flag. The photo shows such an installation that is visible for many miles, and has aroused much favorable comment.—Raymond Hadley, Fairfield, Conn.

Ground Disk Retains Moisture

A metal ground disk, containing a chemical compound that has the property of attracting and retaining moisture, provides a ground contact of 175 sq. in. of metal, highly sensitive to radio-electric energy. The chemical in the disk is claimed to retain moisture indefinitely, insuring a good ground for the set at all times. The outfit is provided with ground wire of sufficient length for the average installation.

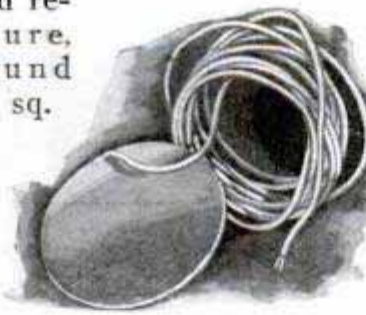

Loose Connections Frequent Cause of Trouble in Receivers

Loose connections are a common cause of trouble; they may be present in a new set fresh from the factory, or may develop in a set that has given good service. This often happens in shipping and is not due to faulty workmanship; the stiff busbar wire used in the circuit is not flexible enough to withstand heavy strains, and breaks in the soldered connections are not uncommon. In the home-built set breaks often occur when the set is removed from

the cabinet or subjected to unskillful handling. If loose connections are suspected, pull each wire separately until the loose joint is located, and apply the soldering iron at once. Too often the solder is depended upon to keep the connection secure, but this is not sufficient. Butting two wires together and applying solder makes a poor electrical connection, and one having a high resistance, even though the solder holds. Always loop the wire around and pinch the loop tight on the wire to be connected before applying the solder. This will not pull loose. Have all wires perfectly clean before attempting to make a joint. Now that under-subpanel wiring is in vogue, stiff busbar wire need not be used for the entire circuit, as it is hidden below the subpanel. Stranded insulated wire may be employed, although this is not always advisable because of the high resistance offered if one strand escapes the solder. Soft drawn No. 16 copper wire, carefully insulated with a good grade of spaghetti tubing will give excellent results.

Radio Antenna of Unusual Design

The illustration shows an antenna of unusual design that has recently made its appearance on the market. The four large receptacles are 10 in. in diameter and the smaller ones 6 in., and the eight together have 854 sq. in. of receiving area. The unit is made of conductive weatherproof material, and the center piece, or junction member, is of porcelain, insulating it from the mast. To install the aerial, a piece of ordinary 3/4-in. pipe, threaded at both ends, is required, together with a base

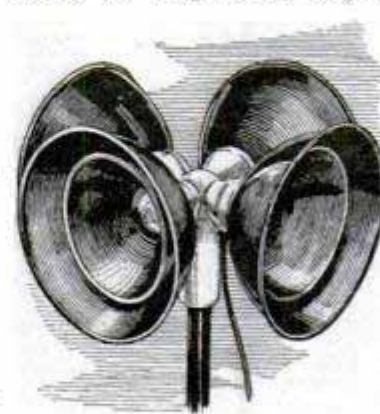

fixture that may be obtained at any radio-supply store. A pipe, 6 ft. long, is suggested if the unit is to be installed on the ridge of a house. The claim is made

that this type of antenna has many advantages in that it is more selective, minimizes interference and is not directional.

*Yale Specialty Supply Co
123 W. 15th St. Kansas City, Mo*

100 P. A

1048. R

*How. Way Universal Antenna Co.
Rapid Rapids*

*\$12.00 J.O. B
Grand Rapids*

1434 Carroll Ave
Chicago 309
1123-Q

When Local Signals Fade

Fading signals are not always confined to the distant stations; it sometimes happens that signals from the local station behave similarly. The trouble is not in the strength of the signal but usually lies in a defective rheostat. Adjust the rheostats and watch the filaments of the tubes; the flickering or dimming of a tube when a certain point on the rheostat is reached indicates a loose connection that will cause this peculiar fading effect. Take off the rheostat, clean the resistance wire with a small piece of emery cloth and bend the contact arm so as to obtain a good contact at every point. Upon replacing the rheostat, no more trouble will be found as far as local stations are concerned.

Storage B-Battery Has Built-In Charger Unit 1125-Q

A wet B-battery with a built-in charging unit is now available. Two gravity balls, located in one cell, indicate the state of charge. When recharging is necessary, the switch may be thrown and the noiseless charger brings the battery back to full charge. There are no wires to disconnect. The rack is constructed of steel, finished to harmonize with the brown porcelain cell tops, and rests on rubber feet. The clip shown at the top is provided to enable the detector voltage to be varied; the extension cord and plug may be per-

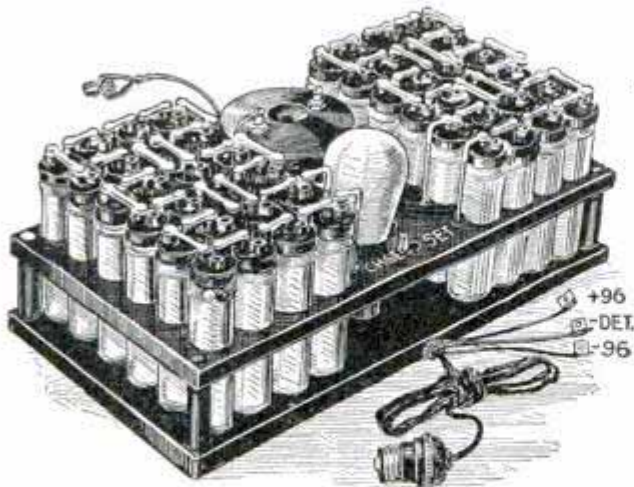

Storage B-Battery Showing Built-In Charging Unit permanently attached to a light socket. Leads for the set connections are also provided, and the unit is a complete source of B-battery supply that is easy to keep at maximum efficiency.

Zinke Co., 1326 S. DuSable Ave

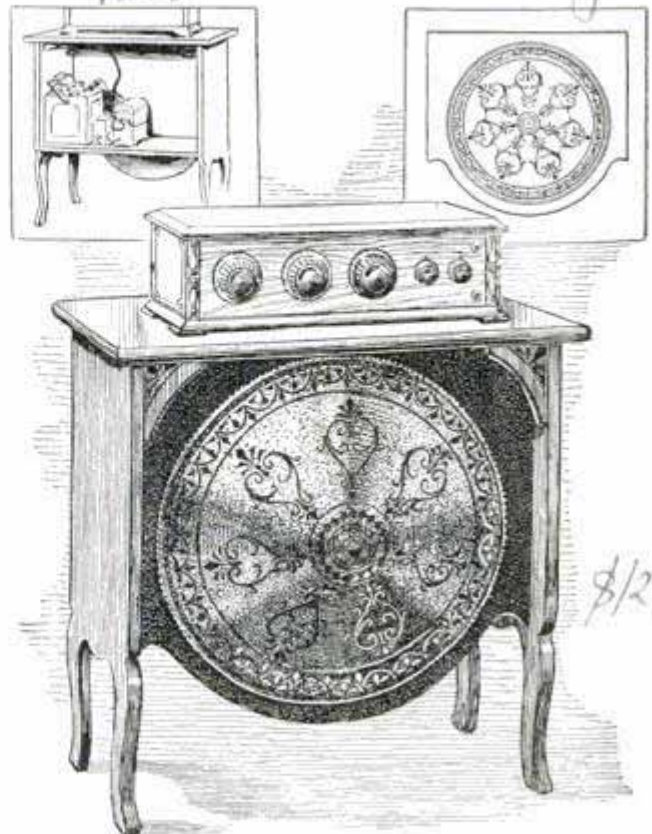

\$129.00

Console with Cone Loud Speaker; Above, Rear View, Showing Battery Compartment and Cone with Sounding Board Removed

Console Front Is Cone Speaker

An attractive console with a 22-in. cone loud speaker and sounding board forming the front of the cabinet represents a new note in design. The speaker with its spruce sounding board may be quickly removed to permit access to the batteries and charger, as shown in the inset at the upper right. The rear view, at the left, shows the battery compartment. Ample room is provided for accessories, and the back is left open to provide good circulation around the batteries. This unusual combination is pleasing in appearance, and the tone of the speaker is said to be exceptionally good.

Potentiometer for R.F. Tube Control

To control the oscillating tendencies of the r.f. tube, a potentiometer offers a method that is advised unless some other form of control is provided. The potentiometer should be placed across the A-battery, and the movable arm put in the grid circuit of the first tube. If the negative return of this tube is connected to the ground, it should be removed before the potentiometer is put into the circuit.

net agent

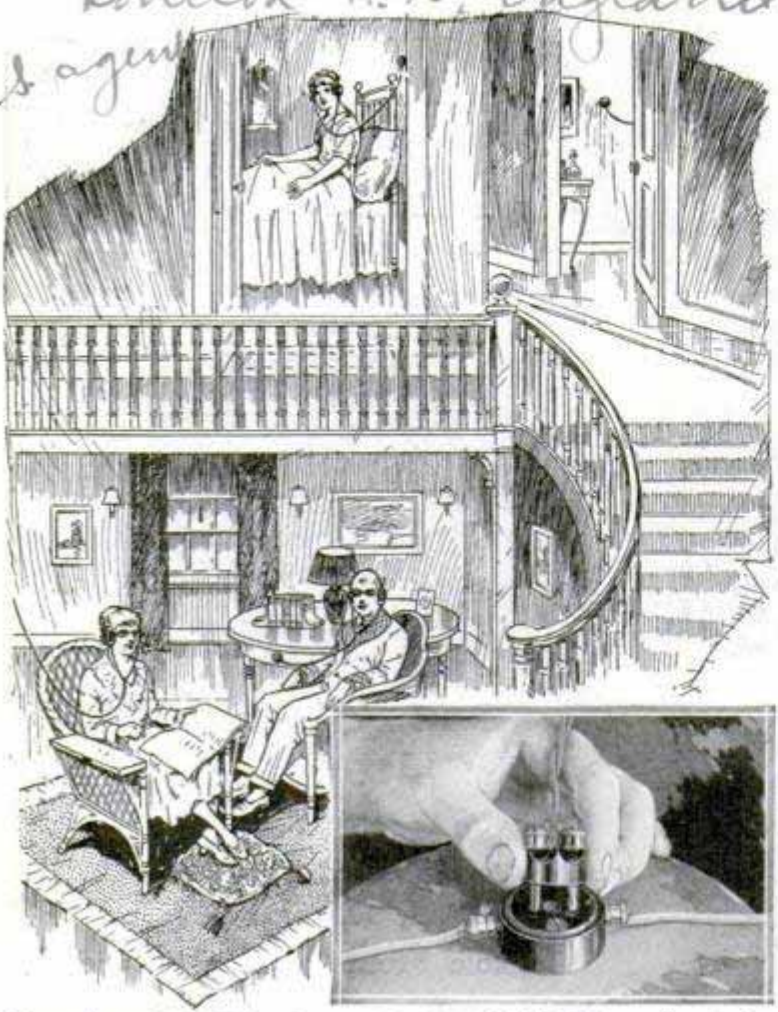

Photo Shows Plug Being Inserted in Jack, While Illustration Indicates a Variety of Applications in the Home

Radio Jack for Inter-Room Connections

The new radio jack, of English origin, shown in the illustration has many useful applications. With it, a loud speaker or phones can be installed in any room in the house. The plug is so designed that the connecting of another speaker or pair of phones does not interfere with any others that may be in use at the same time. It consists of two parts, a circular base and an adapter fitted with two pins. The former is of hard rubber and provided with two brass pins, the ends of which carry terminal nuts. One pin is fixed, while the other may be slid in or out for a fraction of an inch, and behind the sliding pin lies a small spiral spring capable of

exerting a pressure of seven pounds. When the plug is withdrawn, the spring forces the moving pin against the fixed pin, closing the circuit and shorting out the jack. When the plug is inserted in the jack, the pin is forced out, and the current from the set takes the path through the additional phones or loud speakers. The jacks may be mounted under tables, in cupboards or on the wall, and the connecting wires hidden. Small jacks of the same type may be mounted on the sub-panel of a radio set, wherever a lead is to be broken occasionally. For instance, they may be included in plate leads of tubes, to permit a milliammeter to be inserted, or they may be used as lightning arresters and aerial connectors.

Choke Coil for Reducing Squeals

A regenerative set subject to howls and squeals can often be materially improved by the addition of a choke coil placed in series with the primary of the first a.f. transformer. The lead from the plate of the detector tube to the P-post on the a.f. transformer can easily be traced, and it is a matter of a very few minutes to install the choke coil. These choke coils can be purchased or made by winding from 150 to 200 turns of No. 30 s.c. wire on a bakelite or cardboard form, 1 in. in diameter.

Battery Cable Simplifies Wiring

Battery cables with various-colored leads greatly simplify wiring, the colored leads acting as guides to reduce the risk of error. These battery cables can be obtained in 5-ft. lengths, with five covered leads enclosed in one fabric. They are provided with five lugs or three lugs and two storage battery clips.

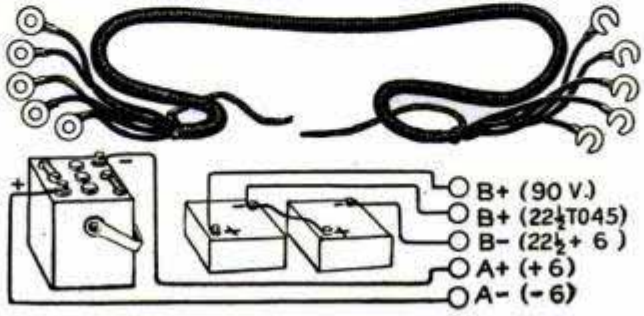

Battery Cable with Five Colored Leads, and Diagram Showing Battery Connections

Deley Products Co.
199 Lafayette St.

802-3



Feeding Stations for the Birds

By BOB BECKER

AMONG winter pastimes that grow in popularity with adults and youngsters, operating a "bird cafeteria" is gradually forging to the front because of the genuine amusement the outdoor-restaurant owner enjoys. When winter comes,

our feathered friends can be induced to stay around the backyard or orchard of a suburban dwelling, or kept close to the barnyard of the farm, by the establishment of feeding stations to which the hungry birds come for food. Quite aside from the amusement feature is the great good you do when you serve a meal to them. There are times following severe ice storms when

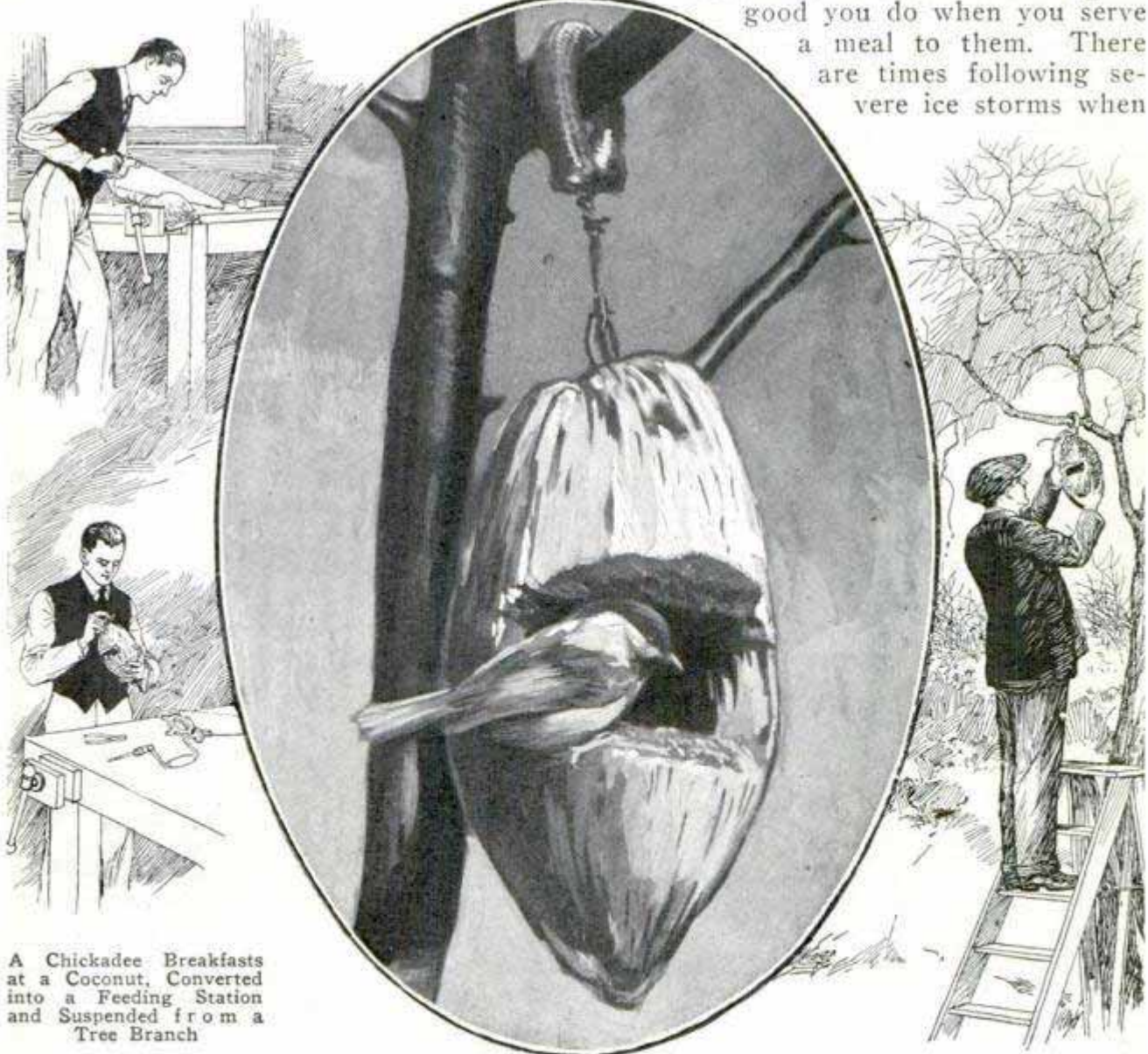

A Chickadee Breakfasts at a Coconut, Converted into a Feeding Station and Suspended from a Tree Branch

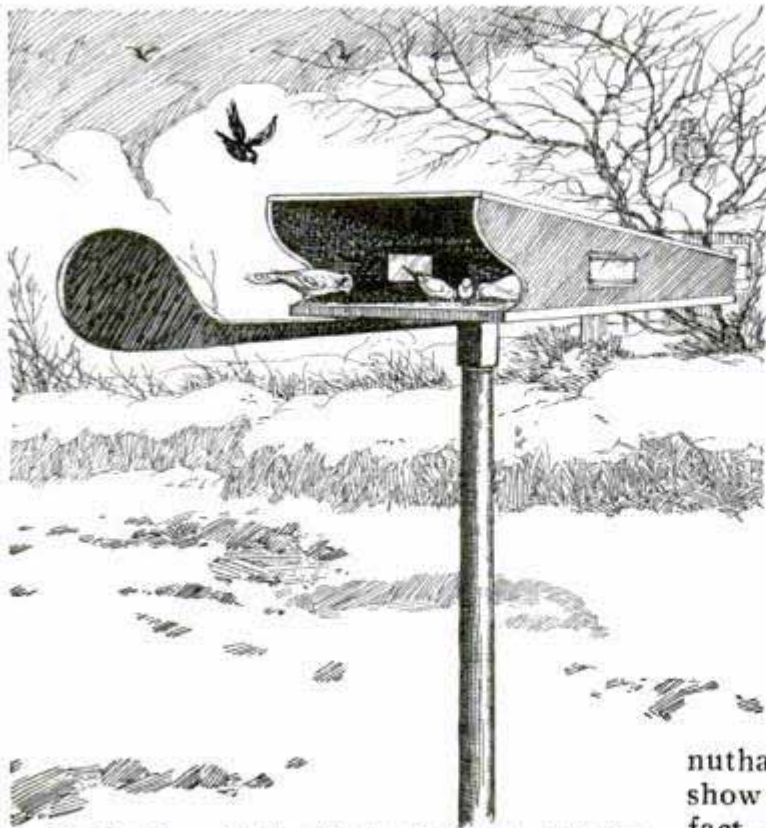

A Weather-Vane Feeding Station Is Easily Made by Any Boy, and Provides Constant Protection for Both the Food and the Birds

a handful of grain means the difference between life and death to such a bird as the bobwhite or quail.

The simplest kind of feeding station is an inexpensive suet holder. Beef or mutton suet is the cheapest and best food for insect-eating winter birds. It does not freeze or spoil, produces a lot of heat and is nourishing. The clownish bluejay, the little black-capped chickadee who sings ever so cheerily even on the coldest days, the red-headed woodpecker, the screech owl, the nuthatch, known as the "upside-down bird," the downy woodpecker, and many other birds, are fond of ordinary suet. If you put out a few chunks of this inexpensive but highly appreciated food this winter, you will be surprised at the number of birds that will visit you daily.

You can make a suet holder at home. Take a piece of $\frac{1}{2}$ -in. netting and make a holder 6 in. wide, 8 in. high and 2 in. deep. If some of the wires at the corners stick out, so much the better. Your feathered boarders will perch on these as they get a square meal. Nail this holder to a flat board about 3 in. wide, and tack a piece of old leather, tin or a strip of rubber from an old inner tube, over it as a cover. Anything that will shed rain and snow will do.

Attach the holder to the south side of a tree. If there is a tree close to a sitting-room window, put it there, and you will have lots of fun watching the birds.

An even simpler method of bringing the birds close to you is the following: Buy a piece of suet, about one pound in weight, and tie it to a branch or to a tree trunk in your yard. If you use just one or two loops of twine the larger birds will soon make away with the lump, so it is best to crisscross the pieces several times with stout cord. If you would like to see a little winter circus with birds doing acrobatic stunts, such as standing on their heads, etc., fasten a chunk to the underside of a branch. The chickadees,

nuthatches and woodpeckers will put on a show for you when they come to it. In fact, you will see the nuthatch do all kinds of upside-down tricks as he pecks away at the suet to get a square meal.

A few minutes' work some evening will make a simple yet efficient food counter for the home, one to which a number of birds usually can be attracted. One or two boards, two or more pieces of lath or old molding, a few nails and a couple of squares of old mosquito netting are needed to make this simple food shelf. Cut your boards to between 14 and 16 in. long. You will want about a 12-in. width for your shelf. To prevent strong winds from blowing the food away, tack a piece of molding or lath around its edges. Three small holes, covered with netting, in the bottom of the shelf will serve as drains to keep the cafeteria free from water. When completed, fasten the counter to a tree near a window, to a corner of the house, or to one end of a window sill. If possible, locate it on the south side of the house. The shelf can be made more sheltered by nailing a vertical board to one or both ends.

Now you are ready to serve meals and here are some tips on "which foods for which birds." The attraction of suet has already been noted. Stock one side of the shelf with suet and bread or dog-biscuit crumbs. The cardinal, or redbird, likes crumbs. Many of these handsome song-

sters winter in the north and can be attracted to a food counter. The brown creeper, the bluejay, the junco, the mocking bird, chickadee and crow have been known to eat crumbs. Hemp seed, chaff, cracked corn, oats, canary seed, buckwheat, broken nuts, millet seed, puffed wheat or rice, rolled oats (the kind you eat as oatmeal for breakfast), sunflower seeds and fat pork are other foods eagerly eaten by various birds which, in different parts of the country, may choose to stay around all winter.

One of the neatest and most decorative bird cafeterias that you can establish in

your yard is made from a coconut. Buy one or more nuts that are dried out (they are not expensive) and proceed as follows: First, cut a small hole in the side of the nut. This may be of any size. If you want large birds to be your boarders cut a hole that will let them get their heads in. If you want to attract only the chickadees and nuthatches make the hole not more than $2\frac{1}{2}$ or 3 in. in diameter. Into the top of the nut put a screw eye, attach a piece of wire or stout cord to the eye and suspend the coconut from a limb of a tree in an accessible position, so that you can easily fill the interior with foods

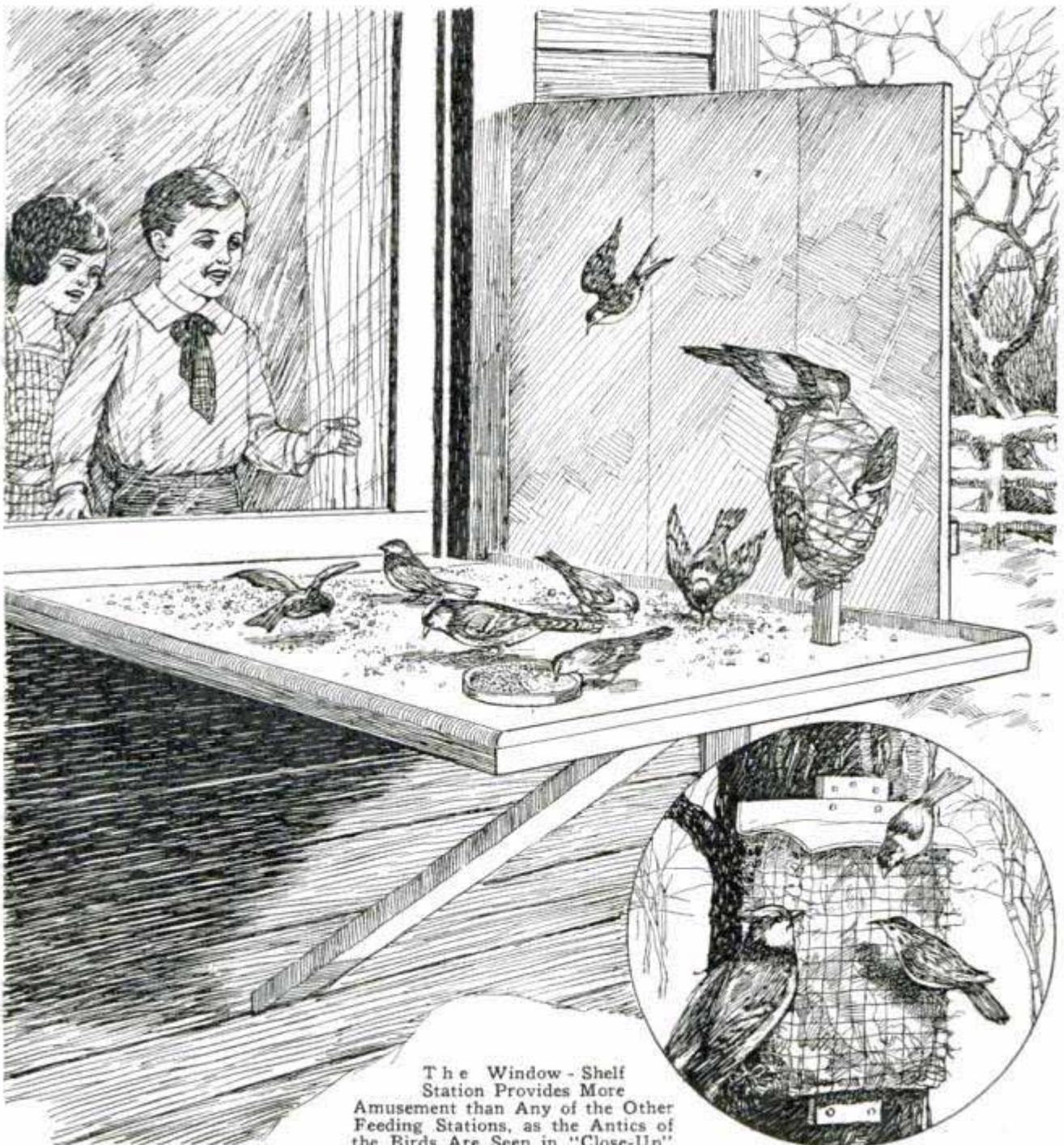

The Window - Shelf Station Provides More Amusement than Any of the Other Feeding Stations, as the Antics of the Birds Are Seen in "Close-Up"

for your bird guests. Chopped suet with peanuts or other food admixture is the bill of fare suggested for this coconut restaurant.

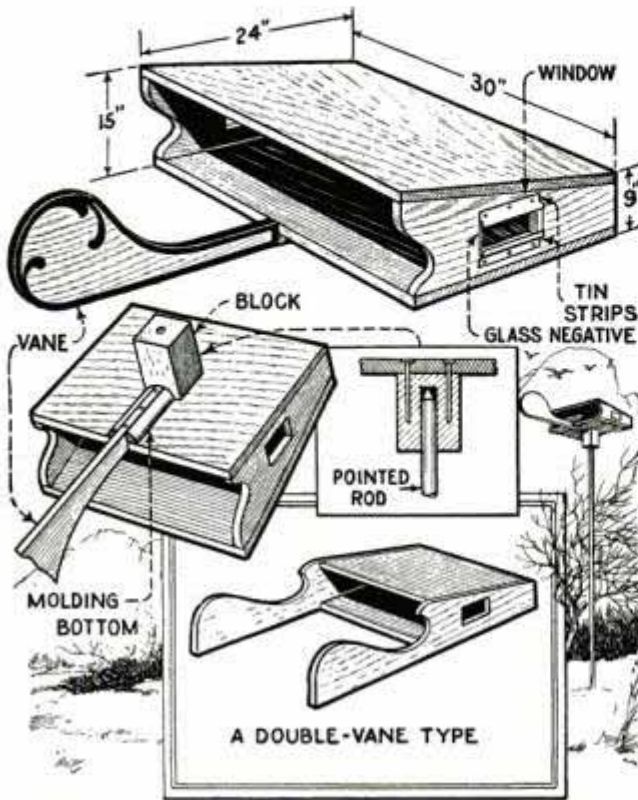

Constructional Details of Two Types of Weather-Vane Feeding Stations

Another way to rig up a coconut is to bore a small hole in one of its ends, wrap wire mesh around it, fasten a piece of stovepipe or other wire to the mesh and then suspend the nut from a branch near the house or from the porch. If possible place your station near a window so that you can watch your feathered guests. The wire mesh around the nut is rather desirable, as it gives the birds a good purchase on the nut when they alight on it.

For large gardens, farmers' orchards or estates, the weather-vane feeding station is a serviceable and very popular type. Any adult or boy handy with a saw and hammer can make one of these. The idea behind the weather-vane feature is to have a feeding place that swings with the wind, thus providing shelter for the birds as well as for the food.

Here is the way to make one of these weather-vane feeding stations so that it will be not only efficient but attractive. Take some $\frac{1}{2}$ -in. boards and construct a three-sided box, 24 to 30 in. long, 16 to 24 in. wide and 15 in. high at the open side. Let the top slope back so that it

will be only 8 or 9 in. high at the rear of the box. For the floor use a fairly heavy board, as you want to nail a couple of weather vanes to it. In making the vanes you can devise all sorts of artistic designs to obtain an ornamental and attractive effect, but do not make them less than 2 ft. in length. The ends should be 8 to 10 in. wide, to make the whole swing easily in the wind.

The weather-vane station should be set upon a pole reaching 5 to 6 ft. above the ground. At this height the food counter is safe from neighborhood cats. One of the simplest ways to pivot the feeding station is to bore a hole in the center of the bottom of the box and also into the center of the pole. Make this just a trifle larger than the biggest spike that you can buy. Grease the spike, drop it into the hole, and you have a center pivot which will allow the station to swing as the wind blows. Another way is shown in the drawing.

Probably the most attractive and by far the most entertaining method of feeding birds during the winter months is to lure them to a window shelf. It means a three-ring circus for most any winter day, and the home owner can sit in a comfortable chair inside the house and watch the fun. Another advantage of luring winter birds to a window shelf is that crows won't be among those present. The black rascal refuses to get chummy in this manner.

Improving the Rain Spout

During the winter months perpendicular rain spouts are often weighted with ice and wall anchors are not always strong enough to hold the weight. After a spout had fallen twice in one winter, we hit on the plan shown in the illustration. Usually the spout is cut and swaged at the lower end where it enters

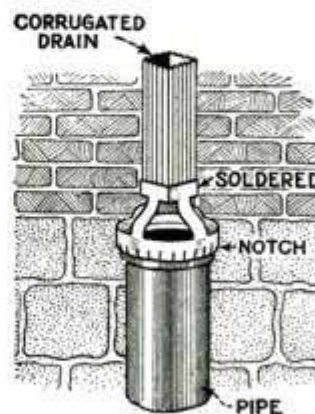

the cast-iron or tile soil pipe. This arrangement allows the latter pipe to settle

and draw away from the gutter, throwing all of the weight of the pipe and ice on the wall anchors. To overcome this, we designed a bell flange, or collar, which was soldered to the outside of the spout and then flanged around the bell of the soil pipe. This gives more support and rigidity to the whole structure and thus will prevent further trouble from this cause.—O. S. Sprout, Lancaster, Pa.

Convenient Tool Chest for Auto

Finding it annoying to have to dig under the back seat every time I needed a small wrench, screwdriver or pliers, I put a tool compartment rack on the door of my car. I pulled off the lining of the front door and cut away the upper half of the metal lining. Then I made a little door of three-ply veneer to fit this opening, covered it with a piece of top material and finished it with some binding tape and black-headed upholstery tacks. On the inside of the door I made leather loops for the tire gauge, a pair of pliers, two screwdrivers, a small crescent wrench and a platinum file. In the pocket part of the door I keep a canvas water bucket, a parts catalog, a celluloid glare shield, extra valve cores and some coil points. The covering of the tool door is tacked onto the frame of the car door, thus completely concealing the

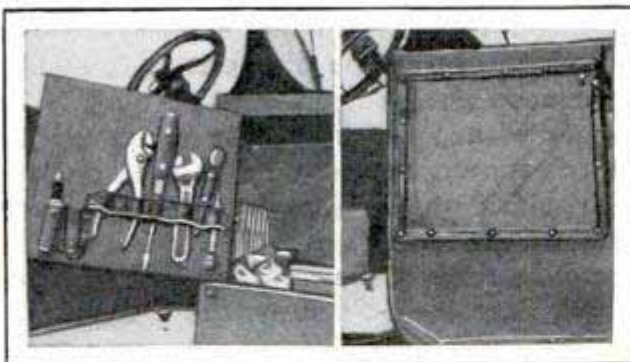

Compartment in Front Door of Auto Makes Tools Easily Accessible

hinges. There is a little button at the right, near the top, to keep it closed.—H. J. Blacklidge, Tucson, Ariz.

☐ Before putting on a tire casing, wipe it carefully with a moist rag to insure that the inner tube will not be damaged by dirt or sand lodged in the casing.

Lads Make Their Own Ice Skates

Santa Claus had failed to furnish skates for these boys, so they decided to make them themselves. They proved their in-



Lads Make Their Own Skates from Pieces of Firewood and Lengths of Wire

genuity by getting some wire barrel hoops, a few pieces of firewood and some string, and from these they fashioned the skates, which proved satisfactory and serviceable. The wood was whittled down to the approximate size of their feet and the front rounded, as shown in the photo. A shallow groove was cut along the edge to receive the wire, which was securely stapled on at the top and back. The wire was filed to a triangular form to prevent the skates from slipping sideways.

Testing Contact of Charging Clips

A pocket voltmeter with the terminals marked is useful when charging storage batteries at home with a small portable charger. The voltage is taken on the clips while the charger is going, and if much higher than the usual voltage of the battery, indicates a poor contact of the clips with battery terminals. Cleaning of the clips and terminals will bring down the voltage unless the battery is badly run down, when it may have a high resistance for a time, until the coating is removed from the plates. The voltmeter is also useful to show which terminal is positive if the markings are worn off.—E. T. Gunderson, Jr., Humboldt, Iowa.

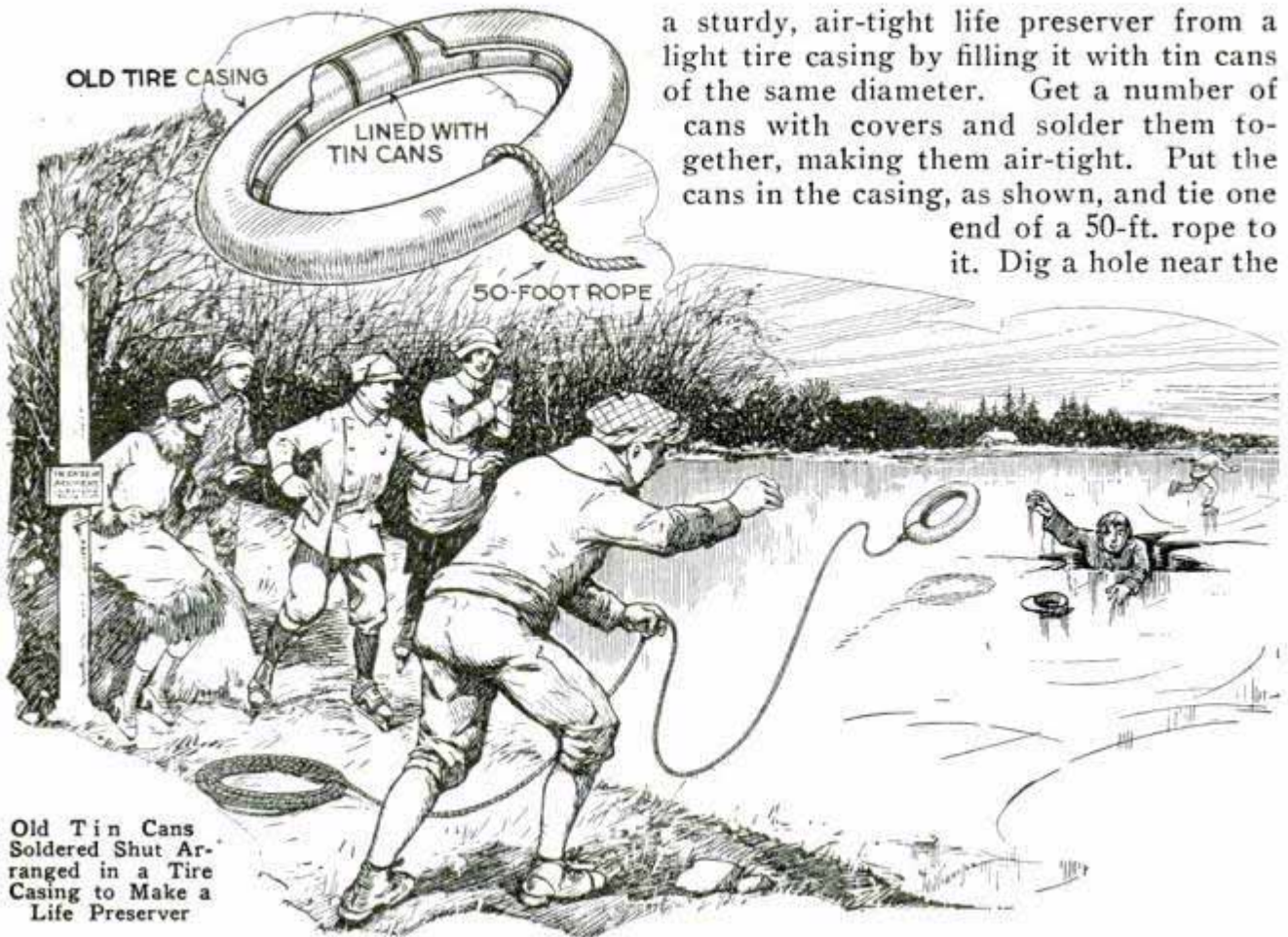

Old Tin Cans Soldered Shut Arranged in a Tire Casing to Make a Life Preserver

a sturdy, air-tight life preserver from a light tire casing by filling it with tin cans of the same diameter. Get a number of cans with covers and solder them together, making them air-tight. Put the cans in the casing, as shown, and tie one end of a 50-ft. rope to it. Dig a hole near the

Life Preserver for the Skating Pond

Whether you skate on a small pond or a large lake, you should have a life preserver hung upon a post near the edge of the ice in case of accident. You can make

edge of the lake and set up a tall post, with its top well out of the way of curious youngsters. Drive a spike near the top of the post and another one a few feet lower down. Then place the tire over the top nail and coil the rope on the other one.

Non-Slipping Stair-Carpet Rods

If metal rods are used to hold a stair carpet in position it will be found that they have an annoying tendency to slip out of the eyes. This can be prevented by filing a notch in each, as shown in the drawing. If screweyes or clips are used to hold the rods, the latter will be forced against the former by the carpet, the notches registering with the clips, so that

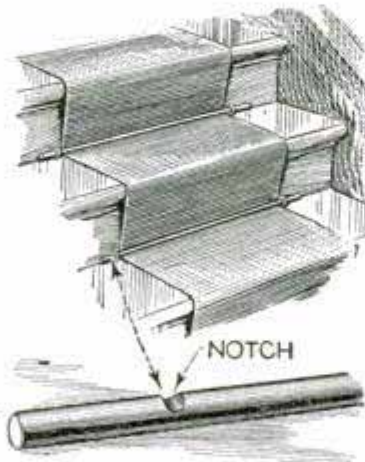

the rod cannot slip out sideways. The notch need only be filed out at one side, and need not be deep. It can quickly be made with a flat file. The width of the notch should be about $\frac{1}{16}$ in. greater than the width of the screweye. To remove the rod the latter is pressed down until the notch is clear of the screweye.—C. A. Oldroyd, Barrow-in-Furness, Eng.

Buzzer Arranged to Prevent Running with Emergency Brakes On

Motorists, especially beginners, sometimes forget to release the emergency brakes when starting and their attention is not called to this fact until they smell burning paint and brake lining. But it is then too late, as the brakes will have to be readjusted or relined, which is expensive in any case, and annoying because of the

delay of having them fixed. A buzzer and switch, in combination with the emergency brake and ignition system, can easily be wired so that, when the emergency brakes are on, the buzzer will give warning as soon as the ignition is turned on, and cease sounding the moment the brakes are released. The materials necessary for this installation are a door buzzer, a stop-light switch and some insulated wire, which can be purchased at any accessory house. Fasten the switch under the car in a suitable position, or according to the directions that accompany it, to connect with the adjustable clamp on the emergency brake rod, as shown, so that when the brakes are on the switch will be thrown in. The buzzer can be fastened anywhere on the dash behind the instrument board. Connect, or ground, one side of the switch to the frame of the car and the other side to the buzzer terminal. Connect the other terminal of the buzzer to the wire that leads from the ignition switch to the high-tension coil, or the terminal on the coil that this wire connects to.

This done, everything should be in working order, and the buzzer will give warning as soon as the ignition switch is turned on, provided the emergency brakes

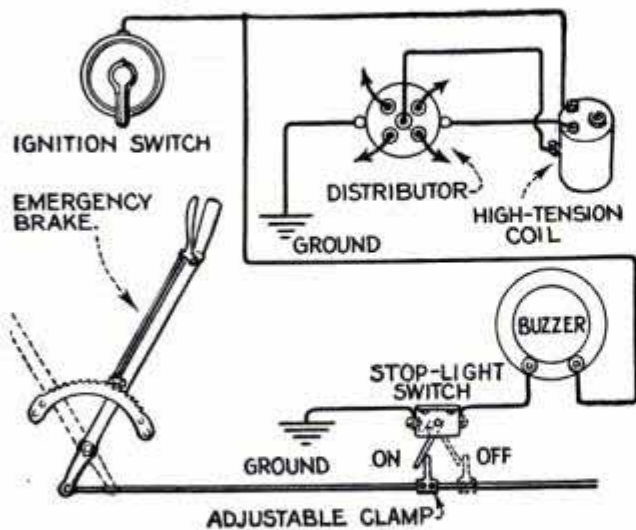

Buzzer Sounds Warning That Emergency Brake Is On When Starting Car

are on and the stop-light switch has been so adjusted that it is closed.—Francis G. Le Merle, Washington, D. C.



Whirling Clown Amuses Children

By pulling a string, a small figure of a clown, made of wood, can be whirled back and forth rapidly. A slat, cut from a piece of cigar-box wood, serves as a base and a peg is provided in the center for a spool to rotate on. At one end, a rubber band is fastened by means of a staple or screweye, and a length of cord is attached to the rubber band, looped around the spool and then passed through two staples, as indicated in the drawing. The clown also is cut out of cigar-box wood, painted suitably and attached to the top of the spool. Pulling the cord causes the spool and the clown to turn in one direction and releasing the cord allows the rubber band to contract, making the spool turn in the opposite direction.—E. F. Gustafson, Chicago, Ill.

Retouching Scuffed Places on Furniture

Mix a little color with turpentine to the same shade as the surrounding surface. Dip the end of your finger in shellac and touch the scuffed spot. Then immediately dip your finger in the color and apply it on the shellac. This will dry in a short time and the color will remain. When all the spots have been thus attended to, shellac, varnish or polish in the usual way.—Francis W. Henry, Pottsville, Pa.

Exhaust-Heater Coffee Pot for the Car

Hot, fresh coffee is invigorating on an auto trip so I made an exhaust-heated

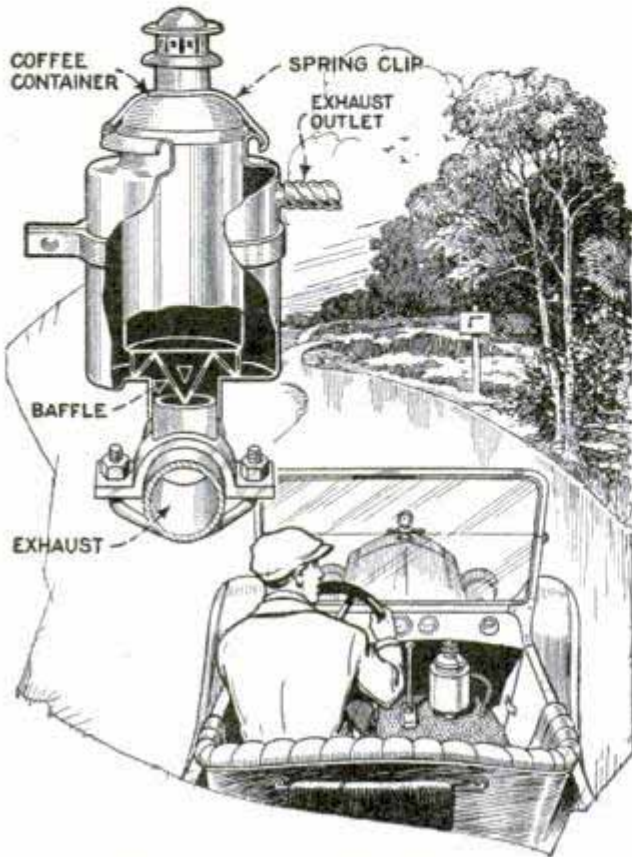

Exhaust Heater Mounted under Dashboard Is Handy for Making Coffee on Long Trips

coffee pot for my car. A hole was cut in the exhaust pipe just ahead of the dash and a regular cut-out, with the valve removed, was attached just above the hole. A tinner made the outside retainer to fit a standard metal jar. The retainer was provided with a neck underneath to fit over the open cut-out, to permit entrance of the exhaust gas. A hole was drilled in the side near the top, a short nipple was soldered over it and a length of flexible, metallic hose was attached to provide an outlet for the exhaust. The top of the retainer was provided with a spring clip to hold the jar securely. Within the retainer, at the bottom, I had a concentric conical member, which served to deaden the effect of the exhaust both as to noise and pressure on the jar. Ports were cut through this piece so that the exhaust gases could readily pass through it and around the jar but not directly against it. The retainer was fastened to the car by means of a strap-iron bracket. Besides making coffee, one can boil eggs and cook soup, etc.,

in this device. It will prove a boon on long trips, picnics, and the like.—C. C. Hermann, Moline, Ill.

Care of Knives and Forks

Silver knives and forks often have separate handles and pouring hot water over them when washing will cause the handles to loosen on the shanks. This can easily be repaired without going to the expense of taking them to the jeweler or some other party doing this kind of work. Heat the handles carefully without direct contact with fire and remove all the material which the handle holds. Then prepare a mixture consisting of beeswax, $\frac{1}{4}$ lb.; plaster of paris, $\frac{1}{4}$ lb., and rosin, 1 lb. Melt these ingredients together and fill the hole in the handles with the mixture. Before the handle cools insert the shank, being careful that it is in alignment so that the job will not have to be done over. The mixture can be put aside and used again, reheating it each time. It is inexpensive and easy to make so that this method offers a convenient and economical means of repairing and keeping the knives and forks in good shape all the time.—L. H. Georger, Buffalo, N. Y.

Tap Wrench Holds Countersink

When drilling holes in wood, it is inconvenient to change often from a bit to a countersink if both are used. If the countersink butt is squared with a file, as shown in the drawing, it may be fastened in a tap wrench, and can then be handled with much more convenience and does not have to be put in the chuck of the brace each time.—Richard C. Tarr, Gloucester, Mass.

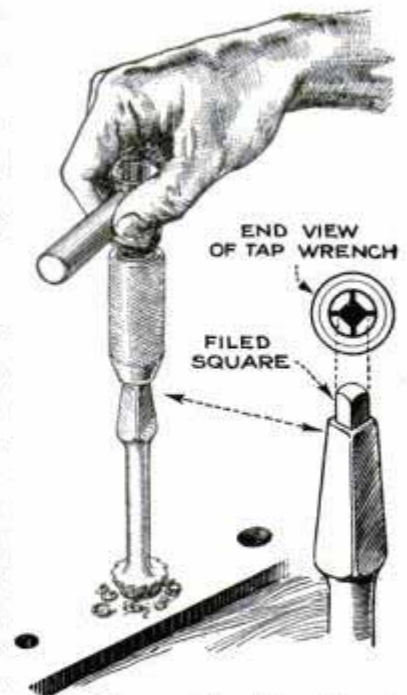



Increasing Jazz Effect of Drum

Jazz for the eye as well as for the ear is the idea of a drummer in a jazz orchestra, who has embodied his plan in a drum that displays a "moving" picture. He had a scene painted on the drumhead to represent a woman pouring water from a vase and, when the device is operating, it seems as if the water actually flowed. The effect was obtained by means of a revolving disk of celluloid, painted as indicated. The disk is driven by means of a fan motor, which is wired in series with two small electric-light bulbs. These serve the double purpose of reducing the speed of the motor and furnishing illumination. Two additional colored lights operated by a small thermo-static sign flasher intensify the effect of motion and color. The motor and disk are supported on a wooden post attached to the shell of the drum by means of two brass angle brackets. A length of flexible cord with a plug attached is connected to the motor, so that it is

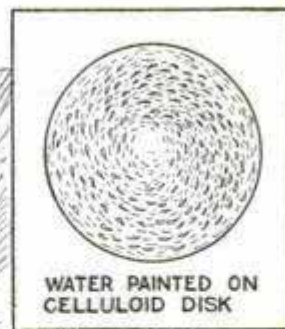

Drummer Intensifies Effect of Orchestra's Jazz Music by Realistic Display of Moving Water Poured from a Jug and Intermittent Flashes of Colored Lights

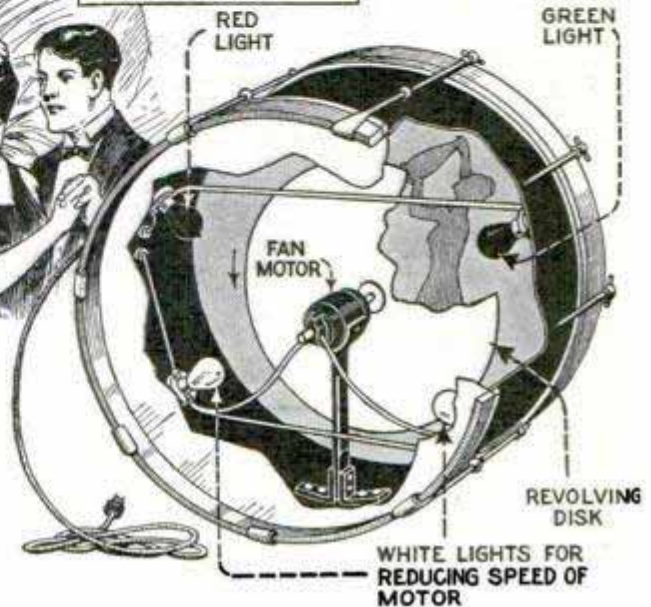

possible to plug in at any convenient socket. So realistic is the effect of this simple device that, when it was tried out at several fraternity dances, much sport was had in holding punch glasses near the figure in the scene as if getting some of the water.—H. N. Loeb, Cincinnati, Ohio.

Dollar-and-Dime Can Opener

Next time you have to open a can having a friction cover, take a silver dollar and a dime and pry off the cover as shown. The dollar gives enough leverage in the right place and the dime is slipped under the cover to raise it easily. You will save time, patience, a knife blade and also avoid the possibility of cutting yourself.—F. Bentley, Missouri Valley, Iowa.

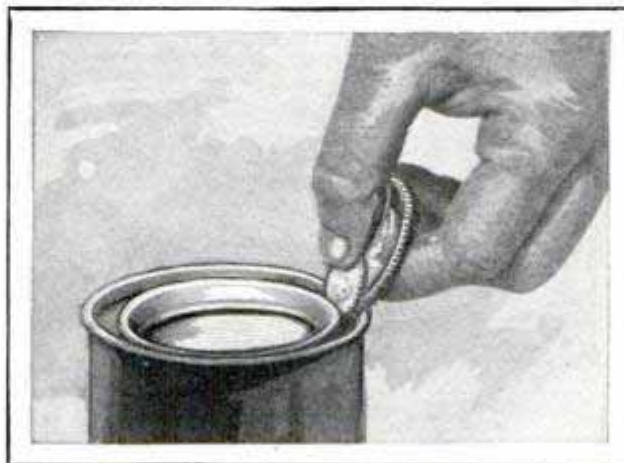

Method of Opening Can by Using a Dollar and a Dime as a Lever

Runners for the Motorcycle

During the winter months of continuous snow, near Lake Superior, it is often

attached to the axle. In order to provide traction, it is, of course, necessary to use a skid chain on the rear wheel.—J. H. Deniston, Bayfield, Wis.



Provision of Runners on Motorcycle Permits Travel through Heavy Snow

impossible to travel with autos. A doctor must, however, make his calls and as a horse and cutter are too slow, one doctor adapted his motorcycle to the snow-covered roads by the addition of runners, as shown in the photo. The front runner is made from an old wagon tire, 4 in. wide and 36 in. long. A 10-in. section at the front and a 3-in. section at the rear are curved upward. The runner is fastened to a 2-ft. length of 4 by 4-in. wood, gouged out to fit the tire, and the wheel is attached to the runner by means of clamps, shaped to fit around the rim and held in place with bolts. The runner is attached when the tire is partly deflated so that there will be a very tight fit when the tire is pumped up. The sidecar wheel is removed and a runner is provided. It is also made from a 36-in. length of old wagon tire, 2 in. wide, and is supported by a U-brace

How to Stencil Neatly

With painted and lacquered furniture quite the vogue at the present time, the following method for applying stencils will be helpful for the home worker. Cut any size or design suitable from light tag or two-ply bristol board. Fasten it to the work with four 2-oz. tacks to hold the stencil in place. Then, with a soft printers' roller, well inked, go over the stencil, applying pressure enough to make sure that the ink comes into the small corners. In removing the stencil care should be taken, when withdrawing tacks and lifting stencil, that the ink is not touched, and you will have a neat, clean-cut design, without hairy or fuzzy edges. The ink will dry as quickly as ordinary paint. If desired, a light coat of varnish may be applied over the design when dry.

Shield Keeps Auto Engine Warm

It is necessary that your Ford be kept warm on cold days if you are using it. This can be done by obtaining a piece of

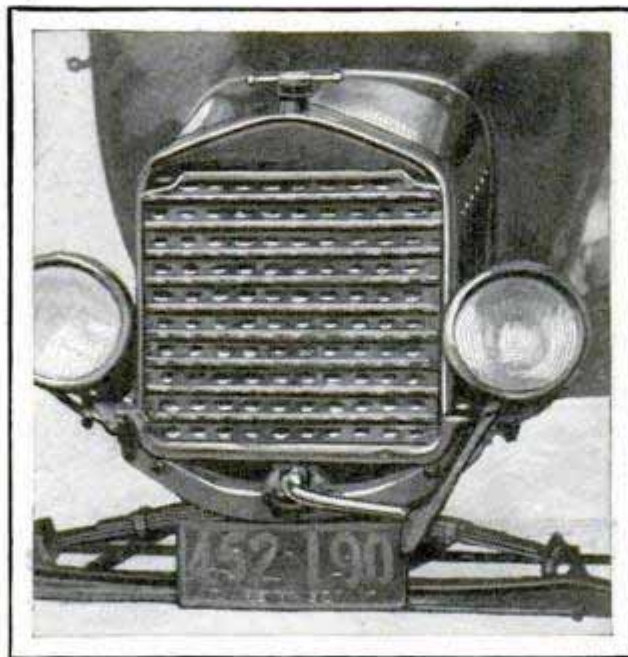

Radiator Cover for Cold Weather Can Be Made from Metal Lath

metal lath of the kind shown in the photo, cutting it to fit over the front of the radiator and attaching it with a couple of stove bolts. This, when painted black, will have the appearance of a winter front that has been purchased at some accessory store and will answer the purpose almost as well. It allows enough air to enter but the engine cannot overheat on a cold day.

Shipping Dept. Fore and aft.
 Huntington, NY
 Model Ship Supplies Box 613,
 Freeida
 NY.

BUILD YOUR OWN SHIP MODEL



by J. Earle Miller

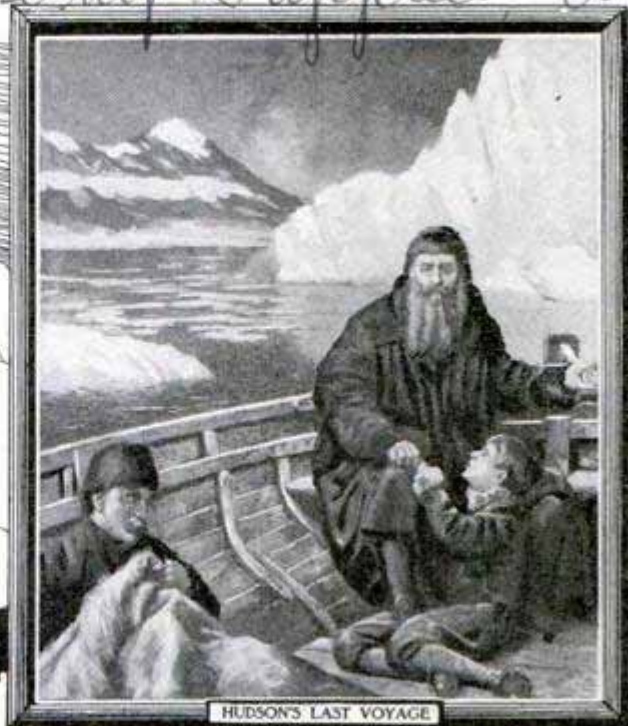

After Painting by John Collier

Parts 1, 2, 3 and 4 appeared in the October, November, December, 1926, and January, 1927, issues

YOU are now ready for the job of fitting the running rigging, and for this 84 blocks are required, of the size shown in one of the drawings in the preceding article. They can be obtained from the model-supply house. Department stores sell hard wooden beads, about $\frac{1}{8}$ in. in diameter, and these can be made into very effective blocks; they require to be flattened on two sides and trimmed to shape, as shown in the drawings, and this means patient work, but it will save some money. Another way to make them is to get a cheap folding rule, in the ten-cent store, cut it into strips and make the blocks from these. Be sure the rule is made of boxwood. The strapped blocks have a fine wire twisted around them, in the "score" on the sides, some with a hook on top, and some with a hook on top and an eye at the bottom. Examination of the enlarged sketch of the lift block in one of the drawings will make this clear.

The first step is to attach the yards and the lifts, the latter being the tackle by means of which the yards are raised and lowered. The yard is held to the mast by means of a wire "parrel" (shown in the top left-hand corner of illustration on page 322), one ring of the wire embracing the mast and another the yard. The lifts of the main and fore lower yards are fitted in the same manner. Number 60 holes are

drilled through the yardarms, just inside the black tips, and an eye, made of fine wire, fastened through the holes, the eye being on top of the yard. Hook a block in the eye, then fasten another block to an eye on the cap of the lower mast and attach the end of a length of button thread to the eye on the bottom of the strap. The button thread may be black, but it is better to use the light-tan thread sold in the ten-cent store, as it is more nearly the color of the actual rope. The end of the thread is now passed through the block on the yardarm, from the bottom to the top, then around the block hooked to the cap of the lower mast, and passed through the lubbers' hole to the deck; the part that leads on to the deck is the halyard, and the main-yard halyard is passed through one of the holes in "Noah," around the windlass and belayed, or made fast, to the bollard. The foreyard halyards are belayed to pins driven through the lower mast about $\frac{3}{4}$ in. above the deck. Remember that in most of the drawings only the rigging on one side of the yards is shown, and that the other side is rigged in exactly the same manner. The rigging on the model, while following very closely the original, has been simplified to a certain extent, as it is almost an endless task to build a model of this size exactly to scale in every respect.

Better to buy blocks plain and put

blocks are cheaper

The lifts and halyards for the fore and maintopsail yards are fitted in the same way, but the lift for the lateen yard on the mizzen is single, and attached at the center of the yard, the upper block being hooked into the end of a short length of thread—a pendant—fastened just under the mizzen top, and the halyard belayed at the starboard pin rail.

Very neat brass belaying pins can be obtained from the model-supply houses, but a short length of an ordinary pin, driven through the hole in the pin rail and projecting $\frac{1}{4}$ in. above and below it, will answer just as well. The ends of the lines should be belayed to these in the form of a figure eight, not simply wound around them; a drop of shellac keeps them from coming free. Owing to the difficulty of getting the hands among the rigging, all lines should be cut about 1 ft. longer than necessary. Take an 8-in. length of $\frac{1}{8}$ -in. wire, grind the ends down to about $\frac{1}{32}$ in. for a distance of 1 or 2 in., and then form a small eye on one end and a hook on the other. By threading the end of the thread through the eye, then holding the end in one hand, so as to keep it taut, and the wire in the other, it is possible, working from the opposite side of the model, to belay the ends without difficulty.

The lateen yard hangs at an angle of 45° to the yard, and is fitted with a peak halyard at the upper (the left or port) yardarm. This is attached by means of a crowfoot, as shown, and a euphroe can be used instead of a block for the latter. This fitting simply consists of a thin sliver of

boxwood, drilled for the crowfoot threads and the end of the halyard. The other end of the halyard runs through a block under the maintopmast cap, then down to a block about 2 in. away from the mast. From an eye on the starboard side of the quarterdeck rail, a length of thread runs around this block, and then back to the quarterdeck pin rail, where it is made fast.

The drawings show all details of the rigging, and if the lead

of each rope is carefully studied, there should be no trouble in rigging the model. All lines leading from the fore and maintop-

masts straight down to the deck go through the lubbers' holes in the tops. Do not set up any of the lines on one side too taut until the corresponding line on the other side has been rigged, otherwise the trim of the yards will suffer. The spritsail yard, on the bowsprit, is parreled to the latter in the same manner

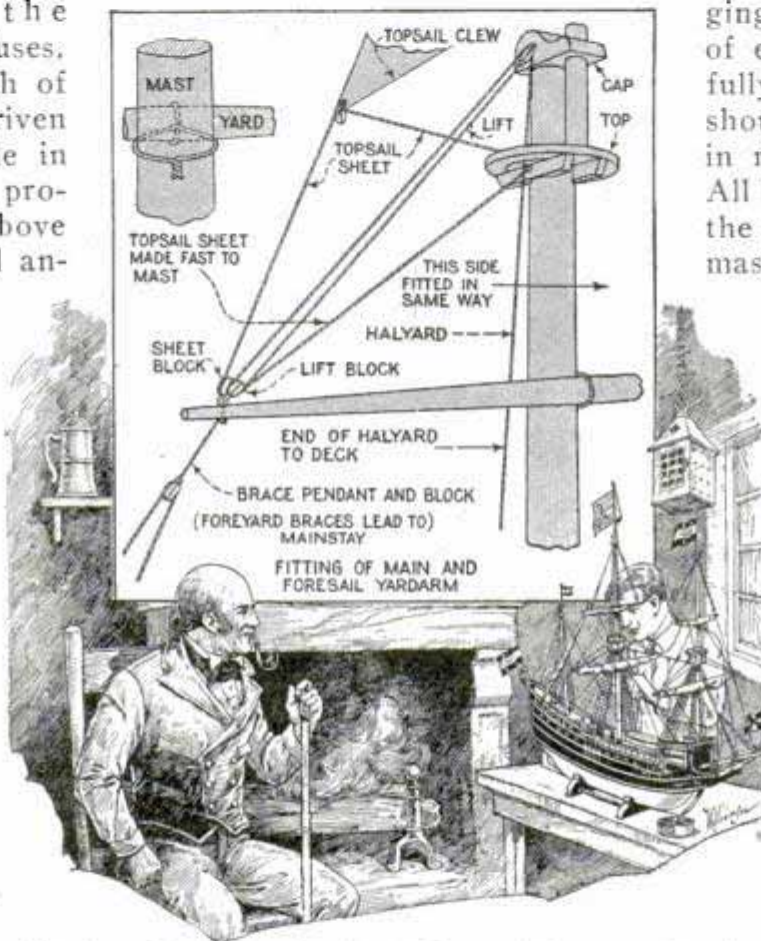

Wire Parrel for Yards; Details of "Dummy" Sheets on Topsails, and Lifts and Halyards of Main and Foreyards

as the other yards are attached to the masts, but the lifts, on this yard, become "outhauls." The cargo whips, shown in one of the drawings, need little description. They are attached by means of pendants to a heavy thread stretched from main to foremast, under the tops.

The braces are the tackle by means of which the yards are swung from side to side, and these are fitted next. The braces on the spritsail are rigged as shown in the bow view, the standing end (the end made fast) being attached to the forestay, 3 in. up from the bowsprit. The other end goes down around a block on the yardarm, up through another block on the forestay, just above the standing end,

through a block under the top and down to the pin rail. Both sides are rigged alike.

The foreyard braces are led straight back to the mainstay, and the foretopsail-yard braces to the maintopmast stay. The latter run up to a point on the stay $3\frac{1}{2}$ in. from the upper end. The main braces run back to blocks hooked to eyes on the quarterdeck bulwark rail, and the maintopsail braces to blocks hooked under the mizzen top. Remember there is a brace on each side of the yard. The lateen-yard braces are clearly shown.

The sails and their lines come next in order. On this model the sails are furled, but, of course, the reader can have them spread if he desires. The material used is unbleached muslin, which is of a light-tan color. Do not use white. In order to make a neat job of furling, the sails were cut the full width, but only half the "drop" or height. All the sails are cut so that they will be 1 in. shorter than the yard when hemmed or bound. If a sewing machine is available, they should be hemmed on all four edges; if not, the raw edges can be bound with $\frac{1}{2}$ -in. adhesive tape so as to provide a $\frac{1}{4}$ -in. reinforced edge or hem. If the sails are to be

furled, the drop of the main and foresails is $3\frac{1}{2}$ in.; that of the maintopsail, foretopsail and spritsail $2\frac{1}{2}$ in., and the triangular lateen sail measures $9\frac{1}{2}$ in. along the yard, $7\frac{1}{2}$ in. along the foot and $3\frac{1}{2}$ in. along the leech, or short side. The foot, with the yard at 45° , is parallel to the deck plane.

If the sails are to be set, the mainsail should be 6 in. in the drop, the maintopsail 6 in., the foresail $4\frac{1}{2}$ in., foretopsail 5 in., spritsail 3 in., and the lateen sail 6 in. When the sails are set, the yards are attached as high on their respective masts as they will go, hoisted up, in other words, and the spritsail yard is hauled out on the bowsprit. When furled sails are used, the yards are dropped down to about the points shown on the assembly drawing and, of course, the spritsail yard also is hauled in.

On the sails, the edge that is attached to the yard is called the head and the opposite edge the foot. The two side edges are the leeches, and the corners

General View of Model Completely Rigged: Follow This Only as a General Guide, and Consult Other Drawings for Details

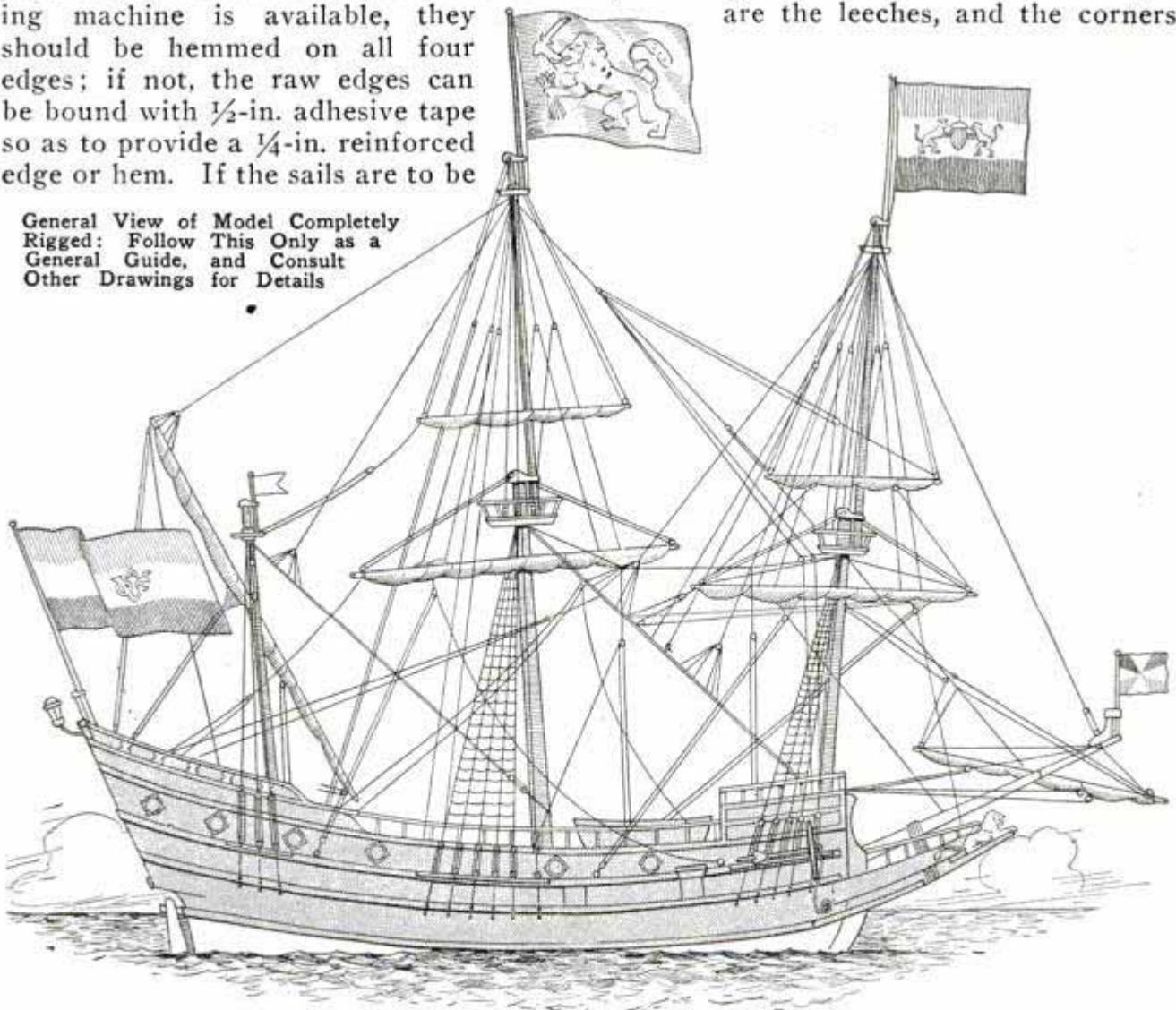

of the sail the clews. The middle of the sail is the bunt. The sheets are not the sails, but the tackle attached to the lower clews of the sails for handling them and holding them fast against the pressure of the wind. The sheet blocks are fastened by means of fine wire to the lower clews of the sails. The port main sheet runs from the eye in the strap of the sheet

block around a block wired to the after boomkin, then around the sheet block again and down to the main pin rail. The port side is rigged the same way. There is also a single line (the tack) leading from each clew of the mainsail down through a hole in the forward boomkin and back to the rail. The foresheets are rigged to the middle boomkin, then to the forecastle rail; the port foretack runs down under the beak and up to the starboard forecastle pinrail, and the starboard foretack in the reverse way. The lateen sail, having but one lower clew, has only one sheet. The topsail sheets are more or less dummies, and their rigging is shown on page 322. The yard in this drawing is shown dropped, of course; if the sails are set it will be hauled closer up under the top.

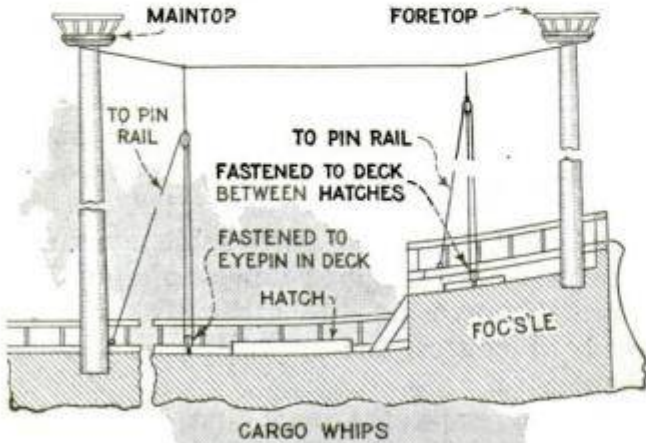

Looking at the view showing the after side of one of the courses, as the lower sails are called, the purpose of the various lines is as follows: The clew garnets (called clewlines on the upper sails) haul the clews up to the yard. This is shown very clearly in the illustration of a modern yacht below. The buntlines are attached to the after side of the foot of the sail then pass under the foot, up

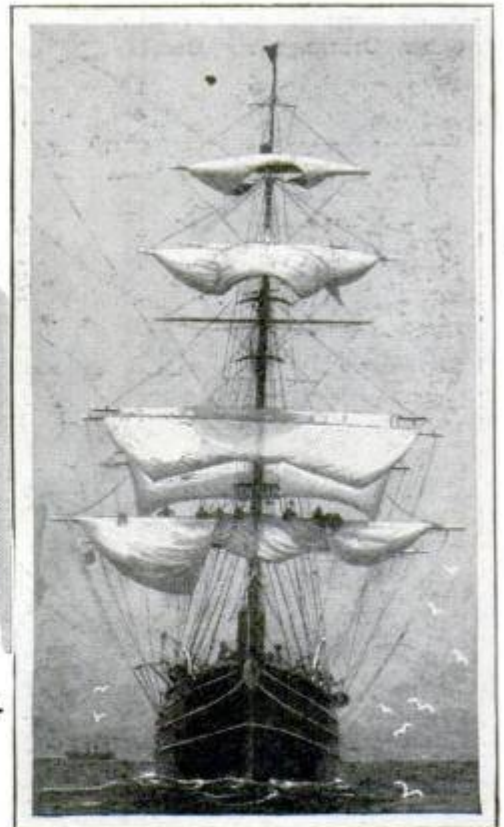
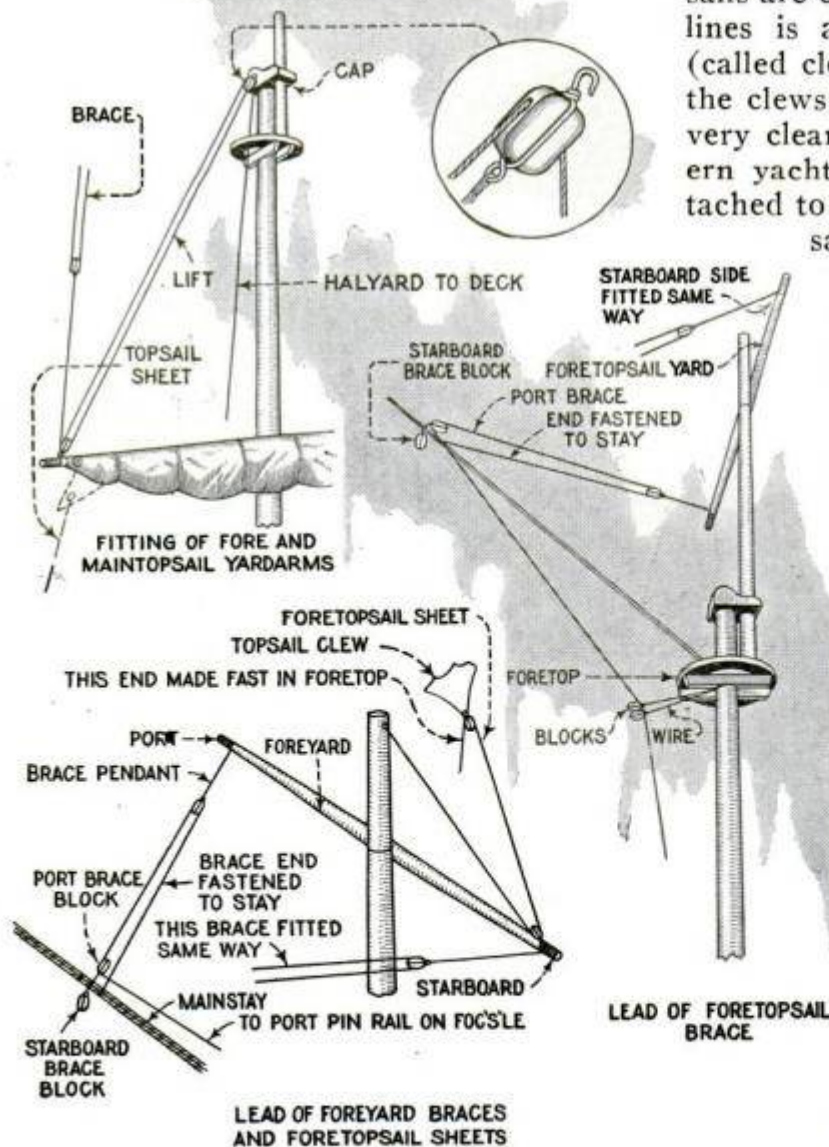

Right, Modern Yacht "Aloha," Showing How Sails Are Clewed Up Ready for Furling

to blocks on the forward side, as shown, and down to the deck; they are for hauling the body or the bunt of the sail upward and forward for convenience in furling and stowing. The leech lines serve a similar purpose. While these lines can be dispensed with, they add considerably to the realism and appearance of the model. The sail is attached to the yard by wire rings passing through the head of the sail and around the yard; while not exactly correct, this is sufficient for our purpose. On the original model, after the sails were attached and furled, they were given a light coat of orange shellac to add to the antique appearance of the whole. If the reader desires, he can furl and attach the sails before slinging the yards, and probably he can make a neater job in this way. The furled sail looks best when full at the center, tapering to the yardarms and well up on the yard.

About the only practical way to "belly" the sails, if they are made to be set, is to sew soft copper or iron wire in the hems, and bend the wires to keep the belly in the sail, also giving the latter a coat of shellac. It is well, too, to draw parallel lines with a soft black pencil vertically on the sails, about $\frac{5}{8}$ in. apart, to mark the cloths making up the sail.

The dimensions of the various flags are as follows: The flag at the main, which was the banner of the Dutch States General, is $4\frac{1}{2}$ by $2\frac{7}{8}$ in.; the fore flag, which was the flag of Amsterdam, is 3 by $2\frac{1}{4}$ in.; the mizzen, the pennant of the city, $\frac{1}{2}$ by $\frac{7}{8}$ in. with a $\frac{1}{4}$ -in. swallow tail; the stern staff, the flag of the East India Com-

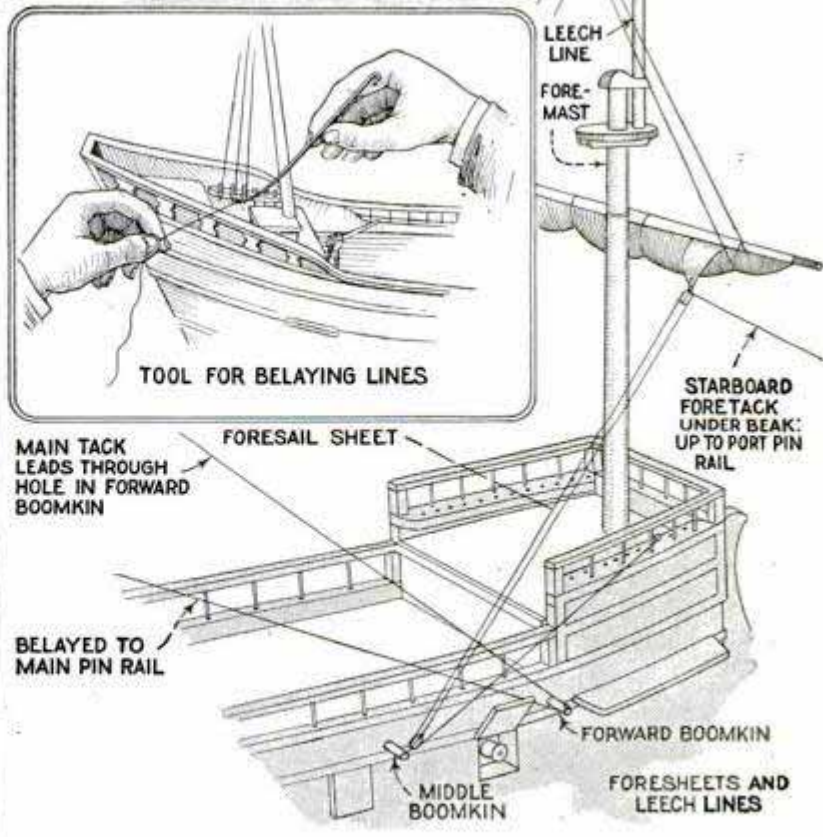
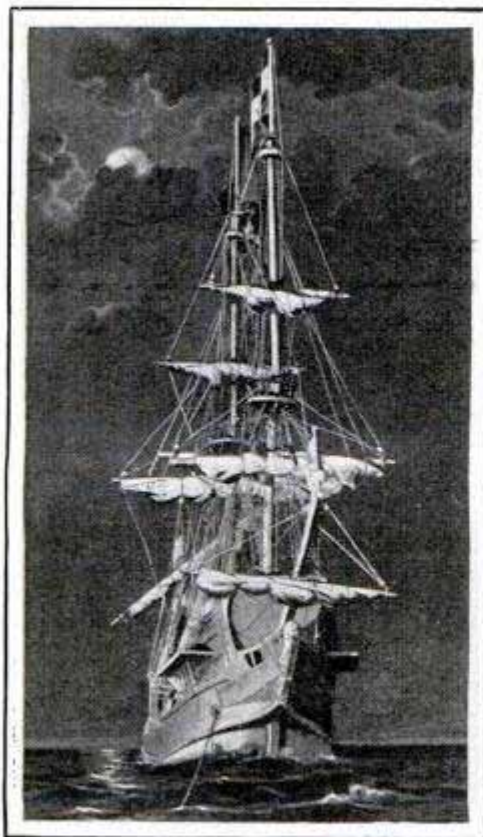
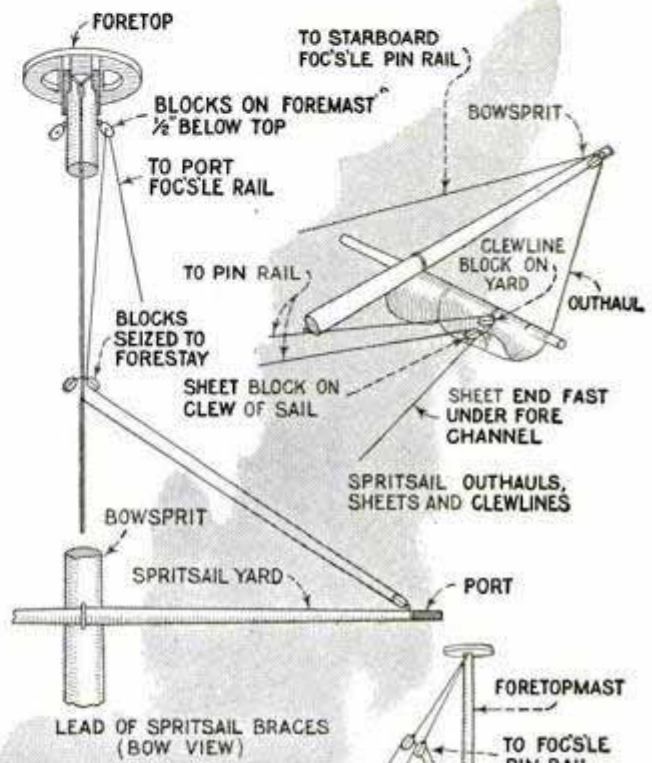

How the Wire Tool Is Used for Belaying the Running Rigging; Note Wire Pendants for Leech Line Blocks

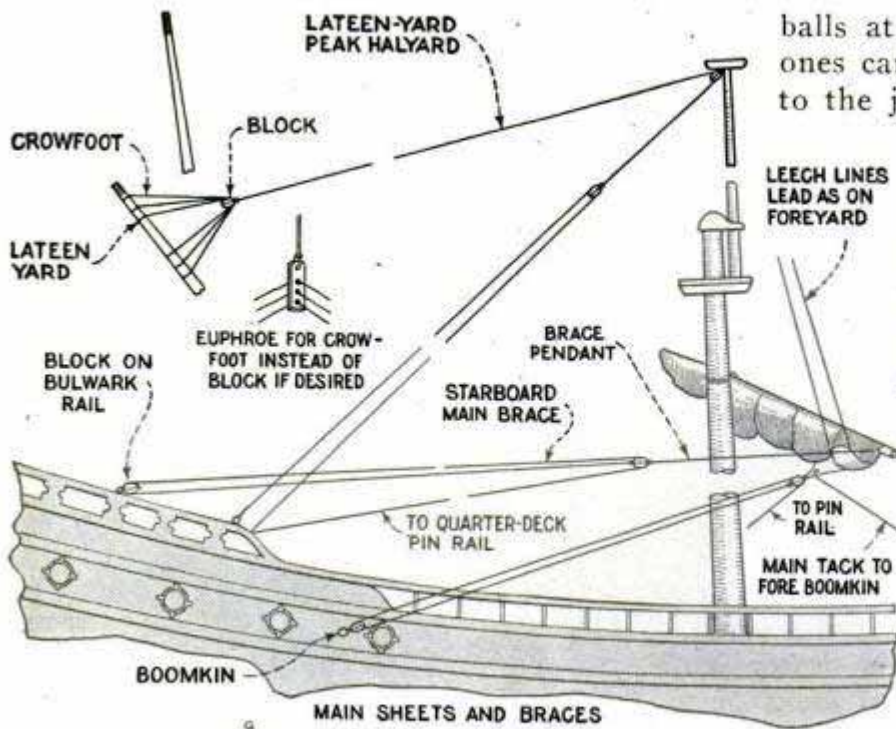

balls at the masthead; the smaller ones can be attached with fine wire to the jackstuffs.

The last job is the making of the anchors, and full details for this and the making of the hawse-pipe lips are given in one of the drawings. The anchors are stowed on the fore channels and lashed to the shrouds. Do not use chain for the anchor cables, as chain was not in use at the period of the "Half Moon"; use heavy cord that looks as much like rope as possible. Now go over the model and retouch all

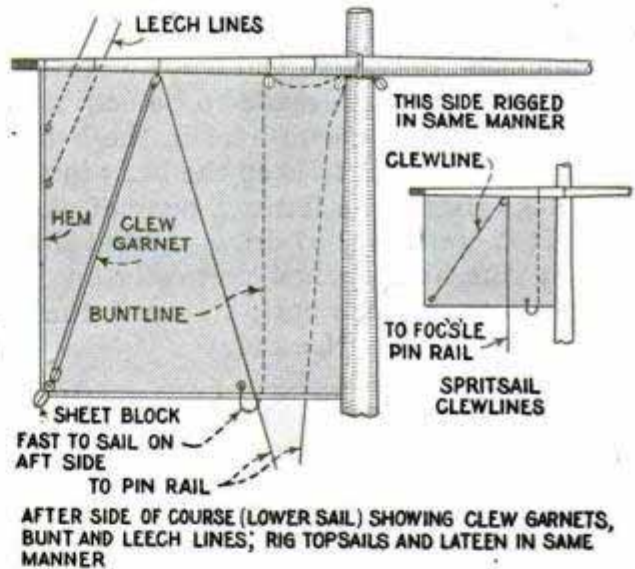
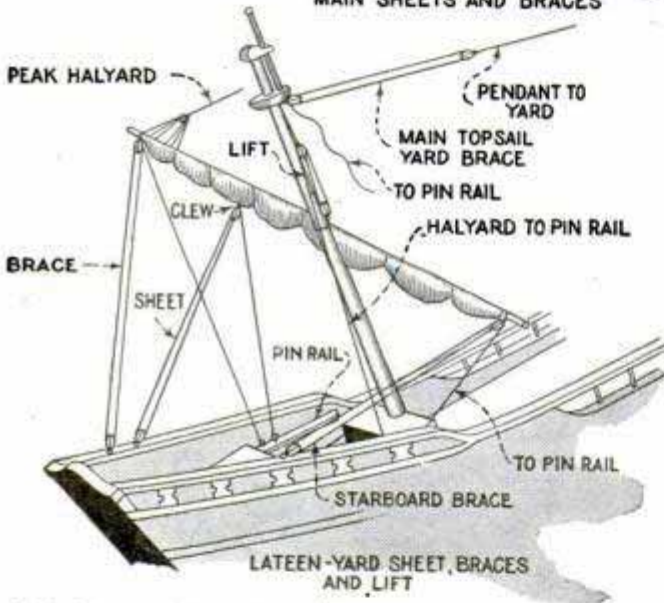

The Lower View Shows How to Construct Very Simple but Effective Built-Up Anchors

pany (Ost Indische Cie Van Amsterdam), $4\frac{1}{2}$ by $2\frac{7}{8}$ in., and the flag on the bowsprit, which was a "prinzen gosch" of the States General, $1\frac{1}{2}$ by $1\frac{1}{8}$ in. A key to the colors is given in the drawing of the flags. They are made of unbleached muslin, given a coat of shellac, to stiffen them and to prevent the paint from running. The flags on main, fore and the stern staff are hoisted on halyards that run through holes drilled in the

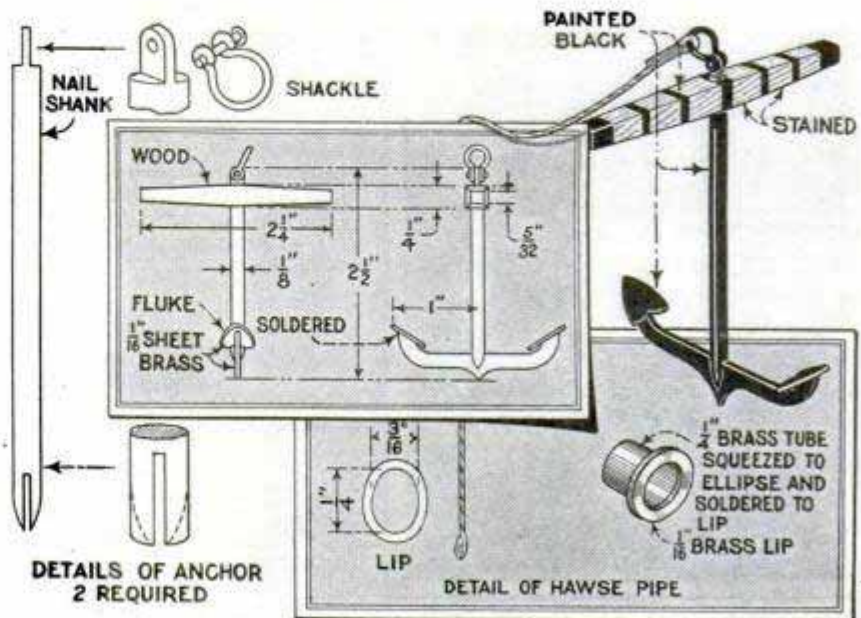

Any large paint store or Lee Voe & Co
 POPULAR MECHANICS
 Reynolds #40 Tube Chicago

29 S Walach

necessary parts with paint, including the touching up with flat black paint of all pin-heads and wire fittings, and your model will be completed.

One final word. You have been instructed previously to use automobile paints ground in japan for the model. Now, the color scheme used on the original model may be modified or changed in any way that appeals to the maker, but you should stick to the flat paint specified, and, on no account, use a shiny paint or enamel anywhere. After several coats of the flat paint have been applied, and have dried, if the paint is rubbed briskly with a clean soft rag, it will acquire a soft polish that makes the hull look as if the surface had been worn by handling for years; in other words, it gives a sort of artificial "patina," that antique collectors talk about. As the cloth polishes only the high spots, and the corners of the strake joints, etc., remain flat, the effect of age is heightened. If the color scheme is changed, keep the new colors as subdued as possible, consistent with good decorative effect, since glaring, new-looking colors on a model of this type are entirely out of place. You do not want to make a fake antique, of course, but neither do you want a model of a vessel of this period to look like a cheap factory-made toy. A number of ways to "age" the model will occur to the builder, such as smudging the brighter colors with darker paint, but do not overdo these things, or it may easily happen that you will spoil the very effect you are trying to achieve.

Owing to limitations of space, there may be some details that we have not made quite clear to the reader. In case of any doubt or difficulty, simply drop a line to

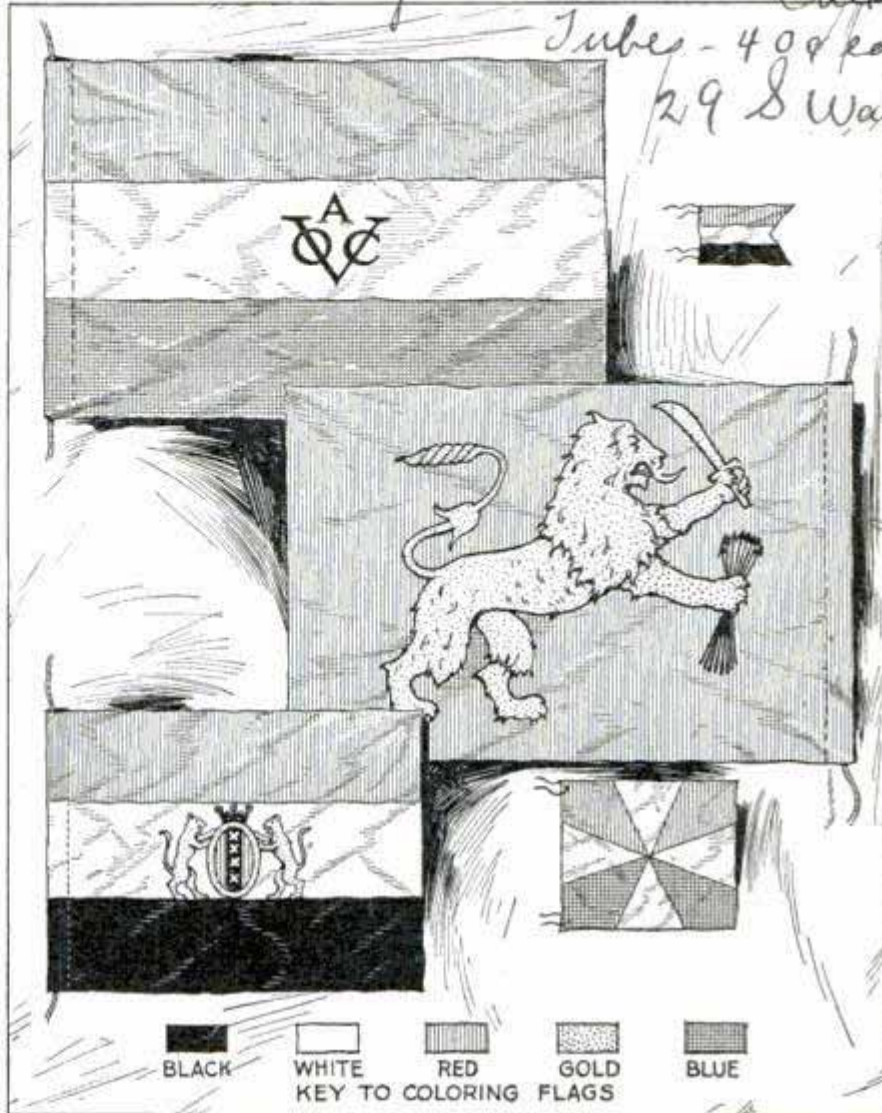

Upper Left, East India Company's Flag; Upper Right, Amsterdam Pennant; Center, Flag of States General; Lower Left, Flag of Amsterdam; Lower Right, "Prinzen Gosch" of States General

Don't flag and fairlead block can't be purchased

Amateur Mechanics department, and we shall be very glad to serve you with advice and help in every possible way.

Holding Tire Valves Open

It usually takes some time to let the air out of a tire, but the simple tool shown in the illustration, which holds the tire valve open, allows the air to escape and frees the motorist's hands to do other work. The tool is a short piece of wire with a hook bent at one end, to hold the valve open, and a loop on the other end, to catch the

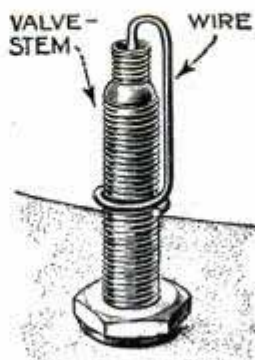

threads of the valve stem.—E. A. Goering, Langenburg, Sask., Can.

Flags can be bought from Sea Arts Guild 405. 9 Eleventh Ave. N.Y.C.

Running Lampcord through Metal Molding

Lampcord on the floor is broken and worn out rather easily and always collects dirt besides being a fire risk. To overcome these troubles, the installation



Lampcord Protected from Injury by Installing It in Metal Molding Screwed to Baseboard

shown in the drawing will be found practical. Metal molding of the kind used by electricians for concealing wires run over walls and ceilings is obtained, and an elbow fitting if a corner has to be passed. The molding comes in any color and shade desired to match woodwork. Run it along the baseboard and screw it in place, as indicated. The lampcord is inserted in the molding and the cover snapped on so that one can only see the plug and the socket end of the lampcord.

Dark-Room Light "Pirates"

Recently I made some experiments to find out what damage was done by light "pirates" in the photographic dark room. My pirates consisted of a red light, a lighted cigaret, the rays from a luminous-dial wrist watch and the flash from an electric switch. For ordinary work these lights do no serious damage, but for the particular operator handling ordinary work, and for all work of precision, it is wise to guard against them. No so-called safety light is absolutely safe. The rays from any red light register upon a film, but it is rather a matter of how much ex-

posure the film can stand without doing any serious damage. A red light, which I had always considered safe with portrait film, showed considerable registration upon a piece of dry film exposed for one minute at a distance of 3 in. Such long exposure to a dry film is seldom necessary, and it is true that a wet film is less sensitive, but this exaggerated result showed that some registration would take effect upon wet film while exposed to the red light for examination in the process of development.

There are a few photographers of my acquaintance who persist in smoking cigarets in the dark room. This is unsafe even in the most adverse working conditions. Cigaret light is white, and three puffs of a cigaret held 6 in. away from a piece of dry film resulted in considerable fogging and was sufficient to ruin the film. A 30-second exposure of a piece of portrait film to the luminous dial of a small wrist watch resulted in the complete breaking down of the silver deposit. One minute's exposure at a distance of 4 in. made a noticeable registration. A flash from an electric switch registered enough to ruin a film. Although this exposure was for a fraction of a second, the flash contained rays, to which portrait film is very sensitive.—Edward H. Flaharty, Parco, Wyo.

Emergency Tire Chain

Many motorists do not have chains, and during the summer months it sometimes happens that they are caught on soft ground or mud unexpectedly. It is better

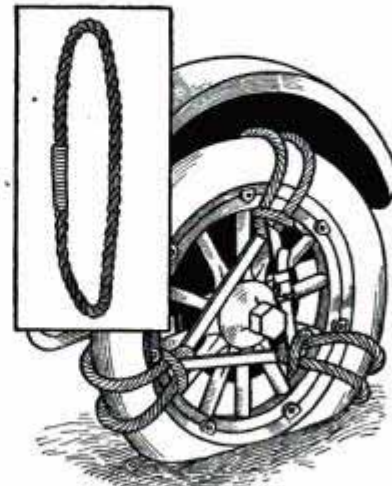

to be prepared for such emergencies by carrying along six endless ropes and two strong leather straps. When you get on soft ground where you cannot make any headway, slip the ropes over the wheels as shown in the drawing, holding them in place with the straps.

Rubber Band Replaces Book End

When books do not completely fill a shelf or are placed elsewhere without any support for the end ones, a strong rubber band will be found an efficient substitute for book ends. The band is slipped around the last two or three books and placed so as to coincide with the framing lines of the title so that it will not be conspicuous. Books held together in this way will stand quite firmly, preventing those next to them from falling, and a rubber band is likelier to be at hand than an extra book end.—Harold E. Benson, Denver, Colorado.

Several Drawers Locked with One Bolt

To eliminate the necessity of individual locks for the several tool drawers in his workshop, a garage owner made use of the illustrated attachment, which locks or releases all the drawers from one point at the end of the bench. A length of $\frac{1}{2}$ -in. round steel rod was shaped in the manner shown and attached to the bench just below the drawers by means of heavy staples, which were clinched on the inside. The rod was bent at a right angle at one end of the bench and formed into an eye large enough to pass over a screw-eye to which a padlock is attached, as shown. Another screw-eye is fastened to the bench above the bar. The operation is obvious.

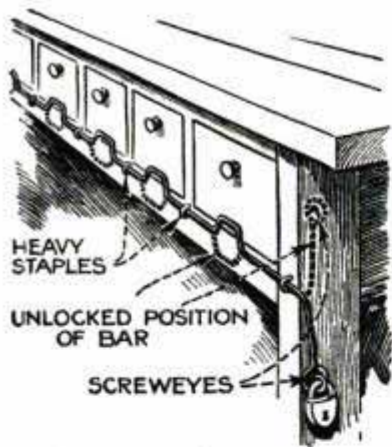

which a padlock is attached, as shown. Another screw-eye is fastened to the bench above the bar. The operation is obvious.

Making Gold Leaf Adhere Permanently

To make gold leaf adhere permanently to any surface, try the following: Put some isinglass in a little water and heat slowly without allowing it to boil. Add as much nitric acid as isinglass. Allow the mixture to cool and apply carefully with a brush. This mixture not only makes a permanent job of the work, but will not be absorbed by the paper pages of any book on which it may be used.



Paper Pulp Makes Good Fuel

I have been making paper fuel of the kind shown for a number of years from scrap paper that accumulates around the house. Each year I make enough to last the whole winter, burning it in an open grate. The paper is soaked to form a pulp and is then pressed into shape using molds made of 4-in. iron soil pipe, 12 in. long and sawed lengthwise. It is then allowed to dry out thoroughly. This makes good fuel, which gives plenty of heat, is economical and serves well also as kindling for starting a coal fire.—John E. Mason, Hamilton, Ont.

Setting Mousetraps

The danger of setting mousetraps can be eliminated by using the method shown in the illustration. A $\frac{3}{4}$ -in. hole is drilled through the wood base of the trap just under the end of the bait pan. By inserting the finger in the hole from the underside of the trap and lifting the pan to the position indicated, so that it engages with the catch holding the spring, you are fully safeguarded against any chance of injury to your fingers.

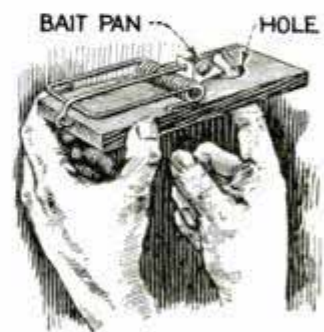

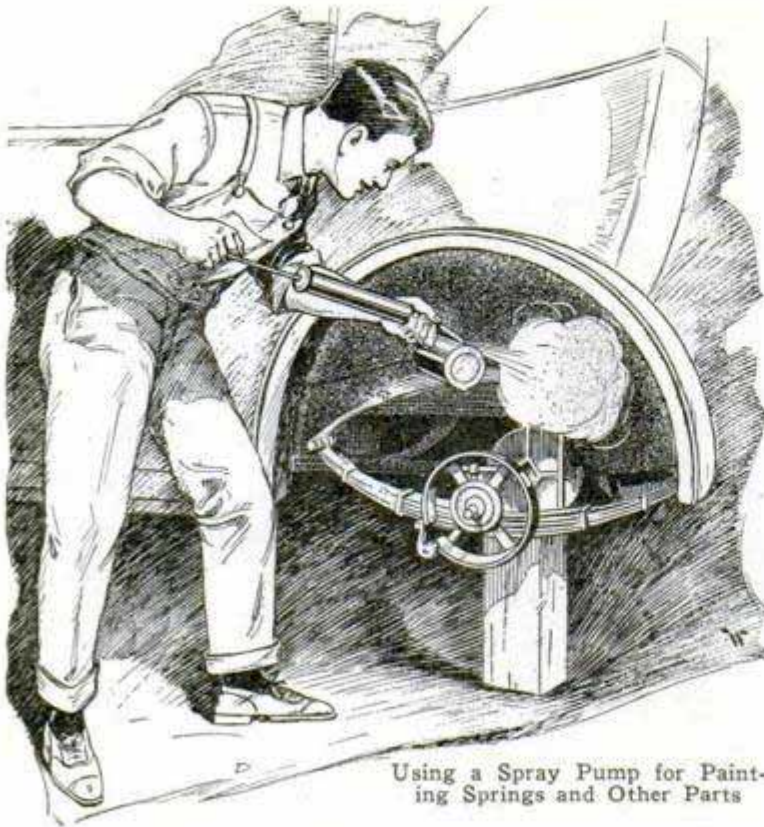

Using a Spray Pump for Painting Springs and Other Parts

Spray Pump for Painting Springs

Usually a good brush is used for painting the body and fenders of a car, as these surfaces are smooth and can be thoroughly cleaned before applying the paint. However, it is quite a difficult matter to clean the springs and other parts under the car and by painting them with a brush one always picks up dirt out of the cracks and corners, which covers the brush and spoils the painted surface. By doing the painting with a spray pump, as shown in the drawing, this trouble is avoided. If ordinary rust-proof paint is used no thinner is necessary, but auto enamel should be diluted with about ten per cent of turpentine. The spray enters the cracks and crevices, and places which are inaccessible with a brush.

Soot for Furnace Covering

When cleaning out some large flue pipes at a power plant where a lot of wood, sawdust, etc., was burned in the boiler furnaces, a large quantity of soot had to be removed. As an experiment I made a thick mixture of this soot with water, then used equal parts of the soot mixture and ordinary asbestos cement to cover a heater, using the ordinary form of wire

netting as a holder for the compound. When the soot-asbestos covering dried out, not only had it fewer cracks than the asbestos coverings on other heaters, but the soot-asbestos surface also was cooler than the all-asbestos, which meant an appreciable saving in boiler efficiency.—J. E. Noble, Toronto, Can.

Vacuum Cleaner Helps Heat Second Floor

In old furnace installations the pipes often lead only to the first-floor rooms and the upper rooms are provided with floor registers extending through to the ceiling of the room below. The upper rooms get their heat in a very slow and indirect fashion in this way, and if these rooms have to be heated quickly, some auxiliary apparatus is almost necessary. One housewife overcomes the difficulty in a simple manner. When an upper room is to be heated she simply takes the dust bag out of the vacuum cleaner, places the sweeper over the open register and turns on the current. Acting as a power circulator the sweeper draws the warm air from the

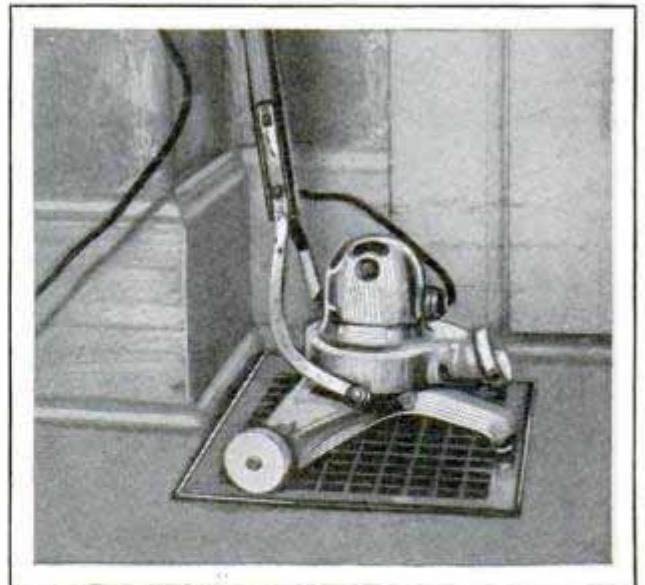

Using a Vacuum Cleaner on Second-Floor Register to Draw Heat into Upper Rooms

room below and shoots it out into the cold upper room. It does it so fast and effectively that only a few minutes are required to make a large room comfortable.

Substitute for Child's Bow

An easily made substitute for a bow, which is especially desirable for children interested in archery, can be made from a discarded automobile inner tube. A strip, about $\frac{1}{2}$ in. wide, is cut across the tube, making a large rubber band. The arrows, which should be about 16 in. long, can be made from reeds or cat-tail rushes, by driving a shingle nail into the thick ends and wrapping them with adhesive tape. The arrows need not be feathered. To shoot them, slip the band over the thumb and first finger of the left hand. Then place the arrow in the band, grasping it through the rubber with the thumb and finger of the other hand. Stretch the band to its limit, then release it, and the arrow will be driven out of sight if aimed into the air. The thumb and finger serve as a crotch, while the band serves both as bow and string. Arrows may be shot with great accuracy as it is comparatively easy to aim. In shooting with the band, as with the bow, the arrow should be pulled back in line with the eyes. Children in our neighborhood are able to shoot nearly 200 ft., although 25 to 50 ft. is better for target practice.—C. Bernard Petersen, Minneapolis, Minn.

Sealing Extension-Cord Plug

One of the most common causes of short circuits in extension cords is the loosening of the bared ends from the screws in the plug, which in turn is caused by strain on the cord. A knot is usually tied in the cord by electricians to take the strain, but the method shown in the drawing is an additional safeguard. Melt some sealing wax and after fastening the bared ends tightly, pour in the wax until it is level with the outside edge.—Adolph F. Lonk, Chicago, Ill.

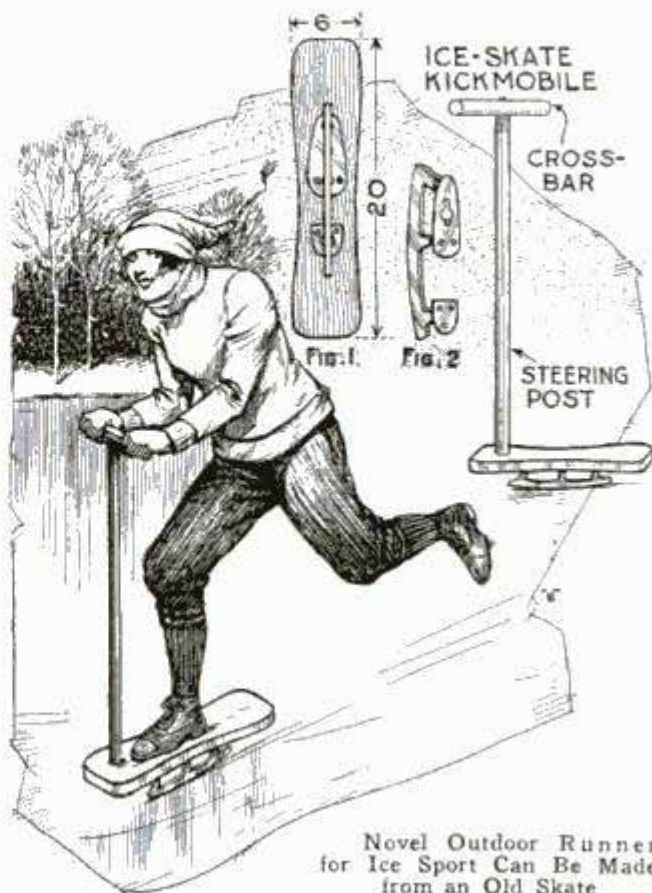
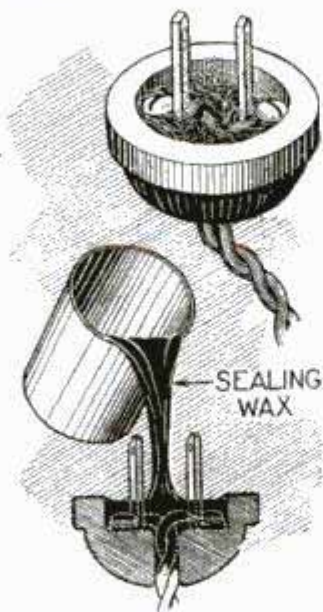

Novel Outdoor Runner for Ice Sport Can Be Made from an Old Skate

An Ice "Kickmobile"

Boys will find the "kickmobile" shown here quite different from ordinary outdoor winter devices. Fig. 1 is the footrest, about 20 in. long and 6 in. wide. It is made of 1-in. wood and an ice skate is securely screwed to it, as indicated. A steering post, with a crossbar attached to the top, is also provided, which completes the runner. The steering post can be made from a piece of willow branch or a strong broom handle, set snugly in a hole drilled in the center of the base, toward the front.

Vulcanizing Small Holes in Auto Tops

When a tear occurs in the top of an automobile, it is usually patched by the cement method or else the hole is stitched like the hole in a stocking. A better method of repair is to vulcanize the top. Fill the opening carefully with the heavy rubber mastic or tire dough used in filling small holes in casings. Then heat two flat-irons and press them against the rubber from each side, being careful not to have the iron so hot as to scorch the fabric. In three or four minutes the rubber will be vulcanized.—L. B. Robbins, Harwich, Massachusetts.

Tin Cup Used as a Level

On a camping trip, I had occasion to make a table and seat. As there was nothing horizontal or vertical to use to



Tin Cup Filled with Water Makes a Serviceable Level for Campers in Making Furniture and for Other Purposes

plumb things up, I took a tin cup and filled it to within $\frac{1}{8}$ in. of the brim and found that it made a very serviceable level. Table and seats came out perfectly true.—Albert L. Ball, Niagara Falls, N. Y.

Tape on Child's Legging

It is possible that many a young mother does not know a good method of keeping her child's legging elastic in condition, as it soon wears out under the child's foot. An easy and permanent method of mending is to buy a roll of electric tape from the 10-cent store and cover the elastic of each legging in the following way: Begin by unrolling several inches of the tape, then start at the point where the elastic is joined to the legging at the side and lay the end of the tape across the elastic in such a manner that the adhesive side will be stick-

ing to the elastic. Continue to wind the tape around the elastic, several turns, by bringing the tape through the opening where the child's foot goes, and at the same time taking care to overlap the edge of the tape at each turn. In this way you will cover the entire elastic and terminate the winding at the end opposite that at which you started. You will find such a covering will enable the child to play about in wet weather, during winter, as the electric tape is not only waterproof but very tough and durable.—J. R. Clough, Washington, D. C.

Lighting a Fire in a New Fireplace

New fireplaces are likely to smoke badly when a fire is first built in them, due to the dampness of the flue. This is also true of a fireplace that has been unused for a considerable length of time. To overcome this smoking is a simple matter. Open any dampers and hold a lighted newspaper high up under the arch and at the beginning of the throat. One or two such applications of heat will absorb the moisture from the surface of the flue bricks and the fire can then be built with little danger of smoking.

Changing Tone of Auto Horn

By taking a piece of old inner tube and slipping the end over the horn, as shown, a new tone can be obtained. A loud horn can be made to produce a soft tone resembling the moo of a cow. Horns having an armature give the best results. The piece of inner tube should be about 1 ft. long, and small pieces are cut off until the desired tone is obtained.—Carlton Groat, The Dalles, Oreg.

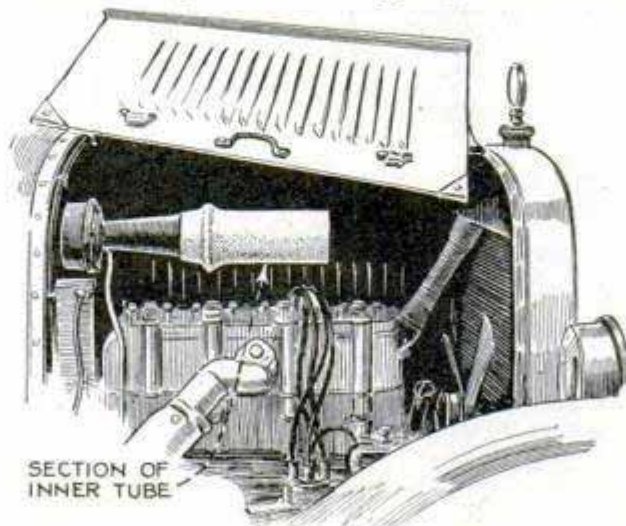

Section of Inner Tube Slipped over Auto Horn Changes Its Tone Agreeably

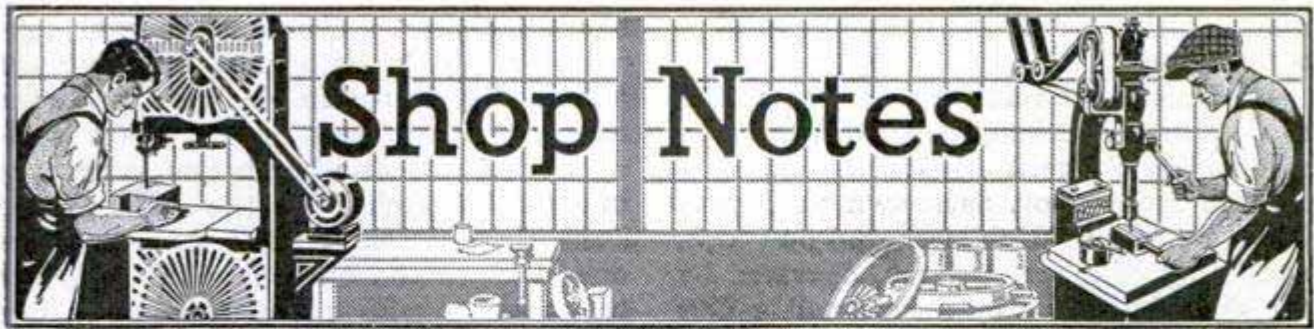

All Shop Notes published in 1926, in book form—Fifty Cents—from our Book Department

What You Should Know About Locks

By A. C. LESCARBOURA

SO long as we have locks, the home owner must know something about these seemingly intricate, yet really simple, devices. It may be that he wishes to repair a lock. Again, he may wish to make a key, or to change the lock so as to render the issued keys useless. In any event, a little knowledge about locks will save a lot of time and trouble.

To begin with, there are three general types of locks to be found

and rim types are about the same, so that Fig. 2, showing the inside of the rim-type lock, actually covers both cases.

The operation of the usual door lock is simple enough. The key is inserted in the keyhole, and the turning motion causes the bolt to be thrown back. However, by studying the details of Fig. 2, it will be noted that there is a barrier, B, which prevents the key from turning unless the tongue of the key is cut with slots to clear the barrier. Sometimes there is also a nib on the lock plate, and it is in order to clear these barriers that ordinary keys are slotted and grooved in characteristic fashion. Ad-

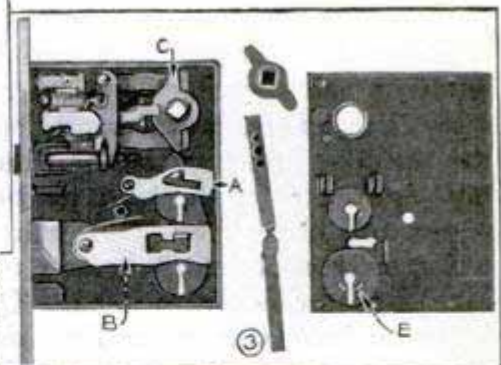
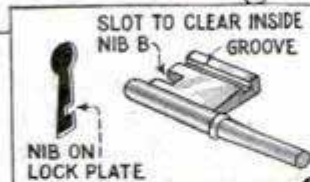
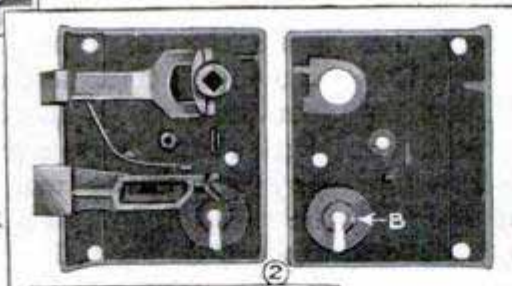
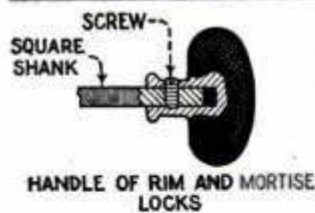

in the average home. The door locks are usually of the ordinary mortise type, with the lock proper let into a slot cut in the edge of the door. Fig. 1 shows the mortise type of lock being removed for examination and repairs. The rim type, on the other hand, merely screws on one side of the door—the inside, of course. The internal details of both mortise

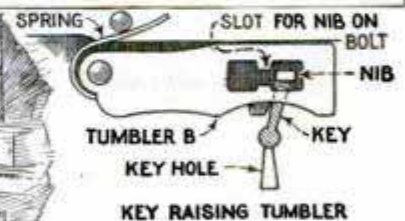

Details of Common Rim and Mortise Locks; Also Interior View of Front-Door Lock with Split Handle and Locking Pins

ditional keys may be made by following the profiling of an

existing key, or taking the lock apart and studying the barriers so as to file the key to pass them.

Because of the relative ease with which the ordinary lock may be picked, the lock mechanism is generally more elaborate for the front door, as shown in Fig. 3. Here is a combination latch-and-bolt lock, consisting of a spring latch, operated by the door knobs or by a key, and a bolt lock for the lower portion, also operated by a key. The latch is the portion ordinarily employed during the day, but the bolt is used at night. The latch may be opened by turning the inside or the outside knob, provided the buttons or small lever on the edge of the lock are not thrown so as to lock the cam which is moved by the outside knob. The inside has its own cam which is always free to turn. Should the outside knob cam be locked, then a key must be used to throw back the latch independent of the cam. The cam C is the one connected with the outside knob. In this view it is shown locked by the push buttons.

Keys are cut for the foregoing lock in much the same way as for the simple door lock, except that there must be notches cut on the end and side of the key, since the key must not only clear a barrier, indicated by E in this view, but also lift a "tumbler" to permit throwing back the latch or the bolt, as the case may be. The tumblers are shown at A and B, and in detail in the sketch. The key must have a slot on its face, cut to exact depth, to lift the tumbler just high enough but not too high, so as to let the latch or bolt nib or projection slip through. Such a lock is necessarily more complicated and therefore more difficult to pick. Ordinarily, just one lock, the upper lock or latch, is for day use in this combination. The lower lock or bolt is used only at night, and is then locked from the inside with the key.

It may be desired to reverse the way in which the door is to close, or, when the lock is purchased, the bevel or slant of the latch tongue may be wrong. This may be reversed by pulling the tongue back clear of its slot, and then reversing it. The cams shown at C must also be turned around, as the manner in which this lock works is to have one of the cams lock

with the buttons or small lever on the edge of the lock, so that the outside knob cannot throw back the latch and a key must be used, while the inside knob is always ready to throw back the cam that is always free, so that a key is unnecessary to unlock the latch from the inside. The shaft that passes through the lock from one knob to the other is split, and each half engages with one of the cams. The portion of the shaft with the pins goes to the outside, so that the knob cannot be removed from that side and the shaft then pushed through the door so as to operate the free cam and unlock the door without a key.

Inside the home, there are various cabinet locks having internal details quite similar to those shown in Figs. 4 and 5. Here is a lock having a number of tumblers, all of which must be lifted a certain distance by the notches in the key before the bolt is presented with a straight or alined slot in the tumblers through which the nib on the bolt may slip back. This is a complicated lock to file a key for. The best plan is to remove the tumblers and proceed to file the key so that its notches raise the tumblers, one at a time, to the point where the slot is in perfect alignment. Care must be taken to get the tumblers back in their proper order, otherwise the combination will be changed. However, if it is desired to change the combination of the lock so as to render outstanding keys useless, the tumblers of any lock having two or more tumblers may be rearranged and a new key fitted to the revised combination.

The next popular type of lock found about the home is the pin-tumbler, or cylinder, lock, commonly known as the Yale lock. This is a compact lock, virtually fool-proof and capable of unlimited combinations. Figs. 6 and 7 show the essential parts of this type of lock. It will be noted that the lock is composed of a cylinder, A, and a body, B, together with a series of pins, C and E, which serve to lock the cylinder rigidly in the body so that the former cannot turn. However, if the pins E are pushed flush with the curved face of the cylinder, then the cylinder can be turned with the key, and the bolt of the lock, which comprises the mechanism fastened on the inside of the usual door, can

be thrown back to unlock the door, through the parts G, H and F. The part shown here, in other words, is a sort of a gateway through which the key must pass before it can throw the bolt and unlock the lock itself. Now the pins of this lock are divided into two members, one called the combination pin, E, and the other the locking pin C. (The double split pin, comprising two pins for the locking pin, will be explained later.) The combination pins fit into the cylinder, with the locking pins pressing down on them because of the coiled springs, D. Normally, the combination pins, being

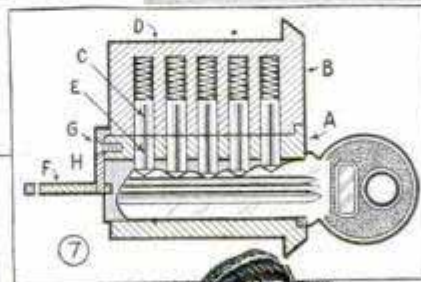
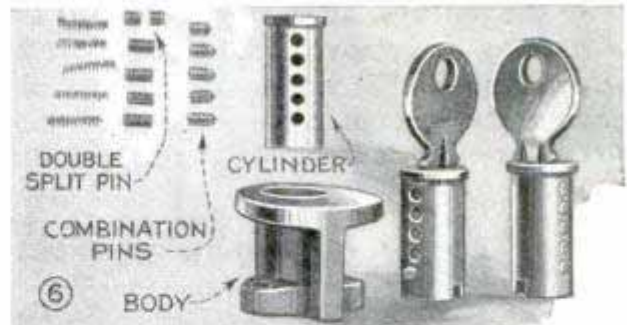

tumbler locks, and the home key may be designed to fit both locks, while the garage key may be designed to fit just the garage lock. This is especially desirable when the help is provided with a key to fit just a certain lock, while the master has a key that will fit several doors. There is nothing more to

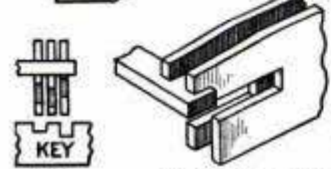
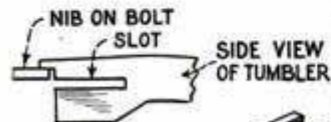

SKETCH OF TWO TUMBLERS SHOWING VARIATION IN LOCATION OF SLOTS

Cabinet Lock with Multiple Tumblers, and Internal Mechanism of Pin-Tumbler Locks

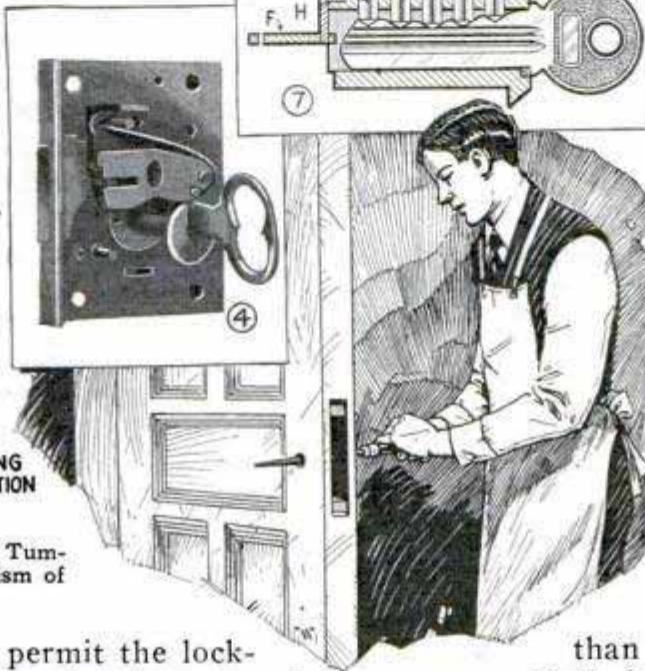

such an arrangement than to have the two locks—or more if desired—arranged with the same combination as the house. The house lock, however, is provided with plain pins, while the garage lock is provided with a split pin. The chauffeur's key is arranged so as to operate the split pin on one section, while the master's key is arranged to operate the split pin on the other section, corresponding with the solid pin of the home lock. In this manner, one person may have a key to open a number of locks, while others may be provided with individual keys for their individual locks. This arrangement may be multiplied any number of times through the use of split pins.

of different heights, permit the locking pins to enter more or less into the cylinder holes, thus locking the cylinder with the body and preventing the cylinder from turning. A key which is properly shaped so far as the lengthwise grooves are concerned, may be inserted into the keyhole. Its teeth will raise the combination pins more or less. If the key is the correct one, the teeth will raise the combination pins to the correct height, thereby bringing the combination pins and the locking pins flush with the space between cylinder and body, and permitting the cylinder to be turned by the key.

Fig. 6 shows the results of inserting the proper key, at the right, and the wrong key, at the left; note how the combination pins are lined up in the former.

The purpose of the split pin is to enable one key to fit just one lock, while another key may fit that lock and another lock as well. For example, the home and the garage may both be fitted with pin-

To file a key for the pin-tumbler type of lock, it is necessary to take the lock apart. Some locks have provision for doing so, usually in the form of a sliding cap over the top of the body. Others have no such provision, and then it becomes necessary to file off the top of the body so as to ex-

pose the springs, after which each of the parts may be removed. The key must be selected so that it will fit in the keyhole, having the proper arrangement of side slots. If a key is at hand for the lock, the

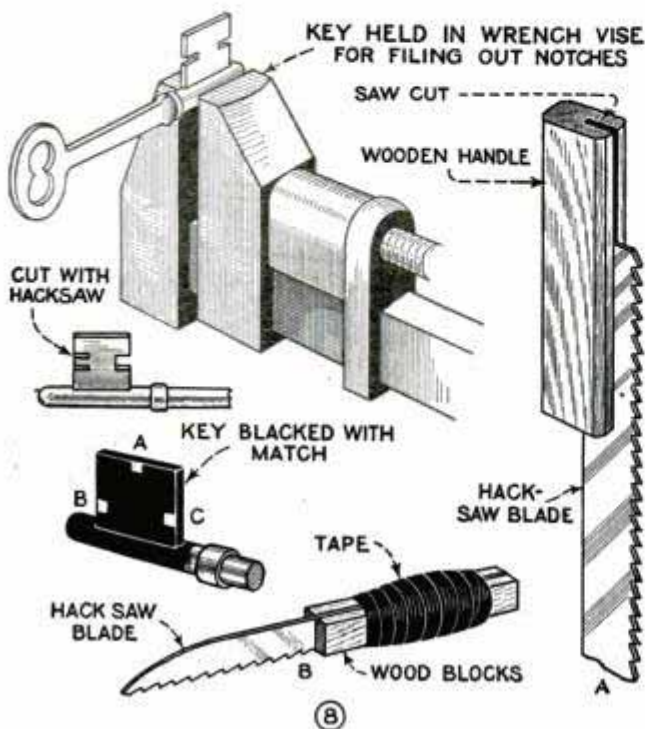

Hints for the Amateur Key Filer, Showing How the Position of the Wards Is Located without Taking the Lock Apart

lock need not be filed apart. Instead, the screws and plate may be removed from the rear of the body, after taking the lock proper from the door; the key inserted so as to line up the combination pins, and the cylinder withdrawn, so that the combination pins remain in the cylinder while the other pins and springs fall out. This is not harmful, but it is quite a tedious job to reassemble the pins and springs. Nevertheless, this practice is perhaps simpler in the long run than to file off the top of the body and then have to make a new cover.

To file a key for the pin-tumbler lock, the blank should be inserted in the cylinder and the combination pins placed in their respective holes. Be sure the key is all the way in. Now gently tap the pins, which causes a small mark to be made on the edge of the blank to indicate where the filing is to take place. In filing a key of this kind, only one of the pins should be fitted at a time. It will be necessary to try the key frequently, and not to bear too hard on the file, since a small error in filing will render the key useless. A

three-cornered file may be used for the purpose, but as it is not of the proper angle it must be tilted from side to side to approximate the angles of the original key. It is not advisable to hold a key that fits up against the one to be filed, because to file the original even slightly is apt to ruin it. Keys can be made in special machines, following the notches of the original and in no way affecting the accuracy and fit of the latter. This is the quickest and easiest way to duplicate keys.

Now a few words on key fitting in general. When a vise is not available, and especially when it is desired to do the fitting near the lock, a monkey wrench can be used, as shown in Fig. 8. Set up the knurled screw with a pair of automobile or lineman's pliers and the wrench will hold nearly as well as a vise.

To fit a key to a common mortise or rim lock, without taking the lock apart, obtain a key blank which will nearly or quite go into the keyhole, hold the key close above a lighted match or candle until smoked evenly and completely. Place the key in the lock as far as it will go and turn it back and forth, then remove from the lock and seek the bright spots where the black has been wiped off the key by the wards in the lock.

Bright spots are shown at A, B and C, and cuts must be made in the key to remove the metal at these points. Possibly the key will not go into the lock and bright spots may be found at the inside edge of the blade, indicating too little distance between the blade and the collar, in which case it will be necessary to file away some of the blade, if it is wide enough, or to work back the collar a bit. If no thin "warding file" is at hand, cut in the key with a hacksaw as shown; then break out the thin piece and file smooth.

Bits of broken hacksaw blades make good key tools. Cut a hacksaw slot into the handle block, as shown in the illustration, then fill the groove with "smooth on" cement, and push the blade into the handle. Next day, the saw will be found solidly set in the handle. If no smooth on is at hand, set the blade with litharge and glycerin. A "ready-to-wear" file may be quickly made by placing two bits of wood on either side of the hacksaw blade, and then winding on tape to form a handle.

Practical Tar-Cutting Machine

In construction work there is frequent need of tar, and the cutting of this product is more or less troublesome. One contractor made the machine for this purpose shown in the photo, and found that it was effective and timesaving. It consists of a wooden framework with a platform at the front for holding the cakes of tar to be cut,

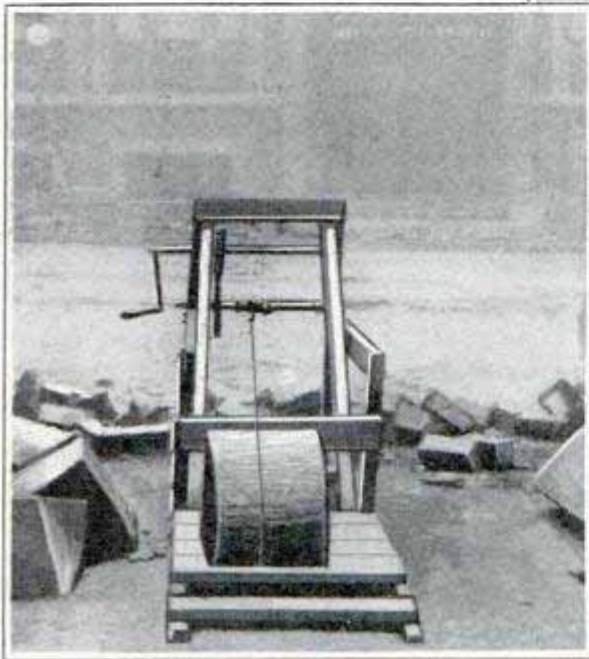

Platform and Mechanism for Cutting Large Cakes of Tar with Little Effort and at a Considerable Saving of Time

and the operating mechanism, which comprises a crank, two gears and a winch arrangement, at the other end. A stout wire is attached to the winch and to the framework so that it can be placed over the cake of tar. Then, upon turning the crank, the wire is drawn through the tar with little effort.—Roy M. Singer, Chicago, Illinois.

Gassing Best Means for Killing Ground Hogs

With steadily increasing farm acreage in the middle west given to legume crops, alfalfa clover and soy beans, the damage caused by the ground hog, or woodchuck, is becoming serious. It is especially fond of these crops and, besides, its burrowing makes the ground rough and hard to cultivate and often starts the forming of a ditch. Trapping and bounties have been

used to fight the pests, yet they seem to be on the increase. Gassing them is a new method which has been tried successfully in several localities in Iowa. Calcium cyanide is used. In the entrance to

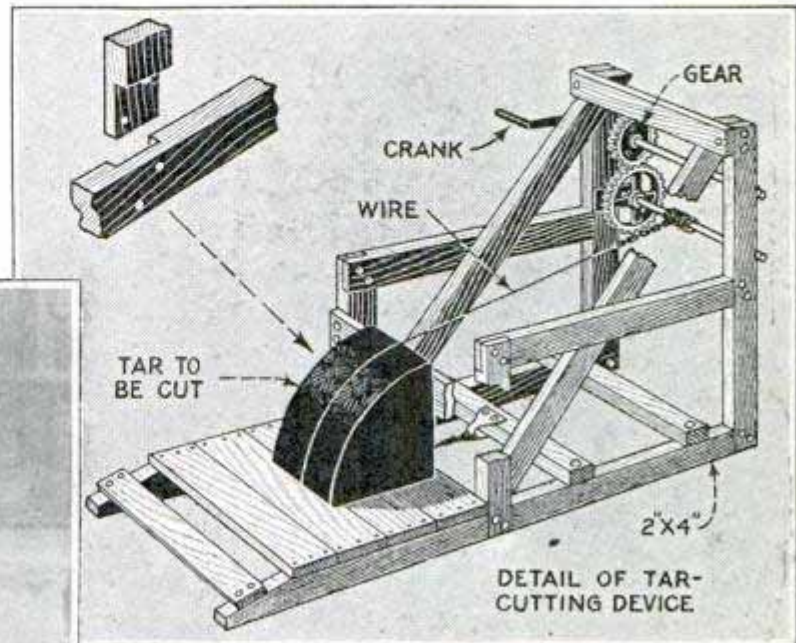

the burrow 2 or 3 oz. of the chemical is placed. A long-handled kitchen spoon gets the material far enough into the hole, then the entrance is plugged with grass, sod, or an old gunny sack, to avoid any risk to the operator. The moisture in the soil causes the calcium cyanide to give off hydrocyanic-acid gas, which is so deadly that it kills the pests in a few seconds. In one township of Iowa, where about 6,000 burrows were treated, only a very few of them opened again, showing that the animals had been killed in great numbers.—F. L. Clark, McGregor, Iowa.

Simple Paintpot Hook



A simple paintpot hook intended for use on a ladder is shown in the drawing. It consists of a length of No. 9 galvanized-iron wire bent to the shape shown. Fasten it to an ordinary spring snap. This allows the bucket to hang on the outside of the ladder, and the bail will assume a slanting position so that

it is out of the way of the brush.—W. W. Irwin, Albany, Ohio.

How to TAKE CARE GASOLINE

by L. B.

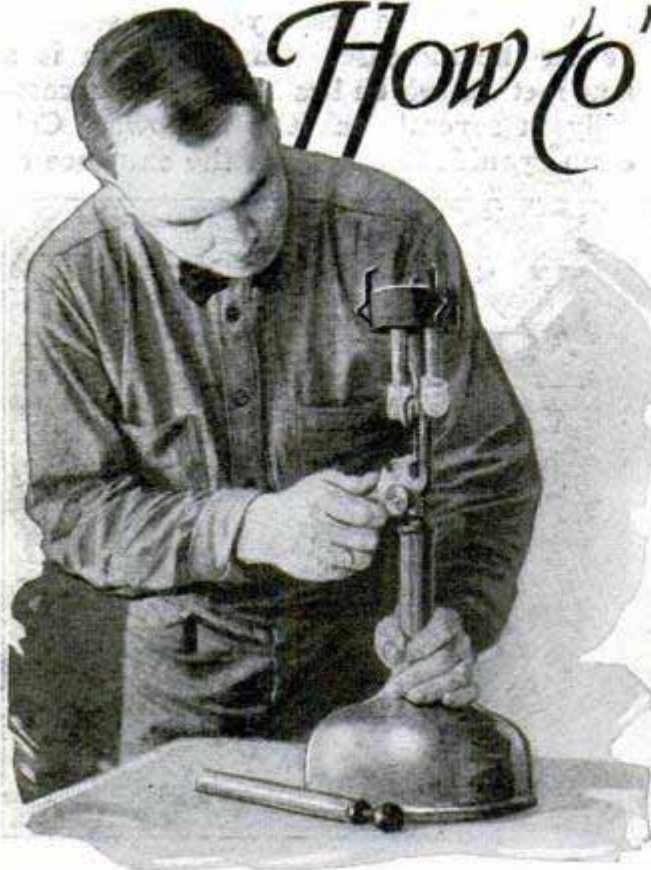

WHERE rural communities are as yet unsupplied with electric current for lighting, gasoline lamps have supplanted the old-style kerosene lamps because of their great illuminating power. Thousands of such lamps are now used and homes are well lighted even without electricity. But, like anything else, gasoline lamps are sometimes subject to little troubles that affect the illumination or cause the lamps otherwise to function improperly.

When the flame dims, the valve steams or the illumination is irregular, just keep in mind that there is practically no danger provided the filler plug is not removed and the gasoline in the fount exposed to air while the lamp is lit or the mantles are in the least bit incandescent. Turn the valve off and wait until the mantles become white and cold and then you can proceed to trace the trouble and remedy it. Troubles with the gasoline-lamp illumination can be traced to either an improper

mixture of gasoline and air in the mixing chamber over the mantles, a plugged generator or impure or dirty gasoline. Either of the first two troubles may be due to several causes, but the elements of poor lighting remain unchanged.

First, last and always, use a good grade of gasoline and strain it when filling the fount. This is essential because the gasoline enters the mixing chamber through a very minute hole and any impurities will surely plug the aperture and cause loss of pressure. Also, good gasoline will form much less carbon than cheap grades, and this keeps the generator passage clear for its normal life.

Dependent upon the above is the most prevalent cause of dimming lights: a carbonized generator or plugged tip. These conditions usually give warning by a gradual dimming of the light, which may extend over a period of several nights. More and more air pressure

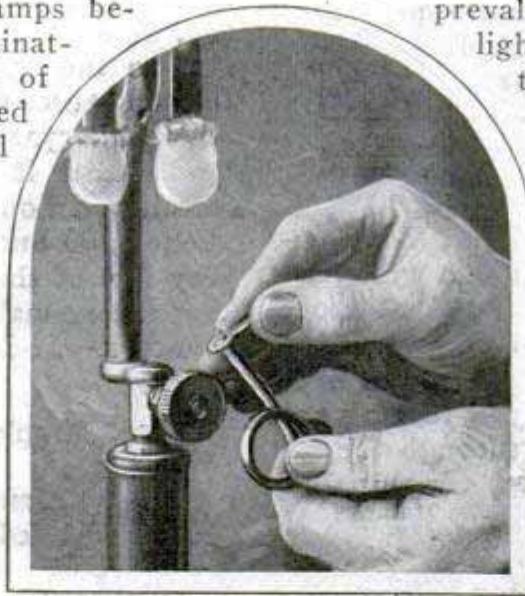

Unscrewing Generator Tip; Right, Inspecting Lead Washer on the Filler Plug

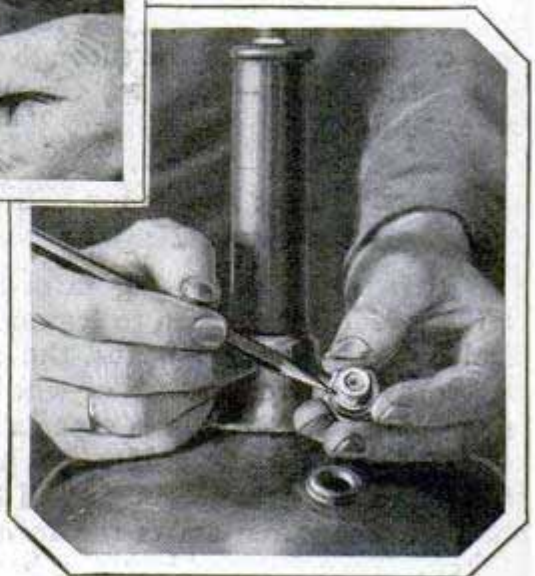

OF YOUR LAMPS

Robbins

must be pumped into the fount as the dimness increases, but finally the brilliancy falls so that the lamp is practically useless. Assuming that there is the required amount of gasoline and air in the fount, it is necessary to remove the generator. This is best done by grasping the circular portion of the generator with the fingers of the left hand and then turning the nut at the bottom of the generator to the left, which unscrews it from the seat below and between the mantles. Use the wrench provided for the purpose or a pair of smooth-nosed pliers.

Lift the generator from its seat, taking care not to injure the mantles, and first inspect the tip. This may be cleared of obstructions by means of the fine wire in the holder usually provided for the purpose by the makers. If, on retrial in the lamp, the light still remains dim, the trouble probably lies somewhere else; undoubtedly the generator is carbonized. Prove this by removing it once more

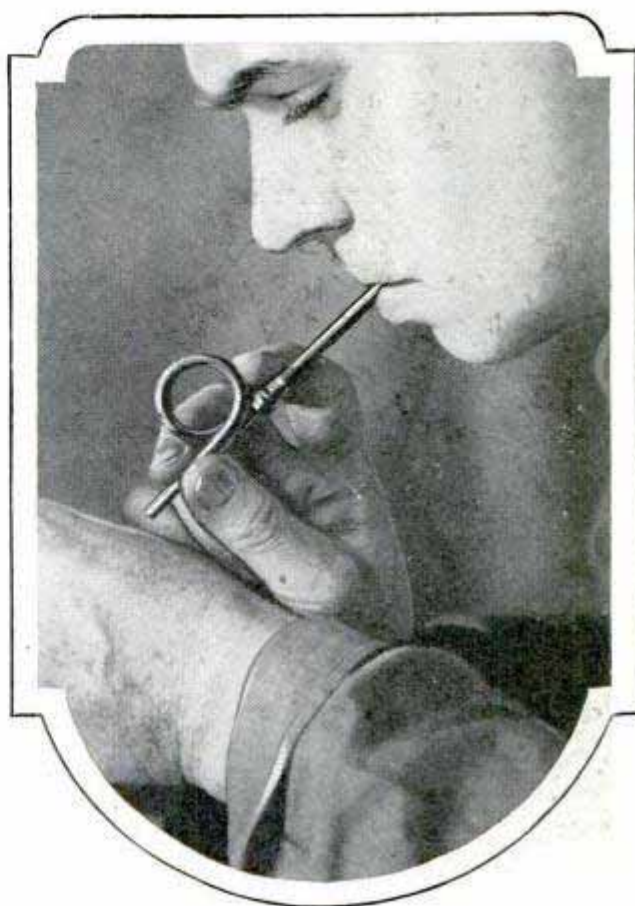

from the lamp and taking off the tip with the wrench. Then blow hard through the threaded end of the generator and attempt

to detect the presence of a stream of air by holding the back of the hand close to the end from which the tip has been removed. In a clean generator, you will be able to feel a fine, cool stream of air on the skin. If the generator is plugged, no passage of air can be felt under normal lung pressure. Throw the generator away and substitute a new one. Trying to clear a carbonized generator is useless labor.

The fine passage is filled with asbestos which, with an accumulation of carbon from long use and low-grade gasoline, eventually makes a solid mass that thoroughly closes the passage to any flow of gas even under high pressure.

When a new generator is to be put in the lamp, clean out the tip and blow through the generator as previously described, so you will be sure of a

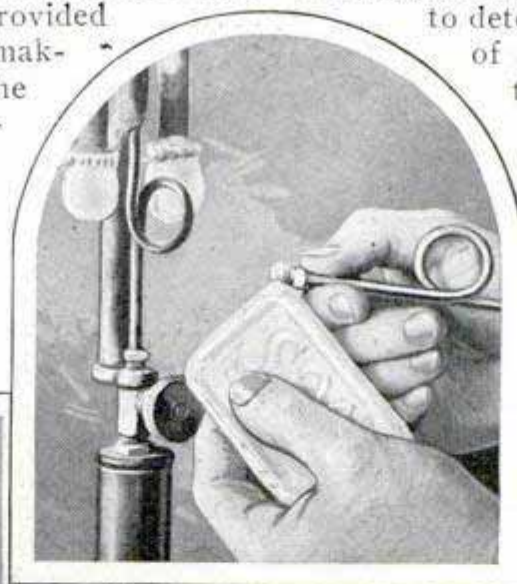

Above, Soaping the Generator Threads; Left, Cleaning Out Generator Tip

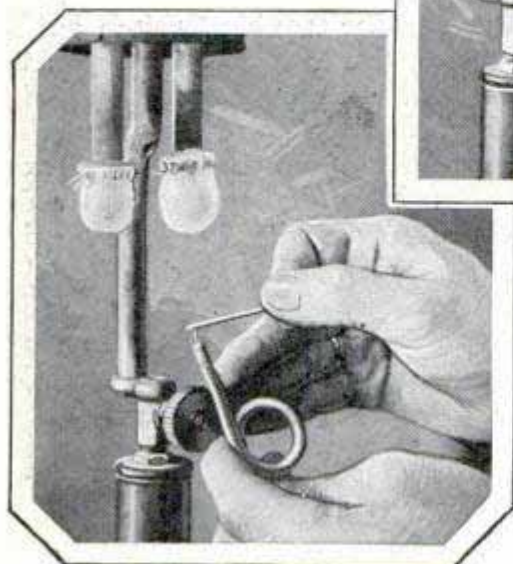

good replacement at the start. Never use a needle to clear a tip. It is much too big and will ream the tip hole so large as

be clogged with soot or other foreign matter. This rarely happens, but if it does, blowing the tubes out with a tire

pump will usually clear them. Another cause may be that the screens at the lower ends of the tubes to which the mantles are attached may be clogged with scale that has dropped from above. Or perhaps they are burned through by heat. If either of these conditions is discovered, remove the screens from the tubes by using two pairs of pliers, as shown, and either clean the meshes or put in new screens. A carbonized generator may also cause this condition, and the removal and treatment of this unit have already been described.

Sometimes, after all the foregoing remedies have been tried, there is still lack of pressure through the generator

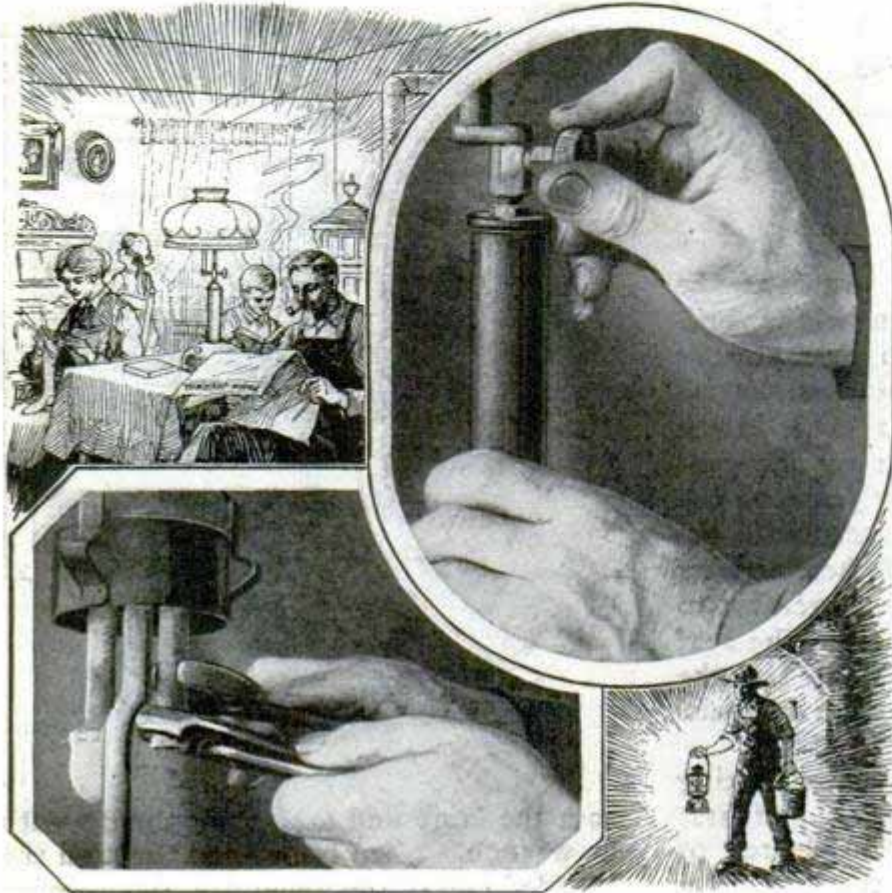

Above, Testing Flow through Valve; Below, Removing Screen from Lower End of Mantle Tube

to render it useless. This hole has been drilled with great accuracy and is large enough to feed the gas into the air chamber above to form a mixture of the right proportions. A larger hole will admit too much gas, the mixture will be too rich and the mantles will blacken, thus destroying the proper functioning of the lamp. When replacing a generator, it is wise to rub the threads of the nut with soap. This is unaffected by gasoline and makes a tight joint. If not soaped, gas is likely to seep around the threads and will sometimes take fire and burn with a small flame. While there is no danger in this, a little soap on the threads will prevent it and make a workmanlike job.

Now let's consider blackening of the mantles. This occasionally happens from no apparent cause, but there is a reason for it nevertheless. As previously stated, it may be caused by a too large hole in the generator tip. If so, the remedy is obvious: renew the tip. In some cases the air chamber above the mantles may

with one or more of the unsatisfactory results following. There is still the possibility that some foreign substance has been forced up from the fount to lodge in the valve and thus cut down the flow of gasoline to that point. To test this, remove the generator and turn on the valve very slowly. If no gasoline spurts out into the fount with plenty of pressure, you have found the trouble. Often opening the valve wide and closing it as quickly as possible will clear it. If not, try running a fine, flexible wire through the crooked opening. Always be careful not to get any soap from the generator threads into this seat, as it will surely lodge in the valve passage below and clog it. As a last resort, release the pressure from the fount and, opening the valve, try forcing air through it by means of an automobile pump. This will often do the trick. Then pour out the gasoline in the fount, strain it, pour back and flush it a second or third time, and then fill with freshly strained gasoline.

Occasionally air pressure cannot be retained in the fount. This, of course, causes the light to dim after the lamp has been lighted a short time and might be mistaken for plugged passages above the fount. A few strokes of the pump will show whether pressure in the fount has escaped. The only probable place this can happen is through the filler plug. Remove the plug, turn it over and inspect the lead washer. If nicked or torn it will surely allow some air to escape. A new one can be quickly slipped on and reseated by simply screwing the plug down in place. Then again there may be a speck of dirt at the bottom of the air stem in the plug. Unthread it and take it out, then squirt a bit of gasoline around it. This will loosen any dirt that may have accumulated around the ball check in this passage and thus allow the ball to close automatically, as it should when the pump is removed from the stem. These two points, and a leaky valve above, are the only three logical points from which air pressure can escape from the fount. So, by eliminating the valve first, any loss of pressure can finally be traced either to the filler-plug washer or the air-stem ball check inside the plug. After considerable use the leather washer to the plunger inside the pump may become so worn as to refuse to pump air into the fount. When this happens, remove the two little screws in the wooden plug in the top of pump, pull out the plug and then remove the plunger rod. As shown in the photograph, the nut holding the plunger washer in place can be removed with a pair of slender-nosed pliers and a new one installed by reversing the procedure. Then a drop of thin oil will lubricate it.

The principle of the lamp is simple.

It consists in forcing a fine stream of gasoline through a continually heated copper tube, to mix with the right proportion of air and flow downward into the mantles as a gaseous mixture. Use clean gasoline and a good air pressure in the fount to force it up. Then keep the valve free and tight-closing, use only free-flowing generators and tips with openings of right bore. When a mantle breaks, replace with a fresh one, because a broken mantle means loss of light and possibly a cracked shade from an escaping flame.

Assuming that you already understand the lighting and general handling of a gasoline lamp, with proper attention and care it should last for years with only an occasional replacement of some part that will naturally burn out from the intense heat. Luckily these parts are few and cost little. Study the few little tools furnished by the manufacturers. Each serves a purpose and should be used when necessary. Then, when a little trouble occurs, you will know how to correct it. There is absolutely no reason for shelving such a lamp because it has failed to shed its former brilliancy. Too many times this has been done, so take down the idle lamp, and, by following the foregoing rules and the accompanying illustrations, you should be able to remedy the trouble.

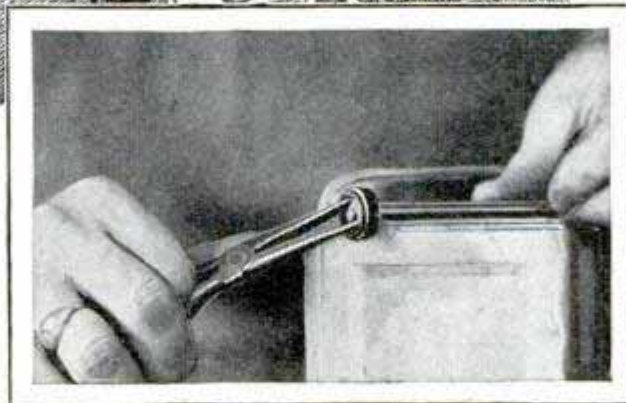

Removing the Nut That Holds the Washer on the End of the Pump Rod



Protecting Tractor Radiator

A shield made by attaching heavy hail screen to a wooden frame and hinging the latter to the base of the radiator of the tractor prevents corn stalks from breaking and bending the fins of the radiator.

The frame with the screen is set at an angle, leaning forward to push the stalks down. It is attached to the top with a brace and hinged, to facilitate its removal and allow cranking of the motor.

Rotating Advertisement on Auto

A phonograph-shop proprietor in Jackson-



Advertising Phonograph Records by Means of Rotating Wheel on Auto Radiator

ville, Fla., who is a firm believer in the advertising value of motion, made a large wheel out of tin, arranged it so that it would turn on a pivot when set in the wind and mounted it on the radiator of his auto. A full-size picture of a phonograph record was pasted in the center of the wheel. As he travels around the city this rotating sign attracts much attention.—Russell Raymond Voorhees, Jacksonville, Fla.

Twine Holds Crankcase Gaskets

To avoid the annoyance, delay and expense of oil-pan or crankcase gaskets slipping out of place while the pan or lower half of the crankcase is being fitted into position, tie the gasket lightly in place by



means of lengths of easily broken twine, threaded through two or more holes in the gasket and pan, as shown in the drawing.

If shellac is used to fasten the gasket, time must be allowed for it to dry be-

fore fitting the pan and it always will be a slow and unsatisfactory job to clean off the old gasket when a new one is needed. By tying the gasket in place, the pan can be set into position without any danger of the gasket slipping off and several studs can be started. Then the twine is pulled out and the rest of the studs are driven in.—G. C. Douglas, Raleigh, N. C.

Keeping Soapstone Handy

While running a lathe I had occasion to use a piece of soapstone very often to determine if the stock was properly centered in the chuck. My soapstone was always getting lost or broken, and I spent more time looking for a new stone than I did in centering the stock. So I devised the simple method of attaching a dozen rubber bands to the stone and fastened these to a length of strong twine suspended from the ceiling. This ended my trouble; the soapstone was always at hand yet entirely out of the way.—Thos. H. Duffy, Juniata, Pa.

Simple Holder for Soldering Copper

The user of either the electrical type or the flame-heated soldering copper will appreciate the attachment shown in the drawing. Bend a small piece of iron or spring wire to form a large coil and clip this to the bit so that the handle end will be heaviest.

When hot, the iron is rested on this simple holder without burning the bench or table top.—G. A. Luers, Washington, D. C.



Easily Made Socket Wrenches

Sections of seamless steel tubing, cut from the frame of a discarded bicycle, can be made into strong, serviceable socket wrenches, which will reach almost inaccessible places and take a firm hold on stubborn nuts and hexagon machine-screw heads. Get a nut of the size you

wish your finished wrench to fit and, after screwing it to a bolt of the same thread, clamp the bolt firmly in a vise. Then, with a hacksaw, cut a piece of tubing from the bicycle frame, long enough to provide a sufficient handhold. Heat the end red-hot and drive it quickly over the nut, tapping the sides to a snug fit. If, by chance, the tubing is a trifle too large, it can be shrunk easily while hot by hammering carefully and turning the metal beneath the hammer, and if too small, a tapering punch driven into the end will enlarge the opening sufficiently. Drill a hole through the handle, insert a piece of round stock for additional leverage, touch up the rough spots with a file, and you will have a good wrench.—J. W. Briggs, Poughkeepsie, N. Y.

Practical Gasoline Brushes for Cleaning Parts

Gasoline brushes for cleaning parts can be made up quickly and at small cost, as shown in the illustration. Open-mouth cans are fitted with a sponge, a roll of felt or a wad of waste. As these brushes are absorbent, they take the gasoline which is contained in the can and apply it to the surface to be cleaned. The use of the materials suggested depends upon the need for either a slow or a rapid feed; the sponge permits an almost continuous flow while the felt only keeps moist. One feature of this method of handling the gasoline is that the brush can be set aside and the stopper will prevent the contents from evaporating.

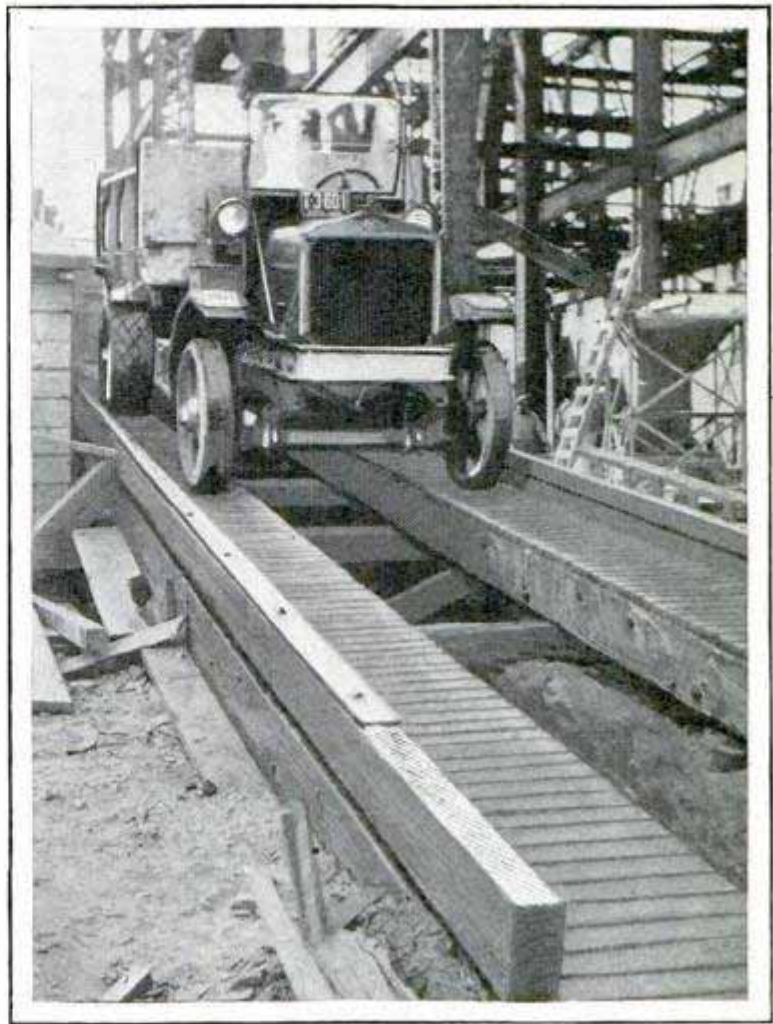
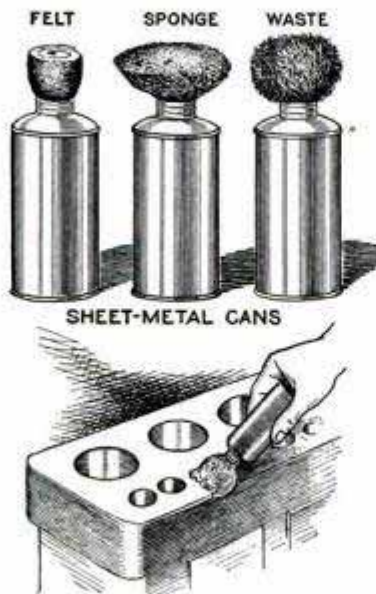

Inclined Runway to Concrete and Sand Bins Which Feed a Mixer Located in Excavation

Runway and Large Material Bins Save Time in Concrete Mixing

By installing his mixing plant and hoisting mast in one corner of the excavation of a building with bins holding 50 yd. gravel and 30 yd. sand, which are filled directly from trucks, a western contractor saves a great deal of time and labor. In order to reach the bins with the trucks, a runway of heavy timbers was laid to them from the curb. The wheelways were made of narrow strips, laid crosswise to afford traction, as there was considerable rise in the runway. Guard rails of heavy timber were provided on the sides. Three men mix concrete and it goes into the building at the rate of a batch, or $\frac{1}{3}$ cu. yd. of concrete, per minute. This method eliminates the gang of laborers who usually wheel the material.—J. C. Coyle, Denver, Colo.

☛ To split off a tight machine nut with a cold chisel is sometimes more economical than to risk ruining the bolt threads.

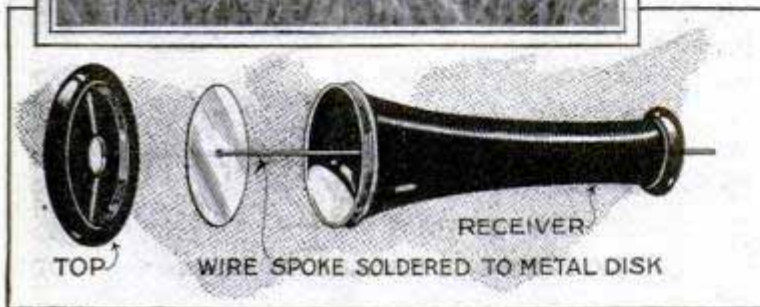

Simple Device for Detecting Leaks in Water Pipes, Made from an Old Telephone Receiver

Device for Detecting Water Leaks

A water company's instrument for detecting leaks in pipes having been broken accidentally, an inspector made a simple and efficient device to take its place. In the small end of an ordinary telephone receiver case he placed a cork, and after cutting from a broken steel spoke in a truck wheel a piece about 3 in. longer than the receiver, he soldered a metal diaphragm, of the same size as the thinner diaphragm removed from the receiver, to one end of the steel wire and filed the other end to a point. Then he removed the cap from the case, inserted the point of the spoke and forced it

through the middle of the cork, seating the new diaphragm in the place the phone diaphragm had occupied. The cap was then screwed on again. When the point of the spoke is applied to a pipe, or to any metal connected with the water system, and the ear placed at the receiver, it is easy to hear running water if there is even a small leak within 200 ft. Leaks 500 ft. away have been detected with this device.

Precautions to Observe in Melting Lead

When working with hot solder or lead the experimenter should take care to prevent the molten liquid from popping into his face when he pours it. Any metal, such as steel and iron, absorbs a certain amount of moisture and, when hot lead or solder is poured into a mold of such material, the liquid will likely splash in every direction, if the mold has not been preheated to drive out the moisture. This precaution never should be neglected. The heating can be done with a blowtorch or the molds may be placed over a gas flame. The same safeguard should be observed in adding bits of dirty solder or lead to a pot of melting metal. The fragments should be dropped in carefully so that there will be no splash, and all dirty pieces should be cleaned.

Sloping Floor for the Garage

Most garages have a perfectly level floor, but if you are building one it will be an advantage to slope the floor slightly toward the door. This enables you to roll the car out of the garage by merely releasing the emergency brake, without the necessity of starting the engine. The incline also prevents water from entering under the door and remaining on the garage floor.—Dale R. Van Horn, Walton, Nebr.

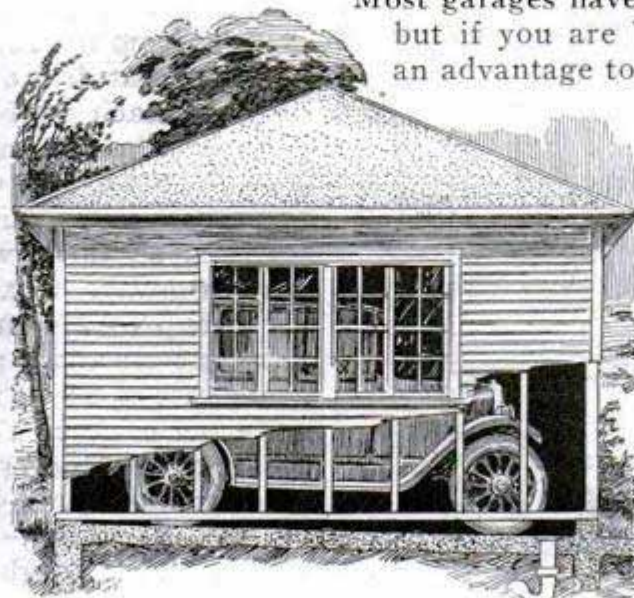

Sloping Concrete Floor in Garage Has Distinct Advantages

Cutting Down the Fuel Bill

By N. L. REA

THE problem of burning the smaller sizes of coal will be an active issue with many householders this winter. Perhaps my experience will be interesting and instructive.

Two years ago I began experimenting with the aim of reducing my fuel bills. My heater is a standard vertical boiler designed for burning the larger sizes of coal. This has a rectangular fire box. First, I began mixing some pea with stove-size coal. Then I mixed two tons of stove, one ton of pea and a half ton of buckwheat. This worked so well that I bought some pea and buckwheat and kept them separate so I could experiment. I tried to obtain new grates with smaller openings for my boiler, but was unsuccessful

and decided to try what could be done with the regular grates.

To make a long story short, I am burning No. 1 buckwheat and getting heat aplenty. The procedure is as follows: The grates are set so they are all even and the openings between them as small as possible. The ends of the shaker extension are marked so that I can keep them in this position. One pair of grates did not match the others and the grates were lowered and these two shifted to match with the rest.

A thin fire is started with chestnut or pea borrowed from the kitchen-range supply, then the buckwheat used altogether. A thinner fire should be carried than when burning the large sizes of coal, as the air does not come through the fuel bed so easily. I

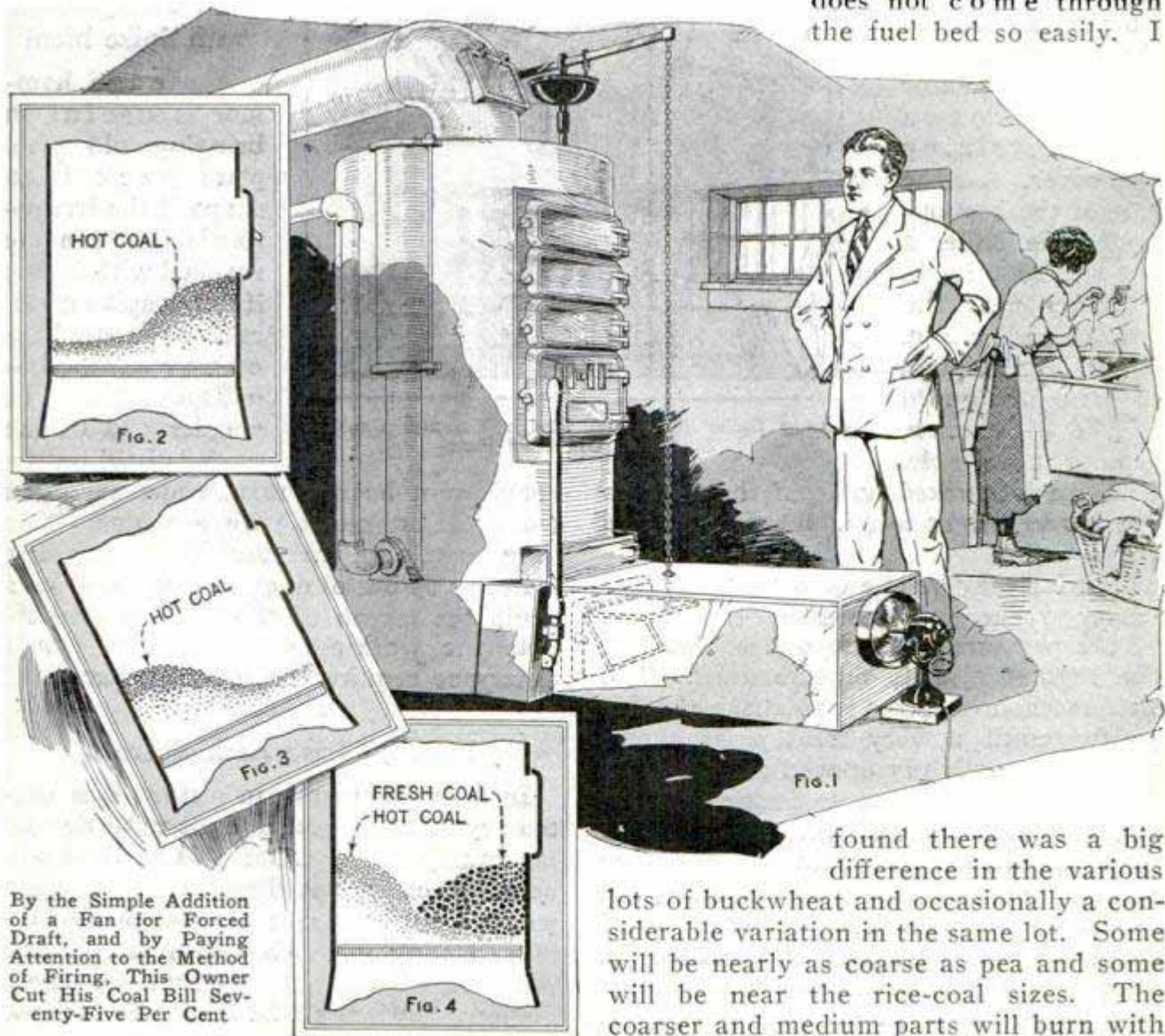

By the Simple Addition of a Fan for Forced Draft, and by Paying Attention to the Method of Firing, This Owner Cut His Coal Bill Seventy-Five Per Cent

found there was a big difference in the various lots of buckwheat and occasionally a considerable variation in the same lot. Some will be nearly as coarse as pea and some will be near the rice-coal sizes. The coarser and medium parts will burn with

natural draft, but the finer stuff needs some encouragement. Then, too, one may want to get heat in short order and the buckwheat is slow to respond to increased draft opening.

My thoughts naturally turned to some way of obtaining forced draft. There was a small 8-in. fan that wouldn't be needed while the boiler was in service and I decided to try to apply that to my problems.

The arrangement is shown in Fig. 1, and is as follows: A box of galvanized iron, with one end open and having the concrete floor as its bottom, was made and set in front of the draft opening, its width being much greater than this. The box is nearly 2 ft. long. A 1/2-in. hole was bored through the cover, so located that the chain from the draft regulator drops through without striking the cover. In the side of the box opposite the boiler I cut a hole 8 in. in diameter near the top, and put a 2-in. collar, large enough to take the guard of the 8-in. fan, around the hole.

The fan is blocked up from the floor to the proper height to match the collar and the opening.

The fan may be idle or running as necessary to meet coal or weather conditions. If the pressure runs up due to the fan, the regulator shuts off the draft. The best method of firing is to shake the fire gently, until a very faint light shows through the slightly opened ash-pit door. Shut down the fan before shaking. Then open the fire door and, with an old spade or light slice bar, work any dead coal or ash out of the back corners and along the side of the fire box. If there are any dead spots in the fire, work them down gently, keeping a thin crust on the bottom. (See Fig. 2.) Then work the bulk of the hot

coal toward the back of the fire box, as shown in Fig. 3, leaving a thin layer of hot coals in front. The new coal is put in the front of the fire box, as in Fig. 4. This gives a belt of red-hot coal across the back so that every bit of gas from the fresh coal is burned. In general the depth of the fire is about half to three-quarters of that carried with larger coal.

Of course, it takes a little more care and some experimenting to learn the right way of handling the coal and draft, but I realized a saving of 75 per cent in my fuel bill and that was worth working for. The radiators were equipped with vacuum-type air valves, and all valves re-packed to eliminate air leaks.

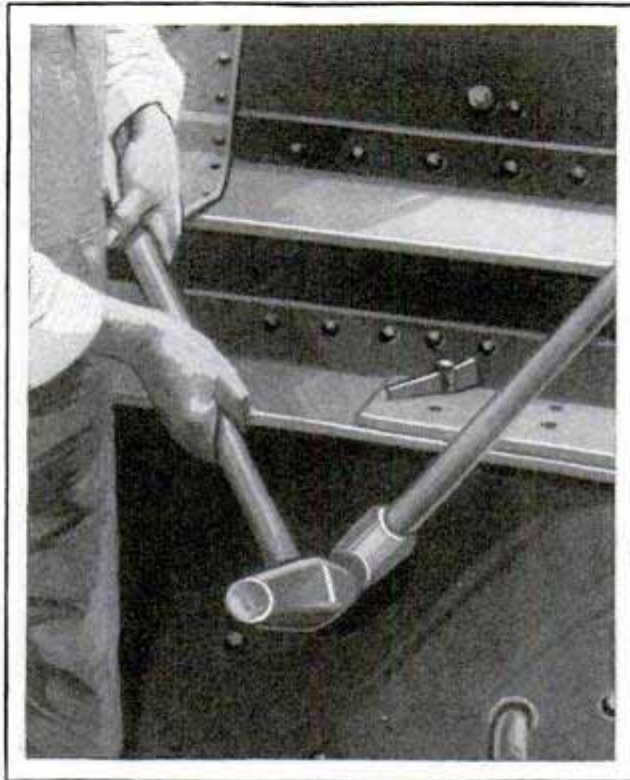

Railway Spike Maul and Sledge Hammer Used to Straighten Old Steel Plate

Steel Straightened with Spike Maul

A sledge hammer is useful in bringing old steel plate back into shape if the irregularities can be reached with it, but if not, a spike maul, such as is used on every railway, is indispensable. The smaller end of the maul is held on the

rough spot by one man, while a second workman strikes it with a sledge. The long handle on the maul allows the first man to stay out of danger from the sledge, while the length of the maul itself permits the working of spots that would otherwise require the use of a bar.

Fitting Wristpins in Pistons

In fitting wristpins in pistons it is customary to ream out the hole until the pin fits snugly in it. Often this method will be satisfactory, but there are some cases where a little more labor will result in a more lasting job. Cast iron and bronze are not always of uniform hardness. Sometimes when a hole is reamed the tool

goes through, the hard spots recede till the reamer is out of the hole and then spring back. This happens especially with a dull reamer. The spring of the metal is slight yet sufficient to make a loose fit after a short while. When a wristpin is driven tightly through such a hole, it bears against the metal only at certain spots, with the result that the hole will not keep its size very long. A better job, because more lasting, is made this way: Ream out the hole about .0005 in. smaller than the wristpin. Drive the pin through after it has been coated with Prussian blue or chalk. The high spots will show up shiny. Carefully remove these with a scraper; drive the pin through a few times, and repeat the scraping till the connecting rod will fall by its own weight when assembled. In scraping the hole, take care to work in different directions; that is, cross the scraping marks to prevent vibration marks. If no micrometer is at hand, another method can be followed. When the hole is reamed until the wristpin starts to go into the hole tight, or starts to bite, it is ready for scraping. A clearance of .002 in. will produce a knock at high speed, the first thousandth is the most important. Pistons get out of round sometimes when driving the wristpin in, even without scraping, but can easily be made round again by light pressure in a vise. Holding it in the hand and hitting it with a wooden mallet or a soft hammer will also do the job.—J. H. Smit, Newark, N. J.

Combination Gauge and T-Square

Carpenters and cabinet makers will find the combination gauge and T-square shown in the drawing very useful. It consists of an ordinary steel rule and a wooden head provided with cleats to hold the rule at right angles. The combination takes less space in the tool box than a separate gauge, ruler and T-square, and is just as handy as the latter.

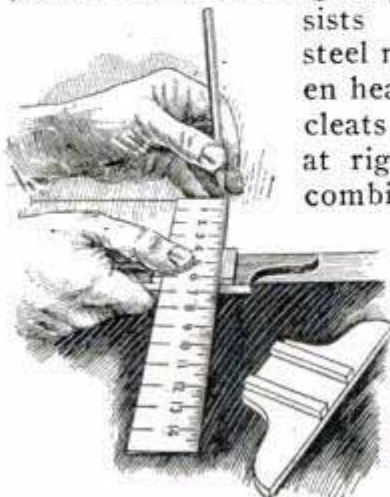

Shield Stops Flying Rivets

Many injuries were suffered by the men in a Denver steel shop from rivets flying through the air, when they were driven out by an air hammer or with a back-out tool and a sledge, so a shield was provided to prevent this. This shield is bent at one end so that it can be hung up in front of the flying rivets. When driven out, they strike the shield and drop harmlessly to the ground.—Jos. C. Coyle, Denver, Colo.



Reinforcing Weak Wagon Wheels

Where wooden wheels are subjected to extremely heavy strain, as in hauling sand, cement, stone, etc., they can be strengthened by the simple and easily made device shown in the photo. It consists of a sheet-iron disk cut out in the center so it can be slipped over the hub on the inside of the wheels and fastened securely to the spokes with U-bolts. The disk offers a counter effect to the outward tilt of the spokes and prevents the wheel from collapsing, no matter how heavy the load may be.—Ralph W. McPherson, Wahoo, Nebraska.

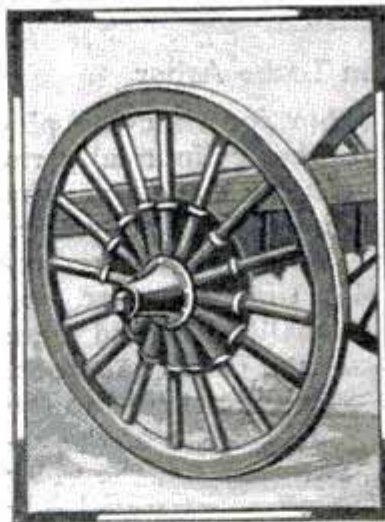

Wood may be preserved indefinitely by keeping it perfectly dry or submerged in still water, to prevent attacks of insects.

Safety Measure for the Electric Switch



The drawing shows a simple but efficient method of making an electric throw switch safe. Raise the switch to a height of about 8 ft. Cut down a broom handle to a length of 4 ft. and have a blacksmith make an iron clamp, about 8 in. long, on which the handle is to pivot, and two links which attach the handle to the switch. Drill two holes through the broom handle, one about 2 in. and the other 10 in. from the end, and mount the broom handle as shown.—Grover Brinkman, Okawville, Ill.

Expansion Lathe Arbor

An expanding arbor for chucking pistons, bushings and other cylindrical parts in the lathe is very easily made from the accompanying drawings. The body is of steel or cast iron. Four holes, intersecting at right angles to the center, are drilled through the smaller part and these are fitted with sections of round bar stock, the outer ends of which are curved to the

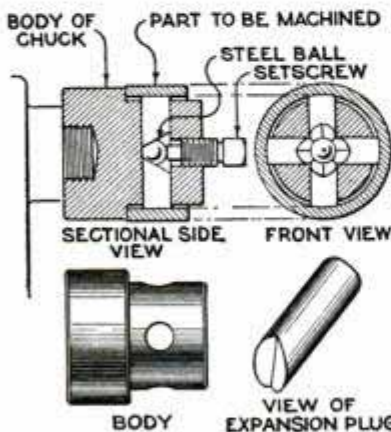

arc of the arbor, the inner ends being slotted with slanting V-grooves for a small hardened-steel ball. When the setscrew in the end of the body is turned in, the ball forces the expansion plugs out on four sides, gripping the work and holding

it tightly. Only a slight movement of the wrench is necessary to set a part on the arbor or release it.—G. A. Luers, Washington, D. C.

Handy Case for Printers

One of my acquaintances, who is employed in a large printing shop, obtained a number of boxes in which sewing cotton had been packed, these being 4 in. wide, 6 in. long and about 1 in. deep. Cardboard partitions, sewed with strong thread, were arranged in them, in the same order as the standard quad cases. Being so small, the boxes can be carried to any part of the shop, the type set from the case and spaced on the spot, instead of running back and forth. Although the boxes are made of cardboard, they last for quite a long time and the cost involved is practically nothing.—H. R. Calhan, San Francisco, Calif.

Improving the Pencil Sharpener for Draftsmen's Use

Pencil sharpeners of the ordinary style grind the lead to a point which is unsuitable for draftsmen. This difficulty can readily be overcome by removing the cutters and grinding the cutting edges toward the handle smooth for about $\frac{3}{8}$ in.

as indicated. This clearance may have to be varied depending upon the casting.—W. J. Edmonds, Whitehall, N. Y.

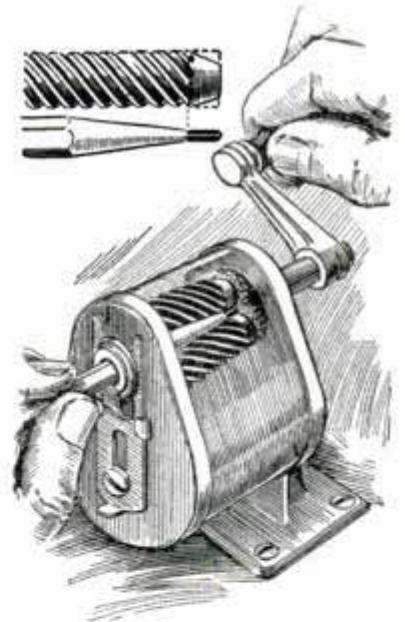

How to Adjust Coulters of Plow to Do Best Work

The rolling coulters of any plow has two particular purposes. First, it should cut through all trash, such as old stalks, grasses, etc., so that the portions of these

outside of the landside will not be turned in with the furrow. Otherwise this trash will be thrown on top of the plowed ground rather than turned under it. Second, the coulter should cut the earth in a clean, straight line so that the moldboard can lift the dirt cut with ease and without breaking or tearing it apart. To do these things, the coulter should be set so that it will run about 3 in. back from the point of the share, that is, the axle of the coulter should be set at this point. Following directly in line with the shin, or outer side of the moldboard, the coulter should be set to cut $\frac{1}{2}$ or $\frac{3}{4}$ in. outside of this. This insures a cleaner-cut furrow and prevents the bank of the furrow from rolling down after the plow has passed. These adjustments should be made after the plow has been started, as it is then easier to find the line in which the swiveled coulter will run, than attempting to get it into the correct position after you have begun plowing.

Large Vise Holds Small One

Experimenters often find use for a small vise, and if a large vise is available it can be used as a holder for the small one as shown in the illustration. The latter is attached near one end of a piece of 2 by 2-in. hardwood, about 1 ft. long. This is clamped in the large vise when in use, and can be held solidly in several positions. The small vise is better located for use than if attached to the top of the ordinary bench, which is often too low for small work. Also, as many small vises have a screw clamp on the base, they will not open far enough to clamp on the edge of a thick bench top. Some small vises have two screw holes for attachment to the top and these can be attached to the hardwood stick by means of two wood screws or stove bolts.

—E. T. Gunderson, Jr.,
Humboldt, Iowa.

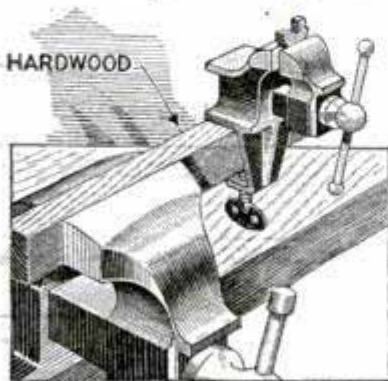

Portable Chicken Fence

To do away with bulky chicken pens that were always in the way when not in use, we made up 8-ft. sections of wood frames of 1 by

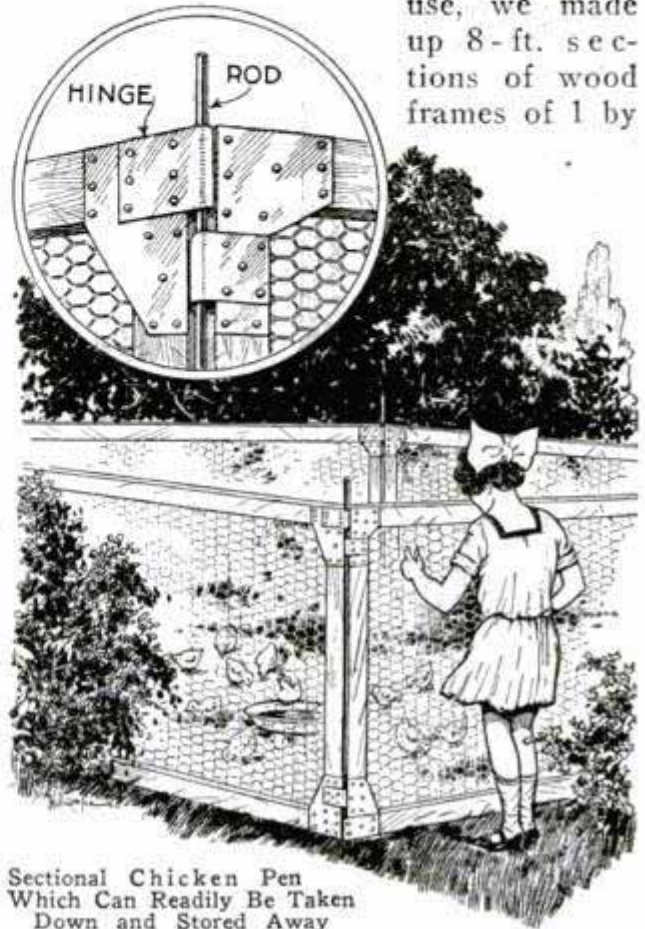

Sectional Chicken Pen
Which Can Readily Be Taken
Down and Stored Away

2-in. material and covered them with fine-mesh netting. At the ends we tacked on loops of tin so that, when the ends of the frames were brought together and an iron rod run through the loops, they served as hinges. For the baby chicks we used as many of these sections as necessary to accommodate them. To insure greater stability the rods may be driven into the ground after they are inserted through the hinge loops. The pen is easily and quickly taken down or moved, and any size or shape of pen that best suits the needs and the ground on which it is to stand can be built. When the chicken season is over these sections come in very handy to protect the garden, new flower beds or to set up a tight but temporary fence wherever needed. And when all use for them is over, they can be taken apart and stored away.—R. W. McPherson, Wahoo, Nebr.

Ⓞ A special file should be provided for filing babbitt and it should be oiled slightly to prevent the metal from sticking.

Tack This Up in Your Home Workshop

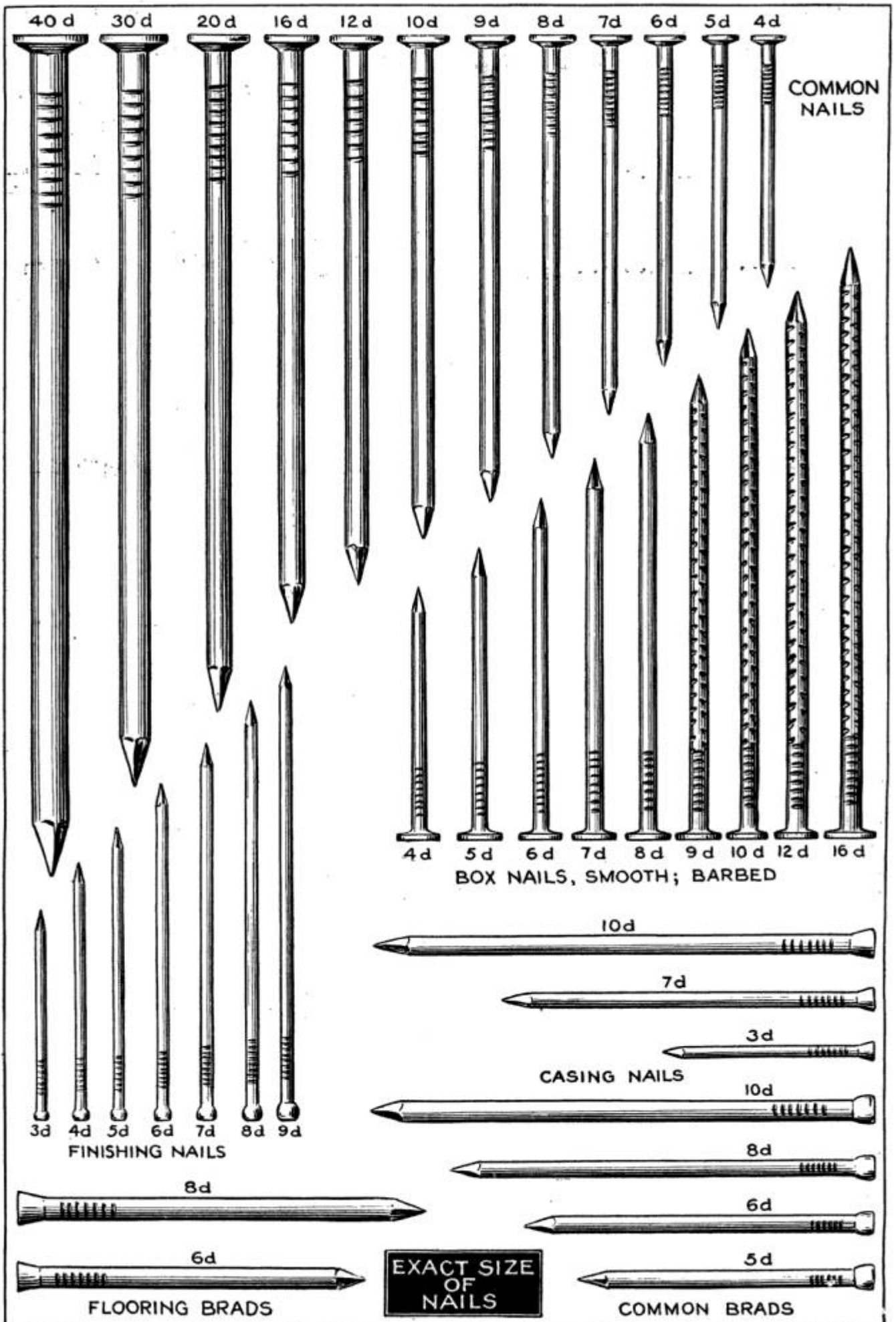

Cement for Asbestos Steam-Pipe Covering

When steam pipes are to be covered with asbestos and the cellular covering so common nowadays cannot be had, a good covering paste can be made as follows: Mix a thick paste of ground asbestos and a solution of sodium silicate. Then add a small amount of calcium chloride to render the mass insoluble after the paste has set. Steam will not soften it, and it will cling to the pipe and offer good insulation.—L. B. Robbins, Harwich, Mass.

Heating the Delivery Truck

During winter months the groceryman, milkman and others, who must deliver their products some distance, will find a heater within the car of a great advantage. Commercial exhaust heaters cost from \$15 to \$25, including the installation, and a serviceable heater can be made at much less expense. Remove the exhaust line and muffler from the car and insert a tee between the forward end of the muffler and the end of the exhaust line, employing 1½-in. pipe fittings. Then screw a vertical section into the tee fitting and insulate the lower section of this where it comes in contact with wood. Place a tee fitting at the top of this vertical pipe and run two branches, as shown, through the truck body. Run two lengths down with their ends just projecting through the floor of the car. During the summer months the ends of the pipes are closed with pipe caps, but in the winter these ends are left open so that the exhaust gases will circulate around the car.

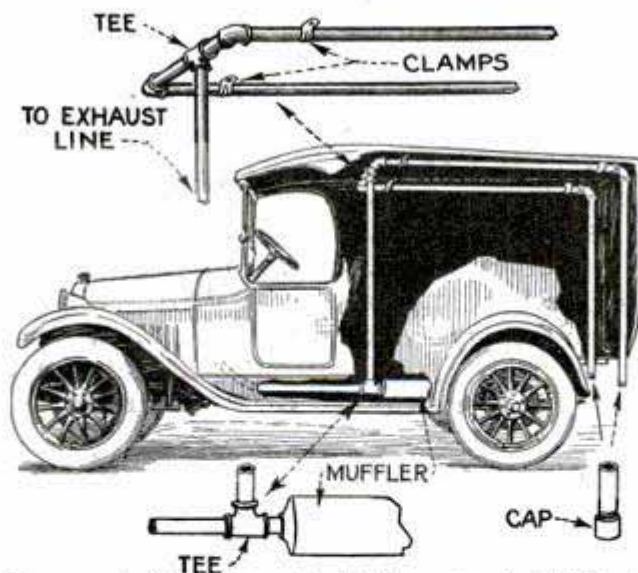

Homemade Pipe Heater for Delivery Trucks Which Is Attached to the Exhaust Pipe

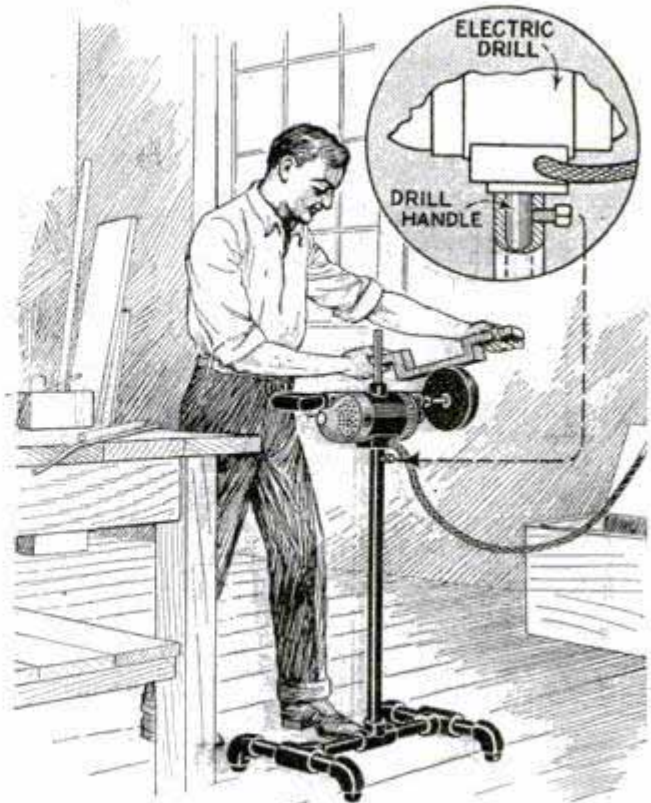

Simple Holder for an Electric Drill Which Permits It to Be Used as a Grinder

Portable-Drill Stand Enables Its Use as a Grinder

Besides being an ordinary holder for the electric hand drill, this stand permits the drill to be used as a grinder. It is made of lengths of ordinary gas-pipe and fittings. The construction is simple and can readily be followed by carefully observing the drawing. A small set-screw is driven into the top end of the upright and locks the handle of the drill securely, as may be seen in the insert.

Ⓞ Rivets should be cut off before they are put into place, so that just enough metal is available for proper riveting.

IN accordance with the editorial policy of this magazine never to accept compensation in any form for what appears in our reading pages, and also to avoid the appearance of doing so, we are obliged to omit the name of the maker or the seller of any article described. This information, however, is kept on file and will be furnished free, by addressing Bureau of Information, Popular Mechanics Magazine, Chicago.

704

Is This Your Home?

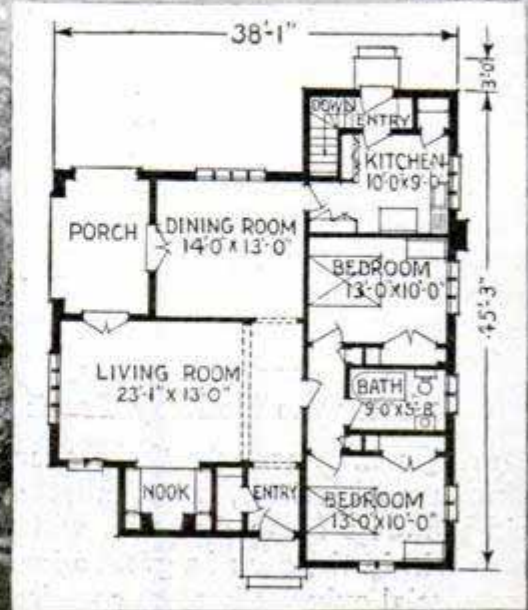

Copyright, Architects' Small House Service Bureau

Plan No. 5B6

QUESTIONS regarding home building addressed to this magazine will be answered by The Architects' Small House Service Bureau of the United States, Inc., controlled by the American Institute of Architects and endorsed by the United States department of commerce. Inclose 10c and self-addressed envelope. Blueprints, specifications and material list for the house shown here may be obtained at nominal cost. Inclose self-addressed stamped envelope for reply. If further information is desired, send 5c and stamped envelope for a 24-page booklet explaining how the Small House Service Bureau functions and showing 12 sample plans. A new booklet, entitled "Fifty Ways to Lower Home Building Costs," illustrated by ten bureau houses actually lived in, and showing how as much as \$1,000 can be saved on a home, may be obtained for 20 cents.

THIS bungalow should appeal strongly to those seeking individuality in a home. It is romantic in character, having its origin in the small farm houses of southern Italy. It has five main rooms, an inglenook, bathroom and five closets. The basement is only partly excavated, although a full basement can be provided.

The building plan of the house calls for hollow tile walls on masonry foundations. The exterior finish is troweled stucco. The roof is of mission tile. A lot from forty-five to fifty feet in width will be required.

There are many interesting features. The general form is unusual, and the treatment of the inglenook and chimney is delightfully impressive. The break in the roof around the chimney softens the outline. The arched entrance doorway, well-proportioned gables, close cornice and casement windows with solid outside blinds combine interesting details, all of which contribute to a successful whole and a happy blending of the various units.

The living room is unusually long for a house of this size, twenty-three feet. An inglenook, containing fireplace, seats and bookcase is the outstanding feature of the room. The dining room faces the garden, and opens directly onto the rear porch. The kitchen is provided with every working convenience, plenty of cupboards and a storage pantry. The bedrooms are separated from the main part of the house by a private hall. Here is a bungalow of distinction that can be built in any section of the country.

Home Builders' Questions

Q. Please advise what is proper to use on a shingle roof, paint or stain? **A.** You may either paint or stain your shingles. In any case they should be preserved with creosote applied under pressure. It can be stained or paint can be applied over it.

Q. Someone has told me that I can get a powdered paint that will be cheaper than ordinary paint. Can I use this for exterior work? Where can I obtain this and how is it mixed? **A.** The paint you are inquiring about is so-called "water paint." It cannot be used for exterior work as it will wash off. Paints that are subjected to weathering must be mixed with a vehicle of oil. Water paints can be obtained in any paint shop.

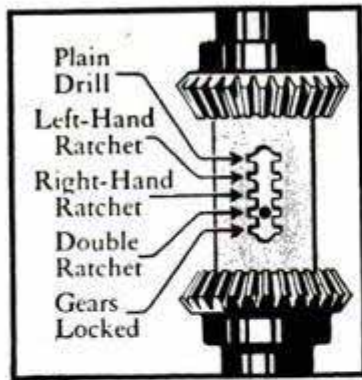

**"YANKEE"
Ratchet Breast Drill
No. 1555**

A finger touch on Ratchet Shifter gives any one of five adjustments.



The "YANKEE"

Ratchet is a Short Cut to Results

With "Yankee" Ratchet Breast Drill No. 1555 set on **DOUBLE Ratchet**, any slight movement of the crank, either back or forth, lets you drill continuously.

Think what this means when you have space for just a half turn—or only an inch.

Nothing need be removed. No lost motion. No lost time.

The four other ratchet adjustments shown above, and two speeds, make this "Yankee" Drill the handiest and fastest ever designed.

You can change speeds instantly without removing drill from work. Just shift lever at base of hub.

Ratchet Breast Drill No. 1555 (Illustrated), 3-jaw; No. 555, 2-jaw. Hold $\frac{1}{2}$ in. Drills. Ratchet Hand Drill No. 1545, 3-jaw; No. 545, 2-jaw. Hold $\frac{3}{8}$ in.

For smaller drilling jobs use "Yankee" Ratchet Hand Drill No. 1530, with five ratchet adjustments.

Some other "Yankee" Tools

Ratchet Screw-drivers
Ratchet Bit Braces
Automatic Push Drills
Automatic Feed Bench Drills
Ratchet Tap Wrenches
Vises, Removable Base

**Dealers Everywhere Sell
"Yankee" Tools**

"Yankee" on the tool you buy means the utmost in quality, efficiency and durability.



Write for
FREE

"YANKEE" TOOL BOOK

This interesting little book is for all lovers of fine tools. It tells just what you want to know about all the famous "Yankee" Tools for making work easier and quicker.

NORTH BROS. MFG. Co., Philadelphia, U. S. A.

"YANKEE" TOOLS

Make Better mechanics

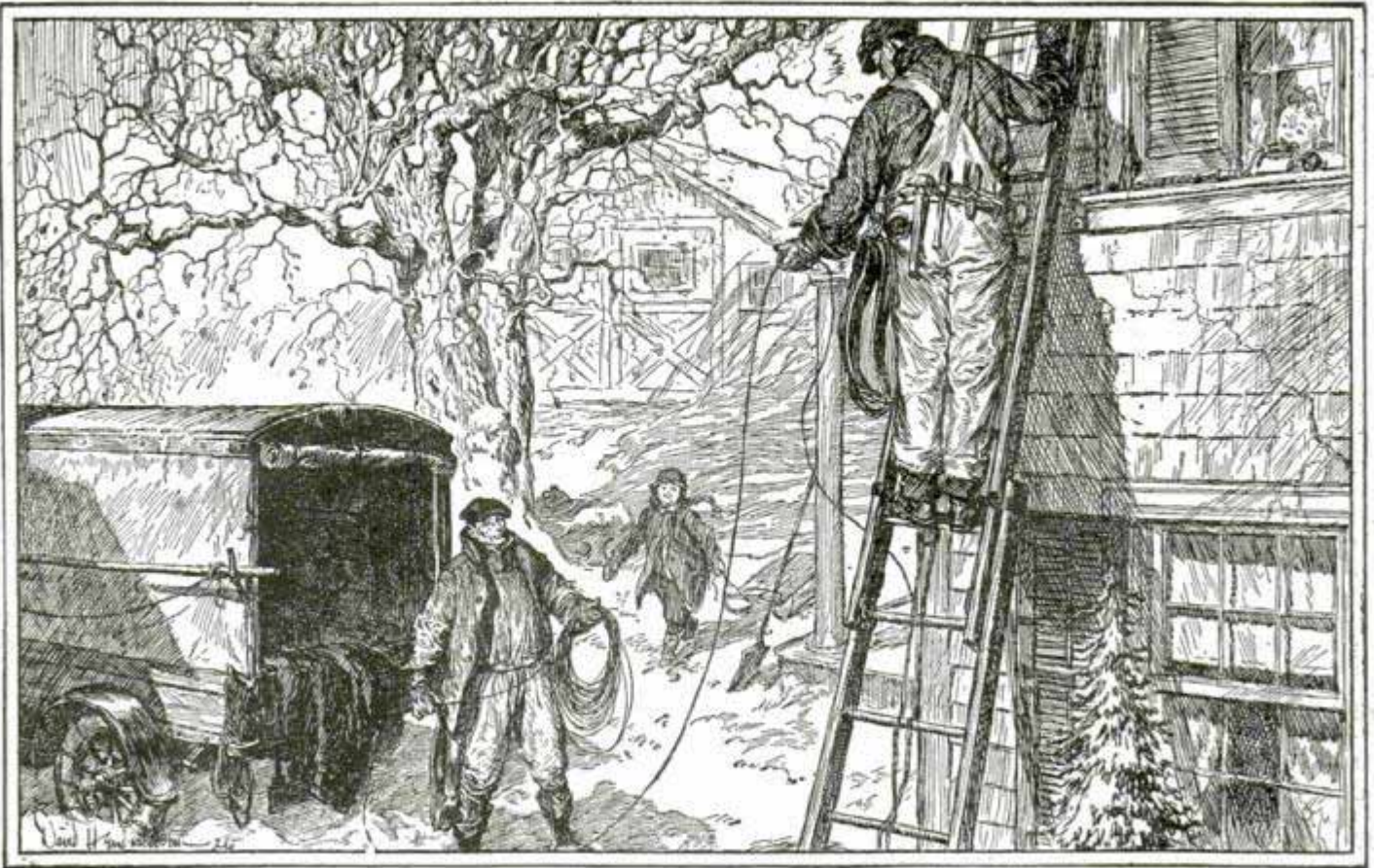

Service All the Way

*An Advertisement of
the American Telephone and Telegraph Company*

It is impossible for a railroad train or a ship to call at the doorsteps of its passengers when they wish to take a journey. To take even a trolley or bus ride, one must go to some definite point where the conveyance stops. On the other hand, the telephone goes all the way to meet the public's convenience.

Each telephone call may be compared to a taxicab, whose destination is controlled by the subscriber. The telephone company extends its wires to the homes and offices of those who desire service, placing its telephones within immediate reach. The call is made at the time, from the point,



and to the place that the subscriber desires. He speaks to the person he wants—wherever he may be.

At the disposal of each telephone subscriber are the talking channels of the entire Bell System. He may make a call a few or thousands of miles, and he may extend his voice to any point, to any person who has a telephone.

This is the essence of communication. Because of it, the number of telephones has increased in the last five years three times as fast as population. Because of it, the Bell System carries more than twenty billion messages in the course of a year.

A turn of the screw tightens the handle



Plumb Hatchet

At good hardware stores everywhere:
No. 2962, Price \$1.60 (except in Far West and Canada)

Always sharp! Always safe!

Sharp! because Plumb-tempered steel holds a keen edge through all kinds of cutting.

Safe! because when the handle loosens (as all handles do) you just turn the screw and it's tight as new again. No loose head spoils the balance, or ruins your work.

Plumb's method of treating the steel gives great strength across the eye. The

Plumb-designed handle gives a sure, easy grip.

It's a real hatchet,—this Plumb. You can sink it deep—or slice just a shaving. Plumb balance sends the blade where you aim it.

Have a *real* hatchet one that stays sharp; one that stays safe. Get a Plumb in your hardware store. Red Handle and Black Head identifies the Plumb Hatchet and other Plumb Tools.

FAYETTE R. PLUMB, Inc., Philadelphia, U. S. A.



He makes \$2,000 a year extra with CORONA

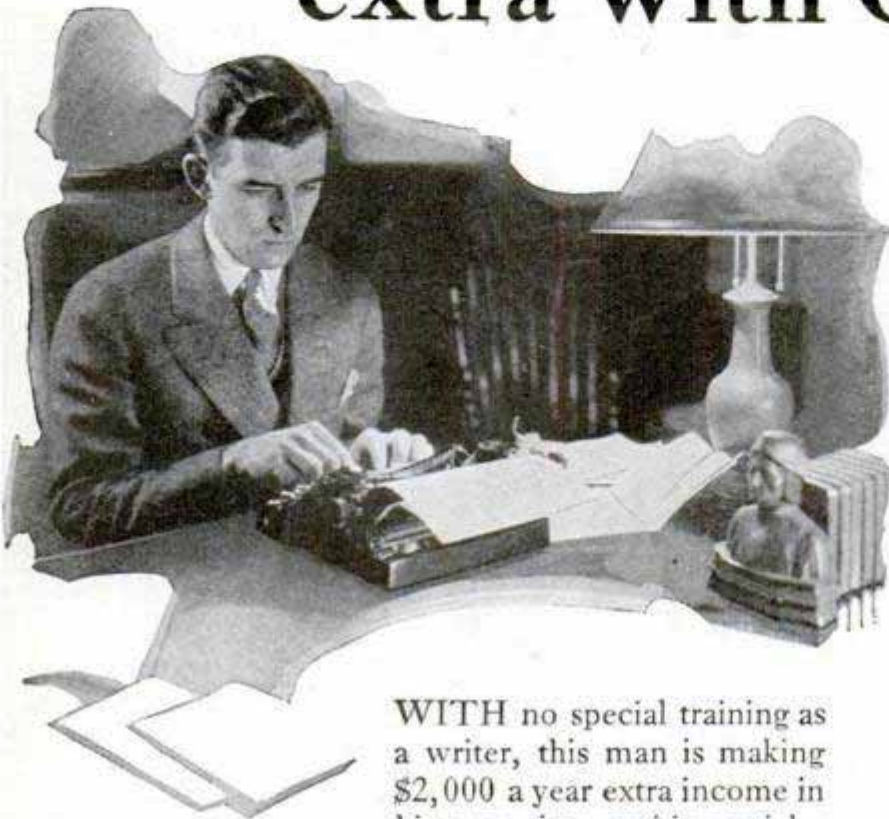

WITH no special training as a writer, this man is making \$2,000 a year extra income in his spare time, writing articles and stories with Corona. Many people have this talent for writing. Few ever develop it.

Nearly all successful writers own Coronas. They tell us that Corona makes writing easy—that it actually helps them think more clearly, write more vividly. Its amazing durability has been proved by the experience of nearly a million users.

Let Corona help you develop your earning capacity. Mail the coupon now. That's the first step. Our free instructions for writers will bring you this useful book without charge or obligation.

L C Smith & Corona Typewriters Inc

Sales offices in principal cities of the world
Established 1903

Also manufacturers of the L C Smith Typewriter, the ball-bearing office machine

You can own this latest model Corona

It's the finest Corona ever built—made by the world's pioneer manufacturers of portable typewriters.

A sturdy, dependable writing machine with standard four-row keyboard, full width (ten inch) carriage, twelve yard, two color, self-reversing ribbon, variable line spacer, everything you expect in an office machine. Yet it is compact, portable, easy to carry with you wherever you go.

Buy a Corona on easy terms

A small deposit puts Corona in your home and then you can pay on easy, monthly terms just like rent. Your Corona dealer will gladly accept a used typewriter, any standard make, as part payment. You need not wait another day. Just look up Corona in your phone book and the dealer will send you one for free examination.

Mail the coupon for the latest Corona literature and details of our easy payment plan.

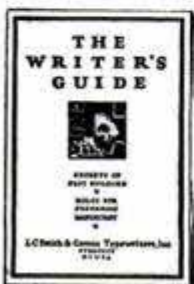

L C Smith & Corona Typewriters Inc
212 E. Washington St., Syracuse, N. Y.

Without obligation to me, please send me a free copy of The Writer's Guide—and complete information about Corona.

This
Book
is Free

Name.....

Address.....

Do you own a typewriter?..... What make?..... Would you like to know its trade-in value?.....

LOOK!

Run *Your* Radio from your Electric Current

And remember, it makes no difference what kind or what make radio set you have, PHILCO Socket Powers will give you *both* A and B radio power from your electric light current—*dependably and constantly*. Here is your opportunity to do away with the ordinary "A" storage battery, dry cell batteries, and "B" batteries.

One switch controls everything. Snap in "ON," and from your house current you get a strong, steady flow of A and B power. Snap it "OFF," and your radio is silent.

No Hum—No Distortion

Philco Socket Powers will give you radio reception without the least hum; without the least distortion. Your electric lighting current will now operate your radio set smoothly and perfectly—*any kind or any make of set*.

No more recharging to do; no more dry batteries to replace; no more fuss; no more bother, and better still, improved reception.

Yours On Very Easy Payments

You can buy PHILCO AB Socket Powers on *Easy Payment Terms* from any Philco dealer in your town. You merely make a small first payment—balance monthly.

Go to your Electrical Dealer, Department Store, Electric Light Company, Music Dealer or Battery Service Station; tell them you read this advertisement and you want the PHILCO RADIO SOCKET POWER.

Mail This Coupon Now

Visit the Philco dealer, or if you prefer, mail this coupon to us and we will give you the full details direct from the factory. We will send you complete information on our Easy Payment Plan and Trade-In Allowance offer for your old storage battery.

Sign your name and address to this coupon, and mail it to us today. The coupon is not an order. It does not place you under the slightest obligation. It is merely a request for the full details and free illustrated literature describing these famous Philco Socket Powers.

Philadelphia Storage Battery Co.
Philadelphia, Pa.

Dept. 1432

PHILCO Radio "A" and "B"
Socket Power © H.B.B.



Installation FREE

No matter where you live there is almost sure to be an authorized PHILCO dealer near you who will deliver a brand-new Philco Socket Power to your home on the day and hour you desire. He will connect it to your radio set at *no additional cost to you*.

The Philco dealer in your community guarantees you complete satisfaction.

Trade In Your Old Storage Battery

Yes, any one of the many thousands of Philco dealers will make you a very liberal trade-in allowance for your old "A" storage battery on the purchase of a brand-new Philco AB Socket Power.

It makes no difference what make of "A" storage battery you now have or how old or worn out it may be, the Philco dealer will give you a surprisingly liberal allowance.

SPECIAL COUPON

Philadelphia Storage Battery Co.,
Ontario and C Streets,
Philadelphia, Pa.

Dept. 1431

Gentlemen:

Please send me, without cost, illustrated literature describing the famous Philco A and B Socket Powers. I also desire full details of your Easy Payment Plan and Trade-In Allowance offer. It is understood that this request places me under no obligation.

Name

Address

Name of your radio set

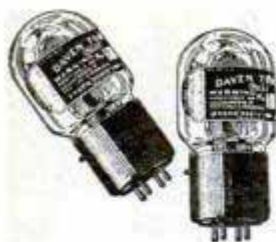

The Daven Mu 6 and Mu 20 Tubes

Clarify and beautify Tone by utilizing the full power of which your set is capable without blasting or choking. MU 6, \$4.50. MU 20, \$4.



Daven Condenser

Type A. Proper capacity for resistance coupling. Will pass every audible frequency without blocking. \$1.



Daven Leakandenser

A patented combination of grid leak and grid condenser which, besides saving space, insures clear detection at all times. Equipped with soldering lugs. \$1.



Daven Ballast Resistor

Eliminating a rheostat, this Daven device improves reception by insuring constancy. Conserves battery current. Indestructible. All capacities, one to five tubes. Special mounting, \$1. Without mounting, 75c.

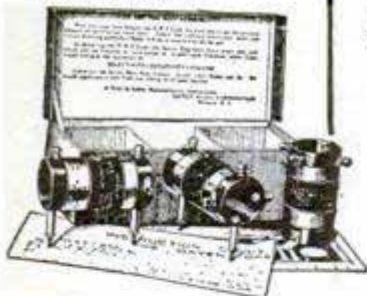

Daven Radio Frequency Coils

Extremely sensitive. Extremely selective. Give both volume and ease of control. Eliminate self-oscillation, because of small interaction field. Responsible for the Daven Bass Note Circuit's perfect radio end. Set of 3, \$8.

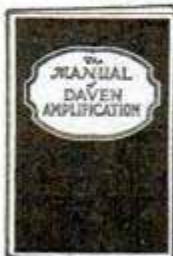

Latest Edition Daven Manual

Tells how to apply Daven Amplification to any type of set. Full and complete information. 25c at Daven Dealers. (30c by mail.)

Daven Revolutionizes Radio Tone

BACK of every Daven Radio Accessory is one aim—to improve and perfect Tone in radio reproduction. Doing away with extraneous noises, avoiding distortion, preventing losses, are a few of the ways in which the Daven Radio Products contribute to the production of natural tone.

The clear, deep, natural tone of the Daven Bass Note Circuit which utilizes the various Daven units to fullest advantage, is proof of the success of the Daven aim.

This new radio hook-up, which we sincerely believe to be the most satisfying circuit ever produced, and whose principle is the basis of the leading factory built sets of the coming year, may easily be built by any radio enthusiast. The necessary units are obtainable everywhere that good radio parts are sold; or the Daven Bass Note Set may be obtained in factory built form.

The leading radio dealers in town are usually Daven Dealers. If you want to be thoroughly up-to-the-minute on radio, make a point of hearing the Daven Bass Note Set, the most perfect toned reproducer.

Complete Daven Catalog Free on Request

"The Sine of Merit"

DAVEN RADIO CORPORATION

TRADE MARK "Resistor Specialists" REGISTERED
162 SUMMIT ST. NEWARK, N. J.

DAVEN

FAMILY OF RADIO PRODUCTS



Daven Bass Note Set

Manufactured by the Port Manufacturing Company—our Radio Set Division. Six tubes. Economical of space. Handsome mahogany cabinet, \$150. West of Rockies, \$160.



Daven Glastor

The Transparent Resistor. Contributes to tone by its accuracy, performance, absolute noiselessness. A big advance in resistor construction. All resistances, 50c to \$1.



Daven Hi-Duty Glastor

A transparent resistor especially made for B Eliminator use. Will not deteriorate or lose value under the extremely high current required for eliminator use. \$1.



Daven Resistor Mount

A base of molded bakelite. Firmly attached clips and soldering lugs. Mount only 35c.



Daven Resisto-Couplers

Valuable for assembling resistance-coupled amplifiers. Each coupler has two pairs of clips. The type A coupler is connected in the base. Mount only \$1.50.

Daven Amplifier Kit

Contains all necessary units for manufacturing a Daven Amplifier. Includes Glastor Resistors and Resisto-Couplers. \$8.



Daven Super Amplifier

A complete assembling of the Daven Amplifying units in a convenient-to-attach unit which amplifies all of the music without distortion. Thoroughly tested. Without tubes, \$15. LONG WAVE AMPLIFIER, without tubes, \$20.



New Book for Set Builders

Tells simply, yet completely how to assemble a Daven Bass Note Set. Lifesize diagrams. Anyone can follow it. 25c at Daven Dealers. (30c by mail.)

There isn't anything that gives a man more satisfaction than the knowledge that, whatever the job, back of him are the right tools—Starrett's.

You owe it to yourself to own a full kit of Starrett Tools.

Catalog No. 23 "AP" illustrates and describes them all. Ask us to send you a copy.

THE L. S. STARRETT CO
World's Greatest Toolmakers
Manufacturers of Hacksaws Unexcelled
Steel Tapes—Standard for Accuracy
ATHOL, MASS

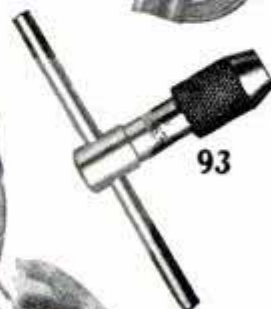
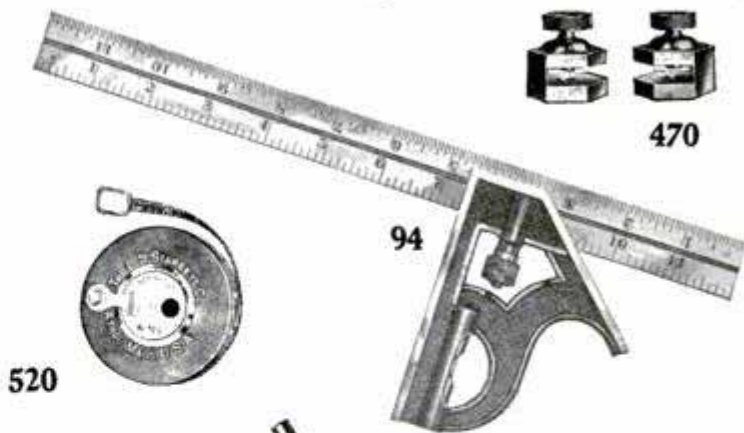
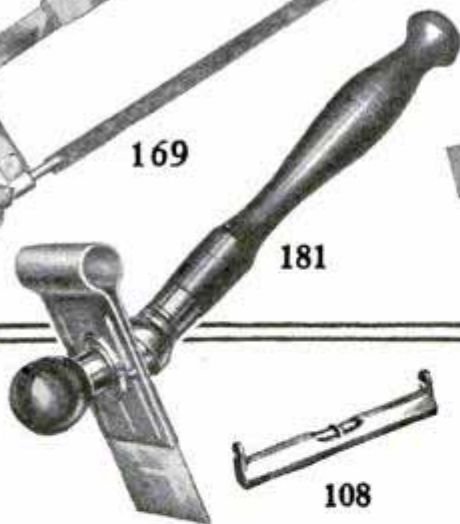
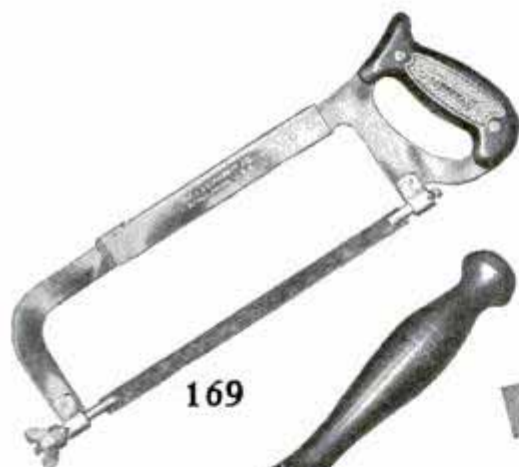

470

94

520

93

Here are some of the tools you need
Combination Square No. 94. Steel Tape No. 520.
T Handle Tap Wrench No. 93. Pistol Grip
Hacksaw Frame No. 169. Combination Tool
No. 439. Floor, Bench and Cabinet Scraper
No. 181. Aluminum Line Level No. 108.
Stair Gage Fixtures No. 470

471

Use Starrett Tools



Ride home in half the time!

SAFE-COMFORTABLE-EASY TO RIDE

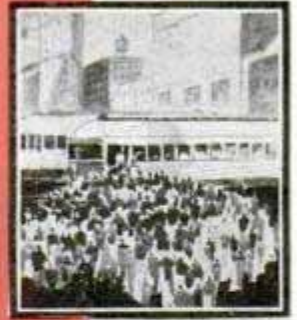

A comfortable spin in the fresh air!

At quitting time you breeze home in comfort—while the other men are jamming into crowded street cars or busses. You get fresh air all the way—save time—enjoy a great outdoor sport—all at a cost of one cent per mile!

The Harley-Davidson Single—new-type motorcycle—is the engineering triumph of a company that has been a leader in the industry for many years. When you buy a Harley-Davidson you are buying *dependable transportation*.

The Single is easy to ride and control—*safe*. Parks in any 2x8 foot space—*convenient*. Travels 80 miles on a gallon—*economical*. Powerful Ricardo-head motor.

Write us for illustrated catalog.

Easy to buy, too. Ask your Harley-Davidson dealer about his Pay-as-you-ride Plan. Price complete with 3-speed transmission and full electric equipment, f. o. b. Milwaukee \$235

Harley-Davidsons will be on display at the National Motorcycle show, Madison Square Garden, New York City, Jan. 31 to Feb. 5.

The HARLEY-DAVIDSON MOTOR COMPANY
Department P Milwaukee, Wis.

HARLEY-DAVIDSON

[New-Type Motorcycle] *Single*

Big sales opportunities in open territories.

HARLEY-DAVIDSON MOTOR CO.
Department P, Milwaukee, Wis.

Send free literature describing the "Single".
 Send details of your dealer proposition;
is my territory open?

Name.....
Street or R. F. D.....
City..... State.....



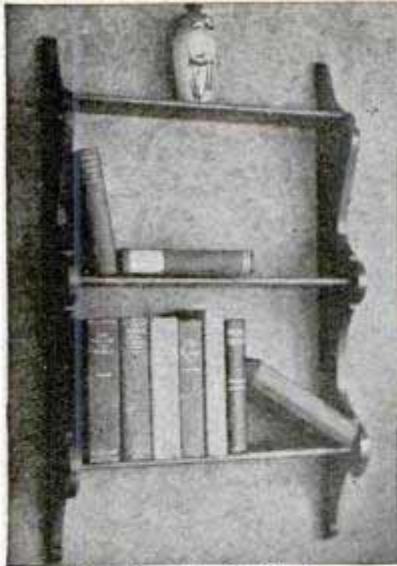

Hanging Book Shelves

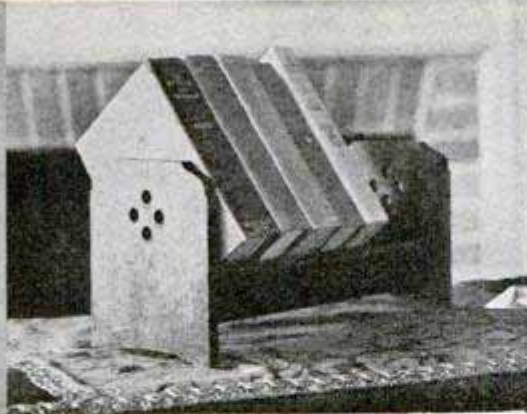

Book Trough



End Table



Handiest Tool in your Work Shop

Perhaps you have never thought of the special advantages of using LePage's Liquid Glue. It is always ready for immediate use. No weighing, soaking or heating is required. The quality is always the same. It "sets" slowly enough so that you have plenty of time to place the joints together exactly as they should go. Slow setting also allows LePage's to penetrate the wood, increasing the strength of the joint. LePage's Liquid Glue is equal in strength to any animal glue. Buy a can for your workshop. It is the easiest, quickest, handiest form of glue. Insist on LePage's.

Recipe for making LePage's Gesso

To make one cup of LePage's Gesso, you need 1 gill can of LEPAGE'S GLUE, 1 1/4 cups whiting, 3 teaspoons linseed oil and 3 teaspoons varnish. Place whiting in mixing bowl and pour in slowly in this order, LEPAGE'S GLUE, linseed oil, and varnish. Mix until smooth. All ingredients obtainable at nearest hardware store.

Attractive Furniture you can make yourself

LEPAGE'S Craft Books will show you how

DESIGNED by an expert, attractive, artistic, useful and easy to make. This briefly describes the furniture pieces which LePage's NEW Craft Books will show you how to make in your home work shop.

"LePage's Work Shop Book" contains complete directions for making a taboret, footstool, hanging book shelves, book trough, end table with book trough, and a number of simple things which perhaps your boy would like to make. The printed directions for making, step by step, are supplemented by dimension drawings and illustrations made from photographs of the finished pieces of furniture.

LePage's "Practical Suggestions for the Home Work Shop" will help you come closer to equalling the skill of the trained cabinetmaker. It tells you how to make strong joints with glue, and with glue in its most convenient form—LePage's Liquid Glue.

This book also shows you how

to cover up small defects in your craftsmanship. Now and then a tool will slip and an error is made. Or there are holes to be filled where nails or screws have been countersunk. Or the edges of a joint are not exactly even. A simple new way to repair these defects is with the use of LePage's Gesso instead of putty. LePage's Gesso will stick to any surface—wood, metal, glass, etc., and will stand 1,000 lbs. breaking strain as explained in the books. It can be sandpapered, planed and painted or stained just like wood. We give you in the small panel at left a simple formula for making LePage's Gesso, but of course we tell you more about it in the books themselves, together with practical information on decorating your finished articles with Gesso.

Send 10 cents for these NEW LePage's Books

The practical and useful help of these two books is yours for only 10 cents. Just write your name and address on the coupon below, tear the coupon out and mail it to us today with 10 cents in coin or stamps, and we will at once send you a copy of each, postage paid. Address LePage's Craft League, Dept. RR-5, Gloucester, Mass. Tear out the coupon now so you will not forget it.

MAIL THIS COUPON

LePage's CRAFT LEAGUE, Dept. RR-5, Gloucester, Mass.

Gentlemen: Enclosed you will find 10 cents (coin or stamps) in payment for "LePage's Practical Suggestions for the Home Work Shop," and "LePage's Work Shop Book." Please send a copy of each to:

Name.....

Street.....

City..... State.....

LEPAGE'S GLUE

Bottles, Tubes, Cans

Add the new Balkite Combination



U. S. Patent, Oct. 12, 1926

to your radio set now
with your "A" battery it supplies
all radio power automatically from
the light socket



Balkite "B"

—3 new models

Eliminates "B" batteries and supplies "B" current from the light socket. Three new models. Balkite "B"-W at \$27.50 for sets of 5 tubes or less requiring 67 to 90 volts. Balkite "B"-X for sets of 8 tubes or less; capacity 30 milliamperes at 135 volts—\$42. Balkite "B"-Y for any radio set; capacity 40 milliamperes at 150 volts—\$69. (In Canada "B"-W \$39; "B"-X \$59.50; "B"-Y \$96.)



**The New
Balkite Charger**

MODEL J. Has two rates. A low trickle charge rate and a high rate for rapid charging. Can thus be used either as a trickle or as a high rate charger. Noiseless. Rates: with 6-volt battery, 2.5 and .5 amperes; with 4-volt battery, .8 and .2 ampere. Price \$19.50. (West of Rockies \$20. In Canada \$27.50.)

MODEL K. For those who require a charger of limited capacity only, the Balkite Trickle Charger \$10. (West of Rockies \$10.50. In Canada \$15.)

All Balkite Units operate from 110-120 volt, 50-60 cycle AC. The Balkite Charger is also made in 25-40 cycle model.

Once connected to your "A" battery and set and plugged into the light socket, the new Balkite Combination Radio Power Unit *supplies automatic power to both circuits.* You need not even turn it off and on, for it is controlled by the filament switch already on your set and is entirely automatic in operation.

Balkite Combination can be installed in a few minutes, either near the set or in a remote location. Like all Balkite Radio Power Units it has no tubes, nothing to replace or renew, is a permanent piece of equipment. It is noiseless in operation. It will serve any set now using either 4 or 6-volt "A" batteries and requiring up to 30 milliamperes at 135 volts of "B" current—any set of 8 tubes or less, including power tubes. Ask your dealer. Price \$59.50. In Canada \$83. *Fansteel Products Company, Inc., North Chicago, Illinois.*

Listen to the Balkite Radio Symphony Concerts with Walter Damrosch and the New York Symphony. Balkite Hour, Saturday Nights 9 P. M. Eastern (8 P. M. Central) Standard Time, over WEAf, WEEL, WGR, WFI, WCAE, WSAI, WTAM, WWJ, WGN, WCCO, KSD, WDAF, WOC.

FAN STEEL
Balkite
Radio Power Units

10 Days Free Trial

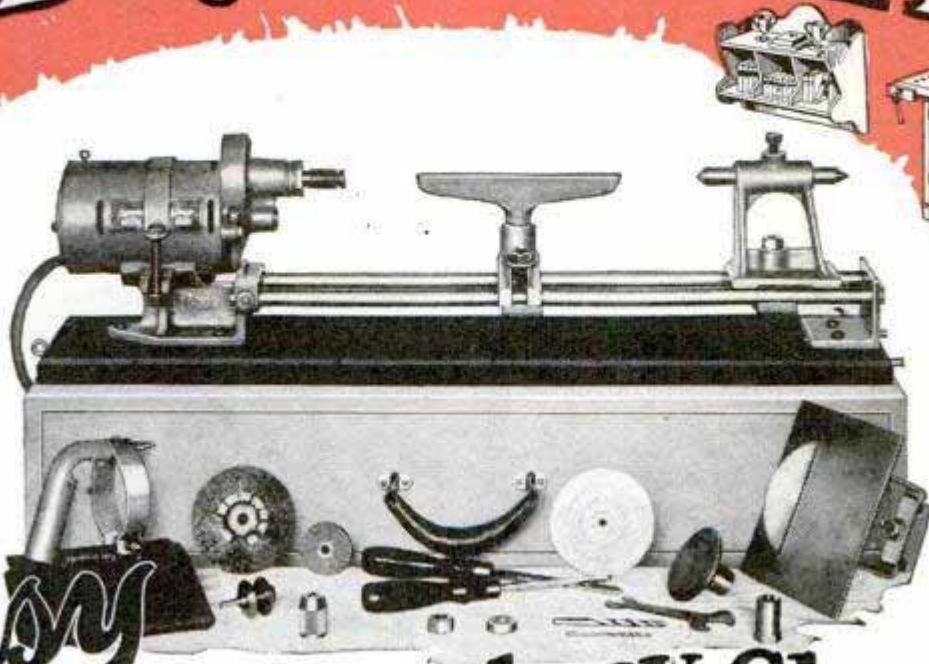

Easy to Make things with Speedway Shop

8 motor driven tools

Here is just what you have been waiting for! The big opportunity! The SpeedWay Shop is a compact and efficient electric workshop for you men who are "handy" with tools, mechanics, or experimenters!

A complete wood-turning lathe, bench saw, scroll or jig saw, a portable electric hand saw, and all accessories for both portable and stationary power drilling, buffing, grinding and cleaning. Attaches to any light socket and converts a work bench into a complete private tool and machine shop.

The SpeedWay Shop is driven by the powerful back geared SpeedWay electric motor—famous the world over.

We are offering you the Shop on a 10 day free trial in your own home. Test it! Experiment with it! Use it as you would your own! You will find it the handiest, fastest metal and wood working outfit you have ever laid your eyes on. It is complete in every sense, and ready for operation.

A Blueprint a month FREE

Each month for a year we will furnish you a blueprint of your own selection free to help you to get maximum service from the SpeedWay Shop and Tools. Write for a list of the interesting blueprints we have for you.

Fascinating! Intriguing! Interesting! That's what users say about the work you perform in your own home with the SpeedWay Shop and Tools. You can make almost anything—attractive, odd furniture, toys, home and garden improvements, radio manufacturing, consoles, bric-a-brac, book shelves—countless useful articles. You can do buffing, polishing, grinding and drilling either at the bench or wherever you find a lamp socket and—all of this for only \$10.00 down—the balance on easy terms.

ONLY \$10.00 DOWN

Don't hesitate. We want you to know more about the SpeedWay Shop and Tools. Every tool in the "Shop" is high-grade, built for regular work. A money maker for the small job man. A pleasure for the householder.

Get the full particulars. Send in the coupon today. Want a shop? It's easy to own one. We make it easy to pay while you enjoy a SpeedWay Shop right in your own home.

ELECTRO-MAGNETIC TOOL CO.

Dept. 22—1830 S. 52nd Ave.,
CICERO [adjoining Chicago], ILLINOIS

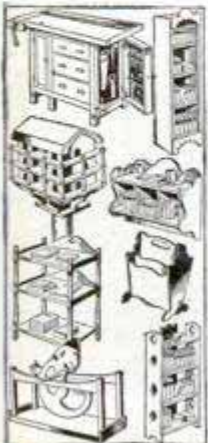

SEND COUPON NOW

Electro Magnetic Tool Co., Dept. 22
1830 S. 52nd Ave., Cicero, Ill.

Dear Sirs: Please send me full particulars about your 10 Day Free Trial. Free Blueprints and Your Easy \$10.00 Down Payment plan on the SpeedWay Shop.

Name.....
Address.....
City..... State.....

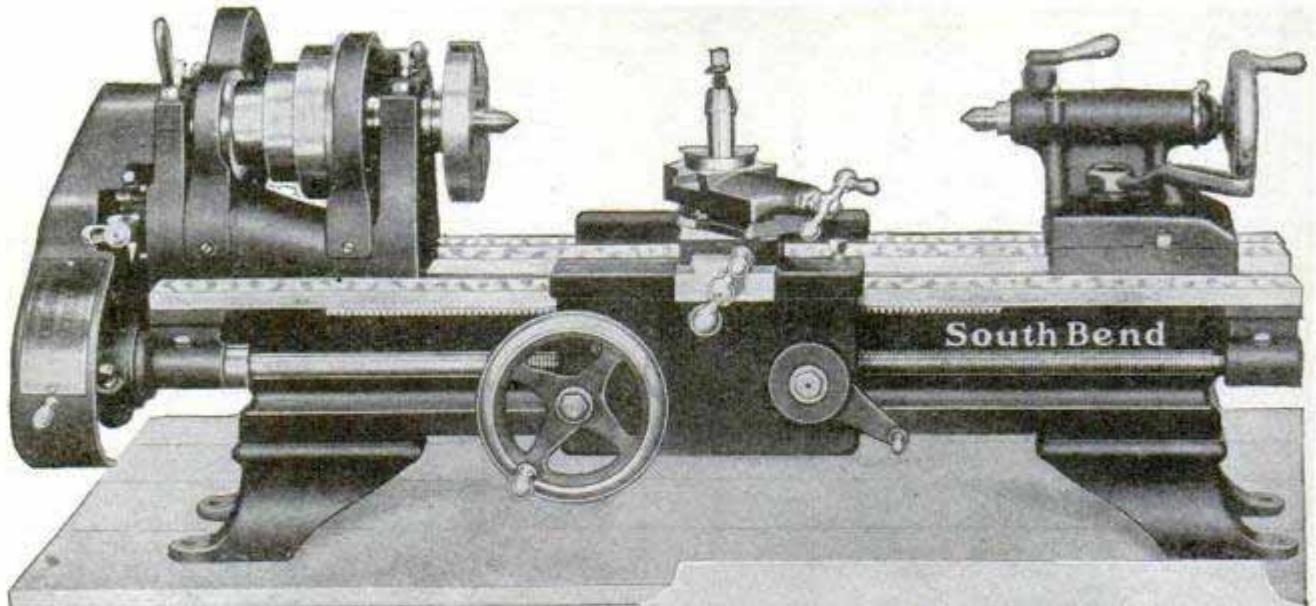

No. 22 Junior — 9"x3'
Back Geared
Screw Cutting
Bench Lathe

\$150

(Easy Terms If Desired)

**A Good Lathe
At a Moderate Price**

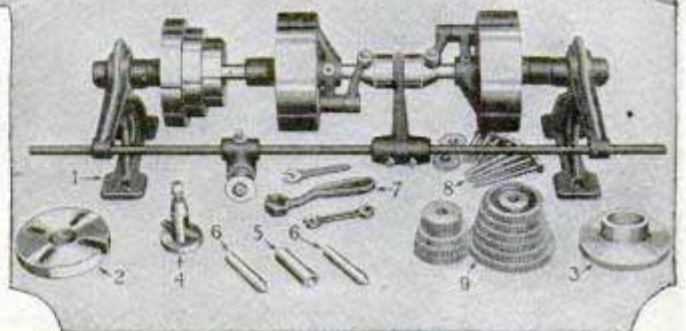

Countershaft and Equipment Included in Price

This is our regular 9"x3' Standard Change Gear Lathe—a high grade tool of accuracy and precision—stripped of parts not needed in the average shop. It is a practical tool for the small shop where a wide range of work must be taken care of.

Specifications

Swing over bed 9 1/4 inch
Length of bed 3 ft.
Size of Centers No. 2 Morse
Taper
Distance Between Centers 18"
Hole through Spindle 3-4 inch
Net weight Lathe C'shaft 375
lbs.

Features

Powerful Back Geared Head
Stock
Six Spindle Speeds
Headstock Spindle Ground all
Over
Phosphor Bronze Spindle Bear-
ings
Power Feed to Carriage
Set-over Tail Stock
Graduated Compound Rest
Micrometer Graduated Collars
on Cross Feed and Com-
pound Rest

Attachments

Draw-in Collet Chuck
Graduated Taper Attachment
Milling and Keyway Cutting
Attachment
Electric Grinding Attachment
Turnstile Bed Turret
Chucks, and many other at-
tachments

Some of the Work You Can Do

This lathe is equipped to cut standard screw threads, right or left, 4 to 40 per inch, machine pistons, reface valves, true armatures, undercut mica, turn, bore, chuck, drill, ream, face, file, polish, and many other jobs coming into the general repair shop.

Only 1/4 H. P. Motor Required

The No. 22 Junior Bench Lathe can be driven from overhead countershaft or 1/4 H. P. Reversible Motor, connected to light socket.

Send for Bulletin No. 22-J describing in detail this precision lathe, and showing some of the work that can be done.

South Bend Lathe Works
618 E. Madison St. South Bend, Ind.

The New Line of South Bend Lathes

In the past 20 years over 35,000 South Bend Lathes have been built and are giving satisfactory service in all lines of work.

South Bend Lathes are built in two types—Quick Change Gear and Standard Change Gear Lathes. Quick Change Gear Lathe provides screw cutting without removing gears, while Standard Change Gear Lathes are equipped with loose change gears for this purpose.

There is a South Bend Lathe for every job—from 9-in. to 24-in. The most popular sizes are listed below.

Size of Lathe	Quick Change	Standard Change
9"x 3'	\$ 258.00	\$ 228.00
11"x 4'	308.00	268.00
13"x 5'	387.00	337.00
16"x 6'	521.00	461.00
18"x 8'	693.00	628.00
21"x10'	1032.00	949.00
24"x12'	1437.00	1338.00

For complete details write for illustrated Catalog No. 87.

SOUTH BEND LATHES

21 Jewel Burlington

Just Out

Latest Designs in Watch Cases beautifully illustrated in our booklet. Send for FREE Copy.

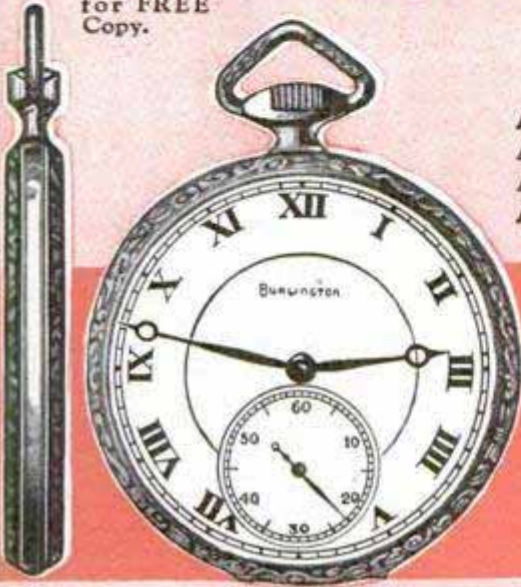

Adjusted to the Second
Adjusted to Temperature
Adjusted to Isochronism
Adjusted to Positions

21 Ruby and Sapphire Jewels
25 Year Gold Strata Case

Your Choice of Dials
(Including Montgomery R. R. Dial)
New Ideas in Thin Cases

Only \$**100**
Down

Only One Dollar Down will buy this masterpiece of watch manufacture. The balance you are allowed to pay in small, easy, monthly payments. The Burlington — a 21-Jewel Watch — is sold to you at a price much lower than

that of other high-grade watches. Besides, you have the selection of the finest thin model designs and latest styles in watch cases. Don't delay! Write for the FREE Watch Book and our SPECIAL OFFER today.

Write While This Special Offer Lasts

Get the Burlington Watch Book by sending this coupon. Find out about this great special offer which is being made for only a limited time. You will know a great deal more about watch buying when you read this book. You will be able to "steer clear" of the over-priced watches which are no better. Remember, the Burlington is sent to you for only One Dollar down, balance in small monthly payments. Send the coupon for watch book and our special offer TODAY!

Burlington Watch Company

Dept. 13-52 19th St. and Marshall Blvd., Chicago
Canadian Address: 62 Albert St., Winnipeg, Manitoba

Please send me (without obligations and prepaid) your free book on watches with full explanation of your \$1.00 down offer on the Burlington Watch.

Print name and address plainly

Name _____

Address _____

Burlington Watch Company

Dept. 13-52, 19th Street and Marshall Blvd., Chicago
Canadian Address: 62 Albert Street, Winnipeg, Manitoba



Accept 10 Days' Proof

Let us prove that the claims millions of men make for this unique shaving cream are justified

GENTLEMEN: We make no claims for Palmolive Shaving Cream other than the fact that millions of men, once wedded to rival preparations, have shifted to this new creation.

Hence—that it is worth a trial. So we send 10-day tubes for that purpose. Will you accept one as a courtesy to us?

Our sixty years experience as makers of Palmolive Soap, the world's leading toilet soap, are embraced in this creation.

5 new factors

1. Multiplies itself in lather 250 times.
2. Softens the beard in one minute.
3. Maintains its creamy fullness for 10 minutes on the face.
4. Strong bubbles hold the hairs erect for cutting.
5. Fine after-effects due to palm and olive oil content.

Just send coupon

Your present method may suit you well. But still there may be a better one. This test may mean much to you in comfort. Send the coupon before you forget.

THE PALMOLIVE COMPANY
(Del. Corp.),
CHICAGO, ILL.



3450

10 SHAVES FREE
and a can of Palmolive After Shaving Talc

Simply insert your name and address and mail to Dept. B-1274 The Palmolive Company (Del. Corp.), 3702 Iron Street, Chicago, Ill.

Residents of Wisconsin should address The Palmolive Company (Wis. Corp.), Milwaukee, Wis.

(Please print your name and address)



Save more than ever This 6 Room Bungalow **\$1493** NOW FREIGHT PAID
Price includes everything complete — lumber cut-to-fit, FREIGHT PAID to your station.

New Low Prices Our customers claim average savings of 47% over local prices. This year reduced prices make possible still greater savings.

We Loan You Money to Build

We ship you any home you select, ready to erect, and ADVANCE YOU CASH to help you build. You pay us in small amounts monthly, just as you pay your rent—and your rent money is saved instead of spent. Send 25c in coin today for beautiful Color Book of Sterling Home Plans and you can be living in a home of your own a month from now.



INTERNATIONAL MILL & TIMBER CO.
724 S. Wenona Ave. BAY CITY, MICH.

NEW DISCOVERY

AUTO STROP BLADE RENEWER—FOR AUTO STROP BLADES ONLY—Positively MAKES DULL BLADES NEW.
25¢ Postpaid—Agents Wld.—MCKENZIE—Box 9—LONG BEACH, CALIF.

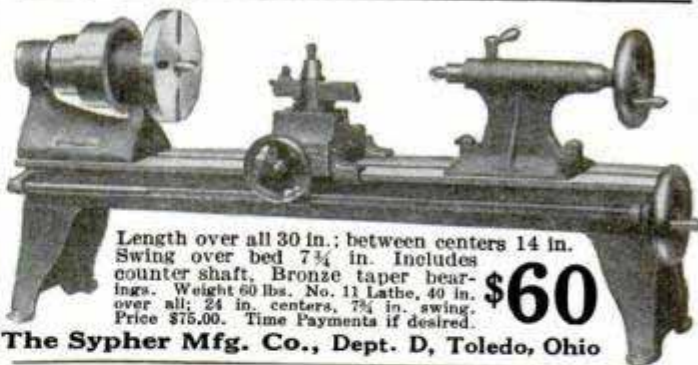

Length over all 30 in.; between centers 14 in. Swing over bed 7 3/4 in. Includes counter shaft. Bronze taper bearings. Weight 60 lbs. No. 11 Lathe, 40 in. over all; 24 in. centers, 7 3/4 in. swing. Price \$75.00. Time Payments if desired.

\$60

The Sypher Mfg. Co., Dept. D, Toledo, Ohio



A Motor Boat—for half the cost!

The Super Elto clamps on any open boat—gives all motor boating pleasures at amazingly small cost. Powerful, speedy, reliable. Light and portable. Write today for intensely interesting catalog!



Elto Outboard Motor Co.
Ole Evnrude, Pres.
Dept. 28 Mfrs. Home Bldg.
Milwaukee, Wis.

The Super Elto

"Starts With a Quarter Turn"

7 Tube Set

Single Dial Radio

30 DAYS FREE TRIAL

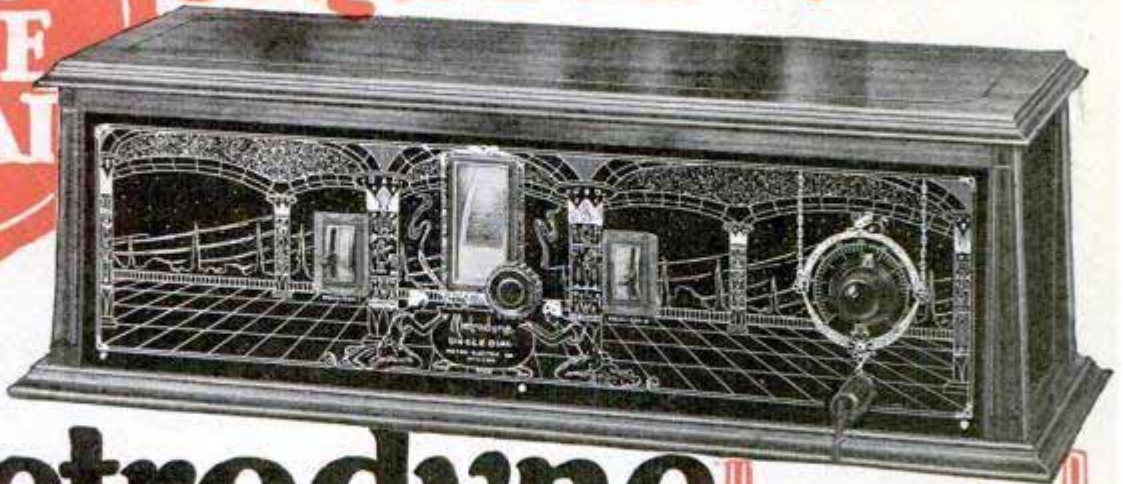

The Metrodyne

ONLY ONE DIAL TO TUNE

Retail Price
\$75
Completely Assembled
BIG DISCOUNTS TO AGENTS AND DEALERS

Wonderful offer direct from the factory! The world's greatest radio. A perfect working, single dial control, 7 tube receiver. And just to prove our claims, we will ship it to your home for 30 days' free trial. Test it under all conditions. Test it for distance, volume and tonal quality — and if you are not convinced that it is the best single dial set you ever heard, return it to the factory. We don't want your money unless you are completely satisfied.

BIG PROFITS TO AGENTS AND DEALERS

Our Agents and Dealers make big money selling Metrodyne Sets. You can work all or part time. Demonstrate the superiority of Metrodynes right in your home. Metrodyne Radios have no competition. Lowest wholesale prices. Demonstrating set on 30 days' free trial. Greatest money-making opportunity. Send coupon below—or a letter—for our agent's proposition.

Metrodyne Super-Seven Radio

A single dial control, 7 tube, tuned radio frequency set. Approved by America's leading radio engineers. Designed and built by radio experts. Only the highest quality low loss parts are used. Magnificent, two-tone walnut cabinet. Artistically gilded genuine Bakelite panel, nickeled piano hinge and cover support. All exposed metal parts are beautifully finished in

24-k gold. Easiest set to operate. Only one small knob tunes in all stations. Dial is electrically lighted so that you can log stations in the dark. Volume control regulates reception from a faint whisper to thunderous volume, 1,000 to 3,000 miles on loud speaker! The Metrodyne Super-Seven is a beautiful and efficient receiver, and we are so sure that you will be delighted with it, that we make this liberal 30 days' free trial offer. You to be the judge.



6 Tube Set \$48.50
RETAIL PRICE
Completely Assembled

METRODYNE SUPER SIX RADIO ON 30 DAYS' FREE TRIAL

Wonderful 6 tube, long distance radio set. Approved by America's leading Radio Engineers. Easy to operate. Dials log easily. Tune in your favorite stations instantly on the same dial numbers every time. No guessing. 30 days' free trial.

Mr. Howard of Chicago said, "With 5 Chicago Stations on the air I tuned in 17 out-of-town stations, including New York and San Francisco on loud speaker very loud and clear."

We are one of the pioneers of radio. The success of Metrodyne sets is due to our liberal 30 Days' Free Trial Offer, which gives you the opportunity of trying before buying.

MAIL THIS COUPON 
or send a postal or letter. Get our proposition before buying a radio. Deal direct with manufacturer—**Save Money.**

Mail COUPON Below!
Let us send you proof of Metrodyne quality

C. J. Walker, Mariposa, Calif., writes: "Received my Metrodyne Single Dial set O. K. I believe that these one-dial sets are going to be excellent sellers. I had no trouble in tuning in stations enough to satisfy anyone, so you will please send me another set."

Roy Bloch, San Francisco, Calif., writes: "Very often we travel from New York to the Hawaiian Islands quickly—from station to station—by means of the little tuning-knob which operates the electrically-lighted dial. The Metrodyne Single Dial Set is much easier to operate than any radio set I've ever seen."

We will send you hundreds of similar letters from owners who acclaim the Metrodyne as the greatest radio set in the world. A postal, letter or the coupon brings complete information, testimonials, wholesale prices, and our liberal 30 days' free trial offer.

METRO ELECTRIC COMPANY
2161-71 N. California Ave., Dept. 142
Chicago, Illinois

Gentlemen:
Send me full particulars about Metrodyne 6 tube and 7 tube sets and your 30 days' free trial offer.

Name.....
Address.....

If you are interested in AGENT'S proposition, place an "X" in the square

METRO ELECTRIC COMPANY
2161-71 N. California Ave., Dept. 142, Chicago, Illinois

"It's dead easy to learn to play a Lyon & Healy Sax" ... says Conrad Nagel



"If you ever thought you'd like to play some musical instrument, take my advice and get a Lyon & Healy Sax. Try it and see if you don't agree with me."

Conrad Nagel

CONRAD NAGLE, popular screen star, hero in "Tin Hats," "The Mysterious Island," and other Metro-Goldwyn-Mayer feature films—his advice is worth listening to. Why envy the other fellow his good times, popularity, extra spending money when you can enjoy the same things too? If you can whistle a tune you can play this new Lyon & Healy Sax.

Amazing Beauty of Tone

You will learn quickly because we have simplified the fingering, made it easy for you to play, easy to produce, full, rich tones. That's why amateur musicians like Nagel prefer the Lyon & Healy. Professional players, also, choose it because of its accurate adjustment, improved action for hair-trigger finger work, exact pitch, resonant and mellow tones. Entirely made in our own factories. Guaranteed by this, the most famous music house in the world.

Free Trial! Free Instructions!

Learn about our generous six-day Free Trial in your own home. Discover how easy it is to purchase a professional Lyon & Healy on our special time payment plan. You can pay as you play! Read about our new, simple "Teach Yourself" Course. Quick, easy. You can't get it anywhere else. Free with a Lyon & Healy. All told in our big Saxophone Book. Sent FREE on request. Mail the coupon for it now. Mention whether interested in saxophone or in genuine Lyon & Healy Trumpet, Cornet, Trombone, Banjo, Ukulele or Guitar. But act now!



Lyon & Healy

Everything Known in Music
76 E. Jackson Blvd., Chicago

----- **[Mail the Coupon Today!]** -----

LYON & HEALY, Inc. Factory Sales Division
76 E. Jackson Blvd., Chicago
Send FREE your new Saxophone Book with details of Free Trial Offer, "Easy to Pay" plan and Free Instructions.

Name _____
Street _____
City _____ State _____
Instrument _____

New and Used Auto Parts at 30 to 80% Saving

Our stock of new and used replacement parts is the largest in the world. No matter what you need, write to us for prices. You will save from 30 to 80% and parts can be obtained from us which it is impossible to get elsewhere.



Get Our Big Parts Book—FREE

Our Big 80-page Parts Catalog is the largest book of its kind ever issued. Everything for the automobile at cut prices—less than regular wholesale.

An enormous volume of business and quantity purchases make our low prices possible. Nationally advertised products. All new except where specified—Timken Axles and Bearings—Brown-Lipe Transmissions—Pistons—Rings—Hayes and Firestone Wheels—Rims—Tires—Tubes—also a complete line of Accessories. If it's for an auto, you will find it listed in our big parts Book.

Write Today for Your Copy—It's FREE

WARSHAWSKY & CO.

World's Largest Replacement Parts House
1915-35 So. State St., Dept. PM-2, CHICAGO, ILL.

FREE New Book FACTORY PRICES

Save 1/3 to 1/2

New FREE book quotes **Reduced Factory Prices**. Introduces sensational **5-Year Guarantee Bond** on Stoves, Ranges, Furnaces, 200 styles and sizes. Beautiful porcelain enamel ranges and combination gas and coal ranges in soft grey and delft blue.



Mahogany porcelain enamel heating stoves. Cash or easy terms—as low as \$3 down, \$3 monthly. 24 hr. shipments. 30 day free trial.

Heating \$27²⁰ up Stoves

360 day approval test. Satisfaction guaranteed. 26 years in business, 600,000 customers. Write today for your copy of this FREE book.

KALAMAZOO STOVE CO., Mfrs.
391 Rochester Ave. MICH.

Ranges \$37⁷⁵ up

KALAMAZOO

MICH.

"A Kalamazoo Direct to You"
Trade Mark Registered

Own a Typewriter !

A Bargain You Can't Ignore! Try It Free, and See!

\$3⁰⁰
and
**It's
Yours!**



GET YOUR typewriter now. A genuine Shipman-Ward rebuilt Underwood is the one you want — "the machine you will eventually buy!" Everyone needs it; now anyone can afford it. Don't send a cent—but do get our big special offer—our valuable book on typewriters and typewriting—free. You can learn to write on this standard-keyboard machine in one day. A week after the expressman has brought it, you'd feel *lost* without it. A trial will *prove* it—and doesn't cost you a penny!

A New Plan

Our rebuilt plan gives you the *best* machine and saves you a *lot* of money. The Underwood is so famous a make, and No. 5 so popular a model, you'll have to speak up if you want one of the lot we are just completing now! We rebuild from top to bottom; *replace every single worn part*; each machine is in *sparkling* condition. New typewriters are commonly guaranteed for a year; we guarantee these completely rebuilt Underwoods *five years*: That's our Better-Than-New Guarantee! And we guarantee a big saving in money!

We don't ask for a cent now. Nor any money at all, unless you are completely won by the wonderful writing machine we ship you for an unrestricted 10-day free trial. When you do buy, take advantage of our very liberal scale of monthly payments. A host of our patrons have paid for their typewriters out of money made typing for others. (One woman made a *thousand dollars* at home last year with her Underwood.)

Free Trial Offer

If you know typewriters, you know the perfect work and the ease and speed of an Underwood. If you have never owned a typewriter, start with the finest! You can try this one at our risk. But, the time to act is NOW. Don't miss out on this present bargain offer. Don't



This is a
Genuine
UNDERWOOD
*
The ace of
All Writing
Machines!

*** Act NOW If • Ever ! ***

FREE!

do longer without the convenience of a typewriter. Our plan gives you the opportunity of a *thorough trial* before you buy. You run no risk whatever. You start to pay for your typewriter *after* you have found it the one and only machine for you! But get the facts before this lot of machines is all in use. Clip the information coupon before you turn the page. It will pay you! Note the very useful book you will receive free! Write for full particulars at once. Get our catalog that tells how we rebuild these wonderful Underwood typewriters in the largest factory of its kind in the world, and lowest prices and terms in existence. We will also include free, the new Type Writing Manual—it gives many examples of uses for your typewriter: in business accounts, social correspondence, recipes, shopping lists, household accounts, etc.; school work, literary work, etc. Clip coupon now!



Mail to SHIPMAN-WARD MFG. CO.
2122 Shipman Building, Chicago
Please send me full offer, with Type Writing Manual FREE, prices, terms, etc., and full information about your FREE course in Touch Typewriting. All without obligation; this is NOT an order!

Name.....
Street.....
P. O.....

wanted

100,000 CARPENTERS and Home Mechanics to Try this IRWIN AUGER Bit



A sincere trial is all that is needed to convince you of the speed, toughness and superior cutting qualities of the Irwin Mainbor Bit No. 62-T, specially designed and manufactured for carpenters, cabinet makers, home mechanics and handy men.

Made to cut quick and clean. Made to save time. Made to save effort.

Just try this Irwin Bit—you're sure to like it.

Special Offer

To those who have never used the Irwin Mainbor Bit we will send postpaid, for 25c, one Mainbor No. 62-T in the one-half inch size, that lists at 65c.

This is well below the cost of production. In fact we make the price of 25c just to cover the cost of handling and mailing, and to eliminate the idle inquiry.

We want to receive requests for this sample bit from sincere workers—interested in learning of a better tool. Just mail the coupon, with 25c and we will send the sample bit postpaid. Only the one size will be sent, and only one will be sent to an individual.

If you don't feel, after buying the bit, that it is the best you have ever used—send it back, tell us why and we will refund your money by return mail. Send the coupon today.



The Irwin Auger Bit Co.
Wilmington, Ohio

"Largest Makers of Wood Boring
Tools in the World"

The IRWIN Bit

REG. U.S. PAT. OFF.

The Irwin Auger Bit Co.
Wilmington, O.

Enclosed find 25c for which please mail postpaid, one of
your Mainbor No. 62-T bits.

Name.....

St. Address.....

City and State.....

CLIP THIS COUPON

Repair Any Auto or Auto Truck

Examine These FREE NEW AUTO BOOKS

Be an expert auto repair man. You can have the skill that makes every complicated trouble as easy to fix as taking out a spark plug. Learn every detail of all makes of cars and trucks. Know exactly how to find what's wrong and how to make all repairs quickly. These great new Auto Books show you how.

MAKE MONEY REPAIRING AUTOS

Over 12 million cars are in operation and thousands of men are needed to keep them in good going condition. There are more jobs open than there are good men to fill them. Never before have expert auto repair men been in such great demand and made so much money. Now is your great money-earning opportunity in the auto repair business. Every mechanic, every chauffeur, every car owner needs this great New Library of Automobile Engineering.

Tells About
Explosion Motors, Welding, Motor Construction and Repair, Carburetors and Settings, Valves, Cooling, Lubrication, Fly-Wheels, Clutch Transmission, Final Drive, Steering Frames, Tires, Vulcanizing, Ignition, Starting and Lighting Systems, Shop Kinks, Public Garage Design, Equipment and Operation, Electrics, Storage Batteries — Care and Repair, Steam Cars, Motorcycles, Commercial Trucks, Glossary, More than 100 blue prints Wir'g Diagrams.

Shipped Free You Make No Deposit

Let us send you the complete five-volume set of Automobile Engineering for one week's examination. Read the simple directions for repairing every automobile trouble. Five thick volumes, 5 1/2 x 8 3/4 inches, flexibly bound and stamped in gold, 2,000 pages, 2,100 illustrations, wiring diagrams, etc. Everything in plain, every-day language, simple to understand. If you decide to keep them, send only \$2 in ten days, and \$3 a month thereafter until the special introductory price of \$24.80 has been paid.

Employment Service Free

In addition to all this, those who send now will be entitled to the services of our Employment Department without charge. We are in daily contact with firms all over the country who need good men and are willing to pay big. This service costs you nothing. Don't miss this special offer. Send now.

Send No Money

Don't send a penny! Your name and address in the coupon brings the five books to you at once for ten days' trial.

Mail Coupon NOW.

American Technical Society
Dept. AA-219, Chicago, U. S. A.



Starting and Lighting



Welding

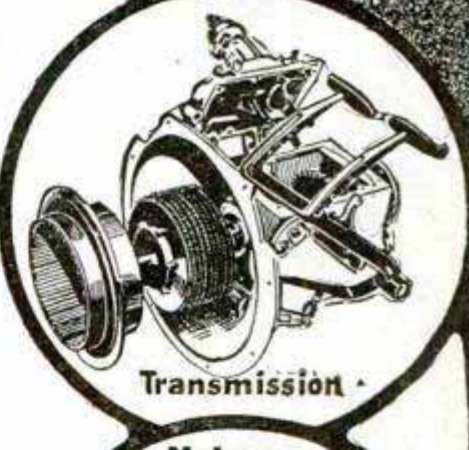

Transmission

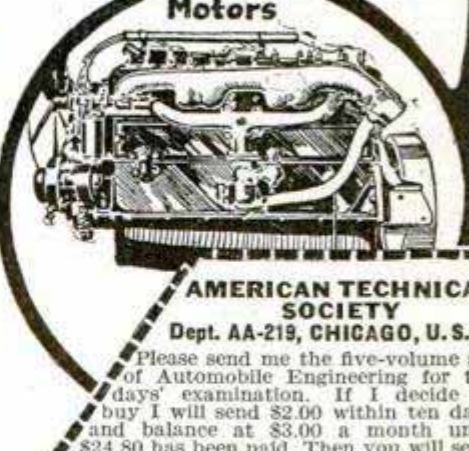

Motors



AMERICAN TECHNICAL SOCIETY
Dept. AA-219, CHICAGO, U. S. A.

Please send me the five-volume set of Automobile Engineering for ten days' examination. If I decide to buy I will send \$2.00 within ten days and balance at \$3.00 a month until \$24.80 has been paid. Then you will send me a receipt showing that the set of books are mine and fully paid for. If I think I can get along without the books I will return them, after 10 days, at your expense. To insure prompt shipment fill out all lines.

Name

Address

Reference

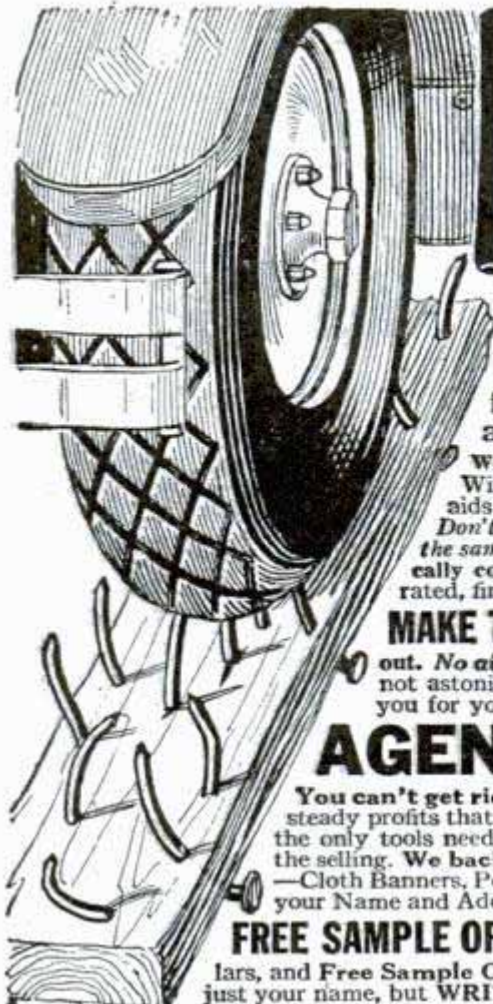

No More Punctures

PROTECT YOUR TIRES IN ONE MINUTE

Tires Hammered Full of NAILS, Leak No Air

GALACITE—a Scientific, Viscous, Pneumatic Cement (*not a liquid*) SEALS PUNCTURES instantly and automatically the moment they occur. One application made in a minute, without taking tire off wheel or rim, does the work. Seals slow leaks and porous tubes.

Will not injure tire or tube. On the contrary, Galacite aids in preserving rubber, often doubling tire life. *Don't confuse Galacite with anything else ever intended for the same purpose.* It is new, different, clean, and scientifically correct, manufactured by a long established, highly rated, financially responsible concern.

MAKE THIS TEST: Take a hammer—drive as many nails into a tire as you wish—then pull them out. *No air will escape. No pressure will be lost.* If you are not astonished and delighted with results, we will even pay you for your time and trouble.

AGENTS—Big, Quick Profits

You can't get rich in an hour—but you can make immediate-sure-steady profits that are amazing. A hammer and hand full of nails are the only tools needed—no lengthy arguments—a demonstration does the selling. We back our agents with powerful advertising helps—Cloth Banners, Posters, Newspaper Ads, and Circulars printed with your Name and Address. The price per tire is very low.

FREE SAMPLE OFFER. Get the facts and get them now. RUSH your name to us for full particulars, and Free Sample Offer. Territory is going fast. Send no money, just your name, but **WRITE TODAY.**

C. F. Johnson & Company, 19 W. Jackson Blvd., Chicago, Ill. Dept. 455

MAKE THIS TEST
We will pay you for the few moments of your time used if you are not astonished and delighted with the results.



Your Coat and Vest Can Be Matched with New Trousers

Save the price of a new suit. We match hundreds of coats and vests satisfactorily every day. Each pair tailored to your measure. 80,000 patterns. We submit sample of cloth for your approval. Just mail your vest or a sample of the suit.

We employ no agents.

Enclose return postage if vest is sent.

ACME PANTS MATCHERS
Dept. A C 14 20 W. Jackson, Chicago



MOVIES IN YOUR HOME

Write for interesting catalog of movie machines and films—Low Prices.

PILGRIM CO., DEPT. 117, MEDFORD, MASS.

REDUCED PRICES ON ENGINES

Now—big sale on most practical farm engine ever built—the famous **OTTAWA**. Low cash prices—easy terms—on all sizes 1½ to 7 H-P. Each engine pulls big surplus of power. Easy starting. You must be satisfied or money refunded. 30 day trial. 10-year guarantee.

FREE BOOK

—“How to Know Better Engines.” Write today for your copy. A post card brings it.

OTTAWA MFG. CO.
531 D King St., Ottawa, Kan.
Desk 531 D Magee Bldg., Pittsburgh, Pa.

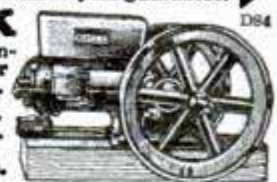

Information on any book free. Write Popular Mechanics Press, Chicago, Ill.

Starts Cold Motor

INSTANTLY; New **QUICK-START** electric-heat primer, for **FORDS** and others. Principle adopted by Lincoln, Packard, Chrysler. Three devices in one.

GREATEST GAS SAVER YET INVENTED

Prevents carbon. Saves battery; saves oil. **Agents:** Quick-selling year-round article. Bigger margin of profit for you. Special **FREE Deal.** Write **W. C. Kutscho, Inventor.**

Electric Superstarter, Dept. 103-1, Grand Rapids, Mich.



\$100 WEEKLY

Hundreds making it. Selling marvelous auto invention—all cars. One size—fits all cars. Easily demonstrated Pocket size. Installed in 3 minutes. We guarantee sale. Send for free introductory sample offer and Crew Managers proposition.

MAE AUTO PRODUCTS COMPANY
DEPT. 502, 6355 BROADWAY, CHICAGO

FREE
Introductory
OFFER.



YOU CAN PLAY

The Weir **JAZZITHA**
The one string
Hawaiian Guitar

Play all the popular melodies at once and surprise yourself and friends. No lessons or knowledge of music necessary. The music is written in numbers.

The **JAZZITHA** is 19 inches long, nicely finished in lacquer. Comes with pick, bar and 10 son leaflet, and

FREE—3 extra strings worth 25 cents. **SEND NO MONEY**—pay the postman \$1.47 plus postage on delivery.

No C.O.D.'s to Canada or foreign countries. Send money order (only) for \$1.75. This includes postage.

Extra—5 music books, 5 latest and different songs in every book, 25c. each book, the 5 books for \$1.00

THE JAZZ STUDIOS, Dept. 582
2512-41st Ave. Long Island City, N.Y.

Please print your name and address plainly

\$1.47



LIGHTING MATCHES WILL MAKE YOU \$300 to \$2500 a Month

Amazing "Sure-Fire" Demonstration

Sells by thousands new automatic attachment that Sworn Public Tests prove makes Fords run

43.8 MILES ON 1 GAL. OF GAS

This simple, but sensational demonstration easily convinces and astonishes even the skeptical. Agents everywhere report wonderful results. Mr. R. K. Waite ordered 1000 devices in 1 month. Profit \$3000.00. Mr. Clyde B. Jones sold 63 devices in 1 day. Profit \$189.00. No experience needed. Thrilling demonstration sells for you. Guaranteed results of Blanche Control, backed by National advertising, assure such remarkable savings, to users that sales by Blanche Agents are made faster and in greater volume than ever before known in the Direct Selling Industry. One demonstration never fails to bring big returns.

1 FREE TO INTRODUCE

Also Free Blanche Plan that starts you in a real business without capital or previous experience. Start to make big money—beginning Now! Write today without fail.

Blanche Auto Devices Co.

Dept. 805-B

157 E. ERIE ST., CHICAGO, ILL.

Cadillac and Delco Light now use as Standard Equipment Thermostatic Carburetor Control under Blanche License.

STRONGEST GUARANTEE

in Automotive history backs sale of Blanche Controls. Guaranteed to increase miles 50%—100%—eliminate carbon, save half oil, and to **START MOTOR IMMEDIATELY IN ANY WEATHER**

SALES Guaranteed

\$15.00 a Day Guaranteed To Distributors

Lighting Fixtures READY TO HANG

(Direct from the Manufacturer)

Completely wired, including glassware. Send for New Catalogue No. 27. Just reduced prices. Special proposition to DEALERS.

ERIE FIXTURE SUPPLY CO.
STA. A ERIE, PA.

MOTORCYCLES

Price \$10 and up purchased through our Co-Operative Plan for as low as \$1.00 down and \$1.00 per week

Indians Harley-Davidsons Ace Henderson and Clevalands

Send for Bulletin A.
Motorcycles shipped to all parts of the world

WALKER-INDIAN CO., 188 Mass. Ave., BOSTON

MEN EXTRA MONEY

women!

\$130. QUICKLY—EASILY

PER MONTH

Hundreds of ordinary people are selling famous Premier Accident and Sickness Policy. Entire costs \$10 yearly. Pays \$5,000 for stated Accidental Death, \$25. Accident and Sickness benefits, hospital benefits, emergency relief fund, other benefits. No medical examination, anyone 16 to 71 accepted.

No selling ability required. Strong old-line company. Liberal commission or salary, bonus. Direct-by-mail outfit, advertising campaign. Policy sells itself. Write for territory.

UNDERWRITERS A-702, Bonnell Bldg. Newark, New Jersey

OLD MONEY WANTED

We Paid \$200 to J. D. Martin of Virginia FOR JUST ONE COPPER CENT

"Please accept my thanks for your check for \$200.00 in payment for the copper cent I sent you. I appreciate the interest you have given this transaction. It is a pleasure to do business with a firm that handles matters as you do.—JULIAN D. MARTIN, Virginia

Post yourself! It Pays! We paid Mr. Manning New York \$2500 for a single silver dollar. Mrs. G. F. Adams, \$740 for some old coins. W. F. Wilharm, Pennsylvania, \$13,500 for his rare coins. In the last 20 years we have paid hundreds of others handsome premiums.

All Kinds of Old Coins, Medals, Bills and Stamps Wanted

\$1.00 to \$1,000 paid for certain old cents, nickels, dimes, quarters, etc. Right now we'll pay \$50 for 1913 Liberty Head nickels (not Buffalo) \$100 for 1894 dimes, "S" Mint. \$8.00 for 1853 quarters, no arrows. \$10 for 1866 quarters, no motto. \$200 each for 1884 and 1885 Silver Trade Dollars. 10cents each for 1912 "S" Mint nickels, etc.

Big Cash Premiums for Hundreds of Coins Now Circulating

There are literally thousands of old coins and bills that we want at once and for which we will pay big cash premiums. Many of these coins are now passing from hand to hand in circulation. Today or tomorrow a valuable coin may come into your possession. Watch Your Change. Know what to look for.

You'll Open Your Eyes When You Read Our Big Illustrated Coin Folder Send 4 cents. We will send at once our highly illustrated and interesting Coin Folder. WRITE TODAY for this eye-opening, valuable wealth of information on profits that have been made from old money. No obligation on your part. You have nothing to lose—everything to gain

Will pay up to \$80.00

Will pay up to \$50.00

Up to \$100.00 for this coin

Will pay up to \$10.00

Up to \$2.00 for this coin

Will pay up to \$100.00

Up to \$100.00

SEND COUPON NOW



Send this COUPON NOW

Numismatic Company of Texas, Dept 220, Fort Worth, Texas

Please send me your large Illustrated Coin Folder for which I enclose 4 cents.

Name _____

Address _____

City _____ State _____

FORDS

no freezing no boiling!



Great Gas Saving

No need for winter fronts, summer pumps, or gas savers. The wonderful **Airlock does all three.** An absolutely genuine article which prevents freezing or boiling in any climate running or standing. It fuelizes and decarbonizes besides. Installed like a motometer. Makes an amazing demonstration. Sells like machine guns fire. Agents with Fords make \$50 daily. Free trial always. Address

AIRLOCK PRODUCTS
Box 588 Burnett, California

Send me Agents free trial offer of your sensational Airlock.

Name.....
(Print plainly)

Address.....

I STOP Foot Pains or you pay nothing



SLIP a new and amazing band on the most painful feet. Within 10 minutes every trace of pain has vanished. This band acts to strengthen and support the vital muscles whose weakened condition causes 94% of all foot troubles, medical authorities say. Wear stylish shoes again, walk and dance without a twinge.

No stiff props to further weaken the foot. This is a strong, super-elastic yet amazingly thin, light band. It's called the Jung Arch Brace and acts through correct tension and scientific design to strengthen muscles naturally. Soon you do without it—feet are well.

Test it 10 days. If not amazed and delighted your money returned. Go to druggist, shoe store or chiropractist. If they can't supply you use coupon below and pay postman. Send for free book on foot and leg troubles.

JUNG'S
The "Original"
ARCH BRACES

FREE if it fails

Jung Arch Brace Co., 222 Jung Bldg., Cincinnati, O.
Send 1 pair Wonder Style, \$1 and postage. Miracle Style (extra wide for severe cases), \$1.50 and postage. Send free book.

Shoe size.....Last.....

Name.....

Address.....

P. O.....State.....

Canada: Kirkham & Roberts, Pacific Bldg., Toronto.
Canadian prices: Wonder, \$1.25; Miracle, \$1.75.



Ready
for you

FREE FOLDER

TELLS ALL ABOUT THE
15 New Features

as well as the many other features of the wonderful Motor that thrilled the world in 1926 by its remarkable speed and power. You will want to know especially about "The Pilot" — a NEW device that steers your boat in any course you choose — straight or curved, without attention from anyone. Leaves you free to cast, or troll or rest. The New—

LOCKWOOD FORMERLY BOAT MOTOR

also offers you many other advantages—improvements in Power, in Speed, in Ease of Starting, in Stopping, in Convenience and Durability. Find out all about them before you choose any Motor. Get the facts now.

WRITE FOR FREE FOLDER

Just out — See how Lockwood is blazing the way by advanced engineering methods backed by 23 years of marine engine building experience. (24)

LOCKWOOD

MOTOR COMPANY
716 Jackson St. Jackson, Mich.

FREE

1000
Illus-
trations

ELECTRIC FIXTURE CATALOG!



Write today for your copy. Save 50% direct from Manufacturer. No Middleman's Profit. OUR SPECIAL: 8 Room Electric Set, ready to hang, \$24.50—Other bargains.



UNITED LIGHTING FIXTURE CO.
83 Flatbush Ave. Dept. P, Brooklyn, N. Y.



I'll Set You Up in the Oil Business

Without Investment

I want an ambitious, energetic man in every county to join me in the oil business. I'll make him my partner, furnish everything that's needed to do business and divide the profits 50-50 every week.

I have hundreds of men now with me on this basis—ready for a hundred more, part or full time. It's a chance of a lifetime. In this business you can make

\$50 TO \$250 A WEEK

Your Share of the Profits

Wengard, in Ohio, made \$430 for his share in one week. Montgomery, in Iowa, made \$216 the first week he started. Hundreds are making \$200 to \$500 every month the year round. It's a great business. Everybody buys oil. You simply take orders on Long Credit Terms for nationally known lines—Cen-Pe-Co Motor Oils—Columbia Paints and Roofing. We ship direct from nearby warehouse and collect. Pay you every week.

Write Quick for this chance. Just say, "I am interested in your proposition", in a letter or on a postcard. Mail it and I'll send complete particulars by return mail. First applications get the preference. **Act Now!**

P. T. Webster, General Manager
Central Petroleum Co. 342 Century Bldg.
CLEVELAND, O.

This 5-Room House
Materials**\$1795**Plan No.
633

Choose From 100 Plans!
Buy Direct From Mill,
and Save \$200 to \$2,000!

You Can Build Your Own Home By the Gordon-VanTine Plan-Cut System

We ship direct from mill all lumber and materials sawed, cut and fitted, complete blue-prints and full instructions.

Easy to build as swinging a hammer! Every part numbered according to plan. No sawing, beveling or notching to do. All the figuring, measuring, roof-pitches, angles already done for you. No cutting of heavy floor-joists, rafters or timbers. Even the doors are mortised for locks.

Saves 30% Labor And 18% Lumber Waste

The biggest item in building is labor. Save carpenters' hours and you save the costliest part of your building. This the Gordon-Van Plan-Cut system does for you. And there is no wasted lumber, no expensive "kindling wood" when you are through!

Staunch Because Accurate

As every piece is cut absolutely true to steel-gauge measurements, the parts all fit solidly and tightly. This gives you a stronger, stouter, better-built house. You will find your Gordon-Van Tine

Also Garages, Summer Cottages, Barns, Poultry Houses. Material Plan-Cut—build yourself and save money. Ask for catalog.

house the most solid, permanent in your community.

100 Distinctive Homes

Each designed by skilled architects. Planned for beauty, comfort, best arrangement. Many built-in conveniences to save steps and lighten housework. Highest quality material throughout—*guaranteed!*

Guaranteed Price

The price you pay us includes all lumber, lath, shingles, doors, windows, trim, stairwork, hardware, paint, tinwork, nails, varnish and enamels. We guarantee there will be no extras. Cement and brickwork you buy locally.

Wholesale Prices

Our immense volume, the economies created by 200,000 customers, and buying at the source, give you the benefit of *wholesale prices*. Many save \$200 to \$2,000. Get the full facts today!

20 Year Guarantee

furnished with every Gordon-Van Tine Home, backed by \$2,000,000 resources.

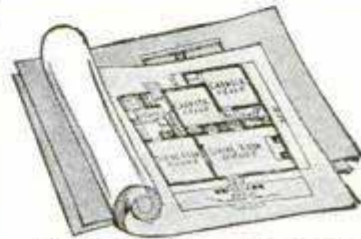

Floor Plan Home No. 633

Ordinary Rafter must
have four cuts made
by hand

Gordon-Van
Tine Rafter comes
all cut by machine

Our power-driven saws cut, notch and bevel rafters and other pieces in a fraction of the time it would take a carpenter to do by hand. Altogether we save you \$940 saw-cuts in the material for this house.

**Send For This 140-
Page Book of Homes!**
FREE!

Shows photos, floor-plans, specifications, prices of 100 charming homes — Bungalows, Colonial, city and country homes. Explains Plan-Cut System.



Mail Coupon or PostCard

Gordon-Van Tine Company
926 Case Street, Davenport, Iowa

Satisfaction Guaranteed or Money Back.

Please send me Book of 100 Home Plans.

Name.....

Address.....

Gordon-VanTine

Established 1865

PLAN-CUT Homes

Diamonds

Here at 60% of Market Price

Never in three quarters of a century have we offered such amazing bargains. Hundreds of money-saving opportunities in latest Diamond Bargain List, equalling those shown here.

Here's why we can offer such remarkable values: This 75 year old firm—rated at over \$1,000,000.00 capital—the largest and oldest diamond banking institution of its kind in the world has made loans on Diamonds, Watches, and other jewels in excess of \$25,000,000.00.

Why Pay Full Prices

Costs Nothing to See
Thousands of unpaid loans. Must sell now. Diamonds, Jewels, Watches and other Gems of unusual qualities—at an entirely different price basis—viz: loan values not market values. At our risk we send you any bargain you wish for absolutely free examination. No red tape. No obligation. Don't buy unless satisfied you can not match the bargain at 60 per cent more. **Diamonds of desirable quality at \$125 per carat. Yes, some even lower priced—also finest gems obtainable at higher per carat—but proportionately low bargain prices. Our bargains have guaranteed loan values also, unlimited exchange privilege at full prices.**

Latest List Diamond Loans

Send at once for latest list. Thousands of unpaid loans and other special advantage bargains. Many from big cash deals direct with European diamond cutters. Every gem described in full detail with exact weight, color, quality, etc. Get details of Free Examination Offer. No obligation. List is free.

MAIL COUPON NOW



\$38⁵⁰
1/2-3/16 Ct.
Perfectly Cut



\$186
1-5/32 Ct.
Blue White



\$62
1/4 Ct.
White Gold



\$55
5/2 Ct. Show cluster

Only Opposite Post Office

Jos. DeRoy & Sons
1953 DeRoy Bldg., Pittsburgh, Pa.
Without obligation, send me free, your latest Bargain List of Diamonds, Watches and other jewelry.

Name.....
Address.....
City..... State.....

NEW VEST POCKET ADDING MACHINE

BABY CALCULATOR
CHICAGO U. S. A.
PATENT APPLIED FOR



**ADDITION
SUBTRACTION
MULTIPLICATION
DIVISION**

Guaranteed

ADDS, SUBTRACTS, MULTIPLIES, DIVIDES
Does work of \$300 machine. Guaranteed 5 years. NOT A TOY.
Made of steel and indestructible. Million dollar capacity. Fits in pocket. Will not make mistakes. So simple child can operate it. Instructions furnished. Everybody should carry one for figuring.

FREE TRIAL

\$2.50

Total Cost

SEND NO MONEY—Just name and address. We will ship calculator immediately. (On delivery pay postman \$2.50 (Plus few cents Postage). (If outside U. S. send cash). If not satisfied after 10-day trial you get your money back. **THOUSANDS OF SATISFIED USERS.**
This is lowest priced practical calculator made. "Why pay more for inferior imitations?" Order from this ad.

----- Mail Coupon Today -----

BABY CALCULATOR SALES COMPANY
Dept. 41, P. O. Box 1118, CHICAGO, ILL., U. S. A.

I am enclosing \$2.50—send adding machine prepaid.
 Send Adding Machine C. O. D. \$2.50 plus postage.

Name.....
Address.....
City..... State.....

AGENTS

Write for big commission and territory proposition.

It's easy to Sell Wright Clothes

BECAUSE WE SUPPLY YOU WITH A LIST OF ACTUAL PROSPECTS

You can make \$50 to \$125 a week taking orders for WRIGHT wonder clothes, because you can devote your time calling on men actually ready to buy. We pay for newspaper ads, circularizing, etc. Write today for sensational offer!

I will pay you \$400 to \$600 in cash on every Order

ALL-WOOL, Tailored to measure suits and overcoats, \$23.50 and \$31.50. Two price ranges to meet every quality and price competition. Over 70 smart, new fabrics at \$23.50. Real co-operation by furnishing live "leads" and in many other ways, will make 1927 your banner year.

SAMPLE OUTFIT GIVEN!

No charge or deposit to men who qualify. Full or part time. Many men with no selling experience have made good with this wonderful line. To apply, with this wonderful line, territory, state name, address, age, territory, experience, references, how long at present address, married or single—tell us all about yourself.

ANSWER QUICK!



WRIGHT & CO.

QUALITY TAILORS
Dept. 205, 2300 Wabansia Avenue, Chicago



KING

Band Instruments

EVERY MAN A MUSICIAN

THERE is music in all of us. Every normal man longs to "make music." The man who plays—who can express himself in harmonic sound—leads a richer, fuller life. Through artistic accomplishment he learns to appreciate all art.

Let us tell you how easy it is to master a good band instrument or saxophone; how King Instruments help you to learn quicker and play better; and how simple it is to make a ten day free trial of any "King" right in your own home.

The coupon will bring you complete information, including the story of your favorite instrument.

The H. N. White Co., 5211-84 Superior Ave., Cleveland, O.
Kindly send your illustrated catalog.

Instrument.....

Name.....

Address.....

City..... State.....



Abraham Lincoln and the Harmonica

On one of his journeys for a debate with Douglas, Abraham Lincoln picked out of his pocket a little harmonica and played upon it, seeming to get happiness in the playing thereon. Says Carl Sandburg in "Lincoln, The Prairie Years": "Someone remarked about his playing on the harmonica and he said: 'This is my band; Douglas had a brass band with him in Peoria, but this will do for me.'"

Back in the days when Abraham Lincoln was engaged in his world-famous debates with Stephen A. Douglas, the Hohner factories were engaged in making "The World's Best" Harmonicas. Today, Hohner Harmonicas are available at leading dealers the world over. Ask for the Free Instruction Book. M. Hohner, Inc., Dept. 181, 114 East 16th St., New York City.



CALCULATIONS

In Office, School, Store and Shop can be instantly made with the Midget Slide Rule. It gives the answer to any problem involving fractions, mixed-numbers, decimals, whole-numbers, roots, powers, Logs, and Trig. Functions. Thousands of these rules are used by Accountants, Engineers, Clerks, Students, etc. It is the most versatile calculator ever invented. If you have any figuring to do, order a Midget Slide Rule on trial. Made of aluminum with figures on white celluloid. Size 4". Price with Instruction Book \$1.50. Leather Case, 50c extra. Catalogue Free. Bent C. O. D. if desired. Your money back if you are not satisfied.

GILSON SLIDE RULE CO., Niles, Mich.

EASY \$100 a Week

FUGO

FIRE EXTINGUISHER

Unusual opening for live agents in every locality. Make \$5000 or more a year—*easy*. Fugo—the instantaneous automatic fire extinguisher—is needed and wanted in every home, store, theatre, garage, shop, school, automobile, etc. Cheapest fire protection available today. Within reach of all.

1 Qt. Size \$5.00 2 Qt. Size \$7.50

Recharged in a jiffy.

Amazing 30-second demonstration clinches sale—each one sold sells others. Territory going fast. Write at once for wonderful proposition that will **MAKE YOU BIG MONEY.**

THE NATIONAL FORMALET CO.
6535 Metta Ave., N. E. Cleveland, Ohio



Don't let unruly hair spoil that shot!

SHOOT!

Score tied! Two minutes to go! Then—a lightning dribble down the floor, a sudden turn, and—

"Make that basket!" ...

At times like this your hair won't get in your eyes if you use—*Stacomb*. And at times when you want your hair to look its best—smooth, lustrous, in perfect order ...

To make unruly hair lie down more fellows rely on *Stacomb* than any other dressing for the hair!

And here's the secret—no matter how stubborn your hair is, *Stacomb* keeps it in place, right—*all day long*.

And more!—*Stacomb* never leaves your hair sticky nor gummy. Nor dry and "dead," as wetting with water leaves it. *Stacomb* supplies the oils your hair needs. Helps to prevent dandruff.

Stacomb comes as a combing cream—in jars and tubes—and now in the popular new liquid form as well. All drug and department stores.

FREE OFFER *Stacomb*

Standard Laboratories, Inc.
Dept. BB-4, 113 W. 18th St., New York

Send me free sample of *Stacomb* as checked:—
Original, cream form New liquid form

Name

Address

AGENTS! EXPERIENCE UNNECESSARY



Science has finally produced it. An instantaneous metal cleaner—neither sloppy liquid nor messy paste. Dry magic floss. Touch it to nickel, copper or brass. The metal shines bright and clean instantly! No hard rubbing! Lightning Silver Cloth does same for Silverware. Lightning Furniture Floss instantly cleans and puts high lustre on Furniture. No liquid! Lightning Products all approved by Good House-keeping Institute. Agents making up to \$30 a day!

AMAZING DISCOVERY ABOLISHES METAL AND FURNITURE POLISH

Imagine! Touch tarnished articles with a Lightning Polishing Cloth or Floss and you make them bright as new. Demonstrations positively astonishing! Every one a sale! Agents collect real money on every call.

Makes a Sensational Demonstration!

Everybody Buys These Products. Housewives buy the Lightning Silver Cloth and Furniture Floss. Autoists buy Lightning Polishing Floss. Sell all three to stores and offices in big quantities. Nothing else like them. Sure big, quick MONEY GETTERS.

Sample Free! Exclusive territory. Real cooperation. Triple profit. Answer this ad at once. Make big money. Easy! Quick! Don't delay. Write NOW! FREE test sample and proposition by return mail.
C. R. LIGHTNING PRODUCTS CORP., 1773 Greenleaf Ave., Chicago

PLEASURE, PROFIT and POPULARITY for YOU!



Start to Play the Very First Day!

YOU can play the Xylorimba

Extra Money—Hosts of Friends Loads of Fun Within Your Grasp Free Trial... Easy Monthly Payments



Fame and Money Broadcasting



Center of Attraction at Gatherings



Big Money at Dances

WHO doesn't want to be the "life of the crowd" at parties, entertain the whole family, and make \$5 to \$25 a night besides?

Earns \$60.00 a Week

Ralph Smith, Chicago, says: "Played 20 minutes at wedding, Received \$20." L. E. Hallman, Reading, Pa., writes: "Within 30 days had more jobs than I could handle and had never played an instrument before." Eight-year-old Michael Howe is playing "big time" vaudeville at reported salary of \$250 a week.

Start to play the very first day, even if you can't read a note. Free lessons, furnished with each instrument, make it easy to learn.

SEND TODAY FOR FREE BOOK!

It tells all about free trial and easy payment plan. Soon you will have your Xylorimba. Have the time of your life learning to play. Then delight and astonish friends and family. Be the center of interest at gatherings. Make real money at dances. It's easy once you make up your mind. Mail coupon today!

MAIL COUPON TODAY!

J.C. Deagan, Inc., Dept. 1452, 1770 Beretan Av., Chicago
Please send me full details on the Free Trial offer and easy payment plan of the Deagan Xylorimba.

Name _____
Address _____

Dealers: We have a plan that will interest you.

PRICES REDUCED

Only \$3 Down Express Prepaid



A Year to Pay

Yes, lowest prices on UNDERWOOD, REMINGTON, L. C. SMITH, ROYAL, and all standard makes on easiest terms ever offered. Re-manufactured like new by the famous "Young Process" to give a lifetime of service.

10 Days Trial Our liberal "direct from factory plan" saves half. You actually use the typewriter 10 days without obligation to buy. Let us prove we have the greatest typewriter bargains ever offered. You actually save from \$40 to \$50.

Big Illustrated Catalog FREE This interesting valuable book explains fully how "Young Process of Re-Manufacturing" guarantees you highest quality, perfect service and satisfaction. Rush coupon today to

YOUNG TYPEWRITER CO., (Est. 1911)

SEND COUPON NOW

Young Typewriter Co., Dept. 1102, 654 W. Randolph St., Chicago
Send me Free book and Special Reduced Prices and Prepaid Express offer. This does not obligate me in any way.

Name.....
Address.....
City..... State.....

Auto Owners WANTED!



To Introduce & Use **HYDRO Insured TIRES**

Hydro Agents make money selling the only Tires in the World Insured for One Year against all road hazards regardless of mileage. **HYDRO TIRES** sell fast because they have no competition in price; no rival in quality; no imitation in appearance and no equal in the Insured Protection to the user. Insurance Policy with every tire.

HYDRO Insured TIRES
"The Most Beautiful Tire in America"

are made by the only tire factory in America selling its own product, through authorized Salesmen-Agents. We offer opportunity of lifetime to establish profitable tire business of your own. No capital required. Sales kit and advertising helps furnished. Exclusive territory granted. Write today for catalog and complete information about the Hydro Agency Plan.



HYDRO-UNITED TIRE CORP.
Address Dept. PM12
Chicago, Ill. POTTSTOWN, PA. Millersburg, O.



BUCHSTEIN'S FIBRE LIMB

is soothing to your stump—strong, cool, neat, light. Easy payments. Braces for all deformities. D. BUCHSTEIN CO. 610 3rd Ave., So. MINNEAPOLIS, MINN.

Send for Catalog Today

Big 3-ft. Telescope

Makes people and objects miles away seem close. Brings new pleasures to home, farm, camp, travel, sport. See moon and stars as never before. New Ferry "Wonder" telescope has 5 sections—over 3 ft. long open, 12 in. closed. Fully brass bound. Powerful lenses.

FREE! Yes, Absolutely FREE! Hand-some leatherette covered Carrying Case, light, strong, complete with strap. Handy for farmers, auto tourists and hikers.

5 Sections 8-Power Lenses Thousands Delighted!

"I am delighted with the 'Wonder' telescope. Today I have been watching submarines 3 miles off the coast."—Philip Brush. "I can see across the Mississippi 3 miles and see people fishing."—M. L. Thorn. "I am nearly 80 years old and if I could not get another would not take \$10.00 for it."—A. R. Walker. "I can tell time on the church clock 5 miles away."—Edward Foster. "Could tell color of aeroplane 4 miles away."—Mrs. L. M. Yarbrough. "I saw a Light House 18 miles away."—Clyde Scribner.



Send No Money

Send name and address and Ferry Wonder 3-ft. Telescope with free Carrying Case will come by return mail. Pay postman special bargain price of \$1.85 plus a few cents postage. Satisfaction guaranteed or your money back. Supply limited.

Order Today! **FERRY & CO., Dept. 9772, CHICAGO**

Look *sent on* Approval

Adjusted to the Second
Adjusted to Temperature
Adjusted to Isochronism
Adjusted to Positions
21 Ruby and Sapphire Jewels
25 Year Gold Strata Case
Your choice of Dials
(Including Montgomery R. R. Dial)
New Ideas in Thin Cases

The 21 Jewel Santa Fe Special

We will send this famous watch, express prepaid, for you to examine, to inspect, to admire, to approve, without one penny advance payment. Examine the watch and be convinced it's the best watch buy you ever saw. Just a small payment down, the balance in easy MONTHLY payments. You use the watch while paying for it.

Save 1/3 to 1/2 of Your Money

By purchasing this Famous Santa Fe Special Watch. Not only are you saving money from the present day prices of watches, but you can still secure the "Santa Fe Special" Watch, at the same low prices and terms that have made our watches famous.

Ladies' Wrist Watches

Artistic, dependable ladies' wrist watches — perfect timepieces, beautiful hand engraved cases in white or green gold. Send for New Watch Book and see the new shapes and designs. Sent on approval and sold on payments.

Write for "Santa Fe" Watch Book

Clip the coupon, fill out and receive the FREE WATCH BOOK just off the press. All the newest watch case designs in white or green gold, fancy shapes and thin models are shown. Read our easy payment offer. Wear the watch 30 days FREE. Watch sent for your examination and approval without a penny down. Nothing to risk. See the watch before you buy. Write for New Book Today and Select Your Watch, Mail Coupon.

SANTA FE WATCH COMPANY

26 Thomas Building, Topeka, Kansas
(Home of the Great Santa Fe Railway)

A LIMITED OFFER!

With every Santa Fe Special, a beautiful gold chain or strand of exquisite pearls. Write while offer lasts.

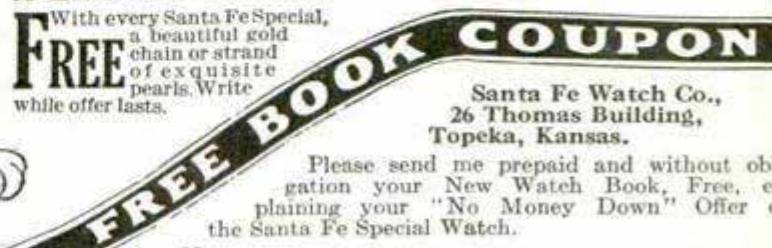

Santa Fe Watch Co.,
26 Thomas Building,
Topeka, Kansas.

Please send me prepaid and without obligation your New Watch Book. Free, explaining your "No Money Down" Offer on the Santa Fe Special Watch.

Name.....

Address.....

State.....



Men in every walk of life
now wear Strap Watches

Earn \$100 a Week Profits in Advance

I pay men \$100.00 a week and up by my plan which I want to send you at once. Be your own boss, work where and when you like. You can do fine even without previous experience. **Biggest values—positively sell on sight.**

Profits in Advance

My plan pays biggest profits and commission in this line, all paid in advance, we attend to

delivering orders and collections.

TAILORING

Astonishing values get orders easy when you show samples of our tailored to order, all wool, suits and overcoats—one price \$31.50. Our advertising helps you take orders quick.

FREE!

This big, fine sample outfit furnished free, contains 100 big all wool samples, all one price, \$31.50, fine colored fashions, stationery, supplies, tape, etc. All in classy, fine carrying case. Also complete sales manual, we place you in **Big Money Class.**

W. Z. Gibson, Inc., Chicago

Dept. B-516, 161 West Harrison Street

Without obligating me in any way, please send me complete information regarding your new plan to earn \$100 weekly.

Name.....

Address.....

City..... State.....

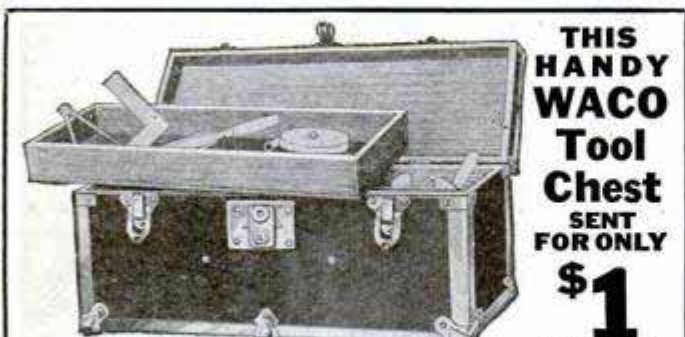

THIS HANDY WACO Tool Chest SENT FOR ONLY \$1

"Your Waco Chest is the finest thing in my workshop."
Hollis Root
Glencoe, Ill.

A real chest for small tools. All metal covered, metal bound wood chest that measures 17x8x8. Heavy plated bumpers and corners make it very substantial and attractive. Keep your tools under lock and key, hammers, screw-drivers, wrenches, pliers, tape-line, plane, squares, drill bits, bolts, screws, everything. Carry it anywhere. Send only \$1.00 (bill, money order or check) with your order. Pay the postman just \$4.00 plus a few cents postage and you own it. Absolutely guaranteed. Send it back if not what you need.

WACO TOOL WORKS, 2915 So. Wabash Ave., Chicago, Ill.
Enclosed find \$1.00 for Tool Chest. Will pay balance \$4 on arrival, Satisfaction guaranteed.

Name.....
Town.....

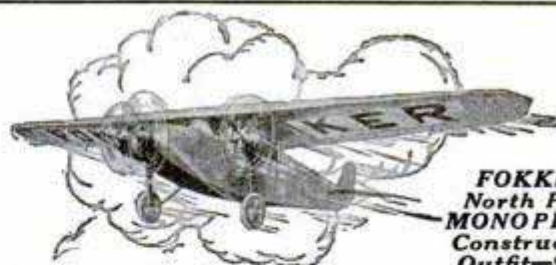

FOKKER North Pole MONOPLANE Construction Outfit—\$8.50

BUILD AND FLY MODELS OF Famous Airplanes!

It's the most interesting thing you ever tackled; develops your mechanical ability; teaches the principles of aviation; shows you the parts of big machines, how they are constructed and covered, what makes them fly, and many other things real aviators must know. Any bright boy can do it. Ideal Scale Drawings and Building-Flying Instructions show how, and Ideal Model Airplane Construction Outfits contain everything needed. For 25 cents we will send you the complete plans (3 ft. size) for any one of the following famous airplanes:

Every Boy's Airplane

The finest idea in Model Airplanes. Looks like a real one; clips together easily and quickly, ready to fly in 2 hours. **ONLY \$6.00**

FOKKER North Pole Plane; Curtiss JN4D-2 Training Plane; DeHavilland "Round-the-World" Flyer; NC-4 Naval Seaplane; Bleriot, Nieuport or Taube Monoplane; or Cecil Peoli Racer. Send 25c now and get plans for the one you want to build. (All 8 plans for \$1.50.)

Catalog Model Aeroplanes, Flying Toys and Supplies, 5c postpaid.

Ideal Aeroplane & Supply Co.
408 West Broadway, New York



Ask your Dealer for Ideal Model Aeroplane Construction Outfits.



EASY TO BUILD THINGS

"S-B" Big Economy Wood Metal Saw. A real tool. Strongly built. Fully guaranteed. Tilting table, 10x13, 6" combination saw. Adjustable top. Replaceable Phosphor Bronze Bearings. Ripping capacity 2". **\$19.90**

F. O. B. Chicago

JUST THE TOOL FOR BUILDING THINGS AT HOME

Radio, Patterns, Carpenter Work and numerous other practical and useful articles. Without saw, \$17.00. We also manufacture Motor-Driven Saws, Bench and Stand Type. end for descriptive circular.

Scott-Bansbach Machinery Co., Dept. 227, 130 S. Clinton St., CHICAGO, ILLINOIS

RADIO AGENTS: NOTICE!

Just out—latest, greatest, 5 tube set made. Built-in speaker, front drop panel, piano hinged top. Temple speaker with finest unit, walnut finish two toned cabinet etched in gold 32x10x9 all complete with 5 matched tubes, and complete aerial outfit to retail at only **\$59.50** less handsome commissions to you. Wire or write for detail's quick!

AERIAL ELECTRIC CO. LA SALLE and KINZIE CHICAGO, ILL.

Boils 50 Gallons In Less Than Hour

No Other Compares With This

Improved Oil Burner

Use Ordinary Kerosene or Coal Oil
[Burns Outdoors as Well as Indoors]

THE most remarkable Kerosene Burner ever built. Boils down apple cider, maple syrup, molasses, etc., in half the ordinary time. Ideal burner for dairies, butchers, indispensable on the farm.

PRODUCES TERRIFIC HEAT WITH SILENT BLUE FLAME

**NO NOISE
NO SMELL
NO SMOKE
NO SOOT**



So efficient it produces amount of heat of City gas at half the cost. So simple anyone can install and operate. Double generator assures continuous operation without shut-downs. Nothing to wear out, starts in a jiffy, will last a life time. Every burner guaranteed fully. Write for special introductory price. Free descriptive catalog.

HOME MANUFACTURING CO.
Dept. 43, 18 E. Kinzie Street, CHICAGO

I made \$93 my first week



"Since then I've been earning over \$100 every week selling the Stay-Prest Trousers Presser"—says S. L. Patterson of Iowa. Jack Ames made \$24.00 in four hours. Randle sold twenty-five the first day. Mary Roberts cleared \$10.00 in one evening. You too can make big money by selling this

Wonderful New INVENTION
Stay Prest Trousers Presser

Keeps pants always pressed. Puts in knife edge crease, removes baggy knees and smooths out entire surface. Easy to use—takes only a few seconds. No steam or heat. Saves nap of cloth. Lengthens life of trousers. Durably made of hardwood—lasts years. Finished in black leatherette. All metal parts heavily nicked. Looks rich. Fits any size trousers. Folds to 15 inch package to fit small handbag. Over 250,000 in use.

Profits in Advance

Your profits in advance. Simply write orders. We ship and collect. Stay-Prest sells quickly—average sale made in 8 minutes. 40% profit. Newest thing out. Big repeater.

FREE ~ To Man or Woman

Special offer enables you to obtain Selling Outfit absolutely free—everything you need to take orders. We guarantee you will make sales. Write for plan and exclusive territory.

The Getgey-Jung Co., B-121 G. & J. Bldg., Cincinnati, Ohio
Smith & Bourke, 110 Dundas Street, London, Ontario, Canada

The Best Friend on the Road

A great traveling companion, this Barbasol. No tools to pack except the good old razor. No brush. No rub-in. And a real head-barber shave! 35c and 65c tubes.



The Barbasol Co. Indianapolis Ind.

I enclose 10c. Please send trial tube.

Name

Address

.....

P-M-2-27

For Modern Shaving



Agents - Salesmen

New, patented Cigarette and Match Case. Holds a package of cigarettes and box of safety matches. Made of grain finish, black leatherette.

A whirlwind seller—write for particulars on liberal profit proposition.

ALL-IN-ONE SALES COMPANY

Dept. A-2 2810 Portland Ave. Minneapolis, Minnesota

SAMPLE 50c

Chemical Tricks for Boys



Surprise and puzzle your friends with magic chemical tricks; make ink, dye cloth, test water and soil; write secret letters with invisible ink; pour blue, brown and black liquid from a pitcher of water. All these and many more chemical stunts are easy with Chemcraft Junior. It's the best box of fun you ever had! Get yours now. Order at once and we will include the New 1927 "Boy's Hand Book of Chemistry," a regular 25-cent book containing 60 pages of experiments, formulae, chemical facts and money-making ideas; both for only **35c**

The Porter Chemical Co.
113 Summit Ave. HAGERSTOWN, MD.

SAVE 1/2 ON PLUMBING & HEATING SUPPLIES

CATALOG FREE

90 pages. Beautifully Illustrated—Warranted high quality or money back. Get our Catalog before you buy.

STANLEY PLUMBING SUPPLY CO., Inc.
1000 Spring Garden St. PHILA., PA.

\$150 to \$300 MONTHLY PROFIT WITH THIS ONE DAY BATTERY CHARGER

30 DAYS FREE TRIAL ON ABSOLUTE MONEY BACK GUARANTEE

Charge batteries in 1/4 the time required by others and get the business. Latest method recommended by the leading battery companies and approved by the U. S. Bureau of Standards. **BIG YEAR ROUND PROFITS.** Best paying business in automotive field. Requires no special experience, uses small space. **30 DAYS' FREE TRIAL** at our risk under absolute money back guarantee. Write today for bulletin X, giving full particulars.

HOBART BROS. CO. Box M-271 TROY, OHIO

and it cost only \$16.50 monthly



DEVITT 8" COMBINATION SAW

13 TOOLS IN ONE

Saw table raised, showing Emery wheel, saw guard and drill attachment.



Planer attachment on saw table.

Showing Sanding disc attached.



Table tilted for beveling.

Dado head attached for grooving.

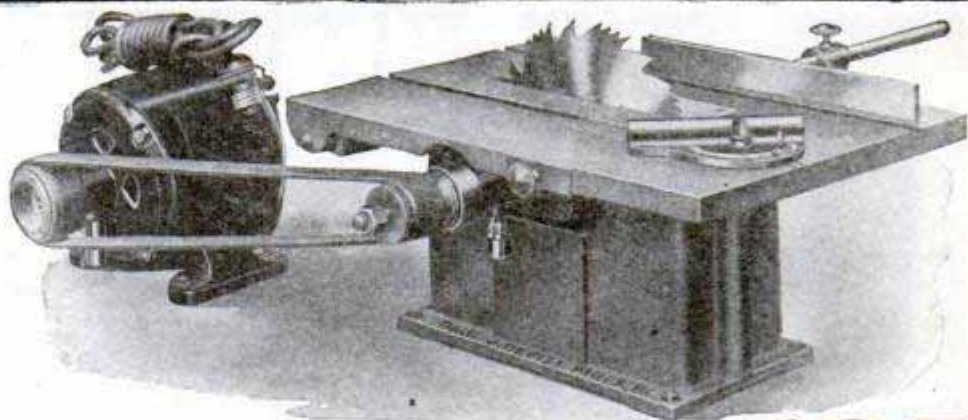

YOU save a great deal of money, time and space by buying a Devitt 8" Combination Saw. Why buy special tools for beveling, grooving, buffing, etc.? The Devitt Combination Saw will rip, cross cut, bevel, miter, groove, mortise, tenon, drill, rabbet, grind, buff and polish. The attachments are easily and quickly adjusted. The saw and motor when set up ready for work occupy very little room. The $\frac{1}{4}$ H. P. 60 cycle 110 volt A. C. motor can be run from a light socket and provide power for other purposes when the saw is not in use. A cut up to $2\frac{1}{4}$ " can be made with the 8" Combination Saw without planing. The ideal machine for shop, factory or home, complete with attachments: 12"x16" table, 8" Combination Saw, iron pulley for saw table, 12" ripping fence, adjustable cut off miter gauge, motor-specifications as above, 1 1/4" endless leather belt, wood pulley, 8 ft. cord and plug, 6" buffing wheel, 3/4" 3 jaw drill chuck, 5" emery wheel, 8" sander, saw guard, and 2" dado insert. \$35.00 F. O. B. Phila. Height 16", shipping weight, 100 lbs. (Planer attachment to fit on table top will smooth pieces up to 2' wide, \$12.00 extra F. O. B. Phila.)

\$35
F. O. B. Phila.

Write for our beautifully illustrated 4 page circular.

PAUL J. DEVITT 1102 South 2nd Street PHILADELPHIA, PA.

Italian Accordions

We manufacture and import all kinds of first-class hand-made

ITALIAN ACCORDIONS

the best in the world. Ten year guarantee. Our prices are lower than any other maker's. Free Accordion instructions to buyers. Write for FREE catalog.



RUATTA SERENELLI & CO.
1014 Blue Island Ave., Dept. P, CHICAGO, ILL.



CLASS PINS 25¢
NEW CATALOG FREE!

DESIGNS SHOWN—SILVER PLATE 25¢ EA., \$2.75 DOZ., STERLING SILVER 40¢ EA., \$4.00 DOZ., GOLD PLATE 35¢ EA., \$3.50 DOZ.
3395 1 OR 2 COLORS ENAMEL, ANY LETTERS AND DATE



BASTIAN BROS. CO. 20 BASTIAN BLDG. ROCHESTER, N.Y.

Catch Fish!

Eels, Mink, Muskrats with our new fold-in; galvanized STEEL WIRE TRAP. Write for our FREE TRAP OFFER and Bargain Catalog. \$1 Box of our famous Fish Bait FREE to introduce our traps. **WALTON SUPPLY CO., 3500 JUNIATA AVE., ST. LOUIS, MO.**



Beauty of finish

What do you look for in a finish—beauty, color, durability? Valspar gives woodwork and metalwork all three, plus absolute water proofness. Send 20c for sample can and literature. Valentine & Co., 452—4th Ave., New York, N. Y.



Clear and in Colors

VALSPAR

Colors: Red (Light and Deep), Green (Medium and Deep), Blue (Light, Medium and Deep), Vermilion, Yellow, Brown, Ivory, Gray, Orange, Black, White, Mahogany, Oak (Light, Dark), Walnut, Cherry, Moss Green, Clear.



Speed Lathe \$10.50

complete with spur center and adjustable rest. Longer bed \$1.00 per additional foot.

7" swing, 24" metal bed, 3 speed cone pulley. **JEFFERSON MFG. CO., FAIRFIELD, IOWA**



\$25.00 PAID DAILY

FREE SLICKER for WORKERS for just a little work on your part **WOMEN, MEN WANTED**

It's Easy. You show raincoats. We deliver and collect. **WRITE FOR FREE OUTFIT**
Super Built Co., Box 453, Desk 2, Chicago, Ill.

\$150 to \$300 MONTHLY PROFIT WITH THIS ONE DAY BATTERY CHARGER

30 DAYS FREE TRIAL
ON ABSOLUTE MONEY BACK GUARANTEE

Start a **Big Profit-Making Business** of your own—"One Day Battery Charging." Requires **small space** and **practically no investment**. Anyone can successfully operate. Charges batteries in $\frac{1}{4}$ the usual time at $\frac{1}{4}$ the cost. **Every car owner a customer**. The HB One Day Battery Charger will pay for itself on easy monthly payment plan with practically no expense to you—and bring you a handsome profit besides. **Write for full particulars in Bulletin M. NOW!**
HOBART BROS. CO. Box M-27 TROY, OHIO

and it cost only \$16.50 monthly



THIS MAN has started *Thousands* on the road to *Fame and* *Fortune!*



He can do the Same for YOU

THIS famous instrument maker, F. A. Buescher, the man who made the first saxophone *ever produced* in this country, is responsible for the fame and success of *thousands of musicians*.

Many of them *never dreamed* they could do anything with music. They took it up "just for fun" and *they were amazed* to find how *easily* they learned to play their Bueschers. They made rapid progress. Today their names are famous *throughout the land*.

Buescher Makes It Easy

You can learn to play any Buescher instrument. You do not have to be "talented" or "gifted." If you can whistle a tune, if you can mark time to music, *you can learn* the scale—then easy tunes—then there is

no limit. But *only with a Buescher* is this rapid progress *assured*. Simplified fingering; easy blowing; perfect tuning give you *special advantages*. You don't have to fuss and favor for certain notes. Just open the key and *blow normally*. You'll say it's like *play*.

Free Trial, Easy Terms

Buescher will send you any True Tone Instrument for six days' trial in your own home. See what you can do. Then send a small down payment and pay the balance monthly. Satisfaction guaranteed. Mail coupon below for catalog of your favorite instrument. Do this Today.

BUESCHER BAND INSTRUMENT CO.
Everything in Band and Orchestra Instruments
1915 Buescher Block
Elkhart, Ind.



Mail THIS ~

COUPON

Buescher Trumpets, Trombones, and other band instruments are superior in easy playing, perfect tonal qualities, and are used by the leading artists throughout the world. Any instrument sent on six days' trial. Easy terms of payment. Mail coupon for special catalog of your favorite instrument.

BUESCHER BAND INSTRUMENT CO.		365
1915 Buescher Block, Elkhart, Ind.		
Gentlemen: Without obligating me in any way please send me your free literature. I am interested in the instrument checked here. Saxophone <input type="checkbox"/> Cornet <input type="checkbox"/> Trumpet <input type="checkbox"/>		
Trombone <input type="checkbox"/> Tuba <input type="checkbox"/> Mention any other.....		
How old are you?.....Do you play any instrument?.....		
What?.....		
Name.....		
Address.....		
City.....		State.....

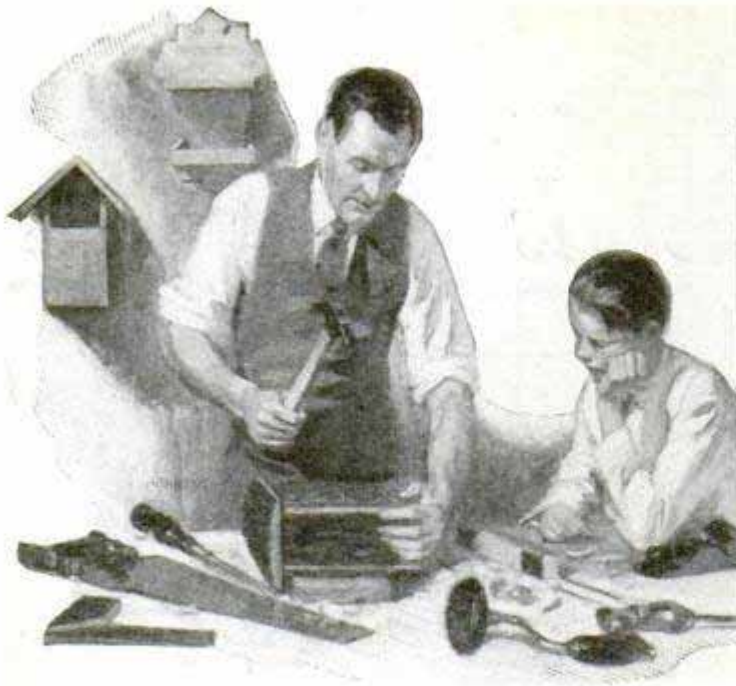

*Buy separately
or in assortments*

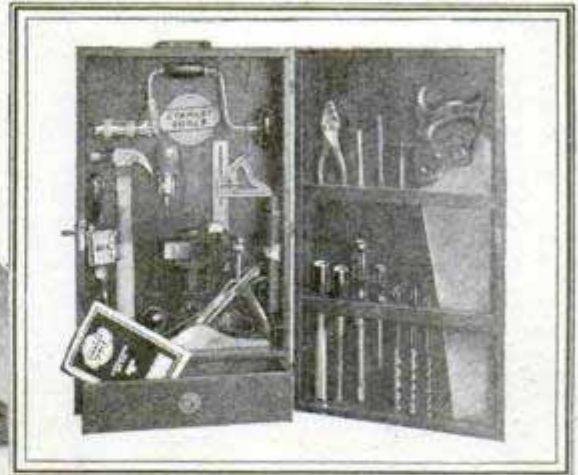

To bird lovers only!

DO you know that a bird house which is properly made for a bluebird or a swallow will repel a wren or robin? Stanley Plan No. 9 tells how to make several types of bird houses—each designed to attract a particular species. It will show you how to make homes that will attract your favorite birds and keep the undesirable ones away.



Of course you know that good work calls for good tools. The amateur user needs good tools just as much as the professional. Most carpenters use Stanley Tools because their wide experience has taught them that the name Stanley stands for correct design, perfect balance, and great durability. And Stanley Tools are

standard equipment in thousands of manual training classes.

You can buy Stanley Tools separately and so collect your own set. For your convenience in buying there are also complete sets of Stanley Tools in chests at a wide variety of prices from \$15 to \$95. Or there are assortments in strong cardboard boxes containing directions for making your own tool chest. Price \$2.15 to \$20.



Stanley Plan No. 9 will give you the right start. Your hardware dealer has this plan as well as other Stanley plans for making useful articles, or he can get them for you. Ask him also for Catalogue No. 34-D, which shows the most complete line of woodworking tools on the market. If he cannot supply you write direct to The Stanley Works, New Britain, Conn. The plans cost only 10c each. The catalogue is free.

The best tools are the cheapest to use
Ask your hardware dealer

STANLEY TOOLS

SAWS THAT CUT METAL FASTER

THE High Speed Steel Teeth of Simonds Inserted Tooth Saws make short work of heavy, tough metal-cutting jobs. The plates of wear-resisting steel are tempered to give maximum strength and stiffness for heavy duty cutting.

SIMONDS SAW AND STEEL COMPANY
 "The Saw Makers" Established 1832
 Fitchburg, Mass.



Branches and Service Stations in Principal Cities

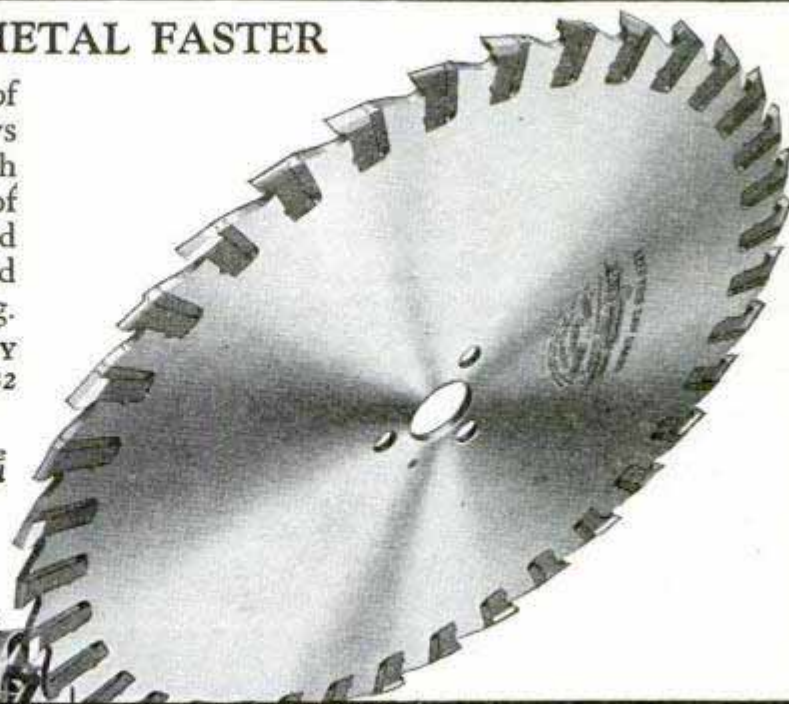

SIMONDS

Pronounced SI-MONDS

SAWS FILES KNIVES STEEL

\$25 to \$45



GET THE NEW IDEA BATES MOTOR SAW — 6 SAWS IN 1 —

Does the work of band-saw, rip-saw, cross-cut, miter, bevel and scroll-saw. A wonder worker for the home shop. Direct drive! Can't stick! Cuts 2" wood. Most amazing variety saw ever invented. Does more, costs less! Not a toy. Write for circular.

BATES MOTORCRAFT COMPANY
 Dept. M 28 N. Clinton CHICAGO, ILL.

Interlox

MASTER SLIDE RULE

Takes accurate inside or outside measurements

MASTER RULE MFG. CO.,



Works fast. Slides in and out quickly. Durable made of brass trimmed boxwood. Any length 2 to 8 feet, 20 cents per lineal foot. If not at dealer's, sent postpaid.

Dealers and Agents: request attractive proposition



Toolmakers and Machinists FIND GERSTNER Tool Cases

valuable because of the time they save. No tools mislaid — every tool has its place. Use one and you will wonder how you got along without it. Catalog free.

A. Gerstner & Sons

438 Columbia St., DAYTON, OHIO

BURN YOUR NAME ON TOOLS WITH THE ARKOGRAF

PROTECT YOUR TOOLS FROM THEFT

Write with electricity any name or design on the hardest and finest tools and instruments, or any metal, like writing on paper with pen or pencil. Complete Outfit \$3.50 — Prepaid Anywhere. Interesting Illustrated circular free. Write today. Agents wanted.

ARKOGRAF PEN CO., 1171 E. Stark St., Portland, Oregon

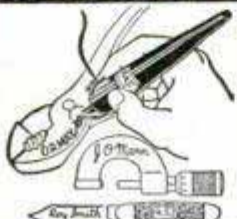

For sure grip... or clean snip!



In wrenches and pliers you want "gripping power." In wire cutters, nippers, and tin snips you want "snipping power." In Crescent-Smith & Hemenway Tools you find both at their best.

Hardware and accessory dealers have them.

**CRESCENT
 TOOL COMPANY**
 210 Harrison St.
 Jamestown, N. Y.

CRESCENT and Smith & Hemenway TOOLS

Fastest Cutting

**Saws Fifteen Cords
a Day!**



**Men—
Let Me Send You My
Greatest LOG SAW Offer!**



It's easier now than ever before to own this fastest-cutting, easiest-moved, most powerful Log Saw. Now, you can make big money sawing firewood, stave-bolts, ice, shingle timber, etc. Write today for full details of this most wonderful offer. Know how easy it is to make big money sawing fifteen cords of wood a day with no hard work.

350 Saw Cuts a Minute—

nearly six each second. Just think of it—now you have a log—in a few seconds it's all sawed up into lengths you can use—without any hard work! The OTTAWA has balanced crank shaft, power force feed, friction clutch.

Make BIG MONEY—

Wood selling at \$3 a cord brings owner \$45 a day. Saw your own wood—go into the wood business. Don't let the lack of ready money stop you. Remember, we sell on very easy terms. More in use than all others combined.

**ONLY
\$39**

**Puts the OTTAWA
Working for YOU!**

I average \$20 profit a day with my OTTAWA. — J. Schill, New York. "My OTTAWA has earned \$700 for me." — S. Graham, Wisconsin. "I can make more money with the OTTAWA than by farming." — D. Goff, Missouri.



OTTAWA 4.H.P. LOG SAW

30 Days to Try—one whole month to use the OTTAWA at your own sawing. Shipped on trial only—backed by 10-year guarantee. Prove to yourself how easy you can saw 15 cords or more a day—at a cost of 1 1/2¢ a cord.

FREE Send me your name and address on postcard today, so I can send you my wonderful new edition of the "Wood Sawing Encyclopedia." Educational, instructive. Be sure to investigate—will help you to make big money.

HARRY OVERMAN, Pres. OTTAWA MFG. CO.
1742-P Wood St., Ottawa, Kans. Room 1742-P, Magee Bldg., Pittsburgh, Pa.

To Save You Freight—and get your machine to you a few days after you order, I ship from: Ottawa, Kan.; Pittsburgh, Pa.; St. Paul, Minn.; Albany, N. Y.; Memphis, Tenn.; Indianapolis, Ind.; Pueblo, Colo.; Ft. Worth, Texas; Portland, Ore.; San Francisco, Cal.

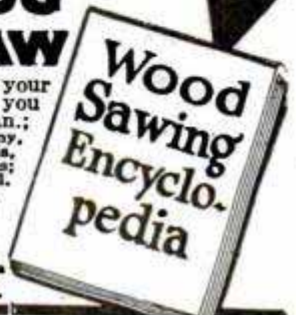

**PARKS
WOODWORKING MACHINES**

*Cabinet
Shop
Special*

\$290

with Motor

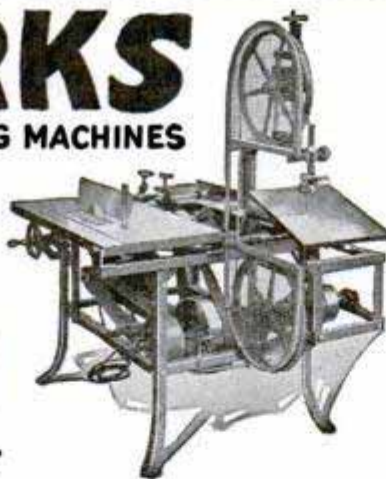

You ought to have this handy Parks in your shop. It is a compact, complete machine designed just like a big production outfit at one-fifth the cost. Includes 8-inch circular rip and cross cut saw with polished cast-steel saw table, 16-inch band saw with tilting table for bevel-sawing, 6-inch jointer, and motor operating from any light socket. Just plug in and go to work! Fits in a corner of your basement. Does any kind of cabinet and joinery work. Add lathe, shaper and other attachments any time at small cost. For the man who does "odd jobs" in his off time this Parks is a big money maker. Turn out as much as a four-man shop working by yourself.

Write for circular and Parks complete catalog of handy woodworking machinery.

The Parks Ball Bearing Machine Co.

1500-1540 Knowlton St. Cincinnati, Ohio

Canadian Factory: 208 Notre Dame East, Montreal, Can.

Makes Old Ford a Tractor

Now you can convert that old Ford car into a useful farm tractor without altering any Ford parts. We furnish the traction wheels, drive gears and auxiliary axle and mountings, ready to clamp on to the Ford frame. Pulls 16' plow.



Write for Free Particulars.
SHAW MFG. CO., Dept. S. Galesburg, Kan.

**REMINGTON
PORTABLE TYPEWRITER
Dealers and Branches Everywhere**

**Imperial
Sanitary
Floor**

Put on like Plaster
Wears like Iron
-waterproof
fireproof
resilient
noiseless
dust-
less



A composition material easily applied in plastic form over practically any kind of floor. Laid about 3/8 inch thick. Imperial floor does not crack, peel or come loose from foundation. A continuous, fine-grained, smooth, non-slipping surface. No crevices to gather grease, dirt, dust, disease germs or moisture.

Ideal Floor for Kitchen, Pantry, Bath Room, Laundry, Porch, Garage, Restaurant, Theatre, Hotel, Factory, Office Building, Railroad Station, Hospital—wherever a beautiful, substantial floor is desired. Several practical colors. Full information and sample FREE of your first and second choice of colors.

Imperial Floor Co., 80-84 Halstead St., Rochester, N. Y.

A. Success for 15 Years

\$542⁰⁰ Earned IN ONE MONTH

A BIG MONEY-MAKING BUSINESS

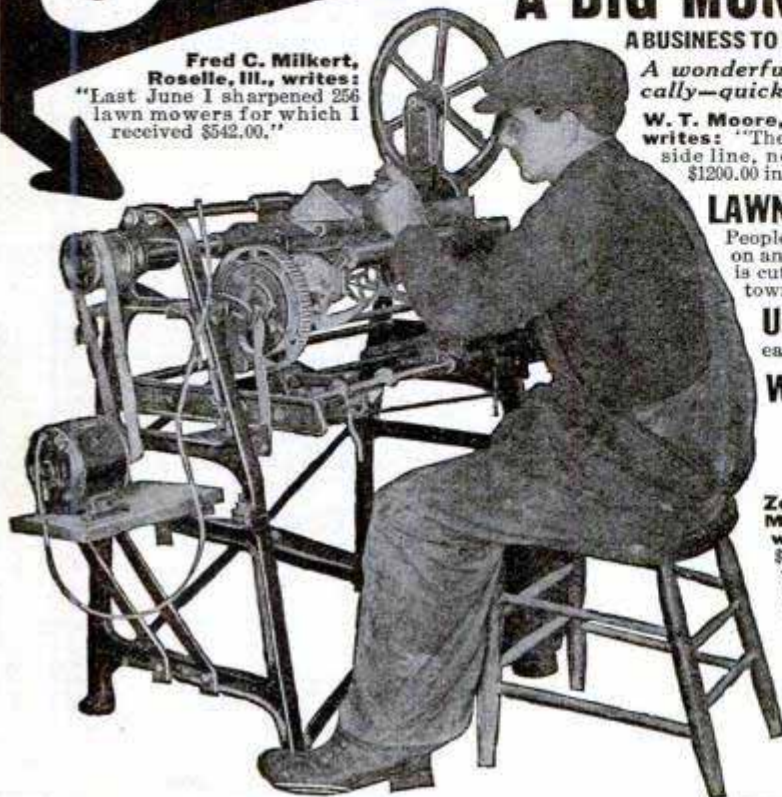

Fred C. Milkert, Roselle, Ill., writes:
"Last June I sharpened 256 lawn mowers for which I received \$542.00."

A BUSINESS TO ENTHUSE OVER—THE "IDEAL" LAWN MOWER SHARPENER

A wonderful invention that sharpens lawn mowers scientifically—quickly—perfectly; does the work as nothing else can.

W. T. Moore, Twin Falls, Idaho, writes: "The Ideal Grinder, as a side line, netted me a profit of \$1200.00 in 90 days."

W. F. Kendt, Buffalo, writes: "I sharpened 994 lawnmowers last season and the receipts were nearly \$2,100 which is not bad for a side line."

LAWN MOWERS SHARPENED TO RAZOR EDGE

People glad—owners delight in mowing lawn with mower sharpened on an "Ideal." Mower runs light—click-click-click and the grass is cut. Build permanent business for yourself. Start Now! No town too small.

Use Your Spare Time If you work at a trade, put an "Ideal" in your basement and earn \$4 to \$6 an hour evenings and Saturday afternoons.

WRITE TODAY for full information of this wonderful money-making machine. **FREE**

THE FATE-ROOT-HEATH MANUFACTURING COMPANY
Plymouth, Ohio

Zeno Brandon, Middletown, Ohio, writes: "I made \$820.70 in 55 days with my "Ideal." Have made as high as \$38.70 in oneday."

USE THIS — MAIL IT TODAY

The Fate-Root-Heath Company
818-844 Bell Street, Plymouth, Ohio

Please mail free Illustrated Catalog and booklet with scores of letters from "Ideal" owners and pictures of their shops.

Name _____

Address _____

Agents \$12⁰⁰ a day

NEW Self-Heating IRON

New invention now makes ironing easy in every home. Ends hot stove drudgery. Cuts ironing time in half. Saves steps. Costs one cent for 3 hours use. No attachments. No cords. No tubes. Gives quick regulated heat. Guaranteed. Sells fast. Mrs. Wagner, Ohio, sold 24 in few hours spare time. Moyer, Pennsylvania, made \$164 in one week. You can do as well. Work all or spare time. No experience needed. No capital. New plan. Simply take orders. We deliver and collect. Commissions paid same day you take orders. Send for exclusive territory and FREE OUTFIT OFFER. Write today.



THE AKRON LAMP CO., 32 Iron St., AKRON, OHIO

THIS WONDERFUL INVENTION



converts any ordinary cook stove into a gas stove. OXO-GAS is made from kerosene and air. Cheaper, cleaner and more efficient than coal. Responsible distributors wanted.

GLORIA LIGHT CO.

111-2 N. May St. Chicago, Ill.

KINKADE GARDEN TRACTOR AND POWER LAWNMOWER

A Practical, Proven Power Cultivator for Gardeners, Suburbanites, Truckers, Florists, Nurserymen, Fruit Growers.

AMERICAN FARM MACHINE CO.
1058-33rd Ave. S. E., Minneapolis, Minn.



Catalog Free

PLUMBING and HEATING

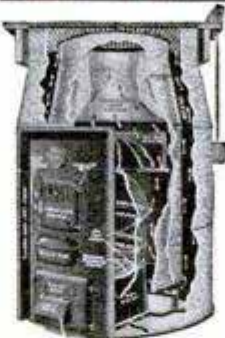

ALL-CAST PIPELESS FURNACE

home. Kinks and Wrinkles and Savings that will surprise you. With our simplified plans and new easy method, you can do the installing. We loan tools FREE. Our Bonded Guarantee is backed by Million Dollar Plant and 50 Years in Business.

HARDIN-LAVIN CO.

Established 1876

107-17 West Pershing Rd., Chicago, Ill.
MAIL THE COUPON NOW!

HARDIN-LAVIN COMPANY,

107-17 West Pershing Rd., Chicago, Ill.

Gentlemen: Please send me your FREE BARGAIN CATALOG with special wholesale prices. I am interested in:

- | | | |
|--|---|---|
| <input type="checkbox"/> Water Supply System | <input type="checkbox"/> Stm. Htg. Plant | <input type="checkbox"/> Warm Air Furnace |
| <input type="checkbox"/> H. W. Heating Plant | <input type="checkbox"/> Pipeless Furnace | <input type="checkbox"/> Bathroom Outfit |

NAME _____

ADDRESS _____

P. O. _____ STATE _____

Buy at Wholesale—Save Half

Send coupon for FREE bargain catalog. Explains our new easy method and shows everything in highest grade Plumbing Outfits, Heating Plants, Water Supply Systems, Pipe, Fittings, etc. For 50 years we have been saving our customers hundreds of thousands of dollars and now we have made arrangements so that you can BUY ON EASY TERMS.

FREE PLANNING SERVICE

Send us a rough sketch of your rooms and we will figure the wholesale cost of Heating Plant or Plumbing Outfit designed especially to fit your



PM-2-27

Print Your Own

Cards, stationery, circulars, tag, labels, paper. Complete Outfits, \$8.85 up, Job Presses \$11 up, Rotary \$149. Card Cutters, \$3. Save money. Print for others, big profits. All easy rules sent. Write for catalog presses, type, paper cards, ink etc. **THE KELSEY CO., H-37, Meriden, Conn.**



The Old Reliable Credit Jewelers

LOFTIS BROS. & CO.

Dept. K-894
108 N. State St.
Chicago, Ill.

DIAMONDS

GENUINE DIAMONDS GUARANTEED AT IMPORTERS' PRICES



No. 841 Platinum \$150 \$3.75 a wk
No. 833 \$37.50 \$1.00 a wk
No. 12 \$100 \$2.50 a wk
No. 851 \$48.50 \$1.25 a wk
No. 847 \$150 \$3.75 a wk

Unusual Diamond Values

CASH OR CREDIT
These Diamonds are finest quality, blue white gems, radiantly beautiful, set in Solid 18 karat White Gold mountings, artistically pierced and engraved. Satisfaction guaranteed or money back. Goods sent for your free examination on request—order now!

CREDIT TERMS: Pay one-tenth down; balance a weekly, semi-monthly, or monthly at your convenience. All goods delivered on first payment.

Railroad Watches—Guaranteed to Pass Inspection
HAMILTON No. 992, 21 Jewels, Adjusted to 5 Positions, Gold filled \$55
25-Year Case
ELGIN'S LATEST RAYMOND, 21 Jewels, 8 Adjustments, Runs 40 hours one winding, Gold filled 20-Year Case \$55
ILLINOIS "BUNN SPECIAL," 21 Jewels, Adjusted to 5 Positions, Gold filled 25-Year Case \$50
Railroad Watches sold on our regular credit terms

17-Jewel Elgin No. 15
Green gold, Elgin watch, 25-year quality case; 12 size, gilt dial, \$300 month \$30; \$3. down \$30 month



Diamond Catalog Free!
Big 132 page book, illustrating our Diamonds, Watches, Jewelry, Silverware, and gift articles for all occasions, sent absolutely free. Write today.



Diamond Wedding Rings
in solid 18-k white gold; 3 Diamonds, \$22.50; 5 Diamonds, \$32.50; 7 Diamonds, \$42.50; 9 Diamonds, \$52.50; 12 Diamonds, \$67.50. In solid platinum with 3 Diamonds, \$50; 5 Diamonds, \$70; 7 Diamonds, \$80; 9 Diamonds, \$100; surrounded by Diamonds, \$200.

No. 855 Ladies' Wrist Watch
Solid 14-k white gold case, engraved, fancy wing ends, 15-Jewel movement, guaranteed, \$30. \$300 month \$3.00 down

Our References: Any Bank or Banker in U. S. A.

WITTE Log Saw

Wico Magneto



Built and Guaranteed by WITTE

LOW PRICE EASY TERMS

COMPLETE outfits, everything you need when you go into timber. No extras to buy. Saws 15 to 25 cords a day. Cheapest to operate—runs all day at cost of 2c an hour per H-P. Burns any fuel with big surplus of power for any work. USE IT FOR OTHER WORK. Completely equipped with WICO magneto, speed and power regulator, throttling governor and 2 fly-wheels so can be used for any other jobs—pumping water, grinding grain, etc.—an all-purpose outfit that will work every day in the year. Only 3 minutes to change from log saw to tree saw—10 seconds to clamp to tree. Fastest felling ever known. Fells trees from any position.

Lifetime Guarantee

FREE BOOK Simply send name today for NEW catalog, lower prices special offers, and how to make money with these rigs. Tells all about engines, sawing outfits and pumps.

WITTE ENGINE WORKS

6744 Witte Building KANSAS CITY, MISSOURI
6744 Empire Building PITTSBURGH, PA.
6744 Witte Building SAN FRANCISCO, CALIF.

"3 HOURS SHIPPING SERVICE"

MEN DOUBLE YOUR INCOME

SELL PIONEER \$23.50 TAILORING FULL OR PART TIME

Make \$12 a day from start—part time men \$5 an hour selling famous Pioneer tailored-to-measure, all-wool suits at \$23.50. Commissions paid in advance. Striking leather brief case containing 100 large swatch samples furnished—other equally remarkable values at \$29.50 and \$34.50. We train the inexperienced. Men with determination and willingness to work for success write for this big money-making opportunity—today!

Cash Paid Daily

PIONEER TAILORING CO., 159 W. Harrison St., Dept. B1116, CHICAGO



New Plan!

makes it easy

\$50.00 to \$100.00 Weekly

Selling Shirts Direct to Wearer. No capital or experience needed. Spare or full time. Established 1885. Represent a real manufacturer.

WRITE FOR FREE SAMPLES
MADISON SHIRT MILLS, 562 BROADWAY, NEW YORK



Big Money

Made by agents selling our wonderful Facial Soap, Perfumes, Toilet Articles, Spices, Extracts, etc. Free cake of soap and agents' terms mailed to any address.

LACASSIAN CO. Dept. 455 ST. LOUIS, MO.

WHITE FLAME BURNERS

make your old kerosene lamps and lanterns give a brilliant white light better than electricity or gas. Doubles your light. Saves oil. NO MANTLE TO BREAK. Guaranteed Safe and Reliable. Delights every user. Send now for complete sample postpaid 50 cents, stamps or coin, 3 for \$1.25. Money Back If Not Satisfactory. Live Representatives Wanted. Exclusive Territory.

WHITE FLAME LIGHT CO., 68 Clark Bldg. Grand Rapids, Mich.



Women Simply Can't Resist This Fast-Selling Line

Just show women this exquisite display of dress goods, silks, wash fabrics and you can't keep them from buying. Men and women agents needed to devote full or spare time. Good commissions. Average \$40 to \$85 a week. 1,000 samples furnished. Write quickly.

THE NATIONAL IMPORTING CO.
Dept. 0-6, 569-573 Broadway, N. Y. C. 1000 Beautiful Samples



WADE AMATEUR MECHANICS, REPAIR SHOPS, INVENTORS, STUDENTS

BENCH LATHE

A real machine tool for the home work bench—capacity 4" dia. x 12" length. For Metal—Wood—Composition Materials. Turning—Facing—Boring—Drilling—Winding—Thread Cutting. Accurate—Strong—Quiet—Compact. Slide-rest has travel entire length of bed. Leadscrew inside bed. No. 1 Lathe, plain head—between centers, \$7.00. Complete line of accessories at equally low prices. Write for free catalog.

THE GEROLD CO., Dept. P-31, 120 Liberty St., New York



Here's \$100 A WEEK and a Hudson Coach

If you want to make *given!*
\$100 a week clear, net, We will show you how without training or experience you can earn from \$10 to \$20 a day *at once*—how you can quickly have an income of \$100 a week every week in the year—and how you can get a Hudson Super-Six Coach in addition to your large earnings.

\$47 in One day

Henry Albers cleaned up \$47 in one day. G. M. Collum finds it easy to clear \$250 a month *in his spare time*. Christopher Vaughn made \$125 in one week. Right now we need more men and women like these to represent us everywhere. We furnish everything you need **FREE**. You can devote spare time or full time. The work is easy and pleasant—the profits amazing. Write at once for details of this money-making offer. It costs you nothing to investigate. But don't delay—don't wait until it's too late. Be the first to apply from your locality. Write today.



THE AMERICAN PRODUCTS CO.
Dept. 7005 Cincinnati, O.

Going to Build Remodel or Repair?

DON'T think of building a new home or repairing an old one without a copy of our free woodwork catalog.

To those who contemplate building or remodeling, this book is a valuable work of reference. In it are found the latest ideas and most advanced styles for everything in millwork. It illustrates and describes windows and sash of all kinds, including porch and storm sash, doors, frames, mouldings, screens, porchwork, stairwork, hardwood flooring, interior finish, cabinet work—in fact, practically everything in manufactured millwork. Every article in the book shows a low money-saving price direct to you.

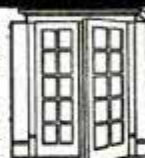

FREE ESTIMATES

Send us your lumber and millwork bills for a free estimate. Let us quote prices on your material and tell you the exact amount of freight. Then compare our prices with others. This service costs you nothing and places you under no obligation whatever.

CHICAGO MILLWORK SUPPLY CO., 1444 W. 37th St., Chicago, Ill.
PLEASE SEND ME YOUR FREE BOOK

Name _____ St. No. _____
Town _____
State _____
Occupation _____

Book is Free

ADDING PENCIL

STARTLING INVENTION

ADDS
CALCULATES
COUNTS
CHECKS



GUARANTEED

Absolutely accurate. Ends all mistakes. Fountain pen size. Send for yours TODAY.

AGENTS

Make \$20 or more daily. Easy. Millions want it. Great opportunity. Reserve your territory immediately.

Add-O-Graph Pencil Co., D - 36, St. Louis, Mo.

AGENTS 500% PROFIT

GENUINE GOLD LEAF LETTERS

S guaranteed to never tarnish. Anyone can put them on stores and office windows. Enormous demand, large profits. Paul Clark says: Smallest day \$28.70. R. L. Reel made \$920 in two months. Write today for free sample and liberal offer to general agents.
METALLIC LETTER CO., 433-B N. Clark St., CHICAGO

DEAFNESS IS MISERY



Millions of people know that, but Multitudes of persons with defective hearing and Head Noises are again enjoying conversation, go to Theatre and Church because they use Leonard Invisible Antiseptic Ear Drums, which are Tiny Megaphones fitting in the Ear entirely out of sight. No wires, no batteries, no head piece. They are Unseen Comforts and inexpensive.

Fill in and mail coupon today

A. O. Leonard, Inc., Suite 603 70 5th Ave., N. Y.

Please send me without obligation; your FREE Illustrated Booklet about Deafness and Sworn Statement of Inventor.

Name Mr. _____
Mrs. _____
Miss _____ (Print or write name plainly)

Street _____

City _____ State _____

Shoot the Best Gun

The NEW BENJAMIN is the finest air rifle ever made. Unlike all others. Has amazing accuracy—shoots hard and far. It's the original American genuine AIR operated rifle. One to six pump strokes compress air to any desired degree of power. Same force as in air drills and air hammers except you control the shooting force. Never loses force—no springs or levers to get out of order. Makes crack shots quickly, inexpensively. Gives years of delightful recreation with utmost safety. At your dealer's, or sent postpaid for \$5.00.

Shoot 5 Days FREE

We give you five days, ammunition supplied, to test the NEW BENJAMIN. If in this time you don't believe it to be the finest air rifle you've ever seen or used, and if you don't believe it is the one and only air rifle for you, return it, postpaid, and your money will be refunded at once.

The NEW BENJAMIN

AIR RIFLE

America's Original Air Rifle

\$5 at your dealer's or sent postpaid direct from factory on FREE Trial as above if dealer does not handle it—write for our wonderful offer.

Get This Book and Details FREE



BENJAMIN AIR RIFLE & MFG. CO.
845 N. Broadway, St. Louis, Mo.

Please send your amazing offer and free copy of "The Shooter's Art," telling how to become a crack shot, how to hold, aim, and handle guns and guide others in use of guns.

Name _____

Address _____

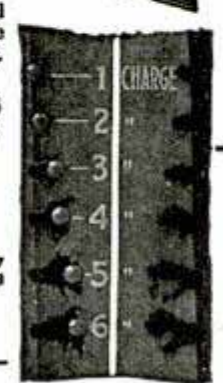

\$351⁰⁰ CLEARED ~ IN ONE DAY

So writes W. H. Adams of Ohio in August 1925. V. A. Marini of California reports \$11275 sales in three months. Jacob Gordon of New Jersey \$4000 profits in two months." Alexander of Pennsylvania "\$3000 profits in four months." Ira Shook \$365 sales in one day. Bram bought one outfit April 5 and 7 more by August 28. Iwata, bought one outfit and 10 more within a year. Mrs. Lane of Pittsburg says "sold 8000 packages in one day. J. R. Bert says "only thing I ever bought that equaled advertisement." John Culp says:

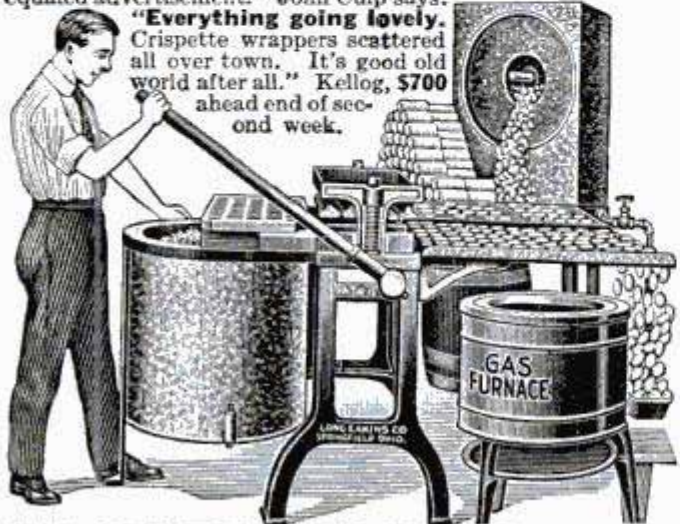

"Everything going lovely. Crispette wrappers scattered all over town. It's good old world after all." Kellog, \$700 ahead end of second week.

WE START YOU IN BUSINESS

Furnish secret formulas, raw material, and equipment. Little capital required; no experience needed.

Build a Business of Your Own

No limit to the sale of Crispettes. Everybody likes them. It's a delicious food confection. Write for facts about a business that will make you independent. Start now, in your own town.

Profits \$1000 a Month Easily Possible

Send postal for illustrated book of facts. It contains enthusiastic letters from others—shows their places of business, tells how and when to start, and all information needed. Free. Write now!

LONG-EAKINS COMPANY
228 High Street Springfield, Ohio

Beautiful HOUSES \$900 and BUNGALOWS

CAN BE BUILT FOR AND UP
This and many others in my new book, Building Plans for Modern Homes, will save you hundreds of dollars. One of the most complete and comprehensive books of plans ever published by any architect. New edition just off the press. Nearly 600 floor plans and photographs of Colonial houses, bungalows, etc., costing from \$200 up; gives sizes and cost to build. Sent postpaid for \$3.00.



FREDERICK H. GOWING
ARCHITECT
101 Tremont St., BOSTON, MASS.



Any Wurlitzer Instrument Try in Your Own Home

See for yourself the superior quality of these famous instruments, the result of 200 years' experience. Every known instrument. No expense for trial. Easy terms if desired.

Send for New Catalog—Free
Rudolph Wurlitzer Co., Dept. 1772
Cincinnati Chicago San Francisco
Address city nearest where you live.



MAKE FORD Into The "LARK"

\$5⁰⁰ Red-i-Kut life size patterns Class—Snap



Famous sure-fit RED-I-KUT life-size patterns and picture instructions show how you can easily convert your Ford into this Fast, Easy, Sport Car as thousands have done, with easily obtained materials. No need to lay up the car. Rear seat folds, making 4-passenger car. Send 10c coin for actual body photo and new manual of other distinctive sport body patterns from \$3.50 up—"RKO" Steel "Swing-Lo" Irons, Tops and Windshields. ORDER RIGHT NOW.

KUEMPEL COMPANY, 81 Kuempel Bldg., GUTTENBERG, IOWA

Great New



Invention for seekers of Health Power Beauty

Elco Health Generators at last are ready for you! If you want more health—greater power to enjoy the pleasures and delights about you, or if more beauty is your desire—write! Ask for the book on these inventions which has just been prepared. It will be sent to you without cost. It tells you how Elco Health Generators aid you in leaving the lethargy and hopelessness of bad health and weakness behind forever. Re-vitalize yourself. Bring back energy. Be wholly alive. Write today!

10 Days Free Trial—Write for FREE BOOK



These great new inventions generate High Frequency Violet Ray, Mechanical Vibration, Medical Electricity and Ozone. Combined or separate.

They operate on the electric light in your home or on their own motive power at less than 50 cents per year. Elco Health Generators are positively the only instruments which can give you in one outfit Electricity, Violet Ray—Vibration and Ozone—the four greatest curative agents. Send coupon below. Get the Free Book NOW!



For All These:

- | | |
|-------------|-----------------|
| Rheumatism | Asthma |
| Gout | Hay Fever |
| Lumbago | Sore Throat |
| Neuralgia | Catarrh |
| Sciatica | Deafness |
| Headache | Insomnia |
| Nervitis | Pain |
| Nervousness | Development |
| Circulation | Skin Disease |
| Weakness | Pimples |
| Paralysis | Scalp Disorders |
| Eye Trouble | Obesity |

MAIL the COUPON for FREE Book!

Do not put this paper down without sending the coupon. Don't go on as you are with pains and with almost no life and energy. You owe it to yourself to be a better man or woman. You were put here to enjoy life—not just to drag through it. So do not rest another day until you have put your name on the coupon here. That will bring the whole story of these great new inventions. Do it today—now.



Lindstrom & Company
30 West Lake Street, Dept. 93-52, Chicago, Ill.
Please send me your free book, "Health—Power—Beauty" and full information on your 10-day Free Trial Offer.

Name.....

Address.....

Agents Wanted



Charge it!

Full Year to Pay
All transactions strictly confidential
10 Days Free Trial

Pin only \$1 to your order, and your choice comes to you parcel-post prepaid on 10 Days Free Trial. Then pay postman only \$1 more on delivery, and after free trial pay balance in 12 equal monthly payments. Satisfaction guaranteed or money back.

FREE
"Royal Book of Gems"
Thousands of special values in genuine diamonds, watches and jewelry illustrated. Your copy sent immediately on request.
No Red Tape—No Delay

NO. MA1
672.50

A FULL YEAR TO PAY

Look Prosperous Wear Genuine Diamonds!



MA3— Lady's wrist watch latest style solid 14 K gold, highest grade 17 ruby and sapphire jewel movement, lifetime guarantee. Featured at **\$22**



MA2— Beautifully hand engraved wedding ring, 18 K white gold, with 5 genuine blue white diamonds—Featured at **\$29.50**



MA4— Fiery blue white diamond—best quality 18Kt. white gold—artistically carved, hand pierced, lady's mounting. Featured at **\$49.50**



MA5— Three perfectly matched blue white diamonds set in a beautifully hand pierced mounting—18Kt. white gold—latest creation. Featured at **\$36.75**



MA6— Something he will like and use. Famous Elgin strap watch, 20 year guaranteed green gold-filled case, radium dial—accurate time-keeper. Featured at **\$24.50**

Established 1895

ROYAL DIAMOND & WATCH CO.
Address Dept 1759 170 Broadway, N.Y.

PLUMBING - HEATING WATER SYSTEMS



SAVE UP TO 40%

Wonderful bargains—everything guaranteed. Full line of plumbing and heating supplies. Hot water, steam heating plants and fixtures and water systems at big savings.

Install Them Yourself
Finest materials all brand new and perfect. Tell us your wants and mail us a rough sketch of your rooms.

SEND FOR PRICE LIST
B. KAROL & SONS CO. 800 S. KEDZIE AVE. Dept. 20 CHICAGO

MOTORCYCLES



LESS THAN HALF COST

Ace, Indian, Cleveland, Harley-Davidson, Henderson Motorcycles and Sidecars, new, used and rebuilt. **Rider Agents Wanted.** Write for FREE trial offer, agent's free outfit and big bargain bulletin. **New American Bicycles** in different styles and colors. Write for illustrated catalog giving our money saving prices.

AMERICAN MOTOR CYCLE CO.
2047 W. Chicago Ave., Dept. 235 Chicago

You-and This New Machine Can Earn \$500 a Month



Operate a Tire Repair Shop
70,000,000 Tires in use. America's greatest opportunity for men with small capital. We furnish everything—\$100 and up. **Easy payments.** We train you **FREE** right at home. Start making money at once. Write today for **Free Book of Opportunity.**

Haywood Tire Equipment Co. 1344 S. Oakley, Chicago

MOTORCYCLES

WE WILL TRUST YOU Pay Us While You Ride
Hendersons, Harley-Davidsons, Indians
Slightly used and Rebuilt. Hundreds to select from.
Send 10c for list today.
MYEROW BROS. CO., 15 Berkeley St., Boston, Mass., U. S. A.

SHAW MOTOR ATTACHMENT

MAKES YOUR BIKE A MOTORCYCLE!
A high grade 2 1/2 H. P. motor attachment quickly clamped on any bike frame. Speed 4 to 40 miles an hour, 90 to 125 miles per gallon of gas.
Special Low Price Now! Write today for Complete Description and Special Low Prices on SHAW Motor Attachments and the SHAW Complete Motorbicycle.
SHAW MANUFACTURING COMPANY
Dept. 37 Galesburg, Kansas



STOP FORD CRANKSHAFT END-PLAY!

C-A ADJUSTABLE BEARING corrects and prevents end-play without removing motor. Eliminates many troubles. Easy to install—simply drop pan. Only **\$3.75.** Ask your dealer or sent prepaid by **ADJUSTABLE BEARING CO.,** Dept. P, 405 Virginia Ave., Indianapolis, Ind.

AGENTS
Make big earnings, taking orders for made-to-individual measure suits at less than ready-to-wear prices. Giant Chicago wholesale house makes world's greatest values at \$23.50 and \$29.50. Your profit \$4 and \$5 per sale in advance—we deliver and collect. No experience needed, work full or part time.
FREE OUTFIT Send no deposit. Write for details of our unique money-making plan. Nothing like it ever before offered. Act at once. **General Tailoring Co.,** Dept. 92, 92 South Franklin Street, Chicago. Est. 1903.

NO JOKE TO BE DEAF

—EVERY DEAF PERSON KNOWS THAT
I make myself hear, after being deaf for 25 years, with these Artificial Ear Drums. I wear them day and night. They stop head noises and ringing ears. They are perfectly comfortable. No one sees them. Write me and I will tell you a true story, how I got deaf and how I make you hear. Address
GEO. P. WAY, Artificial Ear Drum Co. (Inc.)
80 Hoffman Bldg., 2539 Woodward, Detroit, Mich.



ALL FREE **22 CAL. RIFLE**
10 year guar. Watch with chain and ring, large Eastman Roll Film Camera or 22 cal. Hamilton Rifle, yours for introducing finest assorted perfume at 15c a bottle. Send for 20 bottles and choose gift as per offer in our catalog. We trust you—just write to **BELL PERFUME CO.,** Dep. C153, Chicago, Ill.



**Beisser
Key
Machine—
Independence
and Big Profits!**

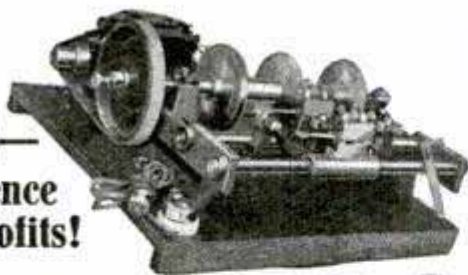

Why Be a Slave?

Be your own boss and make more money besides. Only a small investment for a Beisser Key Machine and you start a business of your own; no experience necessary, **WE TEACH YOU HOW.** The only machine that will cut any kind of key perfectly, by number, without need of taking locks apart, including first keys for Yale and automobile locks. With our instructions you also learn how to open and repair all kinds of locks; become an expert locksmith and safe man. We have put hundreds of others in the way of making big money. Very simple and easy to learn and very profitable. Write our School Dept. for full details and **BE INDEPENDENT FOR LIFE!**



BEISSER KEY MACHINE CO.
407 E. Fort Street, School Dept., Detroit, Michigan



TOOL CASES

for Machinists, Repairmen and Tool Makers; none better; thirty styles. Quartered Oak and all metal. Ask for booklet

"BUILT FOR SERVICE"
The Yarder Manufacturing Co.
TOLEDO, OHIO

PLASTIC WOOD
Marvelous invention that
Handles like Putty~

Hardens into Wood



Use **PLASTIC WOOD** for filling holes and cracks, making casters solid in chairs or wherever wood needs repairing.

As it comes from the can, **PLASTIC WOOD** can be moulded in the fingers. It hardens on exposure to the air and can be worked with woodworking tools or turned on a lathe.

PLASTIC WOOD will adhere to metal or tile surfaces as well as to wood—nails will not split it—takes paint, stain and varnish.

If your hardware dealer cannot supply you with **PLASTIC WOOD** write to the factory—1/4 lb. can, 35¢; one pound can, \$1.00.

ADDISON-LESLIE COMPANY
40 Boliver Street
Canton, Mass.

**Sensational
Typewriter Offer**



*The World's Only
Ball Bearing Typewriter*

NEVER has there been such a typewriter bargain on as easy terms! A genuine Silent Ball Bearing L. C. Smith at a 40% savings!

Only the L. C. Smith has all these features:

Ball bearings (636 of them) at all points of wear. All the writing visible all the time. Non-shift carriage. 2-color ribbon. All the latest operating conveniences. Beautiful—renewed.

If you decide to keep it
only **\$3⁰⁰**
DOWN
BALANCE
EASY
TERMS

Guaranteed 5 Years

Money cannot buy a better typewriter. U. S. Government bought 50,000. The choice of railroads, big corporations like the Standard Oil Co., etc., because of its exclusive ball bearing feature. Easiest running, longest wearing of typewriters.

Send No Money!

Just mail coupon. Without delay or red tape, typewriter will be shipped you. Use it 10 days. See how speedy and easy it runs—the perfect work it turns out. If not delighted, return at our expense. You'll want to keep it. You can, for \$3 down and \$5 monthly. Now is the time to buy. \$3 worth of extras free. Send coupon now before offer is withdrawn.

\$40 SAVED by Using this Coupon
SMITH TYPEWRITER SALES CORP.
112-360 E. Grand Ave., Chicago

Ship me the L. C. Smith, F. O. B. Chicago. On arrival I'll deposit \$3 with express agent. If I keep machine, I'll send you \$5 a month until the \$66.70 balance of \$69.70 price is paid; the title to remain with you until then. I am to have 10 days to try the typewriter. If I decide not to keep it, I will repack and return to express agent, who will return my \$3. You are to give your standard 5-year guarantee.

Name.....
Address.....
City..... State.....
Employed by.....

PATENT

Protect Your Ideas

Take the First Step Today

If you have a useful, practical, novel idea for any new article or for an improvement on an old one, you should communicate with a competent Registered Patent Attorney AT ONCE. Every year thousands of applications for patents are filed in the U. S. Patent Office. Frequently two or more applications are made for the same or substantially the same idea (even though the inventors may live in different sections of the country and be entirely unknown to one another). In such a case, the burden of proof rests upon the last application filed. Delays of even a few days in filing the application sometimes mean the loss of a patent. So lose no time. Get in touch with me at once by mailing the coupon on the opposite page.

Prompt, Careful, Efficient Service

This large, experienced organization devotes its entire time and attention to patent and trade mark cases. Our offices are directly across the street from the U. S. Patent Office. We understand the technicalities of patent law. We know the rules and requirements of the Patent Office. We can proceed in the quickest, safest and best ways in preparing an application for a patent covering your idea. Our success has been built on the strength of careful, efficient, satisfactory service to inventors and trademark owners located in every state in the Union.

NO CHARGE for Information On How to Proceed

The booklet shown here contains valuable information relating to patent procedure that every inventor should have. And with it I will also send you my "Record of Invention" form on which you can sketch your idea and establish its date before a witness. Such evidence may later prove valuable to you. Simply mail the coupon and I will send you the booklet, and the "Record of Invention" form, together with detailed information on how to proceed and the costs involved. Do this NOW. No need to lose a minute's time. The coupon will bring you complete information entirely without charge or obligation.

My Patent Law Offices
Just Across
Street From
U.S. Pat. Office



Above is a view of my drafting and specification offices where a large staff of experienced experts are in my constant employ. All drawings and specifications are prepared under my personal supervision.

NEWS

Inventors
Write for these **Free Books**

Strict Secrecy Preserved

All communications, sketches, drawings, etc., are held in strictest confidence in strong, steel, fireproof files, which are accessible only to authorized members of my staff. Feel free to write me fully and frankly. Your case will have my personal attention. It is probable that I can help you. Highest references. But **FIRST**—clip the coupon and get my free book. Do **THAT** right now.

Clarence A. O'Brien

Registered Patent Attorney

Member of Bar of: Supreme Court of the United States; Court of Appeals, District of Columbia; Supreme Court, District of Columbia; United States Court of Claims. Practice confined exclusively to Patents, Trade marks and Copyrights

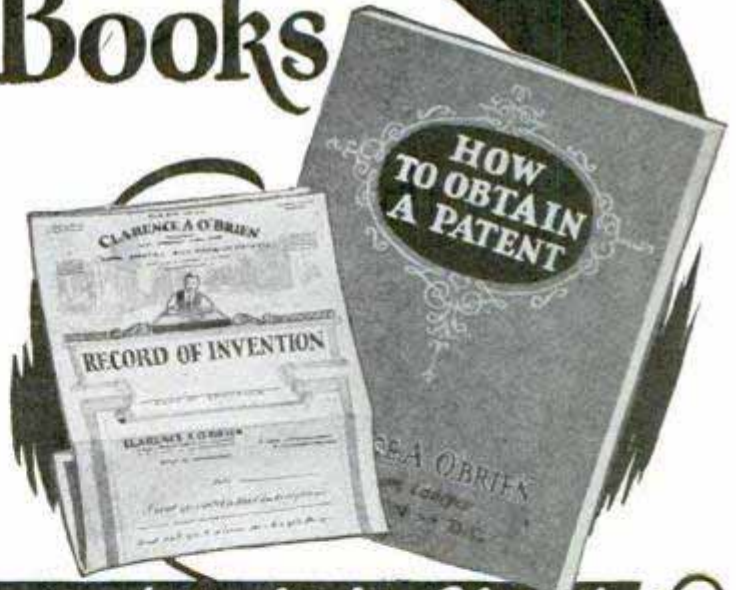

Clip this Coupon and Mail it Now!

CLARENCE A. O'BRIEN, Registered Patent Attorney

70-T Security Savings and Commercial Bank Bldg., Washington, D. C.

Please send me your free book, "How to Obtain a Patent," and your "Record of Invention" form without any cost or obligation on my part.

Name.....
(Important: Write or Print name clearly.)

Address.....

PATENTS TRADE-MARKS AND COPYRIGHTS

Have You An Idea?

Our Offer: FOR THE PROTECTION
OF YOUR INVENTION
YOUR FIRST STEP

Before disclosing an invention the inventor should write for our blank form

"RECORD OF INVENTION"

This should be signed and witnessed and returned to us together with model or sketch and description of the invention for **INSPECTION and INSTRUCTIONS**

No Charge for the Above Information

**Our Four Books Mailed
Free to Inventors**

Our Illustrated Guide BOOK

HowtoObtain a Patent

Contains full instructions regarding U. S. Patents. Our Methods, Terms, and 100 Mechanical Movements illustrated and described.

Our Trade Mark Book

Shows value and necessity of Trade Mark Protection. Information regarding *Trade Marks and unfair competition in trade.*

Our Foreign Book

We have Direct Agencies in Foreign Countries, and secure Foreign Patents in shortest time and lowest cost.

Progress of Invention

Description of World's Most Pressing Problems by Leading Scientists and Inventors.

We Regard a Satisfied Client as our best advertisement, and furnish anyone, upon request, lists of clients in any state for whom we have secured patents.

**Highest References—Prompt Attention
—Reasonable Terms**

VICTOR J. EVANS & CO.

PATENT ATTORNEYS

Main Offices: 956 9th St., N. W., Washington, D. C.

Opposite U. S. Patent Office

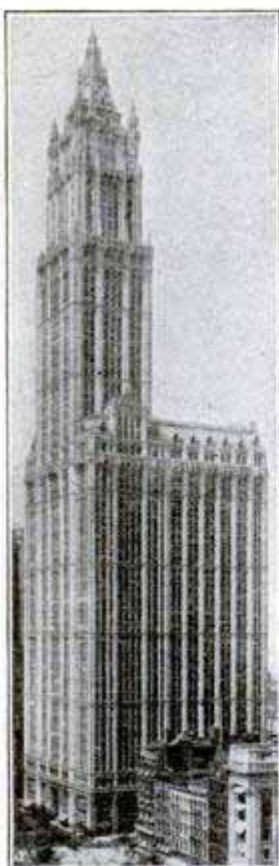

Our New York Office
Suite 1007 Woolworth Bldg.

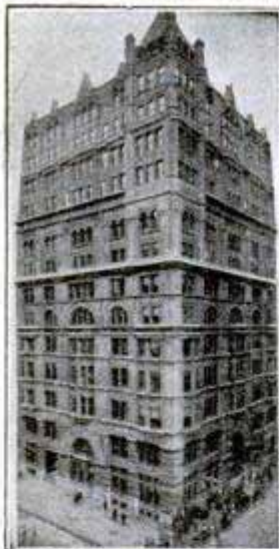

Our Philadelphia Office
Suite 714-15 Liberty Bldg.



Our Washington Office
Victor Building

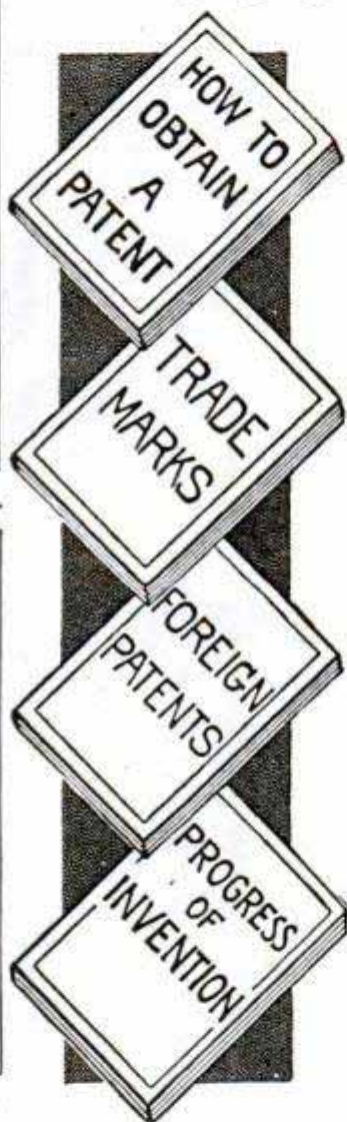

PATENTS TRADE-MARKS AND COPYRIGHTS

IMPORTANT

TO HAVE YOUR CASE MADE SPECIAL AND AVOID DELAY YOU SHOULD HAVE YOUR CASE MADE SPECIAL IN OUR OFFICE to secure protection, save correspondence and secure early filing date in Patent Office. To secure special preparation of your case send \$25.00 on account with model or sketch and description of invention.

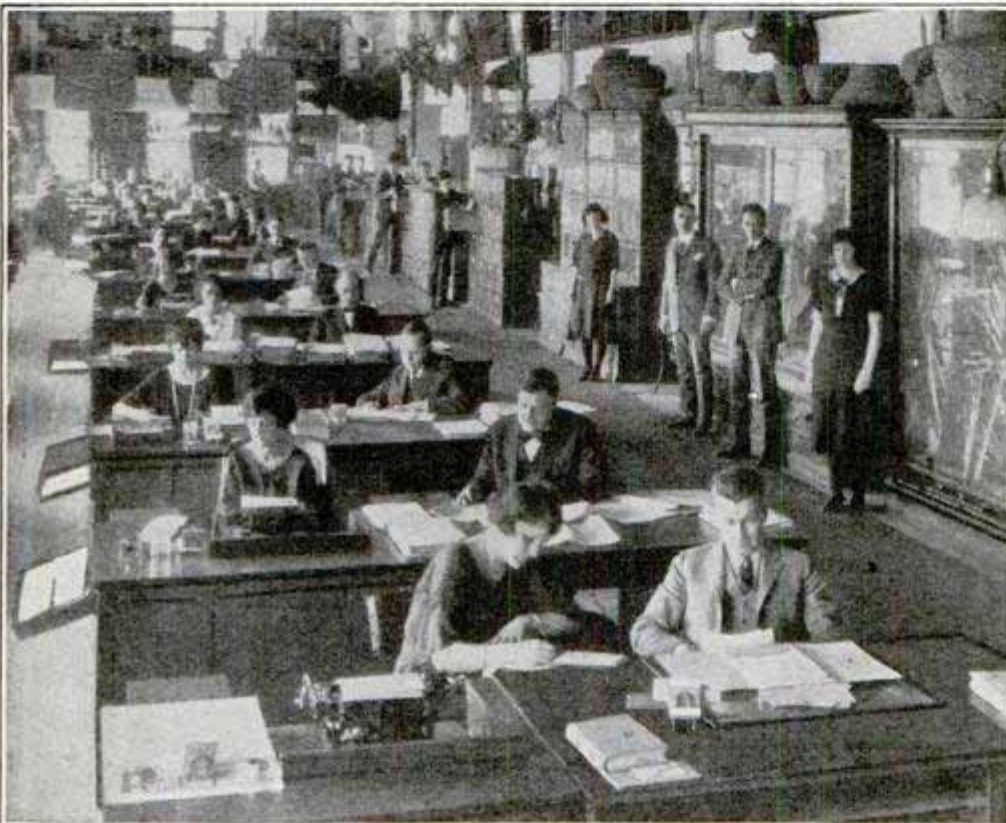

MAIN OFFICE, VICTOR J. EVANS & CO.—VICTOR BUILDING, WASHINGTON, D. C.

Our Lawyers Practice in all U. S. Courts and defend Clients in Suits involving Patents, Trademarks and Copyrights

All Communications and Data Strictly Confidential. Interference and Infringement Suits Prosecuted

OUR ORGANIZATION OFFERS PERSONAL SERVICE By Experienced Patent Lawyers, Solicitors and Draftsmen



Our Chicago Office Suite 1114 Tacoma Building



Our Pittsburgh Office Suite 514 Empire Building



Our San Francisco Office Suite 1010 Hobart Building

**FREE
COUPON**

**VICTOR J. EVANS & CO.
PATENT ATTORNEYS**

NEW YORK OFFICES
1007 Woolworth Bldg.

CHICAGO OFFICES
1114 Tacoma Bldg.

PHILADELPHIA OFFICES
714-715 Liberty Bldg.

PITTSBURGH OFFICES
514 Empire Bldg.

SAN FRANCISCO OFFICES
Hobart Bldg.

MAIN OFFICES: 956 9th Street, N. W., WASHINGTON, D. C.

Gentlemen: Please send me *Free of Charge* your books as described on preceding page.

Name

Address

PATENTS

"While I am convinced that a claim covering this idea could have been drawn and would have been novel, this idea is not expressed in the claims in suit, and cannot be read into them."

—Judge Tuttle,
in Great Western Mfg. Co. vs. Lowe

Your patent attorney must have skill and experience enough to see that your patent claims cover your invention completely.

MUNN & CO. PATENT ATTORNEYS

Associated for 81 years with the Scientific American

1572 SCIENTIFIC AMERICAN BLDG.
24 West 40th Street, New York

523 SCIENTIFIC AMERICAN BLDG.
Washington, D. C.

1312 TOWER BUILDING
Chicago, Ill.

520 VAN NUYS BUILDING
Los Angeles, Cal.

655 HOBART BUILDING
San Francisco, Cal.

Ask for free copy of "Patents—A Book of Facts Every Inventor Should Know" and for "Inventor's Diary." Send for it NOW.

INVENTORS PROTECT YOUR IDEAS

Before disclosing your invention send for our Evidence of Invention Blank. This should be signed and witnessed and returned to us with a model or sketch and a description of your invention for our *Inspection and Instructions* which are free.

Also send for

Our guide book "How to Get Your Patent" which is sent free upon request. This book includes full instructions regarding U.S. Patents, Trade Marks, our Terms, Methods, etc.

WRITE TODAY

RANDOLPH & COMPANY
300 Victor Bldg., Washington, D. C.
Please send me FREE OF CHARGE your Evidence of Invention blank and your guide, "How to Get Your Patent."

Name.....

Street.....

City.....State.....

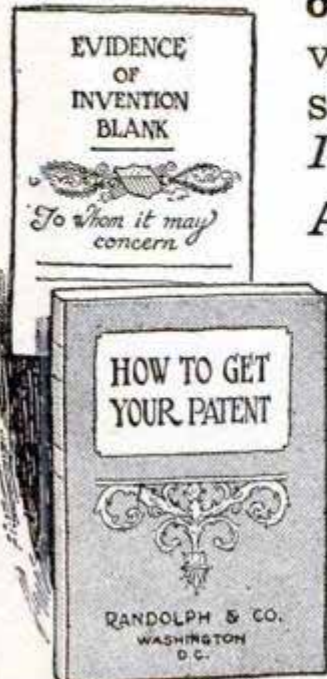

Terms Reasonable Best References

RANDOLPH & CO.

300 Victor Bldg. Washington, D. C.

PATENTS

Send us sketch or model for advice and exact cost of patent. Our book "How to Obtain a Patent" sent free. It tells how to apply for Patents, Trade Marks, Foreign Patents, Copyrights, etc.; gives information on Patent Procedure; tells what every inventor should know. Thousands of Inventors, who are our clients, are our reference.

CHANDLEE & CHANDLEE, 25 Years' Experience
473 7th St. Washington, D. C.

Have You An Invention?

If so the WORLD PROGRESS will send you upon request sample copy Free containing SUGGESTIONS TO INVENTORS as to Inventions Needed. We invite manufacturers to address us regarding inventions they want.

Subscription for one year 60 cents
WORLD PROGRESS PUB. CO., Inc.
Room 203 Victor Bldg. WASHINGTON, D. C.

PATENTS

TradeMarks, Copyrights, Patent Litigation Handbook with illustrations, 100 mechanical movements. Sent free on request.

ALBERT E. DIETERICH
formerly member examining corps U. S. Patent Office
PATENT LAWYER and SOLICITOR
621-A, Ouray Bldg.
27 Years' Experience Washington, D. C.

GEARS ALL KINDS SMALL

The most accurate made and prices reasonable. We carry a complete line of gears in stock for immediate shipment. Can also quote on special gears of all kinds. Send us your inquiries.

WRITE FOR CATALOGUE 10
CHICAGO STOCK GEAR WORKS
105-109 S. Jefferson St., CHICAGO

PATENTS

To the Man with an Idea

I offer a comprehensive, experienced, efficient service for his prompt, legal protection and the development of his proposition.

Send sketch, or model and description, for advice as to cost, search through prior United States patents, etc. Preliminary advice gladly furnished without charge.

My experience and familiarity with various arts frequently enable me to accurately advise clients as to probable patentability before they go to any expense.

Booklet of valuable information and form for properly disclosing your idea free on request. Write today.

Richard B. Owen, Patent Lawyer
9-303 Owen Bldg., Washington, D.C.
41-E Park Row, New York City

TRADE-MARKS REGISTERED

PATENTS

Booklet Free **Highest References**
Promptness Assured **Best Results**

Send drawing or model for preliminary examination of Patent Office records.

ALL BUSINESS GIVEN PROMPT AND PROPER ATTENTION

Listed Patent Lawyer in the latest editions of the Rand-McNally Directory of Bankers and Attorneys, of Chicago, Ill.; The Baggott & Ryall Directory of Attorneys, New York City; The Lawyers Guaranteed Directory, Detroit, Michigan; The Lawyers and Bankers Quarterly, published by the Legal Directory Publishing Company of St. Louis, Mo.; the American Lawyers Annual, Cleveland, Ohio.

WATSON E. COLEMAN,
 REGISTERED PATENT LAWYER

Victor Building, 724 Ninth Street, N. W.
WASHINGTON, D. C.

PATENTS

As one of the oldest patent firms in America we give inventors at lowest consistent charge, a service noted for results, evidenced by many well known patents of extraordinary value. *Book, Patent-Sense, free.*

LACEY & LACEY
 Established 1869
 646 F St., Washington, D. C.

BLUE BOOK ON PATENTS

AND PRIORITY RECORD BLANK GRATIS.

MONROE E. MILLER, PATENT LAWYER
 411-3 Ouray Building, WASHINGTON, D. C.
 ELECTRICAL AND MECHANICAL EXPERT



Inventors and Mechanics
 Send 2 cent stamp for
Gear or Material Catalogs
COLBURN GEAR & MFG. CO.
 98 Holmes St., Quincy, Mass.

DON'T WEAR A TRUSS

BE COMFORTABLE—

Wear the Brooks Appliance, the modern scientific invention which gives rupture sufferers immediate relief. It has no obnoxious springs or pads. Automatic Air Cushions bind and draw together the broken parts. No salves or plasters. Durable. Cheap. Sent on trial to prove its worth. Beware of imitations. Look for trade-mark bearing portrait and signature of C. E. Brooks which appears on every Appliance. None other genuine. Full information and booklet sent free in plain, sealed envelope.



BROOKS APPLIANCE CO., 107 State St., Marshall, Mich.

HAIR GROWS!



when our Vacuum Cap is used a few minutes daily. Sent on 60 days' FREE trial at our expense. No drugs or electricity. Stops falling hair, cures dandruff. A postal brings illustrated booklet.

MODERN VACUUM CAP CO.
 558 Quincy Denver, Colorado

Fibre-Lite Limbs

BRACES AND TRUSSES

DO NATURE'S WORK. GREAT INVENTION. EASY TERMS. AGENTS WANTED
 WRITE FOR FREE FIBRE SAMPLE. **WORMAN CO.** 252-P HENNEPIN AVE. MINNEAPOLIS, MINN.



PATENTS

Don't Lose Your Rights To Patent Protection

Before disclosing your invention to anyone send for blank form "EVIDENCE OF CONCEPTION" to be signed and witnessed. As registered patent attorneys we represent hundreds of inventors all over the United States and Canada in the advancement of inventions. The form "Evidence of Conception," sample, instructions relating to obtaining of patents and schedule of fees sent upon request.

LANCASTER & ALLWINE

480 Ouray Bldg. WASHINGTON, D. C.
Originators of forms "Evidence of Conception."

Deafness



Perfect hearing is now being restored in all cases of deafness caused by Catarrhal troubles, Relaxed or Sunken Drums, Thickened Drums, Roaring or Hissing Sounds, Perforated, Wholly or Partially Destroyed Drums, Discharge from the Ears, etc.

Wilson Common-Sense Ear Drums

require no medicine but effectively replace what is lacking or defective in the natural ear drums. They are simple devices, which the wearer easily fits into the ears where they are invisible.

Free Book on Deafness

Soft, safe and comfortable. Write today for 168-page book on deafness giving full particulars and many testimonials. The hearing of thousands of grateful users has been restored by these "little wireless phones for the ears."
WILSON EAR DRUM CO., Incorporated
 356 Todd Building LOUISVILLE, KY.



United States Capitol

MAN ALIVE!

This Amazing Device Adds \$6750 A Week To Your Income



Ve Po Ad—the most sensational invention of the age! This remarkable little vest-pocket adding machine does the work of a \$300 machine. Adds up to a Million! Never gets out of order. Fully guaranteed. More than 100,000 in use!

Sells For \$2.95 — You Make \$1.35

Less than 10 sales a day brings you \$67.50 a week. Ve Po Ad astounds and fascinates. Positively accurate. Made of finest etched brass and handsomely cased in blue leatherette cover. Astonishing money saving value for \$2.95! Hundreds of prospects—merchants, grocers, butchers, farmers, garage men, salesmen—all need Ve Po Ad and buy like a flash on a minute's demonstration. You make 100% on each sale!

Get One FREE

No wonder salesmen are dropping everything to take up this record-smashing, fast-selling adding device. Shapiro out in California has made over \$475 a week selling Ve Po Ads. You can make money just as fast. No experience necessary. Write immediately for full details about FREE Ve Po Ad we will give you.

Reliable Typewriter & Adding Machine Corp.
180 West Washington St., Dept. 42, Chicago, Ill.

Factory to Rider

Saves \$10 to \$25 on the Ranger Bicycle you select. You can have your choice of 44 Styles, colors and sizes. Delivered free on approval, express prepaid, for 30 DAYS' FREE TRIAL. Bicycles, \$21.50 up \$5 a Month on our Liberal Easy Payment plan. Parents often advance first payment.



Best quality, at factory prices, express prepaid. Lamps, wheels and equipment, low prices. Send No Money, do business direct with makers. Write today for free Ranger Catalog, factory prices and marvelous easy payment terms.

Mead CYCLE COMPANY
DEPT. C110 CHICAGO

AGENTS AND SIGN MEN

Now Making \$50.00 to \$100.00 and Up Per Week Selling Our GOLD LEAF SIGN LETTERS



For store and office windows, board signs, trucks and glass signs. We also make to order script signs and business emblems singly or by the thousands. A permanent business. No capital or experience required. Big demand in every city. Samples and Literature Free.

CONSOLIDATED SIGN LETTER CO. 69X W. Van Buren CHICAGO, ILL.



"Independent" GOLD POINT \$2
Lever, Self-Filler Stylopen
"Makes Writing a Pleasure"
Jumbo, \$3.50; Red, \$3.00; Black

J. C. ULLRICH & CO., 161 Washington St., N. Y. Est. 1884 Agents Wanted

\$616 in One Month
Writes Bodine-Also
WON FREE FORD

"Harley" offers the one big chance for quick, big incomes to agents. "Harley" line of things people eat used by housewives for 30 years. J. R. Moore made \$1124 in one month—W. J. Glasstetter \$125 in one day—R. S. Burris \$56.25 from 2 orders.



Free Fords The "Harley" line sells itself. Every demonstration a sale—every sale a satisfied customer. Get your Free Territory and Free Sample Offer quick. Clean up big this year. Spare no full time. Free Fords to producers. Write for full details. Costs you nothing—we furnish everything. Learn about our big premium plan.

THE E. C. HARLEY COMPANY, Dept. B-393, Dayton, Ohio

How I Saved Half My Coal

"I had a hot air furnace in our house before I got the Bulldog and our 7-room house was always cold. With the Bulldog it only takes half as much coal and we had weather below zero, and the house was nice and warm in the morning when we got up. We never have the draft on more than a half hour at a time and it has the place red hot." That's the marvelous record of the Bulldog Pipeless Furnace as told by Jess T. Conrad, 1211 W. Arch St., Shamokin, Pa.

Heats 7 Rooms Instead of One!

"With the Bulldog, we find it takes a little more coal to heat the whole seven room house than it did to heat one room with a stove using chestnut coal."—J. B. Smith, 19 Elm Street, Somerville, N. J.



BULLDOG PIPELESS FURNACE

If you are even thinking of a pipeless furnace, or any furnace, write for our free catalog. The Bulldog is one furnace you MUST investigate. Comes completely erected. Fits any height of basement and you install it yourself.

No Money Down

The Bulldog is sent for free inspection

Then, if satisfied, you make only small monthly payments at our amazingly low price. Factory connections in both East and West. We ship from nearest point. Don't consider buying any furnace until you find out about the Bulldog. Write at once for our special offer and our free catalog together with the wonderful record of Bulldog success. Mail this coupon today.

Babson Bros.

19th and California Ave., Dept. 13-52 Chicago

Without obligating me in any way please send me your free catalog and special offer on the Bulldog Pipeless Furnace.

Name.....

Address.....

THE "SPRING-STEP"

A new Keds built for speed —

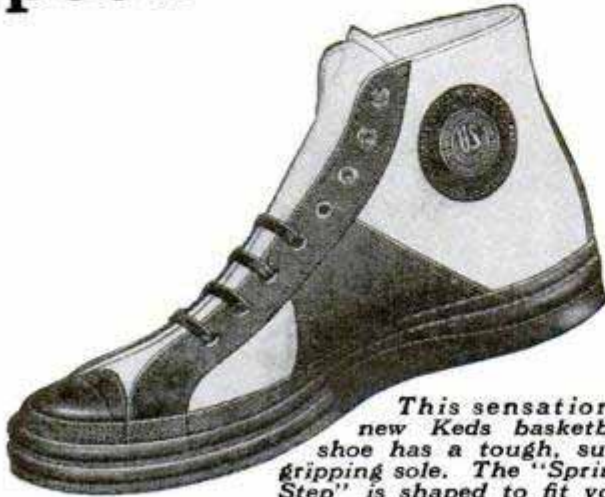

This sensational new Keds basketball shoe has a tough, sure-gripping sole. The "Spring-Step" is shaped to fit your feet—has a special sponge rubber arch cushion—cushion heel to absorb shocks that tire muscles—strap to support the instep. Comes in white with black trim.

"A BOY'S biggest asset is his speed of foot," writes a world-famous athlete. He adds, "Your shoes must be *exactly* right." *And he plays in Keds!*

Even in fastest action, this special Keds basketball shoe grips surely. The soles are tough and springy. They absorb the jars that tire muscles and slow down play. The uppers are very light yet so strong they protect the ankles against sudden twists and sprains. And the special Feltex innersole helps to keep the feet comfortable.

There are Keds for every sport, indoors and out. Ask for Keds by name. *And be sure to look for the name Keds on the shoe.* Keds come in all popular styles, at prices from \$1.25 to \$4.50. They are made only by

United States Rubber Company

Keds

Reg. U. S. Pat. Off.



*They are not Keds unless
the name Keds is on the shoe*

Please Mention Popular Mechanics



WHITING'S CELEBRATED BRUSHES ADAMS SUPERIOR BRUSHES

The quality of the bristles in Whiting-Adams brushes is an advantage all around. It makes them wear longer and work better.



WHITING-ADAMS
BOSTON
BRUSH MAKERS FOR 118 YEARS

MOVIES In Your Home



Our marvelous, practical **Movie Machines** sell as low as \$3.75 post-paid, and use same size film as big theatres. We also have wonderful films at lowest prices—with a new film exchange service.

Don't Miss This!

Write NOW for Free Catalogue.
PARAMOUNT MANUFACTURING CO.
Dept. MD, Boston, Mass.

Knowing
tomorrow's
weather today is
possible with a ~

Tycos Stormoguide

If your Dealer cannot supply You, write

Taylor Instrument Companies
ROCHESTER, N.Y.

Canadian Plant, Tycos Bldg Toronto

There's a Tycos or Taylor Thermometer for Every Purpose

THIS WONDER WORKING SHOP

Will Make You a Craftsman

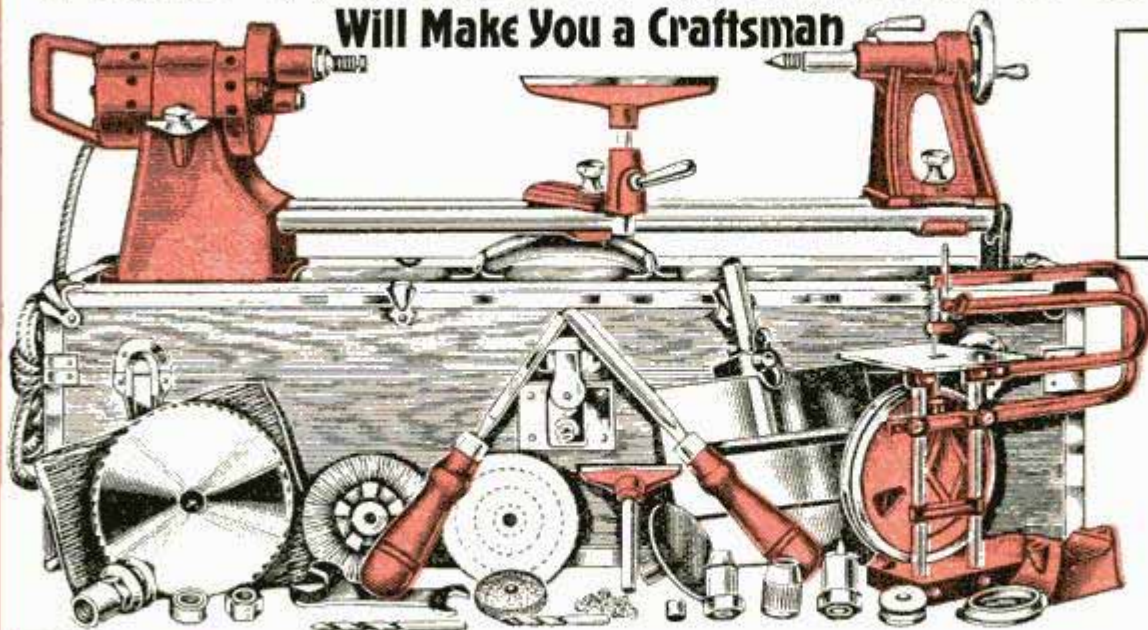

only
\$10.00
down

SENT
ON
TRIAL



A COMPLETE SET OF PRECISION TOOLS electrically driven that will make you an accomplished workman. It is a chest full of tools that has been designed by a master for the private use of tool lovers and men who want to build, construct, invent and create at home. You will be able to make everything— attractive odd furniture, toys, home and garden improvements, all around manufacturing, repairing.

The Red Jacket 1927 model is a perfect woodworking equipment and has my O.K.
W. L. Aylward,
Mastercraftsman

NOW! MAKE THINGS AT HOME WITH THE NEW **RED JACKET** HOME WORK SHOP

The complete equipment consists of the powerful Red Jacket Motor, with direct drive to an accurate wood turning lathe (capacity 9 in. x 34 in.); a bench saw, that has depth and side gauges; scroll and jig saw; and all accessories for both portable and stationary power drilling, buffing, grinding and cleaning. Attaches to any light socket and converts your work bench into a complete private tool and machine shop.

These are genuine electric tools. They are not toys or fragile in any respect. Created for "handy" men. So compact, reliable and efficient that you can accomplish any job with it, and so inexpensive that any one can own it. Unconditionally guaranteed. Our literature is very interesting and fascinating and explains everything. Don't delay. Learn all about the Red Jacket Home Work Bench now.

Turning
Sawing
Winding
Spinning
Grinding
Buffing
Polishing
Cabinet
Making
Scroll
Sawing
Drilling
Repairing
Dove
tailing
Pointing
Joining
Sharpening
Sanding
Scratching
Carving
Successful
Master-
pieces

THE WACO GUARANTEE

IF IT IS NOT WHAT YOU WANT WHEN YOU GET IT—SEND IT BACK

SPECIAL CRAFTS COURSE

And blueprint service is free to Red Jacket Shop owners—all that there is to know about handicraft methods, raw materials, woods, carving, sawing, turning, designing, carpentering, decorating, is taught by special correspondence.

BUY ON YOUR OWN TERMS

Only \$10.00 down. Liberal discounts for cash. Easy monthly payment plans. It is no hardship to own a Red Jacket.

INTERESTING LITERATURE FREE

Just send the coupon. You will be surprised with all it contains. Beautiful, Instructive, Fascinating, Interesting.

Everything Explained in Our Literature

Active Dealers and Agents Wanted

10 DAYS' FREE TRIAL

Our literature tells you how to start a job of your own. If you are not pleased return the Shop.

2 OUNCES

of interesting reading will be sent you gratis. Send the coupon below. Sit back—see what we send you. It's free.

Mail This to Waco

Learn All About the Red Jacket



free
CRAFTS
COURSE

free
BLUE
PRINTS

WACO TOOL WORKS,
2915 So. Wabash Avenue, Chicago, Illinois.
Manager, Dept. 102. Please send me particulars about 10-day free trial, free blue-prints and \$10 down payment.

Name.....

Address.....

LUMINOUS PAINT

Make Your Watches, Clocks, Etc., Visible by Night

The very latest discovery in the scientific world. Hitherto, practically unobtainable except at an exorbitant price, we have at last succeeded in producing this remarkable LUMINOUS PAINT, which, applied to the surface of any article, emits rays of white light, rendering it perfectly visible in the dark. **THE DARKER THE NIGHT, THE MORE BRILLIANT IT SHINES.** Quite simple to use. Anyone—you can do it. A little applied to the dial of your watch or clock will enable you to tell the time by night. You can coat the push buttons or switch plates of your electric lights, match boxes, and innumerable other articles; make your own Luminous Crucifixes, Luminous Rosaries, etc. Small bottle, price 25c. Larger sizes, 50c and \$1 postpaid. **JOHNSON SMITH & CO., Dept. 803 RACINE, WIS.**

Serpent's Eggs Exploding Cigarettes

Box contains 12 eggs. When lit with a match, each one gradually hatches itself into a snake several feet long, which curls and twists about in a most life-like manner. Price per box, 10c postpaid, 3 for 25c.



CIGARETTE MAKER



Roll your own and save money. Makes them better and quicker besides saving more than half. Use your favorite brand of tobacco. Neat, useful and handy. Pocket size, weighs 1/2 oz. Made entirely of metal, nickel-plated. Price 25c postpaid.

MIDGET BIBLE

GREAT CURIOSITY
Smallest Bible in the World. Size of a postage stamp. 200 Pages. Said to bring good luck to the owner. A genuine work of art. Must be seen to be appreciated. Make good money selling them to friends, church acquaintances, etc. PRICE 15c each, 3 for 40c, 12 for \$1.35, 100 for \$7.50. Also obtainable in Leather Binding, with gold edges. Price 50c each, 3 for \$1.25, \$4.50 per doz. Magnifying Glass for use with Midget Bible, 15c.



STAGE MONEY



With a bunch of these bills, it is easy for each person of limited means to appear prosperous by flashing a roll of these bills at the proper time and peeling off a genuine bill or two from the outside of the roll. The effect created will be found to be all that can be desired. Prices, postpaid: 40 Bills 20c, 120 for 50c, or \$3.50 thousand postpaid.

Wonderful X-Ray Tube

A wonderful little instrument producing optical illusions both surprising and startling. With it you can see what is apparently the bones of your fingers, the lead in a lead pencil, the interior opening in a pipe stem, and many other similar illusions. A mystery that no one has been able to satisfactorily explain. Price 10c, 3 for 25c, 1 dozen 75c. Johnson Smith & Co.



Good Luck Ring

Quaint and Novel Design

A VERY striking and uncommon ring. Silver finish, skull and crossbones design, with two brilliant, flashing gems sparkling out of the eyes. Said by many to bring Good Luck to the wearer, hence its name, Good Luck Ring. Very unique ring that you will take a pride in wearing. ONLY 25 CENTS.

JOHNSON SMITH & CO.

Dept. 803 RACINE, WIS.

A De Luxe Edition of our new 1927 CATALOG mailed on receipt of 25c. Handsome binding. Bigger and better than ever. Only book of its kind in existence. 550 pages of all the latest tricks in magic, the newest novelties, puzzles, games, sporting goods, rubber stamps, unusual and interesting books, curiosities in seeds and plants, etc., unprocurable elsewhere. Remit by Stamps, Coin, Money Order, Check, etc. Unused U.S., Canadian and Foreign Stamps also accepted.

BLANK CARTRIDGE PISTOL

Protection against Burglars, Tramps & Dogs

Prices
50c
\$1.00
Post-paid



Well made and effective; modelled on latest type of Revolver; appearance alone is enough to scare a burglar. When loaded it may be as effective as a real revolver without danger to life. It takes standard 22 Cal. Blank Cartridges obtainable everywhere. Price 50c, superior quality, \$1.00 post-paid. Blank Cartridges, by express, 50c per 100 Holster (Cowboy type) for Blank Cartridge Pistol, 50c Johnson Smith & Co., Dept. 803, Racine, Wis.

BOYS! BOYS! BOYS! THROW YOUR VOICE



Into a trunk, under the bed or anywhere. Lots of fun fooling the teacher, policeman or friends.



THE VENTRILO
a little instrument, fits in the mouth out of sight, used with above for Bird Calls, etc. Anyone can use it.

Never Fails. A 16 page course on ventriloquism, the Ventrillo, ALL FOR 10 CENTS



Everything about the Ku Klux Klan told in a clear, fearless manner. Book tells all—How it started and was oppressed in 1871—The New Ku Klux Klan—How Organized—How Members are Enrolled—Oath of the Klan—Questions for Candidates—Creed—Objects of the Order—Obedience—Fidelity—Pledge of Loyalty—Ku Klux Klan and the Masons—The Jews—The Masons—Real K. of C. Oath—The Negro Ku Klux Klan, etc., etc. Latest and most complete book on the Klan published. Price 35c, Postpaid. Stamps or Coin

Popular Watch Charms

JUST LIKE ORDINARY CIGARETTES. BUT SUCH REAL STARTLERS! The box contains ten genuine cigarettes of excellent quality. They appear so real, but when each cigarette is about one-third smoked, the victim gets a very great surprise as it goes off with a loud BANG! A great mirth provoker yet entirely harmless. Price 25c per box.

Very pretty little curiosities and decidedly novel. Fitted with Magnifying Lenses that enlarge the picture to a very surprising degree; in fact, it seems almost incredible that a clear picture could be possible in such a small compass, and how sharp and distinct they show up when you look through. Come in assorted views—Actresses, views of Panama Canal, Lord's Prayer in type, etc.

Mystic Skeleton

A jointed figure of a skeleton 14 in. in height, will dance to music and perform various gyrations and movements while the operator may be some distance from it.



Two very novel metal badges, nickel plated, that you can wear, giving you fun out of all proportion to their trifling cost. 10c, each badge, 3 for 25c, or 75c per doz. postpaid anywhere.

MAGIC FLUTE

The Magic Flute, or Humanation, is a unique and novel musical instrument that is played with nose and mouth combined. There is just a little knack in playing it which, when once acquired after a little practice, will enable you to produce very sweet music that somewhat resembles a flute. There is no fingering, and once you have mastered it you can play all kinds of music with facility and ease. When played as an accompaniment to a piano or any other musical instrument, the effect is as charming as it is surprising.



LOOK 35c Look



Wonderful instrument. Greatest thing yet. Nine separate articles in one. Everybody delighted with it. Odd, curious and interesting. Lots of pleasure as well as very useful. It is a double Microscope for examining the wonders of nature. It is also an Opera Glass, a Stereoscope, a Burning Lens, a Reading Glass, a Telescope, a Compass, a Pocket Mirror, and a Laryngoscope—for examining eye, ear, nose and throat. It is worth all the cost to locate even one painful cinder in the eye. Folds flat and fits the pocket. Something great—you need one. Don't miss it. Sent by mail, postpaid. Price only 35c or 3 for \$1.00

HOT DOG! SENSATIONAL NEW NOVELTY

It is made of rubber like a small balloon. Contains a curious chemical that acts in a most remarkable way. Squeeze the deflated balloon with the hand and it suddenly becomes quite warm and fills itself up with air. It is SELF-BLOWING. Play all sorts of jokes with it. Lay it on a chair; place it secretly underneath anyone; underneath anyone's pillow; drop it in someone's pocket, and after a short time, when friction causes the chemicals to act, a large and superbly colored balloon develops. Each Hot Dog in a small box. Quite harmless, but loads of fun. 15c, each, 3 for 40c., \$1.35 doz. postpaid.



Female SEX Indicator 25c Male Sex Indicator
Hold the MAGIC INDICATOR over a man's hand—Instantly it moves in a straight line, backward and forward. Hold it over a woman's hand and it describes a complete and continuous circle. The same action can be obtained over a letter written by a man or woman, etc. It is fascinating; baffling. We have never been able to figure out how it's done, but we've never seen it fail. Many novel and entertaining feats may be performed with the Sex Indicator. For example, similar results can be obtained with animals, cats, dogs, rabbits, over birds, chickens, canaries, etc. Also used to predetermine the sex of chicks and birds, etc. In fact it is sold as a patented egg tester in Europe. Price 25c, or 3 for 85c. ppd. JOHNSON SMITH & CO., Dept. 803, RACINE, WIS.

COMIC CELLULOID BUTTONS



These Comic Celluloid Buttons provide subjects for pleasant jokes and amusing conversation and thus smooth the way to a more familiar acquaintance and cordial friendship. There are seventy different titles altogether, all very wittily worded and quite unobjectionable. Wear one and see the effect. All four Buttons illustrated above will be sent postpaid to any address for **ONLY 20c** or a dozen, all different, for **45c**.

SURPRISE SOAP KEYLESS LOCKS



You've heard of people turning green with envy but they haven't turned half as green as the fellow who unwittingly uses this soap. It is an exact duplicate of an ordinary piece of soap. Secret: it contains a chemical which acts like a dye as soon as it comes into contact with water. **PRICE 15c postp'd.**

These clever locks cannot be opened unless you know the combination. No key necessary. For your locker, bicycle, tool chest, mail box, thousands of uses. Backlocks and tumblers nickel plated. Weighs trifling over one ounce. Small, yet strong. Secret and full instructions with each lock. **PRICE 25c** or 3 for **65c** postpaid.



25c Postpaid

Every Boy His Own Toy Maker

Greatest boys' book written. Tells how to make a Pinhole Camera, a Canoe, model Railroad, a Telephone, Boomerang, Telegraph Instrument, Box Kite, Talking Machine, Microscope, Electric Motor, Electric Door Bell, Water Wheel, Paddle Raft, a pair of Skis, a Dog Sled, Bird House, Rabbit Yard, etc. 64 pages, 150 illustrations. **PRICE, 10c** postpaid; 3 for **25c** postpaid.



INVISIBLE INK

The most confidential messages can be written with this ink, for the writing **Makes No Mark.** Cannot be seen unless you know the secret. Invaluable for many reasons. Keep your postals and other private memorandums away from prying eyes. Great fun for playing practical jokes. **Only 15c** a Bottle; 3 for **40c**.



REAL PISTOL Miniature Watch Charm Pistol

Exact reproduction of a real pistol; actually fires **Real BLANK CARTRIDGES** of miniature size. Illustration is actual size. **1 1/4** inches long, with ring at end for attaching to watch chain. Looks like a regular pistol. Pull the trigger and it goes off with a loud bang. Pistol is break-open type; illustration shows position for loading. Made entirely of high grade steel, nickel plated, octagon barrel, handsomely engraved handles, complete in box with cleaning rod. **PRICE \$1.75.** Also furnished with **pearl handles, \$2.50.** **BLANK CARTRIDGES, 50c** per box of 25. **JOHNSON SMITH & CO., Dept. 803, RACINE, WIS.**



RESURRECTION PLANT

One of the most wonderful plants known. Possesses the strange power of turning in a few minutes from an apparently lifeless, dry herb to a **BEAUTIFUL LIVING FERNLIKE PLANT** of a dark green color. Simply place the plant in saucer of water, it will open up and start to grow in 20 minutes. When taken out it will dry up and go to sleep until placed in water again. Fine house plant—summer or winter. **10 cents** each or 3 for **25c.**, 75c per doz., postpaid.



Microphone Transmitter Button



You can easily make a highly sensitive detectophone by using this Transmitter Button to collect the sound waves. You can build your own outfit without buying expensive equipment. It is simple and inexpensive. You can install an outfit in your home and hear conversations being held all over the house. You can connect up different rooms of a hotel. This outfit was used by secret service operatives during the war. It is being used on the stage. It is ultra-sensitive and is the greatest invention in micro-phones. You can mount the button almost anywhere—card board boxes, stove pipes, stiff calendars, on the wall behind a picture frame, etc. Button is so light and small it cannot be detected. Persons can be overheard without suspecting it. You can listen in on conversations in another room. A deaf person in the audience can hear the speaker. Connected to phonograph, piano or other musical instrument, music can be heard hundreds of feet away. Button may be used to renew telephone transmitters; often makes an old line "talk-up" when nothing else will. The ideal microphone for radio use; carries heavy current and is extremely sensitive. Amplifies radio signals. Countless other similar uses will suggest themselves. Experimenters find the button useful for hundreds of experiments along the lines of telephones, amplifiers, loud speakers, etc. Many fascinating stunts may be devised, such as holding the button against the throat or chest to reproduce speech without sound waves. \$5.00 is given to anyone who sends in a new suggestion for the use of the Button providing the manufacturers find it suitable for use in their literature. **PRICE \$1.00 POSTPAID ANYWHERE.**



Send remittance (Postage Stamps accepted) for all articles listed on above and previous page to

MAGICIAN'S OUTFIT

Apparatus and Directions for a Number of Mysterious Tricks Enough for an Entire Evening's Entertainment

ANYONE CAN DO THEM 75c



It is great fun mystifying your friends. Get this Conjuror's Cabinet, and you will be the cleverest fellow in your district. It contains the apparatus for seven fantastic tricks, including The Disappearing Rose, that, when placed on the lapel of your coat, vanishes from sight at will; the Magic Vase and Ball Trick (a Wooden Ball is placed inside, and upon replacing the lid has disappeared and is found in someone else's pocket); The Magic Nail with which you can apparently cut your finger almost in two; the Wonderful Card Trick (a card is placed in an envelope, and when open an entirely different card is found); The Disappearing Coin Box (a coin is placed in the little wooden barrel, and, when opened, is found to have vanished entirely, or can be made to change into a coin of another denomination); The Famous Dissolving Penny Trick; The Glass Goblet and Vanishing Coin Trick (a coin is dropped into a glass of water, and when the water is poured out the coin has vanished). With the tricks described above we send full printed instructions for performing each trick, so that anyone can readily perform all the tricks to the great amusement of their friends or the public. Any boy of ordinary intelligence, with this Cabinet of Tricks in his possession, can give a parlor entertainment not inferior to some regular magicians. Besides the tricks contained in the Cabinet, there are many other feats and illusions fully explained with full printed instructions, for which you easily make or procure the necessary apparatus. This unexcelled Cabinet of Tricks for **ONLY 75 CENTS POSTPAID TO ANY ADDRESS.**

Great Fire Eater

Most Sensational Trick of the Day! With the Fire Eater in his possession any person can become a perfect salamander, apparently breathing fire and ejecting thousands of brilliant sparks from his mouth, to the horror and consternation of all beholders. Harmless fun for all times, seasons and places. If you wish to produce a decided sensation in your neighborhood don't fail to procure one. We send the Fire Eater with all the materials, in a handsome box, the cover of which is highly ornamented with illustrations in various colors. **Price of all complete only 30 cents,** postpaid.



SQUIRT ROSE

25c A REAL STARTLER. This is the most popular of all squirt tricks. The flower in your coat looks so fresh and sweet that everyone is tempted to inhale the delightful perfume. Then is the moment to press the bulb. Geewhikkens! Don't they jump? There is a very long rubber tube that easily reaches to the pocket of your coat or trousers, and the bulb is large enough to make a dozen shots with one loading. **PRICE 25c** each, or 3 for **65c** postpaid.



PISTOL, OPERA & FIELD GLASS

PRICE POSTPAID, \$1.00 It is made in the shape of and looks like a regular Automatic Pistol. No one is likely to stop and ask you whether it is real or not. Thus it is likely to prove itself very handy in an emergency. On pressing the trigger it opens up, as shown in the illustration at the right, revealing nine most useful articles—Opera and Field Glass, Telescope, Mirror, Magnifying Glass and Burning Lens, Reading Glass, Sun Dial, Sun Compass, etc. In the handle of the revolver there is a place for various pocket necessities, such as First Aid Articles, Buttons, Pins, etc. The Pistol is of sheet metal, blued finish, that can be carried comfortably in pocket. **PRICE \$1.00.**



LOOK!

SURPRISE MATCHES

More fun than fighting with your wife. Look just like ordinary matches. Put up in boxes just like regular Safety Matches. As the victim tries to light one he gets quite a surprise. **PRICE 10c** per box, 3 boxes for **25c,** or 12 for **75 cents.**



SEEBACKROSCOPE

By merely placing this clever instrument to your eye, you can see what is going on behind your back, and sometimes you see very interesting things when no one thinks you are looking. Why it is just like having eyes at the back of your head. **PRICE ONLY 25 cents,** postpaid, 3 for **50 cents.**



NEW BOOK ON ROPE SPLICING

A most practical handbook giving complete and simple directions for making all the most useful knots, hitches, rigging, splices, etc. Over 100 illustrations. All about wire rope attachments, lashing, blocks, tackles, etc. 37 Heraldic Knots illustrated. Of great value to mechanics, riggers, campers, boatmen. **Price 20 cents** postpaid.



The "Little Giant" Typewriter

A First Class Writing Machine For \$1.50 A perfect little typewriter for \$1.50. There are thousands of persons who would like to use a typewriter but whose needs and business do not warrant the expense attached to the purchase and use of a fifty or seventy-five dollar machine. To such persons we cordially recommend our Little Giant. It is strongly made, but simple in construction, so that anyone can quickly learn to operate it, and write as rapidly as they would with pen and ink. The letters of the alphabet most frequently used are so grouped as to enable one to write rapidly, the numerals 1 to 10, and the punctuation marks being together. With this machine you can send your best girl typewritten love letters, address envelopes, make out bills, and do almost any kind of work not requiring a large, expensive machine. With each typewriter we send a set of ink and full printed instructions for using the machine. **Price complete \$1.50** by mail postpaid to any address in the world.





Three-Fourths Size



BS

A NEW SPEED INDICATOR —Vest Pocket Size

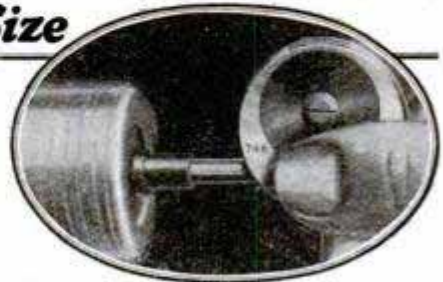

EASY TO USE — Counts like a Pulse

Speed indicators have been made before—but never one like this. The size of No. 746 alone makes it different from any other such device. It slips into the vest pocket as easily as a watch. Light in weight—only 1½ ounces.

And it's accurate! Counts the hundreds of R. P. M., beating them out like a pulse. Easy-to-read dials give direct readings up to 100—giving you exact R. P. M. at any speed.

No. 746 is simple in construction. Only four major parts. And into its manufacture has gone the skill that has made

Brown & Sharpe precision tools famous for accuracy all over the world.

For such a quality tool the price is very moderate—in- **\$1.50**
cluding 2 rubber points, only

Men who are responsible for checking the speed of shafting and maintaining the R. P. M. of machines need a device like Vest Pocket Speed Indicator No. 746. It measures accurately all speeds, giving exact readings in either direction. Get this device from your hardware dealer. Also ask him for a Brown & Sharpe Small Tool Catalog. If he cannot supply you write us direct.

BROWN & SHARPE MFG. CO.
Providence, R. I.

BROWN & SHARPE TOOLS

World's Standard for Accuracy



HAND-FORGING AND WROUGHT-IRON ORNAMENTAL WORK

Complete instructions, with photographs and drawings, for making the most attractive styles of ornamental iron work.

Andirons	Grilles	Rosettes
Scroll Work	Leaf Work	Hinges
Bulbs	Drawer Pulls	Door Plates
Window	Door Keeps	Spiral Deco-
Fasteners	Fire Sets	rations
Lamps	Candle Sticks	Picture
Coat Racks	Chairs	Frames

Thomas F. Googerty, the author, is one of the best-known makers of this type of metal work. The illustrations are all of work made by the author. Almost every page has one or more illustrations either made from drawings or from photographs. Anyone interested in this type of work can soon develop his ability so that he can make these articles for his own use or for sale. There is a growing demand for articles of this type.

Send No Money Simply write a postal for this book of instructions, asking that "Hand-Forging" be sent C.O.D. When postman hands you the book, pay him the postal charges and \$2.00.

POPULAR MECHANICS PRESS, Room 702, 200 East Ontario St., Chicago, Illinois

OUTDOOR SPORTS THE YEAR 'ROUND

Popular Mechanics New Useful Book—Outdoor sports appeal to us all. But the fun is double when you make your own devices. There are 226 clearly written and concise articles telling how to make equipment for new and popular sports of many kinds in the new Outdoor Sports book. There are clever devices for such sports as:

Swimming	Trapping	Photography	Kite flying
Camping	Tobogganing	Tennis	Summer games
Football	Baseball	Outdoor winter	Nutting
Swinging	Fishing	games	Pushmobiling
Trolley coasting	Golf	Skating	Racing
Roller skating	Boat sailing	Boating	Skiing
	Toy making		

It is easy to make the devices described because there are 317 helpful illustrations. The articles are clear enough for boys, yet interesting enough for any man.

Send No Money Just write your name and address on a postal card and say that you want Outdoor Sports the Year 'Round. When the postman hands you the book, give him \$1.50 plus the few cents postage. That is all. If you live outside the U. S. or if you are not at home when the postman delivers the mail, then send \$1.50 with your order. Address your postal to

POPULAR MECHANICS PRESS Room 102, Popular Mechanics Bldg. 200 E. Ontario St., Chicago

30 DAYS FREE IN YOUR HOME

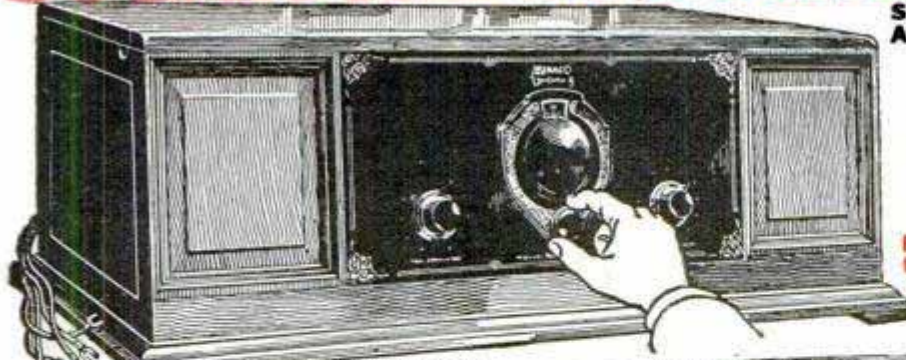

Built like—to look like—and perform like \$200 sets

Real Single Dial Control!

Magnificent Big Powerful Miraco "Unitune-5"
Get Special Offer! Amazing Low Price!

The celebrated Miraco Ultra—U. S. Navy type circuit, has also been adapted to Single Dial Tuning—without sacrifice of selectivity, volume, clearness, power, tone, or distance getting qualities! In the magnificent big Miraco Unitune, above shown, you turn one vernier knob for stations everywhere. Beautiful hand-rubbed, piano-hinged, solid walnut cabinet, 28 in. long, 15 in. deep, 10 in. high. Sloping Bakelite panel in walnut finished to match. Also offered on 30 days' free trial!

Coast to Coast and Foreign Reception Certified by Miraco users

MIRACO RADIO GETS 'EM COAST TO COAST
Send for Proof!
Enormous sales again enable us to add hosts of costly new features, latest refinements and up-to-the-minute improvements. Miracos this year are still better—more beautiful—more selective—more powerful for less money than ever before.

USER-AGENTS WANTED - WRITE!
Reports from users everywhere leave little for us to add. These are only a few of the many in our files and which we receive daily. Send coupon for plenty of additional proof and testimony of nearby users.

Miraco Separates Stations That More Expensive Sets Can't

Logged stations from coast to coast the second evening we had Miraco and got some difficult stations because of so many broadcasting stations coming in under the same number. We can separate them where some of the best receiving sets in the neighborhood cannot. We are well pleased with the set and heartily recommend it.

W. J. PRINSON, Seibert, Colorado.

N. Y. Heard Europe

I received six foreign stations during last week: 21.0, OEH, OAX, Lima, Peru, Hamburg, Germany; PTT, Paris, France; SCR, Brussels, Belgium. The Miraco is some set!

Local and distant stations come in so loud that you have to shut it down. Had Porto Rico on the loud speaker last week so you could hear it through the whole house.

GUS ESHMAN, Fulton, New York.

Beats \$200 to \$300 Sets in Demonstration

Miraco is the best performer in this town. I have demonstrated against \$200 and \$300 sets and beat them for distance and quietness.

ORREN W. FAWCETT, Saybrook, Illinois.

Experts Say It Can't Be Beat

I am very well pleased with my Miraco. Fact is, it was such a surprise that I haven't gotten over it yet. I have operated sets all over the world for the last seven years. I think that I ought to have some idea of what a broadcast receiver should be. I am sure that you have a set that can't be beat. I logged fifty-six stations first night.

A. W. BRYANT, Terre Haute, Ind.

Out Performs Costlier Sets

Like the Miraco very much. The first night I received KFI (Los Angeles), WPG, WHN, CFCF. This is covering from coast to coast; received 47 stations that night, and the next night I received 27 stations. That is more than a lot of sets are doing that cost from \$9 to \$100 per cent more than mine. It is all you claimed it and a little more.

C. A. MOONZ, Van Dyke, Mich.

Alaska Hears Chicago

I am living up here in Alaska one thousand miles from Seattle and it takes a good receiver to pick up any radio in this district, especially near Juneau, our Capital City, which seems to be bothered with electrical currents and static, but the Miraco picked up stations as far as Chicago. I've heard Omaha several times.

LESLIE F. PARKER, Gustavus, Alaska.

Finds It Superior to High Priced Set

Miraco is working fine. Have compared it with the (names expensive set) and find it superior in performance. The most pleasing feature of this machine is the counter balancer. I haven't seen another set with this remarkable feature, and it makes an impression on those who hear and see.

WILLIAM R. CUMMEL, Mapleton, Iowa.

Tested and approved by all of Radio's Highest Authorities



Send Coupon for Amazing Special Offer!

Greatly Reduced Wholesale Prices!

Big Discounts to User-Agents who will allow friends to listen to their MIRACOS.

BEAUTIFUL-BIG-POWERFUL Ultra Selective **MIRACO** Ultra's

Retail LIST Price **49.75** GET SPECIAL OFFER now only **29.75** one year GUARANTEE

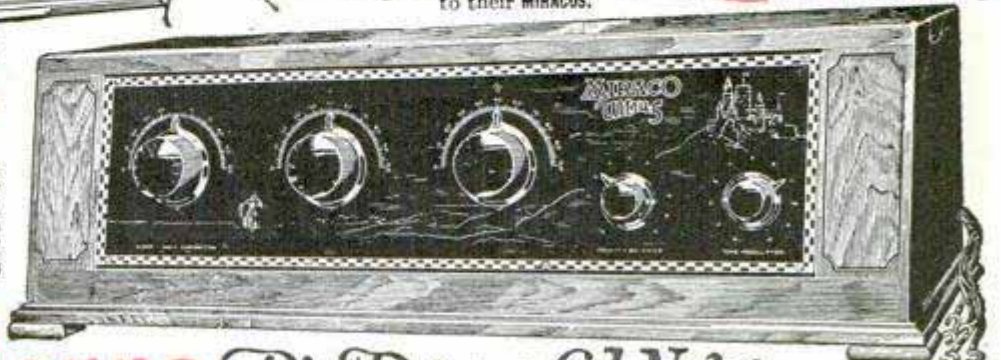

27 in. Long Solid Walnut Cabinet

Big Powerful New MIRACO

ULTRA-SELECTIVE LONG DISTANCE RECEIVERS - EASY ON CURRENT

Tremendously increased sales of the beautiful big Miraco's—due to user-agents finding them unbeatable among the fine, high-grade sets (even at several times the price!) for razor-edge selectivity combined with extreme long distance reception, clear natural tone, powerful loud speaker volume and economical operation—enable us to GREATLY REDUCE the wholesale prices. Latest, up-to-the-minute models—Sets and accessories! Get the big new discounts and Amazing Special Offer! Send postal or the coupon today—Now!

Compare with Any 6 to 8 Tube Sets—

Unless 30 Days' Trial proves your Miraco the most selective, the clearest toned and most powerful distance-setter among sets using up to 8 tubes—don't buy it! Enjoy a powerful big Miraco in your home—at our risk—and be thoroughly convinced. Your verdict final—absolutely no strings to our offer. Satisfaction unconditionally guaranteed.

Operate from Light Socket or Batteries

Miracos are specially adapted and unsurpassed for economical operation with A- and B-light socket power supply units—or with batteries. Power tubes and more than 90 volts of "B" Current may be used, although the power built right into a Miraco makes unnecessary the use of other than regular tubes and 90 volts.

Factory Prices Save You 1/2! Send Coupon

Save or make a lot of money on sets and accessories by dealing direct with a big, old, reliable manufacturer (7th successful year). Greatly reduced wholesale prices—get User-Agent's Special Offer on Demonstrating Set (no contract to sign, no red-tape). Our offer will AMAZE you. Send Coupon now!



RELIABILITY!
The Midwest organization was one of the very first to engage in the manufacture of radio sets. We consider them to be both morally and financially responsible. They have a reputation for fair and square dealings.—THE PROVIDENT SAVINGS BANK & TRUST CO.

7th ANNIVERSARY SPECIAL!

Only \$19.95 net—an unheard-of price for a high-grade fully guaranteed 5-tube radio! It's the new \$30 (retail list) Miraco Compact—14" wide, finished in brown mahogany. Can't be equalled anywhere near the price in quality of construction, selectivity, distance-getting power, tone, ease and economy of operation—let 30 days' trial prove this! Complete with high-grade accessories—nothing else to buy—only \$49.85 net. Act quick—supply limited. Get Special Offer! Another bargain, direct from factory. Coast to Coast range. Powerful, selective; clear, sweet tone.

FREE!
30 DAY TRIAL!
5 TUBE GUARANTEED RADIO
\$19.95

All the Proof you want is waiting for You!

Coupon or postal brings reports from hosts of users in your vicinity and elsewhere proving that Miraco sets at rock-bottom money-saving factory prices, outperform sets costing up to four times as much. You can also buy speakers, tubes, batteries, etc., at big savings from us! Get our proposition before spending money elsewhere.

MIDWEST RADIO CORPORATION
Pioneer Builders of Sets

407-W Miraco Building
Without obligation, send free literature, testimony of users, AMAZING SPECIAL OFFER and full particulars of your big money-saving factory-price proposition on Guaranteed Miraco sets and all radio supplies. () User () Dealer () Agent

NAME
ADDRESS

Send coupon for Amazing Special Offer!

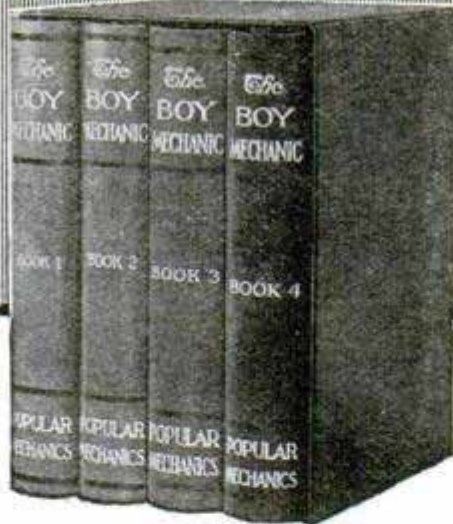

3,849
Ideas

3,917
Pictures



It's Fun To Make Things

Let the other boys wonder how you can make so many interesting things. Make your own motor sled. Make your own radio. Make your own skis and snowshoes. You can learn how to make almost anything that any boy could want by following the pictures and the simple directions in

The Boy Mechanic Library

And just think of it, there are nearly 4,000 separate articles in the four beautiful volumes! Some of the most fascinating subjects are listed below.

How To Make Things—How To Do Things

Boats	Carpentry	Electrical devices
Winter sports	Painting	Photography
Camping	Toys	Music
Ice boats	Fishing	Outdoor games
Water sports	Fruit growing	Stoves
Toboggans	Entertainments	Furnaces
Tents	Automobile	Wireless
Skis	House decorations	Tricks
Indian snowshoes	Drafting	Puzzles
Skating	China painting	Bicycle
Gymnasium	Decorative metal work	Flowers
Wind wagons	Furniture making	Hunting
Motor sleds	Farming	Kites
Radio	Poultry	Metal working tools
Magic	Models	Secret locks
Trapping	Laboratory helps	Swings
Pets	Household helps	Sleds
Leather work	Wood working	Power devices

Learn how to make things to sell. Learn how to make things to enjoy yourself. Buy the complete library, including Book 1, Book 2, Book 3 and Book 4.

SEND NO MONEY Four Books for only

Simply sign your name and address to the attached coupon and mail it at once. When the postman delivers the books to your door, pay him the price of the books and the few cents postage. That is all.

\$7

POPULAR MECHANICS PRESS
Popular Mechanics Building, Room 102, Chicago, Ill.

..... Mail The Coupon Today

Popular Mechanics Press,
Popular Mechanics Building, Room 102, Chicago, Ill.

Please send me at once C. O. D. The Boy Mechanic Library comprising Book 1, Book 2, Book 3, and Book 4. I will pay the postman \$7 and the few cents postage.

Name.....

City.....State.....

Street No. or R. F. D.....

If you want individual books at \$2 each, check the numbers of the books you want: 1 2 3 4



NEW LOW PRICES
EASY TERMS
IMPROVED

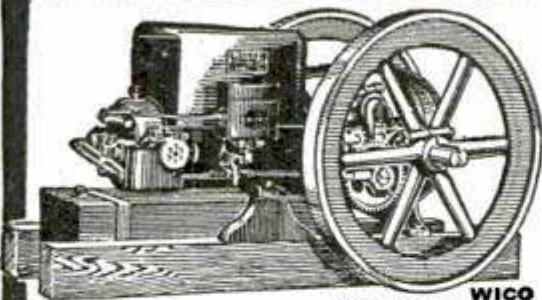

WICO
Magneto Equipped

WITTE ENGINE

150,000 WITTE Engines in daily use. Sold all over the world, but to the honest American farmer I sell at Wholesale, DIRECT Factory Price, Special Easy Terms and No Interest.

Develops more than rated power from almost ANY FUEL. THROTTLING GOVERNOR enables use of cheap distillate. Valve-in-head motor. Semi-steel construction. Fewer parts. Free from usual engine trouble. LIFETIME GUARANTEE. Many NEW REFINEMENTS and LOWER PRICES.

Get my NEW COMBINATION OFFERS ON SAWING and PUMPING OUTFITS.



FREE Big New Illustrated Catalog just out shows latest improvements. How to make money with WITTE Outfits. Solves all farm power problems. 57 years practical experience. Send name—no cost—no obligation.

3 hour Shipping Service.

WITTE ENGINE WORKS

1743 Witte Building, KANSAS CITY, MO.
1743 Empire Bldg., PITTSBURGH, PA.
1743 Witte Bldg., SAN FRANCISCO, CAL.

EXPOSED!

69 Tricks of Mediums Fully Explained

Every detail given for performing the seemingly impossible feats of famous mediums. Startling revelations that show how easy it is to fool the credulous. Many of these tricks have made the greatest magicians wonder.

You Can Do These Tricks

What makes a trick good is its simplicity. No complicated or expensive apparatus needed for these, the best of spiritualistic tricks. You can do such wonders as:

1. Produce spirit message on blank paper.
2. Read messages while blindfolded.
3. Produce spirit rappings.
4. Produce spirit voices.
5. Produce writing on blank slates.
6. Read sealed letters in total darkness.
7. Reproduce a burned message.
8. Read messages retained by the writers—and 61 other marvels used in spiritualistic seances.

Make Money Giving Entertainments

Clubs, Lodges, Sunday Schools, Churches, and organizations of all sorts are eager for entertainers who can mystify audiences with such inexplicable manifestations as these. You can make from \$10 a night up to \$50 or more, depending upon the size of the community in which you work. Anyone can do this. You need no special gifts.

Send No Money Just write a postal for our marvelous book, "Behind the Scenes with the Mediums." When postman hands you book, pay him \$1.50 and postal charges.

POPULAR MECHANICS PRESS
Room 702 200 East Ontario Street CHICAGO, ILL.

WET CELLARS MADE DRY
from the Inside!

DAMP musty cellars are unsanitary, a danger to health and a poor place to store valuable material.

Where water or moisture seep in through cracks or porous spots in the floor or walls, you can make and keep your cellar dry and sweet—a fit place to work, free from odor, mold and rust—by filling the cracks and coating the moist surface with Smooth-On No. 7.

This is the one practical waterproofing that you can apply yourself, easily, from the inside, to wet or dry surface and with every assurance of thorough watertightness, even in the wettest seasons.

Excellent also for patching concrete floors, waterproofing garage, stable and washroom floors, brick walls, cisterns, septic tanks, water troughs, fountains, fish ponds, swimming pools, manure pits, etc.

About 25 pounds of Smooth-On No. 7 are required for each 100 square feet of surface covered, and no experience is necessary. Complete instructions on this package.

Sold in 5-pound cans and 25, 50 and 100-pound kegs.



Write for
FREE BOOK

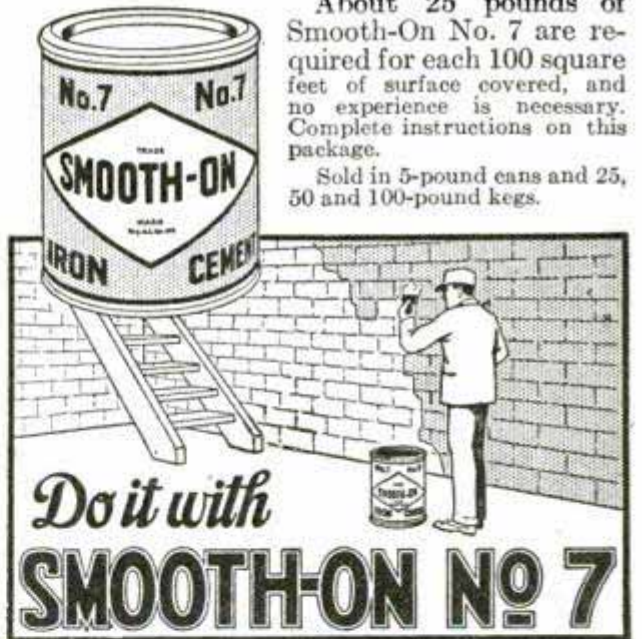

SMOOTH-ON MFG. CO., Dept. 37-7,
574 Communipaw Ave., Jersey City, N. J.
Please send the free Smooth-On Repair Book.

Name

Address.....

**Return this coupon for
FREE copy of Booklet**



Play America's Most Popular Instrument The Trumpet

IT'S one of the most popular instruments in an orchestra. And it's easy to learn to play. With a few short lessons you can run the scales. Before you know it you'll be playing hundreds of fascinating melodies. The ideal trumpet for all

orchestra and solo work is the PAN-AMERICAN. It has a brilliancy and color range that musicians appreciate. It's the "trick" instrument of every band and orchestra.

Own a PAN-AMERICAN TRUMPET. It's the instrument you need for home—school—church—and orchestra work.

A small down payment—easy monthly installments—gives you a PAN-AMERICAN TRUMPET, and a chance to be a "leader" in any musical organization.

Send coupon for complete information and catalog of PAN-AMERICAN instruments—America's most famous line of band and orchestra instruments.

SEND NO MONEY—MAIL COUPON

COUPON

THE PAN-AMERICAN BAND INSTRUMENT & CASE CO.
Dept. G-5, Elkhart, Indiana

YES—Send me complete information on PAN-AMERICAN Trumpets and other band instruments. I would like to learn to play.....(instrument).

Name.....

Address.....

City..... State.....

My local Music Dealer is.....

One Year To Pay



No. CS2—Price \$62.00
\$2 Down and \$5 a Month

This big cluster of seven best grade sparkling blue white diamonds is set in **SOLID PLATINUM** in this solid white gold ring. Guaranteed to stand any test.

18 KARAT

No Red Tape

10 Days Trial

SEND NO MONEY You pay \$2.00 to postman after you get this ring. If you keep it, pay only **\$5.00 a month for 12 months**. If you are not satisfied after seeing the ring, return it in 10 days and we will return your money—every cent. You take no risk in ordering this beautiful, flashing diamond cluster ring. Pay for it in monthly installments, like putting money in a bank.

Cluster Looks Like \$600 Solitaire

You now can buy this gorgeous ring at the wholesale price. Compare it with similar rings at \$100.00. **We guarantee it to stand any test or comparison.** It is the greatest bargain ever offered by any Diamond Importer. We will give you 8% more than you paid for it when you exchange it for a larger diamond ring.

WRITE FOR JEWELRY CATALOGUE

This beautiful diamond cluster ring is a sample of the unexcelled values we offer our customers. A thousand and one other selections are shown in our catalogue. Bring our store into your home.

STERLING DIAMOND & WATCH COMPANY

(Diamond Importers—\$1,000,000 Stock—Est. 1879)

1540 Broadway Dept. 2235 New York, N. Y.

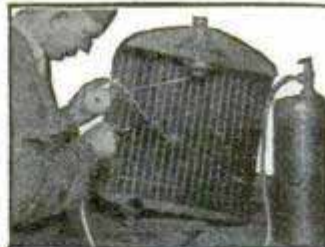

The Handy Tool for the Handy Man

TORIT No. 23 Acetylene Torch

PAT. JAN. 5, 1920

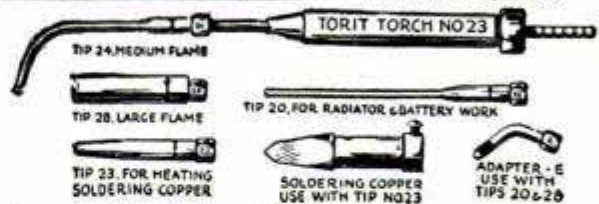

Uses Acetylene Only. No oxygen or air pressure required. Tips suck in air. Simply connect to Presto auto tank, light gas, and the outfit is put to work. **Gives Heat Instantly!** Beats anything you ever tried for soldering, radiator repairing, melting, lead burning, tempering, heating, light brazing, etc. Consists of torch, 4 tips for different kinds of work, soldering copper, 5 feet rubber tubing, tank connection, and full instructions. All ready to use. **Quickly \$7.50 pays for itself.** PRICE, complete, *without tank*, \$7.50

ST. PAUL WELDING & MFG. CO.

177 West Third Street

Saint Paul, Minnesota

No Joke to be Bald



Grow New Hair Quick

Let Me PROVE It To You FREE

What I accomplished on my own head, pictured above, I believe I can do for you, provided you are under 45 years of age and loss of hair was not caused by burns or scars. Anyhow, *I must succeed or you pay nothing.* No apparatus—my home treatment is simple, quick and inexpensive.

Send No Money Just your name and address and I will mail you full information with PHOTOGRAPHS, NAMES and addresses of men and women who have successfully used my treatment for dandruff, falling hair and particularly for baldness. Write Now. A postal will do.

VREELAND'S, 1352 Euclid-Windsor Bldg. CLEVELAND, OHIO

STOP USING A TRUSS



Reduced Fac-Simile Gold Medal



Grand Prix

STUART'S PLAPAO-PADS are different from the truss, being mechanic-chemico applicators made **self-adhesive** purposely to hold the distended muscles securely in place. **No straps, buckles or spring attached—cannot slip, so cannot chafe or press against the pubic bone.** Thousands have successfully treated themselves at home without hindrance from work—most obstinate cases conquered. **Soft as velvet—easy to apply—**

inexpensive. Awarded Gold Medal and Grand Prix. Process of recovery is natural, so afterwards no further use for trusses. We prove it by sending Trial of Plapao absolutely **FREE**

Write name on Coupon and send **TODAY.** **PLAPAO CO., 733 Stuart Bldg., St. Louis, Mo.**

Name.....

Address.....

Return mail will bring Free Trial Plapao.

Books on 67 Practical Subjects

Popular Mechanics Press specializes in supplying the outstanding best book on any subject. Check the books you want, and mail this advertisement as your order blank.

ARCHITECT Architectural Drawing . . . \$1.50	FUR RAISER Outdoor Opportunities . . . \$1.50
ARMATURE WINDER Armature Winding . . . \$3.00	FURNITURE MAKING Mission Furniture Making. (3 vols.) . . . \$3.00
ARTIST Practical Art . . . \$5.00	GLASS WORKER Decorative Glass Processes . . . \$3.25
ARTS CRAFTS Art Metal Work . . . \$4.25	HAND FORGING Hand Forging and Wrought Iron Ornamental Work . . . \$2.00
ASTRONOMY Amateur Telescope Making . . . \$2.00	HOME BUILDING Concrete Houses . . . \$3.00
AUTOMOBILE Dyke's Encyclopedia . . . \$6.00	HYPNOTISM Practical Lessons in Hypnotism . . . \$1.25
AVIATOR Practical Aviation . . . \$3.00	INTERIOR DECORATOR Interior Wall Decoration . . . \$4.00
BOAT BUILDER 22 Different Boats . . . \$0.50	INVENTOR Inventors' Manual . . . \$1.50
BOOKKEEPER Bookkeepers' Handbook . . . \$1.00	LATHE WORK Lathe Handbook . . . \$0.50
BOYS' BOOKS The Boy Mechanic (4 vols.) . . . \$7.00	LEATHER WORKER Artistic Leather Work . . . \$1.25
BRICKLAYER Plain and Fancy Brickwork . . . \$1.50	LOCKSMITHING 500 Tricks of the Trade . . . \$1.50
CABINET MAKER Furniture Making . . . \$3.50	LOOM FIXER Practical Loom Fixing . . . \$1.50
CALCULATOR Ropp's Calculator . . . \$1.00	MACHINIST Complete Practical Machinist . . . \$3.00
CARPENTER Carpenter's Handbook . . . \$1.50	MAGIC Modern Magic . . . \$2.00
CARTOONING Cartooning Made Easy . . . \$3.00	MASON Practical Stone Masonry . . . \$1.25
CHEMISTRY General Chemistry . . . \$3.75	MATHEMATICS Mathematics for the Practical Man . . . \$1.50
CIVIL SERVICE Course in Civil Service . . . \$1.50	MECHANICAL DRAFTSMAN Practical Course in Mechanical Drawing . . . \$1.00
CONCRETE 173 Ways of Using Concrete . . . \$0.50	MODEL MAKING Model Making . . . \$3.00
COOKING Foods from 20 Lands . . . \$1.50	OUTDOOR SPORTS Outdoor Sports the Year 'Round . . . \$1.50
DETECTIVE Instruction for Detectives . . . \$1.00	PAINTING Owen's Paint Guide . . . \$1.00
DIESEL ENGINES Diesel Engines, Marine, Locomotive, Stationary . . . \$5.00	POULTRY RAISER \$4,223 from a Town Lot . . . \$1.00
DOG FANCIER Dog Lovers' Companion . . . \$1.00	PSYCHO-ANALYSIS Outwitting Our Nerves . . . \$2.50
DRAWING Drawing Made Easy . . . \$1.25	RABBIT RAISING Practical Rabbit Keeping . . . \$1.50
DRILLING Drilling and Thread Cutting . . . \$0.50	RADIO Lefax Radio Handbook . . . \$3.50
ELECTRICIAN American Electricians' Handbook . . . \$4.00	REFRIGERATION Homemade Refrigerating Machine . . . \$0.50
ELECTROPLATER Electroplating . . . \$1.00	SHIP MODELS Ship Model Making . . . \$2.50
ENGINEER Bailey's Handbook for Stationary, Marine, Diesel . . . \$2.00	SHOP WORK Shop Notes (16 vols.) . . . \$7.50
ENGLISH Self-Improvement in English . . . \$2.50	SPIRITUALISM Behind the Scenes with the Mediums . . . \$1.50
ENTERTAINMENTS Money-Making Entertainments . . . \$1.25	TAXIDERMIST Methods in Taxidermy . . . \$3.50
ETIQUETTE Book of Etiquette (2 vols.) . . . \$1.98	TOY MAKER Toy Manufacture . . . \$1.50
FARMER Popular Mechanics Handbook for Farmers . . . \$1.00	WELDER Welding Encyclopedia . . . \$5.00
FORD My Ford, Its Care and Repair . . . \$3.00	WIRING House Wiring . . . \$1.00
FORMULAS 10,000 Formulas . . . \$4.00	WOOD WORKER Wood-Working for Amateur Craftsmen . . . \$1.00
	WRITER Free-Lance Writers' Handbook . . . \$5.00

Send No Money

Just check the books you want, write your name and address below, and mail the whole advertisement. It is your order blank. When postman hands you books, pay him the price and the postal charges. If you prefer to send cash, postage will be prepaid. We have many other books on these subjects and on 2,000 other subjects. Catalog free.

CHECK THE BOOKS YOU WANT AND MAIL TODAY

Name.....

City.....State.....

Address.....

Mail to Popular Mechanics Press,
Room 702, 200 East Ontario St., Chicago, Ill.

Learn this Great Hindu Mystery



A Mango tree grows before your eyes . . . folks think it is hypnotism . . . but it's not . . . it is Legerdemain — sleight-of-hand . . . One of the many mystifying Illusions taught in the —

Great Tarbell Course of MAGIC

Now—at last—for the first time—the secrets of this and other great mysteries may be yours. Dr. Tarbell—not merely the performer, but the teacher of performers, has been prevailed upon to unfold the most jealously guarded secrets of MAGIC—that YOU may learn at home in spare time, in a few months, what great magicians have taken years to discover.

Earn \$250 to \$1000 a Month

Everyone knows that stage magicians make tremendous salaries. But you may not realize that there is also big money for the amateur or semi professional in giving entertainments at clubs, schools, church affairs and other gatherings right in your own town and locality. Magic also pays splendid returns to the business man through the popularity and prestige it brings him. Magic to the salesman—is the golden key that opens all doors. Dr. Tarbell will teach you ALL of the many branches of Magic—the most mystifying card tricks—effects for parlor gatherings, club tricks, everything up to and including massive stage illusions. And more than all that, he trains you in the very principles of magic—things that many professional magicians have yet to learn.

Mail Special Offer Coupon

Write at once if you think you might be interested. The Tarbell Course is now offered at a Special Price so low that it must be advanced in the near future. Why delay? Here is your wonderful chance to gain plenty of money and popularity. Send the coupon at once. Get all the details without one bit of obligation to buy.

**Tarbell System, Inc., Studio 93-52,
1920 Sunnyside Avenue, Chicago**

Tell me all about Dr. Tarbell's new and simple system by which I can learn the secrets of Magic at your Special Low Rate now open to me.

Name.....

Address.....

Age.....

IMPORTANT



-as
the
TUBE
Itself

Amperite alone can supply automatically, the self-adjusting filament control your tubes require for perfect rheostat regulation under all

varying conditions. Insist upon Amperite—and accept nothing else. Simplifies wiring. Eliminates hand rheostats. Specified by leading engineers in every popular circuit. Types for all tubes. Price \$1.10 mounted (in U.S.A.). At all dealers.

Radiall Company, 50 Franklin St., New York City



FREE

Write Dept. PM2 for Hook-Ups and Construction Data.

AMPERITE

REG. U.S. PAT. OFF.

The "SELF-ADJUSTING" Rheostat

Books on all subjects are sold by Popular Mechanics Press, 200 East Ontario Street, Chicago, Illinois.

WE PAY FREIGHT
5 ROOMS AND PORCH BATH INCLUDED - **\$548⁰⁰**

OTHERS \$379.00 UP
HANDSOME BIG CATALOGUE FREE

Prices include all lumber, millwork, roofing, lath, hardware, paints, nails. Plans furnished FREE. Freight paid East of Mississippi and North of Mason-Dixon Line, also Minnesota, Iowa, Missouri. Write for Catalogue Now
Dept. 122—LEWIS MFG. CO., Bay City, Mich.

FREE

NEW 1927 Radio Catalog

WRITE TODAY TO

Chicago Salvage Stock Stores

509 S. State St. Dept. PM Chicago, U. S. A.



MORE THAN a score of new circuits—all the latest and best. Complete parts at prices that mean big savings for you. And all the latest parts and accessories as advertised in current radio magazines. The largest, most complete and up-to-date radio stock in the world. Yours to choose from in this new catalog. Write for your copy.

SOLDERALL

METAL IN PASTE FORM



The only convenient metal solder

Every Electrical Connection needs Solderall for perfect reception **25¢**
The SOLDERALL CO., NEWARK, N.J.

Make Worth-While Models of Decorative Ships



Pay Postman \$2.50 upon Delivery

Simplified instructions enable any handy person to make a Picturesque Barbary Pirate

Felucca and a Beautiful Spanish Treasure Galleon (both of the 17th century) with a few simple household tools, almost without expense.

These are **not** scale-models that require a knowledge of naval architecture, infinite patience and months of time to build, but "Sketch Models" that are correct rendering in general appearance of the original ships. By following the building principles in this book, any type of sketch model can be made. Pay postman \$2.50 upon delivery.

POPULAR MECHANICS PRESS
200 East Ontario Street CHICAGO

30 Days Free Trial

**Just Out -
1927
Model**

Yes Sir!
You can put a new 1927 Westingale Radio in your home and use it to your heart's content on **30 Days' Trial**. Listen to music, concerts, news, sports, market reports from stations all over the country. Compare it with old style 3 or 4 dial sets costing more, then if not convinced that Westingale gives you the greatest Radio satisfaction and the best value for your money, **you don't have to keep it.**

**New ONE
Dial Radio**
\$57⁰⁰
Retail Price

NOW! Westingale offers the last word in Radio. Either 1 or 2-Dial Control — easiest to tune and years ahead in powerful reception and tone. Newest period type cabinets, two-tone walnut finish. The front panel embossed in dull gold with artistic Spanish Galleon design. Unbeatable for performance, appearance or price.

2-Dial, 5 tubes \$47⁰⁰
1-Dial, 5 tubes \$57⁰⁰

Where else can you get so much for the money on 30 days trial? Why pay more? Why take chances? Why not have the **NEWEST** Radio when you can try them at our risk. Before you buy get our **Free Catalog and 30 Day Trial Offer**

Westingale Electric Co.
Department 174
1751 Belmont Ave., Chicago, Ill.



**Big Discounts
to Agents**

(7)

AGENTS WANTED BUY at COST Your own Radio Free. Get demonstrator set on 30 Days' Trial—make \$100 a week easy. Full or spare time. Big discount on first set placed in each locality. Be first—write today for dealers' discount and full details.

Let us recommend the best books to study on any subject. Popular Mechanics Press, Chicago, Illinois.

Simplified Radio Blueprints

Blueprints for the most popular sets described in Popular Mechanics Magazine can be obtained for a charge just sufficient to cover the cost of production and mailing. The sets for which blueprints are available are:

- Simple One-Tube Receiver..... April 1926 — 15c
- Two-Tube, Loud Speaker Set..... July 1925 — 10c
- Three-Tube, Cockaday Receiver..... April 1925 — 10c
- Three-Tube, Low-Loss, -Short-Wave Set..... Oct. 1925 — 10c
- Three-Tube, Loud Speaker, Loop Set..... Dec. 1926 — 15c
- Three-Tube, 15 to 550 Meter Set..... Nov. 1926 — 15c
- Four-Tube, Loop Set, for Car or Home..... Aug. 1926 — 15c
- Five Tube, Browning-Drake Set..... May 1926 — 15c
- Six-Tube, Self-Contained Receiver..... July 1925 — 10c
- Six-Tube, Counterphase Receiver..... Feb. 1926 — 15c
- Six-Tube, Portable, Loop Set..... June 1926 — 15c
- Six-Tube, Perfect-Tone Receiver..... Nov. 1925 — 10c
- Eight-Tube, 1927 Model Superheterodyne; this set of blueprints includes drilling templates and extra photos..... Oct. 1926 — 75c
- B-Battery Eliminator..... Mar. 1926 — 15c
- Non-Radiating Unit..... May 1926 — 15c
- Simple Tube Tester and Chart..... July 1926 — 15c

Address the **RADIO DEPT.**
Popular Mechanics Magazine
200 E. Ontario St., CHICAGO

Back numbers of the magazines describing the construction of the sets can be obtained from our Circulation Department, price 25 cents each.

RADIO PANELS OF GENUINE BAKELITE

Cut, drilled and engraved to order. Send rough sketch for estimate. Our New Catalog on Panels, Tubes and Rods—all genuine Bakelite—mailed on request.

STARRETT MFG. CO. 524 S. Green St. Chicago, Ill.

A & B Battery Charger ONLY \$2



SATISFACTION GUARANTEED
Charges any type of storage A or B battery, using a few cents worth of ordinary house current, either alternating or direct. Cannot injure battery. Complete directions enclosed. Anyone can operate. No expensive "extras" to buy. Why pay \$10.00 to \$15.00 for a charger when you can get this splendid GUARANTEED R. B. Charger by mailing us two dollars (bills, money order, check or stamps) plus ten cents in stamps or coin to pay mailing costs. Charger will be sent postpaid. If you are not satisfied, return within five days and we will refund your money. Order at once—TODAY.

R. B. SPECIALTY CO.
Dept. G-2 308 East Third St., Cincinnati, O.



**With the "Trouble-Shooters"
of the North Atlantic**

ICE-BERGS—towering, ponderous, deadly mountains of ice drift southward from the ice fields of the Arctic into the traffic lane of trans-Atlantic steamers.

Locating and destroying them is the perilous and never-ending duty of the United States Coast Guard cutters.

Shell fire and high explosives, however, often fail to blow the bergs from the sea, and warnings are then broadcasted by radio to every ship whose course lies through the danger zone.

Smooth power, unfailing dependability over long periods and under all conditions of service are qualities demanded in the radio batteries used in this dangerous naval service.

The fact that Burgess Batteries meet those requirements recommends them to you for your own receiving set.

Ask Any Radio Engineer

BURGESS BATTERY COMPANY

GENERAL SALES OFFICE: CHICAGO

Canadian Factories and Offices:
Niagara Falls and Winnipeg



BURGESS RADIO BATTERIES

**LYNCH
METALLIZED**

WARRANTED FIXED RESISTORS

THE vital importance of a silent, accurate resistor cannot be overestimated. Comprising a concentrated metallized deposit one-thousandth of an inch thick, upon a glass core and sealed forever within the tube, each Lynch Resistor is warranted absolutely noiseless, permanently accurate, dependable! Guaranteed accuracy—10%; in production they average 5%. .25; .5; 1; 2; 3; 4; 5; 6; 7; 8; 9; 10 Meg., 50c. .025; .09; .1 Meg., 75c. Single mounting, 35c; Double, 50c. If your dealer cannot supply you, send stamps, check or money order. We ship postpaid same day order is received.

Dealers—Get on our mailing list; we keep you posted on new developments. Write us today!

ARTHUR H.
LYNCH, INC.



4-26-A
250 W. 57th Street
New York, N. Y.

Metal Magic

A touch of heat and it's done

If you've never used Kester Metal Mender before, you'll think it's magic—it's so easy to use. Think of soldering as well as an expert, right in your home. You can—just ask your dealer for Kester, the solder anyone can use.



free sample upon request

KESTER METAL MENDER

CHICAGO SOLDER COMPANY
4201-339 Wrightwood Ave., Chicago, U. S. A.
Est. 1899

Save 20 to 50% FREE RADIO CATALOG

LATEST IN HOOK-UPS AND RADIO

NEW 1927 EDITION—FREE 164 PAGES
The Barawik Company, pioneers in radio, now offers you through its Radio Catalog and Guide, greater bargains than ever before in standard sets, parts, kits and supplies. No matter what parts you want, for whatever circuit or hook-up—you may prefer, we can supply them to you at big savings. Special prices on sets, tubes, batteries, cone speakers, cabinets, etc.
Write today for free 164-page Radio Catalog and Builders Guide, showing radio's newest creations. Also please include name of another radio fan when writing.

THE BARAWIK COMPANY
540-551 Monroe St. Chicago, Ill.

POPULAR
These Aero Coils
Improve Any Radio Receiver!



These sensitive Aero Tuned Coils has never failed to improve any radio receiver. Tremendous selectivity, and improved results are sure to result from their use.

This kit of Aero Coils have a much lower high frequency resistance than other types of inductances. You should use them in any circuit, if you want the best possible results.

FREE Big 8-page 4-colored layout system (actual size blue prints) and complete instructions for building the 5-tube Aero-Dyne Receiver free with each kit. Also insert showing how to wire for a power tube if desired. Extra copies, 75c each.

Get these Aero Coils from your dealer. If he is out of stock, order direct from the factory.

AERO PRODUCTS, Inc.

Dept. 107, 1772 Wilson Ave., CHICAGO, ILL.



THIS 68 PAGE RADIO CATALOG

FREE

Contains 75 Radio "Hook Ups," 300 Illustrations, 650 articles, 8 page Log Book of all U. S. Broadcast Stations.

"Build your own with 'RASCO' Parts"
 RADIO SPECIALTY CO., 98 E. Park Place, New York, N. Y.

RADIO BOOK FREE

Tells how you can make big money in world's newest and greatest field. Presents lifetime opportunity in Radio. Right now we want live agents and dealers in every locality, \$60 to \$100 a week easy.

40% TO 60% PROFIT

FREE Simply send name for this big illustrated book explaining liberal profit proposition and how to get latest radio goods at wholesale. Also prices on parts, sets and accessories and amazing special offers—all free. Write today.

STANDARD RADIO CO. 1402 Walnut Street KANSAS CITY, MO.



5 Tube Set
 only \$39.50 RETAIL

Tower Scientific Headset



\$2.95

Largest Selling Headset in the World!

Tower Phones are known the world over for their high quality and efficiency. Easy fitting, durable, scientifically correct. Used by winners in the trans-Atlantic tests and by those who obtain the best results from their radio. Every receiving set owner needs phones as auxiliary equipment and for tuning-in distant stations.

Tower Products are backed by a guarantee that counts—the enthusiastic endorsement of more than 2,000,000 owners.

On Sale from Coast to Coast. If your Dealer is not stocked, order direct. Satisfaction or money refunded.

TOWER MFG. CORP., Boston, Mass.

Also Mfgs. of the famous Little Spitfire Headsets

\$1.95



SW
Element-Lockt Radio Tubes

Triumph of Engineering!

What a Difference in Reception!

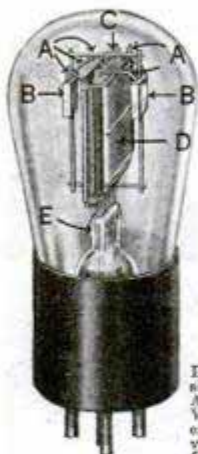

- (A) Five Rigid Bands that unite the three Elements (Filament, Grid, Plate) into ONE UNIT! Locks them together! The three elements are scientifically spaced to the 1000th part of an inch. Good reception depends upon maintaining that exact PRECISION in spacing. In ordinary tubes the spacing is easily upset, which accounts for noise, squeals, howls, distortion. This cannot occur in "ELEMENT-LOCKT" Tubes, because all 3 Elements are Lockt-together. They act as ONE UNIT!
- (B) PROCESSED GLASS PRISMS supporting the five Rigid Bands. Prisms are non-porous; free from disturbing gases; confirmed by U. S. Bureau of Standards.
- (C) FILAMENT, purest alloy; impregnated with costly thorium; easily rejuvenated—giving tube years of life.
- (D) PLATE—specially treated, heat resisting, cannot warp.
- (E) GLASS STEM, extra wide for solid immovable support to the three elements.

What a Difference They Make!

DETECTOR type is very soft—especially sensitive on distant signals. AMPLIFIER type is High Exhaust—giving greater Amplification. Try them! Note the difference in reception! Voices become alive, rich, human! Music becomes mellow, exquisite, enchanting! High notes ripple and sparkle! Great volume! Great distance! You will be AMAZED at the difference! Your friends will think you have a new Radio Set.

Sold Direct—Special Introductory Price \$1.50

Made to sell for \$2.50 each. To popularize our "Direct-by-Mail" values, we feature them at Introductory price \$1.50 each, any quantity. Sent promptly for 10 Days' Trial upon receipt of Check or Money Order! Or sent C. O. D. if preferred. If you wish to return them at end of 10 Days, your money will be refunded in FULL! Type 201a or 199; each \$1.50.

Amazing 3000-Hour Replacement Guarantee

Should any tube prove defective within a period of 3000 hours' use—we guarantee to replace it FREE of charge—AMAZING GUARANTEE! Send Check or Money Order with Coupon!

SEEVER-WILLIAMS CO., Radio Division
"2 Generations of Honorable Dealings"
 Importers, Exporters, National Mail-Order House
365 Washington St., Boston, Mass.
 Manufacturers, Sole Distributors of "ELEMENT-LOCKT" Tubes

Write quantity desired in the proper box below: Check type desired in proper box below:

Amplifier tubes Detector tubes Do you require 201a type? or 199 type?

Name.....

Address.....

Clip and Mail this Ad. TODAY! Special Prices for LIMITED TIME only. Money back if not delighted. Pop. Mch. 2-27

If you wish them sent C. O. D. put cross here

"B" BATTERY ELIMINATOR

Only \$ **7.95**

MONEY-BACK GUARANTEE

No more worry with "B" Batteries! Hook up a Roll-O "B" Battery Eliminator and forget battery troubles forever. This wonderful new invention means better reception, sharper tuning. Gives you more real pleasure from your set.

Completely Equipped—No "Extras" to Buy
 Operates perfectly on direct or alternating current, giving up to 90 volts current, and using the full wave of the power supply. Simple directions enclosed—anyone can plug it in to any kind of set up to six tubes. Constant voltage gives set more power. Costs no more than set of good "B" Batteries. Solidly built in beautifully finished metal case, with genuine Bakelite top.

SEND YOUR ORDER NOW

Don't blame your set because run down "B" Batteries won't let it work right. Order your Eliminator NOW. Write name and address on a piece of paper, pin a dollar bill to it, and mail it TODAY. Pay postman balance (\$6.95 plus a few cents postage) when he delivers your Eliminator. Use it ten days. If not more than satisfied, return it and get your money back. Roll-O Trickle Charger, for either "A" or "B" Batteries, only \$3.95 (plus few cents postage). Send \$1.00 with order—balance C. O. D. Satisfaction guaranteed or money refunded.

THE ROLL-O RADIO CO.
 Dept. S-1 Third and Sycamore, Cincinnati O.

Send \$1.00

SECTION

FREE!

This
84 PAGE RADIO BOOK

SAVE 1/3 to 1/2

The World's Largest Exclusive Radio Mail Order House
 will send you—FREE—this wonder catalog of radio bargains containing over 2000 items of everything in RADIO, including all the latest Sets, Kits, and Parts, at rockbottom prices that Save you 1/3 to 1/2

5-TUBE SETS AS LOW AS \$24.90
LATEST 1927 MODELS

Table and Console models with built-in loud speakers. Beautiful, genuine mahogany and walnut cabinets. All sets at amazingly low prices.

SEND FOR BOOK TODAY
 We cannot begin to tell all about this wonderful Radio Book. Simply send letter or postal, and this bargain radio catalog will come to you absolutely free. Write Today.

RANDOLPH RADIO CORP.
 180 N. Union Ave., Dept. 221, Chicago, Ill.

American RADIO Now—

50% DISCOUNT ON RADIO!

BIG NEW 1927 CATALOG-FREE

Dealers, Agents, Set Builders—get our big 1927 Catalog—225 nationally advertised lines. Lowest prices in America! Largest, most complete stock. Radio's latest developments. It's FREE—send for your copy now. American Auto & Radio Mfg. Co., Inc. 1424 McGee St., Kansas City, Mo.

SM Do You Know the Secret of Quality Reproduction?

"The Secret of Quality" tells you simply and concisely how to get the most out of your amplifier—how to get quality. This 96 page booklet is yours for the asking—it's free. Write for your copy.

SILVER-MARSHALL, INC., 840 W. Jackson Blvd., Chicago, U. S. A.

FROST-RADIO
 Type 880 Super Variable Resistance

These new non-inductive, variable high resistance units are precision instruments which operate smoothly and noiselessly from zero to maximum rating. Have low temperature coefficient. Lever makes positive rolling contact with resistance element with absolutely no wear. Designed for use as tone and volume control, for resistance coupled amplification, to control regeneration, and as a stabilizer. Furnished in following resistances: 50,000, 100,000, 200,000, and 500,000 ohms. List: \$1.25.

HERBERT H. FROST, Inc.
 160 N. LaSalle St., Chicago New York City Los Angeles

Half Actual Size

SEND for most complete Binocular catalog FREE!



This model \$1950

Shows many styles for sports, motoring, yachting, bird study. Double your joy in every outdoor activity. Special Geneva patents. Free 10-day trial offer. Write today for full details.



Crosman Pneumatic — the .22 that makes records

Sporting world wild over this new .22 rifle—Army men, explorers, marksmen, etc. Accuracy that astonishes—makes better shooting easy. Adjustable power from air under enormous pressure, invention of West Pointer. Noiseless, smokeless, no cleaning.

MONEY BACK IN 10 DAYS

Thousands of users delighted. Saving on ammunition soon pays for gun. Legal in cities—yard, attic, etc. Only \$15 (\$17.50 west of Rockies), prepaid. Try it 10 days. Money back on request. Order today.

GENEVA OPTICAL COMPANY
41 Linden Street Geneva, N. Y.



The Lure of the Ancient Trail

THERE are trails that are older than history waiting for you today. Out through the purple hills they lead to that land of dreams-come-true. Go follow these trails—these water trails at the helm of a sturdy "Old Town Canoe."

For "Old Town Canoes" are durable and strong. They are light in weight and surprisingly easy to handle. Their lines are graceful and trim—patterned after actual Indian models. Remarkably low in price too. \$58 up. From dealer or factory.

Free illustrated catalog gives prices and complete information about sailing canoes, square stern canoes for outboard motors, dinghies, etc. Write today. OLD TOWN CANOE Co., 1762 Middle Street, Old Town, Maine.

"Old Town Canoes"



R4548

ELECTRICIAN'S-RADIO KNIFE. Sheepfoot blade for scribing, coping, and general work. Combination screw-driver and wire-scraper, equipped with a lock device. Genuine English cocobolo handle. Nickel Silver bolsters. Brass lining. Length, closed, 3¼ inches.

At Last— A Real Knife

for the Radio Tinker

REMINGTON skill has made available what many have looked for in vain—a real knife. For over a century Remington has been developing scientific, thorough, and exact heat-treatments for steel. Remington's methods of forging, hardening, and tempering insure blades with the remarkably keen, durable, and uniform cutting edges which are a distinguishing feature of all Remington pocket cutlery.

And, remember, there is a Remington knife especially made for every purpose for which a knife is used. The Electrician's and Radio Knife shown above has a combination screw-driver and wire-scraping blade equipped with a locking device. It is just the right tool to use on a hook-up, or on the occasional wiring job around the house. If your dealer doesn't have this knife in stock, he will gladly order it for you. Send us his name and we will mail you a circular describing our carpenter's and mechanic's knives.



R6353

MECHANIC'S KNIFE
Equipped with large, strong, sabre blade. Small clip blade. Punch or reamer blade. Stag handle. Nickel Silver bolsters and shield. Brass lining. Length, closed, 3½ inches.

Remington Arms Company, Inc.
Established 1816
25 Broadway New York City

Remington

© 1927 R. A. Co.

Rifles Ammunition Shotguns Game Loads Cutlery Cash Registers

Be the Life of the Party



Play a Tune in 10 Minutes

Popularity—new friends—money-making opportunities come to those who can play!

Now you can pick up your favorite stringed instrument and play a tune almost instantly. NO knowledge of music needed. NO expensive lessons. NO weeks of tiresome practice. Play tunes, from the start. Play by numbers. Surprise and astonish your friends. **Amazing new invention** makes it easy to play Ukulele, Banjo Ukulele, Tenor Banjo, Guitar, Mandolin. Just press the keys and play.

Trixie Friganza, famous Vaudeville Star, wrote: "I played in 3 minutes and never touched a stringed instrument before."
 John A. Crusier: "I was skeptical about anyone playing tunes instantly but have changed my ideas completely."
 W. B. Mathis: "Your advertisement didn't tell the half of it."
 Mrs. A. Kasen: "My friends and I play wonderful tunes. The more we play the better it gets."

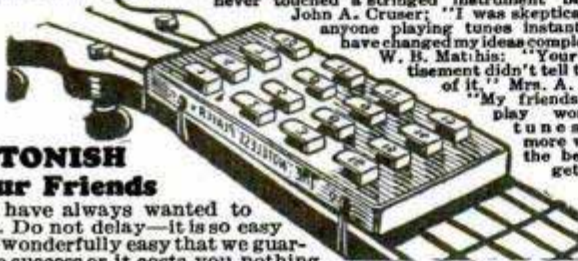

ASTONISH Your Friends

You have always wanted to play. Do not delay—it is so easy—so wonderfully easy that we guarantee success or it costs you nothing.

SEND FOR FREE BOOK!

More popularity—more fun from life—new friends—money-making opportunities. If you want to play tunes at once—send today for a free book about **FERRY E-Z Playing stringed instruments**. Soon you, too, can know the joy of making your own music. "No play, no pay." E-Z Playing Instruments are sold complete or the E-Z Player can be attached to your own stringed instrument in a jiffy.

Mail coupon today

FERRY & CO., Dept. 1772, Chicago, U. S. A.

Send free book telling how I can get more fun out of life, make more friends, have greater opportunities for getting ahead by learning to play my favorite stringed instrument in 10 minutes. No obligation.

Name

Address

City..... State.....



Agents! \$20 a day

- Meat Tenderer
- Mince Knife
- Cleaver
- Ice Tool
- Food Chopper
- Fish Scaler
- Nut Crumbler

HANDIEST TOOL IN THE KITCHEN. Housewives all say "Just what I want." The **Ideal Fiber Cutter** is a real household aid. *Tested and Approved by Good Housekeeping.* Two minute demonstration sells it—**100 PER CENT PROFIT.** Boorem, Pennsylvania says, "Have bought my home and car with Cutter profits." Bassett, Washington, new agent, writes, "Made \$7.50 in 2 hours today." You can do as well. No experience needed. Work spare or full time. Write for details.

THE TYLER COMPANY, Dept. M-7 Muncie, Indiana



Gibson Mastertone Stringed Instruments

Ralph Dexter famous banjoist N. Y. C. uses a Gibson

GIBSON banjos are today's most popular instruments. Snappy, powerful, musical tone wins instant admiration, everywhere. Easy to learn, easy to own. Send for catalogs and details of easy payment plan on Gibson banjos, guitars, mandolins, ukeleles.

Gibson Inc., 203 Parsons St. Kalamazoo, Mich.

MEN A New Business of Your Own! \$12 to \$30 Daily!

Now, within your grasp lies the opportunity to bid farewell to drudgery. Already, throughout the world Nestler Operators are showing automobile owners how they can obtain 75% more mileage from tires they usually discard and cut their tire costs IN HALF.

A New Plan permits ambitious men to operate the Nestler Process and Equipment and pay out of their profits.

This Book FREE

EASILY LEARNED Every Nestler Licensee obtains a Manual of Instruction showing this simplest, fastest, best way of repairing and retreading tires of all types, including balloon and truck.



GET THE FACTS Do not delay. Write at once for "The Nestler Plan" describing this profitable new business. If possible, call for a demonstration.

NESTLER RUBBER FUSING CO. INC.

Dept. M2, 245 West 55th Street, New York City, N. Y.



The CRESCENT

20" band saw, 4' and 6' bench jointers, No. 12 saw table are adapted for use wherever there is wood work to be done. These machines are small but are substantially built. Ask for circulars.

In the larger sizes we can supply band saws, saw tables, jointers, shapers, variety wood worker, planers, planers and matchers, disk grinders, cut off table, swing saws, borers, hollow chisel mortisers, tenoners, self feed rip saw, universal wood workers.

THE CRESCENT MACHINE CO.
93 Columbia Street, Leetonia, Ohio, U. S. A.

Skin Troubles

Cleared up—often in 24 hours. To prove you can be rid of Pimples, Blackheads, Acne Eruptions on the face or body, Barbers' Itch, Eczema, Enlarged Pores, Oily or Shiny Skin, simply send me your name and address today—no cost—no obligation. **CLEAR-TONE** tried and tested in over 100,000 cases—used like toilet water—is simply magical in prompt results. You can repay the favor by telling your friends; if not, the loss is mine. **WRITE TODAY.**
E. S. GIVENS, 429 Chemical Bldg., Kansas City, Mo.

"I would not part with it for \$10,000"

So writes an enthusiastic, grateful customer. In like manner testify over 100,000 people who have worn it.

The Natural Body Brace

Comfortable and Easy to Wear

Overcomes Weakness and Organic Ailments of women and men. Develops erect, graceful figure, brings restful relief, comfort, health and strength.

Not Sold in Stores—

Made to Measure—Makes work easy and walking a pleasure; replaces and supports misplaced internal organs; reduces enlarged abdomen; straightens and strengthens the back; corrects stooping shoulders; develops lungs, chest and bust; relieves backache, curvatures, nervousness, ruptures, constipation.

Get Well—Stay Well Write today for illustrated booklet, measurement blank, etc., and read our very liberal proposition.

HOWARD C. RASH, Pres., Natural Body Brace Co.
223 Rash Building • • SALINA, KANSAS



30 Days Free Trial



LEARN to Play JAZZ

These Books are Simple and Illustrated for Self Teaching

Saxophone	30c	Mandolin	30c
Accordion	30c	Ukulele	30c
Guitar	30c	Piano	30c
Tenor Banjo	30c	Violin	30c

Any one of the above at 30c apiece or the entire set of 8 for \$2.00 pp.

HALLEY COMPANY, 849 E. 75th St., CHICAGO

Wait Just a Moment, Mr.!

Before You Light That Cigarette, Cigar or Pipe—Or Take a Chew of Tobacco—

REMEMBER THIS:

That no man can escape the bad effects of tobacco. Its active principal—nicotine—is a deadly poison which, in time, is simply bound to injure your health—perhaps seriously.

Most tobacco users realize this. But when they try to quit unaided they find it next to impossible because of the almost unbreakable hold the habit has on them.

Thousands of inveterate tobacco users have found it easy to quit with the aid of the



Keeley Home Treatment For the Tobacco Habit

A sane, scientific Treatment based on the prescription of Dr. Keeley, who founded the famous Keeley Institute for liquor, drug and tobacco addicts more than 50 years ago. Quickly and completely banishes all craving for tobacco in any form. Contains no habit-forming drugs. No bad after-effects. Not a tobacco substitute. A wonderful tonic. Improves appetite and digestion.

Money-Back Guarantee If, after taking this Treatment according to directions you can honestly say you have not been benefited, we will refund your money.

MAIL COUPON for FREE BOOK which gives plain facts about the injurious effects of tobacco and tells how easy it is to quit with the aid of this remarkable treatment.

THE KEELEY INSTITUTE

Dept. P. M.-2 DWIGHT, ILL.

The Keeley Institute, Dept. P.M.-2, Dwight, Ill.

Send without obligation your free booklet telling how to rid myself of the tobacco habit.

Name

Address

Health and Strength Thru

Renulife

VIOLET RAY

Treatments at Home

Thousands of chronic sufferers have found new health, radiant vitality, energizing vigor with **Renulife**, the health-giving Violet Ray Generator that drives poison and waste tissue from your blood. Read what they say:

Crippled 14 Years

"Renulife Violet Ray has put me on my feet after being a cripple for 14 years. I had rheumatism from my hips down to my feet. Everyone is surprised how good I can walk now—thanks to the Renulife Generator."

Paralysis Victim

"I had an attack of paralysis and my entire left side was afflicted. It also left me with very little desire for food, therefore my strength wasted quickly, but after persistent application of your Violet Ray, I am gaining continually."

Didn't Know What a Night's Rest Was

"I had neuritis in both my arms and sciatica in my left limb, and suffered so much I didn't know what a night's rest was. After taking fifteen treatments with Renulife I sleep much better, and whereas my limb was so painful I could only sit for about fifteen minutes, now I can sit as long as I please."

Could Scarcely Breathe

"My son had Chronic Bronchial Asthma. Every time we had rainy or foggy weather these attacks came on. He could scarcely breathe. Since taking Renulife Ozone treatments he has had but one slight attack."

Free Book and Treatment Offer

Renulife operates from any light socket and is as gentle and soothing in its action as a ray of sunshine. You can easily give yourself health treatments with the Renulife Generator in your own home. Remember over 85,000 of these instruments are in use. *Renulife is a wonderful time-tested product backed by a rigid guarantee.* Prove this to your own satisfaction now by trying Renulife free in your own home! Make yourself the sole judge of Renulife merit.



Check any ailments on which you want information.

- | | | |
|--|------------------------------------|--|
| <input type="checkbox"/> Asthma | <input type="checkbox"/> Dandruff | <input type="checkbox"/> Nervousness |
| <input type="checkbox"/> Bad circulation | <input type="checkbox"/> Deafness | <input type="checkbox"/> Neuralgia |
| <input type="checkbox"/> Blackheads, | <input type="checkbox"/> Dyspepsia | <input type="checkbox"/> Neuritis |
| Pimples | <input type="checkbox"/> Eczema | <input type="checkbox"/> Prostatic Trouble |
| <input type="checkbox"/> Bronchitis | <input type="checkbox"/> Hay Fever | <input type="checkbox"/> Rheumatism |
| <input type="checkbox"/> Catarrh | <input type="checkbox"/> Insomnia | <input type="checkbox"/> Skin Disorders |
| <input type="checkbox"/> Colds | <input type="checkbox"/> Lumbago | <input type="checkbox"/> Sore throat |
| <input type="checkbox"/> Constipation | <input type="checkbox"/> Pain | <input type="checkbox"/> Sprains |

Any others? _____

RENULIFE ELECTRIC COMPANY
103 Renulife Building, Detroit, Michigan

Without obligation, please send me details of your **FREE TRIAL PLAN**, in accordance with your offer in Popular Mechanics.

Please send **FREE Book**.

Name _____ (Please Print)

Address _____

Town or City _____ State _____

AGENTS WANTED—Write to Salesmanager



Head Your Own BUSINESS

Make \$20 to \$40 a Day

No large capital needed

No Dull Seasons

Floor surfacing has grown to be a big business. It is clean—Healthy—Always inside. There are no dull seasons—It is independent of weather conditions. No large capital required—One man—One machine—\$20 to \$40 a day—And all the work you can possibly handle. Every private home, apartment, hotel, office building, bowling alley, dance floor—Every contractor, builder, master carpenter—They all need your service. Every new floor has to be surfaced—Thousands of old floors need resurfacing. The old hand scraping way is too slow—Too expensive.

The American Universal FLOOR SURFACING MACHINE

Electrically operated, does the work of six hand scrapers—Does it better and faster. It is a real opportunity for the man who wants a permanent, profitable, pleasant business of his own. No special training is required—The machine does the work. Become a floor surfacing contractor and get out of the uncertain poorly paid wage earning class. Write today for the American Universal Plan.

The American Floor Surfacing Machine Co.
515 So. St. Clair Street, Toledo, Ohio

The American Floor Surfacing Machine Co.,
515 So. St. Clair St., Toledo, Ohio

Please send me, without obligation on my part, full information about the "American Universal" Floor Surfacing Machine.

Name

Street

City..... State.....

\$10 a Day for You



Many making more while establishing a permanent business for themselves. Introduce our big line by giving a Carving Set FREE to each customer ordering our 11 Piece Toilet Goods Assortment at \$2.25. NO FANCY TALK. Experience unnecessary. Walter Harris

SOLD 800 IN 6 WEEKS—PROFIT OVER \$600

We will send sample outfit Post Paid for \$2 Deposit.

E. M. DAVIS COMPANY Dept. 5650 Chicago, Ill.

JUST OUT Shop Notes

479 Articles FOR 1927 374 Pictures

This announcement will be welcomed by thousands because they have learned that each yearly issue of Shop Notes contains dozens of short cuts that save time and money. Every article is written by some man who has tried the idea and found it worth money. The variety of subjects covered is one reason why so many buy Shop Notes each year. In many ways the 1927 issue surpasses previous numbers. The following brief list will give you an idea of the variety of subjects covered.

SOME OF THE SUBJECTS

- | | | | | | | | | | | | | | | | | | | | | | | | | | | | | | | | | | | | | | | | | | | | | | | | | | | |
|----------------|-------------------------|------------------|-----------------------|------------------|---------------------------|-------------------|--------------------------|---------------------------|----------------------|------------|----------------------|-------------------|-------|-----------------|------------------------|-----------------------|-------------------|-------------------|------------|-----------------|--------------------|------------------|-------------------|---------------|-------------------|----------------|---------------|----------------|------------------------|--------------------|----------------|-------------|---------------------|---------------------|------------------|-------------|----------------|----------|-------------------|-----------|---------|----------|----------------------|-----------------|-------------------------|-------------------|-------------------------|--------------|----------------------------|-----------|
| Auto Repairing | Battery Care and Repair | Lapping Bushings | Bracing Fence Corners | Novel Cab Stands | Cleaning Lantern Chimneys | Outside Hay Chute | Repairing Air Compressor | Durable Nests for Poultry | Boxes for Cream Cans | Shop Tools | Electrical Equipment | Homemade Elevator | Wings | Cleaning Enamel | Concrete Working Ideas | Carpenters' Shortcuts | Fitting Made Easy | Ventilation Flues | Tool Boxes | Printers' Helps | Making a Blowtorch | Garage Equipment | Irrigation Canals | Jewelry Kinks | Draftsman's Kinks | Lathe Operator | Electroplater | Cabinet Worker | Lumber Yard Management | Mechanical Drawing | Farmer's Helps | Micrometers | Sheet Metal Working | Painter's Equipment | Motorist's Helps | Storekeeper | Pattern Making | Drainage | Outdoor Air Press | Workbench | Welding | Plumbing | Using Spindle Drills | Making Grinders | Raising Vertical Piping | Cutting Wallboard | Rubber Stamp on Thimble | Pin Stamping | Service Station Attendance | Lettering |
|----------------|-------------------------|------------------|-----------------------|------------------|---------------------------|-------------------|--------------------------|---------------------------|----------------------|------------|----------------------|-------------------|-------|-----------------|------------------------|-----------------------|-------------------|-------------------|------------|-----------------|--------------------|------------------|-------------------|---------------|-------------------|----------------|---------------|----------------|------------------------|--------------------|----------------|-------------|---------------------|---------------------|------------------|-------------|----------------|----------|-------------------|-----------|---------|----------|----------------------|-----------------|-------------------------|-------------------|-------------------------|--------------|----------------------------|-----------|

6,000 Ideas on All Shop Work

There are now 16 volumes of Shop Notes available. And this unrivaled library of shop helps may be had for a special price of \$7.50. If you do not have the back numbers of Shop Notes, you should purchase the entire library. The following are now available:

- 1908, 1912, 1913, 1914, 1915, 1916, 1917, 1919
1920, 1921, 1922, 1923, 1924, 1925, 1926, 1927

Amateur's Guide PROFESSIONAL'S HANDBOOK

Both amateurs and professionals find Shop Notes of wonderful value. The articles are so clearly written and so thoroughly illustrated that even a boy can follow them. Teachers of Manual Training should have the complete library.

SEND NO MONEY

Don't send a penny. Just fill in the coupon with your name and complete address, indicate whether you want the whole library or the special offer of 1927 Shop Notes and Lathe Handbook for 98 cents. When the books are delivered to you, pay the postage and deposit price of books with postman.

SPECIAL OFFER COUPON

POPULAR MECHANICS PRESS,
200 E. Ontario St., Room 712, Chicago, Ill.

Send me, as per your special offer the following books. I will pay postage and the price of books when they arrive. My money will be refunded if I am not satisfied. (Check what you want.)

- 1927 Shop Notes and Lathe Handbook, 98 cents Complete Shop Notes Library (16 vols.) \$7.50

Name.....

City..... State.....

Street and No.....

Big Money Repairing Balloon Tires This Easy Way



Go into business for yourself. Become independent, well-to-do. Take advantage of tremendous revival in tire repair business. Millions of balloon tires in use now need repairs.

An easy way to make money. Small capital. No experience is needed. Plenty of jobs. Every motorist a prospect.

SHALER

Balloon Tire Vulcanizer

Lowest priced complete tire repair plant. Repairs fabrics, cord and balloon tires. Does just as good work as high priced machines. Anyone can operate it. Made by world's largest manufacturers of tire vulcanizers. Endorsed by leading tire makers and used by hundreds of repair shops. Guaranteed to do first class work.

FREE ON TIRE REPAIRING. BOOK Tells how to make big money and become established in business of your own. **WRITE QUICK!**

C. A. SHALER CO., 2702 Fourth St., Waupun, Wis., U.S.A.
World's Headquarters for Tire Repair Equipment

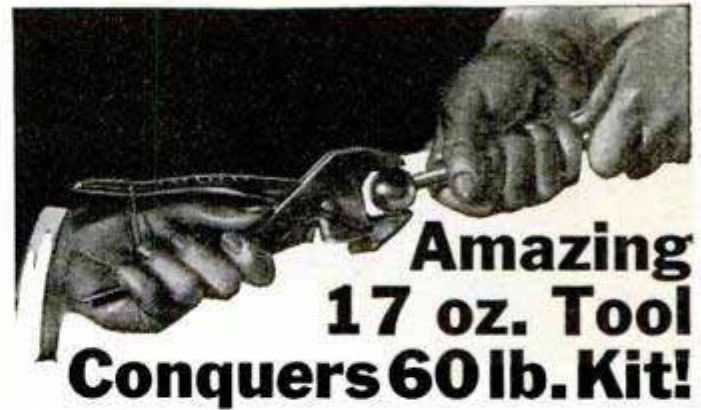

Amazing 17 oz. Tool Conquers 60 lb. Kit!

One of the most revolutionary tools ever invented! Does all work of other tools costing \$50 and more! And yet so light, and easy to handle—a tool of 1,000 uses. Just the "hand-grip" of a plain rubber band holds a hard bearing ball—the hardest to hold thing known—against a 300-pound pull!

A Grip That Force of a Ton Can't Break

No wonder the Buick Motor Company bought more than 1,000 of this amazing new tool. Flint Automobile Company and thousands of other big factories have adopted it. Thousands of housewives use it, too. It's so simple, it does so many amazing things. Every auto owner needs it. Every mechanic. It was equipment for the U. S. World Flight. Creates a sensation everywhere. Just its amazing 1-ton grip makes it worth ten times its cost.

The amazing Eifel-Flash Plier-Wrench is a true ratchet speed WRENCH that automatically locks its death grip jaws on the smoothest chewed up nut and won't let go. Will remove broken studs, taps, drills, etc., with ease. Actu-

ally outgrips a 40-lb. vise and applies 1-ton grip at jaw tips. Yet a grip so fine that you easily can make a coil spring with hair-fine piano wire! At last a light, easily carried kit that replaces 20 or more tools—one tool to do all jobs requiring 20 other tools, and many none of the 20 can do.

AGENTS \$200 a Week

PLIERENCH representative* earn amazing incomes demonstrating this wonderful new tool! One man alone sold nearly 10,000 in just one state. Fastest seller known. Factories buy by hundreds. Every auto owner and home buys. We have wonderful special proposition to agents. Mail coupon for full details. Why not earn \$75 to \$200 and more a week, spare or full time?

FREE!

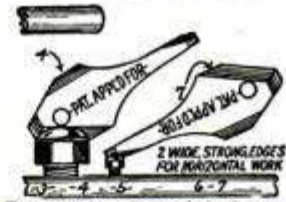

Every person who sends in the coupon below will receive absolutely FREE our wonderful E-F Angle Screwdriver—The World's Greatest Small Tool. Fits key rings, keychain or vest pocket, and does all work of other screwdrivers as well as removing bottle caps and corks, and hundreds of other things. Yours FREE without obligation.

ABSOLUTELY GUARANTEED

The Eifel PlierWrench is positively guaranteed. Thousands and thousands of mechanics and great factories have tested it under most trying conditions. They found it does amazing things. "Rather use it than my entire \$100 tool kit." is the way they write. If you, too, are not delighted after thorough test, your money will be returned fast as mails can carry it.

10 DAYS FREE TRIAL - MONEY BACK IF NOT SATISFIED

THE NEW **INKOGRAPH** SELF FILLER
IMPROVED GREATEST VALUE EVER OFFERED

The Perfect Writing Instrument

Writes with ink easy as a lead pencil. Won't skip, blot, scratch, leak or soil hands. Irresistible uniform flow of ink improves handwriting.

Makes three carbon copies with original in ink. Guaranteed—Send No Money. Pay postman \$1.50 plus postage.

INKOGRAPH, CO., Inc.
193-71 Centre St., New York City

Actual size 6 in.

DEALERS
Send for Catalog

By Writing HOMEWASTE

The **INKOGRAPH** ACCORDION EXPANSION

A hard, round, smooth ball-like 14-kt. Gold Point.

AGENTS Send for Inkograph or write for Sales plan booklet which tells how to make big money

\$69²⁵
CASH

Electrify Your Shoe Shining Stand

Give a better shine in half the time. We also make complete stands, with power brushes, folding footrests, automatic counter and many other features. Time payments if desired.

HASTY & JOHNSON, ELGIN, ILL.

Special Introductory Price Only \$3⁶⁵

Thousands pay regular price of \$5 for this amazing tool. For wider introduction your special price is only \$3.65—If you act at once. Remember, you take no risk. Your money instantly returned if not satisfied. Send no money now. Merely pay postman \$3.65 for complete kit, containing two extra instantly changeable jaws for pipe WRENCH and chain tool work, in handy holster for easy carrying. Also Free, a wonderful \$10,000 Manual of Mechanics every worker with tools needs. Act today. Get this tool at this amazing low price.

THE FLASH SALES CORP'N

Dept. BP-4809, N. Ashland Ave., Chicago, Ill.

(Show with "X" number desired)

Flash Sales Corp., Dept. BP-4809 N. Ashland Ave., Chicago, Ill.

1. Send me rush your amazing new Eifel-Flash PlierWrench KIT. I will pay postman \$3.65 on arrival. It is understood I may return Kit and get my money back, if not delighted.
2. Send me user literature.
3. Am interested in Salesman's Big Proposition.

Name.....
Route No., Street.....
P. O. City.....State.....





"How I Licked Wretched Old Age at 63"

"I Quit Getting up Nights—Banished Foot and Leg Pains . . . Got Rid of Rheumatic Pains and Constipation . . . Improved Embarrassing Health Faults . . . Found Renewed Vitality."

"At 61, I thought I was through. I blamed old age, but it never occurred to me to actually fight back. I was only half-living, getting up nights . . . embarrassed in my own home . . . constipated . . . constantly tormented by aches and pains. At 62 my condition became almost intolerable. I had about given up hope when a doctor recommended your treatment. Then at 63, it seemed that I shook off 20 years almost overnight."

Forty—The Danger Age

These are the facts, just as I learned them. In 65% of all men, the vital prostate gland slows up soon after 40. No pain is experienced, but as this distressing condition continues, sciatica, backache, severe bladder weakness, constipation, etc., often develop.

Prostate Trouble

These are frequently the signs of prostate trouble. Now thousands suffer these handicaps needlessly! For a prominent American Scientist after seven years of research, discovered a new, safe way to stimulate the prostate gland to normal health and activity in many cases. This new hygiene is worthy to be called a notable achievement of the age.

A National Institution for Men Past 40

Its success has been startling, its growth rapid. This new hygiene is rapidly gaining in national prominence. The institution in Steubenville has now reached large proportions. Scores and even hundreds of letters pour in every day, and in many cases reported results have been little short of amazing. In case after case, men have reported that they have felt ten years younger in six days. Now physicians in every part of the country are using and recommending this treatment.

Quick as is the response to this new hygiene, it is actually a pleasant, natural relaxation, involving no drugs, medicine, or electric rays whatever. The scientist explains this discovery and tells why many men are old at forty in a new book now sent free, in 24-page, illustrated form. Send for it. Every man past forty should know the true meaning of those frank facts. No cost or obligation is incurred. But act at once before this free edition is exhausted. Simply fill in your name below, tear off and mail.



THE ELECTRO THERMAL COMPANY

2166 Main Street Steubenville, Ohio

THE ELECTRO THERMAL CO.,
2166 Main Street, Steubenville, Ohio.

Name

Address

City State

Western address: Suite 21-J, 303 Van Nuys Bldg.,
Los Angeles, Calif.

Famous
MARWOOD
Now
Sold on



Easy Terms

1 Dial
6 Tube
\$43⁸⁵

Get Agents Price-Save 50%

Great news! Now own a famous Marwood at the world's lowest price for real quality—and pay on easy terms. The only Radio sold direct on easy terms—proof that the Marwood MUST be a wonder. A year ahead with 4 big exclusive improvements—Super-Selectivity, Power-Tube Volume, New Easy-Tuning Principle, New Tone Quality. Save half—and get a Radio that can't be best at ANY price. It's a beauty—figures etched in gold.

Both Models
Shipped
**Complete
With All
Accessories**

30 Days Free Trial

We trust you. Prove the Marwood the best buy in America. Don't buy a Radio till you get our easy terms, 30 Days' Free Trial. Agent's Confidential Low Prices, Free Radio plan, new Catalog, Agents—Write quick for territory. Make big, easy spare-time money.

6 Tube
3 Dial
\$36⁸⁵

MARWOOD RADIO CORPORATION
1747—856 Morse Ave., Chicago, Ill.



American Poultry Journal

Oldest, Largest and Best

9 MONTHS' TRIAL 25 cts.

1 Year 50c 3 Years \$1 5 Years \$1.50

Averages over 100 pages per issue—tells how to feed, house and breed; how to secure high egg production; how to hatch and rear poultry successfully. Established 1874. Only 25c for 9 mos. Stamps accepted.

American Poultry Journal, 14-523 Plymouth Court, Chicago

Per Chick Hatched "SUCCESSFUL" Is Cheapest To Buy



Mail a postal—Get our offer. Poultry lessons free to every buyer. Eastern customers will be served quickly from our Eastern Warehouse. Catalog FREE. Make green, egg-making feed in "SUCCESSFUL" Grain Sprouters.

34 Years of Big Success
Des Moines Incubator Co., 689 Second St., Des Moines, Iowa

FREE Book HOW TO FEED AND CARE FOR CHICKS

Gives Money Making Secrets of Poultry Raising. Tells how to hatch, care for and feed chicks until fully grown. Gives plan of Poultry and Brooder Houses. Describes Miller's "IDEAL" INCUBATORS with Patented Egg Turning Trays. Oil and Coal Burning BROODERS. Eggs for hatching—Baby Chicks—BARGAIN PRICES. WRITE TODAY!
J. W. MILLER CO., Box 12, Rockford, Ill.



FOY'S BIG BOOK, in Colors

A complete guide to successful Poultry and Squab Raising. Low prices on CHICKS, Breeding Stock and PIGEONS.

Write Today! FREE!
FRANK FOY, Box 18, Clinton, Iowa



PLANS for Poultry Houses

All styles, 150 illustrations; secret of getting winter eggs, and copy of "The Full Egg Basket." Send 25 cents.
INLAND POULTRY JOURNAL, Dept. 74, Indianapolis, Ind.



68 BREEDS Valuable New Poultry Book Free—100 Pages.

Fine Pure-bred Northern raised chickens, ducks, geese, turkeys, eggs, baby chicks, incubators & brooders at lowest prices. America's great industry. My 45th year.
W. A. Weber, Box 28, Mankato, Minn.



64 BREEDS Most Profitable chickens, ducks, turkeys and geese.

Choice, pure-bred northern raised. Fowls, eggs and incubators at low prices. America's great poultry farm. At it 34 yrs. Valuable 100-page book and catalog free.
R. F. Neubert Co., Box 908, Mankato, Minn.

Turn Your Ideas Into Profits

Whether you are interested in light manufacturing, repairing or experimental work; whether you are a mechanic, engineer, amateur, or student; whether you work in wood or metal, your ideas can be turned into profits with accuracy, speed and economy on

The *Baby Grand* Lathe

A sturdy, practical lathe of small size, high quality and at low price. Operation same as large lathes. Made of selected materials by skilled machinists who specialize on lathe building. Quantity production explains the low price. Not a toy but a practical machine for all small work. Hundreds in use in shops large and small the country over. Sold direct from factory to you on positive money-back guarantee. We also make Bench Drills and Grinders.



The Watson Mfg. Co.

102 Watson Bldg., Toledo, Ohio, U. S. A.

Write today for illustrated folds giving complete description and prices.

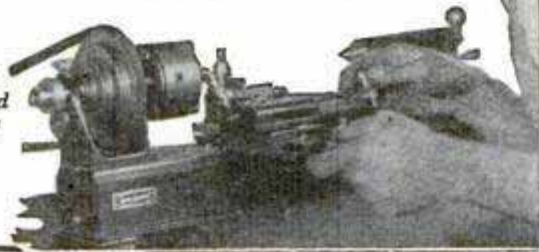

Have New Hair or Pay Nothing



At last a home method endorsed by science. *Marvelous Infra-Red Rays* simply applied

Dandruff, falling hair ended. Scalp tissues given new life. Then, within 30 days, luxuriant new hair! This is the amazing discovery of a noted surgeon. Once himself

bald, his hair is now full and thick.

Famous Surgeon's Discovery

Here is his own personal treatment, called Dermo Ray. Guaranteed to bring you these same results in 30 days or you don't pay a cent. You can use Dermo Ray in any home with electricity. The first easy home method scientifically correct!

These Facts Proven FREE

Full facts, opinions of authorities, and details of special trial offer sent free, if you mail special coupon below. To end your scalp and hair troubles, act at once. Print name and address clearly.

FREE TRIAL OFFER

The Larson Institute, Dept. 9,
6 N. Michigan Ave., Chicago, Ill.

Gentlemen: Send me at once without obligation full particulars—in plain envelope, about 30-day free trial of Dermo-Ray.

Name

Address

City..... State.....

TYPEWRITER PRICES CUT

Your Choice \$2⁰⁰ DOWN



Your choice of world's best typewriters; late models, visible writer; standard keyboard; 84 characters; 2-color ribbon. Low price.

Famous No 5 Underwood \$35¹⁰ SAVE



Self-starter, visible writer, universal keyboard with 84 characters, back spacer, automatic ribbon reverse, shift lock key, 2-color ribbon, marginal stops, variable platen for writing on ruled paper. Exceptional offer.

Standard No 10 Remington \$42¹⁰ SAVE

Very latest model, contains 2-color ribbon, full standard keyboard, 84 characters, back spacer and automatic ribbon reverse. Specially adapted for correspondence, card writing and statement work. Priced at a big saving.



Famous No 10 Royal \$42¹⁰ SAVE



Up-to-date improvements and attachments. Visible writer, universal standard keyboard, 84 characters, 2-color ribbon, back spacer, shift lock key, variable platen, inbuilt tabulator, easy and fast in operation. A bargain at this great saving.

Visible No 8 L.C. Smith \$42¹⁰ SAVE

10 Days' Free Trial All late models, completely rebuilt and refinished brand new. Guaranteed 10 years. Just send for our big Free catalog showing actual machines in full colors. Also our direct-to-you easy payment plan and special 10-day Free trial offer. No obligation. Write today.

INTERNATIONAL TYPEWRITER EXCHANGE
184 West Lake Street Dept. 294 Chicago, Ill.

INTERNATIONAL TYPEWRITER EXCHANGE
184 W. Lake Street, Dept. 294, Chicago, Ill.
Please send FREE your catalog showing each machine in full colors, also your special Free Course in Touch Typewriting offer. This is no obligation on my part whatever.

Name.....

Address.....

Town..... State.....

Make FURNITURE at Home

You Can Do It in Spare Time—It's Easy

THE simple designs in furniture are, after all, the most attractive. And the best of the easily-made styles have been gathered into "Popular Mechanics Furniture-Making Books." These books are filled with pictures that show you how the finished piece looks, and how to lay out, saw, and put together the various parts. You are also told how to finish your furniture in the most attractive ways. Nowhere else will you find instructions more clear. Nowhere else will you find such a marvelous assortment of simple designs to select from. Think of it! 142 different designs, including all the pieces of furniture and the different styles of lamps you need to make your home a pleasant place to live.

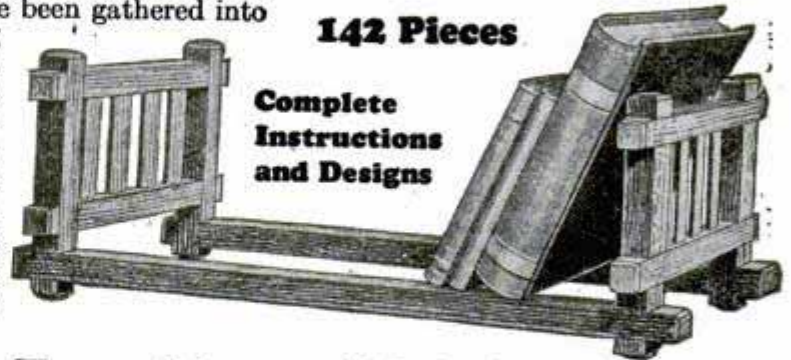

142 Pieces

Complete Instructions and Designs

Popular Mechanics Furniture-Making Books

Tell How to Make These 142 Pieces of Furniture and Lamps

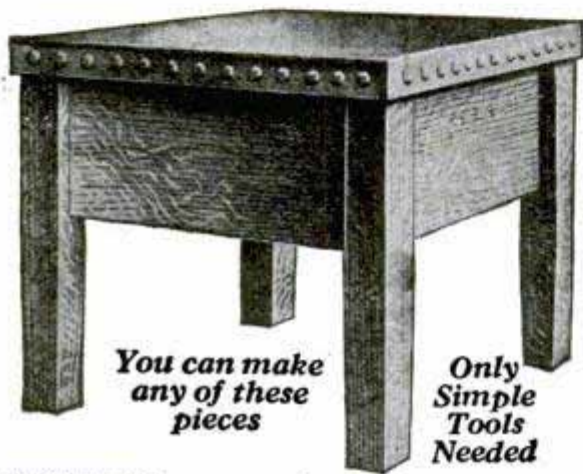

You can make any of these pieces

Only Simple Tools Needed

- Settee
- The fuming of oak
- How to make black wax
- 40 styles of chairs, beginning with the Egyptian style made 500 years before Christ
- Piano bench
- A shaving stand
- A waste paper basket
- A cellorette pedestal
- A princess dresser
- A sideboard
- A window seat
- A plant stand
- A bedside medicine stand
- A hall chair
- A side chair
- An arm chair
- A book case
- A lamp stand
- Extension dining table
- An oak-bound cedar chest

- A dresser for child's playroom
- Arts and crafts oil lamp
- China closet
- An oak bedstead
- A footstool
- A library set in pyro-carving
- A grille with pedestals to match
- A lady's writing desk
- A telephone stand and stool
- An oak medicine cabinet
- Home-made mission chair
- A lamp stand and shade
- A porch chair
- A chair
- A morris chair
- A mission book rack
- A substantial library table
- A mission candlestick
- A low-back mission chair
- A magazine stand
- A lawn swing
- A portable table
- A combination billiard table and davenport

- Easily made book shelves
- A blacking case tabouret
- A Roman chair
- A roll top desk
- A pyrographer's table
- A piano bench
- A library table
- A princess dresser
- A sewing box
- A fern stand
- A wardrobe
- An oak table
- A book trough
- An oak serving table
- An umbrella stand
- A shaving-dish buffet
- A writing desk
- A music rack and book stand
- A dictionary and magazine stand
- A leather back arm chair
- A wall shelf
- A pedestal
- A magazine rack
- A hall tree

- One-light portable lamp
- Two-light portable lamp
- Four-light chandelier
- Dining-room dome
- Reading lamp
- Parlor or den lantern
- Lantern
- One-light portable
- Shade for droplight
- Four-light chandelier
- One-light bracket
- Piano lamp
- Newel post lamp
- Electric candle sconce
- One-light bracket
- Droplights
- Reading lamp No. 1
- Reading lamp No. 2
- Square dining-room dome
- Mission chandelier
- Desk light
- Droplight No. 3
- Chandelier
- Hexagonal library lamp
- Hexagonal dome
- Lamp No. 1
- Lamp No. 2
- Lamp No. 3
- Lamp No. 4
- Conventional patterns
- The butterfly design
- The pyramid design
- An oak buffet
- Oak stain
- A plain oak hall clock
- A rocking chair

- A curved back arm chair
- A plate rack
- A tool for marking dowel holes
- A magazine table
- A waste paper basket
- A writing desk
- A couch with cushions
- Shade for dining room
- How to bend wood
- A smoking stand
- A china closet
- A leather-covered footstool
- Arts-craft mantel clock
- A music stand
- Wall case with mirror
- A table for the den
- A burlap-covered seat
- A quarter-sawed oak settee
- A screen
- A mission book rack
- A round extension table
- An arm dining chair
- A hall bench
- A sewing table
- A side chair
- Another piano bench
- Another screen
- A folding card table
- A magazine stand
- A tabouret
- A porch swing
- A foot warmer
- Plate rack
- A mission sideboard

IDEAL BOOKS For Manual Training Courses

Men and boys, alike, find these books to be marvels of simplicity and fascination. Boys just starting manual training courses, will find in these books instructions and designs that will make their work both interesting and profitable, for the pieces so clearly described may be readily sold at a good profit.

33 Lamps to Choose From



Save Half the Cost of Furnishing Your Home

It's Fun to Make Things. It's Profitable to Make Furniture and Lamps

This valuable set known as "Popular Mechanics Furniture-Making Books," includes the five volumes of which thousands have been sold:

1. Mission Furniture and How to Make It, Book 1
2. Mission Furniture and How to Make It, Book 2
3. Mission Furniture and How to Make It, Book 3
4. Lamps and Shades in Metal and Art Glass
5. Arts-Crafts Lamps and How to Make Them

Send No Money

Don't send a penny (if you live in the U. S.). We want you to have these valuable books in your hands before you make any deposit. When the postman hands them to you, pay the postage, and deposit \$4.95 for the five books. If you are not delighted with your purchase, we will promptly refund the entire purchase price. Nothing could be fairer than that. Just write a postal and say, "Send me the Popular Mechanics Furniture Making Books." Single books, \$1 each.

POPULAR MECHANICS PRESS
Room 102, 200 East Ontario St., Chicago

EDWARDS WILL SAVE YOU MONEY ON METAL ROOFS

We own our own steel mills, roll our own sheets, make them into high-grade REO METAL SHINGLES, Sidings, Ceilings and Roofings of every type and style for every kind of building. We control every operation from the raw material to the finished roof and we sell direct from our factories to the user. Not a dollar to divide with anybody but the customer! You get better value for less money.

OUTLAST THREE ORDINARY ROOFS

EDWARDS METAL ROOFS are weather-proof, lightning-proof, fire-proof! The galvanizing bends with the metal. No tools required.

LOW-COST ALL-METAL GARAGES

Any size. Any style. Portable. Ready to erect. Complete with frames, doors, sash and hardware. Ornamental and durable, economical. Blue-prints and complete instructions FREE.

Write today. Get our low prices and Free Samples. Ask for Roofing Book No. 150 or for Garage Book No. 150

THE EDWARDS MFG. CO.
200-250 Butler St. Cincinnati, O.



THE WOTEN GASOLINE ENGINE

Air-cooled—Water-cooled. One H. P. in 20 pounds. Handiest little engine ever made. Ideal wherever power is needed. Also the Metalum Model Airplane Engine, one-half H. P. in 3½ pounds. The market demands them in thousands. Generous agency propositions on request. Complete line of small gasoline and steam engines, battery chargers, etc. Catalogue Free.



DYNAMIC MANUFACTURING CO.
First Nat'l Bank Bldg., Dept. 7, CHICAGO

Start "Part time"

Earn an extra \$10—\$25 (or even \$30—\$40) weekly using spare time to take orders—proven method—for Emerson Master Built Tailoring, honestly powerful values at popular prices. With this trial to

Prove it a Moneymaker

You lay the foundation for a big clean business, a satisfying income! Your customers come back for more of our wholesale values plus square-deal service. No experience needed. No money risk. I coach and help you to

Become Independent

Our Master-Agency Plan soon builds you \$200 monthly income. Free advertising helps, fine leads, etc. WIN with the Emerson Master Built Tailoring—Fully Guaranteed and Backed Up—\$23.50, \$28.50, \$36.50, \$42.50. \$4 to \$7 commissions. Write for agency and free selling outfit. Tell all about yourself. Name 3 references. E. E. OPLINGER, Gen. Mgr.

Emerson Wholesale Tailors

Dept. 1000, 635-637 Arch St., Philadelphia, Pa.

Grab This New

Live Seller Quick



Amazing New Invention!

EVER since I got stuck in mud up to the axles about a year ago and paid \$25 for towing, I have been experimenting in the perfection of a device which could be quickly locked on the rear wheels to afford powerful traction sufficient to force any car or truck out of mud, sand or snow. The result is my patented

Gets-U-Out Pressed Steel Tire Lug (Patented—Nothing Like It)

It Gets You Out of Mud, Sand, Snow

Two on each rear wheel does the trick in a jiffy. And it's so simple to slip them on and off, a woman driver can do it easily. Sturdy construction, with nothing to get out of order, my Lugs will last for years. On the market only 30 days, yet hundreds of car owners are already using them successfully.

J. J. Andrest, of Minnesota, says:

"Your Lugs have never failed to pull my heavy 2-ton truck out of deep mud, sand or snow."

\$75 to \$150 Weekly Easy

I don't care if you've never sold before, you'll positively coin money—full or spare time—with this new, year 'round specialty. And it isn't necessary for you to spend your bank roll either. Sells in Sets of 4 at a low price, with 100% profit to you. Every car owner buys.

FREE SAMPLE OFFER

Just clip and mail the FREE OFFER COUPON—NOW—and cinch your territory on this whirlwind seller. Act quick.

ART BENSON, Gen. Mgr.
Chicago Tire Lug Company

750-338 W. 47th St.
CHICAGO, ILL.

Guarantee

I hereby agree to refund the full purchase price if my LUGS fail to force any car or truck from mud, sand or snow.

ART BENSON

Art Benson, Gen. Mgr., CHICAGO TIRE LUG CO., 750-338 W. 47th St. CHICAGO, ILL.

I want to get my share of the big money to be made with your new GETS-U-OUT PRESSED STEEL TIRE LUG. Send me the facts without obligation about my profit and your FREE SAMPLE OFFER.

Name.....
Address.....
City..... State.....

FREE OFFER COUPON—MAIL NOW

You Can Do It With a Boice and Save Money, Time and Labor

Boice-Crane Bench Machines are the most economical machines you can buy. They save you money on first cost, require little power and last a lifetime. Practical, amazingly efficient and speedy.



8" Bench Lathe

Does turning, drilling, sawing, sanding, grinding and jig sawing in wood or soft metal. Swings 8". Capacity 19" C. to C.

4" Bench Jointer

Tables 36" long. Safety head with knives 4 1/2" wide. Ball bearings. Fence tilts 45 degrees both ways. Cuts mouldings.



14" Band Saw

Table 12"x14" tilts 45 degrees. 14" wheels. Saws 7" stock. Uses blades 3/16" to 1/2" wide. Bronze bearings throughout.

Send 10c for new 1927 catalog showing these and other Boice-Crane Bench Machines.

Send today, NOW!

Handisaw Model 2

Does ripping, mitering, grooving, sanding, grinding and drilling with ease and accuracy. Table 10"x13". Saw 7" diameter. Cuts 2 1/8" stock. Dadoes 5/8"x5/8". Cuts mouldings.

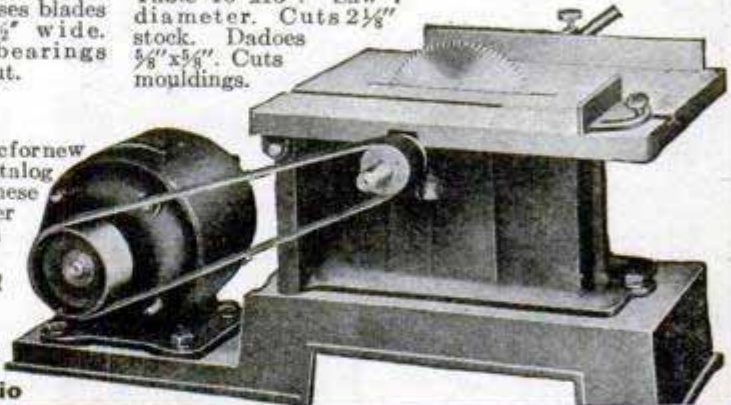

W. B. & J. E. Boice

Dept. P.M.2-C Toledo, Ohio

A Genuine \$2 Knife for \$1.18 Postpaid
Handy shaped blade makes this knife best for mechanics, sportsmen and farmers; light but strong; re-sharpened easily. Stag handle. German silver finish; blades file tested, hand forged from razor steel and warranted.

Direct at Factory Prices
Sample \$1.18 3 for \$3.00 Postpaid
Hand Forged Razor Steel Blades
Send for our 100-page FREE List and "HOW TO USE A RAZOR."
Maher & Grosh Co.
106 A St., Toledo, Ohio

New Improved SPORS Fountain Pen. 60 Day Trial. Money back if not pleased

Agents' Sample **65c** Sells for \$1.25. Writes like a \$7 Pen
Make \$10 Daily Easily

Comes in Red or Green
GUARANTEED 2 YEARS
Improved Point

FREE
New and unusual Mail Order Distributing Plans and Large Wholesale Specialty Catalog showing best sellers from all parts of the world.
F. SPORS CO., LESUEUR CENTER, MINN.

KRAG CARBINE STYLE

22 inch Barrel, 5 shot Box Magazine. The choice of hundreds of Big Game Hunters. Barrel slightly used and refinished, other parts NEW. First class serviceable condition. Shipping weight, 13 lbs.
Krag Bayonets 40 cents each. Postage Extra—Shipping Weight 2 1/2 lbs.
Terms Strictly Cash. No C. O. D. Shipments.
Catalogue Free on Request

PRICE F.O.B. \$15

W. STOKES KIRK, 1627-P. M., North 10th St., Phila., Pa.

BIG VALUE FOR 10 CTS.

6 songs, words and music; 25 Pictures Pretty Girls; 40 Ways to Make Money; 1 Joke Book; 1 Book on Love; 1 Magic Book; 1 Book Letter Writing; 1 Dream Book and Fortune Teller; 1 Cook Book; 1 Base Ball Book, gives rules for games; 1 Toy Maker Book; Language of Flowers; 1 Morse Telegraph Alphabet; 12 Chemical Experiments; Magic Age Table; Great North Pole Game; 100 Conundrums; 3 Puzzles; 12 Games; 30 Verses for Autograph Albums. All the above by mail for 10 cents, and 2 cents postage.

ROYAL SALES CO., Desk 318, Norwalk, Conn.

Win \$3500.00 Find the Twin Bags!

Here's a—NEW—puzzle. If you're a puzzle fan—CAN YOU FIND THE TWIN BAGS? NO, they're not all alike—even though they look alike. Only two of these bags are identical in every way. Some have the \$ sign, others not; some have one line under penny ciphers, some two lines, some have commas between the 3 and 5, some have two tie strings, some none, some one string out to left, others to right. Each one is different from the rest except two—find them—mark them with a cross—send your answer. \$3000.00 first prize—399 others, and duplicate prizes in case of ties. If you find the twin bags I will give you 8000 points toward first prize and tell you how to get additional easy 1000 points that wins—only 9000 points wins the \$3000.00. \$500.00 Extra for Promptness—making total first prize YOU CAN WIN \$3500.00. SEND NO MONEY—nothing to buy now or ever—just find the twin bags—mark them and answer today.

F. G. STAYTON, Advertising Manager, Room 124 54 West Illinois Street, Chicago, Ill.



FREE

Use of Land

For One Year

Then 34 Years to Pay

READ this amazing farm offer. Rich fertile land, some of the finest in the world at an average of \$15 an acre—pay 7% down then use it a year, free of charge. Then 34 years to pay.

Low interest—low taxes—no taxes on improvements, buildings, machinery, live stock or personal effects—big yields—that is the secret of the success of Canadian farmers. Many are rich—all are prosperous. You can be, too. Come—see for yourself the chances to become independent—wealthy. Stock, grain, hogs, dairy and mixed farming all thrive here. Western Canada won the Grand Championship of both wheat and oats at the Grain and Hay Show of the 1926 International Live Stock Exposition. You can succeed, too.

Stop Paying the Penalty of High Priced Land

Come, help us bring man power to Canada's fertile acres. We want business-like farmers to build the country. This big railroad offers every inducement.

Good markets, modern schools, roads, churches and amusements make life here desirable—attractive. Thousands of American farmers are prospering here. Don't pour your profits into high priced land. Come to Western Canada.

IRRIGATED FARMS, TOO

In Sunny Southern Alberta we offer irrigable farms that produce wealth in coarse grains, alfalfa, sugar beets, pasture, etc. These lands for sale on the same amazing terms.



You Cannot Buy Until You Investigate

Inspect the land before buying. Special low-priced inspection trips are arranged. Mail the coupon for full information—no obligation.

C. A. VAN SCOY
Supt. of Colonization, Dept. 502
Canadian Pacific Ry. Depot
Winnipeg, Canada



The farm home of J. S. Samis

Read What These Farmers Say:

I started with \$600—now I have 960 acres improved, stocked and paid for.
J. S. Samis, Alberta

Come here and give your children a chance to do well; own your own home and prosper.

Mrs. L. F. Pinkerton, Alberta, Canada

I farm 960 acres; raise thoroughbred hogs and cattle. Raised 19,000 bushels of wheat, oats and barley this year. Come to Canada.
F. J. McLoy

C. A. Van Scoy, Supt. of Colonization
Dept. 502, Canadian Pacific Ry. Depot
Winnipeg, Man., Canada

I am interested in learning more about:

- Prairie Provinces of Canada
 Irrigation Farming in Sunny Alberta
 Business and Industrial Opportunities in Western Canada.

My Name.....

Address.....

Town.....State.....

BOOKS ON ALL SUBJECTS

ARE SOLD BY
POPULAR MECHANICS PRESS
200 E. Ontario St., Chicago, Ill.

It's Fun to Make Things of Wood

Our book tells you how to use tools, how to care for them, how to figure a lumber bill, how to make bird box, taboret, umbrella stand, magazine stand, table and cabinet. Many pictures. **Send no money.** Just ask for "Woodworking for Amateur Craftsmen." Pay postman 98c and postage.

Popular Mechanics Press, Room 710, 200 E. Ontario St., Chicago, Ill.

The Man Gets Ahead Who Studies

Popular Mechanics Press will advise you what books to read to advance in your trade
200 EAST ONTARIO STREET, CHICAGO, ILL.



BOW LEGS?

OUR GARTER (Pat'd)
Makes Trousers Hang Straight

If Legs Bend In or Out. Self Adjustable.
Free Booklet—Plain Sealed Envelope

THE T. GARTER CO. Dept. 2, New London, New Hampshire

"I Made \$3,000 in 3 Months from the New Food Sensation Greaseless Doughnuts"

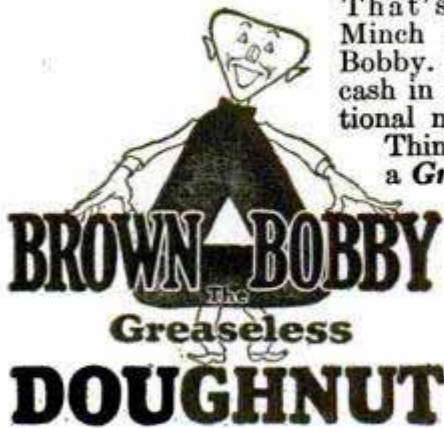

That's what Thomas Minch did with Brown Bobby. You, too, can cash in big on this sensational new food product. Think of it! Actually a **Greaseless Doughnut!**

Mrs. Nelson, Rockford, Ill., makes Brown Bobbys at home. "Sold 90 doz. last week. Will sell 3 times that many this week. Wonderfully easy."

Fair Store, Chicago, says: "It's a great money-making device." "The demand for Brown Bobby is beyond my wildest expectations," writes Jas. O'Connor, Chicago.

So it goes everywhere. Investigate!

Big Profits for YOU!

Millions of greasy doughnuts are sold daily, hard as they are to digest. What a mammoth market for Brown Bobby! Cooked without a trace of grease to a golden brown—crisped to a feathery lightness—Brown Bobby is positively the food sensation of the age. No one thought a doughnut could be made without grease. But WE did it. And YOU can get in on the first easy profits.

Simple, Easy and Sure

Get this! With one simple, inexpensive, electrically operated machine, you can turn out a full dozen Brown Bobbys every 3 minutes—cost, less than 1c each. No baking skill required. Just add water to our patented "Mix." No bother. No boiling grease. No odor. A child can do it. Big money for women making Brown Bobbys at home. Tremendous opportunities in every town for a thriving business on a surprisingly small investment. Wherever there are hungry people, Brown Bobby is a sure hit. In lunch rooms, drug stores, wherever food is sold Brown Bobby offers a chance for amazing profits. Special openings for Brown Bobby Specialty Doughnut Shops in every town.

Write Quick! Be the first in your locality to get the first easy profits. Whatever your present line-up, let us present you a plan that will be feasible and full of opportunity for a steady, paying business. Just mail the coupon! Get the facts now. Profits are waiting.

FOOD DISPLAY MACHINE CORP.

28 E. Jackson Blvd., CHICAGO, ILL.

Food Display Machine Corp., Dept. 13-52
28 East Jackson Blvd., Chicago, Ill.

Gentlemen: Please send me the plan by which I can cash in on Brown Bobby, the Greaseless Doughnut. It is understood that this obligates me in no way whatever.

Name.....

Street.....

City..... State.....

What \$1 Will Do!

Yes, only \$1 will bring your choice of these Big Bargains for your approval and 15 DAY TRIAL. Simply pin \$1 bill to this ad, indicate your selection and mail it TODAY. If you can duplicate your selection for less money elsewhere, send it back and your \$1 will be refunded. If satisfied, pay balance in 10 equal monthly payments. NO RED TAPE—PROMPT DELIVERY. DEALINGS CONFIDENTIAL.

B80--Ladies 18K White Gold Ring; beautiful design. AA 1 Blue-white Diamond. \$50 \$4.90 a Month.

B81--Ladies hand-engraved 18K White Gold Birthstone Ring set with 2 Blue-white Diamonds. Any birthstone furnished. \$25. \$2.40 a Month.

B82--Ladies hand-carved 18K White Gold ring, with 2 Blue-white Diamonds. \$45. \$4.40 a month.

B83--Gents 14K Solid Gold hand-engraved Ring with AA 1 Blue-white Diamond set in White Gold square top \$42.50. \$4.15 a Month.

B84--14K White Gold Wrist Watch; 4 Blue, white Diamonds; 4 Blue Sapphires, Guaranteed 15 Jewel movement. \$42.50. \$4.15 a Month.

B85--Famous Bulova Gents Strap Watch 14K Gold filled case, guaranteed 15 Jewel movement. \$28.50. \$2.75 a Month.

B86--12 size 21 Jewel Illinois Victor Watch; 14K Green Gold filled case. Price \$45. \$4.40 a Month.

3000 Big Bargains in Diamonds, Watches and Jewelry shown in this catalog. Send for it Today—it's FREE.

L.W. SWEET Inc.
DEPT. 57-G 1660 BROADWAY NEW YORK

\$26⁵⁰ down for this genuine slate bed Brunswick Home Billiard Table with folding legs. Write for details.

The BRUNSWICK-BALKE-COLLENDER CO., Chicago, Ill.

SKIN-TROUBLES

ANDRE'S ACNE CREAM is Excellent for all Skin Troubles

no matter how severe or chronic. Pimples, Blackheads, Eruptions on face or body. Eczema, Barbers' Itch, Scabs, Crusts, Pustules, Enlarged Pores, Oily, Shiny or Itching Skin. Lightens Freckles, softens and whitens the skin. Immediate Results. Write for full particulars.

Andre & Co., 4029 Cottage Grove Av. Suite 451, Chicago, Ill.

366 SHORT CUTS FOR CARPENTRY WORK

Popular Mechanics New Carpenter's Handbook is filled with illustrated short cuts and improved methods for doing all sorts of carpentry work and odd jobs. Each idea was discovered by a practical man in the course of his work. Each idea is practical, a time-saver, a money-saver. The 229 Pictures are so clear that in many cases, the picture itself explains the short cut. This new book is a book for professional carpenters, for amateurs, and for boys. It is destined to be just as popular as the many other handbooks published in recent months. This new book is beautifully bound in golden brown cloth, is a handy size, and sells for the remarkably low price of \$1.50.

Send No Money Simply write a postal saying that you want Popular Mechanics New Carpenter's Handbook. It will be sent C. O. D. and you may pay the postman the price of the book and the few cents postage when he delivers the book to you. If you live outside the U. S. or if you are not at home when the postman delivers your mail, send \$1.50 with your order.

POPULAR MECHANICS PRESS
Room 707, Popular Mechanics Bldg., 200 E. Ontario Street, Chicago, Ill.

This cutter is quickly sharpened

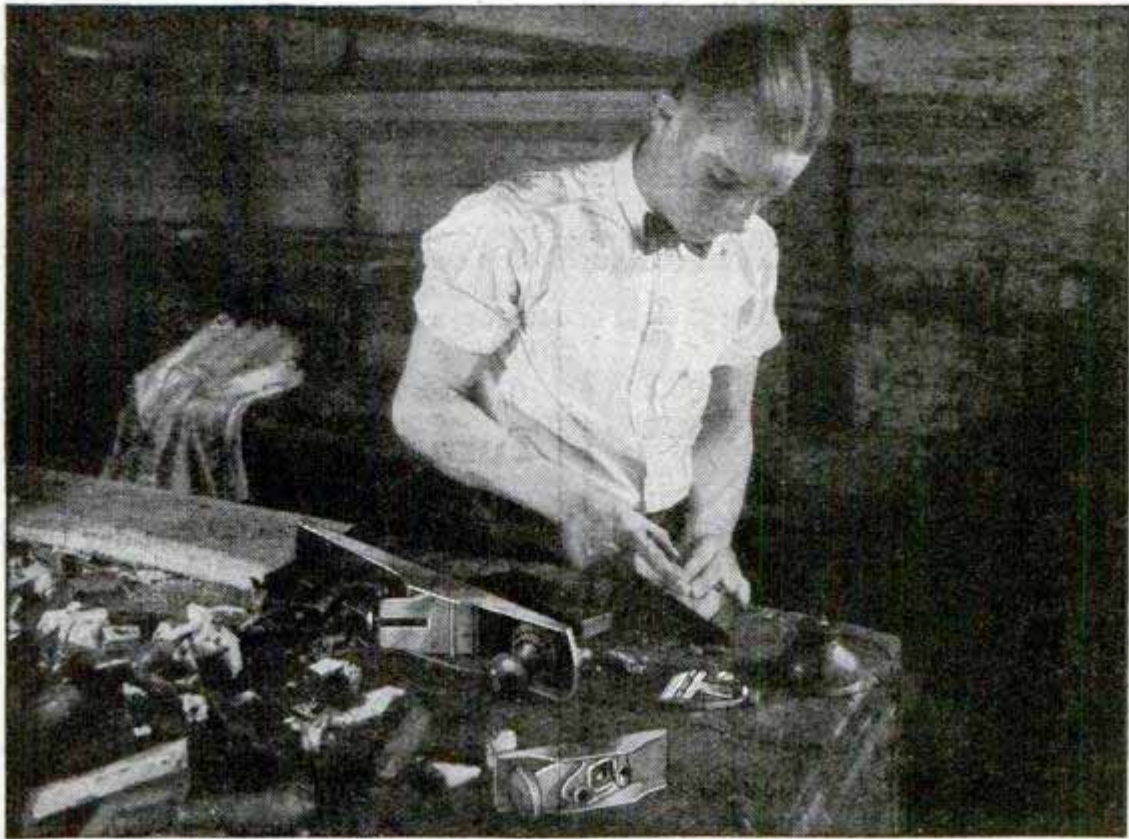

JUST feel the edge of a Sargent cutter when you've rubbed it up a bit. "Sharp" is the word. It's the chromium steel that does it—the unusually tough and wear-resisting steel which permits the use of a thinner and more quickly sharpened blade.

But that's not the only reason why this particular Sargent cutter is so easy to sharpen. This chap is using an Auto-Set—which has a time and labor saving feature found in no other plane. *The*

Auto-Set cutter may be removed and replaced without changing the original adjustment.

The Auto-Set together with the small steel block plane should be on every school and home work-bench. They are lasting and inexpensive—costing less than you would expect to pay for the planes that so many professional carpenters use. See them at your hardware dealer's and write us for descriptive booklet.

SARGENT & COMPANY, *Manufacturers* 49 Water Street, New Haven, Conn.

SARGENT

PLANES



*Sargent Steel
Block Plane
No. 5206*

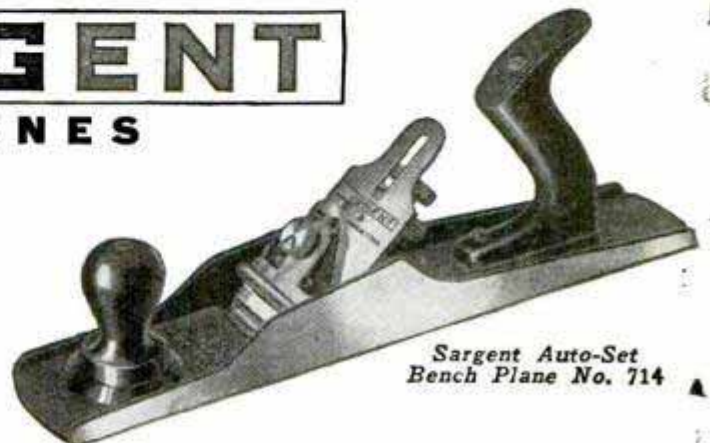

*Sargent Auto-Set
Bench Plane No. 714*

Make big money from repair work



Practically every householder spends at least \$10.00 to \$50.00 each year and many spend several times that much on simple repairs that can be made *quickly, easily and well* with

Smooth-On No. 1

With a can of Smooth-On, you can save this money in your own home—and by doing similar repair work for others, you can make money.

No skill is required to make repairs and the amount of Smooth-On used on any one job seldom costs more than a few cents.

Typical repairs that can be made perfectly with Smooth-On:—Stopping leaks in steam, water, gas, oil or stove pipes, mending cracks, breaks or leaks in furnaces and boilers, radiators, tanks, sinks,

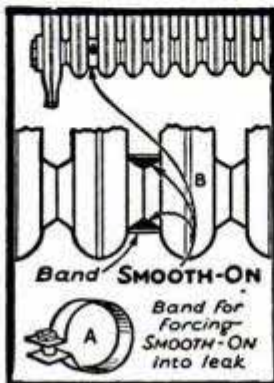

Look at radiator joint stopped with Smooth-On

pots and pails, making loose handles tight on umbrellas, knives, hammers, brushes, drawers, etc., tightening loose screws, hooks, locks, door knobs, etc.

On the Automobile:—Making bursted water jackets and pumps good as new, stopping leaks in radiator, hose connections, gas tank and gas, oil and exhaust lines, making a fume-proof joint between exhaust pipe and tonneau heater, tightening loose headlight posts, keeping grease cups, hub caps, and nuts from loosening and falling off, etc.

To get perfect results, write to us for and use the Smooth-On Repair Book. Free if you return the coupon.

Get Smooth-On No. 1 in 7-oz., 1-lb. or 5-lb. tins at any hardware store or if necessary direct from us.

SMOOTH-ON MFG. CO.
Dept. 37, 574 Communipaw Ave.
JERSEY CITY, N. J.



Write for **FREE BOOK**



Do it with SMOOTH-ON

SMOOTH-ON MFG. CO., Dept. 37, 574 Communipaw Ave., Jersey City, N. J.

Please send the free Smooth-On Repair Book.

Name.....

Address.....

A Perfect Heat Machine for Mechanic or Handyman

Every man who has ever used a Turner Blotorch *Master No. 45* says that it is "the best ever." From soldering a leaky pan to fine radio or electrical work—the *Master No. 45* is supremely efficient and economical. If you want a perfect heat machine



Ask for the **Turner Master No. 45**

400° greater heat with present-day kerosene or gasoline. Perfect flame regulation. Absolute safety; one opening in tank and that above fuel line; safety valve. Large, comfortable, pistol grip handle.

Write for a **TURNER MASTER No. 45 \$7.75** Post-paid
Fearlessly Guaranteed

THE TURNER BRASS WORKS
Industry Ave., Sycamore, Ill.

You Can Have Extra Money

—or a business of your own

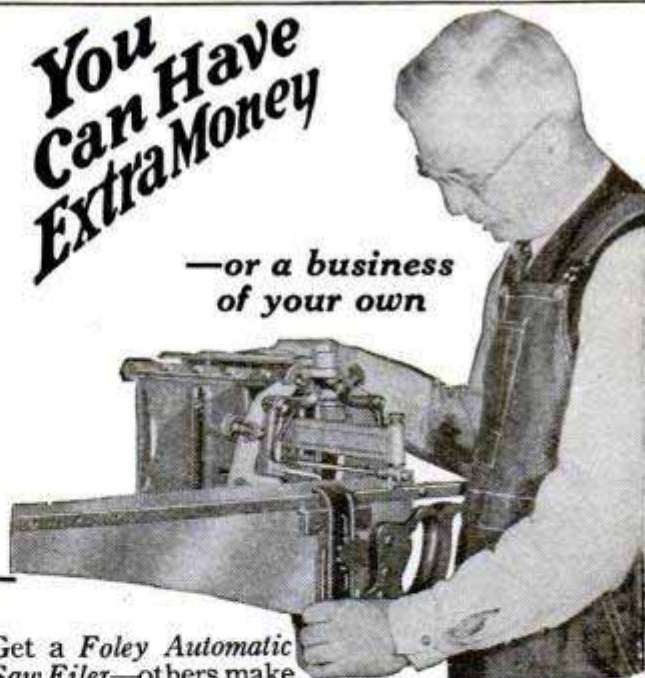

Get a *Foley Automatic Saw Filer*—others make \$20 a day with it, in their own business, filing saws for carpenters, contractors, schools, shops, and woodworking plants. B. V. Kennedy of Adrian, Mich. says: "I file 15 to 18 saws a week. I work 8 hrs. a day for the N. Y. Central R. R., so my filing is done mostly evenings." No studying or experience. Practically no competition for the first man who gets started in this big paying business in every community—*be that man.* Write today for **FREE INFORMATION.**

Foley Saw Tool Co., 212 Foley Bldg. 914 E. Lake St. Minneapolis, Minn.



1/4-inch holes thru 1/2-inch Cold Rolled Steel in 13 Seconds

NOT just one hole, but hole after hole, hour after hour. No overheating—no letting up—no distress signs. The same smooth, dependable drilling for long periods.

A drill that performs like this in hard shop service won't go back on you.

No. 1042 is called a Heavy Duty Drill because it's motored heavy enough to *more* than justify that title. No job that comes within its range is too hard

for this drill. Uninterrupted performance is built into every part of every electric drill bearing the Goodell-Pratt nameplate. There are no weak points.

Write us for folder that tells complete details. Then order through your tool merchant. If he hasn't stocked your Goodell-Pratt Electric Drill, he can get it for you quickly.

Note these features and refinements of Goodell-Pratt Electric Drills

MOTORS—Powered for continuous drilling at the rated full capacity.

PATENTED SELF-OILING ARMATURE BEARINGS—Long, special, high-speed bearings, in perfect alignment; automatically lubricated from capacious leak-proof oil reservoirs.

EFFICIENT VENTILATION—Uninterrupted flow of clean air through the motor.

PATENTED CABLE LOCK—Eliminates most connection troubles. Cannot be pulled or jerked out.

GEAR OPERATED CHUCK—Ball bearing, with self-tightening action that makes the key unnecessary most of the time.

ACCESSIBILITY—Every vital part surprisingly get-at-able.

WIDE-FACED HARDENED GEARS—Double gear speed reduction—hard bronze gear and spindle bearings—instant switch control.

HOUSING—Polished aluminum, with pleasing lines. Good looks as well as remarkable efficiency make Goodell-Pratt Electric Drills a real joy.

Type Schedule

Universal Motors—for A. C. or D. C.—for 110 and 220 Volts

Type	Lbs. Wgt.	Capacity	Approx. No Load Speed	Type	Lbs. Wgt.	Capacity	Approx. No Load Speed
1042	6	1/4" Heavy Duty	1800	1045	18	1/2" Standard	650
1043	11	3/8" Heavy Duty	1100	1046	21	1/2" Heavy Duty	600
1044	12	1/2" Light Duty	700	1048	22	5/8" Heavy Duty	550

GOODELL-PRATT COMPANY, GREENFIELD, MASS., U. S. A.

MAKERS OF *Toolsmiths* MR. PUNCH

GOODELL-PRATT

1500 GOOD TOOLS

**CROSLLEY 1927
RADIOS**

Each set giving the utmost in radio enjoyment at its price. All prices slightly higher west of the Rocky Mountains. All prices are without accessories.



The 5-50—\$50

Enthusiastic owners report amazing performance—a drum delivering stations loud, clear and sharp; each an almost imperceptible turn of the drum apart. Write station letters on drum, return to them at will. Single drum Station selector. Accumulators, power tube adaptability and all metal chassis that shields the units from each other. Beautifully finished. Mahogany cabinet, rose gold trimmings.



The 5-75 Console—\$75

This set includes ideas for radio reception perfection not found in any other radio. Marvelous exclusive Crosley "Crescendo" and "Accumulators" increase volume on distant stations and bring in programs entirely missed and passed by on ordinary one-dial control radio. Console model stands 40 inches high. The Crosley Musicone is skillfully built into the cabinet in a manner which is both an artistic and an acoustical triumph. Ample space for batteries and accessories.



**"6 Tube RFL-90"
Console, \$90**

Introducing the double drum station selector! Crosley's winning non-oscillating perfectly balanced tuned radio set. Includes Musicone skillfully built into exquisite console mahogany cabinet of two-tone finish to match finest surroundings. Room for batteries and all accessories; 40 inches high; 30 1/2 inches wide.

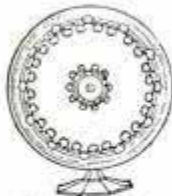

**The Crosley
Musicone**

The secret of the popularity of this biggest selling loud speaker on the market lies in its actuating unit. This and NOT the cone shape is the reason for its perfect reproduction of all audible sound. BEWARE of imitations. There is only one genuine Musicone. It is built solely by Crosley under mass production methods which makes its unmatched value possible.



"—as long as I can pick up 27 programs in 30 minutes beside our 3 locals interference won't bother me

"I sat down the other night with this Crosley set. One control. Beginning at one end of the broadcasting wave band, I tuned in 27 stations, loud and clear, just like the Cincinnati stations, three of which were going full blast. I listened to each program; identified it; didn't hear any others in the background, and passed on to the next,—all with one finger. It was between 7:00 and 7:30 P. M. Central Standard Time.

The air was certainly full. Some of the stations were less than a dial marking apart. It is amazing how the jiggers they call "accumulators" helped on such fine separation.

Even using a hundred-foot aerial the local stations were easy to go through. One of them only a few blocks from my home.

Some radio, I call it! \$50.00 seems too little. I'd like to see some two-hundred-dollar sets do as well!"

Write Dept. 15, for Catalog

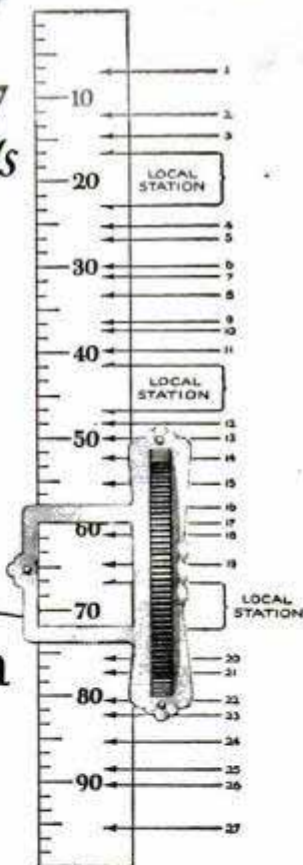

The above scale reading shows how stations picked up by Mr. X—appeared on the Crosley graphic drum station selector. Name on request.

**Single Drum
Control**
\$ 50.
Prices slightly higher West of the Rocky Mountains.

THE CROSLLEY RADIO CORPORATION

CINCINNATI, OHIO

Powel Crosley, Jr., Pres.

Crosley sets are licensed under Armstrong U. S. Patent No. 1,113,149, or under patent applications of Radio Frequency Laboratories, Inc., and other patents issued and pending.



AMAZING INVENTION WORKS WONDERS

With All Kinds of Razor Blades

Makes Blades Keener Than New—Prolongs Their Usefulness for Months and Even YEARS—And Gives Coolest Shaves Imaginable! See Generous Special Offer Below! Send Coupon Now!

365 Shaves a Year With Same Blade!

KEEN, velvety shaves forever and no more blades to buy! That's what the astonishing invention of a St. Louis man offers the great army of American shavers today!

KRISS-KROSS revolutionizes all old-style methods of shaving. Its performance is so sensational that it seems hardly fair to call it a stropper. Rather it is a super-stropper or blade-rejuvenator! Almost literally it makes a new blade out of an old one every day—and gives them a sharpness they seldom possess when brand new! Actually—you can often take a blade right out of a fresh package and improve it as much as 100% in eleven seconds with KRISS-KROSS!

Magic Diagonal Stroke

Until you've seen KRISS-KROSS, and tested its uncanny dexterity yourself, you'll never know how amazing it really is! It employs the famous diagonal stroke, same as a master barber uses. Never before has anyone captured the secret of reproducing it automatically. Eight "lucky leather grooves" do the trick in 11 seconds, with a precision it takes a master barber years to attain.

But that's not all, KRISS-KROSS embodies still another feature that has hitherto baffled mechanical reproduction. It strops

from heavy to light. It's absolutely uncanny the way the strokes grow lighter and lighter until an adjustable, automatic jig flies up and notifies you that your blade is ready—ready with the keenest-cutting edge that steel can take!

KRISS-KROSS not only produces unbelievable sharpness—but prolongs the life of any razor blade for months and even years. Fits all brands and makes except Durham. Eliminates 83% of shaving costs—and gives you keen, velvet-smooth shaves forever!

3-in-One Razor FREE

And now for my surprising offer. To introduce KRISS-KROSS, I am giving with it Free a new kind of razor. Possesses remarkable features. Instantly adjustable to any shaving position: (1) T-shape; (2) straight (old style); (3) or diagonal (new way). Gives a sliding instead of pulling stroke. Simply zips right through the toughest crop of whiskers. Comes with 5 special-process blades and is entirely unlike anything you ever saw before!

Send for Free Offer Today

Send for full information on these remarkable new inventions today. Write for illustrated description and full details of free razor offer. It's even more remarkable than I can tell you in this short space. Clip the coupon now! Mail it today!

**FITS ALL
BLADES**

**CUTS SHAVE
COSTS 83%**

**ENDS BUYING
BLADES**

**JIFFY
QUICK**



AGENTS:

Make big money with KRISS-KROSS. FREE razors boost your profits amazingly. H. King made \$66 in one day. H. C. Paire made \$104 in 3 days! Others average \$350 and up to \$750 a month! Spare time workers, Office and Factory men make \$6-\$12 extra a day showing KRISS-KROSS to friends and fellow employees. Get details at once. Check bottom of coupon and mail it tonight!

Rhodes **KRISS KROSS**
RHODES MFG. CO. **STROPPER**
Dept. B-371, 1418 Pendleton Ave., St. Louis, Mo.
Largest Manufacturers of Mechanical Stoppers in the World

Rhodes Mfg. Co., Inc., Dept. B-371,
1418 Pendleton Ave., St. Louis, Missouri.

Without obligation, please send me illustrated description and full details of your special introductory offer on KRISS-KROSS super-stropper and FREE 3-way razor.

Name.....

Address.....

Town..... State.....

() Check here if interested in making money as authorized KRISS-KROSS representative.

Solid walnut cabinet. Compartments for all batteries—no unsightly wires. Built in imported loud speaker.

Five tube, tuned radio frequency. Cabinet 50 inches long, 26 inches deep and 42 inches high. Retail price including all accessories

215.00

Built to equal the best in radio and yet sell at a price within the reach of all.

OZARKA



Handy portable radio, built-in loud speaker. Compact, light in weight, uses dry cells. An ideal instrument for home use as well as outdoors. Weight complete 25 lbs. Retail price including all accessories..... **\$75.00**



Five tube tuned radio frequency, built-in loud speaker and space for "B" batteries. Cabinet 25" long and 16 1/2" deep. Bronze panel, longest distance possible, selective and a tone which will please. Retail price complete with all accessories..... **\$100.00**



Extra long distance radio, loud, clear reception coast to coast. Large cabinet, space for "B" batteries. Furnished complete with imported English Hi-Power loud speaker built to more than meet any competition for distance, tone, volume or selectivity, retails complete with loud speaker and accessories for..... **\$132.50**



Make More Money Sell Radio in Spare Time-Evenings

IN four years we have taught 4500 men how to make \$50 to \$100 a week selling Ozarka radio instruments, evenings.

These men were not experienced salesmen—our (12) FREE Sales Lessons taught them just what they needed. They did not understand radio—our (10) FREE Radio Service Lessons gave them the technical knowledge they needed. Today many of these men have been so successful they have been able to give up their jobs, put all their time on Ozarka. Many have other men working for them.

What these men have done, others can do, who are willing to try.

Ozarkas are sold in competition with all other instruments—results speak for themselves—distance, volume, tone, selectivity and appearance. Your selling price is away under any instrument of similar high quality—the commissions are large, from \$30.00 to \$80.00 a sale—two sales weekly is a low average.

We not only furnish sales and service lessons and leads from our national advertising but attractive literature, booklets, letterheads, envelopes, business cards, window signs,

movie slides and movie reels all with your name printed on them. Your selling is made just as easy as possible—the results of these 4500 men prove this. The necessary investment is small—the possible profits are large. In territory, not now covered, we need exclusive Ozarka representatives.

Send for Our 100-Page Book —The Ozarka Plan

You'll find this book very different to any you ever read—it's a true story of life, why some men struggle to get ahead while others make money rapidly. You'll find it a thoroughly tried out and proven plan of making money in your spare time—an entirely different and easier plan of selling radio—the one article in big demand today.

While this book has been expensive to publish it is FREE to any man who is anxious to get ahead. It has meant a turning point in many a man's life—it may mean the same to you. Costs nothing to get it, and yet may mean so much. If you really want to make more money, you'll send for it today! Simply use the coupon below!

Use This Coupon!

OZARKA, INC.,
128 W. Austin Avenue C,
Chicago, Ill.

I am greatly interested in the FREE Book, Ozarka Plan No. 100, telling how I can establish myself in the radio business and increase my present income.

Name.....

Address..... City.....

County.....

OZARKA INCORPORATED

128 W. Austin Avenue C : Chicago, Illinois