

# POPULAR MECHANICS

## MAGAZINE

WRITTEN SO YOU CAN UNDERSTAND IT

REG. TRADE MARK GREAT BRITAIN INC. 40429

REG. U.S. PAT. OFF.



SEE PAGE 65



Mr. Happy Man Says:  
"Make HIM Happy  
with an ATKINS Saw"

For the man who likes good tools there's no finer gift than an ATKINS "400" Hand Saw—the "Finest on Earth." It will make him happy on Christmas Day, and every day he uses it. This Lifetime Saw is made of "Silver Steel." It will cut faster and easier, and hold its keen edge longer than any saw he ever used.

For boys, the ATKINS "Junior Mechanic" Saw makes a most useful gift. Ask your dealer today for these two ATKINS Saws, packed in colorful Christmas boxes. Write us for free folder—"The Saw in the Home."

E. C. ATKINS & CO., Estab. 1857, 426 So. Ills. St., Indianapolis, Ind.

**ATKINS SILVER STEEL SAWS**

WITH ALL THEIR EXCLUSIVE FEATURES CONN INSTRUMENTS COST NO MORE

# Hydraulic Expansion

Makes Every Conn *Easy to Play*—  
*Beautiful in Tone*—*Perfect in Scale*

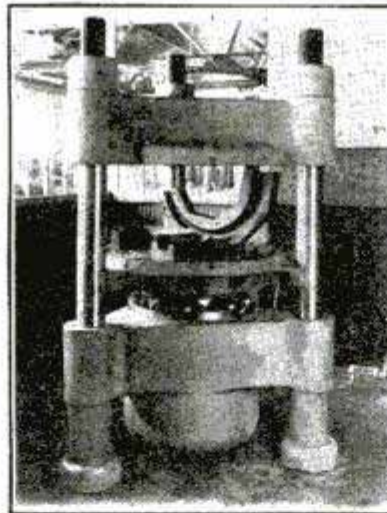

THE uniformly high quality of every Conn instrument is due to our development of machinery and exclusive processes which insure accuracy to the thousandth of an inch! Chief of these processes is the famous hydraulic expansion method, originated and developed by Conn at a cost of a half-million dollars!

In great presses, like the one shown at the left, every piece of tubing is expanded to exact proportions; the interior is smooth as glass, a perfect carriage for sound waves. This insures the Conn qualities of easy blowing, beautiful tone, perfect pitch.

## Free Trial; Easy Payments

Start now to cultivate your musical "bump" with a Conn. New, easy instruction methods and Conn's easy-playing features enable you to play acceptably in a few weeks!

Musical ability brings popularity; you're welcome everywhere. Music study sharpens the intellect, equals mathematics in mind training, educators say. Earn a college education playing part time. Take your place in a big-paying, fascinating profession, if you choose.

SEND THE COUPON TODAY for details of FREE TRIAL, EASY PAYMENT plan on any Conn instrument for band or orchestra.

**CONN**  
BAND  
INSTRUMENTS  
WORLD'S LARGEST MANUFACTURERS

C. G. CONN, Ltd.

131 Conn Bldg., Elkhart, Ind.  
Gentlemen: Please send free literature and details of free trial offer on

..... [ Instrument ] .....

Name.....  
St.....  
City, State.....  
County.....

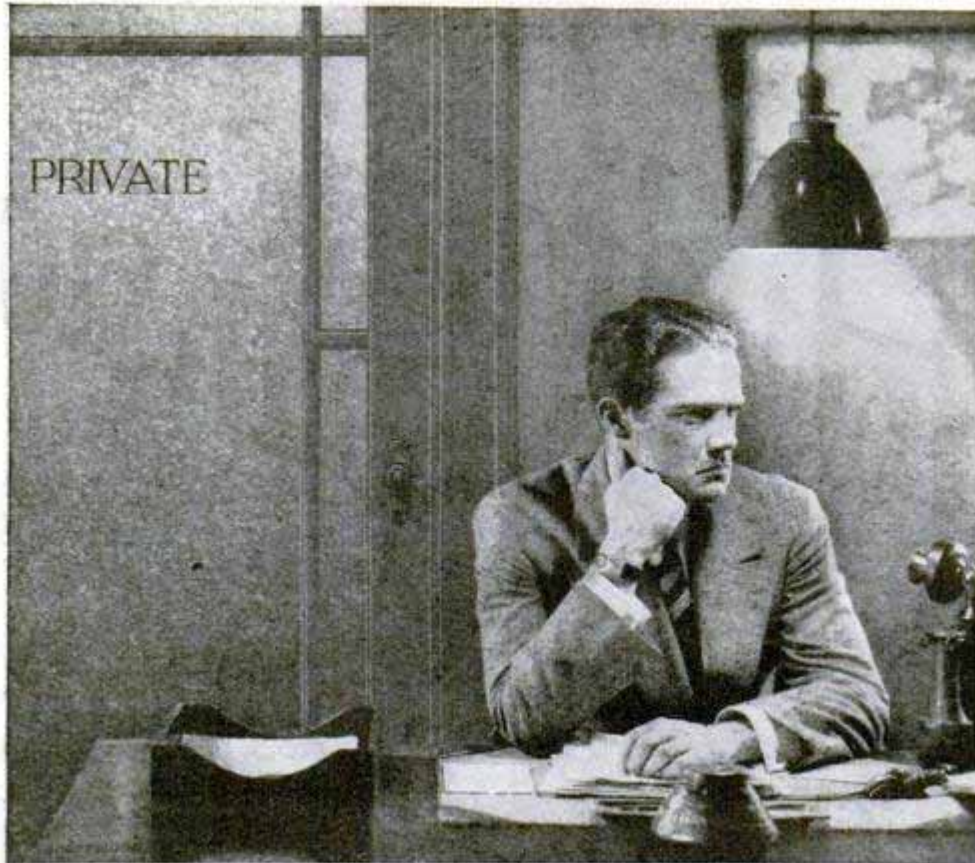

## Held back by—what? —perhaps it's *comedones*

FOR five years he had watched men come and go—up to better jobs. He knew he was not stupid. Something kept him back. Something made them promote other men— younger men. What could it be?

\* \* \*

It is unfortunate that many men suffer from *comedones*—the scientific name for blackheads. These disfiguring blemishes keep you from being clean-cut and attractive. They are often responsible for lack of business success. For while you yourself may not be conscious of them, others notice them. You

**TEAR OFF NOW! YOU MAY FORGET**



Use at Home  
after Shaving

may have wondered why success never comes. Perhaps it's *comedones*.

Pompeian Massage Cream gets in where comedones form, rolls out dirt and oily secretions, leaves your skin clean and healthy.

*Try this treatment:* After you shave, spread Pompeian Massage Cream generously over your face—and rub. Continue to rub until the cream rolls out. Note how dark the cream looks. That's the dirt that was in your pores.

Don't let comedones form. Use Pompeian Massage Cream every day—especially when engagements demand that you look your best. To get the full benefit, use Pompeian Massage Cream regularly at home after shaving. Your face will feel and look like a million dollars. 60c jars at all drug stores.

THE POMPEIAN LABORATORIES  
Dept. 45, Cleveland, Ohio

Gentlemen: I enclose 10c (a dime, coin preferred) for a special trial tube of Pompeian Massage Cream.

Name .....

Street  
Address .....

City..... State.....

SEND FOR  
10-DAY TRIAL  
TUBE

For 10c we will send a special trial tube containing sufficient cream for many delightful massages. Positively only one trial tube to a family on this exceptional offer. Use this coupon now.



*For Men!*

# Popular Mechanics Magazine

200 E. Ontario Street, Chicago, U. S. A.

H. H. WINDSOR, Founder

H. H. WINDSOR, Jr., Editor and Publisher

London: Hachette & Cie.,  
16-17 King William Street, Charing Cross, W. C. 2

Paris: Hachette & Cie.,  
111 Rue Reaumur

Melbourne: Gordon & Gotch  
509-513 Little Collins St.

ISSUED MONTHLY

SUBSCRIPTION:

SINGLE COPY, 25 CENTS

In United States and its possessions, also Canada, Cuba, and Mexico, per year, postpaid - \$2.50

To all other countries in the Postal Union - 3.00

All subscriptions are discontinued at expiration. Please examine the date printed on your wrapper.

Entered as Second Class Matter Sept. 15, 1903, at the Post Office at Chicago, Illinois, under Act of March 3rd, 1879.

Entered as Second Class Matter at the Post Office Department, Canada.

Published monthly by POPULAR MECHANICS CO.

Copyright, 1927, by Popular Mechanics Co.

Copyright in Australia. Copyright in France

Vol. 47

Contents for January, 1927

No. 1

Accident—death toll for year	86	Bullet-Proof armor expands when struck by bullets	62
Advertising—shop window display test made on shoppers	106	police armor	50
Aerial Warfare—how the army is pitting its guns against airplanes	31	Butterflies—turned into jewelry	76
Airplane		Calculating Machine—coin tabulator and checker	120
how stunt flying is taught	27	Camera— <del>slot-machine camera</del> takes eight pictures at once	73
latest engines of the sky	114	Card (Playing)—mystifying card trick	82
light metals to aid long flights	42	Cathode Ray—new ray makes cold stones glow	1
tilting wings on	14	Cattle—roller run over hide tells expert size of cattle	64
Airship—new principle of flying in dirigible	109	Cement—sieve for, holds water	89
Alarm—light controlled by stairs acts as burglar alarm	35	Checkers—magnet holds to board	71
Anatomy—electric stretching machine aids physical culture	6	Churn—operated like pump	26
Animals		Coal—as substitute for stone used in bungalow	29
do they think?	100	Crime	
living monsters sought in Congo	99	ears in vaults foil robbers	97
Archery		invisible black-light rays to trap burglars	81
bow held in feet for trick shots	51	lamp for telling forgeries	33
for indoors or outdoors	34	Desert—flag brings water to miners in desert camp	47
Architecture		Disease—why we "see stars"	79
confectionery store built in shape of freezer	15	Drawing Instrument—folding outfit for	96
dream cathedral of curves	97	Dye—American trade gaining	3
new method of construction to resist earthquakes	120	Dynamite—lessons in firing taught from auto truck	98
sidewalks for upper floors of buildings	89	Earthquake—underground less severe than on surface	30
Astronomy		Eggs	
Mars' latest visit leaves riddle unsolved	8	store eggs on turning rack to prevent spoiling	49
secrets of heaven to be revealed at glance	84	test strength of shells with hammer	105
Automobile		Electric Light—newest street lights	71
sawed in two makes portable power plant	46	Electricity—how shower of looks shown on photo	78
United States has more automobiles than tele-phones	51	Elevator—air to lift autos	95
Automobile Driving—loop the loop in caged auto	107	Elk—big elk broken to harness	6
Automobile Lighting—spotlight on radiator operated from dash	81	Eye—how far can you see? Uncle Sam gives answer	16
Automobile Lubrication—tube for greasing motors	44	Fan—for furnace cools house in summer	57
Automobile Parking—sidewise drive for autos simplifies parking	42	Fire Alarm	
Automobile Racing—auto race driver sits inside of steering wheel	17	box for	75
Automobile Radiator—dashlight tells if water is low	3	records fingerprints	83
Automobiles—Repairing		Fire Protection	
4 chassis mended without tools	23	mixer makes foam stream to smother fires	25
compressor for valve spring	105	safety fire escape on wire	95
Automobile Tire—safety auto tire inflater	4	First Aid—roadside station	41
Automobiles—Design		Flashlight—bulb attached to dry cell	107
latest in European exhibits	60	Gas—home generating plant	51
sedan for eight passengers serves as ambulance	83	Gauge—trigger gauge for gas tanks	73
Automobiles—Equipment and Supplies		Geology—are the continents drifting in a sea of rock?	45
clothing bag on auto seat	99	Goggles—attached to helmet	17
trunk fits under seat	75	Golf—course in an armory has eighteen holes	29
Aviation		Great Lakes—levels ruled by rains survey shows	28
machine on back makes man fly	13	Greenwich, England—world crossed in a stride on meridian line	106
way to save airmen's eyes sought	88	Grinder—electric, for skates	19
Barge—as floating cabaret	3	Gun—shotgun for one-handed man	35
Bears—tear gas fails to stop in Yosemite	25	Hands—what yours tell	20
Bees—kept in glass hive to study their habits	113	Hats—molded of wood pulp for English miners	25
Bicycle—cyclists ride on the top and side of ball	28	Health—time you hold breath index of	75
Binder—memorial to inventor of binder twine knotter	83	Hospital—perfumed air for	81
Bird—shoebill stork added to zoo	96	House	
Boats and Boating		of steel and turf	112
boat made from stovepipe	65	things to look for in buying a home	52
oarsman's scull for racing	23	House Plan	176
Brake—magnetic street car brakes	17	Household Devices	110
Bridge—memorial featured by curve	19	Housing Problem—model villages to solve English	24
Building Construction—sinking building tests skill of engineers	28	Industrial Efficiency—counter attached to hopper	59
		Insects—blown out of lights with fans for movies	47
		Inventions	
		luck in the laboratory	58
		patents granted women	56
		Kites—man-lifting kites used in taking photographs	63

[Continued on Page 4]

Light			
on top of tall tower emphasizes its height	44	Sink—for small apartment	80
ray of artificial sunshine aids dental treatment	7	Skyscraper—twenty-seven years life	41
Log Cabin—hollow log on auto trailer serves as		Slot Machine—sanitary vender for bread	106
tourist's home	30	Sound—phone amplifier in subways aids in calling	113
Lorgnettes—for army men aid in reading maps	72	stations	113
Magnifying Glass—worn on hand	63	Sports—stricter test of high jump	13
Mental Test—tests for motormen to assure public safety	5	Stadiums—of today rival those of ancient times	63
Metallurgy—old mining problem solved by accident	95	Steam—burning flame under water makes steam	
Model		swiftly	15
cardboard dolls play part in designing machine	43	Steeplejack—as Santa Claus climbs liner's funnel	113
Europe's high tariff walls shown on map	87	Street Railroad	
gold model of airship "Norge"	47	baggage rack on street car	34
houses of blueprints	72	gear for street car to reduce noise	109
locomotive in soap	26	Swimming	
progress of sea transportation shown by	109	force of strokes measured by meter	18
tiny grand piano fits in the hand	46	sleeve floats for swimmers	81
Money—coin of first Roman republic weighs half pound	30	Telegraph—land wire laid by airplane for emergency	99
Monument		Telephone	
heroes of world war battle honored by	86	long-distance phone depends on "booster" tubes	80
soldiers of world war who died in Sweden honored	49	shooting trouble in your line	90
Motor Bus		Tile—for bathroom and kitchen made in large units	62
pay as you enter bus	43	Tool—five combined in one	88
staggered seats in auto bus	88	Toys—dolls play mimic football	18
Moving Picture Projector		Traffic—take kinks out of river to relieve	4
kite camera takes movies of troops at drill	49	Tricycle—auto as ambulance	64
peep tube on movie camera	78	Weather	
Musical Instrument		made to order while you wait	36
cymbals, folding holder for	41	maps sent by radio protect navigation	80
pitch pipe like harmonica	33	paper petals tell by changing color	108
ukulele concealed in cane	15	Wheel—wooden spoke tightener	108
Naval Warfare—contact with the enemy	66	Woodwork—lock-joint woodwork keys easily taken	98
Navigation		apart	98
how voices from sea guide ships to port	113	X-Rays—meter to measure	62
submarine lights to guide ships and airplanes	83		
Navy—U. S. builds first cruiser under arms treaty	7		
Needle—split sewing machine	87		
Paper—from mulberry bark	48		
Patent—lack of office space hampers efficiency	4		
Petroleum			
chemists to seek way of making	89		
oil wells to oust houses	74		
Photography			
adjustable dial marks time for developing	108		
dark room on motorcycle	70		
pictures of brain messages taken by wireless	59		
Picture—face in card moves as edges are pressed	57		
Pigeons—school for homing pigeons	70		
Plug—handle for electric	58		
Postage Stamps—portrait in	86		
Postal Service—marines guarding mails	2		
Radio Aerial			
armored aerial minimizes static	132		
tip on raising aerial masts	123		
Radio Apparatus—fads and novelties of radio world	133		
Radio Application			
hot air used to paint pictures by radio	43		
secret of earth's interior explored by radio	46		
Radio Battery—pilot light for battery charger	128		
Radio Battery Charger			
pocket type charge indicator	122		
single tungar battery charger	125		
Radio Coil—coil testing tool	124		
Radio Condenser			
drum type control unit	124		
has bakelite shaft	124		
Radio Construction			
clean contacts mean clear reception	129		
testing insulating materials	127		
when radio works better with gridleak out	132		
Radio Loud Speaker			
combination easel and wall speaker	132		
homemade cone speaker	121		
Radio Plug—handy multi-connector	134		
Radio Operation—getting rid of lighting plant interference	122		
Radio Receiver—seven-tube neutrodyne operates from loop aerial	134		
Railroad			
big storage battery engine to speed switching	48		
railway tracks that travel	73		
roller-bearing railway cars	33		
wreck trains always ready	112		
Riding—horsemen standing on saddle leap hedge	19		
Road—oil keeps drift sand off	98		
Sand—from Africa blown to France	15		
Sander—runs from light socket	50		
Science—how it aids industry	78		
Searchlight—read forty miles away by	57		
Seed—puff-ball's explosion shows nature's skill as sower	74		
Silicon—is newest metal	108		
Silk—from worms to fabric	79		

## AMATEUR MECHANICS

Automobiles—Heater—deflector for auto heater	143
Automobiles—Repairing—lifting valve rocker arms	142
Bath—improvised pressure shower	146
Ghost—spooks in the dark	143
Infant—carrier for small auto	145
Laundry—reducing labor of hanging clothes	145
Model—build your own ship model	151
Music—lighting effect for jazz orchestra bass drum	150
Pencil—removing stuck lead from tip of refillable	146
Picture—kink for hanging	149
Poultry—automatic chicken feeder	142
Sander—for home workshop	144
Skating—fancy	135
Stool—handy all-purpose	150
Tile—novel use for drain	144
Toy—make kicking mule	147
Tweezer—powerful	145
Umbrella—identification tag on	143

## SHOP NOTES

Auger—chuck	170
Automobile—auto used for train service	173
Automobiles—Lighting—how to adjust your auto head-lights	155
Baseboard—improved baseboard and shoe	174
Building Construction—scoop excavator used to smash concrete slabs	171
Compressed Air—compressor made from old motor	173
Door—frames for wide openings	167
Ford Car—assembly of new type Ford transmission bands	167
Furnace—feed for combustible waste	167
Hole—cotter pin drill jig	167
Holster—for service station attendant	167
Ice—making artificial on farm	157
Loading and Unloading	
improved snubbing for unloading tanks	162
sandbag pulls hay fork back	171
Milling Machinery—attachment for milling hexagon on shaft	170
Painting	
brushes kept in oil	172
pot hanger	174
Rivet—protection for the heater	163
Safety Devices and Measures—eliminating static on line shaft	170
Shears—altered snips cut heavy sheet iron	161
Sheet Metal	
strengthening plate by countersinking riveting	172
trestle for work	164
Signs and Signboards—revolving	172
Smoke—escape from workshop	175
Solder—applying acid to solder jobs	163
Truck—for moving shop trays	175
Wrench—for grinder	174

# DRAKE'S PRACTICAL MECHANICAL BOOKS

St  
St  
**THEY WILL RAISE YOUR PAY—**

**ORDER ON 5-DAY TRIAL**

Str  
Sub  
Sug  
St  
Tal  
Tem  
Vaul  
Too  
Wal

The books listed below will perfect you in your chosen trade—paye the way to the big positions. Written in non-technical language—easy to read and understand. *Every book covers its subject completely. An entire course of instruction condensed into one volume.* Your choice sent postpaid—you benefit 5 days—money refunded in full if not entirely satisfactory. Order direct from this page.

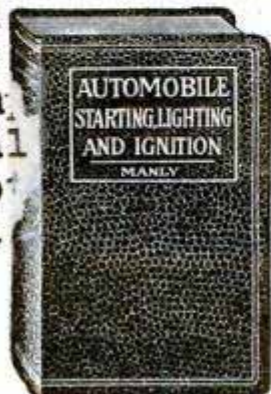

## Automobile Books

- Automobile Starting, Lighting and Ignition, by Manly... 700 pp. \$3.00
- Brookes' Automobile Handbook. \$2.00
- Ford Motor Car, Truck and Tractor, by Manly... Cloth \$1.50
- Automobile Battery, Care and Repair, by Manly... Leatherette \$2.00
- Motorecycle Handbook, by Manly \$1.50

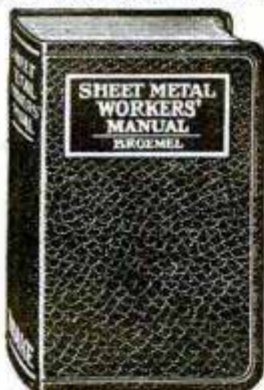

## Shop Practice Books

- Sheet Metal Workers' Manual... \$2.00
- Oxy-Acetylene Welding and Cutting... Cloth \$1.25
- Slide Rule and Logarithmic Tables. \$2.00
- Handbook for Millwrights... Cloth \$2.00
- Machine Shop Practice... Cloth \$2.00
- Mechanical Drawing and Machine Design... Cloth \$2.00

**ORDER DIRECT FROM THIS PAGE —ON OUR MONEY-BACK PLAN**

The books listed above are only a few of the many in our catalogue, which you will receive promptly after filling out and mailing us the attached coupon. For quick action order direct from this page—cross name of each book wanted and send in with price quoted. We prepay postage and send the books on our money-back plan.

**FREDERICK J. DRAKE & CO.**  
PUBLISHERS

1008 Michigan Ave., Chicago

Drake Books Are For Sale at All Book Stores

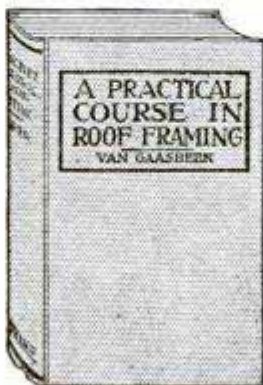

## Carpentry Books

- Cloth Binding
- Modern Carpentry, 2 vols. \$3.00
  - The Steel Square, 2 vols. \$3.00
  - Modern Estimator... \$1.50
  - Timber Framing... \$2.00
  - Builder's Architectural Drawing... \$2.00
  - Concretes... \$1.50
  - Practical Bungalows... \$1.00
  - Roof Framing, by Van Gasbeek... \$1.50

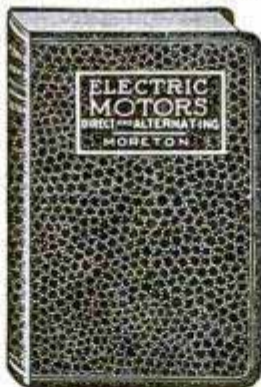

## Electrical Books

- Telephony, Including Automatic Switching, by Smith, 450 pp. Leatherette \$2.50
- Practical Applied Electricity... \$2.00
- Wiring Diagrams and Descriptions. \$1.50
- Armature and Magnet Winding... \$1.50
- Electric Motors, D. & A... \$1.50



## Painting and Decorating

- Ross Crane Book of Home Furnishing and Decoration... Cloth \$3.00
- House Painting Methods with the Brush and Spray Gun, by Vanderwalker. Cloth... \$2.00
- Interior Wall Decoration, by Vanderwalker... Leatherette \$4.00
- The Mixing of Colors and Paints, by Vanderwalker... Cloth \$2.00
- A Show at Sho' Cards... Cloth \$4.00
- Sign Painting, by Atkinson... Cloth \$4.00
- Strong's Book of Designs, Leatherette \$4.00
- Modern Painter's Cyclopedia. Cloth \$2.00
- Automobile Painting... Cloth \$1.50
- New Hardwood Finishing... Cloth \$1.50
- Wood Finishing, Plain and Decorative... Cloth \$2.00
- Owen's Paint Guide... Cloth \$1.00

## Steam Engineering

- Swingle's Handbook for Steam Engineers and Electricians. Leatherette... \$4.00
- Examination Questions and Answers for Marine and Stationary Engineers. Leatherette... \$2.00
- Steam Boilers... Leatherette \$2.00
- Swingle's Catechism of Steam, Gas and Electrical Engineering. Leatherette \$1.50

## Modern Languages

- By Prof. P. S. Allen, U. of Chicago
- French without a Teacher... Cloth \$1.25
  - Spanish without a Teacher... Cloth \$1.25
  - German without a Teacher... Cloth \$1.25
  - Everyday French... \$1.25
  - Everyday Spanish... \$1.25

**FREDERICK J. DRAKE & CO.**  
1008 Michigan Avenue  
Chicago, Ill.

GENTLEMEN:—Please send me free, postage paid, your illustrated catalogue which lists and describes 200 Practical Mechanical Books for Home Study.

My name is .....

and my address .....

.....

**Mail Coupon For Free Catalogue**  
**Your Guide to Home Study**

You may  
have  
a desk,  
but—  
do you get  
the  
salary  
?



JOHN A. HALL,  
C. P. A. (Fla.)  
ROBERT PENTLAND, JR.,  
C. P. A. (Fla.)  
FRANK L. COWLES,  
C. P. A. (Fla.)  
GEO. F. McCALL, S. A.

Hall, Pentland and McCall  
Audits - Systems - Taxes  
News Tower, Miami

Jacksonville  
Miami  
Tampa  
Sanford  
West Palm Beach  
Daytona Beach  
Lakeland  
Orlando  
Washington, D. C.

LaSalle Extension University,  
Chicago, Illinois.

Gentlemen:

When I enrolled for Higher Accountancy in 1919, I was a clerk with a clerk's wage.

Now I am a member of a firm having offices in nine cities. Our staff includes fifteen C.P.A.'s and more than thirty other accountants. This rapid progress in six short years is largely due to my LaSalle training.

Several of our staff are LaSalle members and all of our men know of our warm appreciation of LaSalle accountancy training. I only wish that every man could realize the unusual opportunity offered by this training for substantial business progress.

Yours very truly,

THE DESK in the private office of Robert Pentland, Jr.—member of the Florida State Board of C. P. A. Examiners and partner in the largest firm of Certified Public Accountants in the State of Florida—is about the same size as the desk he had when he was a clerk, in 1919. And there's no great difference in looks—

But his income today is more than ten times as large. His firm has offices in nine cities, and employs fifteen C. P. A.'s and thirty other accountants. And he is not yet thirty!

How did he boost his earnings so tremendously—in just a few short years?

He employed three aids: First, initiative—the courage to make a start. Second, energy—the willingness to work. Third, LaSalle adult business training—the short cut to high-salaried positions.

His first step was to send to LaSalle for information regarding home-study business training—to help him plan *intelligently*.

The coupon brought him "Ten Years' Promotion in One," the story of how one man, after many wanderings, found the path to responsibility and power. It brought him also a 64-page book, "Accountancy, the Profession that Pays," wherein he learned how he could enter a highly profitable profession, how he could step ahead to some of the most attractive and remunerative places in the entire range of business.

Below is just such a coupon as Mr. Pentland signed. Ahead of you are opportunities as great—even greater. If, one year from today, you would look back on a twelve months' record of *achievement*—fill in, clip and mail the coupon NOW.

### Find Yourself Thru LaSalle!

LA SALLE EXTENSION UNIVERSITY, Dept. 164-HR CHICAGO

I shall be glad to have your 64-page booklet about the business field I have checked below. Also a copy of "Ten Years' Promotion in One," all without obligation.

- |                                                                     |                                                                      |
|---------------------------------------------------------------------|----------------------------------------------------------------------|
| <input type="checkbox"/> Higher Accountancy                         | <input type="checkbox"/> Traffic Management—Foreign and Domestic     |
| <input type="checkbox"/> Business Management                        | <input type="checkbox"/> Railway Station Management                  |
| <input type="checkbox"/> Modern Salesmanship                        | <input type="checkbox"/> Banking and Finance                         |
| <input type="checkbox"/> Law; Degree of LL. B.                      | <input type="checkbox"/> Personnel Management                        |
| <input type="checkbox"/> Commercial Law                             | <input type="checkbox"/> Modern Business Correspondence and Practice |
| <input type="checkbox"/> C. P. A. Coaching for Advanced Accountants | <input type="checkbox"/> Expert Bookkeeping                          |
| <input type="checkbox"/> Effective Speaking                         | <input type="checkbox"/> Business English                            |
| <input type="checkbox"/> Modern Foremanship                         | <input type="checkbox"/> Commercial Spanish                          |
| <input type="checkbox"/> Industrial Management                      |                                                                      |

Name \_\_\_\_\_ Present Position \_\_\_\_\_

Street \_\_\_\_\_ City \_\_\_\_\_ State \_\_\_\_\_



these  
books  
free!



# BUILDERS

## TRADE GUIDES

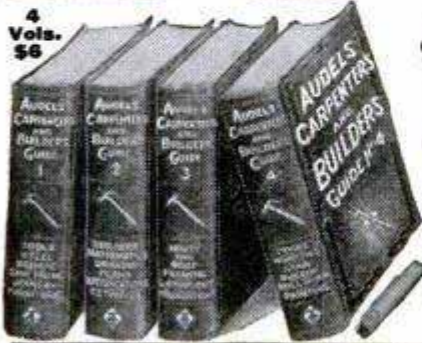

4 Vols. \$6

### AUDELS CARPENTERS AND BUILDERS GUIDES—4 VOLS. \$6

Inside Information for Carpenters, Builders, Joiners, Building Mechanics—all Woodworkers. **1600 pages; 3700 diagrams; flexible; pocket size.** Short-cut instructions, new methods, ideas, solutions, plans, systems—money saving suggestions. An easy progressive course for the apprentice. A practical daily helper and Quick Reference for the master worker. A Helping Hand to Easier and Better Work and Better Pay. To get this aid for yourself, simply fill in and mail the FREE COUPON below.

**INSIDE TRADE INFORMATION ON:**

How to use steel square; How to file and set saws; How to build furniture; How to use mitre box; How to use chalk line; How to use rules; How to make joints; Carpenters' arithmetic; Mensuration problems; Estimating strength of timbers; How to set girders and sills; How to frame houses and roofs; How to estimate costs; How to build houses, barns, garages, bungalows, etc.; How to read and draw plans; Drawing up specifications; How to excavate; How to use settings 12, 13 and 17 on the steel square; How to build hoists and scaffolds—skylights; How to build stairs; How to put on interior trim; How to hang doors; How to lay floors; How to paint.



4 Vols. \$6

### AUDELS PLUMBERS AND STEAMFITTERS GUIDES—4 VOLS. \$6

A new set—just out! A practical, illustrated, Reference Library and Study-Course for Master Plumbers, Journeymen and Apprentice Steamfitters, Gas Fitters and Helpers, Sheet Metal Workers, Draughtsmen, Master Builders, Engineers and all Building Trade Students. **1670 pages; 3642 diagrams; flexible; pocket size.** Guides explain all the principles, advances and short cuts of the Plumbing and Heating trade. Contains instructions on how to figure and estimate jobs. Use FREE COUPON below to examine, without obligation, this valuable work.

**INSIDE TRADE INFORMATION ON:**

Soldering, tinning. Joint wiping, bending, beating. Pipe—iron—steel, threading. Mathematics, tables, physics. Materials—iron, steel, copper, brass, lead, tin, antimony. Sheet metal—galvanized—plate. Sanitation, syphonage, tanks. Drainage, sewage, purification. Fixtures—bath—kitchen. Pipe fittings, soil pipe, tools. Laying out work. Roughing. Screwed fittings, flanges, joints. Pipe bending, examples. Elbows. Heating, ventilation, refrigeration. Water supply, mains, wells, tanks. Gas-fittings. Underwriters. Sheet metal work, problems, methods, Brazing, heating, lead burning. Welding, various welds, methods. Blacksmithing, forges, tools.

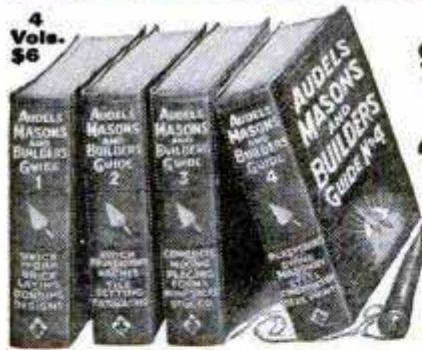

4 Vols. \$6

### AUDELS MASONS AND BUILDERS GUIDES—4 VOLS. \$6

A new, complete, illustrated trade reference library, for Bricklayers, Cement Workers, Plasterers, Tile Setters and Stone Masons, including a practical outline of Steel Construction. **1100 pages; 2067 diagrams; flexible; pocket size.** A practical Trade Assistant explaining modern methods of masonry construction. Easy to understand and apply. A reliable and authentic reference work and study-course for Master Journeyman and Young Mechanic. Use FREE COUPON below and find out for yourself, without obligation, whether this set will benefit you.

**INSIDE TRADE INFORMATION ON:**

Bricklaying, tools, materials; Brick designs, patterns, bonds; Setting frames and foundations; Mortars, scaffolds, estimating; Mortars and mortar mixing; Tile setting, mosaic, hollow tile; Straight edge test, troweling; How to figure brick work; Safe loads, piers, chimneys; Boiler settings, anchors, fire stops; Laborables; Concrete, forms; How to figure concrete work; Stucco—on old and new buildings; Plastering—wood lath—metal; Plasterers agreement; Plastering on various surfaces; Stonemasonry; Cutting, finishing, estimating stone; Derricks, rigging; Steel construction; Fire proof; How to read blue prints.



### PRACTICAL ELECTRICITY — 1 VOL. \$4

Audels Handy Book of Practical Electricity is a simplified Ready Reference and Study Course in one pocket size, leather bound volume—for Engineers, Professional Electricians and Students. **1040 pages; 2600 diagrams; flexible red leather bound.** A reliable authority and handy helper for every electrical worker. Contains important and valuable wiring diagrams, calculations, machine sketches, helps on maintenance and repair. Use this FREE COUPON today and find out, without obligation, how this handy book will help you in your daily work.



**INSIDE TRADE INFORMATION ON:**

Electro-Therapeutics, X-Rays, Shocks, Welding, Brazing, Radio Hook-ups, Motion Pictures, Telephone, Telegraph, Cranes, Bells, Elevators, Pumps, Tools, Ship Drive, Railways, Vehicles, Automobile Electric Systems, Ignition, Generation, Lighting, Plant Management, Power Plans, Armature Winding, Repairing, A. C. Motors and Apparatus, D. C. Motors and Apparatus, Alternator Construction, Dynamos, Wiring Diagrams, Sign Flashers, Cable Splicing, Power Wiring, Outside Wiring, Switches, Lighting, Rectifiers, Converters, Transformers, Fuses, Circuit Breakers, Rheostats, Electro Plating, Electrolysis, Storage Batteries, Magnetism, Electrical Energy, Conductors, Insulators, Static, Dynamic, Radio Electricity, Applications, Ready Reference and Index Covering the entire field of Modern Electricity.

### Learn More and You Will Earn More!

Know your job and you'll never be without one. The skilled man is always in demand. Knowledge is power. Learn your trade thoroughly by easy reading. This coupon is your opportunity for advancement and better pay. You risk nothing in sending for Audels Guides for free examination. Send it NOW!

**FREE EXAMINATION COUPON**

**THEO. AUDEL & CO.,**  
65 W. 23 ST., NEW YORK CITY

Please mail me for free examination the books marked (x) below. If I find them satisfactory, I agree to mail \$1 in 7 days, on each set ordered, and to further mail \$1 monthly on each set until I have paid the purchase price.

4 CARPENTERS GUIDES \$6     4 PLUMBERS GUIDES \$6

4 MASONS GUIDES \$6     1 ELECTRICIANS HANDY BOOK \$4

NAME .....

ADDRESS .....

OCCUPATION .....

EMPLOYED BY.....IT30



# 3 World-Famous B.W. Cooke "JOB-WAY" AUTO LESSONS

## GET THE FACTS!

**About the Tremendous Money-Making Opportunities in the WORLD'S BIGGEST BUSINESS!**

Find out how you can get into this gigantic Auto Business! Think of it—7 Thousand Million Dollars paid to Auto men every year for upkeep alone! See why there are so many Tremendous Opportunities for the trained Auto Man to get Big Raises in Pay QUICK!—opportunities waiting for YOU! My Free Book shows why. My Free Lessons show how you can take advantage of these wonderful Opportunities.

## Be an Auto Expert

If you want to boost your pay quick, Mail the Coupon now. Be an Auto Expert. It's the one Business for the red-blooded, ambitious man who wants to make real money! I help you do it. Get all the particulars about my lifetime Employment Service and my lifetime Consultation Service—both of which I include Free of Extra Charge.



**3 JOB Tickets also FREE**

**ACT QUICK!**  
My Big New Auto Book Also FREE!

Coupon brings this startling, revolutionary, new Auto Book, also absolutely Free! Shows how hundreds of men have reached Big Pay in amazingly QUICK Time! Shows what you can do!

Send for it Now!

**MAIL THIS COUPON NOW!**  
Send 3 AUTO Lessons and a BOOK FREE

**B. W. COOKE DIRECTING ENGINEER Dept. 116**  
CHICAGO MOTOR TRAINING CORPORATION,  
1916 Sunnyside Avenue, Chicago, Illinois

Dear Sir: Send me absolutely FREE and without any obligation on my part, 3 "Job-Way" Lessons and Jobs. Also your Auto Book FREE and full particulars of your 4 Outfits Offer.

Name.....  
Address.....  
Town.....  
State.....

**Coupon Brings Full Details of my 4 OUTFITS OFFER**  
Includes Tools, Tool Bag, Electrical Test Bench, Also 303 Wiring Diagram Charts, Also Special Electrical Outfits.

# NOW Absolutely FREE!

## I'LL IMPROVE That I Can Put YOU in Line for the BIG PAY JOBS—QUICK!

Clip coupon now! I'll send you absolutely FREE OF CHARGE—with positively no obligation on your part—3 "JOB-WAY" Auto Lessons and 3 Job Tickets and my big, new Auto Book also FREE! I want you to see for yourself—just why B. W. Cooke "JOB-WAY" Training is bringing so many men BIG Money in such remarkably quick time. I want you to see what it can do for you!

Find out how I train you **AT HOME!**

Don't sell your time for low pay! You don't need to! Get all the Facts! Find out how you can become a Big Pay Man in amazingly quick time! See how I train you this fascinating, easy, new way—with LESSONS—JOB TICKETS—TOOLS—and ACTUAL AUTO JOBS! These 3 FREE Lessons show you why you can stay home; keep your present job! They prove that you don't have to leave your doorstep—that you can Master every branch of Auto work right in your own home. Send Coupon while I can still offer you these 3 Lessons and 3 Job Tickets absolutely FREE!

## See How You Can Earn up to \$150 a Week

If you're earning a cent less than \$60 a week, clip coupon now! Get the proof. See for yourself how easily you can master Auto work right in your own home—and how quickly you can get in line for the big Auto Jobs that pay up to

\$10,000 a year and more—or in a Money-Making Auto Business of your own. Remember—these lessons and Jobs come to you absolutely FREE of charge and without any obligation on your part whatever.

**Send Coupon at ONCE!**

Learn how men without a day's previous auto experience, and only common schooling become Garage Owners, Superintendents, Managers and can earn up to \$150 a Week and more! See why hundreds of men have found "JOB-WAY" to be such interesting, practical Training!

I stand ready to give you absolute proof. Clip COUPON NOW and I'll rush your Lessons to you Absolutely Free!

**B. W. Cooke**  
Directing Engineer  
**Chicago Motor Training Corporation**  
1916 Sunnyside Ave.  
Dept. 116 CHICAGO

# THIS MAN WOULDN'T STAY DOWN

*The true story of a man  
who won where others failed*

## Gets Tired of Small Salary



He was putting in long hours at unskilled work. His small pay scarcely lasted from week to week. He saw other men promoted. Then he learned the *reason*. They had special training. So one day he made up his mind that he was going to get that kind of training too.

## Makes Important Resolution



"I've thought it all out, Grace! I'm as good a man as any of them. All I need is special training—and I'm going to get it. If the International Correspondence Schools can raise other men's salaries, they can raise mine too. I'm going to mark and mail the coupon tonight and find out how."

## Starts to Study



No matter where you live, the I. C. S. will come to you. No matter what your handicaps, the I. C. S. has a plan to meet your circumstances. No matter how limited your education, the wonderfully illustrated I. C. S. textbooks make it easy to learn.

## Tells Wife of \$50 Increase



"I've been promoted with an increase of \$50 a month, Grace. And the first extra money is yours. Just a little reward for urging me to study at home. The Boss says my spare-time training has made me a more valuable man to the firm. We're starting up easy street, thanks to you and the I. C. S."

## His Employer Praises Him

"He's the first man I think of whenever there's a position open. And he always made good because he prepared himself for the job ahead. We pay him \$100 a week now and he will be earning even more some day. I wish we had more men like him."



## Now Owns Own Home

In city, town and country, thousands of men have good positions and happy, prosperous homes because they let the I. C. S. prepare them for promotion. Why don't you find out what this great school can do for you? It takes only a moment to mark and mail the coupon, but that one step may be the means of changing your entire life.



## Mark and Mail the Coupon Today!

INTERNATIONAL CORRESPONDENCE SCHOOLS  
Box 5620-E, Scranton, Penna.

Without cost or obligation, please send me one of your booklets and tell me how I can qualify for the position or in the subject before which I have marked an X:

### BUSINESS TRAINING COURSES

- |                                                                  |                                                 |
|------------------------------------------------------------------|-------------------------------------------------|
| <input type="checkbox"/> Business Management                     | <input type="checkbox"/> Salesmanship           |
| <input type="checkbox"/> Industrial Management                   | <input type="checkbox"/> Advertising            |
| <input type="checkbox"/> Personnel Organization                  | <input type="checkbox"/> Better Letters         |
| <input type="checkbox"/> Traffic Management                      | <input type="checkbox"/> Show Card Lettering    |
| <input type="checkbox"/> Business Law                            | <input type="checkbox"/> Stenography and Typing |
| <input type="checkbox"/> Banking and Banking Law                 | <input type="checkbox"/> Business English       |
| <input type="checkbox"/> Accountancy (including C.P.A.)          | <input type="checkbox"/> Civil Service          |
| <input type="checkbox"/> Nicholson Cost Accounting               | <input type="checkbox"/> Railway Mail Clerk     |
| <input type="checkbox"/> Bookkeeping                             | <input type="checkbox"/> Common School Subjects |
| <input type="checkbox"/> Private Secretary                       | <input type="checkbox"/> High School Subjects   |
| <input type="checkbox"/> Spanish <input type="checkbox"/> French | <input type="checkbox"/> Illustrating           |

### TECHNICAL AND INDUSTRIAL COURSES

- |                                                                           |                                                                      |
|---------------------------------------------------------------------------|----------------------------------------------------------------------|
| <input type="checkbox"/> Electrical Engineering                           | <input type="checkbox"/> Architect                                   |
| <input type="checkbox"/> Electric Lighting                                | <input type="checkbox"/> Architects' Blueprints                      |
| <input type="checkbox"/> Mechanical Engineer                              | <input type="checkbox"/> Contractor and Builder                      |
| <input type="checkbox"/> Mechanical Draftsman                             | <input type="checkbox"/> Architectural Draftsman                     |
| <input type="checkbox"/> Machine Shop Practice                            | <input type="checkbox"/> Concrete Builder                            |
| <input type="checkbox"/> Railroad Positions                               | <input type="checkbox"/> Structural Engineer                         |
| <input type="checkbox"/> Gas Engine Operating                             | <input type="checkbox"/> Chemistry <input type="checkbox"/> Pharmacy |
| <input type="checkbox"/> Civil Engineer                                   | <input type="checkbox"/> Automobile Work                             |
| <input type="checkbox"/> Surveying and Mapping                            | <input type="checkbox"/> Airplane Engines                            |
| <input type="checkbox"/> Metallurgy <input type="checkbox"/> Mining       | <input type="checkbox"/> Agriculture and Poultry                     |
| <input type="checkbox"/> Steam Engineering <input type="checkbox"/> Radio | <input type="checkbox"/> Mathematics                                 |

Name.....

Street.....

Address.....

City..... State.....



5000 1 X8 8001

# Aviation Booms!



## - and Will Pay Big Money TO DARING YOUNG MEN



**A**VIATION — the sensation of the century — has jumped into the spotlight of world prominence. History has never recorded such amazing developments as have taken place in the past year. Gigantic new projects have been started. America's biggest fortunes are behind them. Financial wizards like

Henry Ford are investing millions in establishing air-ways and airplane factories. A sudden new demand for daring and trained young men in aviation has developed almost overnight. The boom is on—and it spells O-P-P-O-R-T-U-N-I-T-Y in glowing letters a mile high for every young man. Qualify NOW for One of These Exciting Jobs That Will Pay \$4,000 to \$10,000 a Year!

**Get Ready For One Of These POSITIONS**

- Aeronautical Instructor \$60 to \$150 per week
- Aeronautical Engineer \$100 to \$300 per week
- Aeronautical Contractor Enormous Profits
- Aeroplane Repairman \$60 to \$75 per week
- Aeroplane Mechanician \$40 to \$60 per week
- Aeroplane Inspector \$50 to \$70 per week
- Aeroplane Salesman \$5,000 per year and up
- Aeroplane Assembler \$40 to \$65 per week
- Aeroplane Builder \$75 to \$200 per week

### Get Started Now

Get into Aviation at once while it is still in its infancy and the big money is yet to be made. Let nothing stand in your way! Big pay, success and popularity will await the man who qualifies now. Don't wait and see others realize their ambitions while you tremble on the brink of hesitation. Opportunity comes but once to every man. Seize your chance!

### Send For FREE BOOK

Right now we offer you a copy of our Free book, "Opportunities in the Airplane Industry." It will open your eyes to facts you never dreamed of; you owe it to yourself to at



Just off the press. Special limited edition. Get yours immediately and avoid disappointment.

least read it. Get your copy now. No obligation. Mail the coupon tonight!

### Opportunities The World Has Never Seen Before

Experts say Aviation will develop more astonishingly than the automobile industry. It is backed by big money, power and influence, but right now it lacks just one thing: TRAINED MEN with vision. Think of the jobs that will pay \$300 to \$800 a month and possibly more in a new and growing industry. It is almost incredible! Yet that is the situation that Aviation faces in the near future unless trained men can be found.

### Easy To Become Aviation Expert

Now, by a unique system of basic training—evolved to help the industry cope with its need for trained aviation experts—we offer you a chance to qualify for one of these big-paying Aviation jobs. And best of all, you train at home without leaving your present occupation. The method of preparation is simple and easy and the study of Aviation, as we present it, is almost as fascinating as the work itself. You get personal instruction by experts. Every lesson is packed full of interest. You become so interested that you forget that you are working to prepare for big things—it seems more like a game. And only one hour a day will give you the necessary basic training in an amazingly short time.

### AMERICAN SCHOOL OF AVIATION Dept. 1351, 3601 Michigan Ave., Chicago, Ill.

AMERICAN SCHOOL OF AVIATION  
3601 Michigan Ave., Dept. 1351, Chicago, Ill.

Without any obligation, send me your Free Book, "Opportunities in the Airplane Industry," and information about your course in Practical Aviation.

Name .....

Address .....

City ..... State .....

**LEARN**

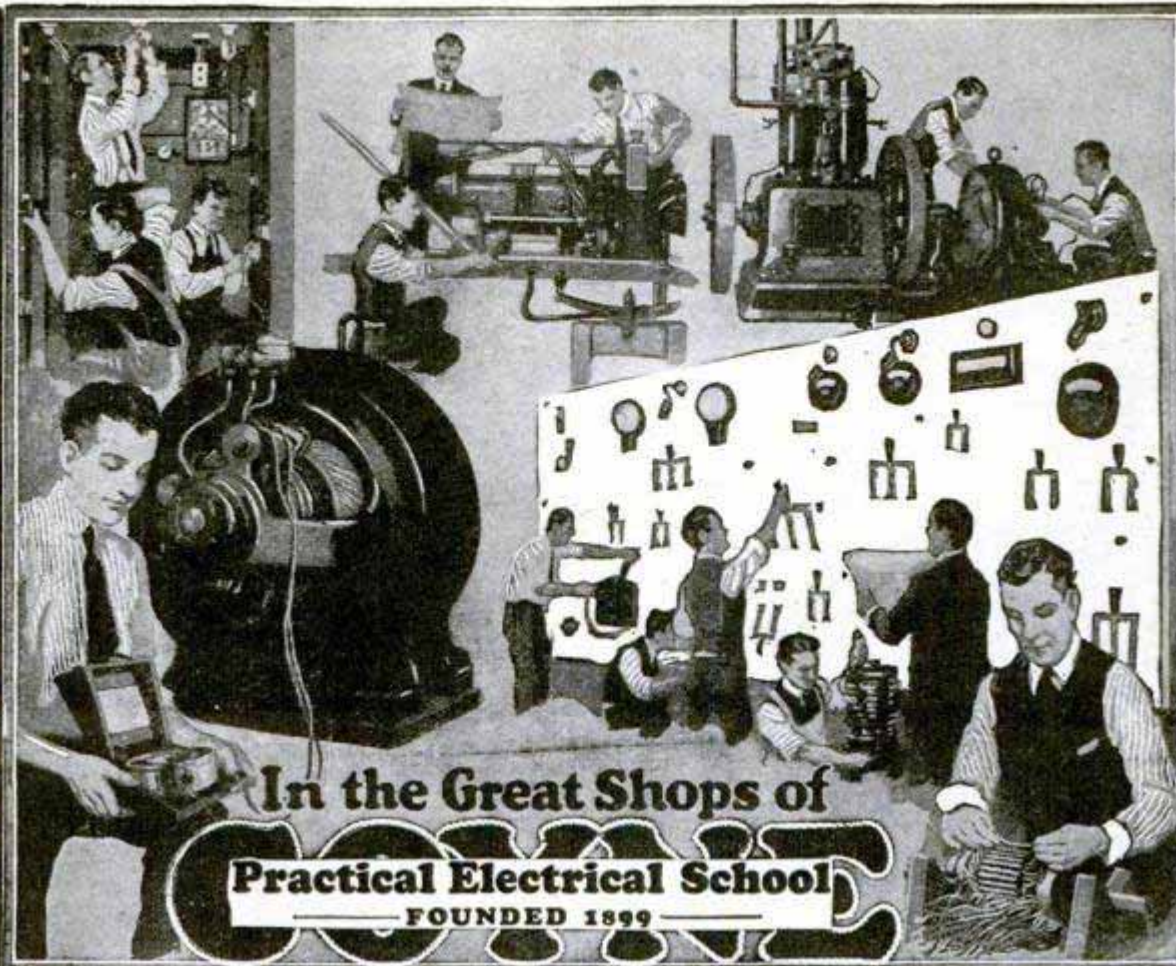

**ELECTRICITY**

In the Great Shops of  
**COYNE**  
 Practical Electrical School  
 FOUNDED 1899

**MAKE \$200 to \$800 A MONTH**

**EARN BIG PAY!**  
**Make \$200 to \$800 a Month**

Why work for small pay. Why be satisfied to make \$25.00 or \$30.00 or even \$40.00 a week in a disagreeable job where you never know when you might get fired. Do pleasant work. Be an **ELECTRICAL EXPERT** and earn \$200.00 to \$800.00 a month or go in business for yourself and earn up to \$10,000 a year.

**All Practical Work, No Books**

I train you on actual Electrical Machinery. I don't teach you a lot of useless theory. My training gives you useable knowledge on the same kind of machinery you will find in Power Houses, Plants and industrial businesses.

**Free Railroad Fare to Chicago**

For a short time I'll pay your Railroad Fare to Chicago, and besides I'll include Free my two big Courses, Auto and Radio Electricity.

**My Big Free Book Tells Complete Story**

I haven't space here to tell you the advantages of my training but I'll send **ABSOLUTELY FREE** my big new book with over 150 actual photographs and success stories of my graduates. It tells you all about my employment service after graduation and how you can earn your expenses while attending my school. **FILL OUT THE COUPON NOW AND MAIL IT AT ONCE.** You owe it to yourself to get the facts.

H. C. Lewis, Pres.  
**Coyne Electrical School**  
 1300-1320 W. Harrison St.  
 Dept. 17-72 Chicago, Ill.  
 Dear H. C.—I sure want to get all the facts. Send me that big handsome 12x15 inch book. Of course I'm under no obligations and it doesn't cost me a cent.

**COYNE** Founded 1899 H. C. Lewis, Pres.  
**ELECTRICAL SCHOOL**  
 Dept. 17-72  
 1300-1320 W. Harrison St. Chicago, Ill.

Name.....  
 Address.....  
 Town.....  
 State.....

**IN 3 MONTHS**

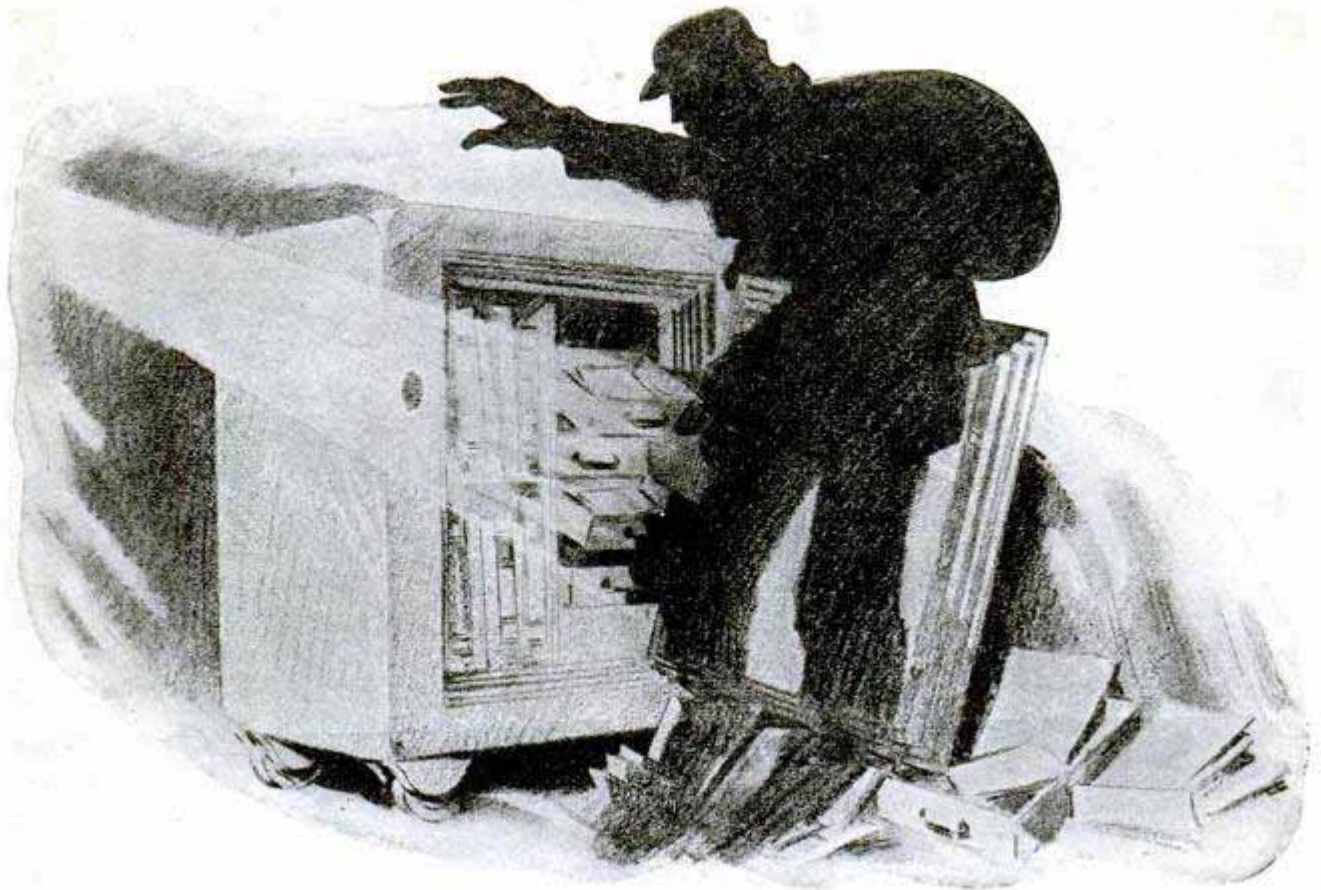

## Follow This Shadow!

**G**O ALONG step by step with operator 38 in tracking down the crook. See how a crafty detective works. How he finds the telltale finger prints—how he tricks the suspect into leaving his prints on the silver cigarette case. More exciting than fiction, yet true, every word of it. No cost or obligation. Just mail the coupon for —

## **FREE** Confidential Reports of Secret Service Operator No. 38

And the best part of it all is this. It may open your eyes to the great future for YOU as a highly paid Finger Print expert. More men are needed right now. This school has taken men just like you and trained them for high official positions. This is the kind of work you would like. Days full of excitement. Big salaries. Rewards.

**UNIVERSITY OF APPLIED SCIENCE**  
1920 Sunnyside Ave., Dept. 93-51 Chicago, Ill.

Gentlemen:—Without any obligation whatever, send me the Free Reports of Operator No. 38 and your new, fully illustrated Free book on Finger Prints.

Name .....

Address .....

Age .....

**Many Earn \$2500 to \$10,000 a Year**  
**You Study at Home in Spare Time**

No advance education is needed. Any man who can read and write, and think can make good. A wonderful book tells all about what others have done. Shows pictures of real crimes and the men who solved them. We'll send you a FREE copy with the free reports. Get the special offer now being made. Mail the coupon.

**University of Applied Science**  
1920 Sunnyside Ave., Dept. 93-51 Chicago, Illinois

# Complete Electrical Engineering Course

**2<sup>in</sup> years**  
**At Home**

**—backed with an agreement to help you find a better job at a 50% raise in pay or money refunded**

We invite ambitious men to look into this combination training and employment offer. It gives you the chance you've been waiting for—to learn **Electrical Engineering** and get into a billion dollar industry with the equipment to get ahead fast.

## Electricity Offers Unlimited Opportunities

Learn **Electrical Engineering** and you can take your choice of many fine, well-paid positions. Or go into some profitable branch of it, in business for yourself. Men denied an early education, men who are in lines of work with little chance to get ahead, men who are working too hard at too small pay—are invited to mail the coupon below for details of our astonishing offer to prepare you for an **Electrical Engineer's** position, and then to help you find it.

### “Can I learn Electrical Engineering?” you ask

“Can I make good in Electricity?” “Can I afford this training?” I'll answer all these questions to your satisfaction. I'll prove to you that with the backing of this million-dollar institution you have education enough to learn **Electrical Engineering** and get ready for a better job and bigger pay.

### Start with the Coupon

Get the **FACTS** about your opportunities in Electricity—they're greater than you ever dreamed. Get 5 Job-Tickets (**FREE**) to see how easy and practical this instruction has been



## 5 Job-Tickets FREE

Carl H. Dunlap, E. E.  
American School, Dept. E-174,  
Drexel Ave. & 58th St., Chicago.  
Send 5 Electrical Job-Tickets **FREE** and information about the opportunities for me in **Electrical Engineering**.

Name.....  
St. No.....  
City..... State.....



made. Finally, get the facts about our agreement to help you better your position and salary which for the first time assures men who take home training of the results they seek, or money refunded. Coupon brings everything—mail at once!

**CARL H. DUNLAP, E. E.**  
**American School**  
Dept. E-174  
Drexel Ave. and 58th St.  
**CHICAGO**



### THE American School

offers home-training prepared by over 200 of America's leading engineers, executives, and educators. Chartered 30 years ago as an educational institution **NOT FOR PROFIT**, like the best resident schools and colleges.

### New, Simplified, Rapid Method —with Lessons, Job-Tickets, and Outfits

Particularly adapted to men with only common schooling. Starts at the very beginning of elementary Electricity and carries you along by easy stages through **Electrical Engineering** subjects. The theory and laws in lessons. Actual practice provided with seven outfits of standard tools and materials, which we supply without extra charge, combined in a new way with Job-Ticket instructions.

### Training Built by 29 Noted Engineers

We have engaged recognized authorities in each branch of Electricity to prepare this instruction, men from the greatest corporations and universities in the U. S.

1. General Electric Co.
  2. Commonwealth Edison
  3. Cutler-Hammer Co.
  4. American Telephone & Telegraph Co.
  5. Westinghouse Electric & Mfg. Co.
  6. Western Electric Co.
  7. Underwriters Lab.
  8. Columbia University
  9. Dartmouth College
  10. Massachusetts Inst.
  11. Armour Institute.
- and many others.

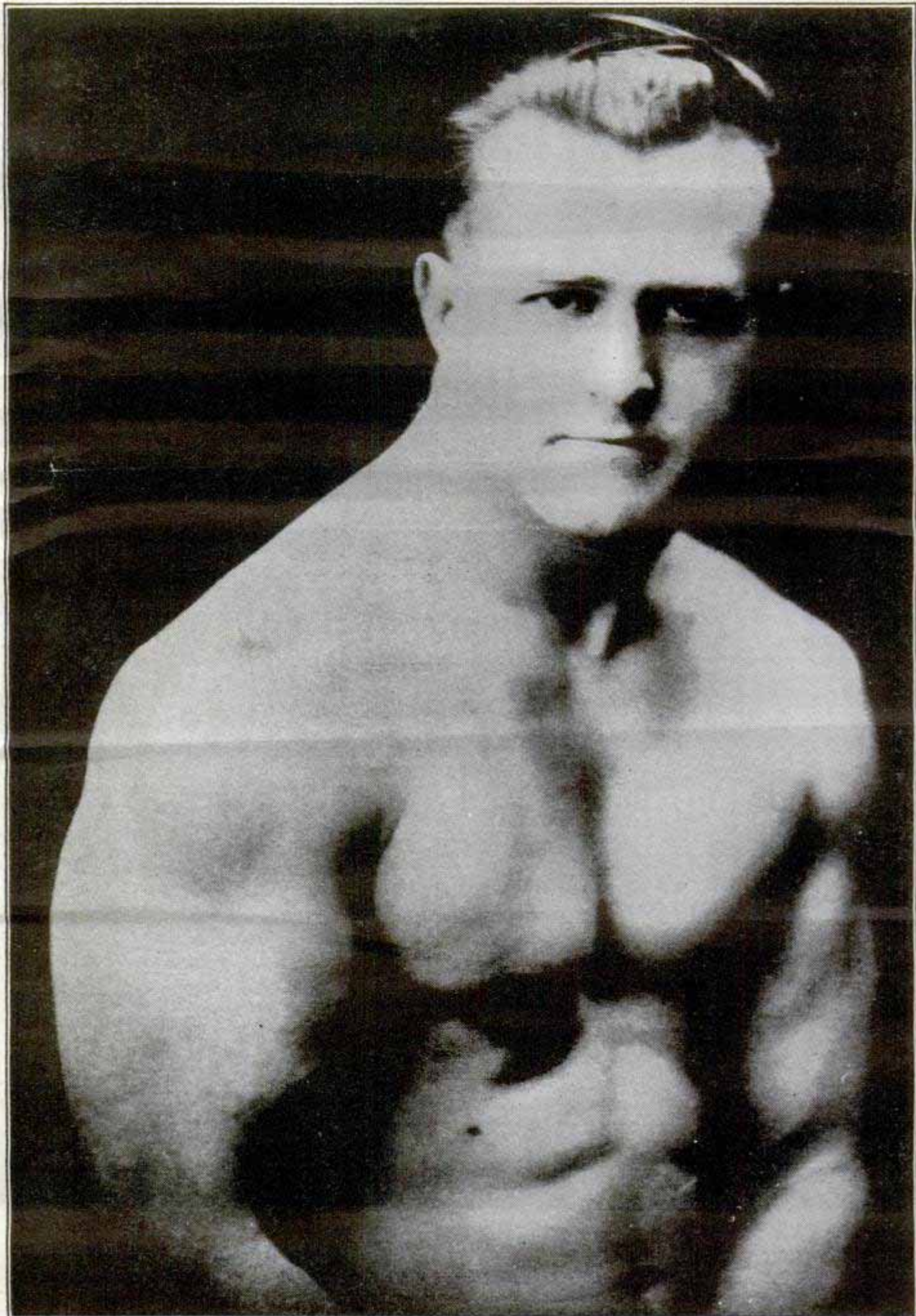

**EARLE E. LIEDERMAN, *The Muscle Builder***

*Author of "Science of Wrestling," "Muscle Building," "Secrets of Strength," "Here's Health," "Endurance," etc.*



# If You Were Dying To-night

and I offered something that would give you ten years more to live, would you take it? You'd grab it. Well, fellows, I've got it, but don't wait till you're dying or it won't do you a bit of good. It will then be too late. Right now is the time. Tomorrow or any day, some disease will get you and if you have not equipped yourself to fight it off, you're gone. I don't claim to cure disease. I am not a medical doctor, but I'll put you in such condition that the doctor will starve to death waiting for you to take sick. Can you imagine a mosquito trying to bite a brick wall? A fine chance.

## A RE-BUILT MAN

I like to get the weak ones. I delight in getting hold of a man who has been turned down as hopeless by others. It's easy enough to finish a task that's more than half done. But give me the weak, sickly chap and watch him grow stronger. That's what I like. It's fun to me because I know I can do it and I like to give the other fellow the laugh. I don't just give you a veneer of muscle that looks good to others. I work on you both inside and out. I not only put big, massive arms and legs on you, but I build up those inner muscles that surround your vital organs. The kind that give you real pep and energy, the kind that fire you with ambition and the courage to tackle anything set before you.

## All I Ask Is Ninety Days

Who says it takes years to get in shape? Show me the man who makes any such claims and I'll make him eat his words. I'll put one full inch on your arm in just 30 days. Yes, and two full inches on your chest in the same length of time. Meanwhile, I'm putting life and pep into your old back-bone. And from then on, just watch 'em grow. At the end of thirty days you won't know yourself. Your whole body will take on an entirely different appearance. But you've only started. Now comes the real works. I've only built my foundation. I want just 60 days more (90 in all) and you'll make those friends of yours who think they're strong look like something the cat dragged in.

## A Real Man

When I'm through with you you're a real man. The kind that can prove it. You will be able to do things you had thought impossible. And the beauty of it is you keep on going. Your deep, full chest breathes in rich, pure air, stimulating your blood and making you just bubble over with vim and vitality. Your huge square shoulders and your massive muscular arms have that craving for the exercise of a regular he-man. You have the flash to your eye and the pep to your step that will make you admired and sought after in both the business and social world.

This is no idle prattle, fellows. If you doubt me, make me prove it. Go ahead, I like it. I have already done this for thousands of others and my records are unchallenged. What I have done for them, I will do for you. Come then, for time flies and every day counts. Let this very day be the beginning of new life to you.

Send For My New  
64 Page Book

# "Muscular Development"

IT IS FREE

It contains over four dozen full-page photographs of myself and some of the many prize-winning pupils I have trained. Some of these came to me as pitiful weaklings, imploring me to help them. Look them over now and you will marvel at their present physiques. This book will prove to be an impetus and a real inspiration to you. It will thrill you through and through. And it's all yours, I don't ask a cent. This will not obligate you at all, but for the sake of your future health and happiness do not put it off. Send today—right now before you turn this page.

**EARLE E. LIEDERMAN**

Dept. 2001

305 Broadway, New York City

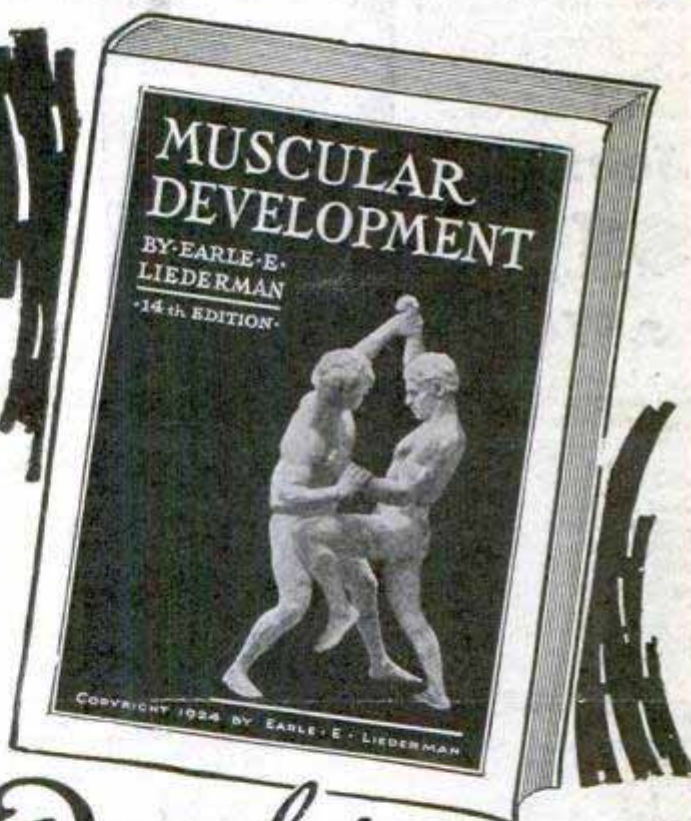

It  
Is  
F  
R  
E  
E

DON'T  
SEND ONE  
PENNY  
—  
YOUR  
NAME  
AND  
ADDRESS  
ON A  
POSTAL  
WILL DO

**EARLE E. LIEDERMAN**

Dept. 2001, 305 Broadway, New York City

Dear Sir: Please send me, without any obligation on my part whatever, a copy of your latest book, "Muscular Development." (Please write or print plainly.)

Name.....

Street.....

City..... State.....

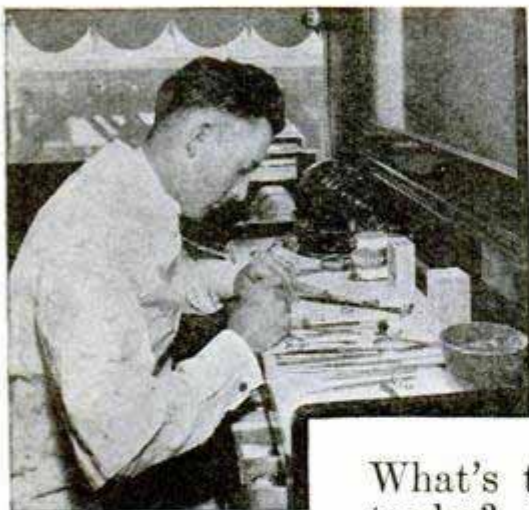

# This Dental Laboratory Expert earns \$20 a day!

What's the use of training for the old, overcrowded trades? If you're going to prepare for big-salaried jobs

or a profitable business of your own GET INTO THE FASTEST GROWING PROFESSION—"Laboratory Dentistry." Biggest opportunity for success of the century, because there are ten times as many jobs as men to fill them, because there are a dozen cities crying for Laboratories for each EXPERT capable of operating one!

Easiest, pleasantest work you ever saw! Your own boss, money and success yours from the very beginning. You can start with a "shoe-string." We prepare you in a few months to run a business of your own, to do any job. Common schooling, ability to use your fingers ALL YOU NEED! Free R. R. Fare to Chicago, Cleveland, Detroit, Boston or Philadelphia for a limited time!



**Jobs Up to \$125 a Week!**

In a business where there are many times as many jobs as Experts, salaries are high, hours are easy, opportunities are everywhere! Dentists recognize the high-standing of our graduates. No books here—learn with tools and instruments. Start quick—get ready in a few months for your big opportunity! Mail Coupon today!

**FREE!**  
R. R. Fare  
TO  
Chicago  
Cleveland  
Detroit  
Boston  
or  
Phila.

## Rubber Plates

Learn to make partial upper or lower plates with soldered, cast or wire clasps, with palatal bars; with lingual bars. McCarrie-trained Students learn to make full rubber plates of every type, including Vulcanite base-plates, butted gums, carved gums, etc.

## CROWNS

Here's only a small part of your practical training in Crown-work: Two-piece, seamless, open-face, Richmond, cast-base porcelain, Carmichael, split-pin, carved (swaged) cusp, cast cusp, etc.

## BRIDGE WORK

Complete training in both fixed and removable bridgework. Interchangeable teeth, gold dummy, Sanitary porcelain dummy jobs—Roach, Gilmore, Bischoff and all forms of east-clasp work is taught—not with books but in actual Laboratory.

## METAL BASE DENTURES

Cast bases of Aluminum, Watt's metal, etc., are included in your training. Both centrifugal and air pressure casting machines are used. Free Book contains complete list of subjects in course.

## 64,000 DENTISTS NEED LABORATORY WORK!

Only a few hundred Laboratories in all the U. S.—most of them in the larger cities. Dentists can't afford to do their own mechanical jobs. They can buy the services of a Laboratory Expert at about \$3.00 an hour and sell their own time at \$6 to \$15 an hour. Dentists will encourage you to learn mechanical Dentistry, start a "Lab" of your own, give them quicker service than sending their work to other cities. Dentists can't wait and keep their patients waiting.

## WE HELP YOU OPEN A LABORATORY OF YOUR OWN!

Many of my graduates open a Laboratory of their own. To encourage more men to go into this wonderful Mechanical profession, we will help you find a good location for your Laboratory, and help you make a success of it. Write for complete information on how you can find yourself in a profitable business of your own after you become a Dental Laboratory Expert.

## INTERESTING BOOK—FREE!

Right this minute there are openings for 150 Dental Laboratory Experts in locations where they can do a business of \$5,000 to \$20,000 a year. But you can't cash in, take advantage of these OPPORTUNITIES until you're Trained. Catalog tells you how quickly and easily you can get ready, how hundreds of others have SUCCEEDED! Tells you how you learn in a few months BY DOING ACTUAL LABORATORY JOBS in the world's greatest Dental Laboratory Schools. Brings you FREE R. R. Fare offer and other big inducements. Write for free Book today!

### EARN while you LEARN!

Day students make all or part cost of course by part-time night work. Night students can find plenty of good jobs "to see them thru."

We'll help you!

## McCarrie School of Mechanical Dentistry

1338 S. Michigan Ave.  
Dept. 62 Chicago, Ill.

McCarrie School of Mechanical Dentistry  
1338 S. Michigan Ave., Dept. 62, Chicago, Ill.

Without obligation, please send me your Free R. R. fare offer and free Book with complete information about how I may become a Mechanical Dentist. How you will help me open a Laboratory, how you will help me find a job while I take my training, etc.

Name.....

St. No. or R. F. D.....

City.....State.....



**James Jacobsen, Winchester, Ky.**  
When I took up the N. S. T. A. course, I was selling shoes for \$35 a week. Now I am earning an average of \$135 a week. I attribute this remarkable progress to N. S. T. A. training.



**C. W. Birmingham, Dayton, O.**  
A few years ago I was working in a shop for \$15 a week. Immediately upon completion of my course I was offered a position through N. S. T. A. My earnings were from \$5,000 to \$6,500 per year. Today I am earning \$7,500 per year.



**F. B. Englehardt, Chattanooga, Tenn.**  
Without this training I would still be working for the other fellow. This year I will make close to \$7,000 — some increase since my enrollment.



**Frank Walsh, Springfield, Mass.**  
I was clearing around \$1,000 a year when I was enrolled with N. S. T. A. I have increased my income to \$7,286. I now own my home, drive a nice car, and have a summer camp. My grateful thanks to N. S. T. A.



**J. E. GREENSLADE, President National Salesmen's Training Association**

# You're Fooling Yourself

## -if You Think These Big Pay Records Are Due to LUCK!

But don't take my word for it! When I tell you that you can quickly increase your earning power I'LL PROVE IT! FREE! I'll show you hundreds of men like yourself who have done it. And I'll show you how you can do it, too.

I'LL come directly to the point. First you'll say, "I could never do it: These men were lucky." But remember the men whose pictures are shown above are only four out of thousands and if you think it's luck that has suddenly raised thousands of men into the big pay class you're fooling yourself!

### Easy to Increase Pay

But let's get down to your own case. You want more money. You want the good things in life, a comfortable home of your own where you can entertain, a snappy car, membership in a good club, good clothes, advantages for your loved ones, travel and a place of importance in your community. All this can be yours. And I'll prove it to you, Free.

First of all get this one thing right: such achievement is not luck—it's KNOWING HOW! And KNOWING HOW in a field in which your opportunities and rewards are ten times greater than in other work. In short, I'll prove that I can make you a Master Salesman—and you know the incomes good salesmen make.

Every one of the four men shown above was sure that he could never SELL! They thought Salesmen were "born" and not "made."

When I said, "Enter the Selling Field where chances in your favor are ten to one," they said it couldn't be done. But I proved to them that this Association could take any man of average intelligence—regardless of his lack of selling experience—and in a short time make a MASTER SALESMAN of him—make him capable of earning anywhere from \$5,000 to \$10,000 a year. And that's what I'm willing to prove to you, FREE.

### Simple as A. B. C.

You may think my promise remarkable. Yet there is nothing remarkable about it. Salesmanship is governed by rules and laws. There are certain ways of saying and doing things, certain ways of approaching a prospect to get his undivided attention, certain ways to overcome objections, batter down prejudice and outwit competition.

Just as you learned the alphabet, so you can learn salesmanship. And through the NATIONAL DEMONSTRATION METHOD—an exclusive feature of the N. S. T. A. System of Salesmanship Training—you gain the equivalent of actual experience while studying.

The N. S. T. A. System of Salesmanship Training and Employment Service will enable you to quickly step into the ranks of successful salesmen—will give you a big advantage over those who lack

this training. It will enable you to jump from small pay to a real man's income.

### Remarkable Book, "Modern Salesmanship," Sent Free

With my compliments I want to send you a most remarkable book, "Modern Salesmanship."

It will show you how you can easily become a Master Salesman—a big money-maker—how the N. S. T. A. System of Salesmanship Training will give you years of selling experience in a few weeks; how our FREE Employment Service will help select and secure a good selling position when you are qualified and ready. And it will give you success stories of former routine workers who are now earning amazing salaries as salesmen. Mail the attached coupon at once and you will have made the first long stride toward success.



Dept. A-12

N. S. T. A. Building,

Chicago, Ill.

National Salesmen's Training Association, N. S. T. A. Building, Dept. A-12 Chicago, Ill.

Send me free your book, "Modern Salesmanship," and Proof that I can become a MASTER SALESMAN.

Name.....

Address.....

City..... State.....

Age..... Occupation.....

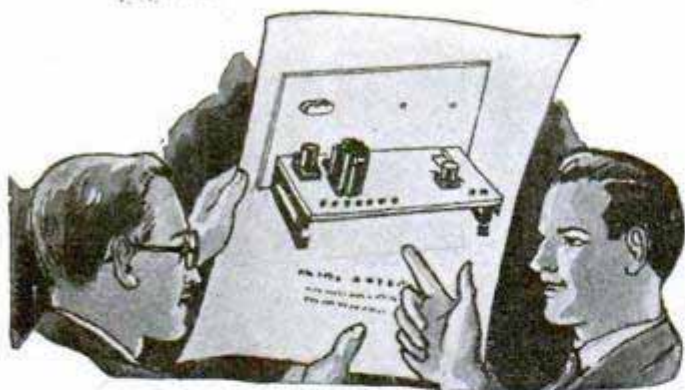

# DRAW PICTURES OF YOUR IDEAS

## Get the "Knack" In One Evening

A good picture is worth a million words. Pictures are easy for any mind to grasp QUICKLY. Every salesman, inventor, clerk, business man, professional man, should know how to make PICTURES of his ideas. And now you don't need to say, "If I could only draw, I'd show you how it works!" You CAN draw, once you learn "Perspective"! Joseph Cummings Chase will show you quickly and easily, in this simple, new way. Also, how to make fine lettering, designs from flowers and animals, make posters, draw heads and faces.

### Remarkable New Method

When you try to make your sketches look "real" on paper, you are bothered by ignorance of "Perspective." You wonder how to make flat surfaces "lie down"; how to make curved ones "round out." It's easy when you know the secret. Just a few lessons on "Free Hand Drawing," by Joseph Cummings Chase, the famous artist, will give you the whole trick of using "Perspective" correctly. Then you can draw mechanical objects, houses, and people in any position, just as you imagine them.

### Five Days' Trial — Send No Money

You can examine Mr. Chase's remarkable course in FREE HAND DRAWING (in 12 lessons) without obligating yourself in any way. Just send address on coupon, without money. Pay postman only \$1.95 plus postage. Money back at once if desired. Easiest way to get the whole knack of drawing.

Mail the coupon today.

**DRAW**  
Faces  
Figures  
Inventions  
Lettering  
Posters  
Etc.

**Arthur R. Patterson,**  
21 Wisner Building,  
Rochester,  
N. Y.

Arthur R. Patterson,  
21 Wisner Bldg.,  
Rochester, N. Y.

You may send me Mr. Chase's "FREE HAND DRAWING" in 12 lessons. I will pay postman \$1.95 plus postage, but can return course within five days for full refund of money if I am not fully satisfied.

Name .....

Address .....

City.....State.....

(Outside U. S. \$2.25, cash with order)



... and, perhaps you, too, due to the lack of money, time and education necessary to master a trade, wonder what to get into *quickly* and make the most out of. Haven't you *overlooked* the very thing you are looking for? 60,000 Moler graduates *know* Modern Barbering is easy to learn, *quick* to earn, *clean* and **FASCINATING!** **FIND OUT!** Write for catalog "B-1."

Address the Branch  
of the **MOLER SYSTEM OF COLLEGES** nearest you.  
(Street address not needed)

- |                  |                  |                     |
|------------------|------------------|---------------------|
| Chicago, Ill.    | Detroit, Mich.   | Fargo, N. D.        |
| New York, N. Y.  | Denver, Colo.    | Memphis, Tenn.      |
| St. Louis, Mo.   | New Orleans, La. | Dallas, Tex.        |
| Kansas City, Mo. | Omaha, Nebr.     | Houston, Tex.       |
| Cincinnati, Ohio | Milwaukee, Wis.  | San Antonio, Tex.   |
| Cleveland, Ohio  | Atlanta, Ga.     | Toronto, Ont., Can. |

## STAMMER

Write for my free book "Millard's Advanced Natural Corrective Course" and a free copy of my speech magazine. 10,000 cases successfully treated. Est. 24 years. Largest school for stammerers in world. Millard Inst. of Normal Speech, 2317 Millard Bldg., Milwaukee, Wis.



Wonderful, new device, guides your hand; correct your writing in few days. Big improvement in three hours. No failures. **Complete outline FREE.** Write C. J. Ozment, D-34, St. Louis, Mo.



**WHY NOT** spend Spring, Summer and Fall gathering butterflies, insects? I buy hundreds of kinds for collections. Some worth \$1 to \$7 each. Simple outdoor work with my instructions, pictures, price-list. Send 10 cents (not stamps) for my illustrated Prospectus before sending butterflies.  
**MR. SINCLAIR, DEALER IN INSECTS,**  
Dept. 6. Box 1424. San Diego, Calif.

## LEARN WATCH REPAIRING



You can learn by our modern and original system of instruction every part of the **Watch Repairing Trade** at home as good or better than at a shop. You can earn money while learning and secure a well paying position or start in business after completing our course of instruction. Good watch repairers are always in demand and earn from \$50 to \$75 per week. For particulars apply to the **Wisconsin School of Watch Repairing**  
166 Mason St., MILWAUKEE, WIS.

# FREE!



**"MEN! Here's  
the 'dope' you've  
been looking for-**

**How TO GET INTO THE  
RADIO BUSINESS"**

J.E.S.

**\$50 to \$250 a Week  
in Work That is  
Almost Romance**



**These Instruments  
FREE of Extra Cost**

All instruments shown here and others—SIX BIG OUTFITS—sent to all our students free of extra cost under short time special offer. **Clip coupon now**—find out all about this big unequalled offer while you still have time to take advantage of it. Our training is intensely practical—these instruments help you learn to do the practical work. Receiving sets, from simplest kind to thousand-mile receiver. Many other big features.

**My Radio Training Is the Famous  
"Course That Pays for Itself"**



**J. E. SMITH  
President**

Spare time earnings are easy in Radio when you know it the way we teach you. Increase your income almost from the start of your course thru practical knowledge we give you. We show you how to hold the job, then our big Free Employment Department helps you get one. Free Book "Rich Rewards in Radio" tells how.

Howard B. Luce of Friedens, Pa., made \$320 in 7 weeks during his spare time. D. H. Sult of Newport, Ark., writes, "While taking the course I earned in spare time work approximately \$900." Earl Wright of Omaha, reports making \$400 in a short time while taking his course—working at Radio in his spare time only! Sylvester Senso, 207 Elm Street, Kaukauna, Wis., made \$500.

And when your training is completed you're ready to step into a real big Radio job like C. C. Gielow, Chief Operator of the Great Lakes Radio Telegraph Company; E. W. Novy, Chief Operator of station WRNY; Edward Stanko, Chief Operator of Station WGR; and hundreds of other N. R. I. trained men. The National Radio Institute, originators of Radio Home-Study Training, established 1914, today offers you the same opportunity these men had, under a bond that guarantees you full satisfaction or money refunded. It's your big chance to get into Radio!—mail coupon for FREE Book and proof!

If you're earning a penny less than \$50 a week, clip coupon now for FREE BOOK! New book, profusely illustrated, tells all about the Radio Profession, thousands of openings—in work that is almost romance! YOU can learn quickly and easily at home, through our tested, improved methods, to take advantage of these great opportunities! Why go along at \$25 or \$35 or \$45 a week, when you can pleasantly and in a short time learn to be a Radio Expert, capable of holding the big jobs—paying \$50 to \$250 a week?

**Clip Coupon for Free Book**

Don't envy the other fellow who's pulling down the big cash! Our proven home-study training methods make it possible for you, too, to get ready for a better job, to earn enough money so you can enjoy all the good things of life. Most amazing book ever written on Radio tells how—thousands of interesting facts about this great field, and how we can prepare you, quickly and easily in your spare time at home, to step into a big-pay Radio job. You can do what thousands of others have done through our training. GET THIS NEW FREE BOOK. SEND COUPON TODAY.

**J. E. SMITH, President**

**National Radio Institute  
WASHINGTON, D. C.**

Dept. A-85

**NOW!  
Special  
Short Time  
Offer  
6  
BIG  
OUTFITS**

**Radio  
Needs  
Trained  
Men**

**National  
Radio  
Institute,  
Dept. A-85,  
Washington,  
D. C.**

Dear Mr. Smith:  
Without obligating me in any way, send me your big FREE BOOK, "Rich Rewards in Radio," and all information about your practical, home-study, Radio Course.

Name.....

Address.....

Town..... State.....

**SEND THIS COUPON TODAY**



# LICKED!

Yes, licked! Twenty-five years old and still working in a small job at a small salary.

Why? Well, chiefly because he felt he didn't need special training. And now that he realizes the need, he still keeps putting it off — and off — and off. He'd rather shoot pool or stand around the corner than spend an hour each night in money-making spare-time study.

And the pity of it is that he has just as much natural ability as most of the men who have gone ahead of him. He could be earning three times his present salary if he only had special training.

Are you like that? Are you going to work for a small salary all your life? Or are you going to get the special training that employers everywhere are looking for? It is for you to decide.

Nobody can force you to mail this coupon to the International Correspondence Schools. That's a matter entirely in your own hands. But remember this — the sooner you send it in, the sooner you are going to get a better job and a better salary.

**INTERNATIONAL CORRESPONDENCE SCHOOLS**  
Box 5621-E, Scranton, Penna.

Without cost or obligation, please send me one of your booklets and tell me how I can qualify for the position or in the subject before which I have marked an X:

**BUSINESS TRAINING COURSES**

- |                                                                  |                                                                           |
|------------------------------------------------------------------|---------------------------------------------------------------------------|
| <input type="checkbox"/> Business Management                     | <input type="checkbox"/> Salesmanship                                     |
| <input type="checkbox"/> Industrial Management                   | <input type="checkbox"/> Advertising                                      |
| <input type="checkbox"/> Personnel Organization                  | <input type="checkbox"/> Better Letters                                   |
| <input type="checkbox"/> Traffic Management                      | <input type="checkbox"/> Show Card Lettering                              |
| <input type="checkbox"/> Business Law                            | <input type="checkbox"/> Stenography and Typing                           |
| <input type="checkbox"/> Banking and Banking Law                 | <input type="checkbox"/> Business English                                 |
| <input type="checkbox"/> Accountancy (including C.P.A.)          | <input type="checkbox"/> Civil Service                                    |
| <input type="checkbox"/> Nicholson Cost Accounting               | <input type="checkbox"/> Railway Mail Clerk                               |
| <input type="checkbox"/> Bookkeeping                             | <input type="checkbox"/> Common School Subjects                           |
| <input type="checkbox"/> Private Secretary                       | <input type="checkbox"/> High School Subjects                             |
| <input type="checkbox"/> Spanish <input type="checkbox"/> French | <input type="checkbox"/> Illustrating <input type="checkbox"/> Cartooning |

**TECHNICAL AND INDUSTRIAL COURSES**

- |                                                                     |                                                                          |
|---------------------------------------------------------------------|--------------------------------------------------------------------------|
| <input type="checkbox"/> Electrical Engineering                     | <input type="checkbox"/> Architect                                       |
| <input type="checkbox"/> Electric Lighting                          | <input type="checkbox"/> Architects' Blueprints                          |
| <input type="checkbox"/> Mechanical Engineer                        | <input type="checkbox"/> Contractor and Builder                          |
| <input type="checkbox"/> Mechanical Draftsman                       | <input type="checkbox"/> Architectural Draftsman                         |
| <input type="checkbox"/> Machine Shop Practice                      | <input type="checkbox"/> Concrete Builder                                |
| <input type="checkbox"/> Railroad Positions                         | <input type="checkbox"/> Structural Engineer                             |
| <input type="checkbox"/> Gas Engine Operating                       | <input type="checkbox"/> Chemistry <input type="checkbox"/> Pharmacy     |
| <input type="checkbox"/> Civil Engineer                             | <input type="checkbox"/> Automobile Work                                 |
| <input type="checkbox"/> Surveying and Mapping                      | <input type="checkbox"/> Airplane Engines                                |
| <input type="checkbox"/> Metallurgy <input type="checkbox"/> Mining | <input type="checkbox"/> Agriculture <input type="checkbox"/> Navigation |
| <input type="checkbox"/> Steam Engineering                          | <input type="checkbox"/> Mathematics <input type="checkbox"/> Radio      |

Name.....  
Street.....  
Address.....

City.....State.....

Occupation.....

Persons residing in Canada should send this coupon to the International Correspondence Schools Canadian, Limited, Montreal, Canada.



## Young outdoor men wanted

Interesting, vigorous outdoor work in a growing organization where merit wins advancement. Good starting wages. Permanent positions and a real future for men who make good. Our present field force of Davey Tree Surgeons cannot meet the increasing demand. So we are selecting now, to enter our employ, a few sturdy, clean young men, thorough Americans, single, between 20 and 30 years old, free to travel, industrious, with good practical education, and able to give good references. Write for qualification blank to serve in place of personal interview.

The Davey Tree Expert Co., Inc.,  
639 Federal Bldg., Kent, Ohio.



**\$100<sup>00</sup> EARNED BY YOUNG ARTIST IN 2 DAYS**

Well-trained artists earn splendid incomes. The Federal home-study Course is a proven result-getter. If you like to draw, send 6c in stamps for 56-page book "Your Future." State your age and present occupation.

**FEDERAL SCHOOL OF COM'L DESIGNING**  
624 Federal Schools Building  
Minneapolis, Minn.

# Music Lessons

## UNDER MASTER TEACHERS

# At Home

### A Complete Conservatory Course by Mail

Wonderful home study music lessons under great American and European teachers. Endorsed by Faderewski. Master teachers guide and coach you. Lessons a marvel of simplicity and completeness.

The only recognized Conservatory of Music giving lessons by the UNIVERSITY EXTENSION METHOD.

The ideal of a genuine Conservatory of Music for home study based upon lessons containing the cream of the life's teaching experience of Master Musicians, reinforced by the individual instruction of specialists, is now attained.

*The instruction of a master—the individual touch of an accomplished teacher—is yours to command from the very moment you enroll.*

The University Extension Conservatory, by adopting the Personal Instruction Method, has placed home music study beyond question as to results. Anyone can learn at home.

**Any Instrument** Write telling us course you are interested in—Piano, Harmony, Voice, Public School Music, Violin, Cornet, Mandolin, Guitar, Banjo, or Reed Organ—and we will send our Free Catalog with details of course you want. Send now.

**UNIVERSITY EXTENSION CONSERVATORY**  
350 Siegel-Myers Building Chicago, Illinois

# These Real Blue Prints and two Books Sent **FREE**

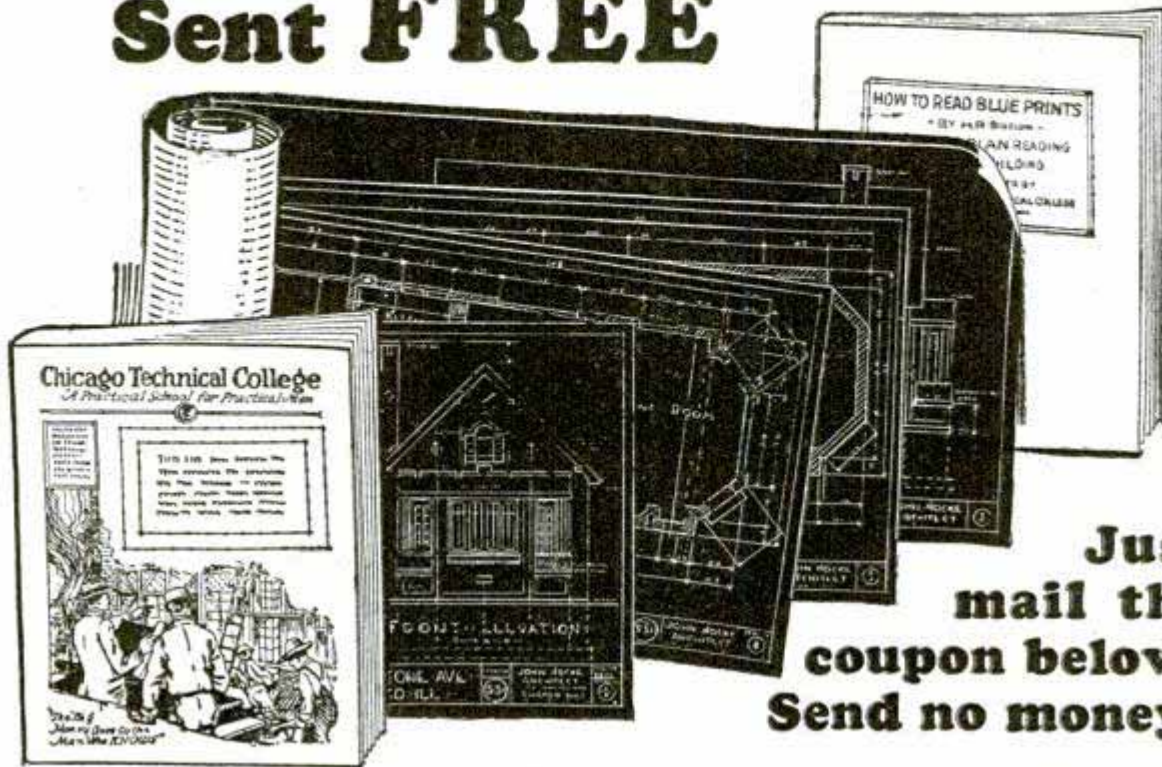

**Just  
mail the  
coupon below!  
Send no money!**

Every builder can get these real blue print plans and our book "How To Read Blue Prints" without sending us a penny. Just send the coupon. Lots of valuable and interesting information—all free. Yes, and we'll send along another book on building; it tells why "the big money goes to the man who *knows*." It explains the practical Chicago Tech. easy method of home-training for men in the building trades. Learn how to get the jobs that pay most money or how to get into your own business as a building contractor.

## **Plan Reading—Estimating—Superintending, etc.**

**Train at Home to MAKE MORE MONEY No Schooling Necessary**

Learn how to read plans, lay out work and run jobs. Your spare time is enough. Wherever you may be—whatever your job—we can help you quickly to fill a higher place and have a bigger income. Age does not matter. Previous school training is not needed. This is a practical course for practical men, prepared by practical instructors who have been through every branch of the building game themselves. You owe it to yourself to find out how to make more money.

### **To Builders Living in or Near Chicago**

Visit our Day or Evening School for builders and see with your own eyes the work we do. 1000 builders attend each year. You can get the same training *at home*. Same lessons—same blue prints—same practical instructors—same successful results.

**Get the Facts** Find out how little time it takes to make more money—much more money—in building. Write today. The coupon brings all *Free*.

**Chicago Technical  
SCHOOL for BUILDERS**

Dept. A-140, 118 East 26th St., Chicago, Ill.

### **Mail the Coupon—NOW**

**Chicago Technical  
SCHOOL for BUILDERS**

Dept. A-140, 118 East 26th St., Chicago, Ill.

Please send me without obligation. Free and Postpaid, your two Books and Blue Prints for Builders. It is understood that no salesman will call on me.

**(Please Write or Print Name Plainly)**

Name.....

Address.....

City.....State.....

Age.....Occupation.....



**Earn Big Money as a Cartoonist!**

Millions of dollars were spent last year on comic strips, political and sport cartoons, animated cartoons, etc. Scores of new good cartoonists are needed now to meet the ever-increasing demand for this work. Never before have the opportunities in this fast-growing field been so many, so varied or so high-paying.

**Easy Now to Learn CARTOONING at Home**

Regardless of how little you know about cartooning now, you can easily be qualified for a position in this attractive, high-salaried business. This home-study method starts you at the simplest fundamental principles of cartoon-making and takes you through every branch of humorous and serious cartooning.

You will be amazed at how quickly it teaches you to draw salable work. Many students of this method began to sell their drawings before they were half through their courses. The training paid for itself long before they finished it.

Learn cartooning this easy way. Enjoy the fascinating life of a successful cartoonist—easy hours, freedom from routine, your own boss, and \$3,000 to \$15,000 a year for this work that is play!

**Send for FREE BOOK**

Learn more about the wonderful opportunities in Cartooning, and details about this remarkable home-study method. A handsomely illustrated booklet has just been prepared which, upon request, will be sent to you without the slightest obligation. This booklet gives a thorough outline of the cartooning field, and explains in detail this wonderful method of teaching cartooning. Send for it today! Washington School of Cartooning, Room 301-E, 1113-15th Street, N. W., Washington, D. C.



**Washington School of Cartooning**  
Room 301-E, 1113-15th St., N. W., Washington, D. C.

Please send me, without obligation, your Free Booklet on Cartooning and full details of your home-study method of teaching Cartooning.

Name .....  
(Print Name Plainly)

Address .....

City.....State.....

(If under 16, please give age.....)

**CAMERA FREE**



**Your Choice—\$100 Professional MOTION PICTURE Camera or Professional View Camera**

Be a Motion Picture Cameraman, Portrait, News or Commercial Photographer. Earn a handsome salary or own a studio and set your own prices! No experience needed. Spare time work. Big money to be made while you are learning!

**Learn Photography At Home**

A few minutes a day fits you for a big paying position and you get your choice of these standard professional cameras absolutely FREE.

Cameramen and photographers are always in demand. You can quickly qualify for this easy, fascinating work.

**Earn \$75 to \$250 a week**

Big money in all branches. Hundreds of positions now open pay \$75 to \$250 a week and more! The most interesting profession in the world. Write for FREE BOOK.

Send name and address for big, new, illustrated book on Professional Photography. Explains amazing opportunities. Write for your copy tonight!

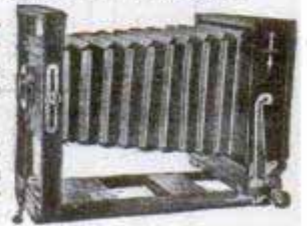

**NEW YORK INSTITUTE OF PHOTOGRAPHY**  
Dept. 49 12 West 33rd St., New York City

**Write NOW for FREE BOOK**

NOTE—If you prefer to come to one of our studios for instruction write for Catalog R-49 to nearest address: 10 West 33rd St., New York City, or 630 S. Wabash Avenue, Chicago.

**LEARN WATCH REPAIRING**

Be a watchmaker—you can learn this profitable trade by correspondence in a few weeks in your own home by the DeSelms Chart System. After you complete the course you will know a watch from A to Z. You will know just what the matter is and how to repair one. When you graduate you will be a practical watchmaker and repairer and competent to fill any position. Positions for our graduates. Ask for our Free Book. It explains our system and terms.



**THE DeSELMS WATCH SCHOOL**  
LOGANSFORT, INDIANA

**“STAMMERING**

**Its Cause and Cure”**

You can be quickly cured if you stammer. Send 10 cents, coin or stamps, for 288 page cloth bound book on Stammering and Stuttering. It tells how I cured myself after Stammering and Stuttering for 20 years. **BENJAMIN N. BOGUE**  
6939 Bogue Building, 1147 N. Ill. St. Indianapolis

**GOV'T. POSITIONS**

**\$35 TO \$75 WEEKLY**

- ( ) Railway Mail Clerk
- ( ) P. O. Clerk
- ( ) Forest Ranger
- ( ) File Clerk
- ( ) Matron
- ( ) General Clerk
- ( ) Chauffeur-Carrier
- ( ) Skilled Laborer
- ( ) Watchman
- ( ) Postmaster
- ( ) RFD Carrier
- ( ) Meat Inspector
- ( ) Special Agent (investigator)
- ( ) Stenographer-Typist
- ( ) Immigrant Inspector
- ( ) City Mail Carrier
- ( ) U. S. Border Patrol
- ( ) Typist
- ( ) Seamstress
- ( ) Steno-Secretary
- ( ) Auditor

Mr. Ozment, Dept. 111, St. Louis, Mo.

Send me particulars about positions marked "X" —salaries, locations, opportunities, etc.

NAME .....

ADDRESS .....



# Discovered!

## The Secret of Caruso's Amazing Vocal Power



"The Songbird of the Ages," Enrico Caruso. The richness, the fullness, the beauty and the astounding power of his voice was due to the exceptional development of his Hyo-Glossus muscles.



Eugene Feuchtinger, musician-scientist, who discovered the function of Hyo-Glossus in voice production, and whose famous "Physical-Voice-Culture" system has developed thousands of voices.

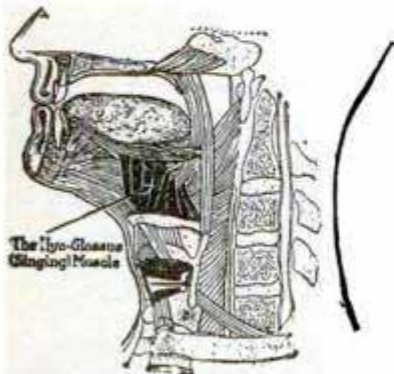

Diagram of the Normal Throat showing the Complete Vocal Mechanism. Your throat looks like this. So did the throat of the great Caruso. The Physical-Voice-Culture system of silent, scientific exercises will develop your vocal organ to its full strength.

**T**HIS IS AN AGE OF MARVELS. Wonderful scientific discoveries have changed our mode of living and our mode of thinking.

One discovery of tremendous benefit to all humanity is the discovery of the principle of voice control by Eugene Feuchtinger, A. M.

His resulting system of voice development revolutionizes old methods, and changes voice development from a little understood art to an exact science.

More than that, it brings a Perfect Voice within the reach of every man and every woman who desires a stronger, richer voice for either singing or speaking.

Prof. Feuchtinger's method is founded on the discovery that the Hyo-Glossus muscle controls the voice; that a strong, beautiful voice, with great range, is due to a well developed Hyo-Glossus—while a weak or a rasping voice is due to under-development of this vital vocal muscle. A post-mortem examination of Caruso's throat showed a superb development of Hyo-Glossus muscles. But it required years of training under the old method to produce this development.

You can develop your Hyo-Glossus in a much shorter time by Prof. Feuchtinger's wonderful scientific method. You can take this training under the direction of the Professor himself, wherever you may live. And the cost is so low that it is within the reach of every ambitious man or woman.

## 100% Improvement in Your Voice—Guaranteed

Professor Feuchtinger's method is far simpler, far more rapid, far more certain in results than the tedious, haphazard methods of ordinary vocal instructors.

Under his direction, your voice will be made rich, full and vibrant. Its overtones will be greatly multiplied. You will add many notes to its range and have them clear, limpid and alluring.

We **ABSOLUTELY GUARANTEE** an improvement of 100 per cent. If you are not absolutely satisfied that your voice is doubled in volume and quality, your money will be refunded. You alone, are to be the judge.

### You Do Not Know Your Real Voice

Until you have tried this system, you cannot know the possibilities of your vocal gifts. Physical-Voice-Culture **PRODUCES** as well as **DEVELOPS** the true voice. It corrects all strain and falsetto and makes clear the wonderful fact that any normal person can develop a fine voice if correctly trained. Thousands of delighted graduates

testify to this. Many of them grand opera stars, concert singers, speakers, preachers, actors and educators.

# FREE!

The Wonderful New Book—  
"Physical-Voice-Culture"

Send the coupon below and we will send you **FREE** this valuable work on voice culture. Do not hesitate to ask. Professor Feuchtinger is glad to have us give you this book. It's free and need not be returned. You will do yourself a great and lasting good by studying this book. It may be the first step in your career. Do not delay. Send the coupon **TODAY!**

**Perfect Voice Institute**

Studio 93-51

1922 Sunnyside Ave., Chicago, Ill.

Please send me copy of your new free book "Physical-Voice-Culture". I understand that this is free and there is no obligation on my part. I am interested in

Singing  Speaking  Stammering  Weak Voice

Name .....

Address .....

# BOYS

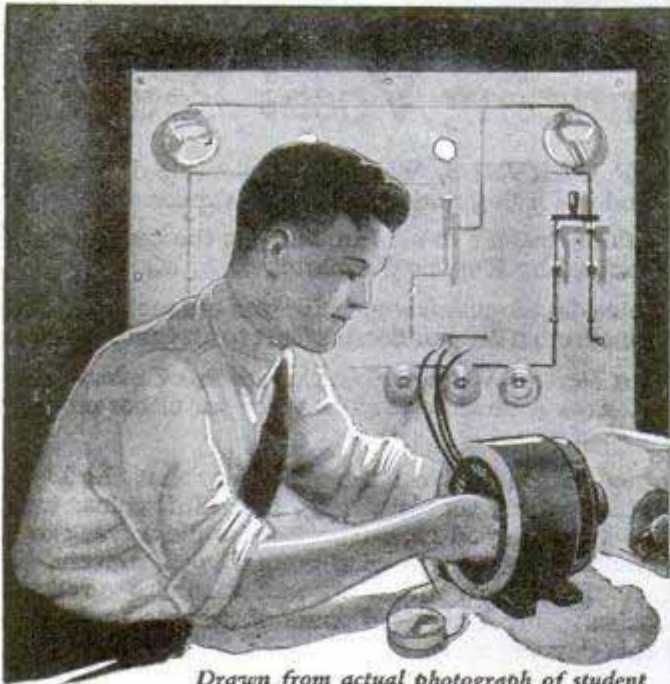

Drawn from actual photograph of student doing spare time electrical work

## Learn Electricity Make Big Money

How would you like to earn two or three dollars every evening after school and prepare yourself for a fine big job at the same time? Here's the opportunity of a lifetime for you fellows who like Electricity. Begin right now to prepare yourself for a regular man's size job in this fascinating field. Your chances for a big success are simply wonderful—the pay is big (thousands of men earn \$70 to \$200 a week) and advancement comes swift and sure.

### I Will Train You at Home

With my easily earned, spare time Electrical Course I will train you at home like I have trained hundreds of other boys who are now big successful men. It will not interfere with your school work and you can earn more than the small cost of the course doing odd electrical jobs in your spare time. The Course pays for itself. I will show you how to get this work and how to do it. Some of my boy students make \$10 to \$15 a week this way.

### Tools, Apparatus and Radio Course—Given Without Extra Charge

Send me the coupon below and I will tell you all about the big outfit of tools, apparatus and instruments and a new Radio Course that I am giving to my students for a limited time. I will send you my big interesting Electrical Book and a sample lesson, too—all Free. You will be tickled with the things I will send you Free. Mail the coupon right now.

L. L. COOKE, Chief Engineer  
Chicago Engineering Works  
Dept. 011 CHICAGO

### Look What This Boy Is Doing

"Although the School term is coming to a close, and I am pretty busy with my examinations, I manage to keep up with my electrical studies and work."

"I guess I forgot to tell you I am now in business for myself. Am doing fine, but owe it all to you. If it had not been for your Course, I, being under age, could not have secured my license in this town. But I got it, and now have all the work I can do, averaging \$20 to \$30 a week, thru spare time work."

"I went out on a job tonight after school, on which I made \$3 and brought home another on which I made \$2.60—\$5.60, for 4 hours' work and no material furnished by me."

ROGERS SMITH,  
1215 Chestnut St.,  
Greenville, N. C.

### Use This "FREE BOOK" Coupon

L. L. COOKE, Chief Engineer,  
Chicago Engineering Works,  
Dept. 011 2150 Lawrence Avenue, Chicago

Send me your Big Outfit Offer, your big Electrical Book, Sample Lesson and particulars of your Electrical Course and Extra Radio Course. This will not obligate me in any way.

Name.....

Address.....

This Coupon only for use of boys 15 years old or more.

Learn to Write

## I Teach by Mail

I CAN make a good penman of you at your home during spare time, no matter where you live or how poorly you now write. My simplified system has shown thousands of others the way to good penmanship during the past twenty years—it can and will do the same for YOU!

### Beautifully Illustrated Book "How to Become a Good Penman" FREE!

It contains general information, with testimonials and beautiful specimens of penmanship showing what others have accomplished by the Tamblin System. (Your name elegantly written on a card if you enclose stamp for postage.) WRITE TODAY. Address

F. W. TAMBLYN  
418 Ridge Bldg., Kansas City, Mo., U. S. A.

F. W. Tamblin



## SAXOPHONE MUSIC Catalog

Just out—complete catalog of latest jazz hits, also standard saxophone solos, duets, trios, quartettes—2,000 selections. Largest general dealers of saxophone music and supplies in the world. Expert repairing. Send for free catalog today.

FINDER & URBANEK Inc., Dept. 2057, 1322 West Congress St., Chicago

## Learn Furcraft

Learn by mail, evenings at home, to Renew, Repair and Make-up all kinds of fur garments. Learn glazing, ironing and storage. Big demand, big need for your service in every neighborhood. \$3 an hour in your spare time or a real business now and a fur shop later. We teach you secret processes. Earnings start in 30 days. Uncrowded field for men and women. FREE BOOK—Send now for free book giving details. No obligation.

Northwestern Fur Co. 1771 Sunderland Bldg. OMAHA, NEBRASKA

## Learn Photography at HOME

Earn \$3,000 to \$10,000 a year. Prepare quickly during spare time. Also earn while you learn. New easy method. Nothing else like it. Send at once for free book, "Opportunities in Modern Photography" and full particulars. Special offer open now. International Studios, Inc., Dept. 1351, 3601 Michigan Ave., Chicago, U. S. A.

## Learn to PAINT SIGNS and SHOW CARDS

We quickly teach you by mail, or at school, in spare time. Enormous demand. Big future. Interesting work. Oldest, foremost school. EARN \$50 TO \$200 WEEKLY. John Vasson, N. Y., gets \$25 for single show card. Crawford, B. C., says, 'Earned \$200 while taking course'. Send today for free information, samples and guarantee. DETROIT SCHOOL OF LETTERING 154 Stimson Ave. Est. 1899 Detroit, Mich.





# Afraid of My Own Voice But I Learned to Dominate Others Almost Overnight

**S**UDDENLY the boss turned to me and 'queried, "Well Conroy, what's your opinion?" They all listened politely for me to speak and in the silence I heard my thin, wavering voice stammering and sputtering a few vague phrases. Like a flash Stoddard interrupted me and launched on a brilliant description of his plan. All sat spellbound as he talked—my views were forgotten—and yet I have been studying the problem for months and I was prepared to suggest a sound, practical plan which I knew would solve all our difficulties.

And that was the way it always was—I was always being given opportunities to show my ability and always failing miserably. I was bashful, timid, and nervous—I never knew how to express myself, how to put my ideas across. In fact, I was actually afraid of my own voice!

In social life, too, I was a total loss—I was always the "left-over"—the one who sat back and watched the others have a good time. I seemed doomed to be an all around failure unless I could conquer my timidity, my bashfulness, my lack of poise and inability to express myself.

## What 15 Minutes a Day Will Show You

- How to talk before your club or lodge
- How to propose and respond to toasts
- How to address board meetings
- How to tell entertaining stories
- How to make a political speech
- How to make after-dinner speeches
- How to write letters
- How to sell more goods
- How to train your memory
- How to enlarge your vocabulary
- How to develop self-confidence
- How to acquire a winning personality
- How to strengthen your will power and ambition
- How to become a clear, accurate thinker

## In 15 Minutes a Day

And then suddenly I discovered a new easy method which made me a powerful speaker almost overnight. I learned how to bend others to my will, how to dominate one man or an audience of thousands. Soon I had won salary increases, promotion, popularity, power. Today I am able to rise to any occasion, to meet any emergency with just the right words. And I accomplished all this by developing the natural power of speech possessed by everyone, but cultivated by so few—by simply spending 15 minutes a day in the privacy of my own home.

There is no magic, no trick, no mystery about becoming a powerful and convincing talker. You, too, can conquer timidity, stage fright, self-consciousness and bashfulness, winning advancement in

salary, popularity, social standing, and success. It is the power of forceful, convincing speech that causes one man to jump from obscurity to the presidency of a great corporation; another from a small unimportant territory to a sales-manager's desk; another from the rank and file of political workers to a post of national importance; a timid, retiring, self-conscious man to change almost overnight into a popular and much applauded after-dinner speaker.

## Send for this Amazing Book

This method of training is fully described in a very interesting and informative booklet, *How to Work Wonders with Words*. You are told how to bring out and develop your priceless "hidden knack"—the natural gift within you—which will win for you advancement in position and salary, popularity, social standing, power and real success. You can obtain your copy absolutely free by sending the coupon.

**NOW SENT  
FREE**

## NORTH AMERICAN INSTITUTE

3601 Michigan Ave.  
Dept. 1351, Chicago, Ill.



North American Institute,  
3601 Michigan Ave., Dept. 1351,  
Chicago, Illinois.

Please send me FREE and without obligation my copy of your famous book, *How to Work Wonders with Words*.

Name .....

Address .....

City ..... State .....



## Learn to Play JAZZ by Ear in 90 Days

Be a master of jazz, syncopation, melody. It is easy to learn at home in your spare time. Wonderful Niagara Method shows you how.

By R. C. JAMES

How I used to wish that I could sit down at the piano and pour out the golden syncopation of American melody, like the jazz piano players I had heard. How I used to wish that I could be the popular one in every crowd.

But I could not play a note. I did not know a thing about music.

### Niagara Method Shows The Way

Then somewhere—just as you are reading this—I read of the Niagara Method which makes piano playing wonderfully simple. I sent for Director Wright's book "The Niagara Secret." I read the book, and I knew it was right.

I followed Director Wright's principles, and in no time I had caught on to his ideas.

### Simple—Easy—Delightful

And the best part of it all is that there is nothing hard about the Niagara Method. In a short time, by following Director Wright's principles and by devoting a part of my spare time to the practical application of his course, I soon learned to play.

No tiresome scales—no arpeggios to learn—no weary hours of practice—no do-re-mi—no meaningless exercises. If you know the Niagara Method, you can sit down and reel off any popular song which the high-priced orchestra leaders play in the cabarets, clubs, hotels, dance halls, or theaters.

### Decide to Begin Now

If you have never played a note, or if you do play—no matter how well—you too may become a master of jazz and melody by learning the simple, wonderful Niagara Method.

### FREE BOOK

Don't wait another day. Send the coupon now for the "Niagara Secret." This book is yours absolutely FREE. If 10c (coin or stamps) is enclosed you also receive wonderful booklet "How to Entertain at Piano."

Ronald G. Wright, Director  
Niagara School of Music,  
Dept. 958 Niagara Falls, N. Y.



### CLIP THIS COUPON NOW!

NIAGARA SCHOOL OF MUSIC, Dept. 958, Niagara Falls, N. Y.

Without obligation mail me your book "The Niagara Secret." I enclose 10c for book "How to Entertain at Piano"

Name \_\_\_\_\_

Street \_\_\_\_\_

City \_\_\_\_\_ State \_\_\_\_\_



## DRAWING IS A WAY TO FORTUNE

Ali Hafed, a Persian farmer, sold his acres to go out and seek his fortune. He who bought the farm found it contained a diamond mine which made him fabulously rich. All Hafed overlooked the great opportunity at his door to go far afield in search of wealth—which illustrates a great truth.

**EARN \$200 TO \$500 A MONTH**

If you like to draw, develop your talent. Your fortune lies in your hand. Present opportunities for both men and women to illustrate magazines, newspapers, etc., have never been excelled. Publishers are buying millions of dollars' worth of illustrations each year. The Federal Home Study Course has been prepared by such famous artists as Neysa McMein, Norman Rockwell, Charles Livingston Bull, Clare Briggs, Sidney Smith, Fontaine Fox and fifty others. Each student gets individual personal attention. No previous training is necessary. Every step is clear and simple.

FREE, illustrated catalog on request. Complete outline of course with all the details. Just write your name and address in the margin and send it to us.

# Federal School of Illustrating

1137 Federal School Bldg.

Minneapolis, Minn.

## ELECTRICAL

Course for men of ambition and limited time.

Over 4000 men trained.

Condensed course in Theoretical and Practical Electrical

## ENGINEERING

including the closely related subjects of Mathematics and Mechanical Drawing taught by experts. Students construct motors, install wiring, test electrical machinery. Complete course

## IN ONE YEAR

Prepare for your profession in the most interesting city in the world. School established 1893. Send for catalog

**BLISS ELECTRICAL SCHOOL**  
431 Takoma Ave. WASHINGTON, D. C.



## LANGUAGE POWER

Mastery English wins friends, increases chances for success. Sherwin Cody's wonderful new invention gives you language power in only 15 minutes a day fascinating spare-time study at home. No rules to memorize. Learn correct English this new, easy way. Write for free book today.

SHERWIN CODY SCHOOL OF ENGLISH  
51 Searle Bldg. Rochester, N. Y.



## Learn Watchwork, Jewelrywork and Engraving

A fine trade commanding a good salary, and your services always in demand. Address: **Horological**, Dept. P. Bradley Institute, PEORIA, ILLINOIS, for our latest catalog.

# Welding

Become a Welding Expert! Then earn top wages or go into business for yourself. We train you at Home, in your Shop, or on the Job. "Kerr's Training Course for Welders" is a thorough course in practical experience, covering all metals. It trains you in WHAT TO DO and HOW TO DO IT. Write at once for terms and enrollment card. (State if you have the use of a welding outfit.)

**KERR'S WELDING SCHOOL** Dept. 2, 752 N. Broadway  
LOS ANGELES, CALIF.

# Magic

Learned Easily  
at Home

Astonish  
Your Friends!

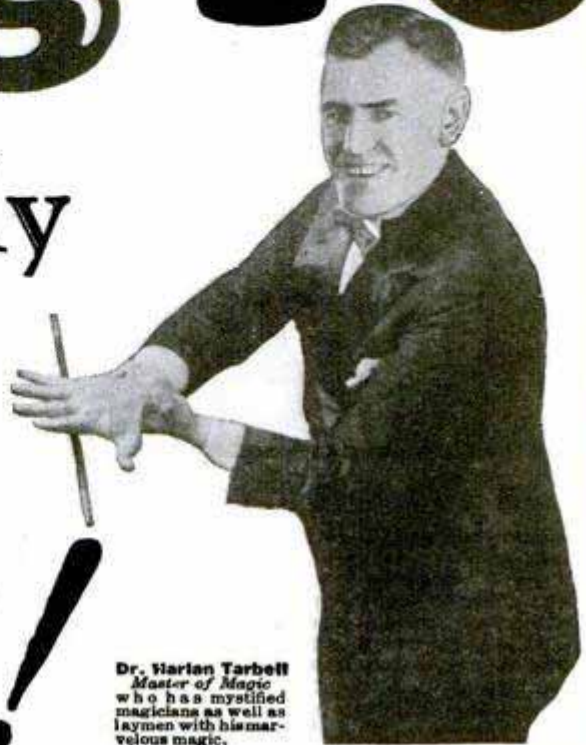

Dr. Harlan Tarbell  
Master of Magic  
who has mystified  
magicians as well as  
laymen with his mar-  
velous magic.

Gain the magnetic popularity that makes you the center of any crowd. Business and social success is assured the man who can perform mystifying tricks. You can earn big money on the side or as a professional, as well as being the most popular person in your crowd. Why envy others' skill? You can learn Magic yourself, quickly and easily.

read  
what the Great  
Madame  
Hermann says:  
My Dear Dr. Tar-  
bell: I have read  
with interest your  
course in Magic.  
It is the most ori-  
ginal and perfect  
work of its kind I  
have seen. I highly  
recommend it.  
—A. Hermann

Earn \$250 to  
\$1000 a Month

even sleight of hand, generally supposed to require long practice, is NOW made simple to learn. For Dr. Harlan Tarbell, one of the really Great Magicians, has finally opened up the secrets of his profession in a completely illustrated course offered at a merely nominal cost. Through the wonderful Tar-

bell system you will be able to mystify and entertain your friends. After that Dr. Harlan Tarbell takes you through the entire maze of sleight of hand, card tricks and elaborate stage diversions. The apparently superhuman doings of the accomplished magician becomes as simple as ABC.

**The First  
and Only  
Course  
in Magic**  
ever offered to the  
public teaching  
Real Professional  
MAGIC

## Great Special Offer!

There is a tremendous demand for magic entertainment. Clubs, Lodges, Charity and Social affairs—all will pay high fees to the man who knows Magic. Dr. Harlan Tarbell really gets as high as \$250 for a half hour's work right now. Opportunity everywhere to make money aside from your regular occupation. Salesmen find it a tremendous asset. Find out all about this unprecedented opportunity to learn Magic. Learn about the great Special Price and Easy Payment Offer we are making Now, for a limited time only. The coupon brings full details without any obligation. *Mail it TODAY.*

**Tarbell System, Inc.**

1920 Sunnyside Ave., Studio 13-51 Chicago, Ill.

## Mail This Coupon NOW!

- Tarbell System, Inc., Studio 13-51
- 1920 Sunnyside Avenue, Chicago, Illinois
- Gentlemen: Without any obligation send me your free literature and information all about your wonderful "Tarbell Course in Magic." Also tell me about your great Special Price Offer and Easy Payment Plan—offered NOW for limited time only.
- Name.....
- Address.....
- .....Age.....



# High School Course in Two Years!

## You Want to Earn Big Money!

And you will not be satisfied unless you earn steady promotion. But are you prepared for the job ahead of you? Do you measure up to the standard that insures success? For a more responsible position a fairly good education is necessary. To write a sensible business letter, to prepare estimates, to figure cost and to compute interest, you must have a certain amount of preparation. All this you must be able to do before you will earn promotion. Many business houses hire no men whose general knowledge is not equal to a high school course. Why? Because big business refuses to burden itself with men who are barred from promotion by the lack of elementary education.

### Can You Qualify for a Better Position

We have a plan whereby you can. We can give you a complete but simplified high school course in two years, giving you all the essentials that form the foundation of practical business. It will prepare you to hold your own where competition is keen and exacting. Do not doubt your ability, but make up your mind to it and you will soon have the requirements that will bring you success and big money. **YOU CAN DO IT.**

Let us show you how to get on the road to success. It will not cost you a single working hour. Write today. It costs you nothing but a stamp.

## American School

Dept. H-174, Drexel Ave. and 58th St., Chicago

### American School

Dept. H-174, Drexel Ave. and 58th St., Chicago

Send me full information on the subject checked and how you will help me win success.

- |                             |                           |
|-----------------------------|---------------------------|
| ....Architect               | ....Business Law          |
| ....Building Contractor     | ....Lawyer                |
| ....Automobile Engineer     | ....Machine Shop Practice |
| ....Automobile Repairman    | ....Mechanical Engineer   |
| ....Civil Engineer          | ....Shop Superintendent   |
| ....Structural Engineer     | ....Employment Manager    |
| ....Business Manager        | ....Steam Engineer        |
| ....Cert. Public Accountant | ....Foremanship           |
| ....Accountant and Auditor  | ....Sanitary Engineer     |
| ....Bookkeeper              | ....Surveyor (& Mapping)  |
| ....Draftsman and Designer  | ....Telephone Engineer    |
| ....Electrical Engineer     | ....Telegraph Engineer    |
| ....Electric Light & Power  | ....High School Graduate  |
| ....General Education       | ....Wireless Radio        |
| ....Vocational Guidance     | ....Undecided             |

Name.....

Address .....

## Books on 67 Practical Subjects

Popular Mechanics Press specializes in supplying the outstanding best book on any subject. Check the books you want, and mail this advertisement as your order blank.

- |                                                                                    |                                                                                 |
|------------------------------------------------------------------------------------|---------------------------------------------------------------------------------|
| <b>ARCHITECT</b><br>Architectural Drawing \$1.50                                   | <b>FUR RAISER</b><br>Outdoor Opportunities \$1.50                               |
| <b>ARMATURE WINDER</b><br>Armature Winding... \$3.00                               | <b>FURNITURE MAKING</b><br>Mission Furniture Making, (3 vols.).....\$3.00       |
| <b>ARTIST</b><br>Practical Art.....\$5.00                                          | <b>GLASS WORKER</b><br>Decorative Glass Processes.....\$3.25                    |
| <b>ARTS CRAFTS</b><br>Art Metal Work.....\$4.25                                    | <b>HAND FORGING</b><br>Hand Forging and Wrought Iron Ornamental Work.....\$2.00 |
| <b>ASTRONOMY</b><br>Amateur Telescope Making.....\$2.00                            | <b>HOME BUILDING</b><br>Concrete Houses.....\$3.00                              |
| <b>AUTOMOBILE</b><br>Dyke's Encyclopedia... \$6.00                                 | <b>HYPNOTISM</b><br>Practical Lessons in Hypnotism.....\$1.25                   |
| <b>AVIATOR</b><br>Practical Aviation....\$3.00                                     | <b>INTERIOR DECORATOR</b><br>Interior Wall Decoration.....\$4.00                |
| <b>BOAT BUILDER</b><br>22 Different Boats....\$0.50                                | <b>INVENTOR</b><br>Inventors' Manual....\$1.50                                  |
| <b>BOOKKEEPER</b><br>Bookkeepers' Handbook.....\$1.00                              | <b>LATHE WORK</b><br>Lathe Handbook.....\$0.50                                  |
| <b>BOYS' BOOKS</b><br>The Boy Mechanic (4 vols.).....\$7.00                        | <b>LEATHER WORKER</b><br>Artistic Leather Work..\$1.25                          |
| <b>BRICKLAYER</b><br>Plain and Fancy Brickwork.....\$1.50                          | <b>LOCKSMITHING</b><br>500 Tricks of the Trade..\$1.50                          |
| <b>CABINET MAKER</b><br>Furniture Making....\$3.50                                 | <b>LOOM FIXER</b><br>Practical Loom Fixing..\$1.50                              |
| <b>CALCULATOR</b><br>Ropp's Calculator.....\$1.00                                  | <b>MACHINIST</b><br>Complete Practical Machinist.....\$3.00                     |
| <b>CARPENTER</b><br>Carpenter's Handbook..\$1.50                                   | <b>MAGIC</b><br>Modern Magic.....\$2.00                                         |
| <b>CARTOONING</b><br>Cartooning Made Easy..\$3.00                                  | <b>MASON</b><br>Practical Stone Masonry.....\$1.25                              |
| <b>CHEMISTRY</b><br>General Chemistry....\$3.75                                    | <b>MATHEMATICS</b><br>Mathematics for the Practical Man.....\$1.50              |
| <b>CIVIL SERVICE</b><br>Course in Civil Service..\$1.50                            | <b>MECHANICAL DRAFTSMAN</b><br>Practical Course in Mechanical Drawing....\$1.00 |
| <b>CONCRETE</b><br>173 Ways of Using Concrete.....\$0.50                           | <b>MODEL MAKING</b><br>Model Making.....\$3.00                                  |
| <b>COOKING</b><br>Foods from 20 Lands..\$1.50                                      | <b>OUTDOOR SPORTS</b><br>Outdoor Sports the Year 'Round.....\$1.50              |
| <b>DETECTIVE</b><br>Instruction for Detectives.....\$1.00                          | <b>PAINTING</b><br>Owen's Paint Guide...\$1.00                                  |
| <b>DIESEL ENGINES</b><br>Diesel Engines, Marine, Locomotive, Stationary.....\$5.00 | <b>POULTRY RAISER</b><br>\$4,223 from a Town Lot \$1.00                         |
| <b>DOG FANCIER</b><br>Dog Lovers' Companion \$1.00                                 | <b>PSYCHO-ANALYSIS</b><br>Outwitting Our Nerves..\$2.50                         |
| <b>DRAWING</b><br>Drawing Made Easy...\$1.25                                       | <b>RABBIT RAISING</b><br>Practical Rabbit Keeping.....\$1.50                    |
| <b>DRILLING</b><br>Drilling and Thread Cutting.....\$0.50                          | <b>RADIO</b><br>Lefax Radio Handbook..\$3.50                                    |
| <b>ELECTRICIAN</b><br>American Electricians' Handbook.....\$4.00                   | <b>REFRIGERATION</b><br>Homemade Refrigerating Machine.....\$0.50               |
| <b>ELECTROPLATER</b><br>Electroplating.....\$1.00                                  | <b>SHIP MODELS</b><br>Ship Model Making...\$2.50                                |
| <b>ENGINEER</b><br>Bailey's Handbook for Stationary, Marine, Diesel.....\$2.00     | <b>SHOP WORK</b><br>Shop Notes (16 vols.)..\$7.50                               |
| <b>ENGLISH</b><br>Self-Improvement in English.....\$2.50                           | <b>SPIRITUALISM</b><br>Behind the Scenes with the Mediums.....\$1.50            |
| <b>ENTERTAINMENTS</b><br>Money-Making Entertainments.....\$1.25                    | <b>TAXIDERMIST</b><br>Methods in Taxidermy..\$3.50                              |
| <b>ETIQUETTE</b><br>Book of Etiquette (2 vols.).....\$1.98                         | <b>TOY MAKER</b><br>Toy Manufacture....\$1.50                                   |
| <b>FARMER</b><br>Popular Mechanics Handbook for Farmers.....\$1.00                 | <b>WELDER</b><br>Welding Encyclopedia..\$5.00                                   |
| <b>FORD</b><br>My Ford, Its Care and Repair.....\$3.00                             | <b>WIRING</b><br>House Wiring.....\$1.00                                        |
| <b>FORMULAS</b><br>10,000 Formulas.....\$4.00                                      | <b>WOOD WORKER</b><br>Wood-Working for Amateur Craftsmen....\$1.00              |
|                                                                                    | <b>WRITER</b><br>Free-Lance Writers' Handbook.....\$5.00                        |

## Send No Money

Just check the books you want, write your name and address below, and mail the whole advertisement. It is your order blank. When postman hands you books, pay him the price and the postal charges. If you prefer to send cash, postage will be prepaid. We have many other books on these subjects and on 2,000 other subjects. Catalog free.

**CHECK THE BOOKS YOU WANT AND MAIL TODAY**

Name.....

City.....State.....

Address.....

Mail to Popular Mechanics Press, Room 705, 200 East Ontario St., Chicago, Ill.



# They Used to Call Me a "Wet Blanket"

—until I amazed them with  
my sudden musical ability

WHEN I received my invitation the very day of the party I knew what it meant. Somebody couldn't attend. And I was selected as a mere "fill in."

That hurt! I had never been popular at parties. Yet now they sent me a last minute invitation—just to make an even number.

But I swallowed my pride and went. They little knew what a surprise was in store for them!

It certainly was a jolly party. But, as usual, I sat alone in the corner—apart from the rest—actually just an onlooker. Only this time I had a secret up my sleeve!

Then someone suggested music (I knew they would!). Alice Blake gave a violin solo. Bob Johnson played a lively banjo selection. Suddenly a guest arose and politely turning to me said, "Do you play anything, Mr. Horton?"

The room was hushed. Obviously embarrassed I got up. My usual "No!" was on the tip of my tongue. But just then the silence was broken by a whispering voice, which said, "He can't do a thing. Why, he's the world's champion wet blanket!"

That decided me! I'd risk it! "Yes," I exploded, "I'll be glad to play!" And they stared at me in amazement!

In one breathless moment I had "arrived!" I who was never a hit at any party! Now at last I was really popular! You should have seen them rush forward to congratulate me!

"It seemed impossible!" they chorused. "We're certain you never could play before! Who's your teacher? What's the secret?"

"Folks," I replied beaming, "you're right. I never **could** play. I never even **thought** I could learn. But now—well I **can't** show you my teacher—but I **can** tell you the secret!"

And I did!

I told them how I had heard of the U. S. School of Music—and their wonderful course which teaches anyone to play—right at home and without a teacher. I investigated, I explained, because it didn't cost a cent. And I found that it was even better than I ever dared to hope.

Now I can play anything. I amuse myself—entertain others—sometimes play for money. Even the first few times I played in an orchestra I made more than enough to pay for the course!

You, too, can learn to play your favorite instrument by this easy "at home" method that has helped almost half a million people to increased pleasure and financial gain. No need to know a thing about music—progress is rapid because every step is easy to understand. Pick out the instrument you want to play. The U. S. School of Music does the rest. And it costs just a few cents a day!

## Free Book and Demonstration Lesson

Beautifully illustrated free book and demonstration lesson prove how anyone can learn to play his favorite instrument quickly—and at only a fraction of what old slow methods cost.

If you are really eager to learn to play—if you honestly yearn for the popularity, pleasant associations and increased income that musical ability can bring—then act TODAY. Sign and mail the coupon NOW. Instruments supplied when needed, cash or credit. U. S. School of Music, 71 Brunswick Bldg., New York City. (Please Write Name and Address Plainly.)

U. S. School of Music,  
71 Brunswick Bldg., New York City.

Please send me your free book, "Music Lessons in Your Own Home," with introduction by Dr. Frank Crane, Demonstration Lesson and particulars of your Special Offer. I am interested in the following course:

Have you above instrument?.....

Name.....

Address.....

City..... State.....

### Choose Your Course

Piano	Harmony and
Organ	Composition
Violin	Sight Singing
Drums and	Ukulele
Traps	Guitar
Mandolin	Hawaiian
Clarinet	Steel Guitar
Flute	Harp
Saxophone	Cornet
Cello	Piccolo
	Trombone
Voice and Speech Culture	
Automatic Finger Control	
Piano Accordion	
Banjo (5-String, Plectrum and Tenor).	

### I Surprised Them

I strode over to the piano. Then I played—almost like a professional! Jazzy tunes—classical rhythms—peppy Spanish numbers. At first they stared. Then they smiled in approval. Finally they burst into unrestrained applause.

# LEARN CARTOONING



The Landon PICTURE CHART method of teaching makes ORIGINAL drawing easy to learn. Hundreds of sketches like the above explain every step in creating ORIGINAL heads, figures, animals, etc.

## Successful Cartoonists Earn Big Salaries

The cartoonists who draw "Freckles and His Friends," "Winnie Winkle," "Regular Fellers," "Cicero Sapp," "Guss and Gussie," "Mom 'n Pop" and hundreds of other artists, including Dorman Smith, Ethel Hays and Edwina, credit their start to the Landon Course of Cartooning. They learned to draw through the Picture Chart Method in their spare time, at home, and are now earning from \$75.00 to \$300.00 and more per week. Send 6c in stamps today for sample Picture Chart and full explanation of this wonderful course and information showing possibilities for you. *Please state your age.*

### The Landon School

138 National Bldg., CLEVELAND, OHIO

# Business

Master the fundamentals of marketing, law and business, employment psychology, advertising, purchasing, accounting, etc. Practical help for the business man who aims to broaden his vision and be more efficient. You may start these Home Study courses any day. Send for catalog.

## The University of Chicago

107 Ellis Hall

Chicago, Illinois

## PIANO JAZZ

By Note or Ear. With or without music. Short Course. Adult beginners taught by mail. No teacher required. Self-Instruction Course for Advanced Pianists. Learn 259 styles of Bass, 684 Syncopated Effects, Blue Harmony, Oriental, Chime, Movie and Café Jazz, Trick Endings, Clever Breaks, Space Fillers, Sax Slurs, Triple Bass, Wicked Harmony, Blue Obligato, and 247 other Subjects, including Ear Playing. 133 pages of REAL Jazz, 25,000 words. A Postal brings our FREE Special Offer.

Waterman Piano School, 1826 W. Adams St. Los Angeles, Cal.

## WANT WORK AT HOME?

Earn \$18 to \$60 a week RETOUCHING photos. Men or women. No selling or canvassing. We teach you and furnish WORKING OUTFIT given with each enrollment. Limited offer. Write today.  
Artcraft Studios, Dept. 50, 3900 Sheridan Rd., Chicago

## LEARN WATCHMAKING

and become independent. We help you secure a position.

Easy to learn. Send for FREE CATALOG.  
ST. LOUIS WATCHMAKING SCHOOL, Dept. 5, ST. LOUIS, MO.

# \$20,000.00 DAILY WAGES

## PAID TO AUTO MECHANICS

**Learn in 8 Weeks** Ten thousand men have been qualified by my practical, easy-to-learn Shop Method of teaching with real tools on real equipment. I guarantee your money back if I fail. No book study.

**I Pay Your Railroad Fare to my training shops and Board You 8 Weeks FREE**

My eight weeks' course is complete. No extras to pay for. This offer is limited. Save one-third while it lasts. Act promptly. Mail the coupon today. Remember "Mac" is one of the world's largest operators of Auto and Tractor Training Schools.

Get your name on the payroll of America's biggest industry and be fixed for life. Auto Mechanics "who know their stuff" are in demand everywhere—never so many jobs as right now waiting for trained men to fill them. No apprenticeship. No education required.

**Wages \$75 to \$150 Weekly** are paid to thousands of auto experts. Others make more as owners of garages and repair shops. What man of 16 or 60 could ask for a Bigger Opportunity? Write today for my remarkable special reduced tuition offer that includes free board and railroad fare.

**Ask for My Big Book — Tells Everything**

**MAIL THIS COUPON FOR MY GREAT OFFER**

# McSWEENEY SCHOOLS

Auto, Tractor and Electrical  
Dept. AW-14

Cleveland, O. Cincinnati, O. Chicago, Ill.

McSWEENEY Auto, Tractor and Electrical SCHOOLS  
Dept. AW-14, Cleveland, Ohio, Cincinnati, Ohio, Chicago, Ill.

Please send your Special Offer and Big Illustrated Book.

Name.....  
Address.....  
City..... State.....



# Tools FREE

of ANY Extra Charge

Also a Drafting Table

Act NOW!



This is NOT a "Student's" Outfit but an Imported Set of Professional Drafting Instruments, a Chief's Drafting Table, and Standard Supplies.

*Yours* for the Asking!

No Extra Cost Whatever. No Conditions except to Reply Promptly. This offer Open

to All who Speak Up NOW!

**I need YOU with 100 firms BEGGING ME to send them more DRAFTSMEN. Many offer to take BEGINNERS, at \$50 a WEEK. Graduates can start at \$90 and \$100! GET BUSY!**

Every industry in this country is using draftsmen in droves! In twenty-five years, I've never been so hard-pushed to turn out enough new men. In fact, it's the shortage that brings you this wide-open offer of all instruments—a real drafting table—full working outfit—complete, standard supplies—even paper and pencils and ink! No extra charge for any of them. That's how I hope to get the required men in record time.

Drafting is the field for any man who wants to get somewhere. For men who want to be heard from. Want work that counts, and pay that makes working worth while and life worth living.

**This Opportunity Doesn't Call for Cash, so Don't Pass It Up for Lack of Ready Money**

Please don't beat yourself by thinking of your finances at this time! It isn't money I want now—it's men. You, if you mean business. What I am after is your application. Once I get that, you'll get action. I'll have you ready to draft for important pay—in any engineering or industrial line you like—before you know it. So get my proposition in front of you this week! Then, if you do enroll, you're in line for my free outfit offer.

**WELL PAID JOBS** are soon sighted by men under Dobe training! They get offers before they're through. Are often spoken for months ahead of graduation. And I have students from 17 years of age to 51 at present time! So: first of all, and right now, send this coupon for my new free book *Successful Draftsmanship*; fully illustrated; explains everything.

I'll teach you draftsmanship by practical methods that make a man easily and quickly finish the whole course. I use modern methods; I employ every short-cut; but I leave nothing out that you have to know to earn \$3500 to \$10,000 a year as a practical draftsman.

**LEARN AT HOME** but on the same kind of actual drafting room jobs we assign you from our own drafting rooms. It isn't hard to do. Drafting isn't "drawing." You don't need "talent." If you are interested and can read and write, I guarantee to make you a good draftsman. (Dobe-trained men are draftsmen and chiefs in big concerns all over the country—and many have made good abroad.)



**YES!**

That's Chief Draftsman Dobe's answer to "Can I Succeed in Drafting?"

**YES!**

Does Dobe really turn out practical draftsmen in a few months?

**YES!**

Is there always such a big call for men who can draft as Want Ads in the newspapers show at the present time?

**YES!**

Do I actually get all instruments and supplies without one dollar's extra cost?

**YES!**

## FREE TOOLS COUPON

CHIEF DRAFTSMAN DOBE

1951 Lawrence Ave., Div. 13-51, Chicago

Send me free and postpaid *Successful Draftsmanship* Book and material telling all about your home course, terms, etc.

Name..... Age.....

Address.....



## "I'm going to raise his salary"

"I've had my eye on him for some time and I know he can handle bigger work."

"He studies those I. C. S. textbooks every chance he gets, and I want to tell you it has made him a valuable man for this business."

"I'm going to raise his salary and give him that new job we were talking about. I wish we had more men like him."

How do you stand when your employer checks up his men for promotion? Does he pass you by as just a routine worker, or does he think of you as a man who is ambitious to get ahead? Won't you be far more likely to get the promotion if he knows you are studying at home and are really preparing yourself to handle bigger work?

Think it over. Then act. It takes only a moment to mark and mail the coupon and find what the International Correspondence Schools can do for you, yet that one simple little step may be the means of changing your whole life. "Do it now."

Mail the Coupon for Free Booklet



**INTERNATIONAL CORRESPONDENCE SCHOOLS**  
Box 5624-E, Scranton, Penna.

Without cost or obligation, please send me one of your booklets and tell me how I can qualify for the position or in the subject before which I have marked an X:

**BUSINESS TRAINING COURSES**

- |                                                                  |                                                                           |
|------------------------------------------------------------------|---------------------------------------------------------------------------|
| <input type="checkbox"/> Business Management                     | <input type="checkbox"/> Salesmanship                                     |
| <input type="checkbox"/> Industrial Management                   | <input type="checkbox"/> Advertising                                      |
| <input type="checkbox"/> Personnel Organization                  | <input type="checkbox"/> Better Letters                                   |
| <input type="checkbox"/> Traffic Management                      | <input type="checkbox"/> Show Card Lettering                              |
| <input type="checkbox"/> Business Law                            | <input type="checkbox"/> Stenography and Typing                           |
| <input type="checkbox"/> Banking and Banking Law                 | <input type="checkbox"/> Business English                                 |
| <input type="checkbox"/> Accountancy (including C.P.A.)          | <input type="checkbox"/> Civil Service                                    |
| <input type="checkbox"/> Nicholson Cost Accounting               | <input type="checkbox"/> Railway Mail Clerk                               |
| <input type="checkbox"/> Bookkeeping                             | <input type="checkbox"/> Common School Subjects                           |
| <input type="checkbox"/> Private Secretary                       | <input type="checkbox"/> High School Subjects                             |
| <input type="checkbox"/> Spanish <input type="checkbox"/> French | <input type="checkbox"/> Illustrating <input type="checkbox"/> Cartooning |

**TECHNICAL AND INDUSTRIAL COURSES**

- |                                                                     |                                                                          |
|---------------------------------------------------------------------|--------------------------------------------------------------------------|
| <input type="checkbox"/> Electrical Engineering                     | <input type="checkbox"/> Architect                                       |
| <input type="checkbox"/> Electric Lighting                          | <input type="checkbox"/> Architects' Blueprints                          |
| <input type="checkbox"/> Mechanical Engineer                        | <input type="checkbox"/> Contractor and Builder                          |
| <input type="checkbox"/> Mechanical Draftsman                       | <input type="checkbox"/> Architectural Draftsman                         |
| <input type="checkbox"/> Machine Shop Practice                      | <input type="checkbox"/> Concrete Builder                                |
| <input type="checkbox"/> Railroad Positions                         | <input type="checkbox"/> Structural Engineer                             |
| <input type="checkbox"/> Gas Engine Operating                       | <input type="checkbox"/> Chemistry <input type="checkbox"/> Pharmacy     |
| <input type="checkbox"/> Civil Engineer                             | <input type="checkbox"/> Automobile Work                                 |
| <input type="checkbox"/> Surveying and Mapping                      | <input type="checkbox"/> Airplane Engines                                |
| <input type="checkbox"/> Metallurgy <input type="checkbox"/> Mining | <input type="checkbox"/> Agriculture <input type="checkbox"/> Navigation |
| <input type="checkbox"/> Steam Engineering                          | <input type="checkbox"/> Mathematics <input type="checkbox"/> Radio      |

Name.....  
Street.....  
Address.....

City.....State.....

Occupation.....

Persons residing in Canada should send this coupon to the International Correspondence Schools Canadian, Limited, Montreal, Canada

# Quick Money in Show Card Making for You!



### LEARN AT HOME

Now remarkably easy to learn show card writing at home—and tremendously increase your income in a few short months. Merchants, retailers and wholesalers everywhere need clever, original show cards. And through this simple, practical home-study method—written by show card experts—you can start at once to develop this rich market—and make \$20 to \$50 a week even in spare time!

No previous training or ability needed. No tedious hours of study necessary. Act now and quickly prepare for the big money opportunities already waiting for you. Many earn from \$50 to \$75 a week—some even more. Uncrowded field. Pleasurable work. Big profitable business of your own.

Postal brings wonderfully illustrated descriptive booklet with full details of startling profession—absolutely free. Send for it NOW!

**WASHINGTON SHOW CARD SCHOOL**

Room 301-E, 1117-15th St., N. W., Washington, D. C.

# FREE



FINE TONE

**\$20 Musical Instruments**

Your choice of a Violin, Tenor Banjo, Hawaiian Guitar, Banjo, Cornet, Ukulele, Banjo Ukulele, Guitar, Mandolin or Banjo Mandolin. You will be proud to own any one of these instruments and we will give you one without cost. A few cents a day for lessons is your only expense. Our system of teaching is so easy that you can play several pieces by note with the first four lessons. We guarantee success or no charge. Instrument and lessons sent on one week's free trial. Write for booklet today, no obligation. Over 200,000 satisfied pupils.

**CHICAGO CORRESPONDENCE SCHOOL OF MUSIC, INC.**  
1632 North Halsted Street, Dept. 165, Chicago, Illinois.

## FOREST RANGERS

Men wanting forest ranger, mail clerk, or other government positions, write for particulars.

**MOKANE, 236, DENVER, COLO.**

## MAKE MUCH MONEY

Your Own Goods, Formulas by experts. Manufacturing Processes. Trade-Secrets. All lines. All kinds. Catalog, special circulars free.

**W. THAXLY COMPANY, Washington, D. C.**

## STAMMERING

fully explained. Quick, easy cure guaranteed. Information, diagnosis, phonograph record and catalog free. America's foremost school. Established 1894.

153 Stimson Ave. The LEWIS INSTITUTE, Detroit, Mich.

# Skin Troubles

Cleared up—often in 24 hours. To prove you can be rid of Pimples, Blackheads, Acne

Eruptions on the face or body, Barbers' Itch, Eczema, Enlarged Pores, Oily or Shiny Skin, simply send me your name and address today—no cost—no obligation. **CLEAR-TONE** tried and tested in over 100,000 cases—used like toilet water—is simply magical in prompt results. You can repay the favor by telling your friends; if not, the loss is mine. **WRITE TODAY.**

**E. S. GIVENS, 428 Chemical Bldg., Kansas City, Mo.**



**LIONEL STRONGFORT**

Dr. Sargent, of Harvard, declared that "Strongfort is unquestionably the finest specimen of physical development I have ever seen."

It will not cost you anything and it will surely help you to broader, bigger, better things and a great deal more happiness.

**SEND FOR MY FREE BOOK**

To know what **Strongfortism** can do for you, send for a FREE copy of my book, "Promotion and Conservation of Health, Strength and Mental Energy."

**LIONEL STRONGFORT**  
Physical and Health Specialist for over 25 Years  
Dept. 283 Newark, N. J.

# Oh! You Misfit

Sailing under the name of man! You know the truth if no one else does—you know what you lack—what you need. You may hide it from others in a way, but you can't hide it from yourself. Are you a victim of any habit that you want to get rid of? Have you a spark of ambition left to be the man you once were, to be the man you ought to be? Are you an easy victim to every little ailment that comes along, going around without snap or ginger, losing ground when you ought to gain it? Then wake up and be a man, not a misfit.

*Deserve the name of man; be vigorous!* It makes no difference if you are a physical wreck, if you join hands with me I'll make you the kind of man that's wanted, the kind of man needed, the kind of man looked for, sought for, bid for all the time, and it will be done without drugs, or tonics or stimulants.

*You will gain in vim and vigor;* your muscular power will increase in flexibility and strength, your nervous system fortified to renew its energy—not bolstered up for the time being, to fall back below the level it was, as it does when you resort to drugs or medicine.

**You Young Man** think of your future—how about it—are you fit—are you qualified—do you feel it in your soul—are others sliding by you doing more—getting more than you are? I know what is dragging you down, what is keeping you down. Come to me, I have helped thousands; physically, mental y, morally. I will help you; will make you the kind of young man that is a credit to any community—I will make you so that your progress in any undertaking will be easier. Just be frank and above board—tell me your troubles. I will guide, direct and point the way; the natural way for you to achieve what I have said—Nature's way. You can gain muscular tissues, be strong, erect in carriage, courageous, and likable to all you meet.

**You Business Man** overworked did you say? You are not doing half as much as you ought with your experience. Never mind, there is a way to get back your aggressiveness, to be right in the fight and enjoy it. You can double your percentage of real worth as a man, and enjoy life as you ought to be able to do. Let me be your guide, your teacher. I have pupils all over the world, learning a system of Health, Strength, moral courage building known as

## STRONGFORTISM

Under my system of practicing **Strongfortism**, you men can build your body up in symmetrical proportions, as nature intended you to be. You will gain greater confidence in yourself. You will attain great strength—capped with the glow of health and the supreme joy of living. You can keep your youth no matter what mistakes you have made, or what your present physical condition is, or what ailment or disorder you have—constipation, rheumatism—no matter what. See that coupon, check what interests you, mail it, and I will send you helpful personal information.

**FREE CONSULTATION COUPON**

Mr. Lionel Strongfort, Lionel Strongfort Institute, Dept. 283, Newark, N. J.

Please send me ABSOLUTELY FREE my copy of your book "PROMOTION AND CONSERVATION OF HEALTH, STRENGTH AND MENTAL ENERGY." I have marked (x) before the subjects in which I am most interested.

- |               |                     |                         |
|---------------|---------------------|-------------------------|
| .. Colds      | .. Increased Height | .. Weak Eyes            |
| .. Catarrh    | .. Pimples          | .. Weak Heart           |
| .. Asthma     | .. Insomnia         | .. Poor Circulation     |
| .. Hay Fever  | .. Short Wind       | .. Round Shoulders      |
| .. Headache   | .. Constipation     | .. Lung Troubles        |
| .. Thinness   | .. Indigestion      | .. Muscular Development |
| .. Rupture    | .. Nervousness      | .. Great Strength       |
| .. Lumbago    | .. Rheumatism       |                         |
| .. Flat Chest |                     |                         |

Name.....

Age..... Occupation.....

Street.....

City..... State.....

# Make That Dream Come True!

Haven't you often pictured yourself playing the Hawaiian Guitar, a happy crowd around you, everybody enjoying and admiring your playing? Now you can reach your goal—and play all the latest hits just as the Hawaiians do!



You can play the HAWAIIAN GUITAR just like the Hawaiians!

**\$15**  
HAWAIIAN GUITAR  
with Genuine Seal Grain  
Fabrikoid Cover  
**FREE**  
when you enroll

### Complete Conservatory Course

52 complete lessons. Pictures explain every move. Our method is simple, practical and interesting—only 4 motions to learn. No tiresome scales and exercises—you play a real piece your very first lesson.

### Expert Instruction by Native Hawaiians

Get the advantage of expert instruction by Kolomoku, Kalaluki, Ferera and Seville—every one famous as both player and teacher. Even if you never touched a musical instrument in your life, under their direction you make rapid headway—you will be astonished when you see how easy it is!

### This Sweet Toned Hawaiian Guitar

In genuine Fabrikoid Case—and complete playing outfit including picks, steel playing bar, etc. sent you free when you enroll. Retailers ask \$15 or more for a similar outfit without the case. Remember, there are no extras—we furnish everything with the course.

### Learn in Spare Time

Pick up your guitar at any time and play. Your lessons are always handy—you can always refer to them. You are never hurried or forced. And no waiting for a class to form—start now—go ahead as fast as you like.

### Pay as You Play

Small first payment starts you. And the entire 52-lesson course comes to just a few cents a lesson! Begin now.

### We Guarantee

in writing to teach you. And after graduation we coach and advise you without charge. Over 45,000 successful graduates.

**Tenor Banjo** and other courses—Violin, Tiple, Tenor Guitar, Banjo Ukulele, Ukulele—under well-known instructors. Write for information.

**FIRST HAWAIIAN CONSERVATORY OF MUSIC, INC.**  
9th Fl., Woolworth Bldg., Dept. 348, New York, N. Y.

Approved as a Correspondence School Under the Laws of the State of New York

### SEND THIS COUPON FOR LIBERAL OFFER!

First Hawaiian Conservatory of Music, Inc.  
9th Fl., Woolworth Bldg., Dept. 348, New York, N. Y.

Please mail full information about your 52-lesson Hawaiian Guitar Course. I am not obliged to enroll unless I want to.

Name \_\_\_\_\_  
Address \_\_\_\_\_  
City \_\_\_\_\_ State \_\_\_\_\_



## QUIT WISHING AND WAITING

# EARN

## \$3500 to \$5000 a Yr.

MAKING CROWNS, PLATES, BRIDGES, etc. for DENTISTS

*Three Months' Training Will Qualify You for Success*

*Hundreds More Dental Mechanics Needed Now and Demand Is Increasing*

### YOU LEARN BY DOING

Individual instruction—no classes whatever. Each student is taught by practical work but is given theoretical training as well. Through our regular clinic, conducted by M. Stein, D.D.S., advance students are also given practice in precious metals on actual cases.

### FREE R. R. FARE—OTHER ASSISTANCE

Besides providing the best of training at the lowest possible cost and refunding the student's R. R. fare to our nearest school, we secure jobs for those who need to earn while learning. Free Tools and Materials, Easy Terms. For full information just write today for Free Bulletin No. 2.

## BODEE DENTAL INSTITUTE

*Established over 30 years*

New York 1755 Broadway	Philadelphia 1305 N. Broad St.
Buffalo 501 Washington St.	Brooklyn 85 Court St.

## A Great Book Free with this pay-raising library

For a short time only we will give every subscriber to the New Library of Machine Shop Practice a copy of French's Engineering Drawing—the greatest book on mechanical drawing ever written. This book makes drawing as plain as day—tells you all about instruments, plans and methods—and prepares you to handle any drawing job you will ever have to do. It comes to you absolutely free with

## Machine Shop Practice

9 volumes—3065 pages—3608 illustrations  
(A combined home study course and reference library)

The New Machine Shop Library is written for practical men. It gives you the best methods for every kind of machine shop work. It explains machine tools and their operation, drawing and design, tool work, gears and grinding, jigs and fixtures, automatic screw machines and their tools and all of the mathematics you will ever have to use. It is plainly written, completely illustrated—the very best kind of help to the machine shop man who wants to advance himself.



**No money down—only 7c a day**

**FREE**

### FREE EXAMINATION COUPON

**McGraw-Hill Book Co., Inc., 370 Seventh Ave., New York**  
Send me for 10 days' free examination the New Library of Machine Shop Practice. If satisfactory, I will send you \$1.50 in 10 days and \$2.00 monthly until the special price of \$19.50 is paid. If not wanted, I will return the books at your expense.  
On receipt of my first payment of \$1.50 it is understood that I am to receive, free of charge, a copy of French's Engineering Drawing.

Signed.....  
Address.....  
City and State.....  
Position.....  
Employer..... P. M. 1-1-27

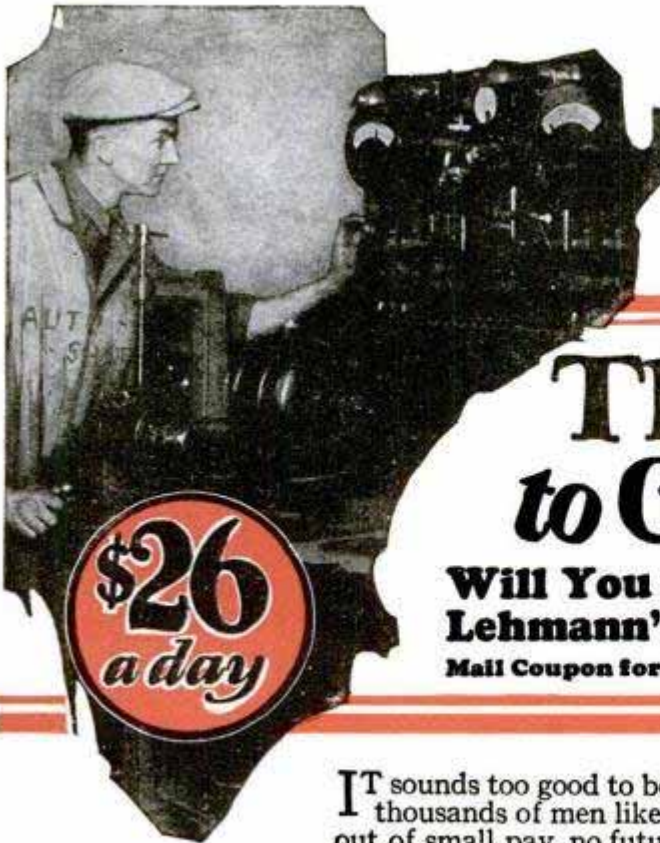

**\$26**  
a day

**Jumps from \$3 to \$26 a Day**

Mr. Cooke: If it had not been for your Course I would still be plugging away for \$3 a day. Instead I nave all the work I can do and my earnings run as high as \$23 to \$26 a day. I owe all my success to your training.—Edward A. Lehmann, 1521 Market St., Oakland, California.

**They Know How to Get the Big Pay**

**Will You Learn the Secret of Lehmann's and Hines' Success?**  
Mail Coupon for **FREE BOOK THAT TELLS ALL**



**L. L. COOKE**  
He is Chief Engineer of the Chicago Engineering Works, Inc., and has trained and helped hundreds of men into Big-Pay Electrical Jobs.

**\$85 a Week —and Going Up!**

Dear Chief: With your Course and your great help and encouragement I am going right over the top. I am making \$85 a week now and still going up. I had only a common school education when I started with you and no electrical experience. Your lessons were easy and clear and I owe my success to you.—R. M. Hines, 1664 Aberdeen Street, Chicago Heights, Illinois.

IT sounds too good to be true—it's hard to believe—that thousands of men like the two pictured here could step out of small pay, no future jobs and earn \$3500 to \$10,000 a year in Electricity. Yet that's just what many hundreds of men have done. Most of them had no previous experience—all of them kept right on with their regular jobs and used spare time only, to prepare for the big-pay jobs they hold.

What was "the something" that brought these men big pay and quick success? What makes it possible for them to earn from two to four times more than you are able to earn working hard every day? They couldn't have used ordinary methods because other men who tried them have failed. They must have gotten hold of something new—something different—something that matches electricity itself. And electricity, you know, is the world's greatest business, growing with leaps and bounds every year and continually demanding more and more trained men.

big-pay class, and which today offers you one of the world's greatest opportunities.

Chief Engineer Cooke has prepared a wonderfully interesting book printed in colors with 64 pages and over 100 pictures, telling all about electricity, the opportunities it offers young men and what these opportunities mean to you. This is the same book that started so many other men on the road to big pay. It's free and it may help you like it helped them. Anyway send for the book and decide for yourself.

There is no obligation on your part and no agent will call on you. Mail the Coupon Now, to—

No matter what you may have heard about home-training—no matter what kind of work you are doing now—you owe it to yourself to find out the secret of these men's success—to find out about Cooke Training which has already lifted hundreds of other men into the

**L. L. Cooke, Chief Engineer**  
**L. L. COOKE SCHOOL OF ELECTRICITY**  
Owned and operated by **CHICAGO ENGINEERING WORKS, Inc.**  
2150 Lawrence Ave., **CHICAGO, ILLINOIS**



**\$85**  
a week

**L. L. Cooke, Chief Engineer**  
Dept. 511, 2150 Lawrence Ave.,  
Chicago, Illinois

Send me your free book about Electricity and proof that the men you have trained are holding big-pay jobs. I understand no agent will call on me and I won't be obligated to take your Course.

Name.....

Address.....

City.....State.....

# See the World FREE!



## Taste Romance and Adventure In the Far Lands of the Earth

How often you've longed to see for yourself the awe of Egypt's pyramids—the beauties of the gorgeous Mediterranean sunset—the squalor of China's ancient cities!

Spend a few years, or the rest of your life, tasting high adventure on the seven seas and in all the world's great ports—roving the earth's highways and byways! You can do it FREE—all your expenses paid—and earn a good salary besides!

Only one profession will carry you around the world at will, travelling like a gentleman, but that's the most interesting and pleasant work there is—Radio Operating! Easily and quickly learned, there's no other profession like it for the man who wants the experiences and pleasures of world-travel. Radio operators are needed—all sea-going ships like the one shown here must carry from one to half a dozen or more.



## Take a Look Beyond the Skyline Without a Penny's Expense

Radio operators aboard ocean liners live luxuriously—they rank as officers of the ship. Meals, a private cabin, all other living needs are furnished free, and besides the operator draws a good salary. You can learn quickly and easily at home in your spare time to be a Radio operator through our practical training methods. Take a look at the FREE BOOK which tells how—mail coupon below.

This U. S. Government-recognized school has been training successful operators since 1914. Our graduates are all over the world. We maintain an Employment Department to put you on your own ship. The world-famous NATROMETER, our own patented invention, obtainable only by students of this Institute, is recognized as the best and easiest way to learn the Radio code. A few short months, with the aid of the famous Natrometer and our quick home training, and you too can be a fully qualified Radio operator, sitting in your cabin like the one shown above, bound out for Liverpool or Nagasaki!

Read the Free Book that tells all about this fascinating profession and our practical Government-recognized methods of training you for it. Send coupon TODAY—no obligation. Special tuition offer now on for limited time includes world-famous Natrometer free of extra cost with your course! Act at once.

**NATIONAL RADIO INSTITUTE  
WASHINGTON, D. C.**

### SPECIAL OFFER COUPON

National Radio Institute,  
Dept. AA-85, Washington, D.C.

Gentlemen: Without obligating me in any way send me your free book and information about your special limited Natrometer offer.



World-Famous Natrometer

Name.....

Address.....

# LAW THIS BOOK FREE!

**Study at Home**  
Become a lawyer. Legally trained men win high positions and big success in business and public life. Greater opportunities now than ever before.

**Earn \$5,000 to \$10,000 Annually!**

We guide you step by step. Degree of LL.B. LaSalle law graduates practicing in every state. We furnish all text material, including 14-volume Law Library. Low cost. Easy terms. Valuable, interesting 96-page book free. Send for it NOW.

LaSalle Extension University, Dept. 164-L Chicago



## Brain Tools

For Architects, Draftsmen, Carpenters, Contractors, Builders and all who expect to build

Men who work with their hands know that headwork gets them more money.

Brain tools make the tools in your tool box at least twice as effective, and the best brain tools you can get are good books—not just any books, but books which tell you the things you want to know, and do it instantly. Carpenters make themselves contractors by learning how to estimate correctly. Contractors are able to handle bigger and more profitable jobs by learning how the big fellows do it, and architects and those who want to enter this highly paid profession earn more money by having facts and figures at their finger tips.

This brand new set of five handsomely bound books covering all phases of architecture, carpentry and building, enables you to get an authoritative, specialized information in a moment. No tedious long hours of reading—no hard grinding study, but instant reference to the vital facts. You don't waste a minute—the new jiffy index puts before your eyes, without wasted time, the things you want to know.

The most complete work of its kind we have ever published; nothing has been overlooked. Use of tools—building construction, heating, lighting, plumbing, architectural drawing, blueprint reading; in short, the most comprehensive and easily understood work of its kind.

### These Books Sent FREE

Yes, this is true. We ship them to you without a penny of down payment. When you get them, look them over carefully—note how easy it is to find what you want to know—test the index in any way you want to and then, if after 10 days you agree that you have at hand a veritable mine of invaluable information, send only \$2.00 and keep the books. After that send us only \$3.00 per month until the small total of \$24.80 is paid. For a short time we will include with each set a complete portfolio of the five basic orders of Architecture. These 58 beautifully illustrated plates are drawn to scale and carefully figured. Size of each 11x15 inches. You'll thank the day you sent for your set.

### Learning Means Earning

and here you have at hand information gathered from hundreds of experts, all for so small a sum you'll never miss the money. Use these books as others have done and you'll get many times their price in a few months. One job alone may repay you several fold. Send for your set today.

### FREE EXAMINATION COUPON AMERICAN TECHNICAL SOCIETY

Dept. G-119, Chicago, Ill.  
You may send me, entirely without obligation, this handsome set of 5 volumes—Architecture, Carpentry and Building. I am to have full ten days in which to look them over and decide if I want to keep them. After which, I will either send them back or send \$2.00 down and \$3.00 per month until the special price of only \$24.80 has been paid. Please include FREE the portfolio of 58 handsome plates.

Name.....

City.....State.....

Reference.....

### Free Membership

Send now and we will include with these money-making books a membership in the American Technical Society which entitles you to free consultation privileges with twenty highly paid experts. This alone is invaluable.



# “GET ON” “Uncle Sam’s” PAYROLL

**\$1700 to  
\$3300 A Year**  
(Every Year)

**Every MAN and BOY 17 UP  
Should Mail Coupon Immediately**

U.S. Government Positions are steady. Strikes, poor business conditions, lockouts or politics do not affect them. U.S. Government employees get their pay for twelve full months every year. There is no such thing as “HARD TIMES” in the U. S. Government Service.

## **RAILWAY POSTAL CLERKS**

Railway Postal Clerks now get \$1900 the first year, being paid on the first and fifteenth of each month. \$79.16 each pay day. Their pay is increased \$100 and \$150 a year. The maximum is \$2700 a year. \$112.50 each pay day. They get extra allowance for hotel expenses when away from home.

## **PAID VACATIONS**

Railway Postal Clerks, like all Government employees, are given a yearly vacation of 15 working days (about 18 days). When on runs they usually work 3 days and have 3 days off duty or in the same proportion. During this off duty and vacation, their pay continues just as though they were working. When they grow old, they are retired with a pension. As Railway Postal Clerks are continually traveling, they have an excellent chance to see the country. They are furnished with a railroad pass.

## **City Mail Carriers—Post Office Clerks**

Clerks and Carriers get \$1700 the first year on regular and automatically increase \$100 a year to \$2100 with further increase to \$2300. They also have 15 days vacation. Examinations are frequently held in the larger cities. City residence is unnecessary.

## **What Will You Earn 5 Years from Now?**

Compare these conditions with your present or your prospective condition, perhaps changing positions frequently, kicking around from post to pillar, no chance in sight for PERMANENT employment; frequently out of a position and the year's average salary very low. **DO YOU EARN \$1900 EVERY YEAR? HAVE YOU ANY ASSURANCE THAT A FEW YEARS FROM NOW YOU WILL GET \$2700 OR MORE A YEAR, EVERY YEAR?**



## **Get Free List of Positions**

Fill out the coupon. Tear it off and mail it today—now, at once. **DO IT NOW**—This investment of two cents for a postage stamp may result in you getting a U. S. Government Job.

**FRANKLIN  
INSTITUTE,  
Dept. E-174  
ROCHESTER,  
N. Y.**

Rush to me entirely free of charge 32 page book with (1) a full description of the position checked below; (2) Specimen coaching; (3) a list of U. S. Government Jobs now open to men, boys, 17 up.

**Railway Postal Clerk (\$1900-\$2700)**  
**Post Office Clerk . . . . . (\$1700-\$2300)**  
**City Mail Carrier . . . . . (\$1700-\$2100)**  
**Rural Mail Carrier . . . . . (\$2100-\$3300)**  
**Bookkeeper . . . . . (\$1320-\$2040)**

Name . . . . .

Address . . . . .

Use This Coupon Before You Mislaid It—Write or Print Plainly



**NOW** → **ONLY \$2.00**  
**Giant Chest Expander**

and

**Progressive Exerciser**

Be a muscular marvel. Have the muscles of a superman. Become strong for your health's sake or to astound your friends with extraordinary feats which only men of giant strength can do. In a few short weeks you will easily do stunts which now seem difficult—then real muscles and strength will be yours—and yours to keep. If you want exercise to just keep in good shape you can reduce the strength of the Progressive Exerciser by eliminating as many cables as you wish. If you want great resistance so as to build up big solid muscles, then use the full strength.

**Send No Money Use This Money Saving Coupon**



**How the Giant Chest Expander and Progressive Exerciser is Made**

The Giant Chest Expander and Progressive Exerciser is made with new live, springy rubber so as to give it long wearing and great resisting qualities. Do not pay more for an exerciser that has forty or less rubber strands to each cable. Get the best and most durable. The Giant Progressive Exerciser has 60 strands of the finest rubber procurable to each cable.

**Free Instructions**

We do not think it enough to send you an exerciser worth double what we ask, but for a limited time, we will also include instructions absolutely free. These instructions are interesting and simple to follow—they show you the short cut to health and strength. Order today before this wonderful offer is withdrawn.

**Your Guarantee**

The Giant Chest Expander is sold with a guarantee that you will say it is the finest you ever saw or your money back.

**5 Cables for strength for \$2** or **double 10 Cables for strength for \$4**

The double strength exerciser has resistance of over 200 lbs.

**How to Order—Send No Money**

Sign your name and address to coupon below and get your Giant Exerciser at the present low introductory price by return mail. The price is made low because we want everyone to enjoy muscles and strength at the lowest possible cost. Don't pay more—order from us—get the most for your money. Use coupon now.

**PROGRESSIVE EXERCISER CO.,**  
 4301 Langdon Bldg.,  
 Broadway and Duane Street, New York

Please send  Your 10 cable Progressive.  
 Your 5 cable Exerciser.

Check the Exerciser you want, and it will be sent you by return mail. Pay postman introductory price, plus few cents postage on arrival. It is understood that if you are not entirely satisfied with your exerciser you may return it within 5 days and get your money back.

Name.....

Street.....

City..... State.....

If you live outside the United States, send cash with order.



Think of being able to offer a suit or topcoat made of the finest quality of pure Virgin Wool; fit, fabric and fashion guaranteed, at the powerfully attractive price of \$23.50! Can you sell such values? You can, if the experience of 2,500 other salesmen means anything. And you don't have to know anything about selling clothing. We'll take you, train and equip you to go out and make a success of this work if you are honest, ambitious and willing to work. If you are, write us. You'll hear from us promptly with the full facts. Address Dept. 2.

**William C. Bartlett, Inc., 850 Adams St., Chicago**

Gentlemen: I'm interested in the opportunity you offer. Please send the facts without obligation to me. 2

Name.....

Address.....

Town..... State.....



**Drum Lessons With the Outfit**

With each genuine Ludwig Trap Drum Outfit we furnish an instruction method. Ludwig drum sets from \$32.50 up. Call on your music dealer or write us for full particulars. Send for free catalog.

World's Largest Makers of Drums and Banjos

**LUDWIG & LUDWIG**  
 1611 N. Lincoln St. Chicago, Ill.

**Anyone CAN LEARN**

No talent or experience necessary. Fascinating work. Pays big money. Complete instruction book tells about: Alphabets, Colors, How to Mix Paints, Show Cards, Window Board and Wall Signs, Ready made letters, Gilding, Tricks of the Trade, a gives 100 Alphabets and Designs. Book and in flexible int. leather-gold edges, a. or ball bearing Show Card Pens. Sent postpaid \$3.00. (C. O. D.) 10c ex. Ogilvie Pub. Co., 57 Rose St. Dept 20, N. Y. City

**EARN MONEY IMMEDIATELY— WE FURNISH EQUIPMENT TO START!!**

**\$75 WEEKLY BUILDING RADIO SETS**

Join the Association! We train you to build and repair radio sets—start you in business—enable you to earn \$3 an hour upwards. **Free 5-Tube Radio Set to members.** Write for special limited-time plan whereby your membership need not cost you a cent. Write today!

**RADIO ASSOCIATION OF AMERICA**  
 Dept. PM-1 4513 Ravenswood Ave., Chicago, Ill.

**MINSTRELS** Musical Comedies and Reviews, with full instructions for staging. You can stage your own show with our books. Full line of plays, stage songs, crossfire, monologues, afterpieces, vaudeville acts and make-up. **CATALOGUE FREE**

**T. S. DENISON & CO., 623 So. Wabash, Dept. 19, CHICAGO**

**Learn Advertising at HOME**

Some of the highest paid men in the world are advertising men. You can learn easily and quickly at home during your spare time. Bigger opportunities now in advertising than ever before. Constant demand for our graduates at big pay. **Send for FREE Book.** Giving interesting information and vital facts—just what you want to know about advertising. Write today!

**PAGE-DAVIS SCHOOL OF ADVERTISING**  
 Dept. 1351 3601 Michigan Ave., Chicago, U. S. A.



# This funny juice-

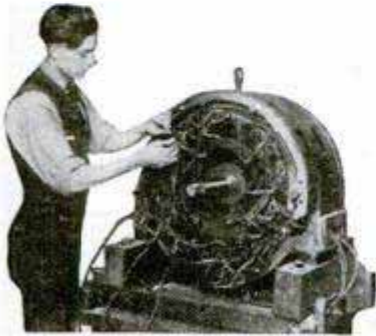

A 25 H. P. Motor for student practice

- helps to run automobiles
- makes radio possible
- makes your telephone work
- makes the wheels go round in thousands of factories
- illuminates homes, factories, office buildings and city streets
- toasts bread, percolates coffee and heats flat-irons
- runs street cars and fast trains

No one knows what it really is—it is called Electricity—but you can learn how to handle it.

**—AND IT WILL PAY YOU**

## \$1<sup>00</sup> per Hour to \$25,000<sup>00</sup> per Year

IF you get a real "kick" out of this subject of Electricity you're *crazy* if you don't make it earn you real money. Pretty plain speaking—but I want to make you *think*. The world's greatest, most successful men were men who worked at things *they liked*. Work is fun if you like your job. If YOU like electricity, *make it pay you real money*.

### Here's Your Chance

To get somewhere you've got to start, haven't you? It'll mean breaking away from home for about 12 weeks—but you and the family will be mighty glad you *started* and *finished* something. Especially something that pays so big.

We'll take mighty good care of you here in the big Greer Electrical Shops. You'll be in company with hundreds of men temporarily away from home, like yourself. And you'll learn Electricity—*oh man*—how you'll learn it! You'll marvel at the way a subject apparently so mysterious is made so easy to understand. Just wait till we turn you loose among our hundreds of motors, rotary converters, generators, telephone and radio equipments. Competent, friendly instructors will show you

how to take 'em apart and put 'em together till you can do it in your sleep.

### How to Get This Training

The coupon at the bottom of this page is the open door to pleasant work and big money in the Electrical Profession. We can't tell the whole story here because it takes a Book to tell it. The book is free. Mail the coupon, and be thankful the rest of your life for doing it. Delayed action never put money in the bank. DO IT NOW.

### What About Automobiles?

Maybe automobiles interest you as much as electricity—or more. There's a lot of money in fixing autos, too. The well trained auto man is never out of a job. He's ready to go in business for himself. Would you like that kind of work? \$6 a day to \$20,000 a year is what it pays you.

Then mark the coupon for the free book on our Automotive Course. We've made automobile experts out of thousands of men who didn't know a carburetor from a universal joint when they came to our big training shops. How much does it cost? You'll be surprised to learn *how easily you can afford it*. Mail the coupon NOW for complete information.

## Greer College of Electrical Engineering

Dept. 102

2024 S. Wabash Ave.

CHICAGO

### FREE Employment Service

Our employment department is ready to help you—while in training and *for life*. Day and evening classes. Low cost. Easy terms.



Using the "wrecker Crane" in the Automobile repair department. Here you learn about all up-to-date auto equipment—by actually using it. Real experience on all makes of cars, under supervision of an expert.

ERWIN GREER, President, Greer College  
Dept. 102, 2024 S. Wabash Ave., CHICAGO.

Please send me your FREE BOOK and offer for it is understood I am not obligated in any way

Electrical  course  
Automotive  course

Name .....

Address .....



**FREE RAILROAD FARE TO CHICAGO IF YOU ACT PROMPTLY**



**I'll Teach You  
to Play a Saw  
in 24  
Hours!**

**C. J. MUSSEHL**, Pioneer Artist on the Musical Saw, has taught thousands to become Experts, Vaudeville Stars and High-Priced Entertainers.

**I'll Loan  
You the  
SAW  
5 Days  
Free**

**Be  
Pop-  
ular—  
Play for  
Money  
or Fun**



**JUST** to prove how quick and easy you can learn to play a saw, I'll send you a genuine, specially tempered Musical Saw for 5 days' trial. I guarantee that in 24 hours you can play tunes like "Old Black Joe" and "Home Sweet Home." Then you quickly learn latest jazz and song hits, operatic and classical music. Amazingly simple—no notes to read, no dreary practice. You don't need to know a thing about music.

**Success Positively Guaranteed**

I have taught thousands to play the Musical Saw. Just three short simple lessons reveal every secret of my twelve years' success as a professional saw musician. Scores have won fame and fortune. Let me prove that you, too, can quickly play like a professional. The Musical Saw's only rival is the violin for sweetness and expression. Tone effects are positively startling and so unexpected that nothing compares to it in winning instant popularity or becoming a salaried entertainer.

**Phonograph  
Record**

**FREE**



Double-disc, demonstration-size phonograph record of beautiful Saw solo and duet, sent with full particulars of my free trial offer. You'll wonder that a saw can produce such marvelous music. But the record proves it. Enclose 10 cents (stamps or coin) to cover record handling and postage. Or if you do not want the record, just ask for my big **FREE TRIAL OFFER**, sent postpaid.

**MUSSEHL & WESTPHAL**  
259 West Water Street, Fort Atkinson, Wis.

**OPPORTUNITIES IN  
Salesmanship**

**Become a Salesman**

Every phase of business revolves around selling. The trained salesman is in demand—he can fix his own hours, choose his own field, control his own pay. His income depends only upon his results—there is no limit to what he can earn. We train you to sell successfully thru the LaSalle problem method under supervision of expert salesmen. Train in your spare time. Low cost; easy terms. 64-page booklet, "The Modern Salesman, Ambassador of Progress," free. Send for it today.  
**LaSalle Extension University, Dept. 164-S Chicago**



**FREE**

**FRENCH**

Learn at home by the New Conversational Method evolved in Europe and introduced in America by the I. C. S. School of Languages. Endorsed by French Embassy. Hundreds of successful students.

Write for Free Booklet  
**INTERNATIONAL CORRESPONDENCE SCHOOLS**  
Box 5626-E, Scranton, Penna.

Learn to **PAINT**  
**SIGNS and SHOW CARDS**

We quickly teach you by mail, or at school, in spare time. Enormous demand. Big future. Interesting work. Oldest, foremost school.

**EARN \$50 TO \$200 WEEKLY**  
John Vassos, N. Y., gets \$25 for single show card.  
Crawford, B.C., says: "Earned \$200 while taking course."  
Send today for free information, samples and guarantee.

**DETROIT SCHOOL OF LETTERING**  
150 Stimson Ave. Est. 1899 Detroit, Mich.



**Hotels Start You With  
Salaries up to \$3,500 a Year**  
— with your living

**HOTELS**, restaurants, clubs, apartments, everywhere need trained men and women—salaries to start up to \$3,500 a year with your living usually included. Over 70,000 high-class positions paying \$2,500 to \$10,000 a year are open every year in the hotels of the United States. Today, this is the 4th **INDUSTRY IN AMERICA**—with over \$1,000,000,000 in new hotels and clubs being built in 1926. These new hotels, clubs, restaurants, etc., will need nearly 200,000 trained men and women. You can have one of these high-class big-pay positions, fascinating work with meals and luxurious apartment usually furnished **FREE!** No previous experience necessary. The Lewis Schools guarantee to give you the valuable knowledge that it has taken some of the most successful hotel men years to obtain—men who are now making \$5,000 to \$50,000 a year. We train you by mail in your spare time at home with the Lewis Simplified Study Plan, and we put you in touch with big opportunities. Our students employed, our methods endorsed by leading hotel men everywhere. Send today for Free Book, "**YOUR BIG OPPORTUNITY**," showing how we can train you for one of these splendid positions, and explaining our Money-Back Agreement.

**LEWIS HOTEL TRAINING SCHOOLS**  
Room AB-388 Washington, D. C.

**FREE BOOK COUPON**  
**LEWIS HOTEL TRAINING SCHOOLS, Room AB-388, WASHINGTON, D. C.**  
Send me without obligation the Free Book, "**YOUR BIG OPPORTUNITY**."

Name.....  
Address.....  
City.....State.....

# Learn to Mount Specimens like These

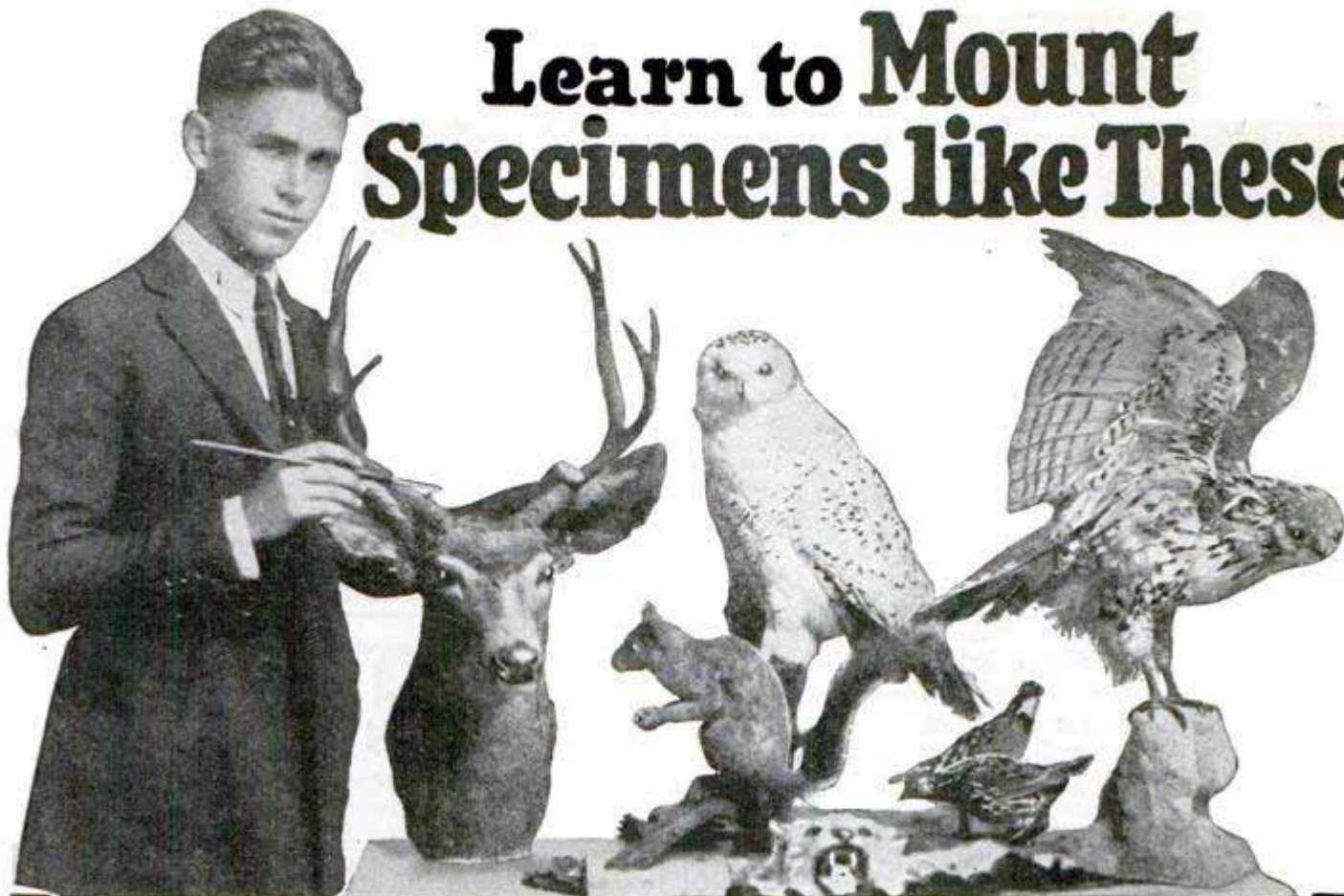

**L**EARN to mount and stuff all kinds of game, animals, birds, fish—tan furs and skins, make beautiful rugs, robes, etc. You can learn *easily and quickly* during your spare time by mail. *Great sport and lots of fun.* Lessons are easy and intensely interesting. Latest museum methods. This school is 20 years old, high class and reliable, and has 75,000 graduates. *Success guaranteed.* Don't delay, but start to learn this extremely fascinating art NOW.

**FREE** Beautifully illustrated book, "How to Mount Game." Explains the secrets of taxidermy. Dozens of photos of mounted specimens. Tells how you can learn this great art, no longer a secret, right in your own home during *spare time*. Tells how to

become a taxidermy artist, how to save your own splendid trophies, how to beautify and decorate your room and home with nature's choicest art.

Tells how young men and boys can make the **BIGGEST MONEY** from their spare time. Don't delay. Clip coupon now. Send **TODAY** for this Free Book.

## Make Big Money—

Taxidermy is the most profitable OF ALL spare time work. Sell your mounted specimens. Mount trophies for your friends, hunters, trappers and fishermen. Have a side business of your own. Be independent. Have plenty of spending money—for athletic goods, radio, books, traps, and for vacations. Here is your opportunity. Don't delay. Send the coupon right NOW.

## Free Book Coupon

Northwestern School of Taxidermy  
1771 Elwood Bldg., Omaha, Nebr.

Send me, absolutely free, your illustrated book, "How to Mount Game." Also tell me how I may learn to be an expert taxidermist easily and quickly by mail. No obligation.



"Be Wise"

Name \_\_\_\_\_

Address \_\_\_\_\_



## "BECOME A LIGHTNING TRICK CARTOONIST"

Send \$1.00 for Laugh Producing Program of 23 Trick Drawings with Instructions. Catalog of Chalk Talk Supplies Free. BALDA ART SERVICE, Dept. 1, Oshkosh, Wis.

## LEARN PHOTO-ENGRAVING

Earn \$200 to \$500 monthly. Photo-Engraving and Photography taught by largest college of its kind in the world. Established 1893. Big demand for graduates. Write for free book. Illinois College of Photography, Box 417, Effingham, Ill.

# PATENTS

Booklet Free Highest References  
Promptness Assured Best Results

Send drawing or model for preliminary examination of Patent Office records.

## ALL BUSINESS GIVEN PROMPT AND PROPER ATTENTION

Listed Patent Lawyer in the latest editions of the Rand-McNally Directory of Bankers and Attorneys, of Chicago, Ill.; The Baggett & Ryall Directory of Attorneys, New York City; The Lawyers Guaranteed Directory, Detroit, Michigan; The Lawyers and Bankers Quarterly, published by the Legal Directory Publishing Company of St. Louis, Mo.; the American Lawyers Annual, Cleveland, Ohio.

**WATSON E. COLEMAN,**  
REGISTERED PATENT LAWYER

Victor Building, 724 Ninth Street, N. W.  
**WASHINGTON, D. C.**

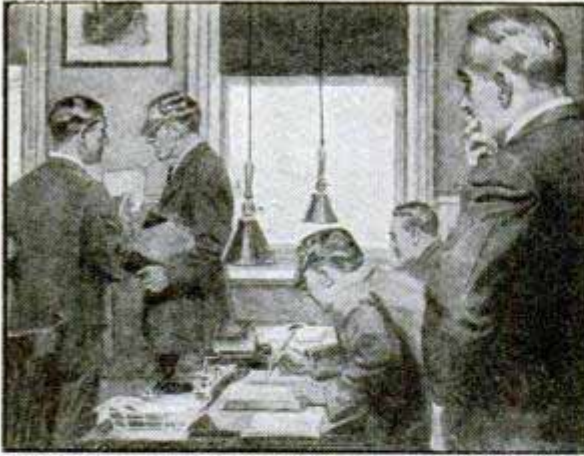

## “Which Man Shall I Promote?”

**W**ILL your employer think of you when the next good position is open? Will he say, “*There’s a man who is training himself to handle bigger work,*” or will he pass you by as just an ordinary routine worker?

Do not try to fool yourself. Your employer is watching you more closely than you may think. He’s constantly checking up on your work, your abilities, your ideals, your aspirations. Stored away in the back of his mind or filed away in black and white, are his impressions of the kind of man you *are* and the kind of man you *want to be*.

He’s willing and anxious to pay you more money the minute you prove that you are worth more money. But he can’t take chances. When he promotes a man, he wants to be sure he will make good.

Decide now—*today*—that you are going to be ready when your chance comes. Choose the position you want in the work you like best—then train for it. You can do it in spare time in your own home through the International Correspondence Schools.

Write today for an interesting descriptive booklet which tells the full story. It won’t cost you a penny, but it may be the means of changing your entire life.

### INTERNATIONAL CORRESPONDENCE SCHOOLS Box 5625-E, Scranton, Penna.

Without cost or obligation, please send me one of your booklets and tell me how I can qualify for the position or in the subject before which I have marked an X:

#### BUSINESS TRAINING COURSES

- |                                                                  |                                                                           |
|------------------------------------------------------------------|---------------------------------------------------------------------------|
| <input type="checkbox"/> Business Management                     | <input type="checkbox"/> Salesmanship                                     |
| <input type="checkbox"/> Industrial Management                   | <input type="checkbox"/> Advertising                                      |
| <input type="checkbox"/> Personnel Organization                  | <input type="checkbox"/> Better Letters                                   |
| <input type="checkbox"/> Traffic Management                      | <input type="checkbox"/> Show Card Lettering                              |
| <input type="checkbox"/> Business Law                            | <input type="checkbox"/> Stenography and Typing                           |
| <input type="checkbox"/> Banking and Banking Law                 | <input type="checkbox"/> Business English                                 |
| <input type="checkbox"/> Accountancy (including C.P.A.)          | <input type="checkbox"/> Civil Service                                    |
| <input type="checkbox"/> Nicholson Cost Accounting               | <input type="checkbox"/> Railway Mail Clerk                               |
| <input type="checkbox"/> Bookkeeping                             | <input type="checkbox"/> Common School Subjects                           |
| <input type="checkbox"/> Private Secretary                       | <input type="checkbox"/> High School Subjects                             |
| <input type="checkbox"/> Spanish <input type="checkbox"/> French | <input type="checkbox"/> Illustrating <input type="checkbox"/> Cartooning |

#### TECHNICAL AND INDUSTRIAL COURSES

- |                                                                     |                                                                          |
|---------------------------------------------------------------------|--------------------------------------------------------------------------|
| <input type="checkbox"/> Electrical Engineering                     | <input type="checkbox"/> Architect                                       |
| <input type="checkbox"/> Electric Lighting                          | <input type="checkbox"/> Architects’ Blueprints                          |
| <input type="checkbox"/> Mechanical Engineer                        | <input type="checkbox"/> Contractor and Builder                          |
| <input type="checkbox"/> Mechanical Draftsman                       | <input type="checkbox"/> Architectural Draftsman                         |
| <input type="checkbox"/> Machine Shop Practice                      | <input type="checkbox"/> Concrete Builder                                |
| <input type="checkbox"/> Railroad Positions                         | <input type="checkbox"/> Structural Engineer                             |
| <input type="checkbox"/> Gas Engine Operating                       | <input type="checkbox"/> Chemistry <input type="checkbox"/> Pharmacy     |
| <input type="checkbox"/> Civil Engineer                             | <input type="checkbox"/> Automobile Work                                 |
| <input type="checkbox"/> Surveying and Mapping                      | <input type="checkbox"/> Airplane Engines                                |
| <input type="checkbox"/> Metallurgy <input type="checkbox"/> Mining | <input type="checkbox"/> Agriculture <input type="checkbox"/> Navigation |
| <input type="checkbox"/> Steam Engineering                          | <input type="checkbox"/> Mathematics <input type="checkbox"/> Radio      |

Name.....  
Street.....  
Address.....  
City..... State.....

Occupation.....  
Persons residing in Canada should send this coupon to the International Correspondence Schools (Canadian, Limited, Montreal, Canada.

## PREPARE FOR AN ART CAREER

—thru the *only* school operated as a department of a large art organization. Commercial Artists trained the “*Meyer Both Way*” earn as high as \$10,000 per year. We today have hundreds of students who had previously studied in other art schools. Why? Because your instruction is based upon our everyday experience in meeting the art needs of leading advertisers. Home study instruction. Write for illustrated book telling of the success of our students.

**MEYER BOTH COMPANY**  
Michigan Ave. at 20th St., Dept. 16, Chicago, Ill.

## ELECTRICITY LEARN IN 12 WEEKS

Finlay method of practical Electrical instruction (now in 24th successful year) prepares you for big paying position in 12 short weeks. Learn by doing actual electrical work. Earn up to \$25 a day. Send at once for free Finlay catalog and full details regarding this wonderful business. Enroll any time. Completely equipped shops and laboratories. Faculty of highly trained experts. Certificates awarded. Students assisted to positions. Success can be yours. Write today and get the facts. Ask about One and Two-Year Courses.

**FINLAY ENGINEERING COLLEGE**  
115 Finlay Building KANSAS CITY, MO.

## LAW in Spare Time

Learn law and earn more money. Qualify for a high salaried executive position or prepare to enter the practice of law. Study at home through the Blackstone Course prepared by 80 prominent legal authorities including Chief Justice William H. Taft. Blackstone graduates practicing law everywhere. LL. B. degree conferred. Magnificent 25 volume law library furnished immediately upon enrollment. Moderate tuition fee. Low monthly terms. Money Back Guarantee. Write today for Free copy of our 128-page book, “The Law Trained Man.”

**BLACKSTONE INSTITUTE, Inc.**  
Dept. 51 4753 Grand Boulevard Chicago  
America’s Foremost Non-Resident Law School

## BIG POULTRY BOOK and FREE New POULTRY BULLETIN



Worth Hundreds of Dollars. Shows how Big Men in Poultry Grew Rich—How Many Started Small, Now Worth Thousands. You can do same if you follow methods outlined in FREE BOOK. Now is the time to make money with poultry.

FREE BOOK and New Bulletin tells what to do each month. Mention variety of poultry you like. Write today without fail.

**AMERICAN POULTRY SCHOOL, Dept. 70, KANSAS CITY, MO.**

**Health Food Directory** — How to select the proper foods for gaining weight; reducing; building vitality; disease resistance; constipation; building muscle, etc. Rates and tabulates standard branded foods. No other book like it. 150 pages of valuable information. Special price 25c. postpaid. Limited edition.  
**Macfadden Publications, Inc., Dept. P.M.1, 1926 B’way, N. Y. City**

**Learn Watchwork, Jewelrywork and Engraving** A fine trade commanding a good salary, and your services always in demand. Address **Horological**, Dept. P, Bradley Institute, PEORIA, ILLINOIS, for our latest catalog.

# Can you fix it

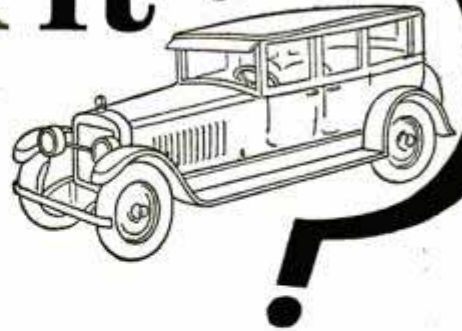

New books have "jiffy index," making all facts instantly available. You find anything you want to know in a moment, in this brand new 1926 edition.

## These books tell how

**H**ERE are the most interesting, the most practical books we have ever published on automobile construction, operation and repairs. Brimful of facts, photographs and explanations so easy to understand that anyone can learn how in almost no time.

Over 2000 pages, with diagrams, blueprints and everything else needed to make anyone an authority on automobiles.

Whether you want to qualify as garage owner, auto repair expert or merely wish to know how to keep your own car 100% efficient, you will welcome these books, especially on our

### No Money Offer

This plan brings this valuable information within the reach of everyone. You don't send us a single penny. You don't have to pay us anything—just send your name and address and we'll send you the complete set of 5 volumes, specially bound in Flexo covers.

Read them carefully; keep them 10 days; find out anything you want to know, and then if you want to keep them, send only \$2.00 then and \$3.00 per month until the special low price of \$24.80 is paid. There is no further obligation.

### American Technical Society Membership Free

This is a great organization for the publishing and spreading of specialized knowledge—we have over a million dollars of resources, enabling us to get the cooperation of the largest automobile manufacturers and dealers, who have furnished us plans and photographs. If you send NOW for this new edition of Automobile Engineering, we will include a Consultation Membership in this great organization.

Eighteen automobile experts will be ready to help you at all times. You can write or wire any time for special information. Answers will be sent to you promptly—without cost.

#### EMPLOYMENT SERVICE FREE

In addition to all this, those who send now will be entitled to the services of our EMPLOYMENT DEPARTMENT without charge. We are in daily contact with firms all over the country who need good men and are willing to pay big. This service costs you nothing. Don't miss this special offer. Send now.

### Don't Hesitate

There are no strings to this offer—it means just what it says. Send name and address on the coupon and ALL of the five books—the complete set—will be sent to you for examination.

Remember one fact only which you can find in these books may save you an expensive repair or help you to a better job.

### Learn All About Autos

Get these five big books on this liberal offer and learn all the things you want to know about autos.

Carburetors, engines, springs and spring suspension, brakes, 4-wheel drives, lubrication systems—all are fully covered.

These complete and comprehensive auto books are yours if you want them on this easy plan. Send for a set NOW; there's nothing to pay.

Jiffy  Index

You don't have to read the books through; the index enables you to put your finger on the information wanted in a jiffy.

### For Free Offer, Use Coupon

American Technical Society,  
Spec. Dept. A-119, Chicago, Ill.  
I would like to look at the 5 Auto Books described above. Send them on your FREE offer. I will examine them carefully and return them in 10 days unless I like them; in which case I will send you \$2.00 then and \$3.00 per month until the total price of only \$24.80 is paid. You are to also send me Free Consulting Membership Certificate in the American Technical Society and I am entitled to the services of your employment department without charge.

Name.....

Street.....

City.....State.....

Reference.....

# Learn to Draw at Home



## Make Your Salary \$100<sup>00</sup> a Week

Everywhere there is a big demand for artists—newspapers, magazines, advertising agencies, department stores, everyone who advertises is glad to pay big money for artists who can produce pictures and illustrations with commercial value.

### Learn at Home This Quick, Easy Way

Our wonderful method makes it possible for anyone to learn Illustrating, Cartooning or Commercial Art. Most of our students never touched a drawing pencil before they studied with us, yet many of them are now making splendid incomes. You can do the same. The simplicity of this amazingly easy way will astonish you. No matter what your present ability—no matter whether you think you have "talent" or not—we can teach you to draw—and draw well.

### Simple Way Makes Success Easy

Our easy way simplifies everything. You start drawing with straight lines, then you begin using curves, and before you realize it you are drawing pictures with shading, action and perspective. And you are taught all the "inside secrets"—the "tricks of the trade" that would otherwise take you years to learn. Our successful Art instructors have had years of experience in commercial art. They know the kind of pictures that sell and they teach you how to make them—in the least possible time.

### Write for FREE BOOK

An interesting and handsomely illustrated booklet, "Quick, Easy Way to Become an Artist," will be sent you without cost.

Mail this coupon for it. Learn how you can easily become an artist in your spare time. Get also full particulars about our attractive offer to new students. Send the coupon NOW. The Washington School of Art, Inc., Room 301-E, 1115-15th Street, N. W., Washington, D. C.

The Washington School of Art, Inc.  
Room 301-E, 1115-15th St., N. W., Washington, D. C.

Please send me without cost or obligation on my part your free book "Quick, Easy Way to Become an Artist." *Print name plainly.*

Name.....

(Mr., Mrs., Miss)

Address.....

City..... State.....

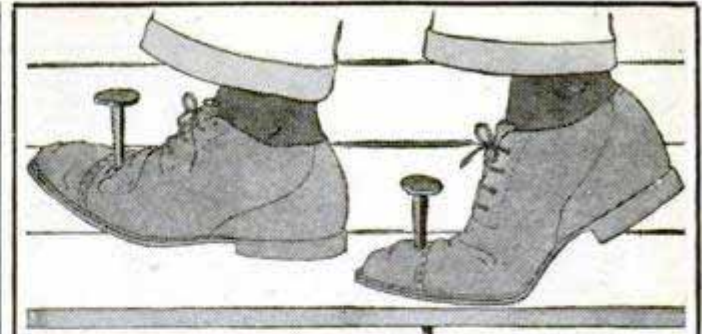

## ARE YOU SPIKED TO YOUR JOB?

Take inventory of yourself. Are you getting anywhere? What is the outlook for your future? Don't let yourself get stale on the job. There are thousands of men right now in offices, factories, or working at trades literally spiked to their jobs just because they haven't the nerve to take advantage of an opportunity when it presents itself. No matter what your line of endeavor is, you would be way ahead of where you are if you knew Salesmanship. Learn to sell your way to Success—and here is how you can do it:

**FREE Book on Salesmanship** We have compiled the greatest book ever printed on Salesmanship, and we are giving it away FREE to ambitious people who want to get somewhere in life. This book contains 300 pages of How-to-do-it information, hundreds of instructive illustrations, teaching you how to sell yourself to others, and how to be successful by simply applying certain principles. This book will be sent you absolutely FREE of charge with a one year's subscription to OPPORTUNITY MAGAZINE, The World's Leading Salesman's Publication, at the regular price of Two Dollars per year. The book alone is worth twice that, but this offer is made for a limited period only to acquaint more men and women with the advantages this great field of endeavor offers. Don't send any money. Pay the postman Two Dollars on receipt of the book, and your subscription starts at once. Address

OPPORTUNITY MAGAZINE  
DESK 22, 750 NORTH MICHIGAN AVENUE, CHICAGO



## MUSIC LESSONS FREE



IN YOUR OWN HOME

Write today for our FREE booklet. It tells how to learn to play Piano, Organ, Violin, Mandolin, Guitar, Banjo, etc. Beginners or advanced players. Your only expense about 2c per day for music and postage used. American School of Music, 51 Manhattan Bldg., Chicago

## MEN WANTED TO LEARN

### Motion Picture Projection

\$2,000 to \$4,000 a Year  
Quickly learned. Short hours, big pay. Best equipped school in Michigan. Projectionists for Movie Houses and Road Shows.

MOVIE OPERATORS SCHOOL  
61 Sproat Street, DETROIT, MICHIGAN

## TELEGRAPHY

(Morse and Wireless) and RAILWAY ACCOUNTING taught thoroughly. Big salaries; great opportunities. Oldest, largest school. Endorsed by Telegraph, Railway, Radio, and Government officials. Expenses low—opportunities to eat a large portion. Catalog free. DODGE'S INSTITUTE, Jones St., Valparaiso, Ind.

## ADDING MACHINE

### Fits Vest Pocket

SEND NO MONEY

A marvelous calculator. Does the work accurately and quickly as a \$300 machine. Invaluable to anyone who uses figures. Don't carry pad and pencil. This startling invention will solve all problems in a minute. Business men, students, professional people, all need this HANDY HELPER.



Counts To 1 Billion

Results in plain sight PRICE all the time -- clears instantly. Made of steel and brass, in handsome case, fits vest pocket; weight only 8 oz. Send for yours now -- you'll save time and money.

Don't send money, just name and address. Pay postman only \$2.95 plus few cents postage. Try it for 10 days. Your money back if not satisfied.

\$2.95

Reliable Adding Machine Corp., Dept. 41  
184 W. Washington St., Chicago, Ill.

### AGENTS

Here's a dandy chance to make money. Everybody wants one. Fine profit. Write for new offer.

# NOW FREE



**B. W. COOKE**  
Directing Engineer

**EARN UP TO \$150 a Week!**

If you're earning a cent less than \$60 a week, *clip coupon now*. Get the *proof* that you can be on your way to **BIG PAY** as an Auto Expert **QUICK!** See for yourself how *fascinating* this training is—how easily you can master Auto Work right in your own home—and how *quickly* you can get in line for the *big Auto Jobs* that pay up to \$150 a week and more—or a Money-Making Auto Business of your own! Remember these Instruction Jobs come to you **ABSOLUTELY FREE** and without obligation. **CLIP COUPON NOW.**

**I'll train you AT HOME** Get these free Instruction Jobs now. See how I train you for Big Pay this fascinating, easy, new way—with **LESSONS—JOB-TICKETS—TOOLS** and actual **AUTO JOBS**. See how thorough, how complete "JOB-WAY" Training is—includes all Electrical work—Ignition, Starting, Lighting—all Mechanical, also Welding, Brazing, Vulcanizing—also Business Course, Salesmanship, Advertising—How to Keep Simple Books—also Students' Magazine, also 4 Working Outfits. Nowhere else can you get this original genuine copyrighted B. W. COOKE "JOB-WAY" Training.

**Be An Electrical-Mechanical AUTO EXPERT THIS BIG AUTO**  
**The World's Biggest Business Needs You BOOK ALSO FREE**

There are so many *Tremendous Opportunities* in this gigantic Auto Industry that I want every ambitious man *who really wants to make more money*, TO HAVE these 6 Instruction Jobs, just to see how easily and quickly I can boost his pay way up. Just think! *Seven thousand Millions of Dollars* are paid to Auto men every year for *upkeep alone—Nineteen Million Dollars a day!* Think what that **MEANS TO YOU**—the Big Pay Opportunities open to you as an auto expert! It's the **ONE** field for the man who wants a **BIG** pay check! **LEARN ALL ABOUT IT NOW!** Coupon brings this startling, revolutionary Auto Book, too, absolutely Free! Shows how hundreds of men have reached Big Pay in amazingly quick time! Shows what **you** can do. Send for it now!

**Act Quick!** Don't delay a minute. Send coupon right now while I can still make you this special offer of 6 Auto Instruction Jobs *absolutely free*—as well as my Big Auto Book, *free too!* Act now!

**B. W. COOKE DIRECTING ENGINEER**  
**CHICAGO MOTOR TRAINING CORPORATION**  
1916 Sunnyside Ave., Dept. 116A Chicago

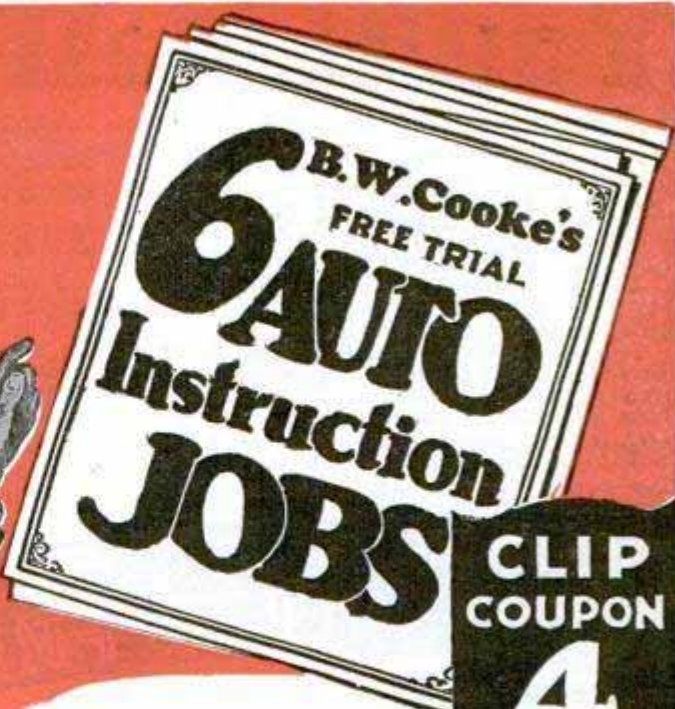

**CLIP COUPON**  
**4**  
**OUTFITS**  
*Free*  
**OF EXTRA COST**

**To PROVE** that "JOB-WAY" is "PAY-RAISE" Training Clip coupon now. I'll send you *absolutely FREE OF CHARGE*—with positively *no obligation* on your part—6 "JOB-WAY" Instruction **JOBS** and my big book! I want you to *SEE for yourself* just why "JOB-WAY" Training is bringing so many men *Big Money* in such *remarkably quick time*. I want you to see how men *without a day's previous auto experience*—and only *common schooling* become Garage Owners, Superintendents, Managers, and earn up to \$150 a week and more! I want you to see why *Hundreds of men* have found "JOB-WAY" Training to be such interesting, most practical money-making training!

That's why I make you this unusual offer—with absolutely no strings on it and *not a single penny's charge*.

**CLIP COUPON NOW** and I'll rush your jobs to you *absolutely Free!*

**Coupon Brings Full Details of My 4 OUTFITS OFFER**  
Includes: Tools, Tool Bag, Electrical Test Bench—Also 303 Wiring Diagram Charts, also Special Electrical Outfit.



**SEND ME LESSONS FREE and BOOK FREE**

Send me **absolutely FREE** and without any obligation on my part, 6 Auto Instruction Jobs. Also your Auto Book **FREE** and full particulars of your 4 Outfits Offer.

NAME.....  
ADDRESS.....  
TOWN..... STATE.....

# You'll Call Me a LIAR!

UNTIL you actually see what I have done for men all over the world; until you try out the system that gave me the name of "the Panther-builder" until you TRY TO DUPLICATE MY PATENTED PROGRESSIVE AND AUTOMATIC EXERCISER AT ANY PRICE! You'll call me a Liar!

I don't blame you. My record in Body-building IS almost too good to be true! And the most amazing part of it is that it IS true!

I could give you a few rubber bands for your money—as others do. I could make five times as much money in this business if I wanted to. I know how. But I won't do it!!

**That's Not My Speed!** I want to make MEN, not money. And I want those men to be my friends.

Here is one of the thousands of men I have built and I am proud of his friendship as well as his magnificent body.

## TITUS—Panther Builder

I trained most of the present day trainers! I taught them what a real body was. Today they make their living—and a good one—with the muscles I gave them. All over the world products of my system of body building have become leading physical directors, the strongest, best-developed men in their locality. You can have that reputation. Do you want it? The training that built the weight-lifting champion of all Europe and hundreds of other marvels of strength can remold your body and give you new life.

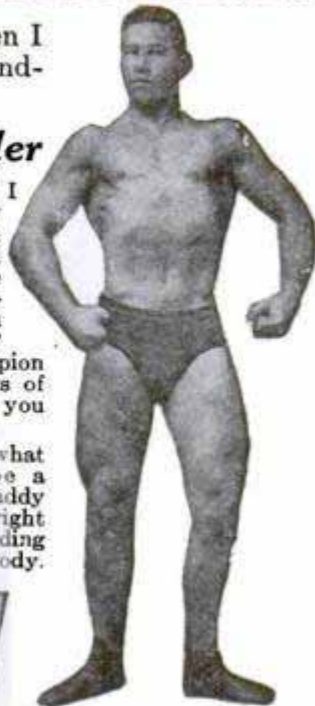

Let me show you what it feels like to be a panther. Let the "daddy of 'em all" prove his right to that title by building YOUR body.

"Be a regular guy," you said to me when I started. "Don't let them call you spider any more!" And, man alive, you got under my skin. Two weeks of your instruction—with your apparatus—made me over from my feet up! I'm a man now, and the credit goes to you!

HAROLD W. LOYD.

**MY NEW BIG BOOK IS A KNOCKOUT AND IT'S YOURS FREE—**

**TITUS, Dept. P-109  
105 East 13th Street, New York City**

Dear Sir: Please send me without cost or obligation, "Better Built Bodies," your New Big Book illustrated with scores of actual photographs of famous strong men you have trained.

Name.....  
Address.....  
City.....  
State.....

Get your copy of this Big New Book NOW. See for yourself how much of a liar I am. It contains true stories more wonderful than fiction. Stories of miracles worked in muscle—miracles that can be worked for you. Don't wait! Don't even turn the page. Tear the coupon out and see for yourself, BETTER BUILT BODIES is FREE to you!

TITUS, Dept. P-109  
105 East 13th St.  
New York

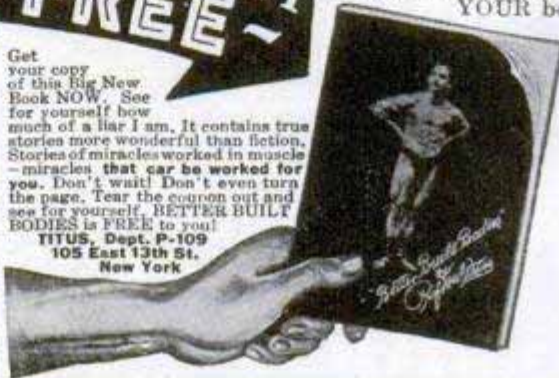

# DO YOU LIKE TO DRAW?

*It's Easy To Learn When Shown In The Right Way*

Some of cleverest cartoonists and comic artists in America today learned how to draw quickly—by following **CARTOONIST EVANS' SIMPLE AND EASY METHOD**. This school is recommended by foremost cartoonists because they know the students are handled right. If you like to draw, send 6c in stamps for **portfolio of cartoons and full details**. The course is **NOT EXPENSIVE**.

**The W. L. Evans School of Cartooning** 821 Leader Building CLEVELAND, OHIO

# AT HOME LEARN TELEGRAPHY AT HOME



**TEACH YOURSELF** in half usual time, at trifling cost, with the wonderful Automatic Transmitter, **THE OMNIGRAPH**. Sends unlimited Morse or Continental messages, at any speed, just as an expert operator would. **Adopted by U. S. Government, and leading Universities, Colleges and Telegraph Schools.** Catalog 6 cents.

**OMNIGRAPH MFG. CO., 13-19 Hudson St., NEW YORK**

# TRAVEL—for 'UNCLE SAM'

**RAILWAY MAIL CLERKS  
MAIL CARRIERS—POSTOFFICE CLERKS  
\$1700 to \$2700 a Year for Life**

No "lay-offs" because of strikes, poor business, etc.—sure pay—rapid advancement. City and country residents stand same chance. Common sense education sufficient—no political influence.

## STEADY WORK

Cut coupon and mail it before turning the page.

**MEN—BOYS  
18 to 45**

Use Coupon Before You Lose It

### COUPON

**FRANKLIN INSTITUTE, Dept. E-175, Rochester, N. Y.** Rush to me, entirely free of charge, (1) A full description of the position checked below; (2) 32-page book, with list of positions obtainable; (3) Free Sample coaching.

- Railway Mail Clerk (\$1900 to \$2700)
- Postoffice Clerk (\$1700 to \$2300)
- City Mail Carrier (\$1700 to \$2100)
- Customs Positions (\$1140 to \$1860)
- Internal Revenue (\$1140 to \$1860)
- Rural Mail Carrier (\$2100 to \$3300)

Name .....

Address .....



# Be a Real Draftsman



**-Earn the BIG SALARIES!**



**O. C. MILLER,**  
DIRECTOR  
EXTENSION WORK

**American School**

*"The day you get acquainted with the American School will be the turning*

*point, the Red Letter day of your life!"* That is the message which a hundred thousand students and graduates send you to celebrate our 30th year of service.

Did you know the American School is chartered as an Educational institution, **NOT FOR PROFIT**, like the best resident schools and colleges?

Did you know our service includes both **TRAINING** and **EMPLOYMENT**—preparation for a better job, then help in placing you in it at a raise in pay?

Mail the coupon—find out about your opportunities for success in Drafting.

## FREE Job Service!

Our employment department will help place you in a good job. Demand exceeds the supply. No charge for nation-wide employment service. Read want-ads for Draftsmen every day in Chicago Tribune or any big city paper—see the opportunities for yourself—and get ready for them.



## Professional Drafting Outfit GIVEN!

You need a fine outfit like this to do precise, neat Drafting. Not one penny of extra charge for this complete, valuable, high grade outfit. Imported instruments. Table board, mahogany-edge T square, triangles, ink, thumb tacks, etc., everything you will need.

**O. C. MILLER, Director of Extension Work**

**3 Drafting Lessons Actually FREE**

I can teach you enough "mechanical drawing" in 12 weeks to get a job as a TRACER. That's not what I mean. When I say "Be a real Draftsman" I urge you to specialize in Architectural, Machine, Electrical, Automotive or Structural Drafting—to learn how to design and calculate **ORIGINAL WORK**. Such jobs pay from \$60 to \$125 a week, depending on experience. I will prepare you at home, in your spare time, for this important, well-paid, fascinating work, and when you're ready for it, I'll help you get one of these jobs!

## DRAFTING MADE EASY TO LEARN!

We start you doing actual Drafting room jobs from the very beginning. Even if you have only common schooling you will make rapid progress by our new one-step-at-a-time method of instruction, developed especially for men employed during the day who find it hard to do the old-fashioned kind of "studying" at night.

### Coupon Brings Three Lessons Free!

Get them. Test your own ability to learn Drafting and get ready for a fine job and big pay. Coupon also brings surprise offer, and complete information about your opportunities for success in Drafting. Mail it today!

**Send 3 Drafting Lessons**

**Free—** Chief Drafting Engineer, American School, Dept. D-174-A, Drexel Ave. & 58th St., Chicago  
Rush 3 Free Drafting Lessons. Surprise offer, complete information, money-back guarantee, etc., to prove I can become a real draftsman at home in spare time.

Name.....  
St. No.....  
City..... State.....



**Dept. D-174-A, Drexel Ave. & 58th St., Chicago**

# From a Dinner Pail Job

**more  
Proof!**

**PROOF**

"In 18 months after I enrolled with you I stepped from my \$5 a day 'Dinner Pail' Job to a Superintendent Job at \$5000 a year with this big electrical construction company. I cannot praise your course too highly."  
A. F. Klemz, 14870 Cloverdale, Detroit, Mich.



**LEARN ELECTRICITY AT HOME**  
By my now famous Work Sheet and Job Ticket Method!

to Superintendent at

**\$5000<sup>00</sup>**

a year!

**Cooke Training Did It**

Klemz—just an ordinary mechanic,—untrained, couldn't earn more than \$5 a day. But "Cooke" training jumped him to \$17 a day,—\$400 a month,—\$5,000 a year. And he's only one of hundreds of men who have been helped into big-pay jobs in the same way.

**"Cooke" Training Will Help You, Too**

Chief Engineer Cooke's now famous "Work Sheet" and "Job Ticket" Method guarantees you simplified, practical instruction along work-shop lines. You learn at home, but you learn as though the Chief stood by your side to show you how and what to do. That means you learn Electricity—**Right**. Hundreds of "Cooke" trained men are now making

**\$3,500 to \$10,000 a Year**

Why not you? Why remain in a small-pay game? Why stay any longer in a line of work that offers no chances for quick promotion or big pay? Electricity is the Big-Pay Field. That's where the big money is being made! That's where you should be. And Electricity needs trained men—needs them badly, thousands of them.

Learn Electricity the "Cooke" way. No experience necessary. Lack of education no drawback. You can read. You can write. That's enough. "Cooke" training will do the rest.

Investigate! Look before you buy. Don't be fooled by big statements and big promises. Be guided by what a training has done for others, because what it has done for others it can do for you. You want the best. Get it. Send for my big

**Free Book of Facts**

It's the same book that brought success to hundreds of other men. It won't cost you a cent. It won't obligate you in any way. But it may be the means of jumping your pay hundreds of dollars a month, just as it has done for hundreds of others. Mail coupon now and get, also, 3 months free subscription to my big Electrical magazine.

L. L. Cooke.



**\$800 in 23 Days for Montrose**

Dear Mr. Cooke: I just finished a contract on a Power line in 23 days and cleared over \$800. If it wasn't for your Course I couldn't have done it.  
Earl R. Montrose, Mono Lake, Cal.



**\$750 a Month for Pence**

Dear Mr. Cooke: My electrical business is going strong, paying me now something over \$750 a month above expenses. It was your wonderful Course that put me where I am.  
W. E. Pence, Albany, Ore.



**FREE!**

Big Electrical MAGAZINE

**3 MONTHS SUBSCRIPTION**

**L. L. Cooke, Chief Engineer,  
L. L. Cooke School of Electricity**

Owned and Operated By  
**Chicago Engineering Works Inc.**  
2150 Lawrence Ave.

Dept. 11 Chicago, Ill.

Chief Engineer Cooke,  
Dept. 11, 2150 Lawrence Ave.  
Chicago, Ill.

Send me at once your FREE Book "The Vital Facts about Electricity," full particulars of your training and enter my name for a 3 months' subscription to your Electrical magazine. This does not obligate me in any way.

Name .....

Address .....

City..... State .....

**The "Cooke" Trained Man is the "Big Pay" Man**

# Classified Advertisements

WORLD'S BEST WANT AD MEDIUM

Advertisements in this section, 30 cents per word, each insertion, minimum 10 words, payable in advance. To be inserted under proper classification in February issue, copy should be in our office December 18th.

## ADVERTISING AGENCIES

**ADVERTISERS**—To buy, sell or to secure agents, salesmen, you can place your 24-word ad. in the following 15 leading Sunday papers for only \$15; circulation over 2,000,000: Age-Herald, Birmingham; Gazette, Little Rock; Journal, Atlanta; Star, Indianapolis; Register, Des Moines; Courier-Journal, Louisville; Times-Playne, New Orleans; Star, Kansas City; World-Herald, Omaha; Courier, Buffalo; Enquirer, Cincinnati; Press, Pittsburgh; Commercial-Appeal, Memphis; News, Dallas; Journal, Milwaukee. Proof of Insertion Guaranteed or Money Refunded. 52-page rate book sent free. Frank W. Lenhoff Advertising Agency (established 1897), 600 North Michigan Blvd., Chicago.

A TEN Dollar Ad may put your proposition over. \$10 pays for a 4 line 24 word classified ad one Sunday in 10 of the largest newspapers. Reach over 7 million readers. Minneapolis Tribune, Buffalo Courier, St. Louis Post-Dispatch, Pittsburgh Press, Indianapolis Star, Atlanta Journal, Detroit Free Press, Birmingham News, Cincinnati Enquirer, Little Rock Gazette. Free catalogue showing other lists of newspapers and magazines sent on request. Ankrum Advertising Agency, 22 West Jackson Blvd., Chicago. Largest classified advertising agency in the world.

**ADVERTISING Service.** Over 25 years' experience building up advertisers. We prepare, plan and place magazine, newspaper and classified advertising. Also write folders, circulars, letters, etc. Describe briefly your proposition. Send your recent advertising matter, proofs of ads, etc. (if any). We will send you "Advertising Simplified," latest book of rates and valuable information. Ask Dun's, Bradstreet or any publication about us. Charles H. Touzalin Agency, 708 Union Trust Bldg., Chicago, Ill.

**ADVERTISE** in the classified section of newspapers and magazines, to secure help, money, or to sell. 24-word advertisement in nine big Metropolitan papers \$10.00. Nearly two million circulation. Many other bargain lists. Write for Free 58-page Directory No. 26. Brinckerhoff Advertising Agency, 37 W. VanBuren, Chicago.

**ADVERTISE** in 24 Big Sunday Newspapers—24 words \$15.00. 300 Rural Newspapers, 28 words \$10.00. 100 Big Weekly Newspapers, 24 words \$5.00. Lists and consultation free. National Advertising Service, Richmond Hill, N. Y.

**ADVERTISE** in 24 Big Sunday Newspapers, 24 words \$15.00. Excellent for securing Agents, Salesmen, and Business Opportunities. Catalog listing 1,000 leading Dailies, Weeklies, Mail Order Magazines, Everything. Free. Wade Advertising, Baltimore Bldg., Chicago.

**WHY advertise?** We sell original letter names. Rural mail buyers, agents, ladies, 5,000, \$25.00; 10,000, \$50.00. Pennell-Standard, Covington, Ky.

**ADVERTISE**—Newspapers, Magazines, Country papers—classified (Want Ads)—display space. Free catalog. Martin, 37B West 39th, New York.

**SIX Word Line**—355 rural weeklies \$3.55. Admeyer, 4112-M Hartford, St. Louis.

**ADVERTISING** in all magazines and newspapers at publisher's lowest rates. Write for Rate Book. Taylor's Advertising Service, 314-16 Brown Bldg., Rockford, Ill.

## FOR ADVERTISERS

**EFFECTIVE Letters Prepared.** Postal Advertising Service, 1151 South Broadway, Los Angeles.

**CIRCULARIZE Original Letters.** Guaranteed Business Getters. Rentalletter Service, Alma, Neb.

**ILLUSTRATIONS.** Cartoons Drawn to Order. McCallip, Box 162, Peoria, Ill.

**YOUR 25 words** once and year's subscription 25c. Capener's Monthly, Box 511, San Jose, Calif.

**CUTS.** Drawings \$1.50. Window Cartoons, 6, \$1.50. GPO, Bx471, New York.

**I WRITE** letters, folders, booklets, complete followup for manufacturers, mail order dealers. Long experience. Write for details. L. Taylor, 314-16 Brown Bldg., Rockford, Ill.

**ATTRACTIVE Posters, Cartoons** in color to order any size, \$1.00. McCallip, Box 162, Peoria, Ill.

**ADVERTISERS' Manual;** New edition. Inside information for advertisers. Post-paid 50c. Economics Publishing Co., Dept. 53, 1475 Broadway, New York.

**ADVERTISE** in 300 country newspapers, 28 words, \$10.00. Keator, Hartford Bldg., Chicago.

**25 WORDS** 88 magazines; \$1.00. Thrice \$2.00. Smith's Service, 1194, Wenatchee, Wash.

**MAIL Order Lists,** every classification. Co-operative Mailing \$3.00—1000. Particulars Free. Field Co., 1145 E. 99th St., Cleveland, Ohio.

**ADVERTISE** 60 weeklies, 25 words, \$1.95; 500 Blotters, \$2.95; 500 Typewriter Letters, \$2.75. Commercial Advertising Service, 5 Pleasant, Worcester, Mass.

**100 MAGAZINES** 7c word, \$4 inch. Information. Porter, 9416a 115th St., Richmond Hill, N. Y.

**PENCIL Advertising**—Your name, address and business imprint on pencils; \$5.50 per gross. M. Ehrman, 530 West 159th St., New York, N. Y.

**LETTERS** and advertisements that create new business. Quinan, 5954 Fourth, Philadelphia.

## SALES PROMOTION

**\$50 TO \$50,000 Daily Sales** Developed During 28 years for clients by our direct mail plans, copy, campaigns. One product, 1923, an idea; this year \$100,000 orders booked. Fifty year old concern desired 50 national representatives in 1925; we produced 40 in three months. 700 dealers in 10 months at \$3 each, for another. Ten years Sales Promotion Manager Larkin Co. Submit sales problems for Free diagnosis. James C. Johnson, 118A Woodbridge Ave., Buffalo.

**SUCCESSFUL Mail Specialist!** Powerful Letters—Circulars—Plans! Free Suggestions. Finkel-Advertising, 15 Fairview, Jersey City, N. J.

**PEPPY Sales Letters Created.** Crompton, 921-A Ontario, Niagara Falls, N. Y.

**LETTERS** that make and retain volume business. Helle, 4158 Gladwin, Detroit, Mich.

## AUTOMOBILE SUPPLIES

**SERVICE** data blue print chart—34 by 48 inches specifying, valve and ignition timing; valve, piston, ring and bearing fitting dimensions. Chart covers eighty 1926 automobile engines. \$1.50 postpaid. C. T. Schaefer, 2641 Russell Ave., St. Louis, Mo.

**BATTERY Tester** and inspector. Regular \$50.00 value; \$32.00. Battery Shop Equipment and Supplies at Wholesale. Adams-Barr, Columbus, Ohio.

**PREVENT** corrosion on storage battery terminals. Send 50c for sample. Results guaranteed or money refunded. Agents write for details. Geo. M. Studebaker, Jr., Box 546, South Bend, Ind.

**RADIATORS** at wholesale prices. All standard makes. Satisfaction guaranteed. Send for prices, stating make and model. Independent Radiator Co., 1119 S. Wabash Ave., Chicago.

**VULCANIZING Auto Tires** is a Paying Business. We have Plants near you from \$50 up. Catalog Free. Instruction Book \$1. Equipment Exchange, 108 East 11th, Los Angeles, Calif.

**620 VALUABLE** kinks for all who own, drive, repair or care for automobiles, only 98 cents. Write us to send you Popular Mechanics Auto Owner's and Auto Repairman's Handbooks. Fully illustrated. Pay Postman 98 cents and few cents postage. Popular Mechanics Press, Room 901, 200 E. Ontario St., Chicago.

**ANTIFREEZE** Prevents Frozen Radiators in coldest weather—guaranteed formula \$1.00. Griffin, 219 East 54th, Chicago.

**MAKE** greater profits by repairing tires on our Vulcanizers. Cost little. Operate efficiently, satisfactorily and economically. Adams-Barr, Columbus, Ohio.

**AUTO Emblems.** Any Lodge. Write. North Central Distributors, Dept. J, Ashland, Ohio.

**BATTERY** Charger anybody can make. Plans and hints on care of battery 50c. Box 134, Ft. Collins, Colo.

**SPECIAL** Chevrolet Cylinder Heads. Send for circular. J. M. Cagany, 1921 East Warne, St. Louis.

**MAGNETOS,** Starters, Generators, Ignition systems, spark plugs, part, timing chains, repairing. Meinert Magneto Co., 1759 E. 21st St., Cleveland, Ohio.

## AUTOMOBILES

**PATENTS.** Time counts in applying for patents. Don't risk delay in protecting your ideas. Send sketch or model for instruction or write for Free book "How to Obtain a Patent" and "Record of Invention" form. No charge for information on how to proceed. Communications strictly confidential. Prompt, careful, efficient service. Clarence A. O'Brien, Registered Patent Attorney, Security Bank Building (directly across street from Patent Office), Washington, D. C. See pages 138 and 139.

**DYKE'S Automobile Encyclopedia.** Latest 14th edition. Information on repairing and adjusting every part of all motor cars. How to find trouble, and fix it. Send No Money. Pay postman the postage and \$6. Popular Mechanics Press, Room 901, 200 E. Ontario St., Chicago, Ill.

## AUTOMOBILE SERVICE EQUIPMENT

**STARTING—Lighting—Ignition Service** most profitable in Automotive field. Small Investment, Big Profits, Pleasant Work. HB Test Bench brings you this business. Write for Free Bulletin TB. Hobart Brothers Co., Box CL22, Troy, Ohio.

**PROFITS.** \$350 monthly earned by Sigel. Only cost him \$16. One-day Battery Charging doing it. Small Space required. Write for Free bulletin CP. Hobart Brothers, Box CL23, Troy, Ohio.

**DEPENDABLE Air Service** brought Caldwell 80% increase in business the first month. More than paid for itself on easy payments. Write for Free Bulletin AC. Hobart Brothers, Box CL 23, Troy, Ohio.

## FOR FORD OWNERS

**FORD Timer, Oil-less and Short-proof.** One year written guarantee. Pay postman \$2.50 on delivery. Big exclusive sales proposition to hustlers. Eclipse Timer Mfg. Co., 2909 Meinecke Ave., Milwaukee, Wis.

**PUT** a "Bingo Timer" on your Ford. Guaranteed best made. Thousands in use. Requires no oil. No more trouble. All Dealers or direct with full particulars—\$1.50. Agents make big money. United Machinery Company, Cincinnati, U. S. A.

**FORD lamp door opener,** postpaid, \$1.25. Peter La-Void, Viroqua, Wis.

**UNDERSLING** with "RKO" Swing Lo Irons. See "Red-I-Kut" ad page 126.

## MOTORCYCLES, BICYCLES AND SUPPLIES

**OVERSTOCKED** Used Motorcycles. 1923 Indian Chief \$95.00, 1923 Harley Davidson \$95.00, 1923 Henderson DeLuxe \$120.00. Two hundred others; write for free list. Myerow Brothers Co., 15 Berkeley St., Boston, Mass.

**GOOD Second Hand Parts** for Indian, Harley, Henderson, Ace and Excelsior Motorcycles. No Junk. Ship C.O.D. No Lists. J. B. Dahl, 3661-63 Archer Ave., Chicago, Ill.

**1923 HARLEY-DAVIDSONS,** \$168; 1922, \$118; 1921, \$111; 1920, \$85; 1919, \$65; 1917, \$50; 1916, \$45; 1915, \$40; 1914, \$35. Guaranteed. Money refunded if not satisfied. Circular free. Wisconsin Cycle Sales Co., 726 National Ave., Milwaukee, Wis.

**MONEY Saving Motorcycle Bargains**—Large stock of Used Harley-Davidson—\$50 and up. Send for FREE bargain bulletin—Now! Motorcycle Parts, accessories, repairs for all makes. Knuth's Harley-Davidson Agency, 2525 Fond Du Lac Ave. Milwaukee, Wis.

**DON'T buy a Bicycle Motor Attachment until you get our prices.** Shaw Mfg. Co., Dept. 27, Galesburg, Kans.

**SEND for Bargain Bulletin.** All makes of rebuilt motorcycles at lowest prices. Used parts half-price. Send Stamp. Ash Motor Corporation, Rochester, N. Y.

**BARGAINS.** Used rebuilt Motorcycles. All makes. Shipped on approval. Guaranteed. Terms. Write for Free List, M. Floyd Clymer, Denver, Colo.

**NEW and used Motor Cycle Parts.** Tower Cycle Co., 3604 Kingsland Ave., Pine Lawn, Mo.

### AVIATION

**TEN lessons in the air of twenty minutes each will make you a pilot by our advanced method of training.** This, together with our five weeks shop course at \$100.00, makes America's oldest aircraft factory the most popular flying school. Work after class hours guaranteed. Special winter evening course, including shop work, field and flying, \$190.00. Employment furnished during the day, paying \$20.00 to \$40.00 per week. Heath Airplane Company, Chicago, Ill.

**AIRPLANES, Motors, Supplies; 100 H. P. Gnome Rotary Motors \$75. Florida; 28 H. P. Lawrence Motor \$125.; Curtiss 90 H. P. slightly used \$250. Leather helmet \$3.75, sheeplined \$5.00; non-shatterable goggles, oval \$2.50; wide vision \$4.00; temperature gauges with 12 ft. tubing \$7.50; leather breeches \$12.00; leather coats \$18.50, or sheeplined \$23.50. Airplane cloth 65c yd.; dope \$2.50 gal. Logan Aircraft, 716 W. Superior, Cleveland.**

**PATENTS.** Time counts in applying for patents. Don't risk delay in protecting your ideas. Send sketch or model for instruction or write for Free book "How to Obtain a Patent" and "Record of Invention" form. No charge for information on how to proceed. Communications strictly confidential. Prompt, careful, efficient service. Clarence A. O'Brien, Registered Patent Attorney, Security Bank Building (directly across street from Patent Office), Washington, D. C. See pages 138 and 139.

**GET In The Flying Game;** Hundreds will be needed. Prepare yourself now. Complete elementary course. Postpaid \$1.00. James Aircraft Company, Box 640, Allentown, Pa.

**LEARN Aviation at America's foremost school.** Earn your tuition if you lack the cash. Send 25c to Box 502, Peoria, Ill., for full particulars.

**THE Age of the Air Is Here.** For reliable information on both airplane building and flying we recommend "Aeroplane Construction and Operation," by Rathbun, a book used in Government Schools. All features of construction treated. Send no money. Pay postman \$2.50 and postage. Popular Mechanics Press, Room 901, 200 E. Ontario St., Chicago, Ill.

**HEATH Propellers—Winners of speed and efficiency at the Philadelphia light plane races—are individually designed and when used on airplanes, sleds or boats, will give real results.** Prices surprisingly reasonable. Send 4c for propeller circular. Blueprints of latest Heath sport monoplanes now ready. Easy and inexpensive to build, using motorcycle engine. Blueprints \$5.00. Heath Airplane Company, Chicago, Ill. (59)

**EARN \$3,500 to \$10,000 a year.** Prepare for flying. Complete home study in mechanics of Aviation. Write for free Catalog. Western Airplane Corporation, Desk K-1, Menadnock Block, Chicago.

**LIGHT Planes and Air Flyers.** Latest development. Complete set original pictures. All Light Planes entered National Air Races, Philadelphia. Complete specifications, important information. One Dollar. Winthrop, Dept. K, 2744½ Hampden Court, Chicago, Ill.

**AERONAUTICS!** Are you keeping pace with the new developments? "Aeroplane Engines in Theory and Practice," by Rathbun describes engines fully. Used as a text in Government Schools and includes all makes. For Mechanician, builder and flyer. Send no money. Just order on a postal. When postman hands you book, pay him \$2.50 and postage charges. Popular Mechanics Press, Room 901, 200 E. Ontario St., Chicago.

**COMPLETE Scale Plans, with Building-Flying Instructions for following 3-ft. Model Aeroplanes, 25c each postpaid; Fokke, North Pole Monoplane; JN4D-2; DeHavilland; NC4; Bleriot, Nieuport or Taube Monoplanes; Cecil Peoli Racer. Complete 48 pp. catalog 5c; listing hundreds of parts and supplies for experimenters. Ideal Aeroplane Co., 165½ Spring Street, New York.**

**AIRPLANE, boat, sled propellers.** Build speedy "Aerodrive" sleds, boats from our blueprints of either type, priced at \$1. Fine leather helmets only \$3. Aircraft supplies list 5c. Everything aeronautical! Ostergaard Aircraft, 4269 North Narragansett, Chicago.

**THE American School of Aviation announces a new correspondence course in Mechanics of Aviation. A thorough training in Practical Aeronautics.** American School of Aviation, Dept. 1861, 3601 Michigan Ave., Chicago, Ill.

**MOTORS: Curtiss OXX-6 Class A (under Fifty Hours) for Plane, Sea-Sled, Motor boat, etc., \$275.00.** All Motor and Plane Spares at Best Prices. Send for Catalogue. Monumental Aircraft Co., 339 N. St. Paul Place, Baltimore, Md.

**AIRPLANES.** How to build them and be sure they will fly. Learn the two most powerful influences on the stability and operation of an airplane. Get our free information, blue prints and propeller literature. Crawford Airplane Mfr., 2225 American Ave., Long Beach, Calif.

**LEARN to fly for \$95 in Florida where it's warm.** No bond required for Solo flights. Miami School of Flying, Box 676, Hialeah, Fla.

**PREPARE in Your Spare Time to Fly and Build Airplanes.** Flying and Evening Shop Course \$150.00. Shop Course only, \$15.00. Wallace Aircraft Co., 4710 Irving Pk. Blvd., Chicago, Ill.

**TWO OX5 motors, and OX5 parts.** Reasonable price for quick sale. Francis Gloden, Deerfield, Ill.

**THREE foot model aeroplane.** Price \$1.00. Circulars free. Aero Shop, 3050 Huribut Ave., Detroit, Mich.

### BOOKS AND PERIODICALS

**ENCYCLOPAEDIA Britannica.** New International. Book of Knowledge, Harvard Classics, etc., Half Price. Dalton Riggs, Crilly Bldg., Chicago.

**BOOKS, Books, Books.** No matter what you want in the scientific book line, I can fill your order. If you cannot find the book you want, send for my book Catalogue today. Levi Bryant, 543 E. 47th Street, Chicago, Ill.

**HYPNOTISM Wins.** 25 Easy lessons and 248 page illustrated reference guide \$2.00. "Mindreading" and Love's Mysteries Explained, 152 pages 60c. Popular Institute, D430 Milwaukee, Ave., Chicago.

**DRAFTING.** Learn Mechanical Drawing. Big demand for men. Pocket-size. Start at beginning and learn by a series of simple lessons. Send No Money. Just write postal for "A Practical Course in Mechanical Drawing." Pay postman postage and \$1. Popular Mechanics Press, Room 901, 200 E. Ontario St., Chicago, Ill.

**LEARN Character Reading from Handwriting.** Wonderful Book, only 20c. Free catalog. F. & R. Co., Hoboken, N. J.

**BOOKS, all kinds 5c.** U. Library, H Essex St., Boston, Mass.

**FORGED decorative articles.** Andirons, fireplaces, scroll and grille work, lamps, candle sticks, coat hangers, knockers and other hand-forged decorative articles can be made with instructions in new printing of "Hand Forging," by Thomas F. Googerty. Profusely illustrated. Send no money. Write a postal asking for Hand Forging. Pay postman postage and \$2.00. Popular Mechanics Press, Room 901, 200 East Ontario St., Chicago, Illinois.

**\$1,000.00 FOR your favorite clippings or verse on Liberty, Freedom and Democracy.** Mail clippings today for use in our forthcoming book, "The Scrap-Book of Human Freedom." Meador Publishing Company, 27 Beach, Boston, Mass.

**READ "Macon Moore,"** real good Detective Story, 250 pages complete, 50c postpaid. List of many other instructive and entertaining books included. J. Rodgers Hoggard, Publisher, Windsor, N. C.

**CURIOUS Books.** Unique Novelties, Stunning Pictures. Samples, 10 cents Prepaid. Linds, 214 W. 34th Street, New York.

**HALF-PRICE.** New-old books. Psychology, Encyclopedias, Business, History, etc. Phipps, Library, 1014 Belmont, Chicago.

### PICTURES AND POSTCARDS

**TRUE-BLUE Pen Pals.** Exchange postcards, stamps. Membership, 25c. Hundreds listings, 10c. Ericson, Elroy, Wis.

**16 MOVIE Star Photos 25c 1-in. size.** Trial 10c. Belmont Shoppe, Downers Grove, Ill.

**EXCHANGE Postcards!** Interesting, educational. Membership and List 25c. Popular Exchange, Windsor, N. C.

**JOIN Live Postcard Club;** membership lists, including catalog, 10c. Harvey Teeple, Decatur, Ind.

**ART Pictures, Books and Novelties.** Catalog 10c. Howard Sales Co., Dept. 15, 1188 Folsom St., San Francisco, Calif.

### GAMES, ENTERTAINMENTS AND PLAYS

**PLAYS, musical comedies and revues, minstrel music, blackface skits, vaudeville acts, monologs, dialogs, recitations, entertainments, musical readings, stage handbooks, make-up goods.** Big catalog free. T. S. Denison & Co., 623 S. Wabash, Dept. 11, Chicago.

**VENTRILOQUISM taught almost anyone at home.** Small cost. Send 2c stamp today for particulars and proof. George W. Smith, Room 8-149, 125 N. Jefferson Ave., Peoria, Ill.

**100 LIGHTNING Chalk Talk Stunts \$2.00.** Cartoonist, 2925 Euclid, Kansas City, Mo.

**CHALK-TALK your way to popularity.** Audiences at your feet if you learn how to entertain with a few simple pictures. Little artistic ability needed. "How to Chalk Talk" tells what to say and what to draw. Profusely illustrated. Make \$10 and more a night. Send No Money. Just order on a postal. Pay postman \$1.00 and postage. Popular Mechanics Press, Room 901, 200 East Ontario St., Chicago, Ill.

### NOVELTIES, CURIOS, ETC.

**BOYS sell the aeroplane propeller wheels.** Something new. Made of wood 12 inches long. Everybody wants one on their car. Sell for 50c. Send 6 cents postage for one. Aero Shop, 3050 Huribut Ave., Detroit, Mich.

**LATEST Invention—Wooden Mystery Airplane.** flies 500 ft. Loops, returns like boomerang. Agents, Xmas seller, 50c, 3 for \$1.00 (coin.) Novelty Supply House, Jamestown, N. Y.

**CONCERTINA Plays by Roll.** Professional size. Little Co., New Bedford, Mass.

### MAGIC TRICKS, BOOKS AND JOKER NOVELTIES

**MAGIC—Tricks, Books and Supplies.** For Amateurs as well as the great professionals. Anyone can learn through our instructions. Feature Acts in Mind-Reading, Spiritualism, Rope Ties, etc. Large illustrated Professional Catalog, 20c. Chicago Magic Co., 140 So. Dearborn St., Dept. B, Chicago, Ill.

**BOOKS, Magic, Mysteries, Magic Tricks, Novelties.** Catalog Free. Singer, 555, Hancock, Wis.

**FOR something different, send 10c for "Fun-Magic-Mystery."** New 80-page Book of 500 Tricks. Also contains Catalog largest line Magic Tricks and Supplies in South, at lowest prices. Send 10c today! Lyle Douglas, Station A, Dallas, Texas.

**NEW Sensational Wrist Shackle Escape** only 85c complete. Wonderful bargains in other tricks and illusions. Catalogs free. Sample trick 10c. F. & R. Co., Dept. F, Hoboken, N. J.

**ELECTRIC Fun!** Seventy stunts, 110 volts, \$1. Cutting Company, Campbell, Calif.

**MAGIC tricks.** Card tricks, Coin tricks, Hypnotism, Ventriloquism. 64-page books. Complete guides, 10c each. Geo. Fenner, 2401 Jefferson, Louisville, Ky.

**ILLUSTRATED Magic Catalog 6c.** Lynn's, 105 Beach, Jersey City, N. J.

**TRICK Cards.** \$1.00 pack, with key, catalog Rare books, Novelties, and Master Key to read cards, 10c. Union Sales Co., 740 W. Madison St., Chicago, Ill.

**BOOKS, Novelties, Tricks, Puzzles, Magic, Mysteries.** Catalog Free. Makary, 339 Mountain St., Pittsburgh, Pa.

**COMPLETE book on Magic.** 563 pages; 318 illustrations. Hundreds of tricks. The standard book for years. Make money giving magic entertainments. Send No Money. Just ask for Prof. Hoffman's "Modern Magic." Pay postman postal charges and \$2.00. Popular Mechanics Press, Room 901, 200 East Ontario St., Chicago, Ill.

**FREE** with \$25 order die box. Send 20c for our large catalogue of tricks, wigs, sensational escapes. Oaks Magical Co., Dept. 548, Oshkosh, Wis.

**SEVEN** Magical Delusions and Catalogs—25c. Gilmaglio, Morgan Park, Ill.

**FIVE** care tricks and catalogs 25c. Midwest Novelty Sales, 7609 Drexel, Chicago.

**READ** sealed messages in dark; messages retained by audience; burned message appears on blank slate; spirit message appears on slate in sitter's presence; spirit rappings; spirits appear in the dark; answer questions written on folded papers while blindfolded. All this you can do with directions in "Behind the Scenes with the Mediums." 69 best secrets of mediums fully exposed. The best because most baffling, yet all easy to do. Send No Money. Just write a postal. Pay postman \$1.50 and postal charges. Popular Mechanics Press, Room 901, 200 East Ontario Street, Chicago, Ill.

### STAMP COLLECTING

**JUST** What Every Stamp Collector Wants. Free. The new 1927 Scott Price List is just out, brimming full of wonderful bargains. Hundreds of Scott Seal packets, sets, and dime sets of guaranteed genuine stamps. Many attractive new packets and sets that every collector, advanced or beginning, should know about. Prices that make every item a real bargain. Also describes the complete line of Scott Albums, from 60 cents to \$55.00; catalogues, hinges, tongs, magnifying glasses, watermark detectors, millimetre scale and perforation gauge and all other accessories needed by the collector. This big illustrated price list of more than 80 pages is free for the asking. Write for it now. Scott Stamp and Coin Co., 1 West 47th Street, New York, N. Y.

**ARABS!** Bandits! Head-Hunters! Egypt (sphinx); Malay (tiger); Tunis (Arab); Turkey (sacred mosque); Belgium (battle between angel and "old horns"); Congo (head hunter)—All of these mysterious and remarkable stamps are contained in our Famous Phantom Packet—55 fine varieties (to approval applicants only) for 8 cents. Nothing like it; order at once! Pacific Stamp Co., Box 138, Helena, Mont. Extra! Send us, with your order for the Phantom Packet at 8c, the names of three friends who collect stamps; we will give you, free of charge, a scarce set of 11 dif. Albania—bandit land! Supply limited; write immediately!

**500 DIFFERENT** Stamps for 25c! Big Collection 500 Different Stamps from Bosnia-Herzegovina, Crete, Epirus, Hong Kong, Iceland, Kenya and Uganda, Liberia, Malta, Nyassa, Tanganyika, Wallis and Futuna, Zanzibar, and other "hard" countries. Catalogue value \$10.00. Price only 25c to Approval Applicants! Special Bargains: 1,000 different 79c; 15 triangle stamps 49c; 100 Africa 50c; 100 Asia 60c; 100 Balkan States 35c; 100 British Colonies 25c; 100 French Colonies, 30c; 100 Portuguese Colonies 50c; All 8 packets for \$3.00! Illustrated Lists Free. Loma Stamp Co., 2221 Madison Ave., San Diego, Calif.

**ANCHERS \$\$\$** Outfit—only 12c! Fine triangle stamp; set German stamps with (pre-war) value forty million dollars (interesting!); perforation gauge, mme. scale; small album; airmail set; scarce stamp from smallest republic on earth; newspaper set; packet good stamps from Travancore, Johore, Dutch Indies, etc. Entire outfit for 12c to approval applicants! (Nice pocket stock book, value 25c, with every order!) Ancher Stamp Co., 148 1/2 Clerk St., Jersey City, N. J.

**\$1.00 FREE.** Black U. S. Postage. Given Away with each order. Pioneer Stamp Album with 500 illustrations, 150 different stamps from 40 countries, Syria, Lebanon, Helaz, Liberia, New French Colonies, British, Portuguese Colonies, South Africa, Australia, 500 hinges, 36 page illustrated catalogue. All for 15c. Big Commission to Agents for the Best approval sheets of stamps ever offered. Write for sample outfit. Hussman Stamp Co., Dept. M, 620 Olive St., St. Louis, Mo.

**BOYS,** Here is Something Different. For each 10c purchase from our net approval sheets we will issue a coupon. These coupons may be exchanged for premiums varying in value from ten cents to five dollars. Write at once for a selection on approval and get our list of free premiums. Fenway Stamp Company, 161 Massachusetts Ave., Boston, Mass.

**200 STAMPS,** Bargain List, Magazine 15c. Approvals. Harvey Teeple, Decatur, Ind.

**MYSTIC'S "Queer Country" Packet!!** Contains scarce stamps from the following strange lands: Alaouites, Antioquia, Corea, Cyprus, Fiji Islands, Gwalior, Hyderabad, Iceland, Jhind, Kenya Uganda, Lebanon, Monaco, North Borneo, Nyassa, St. Thomas Prince, Port. Guinea, Siam, Sierra Leone, Tanganyika, Trinidad Tobago, Ubangi, Upper Volta, Wallis Futuna, Zanzibar. Get this wonderful packet of "freak countries" and make your friends envious! Price only 10c to approval applicants! Write today. Mystic Stamp Company (Dept. 8), Camden, New York.

**FREE!** Berry's Unused Hundred! 100 different, beautiful stamps—all unused!—from far-off countries, which would cost you over \$1.00 if purchased from approval sheets. Included are: Albania, Antioquia, Bosnia, Herzegovina, Chad, Dahomey, Cuba, Fiume triangle, Latvia, Nyassa giraffe, etc. This fine packet absolutely free to approval applicants enclosing 4c postage! Big lists also free. Write today! M. P. Berry, Wrentham, Mass.

**START** a Stamp Collection—70 different stamps from 70 different foreign countries, including Africa, Asia, Australia, Europe, West Indies, etc. Our pamphlet which tells "How to make a collection properly," and price list of albums, packets and sets all for only 16 cents. Queen City Stamp Co., Room 36, 604 Race st., Cincinnati, Ohio.

**MOST** Sensational values; over 140 dif. Algeria, Airplanes, Azerbaijan, Barbadoes, Cameroun, Gabon, Guyane, Irish set, large French Colony packet, largest stamp, 40 year old U. S., gauge, etc., for 10c to approval applicants. List free. 100 dif. U. S. 25c—1,000 hinges 9c—50 Bavaria 7c. Hawkeye Stamp Co., Cedar Rapids, 39, Iowa.

**OUR** Latest 20-page U. S. and Canadian price list free. Stanley Gibbons, Inc., 37 Ann St., New York City.

**ZANZIBAR,** Abyssinia, Travancore, Herzegovina, Quelimane, Mozambique, Stamps, Menagerie Collection, Album, 10c. Liberty, 3974 Arsenal, St. Louis, Mo.

**STAMPS** on approvals 1/4c up. Free premium. Herbert Keigwin, Middletown, N. Y.

**ILLUSTRATED** album, 50 different foreign stamps, packet hinges, perforation gauge, hints to collectors, and big illustrated price list—complete outfit, all for 10c to approval applicants. Special: 1,000 unused stamps only 50c. W. Betts, Clearfield, Penn.

**FRENCH** Colonies Free—Jungles, Tigers, Native Chief, 2c postage. Empire Stamp Co., Toronto, Canada.

**MAGNIFICENT** Packet Foreign Stamps, Beauties from Distant Lands. (Many Richly Colored, unusual designs) free for 2c. Gray Stamp Company, Toronto, Canada.

**1,000 DIFFERENT** Fine Stamps—69 cents. Approvals. Kenilworth Stamp Co., Ridgewood, N. J.

**RARE** Canada Air Stamp 30c, if approvals requested. Canada Stamp Company, Station F, Toronto, Canada.

**BEST** one-cent approvals in America. F. P. Hand, 1117 So. 60th St., Philadelphia, Pa.

**FINEST** One Cent Approvals in the United States. Stanton, Niantic, Conn.

**STAMPS—1,000,** 25c; 500 different, 30c; 1,000, 80c; 2,000, \$3.25. Album holds 2,000 stamps, 60c. Michael, 4444 Clifton, Chicago.

**"INTERNATIONAL"** Set and Packet Collection! Six sets: "Jubilee," "Charity," "Airpost," "Eagles," "Prisoners," "Pictorials." Four Packets: British, French, Dutch Colonies; Precancelled; Bulgaria; "International" 15c Approvals, Adults, Juniors. Deering, Fairmount, Marlborough, Mass.

**206 DIFFERENT STAMPS,** Abyssinia, Liberia, Egypt, Bulgaria, China, Chile, etc.; list and approvals, only 10 cents. W. Mikkelsen Co., 4029 Grace Street, Chicago, Ill.

**1,000 UNUSED** Stamps 75c; 1,000 different, 30c; 2,000, \$3.50; 3,000, \$9.00. Fred Unken, 630 79th Street, Brooklyn.

**9 BATUM,** 25c; 19 Corinthia, 50c; 300 Germany, 75c; 100 Danzig, 55c; 10 Newfoundland, 6c; 16 Armenia, 16c; 7 Lithuania Airpost, 32c; 12 Hayti, 16c; 8 North Ingermanland, 18c; 10 Iceland, 15c. All Different. One Confederate essay, 3c. Frederick Jackson, Dos Rios, Calif.

**100 STAMPS** Free—Also approvals, 2c postage. Dennis, 7763 Logan, Detroit, Mich.

**FREE** 100 beautiful stamps; dollar Argentine, unused Belgium and Congo, Valuable Costa Rica, Shilling value British Colonials, attractive Liberia, Borneo, Nyassa, etc., also U. S. of over forty years ago, free with subscription to six numbers new stamp paper for 12c. Paul Mole; Southampton, N. Y.

**EXCHANGE** stamps, postcards, etc. Membership, 25c. Hundreds listings, 10c. Erickson, Elroy, Wis.

**1000 STAMPS** from far-away lands 25c. Walter Oliver, Williamsville, N. Y.

**ALGERIA,** Bermuda, Bolivia, 5 Ceylon, Cyprus, Grenada, Jhind, Kedah, Kenya, Mesopotamia, Nauru, Nigeria, Sardinia, Tasmania, Zanzibar, 15 Danzig, 116 others, 20c, to approval applicants giving reference. Loughrey, 524 S. Lopez, New Orleans, La.

**NET** Approvals. Try these. Reference Please. Premium Tower Stamp Co., 42 Westville St., Dorchester, Mass.

**STAMPS** Free. 102 different, including Hong-Kong. Postage 2c. Lists free. Fine approvals to adults giving bank, dealer or business references. Stamps bought. Payn Stamp Co., 945 Grande Vista Drive, Los Angeles, Calif.

**APPROVAL** Selections, 50 to 70c below Catalog. Premiums. Reference please. A. Frisch, 83-47 Viator Place, Elmhurst, N. Y.

**FREE** surprise packet to approval buyers. Robinson, 7144 Cornell, Chicago.

**TRIANGLES!** 75% Discount—Special approval sheets with each 5c packet containing set triangles, 2 sets war tax, set airplane, U. S. stamp before 1880, etc.; over 100 different stamps. Murray Stamp Co., 515A Tower Bldg., St. Louis.

**GENUINE** Mexican \$1 Bill Free with 20 different unused stamps for a dime. B. Nagle, 1101 Marion, Reading, Pa.

**FREE!** 12 scarce Azerbaijan and Mammoth Illustrated Price List of wonderful bargains that will surprise you. Special Christmas offers. Pennsylvania Stamp Co., Greensburg, Pa.

**FOR** Christmas—Sample 100 French Colonials, from 25 Colonies, 50 varieties, 13c. Lufbery, Port Orange, Fla.

**50 UNITED STATES** 10c. 60% Approvals. Sets. Reference please. Seldenberg, Baroda Mich.

**FREE—20** Stamps, Gold Coast, Newfoundland, Jhind, With approvals. F. Thorp, Norwich, N. Y.

**110 NEW** Europe All Different, a wonderful collection cataloging several dollars, free to collectors requesting our Net Approvals. Postage 2 cents. Badger Stamp Co., Milwaukee, Wis.

**FREE.** 25 Varieties with 50% Approvals. Norman Rivkin 2728 Humboldt, So. Minneapolis, Minn.

**200 VARIETIES,** Including pretty Jamaica Pictures 15c. C. Jackson, 935 Goodrich, St. Paul, Minn.

**300—300—300—ALL** different stamps (\$6.00 catalogue); 300 hinges, 5 approval sheets; duplicate stamp album; perforation gauge, millimeter scale and ruler to approval applicants for only 20c. Edgewood Stamp Co., Milford, Conn.

**500 MIXED** stamps, China, Persia, India, etc., 15c. Stevens Stamp Co., Walden, (1) N. Y.

**FREE—6** Thrace to Approval Applicants, 2c Postage. Jones, 828 South Williams, Denver, Colo.

**FREE** Hungary Charity No. 565 to 567 and a surprise packet given to those requesting for my 1, 2, and 3c approvals, and also my 50% discount. Chas. W. Schmidt, P. O. Box 4832, Frankford Station, Philadelphia, Pa.

**STAMPS,** 100 varieties, Africa, Brazil, Peru, Cuba, Mexico, etc., 10c. 50 different U. S. 25c; 1,000 mixed, 40c; 1,000 hinges, 10c. List free. C. Stegman, 5941 Cote Brillante, St. Louis, Mo.

**500 DIFFERENT** only 25c (regular price 50c), many unused, from British, French, Italian and Portuguese Colonies, Chile, Fiume, Guatemala, Persia, Slam, etc., to all approval applicants. Big bargain lists free. Victoria Stamp Co., London, Can.

**BORNEO,** Malay, Liberia and 105 other Different Foreign Stamps. Hinges and Lists with Approvals 9c. 55 Different United States, including Commemoratives, 10c. Fennell Stamp Co., Dept. M, St. Louis, Mo.

**FREE.** Good Set to Approval Applicants Sending Postage. J. Maxfield, Box 315, Amsterdam, N. Y.

**STAMPS** Free—Ask for money-saving approvals. John P. Borresen, Cedar Falls, Iowa.

**FINE Approval Selections at 60% discount.** 100 stamps free for 3c postage. Write Now. Wineholt Stamp Co., Woodbine, 26, Penna.

TO approval applicants enclosing 10c for our Marvel Packet of 55 different from Gabon, Togo, etc., we will send—absolutely free—a genuine scarce South African triangle stamp! Curhan Stamp Co., Gloucester, Mass.

**FOREIGN Revenues, Telegraphs, Locals, envelopes, rails, etc. pretty, different, cheap.** Stamped Marine Policy free to applicants with references. Vanderhoof, 1114 Logan, Denver, Colo.

**FREE—100 different to approval applicants.** John Cooley, Fort H. G. Wright, N. Y.

**500 DIFFERENT, 24c; 1,000, 59c; 2,000, \$2.39.** Price List free. Wineholt Stamp Co., Woodbine, 26, Penna.

**1,000 HINGES and Confederate Bill 8c, only to real applicants for approvals.** Pettet Bros., 962 S. Boulevard, Atlanta, Ga.

**109 DIFFERENT, Abyssinia, Azerbaijan, etc. 10c to Approval Applicants only.** Floyd Marsh, 524 Hamilton Ave., Indianapolis, Ind.

**110 DIFFERENT Stamps, many unused, high values, free to collectors requesting our Net Approvals.** Postage 2 cents. Christensen, Milwaukee, Wis.

**SEND \$1.00 for my Approval Sheets of Foreign Stamps. Fine. 200 British Colonies, all different, \$1.25.** C. Taylor, 15 Cross St., Newport, R. I.

**FREE Introductory Offer! New Applicants may select from my New Approvals, 25c net in stamps, free! First-class reference required.** Wm. W. Shufard, 400 N. Ave., 64, Los Angeles, Calif.

**24 VARIETIES Cuban stamps, 10 cents. List of 6,000 low-priced stamps free.** Address Chambers Stamp Co., 111P, Nassau St., New York City, N. Y.

**COVERTCO Packet, 250 varieties unused and used stamps 15 cents.** Covert Stamp, 39 State, Rochester, N. Y.

**1,000 ALL different stamps \$1.00.** New price list of all United States stamps free. Voorhees, 7 South Dearborn St., Chicago.

**PACKET of 23 stamps, no two countries alike. Packet hinges. Set of \$1 and \$2 U. S. Rev., all for 5c.** P. M. Miami Stamp Co., Toledo, Ohio.

**FREE! Loose Leaf Postage Stamp Album at rate of 8 pages each month given with subscription to monthly Journal.** Send 2c stamp for prospectus. United Stamp Co., Marquette Bldg., Chicago, Ill.

**STAMPS, 100 all different. Postage 2c. Lists free.** P. M. Quaker Stamp Co., Toledo, Ohio.

**105 CHINA, etc. 2c. Album (500 illustrations) 3c.** Bullard, Sta. A, Boston.

**100 DIFFERENT U. S. stamps 40c; no cut squares. Approvals all countries; send reference to M. L. Cook, 527 West 46th Street, Chicago, Ill.**

**STAMPS sent on approval at 70% discount. Reference required.** Emory Renoll, Hanover, Pa.

**UNITED STATES—Send on approval. Send me your want list. Ref. Please.** M. Hanna, New Kensington, Pa.

**1,000 MIXED U. S. and Foreign Stamps 25c.** Phil Lunsted, Cape Cottage, Me.

**FREE 40 Czecho Slovakia Stamps to approval applicants. 2c Stamp.** Lightbown's, Osborne Rd., Southsea, England.

**FREE. 200 different stamps to approval applicants.** Auburn Stamp Co., 767 Irving, Syracuse, N. Y.

**50 VAR. Scandinavians 10c.** Gronberg, Box 5441, Philadelphia, Pa.

**TRIANGULAR Stamps—One Nyassa, one Liberia and one Flume for 5c.** Eight Portuguese Colonials added for good measure. Crowder Conmany, Waverly, Baltimore, Md.

**200 DIFFERENT stamps 10c; 1,000 Hinges 10c.** R. H. Carlton, 380 W. So. Temple, Salt Lake, Utah.

#### RARE COINS

**40 OLD coins, all different, \$1.00.** 20 different coins over 100 years old, \$1.00. 12 different Silver coins, \$1.00. 25 different coins, 50c. 100 different Germany War-coins, \$2.00. Oregon Trail Half-Dollar Unc. \$1.25. Claud Denney, Box 315, Dallas, Texas.

**5 DIFFERENT foreign coins, 10c postpaid.** Otto Oddehon, Independence, Mo.

**CALIFORNIA Gold—Quarter Size, 27c; 1/2 size, 53c; 3c Piece and Catalogue, 10c.** Norman Shultz, Box 746, Salt Lake, Utah.

**SPECIAL Prices On United States Commemorative Half Dollars In Uncirculated Condition.** Columbian 69c. Lincoln \$1.23. Alabama \$1.13. Maine \$1.33. Pilgrim \$1.23. Grant \$1.23. Monroe \$1.13. Huguenot \$1.23. Lexington \$1.23. Stone Mountain \$1.13. California \$1.23. Vancouver \$1.23. Sesqui \$1.23. Oregon Trail \$1.23. Norse American \$1.47. 2c Bronze and bargain price list 10c. Arcy, Box 483, Muskogee, Okla.

**OLD Money Wanted.** Will pay Fifty Dollars for nickel of 1913 with Liberty head (no Buffalo). We pay cash premiums for all rare coins. Send 4c for Large Coin Folder. May mean much profit to you. Numismatic Co., Dept. H, Fort Worth, Tex.

**OLD Coins, Large Spring Selling catalogue of coins for sale free.** Catalogue quoting prices paid for coins, ten cents. William Hesselein, 101A Tremont Street, Boston, Mass.

**WE Pay More—Send 12c for Latest Illustrated Buying Book.** Michigan Coin Co., 912 Michigan, Detroit.

**3 DIFFERENT foreign coins and new selling list No. 10 sent for 10 cents.** J. Stephens, 1702 Main St., Elkhart, Ind.

**CALIFORNIA Gold 1/4 27c; 1/2 53c. 5 Different Copper Coins and Lists, 10c. 100,000 German Marks, 10c. 5, \$20 1861 Confederate Bills, 15c. Nickel 3c and 2c, 15c. Flying Eagle Cent, 15c. Al E. Bonsall, Richmond, Ind.**

**SPECIAL—1787 Connecticut and New Jersey Cents, 75c. Dursio, 25 Mulberry, New York City.**

**48 DIFFERENT Bills \$1.00. 3 Porcelain Coins \$1.00.** Brooks, 2725 1/2 Live Oak, Dallas, Texas.

**UNITED STATES and Foreign Money, Medals. Catalogue and Villa Bill 10 cents.** Alexis Mengelle, Colorado Springs, Colo.

**GET Profit and Pleasure in collecting Old Coins. Send 10c for Large Illustrated Coin Catalogue.** You'll be delighted with it. Send for it right now. B. Max Mehl, Numismatist, Mehl Bldg., Dept. P, Fort Worth, Texas. Largest Rare Coin Firm in the U. S.

**\$2 TO \$500 Each Paid for hundreds of Old or Odd Coins.** Keep All Old Money, it may be very valuable. Send 10 cents for Illustrated Coin Value Book, 4x6. Get Posted. Guaranteed Prices. We Buy and Sell. Clarke Coin Office, LeRoy, N. Y.

**RARE Coins, Bank Bills, Stocks, Bonds, Bought and Sold. 3 different Bills, 2 Coins and Price List 10c.** Geo. Best, Cedar Rapids, Iowa.

**UNITED STATES. Large Cent, two-cent bronze, three-cent nickel and Bargain List, 25c. Fifteen dates large cents, \$1.00.** George Coffin, Greenwood Mountain, Me.

#### FOR BOYS

**ENTERTAINMENT for Boys! Our latest Movie Machines and durable Steel Toys are just the thing for real play.** Catalog Free. D. F. Elder & Co., Dept. C, Chelsea, Mass.

**ELECTRIC Toys—Electrical, Mechanical books. Electric Steam Engines. Catalogue 10c.** Manhattan Co., 333a W. Manhattan Blvd., Toledo, Ohio.

**SCHOLARSHIPS Available, Nationally Known Boys' School, Information, Box B, Suite 505, at 522 Fifth Avenue, New York City.**

**FILMS for Toy Machines. 200 feet \$1.50 Postpaid.** Dixie Film Co., Box 2042, Memphis, Tenn.

**FUN making things. Four large profusely illustrated books telling how to make almost everything from a sail boat to a toy automobile propelled by a motorcycle engine. Now \$2 per book or \$7 for the four if ordered at once. Send No Money. Just write a postal saying, "Send the Boy Mechanic Library." Pay postman \$7 and postage. For single books, specify either Book 1, Book 2, Book 3, or Book 4. Popular Mechanics Press, Room 901, 200 E. Ontario St., Chicago, Ill.**

#### CAMERAS AND PHOTO SUPPLIES

**MODERN Photography in all its branches now taught by mail. New Successful Method. Students earning \$300.00 while learning. Big opportunity. Write for particulars and unusual offer open for short time.** Dept. 3432, International Studios, Inc., 3601 Michigan Ave., Chicago.

**SEND any pictures with \$3.00 for 100 photo post cards. Photographs any size and quantity.** Gillespie Commercial Photographer, 11 Portland St., Boston, Mass.

**PHOTOGRAPHIC equipment and accessories of every description are listed and illustrated in our 228-page catalogue. It will pay you to secure a copy which is issued free, as our prices are low. We also deal in used goods which are sold under the same guarantee as new goods. Ask for our Bargain Book. Central Camera Co., Dept. E113, 112 S. Wabash Ave., Chicago, Ill.**

**KODAK Films—Special trial offer; your next kodak film developed, 5c—prints, 2c each.** Moser & Son, 1917 St. James Ave., Cincinnati.

**BIG Money Saved on Photographic Lenses and Apparatus—goods exchanged; repairing done.** Ralph J. Golsen, 1128 Argyle St., Chicago, Dept. P.

**FILMS Developed. Special Trial Offer. Any Size Kodak film developed 5c, prints 3c each. Trial 6x10 Enlargement in handsome folder 40c. Overnight Service.** Roanoke Photo Finishing Co., 209 Bell Ave., Roanoke, Va.

**HAVE You a Camera? Write for Free sample of our big magazine, showing how to make better pictures and earn money.** American Photography, 116 Camera House, Boston, 17, Mass.

**CALENDARS from Your Films—Send us any negative with 25c and we will make for you a 1927 calendar with the picture from your film artistically mounted.** Frank Seobie, Photographer, 68C Sleepy Eye, Minn.

**KODAK Film—Special Trial Offer—Your next roll developed 5c, prints 3c each. Beautiful 6x10 mounted Enlargement 40c. Sameday Service. Fleet Photo Service, 1210 G. N. W., Washington, D. C.**

**KODAK and Graflex Bargains.** Ray, 296 5th Ave., New York.

#### MOTION PICTURES

**FILMS: \$3.00 per reel up. Comedy, Western, Cartoon, Drama, Serial, Educational, Special Features. Best Movie Stars. Free List. Toy Film 200 Feet Postpaid \$1.50.** Dixie Film Co., Box 2042, Memphis, Tenn.

**NEW and Rebuilt Projectors for Theaters, Schools, Churches, Traveling Shows. Supplies and Complete Theater Equipments. Bargain Prices. Free Catalog.** Monarch Theatre Supply Co., Memphis, Tenn.

**\$\$\$ FOR Ideas. Photoplay Plots revised, criticized, copyrighted, marketed. Send for free booklet.** Universal Scenario Company, 244 Security Bldg., Santa Monica and Western Ave., Hollywood, Calif.

**FILMS—Fifty cents, seventy-five, and one dollar. Complete Subjects.** Alton Films, 205 Brush Creek Blvd., Kansas City, Mo.

**TOY FILMS for Sale. Comedies, Westerns. Features at \$3.00 per 1000 feet.** Plymouth Film Service, 2514 Augusta St., Chicago, Ill.

**VICAM Movie Cameras, Supplies, closing out wholesale.** Catalog. Uptown, Clear Lake, Iowa.

**SEND \$2.00 for startling new Cinometer. Gives exact exposure for all Movie Cameras or lenses. Fits pocket. Free Bargain List of Motion Cameras. Bass Camera Company, 109 North Dearborn Street, Chicago, Ill.**

**25-VOLT, 30 Ampere Mazda Lamps, \$2; Motors cheap.** Ray, 296 5th Ave., New York.

#### SCENERY TO RENT

**WORLD'S Most Beautiful Settings for operas, plays, minstrels.** Amelia Grain, Philadelphia.

#### EDUCATIONAL AND INSTRUCTION

**YOU can have a business profession of your own and earn big income in service fees. A new system of foot correction; readily learned by anyone at home in a few weeks. Easy terms for training; openings everywhere with all the trade you can attend to. No capital required or goods to buy, no agency or soliciting. Address Stephenson Laboratory, 1 Back Bay, Boston, Mass.**

**BE a Laboratory Expert. Earn from \$300 to \$500 Monthly. Study Microbiology Sanitation. Day, Evening classes, Diplomas, Degrees Granted. 71-piece outfit Free to students. Write for our Free Prospectus To-Day.** International College of Microbiology, 7202 W. Grand Ave., Chicago, Ill.

**AMATEUR Cartoonists—your drawings criticized by news-paper artist quarter each; five for \$1.00.** McCallp, Box 162, Peoria, Ill.

USED educational matter of all kinds. Sold on repurchase basis. Big saving. Money-back guarantee. List free. (Books bought.) Lee Mountain, Pisgah, Ala.

SCHOLARSHIPS Available, Nationally Known Boys' School, Information, Box B, Suite 505, at 522 Fifth Avenue, New York City.

FIREMEN, Brakemen, Baggage-men (white or colored), sleeping car, train porters (colored), \$150-\$250 monthly. Experience unnecessary. 810 Railway Bureau, East St. Louis, Ill.

MONEY in Verse Writing. Agreeable and Profitable Sideline. This verse brought \$2.00: "May Peace and Joy and Love abide To bless your home at Christmas-tide." Information free. Home School of Verse Writing, W. Passaic Ave., Bloomfield, N. J.

FAMOUS Bailey Handbook—The book that prepares you to pass the examination for any grade of license for Stationary, Marine and Diesel Engineers, Firemen and Boiler Inspectors in any state of the Union or any province of Canada. Flexible cover. Handy Pocket Size. Pay Postman \$2.00 plus the postage when he hands you the package. Popular Mechanics Press, Room 901, 200 E. Ontario St., Chicago, Ill.

LEARN Auctioneering. Five lessons free. American Auction College, Kansas City, Mo.

YOU can write! Turn your ability into cash. Learn the newspaper business. Pin one dollar to this and mail to City Editor, Box 308, South San Francisco, Calif.

STEAMSHIP Positions—Europe—Orient. Good pay. Particulars Free. Box 30, Mount Vernon, N. Y.

LEARN To whistle with your fingers. Easy; useful to everybody. Go in vaudeville as whistler. Complete instructions 25c. Turtle Co., Box 404, Waterloo, Iowa.

\$115—\$400 MONTHLY paid—By Station—office positions. Free passes, experience unnecessary. Write Baker, Supt., (ABT) Star Bldg., St. Louis, Mo.

USED educational matter. Lowest prices; terms. Catalog free. Mention Subject. Fred Goetz, 410-A Sansome, San Francisco.

USED Educational Matter bought, sold, exchanged. Bargain Catalogue Free. Handling, 799 Broadway, New York.

ARE You Interested in Writing short stories, poems, songs, photoplays, For Profit? Then send for our new edition of actual letters from prominent editors, who want your manuscripts. It's Free if you send for it Now. Address M. Mendelsohn, Editor, Dept. 102, Writer's Digest, 22 E. 12th St., Cincinnati, Ohio.

MEN wanting forest ranger positions. \$1,500—\$2,400. Write for particulars and list Natl. forests. Mokane, A-21, Denver, Colo.

EARN \$25 weekly, spare time, writing for newspapers, magazines. Experience unnecessary. Details Free. Press Syndicate, 981, St. Louis, Mo.

INSTRUCTION books, all kinds. Catalogue free. Winholt Book Co., Woodbine, 4, Penna.

DOUBLE Entry Bookkeeping mastered in 60 hours with 8 keys; guaranteed; diplomas. International Bookkeeping Institute, Dept. 8, Springfield, Mo.

YOU need a better grip on mathematics? Tell us to send you a copy of "Mathematics for the Practical Man" only \$1.50. By common sense methods it removes the mystery and difficulties so algebra and calculus are made simple. Assuming your knowledge is limited to arithmetic you quickly and easily gain a working knowledge of Algebra, Geometry, Trigonometry and Calculus. Simply pay postman when he hands you the package. Address Popular Mechanics Press, Room 901, 200 E. Ontario St., Chicago, Ill.

#### RADIO OUTFITS AND SUPPLIES

EXTRAORDINARY Bargain for Christmas! Five cushioned non-microphonic new UX style, white, trimmed eyeletted radio sockets for \$1.00. Postage 10c. Low cost of manufacture makes this possible. Agents wanted. Order now. Norwalk Products Manufacturing Company, Norwalk, Conn.

500-MILE "Pocket" Radio, \$2.00. No Tubes nor Batteries required. Useful and practical, loudspeaker volume. Order direct today. Spencer Laboratories, 116 Atlas, Akron, Ohio.

50H. UNMOUNTED Filter Chokes, \$2.00. 30H. \$1.75. 20H. \$1.00. Write for list of Transformers. Radio Parts Sales Co., Box 24, Orange, N. J.

ELIMINATORS. Power Units, Chargers. Reduced Prices. Simms, Lake, New York.

CROSLY Radios, new, guaranteed latest models and accessories at greatly reduced prices. J. Nold, 27 Chestnut St., Schenectady, N. Y.

LUMINOUS Paint, 25c; larger bottle, 50c. See objects in Darkness. Universal, 319 McKinley, Waukegan, Ill.

RADIO Experimenters—New, perfect parts, over \$5 list, \$1.25; \$10.00 list, \$2.25, pre-paid anywhere. Catalog, circuits, over two pounds, 25c. Kladag, Established 1921, Kent, Ohio.

SAVE 33% on all your radio supplies! Order by mail. Eliminate the storekeeper's profit. We handle only guaranteed quality products. Write for price list now. Midwest Engineering Supply Co., Dept. M, 3318 W. Harrison St., Chicago, Ill.

BIG Money Repairing Radios. Simple Instructions \$1. Duck Mfg. Co., Freeport, Ill.

RADIO Up-to-the-Minute. 1926 edition. Telegraphy, radio reception, vacuum tubes, telephony, how to build receivers, broadcasting, all treated in new book. Send No Money. Pay postman \$1.25 and postage. Just write postal for "Radio Up-to-the-Minute." Popular Mechanics Press, Room 901, 200 East Ontario St., Chicago, Ill.

#### TRADE AND TECHNICAL SCHOOLS

GET a Foreman's Job in any trade. Train yourself to earn more money. Become an expert Blue Print Reader. You can do it in spare time. My training will give you advancement in a few weeks. Write now—tell me what trade you want—I will send my plan at once. Carroll Rumsey, 165 Drexel Bldg., Philadelphia, Pa.

TELEGRAPHY—Both Morse and Wireless—taught thoroughly and quickly. Tremendous demand. Big salaries. Wonderful opportunities. Expenses low; chance to earn part. School established fifty years. Catalog free. Dodge's Institute, Fern St., Valparaiso, Ind.

BIG Pay Jobs. Learn Sign Painting, Decorating, Paperhanging, Show Card Writing, Graining and Marbling by practical training in a few weeks. Chicago Painting School, 148 West Austin Ave., Chicago.

LEARN Bricklaying at home or in school run by contractors. Catalog free. Associated Building Employers, G400, A. B. E. Building, Grand Rapids, Mich.

VULCANIZING Auto Tires is a paying Business. Instruction Book for \$1 Bill. Equipment Co., 106 11th St., Los Angeles, Calif.

MEN wanted to learn machine and tool making. We give you actual practice. G. & L. Machine Works, 1926 So. Wabash Ave., Chicago.

#### BUSINESS OPPORTUNITIES

100 QUICK Profit, Honest, Guaranteed Workable Mail Order Plans and complete instructions including detailed working specifications of plans that have made fortunes. A high-class, complete publication, finished in 1926. Covers all departments of the mail order business. Also teaches you clearly to originate plans of your own and put them into immediate operation. The only work of it's kind ever published. Written by fully competent and reliable authority. Mail Order Service, Box 93, Omaha, Nebr.

READ The Mail Order News—America's Pioneer Mail Trade Journal, Quarter Century Old. Approximately 600 pages yearly of valuable information for beginners an established mail-order houses. Analyzes mail-order business, its opportunities. Practicable mail-order ideas, legitimate money-making schemes, instructive articles. Tells how to start, what to sell. Published monthly. Subscription \$3.00 yearly. Send 25c for sample copy. None free. Mail Order News, 360 Bristol Bldg., New York.

COMPOSITION Floor Making earns industrious men \$12 and more daily if used as trade. Or make business of it with profits up to \$15,000 yearly. We teach everything, show opportunities, explain how to make good. Openings everywhere. Write Semi Title, Dept. C, Hollis, N. Y.

HIRE yourself as Boss! \$250 a week easily made making these Big-selling Specialties. 300% to 900% Profit. Investment Small. No machinery needed. Let me show you how to make Heitit the New German anti-freeze preparation for Radiators; Fibro-seal Guaranteed Puncture Proof; Para-vulkine, no-cement Instant Weld Patch; Super-Radiolyte, 20-minute Battery charging Liquid, and 30 other big money-makers in the House-hold, Food Beverage and Toilet Specialty lines. Valuable Literature Free! Miller, Chemist, 1706-C Jetton, Tampa, Fla.

PATENTS. Time counts in applying for patents. Don't risk delay in protecting your ideas. Send sketch or model for instruction or write for Free book "How to Obtain a Patent" and "Record of Invention" form. No charge for information on how to proceed. Communications strictly confidential. Prompt, careful, efficient service. Clarence A. O'Brien, Registered Patent Attorney, Security Bank Building (directly across street from Patent Office), Washington, D. C. See pages 138 and 139.

ARTIFICIAL marble sanitary flooring instructions, covering wood or cement flooring 1/2 inch thick, fireproof, waterproof, all colors, low cost. Ornamental casting, concrete, plaster, papier-mache decorations, garden furniture, statuary, flexible molds. 17 years instructing the public; particulars and illustrations free. Chris. Mahler, Huntington, N. Y.

ATTENTION! You can have a business of your own. Establish and operate New System Real Estate Business, brokerage and insurance agency in your community. Office at home. Earn \$5,000 year. Representatives wanted everywhere. Send stamp free booklet. Hayes Realty Association, Cincinnati, Ohio.

MUSHAMOLES: New food specialty. Your own parlor or sell restaurants, fountains, etc. Big opportunities. Particulars free. E. Sprinkle, Paris, Ark.

FREE Mail Order information. Write today enclosing Stamp. Ernest Mason, 3900 Broadway, Chicago.

NEW Spare Time Money-Making opportunities. Investigate. Osc. Hanson, Mentor, Minn.

START manufacturing business at home in spare time. Big profits. Only few dollars needed to start. Details free. Joseph Beksell, 1901 South Main, Rockford, Ill.

FURCRAFT—A new and profitable business for men and women. Make big money immediately. Easily and quickly learned at home. No peddling. An uncrowded field and high-class business. Be first in your community. Write today for free book. Northwestern Fur Co., Suite 9771, Sunderland Building, Omaha, Nebr.

MAKE Much Money—Making and Selling Your Own Goods. Formulas by experts. Manufacturing processes. Trade Secrets. All lines. All kinds. Catalog. Special circulars free. B. Thaxly Co., Washington, D. C.

OPERATE Chewing Gum Machines. Large profits. Small Capital. Particulars free. Walter Gum Co., 21 Dodworth St., Brooklyn, N. Y.

\$1 STARTS you in business for yourself! Lifetime opportunity. Particulars free. Thomas W. Myers, 21 W. Locust St., Mechanicsburg, Pa.

GOOD income operating gum peanut machines. Small investment. Sise & Company, Watervliet, N. Y.

MAIL Order Booklet, where to buy Books, Novelties, Specialties, 10c. Harvey Teeple, Decatur, Ind.

TIRE and Battery Shop Equipment at Wholesale. Send for Circular 130. Adams-Barr, Columbus, Ohio.

LEARN to Manufacture—It pays big profits. We teach you how. Start spare time. Few dollars. At home. We show you how to sell. Write for free circular. Heartinger System, 2002 Wyoming, St. Louis, Mo.

\$25 STARTS Clean, Honest, Spare-Time, Home Work, Mail Order Business. Very Easy and Simple. Circular free. B. M. Smith, Box 369, Morristown, N. J.

MIRRORS Resilvered at Home Cost less 5 cents per square foot; you charge 75 cents. Immense profits, plating like new; brassy worn-off autoparts, reflectors, tableware, stoves, etc. Outfits furnished. Details Free. Sprinkle, Plater, 127 Marion, Ind.

EXTRA money raising canaries. Information, stamp. John M. Fisch, Sigourney, Iowa.

RAISING Fur-Bearing Animals of all kinds. Full instructions in one volume complete. Write Patton, 17 N. Wabash Ave., Chicago, for free circular.

GOOD Money easily earned at home spare time silvering mirrors, glass embossing, chipping, frosting, gold leafing, etc., Patterson & Co., Brookville, Ky.

SALESMANAGER for large established corporation. New metal specialty. Sells to all merchants on demonstration. Proven selling merit. Possibilities unlimited. Requires \$500 to \$1,000 Capital. Write for proof. Secretary 1201 Cortland, Chicago.

**ENTER** a new business. Earn \$3,000 to \$6,000 yearly in professional fees making and fitting a foot specialty, openings everywhere with all the trade you can attend to; easily learned by anyone at home in a few weeks, at small expense; no further capital required, no goods to buy, job hunting, soliciting or agency. Address Stephenson Laboratories, (1) Back Bay, Boston, Mass.

**\$3,000 TO \$5,000 Yearly.** Want it? Others are making it. Send check or money order today for our invaluable books "How to Sell Real Estate." \$3.00—and "How to Conduct Real Estate and Insurance Business." \$1.50. Absolute satisfaction guaranteed. Free circulars. Realty Book Co., De. 52, Cleveland, Ohio.

**\$750,000,000 MAIL** order business in 1925. Many grow rich in this great trade. Sell merchandise, information, patented articles various preparations. Breniser's Famous Mail Order Handbooks tell how. Eleven brochures \$3. One book with complete catalog, 25c; none free. Breniser, (Established 1900), 1607 Sansom, Philadelphia.

**MAKE Money at Home—spare or full time.** Our new book, containing 20 Money-Making Plans sent postpaid, 50c. Crittenden, 4132 West 21st Street, Chicago.

**START Profitable Mail Order Business.** Particulars Free. The Wholefield Company, Akron, Ohio.

**START Mail Order Business** of your own at home. We supply catalogues with your address on. Winholt Sales Co., Box 4, Woodbine, Penna.

**OPERATE** money-making mail-order business in spare time. Write for free particulars. Triangle Mail Order Service, 600 Blue Island Ave., R31, Chicago.

**MAKE Money** silvering mirrors, refinishing auto headlights, tableware, metal plating, bedsteads, chandeliers. Outfits furnished. International Laboratories, Dept. 71, 309-5th Ave., New York.

**ESTABLISH** big paying business in your home town or travel. Many opportunities offered. V. Santschi, Glenellyn, Ill.

**POSTAL Success.** Instructive articles of mail selling 3 months 25c. Porter, 9416a 115th St., Richmond Hill, N. Y.

**MAIL Order World** contains \$-getting ideas, opportunities, Triangle Big Mail, 3 months 25c. Mail Order World, 600 Blue Island Ave., Chicago.

**RAISE Money** for invention, any business proposition. Inexpensive, reliable method. Interstate Service, Elizabeth, N. J.

**FREE—Magazine** and Book Catalog. Finko Publishing Co., Toledo, Ohio.

**CONSULTOR** advises you confidentially to achieve success. Box 74, Brooklyn, New York.

**NEW Money Making Schemes.** 100 Business Ideas and Plans. Endless array of opportunities for ambitious people to establish profitable business. Price Postpaid \$2.00. Circular free. Colonial Mail Order Co., Box 369, Morristown, New Jersey.

**MINIATURE Die - Casting Machines** \$50.00. 318 Reed St., Erie, Pa.

**SIGNS and Showcards** easily painted with Letter Patterns. Large variety of Styles and Sizes. Write for free samples. John Rahn, 2120 Neva Ave., Chicago.

**RESPONSIBLE** manufacturer wants competent men to manage office and salesmen. \$300 to \$1,500 necessary; will allow expenses to Trenton if you qualify. Address Manager, 536 Forst Richey Bldg., Trenton, N. J.

**MAKE Money at Home—making toys.** We show you how. Send \$1 for complete working drawings and instructions. DeKalb Designing Co., Decatur, Ga.

**I MADE \$30 a Week Home.** French Breadmaking. 15 years' experience; Free Booklet tells. Ashbrook 67, Marengo, Ohio.

**UNPATENTED Ideas** Can Be Sold. I tell you how and help you make the sale. Free particulars (Copyrighted). Write W. T. Greene, 810 Jenifer Building, Washington, D. C.

**SELL Pro-Tex-Chex.** A Check Protector. Sample 25c Postpaid. Goldstein Bros., Santa Cruz, Calif.

**WE Start You in Business,** furnishing everything; men and women, \$30.00 to \$100.00 weekly operating our "New System Specialty Candy Factories" anywhere. Opportunity lifetime; booklet free. W. Hillyer Ragsdale, Drawer 4, East Orange, N. J.

**MAKE toys and novelties** at home. Big profits. Instructions and illustrations, 25c. Astrolite Company, Sharpsburg, Pa.

**PATENTS Procured;** Trade Marks Registered—A Comprehensive, experienced, prompt service for the protection and development of your ideas. Preliminary advice gladly furnished without charge. Booklet of information and form for disclosing idea free on request. Richard B. Owen, 30-Owen Bldg., Washington, D. C., or 41-R Park Row, New York.

**MECHANICS,** painters, carpenters, start furniture refinishing, painting, handyman shop on nearly nothing; winning plan brings customers quickly. John Braceland, 1139 So. Ninth, Philadelphia, Pa.

**SCHEMER,** Alliance, Ohio, 36p monthly, prints mammoth \$-getters. Subscriber reports \$25,000 from three; another \$10,000 from one. Try your luck. Year, \$1.00; 3 months, 30c.

**DELAWARE** Incorporator. Charters; Fees Small; forms. Chas. G. Guyer, 901 Orange St., Wilmington, Del.

**CHEMICAL Expert** will furnish Formulas and Trade Secrets. All lines. Lists Free. W. L. Cummings, Ph. D., 228 Gordon Ave., Syracuse, N. Y.

**LEARN** the collection business. Good income, quick results. Interesting booklet, "Skillful Collecting" free. National Collectors Assn., Long St., Newark, Ohio.

**EARN \$10** daily silvering mirrors, plating and refinishing metalware, autos, chandeliers, bedsteads, headlights. Outfits furnished. E. Dele Laboratories, 1133 Broadway, New York.

**DEALERS—Bdy Battery Shop** Equipment and Supplies at Wholesale. Get circular No. 131. Adams-Barr, Columbus, Ohio.

**NOW** that you have read all these offers, send 25c for Detailed Information. (None free.) "How" and "What" to Sell by Mail; through Agents; or Direct; We want 100,000 Representatives! Opportunity is knocking—Answer! Surety Service, Dept. 271, 551 Harvard St., Rochester, N. Y.

#### TELEGRAPHY

**TELEGRAPHY—Both Morse and Wireless—taught** thoroughly and quickly. Tremendous demand. Big salaries. Wonderful opportunities. Expenses low; chance to earn part. School established fifty years. Catalog free. Dodge's Institute, H St., Valparaiso, Ind.

#### CHEMISTRY

**EXPERT Chemical Service.** Working formula or process prepared for your special purpose, \$5.00. Write me. W. Stedman Richards, Industrial Chemist, Box 2402, Boston, Mass.

**EXPERIMENTERS' laboratory apparatus.** Chemicals. List 5c. Chemical Apparatus Co., 4402 West End, Chicago.

#### FORMULAS AND TRADE SECRETS

**FORMULAS.** Guaranteed Best Chemical Science can devise. Stamp brings big bunch valuable literature describing Latest Reliable Processes for Manufacturing All Lines. Don't Buy till you've received these Profitable Propositions. No recipe-book Trash. 29 years giving satisfaction. Miller Chemist, 1706-U Jetton, Tampa, Fla.

**SPECIAL formulas** for Manufacturing and Business purposes. Any one you want, including full manufacturing instructions and where to get all supplies, sent for \$5. Satisfaction guaranteed. Announcements of latest formulas for quick-selling seasonable products sent monthly without charge. Write today. National Information Bureau, 316E Sheshard Building, Grand Rapids, Mich.

**SMALL Manufacturer:**—How's business? Sales good? Learn Latest 'Inside' Methods Manufacturing-Selling-Profit Making of Successful 'Home Factory' Operators. \$1.00, postpaid. Satisfaction, or dollar refunded. Particulars Free. Pacific Publishing Co., Box 1380, Prineville, Oregon.

**EASY money maker,** just like I use myself; why not you? Particulars for red stamp. W. P. Stump, Hemet, Calif.

**10,000 FORMULAS.** A real Gold Mine of money-making ideas. Tells how to make almost everything under the sun. You can make and sell cosmetics, mucilage, anti-freeze solutions, battery solutions, beverages, cheese, chewing gum, cleaning preparations, extracts, hair preparations, inks, bluing, leather polish, mirrors, perfumes, polishes, typewriter ribbons, carbon paper, washing powders, liquid soap, and hundreds of other profitable articles. Send No Money. Just write a postal for "Hemley's 20th Century Book of Formulas." Pay postman postage and \$4. Popular Mechanics Press, 200 E. Ontario St., Room 901, Chicago, Ill.

**START** a manufacturing business of your own. Earn \$100.00 weekly. Make your own products. Formulas, toilet articles, perfumes, soap, extracts, etc. We furnish everything and show you how. Valuable catalog free. National Scientific Laboratories, 1934W Broad, Richmond, Va.

**MAKE Much Money—Making and Selling Your Own Goods.** Formulas by experts. Manufacturing processes. Trade-Secrets. All lines. All kinds. Catalog, Special circulars free. B. Thaxly Co., Washington, D. C.

**500 FORMULAS** including Luminous Paint—Renewing Dry Batteries—Resilvering Mirrors—Gas Tonic, Puncture Plugger, 25c. Catalog Free. Ideal Book Shop, Park Ridge, Ill.

**3,000 FORMULAS and Recipes for \$1.00.** Worth while Formulas, Trade Secrets, etc. 368 pages. E. Kephart, 415 East 73rd, New York City.

**\$5 WILL** furnish you with working formula for manufacture of any article—work guaranteed—chemical analysis of any nature. Chemical Technical Laboratories, 173 State St., Boston.

**ANY Formula.** \$1.00. Anything Analyzed, \$2.50. Chemists Association, Indianapolis, Ind.

**FREE—certified formula** Famous Da Zerna Beauty Secret. Kansas Formula Bureau, Holton, Kans.

**20c—ANY Formula—20c.** Dime Information Bureau, Colorado Springs, Colo.

**15,000 FORMULAS** in "Scientific American Cyclopedic of Formulas." Includes following and many others: accidents and emergencies, agriculture, alloys and amalgams, artists' materials, beverages, cements, glues, pastes, mucilages, bleaches, renovating, coloring metals, dyeing, glass, heat treatment of metals, household formulas, ice cream, confectionery, chewing gum, lapidary work, exterminating vermin, lubricants, paints, varnishes, photography, condiments, canning formulas, rubber, soap, candles, soldering, toilet preparations, perfumes, waterproofing, fireproofing, writing materials. Send No Money. Just write a postal. When postman hands you book, pay \$5.50 and postal charges. Popular Mechanics Press, Room 901, 200 East Ontario St., Chicago, Ill.

#### AGENTS WANTED

**AGENTS:** \$11.80 daily in advance, introducing New Insured Hosiery for men, women, children. Must wear or replaced Free. 57 styles, 39 colors, including latest "Silk to the Top" Ladies' Hose. Nyland made \$595 in one month. Edwards, \$460.60 Mrs. Bone, \$425.45. Why not you? Even spare time should pay you \$3.00 an hour. No experience needed. We furnish samples. Silk hose for your own use Free. New plan. No matter what you are now doing, write quick. Macochee Company, Road 2561, Cincinnati, Ohio.

**\$25 TO \$50 a week—\$1 to \$2 an hour** spare time in easy, pleasant occupation. Thousands of men and women are making this income with the famous Ho-Ro-Co Soaps, Perfumes, Toilet Articles, Specialties. Over 200 items; quick sales, appeal in every home. La-Em-Strait Hair Dressing, the fastest seller wherever introduced. Write at once for Free Sample Case offer—the best yet. Ho-Ro-Co., 791 Ho-Ro-Co Bldg., St. Louis, Mo.

**100 MORE** active men to Introduce Chieftain Guaranteed Tailored Shirts 3 for \$4.95. Latest novelties, colors. Dickman, Illinois, in 3 weeks made \$589; Sinton, Texas, in 12 days, \$219.60; Bend, Iowa, in 16 days, \$334.80. Why not you? No experience or capital needed. We deliver and collect. Full working outfit free. Cincinnati Shirt Company, Lane 1581, Cincinnati, Ohio.

**DISCOVERED!** Diamond Rival—Rajah Gems astound Jewelry world and defy detection. Set in artistic Sterling Silver mountings copies of highest priced platinum designs. Sell like wildfire at popular prices. Salesmen and Agents unique selling plan means enormous profits for you. Write immediately for details. Rajah Company, Dept. X-1, Salisbury, N. C.

**SALESMEN** Selling to Men: We have logical side line for you that will sell along with any other line you may now be handling and probably make more money for you, provided you are now selling to men. Get full facts at once by addressing Salesmanager, 844 West Adams, Dept. 702, Chicago.



**\$5 SAMPLE for \$1!** Amazing 30-day offer to interest new salesmen in quickest selling spare-time, side-line article known! Mexican Blu-Flash Gem positively matches finest genuine Diamond side-by-side; de-fies experts; sells on sight! Guaranteed 20 years; sensational profits! \$5 dazzling, brilliant blue-white, sample Gem and free Sample Case proposition mailed you C. O. D. \$1.00 on request. Write quick! Mexican Gem Company, Box P8C, Monterey, Calif.

**AGENTS:** Make \$500.00 before Xmas. Pay daily. No investment. Rhinestone initial Buckles and novelties. Big Xmas and all year sellers. Exclusive territory. Chaton Novelty Co., 606 Blue Island, Chicago.

**AGENTS—\$100 a week for full time;** \$25 to \$50 spare time. Equipment and car free. Exclusive territory. Sound permanent proposition. A rare opportunity, but you must act quickly. Write for particulars today sure. American Products Co., 9019 Monmouth, Cincinnati, O.

**MIRRORS** Realized at Home. Costs Less, 5 cents per square foot; you charge 75 cents. Immense profits, plating like new; brassy worn-off autoparts, reflectors, tableware, stoves, etc. Outfits furnished. Details free. Sprinkle, Plater, 128, Marion, Ind.

**JUST Out—Patented Apron** Without strings, straps, hooks or buttons. On or off in a jiffy. Over 100% profit. Commissions paid daily. Write for free sample offer. Sta-Put Co., 201 N. 11th St., St. Louis, Mo.

**AGENTS** are cleaning up with the National Brush and Broom Set. Sweeps, Scrubs, Dusts, Mops. Costs \$1.00, sells for \$2.00. Free Sample Offer. National Fibre Broom Co., St. Louis, Mo.

**WANTED—County Agents and Representatives** to market the 3A Garage Door Holder. All owners of private garages are instantly attracted by its Simple, Automatic Action. Write for attractive proposition. Knowlson-Stevenson Co., Ann Arbor, Mich.

**AGENTS—Buy direct Neckwear, Hosiery, Lingerie** at lowest Mill Prices. Ask for Circular No. L. Master Knit Mills, New Haven, Ct.

**MAKE Much Money—Making and Selling Your Own Goods.** Formulas by experts. Manufacturing processes. Trade-Secrets. All lines. All kinds. Catalog. Special circulars free. B. Thaxly Co., Washington, D. C.

**AGENTS—Sheridan's Directory** tells where to buy right. 75c postpaid. The Hoosier Specialty Co., Rising Sun, Ind.

**STARTLING Invention: New Shock Absorber** for Fords retails at \$3.50. Big profits easy. Exclusive distributors wanted. M & M Mfg. Co., 31 Station C, Omaha, Nebr.

**AGENTS—500% profit selling genuine gold window letters; Scripts.** Experience unnecessary. Free sample. Premier Letter Co., 121 N. Francisco, Chicago.

**HERE they are; fifty fast sellers** everybody needs and buys. \$50 weekly easily made. B & G Mfg. Co., Dept. 102, Pittsburgh, Pa.

**OUR latest Lingerie, Neckwear, Scarf line** is unequalled for making money. Write for details. Public Service Mills, 725-F 5th Street, Union City, N. J.

**SAMPLES Furnished, 36 Hosiery and Neckwear Styles; 31 Piece Initial Dinner Set** to each customer and one Tie "Free," or both. Ladies' Silk Hosiery 25c per pair, Guarantee, Customer to be the Judge; over 50 colors. We deliver. From 37% to 117% commission; 10% bonus. Send three references to see Beautiful \$10.00 Sample Outfit. Desk D. S. Q. S., Lexington, Ky.

**RAINCOATS—Full line, all prices.** Also leather and sheep-lined coats. Big catalog free. Commissions 25% with bonus. Hydro Raincoat Co., 718 Independence, Chicago.

**SALESMEN:** Write your name and address on a postal and mail to us. We'll show you sure earnings of \$20.00 a day. Will you risk one minute and a one cent stamp against \$20.00? Mind you, we say we'll show you. Address Dept. 3, William C. Bartlett, Inc., 850 W. Adams St., Chicago.

**AGENTS—\$8 to \$24 per day** selling women's coats. Free Outfit. Co-Operative Service, 1265 Broadway, New York, N. Y.

**MARVELOUS New Invention 400% profit.** Liquid Quick Mend for hosiery and fabrics. Tremendous demand. Over hundred other fast sellers. J. E. Johnson Co., Dept. 449, 18 E. Kinzie, Chicago, Ill.

**NEW Way to Make Money—We show you how.** Earn \$15 a day taking orders for our fine made-to-measure tailoring. Your own suit absolutely Free. Write today for new style, convenient, portfolio outfit, large all wool samples, etc. Furnished Free. Progress Tailoring Company, Dept. A217, Chicago.

**EARN \$15 Daily with Direct Factory line** selling three honest to goodness \$2.50 shirts for \$4.95. Fine workmanship and 16 distinctive features makes selling easy. Elaborate outfit free. The Real Shirt Co., Dept. 89, Atlanta, Ga.

**SELL La France Excursions.** Big Commission and Free Trip to Europe. C. Delo-gastra, 228 Washington St., New York.

**99 WOMEN** out of 100 want to buy—Biggest seller today. Enormous repeater. Free sample. Budd Products, 1608 East 66th St., Cleveland, Ohio.

**\$10 DAILY** selling Raincoats, Slickers, newest colors, outfit free. Commissions daily. Albert Martin Co., 22 Quincy, Chicago.

**FIBRE Brooms—detachable handles,** fine finish. Good profits, repeat sales. The Fibre Broom People, 147 New Jersey Ave., Brooklyn, N. Y.

**AGENTS, Portraits, photo-pillow tops,** frames, sheet pictures, medallions, laundry tablets, food products, photo jewelry, guaranteed hose, toilet requisites, luminous crucifixes. Catalog 50 specialties free. 30 days' credit. Jas. C. Bailey Co., Dept. C1, Chicago.

**AGENTS Wanted: Something New.** Every Motorist a Buyer of our Electro-Magnetic-Emergency Wonderlamp; takes only one minute to demonstrate and make a sale; no experience necessary; \$5.00 an hour easily made, either full time or evenings; big Christmas sales. Wonderlamp Co., 920 Fisk Bldg., Dept. 10-A, New York.

**SELL Better Quality All-Wool Made-to-Order suits** at \$31.50. Profitable new field for men who are conscientious and dependable. No experience necessary. Full or part time—\$45 to \$100 weekly and liberal bonus. Commissions paid in advance. We furnish handsome large swatch samples and complete instructions free. Write W. Z. Gibson Inc., 161 W. Harrison St., Dept. A517, Chicago.

**EARN \$15.00 Daily.** Qualify as an Expert Automobile Refinisher, Retrimmer, Cleaner, Interior Decorator. Make automobile specialties. Modern Trade Practice Quickly Learned at Home—Endorsed Everywhere. DeWilde, Sheboygan, Wis.

**\$18 To \$25 daily.** Biggest selling line of 2-piece suits, \$9.95 and \$12.50; 3-piece wool suit, \$17.95 (regular \$28.00 value). All-wool overcoat, \$18.50. Splendid raincoats, slickers and boys' suits. Biggest commissions. Free outfit. "Jim" Foster, Inc., Dept. W394, 2250 S. Spaulding Ave., Chicago, Ill.

**AGENTS, year around weather proof** for nickel. Colored lacquer for automobiles and furniture. Exclusive territory. Name yours. Nitro-Cell Co., 2909-11 Nicollet, Minneapolis.

**PENNANTS—States, Cities, Colleges, Resorts;** 35c Seller; Costs 18c; Sample 25c. Omaha Pennant Works, 715 Baltimore Building, Chicago.

**SELL Super-Power, the blue wonder crystals.** Latest automobile product. Sells like a flash. Saves gas, increases power and pep, removes carbon while driving. Guaranteed harmless. Just pour into gas tank. Steady repeat article. Your profit 100 to 182%. Particulars free, write today. Cassard Specialty Laboratories, 31A Fountain Street, Grand Rapids, Mich.

**AGENTS—Cannasoes, Something Different.** No Samples to Carry. Payday Every Day. Write Us. B. B. C. Co., Binghamton, N. Y.

**SELLING Like Blazes!** Eleven piece toilet goods assortment at \$2.25 with two piece carrying set Free to your customers. 100% profit. Davis Products Co., Dept. 56, 1321 Carroll, Chicago.

**SELL Surety, the Original, Genuine Powdered Hand Soap** and make \$5,000 yearly. We furnish sales plans, advertising and Free Samples. Write quick. Surety Mfg. Co., Dept. 56, 26 W. Washington St., Chicago.

**SELL Pioneer \$23.50 all wool tailoring,** full or part time. \$5 an hour selling our famous tailored-to-measure all-wool suits at \$23.50. Commissions paid in advance. Striking leather brief case containing 100 large swatch samples furnished. We train the inexperienced. Write today. Pioneer Tailoring Co., 159 W. Harrison St., Dept. A1117, Chicago.

**WHY not sell us your spare time, \$2.00 an hour, \$19.70 Daily Easy Full Time.** Introduce 12 months' Guaranteed Hosiery—47 styles, 39 colors for Men, Women, Children, including latest "Silk to the Top" Ladies' Hose—No capital or experience needed—We furnish samples. Silk hose for your own use Free. New Plan. M. H. Mathews, Road 5861, Cincinnati, Ohio.

**AGENTS, energetic men and women,** everywhere, earn \$25 to \$50 weekly with Fiosfork, new every day health necessity; whirlwind seller, every man, woman, child buys; free folder tells how to start money coming fast. Ogden, M'g'r, P. O. Box 4330 P. Philadelphia, Pa.

**YOU can be your own boss with our Key-Check outfit.** Good for \$5 a day stamping names on pocket key checks, fobs, etc. Sample check with your name and address. 20 cents. Pease Die Works, Dept. M, Winchester, N. H.

**REAL Money** selling a great new Health Invention generating Violet Ray, Vibration, Electricity and Ozone. Exclusive Territory now open. Write today. Lindstrom & Co., 39 W. Lake St., Dept. 13-51, Chicago.

**AGENTS—Make a dollar an hour.** Sell new kind of sharpeners. Sharpens all knives and tools quickly. Demonstrating sample free. Premier Mfg. Company, Dept. 63, Detroit, Mich.

**BIG earnings. Square Deal Policy,** sell "Spire Quality Shoes" direct to ladies. Big values, snappy styles, \$4.00 up. Money Back Guarantee. Protected Territory. Write! Spire Shoe Company, Dept. K-103, Cincinnati.

**AGENTS: Only Domestic Pea Huller** on Market. Sells year round. Weight one pound. Retail \$1.00. Home Pea and Bean Hulling Machine Co., Marietta, Ohio.

**WOMEN—\$2 an hour spare time;** new idea sanitary necessity; sells on sight; every woman buys; new feature never before used; designed by physician; revolutionizes old uncomfortable methods; pay every day; no deliveries, no collections no experience or capital required. Particulars mailed in plain envelope. Don't delay. Write Mrs. Mary P. Coleman, Meriden, Conn.

**MEDALLION and portrait men—\$100** weekly easily made selling our line. Samples free. Write for catalog, Chattanooga Art Medallion Co., Chattanooga, Tenn.

**AGENTS—Jonal Rain Pad, Windshield** clear 24 hours, rain or snow. Guaranteed. Sample 15c. Jonal, 2740 N. Whipple St., Chicago.

**WE pay \$48 a week, furnish auto and** expenses to introduce our Soap and Washing Powder. Buss-Beach Company, Dept. A42, Chippewa Falls, Wis.

**ALL-YEAR-ROUND profitable business** selling wonderful new water softener and cleaner. Removes grease, oil, ink and dirt quickly. Every home and business place a live prospect. 100% profit. Big repeat orders. Exclusive territory. Write for free sample. Seacoast Laboratories, Sea Bright, N. J.

**SELL Radium Water Generators.** Entirely new fast seller. Repeat orders sure. Permanent income. Ask Why today. Radium Refinery, 2209 Broadway, Oakland, Calif.

**AMAZING Large Cash Commissions** Introducing Beautiful \$3.95 and \$4.95 Fit-to-Measure Guaranteed Shoes. Actual Samples Furnished. Write for Your Territory. Style Arch Shoe Co., Dept. 106-N, Cincinnati, Ohio.

**THANCO Vanilla—Bottle Yourself!** Concentrated; add water, free labels. Crushes competition! 500% profit! Immense seller, homes, bakeries, stores. Write Thomas Manufacturing Company, Indianapolis, Ind.

**TWO Bits Every Two Minutes.** Here's 25c profit on new household specialty you can sell in two minutes. The Pantong—something brand new. A red hot seller. Full time or sideline. Write to The Tyler Mfg. Co., Dept. CI-11, Muncie, Ind.

**SEEK No Longer! Become independent!** Be your own boss! Become my representative. Introduce sensational 3 In 1 Hot Water Bottle Combination. Startling invention. Every home buys. \$20.00 daily easily earned. No capital needed. I furnish everything. Write for great surprise. President Lobl Mfg., Dept. CI-11, Middleboro, Mass.

**PORTRAITS, photo-pillow tops, frames,** sheet pictures, medallions, merchants' signs, food products, photo jewelry, guaranteed hose, toilet requisites, luminous crucifixes, Catalog 50 specialties free. 30 days' credit. Jas C. Bailey Co., Dept. C-1, Chicago.

**AGENTS**—Best seller; Jem Rubber Repair for tires and tubes; supersedes vulcanization at a saving of over 800 per cent.; put it on cold, it vulcanizes itself in two minutes, and is guaranteed to last the life of the tire or tube; sells to every auto owner and accessory dealer. For particulars how to make big money and free sample, address Amazon Rubber Co., Philadelphia, Pa., Dept. 595.

**COLLECTOR** and solicitor for Pobolac American Pharmaceutical Co., 1551 Donaldson Place, Cincinnati, Ohio.

**BIG Profits! Great Demand! Rich's** pure fruit Concentrated Soft Drinks. Every home, store, drink dealer buys. \$10.00-\$25.00 Daily easy. Sample free. Sol P. Rich Co., 622 S. Sangamon, Chicago.

**GOLD-LEAF Sign Letters**; make and sell; 1,000% profits. Particulars. Johnson Co., Quincy, Ill.

**GOLD Leaf Window Letters and Script Signs**. No experience; 500% profit. Samples free. Consolidated, 69-U West Van Buren, Chicago.

**ACT quick**—amazing discovery—make no freeze radiator solution. Eleven cents gallon guaranteed; forty below zero. Formula \$1.00. Forex Chemical Works, Milwaukee.

**AGENTS**, hundreds of easy money-making plans and propositions. Send 25c stamps. J. Jankow, 443 St. Anns Ave., New York.

**MEN** with Autos in small towns and country districts. One who has confidence of people in his own community is offered fine opportunity to build permanent business paying \$200 and upward monthly. Stetson Oil Co., Desk 5, Cleveland, Ohio.

**AGENTS** Wanted. To sell to retailers and jobbers in any territory; good commission. Write for particulars. Terrio & White, 4224 Lincoln Ave., Chicago, Ill.

**CASH** Paid for Butterflies, Insects. See Sinclair Display Advertisement on Page 18.

**PATENTS**. Time counts in applying for patents. Don't risk delay in protecting your ideas. Send sketch or model for instruction or write for Free book "How to Obtain a Patent" and "Record of Invention" form. No charge for information on how to proceed. Communications strictly confidential. Prompt, careful, efficient service. Clarence A. O'Brien, Registered Patent Attorney, Security Bank Building (directly across street from Patent Office), Washington, D. C. See pages 138 and 139.

**AGENTS**: Our gold-eyed Needle Cases are wonderful sellers; immense profits; \$50 to \$300 weekly; proof and particulars free; sample outfit 10c; factory prices. Paty Needle Co., 231 Davis Square, Somerville, Mass.

**\$500 MONTHLY** proposition. Particulars Free. B. Davis, 1726 Roosevelt Rd., Chicago.

**"MAKE And Sell Your Own Goods"**—Tremendous Profits; No machinery; No experience; We show you how; Write quick for Free Book. Clover Laboratories, (P) Parkridge, Ill.

**YOU Can Make Real Money** operating our copyrighted plan. Restricted territory. National Tire Service Association, Inc., 990 Bergen Street, Newark, N. J.

**REAL** money for you. Our combination Aluminum Cooking set easy to sell. No delivering, no collecting. Make \$10 to \$15 daily. Espy-Riddle Co., Dept. 2, 2325 Carson Street, Pittsburgh, Pa.

**PATENTED**—Sanitary Self-cleaning Comb Write for details. Sample 50c. Sanitary Comb Co., 296 Broadway, New York.

**THREAD-CUTTING** Thimble 25c. Seller Sample 15c. Irvel 3973 Elston, Chicago.

**AGENTS**: Clean up on Eyeglass Cleaner. Carried in vest pocket. Sells itself. Steady repeater. Sample 25c, refunded first order. Philip Amendt, 441 Maple Ave., Phillipsburg, N. J.

**15c ON** every 25c sale means big daily profits. Box 500, Shreveport, La.

**MAKE \$25-\$50** weekly with our beautiful hand-woven bungalow rugs, cushion covers, toy rugs, etc. Free sample. Manufacturers' wholesale prices. Eureka Co., Dept. A, Fairfield, Ill.

**MAKE \$500** Before Xmas Selling New Sports Pens and many other imported gifts. Write for Free Wholesale Catalog. A. Sports Co., Lesueur Center, Minn.

**\$50,000**. PICTURE Man Friedman mad canvassing. Beginners can make \$100.00 weekly with my sales talk. Experienced men make more. Free book. "Profits in Portraits" explains. Samples Free. Picture Man Friedman, Dept. 80, 541 W. Lake, Chicago.

**KLEENZIT** Kleening Pencil—Removes spots and stains from men's garments and similar fabrics. Simply mark spot with cleaning crayon and erase with brush-pad moistened with water. Sells readily at 35c to 50c. Big profit. Argyle Specialty Company, Argyle, Wis.

**SALESMEN**, agents, distributors sell new marvelous shock absorbers; fits all cars; installed quickly; retails \$10; big profits. Anchor Electric Co., 559 Jackson, Chicago, Ill.

**WANTED** Hosiery agents to Make \$25.00 per day selling Hosiery from the factory to the consumers. Men's silk novelty hose, \$16.25 per Gross. Men's silk assorted colors, \$12.00 per Gross. Men's Heather hose, \$21.00 per Gross. Men's silk neckwear, \$12.00 per Gross. Sample dozen sent upon receipt of Money Order plus fifteen cents Parcel Post. Lewis Hosiery Co., 12 N. 3rd St., Philadelphia, Pa.

**AGENTS**—Mosco Corn and Callous Remover will build you a steady repeat business. Send today for pocket size trial outfit. The Moss Co., 357 Searle Bldg., Rochester, N. Y.

**HANZO**—Connect at once with this big time repeat order seller. Staple, used by millions. Free Sample. Hanzo Company, 765 Waveland, Chicago.

**AGENTS**—100 packages spearmint chewing gum, \$2.50 postpaid. Andrew L. White, Mail Order Merchant, R. 1, Holliday, Mo.

**\$16 A DAY** Easy—I start you in auto accessory business; no investment; no experience necessary. Landin, 3433 Montrose Ave., Chicago.

**QUICK** way to make money—every furnace owner a prospect. Write for agency in your city. Home Equipment Co., 1011 Cleveland Ave., South Bend, Ind.

**McDONALD** Polishing Cloth. Cleans gold, silver, nickel. Pays 50c on \$1.00. Full size cloth and terms, 15c silver. Daniel McDonald, 18 Agawam St., Lowell, Mass.

**DISTRICT** Agents: For union made hand tailored all wool suits and topcoats at \$23.50. Prefer married man. \$35.00 weekly to start. Apply W. O. Harvey, Mgr., Box 90, Chicago.

**MAKE** money silvering mirrors, refinishing auto headlights, tableware, metal plating, bedsteads, chandeliers. Outfits furnished. International Laboratories, Dept. 71, 309 5th Ave., New York.

**AGENTS'** Own Brand Soaps and Bug Killers. Columbia Laboratories, 18 Columbia Heights, Brooklyn, N. Y.

**FREE**: Large Wholesale Specialty Catalog, showing latest sellers from all parts of world. A. Lucas Co., 731 East 15th St., Minneapolis, Minn.

**FOR** Christmas. Our Luminous Crucifix shines in the dark and makes a wonderful Christmas present. Our agents always clean up with this Crucifix at this time. W. G. Hannan Co., Dept. B, 2539 S. State St., Chicago.

**GENUINE** Gold Leaf Letters anyone can put on Store windows. Guaranteed to never tarnish. Large Profits. Enormous Demand. Free Samples. Write today. Metallic Letter Co., 438-D North Clark, Chicago.

**"LIQUID-LEATHER"** Fills Holes in Shoes, Rubbers, Tires. Dries Instantly. Pliable, Waterproof. Just Imported from France. Tube Retail 75c—Cost 35c. Sells Housewives. Sub-Agents. Nullife Leather, Hartford, Conn.

**DIFFERENT** Oil Burner sells for \$35. Does the work of \$300 outfit. Flame control adapts it to store or furnace use. Greatest opportunity for agents in years. Big profit. Write for literature. Home Economy Burners, Inc., 312 Marcellus St., Syracuse, N. Y.

**AGENTS**: 100% profit selling our low-priced beautiful and attractive Felt Rugs. Easiest and surest way of doubling your money. Perfect color combinations win instant admiration and insure quick sales. Excellent opportunity to build substantial business. Eastern Mills, Everett, Mass.

**AGENTS**—Demonstrators—To sell the Chrisman Ejector Fork—The latest in kitchen utensils—Sample 50c. The Chrisman Manufacturing Co., 301 Anthel Bldg., Covington, Ky.

**AGENTS**—To sell Catholics—Wonderful Proposition. United Religious Goods Co., 201 United Bldg., Covington, Ky.

**\$50.00 WEEKLY**, pleasant work, applying gold initials on automobiles. \$1.45 profit every \$1.50 job. Experience unnecessary. Free samples. Ralco Monograms, 1043 Washington, Boston, Mass.

**NO Dull Times** Selling Food. People must eat. Federal distributors make big money; \$3,000 yearly and up. No capital or experience needed; guaranteed sales; unsold goods may be returned. We furnish you with sample case, license and Free Samples for customers—Sure repeat orders. Exclusive territory. Ask now! Federal Pure Food Co., A2307 Archer, Chicago.

**GOLD** Sign Letters. \$9.75 for Thousand. Non-Tarnishable. Free sample. Catalogue. Atlas Sign Works, 438 Broadway, Denver, Colo.

**MAKE \$20** daily selling merchants \$1.00 changeable letter display signs. 75c profit every sale. Maze Manufacturing Co., Norwood Station, Chicago.

**BIG** Profits. Sell "No-Splash" 4-Strainer Water Filters. Fast sales, lowest prices; send for 6 dozen, \$1.80 postpaid. Jones Mfg. Co., 243E2 Franklin St., Boston, Mass.

**LAST** Call! Fall in. Here's a Money Maker! Supreme Shirts give 100% satisfaction. Proposition, Kit Free. Supreme Shirt Co., 276-M Fifth Ave., New York.

**SELL** men's neckwear; wonderful proposition. Astor, 318-M Broadway, New York.

**WE** Pay \$50 a Week and Expenses and give Ford Auto to men to introduce poultry and stock compounds. Imperial Co., D-23, Parsons, Kans.

**MANUFACTURE** Very Latest, Biggest-selling Advertised Specialties yourself—No Machinery; investment small—All lines. Stamp brings Valuable Interesting Literature explaining how others sell your products and big bunch lists Guaranteed Formulas. 300 to 1,200% profit to you. Reliable Information Only. No "Master Formula" trash. Miller, Chemist, 1706-V Jetton, Tampa, Fla.

**"AGENTS"** Big Money Selling New Household Cleaning Set. Washes and dries windows. Sweeps, scrubs, mops. All complete only \$2.95. Over half profit. Write Harper Brush Works, 132 Third St., Fairfield, Iowa.

**AUTO** owner tire agent wanted each locality to use and take orders for hand-made Mellinger cord and balloon tires; guarantee bond 15,000 miles; shipped prepaid on approval; get your tires free; no capital or experience required; make \$100 to \$300 weekly. Write for wholesale prices and sample kit. Address Mellinger Tire Co., Dept. 400, Kansas City, Mo., or Dept. 400, Philadelphia, Pa., or Dept. 400, Oakland, Calif.

**AGENTS \$1**. Retail \$3. Your Profit \$2. Wonderful pocket Adding Machine with Magic Writing Pad. Particulars Free. Typewriter Supply, 905 Hersh Bldg., Pittsburgh, Pa.

**AGENTS**—N-R-G Laundry Tablets, the old reliable moneymaker for live agents. Millions sold—200% profit—sales waiting for you. Clothes washed spotlessly clean in 10 minutes without rubbing. Free samples. N-R-G Company, 230 W. Superior, Chicago.

**CALIFORNIA** Roseheads selling like hot cakes. Agents coining money; new stuff. Big profits. Catalog free. Mission Factory P.M. 2228 West Pico, Los Angeles, Calif.

**A BUSINESS** of Your Own—Making Sparkling Glass Name and Number Plates, Checkerboards, Signs. Big Book and Sample Free. E. Palmer, 512 Wooster, Ohio.

**AGENTS**—New Plan, makes it easy to earn \$50.00 to \$100.00 weekly, selling shirts direct to wearer. No capital or experience needed. Represent a real manufacturer. Write now for Free Samples. Madison Company, 566 Broadway, New York.

**GET** Our Free Sample Case—Toilet articles, perfumes and specialties. Wonderfully profitable. La Derma Co., Dept. A, St. Louis, Mo.

**AGENTS**: It's a winner. Combined cigarette and match case. Black grain finish leatherette. Holds Package cigarettes and box matches. Sells on sight. Big profits. Write for details. All-in-One, Dept. A-1, 2810 Portland, Minneapolis, Minn.

**AGENTS** wanted—To sell Ray-O-Lite cigar and gas lighters. Big earnings. Sample 50c. Rapid Mfg. Co., 799-E Broadway, New York.

**OVER 100% Profit**. Self Lighting Gas and Cigar Lighters; Everybody interested, repeat business. Sell individuals, dealers, subagents. Particulars Free. P. Bernhardt, 127 West 30th St., New York.

**MILLIONS** stolen. Remarkable new \$5.00 Check Protector stops forgery. Inks, protects two colors. Sensational sales, profits. Write. Safety Devices Corp., Grand Rapids, Mich.

**AGENTS—Clever Invention!** Inkspoon makes every pen a fountain pen. Fast office seller; big profit, demand increasing everywhere. Exclusive territory offered. Sample free. H. Marul Company, Tribune Bldg., New York, N. Y.

**REMNANT Store, Bethel, Ohio.** Greatest Dry Goods Bargains on Earth. Agents and Dealers.

**WILLIAMS' No-Water Hand Soap.** In tubes, has taken Auto owners by storm; washes dirtiest hands perfectly clean without water; easy demonstration makes quick sale. 150% profit. Williams Co., Dept. 265 Montclair, N. J.

**\$320 PROFIT First Three Days' Sales** for Zindel, Illinois, with Morey Quick Action Auto Rim Tool. Profit \$2 tool. Exclusive territory for hustling agents. Earn \$10 to \$50 cash daily, \$75 to \$300 weekly year round. M. Morey Rim Tool, Blissfield, Mich.

**SELF Threading Needles** find sales in every home. Fine side line; big profits; easily carried. Sample free. Prentice-Lee, 145 East 23rd St., New York.

**\$60-\$200 A WEEK.** Genuine Gold Letters for store windows. Easily applied. Free samples. Liberal offer to general agents. Metallic Letter Co., 438-B North Clark, Chicago.

**WANTED: Local and State Representatives** for famous ready made Artistic Signs, price tickets, etc. No competition. Full protection. Large profits. For particulars write Artistic Signs, 799R Broadway, New York.

**BIG Money and Fast Sales.** Every owner buys Gold Initials for his auto. You charge \$1.50; make \$1.35. Ten orders a day easy. Write for particulars and free samples. American Monogram Co., Dept. 40, East Orange, N. J.

**AGENTS: 500% profit.** "Happy Home Make Shampoo" builds your own big business. Martin of Indiana made \$75.00 in one day. Missouri man made \$750.00 one month. Exclusive territory. Geo. A. Schmidt & Co., Dept. P, 236 W. North Ave., Chicago.

**PERFUMED Beads** from California. Fast Sellers. No Competition. License unnecessary. Big margin. Hire subs. Clean up. Mission, 519PM, 2328w. Pico, Los Angeles, Calif.

**MOCCASIN Manufacturer Wants Agents** Everywhere to sell a complete line of moccasins to wearers. Entire new line. No competition, repeat orders. Get details. Daley Moccasin Co., Fort Covington, N. Y.

**WE Start You Without a Dollar.** Soaps, Extracts, Perfumes, Toilet Goods. Experience unnecessary. Carnation Co., Dept. 2480, St. Louis.

**AGENTS—Make a dollar an hour.** Sell Mendets, a patent patch for instantly mending leaks in all utensils. Sample package free. Collette Mfg. Co., Dept. 404, Amsterdam, N. Y.

**GOLD Leaf Window Letters and Script Signs.** No experience; 500% profit. Samples free. Consolidated, 69U—West Van Buren, Chicago.

**AGENTS—Send for Free Sample "Fret-not" Washday Wonder.** Big Profit. You don't have to talk; if she doesn't buy at sight, leave sample. Exclusive territory. Credit given. Empire Specialties Co., 1549 N. Wells, Dept. 101, Chicago.

**AGENTS make \$100 week** placing advertising Cigar Lighters with glass front. Every dealer wants one. Write for free plan. Drake Mfg. Co., Dept. M, Milwaukee, Wis.

**AGENTS—Sell 5c fast selling candy specialties to stores.** Big profits. Lorrac Products Co., Albany, N. Y.

**MANUFACTURER** lamb wool polishers, dusters. Newhall, 358 Broad St., Lynn, Mass.

**SELL by mail! Big Profits!** Books, Formulas, Novelties, Bargains. Particulars Free. Elfco, 523 South Dearborn Street, Chicago.

**AGENTS make \$3.00 an hour** taking orders for our 40 Fascinating Kitchen Specialties. No competition. Write Quick. General Products Co., Dept. 7-K, Newark, N. J.

**AGENTS—Here's a New One.** "Best-ever Powdered Hand Soap." Sells like wildfire. Marvelous Discovery. Removes grease, paint, ink, oil, in fact anything from the hands. Cannot harm skin. 150% Profit. Great Repeater. Agents simply coin money. "Free Samples Get the Business." Write immediately. Bestever Products Co., 1937 E. Irving Park, Chicago.

**AGENTS—Steady Income.** Large manufacturer of handkerchiefs and dress goods, etc., wishes representative in each locality. Factory to consumer. Big profits, honest goods. Credit given. Send for particulars. Freeport Mfg. Co., 59 Main St., Brooklyn, N. Y.

**POLMET—The Wonderful Polishing Cloth** that cleans all metals without liquid, paste or powder. Approved by "Good Housekeeping" and "Modern Priscilla"—sells fast at 25c. Sample free. Gale & Co., Inc., 15 Edinboro St., Boston.

**AGENTS—Stamping names on Pocket Key Protectors;** sample Check with your name and address, 25c. Stamping Outfits, Emblem Checks, Check Fobs, Name Plates. Hart Mfg. Co., Desk 2, 303 Degraw St., Brooklyn, N. Y.

**MAN in each town** to plate auto parts, reflectors, bathroom fixtures, refinish beds, mirrors, chandeliers; by new method. No capital or experience required. Simple plan of manufacturing at home starts you in big money-making business. Outfit furnished. Free particulars and proofs. Gun Metal Co., Ave. H, Decatur, Ill.

**INSTANT Weld.** Repairs largest punctures without cement or heat. Lenn's profit one day, \$56. Write quick. Free sample; territory going fast. Tourists' Pride Mfg. Co., Desk T, Minneapolis, Minn.

**YOU Can Make Good Durable Paint and Varnish** 40c per gallon. Write Dept. 2 Emmelmann Bros. Mfg. Co., Indianapolis, Ind.

**REPLATE** brassy worn-off Automobile parts, Reflectors, Bath Room Fixtures, Worn Spoons, Forks, etc., with pure silver. Looks like new. Use U-Kan-Plate Polish. Positively no mercury. \$1.00 half pints. Post Paid. Satisfaction Guaranteed. Agents wanted. Dept. A, U-Kan-Plate Co., Philadelphia.

**AUTOMOBILE Specialties.** Guaranteed formulas for all latest money makers. Lowest prices. Write for free lists. Murphy, Chemist, Tujunga, Calif.

**AGENTS, both sexes,** we manufacture and control new household article. Fast seller. Big profits. Exclusive territory. Write now. Connolly, 123 Liberty St., New York.

**AGENTS: Big Money Monogramming by Transfer method.** Catalog Showing Over 50 Styles and Particulars Free. Motorists' Accessories Co., Mansfield, Ohio.

**FREE Sample.** "Rain Shield Wiper." Retail \$1.00—Cost (25 cents). Sold Clear and Rainy Days. No Cloth—No Paste—No Attachment. (1) Rub keeps windshield clear 48 hours. Experience Unnecessary. NuLife Corporation, Hartford, Conn.

**EARN \$10 daily** silvering mirrors, plating and refinishing metalware, autos, chandeliers, bedsteads, headlights. Outfits furnished. E. Decie Laboratories, 1133 Broadway, New York.

### HIGH-GRADE SALESMEN WANTED

**\$100 PER week—Just Show It and Collect.** "Sure-Hold," the screw-driver with fingers that hold the screw and start it where human fingers cannot reach. Positively Sells on Sight. Every mechanic is waiting to buy. Millions Will Be Sold. Made in 3 sizes (to handle any screw or bolt). Sell for \$1.00, \$1.10 and \$1.25 each or \$3.35 per set. To Agents only. Upon receipt of \$2.35 (money order or currency) we will send you sample set by parcel post, prepaid, with agents' confidential price list and full particulars, showing you how to make \$100 Per Week. If you prefer, send 50 cents postage and pay postman \$2.00 upon receipt of sample set. Money Back Guarantee. If you are not delighted with our proposition return the "Sure-Holds" and we will immediately return your money. You take no risk. Biggest Money Maker Today. No Competition. We Guarantee the Sale. Automobile Free. Be First. Sure-Hold Screw Driver Company, Jefferson and Third, Desk X, Seattle, Wash.

**METAL Signs** Sell to every business man and manufacturer in your territory. New illustrated handbook just off press makes expert knowledge and heavy samples unnecessary. A novice can earn \$40-\$50 per week to start. This 64-page pocket-size book illustrates in eleven colors, completely describes and prices every kind of metal sign. Protected territory. Liberal commissions paid promptly. Give references. Stout Sign Company, 2555 Sullivan Ave., St. Louis, Mo.

**TAILORING Salesmen—many men** in your town pay \$10 to \$15 more than our wholesale prices for the same woolsens, workmanship and high-grade, perfect fitting, tailored-to-measure suits and overcoats—all these are live prospects. Complete selling outfit free. 200 choice patterns—all wool, six prices, \$18.50 to \$45.50. Positive 8-day service. Substantial commissions. "Immediate" bonus and special prizes. Protected territory. Free advertising. Experience unnecessary. Our sales manual tells you "how." Write us all about yourself, giving two business references for quick action. Wholesale Direct Tailors, Dept. 1209, 83-89 Ellicott St., Buffalo, N. Y.

**WANTED—Tailoring Salesmen,** make \$60 to \$125 per week. We are the largest made-to-measure tailoring house in the country, furnishing elaborate sample equipment. Over 150 all wool fabrics sell at \$23.50, \$29.50, \$34.50 and \$43.50 which includes commissions of \$3.50 to \$8.50 and bonus. Guaranteed absolute satisfaction, perfect fit, best workmanship, or no sale. We maintain an absolute 6-day delivery schedule. Write for our line and all accessories to be sent free. Tell us all about yourself. Edward E. Strauss & Co., Inc., Dept. 101, 402 So. Market St., Chicago.

**WONDERFUL Opportunity** for reliable man as representative of \$4,000,000.00 firm showing nationally advertised line of staple merchandise to business men. Basic necessity—steady repeater. Underselling competition 30%—Earnings start big, grow larger. Our men earn \$50.00, \$100.00 and more weekly—full or spare time. No experience needed. A few exclusive territories are open. Write for full information—Free. J. B. Simpson, Dept. 1272, 843 Adams St., Chicago.

**\$30.00 A DAY** Guaranteed to Workers taking orders for Goodwear tailored-to-measure clothes at sensational new low price. Tremendous assortment Virgin Wool fabrics. Biggest cash commissions paid daily and special cash bonus besides, makes ours best-paying line in America. \$25.00 Sales Outfit Free. Exclusive Territory. Write at once to Dept. 703, Goodwear Chicago, Inc., 844 West Adams, Chicago.

**SALESMEN—Are You Making Enough Money?** Let us show you how to make Big Profits with Jiffy Washing Tablets. No experience required. Write for Free Sample and Plans. Jiffy Soap Products Co., Dept. A, Dayton, Ohio.

**SALESMEN—Become Independent.** Own Your business, experience unnecessary selling our \$7,500.00 Accidental Death; \$50 Accident; \$25 Sick Weekly Benefits—\$12.50 Yearly. Other Amounts proportionate. Guaranteed steady income from renewals. \$250,000 Deposited Insurance Department. Universal Policy, Dept. A, 30 Clinton St., Newark, N. J.

**MAGIC Moving Window Salesman.** It's Real changeable letter system has actually boosted users' sales 200% to 400%. None but dead dealers indifferent. If you can spot a winner, get the facts and begin pocketing \$100 weekly. Display Products Company, P. O. Box A5123, Gateway Station, Kansas City, Mo.

**MAKE \$100 Weekly** in spare time. Sell what the public wants—long distance radio receiving sets. Two sales weekly pays \$100 profit. No big investment, no canvassing. Sharpe of Colorado made \$955 in one month. Representatives wanted at once. This plan is sweeping the country—write today before your county is gone. Ozarka, Inc., 431 N. LaSalle Ave., M. Chicago.

**MR. BRUSH Salesmen—Old Established** New York Brush Manufacturers require services of men in all territories to sell their extensive line of Sanitary Twisted In Wire Brushes. We pay larger commission than any other Brush House in the country. Write immediately for our proposition. Wire Grip Sanitary Brush Corporation, 15 Mercer Street, New York.

**FOR Sideline and Specialty men** our big line of duplicating salesbooks is a wonderful, consistent, repeating money-maker. Used by every line of business. Commissions every two weeks. Kansas City Sales Book Co., 915 Wyandotte, Kansas City, Mo.

**WE have a line of goods** for which every man in America is a prospect. It has everything any competing line has and something besides. It can be handled profitably by tailoring, shirt, hosiery, necktie, shoe, raincoat and other salesmen now selling to men. For full facts address Salesmanager, 850 West Adams, Dept. 4, Chicago.

**SALESMEN**—Now calling on drug, stationery, jewelry department stores as well as premium users to handle a nationally advertised product in universal demand; liberal straight commission basis; ideal side line. Pocket size samples. Write Inkograph Corporation, 191-81 Center Street, New York, N. Y.

**MEN**—Sell dependable shrubbery, fruit trees, etc. Steady demand. Complete co-operation. Commissions paid weekly. Write Perry Nurseries, Dept. R-1, Rochester, N. Y.

**SALESMAN**: Manufacturer of established line guaranteed tools offers profitable connection to men with mechanical and some sales ability; part time men considered; two average sales daily net \$50.00 weekly; advance against commission. Write for free catalogue and money-making plan. J. G. Woods, Inc., 37 West 20th St., New York, N. Y.

**SALESMEN**—hard workers make real money selling our line. No special experience needed. Great demand. Repeat sales build permanent business. A. Main, Box 382, Cedar Rapids, Iowa.

**TRAVELING Salesmen** Calling on Retail Stores wanted by large manufacturer of fast-selling specialties entirely different from the average. Year-round sales, main or sideline. Big commission paid immediately on original and repeat business. Opportunity for well paid and permanent connection with old-established firm. If not making \$150 weekly, write today. Union Specialty Works, Dept. 222, Boonville, N. Y.

**TOOL Salesmen**—Mechanics—Distribute line auto repair tools. Start exclusive business of your own. 71 Samples in case 60¢ off. Quality Tools Corporation, New Wilmington, Pa.

**SURE Seller** to every merchant—no gamble—big profits—steady repeater—free sample and exclusive territory. Embossed Show Card Co., 9474 Euclid, Cleveland, Ohio.

**FREE Adding Machine** to "Live-Wires" accepting our Dollar-a-Minute Agency. Improved 2-lb. Calculator. Adds, Subtracts, Multiplies, Divides. Work equals \$300.00 machines. Retail \$15.00. Big demand; large profits. Write quick for protected territory. Lightning Calculator Co., Dept. E, Grand Rapids, Mich.

**SALESMEN**—average \$60.00 week selling No-Draft Ventilators to closed car owners. No competition. No-Draft Ventilator Co., Trenton Junction, N. J.

**REPRESENTATIVE** for established trade and soliciting new accounts. Nationally advertised line of essential water and labor-saving equipment, to Industrial Plants, Railroads, Public and Private Garages. Permanent connection to competent man. Gaylord Manufacturing Co., Paterson, N. J.

**RAPID Coin Handler**, and Advertiser combined. A \$4.00 Business Booster. Buy from factory. Canadian Patent for Sale. Bernards Stereopticon Co., El Paso, Texas.

**SALESMAN**: If you want \$6000 this year write us now. Strong line for retail stores. Nationally advertised. Established Company. Liberal weekly advance to producer. Geo. B. Williams, Mgr., 1300 Liberty Bldg., Euclid Ave., Cleveland.

**GOLD Leaf Window Letters** and Script Signs. No experience; 500% profit. Samples Free. Consolidated, 69-V, West Van Buren, Chicago.

**OFFICE specialty salesmen** wanted. Exclusive agencies. Dibb Manufacturing Company, Minneapolis.

**SALESMEN** to sell our Console Radio Advertising deal. Sells at \$85.00. Commission \$20.00. Salesmen now making \$120.00 to \$200.00 per week. The Knight-Tilden Mfg. Company, Greeley, Colo.

**TAKE orders** for coffee, sugar, flour, meats, canned goods, staple groceries also paints, radio sets, tires, auto and tractor oils. No capital or bond required. We deliver and collect. Permanent business. Big pay. Write at once. Hitchcock-Hill Co., Dept. 50, Chicago.

**\$60-\$200 A WEEK**. Genuine Gold Letters for store windows. Easily applied. Free samples. Liberal offer to general agents. Metallic Letter Co., 438-A North Clark, Chicago.

**CALIFORNIA** Rosebuds selling like hot cakes. Agents coinng money. Absolutely new. Big profits. Catalog free. Mission Factory SP, 2328 West Pico, Los Angeles, Calif.

**FOUR \$7.50 sales** to merchants net you \$20.00 daily. Sayers Systems, 2803 Sheffield Ave., Chicago, Ill.

**CALENDAR salesmen**: Our line is the only one that covers entire field. Calendars—Fans—Signs—Pencils—Blotters—Aluminum—Wood—Celluloid. Remembrance advertising for every merchant. Full or part time. Dept. 226, Model Calendar Co., South Bend, Ind.

**ANY Salesmen Can Sell Them!** Merchants everywhere use punchboards. Someone sells them, why not you? Collect big commissions daily. Newest, largest, elaborate catalog sent upon request. Lincoln Sales Co., 9 So. Clinton, Chicago, Dept. D.

**75¢ PROFIT** on \$1.00 sale. Auto furniture and glass cleaner. Your name on label. Exclusive rights—free sample. Mfg.-E, 213 Griswold, Detroit, Mich.

### HELP WANTED

**YOU Are Wanted**. Men—Women 18 up. Get U. S. Government Life Jobs. \$95.00 to \$250.00 Month. Steady work. Paid summer vacation. Pull or experience unnecessary. Common education sufficient. We coach you without leaving home. 32 page book with full particulars Free. Write immediately. Franklin Institute, Dept. E3, Rochester, N. Y.

**WOULD you risk** a 1c postal against the chance to make \$5 to \$15 daily during the next four months with an absolutely new line of Insured Hosiery, guaranteed 12 months. Your pay daily. Monthly bonus extra. Magnificent sample outfit furnished. If so, send name and address now to Maccochnee Textile Company, Road 2601, Cincinnati, Ohio.

**MEN** wanting to prepare for forest ranger or railway mail clerk examinations Write Mokane, A-23, Denver, Colo.

**GOVERNMENT** positions pay \$35 to \$75 weekly. We help you get them. Big List Free. Write, Mr. Ozment, 101, St. Louis, Mo.

**BOYS—Men, 16 Up**. Learn Auto Engineering. Big opportunity. Earn \$35-\$75 week. Experience unnecessary. Learn at home while earning. Sample lessons free. Write immediately. Franklin Institute, Dept. E-400, Rochester, N. Y.

**MEN**, prepare for permanent Forest Ranger Job; \$125-\$200 mo. and home furnished; fish, trap, hunt; experience unnecessary. For details, write Norton, 226 McMann, Denver, Colo.

**CASH paid** for butterflies, insects. See Sinclair Display Advertisement on Page 18.

**\$112 TO \$225 Month**. Men 18-45. Railway Postal Clerks, City Carriers, Post-office Clerks. Steady. 25 coached free. Write immediately. Franklin Institute, Dept. E-16, Rochester, N. Y.

**EARN \$10 daily** silvering mirrors, plating and refinishing metalware, auto, chandeliers, bedsteads, headlamps. Outfits furnished. E. Decie Laboratories, 1133 Broadway, New York.

**MEN Wanted**—prepare as firemen, brakemen, colored train or sleeping car porters, wire for application blank; experience unnecessary; first class roads, no strike. Name position wanted. Railway Institute, Dept. 35, Indianapolis, Ind.

**YOU Are Wanted**. Government Jobs. \$95-\$250 month. Steady. Sample coaching—free. Write today sure. Franklin Institute, Dept. E-16, Rochester, N. Y.

**DON'T** prepare for any Civil Service Examination without seeing our catalogue. Free. Columbian Correspondence College, Washington, D. C.

**BECOME** a Landscape Architect. Uncrowded profession of wonderful opportunity for money-making. Easily mastered by mail. Earn while you learn. Write for book. American Landscape School, 56-E, Newark, N. Y.

**\$158 MONTH**. Men 18 up. Railway Postal Clerks. 25 coached free. Write immediately. Franklin Institute, Dept. E-16, Rochester, N. Y.

**U. S. GOVERNMENT** wants men. \$1,700—\$1,900 and up at start. Railway Mail clerk examination coming. Let our expert (former Government examiner) prepare you for this and also Rural Carrier, Post Office, Customs, Internal Revenue, and other branches. Write today for free booklet. Dept. 8, Patterson Civil Service School, Rochester, N. Y.

**WE Start You in Business**, furnishing everything. Men and women, opportunity to earn \$35 to \$100 weekly operating Ragsdale's original "New System Specialty Candy Factories" anywhere; wholesale or retail. Big commercial candy book free. W. Hillier Ragsdale, Drawer 350, East Orange, N. J.

**MAKE money** silvering mirrors, refinishing auto headlamps, tableware, metal plating, bedsteads, chandeliers. Outfits furnished. International Laboratories, Dept. 71, 309 5th Ave., New York.

**MEN** to train for locomotive firemen on railroads nearest their homes—everywhere; beginners \$150-\$250 monthly; promoted, locomotive engineer, \$3,000-\$4,000 yearly. Best paying positions on railroads. Railway Association, Desk M1, Brooklyn, N. Y.

**\$158 MONTH**. Railway Postal Clerks. 25 coached free. Write immediately. Franklin Institute, Dept. E-16, Rochester, N. Y.

**MIRRORS** Resilvered at Home. Costs less 5 cents per square foot; you charge 75 cents. Immense profits plating auto-parts, reflectors, tableware, stoves, refinishing metalware, etc. Outfits furnished. Details free. Write Sprinkle, Plater, 287, Marion, Ind.

**SILVERING Mirrors**, French Plate. Easily learned; immense profits. Plans free. Wear Mirror Works, Excelsior Springs, Mo.

### BUSINESS SERVICE

**WHOLESALEERS**, Attention! We have the traveling representative you want; let us save you time, trouble, expense and worry; confidential, efficient, gratuitous service. J. M. Dresser, Grand Secretary, United Commercial Travelers, Metropolitan Bank Bldg., St. Paul, Minn.

**FLORIDA Charters**—24 hour service. Representation—Office Space—Resident Agents—Audits—Investigation—Mortgage Loans Placed. Florida names—\$2 per M. Brown, 307 Bisbee Bldg., Jacksonville.

**BOSTON, Mass.**, Address, \$2.00 Monthly. M. Bucknam, 63 Court.

**CAPITAL Seekers**: Gathering Funds, Limited edition. Free booklet. Act. Dickinson Co., 29 South LaSalle St., Chicago, Ill.

### TYPEWRITERS AND SUPPLIES

**TYPEWRITERS**, all standard makes, thoroughly re-manufactured by the famous "Young Process" and shipped direct from factory to you on 10 days' trial. Guaranteed 5 years. Easy monthly payments. Write today for free catalog. Young Typewriter Company, Dept. 5751, 654 W. Randolph St., Chicago.

**UNDERWOOD** Typewriters—only \$3.00 down. Easy monthly payments. Low prices at less than manufacturers. 10 days' free trial. Rebuilt, all worn parts replaced. Just like a new machine. 5-year guarantee. Write for a big free catalogue B-151. Shipman-Ward Mfg. Co., 1511 Shipman Bldg., Chicago, Ill.

**TYPEWRITERS**—All makes; real values; guaranteed. Typewriter Bargain House, Ada, Okla.

**TYPEWRITERS**, all standard makes. \$10 up. Fully guaranteed. Free trial. Write for complete illustrated lists. Northwestern Typewriter Exchange, 121 N. Francisco Ave., Chicago.

### PRINTING, ENGRAVING AND MULTIGRAPHING

**BUSINESS Cards**, \$3 per 1,000. P. A. Laffin, Coshocton, Ohio.

**MULTIGRAPHING**—Printing—Mimeographing. (Bargain offer.) Foster, 4342 North Robey, Chicago.

**PRINTING Special**: 250 Letterheads and 250 Envelopes, \$2.65, prepaid. J. Rodgers Hoggard, Windsor, N. C.

**EMBOSS** your Stationery with Hand Embosser. Circular free. Midwest, Box 47, Springfield, Ill.

**CIRCULARS**—1,000, 3 1/2 x 6 1/2, \$2; 2,000, \$3. 300 words. Drexton, Box 1051, Fargo, N. D.

**BEAUTIFUL** Printing—Stationery, circulars, typewriter letters, etc. Lowest prices on two-color work and long runs. Send copy for free estimate. Pitts, Amana, Iowa.

**PACKAGE** and Mailing Labels (gummed). Rubber Stamps. Desirable lists free. McPherson Popular Print, Middletown, Conn.

**ENVELOPES**, 100 50c; 250 \$1.00; 1,000 \$3.00. Prepaid. Bargain List 3c. Model Company, Manchester, Iowa.

**PRINTING**, Large or small orders shipped quickly in our new shop. "Q" Shop, Roaring Spring, Penna.

**"NEARGRAVURE"** Process—250 Each—Letterheads, Envelopes, Cards, \$4.44 Postpaid. Soliday's, Knox, Ind.

**MULTIGRAPHED** letters, 500, \$2.00, bond paper, Excel Service, 135 Liberty St., New York.

ACME Printing Company, Milwaukee, Wis. Prints—promptly, accurately, reasonably—Send inquiries—No obligations.

250 BOND Letterheads, Envelopes, Billheads, Cards, \$1.35 Each. Economic Press, Leonia, N. J.

LETTERHEADS low as \$1.50—1000. Prices on other printing free. Big-Six, Box 316-B, Scranton, Penn.

SUPERIOR quality printing; attractive samples free. Kay Press, 546 Thurston, Rochester, N. Y.

AGENTS—Dealers: Superfine stationery, \$1.00 thousand. Read also "Distribute," under Miscellaneous.

25,000 LOTS 3 1/2 x 6 Folders, \$40.00; 5 1/2 x 8 1/2 Circulars, \$31.00; Envelope Slips, \$17.00. All Printing Low Prices. Samples Free. Good's Printery, Harrisonburg, Va.

150 BOND letterheads and 150 envelopes printed \$1.50. Lehman Sales Company, Box 249, Duluth, Minn.

5,000 WATERMARKED Bond Letter Heads \$10.00. Other printing reasonable. Samples on request. Harlem Press, 132 W. 26th St., New York.

GUMMED Labels, with name, Business and address, 500—30c; 1,000—50c. P. Wetzel, Valhalla, N. Y.

DISTINCTIVE—Artistic Business Stationery that Creates Confidence. 1,000 Letterheads or Envelopes \$3.00. Samples. Moulton Printing Company, 1410-P East 8th, Kansas City, Mo.

MULTIGRAPH typewriting business correspondence, two dollars thousand. Hammermill Bond Letterheads, four dollars. Mayera Corporation, Monmouth, Ill.

WE print Stationery, Booklets, Catalogs, Circulars. Samples. Commercial Press, Batavia, Ohio.

PERSONAL Stationery: 100 Envelopes and 200 Sheets exquisite bond paper, each with your name and address, \$1.00 Postpaid. Brookside Press, 146 Mt. Joy Place, New Rochelle, N. Y.

1,000 LETTERHEADS or Envelopes, \$3.00. Sent Prepaid. Samples Free. Monitor Press, Morrisville, Pa.

QUALITY Printing! Reasonable Prices! Send for Free Standardized samples and prices. Folders, Circulars. Catalogs our specialty. Ernest Fantus, 525 South Dearborn, Chicago.

YOUR Name and Business address imprinted on Pencils; most resultful advertising. Samples free. Direct-prompt service. (No agents.) S. Musial & Co., 10-12 Lincoln St., Yonkers, New York.

#### PRINTING, OUTFITS AND SUPPLIES

PRINT your own cards, stationery, circulars, paper, etc. Complete outfits, \$8.85; Job Presses, \$11, \$29; Rotary, \$149. Print for others, big profit. All easy, rules sent. Write for catalog presses, type, paper, etc. Kelsey Company, F-11, Meriden, Conn.

PRINTING Outfits. Presses, type, supplies. 4c stamps for information. Wm. E. Nicholas, M-36 Clifton Ave., Everett, Mass.

PRE-USED Printing Presses, Type supplies. List for 2c stamp. Popular Bargains, Richland, Pa.

PRINTING Outfits—Presses, type supplies, type novelties. Send stamp for catalogue. Model Press, York, Penna.

#### DUPLICATORS AND DEVICES

PORTABLE "Stencil-Duplicator," 8x11 \$7. Copies like \$150 mimeograph. F. Gerwin, Dale, Okla.

YOU can make 50 to 100 copies of a letter, notice, etc., at a cost of three cents on a Heyer Quality Duplicator. Write for free trial offer. The Heyer Duplicator Co., 14 S. Wells St., Chicago, Ill.

#### ADDING MACHINES

NEW \$3.50 Automatic Adding Machine. Adds, Subtracts, Multiplies. Absolutely accurate. Capacity \$999,999.99. Fully guaranteed. 75,000 pleased users. Makes adding easy, positive, quick. Eliminates Mistakes. Saves Time. Postpaid \$3.50. Bassett Co., 1458 D Hollywood Ave., Chicago.

FREE trial. Marvelous Calculator, Adds, Subtracts, Multiplies, Divides automatically. Work equals \$300.00 machines. Five year guarantee. Price only \$15.00. Write today for free trial offer. Special: \$3.00 Pocket Calculator, only \$2.00 cash. Lightning Calculator Co., Dept. E, Grand Rapids, Mich.

#### MAILING LISTS

TYPED list—over 6,000 ladies purchased during last 60 days from coupon \$1.60 toilet product—\$3.00 thousand. Dr. Case, Laboratories, Holton, Kans.

1,000, 1926 MAIL names \$4. Circulars mailed. Atlantic Business Bureau, 9416a 115th St., Richmond Hill, N. Y.

1,000 NAMES, \$1.00. Mention Classification. Wineholt Sales Co., 4, Woodbine, Penna.

#### FOR SMOKERS

SEND \$1.25 Box finest quality mild cigarettes. Ideal gift. Sample package 10c silver or stamps. Pocket tin Special Pipe Tobacco 10c. Direct-to-Smoker. French Tobacco Co., Dept. P, Statesville, N. C.

TOBACCO: Kentucky Sweet Leaf. Mel-low with age. Fine flavor. Smoking, 15 lb. \$1.50. Chewing, \$2.25. Pay when received. Ernest Choate, Wingo, Ky.

#### FOR MEN

WEALTH and success are not accidents. Definite, inexorable psychological laws govern them absolutely. To succeed, one must follow them. There is no other way. Get our free booklet—"Why Most Men Fail." Mack Institute, Wabash Sta., PM-4, Pittsburgh, Pa.

AUTOMOBILE—Make your own motor car, toy size, operated with motorcycle engine. Any boy can make it. Costs little aside from engine. Full directions with drawings and dimensions in The Boy Mechanic, Book 3. Send No Money. Pay postman postage and \$2. Popular Mechanics Press, Room 901, 200 E. Ontario St., Chicago, Ill.

OUTDOOR Opportunities. Instructions for raising and selling rabbits, guinea pigs, milch goats, silver foxes, ferrets, white rats, white mice, dogs, cats, pigeons, pheasants, bantams, canaries, bees, frogs, mushrooms, ginseng, and golden seal. All profitable on town lot. Send No Money. Simply write a postal and say: "Send me Outdoor Opportunities." Pay postman \$1.50 and postal charges. Popular Mechanics Press, Room 901, 200 East Ontario St., Chicago, Ill.

#### BOATS AND LAUNCHES

SPECIAL. Clipper Ship materials \$5.00. Hull readycut. Other models. Roy Hancock, 323 Douglas Ave., Portsmouth, Va.

BOAT Building Plans for amateurs. Rowing, sailing, speed, cruising. Free catalog. Rudder Publishing Company, 9 Murray Street, New York.

SHIP Model Book—containing authentic plans of "Benj. Packard," with full-sized proper patterns, \$4.00. Rudder Publishing Company, 9 Murray St., New York.

NEW Boat Book telling how to make 21 kinds of boats. Also many other helpful ideas on boating. Profusely illustrated. With this we include the big book, "Outdoor Sports the Year Round." Directions for making all sorts of devices for outdoor recreation. Send no money. Simply pay the postman \$1.98 plus postage when books are delivered. Popular Mechanics Press, Room 901, Popular Mechanics Building, Chicago, Ill.

BUILD your own boat for this season's use using Brooks Knock-Down parts or patterns. 55 Models, 9' to 40'; send 25c for complete catalog. Brooks Boat Co., Inc., Rust Ave., Saginaw West Side, Mich.

REVERSE gears, propellers, and other equipment bought, sold, exchanged. Wm. H. Baker, Pond St., Quincy, Mass.

SHIP Models—Worth-while—Easy to make. Decorative ships, Picturesque Barbary Pirate Felucca and Beautiful Spanish Treasure Galleon (both 17th century). Instructions so simplified that any handy person can make these models with a few household tools almost without expense. No personal knowledge of ships or naval architecture required. New book only one of its kind. Pay postman \$2.50 plus postage when book is delivered. Popular Mechanics Press, Room 901, 200 East Ontario St., Chicago, Ill.

#### RAZORS AND BLADES

GIVEN away, a "Gillette Razor" to each purchaser of five genuine imported Swedish charcoal alloy steel blades. These blades are in a class by itself. Price 60c, no stamps. C. O. Olson, Grandy, Minn.

FREE Genuine Gillette razor with each \$1 order of 20 double-edged blades. Midwest Supply, Box 475, Nevada, Iowa.

RAZORS—German Made—Imported—A \$3 razor for \$1.10. Blade 3/8 inch hollow ground hand forged from finest German Razor steel, beautiful embossed handles, a real man's razor and every one guaranteed. Each in case for Christmas remaining. Shipped Prepaid for \$1.10. Two for \$2. German strop dressing, applied to strop gives razor blades keenest edge, makes old blades like new, new blades last indefinitely, straight razors never need honing. A 50c package sent for 30 cents. Free—One 50c package strop dressing with each order for razor. Send check, currency or money order. Novelty Advertising Co., Box 352, Nevada, Iowa.

#### FOR THE HOME

MEN! Women! Earn \$1 an Hour at Home, Weaving Colonial Rugs, genuine fluff rugs, fancy fabrics, from new and other materials. Home weavers always busy. You learn in 30 minutes. We guarantee it. Looms now at reduced prices. Liberal Pay-As-You-Weave terms. Solve Your more-money problem by writing for Free Loom Book today. Union Loom Works, 480 Factory St., Booneville, N. Y.

GRANDFATHER'S Clock Works, \$5.00. Build your own case; Instructions free; make good profits selling your friends. Clock works with chimes for old or new cases. Write for full particulars. Clock Co., Ruffner St., Philadelphia.

REFRIGERATING Machine, Homemade. Operates successfully. Gives better service than ice. This and 328 other practical articles in our book "Home Mechanics." Just ask for this and "Handbook for Women" containing 394 valuable household helps and pay postman 98 cents and postage for the two books. Popular Mechanics Press, Room 901, 200 East Ontario St., Chicago, Ill.

SHIP Models, by Capt. E. A. McCann. Instructions and full-scale drawings for making models of Pirate Felucca and Spanish Galleon. 150 pages—only book of its kind. \$2.60 postpaid. Sea Arts Guild, 405W 11th Ave., Milwaukee, Wis.

ETIQUETTE. 378 pages of clear type covers all subjects. Send No Money. Just write a postal asking for "Etiquette. An Encyclopedia of Good Manners and Social Usage." Pay the postman \$1.25 and postal charges. Popular Mechanics Press, Room 901, 200 East Ontario St., Chicago, Ill.

LARGE Fresh Hickory Nuts and Black Walnuts, 25 lbs., \$1.25; 60 lbs., \$2.25; 100 lbs., \$4.00. F. O. B. Eldson Nut Farm, Washburn, Mo.

FOODS from Twenty Lands. Popular Mechanics new Cook Book made up of recipes sent by our readers from 20 countries. Many delightful foreign dishes, and many American ones, too. Only a few copies for sale. Send No Money. Just order on a postal. When postman hands you book, pay \$1.50 and postal charges. Popular Mechanics Press, Room 901, 200 East Ontario St., Chicago, Ill.

FURNITURE. Make Furniture at Home. Popular Mechanics books tell how to make all pieces. "Mission Furniture and How to Make It, Book 1, Book 2, Book 3." Send No Money. Just write a postal. Pay postman postage and \$3. Popular Mechanics Press, Room 901, 200 E. Ontario St. Chicago, Ill.

#### DIAMONDS, WATCHES AND JEWELRY

TRADE your old watch on new Elgin or Waltham. Small difference. Ralph Pile, Somerset, Penna.

#### WATCH REPAIRING

ALL makes of Watches repaired by experts. Write International Watch Service, Box 5P, Fordham Station, New York.

#### ANTIQUES, WAR RELICS AND INDIAN GOODS

GENUINE Sioux Indian Costumes and Beadwork. Buying direct from Indian, our prices are reasonable. Write for price list. Lyon Curio Store, Clinton, Nebr.

FOR Dens. Relics and medals from Europe's Battlefields. Illustrated catalogue, 25c. International, 1889 Albany Avenue, Brooklyn, N. Y.

FLINTLOCK pistols, rifles, swords, Indian relics. Lists free. Collectors Exchange, 1536 Willington, Philadelphia.

#### PHONOGRAPHS AND RECORDS

BUILD your own phonograph. We furnish everything. Catalog sent free. American Phonograph Co., 4116 West 24th Place, Chicago.

**MUSIC AND MUSICAL INSTRUMENTS**

**PLAY** in 5 lessons like an expert. The Dolceana Guitar, sweeter than Violin. We teach anyone to play by note. By correspondence. Write Orpheus Music School, 147 East 23rd Street, New York.

**SONG Poem Writers**—My proposition satisfies. It is different. Richard Broughton, Sioux Falls, S. D.

**SONG Poem Writers**—Address Ray Hibeler, D. I., 2104 N. Keystone Av., Chicago.

**SONGWRITERS**: Send poems for free criticism marketing. Lee Turner, Suite 1237, 5417 12th Avenue, Brooklyn, N. Y.

**PIANO Jazz**: Teaches Ear Piano Playing, Negro Harmony, all styles of bass, novelty effects, etc. Circulars Free. "Piano Bill," 207-A, Ossington, Toronto, Canada.

**I BUY, Sell, Publish Songs**. Chester Escher, 455 Wayne St., Jersey City, N. J.

**VIOLINS**—Genuine handmade masterpieces. Get Details. John Lehto, 935 14th, San Pedro, Calif.

**REAL Jazz Piano lessons**. Latest Hits, taught quickly at home. Booklet and Sample Lesson Free. Address Studio, 7 United Schools of Popular Music, P. O. Box 1959, Boston, Mass.

**DOLLARS** to Cornetists—Trombonists! High notes, attack, tonguing made easier. Full instruction \$1.00. Paul D. Placide, 628 East 29th St., Baltimore, Md.

**LEARN Tenor Banjo Playing**. Little method. Complete instructors (3 books) \$1.00. Quincke, 430 So. Broadway, Los Angeles, Calif.

**SHARPS and Flats**—Free. Very interesting. Send for it Today. Harry L. Alford, 192 No. State St., Chicago, Ill.

**VIOLINS**. Deep, Mellow, Soulful—on credit. Easy terms for wonderful instrument. Get details today. Gustav F. Henning, 2424 Gaylord St., Denver, Colo.

"MUSIC Composed" to words. Bauer Bros., (formerly of Sousa's Band), Oshkosh, Wis.

**WRITE Songs**. Big money and reputation. Write for information. J. Gordon Pub. Co., 201 N. Hoyne Ave., Chicago.

**I WANT Song Poems**. Casper Nathan, 3544 N. Racine, Chicago.

**SONG Poem Writers**—Stamp brings "Song Writers' Guide." Wm. Van Beaver, R1-1239 Elm St., Green Bay, Wis.

**CORNETISTS**—Trombonists—Saxophonists—Clarinetists. Get "Free Pointers." Name instrument. Virtuosi School, Buffalo, N. Y.

**PATENT ATTORNEYS**

**PATENTS**. Time counts in applying for patents. Don't risk delay in protecting your ideas. Send sketch or model for instruction or write for Free book "How to Obtain a Patent" and "Record of Invention" form. No charge for information on how to proceed. Communications strictly confidential. Prompt, careful, efficient service. Clarence A. O'Brien, Registered Patent Attorney, Security Bank Building (directly across street from Patent Office), Washington, D. C. See pages 138 and 139.

**PERCY S. WEBSTER**, 203 Saving and Loan Building, Stockton, California. Long established organization. Patent booklet free.

**PATENTS**, Trade Marks, Copyright procured. Very easy terms. H. Sanders, Registered Patent Attorney, 7 Rand McNally Building, Chicago.

**PATENT** and Trade Mark Lawyers, Mason, Fenwick & Lawrence, Washington, D. C. Established sixty-five years. Best references. Other offices, New York and Chicago. Write us.

**PATENTS** Procured. Prompt Service. Personal, careful and efficient service. Highest references. Moderate fees. Send sketch or model for actual search and advice. Gorge P. Kimmel, Master of Patent Law, 54C Legal Bldg., Washington, D. C.

**LACEY'S Patent Sense**. Valuable book free. See ad page 144.

**PATENTS**—Write for our Guide Books and "Record of Invention Blank" before disclosing inventions. Send model or sketch of your invention for Free Inspection and Instructions. Terms Reasonable. See advertisements on pages 140 and 141. Victor J. Evans & Co., 934 Ninth, Washington, D. C.

If you have a sound commercial invention to sell, send us particulars promptly. American Patents Corporation, Barrister Building, Washington, D. C.

**PATENTS**. Trade marks, copyrights. Prompt, personal, reliable service. Over 36 years' active practice. Write for terms. Book free. Address E. G. Siggers, N. U. Bldg., 918 F Street, Washington, D. C.

**PATENTS**. Booklet free. Highest references. Best results. Promptness assured. Send model or drawing for preliminary examination. Watson E. Coleman, Patent Lawyer, 724 Ninth St., Washington, D. C.

**INVENTORS**—My Book Inventor's Manual, telling what every inventor should know, sent free upon request. Hartwell Balcom, Registered Patent Lawyer, Barrister Building, Washington, D. C.

WE assist selling patent when obtained through us. Patents Bureau, Times Bldg., St. Louis, Mo.

**PATENTS**—Send for form "Evidence of Conception" to be signed and witnessed. Form, fee schedule, information free. Lancaster and Allwine, Registered Patent Attorneys in United States and Canada, 221-Ourray Bldg., Washington, D. C.

"INVENTOR'S Advisor," the valuable Patent book with 139 mechanical movements and illustrations, sent free upon request. M.M. Labiner, Patent Attorney, 3 Parkrow, New York.

**INVENTORS**—Write for our Guide Book, "How to Get Your Patent" and Evidence of Invention Blank. Send model or sketch of your invention for our prompt examination and instructions free. Randolph & Co., Dept. 430, Washington, D. C.

**PATENTS**, Trade-Marks, Designs. This firm has 27 years' experience and gives expert personal service at reasonable rates. We properly protect your invention. Write for free information and exact cost of procuring patent before proceeding. John B. Thomas & Co., 902 F St., N. W., Washington, D. C.

**PATENTS** Procured: Trade Marks Registered—A comprehensive, experienced, prompt service for the protection and development of your ideas. Preliminary advice gladly furnished without charge. Booklet of information and form for disclosing idea free on request. Richard B. Owen, 30-Owen Bldg., Washington, D. C., or 41-R Park Row, New York.

"INVENTORS' Guide" sent free on request: this book contains illustrations of patented inventions and gives valuable information and advice for all who have original ideas or improvements. Frank Ledermann, Registered Attorney and Engineer, Woolworth Bldg., 1712, New York.

**UNPATENTED Ideas Can Be Sold**. I tell you how and help you make the sale. Free particulars (Copyrighted). Write W. T. Greene, 807 Jenifer Building, Washington, D. C.

**INVENTORS**: Send sketch or model for advice and exact cost of patent. Ask for our Free book: "How to Obtain a Patent." Tells what every inventor should know. Established twenty-eight years. Highest references. Prompt service. Reasonable charges. Chandlee & Chandlee, 474 Seventh, Washington, D. C.

**MILLIONS** spent annually for ideas! Hundreds now wanted! Patent yours and profit! Write today for free book—tells how to protect yourself, how to invent, ideas wanted, how we help you sell, etc. American Industries, Inc., 500-Victor Bldg., Washington, D. C.

**INVENTORS** having ideas to patent: Write for Booklet explaining Co-operative Plan for handling your applications. Tells how to sell and safeguard your inventions at lowest cost. Ralph Burch, Patent Lawyer, Jenifer Bldg., Washington, D. C.

**MONROE E. MILLER**, Ouray Bldg., Washington, D. C. Patent Lawyer; Mechanical, Electrical Expert. Booklet and Priority Record blank gratis.

**RICHARD E. BABCOCK**, Patent Lawyer, Washington Loan & Trust Bldg., Washington, D. C. Booklet.

**ESTABLISHED 1864**. Milo D. Stevens Company. Free Booklet, Patents, Trade-Marks, Copyrights. Offices, Monadnock Block, Chicago; Barrister Building, Washington, D. C.

**FOR INVENTORS**

**RELIABLE** information on Patents and Patent Sales, \$1.00. Sales Campaigns Planned. Patent Drawings and Photolithographic Enlargements. C. J. Williams, Pacific Building, San Francisco.

**PATENTS** Procured: Trade Marks Registered—A comprehensive, experienced, prompt service for the protection and development of your ideas. Preliminary advice gladly furnished without charge. Booklet of information and form for disclosing idea free on request. Richard B. Owen, 30-Owen Bldg., Washington, D. C., or 41-R Park Row, New York.

**PATENTS**. If you have an invention which you wish to patent you can write fully and freely to Munn & Co., for advice in regard to the best way of obtaining protection. Please send sketches, or a model of your invention and a description of the device, explaining its operation. All communications are strictly confidential. Our Hand-Book on Patents is sent free on request. This explains our methods, terms, etc., in regard to Patents, Trade Marks, Foreign Patents, etc. "Scientific American" contains Patent Office Notes, Decisions of interest to inventors and particulars of recently patented inventions. Munn & Company, Solicitors of Patents, 1523 Scientific American Building, 24 W. 40th St., New York City; 524 Scientific American Bldg., Washington, D. C.; 1313 Tower Bldg., Chicago, Ill.; 666 Hobart Bldg., San Francisco, Calif.; 521 Van Nuys Bldg., Los Angeles, Calif.

**BEFORE** you spend a lot of money for patents or development, let the Cowles Service advise whether your idea will be profitable. From our confidential service—backed by 40 years of both technical and business experience with inventions—you can get an unbiased, unprejudiced viewpoint on the paying possibilities of your inventions. For information, write Cowles Advisory Service for Inventors and Patentees, Mid City Branch, P. O. Box 2010, Philadelphia, Pa.

If you have a practical, useful invention to sell, send us particulars promptly. American Patents Corporation, Barrister Building, Washington, D. C.

**PATENTS** wanted by manufacturers. Send description. Box 126, Dowagiac, Mich.

**INVENTORS** Universal Educator—contains 900 mechanical movements; 50 perpetual motions. Tells how to obtain and sell patents. Suggests new ideas. Explains how to select your attorney and avoid patent sharks. Special Price, \$1.00 postpaid. Albert E. Dieterich, 621 Ouray Bldg., Washington, D. C.

**ANSWERS** to mathematical problems of office, store, shop, bank, farm, or factory. Explains and simplifies every principle of arithmetic, mechanics and mensuration. Over 2,000,000 sold. Send No Money. Just ask for "Ropp's Calculator." Pay postman \$1.00 and postage. Popular Mechanics Press, 200 E. Ontario St., Room 901, Chicago, Ill.

**PATENTED** Inventions financed. Describe your invention. Write immediately. Floyd Clymer, Desk "F," Denver, Colo.

**WANTED**—Partner to pay Patent Fee on valuable inventions; half interest. Write N. H. Lopus, 712 West Main St., New Iberia, La.

**LACEY'S Patent Sense**. Valuable book free. See ad page 144.

**INVENTORS**—Write for our Guide Books and "Record of Invention Blank" before disclosing inventions. Send model or sketch of your inventions for our free inspection and instructions. Terms reasonable. See advertisements on pages 140 and 141. Victor J. Evans & Co., 157 Ninth, Washington, D. C.

**PATENTS**. Time counts in applying for patents. Don't risk delay in protecting your ideas. Send sketch or model for instructions or write for Free book "How to Obtain a Patent" and "Record of Invention" form. No charge for information on how to proceed. Communications strictly confidential. Prompt, careful, efficient service. Clarence A. O'Brien, Registered Patent Attorney, Security Bank Building (directly across street from Patent Office), Washington, D. C. See pages 138 and 139.

**I SELL Patents**: 25 years' exclusive experience, valuable to you if you have a patent to sell. Charles A. Scott, 773-PM Garson Ave., Rochester, N. Y.

**WANTED**—Specialty to sell agents. Auto or Ford preferred. Box 546, South Bend, Ind.

**INVENTIONS**—Developed to Practical Basis. Non-infringing devices designed. Basic claims suggested. A. Papini, Leonia, N. J.

**SHOP Notes** for 1927. Get your copy now. Only a limited edition. Contains all the articles published in the Shop Notes department of Popular Mechanics Magazine during 1926. Send No Money. Just write a postal and we'll send 1927 Shop Notes and any one of the other following numbers: 1908, 1912, 1913, 1914, 1915, 1916, 1917, 1919, 1920, 1921, 1922, 1923, 1924, 1925, 1926. Pay postman 98 cents and the postage when he hands you the two books. Popular Mechanics Press, 200 E. Ontario St., Room 901, Chicago, Ill.

**ATTENTION:** Sell your ideas yourself. Manufacturers list, any article, \$1.00. Clarence Knol, 1018 Watkins St., S. E., Grand Rapids, Mich.

**REDESIGNING,** Selling and Promoting Patents, High grade Model making and Drafting service at reasonable rates. All our work is strictly confidential and guaranteed. L. C. Johnson Engineering Works, 3405 North Clark St., Chicago, Ill.

**PATENTS Wanted—**We buy and sell practical patents. Big opportunity, undeveloped field. Describe briefly. M. Okamura, Box 1290, Honolulu, Hawaii.

**UNPATENTED Ideas Can Be Sold.** I tell you how and help you make the sale. Free particulars (Copyrighted). Write W. T. Greene, 806 Jenifer Building, Washington, D. C.

**I AM in touch with hundreds of moneyed men and manufacturers who wish to buy good inventions.** Write Hartley, 38 Court St., Bangor, Me.

**MAIL copy of patent or description of invention.** Central Sales Agency, Independence, Mo.

**GET your own patents.** Legal blanks, complete instructions \$1. Cutting Sons, Campbell, Calif.

**INVENTORS Universal Educator—**contains 900 mechanical movements; 50 perpetual motions. Tells how to obtain and sell patents. Suggests new ideas. Explains how to select your attorney and avoid patent sharks. Price (revised edition) \$1.50 postpaid. Albert E. Dieterich, 621-Ouray Bldg., Washington, D. C.

#### PATENTS FOR SALE

**NOTE the Mileage and coolness in the running of Motors,** when equipped with improvements of Patent 1,527,861. C. L. Gintz, Lockport, N. Y.

**OUTRIGHT,** Patent No. 1,594,274 sewing machine oil guard, reasonable to quick buyer. Murray Smith, 8 Bakers Ct., East Rutherford, N. J.

**SLIDE Saxophone.** Slide player for harmonica. All metal chromatic harmonica. Aquatic novelties manipulated by chemicals, Aeroplane, parachute jumper and Zeppelin. F. C. Bender, 306 Wilson Ave., Brooklyn, N. Y.

**OUTRIGHT,** adjustable plant support. No. 1,549,274. H. E. Lewis, New Milford, Conn.

**PATENT pending for five articles in one;** a necessity in every home, barber shops, and many other trades; nothing like it on market. Royalty or Outright. M. Kaplan, 187 Washington Pl., Passaic, N. J.

**FOR Sale—Automobile double inner tube—**reasonable. U. S. patent 1,574,611, and Canadian. A. Dembek, 277 Pennsylvania Ave., Brooklyn, N. Y.

**CAN-OPENER,** Sealer and Dispenser; Cash or Royalty. Illustrated in December Issue. Albert Fonaas, Vancouver Barracks, Wash.

**ATTENTION, Mfrs.:** Outright or royalty. Gas Atomizer for all Autos; 3 to 10 more miles guaranteed. Hundreds of satisfied users. Market for millions. Price Atomizer Co., Baraboo, Wis.

**ABSOLUTELY the best screen Door Fly Trap** ever invented for sale outright or royalty. Joseph Weber, Lone Rock, Wis.

**OUTRIGHT:** The only real automatic car coupling patent on earth which will positively save life and property. Called Type P. Coupler. A. A. Moss, 53 Wallace St., Newark, N. J.

**OUTRIGHT—Royalty;** theft lock for Ford car; locks car in high gear. No. 1,597,629. L. L. Slonaker, 3361 McGraw Ave., Detroit, Mich.

**PATENTED** keyhole cover lock. Want to sell outright or royalty. Tadakuma, 1445 Cahuenga, Hollywood, Calif.

**DANDY Camp Patent.** On market. Sells well. Earl Sanders, Pawnee, Ill.

**THE Sovereign Wind Concentrator** is the cheapest power on earth. Patent for sale. Address L. G. Sovereign, Rt. 2, Milford, Nebr.

**ROYALTY Basis—Tonic Dispensing Comb.** Hollow handle container—Graduated feed—Leak proof. Used detached or with wall tank. W. B. Evans, Hotel Victory, Pittsburg, Calif.

**FOR Sale—2 patents with merit;** one is Man-power Flying Machine; Money getter. Herrick, Rosenath, Battle Creek, Mich.

**WHY let your patents lie idle?** Tell our two million five hundred thousand readers about it! The majority of our readers are especially interested in new ideas and inventions. Ask me to tell you how other inventors successfully sold their patents. M. L. Rund, Mgr., Classified Advertising, Popular Mechanics Magazine, Chicago.

#### ENGINEERING

**ENGINEERING Data:** Pocket loose-leaf Transformers, and distribution diagrams. Send for circular. C. Homan, 193 Berkeley Place, Brooklyn, N. Y.

**SHORTCUTS** in figures. The quickest ways of working all problems. Instructions for drilling yourself to become rapid with figures. Complete, yet simplicity itself. Send No Money. Just write a postal for "Shortcuts in Figures." Pay postman \$1.25 and postage. Popular Mechanics Press, Room 901, 200 East Ontario Street, Chicago, Ill.

#### SURVEYING INSTRUMENTS

**LARGEST stock of new and used surveying instruments** in the country direct from factory. Satisfaction guaranteed or money refunded. Wissler, 619 N. Broadway, St.

#### MODELS AND MODEL SUPPLIES

**PATENTS.** Time counts in applying for patents. Don't risk delay in protecting your ideas. Send sketch or model for instruction or write for Free book "How to Obtain a Patent" and "Record of Invention" form. No charge for information on how to proceed. Communications strictly confidential. Prompt, careful, efficient service. Clarence A. O'Brien, Registered Patent Attorney, Security Bank Building (directly across street from Patent Office), Washington, D. C. See pages 138 and 139.

**MODEL Steam Engines, Boilers and Model Pipe line fittings.** Model Making Supplies. Send 20c for this year's illustrated catalogue and hand book. Bathe Mfg. Co., Dept. D, 5214 Woodland Ave., Philadelphia.

**EXPERT model, instrument and tool work.** Specialties manufactured and packed ready for market. Lowest prices. Swanberg, 5124 N. Kildare Ave., Chicago.

**INVENTORS,** we build high-grade demonstration models. Write us. Nortwood Model Machine Shop, Ethan, S. Dak.

**MODEL steam engines and boilers.** Boat and boiler fittings. Send 10c stamp for catalog. Refunded with first order. Model Machine Shop, P. O. Box 5, Station Y, New York City.

**MODELS, Experimental Work, Light Manufacturing, and Stamping.** Frostholm Bros., Syracuse, N. Y.

**BLUEPRINTS—60 different Models,** steam, gasoline engines, small boilers. List for stamps. United Engineering Works, 620 Monadnock Bldg., Chicago.

**SPECIAL machine builders, tool and die makers, inventor's models,** production work of all kinds. Dept. L, Quality Hardware & Machine Co., Ravenswood and Thorndale Avenues, Chicago, Ill.

**PATTERNS and Models made.** Light Manufacturing. H. W. Hathorn, Mason City, Iowa.

**MODELS, Tools and Dies, and General Manufacturing,** new invention, our specialty. Logan Machine & Manufacturing Co., 126 S. Clinton St., Chicago, Ill.

**HULIT & Co., General Model Makers,** 625 W. Jackson, Chicago, Ill. Specializing in high-grade model work on inventions of merit. Complete Equipment, Experienced Workmen.

**WE make working models for inventors and do experimental work and carry a complete stock of brass gears and model supplies.** Send for catalogue. The Pierce Model Works, Tinley Park, Ill.

**LET our experience be your guide.** Models that are models; Tools and equipment for economic manfg. Patterns of all types; manufacturing in all branches. Satisfaction guaranteed. United Machinery Company, Cincinnati, U. S. A.

#### FOR MECHANICS

**"BLUEPRINT Reading"** is a compact book telling how to read Machine blueprints. Send No Money. Just pay postman postal charges and \$1. Popular Mechanics Press, Room 901, 200 E. Ontario St., Chicago, Ill.

**KINKS on Metal Work.** 419 discoveries for anyone who works with metal. For mechanic, machinist, or the man who tinkers at home. 287 illustrations. Send No Money. Just write a postal asking for "Machinist's Kinks." When postman hands you book, pay postage and price of book, \$1.50. Popular Mechanics Press, Room 901, 200 E. Ontario St., Chicago, Ill.

#### MANUFACTURING

**WELDED sheet metal products** made to order. Transformer cases, Water, oil and pressure tanks, steam jacketed cookers agitated. Circular P. Austin Welding Works, 551-5 W. Quincy St., Chicago, Ill.

**SPECIAL Machinery or parts, dies, tools, metal specialties, models, special gears, stock gears and model supplies.** Send for Catalogue. The Pierce Model Works, Tinley Park, Ill.

**PUNCH Press Job.** Multiple Spacer for mechanics, shipbuilders, boiler makers, draftsmen, etc. Manufacturers wanted. Patented. F. S. Thompson, 836 S. Lincoln, Springfield, Ill.

**OUR factory will make your models,** manufacture your articles as well as build your tools, dies and fixtures. Standard Die & Specialty Co., 1932 Austin Ave., Chicago, Ill.

**PATTERNS, wood and metal.** Models, tools and dies. Brass, bronze, aluminum and iron castings. Screw machine work, production work of all kinds. Write Modern Machine & Pattern Co., Terre Haute, Ind.

**MANUFACTURING Models, Dies, Stampings, Brass Work, one or thousands.** Baum's Metal Specialties, Kansas City, Mo.

**WOOD articles manufacture.** Model supplies; patterns, lumber, mouldings, tools. The Woodcraft, 105 West, 100 Street, New York.

**WIRE goods made to order.** Cooley Mfg. Co., 530 N. Western Ave., Chicago.

**MINIATURE Die—Casting Machines** \$50.00. 318 Reed St., Erie, Pa.

**IDEAS for those who like to tinker with tools, and for professional carpenters.** 40 articles on saws and sawing, 17 on benches and bench equipment, 22 on doors and door hanging, 18 on lumber, 13 on mitering, 74 on tools, 22 on shop equipment, and many others—366 in all, and 229 illustrations. Send No Money. Just write a postal. Pay postman postage and \$1.50. Popular Mechanics Press, Room 901, 200 E. Ontario St., Chicago, Ill.

#### MACHINERY, TOOLS AND SUPPLIES

**DRILLS Sharpened with our Multifax Drill Sharpener.** Send a dozen drills. We return them Sharpened C.O.D. Send for price list.  $\frac{1}{8}$ , 5c;  $\frac{1}{4}$ , 15c. Multifax Manufacturing Co., 182 Wacker Drive, Chicago.

**KEENEDGE and Universal Skate Grinding Holders** have no equal for sharpening skates, \$3.50 and \$5.00 each. Will grind all makes of skates and save time in sharpening Tubes and Hockey skates. Ferodowill Mfg. Co., West Indiana Ave., St. Paul, Minn.

**CONCRETE Building Block Machines and Molds.** Catalogue free. Concrete Machine Co., 5 N. Main St., St. Louis, Mo.

**OTHERS have successfully sold their machinery through our columns—so can you.** Ask me for proof. M. L. Rund, Manager, Classified Advertising, Popular Mechanics Magazine, Chicago.

#### ELECTRICAL

**BURGLAR Alarm Supplies.** Complete alarm outfits for stores, banks, poultry houses and residences. We build relays, large gongs, and furnish instructions. Midnight Alarm Systems, 3218 Cambridge Street, Toledo, Ohio.

**ELECTRICAL Kinks on all phases of practical electricity.** 47 ideas on wiring, 45 on making electrical devices, 19 on lighting, 5 on transformers, 5 on motors, 8 on generators, 11 on switches, 22 on testing, 12 on repairing, 11 on battery manufacture and repair, 5 on telephones, and 9 on electricians' tools. 214 articles. 162 pictures. Send no money. Just write postal for "Electrical Kinks." Pay postman postage, and \$1.50. Popular Mechanics Press, Room 901, 200 E. Ontario St., Chicago, Ill.

**ELECTROPLATING.** New printing of popular book by H. C. Reetz. Complete instructions for plating with all kinds of metals. Send no money. Just write a postal asking for "Electroplating." Pay postman the postage and \$1.00. Popular Mechanics Press, Room 901, 200 East Ontario St., Chicago, Ill.

## ENGINES, MOTORS AND DYNAMOS

NEW Wonder Electric Drilling-Buffing-Grinding Outfit, complete with  $\frac{1}{4}$  H.P. A.C. motor. Introductory Offer \$12.45. New  $\frac{1}{2}$  H.P. 32 volt Farm Plant motors \$17.50. New  $\frac{3}{4}$  H.P. 110 volt A.C. Wash Machine Motors \$7.75. Greatly reduced prices on  $\frac{1}{2}$  and 1 H.P. single phase Motors. Send remittance with order. Satisfaction Guaranteed. Acme Tool Co., 627 West Washington, Chicago.

USED 5KW, 250 light generator, complete. Excellent condition, same as new; very reasonably priced. Ira C. Helmick, Troy, Ohio.

HERE is your opportunity to obtain grinders and buffers, brand new; they are full  $\frac{1}{4}$  H.P., 110 volt, AC, 60 cycle, with cord and plug, with 6" emery wheel on one side and 6" buffer on the other, enclosed dust proof motor. We only have a limited number left at \$15.75 each. Cash with order. Brand new  $\frac{1}{4}$  H.P., 110 volt, AC, 60 cycle, motors with pulley at \$10.00 each. Immediate shipment. General Distributing Co., Security Storage & Van Co., Duluth, Minn.

MOTORS—New GE 110 or 220 volt 60 cycle Single Phase  $\frac{1}{4}$  HP. \$11.90;  $\frac{1}{2}$  HP. \$28.50; 1 HP. \$38.50. Mail \$3 check or money order. We will ship COD anywhere. Motor Specialties Co., Crafton, Penna.

FOR Sale—Complete equipment for charging "A" and "B" batteries and manufacturing "B" storage batteries. Bargain price—under \$200.00. The Mazda Radio Mfg. Co., 35th and Perkins Ave., Cleveland, Ohio.

GOVERNORS for Auto Engines. Let us show you how to make a power plant for the shop or farm. A. C-S Governor Co., 215 W. Manchester, Los Angeles, or Springfield, N. Y.

STEAM Engines, one H.P., \$18.00.  $\frac{1}{2}$  H.P., \$12.00. James Chambliss, Bessemer, Ala.

MARINE engines for all purposes, both two and four cycle. Cady Engine Company, Canastota, N. Y.

ALTERNATING current motor bargains, single and three phase. All sizes, all kinds, both new and rebuilt. Send for new price list. Guaranteed makes only. General Electric, Wagner, Westinghouse, Century. Motors bought, repaired exchanged. Hyre Electric Co., 615 H.Z. So. Dearborn St., Chicago.

$\frac{1}{4}$ -HORSE alternating and direct current used motors, \$8.50. Groove pulleys, 30c Flat, 45c.  $\frac{1}{4}$  Horse, 32 V., 8,000 speed motors.  $\frac{1}{4}$  Horse, 3,000 speed, 110 V., direct current, \$3.75 each. Also other bargains. Queen City Electric Co., 1736 Grand Ave., Chicago, Ill.

DO you want an electric lighting plant on your farm, with your gasoline engine and one of our 1,000 Watt, 32 volt, Westinghouse generators? You can have electric lights in your house, barns, etc., at a very low cost. Run your washing machine, cream separators, etc. The cost of the above generators are \$18.00 each. Write for bargain catalog on engine driven lighting plants. General Distributing Co., Security Storage Bldg., Duluth, Minn.

DIESEL Engines—Marine, Locomotive, Stationary. Growing importance of the Diesel Engine cannot be overestimated. This new book should be in the hands of every student of mechanical engineering, 500 pages, 280 illus. Pay postman \$5 and postage when he delivers book. Popular Mechanics Press, Room 901, 200 E. Ontario St., Chicago.

## BLACKSMITHS

BLACKSMITHS. Make More Money in Job Shop or Factory Doing Hard Jobs Easy. Be a Master Machine and Plow Blacksmith and Expert Tool Dresser and Tempering to a Standard with Collard Tempering Charts. All for One Dollar. Samples Free. W. M. Toy, Sidney, Ohio.

REPAIRS about home easily made with instructions in our new book. Tells exactly how to use tools, sharpen tools and cutlery, repair furniture and cabinets, upholster, work metal, solder, work glass, paint, stain, varnish, hang paper, repair plumbing, repair furnace, repair electrical equipment, repair shoes, repair harness, repair gloves, repair concrete work. Send No Money. Just write a postal and ask for "The Practical Book of Home Repairs." When postman hands you the book, pay him \$2.50 and the postal charges. Popular Mechanics Press, Room 901, 200 East Ontario St., Chicago, Ill.

## BENDING MACHINES

THE famous Hossfeld Wrenchless Universal Bender is the last word in bending machines; bends metal, cold or hot, into most any conceivable shape, including Eye-bolts and Automobile Spring Eyes. Bends up to 1" bars or  $\frac{1}{4}$ " Pipe cold. Used by the largest corporations, yet so inexpensive that even a farm shop need not be without one. Send for Circular. Hossfeld Mfg. Co., Box 344, Winona, Minn.

## FOR SALE—MISCELLANEOUS

ADDRESSOGRAPHS. Letter Folders, Multigraphs, Envelope Sealers, Duplicators, less than half price. Guaranteed. Pruitt Co., 117 No. Market, Chicago.

MOUNTED Wolfskin Rugs. Open Mouth's \$17 each. Satisfaction guaranteed. Strange's Taxidermy Shop, Clarkston, Wash.

HOW to Make and How to Mend. 1,000 articles telling how to repair almost everything in use or needed about a home or farm. Many illustrations, formulas and trade secrets. Especially for amateur mechanics. Send no money. Just ask for "How to Make and How to Mend." Pay postman postal charges and \$1.00. Popular Mechanics Press, Room 901, 200 East Ontario St., Chicago, Ill.

EAT Valencia Peanuts. Excellent, mild, sweet flavor. Ideal for roasting, candy-making, etc., 10 lbs., \$1.25 collect. Rodgers Hogard, Windsor, N. C.

BUY—Exchange—Sell! Many of our readers have for sale or exchange the article you are looking for—and lots of them are looking for the very items you want to turn into cash. Get together! Let our two million five hundred thousand readers know your wishes—they'll help you! Send your ad today to M. L. Rund, Manager Classified Advertising, Popular Mechanics Magazine, Chicago.

GEORGIA Pecans, large paper shell, ideal Xmas gift, 5 lbs., \$3.00 prepaid. Sise Company, Watervliet, N. Y.

MAKE a Telescope; Join ranks of enthusiastic group of amateur astronomers. Fascinating subject treated in new book, only one published in America. "Amateur Telescope Making." Pay postman \$2 and few cents postage on delivery. Popular Mechanics Press, Room 901, 200 E. Ontario St., Chicago, Ill.

## WANTED—MISCELLANEOUS

MAIL us your discarded Jewelry, Gold, Crowns and Bridges, Watches, Diamonds, Silver, Platinum, and old False Teeth. Money promptly mailed. Goods returned if offer refused. United States Smelting Works, (The Old Reliable), Dept. 71, Chicago.

MINERAL Specimens Wanted. Quartz crystals, beautiful mineral formations, polished agate, petrified wood, etc., for collection. Full particulars, prices, etc. H. Vibert, Bound Brook, N. J.

## REAL ESTATE, FARM AND ORCHARD LANDS

50 ACRES and \$4,000 Worth Wood Only \$1,700; \$600 Worth Stock, 4 Cattle, Machinery, etc.; near RR town, high school, markets; spring water, beautiful river view from cozy dwelling, good barn, poultry house. Only \$1,700, part cash. Details pg. 25 big illus. Catalog. Free. Strout Agency, 255-P, 4th Ave., New York City.

ATTENTION—"Get acquainted." Cash for your property. Farm, Hotel or Retail Store, no matter where located; confidential service. Hayes' Business Agency, Cincinnati, Ohio.

OZARKS—10 acres near White River and proposed power dam, \$100, \$5 monthly. Alvin Zimmerman, 1802 N. 5th, Kansas City, Kans.

HERE'S your land. \$10 down and \$10 a month buys twenty acres of my best land near lakes and towns in central Michigan for \$400, or ten acres for \$250. Write at once for free picture book. G. W. Swigart, P-1276 First Natl. Bank Bldg., Chicago.

CASH Paid through Bank or Express for nearby New York, Brooklyn, Long Island, New Jersey lots. Send description and price. Reference any New York Bank. Horace Stripe, Builder, 18 West 34th, New York.

POULTRY Land—\$5 down, \$5 monthly, buys 40 acres Southern Mo. Price, \$200. Send for list. Box 22-N, Kirkwood, Mo.

OREGON Homesteads (late opening) and lands offer exceptional opportunities. Map and details \$1.00. Frank Thompson, Sheridan, Oreg.

SELL your property quickly for cash, no matter where located. Don't pay big commission. Particulars free. Real Estate Salesmen Co., Desk B, Lincoln, Nebr.

PECAN-Orange-Fig Groves "On the Gulf" Monthly payments. Guaranteed care. Big, quick returns. Suburban Orchards, Dept. M, Biloxi, Miss.

## POULTRY

No. 1 LOW Booking Terms; Super-Test accredited chicks. All kinds. Our low prices and good service get the orders. Three color catalog free. Missouri State Hatchery, Dept. 711, Butler, Mo.

KEEP Chickens? Tell us the breed and how many and we'll send you free a copy of the most interesting poultry journal ever published. Poultry Item, Box 71, Sellersville, Pa.

## ROOTS AND HERBS

HERB Doctor Book, 10c. Contains over 250 valuable herb medicine recipes for home use. Shawnee, 145 West 112th St., Chicago.

HERB Doctor Book—10 Cents. 250 Receipts for making herb medicine. Hazard Company, Box 1, Vanderveer Park, Brooklyn, N. Y.

## DOGS AND PETS

REGISTERED Newfoundlanda. Great watchdogs and companions. Levi Birky, Pompeii, Mich.

PEDIGREED Pups, High Class, Police, Airedales, Collies, Chows, Danes, Wire Hair. Maplewood Kennels, Medway, Mass.

GERMAN Police Puppies, pedigreed; females \$20.00, males \$30.00; Airedales \$7-\$15; shipped C. O. D. DeLux Kennels, Flowery Branch, Ga.

HUNTING Hounds—Sold on trial; free descriptive price list. J. E. Adams, Montgomery City, Mo.

PEDIGREED Police Pups. Shipped on 5 days' approval, \$40 up. Frank Tighe, gomery City, Mo.

RAISE guinea pigs. Pay better than poultry or rabbits; easy to raise; little space required. Particulars and booklet how to raise free. Cavies Distributing Co., 3102 Grand Ave., Kansas City, Mo.

ENGLISH Shepherd Puppies. Blacks and Browns. Guaranteed to Heel. H. W. Chestnut, Chanute, Kans.

BEAUTIFUL registered Bull Pups, \$15. Bulldogs, 501 Rockwood, Dallas, Texas.

FOXES, raccoons, muskrats, skunk, ferrets, rabbits, squirrels, mink, opossums. B. Tippman, Caledonia, Minn.

RABBIT Sale—Pedigreed, \$2.00 up. Illustrated book, 10c. Maikranz Rabbitry, New Bethlehem, Pa.

## PERSONAL

ASTROLOGER will read your life. Test prediction for one year, 20c, dimes or stamps. Send year and birthdate. Money back, if dissatisfied. G. Niemeyer, 621 McConnell Terrace, Atlantic City, N. J.

HEALTH is Wealth. Following lectures by mail, 50c each; (1) Art and Common Sense. (2) Auto Suggestion. (3) Auto Intoxication. (4) Erratic Moves. Public Health Instruction, 746 W. 79th St., Chicago, Ill.

HIGH Blood Pressure inexpensively overcome, without drugs. Send address. Dr. Franklin Stokes, Mohawk, Fla.

SEND 25c coin and your date of birth for forecast of your vibrations for 1927. Aryel Synclaire, Numerologist, Box 25, Patton, Calif.

WONDERFUL uses can be made of roots, herbs, flowers, etc. Interesting 96-page booklet containing 250 recipes, some of them the cherished secrets of Indian medicine men and old Herbalists. Free. Box 29F, Station L, New York.

SPEECHES. No matter where you must speak, here is help. 366 pages of instruction and anecdotes, toasts and complete speeches for the amateur or professional. Send No Money. Simply write a postal for "Speeches, Their Preparation and Delivery." Pay postman postal charges and \$1.25. Popular Mechanics Press, Room 901, 200 East Ontario St., Chicago, Ill.

DO you want good live agents—fellows who can get the business? Ask me how others are doing it. I'll gladly render the necessary assistance without cost to you. Address, M. L. Rund, Mgr. Classified Advertising, Popular Mechanics Magazine, Chicago.



**WEALTH** and success come only to them who follow the psychological laws of success. You can't succeed if you don't know how. Get our free book "Why Most Men Fail." Maek Institute, Wabash Sta., P.M. 3, Pittsburg, Pa.

**FORTUNE** telling charts. Send dime and stamp. Elmer Gutknecht, 445 Idaho St., Milwaukee, Wis.

**TOBACCO** or Snuff Habit Cured or no pay. \$1.50 if cured. Remedy sent on trial. Superba Co., N. 3, Baltimore, Md.

**WONDERFUL** health book for only 10c (publisher's price \$1.00). Appreciated by every reader, sick or well. Teaches health the natural way, also suggest reliable self treatment of disease. Address, Author, Box 437, Seattle, Wash.

**HYPNOTISM** and Auto Suggestion. Learn how to hypnotize other people, yourself and animals. Learn clairvoyance, mind reading and telepathy. Clearly explained in "Practical Lessons in Hypnotism and Auto Suggestion." Send no money. Pay postman postal charges and \$1.25. Popular Mechanics Press, Room 901, 200 East Ontario St., Chicago, Ill.

**MISCELLANEOUS**

**DISTRIBUTE** nation-famed "Tool's Hundred Uses." Sample free. Backlund Company, Detroit Lakes, Minnesota.

**CASH** paid for butterflies, insects. See Sinclair Display Advertisement on Page 18.

**PORTRAIT** drawing taught by mail. One original sketch and particulars 25c. Otto Hueser, 4356 N. Lincoln St., Chicago, Ill.

**MEXICAN-MADE** pistol holsters, cartridge belts, lariats; hand-carved belts and holsters; horse-hair belts, hat bands, fobs; rattlesnake belts, fobs. Ingersoll Leather Co., 307 Fannin, Houston, Texas.

**ARTIFICIAL** Eyes. Booklet free. Denver Optic, 359 Quincy, Denver, Colo.

**SAFETY** First! Bathing, sea travelers; carry Pneumatic Swimming Belt, pocket life preserver. Booklet free: "Universal," 309 5th Ave., New York.

**CHOICE** Comb Honey—2 5-gal. cans, \$16.00. Extracted Honey, \$12.00. Bert Hopper, Rocky Ford, Colo.

**IMPORTED** Crystal Point Fountain Pen Can Write on Carbon. U. S. Post Office Using Now. Sample for One Dollar, Woyens, 42 W. 18th St., New York.

**ALASKA** Indian hand made beaded Hair Seal Moccasins, very comfortable and durable; average price for average size \$2.25 per pair Post Paid. Perry M. Horn, Skagway, Alaska.

**YOUR** Name on 15 good pencils mailed anywhere prepaid for \$1. Max Linick, 5 South Wabash Ave., Chicago.

**TATTOOING** Supplies Direct from Manufacturer. "Waters," 965 Putnam, Detroit.

**ALMONDS:** 5 lbs.—\$3, Prepaid. Cotton Route No. 2, Box 570, Pasadena, Calif.

**MIRRORS** Resilvered at Home. Costs Less, 5 cents per square foot; you charge 75 cents. Immense profits plating auto-parts, reflectors, tableware, stoves, refinishing metalware, etc. Outfits furnished. Details free. Write Sprinkle, Plater, 288, Marion, Ind.

**RABBIT** Hunters! Write Me About the "Screw-Bug." Cheaper and Better than Ferrets. Five Days Trial and Money Back Guarantee. Al Grabow, Byron, Ill.

**FORTUNES** in Mines and Minerals. Ore specimen free. Minerals for sale. Buskett, Joplin, Mo.

**WOLF** and Coyote Exterminator Capsules—With formula and instructions; got 9 coyotes one night, brought \$121.50; free circular. George Edwards, Livingston, Mont.

**CAN** You Draw? Make money at home. Something new. No canvassing. Sample and particulars 10c. "Straley," 1017 W. Mulberry, Springfield, Ohio.

**LOCKSMITHING.** 500 tricks of the trade; how to make keys; how to open locks and safes; safe drilling; how to set combinations; key-cutting tables; umbrella work; everything you should know to become a lock expert. Copiously illustrated. Only complete book on subject sold at reasonable price. Send No Money. Just write a postal for "Locksmithing." When postman hands you book, pay \$1.50 and postal charges. Popular Mechanics Press, 200 East Ontario St., Room 901, Chicago, Ill.

**TATTOOING**—learn tattooing, with my outfits. Send for circulars; they explain everything. Sergt. Bonzey, 367 South Main, Providence, R. I.

**I CATCH** from 45 to 50 foxes in from 4 to 5 weeks' time. Can teach any reader of this magazine how to get them. Write for particulars. W. A. Hadley, Stanstead, Quebec.

**CUTS** anybody can make. Simple, cheap process. \$1. Specimens, particulars. 2c stamp. M. Day, Windfall, Ind.

**HOMEOPATHIC** and Biochemic preparations sent postpaid to all parts of the world. Manual and booklets free. Halsey Bros. Co., 615 St. Clair St., Chicago, Ill. Established 1855.

**AMATEUR** Cartoonists: Make money in spare time with new cartoon selling plan. Write Smith's Service, PM1194, Wenatchee, Wash.

**CARTOONING** and commercial art work easily learned with new book. Complete art course beginning with simplest drawings and leading through higher branches of illustration. Profusely illustrated. Send No Money. Just write a postal for "Commercial Art and Cartooning." Pay postman postal charges and \$1.25. Popular Mechanics Press, Room 901, 200 East Ontario St., Chicago, Ill.

**WEEDS**—Cut them with cutter bar on Shaw Garden Tractor. Also plows, cultivates and runs belt machinery. Low prices. Immediate delivery. Shaw Manufacturing Company, Department C, Galesburg, Kans.

**DECORATIVE** work. Directions, for decorating with pressed leaves, antique painting, preserving plants, bouquets of colored grass, tree cone decoration, fungi decoration, decalcomania, crystalized grasses, Grecian painting, copper impressions of leaves, skeleton leaves, leather work, modeling in clay, moss work, paper flowers, pearl work, ornamenting with shells, etching shells, transparencies. All this and much more in "Youman's Household Guide." Send No Money. Just order on postal. Pay postman \$2 and postal charges. Popular Mechanics Press, Room 901, 200 East Ontario St., Chicago, Ill.

# It takes only 8 weeks to get a big job



Geo. Smith owns an agency and repair shop in West Alexandria, Ohio. He makes \$200 a week.



## In the Auto, Tractor and Electrical Business

Read what these men are doing—here is your big chance to get "on easy street." Come to these great shops on the biggest SPECIAL offer ever made. Big firms need trained men. The Auto and Tractor Business is on the boom. Thousands of trained men will be needed during the next few months. I get calls every day from Garages, Battery Stations, Auto Repair, and other successful concerns for McSweeney men. When the big fellows need high grade men they know where to come for them. They want McSweeney trained men. My training is unusual. Scientific tool training—that's the secret. You do things here according to the latest engineering standards. Thousands of dollars have been spent in modern tools and equipment. You'll know a motor like a brother. That's why my men are at home with the biggest shops in the country. If you want to succeed the way Smith, Collins and the rest have—qualify by the same method.

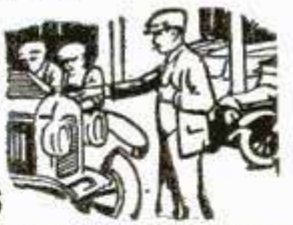

D. M. Collins, Williamsville, West Virginia; writes, "After finishing McSweeney training, I started in as manager of a garage at \$300 per month."

## I'LL PAY YOUR RAILROAD FARE AND BOARD YOU!

In order to fill the openings that now exist, I am making this unusual offer—FREE RAILROAD FARE, FREE BOARD. But even that is not all. I'll tell you about the rest in my letter.

### Send for FREE BOOK

My big illustrated training book tells how others are succeeding. It tells many things you ought to know about Autos and Tractors. Write for it and my short time Reduced Price Tuition offer NOW. It soon expires.

# MC SWEENEY

**AUTO, TRACTOR and ELECTRICAL SCHOOLS**

Cincinnati, Ohio Dept. AR-14, Cleveland, Ohio Chicago, Ill.



McSweeney Auto, Tractor and Electrical Training Shops, Dept. AR-14, (Address shops nearest you) Cincinnati, O., Cleveland, O., Chicago, Ill.

Without any obligation send me your big free book on Autos. Also information regarding Special Reduced Price Tuition temporary offer.

Name.....  
 Street.....  
 City.....State.....

**SAVE \$20<sup>02</sup>**

**Now Only 4.98**

**For This Big 10 Cable Exerciser**



**Victor Master Grip**



**HEY, fellows!!** Put that twenty-dollar bill **back in your Hown pocket!** You don't have to spend all that money for an apparatus. You can get the very best Muscle Building Outfit on the market today for **one-fifth of the regular price!**

You get a Complete scientific course of instruction in **BODY BUILDING—Worth \$10.00.**

**HENRY VICTOR, Dept. M-103**  
**109 East 13th Street**  
**New York City**

Gentlemen:  
 Send me your complete outfit and the two **FREE** books. I enclose the bargain price of only \$4.98. If I am not satisfied, I will return the outfit immediately and my money will be refunded in full.

(2) medium; (3) strong springs. It is also a grip tester, registering from 1 to 100 per cent. Professional strong men and athletes everywhere praise it. No training apparatus is complete without one. Worth at least \$5.00.

And you get this **High Tension 10-Cable Exerciser**, the Champion Muscle Builder of the World! Made with steel reinforced handles—the strongest made. It is progressive and can be used with any number of cables from one to ten. Everlasting quality throughout! When used with my Scientific Course of instruction you will almost see your muscles grow. Your chest expansion will increase, your heart and lungs will have more room, Every muscle and organ in your body will feel like new. Worth \$10.00. That's a \$25.00 outfit if there ever was one! And you get it complete for only \$4.98.

**FREE!**



If I get your order while my supply of these books holds out—I'll include both of them **FREE** with your apparatus. "Boxing," an illustrated book by James J. Corbett, and "Wrestling," by Frank Gotch. Both books are filled with inside dope on boxing and wrestling. I have only a few copies of each left. Get yours by mailing the coupon now. **TONIGHT—** before you go to bed.

**RUSH THE COUPON**

Put your order in the mail now! If you aren't satisfied with the outfit when you get it—ship it back at once—and I'll return your money in full. Don't wait. Get your order going now!

**HENRY VICTOR, Dept. M-103**  
**109 East 13th Street NEW YORK CITY**

Name.....  
 Address.....  
 City.....State.....

**Don't Envy The Plumber BE ONE!**

**\$11.00-\$16.00 PER DAY** and work **EVERY** day, is the Plumber's wage.

Every skilled workman will tell you that Plumbers have the best of it. **WINTER** and **SUMMER** the Plumber is busy at top wages. No skilled Plumber is ever out of a job—compare his opportunities with any trade, plus the opportunities of having your own shop.

We teach you Plumbing with **TOOLS** (not books) under Licensed Master **PLUMBERS** in one of the finest equipped schools in America. We make you a Plumber, every branch is taught thoroughly—Lead Work—Blue Print for plan reading—all other tricks.

**LEARN IN 8 to 12 WEEKS** without previous experience. If you are making less than \$60.00 a week you owe it to yourself to investigate. Get **FREE** catalog that tells in pictures and words how we teach this trade. Special rates now.

**UNIVERSAL PLUMBING SCHOOL**  
 2030 Troost Ave. KANSAS CITY, MO.

**\$10 TO \$20 A DAY**

Actual Figures Show a Shortage of Over 25,000 Painters in the U. S. That's why this is the **BEST TRADE BY FAR** for you to get into. Thousands of jobs open in every large city for men who can do the work. Specialize in the following work:—

Interior Decorating — House Painting  
 Paperhanging — Sign Painting  
 Show Card Writing — Graining and Marbling

**YEAR ROUND WORK AT BIG PAY** or start a business of your own. A few weeks' training at low cost will put you in the Big Pay Class. Write Today for Special Offer. Mr. Allen, c/o Chicago Painting School, 144 W. Austin Ave., Chicago.



**BECOME A RAILWAY POSTAL CLERK**

When everybody else is worrying about his job or looking for work, the U. S. Civil Service Employee is earning good, steady pay in a pleasant occupation of his own selection. **EARN \$1900 to \$2700.** Let me train you to pass the U. S. Civil Service Examination with high rating so you can get a position quickest at \$1900 to \$2700 a year as a Railway Mail Clerk or in Customs, Internal Revenue, Departmental, Immigration, Postmaster, Post Office and Rural Branches. I have trained thousands to successfully pass the examination. Money refunded if unsuccessful in securing a position within one year after exams. Examinations coming. Write today. Mail coupon for catalog.

**PATTERSON SCHOOL** Approved as a correspondence school under the laws of the State of N.Y.  
 DEPARTMENT 81 ROCHESTER, N. Y.

**Patterson School**  
 Dept. 81, Rochester, N. Y.

Write today. Send me without charge your catalog describing this and other U. S. Government Positions.

Name.....Age.....  
 Address.....

# LEARN *to* FLY

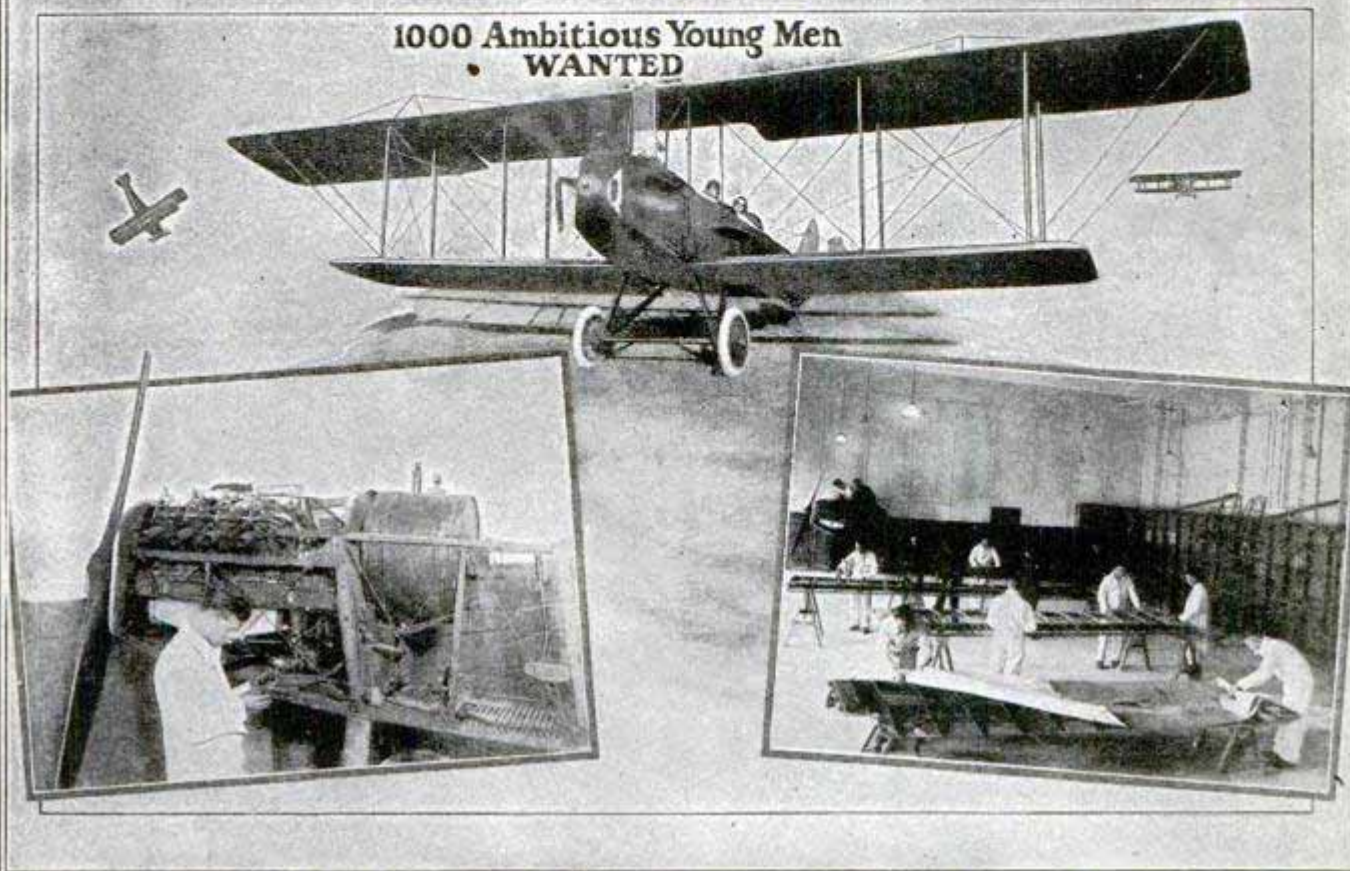

1000 Ambitious Young Men  
WANTED

## Sweeney System of Practical Airplane Mechanics

These photographs show how Sweeney students are trained by DOING. After thorough ground school work, under skilled instructors in the construction and repair of planes, recovering wings, tuning motor, etc., learning everything about the mechanical work by actual practice, the student then, if he wishes, goes into the air and qualifies as a pilot under safe and experienced pilots, with double controls for actual flying. Here's the great business of the future. The National Air Transport alone has invested \$700,000 on the Kansas City air route. They are spending \$1000 a day to operate an over-night service to New York City. Ambitious men are wanted as pilots and ground mechanics. At the great SWEENEY SCHOOL you learn not only by doing, but you get personal instruction.

pilot, you take all the actual flying necessary to make you a competent pilot. Now when you understand that two to seven hours is all the average man needs to learn expert flying you will appreciate what this ample experience in the air under skilled men will do for you. Aviation is no longer a mystery—no longer a hazard; no, it is a business growing greater and more important. This has been wonderfully demonstrated in the successful flights over the North Pole and also in the big part Aviation is now playing in commercial activities. Progress is rapid. More men are needed every day. You can qualify as a mechanic, or an engineer, or repair man, or builder; five men on the ground are needed for one man in the air, but if you want to become a pilot you easily master the work and can go into postal, government, or commercial work. Flyers are in demand, earning big money at fairs, taking up passengers, etc., \$5 for a 10 minute flight is pretty fine pay!

### Opportunities in FLYING

- Aviation Mechanics—\$50-\$125 Week
- Riggers—\$50-\$75 Week
- Flyers—\$125-\$225 Week
- Taxi Service—\$100-\$300 Week
- Aerial Photo Pilot—\$200-\$250 Week
- Special Messenger Service—\$125-\$200 Week
- Aerial Advertising—\$225-\$500 Week
- Crop Dusting—\$125-\$200 Week
- Crop Survey—\$125-\$225 Week

### THE SWEENEY SYSTEM

is divided into two parts. FIRST: You are thoroughly taught in the ground school. This fits you as an aviation mechanic. You can build your own plane and do anything required in aviation mechanics and construction and repairing when you have finished this work. You are thoroughly taught motors, etc., and work with thousands of dollars' worth of new material, including all types of engines—SECONDLY: After completing this work, if you want to be a

### SWEENEY SCHOOL OF AVIATION

LEARN TO FLY BY FLYING  
**Sweeney**  
SCHOOL OF AVIATION  
3306 SWEENEY BLDG, KANSAS CITY, MO.

**SEND NAME TODAY** for full details of this aviation mechanical course and photographs of planes and equipment actually used; also full information as to the commercial end of flying and opportunities for young men.

---SEND THIS NOW---

EMORY J. SWEENEY, President  
3306 Sweeney Bldg., KANSAS CITY, MO.

Please send me full information about your Aviation Course.

Name..... Age.....

Address.....

Town..... State.....

# PAIN and DISEASE

Quickly Conquered by

## VIOLET RAY



Let us tell you how thousands of men and women suffering from rheumatism, neuritis, paralysis, nervousness, skin diseases, headaches, constipation, sprains, prostate trouble, goitre and many other ailments, even hay fever and asthma, have found quick relief—new health and vitality with this marvelous, scientific invention. Pains vanish almost instantly.

# Violetta

**Ten Days FREE Trial**

**For Health—Beauty—Vigor**

Endorsed and used by hospitals, sanitariums and physicians. Every home can now have one. Saves hours, days, months of suffering. No medicine. Painless, pleasant treatment. Only the violet ray can penetrate to every nerve affected. Simple, safe, painless—anyone can use VIOLETTA. Why suffer pain and poor health when you can try VIOLETTA 10 days FREE.

## This Book FREE

Tells all about violet rays—how this marvelous discovery by Nikola Tesla, the electrical wizard, now brings this mysterious curative power to all. Contains many astounding testimonials from our thousands of satisfied users. Send for the facts and our liberal trial offer today. Mail the coupon now.



VI-REX CO., Dept. 131  
2304 Warren Avenue, Chicago

VI-REX CO., 2304 Warren Ave., Dept. 131 Chicago

Please send me your free book on Violet Rays and details of your 10 days' free trial offer.

Name .....

Address .....

City ..... State .....

Ailment .....

## DRAW CARTOONS

Turn Your Talent Into Money

Cartoonists earn from \$50 to \$300 per week—some even more. Remarkable new Circle System of Drawing teaches you in half the usual time. Send for booklet and sample lesson plate explaining full details of the Course.

THE NATIONAL SCHOOL OF CARTOONING  
623 Penton Building Cleveland, Ohio



## Learn TENOR BANJO

**Banjoists!** Earn big money through Charles McNeill's famous Home Study Banjo Course. Simple as A B C—yet has all technical requirements. Includes phonograph records, demonstrating jazz strokes, "breaks" and chords, played by Charles McNeill, 5 years with Isham Jones-Brunswick Records. Easy payments. Send for Free Book.

CHICAGO BANJO INSTITUTE  
Dept. 1351 3345 N. Lincoln St., Chicago, Ill.



9 Big Books covering all subjects fully:

- Surveying
- Map Making
- Roads
- Bridges
- Culverts
- Railroad Engineering
- Estimating for Steel Buildings
- Masonry
- Water Supply
- Water Power
- Cost Systems

Want to make more money?



Be a Civil Engineer

Here is an easy way to learn. You hold your future in your own hands. If you have a grammar school education, and want the advantages of knowledge usually gained in college, you will welcome this new system of reading at home. No long hours of grinding study; just the meat of every subject told in such a simple way that anybody can understand.

These books were prepared by men who were experts, they are full of boiled down facts and easily learned methods which save time and study.

Civil Engineers are more important than ever; steel buildings, bridges, highways, railroads and harbor projects make Engineering more important than almost any other profession.

If you want to get ahead—try this easy way

## We Ship Nine Books FREE

This is a "straight-from-the-shoulder" offer to men who want a big future. If you could hear half the stories of success we receive, you would not hesitate a minute. Send for the books now; just your name and address; and we'll ship the entire set of nine volumes. Keep them ten days, then if you realize how valuable they are to you, send only \$2.00, and after that only \$3.00 per month until the small total of only \$29.80 is paid. A free membership in the American Technical Society will be included if you send NOW. This entitles you to full consultation privileges with 18 engineering experts.

The special jiffy index puts facts at your finger tips

AMERICAN TECHNICAL SOCIETY, Dept. C-119, Chicago

You may send me, for Free examination, your nine new books on Civil Engineering. Unless I return them in ten days I will send you \$2.00 as first payment, then \$3.00 per month until the special price of only \$29.80 is paid. Include membership in the American Technical Society FREE.

Name .....

Address .....

City ..... State .....

Reference .....

What  
could  
you do  
with a  
tooth-brush  
and  
thirty-five  
dollars  
?

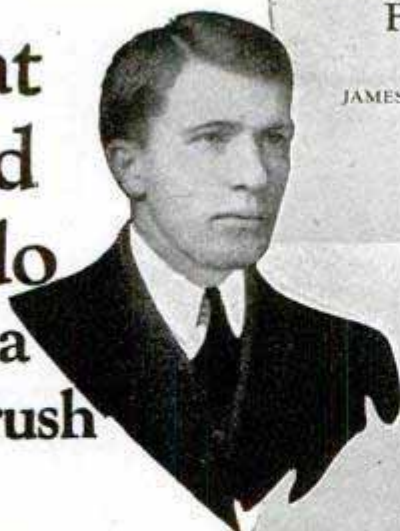

GEO. C. LARSEN, Pres. C. F. STANLEY, V.-Pres. GEO. YUNG, Sec.-Treas.

## Farmers' Union Creamery Company

Dealers in  
DAIRY PRODUCTS

JAMES C. NORGAARD, Manager

Superior, Neb.

LaSalle Extension University,  
Chicago, Illinois.

Gentlemen:

When I arrived in New York, in 1914, I had a toothbrush, \$35 in cash, a lot of pep, and not an English word in my vocabulary.

My first job, in a Wisconsin creamery, paid me \$10 a month and board. At night school, in Green Bay, I learned English.

In the winter of 1919 I took my first course with LaSalle--in Traffic Management. From 1919 to 1921 I pursued LaSalle training in Business Management, and to this course I attribute most of the progress I have since made.

Naturally I am enthusiastic about LaSalle Training, and do not hesitate to say that any man who is eager to get ahead in business will find it the most profitable investment he ever made.

Very truly yours,

*James C. Norgaard*

Manager.

**D**O YOU feel that Fate has handicapped you by a lack of opportunity? If you don't believe that all a man needs is determination to *make* opportunity—to start right where he is and land 'way higher up the ladder—consider James Norgaard.

As he stood on a New York dock ten years ago, he didn't understand a word of English. His equipment for success was \$35.00—and a tooth-brush.

Today he's an officer of the grain exchange, director in the building and loan association, president of an ice cream company, and general manager of one of the largest co-operative creameries in the world.

The really interesting thing is that there's nothing unusual or startling or extraordinary in the plan Mr. Norgaard followed.

Thousands of other men find the same help in LaSalle home-study business training. It's available any and every day, to any and every man of aggressiveness and determination.

See LaSalle clearly. View it simply as a proved short cut to increased earning ability—to money and position and opportunity. It's here for you and as near to you as the mails.

### These Free Books Show How

You are eager to get ahead—you will find it of vital importance to learn more of the success-methods James Norgaard and thousands of others have employed so profitably. We have therefore prepared a special 64-page booklet which outlines these methods in detail. It also points out the big opportunities in the field you are in or wish to enter—shows you how you can fit yourself to get them.

The coupon brings this booklet to you without cost or obligation—also a copy of "Ten Years' Promotion in One." A pencil—an envelope—a postage stamp! Get these two books now—and make your start TODAY!

### Find Yourself Thru LaSalle!

LA SALLE EXTENSION UNIVERSITY, Dept. 164-R CHICAGO

I shall be glad to have your 64-page booklet about the business field I have checked below. Also a copy of "Ten Years' Promotion in One." all without obligation.

- |                                                                     |                                                                      |
|---------------------------------------------------------------------|----------------------------------------------------------------------|
| <input type="checkbox"/> Business Management                        | <input type="checkbox"/> Traffic Management—Foreign and Domestic     |
| <input type="checkbox"/> Higher Accountancy                         | <input type="checkbox"/> Railway Station Management                  |
| <input type="checkbox"/> Modern Salesmanship                        | <input type="checkbox"/> Banking and Finance                         |
| <input type="checkbox"/> Law; Degree of LL. B.                      | <input type="checkbox"/> Personnel Management                        |
| <input type="checkbox"/> Commercial Law                             | <input type="checkbox"/> Modern Business Correspondence and Practice |
| <input type="checkbox"/> C. P. A. Coaching for Advanced Accountants | <input type="checkbox"/> Expert Bookkeeping                          |
| <input type="checkbox"/> Effective Speaking                         | <input type="checkbox"/> Business English                            |
| <input type="checkbox"/> Modern Foremanship                         | <input type="checkbox"/> Commercial Spanish                          |
| <input type="checkbox"/> Industrial Management                      |                                                                      |

Name \_\_\_\_\_ Present Position \_\_\_\_\_

Street \_\_\_\_\_ City \_\_\_\_\_ State \_\_\_\_\_



these books free

# Hawaiian Guitar

## FREE

Worth  
\$18

### When You Enroll

This Hawaiian Guitar expert and professor wants the opportunity to welcome you as a student so you will quickly learn how to play a Hawaiian Guitar—yes, you will be able to play just like the native Hawaiians. To get you started and help your musical success, which will bring you popularity, you will receive a beautiful Hawaiian Guitar, the same as the one pictured, free when you enroll. Our short cut method of instruction will enable you to play a piece almost from the first lesson. Rush coupon for full particulars today and we will reserve a gift Hawaiian Guitar for you.



### Play Quickly

With our short cut method of instruction you will quickly learn how to play Hawaiian Guitar, which will bring you popularity and social success. You learn to play from notes. If you never had any musical training, you will quickly get on, because our nine experts have perfected a course of home instruction which is as simple as learning A, B, C's.

### Picture and Phonograph Record Method Easy

We don't depend upon printed lessons only for your success, but we also furnish pictures of our professors playing, diagrams, charts and phonograph records for each lesson. This practically brings our professors from our studio to your own home and enables you to listen to their playing just as if they were actually in front of you. To prove this is easy, we will send you your first lesson free. Rush coupon now.

HAWAIIAN STUDIO No. 5201  
of New York Academy of Music  
100 Fifth Avenue, New York, N. Y.

Please rush your Free book, "How to Learn Hawaiian Guitar," and my first free lesson. Also reserve a gift Hawaiian Guitar for me. This obligates me in no way whatever.

Name.....  
Address.....  
City..... State.....

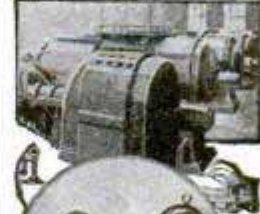

## LEARN BY DOING

Every phase of all branches of

# ELECTRICITY

taught by  
**Actual Practice**

In America's foremost institution for trade training

**No Books Used**

Individual Instruction  
Start Any Day

Write for FREE 64-page catalog

**THE NEW YORK ELECTRICAL SCHOOL**  
44 West 17th St., New York City

### Big Money for You as an Automobile Mechanic

These four practical books, written by five well known teachers of automobile practice, will teach you right in your own home during your leisure time just what you need to know about automobile troubles and repair. They will teach you automobile construction, maintenance and repair as experts know them and will help you to earn an expert's pay.

**Practical Automobile Library: Four Books—\$1.50 in 10 days and \$2 monthly for 6 months—only \$13.50 in all!**

Hundreds of question-answering diagrams—hundreds of clearly-marked illustrations—make the books plain and readily understandable. All the explanations and descriptions are clear, simple, direct. Every chapter is packed with definite, step-by-step, how-to-do-it information. Here is your opportunity to enter a big-pay field.

Send **FREE**

Send No Money  
Mail the Coupon

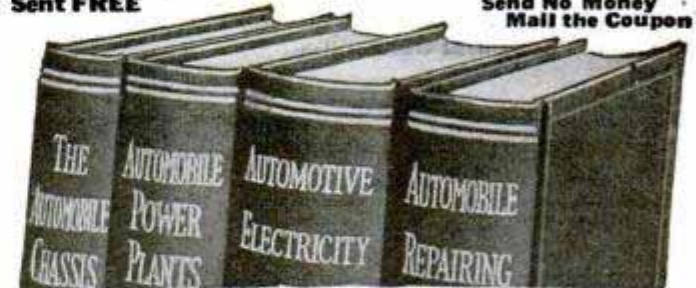

### FREE EXAMINATION COUPON

McGraw-Hill Book Co., Inc., 370 Seventh Ave., New York

Send me for 10 days' free examination the New Practical Automobile Library. If satisfactory I will send you \$1.50 in 10 days and \$2.00 monthly until the special price of \$13.50 is paid. If not wanted, I will return the books at your expense.

Signed.....  
Address.....  
City and State.....  
Position.....  
Employer..... P. M. 1-1-27

 <p><b>BRICK LAYING</b></p>	 <p><b>ELECTRICITY</b></p>	 <p><b>AUTO PAINTING</b></p>	 <p><b>STRIPING</b></p>	 <p><b>PLUMBING</b></p>
<p><b>\$14<sup>00</sup> A DAY</b></p>	<p><b>\$75<sup>00</sup> A WEEK</b></p>	<p><b>\$50 TO \$125 A WEEK</b></p>	<p><b>\$2<sup>00</sup> AN HOUR</b></p>	<p><b>\$300 A MONTH</b></p>

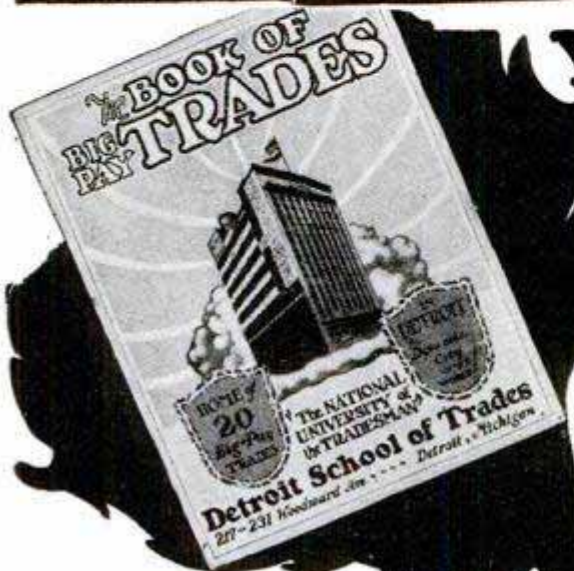

# YOUR OPPORTUNITY

Learn One of these

## BIG PAY TRADES

# QUICK

Don't spend months in school or digging through dry books. Here you learn by doing with tools on actual jobs—you learn right—and you learn quick. Before you know it you're ready for big pay right here in Detroit.

**DON'T Work At a Hard Low-Pay Job Another Day!**

Get out of the grease—leave the rut forever—say "Good bye" to low pay. Take your choice of the clean, big pay jobs and start earning \$50 to \$100 a week right from the start in a real trade.

**Come and Work**

**In Dynamic DETROIT**

A great city—big—throbbing with life—growing—filled with opportunity—crying for men to take big pay for doing the jobs that need doing. Building trades booming. Automotive trades—real trades—always good—get into the spirit of a big city, fastest growing most dynamic in America—do big things with big men—succeed with success in this City of Wonderful Opportunity

**CHOOSE**

**In This Great School We Teach These Big-Pay Trades**

- Bricklaying--\$1.50 to \$1.65 per hour
- Plastering--\$1.50 per hour
- Plumbing--\$1.25 to \$1.75 per hour
- Carpentry -- \$60.00 to \$125.00 per week
- Electrical--\$10.00 to \$14.00 per day
- Sign Painting--\$1.00 to \$2.00 per hour
- Paper Hanging--\$10.00 and up per day
- Interior Decorating--\$10.00 to \$14.00 per day
- Plan Reading and Estimating--\$70.00 to as high as \$250 a week
- Auto Mechanics--\$1.00 to \$2.00 per hour
- Auto Painting--\$9.00 to \$12.00 per day
- Auto Trimming--\$9.00 to \$14.00 per day
- Metal Finishing--\$10.00 per day
- Acetylene Welding--\$1.00 to \$2.00 per hour
- Tool Making--\$70.00 to \$200.00 per week

**Get This New Big Pay Book**

The Most Amazing Door to Quick Big Money You've ever seen. Twenty trades. Pick the one you are best suited for. Work at a job you like. Learn your trade, quick. This book is free.

**Steady Work in Detroit's Big Plants**

Scores of Big plants, body plants, auto plants, wheel makers, tool makers, designers, finishers, strippers—hundreds of real estate developments and new buildings—plenty of work inside or outside—at big pay. Steady work the year around for men who know their trades.

**BIG PAY JOBS GALORE Not Enough Men**

The Detroit School of Trades teaches 20 big pay trades. It is called the "National University of the Tradesman". You don't have to learn some old, low-pay, worn-out business. Send for the book, look through, pick the money you want in the trade you want to learn. Then come here, we'll teach you how and help you get a job. Over three hundred of our men now working in one body plant. Hundreds of others in other plants. Hundreds more needed.

**Think of These Facts**

Hansen made \$183 for one week's work in bricklaying. Brooks jumped from \$35 a week to \$65.85 the first week he left school. Augustine was making \$6.00 a day—learned plastering and makes \$12 a day. Hundreds double their pay. You can do as well. Remember it doesn't cost you a penny for this book. Risk one postage stamp now on what may be the opportunity of a lifetime. Read it, be convinced. Come and see. Succeed for yourself. Send coupon at once. Don't delay. The National University of Trades can do big things for you.

**DETROIT SCHOOL OF TRADES**  
DEPT. 11 DETROIT, MICHIGAN

**FREE** Send Coupon TO-DAY

**THE STATE OF MICHIGAN**

protects you. The great Detroit School of Trades is supervised by the Michigan State Board for vocational education and conforms in every respect to the standards and requirements laid down by this organization, just the same as a State University or Endowed College.

**Detroit School of Trades, Dept. 11 Detroit, Mich.**

Send me Free and without obligation your big new book of BIG PAY TRADES. I am interested in

the \_\_\_\_\_ trade

Name \_\_\_\_\_

Address \_\_\_\_\_

City \_\_\_\_\_ State \_\_\_\_\_

# He thought he could throw me—



Dear Tom: You know how Ted Brown has always been saying he could throw me with one hand tied behind him, if he wanted to. Well, yesterday, he grabbed hold of me and we had it out. Gee, I wish you'd been there. You know how much bigger Ted is than I. He thought he had me licked dead easy—

# but

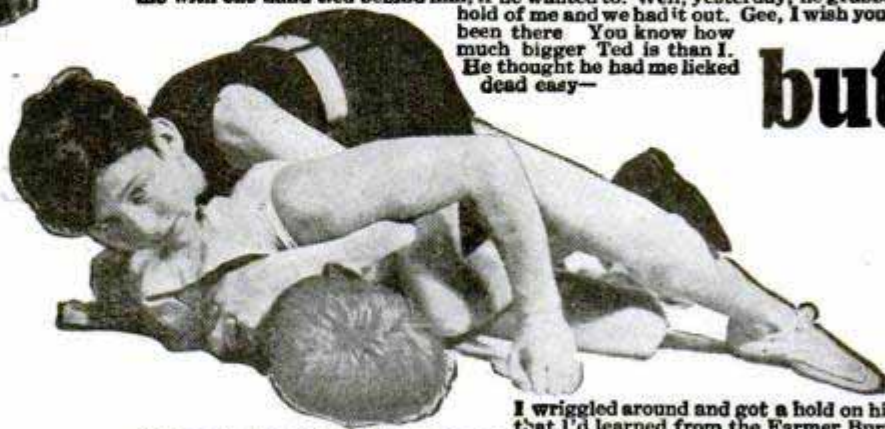

I wriggled around and got a hold on him that I'd learned from the Farmer Burns

School of Wrestling. The next second—KERFLOP, and I had Mister Ted Brown on the ground, yelling for me to quit. It's a cinch to handle a fellow half as big again as you are if you know the secret holds. If I were you I'd write to Burns School for their book about wrestling. So long—FRED.

## Learn Wrestling Secrets from Worlds Champions Farmer Burns and Frank Gotch

Learn the marvelous holds, breaks, blocks and tricks that will enable you to handle big, strong men with ease. The renowned FARMER BURNS—"father of scientific wrestling"—and FRANK GOTCH the world's champion, have prepared a series of lessons in which they reveal the inside secrets of training that will make YOU, too, an expert wrestler. All the great secrets of self-defense and jiu-jitsu illustrated by printed word and picture. The lessons teach you how to become a great athlete, and secret knowledge enabling you to throw boys and men larger and stronger than yourself.

Farmer Burns School  
1771 Railway Exchange Bldg., Omaha, Neb.

Please send me at once without obligation your illustrated booklet on Scientific Wrestling, Physical Culture, Self-Defense, and How to Win. I enclose 10c to help pay for printing and mailing.

Name.....

Address.....

## Wrestling Book Only 10c



Our BIG ILLUSTRATED BOOK tells you all about the advantages in health, vigor and respect that being able to wrestle brings one. It tells you how to learn to become a skilled wrestler in your spare time. Brim full of interesting information about wrestling. Also lots of pictures. INVESTIGATE. Write today for this big book. No obligations. Enclose only 10c to help pay for cost of printing and mailing. State age. Tear out and mail coupon NOW!

Farmer Burns School 1771 Railway Exchange Bldg. OMAHA, NEB.

## Book on Law Free



Write today for this new book. It tells you how a law training will shorten your road to success. It also carries a vital and inspiring message to every ambitious man! Find out about the opportunities that await the law trained man. Find out how you can learn law right in your own home. No obligations. The book is absolutely FREE. Write Today—now while we are making a special reduced tuition offer.

American Correspondence School of Law  
3601 Michigan Ave. Dept. 1351 Chicago, Illinois

Comedies, Dramas, Musical Comedies and Revues, Minstrel Vaudeville Acts How to Stage a Play Make-up Goods Chorus, Songs, Blackface plays. Everything for Burnt Cork Shows and All Amateur Entertainments. Monologs, Dialogs, Speakers.

## PLAYS

CATALOGUE FREE

T. S. DENISON & CO., 623 So. Wabash, Dept. 9, CHICAGO

## Men Are Men Who EARN What They Get That Get Biggest Pay

Get into the automobile business. It's your one best opportunity. But you must know from A to Z automotive construction and operation to reach your fullest ambitions. Get your education where your training will be practical, thorough and scientific and where your diploma will be worth many times more than its cost. Write for our FREE catalogue and complete story of our highly successful institution—established 17 years ago. Address

Stewart Automobile School, 227 West 57th St., NEW YORK CITY

## YOU CAN OIL PAINT

Amazing new method teaches men or women to earn after first lesson. OIL PAINT photos—portraits, landscapes or art subjects. Earn \$18 to \$50 and more a week. OIL PAINT OUT-FIT GIVEN. Send now for free illustrated book. PICTORIAL ART STUDIOS, Inc. Dept. MP, 2731 No. Clark St., Chicago



## TRAVEL—ON "UNCLE SAM'S" PAYROLL

RAILWAY MAIL CLERKS

\$1900 to \$2700 a Year  
Mail Coupon Before You Lose It

FRANKLIN INSTITUTE, Dept. E-176, Rochester, N. Y.

Sirs: Rush to me without charge: (1) Sample Railway Postal Clerk and City Mail Carrier coaching; (2) tell me how to get a U. S. Government job; (3) send 32 page book with list of many positions now obtainable.

Name.....

Address.....

Steady Work—No Layoffs—Paid Vacations—Common Education Sufficient  
MEN—BOYS, 18 UP—RUSH COUPON



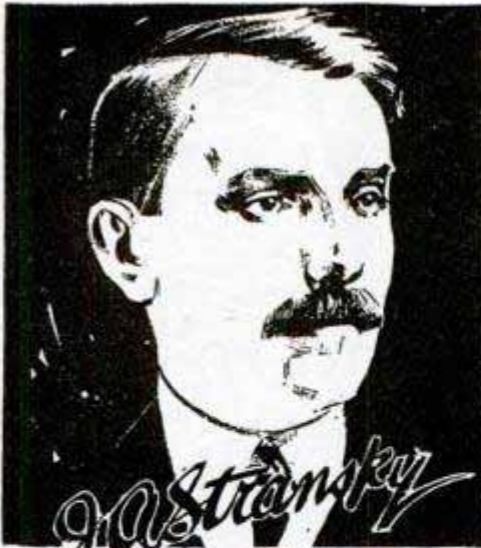

Former candidate  
GOVERNOR, SOUTH DAKOTA

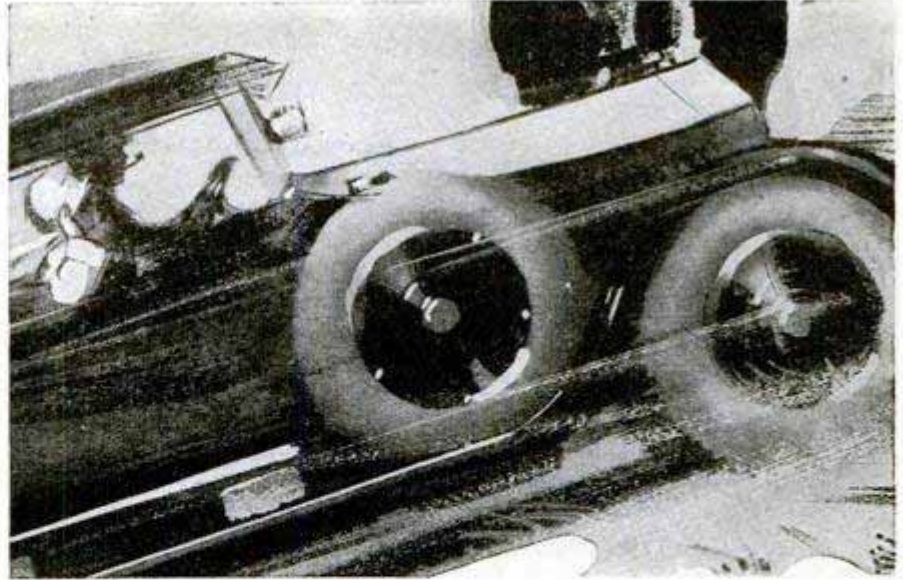

# Saves Half His Gasoline on 492 Mile Trip

An Amazing Little Device, Writes B. O. Finch, Has Saved A Marmon Owner Half His Gasoline. Prior To Installing It, He Was Getting Only 10 To 11 Miles A Gallon. After, On A 492 Mile Trip, He Averaged 20 Miles Per Gallon. So Sensational Are Reports Of Increased Mileage And Power With This Magic Little Invention That A Million Car Owners Now Use It. Learn How You Can Test It At The Inventor's Risk.

## \$75 to \$150 A Week

WHEN a Ford goes 40 miles on a gallon—a Buick 27 miles—a Marmon doubles former mileage—and thousands report similar records—do you wonder why men earn at the rate of \$75 to \$150 a week, just handing it to car owners?

The Stransky Vaporizer is one of the most sensational selling propositions of the last ten years. Full page newspaper ads have spread the story all over America. Most car owners have heard about it. Everybody wants to see it. Man alive, what a money-making opportunity!

## How It Works

This weird little device has astounded automotive engineers who have tested it. It is simple, easy to understand and install. It tends to save gasoline by a new scientific principle of com-

bustion that multiplies the vapor power of the raw gasoline. And the vaporizing principle has been approved in a device now installed as standard equipment on one of the world's leading makes of cars. Naturally, when gasoline is better vaporized, there is less trouble with carbon. Also, you can now clean out already-formed carbon in a jiffy because of this device, the same way carbon is removed from Diesel engines.

Everybody we hear from praises its simplicity, its wonderful savings in gasoline mileage, its foolproof operation. Many have used it from two to seven years and still praise it. Imagine how wonderful it has worked when a million car owners install it—when it is sold all over America and in 29 foreign countries—when distributors compete eagerly to get it.

**J. A. STRANSKY  
MFG. CO.**

DEPT. A-10

PUKWANA, SOUTH DAKOTA

## I Made \$48 in 3 Hours

My gas bill has been cut in half. I have removed every particle of carbon from my engine. Since I installed it, my engine runs as good as new, starts easier and quicker. I went out Saturday about three hours and secured 16 orders.

J. A. Williams.

## \$137.50 in One Week

I received your shipment of fifty Vaporizers two weeks ago. I sold my fifty the first week.

O. F. Foster.

## Daring Sample Offer

So convinced is the inventor that this queer device will increase gasoline mileage and reduce carbon troubles that he makes this daring offer described in the coupon below. It gives you the chance to test this device without risk—and win a cash forfeit if the test doesn't prove the story. It tells why you can make as big an income, full or spare time, as other Stransky representatives. Why delay? Mail it now.

## READ THIS OFFER

J. A. Stransky Mfg. Co.,  
Dept. A-10, Pukwana, South Dakota.

Yes, I'd like to see a sample of the Stransky Vaporizer at your risk. Also tell me how I can earn \$75 to \$150 a week as your distributor. This does not obligate me to buy anything.

Name.....

Street (R. F. D.).....

City..... State.....



## An Easy Way to Learn PHARMACY AT HOME

Graduate pharmacists are always in demand. The work is interesting and pleasant and salaries are good. Many young men open drug stores of their own and become independent.

There's an easy way to learn pharmacy right in your own home in spare time, without losing a day or a dollar from your present work.

The International Correspondence Schools course in Pharmacy supplies the knowledge which it will be necessary for you to have in order that you may pass your State Board Examination.

Just mark and mail the coupon printed below to the International Correspondence Schools, Box 5622-E, Scranton, Pa., and full particulars about the Pharmacy Course or any other work of your choice will come speeding to you by return mail.

### INTERNATIONAL CORRESPONDENCE SCHOOLS Box 5622-E, Scranton, Penna.

Without cost or obligation, please send me full information about the subject before which I have marked an X in the list below:

- |                                                  |                                                                             |
|--------------------------------------------------|-----------------------------------------------------------------------------|
| <input type="checkbox"/> <b>PHARMACY</b>         | <input type="checkbox"/> <b>CHEMISTRY</b>                                   |
| <input type="checkbox"/> Automobile Work         | <input type="checkbox"/> Surveying and Mapping                              |
| <input type="checkbox"/> Navigation              | <input type="checkbox"/> Mine Foreman or Engineer                           |
| <input type="checkbox"/> Agriculture and Poultry | <input type="checkbox"/> Steam Engineer                                     |
| <input type="checkbox"/> Mathematics             | <input type="checkbox"/> Gas Engine Operating                               |
| <input type="checkbox"/> Electrical Engineering  | <input type="checkbox"/> Wireless <input type="checkbox"/> Airplane Engines |
| <input type="checkbox"/> Electrician             | <input type="checkbox"/> Architect                                          |
| <input type="checkbox"/> Mechanical Engineer     | <input type="checkbox"/> Contractor and Builder                             |
| <input type="checkbox"/> Mechanical Draftsman    | <input type="checkbox"/> Architectural Draftsman                            |
| <input type="checkbox"/> Machine Shop Practice   | <input type="checkbox"/> Concrete Builder                                   |
| <input type="checkbox"/> Railroad Positions      | <input type="checkbox"/> Structural Engineer                                |
| <input type="checkbox"/> Civil Engineer          | <input type="checkbox"/> Plumbing and Heating                               |

### BUSINESS TRAINING COURSES

- |                                                                  |                                                                           |
|------------------------------------------------------------------|---------------------------------------------------------------------------|
| <input type="checkbox"/> Business Management                     | <input type="checkbox"/> Salesmanship                                     |
| <input type="checkbox"/> Industrial Management                   | <input type="checkbox"/> Advertising                                      |
| <input type="checkbox"/> Personnel Organization                  | <input type="checkbox"/> Better Letters                                   |
| <input type="checkbox"/> Traffic Management                      | <input type="checkbox"/> Foreign Trade                                    |
| <input type="checkbox"/> Business Law                            | <input type="checkbox"/> Stenography and Typing                           |
| <input type="checkbox"/> Banking and Banking Law                 | <input type="checkbox"/> Business English                                 |
| <input type="checkbox"/> Accountancy (including C.P.A.)          | <input type="checkbox"/> Civil Service                                    |
| <input type="checkbox"/> Nicholson Cost Accounting               | <input type="checkbox"/> Railway Mail Clerk                               |
| <input type="checkbox"/> Bookkeeping                             | <input type="checkbox"/> Common School Subjects                           |
| <input type="checkbox"/> Private Secretary                       | <input type="checkbox"/> High School Subjects                             |
| <input type="checkbox"/> Spanish <input type="checkbox"/> French | <input type="checkbox"/> Illustrating <input type="checkbox"/> Cartooning |

Name.....  
Street  
Address.....  
  
City..... State.....

Occupation.....  
Persons residing in Canada should send this coupon to the International Correspondence Schools Canadian, Limited, Montreal, Canada

## With this Book you can now Explain Rotor



JUST off the press—a brand-new, illustrated book, explaining for the first time in full detail the great, scientific principle on which the Rotor Ship is based. Probably the most startling and fascinating discovery of the century. This book, by the inventor of the Flettner Rotor Ship, Anton Flettner, tells how he got on the track of the idea; the interesting stages by which he developed it; his dramatic struggles. Written simply, directly. 114 illustrations. A book every mechanically minded man and every student wants on his library shelf now. Because the Rotor principle will soon be used in many every-day ways—Rotor Windmills, Rotor Pumps, etc. For \$2 we will mail you a copy postpaid. Order promptly, for this first edition is in great demand. You might have to wait for another printing, if you delay.

E. D. MILLER, 66 Beaver St., New York

**Books on 2,000 Subjects.** New catalog lists books of all sorts. FREE. Write a postal for "Books on 2,000 Subjects." Popular Mechanics Press, Room 101, 200 E. Ontario St., Chicago, Ill.

## ARE YOU SELF-CONSCIOUS? DO YOU STAMMER?

You must overcome Self-Consciousness—Mental Fear—Bashfulness to succeed in the business and social world. Send 10c for amazing booklet, "Road to Poise and Achievement." Tells how thousands have conquered self-consciousness in a very short time. SEYMOUR INSTITUTE, 38 Park Row, Dept. 25, N. Y. C.

*"The Palmer Course would have saved me years of labor."*

*Jim Tully*



JIM TULLY, whose work recently appeared in five different magazines in the same month, one of them *Liberty*, says: "I recall writing my first short story . . . it was a tale of the ring called 'Battle Galore,' and Clayton Hamilton gave me advice on how to 'build it up.' . . . I am certain that the Palmer Course would have saved me years of labor."

Think what it would mean to you to have at your elbow as you write, a man who can impart to you that elusive something that makes characters live and stories grip—what most writers spend years to acquire. That, and more, the Palmer Institute can give you. Though you study in your home, in spare time, you find Palmer Courses uniquely personal.

### PALMER INSTITUTE OF AUTHORSHIP

Palmer Building, Hollywood, Cal. 49-N

CLAYTON HAMILTON - - - President  
FREDERICK PALMER - - - Vice-president

Please send me, without any obligation, details about the course I have checked.

- Short Story Writing  English and Self-Expression  
 Photoplay Writing

Name.....

Address.....

All correspondence strictly confidential  
No salesman will call upon you



# A New Day IS DAWNING ON ONE GREAT FIELD

# ELECTRICITY

**\$200<sup>00</sup> to \$800<sup>00</sup> a Month**  
**Are the Incomes That Trained**  
**Electrical Engineers and**  
**Electricians Make**



There is no limit to the earnings or business possibilities for the trained electrical expert. Every factory, every home, every transportation system, automobiles, aeroplanes, etc., are using electricity more and more for power and convenience.

I can prove to any thinking man who is mechanically inclined, that his greatest opportunities—surest future—will come if he learns this profitable and fascinating trade and science.

### Electricity Must Be Taught

It is practically impossible for a man to become an expert electrician unless he is taught by a man who not only knows electricity, but knows how to teach it. Practical experience on actual electrical equipment—not books—is the only way this trade can be mastered.

### We Teach with Electrical Machinery—Not Books

Every minute of your time in the Coleman Electrical School will be spent on actual equipment, such as used in factories, power-houses, buildings, homes, automotive electricity—such as ignition, starting and lighting systems—electrical refrigeration, telephone and telegraph systems, in fact, the entire field of electricity is covered in a practical way in our school.

### No Guess Work About Our System

It's practical and understandable. YOU LEARN BY WORKING on actual equipment, under the supervision of expert electricians. Our School is completely equipped. Hundreds of generators, dynamos and electrical appliances are here for you to work on. Our School is complete.

### Earn the Big Money That Electrical Experts Earn

Write today for full information about this opportunity School. I will show you a future that is unlimited in its financial returns and is fascinating as well. My catalogue tells the story of the Coleman Electrical School.

### I Have a Christmas Present for You

I offer you until January 10, 1927, an opportunity of attending this School at a tuition rate unheard of before. This special offer includes my complete Scholarship and full privilege of our employment department. Write today for full information about my School. How we teach the business, and the opportunities it holds for you.

**W. H. Coleman, President  
Coleman Electrical School**



**W. H. Coleman, President  
Coleman Electrical School  
1628 Main Street  
Kansas City, Mo.**

Dear Sir:  
 I want to learn about your School. Please send me free and postpaid, your illustrated catalogue that will tell me how you can make me an electrically trained man. It must be free and place me under no obligation.

Name.....  
 Town.....  
 State.....

# Learn To Play The Tenor Banjo



POPULARITY, PLEASURE and PROFIT are rewards for those who learn to play the Tenor Banjo. You need never be lonely if you can strum a lively air on this cheerful instrument. You will soon be very much "one of the bunch." As a source of profit, also, it offers you an attractive livelihood, for the Tenor Banjo has become the most popular orchestra instrument. Players are in constant demand for stage, radio and orchestra.

## Chords Taught by the Martell Method

In a very short time you can learn to play chords on the Tenor Banjo by our simple home study course. Twelve easy lessons studied during your spare moments, will make you highly proficient. Our system was originated and prepared for us by the famous JOHN MARTELL, one of the best known masters of this instrument. Many of his pupils are today popular stage and radio artists.

## Complete Course Only \$7.00 On Easy Terms

For only \$7.00 you can obtain this complete Tenor Banjo course. We offer no banjo with our system because we realize that many already possess an instrument. For those prospective pupils, who have no Tenor Banjo, we have made arrangements with one of the leading manufacturers to supply these instruments at an exceptionally low price (further information on request). As an aid to students, who desire it, we offer this system on easy terms. Just send us \$2.00 and we will send you the lessons in twelve successive weekly mailings. The balance is payable in five weekly payments, \$1.00 each. A 10% discount is allowed to those who make full payment in advance.

**Fill Out and Mail This  
Coupon NOW  
Tomorrow It May Be Forgotten**

NEW YORK INSTITUTE OF MUSIC  
143 East 34th St., New York, N. Y.

- Check One  Enclosed find cash, check or money order for \$6.30 (list price less 10%) in full payment for course.  
 Enclosed find cash or money order for \$2.00 for which please enroll me for the Martell Home Banjo Course. Balance will be paid in 5 weekly installments of \$1 each.  
 Please send further information.

NAME.....

ADDRESS.....

CITY.....STATE.....

# AMAZING STORIES FREE

Stories by  
H. G. Wells, Jules Verne, etc.

In order to get new friends and acquaintances with the wonderful contents of Amazing Stories, the magazine that has grown to an enormous circulation overnight, we will send a copy of the latest issue to anyone who writes, **absolutely free**. Amazing Stories for the first time offers you an opportunity to read novels that will hold you spellbound—they have that scientific twist that baffles, and heretofore were only procurable in volume form at a cost of anywhere from \$2 to \$5 each. Such well known writers as Jules Verne, H. G. Wells, Garrett P. Serviss, and others of equal fame, are among the contributors. In a single issue you get over \$2 worth of reading for 25c. Find out for yourself what a wonderfully interesting magazine **Amazing Stories** is by sending for a free introductory copy of the latest issue. Just send your name and address and you will receive it by return mail.

AMAZING STORIES, 51P PARK PLACE, NEW YORK

## I Made \$100,000

in less than five years as a

### REAL ESTATE SPECIALIST

Started during my spare time, with no experience and less than \$5 capital. If you want to learn the secret of my success and follow my money-making method, send your name and address at once to American Business Builders, Inc., Dept. 44-AA, 18 East 18 St., New York. They send full information free, telling you how you can build up an independent, profitable business of your own by using my amazingly successful system.

## ABSOLUTELY THE LAST CHANCE

### To Get This Great Book FREE

For a short while we have been giving Bishop's great book on ELECTRICAL DRAFTING AND DESIGN free with the pay-raising Croft Library. Hundreds of men have jumped at this big book bargain—a great bargain, indeed, at a special low price—on small monthly payments. It will pay you to see

### The Croft Library of Practical Electricity

A combined reference library and home study course, 8 volumes, 3000 pages, 2100 illustrations, flexible binding, \$1.50 in ten days and \$2.00 monthly for nine months—only 7 cents a day.

The man who gets anywhere in any line of endeavor is the man who KNOWS. And generally the more he KNOWS the more he EARNs.

For the man who wants to know there is nothing better than these eight volumes packed to the covers with sound, helpful information on every phase of electricity from first principles to central station work.



SEE IT FREE—

No obligation to Purchase

By just filling out and returning the coupon below you will have, at no cost to you whatsoever, a practical, useful set of books for 10 days' Free Examination. We take all the risk—pay all charges. You assume no obligation—you pay nothing unless you decide to keep the books. Send the coupon NOW and see the books for yourself. When your first payment of \$1.50 is received we will send you your free copy of Bishop's ELECTRICAL DRAFTING AND DESIGN.

### FREE EXAMINATION COUPON

McGraw-Hill Book Co., Inc., 370 Seventh Ave., New York

Send me for 10 days' free examination the Croft Library of Practical Electricity. If satisfactory I will send you \$1.50 in 10 days and \$2.00 monthly until the special price of \$19.50 is paid. If not wanted, I will return the books at your expense. On receipt of my first payment of \$1.50, it is understood that I am to receive, free of charge, a copy of Bishop's ELECTRICAL DRAFTING AND DESIGN.

Signed.....

Address.....

City and State.....

Position.....

Employer..... P.M. 1-1-37

# Sweeney Says You, Too, Can Have Money in Bank, \$5,000 Home, 2 Cars

**"E. J." Himself**



Listen, man: Do you want money? Do you want independence? Do you want a sure trade that pays \$50 a week up? Do you want to travel and see the world? How would you like a good driving job? Or a place in a repair shop? Or your own service, tire or battery station?

## BIG SPECIAL OFFER

Never before have I made such an amazing offer. I now make it possible for you to come to this Sweeney Million Dollar Trade School right now. If you are mechanically inclined—if you are willing to work and make a little sacrifice for a few weeks you can ABSOLUTELY PROMISE YOURSELF to make your dream come true. You don't need experience; you don't need education. I train you in REAL SHOPS—with tools, not books. Here's a million dollar investment to back my GUARANTEE. Over sixty thousand men in all parts of the country will tell you what I say is true. Over 20,000 of my men are in business for themselves.

HERE'S a letter that shows what you can do. \$10,000 CASH says it is true and genuine. Why man—I can show you 500 or a thousand letters just as good. YOU may not have to go broke to pay for your training. But even if you do, what's the odds? See how well it paid Hawkins to go broke.

Dear E. J.:—

All I can say is I was broke when I left Kansas City—had only 25 cents over my ticket to Meridian; came here—went to work in the Dodge Service Station. Then in N. East Service Station—then opened up a service place of my own. Now moved in a larger place— $\frac{1}{4}$  block square. Keeping six mechanics busy. Just built a nice home for over \$5000. Own my own car, and wife has hers—sedan. Owe no one, have good stock on hand and money in the bank. I can honestly say—it was Sweeney's wonderful training that did it. Before I went to Sweeney's I worked in a dry goods store as clerk—drawing one of top salaries, \$22.50 a week. Now the expenses of my three kids in boarding school are more than the \$22.50 a week I used to make.

I am still with you in the air at night—using an eight-tube set, Western Electric amplifier. A. J. Hawkins, Meridian, Miss.

# MEN WANTED

## Get This FREE Book Today!

Just send me your name and I will send you a 64-page big illustrated book. I have put into this fascinating book a lifetime of mechanical experience. It is full of real pictures—shows how mechanics do all kinds of expert jobs. Lists the opportunities in the business. Tells just what to do—where to go—to make good. Explains step by step how to learn to be a skilled mechanic. Answers every question. Many a mother and father reading this book have been inspired to make sacrifices and help their sons out. Tells all about the world famous Sweeney System—adopted by U. S. GOVT. during the war to intensively train soldier motor mechanics. Shows how easy it will be for you to FIT YOURSELF for a real job, independence and prosperity. I will send this to you free—no cost—no obligation. Write for it today. No colored students accepted. Answer this NOW. Remember I am making the most amazing offer in the history of this school.

**E. J. SWEENEY**

**E. J. SWEENEY,**  
President

**Send this**

**NOW**

**LEARN A TRADE—**  
**Sweeney**  
AUTOMOTIVE & ELECTRICAL SCHOOL  
3331 SWEENEY BLDG. KANSAS CITY, MO.

**EMORY J. SWEENEY, President**  
Dept. 3331 Sweeney Building, Kansas City, Mo.

Send me free, without any obligation on my part, your 64-page catalog and special offer.

NAME.....

GIVE AGE.....

P. O.....

STATE.....

# Learn Drafting in 4 Months

## CHICAGO TECHNICAL COLLEGE

If you are earning less than \$50 a week, here's a vital message that concerns you. The field of Drafting needs wide awake men quick . . . men who are serious about their future. 4 months from today you can be firmly established in drafting's fertile field. Young men with this training earn \$60 to \$100 a week . . . and more.

Here is interesting work. Contact with big business, big men, real go-getters. "Send us more draftsmen" is the call that comes to us, from engineering, electrical and architectural firms, railroads and the country's great building industry where billions are being expended each year. Train with us and you hurdle the low pay handicap. Earn big money. Better living. More for you . . . more for your family.

### FREE 72-Page Book

Find out about this 23-year old school. The organization, men behind it, and our short time courses in Engineering, Electricity, Architecture and Building. This book gives you the facts you want to know. Gives you a vivid picture of the important part you can play in a surging industry. You will want this book . . . will need it. Just mail the coupon. It costs you nothing.

23rd Year

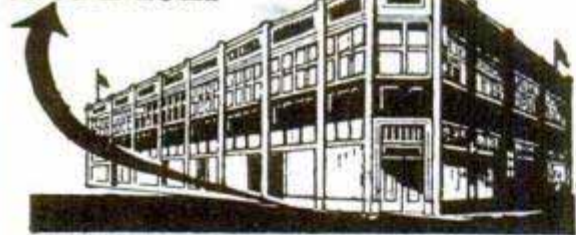

#### In Spare Time At Home

If you can't come to Chicago, learn Drafting at home. Your spare time is enough. Same practical course. Same short-cut methods. Quick, easy — yet thorough.

#### TRIAL LESSON FREE

Test yourself and see how easy to learn Drafting by Chicago Tech method. Trial lesson sent FREE if interested in home-study. Mark coupon.

### In 4 Months at Chicago Tech

Spend 4 happy months at Chicago. Center of engineering progress. Here at this old established and well known school for engineers and draftsmen, 16 weeks of fascinating study and you leave for home. All set to make big money. Equipped to reap rich rewards. Specially trained to enter a field seething with opportunities. A common schooling is all you need. Practical instructors. Part time work available; earn while you learn. Free employment service. Living accommodations arranged for. Day or Evening Classes. Athletics. Enter any time. Graduates quickly get good jobs. Take the step that has meant so much to thousands of our graduates . . . and will mean as much to you. Send no money, just fill in coupon and mail now, today.

#### MAIL COUPON TODAY

**CHICAGO TECHNICAL COLLEGE**  
Dept. A-400, 118 E. 26th St., Chicago, Ill.

Please send me, without obligation, free and postpaid, your 72-page Blue Book and facts about how to qualify for a good drafting job in 4 months.

Name .....

Address .....

Town or City ..... State .....

Age ..... Occupation .....

At Chicago Tech, or  by Home Study. Mark choice with an "x"

**CLIP and MAIL COUPON-NOW**

## EAT FOR OCCUPATION



You would not feed any automobile with milk instead of gasoline, nevertheless you are most likely eating muscle meals to prepare yourself for brain work, etc. Then why wonder when unsuccessful and ailing?

Chemical analysis is not sufficient guide to human diet. Write us for particulars of Government Bulletins describing biological experiments on convicts, hens, cows, etc. Deficient feeding produced disease, whereas full nutrition corrected e. g. paralysis, blindness in hens, rats, etc.; beriberi, skin affections, etc., in men.

Biologic tests made only in the last few years disclose that **three quarters of the food eaten, although good, is inappropriate**, producing WASTE products in blood and tissues, three quarters starvation, lower efficiency, minor ailments, and finally disease, the lowest depth of inefficiency. **FULL NUTRITION** is needed.

Delicious **Brainy** meals make brain work easy. **Muscle** meals, to a brain worker, are mostly injurious WASTE.

To speakers, singers **mucus-making** foods are injurious WASTE.

Removal of WASTE needs **solvent and laxative** meals. Waterfree meals can multiply effects.

Our **chart and key** enable you to separate and trace for yourself the **DIRECT EFFECTS** of each food, to remove waste products, inefficiency, disease. **Educational Booklet 10c. BRINKLER SCHOOL OF EATING, Dept. 42N, 136 West 72nd St., New York.**



### LEARN WATCHMAKING AND ENGRAVING



#### BY OUR PROFIT-SHARING PLAN OUR GRADUATES SUCCEED

One of our Iowa students started in a very small way—now doing over \$30,000 a year. Another in Wisconsin, over \$10,000 the first year. Day or night classes. Call or write for FREE BOOK

Chicago School of Watchmaking, Dept. 2401, 4844 Lincoln Avenue, CHICAGO



## Don't Let Anybody BULLY YOU

### Learn Scientific Tricks of Physical Mastery

By a few simple tricks you can have any assailant at your mercy quick as a flash. The astounding secrets of self-defense, used by the New York Police, are revealed in the marvelous, officially recognized system—

### Captain Wallander's Course All Complete In Physical Training Manual

By Capt. A. W. Wallander

Commander Physical Training, New York Police

A complete course in physical culture. Scores of gripping action photos showing just how to throw a bigger man and overpower him—disarm a hold-up thug—build up muscle—keep in fighting trim. Hundreds of health hints, too; care of the feet, prevention of colds, correct posture, walk without fatigue. This is the genuine book used by the New York Police, now available TO YOU.

**Easy to Learn** Let Capt. Wallander give you his great secrets and detective tricks. You'll hardly believe that such valuable knowledge could be learned so easily.

#### ALL YOURS IN WORLD'S MOST AMAZING COURSE

In Physical Culture and Police circles this volume is world famous. Send immediately for your copy. **DON'T SEND MONEY NOW.** Send coupon today. When volume arrives, pay the postman \$1.97, plus few cents postage. If you are **\$1.97** not satisfied return volume and get money back.

SIEBEL PRESS, 34-C W. 20th St., New York.

Send me Capt. Wallander's Physical Mastery Course as contained in the "Physical Training Manual."

Name .....

Address .....

City ..... State .....

(\$2.25 U. S. Cash with order outside the U. S. A.)



# \$2500 Reward!

## For the Capture of an Unknown Man

Twice he had entered the St. Clair Mansion. What was he after? Who? What was in danger?

Berteau, the famous detective, had warned St. Clair that *the mysterious marauder would come again*. And now—a noise in the passage! The creak of an opening door. A shot in the dark! A capture!

Is this wounded stranger the mysterious intruder? Who could tell? Yet Berteau identified the man without hesitation and won the \$2500 reward.

How did he do it? Easy enough for the Finger Print Expert. He is the specialist, the leader, the *cream* of detectives. Every day's paper tells their wonderful exploits in solving mysterious crimes and convicting dangerous criminals.

## More Trained Men Needed

The demand for trained men by governments, states, cities, detective agencies, corporations, and private bureaus is becoming greater every day. Here is a real opportunity for YOU. Can you imagine a more fascinating line of work than this? Often life and death depend upon finger print evidence—and big rewards go to the expert. Many experts can earn regularly from \$8,000 to \$10,000 per year.

## Learn at Home in Spare Time

And now you can learn the secrets of this science at home in your spare time. Any man with common school education and average ability can become a Finger Print Expert in a surprisingly short time.

# Course in Secret Service

# FREE

For a limited time we are making a special offer of a *professional Finger Print Outfit, absolutely Free, and Free Course in Secret Service Intelligence*. Mastery of these two kindred professions will open a brilliant career for you.

Write quickly for fully illustrated free book on Finger Prints which explains this wonderful training in detail. Don't wait until this offer has expired—mail the coupon now. You may never see this announcement again! You assume no obligation—you have everything to gain and nothing to lose. Write at once—address

**University of Applied Science**

Dept. 13-51

1920 Sunnyside Avenue, Chicago, Illinois

### UNIVERSITY OF APPLIED SCIENCE

Dept. 13-51—1920 Sunnyside Ave., Chicago, Illinois

Gentlemen:—Without any obligation whatever, send me your new, fully illustrated, FREE book on Finger Prints and your offer of a FREE course in Secret Service Intelligence and the Free Professional Finger Print Outfit.

Name .....

Street Address .....

City and State .....

# Science Discovers the Secret of CARUSO'S Wonderful Voice



*Why is it that the humble peasant boy of Italy became the greatest singer of all time? This diagram of his throat will show you. Caruso's marvelous voice was due to a superb development of his Hyo-Glossus muscle. Your Hyo-Glossus muscle can be developed, too! A good voice can be made better—a weak voice become strong—a lost voice restored—stammering and stuttering cured. Science will help you.*

## Your voice can be improved 100%

A few very fortunate persons—like the late Caruso—were born with the ability to sing well. But even Caruso had to develop his Hyo-Glossus muscle before his voice was perfect. You can develop a beautiful singing or speaking voice if your Hyo-Glossus muscle is strengthened by correct training. Professor Feuchtinger, A. M.—famous in the music centers of Europe for his success in training famous Opera Singers—discovered the secret of the Hyo-Glossus muscle. He devoted years of his life to scientific research and finally perfected a system of voice training that will develop your Hyo-Glossus muscle by simple, silent exercises right in your own home. The Perfect Voice Institute guarantees that Professor Feuchtinger's method will improve your voice 100%. You are to be your own judge—if your voice is not improved 100% in your own opinion, we will refund your money.

## Grand Opera Stars His Students

Hundreds of famous singers have studied Physical Voice Culture. Over 10,000 happy pupils have received the benefits of his wonderful training. You do not know the possibilities of your voice. If you want to sing—but lack the proper training because you have not the time nor means to study—here is your chance. You can now train your voice at a very small cost in the privacy of your own home. If you want to improve your speaking voice—if you stammer or stutter—Prof. Feuchtinger will help you.

### Inspiring New Book FREE!

You will do yourself a great and lasting good, by studying the new book, "Physical Voice Culture." It may be the first step in your career. Do not delay. Mail the coupon today.

#### Perfect Voice Institute

1922 Sunnyside Avenue      Studio 13-51      CHICAGO

#### Perfect Voice Institute

1922 Sunnyside Avenue      Studio 13-51      CHICAGO

Please send me FREE your new book, "Physical Voice Culture." I have put X opposite the subject that interests me most. I assume no obligations whatever.

..... Singing ..... Speaking ..... Stammering ..... Weak Voice

Name .....

Address .....

Age .....

# FREE To Machinists

## POPULAR MECHANICS MAGAZINE

has prepared a table of decimal equivalents of the fractions of an inch, a copy of which will be mailed free to any machinist or auto repairman upon application. The table is 16½ in. wide by 23 in. long, printed on good, heavy paper, and will prove of great value in any shop.

There are no strings to this offer; simply send us your name, and the address of the shop or garage in which you work, and the table will be forwarded at once, carefully wrapped, and postpaid.

Address .....

### The Editor, Shop Notes Dept.

Room 101, Popular Mechanics Bldg.  
200 East Ontario Street, Chicago, Ill.

# Do Your Own Paper-Hanging!

"The Expert Paper Hanger,"

by A. Ashmun Kelly, tells you exactly how to remove old paper, prepare walls, trim, paste and hang all kinds of paper, canvas, burlap, etc. Gives tested recipes for best pastes and sizes for all kinds of walls.

## Easy When You Know Methods of Experts

This book shows how to get best results. Explains every detail. No experience needed. You can paper your own home and save money.

### Sent on 5 Days' Approval—Send No Money

Over 185 pages of concise, easily-used information. Handy volume, cloth-bound. Pay postman only \$2.50, plus few cents postage. Money refunded if you return within 5 days.

Catalog of Mechanical and Engineering Books FREE All standard makes on House Painting, Interior Decoration, Wood Finishing, Mechanical Drafting, Auto Mechanics, etc. Send for it now.

DAVID McKAY CO., Dept. 21, 604 S. Washington Sq., Philadelphia, Pa.

DAVID McKAY CO., Dept. 21, 604 S. Washington Sq., Philadelphia, Pa.

Send me "The Expert Paper Hanger" by A. Ashmun Kelly, with your Free Catalog. I will pay postman \$2.50 plus postage, you to refund if I return book in 5 days.  Check here if you wish catalog only.

Name .....

Address .....

City ..... State .....





# He gets the *biggest* check on the payroll!

**J. A. NADEAU**—Owner of Los Angeles Ford agency, says:

"Jimmy Dunn is my best man. The training he got at National Automotive School made him a genuine Automotive Expert. I wish I could get more men like Jimmy. There's no limit to the money they can earn."



**JIMMY DUNN**—Highest salaried man in the Nadeau organization, and only 24 years old, says:

"I owe my success to National Automotive School training. It has increased my pay 450 percent. I certainly advise any man entering the auto industry to get National training."



**"Give us more Expert Auto Men like Jimmy Dunn. We'll pay them \$300.00 a month—and more!"** says J. A. Nadeau, employer

—and three years ago, Jimmy Dunn was an inexperienced "green kid." He knew *nothing* about automobiles—had never earned over \$110 a month—and he realized it would take him years to learn the auto business by working as a garage hand.

So he took a short cut to Big Pay by going to National Automotive School. There expert instructors showed him how to do every kind of repair work. He learned by *actually doing* on all kinds of cars and machinery in the big National shops.

## We Help You Get a Big-Pay Job

Then, National's Free Employment Service got him a job with J. A. Nadeau. In Nadeau's shops, the most difficult jobs were easy to him because of his National training. He rose rapidly—until now he earns over \$600.00 a month. His employer gave him a car in appreciation of the good work he is doing.

## Big Employers Prefer National-Trained Men

You, too, can succeed while still young, *if you have the right training*. In National's shops you pack six years of practical shop experience into six months. The automotive industry needs

men with this training. J. A. Nadeau is hiring more National graduates. C. A. Broom, General Superintendent of Howard Auto Company, Buick distributors, has instructed all branches to give preference to National-trained men. Scores of big employers and the automotive industry generally endorse National's thorough training methods. What greater proof can you ask that National training *insures* your success?



In National Shops you do actual repair work, under Master Mechanics as your instructors.

## Auto Book FREE

Why don't you decide right now to get into the big-pay class? The coupon below will start you. It brings you—*free*—the same Auto Book that started Jimmy Dunn and 16,000 other men on the road to success. It describes the practical methods used by National to develop thoroughly trained Auto men. It tells how National helps you get the job you want.

## Big Motor Boom NOW!

Right now California's biggest motor boom is on. There is a shortage of skilled men to service the millions of cars in the state. Employers are offering \$50.00 to \$150.00 a week for real Auto Experts. Do you want one of these jobs? Then mail the coupon *NOW*.

# NATIONAL AUTOMOTIVE SCHOOL

LOS ANGELES, CALIFORNIA

Over 50,000 cars a day pass National Automotive—one of the busiest corners in the world!



National Automotive School, Dept. 666  
4006 Figueroa St., Los Angeles, Calif.

Send me your big Free Auto Book describing job opportunities now open.

Name.....

Address.....

City..... State.....





## They Don't Laugh at Him Now!

**His salary has been increased 200%**

If Lester B. Marsh of Milwaukee had listened to the "wise boys" five years ago, he might still be a railroad clerk and drawing a clerk's pay.

Instead, he enrolled with LaSalle for training in Traffic Management—meantime taking a place as traffic billing clerk with an industrial concern, just to get experience. In two months, his new boss gave him a raise—five months later another.

More recently he went with the B. & O. Railroad—showed what he knew—and in two months was made chief clerk and later city freight representative.

Now—only a few months ago—he was appointed Traveling Freight Agent, at a salary 200% greater than his salary in 1920. The road ahead is clear for achievement and success.

### Send for Free Book, "Opportunities in Traffic Management"

Where do you belong in this story? Are you one of the fellows who stay in the rut and laugh at the ambitious associate who climbs out and up? Or are you, like Marsh, a determined, persistent user of LaSalle's almost unlimited facilities to help you get ready for a bigger job?

The coupon will bring you, without obligation, a 96-page book that points the way to the big rewards in Traffic Management and shows you how, within a comparatively few months, you can equip yourself to take advantage of them. LaSalle will send it to you FREE.

If you are eager to advance in a field that spells real opportunity, clip and mail the coupon—NOW!

— Find Yourself Thru LaSalle! —

**LA SALLE EXTENSION UNIVERSITY**  
The World's Largest Business Training Institution  
Dept. 164-TR Chicago

I would welcome copy of "Opportunities in Traffic Management," also a copy of "Ten Years' Promotion in One," all without obligation.

#### Traffic Management—

Foreign and Domestic; Training for position as Railroad or Industrial Traffic Manager, Rate Expert, Freight Solicitor, etc.

#### Other LaSalle Opportunities

LaSalle opens the way to success in every important field of business. If more interested in one of the fields indicated below, check here:

- |                                                     |                                                                      |
|-----------------------------------------------------|----------------------------------------------------------------------|
| <input type="checkbox"/> Business Management        | <input type="checkbox"/> Modern Business Correspondence and Practice |
| <input type="checkbox"/> Higher Accountancy         | <input type="checkbox"/> Modern Foremanship and Production Methods   |
| <input type="checkbox"/> Modern Salesmanship        | <input type="checkbox"/> Personnel and Employment Management         |
| <input type="checkbox"/> Railway Station Management | <input type="checkbox"/> Expert Bookkeeping                          |
| <input type="checkbox"/> Law—Degree of LL.B.        | <input type="checkbox"/> C. P. A. Coaching                           |
| <input type="checkbox"/> Commercial Law             | <input type="checkbox"/> Business English                            |
| <input type="checkbox"/> Industrial Management      | <input type="checkbox"/> Commercial Spanish                          |
| <input type="checkbox"/> Factory Management         | <input type="checkbox"/> Effective Speaking                          |
| <input type="checkbox"/> Banking and Finance        |                                                                      |



Name .....

Present Position .....

Address .....

# Why Good Dancers Are Popular

EVERYONE admires and wants to dance with the person who knows the latest steps. There is no need of being a wallflower! By my remarkable new easy method anyone can learn the newest dances at home in a few hours. Much less expensive than from a personal teacher. No music or partner needed. So simple even a child can learn quickly. **Almost one half million have learned dancing by mail.** Your own success is guaranteed.



Posed by Edna Murphy and Arthur Murray

To prove I can quickly and easily make you an accomplished dancer, I will send you **FREE** my 32 page book and **TEST LESSON**. To pay the cost of mailing, handling, etc., send 25c. Learn in private—surprise your friends. Act now and be a good dancer soon!  
**ARTHUR MURRAY, Studio 693, 7 East 43rd St., NEW YORK**

## SHALL I BECOME A POET?

**THOUSANDS OF DOLLARS WON, YEARLY, IN PRIZE CONTESTS.** Nothing more fascinating; nothing so easy to learn; nothing that will get you so quickly into print, as **THE P & P'S COURSE IN VERSIFICATION IN THREE PRINTED PARTS.** Clear, Comprehensive, Practical, Thorough. Prose style enhanced. Hundreds of writers praise the course. **Rev. John R. H. Latchow of Romeo, Michigan, says:** "I wish to express my sincere appreciation for the benefits I have derived from your 'Course in Versification.'" Edition limited. **Price, complete, while they last, \$1.00, postpaid. Address: THE POET & PHILOSOPHER, PUBLISHERS, 238 WEST 55th STREET, NEW YORK CITY**

## ENCYCLOPEDIA BRITANNICA

in the New Form—at a saving of 40 per cent

Write for full details. Address Dept. PM2

**THE ENCYCLOPEDIA BRITANNICA, INC.**  
342 Madison Ave., New York City

## ELECTRICAL OUTFIT

Complete

**\$50**  
value—Real tools. No toys!

## FREE

when you enroll



**TO MAKE REAL MONEY** get into electricity. No matter what your age or education, we can train you in a little while for a real job. A job where you do the bossing at \$65 a week and up. Even electrical tradesmen make big money now. The boom has just started. **WITH OUR TRAINING** you can get the kind of job you've always wanted. Or go into business for yourself. You don't have to know one thing about electricity now. Just put yourself in our hands. A

few fascinating hours a week in work with a real kick.

**WE GIVE YOU** real equipment to work with at home. The same things you use later on the real job. And a money back Guaranty that our training must satisfy you or your money back—every penny.

**22 YEARS' EXPERIENCE** in training men is our record. Commonwealth-Edison, Harnischfeger Corp., Allis-Chalmers are only a few who recommend S. of E. **72 PAGE BOOK FREE** if you mail coupon. Act today. Give yourself a chance.



Charles P. Steinmetz, A. M., Ph. D., electrical wizard of General Electric was for the last 6 years of his life on advisory board of S. of E.

## CLIP NOW!

**SCHOOL OF ENGINEERING**  
Dept. H-PM, 227, Box 572:  
Milwaukee, Wisconsin

Send me **FREE** and post-paid your big 72 page book giving details of your home study course in Electricity and money back guaranty.

**\$65 a Week and Up!**

A chance for a real career in electricity. In your own business or rapid advancement with electrical concerns.

Name .....

Age ..... Education .....

Address .....

City ..... State .....

**You Don't Need to Be  
an Engineer  
or Scientist**

**Learn by  
Actual  
Work**

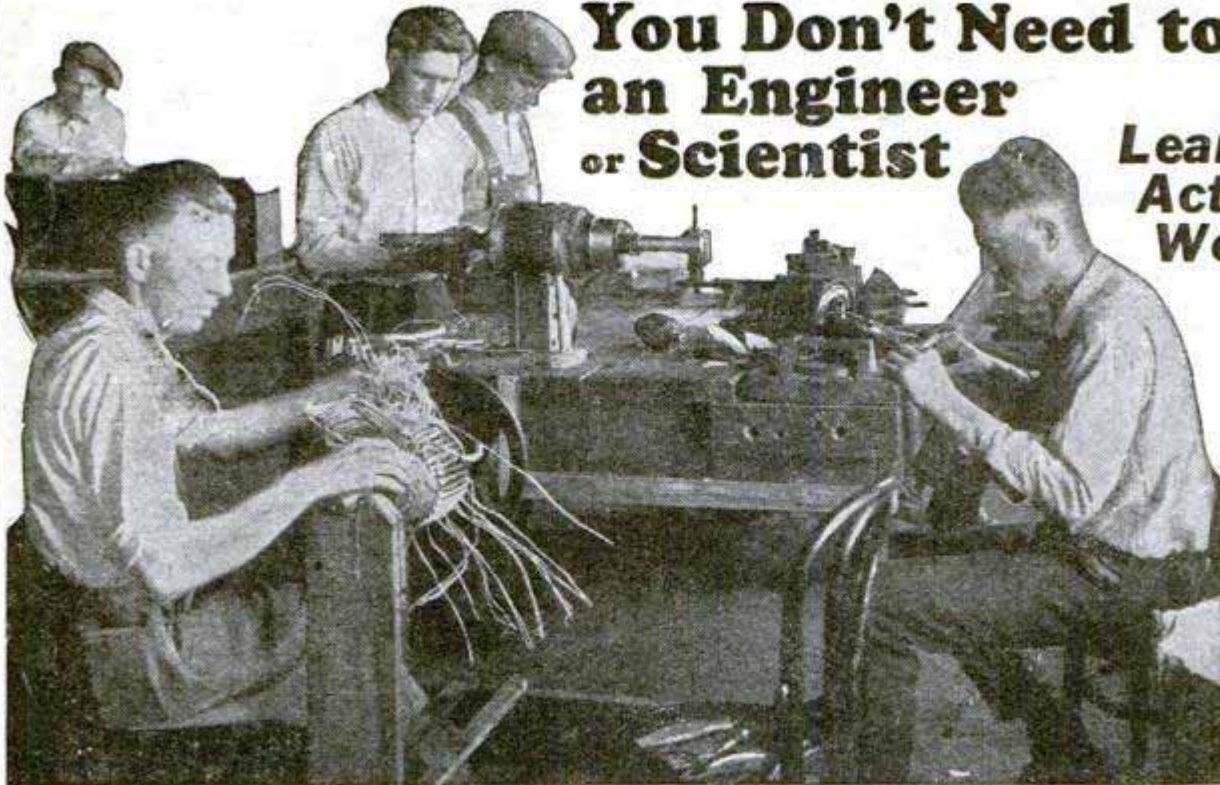

## Be a Practical Electrician

**Y**OU can qualify in three months for a real job by the Sweeney System of Practical Experience.

You don't need to be an engineer or scientist to install, operate and repair all kinds of electrical machinery. We teach with tools. You learn by actually working on our \$150,000 special equipment in this world famous Million Dollar Trade School where we have turned out 65,000 trained mechanics.

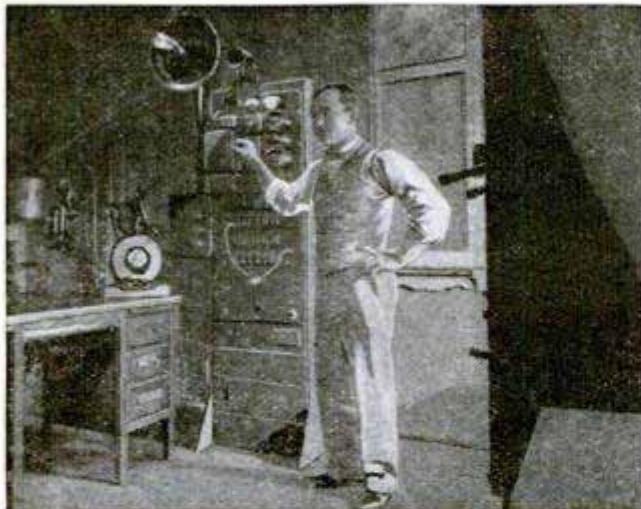

**LEARN A TRADE—**  
**Sweeney**  
**ELECTRICAL SCHOOL**  
3327 Sweeney Bldg., KANSAS CITY, MO.

Direct and alternating current—commercial work in armature and field wiring by actual practice—battery work—automotive electricity, starter and generator—radio broadcasting—care, operation and repair of all electrical machinery. Many of our graduates now in electric light plants—radio operators—electric service stations—electric repair shops. We don't teach designing and engineering but PRACTICAL OPERATION by actual experience on our complete equipment.

### Radio Operators Wanted

Learn to broadcast—be known from coast to coast—talk to millions. Lots of fine jobs open as radio operators. Actual work in our great station WHB. Complete radio course.

### THE SWEENEY SYSTEM

THE SWEENEY SYSTEM—learn by doing—makes you a practical electrician or radio man and opens up countless opportunities of profitable employment.

**Send this  
NOW**

**EMORY J. SWEENEY, President**  
3327 Sweeney Bldg., KANSAS CITY, MO.  
Please send me your Free catalog and special offer.

Name.....Age.....

Address.....

Town.....State.....

**YOU CAN EARN UP TO**  
**\$250** per month  
 salary and  
 expenses



## AS A RAILWAY TRAFFIC INSPECTOR

I have many openings for ambitious chaps in this interesting and dignified profession, where pay is good and opportunities excellent. A Traffic Inspector, sometimes called Traffic Observer, is practically his own boss, sees new faces and sights each minute of the day, and reports only to high officials who reward good work with promotion. Hours are regular—and work is healthful.



RAYMOND A. McCUE

writes: "A little more than six months ago you sent me to a position with a guarantee that it would pay not less than \$120 a month to start. I started at \$120 a month—and am now earning \$180 a month. I am an inspector no longer, but still working for the same system in a strictly confidential line, and am daily in touch with the officials and inspection department."

### No Experience Required

I have trained hundreds of inexperienced men in Traffic Inspection and placed them in good positions upon graduation. I will do it for you. I teach you in three months' spare time home study, and upon completion, I'll place you in a position paying at least \$120 per month salary and expenses to start, or refund your money. (You will notice I said "salary"—and there are no ifs about it.)

Traffic Inspection appeals to live men—it gives variety, independence and opportunity—where you are away from the monotonous desk or dirty shop—where you've an opportunity to "be somebody."

I have hundreds of letters from men I have helped to better themselves. Let me show you some.

Mail coupon today for full information. There's no obligation.

James T. Jarrell, Pres.

Standard Business Training Inst.  
Division 2—Buffalo, N. Y.

Upon Graduation

**POSITION  
SECURED  
FOR YOU**

Standard Business Training Institute  
Division 2—Buffalo, N. Y.  
Yes, I'd like to know something about  
Traffic Inspection. Send me your free  
booklet, "A Profession of Protection."  
Name.....  
Address.....  
City or Town.....

**\$7500** 400 Cash Prizes  
 Yes! 400 persons—men, women, boys, girls—who send me their names and addresses are going to receive prizes—from \$5 to \$3000—with \$500 additional for promptness. I make this offer because I want to send everyone who answers this announcement an absolutely FREE sample of my products. Send no money! No obligations! Nothing to buy—now or ever! Just say: "Send me your free sample. How can I get a prize?" Write today!

F. G. STAYTEN, Room 61, 54 W. Illinois St., Chicago, Ill.

## TELEGRAPH—RADIO

\$18 to \$35 a week while training for Radio and Telegraph Operator jobs at \$150 to \$300 per month. Write for particulars.

CHICAGO TELEGRAPH INSTITUTE

Dept. 1-1-7 1338 S. Michigan Avenue, CHICAGO

**HOT PIANO!** I received \$10 for 3 hours playing last night! There were other pianists present but they hadn't a chance. The crowd wanted real jazz and they picked on me; and I played it all by ear! Do you want to learn to play lovely harmony and jazzy melodies by ear? Write today! "PIANO BILL," 207 Ossington Ave., Toronto, Can.

## LEARN TO FLY

MAKE \$75.00 TO \$200.00 WEEKLY

We teach you theoretical and practical aviation by mail. Write for FREE illustrated folder.

UNITED STATES SCHOOL OF AERONAUTICS  
(DEPT. F) MAYWOOD, ILLINOIS



### LEARN to Play JAZZ

These Books are Simple and Illustrated for Self Teaching

Saxophone	30c	Mandolin	30c
Accordion	30c	Ukulele	30c
Guitar	30c	Piano	30c
Tenor Banjo	30c	Violin	30c

Any one of the above at 30c apiece or the entire set of 8 for \$2.00 pp.

HALLEY COMPANY, 849 E. 75th St., CHICAGO

## Big Money in Poultry



Eggs Turn into Dollars FAST!

Make \$1,000 a Year in Spare Time—Easy

Lots of room for YOU in the poultry business. 85% of the people of this country live in cities. EVERYBODY eats eggs and poultry meat—but only 15% produce them. Why not let the "other fellow" pay YOU the fancy prices? Easy to get started in back yard, on vacant lot or farm. We GUARANTEE success if you follow our methods. We show you how to feed for eggs, in winter, when eggs are high in price; how to cut feed bills; how to keep flocks healthy; how to tell laying hens, PAY-BIRDS, from loafers. Our course, produced by eighteen famous experts, endorsed by 30 leading agricultural schools, gives you thousands of sure, proved, tested Methods that make PROFITS CERTAIN. FREE book tells what we're doing for others—and what we can do for you.

### Others Say:

"You have opened up to me a pleasant and profitable way of gaining an independent living."

Seldon Anderson, R. I.

"When I enrolled for your course, I knew nothing about poultry keeping. I am now successfully operating a commercial poultry farm."

W. J. Warthen, Conn.

"Your course was a splendid investment. I recommend it for both beginners and experienced poultrymen."

Y. W. Ow, Hawaii.

MAIL COUPON TODAY



Mail this now

The National Poultry Institute  
Washington, D. C. Dept. 411-E

I am interested in your plan on "How to Raise Poultry for Profit." Send me your FREE book, without obligation on my part.

Name.....  
Address.....



**I Guarantee**  
to help  
you get  
**A Better Job**

**I**F you are now earning \$40 a week or less I guarantee to prepare you for a fine Drafting Job at home in your spare time — I guarantee to

help you find such a position at increased pay, within 60 days after you complete this training, or I will refund the small amount you pay for tuition. We make this agreement to prove that this training WILL make you a REAL DRAFTSMAN! Back of this guarantee are the entire resources and reputation of this million dollar institution.

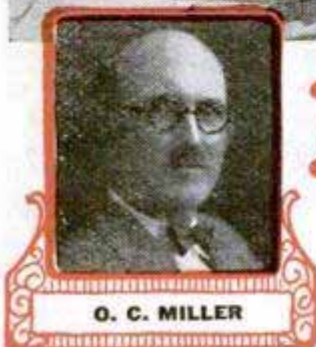

**O. C. MILLER**

**Director Extension Work  
American School**

I have recommended Drafting to hundreds of men, including the sons of many personal friends. I recommend it to you for the same reasons: Drafting offers more and better positions, higher salaries, richer opportunities for promotion than other lines of work, yet it may be quickly and easily learned at home, in spare time. You need no artistic "talent" to master it because the work is purely "mechanical." Yet it brings you into the heart of industrial activity, where important plans are originated, where all building and manufacturing are begun and detailed and supervised.

## Go into DRAFTING! Salaries \$60 to \$125 a Week

Drafting is the entering wedge to success in all building and engineering lines, in electricity, auto and mechanical industries. Thousands of well-paid positions are open **right now** in all parts of the U. S. The demand for real Draftsmen, capable of designing and calculating ORIGINAL WORK far exceeds the supply. Drafting is fascinating, pleasant work. It brings you in contact with the BIG MEN of Industry and so offers frequent opportunities for promotion.

### Drafting Made EASY to Learn!

You'll be surprised how QUICKLY you can learn by our new one-step-at-a-time method! We start you off doing actual Drafting room jobs from the very beginning. Soon we give you practice in advanced engineering subjects.

We frequently can place our students in well-paid beginner's positions within a few months after enrolling.

This guaranteed training, backed with a definite employment service, is within your reach: in understanding, because sim-

plified for men with only common schooling; in cost, because the tuition is low and the terms **only a few dollars a month!**

You owe it to yourself to look into the opportunities waiting for you in DRAFTING. Find out what salaries are paid to trained Draftsmen, what positions are open, what sort of progress they make. Find out how easily you can learn the work, and how we help you every step of the way until you are actually in a good Drafting Job. Mail the coupon—NOW—and I'll give you all the facts.

*O. C. Miller*



### Professional Outfit Given

You will naturally expect the American School to give you the best kind of instruments and tools with the best kind of training. This outfit is good enough to use professionally after you finish your training.

**O. C. MILLER, Director Extension Work**

**The American School**

Dept. D-174

**Drexel Ave. & 58th St., Chicago**

**O. C. MILLER, Director Extension Work  
THE AMERICAN SCHOOL, Dept. D-174  
Drexel Avenue & 58th Street, Chicago**

Send me facts about the opportunities I can find in Drafting, and explain how I can become a real Draftsman at home in spare time.

Name.....

St. No.....

City.....

State.....



# New Way to Make Money at Home



Tilt Top Tables



Brass Candle Sticks



French Powder Box Dolls



Many Parchment Shades



Handy Magazine Rack

WOULD you like to turn spare hours into dollars? Would you like an independent business of your own? Here is a new way to earn money, unlike anything ever offered before. There is no canvassing, no tedious drudgery. This is the most delightful kind of work. And it pays amazingly well. Many have earned from \$20 to \$50 a week and more.

### No Special Ability or Experience Needed

The national organization known as Fireside Industries has openings for new members to decorate Giftwares at home. You have only to follow the simple directions for decorating all kinds of fascinating articles, hand-painted candlesticks, plaques, picture frames, greeting cards, wooden toys, parchment lamp shades, hand-painted furniture, batik and other beautiful art novelties. Under the wonderfully simple method devised by our Art Director, Mr. Pettit, even a child could do the work. Complete outfit furnished every member, free.

### Your Satisfaction Guaranteed

Think of decorating a pair of candlesticks, for example, in one hour and realizing a profit of \$2.00! Best of all, we are sure that you can learn to do the work successfully. There is absolutely no risk, nothing to lose.

### Beautiful Book FREE

No matter where you live you can be one of the happy, successful members of Fireside Industries. Mail the coupon or write today for the beautiful illustrated Book that explains everything. We will send it FREE. But you must be prompt as new members are wanted at once; this golden opportunity may not come to you again. Enclose 2c stamp to help pay postage.

Member National Home Study Council.

**FIRESIDE INDUSTRIES, Dept. 66-A, ADRIAN, MICH.**

**FIRESIDE INDUSTRIES, Dept. 66-A, Adrian, Mich.**  
Gentlemen: Without obligation on my part, please send me, FREE, the book of Fireside Industries which tells how I may earn money at home by Decorating Giftwares; also particulars of your Money-Back Guarantee and special cooperative privileges and services. I enclose two cent stamp.

Name.....  
Address.....  
City..... State.....  
(Write in pencil—ink will blot.)



# Choose as Your Profession Electrical Engineering

Electricity offers a brilliant future to the young man who is about to choose his career. Never before has there been such wonderful opportunity in this great field. Big paying positions in electrical work the world over are open to trained men—men who possess specialized, practical knowledge. Come to the School of Engineering of Milwaukee—the largest and best equipped electrical school in America. Here you are trained in both theory and practice by a faculty of experts. You learn in large, completely equipped laboratories. If you have 14 high school credits or equivalent, you can become an Electrical Engineer with a Bachelor of Science degree. Any credits you may lack can be made up in the short intensive Junior Electrical Engineering Course.

## B.S. Degree In 3 Years

### A Complete, Pradical, Electrical Education

Learn by the thorough, approved scientific methods which our twenty years of specializing enable us to give you. In addition to Electrical Engineering, the following complete courses are given: **A. C. and D. C. Armature Winding—Wiring and Testing—Junior Electrical Engineering—Electrotechnics—Commercial Electrical Engineering—Automotive Electricity—Radio Broadcasting Transmitters, Receivers & Code.**

## Earn While You Learn

By our special system you may earn part of your way while learning. Our Employment Department will secure you a position to which you may devote a part of each day, spending the remainder at the school. This plan both solves the students' financial problems and provides splendid experience at the same time. Low tuition fee. Board and room reasonable. Daily Broadcasting WSOE. School Orchestra. Fraternities.

**New Term Begins NOW**

### Write for FREE Catalog

Write today for our free, illustrated catalog. Read about this wonderful institution and the great opportunities that lie before you. Find out about our specialized method of training and the details of our "Earn While You Learn" plan.



FOUNDED 1905  
Dept. P.M. 127, Jackson and Oneida Sts., Milwaukee, Wis.

**SCHOOL OF ENGINEERING OF MILWAUKEE**  
Dept. P. M. 127 Jackson and Oneida Sts. Milwaukee, Wis.

Without obligating me in any way, please mail free 64-page illustrated book, "Electricity and the One Best Way to Learn It," and particulars regarding the course I have marked with an X.

- ..... **Electrical Engineering.**
- ..... **Commercial Electrical Engineering.**
- ..... **Junior Electrical Engineering.**
- ..... **Electrotechnics.**
- ..... **Armature Winding.**
- ..... **Light, Motor Wiring and Testing.**
- ..... **Automotive Electricity.**
- ..... **Radio.**
- ..... **Home Laboratory Service.**

Name.....Age.....  
Address.....  
City.....State.....  
Education.....

ENGINEER, estimator for structural steel and ornamental iron work shop, located in Northern Florida. Must have considerable experience and be capable of making complete estimates. Also capable of doing some sales work. Apply by letter immediately stating fully age, salary desired and where.

ORNAMENTAL iron draftsmen wanted. Permanent positions for capable draftsmen. State experience, salary desired in first letter. The Business Office, Box 415.

WANTED—A first-class ornamental iron draftsman, competent to take charge and develop an efficient ornamental drafting department; none but thoroughly experienced men will be considered. apply by mail, giving complete outline of experience, salary expected, and date available. Iron Works, 28th Street.

# WANTED!

## Ornamental Iron Draftsmen—at Big Pay!

Here's one profession where the job goes after the man. Beginners get \$65 a week. Would you like to earn \$500 a month or more in a high-grade position, with splendid chances to advance? The competent Ornamental Iron Draftsman has the highest paid job in drafting.

### Get Into This Growing Business—NOW!

It was almost unknown 25 years ago. Today hundreds of architects and ornamental iron manufacturers cannot find good men. Read the classified ads above, clipped from recent trade papers. We are receiving requests constantly for qualified men.

Large office buildings, stores, theatres, etc., use ornamental iron and bronze costing hundreds of thousands of dollars for entrances, stairways, store fronts, elevators, etc. It has become a big, permanent factor in modern building construction.

#### Learn at Home

The ordinary draftsman cannot do this work, but he can learn in spare time. The American Institute Course gives you a thorough training in everything the ornamental iron draftsman must know. No books or higher mathematics, or previous experience necessary. Practical from A to Z, 22 years' experience back of this Course. We help you get a good position as soon as you can qualify, without charge.

vious experience necessary. Practical from A to Z, 22 years' experience back of this Course. We help you get a good position as soon as you can qualify, without charge.

#### Get This Book

Look into this—now! Get this book "KNOWLEDGE, Your Greatest Asset," post yourself on this business, and learn what rapid progress is possible if you start with the right training. Mail the coupon now or write us, giving your age and occupation.



American Institute of Ornamental Iron & Bronze  
3011 Hennepin Ave.  
Minneapolis, Minn.

Please send book "KNOWLEDGE Your Greatest Asset."

Age..... Occupation.....

Name.....

Write address plainly in margin



"Mac" Himself

America's Foremost Trainer of Auto and Tractor Mechanics.

# HELP! HELP! HELP!

Thousands of **BIG PAY JOBS** CRYING FOR **TRAINED AUTO MECHANICS**

Louder and louder comes the call for more expert auto and tractor mechanics for Big Pay jobs. Millions of jobs and only a few thousand men properly prepared to fill them. If my great schools were twenty times as big I could not turn out mechanics fast enough to meet the demand for trained men.

You Learn **8 WEEKS** in Only

**\$85 to \$125 WAGES** Weekly

My practical training is complete and is easily learned in 8 short weeks. Your money back if not satisfied. No extras to pay for. No book study; very little schooling required. Read below my special LIMITED FREE OFFER.

Work at home or see the world. Or open your own repair shop and earn up to \$10,000 yearly profits. Men who know how to repair American made cars are needed in every foreign country. Thousands more shops are needed, here and everywhere. Send the coupon TODAY sure.

## MCSWEENEY AUTO, TRACTOR AND ELECTRICAL SCHOOLS

Dept. AX-14 Cincinnati, Ohio  
Cleveland, Ohio  
Chicago, Ill.

**HURRY!** I pay your R. R. fare to my school and Board you 8 weeks

**FREE**

MCSweeney Auto, Tractor and Electrical Training Shops, Dept. AX-14, (Address shops nearest you) Cincinnati, O., Cleveland, O., Chicago, Ill.

Without any obligation send me your big free book on Autos. Also information regarding Special Reduced Price Tuition temporary offer.

Name.....

Street.....

City..... State.....

# Money-Making Tools



To those who enroll in near future—tools **FREE** of any extra cost whatever. Also, a drafting table! Act now!

**I need YOU with 100 firms BEGGING ME to send them more DRAFTSMEN. Many offer to take BEGINNERS, at \$50 a WEEK. Graduates can start at \$90 and \$100! GET BUSY!**



Drafting is the BIG field, men. Every industry you can name BEGINS with the draftsman. Without mechanical drawings—by the thousands—every shop in the land would be STOPPED.

In fact, it is the SERIOUS SHORTAGE of draftsmen that brings this offer: *I will furnish all instruments, supplies, even to the table, to those who start now!*

**PAY AS YOU GO** Don't give me the excuse that you have no ready money for this golden opportunity. I am not so interested in cash; I want your application. I want at least 200 men to start *right now*. I want them ready to recommend by Spring! We will get a flood of letters saying "send us draftsmen," from every sort of industrial and engineering concern, and we *must* make good.

The first week's pay envelope of many a Dobe-trained draftsman has held enough to cover the entire cost of the course! Most students learn evenings, keeping on with their old work until ready to step into somebody's drafting room. The first month equips you to take on simple drafting jobs on the side. It helps you learn; I gladly permit this.

### Well-Paid Positions Every Way You Turn

A draftsman soon forgets the days when he used to wonder where to get a job. Instead, he asks "What line of work interests me most?" And "What part of the country suits me best?" Twenty of my graduates went to Florida this year; three are in Japan; last month one wrote me from Ceylon. And I wish we had the count of how many Dobe draftsmen have become chiefs!

Positions loom up almost as soon as you are enrolled in a Dobe class! We receive requests *daily* for junior men—for men only partly through our course. "We'll take a *beginner*," some concerns write us, "so long as he is a Dobe-trained man and has begun *right!*"

**IT'S EASY** and interesting to learn drafting. For drafting isn't "drawing"! You don't need any "talent." A draftsman uses *tools* for every line and every curve. You couldn't make them crooked if you tried! That's why drafting is so easily learned—and so interesting. *For you do everything by rule.* So, I guarantee to make *anyone* a finished draftsman; if you can read and write, you can learn this line. One of my students is 51 years old; another is just seventeen. *But they'll all be making a grown-up salary by Spring!*

**WARNING!** The special offer of tools is for immediate action. Don't expect me to hold it open indefinitely. Clip the coupon *now* for free book:

CHIEF DRAFTSMAN DOBE, Div. 83-51  
1951 Lawrence Avenue  
Chicago

### Special Tool Offer

Send me **FREE** and **POSTPAID** Successful Draftsmanship Book and material telling all about your home course, terms, etc.



Name.....Age.....

Address.....

P. O..... State.....



# WANT THIS JOB

**\$141<sup>67</sup> to \$275 MONTH**

ON REGULAR MAIL CARRIERS (City or Rural)

FRANKLIN INSTITUTE Dept. E 311

Rochester, New York

Steady—common education sufficient. Big chance for men, 18 up. Rush to me, WITHOUT CHARGE 32-page book with full particulars telling how to become a mail carrier or Post Office Clerk. Send sample coaching.

Mail Coupon Today Sure Name.....

Address.....

## Better Handwriting

Easily learned, on wonderful new patented device. Children like it, adults pleased. Agents wanted. Sample 98c. Write for information today. VIC. HANSEN, WALLACE, IDAHO

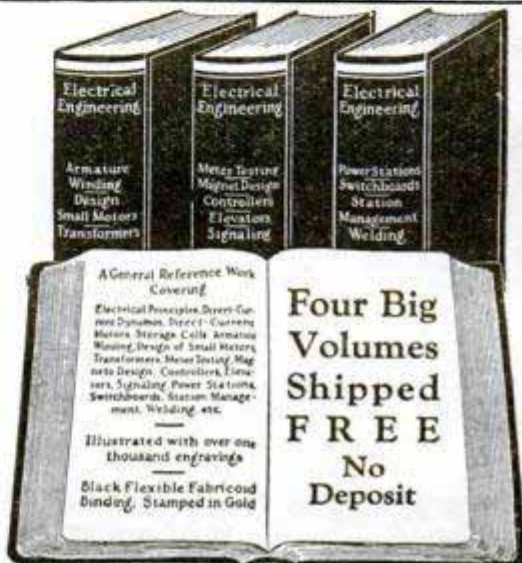

Four Big Volumes Shipped **FREE** No Deposit

## This Secret Helps Make Money

Know how to find what you need to know, easily and quickly, when you need to know it. That's the Secret. No need for long, tedious hours poring over "lessons" at home or in the classroom. Men who know this Secret get any job done, while others are wondering how to do it! How simple and easy this is, is here explained for every ambitious man who will take advantage of this Extra Special Offer to become an **Electrical Expert.**

## SCANT SCHOOLING NO BAR TO SUCCESS

Costly technical education, years of study not necessary. Steinmetz, of General Electric, was a poor, uneducated immigrant. Benjamin Franklin, who first drew electricity from the clouds, went to school only 2 years. Edison was a railway clerk. Volta, Faraday—ALL THESE WERE MEN OF SCANTY SCHOOLING. They had none of the advantages now offered you to help you become an expert in electricity.

## INCREASE YOUR EARNINGS

Benefit by the knowledge and experience gained by hundreds of electrical experts. All the important facts are in these 4 compact volumes—everything that you will need to know about electricity. With these books you should INCREASE YOUR EARNINGS far beyond what you can *ever* make if you go on in your present job. Clearly and simply written, anyone can understand. Dynamos, motors, lighting, signals, wiring, radio—with these books you can design, build or repair them all. Whatever you need, it's there, instantly available. THE SECRET, JIFFY INDEX shows at a glance any subject you need, everything about it, completely told, diagrammed and illustrated, without reading pages and pages. Now offered at the lowest price and on the easiest terms we ever made.

## SEND NO MONEY

Only name and address—then when the books arrive show them to your friends. No lessons, no examination papers, no studying required. JIFFY INDEX shows anything you want in less than a minute. If convinced, send only \$2.00 in ten days, then only \$3.00 monthly until you have paid the special low price of only \$19.80 for all. MEMBERSHIP FREE! If you send now, we will make you a member of the American Technical Society, giving you all the privileges of consulting our experts any time without cost. This alone is a priceless advantage. Our Employment Department is also at your disposal. Keep the application blank we send with the books to be used if you decide to look for a better job. So send TODAY!

AMERICAN TECHNICAL SOCIETY, ELECTRICAL DIVISION, E-119, CHICAGO, ILLINOIS. You may send me your new complete Electrical Engineering library, (1926 edition), 4 big volumes, bound in flexible covers, for ten days' Free Examination. If satisfied, I will send you \$2.00 then and \$3.00 per month until the special low price of only \$19.80 is paid, otherwise I will return them and owe you nothing.

Name.....  
Address.....  
City..... State.....  
Reference.....



# Learn How to BOX

## JIMMY DeFOREST BOXING COURSE

### Develops Champions by Mail

In 20 weeks, the system of Jimmy DeForest, *World's Greatest Trainer and Maker of Champions*, gives you the priceless knowledge that made Jack Dempsey his millions and fortunes for a host of other Jimmy DeForest-trained ring stars. Every 6 months, 30 pupils are selected from all weight classes and recommended to leading promoters for engagements. That's how promising lads are brought to the front at once. Jimmy DeForest-trained boys, once rank amateurs, are today earning big money; weaklings have been made strong; men have learned the art of self-defense.



### Hundreds of Successful Pupils

Joe Canamare, DeForest-trained boxer, hailed by leading boxing authorities now as the coming welter-weight champion, was a laundry delivery boy on the New York East Side a short time ago. Jimmy Clifton, telegraph operator at Wellington, Colo. won a K.O. over an old-timer in his very first battle immediately after finishing the course. Hundreds of other DeForest pupils are earning big money in the ring today.

### Send for This Book Today!

Send for the famous book, "THE GOLDEN AGE OF BOXING," greatest book of its kind ever written. Full of valuable information, photos of great fighters and pupils who became successes overnight. Enclose 10c to cover cost of mailing.

**JIMMY DeFOREST BOXING COURSE** 347 Madison Ave., Box 613, NEW YORK CITY

## The Lincoln Sport Plane



Build and fly it yourself

100 miles per hr.  
30 h. p. motor

Blue Prints and material now ready for builders. Send 25c for illustrated book. It tells you how. New flying school opens March 1st. Earn while you learn.

LINCOLN AIRCRAFT COMPANY, Dept. 2, LINCOLN, NEB.

## LEARN PIANO TUNING AT HOME

Send for FREE copy of the 28th ANNIVERSARY EDITION of our book "Winning Independence." Read how students master TUNING with our Tune-A-Phone, and WHY our graduates head the profession in all parts of the world. With Bryant's patented devices, tools, charts, and lessons, one learns quickly and easily. Low tuition, easy terms; Diploma granted. MONEY-BACK GUARANTY. \$10 to \$25 a day; exceptional opportunities, and an ideal profession await you.



BRYANT SCHOOL OF TUNING (71) Bryant Bldg., Augusta Michigan

Learn In **10 WEEKS** at Home

Become a **RADIO EXPERT**

Earn Big Money In this Gigantic Fascinating Field!

**AERO-SYSTEMS, INC.**  
Offers You America's Lowest-Priced High-Grade RADIO COURSE

**WE GUARANTEE TO REFUND TUITION IF YOU ARE NOT SATISFIED WHEN YOU COMPLETE THE COURSE**

Now you can get a complete RADIO course at a ridiculously low price. Train to become a high-salaried expert or merely to make and understand your own sets. Write for particulars before price goes up.

**Aero-Systems, Inc., Dept. 101**  
19 South Wells Street, CHICAGO, ILL.  
MAIL THIS COUPON NOW!

**AERO-SYSTEMS, INC., Dept. 101, 19 S. Wells St., Chicago**  
Please send me full particulars of your amazingly low-priced Radio course.

Name.....  
Address.....

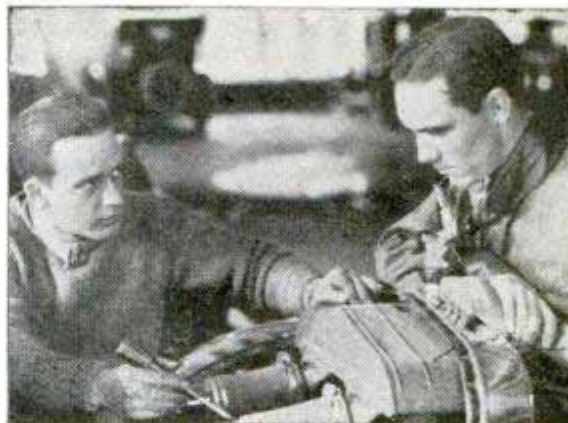

# Automobile Experts in Demand

Study with the same school that helped to train many leading men in the automobile industry

THE best proof of the value of the home-study courses of the International Correspondence Schools is the success of I. C. S. students. This success is especially apparent in the automobile industry.

Jesse G. Vincent, Vice-president of the Packard Motor Car Co., is a former I. C. S. student. So is Walter P. Chrysler, President of the Chrysler Motor Corporation. E. V. ("Eddie") Rickenbacker, Vice-president of the Rickenbacker Motor Car Co.; Hiram Walker, Chief Engineer of the Chandler Motor Car Co., and John Moore, designer of the famous Ansted Motor, are also former I. C. S. students.

The first step they took was to mark and mail an I. C. S. coupon similar to the one printed below. Make your start the same way and make it right now. We'll gladly send you complete information about the I. C. S. Automobile Courses or any other course in which you are interested.

### INTERNATIONAL CORRESPONDENCE SCHOOLS

Box 5623-E, Scranton, Penna.

Without cost or obligation on my part, please send me one of your booklets and tell me how I can qualify for the position or in the subject before which I have marked an X:

- |                                                                           |                                                                      |
|---------------------------------------------------------------------------|----------------------------------------------------------------------|
| <input type="checkbox"/> Complete Automobile Course                       | <input type="checkbox"/> Gas Engine Operating                        |
| <input type="checkbox"/> Automobile Electric Equipment                    | <input type="checkbox"/> Complete Gas Engine Course                  |
| <input type="checkbox"/> Electrical Engineering                           | <input type="checkbox"/> Architect                                   |
| <input type="checkbox"/> Electric Lighting                                | <input type="checkbox"/> Architects' Blueprints                      |
| <input type="checkbox"/> Mechanical Engineer                              | <input type="checkbox"/> Contractor and Builder                      |
| <input type="checkbox"/> Mechanical Draftsman                             | <input type="checkbox"/> Architectural Draftsman                     |
| <input type="checkbox"/> Machine Shop Practices                           | <input type="checkbox"/> Concrete Builder                            |
| <input type="checkbox"/> Railroad Positions                               | <input type="checkbox"/> Structural Engineer                         |
| <input type="checkbox"/> Civil Engineer                                   | <input type="checkbox"/> Chemistry <input type="checkbox"/> Pharmacy |
| <input type="checkbox"/> Surveying and Mapping                            | <input type="checkbox"/> Airplane Engines                            |
| <input type="checkbox"/> Metallurgy <input type="checkbox"/> Mining       | <input type="checkbox"/> Agriculture and Poultry                     |
| <input type="checkbox"/> Steam Engineering <input type="checkbox"/> Radio | <input type="checkbox"/> Mathematics                                 |
- BUSINESS TRAINING COURSES**
- |                                                                  |                                                 |
|------------------------------------------------------------------|-------------------------------------------------|
| <input type="checkbox"/> Business Management                     | <input type="checkbox"/> Salesmanship           |
| <input type="checkbox"/> Industrial Management                   | <input type="checkbox"/> Advertising            |
| <input type="checkbox"/> Personnel Organization                  | <input type="checkbox"/> Better Letters         |
| <input type="checkbox"/> Traffic Management                      | <input type="checkbox"/> Show Card Lettering    |
| <input type="checkbox"/> Business Law                            | <input type="checkbox"/> Stenography and Typing |
| <input type="checkbox"/> Banking and Banking Law                 | <input type="checkbox"/> Business English       |
| <input type="checkbox"/> Accountancy (including C.P.A.)          | <input type="checkbox"/> Civil Service          |
| <input type="checkbox"/> Nicholson Cost Accounting               | <input type="checkbox"/> Railway Mail Clerk     |
| <input type="checkbox"/> Bookkeeping                             | <input type="checkbox"/> Common School Subjects |
| <input type="checkbox"/> Private Secretary                       | <input type="checkbox"/> High School Subjects   |
| <input type="checkbox"/> Spanish <input type="checkbox"/> French | <input type="checkbox"/> Illustrating           |

Name.....  
Street Address.....  
City..... State.....  
Occupation.....

If you reside in Canada, send this coupon to the International Correspondence Schools Canadian, Limited, Montreal

# Adventure!

**BE A  
NEWSPAPER  
AND MAGAZINE  
WRITER**



Learn at Home Through Practical Copy-Desk Method. We Will Test Your Ability in Advance.

**N**EWSPAPER and Magazine Writing! Here's the ideal field for every ambitious man and woman who wants to touch life at all corners, and who is looking forward to a comfortable, permanent, ever-increasing income in a profession that grips with an incomparable fascination.

## Big Demand for Properly Trained Writers

Start now to master the essentials of modern newspaper and magazine writing under the personal direction of expert New York newspaper men. You learn by the "Copy Desk" method—the same way that newspaper and magazine editors would train you if they had the time and inclination. You will be given actual story assignments. Your every effort is given the benefit of constructive criticism. Many earn even while learning. Successful writers earn from \$3,000 to \$15,000 a year. There are also wonderful spare time opportunities in newspaper writing as special and country correspondents for city papers. Our home-study course, the most complete and authoritative ever offered—is being endorsed by leading editors everywhere.

Let us test your ability and tell you in advance whether you are naturally qualified to win success as a newspaper and magazine writer. No obligation. Mail coupon now. Newspaper Institute of America, 25 West 45th Street, New York City.

Newspaper Institute of America,  
25 West 45th St., New York City.

71

Please send me your Test and information regarding your course in Newspaper and Magazine writing.

Name.....  
(State Whether Mr., Mrs. or Miss)

Address.....

City..... State.....

Note: No salesman will call on you.

## OUTDOOR SPORTS THE YEAR 'ROUND

**Popular Mechanics New Useful Book**—Outdoor sports appeal to us all. But the fun is double when you make your own devices. There are 226 clearly written and concise articles telling how to make equipment for new and popular sports of many kinds in the new **Outdoor Sports book**. There are clever devices for such sports as:

- |                  |              |                |              |
|------------------|--------------|----------------|--------------|
| Swimming         | Trapping     | Photography    | Kite flying  |
| Camping          | Tobogganing  | Tennis         | Summer games |
| Football         | Baseball     | Outdoor winter | Nutting      |
| Swinging         | Fishing      | games          | Pushmobiling |
| Trolley coasting | Golf         | Skating        | Racing       |
| Roller skating   | Boat sailing | Boating        | Skiling      |
|                  |              | Toy making     |              |

It is easy to make the devices described because there are 317 helpful illustrations. The articles are clear enough for boys, yet interesting enough for any man.

**Send No Money** Just write your name and address on a postal card and say that you want **Outdoor Sports the Year 'Round**. When the postman hands you the book, give him \$1.50 plus the few cents postage. That is all. If you live outside the U. S. or if you are not at home when the postman delivers the mail, then send \$1.50 with your order. Address your postal to

**POPULAR MECHANICS PRESS** Room 101, Popular Mechanics Bldg., 200 E. Ontario St., Chicago

## Handbook for Farmers

861 discoveries by practical farmers, telling how to make, repair or improve the various devices and machines used about a farm or garden. 683 illustrations. "The Most Remarkable Book Ever Published for Farmers," says one authority. **Send No Money**. When the postman delivers the book to you, hand him \$1 plus the few cents postage.

**POPULAR MECHANICS PRESS**  
Popular Mechanics Building, Room 101, Chicago, Ill.

## Handy Mechanic's Library

Includes four practical books, suitable either for mechanic or amateur, as follows: **Lathe Handbook No. 1**; **Shop Notes, 1923**; **Auto Repairman's Handbook No. 1**, and **Shop Notes for 1922**. The four for \$2. **Send No Money**. Simply write a postal asking that **The Handy Mechanic's Library** be sent. Hand the postman \$2 plus few cents postage when he delivers the books to you.

**POPULAR MECHANICS PRESS**, Popular Mechanics Bldg., Rm. 101 Chicago, Ill.



## "Learning to Fly"



Send dollar bill for complete course in aviation logic, written by **Murphy McHenry**, licensed and recognized pilot. If you intend taking actual flying lessons, you need this important, accurate information first. **Learning to Fly** is simple, interesting, direct, and includes description of actual experiences in an aeroplane. Prepare now for big future developments in civil aviation. First step is taken when you send \$1 Bill for course **Learning to Fly**.

o Pin o

Course is sent you complete on receipt of coupon and \$1

**AIRWAY SCHOOL**  
Dept. 5, San Mateo, Calif.  
Gentlemen: Enclosed find One Dollar for which please send me, postpaid, **Murphy McHenry's** course in aviation logic, complete.

Name.....  
Street, Number.....  
City..... State.....

# Learn **ELECTRICITY** in Los Angeles!

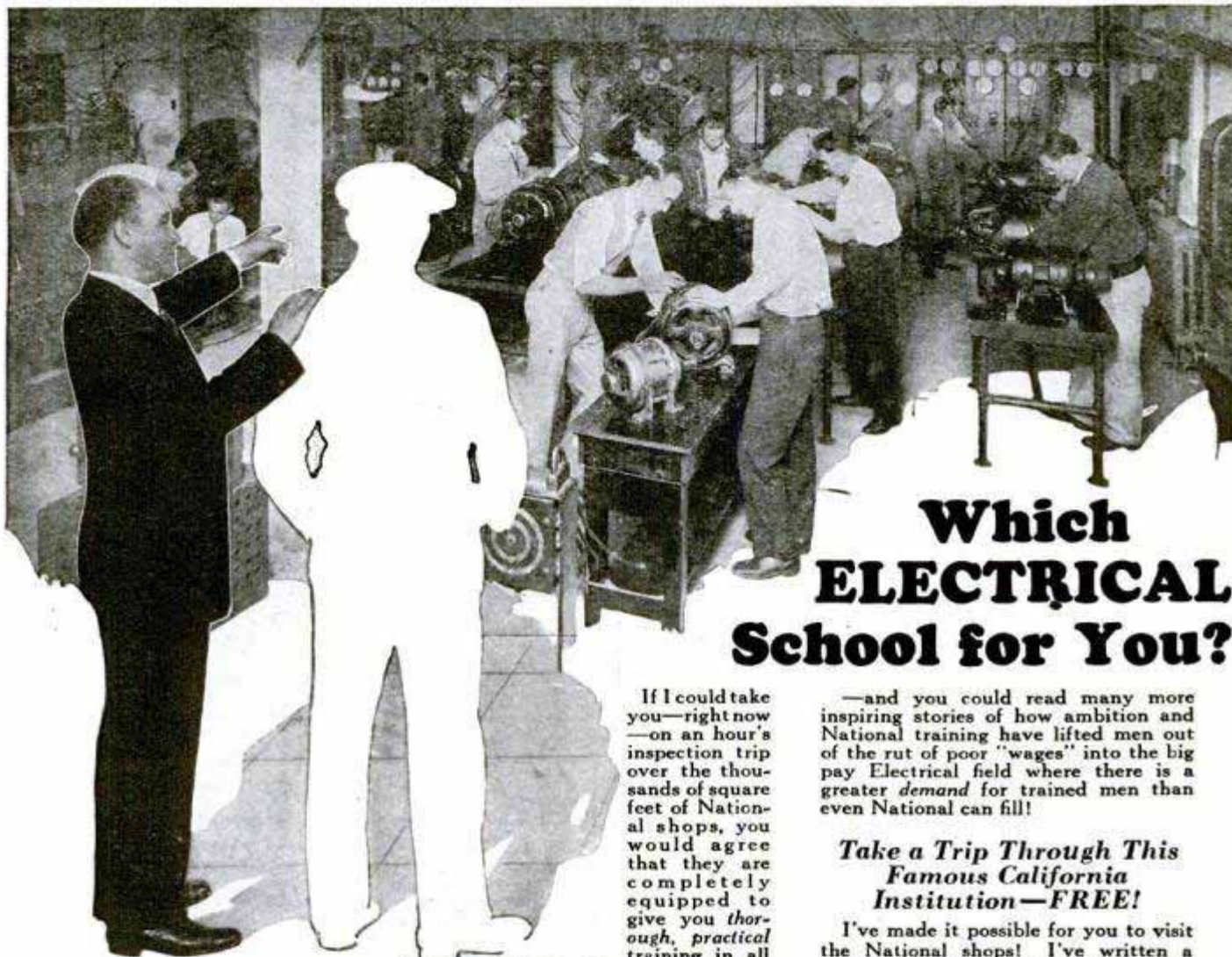

## Which **ELECTRICAL** School for You?

—and you could read many more inspiring stories of how ambition and National training have lifted men out of the rut of poor "wages" into the big pay Electrical field where there is a greater demand for trained men than even National can fill!

### Take a Trip Through This Famous California Institution—FREE!

I've made it possible for you to visit the National shops! I've written a book that tells you all about National. Hundreds of illustrations. It describes life in California—tells about the vast California hydro-electric projects that are always calling for National trained electrical graduates—explains how National's Free Employment Dept. helps you get these big pay jobs, and also helps get you part time jobs to pay your way while training—tells about National's unusually successful training methods and the sensational Lifetime Instruction Offer. This book tells you the truth about your opportunities in Electricity. It has changed the lives of thousands of young men—and you owe it to your future to read this book. I'll send it to you free if you'll sign and mail this coupon now.

### Send This For Big FREE ELECTRICAL BOOK

President J. A. Rosenkranz,  
National Electrical School,  
Dept. 502, 4006 Figueroa Street,  
Los Angeles, Calif.

Send me your Free Electrical Book describing National training and Electrical Opportunities.

Name.....  
Address..... City..... State.....

## To You!

Step into this picture—and see for yourself how this big institution trains you for the Electrical field.

A quarter-century success training men for bigger pay!



If I could take you—right now—on an hour's inspection trip over the thousands of square feet of National shops, you would agree that they are completely equipped to give you thorough, practical training in all branches of electricity. In every department you would see hundreds of ambitious boys and grown men working side by side with instructors who actually show them how to do practical work on thousands of dollarsworth of actual shop equipment—how to take care of high voltage in big central power stations—how to build new motors—wind armatures—wire houses—operate radio stations and "talk" to all parts of the world through the air—how to do everything a man must know before he becomes an Electrical Expert.

### Raise Your Pay from \$50 to \$125 a Week!

Then I would take you in my office and show you the records of 16,000 men who have taken National training. You could read hundreds of letters like these—

"I increased my salary from \$100 to \$500 a month after leaving National."

"I could never have made \$10,000 last year—in a shop of my own—if I hadn't gone to National."

"I'm foreman now—at \$150 a week—in the same plant where I was making \$20 a week before I went to National."

# NATIONAL ELECTRICAL SCHOOL

Dept. 502  
4005 Figueroa Street

LOS ANGELES, CALIFORNIA

# This Tenor Banjo FREE

WORTH \$18



When You Enroll

This handsome full size, professional tenor banjo is yours when you enroll. We want to make one thousand new friends this month. We want to present one of these wonderful, delightful instruments as a gift to each of one thousand readers of this magazine—and here's why.

Before becoming a professor, and a lover of music, particularly the tenor banjo, Prof. Six yearned and yearned for the possession of a genuine, professional instrument, the same kind used by the big, successful professionals of the world. Now we want you to succeed. We want to help every music-lover that we can, attain success, and this gift offer is made to pave the way for you, and no previous musical knowledge is necessary.

We have another surprise for you! Not only do we start you on the way to popularity, success and fame by supplying you with an instrument that you can compare to any used or displayed in your town, but under personal supervision you will be given, by mail, the benefit of Professor Harry S. Six's twenty-two years' experience as director of Glee and Instrumental clubs of New York University. We don't just send you a lot of printed words and instructions and trust to luck that you will catch on. Our method is different and has proven to be the simplest devised by man—that is why we claim you'll be able to play in thirty minutes. Put us to the test.

## Learn in 30 Minutes With My Picture Method

Arthur Brisbane, the highest paid journalist in the world, once said that "a single picture is worth a thousand words." He was right, for it stands to reason, when you take your instrument in hand along with the actual photographs of our professor in action as your guide, it is easy to imitate and do the right thing. But that is not all.

**Phonographic Records Free** We also furnish as an additional guide, phonographic records of our professor playing the piece you are learning, along with our thorough, printed and illustrated, easy-to-read course.

Doesn't that sound easy? It is easy. If you could sit at our desk and see the letters and telegrams from our pupils you would be convinced that we have perfected the simplest, yet most highly efficient course to insure your mastery of the tenor banjo.



## Don't Send a Single Cent

Investigate offer today. Don't put off until tomorrow, because you might forget and miss this wonderful opportunity. It might be the turning point in your career. Don't send a single cent. Just drop a line—use coupon or postal card will do—telling you are interested in receiving full particulars about course and to reserve one regular eighteen dollar, full size professional tenor banjo for you, which is offered as a gift.

Act quickly, because there may not be enough gift banjos to go around for the million or more readers of Popular Mechanics. This does not obligate you in any way. Therefore, do not hesitate—put in your reservation now, this very minute. You will soon join our happy army of enthusiastic finished tenor banjo musicians.

**EARN BIG MONEY**

Hundreds have started orchestras and are making money.

**FREE BANJO COUPON**

New York Academy of Music  
Studio 101-100 Fifth Ave., New York

Please rush all free information relative to your Tenor Banjo Course and reserve a gift banjo for me. This obligates me in no way whatever.

Name.....

Address.....

City..... State.....

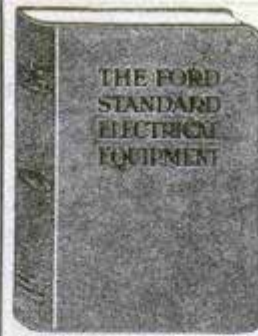

## All About Ford Electrical Equipment

Battery, Ignition, Starting, Lighting

All these are thoroughly treated. The explanations are so simple that even a boy can quickly learn all of the fine points about Ford electrical systems. Don't pay big garage bills. Fix it yourself. Don't be delayed on your trip. Carry this book with you and find your trouble quickly. Electrical troubles are about the most difficult for an amateur to find, yet their correction is very simple when you know how. Order today "The Ford Standard Electrical Equipment." The book is a handy size and is attractively bound in leather.

**Send No Money** Just write a postal and say that you want "The Ford Standard Electrical Equipment." When the postman hands you the book, pay him \$1.98 and the postage.  
POPULAR MECHANICS PRESS, 200 E. Ontario St., Room 101, CHICAGO, ILL.

## Mathematics Made Easy by ROPP'S CALCULATOR AND SHORT-CUT ARITHMETIC

Shows the Answer as Quickly as a Watch shows the Time to all Problems likely to occur in the Office, Store, Shop, Bank, Farm, or Factory.



Explains and simplifies every principle in Arithmetic, Mechanics, and Mensuration.  
**PRICES POSTPAID**  
Desk Size...\$1.50  
Leatherette, Pocket Size...\$1.00  
Pocket Size, Cloth...\$0.50  
Pocket Size, Paper...\$0.35

Popular Mechanics Press, Room 101, 200 E. Ontario St., Chicago

## WHAT IS A BAR BELL?

A BAR BELL is simply a long-handled dumb-bell. It has many advantages over a pair of dumb-bells. For instance, it is far easier to handle a 50-lb. bar bell than two 25-lb. dumb-bells. Again, with a bar bell you can do certain back and leg exercises where it would be awkward to handle a pair of dumb-bells. The bar bell became

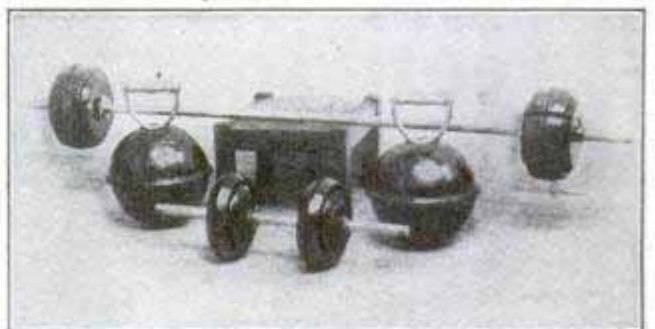

## One of the Milo Bar Bell Sets The Greatest of All Body Builders

when the adjustable feature was added—for then it became possible to employ the progressive method of exercise which has proven to be the only way in which a man of below average physique can gradually but steadily improve his build, his muscular development, and his stock of organic vitality until he becomes a physical superman—the very pattern of health and beauty.

**USE COUPON FOR FREE BOOKLET**

THE MILO BAR BELL CO.,  
Dept. 501, 2747 N. Palethorp St., Philadelphia, Pa.

Gentlemen: Please send me, without obligation on my part, your free booklet entitled "Health, Strength and Development and How to Obtain Them."

Name.....

Address.....

City..... State.....

# No More Blades To Buy!

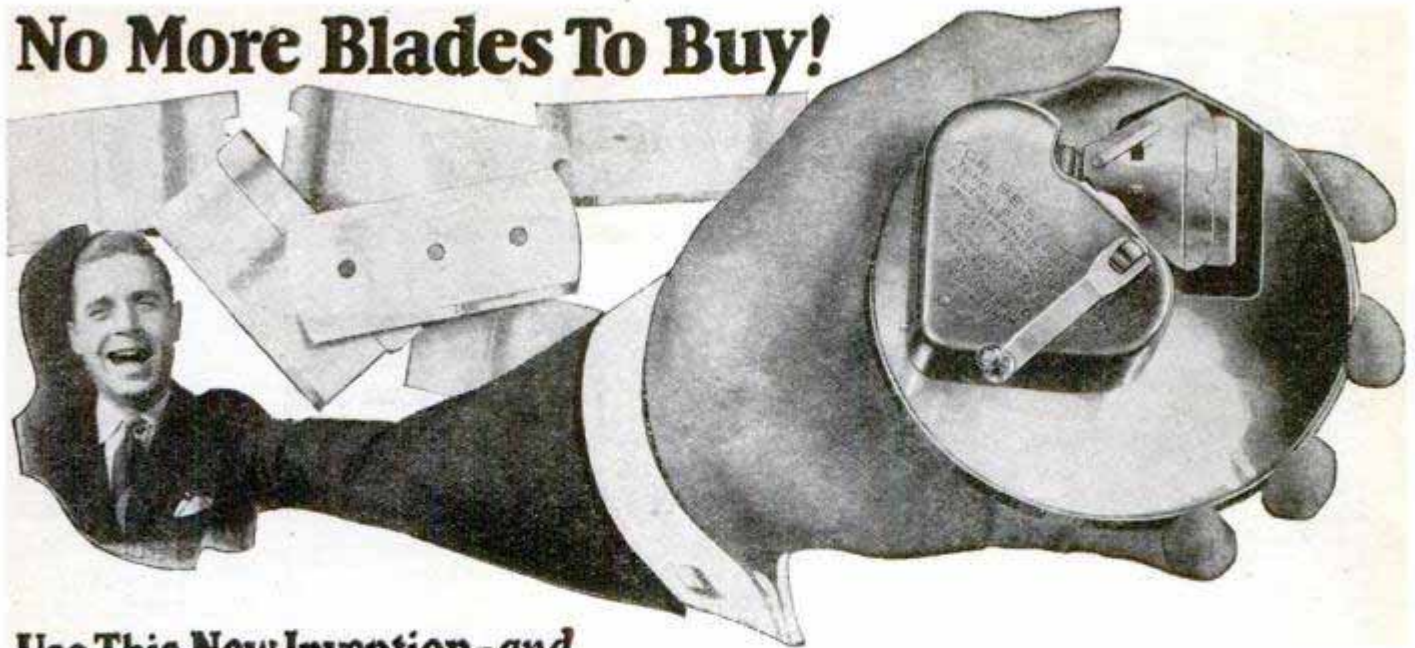

Use This New Invention—and

*I'll Guarantee*

# To Keep You In Keen Razor Blades for Life!

**GIVES  
Coolest  
Shaves  
Imaginable**

**MAKES  
Blades  
Keener  
than New**

**CUTS  
Shaving  
Costs  
83%**

**FITS  
Any Make  
of Razor  
Blades**

**SEE  
Free  
Offer  
Below**

**K** EEN, velvety shaves forever and no more blades to buy! That's what the astonishing invention of a St. Louis man offers the great army of American shavers today!

KRISS-KROSS is destined to revolutionize all existing traditions of shaving! Its performance is so sensational that it seems hardly fair to call it a stropper. Rather it is a super-stropper or blade-rejuvenator! Almost literally it makes a new blade out of an old one every day. No longer do you find that your blades "die" after five or six shaves. KRISS-KROSS "brings 'em to life" a surprising way, week after week and month after month—and endows them with a keenness that they never possessed when brand-new! Actually—you can take a blade right out of a fresh package and improve it as much as 100% in eleven seconds with KRISS-KROSS!

## Magic Diagonal Stroke

Until you've seen KRISS-KROSS, and tested its uncanny dexterity yourself, you'll never know how amazing it really is! It employs the famous **diagonal stroke**, same as a master barber uses. Never before has anyone captured the secret of reproducing it automatically. Eight "lucky leather grooves" do the trick in 11 seconds, with a precision it takes a master barber years to attain.

But that's not all, KRISS-KROSS embodies still another feature that has hitherto baffled mechanical reproduction. It stropps from **heavy to light**. It's absolutely uncanny the way the strokes grow lighter and lighter until an automatic jig files up and notifies you that your blade is ready—ready with the keenest cutting-edge that steel can take!

KRISS-KROSS produces unbelievable sharpness and prolongs the life of any razor blade for months and even years. Fits all brands and makes except Durham. KRISS-KROSS solves your blade problem for all time and gives you keen, velvet-smooth shaves forever!

## 3-in-One Razor FREE

And now for my surprising offer. To introduce KRISS-KROSS, I am giving with it Free a new kind of razor. Possesses remarkable features. Instantly adjustable to any shaving position: (1) T-Shape; (2) straight (old style); (3) or diagonal (new style). Gives a sliding instead of pulling stroke. Simply zips through the toughest crop of whiskers. Comes with 5 special-process blades and is entirely unlike anything you ever saw before!

## Send for Free Offer Today

Send for full information on these surprising new inventions today. Write for illustrated description and full details of free razor offer. It's even more remarkable than I can tell you in this short space. Clip the coupon now. Mail it today.

## AGENTS! \$30.00 a Day and up

Make big money with KRISS-KROSS. Giving away FREE razors boosts your profits amazingly. H. King made \$66 in one day. N. C. Paige made \$104 in 3 days! Others average \$350 and up to \$750 a month! Spare-time workers, Office and Factory men make \$6-\$12 extra a day showing KRISS-KROSS to friends and fellow employees. S. Kantala made \$154 extra just working evenings three weeks. Get details at once. Check bottom of coupon and mail it tonight!

*Rhodes* **KRISS KROSS**

**RHODES MFG. CO. STROPPER**

Dept. A-371, 1418 Pendleton Ave., St. Louis, Mo.

*Largest Manufacturers of Mechanical Stoppers in the World*

Rhodes Mfg. Co., Dept. A-371  
1418 Pendleton Ave., St. Louis, Mo.

Without obligation, please send me illustrated description and full details of your special introductory offer on KRISS-KROSS super-stropper and FREE 3-way razor.

Name.....

Address.....

Town..... State.....

( ) Check here if interested in making money as authorized KRISS-KROSS representative.

# I'll Put You *in this*

## FREE Employment Service

Your share of the big money. Your own business. Your success in life. What about these things? I know you are ambitious and want to get ahead—fast. Are you mechanically inclined? If so, then read every word of my message. Right this minute I am placing an opportunity before you to win rapid promotion and a future success which you can make just as big as you want it. **Trained Auto Men are Wanted.** It's a wonderful business. It's the biggest business in the world! It is growing so fast that there are at present 269 cars to every repair shop. This wonderful field is sorely in need of trained men. It is your marvelous opportunity. Come to Detroit now and learn this business right. Within a short time I will send you out on the road to big money.

Three-quarters of all the cars are made right here. Study autos where they are made. Learn at the famous Michigan State Automobile School—unanimously endorsed by the auto industry. Here in Detroit, nationally famous automotive engineers approve and recommend this training because it is complete, comprehensive, practical and because our instructors are experts. This school knows **how to train you right**, and that is what you want and need to make the most money in this fascinating business. Mail me the coupon today for full particulars.

*A. G. Jeller*  
President

### EARN WHILE YOU LEARN

If necessary, we assist you in securing part-time work to earn money each week. Students who enroll in our evening course are assisted to full-time day jobs. Ask for details, and when writing please explain your circumstances fully.

### I'll Give You These Detroit-Made Cars, Latest Models, to Work On

Oldsmobile, Oakland, Jewett, Essex, Hudson, Reo, Packard, Buick, etc.—just some of the new Chassis recently received for you to practice on. All latest model cars. Our location in Detroit, the Automobile center of the world, and our contact with automobile manufacturers, brings us close co-operation and endorsement. This means much to you. Always the latest and most

up-to-date equipment and continually being improved.

### Detroit's Motor Industry Endorses This Training

Greatest auto factories endorse "Michigan State" training methods, because they are thorough, practical. Because they put knowledge in your head and skill in your hands. Hudson Motor Car Company says, "This School is thought very highly of by the automobile men of Detroit, and is considered one of the best equipped and efficient schools in the country. You will make no mistake."

### Detroit-Trained Auto Men Get the Best Paying Jobs

Detroit men are preferred. The Michigan State Automobile School is known the world over. Wherever autos are used—Detroit trained men get the best jobs, highest pay. You will be wanted in Detroit, in your home town, in garages throughout the country. We place many of our graduates directly. This Employment Service is absolutely free. L. T. Middlebrooks (Cal.) writes: "Getting the best pay I ever received and all credit to the school."

## MICHIGAN STATE

301 Auto Bldg., Detroit, Mich.

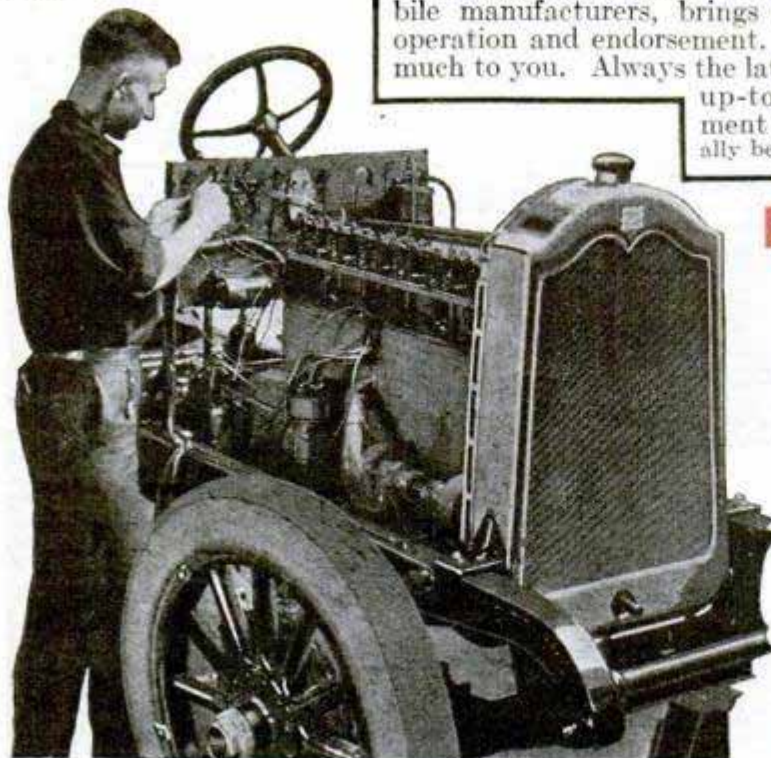

Learn Autos Where Autos Are Made

# BIG MONEY Business

## Positions Now Open

A hundred thousand more trained men are needed at once in this wonderful big paying field. Great opportunities are coming up every day. E. J. Asbury (W. Va.) says, "I am clearing \$50 a week just at home. Haven't even got a shop yet." The demand for trained men is far greater than the supply. Look into any garage—everybody is busy, they have more work than they can do. Men working overtime, all at extra pay. That means big money for repairmen and boss. The year ahead is predicted to be the **biggest of the industry**. That means great money-making advantages to men who start in the business now.

**20,200,000**  
Automobiles in U.S.  
One Car to Every  
6 People  
**269 Cars to Every**  
Repair Shop  
Thousands more Trained  
Men are Needed

## Work With Detroit Standard Auto Shop Tools— and Learn to Use Them Right!

You learn, with tools, from real practice, how cars are made and how to repair them. You have head training as well as hand training. The man whose hands only are trained fails when he hits the hard jobs. There are no hard jobs for Michigan State trained men, for they have the **knowledge in their heads** to guide the **skill in their hands**. John Grahek (Minn.) writes: "I average \$325 a month on labor plus \$100 profit on parts and accessories."

**NEW AUTO BOOK FREE**

## The Auto Business Needs You NOW

Auto Electricians, Garage Foremen, Service Managers, Repair Shop Owners, Sub-Dealers in autos, General Distributors—all these big paying positions are calling to you. What a chance for the trained man! Car owners search for reliable repair shops. Garage owners advertise for competent mechanics. They don't want green men, but the skilled auto man always has a job. There is a dire need for good garages and battery shops, tire shops, welding shops and electric service stations. Open a shop any place, right at home where your friends are or in some other town or at country cross roads. There is a fortune in this business for you.



**Send for it Today**

**Mail Today!**

### Home Study Course

For those who cannot come to Detroit now for their training, we have a special Home Study Course. This course covers the same subjects in detail as our regular course. The knowledge you gain in the first week or two in the Home Study Course should enable you to get a job in a garage right away.

### \$2 Starts You

New Plan starts you on the first two lessons of your Home Study training for \$2.00. Act at once. Sign coupon and mail TODAY.

### FREE Business Course

The former Service Manager of the Packard Motor Car Company trains our students in the business end of running a garage. This business training is worth over a hundred dollars alone, but it costs you nothing extra, another one of the big advantages of Michigan State training. All students get this business course without extra charge.

### Send the Coupon Now

Get all the interesting facts. Mail the coupon at once for big FREE Catalog and for full information concerning your future. It's illustrated with photos of school equipment, factory production and other interesting matter. It contains hundreds of letters from our successful graduates. It tells you how you, too, can get a good paying job—how you can go into business for yourself with little capital. Mail the coupon or send us a postal card today. *Write now.* (We do not enroll colored students, except for our Home Study Course.)

# AUTOMOBILE SCHOOL

3729 Woodward Ave. Detroit, Mich.

**The Automobile Center**

**Michigan State Automobile School  
301 Auto Building, Detroit, Michigan**

Send me free and without obligation full information about Detroit training to make the most money. Also send me FREE your big new illustrated Catalog and Automobile Training Book.

Name.....  
St. No. or R. F. D.....  
City.....State.....

I am interested in  
( ) 12 weeks' Auto Course  
( ) 30 weeks' Master Course  
( ) Home Study Course

# PICK THE JOB YOU WANT

There's a way to get it



Men don't just **fall** into easy jobs or **big pay** positions—they prepare for the big chance **before** it comes.

Make up your mind today what you want to be, then take the first step at once. You don't have to go to college to get ahead. Other men have gone there for you and have put the things they learned there and through years of practical experience into easily understood books which give you a short cut to a better and bigger job.

We have picked 13 of the best paying professions and have published for your benefit new editions of the most practical, the most valuable books we have ever printed on the subjects covered.

### JIFFY INDEX

Our new Jiffy Index makes each book a quick reference work—no time need be wasted in search or study—put your finger on the facts you want instantly.

### PAY-RAISING BOOKS

Automobile Engineering, 5 volumes, over 2,000 pages . . . . .	\$24.80
Civil Engineering, 9 volumes, 3,900 pages, 8,000 pictures . . . . .	25.80
Business Management, 8 volumes, 2,500 pages, well illustrated . . . . .	29.80
Fire Prevention and Insurance, 4 volumes, 1,500 pages, 600 pictures . . . . .	14.80
Electrical Engineering, 4 volumes, complete in every way . . . . .	19.80
Modern Shop Practice, 6 volumes, 2,300 pages, 2,500 pictures . . . . .	24.80
Steam and Gas Engineering, 7 volumes, 3,300 pages, 2,500 pictures . . . . .	24.80
Law and Practice (with reading course), 13 volumes, 6,000 pages, illustrated . . . . .	49.80
Telephony and Telegraphy, 4 volumes, 1,728 pages, 2,000 pictures . . . . .	14.80
Sanitation, Heating and Ventilating, 4 volumes, 1,454 pages, 1,400 pictures . . . . .	14.80
Drawing, 4 volumes, 1,578 pages, 1,000 pictures, blue prints, etc. . . . .	14.80
Employment Management and Safety Engineering, 7 volumes, 1,800 pages, 540 illustrations, charts and diagrams . . . . .	24.80
Architecture, Carpentry and Building, 5 volumes, includes 58 beautiful architectural plates free . . . . .	24.80

### SHIPPED FREE

Words alone cannot describe the full value these books may be to you, so we ship Free for Examination. Pick the set you want, the price is plainly shown, but **Send No Money**; just your name and address, and the books will be sent promptly.

Take ten full days to read, test and examine them. You'll realize at once what a tremendous force for your future they can be.

After ten days you send only \$2.00; then \$3.00 per month until the balance is paid. **There Are No Interest Charges of Any Kind**; the price shown is the total.

### EMPLOYMENT SERVICE

For the benefit of red-blooded men who look forward to bigger earnings and greater responsibilities—which we give through these books—we conduct a complete employment department and include this service without cost. We are in close touch with a great many employers whose needs you might never hear of except through us.

AMERICAN TECHNICAL SOCIETY,  
Dept. X-119, Chicago, U. S. A.

Please send me set of.....

.....

.....

for 10 DAYS' examination. I will examine the books thoroughly and if satisfied, will send \$2.00 within 10 days and \$3.00 each month until I have paid the special price of \$..... If I decide not to keep the books I will return them at your expense at end of ten days.

Name.....

Address.....

Reference.....

## Be a High-Salaried GARMENT DESIGNER

Join this wonderful profession with its amazing opportunities for both sexes. Clean, dignified work.

**PARRY PRACTICAL TRAINING** qualifies you in a few weeks to hold **BIG-PAY** positions in America's largest fashion salons and clothing and fur industries.

**MEN AND WOMEN EARN \$75 TO \$500 EVERY WEEK**

No experience needed. This long-established school is the only one officially recommended and endorsed by Chicago Designers' Association of Women's Apparel. Write for full particulars of special offer.

**PARRY GARMENT DESIGNING INSTITUTE**  
Dept. 101, 19 S. Wells St. Chicago, Ill.

**Mail This Coupon Now**

R. H. Parry, Director, PARRY GARMENT DESIGNING INSTITUTE  
Dept. 101, 19 South Wells Street, Chicago, Illinois

You may send FREE particulars of Designing Course checked.

MEN'S GARMENTS       WOMEN'S GARMENTS       FUR GARMENTS

Name.....

Address.....

## No Better Christmas Present for \$2.50

than a year's subscription to

## Popular Mechanics Magazine

Containing 4500 Pictures and 3600 Articles

Much of it Interests Everybody

Most of it Interests Anybody

All of it Interests Somebody

Order through your Newsdealer or address the Publisher

## POPULAR MECHANICS COMPANY

200 East Ontario Street, CHICAGO, ILL.

# Free Trial

In Your Own Home



FREE Instruction with Every Instrument

## Deagan Xylorimba

Become a crack Xylorimba player right in your own home. Easiest instrument to play. Learn in a few hours with our 14 free complete lessons. Earn \$50.00 to \$200.00 a week. Deagan instruments are world-renowned—used extensively in leading dance, theatre and concert orchestras.

**FREE LESSONS—A YEAR TO PAY!**

Our free trial, easy payment plan makes it easy to learn at home. Send coupon below for illustrated literature and details of our special free trial offer.

### Send Coupon Today!

**J. C. DEAGAN, Inc., Dept. 1451,**  
**1770 Berceau Ave., Chicago, Ill.**

Dear Sirs: Without obligation, please send me literature and information regarding your free trial Deagan Xylorimba.

Name.....

Address.....

City..... State.....



APPROVED BY 18 MONTHS OF PUBLIC USE  
NO OTHER BATTERY IS LIKE IT

Eveready Layerbilt  
"B" Battery No. 486,  
the Heavy-Duty bat-  
tery that should be  
specified for all loud-  
speaker sets.



The Layerbilt patented construction revealed. Each layer is an electrical cell, making automatic contact with its neighbors, and filling all available space inside the battery case.

## Practical tests prove this new product to be the most economical of "B" batteries

IN DAILY use in the home, Eveready Layerbilt "B" Battery No. 486 has fulfilled the promises made for it in laboratory tests. More than a year's study of the performance of this battery in the hands of the public, has shown that it is the most satisfactory and most economical "B" battery ever developed. All loud-speaker sets require Heavy-Duty batteries—and the Layerbilt has proved itself absolutely the best of them all.

Eveready Layerbilt's unequaled service is due to its unique construction. All other

dry cell "B" batteries are made of cylindrical cells, with many soldered connections, and a great deal of space is wasted between the cells. The Layerbilt is built up of layers of flat current-producing elements, that make connection with each other automatically, and that fill all available space inside the battery case. It is every inch a battery. In it you get more active materials than in any other battery and the Layerbilt construction makes those materials more efficient current producers.

Just remember this about

"B" batteries—Heavy-Duty batteries are more economical than the smaller Light-Duty batteries on all loud-speaker sets, and the patented exclusive Eveready Layerbilt No. 486 is the most economical of all.

Manufactured and guaranteed by  
NATIONAL CARBON CO., INC.  
New York San Francisco  
Canadian National Carbon Co., Limited  
Toronto, Ontario

Tuesday night is Eveready Hour Night—  
9 P. M., Eastern Standard Time, through  
the following stations:

WEAF—New York  
WJAR—Providence  
WEEI—Boston  
WTAG—Worcester  
WFI—Philadelphia  
WGR—Buffalo  
WCAE—Pittsburgh  
WSAI—Cincinnati

WTAM—Cleveland  
WWJ—Detroit  
WGN—Chicago  
WOC—Davenport  
WCCO—Minneapolis  
WCCO—St. Paul  
KSD—St. Louis  
WRC—Washington



How Chain of Submarine Searchlights Would Safeguard Travel; Artist's Drawing of Lamps, Set in Shallows, to Guide Craft of Air and Sea; Lights Would Also Define the "Rule of the Road"—See Page 83

# Popular Mechanics Magazine

REGISTERED IN U. S. PATENT OFFICE

WRITTEN SO YOU CAN UNDERSTAND IT

Vol. 47

JANUARY, 1927

No. 1

## New Ray <sup>Cathode</sup> Makes Cold Stones Glow

Rocks Lit for Hours after Exposure to It, While Light Also Grows Hair and Kills Germs

728

Schenectady N.Y.

**M**AKING cold stones glow with brilliant lights, growing luxuriant hair on a rabbit's ear and producing more electrons, or beta rays, with a single small tube than could be obtained from 2,000 times all the radium in the world are some of the things done with a new cathode-ray tube discovered by Dr. W. D. Coolidge, of the research laboratories of the General Electric company.

With only about one pound of radium in existence, the Coolidge tube, at the turn of a switch, can produce beta rays equal to those that would be given off by a ton of nature's product, and, whereas man has never found a way to control the radium rays or regulate the disintegration of the substance that produces them, the electrons from the new tube can be regulated, and when the rays are not needed production ceases.

What the practical application of the tube will be remains to be seen, as the discoverer has not yet tried the rays on human beings. In the only experiment made on a living organism, the ear of a rabbit was given a tenth of a second exposure, with the result that its brown hair disappeared. After the scab of the burn

dropped off, the exposure was repeated, and the rabbit grew a new crop of hair, twice as thick as the old and white instead of brown.

Cathode rays have been known for many years, at first only as they existed inside vacuum tubes. Thirty years ago a European scientist succeeded in getting some of them outside the glass by passing them through a tiny "window" of aluminum foil cemented to the glass wall of the tube. The window, however, was very small and the operating voltage slight.

The new Coolidge tube is a marked improvement on previous efforts, because it has a large window, three inches square, made of nickel foil several thousandths of an inch thick and capable of withstanding an atmospheric pressure of more than 100 pounds, while the tube is shielded with a copper cylinder to prevent puncturing of the glass by the electrons. A

**Giant Cathode-Ray Tube Perfected by Dr. Coolidge; It Produces 2,000 Times as Many Beta Rays as All the Reclaimed Radium in Existence, Kills Insects and Germs, and Also Makes Stones Glow with Cold Light**



tungsten filament, similar to the one in a radio tube, gives off the electrons at the relatively low speed of a mile a second. Between the window and the copper shield, however, there is impressed upward of 350,000 volts of direct current, and when the rays go through

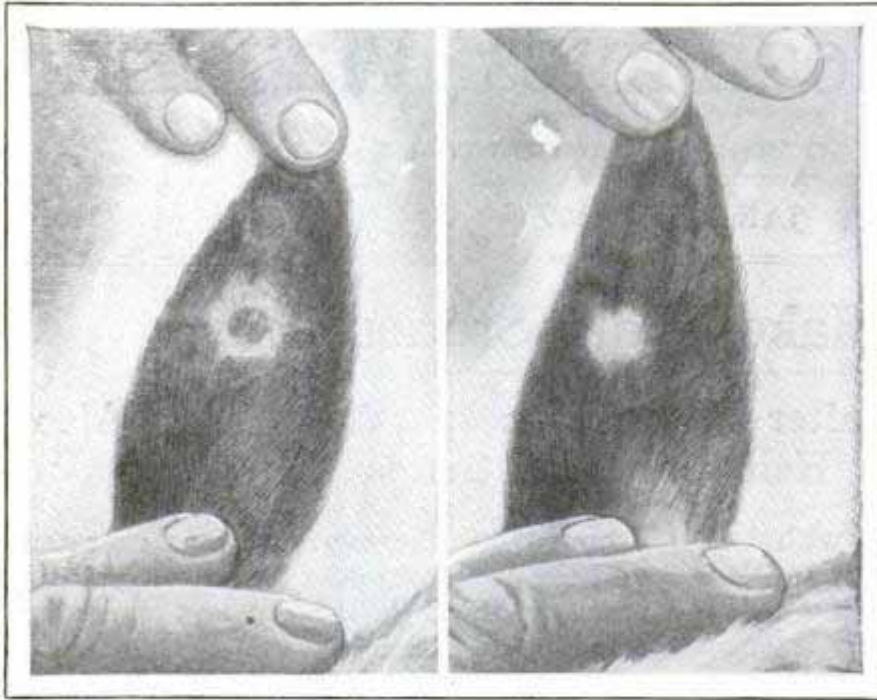

Rabbit's Ear, Left, with Scab Marking Spot Where Hair Was Burned Off, and, at Right, New Hair of Different Color after Second Exposure

space they speed up to an average velocity of 150,000 miles a second. They reach that speed in the space of an inch, and then pass on out of the high-tension current and coast along, with little loss of velocity, passing through the window.

Operated in the dark, the window is seen surrounded by a ball of luminous purple haze, about two feet in diameter, made by the air being ionized or broken up by the rays. One of the startling experiments made with the tube was the production of a new yellow compound, deposited as a light, fluffy powder when the rays were passed through acetylene gas. The powder is insoluble in any chemical yet tried on it, and, as it adheres tightly to metals, may be developed as a new protective coating for them. Castor oil also can be solidified by exposure to the electrons.

Bacteria and flies are killed almost instantly by the rays, but, as the rabbit escaped with only a slight burn, there seems small danger that it might be developed into a "death ray" to be used against human beings or, in fact, any large organism.

Exposure of various kinds of minerals produced a wide range of cold light. A lump of calcite, a colorless and transparent mineral, glows with a bright orange light, and the glow continues for several hours after exposure. Granite, a mixture of several minerals, glows with a variety of brilliant colors, some fading away im-

mediately and others remaining for a long time. Numerous other materials can be made to change color.

The tube is still a laboratory development, but even though no commercial possibilities are ever found for it, either in medical or industrial work, it is expected to prove invaluable in scientific investigations of electronic phenomena.

### MARINES GUARDING U.S. MAILS CARRY MACHINE GUNS

78  
Detachments of marines, equipped with a type of machine gun that can be fired from the hip, guarded the mails during and before the holiday season to foil bandits. The soldiers were sent with the cars and accompanied the trucks about



*in New York.*

This Marine Has Landed and Is Ready for the Mail Bandits; a Corporal Equipped with Machine Gun

the cities. An advantage of the special gun is its light, compact form and its rapid fire, which enable one man to cope with several attackers.



Its Days of Commercial Service Over, This Old Barge Has Been Converted into a Floating Restaurant, to Entertain Parisian Amusement Seekers; Towboat in the Foreground

**BARGE AS FLOATING CABARET POPULAR IN PARIS**

Variety in entertainment is enjoyed in Paris on an old barge which has been remodeled into a floating restaurant and roof garden. It is towed along the Seine or can be pulled to any desired spot for anchoring. Patrons are carried to and from shore by a tender with an outboard motor. The craft lies low in the water, so that the windows of the restaurant are only a few inches above the surface. Brightly colored furniture, potted trees, imitation mooring posts and a broad flight of stairs leading to the water's edge are features of the equipment.

**AMERICAN DYE TRADE GAINING TARIFF REPORT SHOWS 8/2**

More than ninety per cent of the total quantity of dyes used in the United States in 1925 was made in this country, and large amounts of the lower-priced colors were exported, the tariff commission reports. The output in coal-tar dyes of seventy-five firms was more than 86,000,000 pounds that year, an increase of nearly 18,000,000 pounds over 1924. Despite the large production, the number of firms making dyes has been reduced, chiefly

*Christian Science Monitor*  
10/27/26.

owing to keen competition. The development of the industry has also been marked by the production for the first time in the United States of many vat dyes, direct-developed dyes and special colors for rayon and certain mixed fibers.

**BATTERY LIGHT ON AUTO DASH TELLS IF WATER IS LOW**

To prevent injury to automobile storage batteries, a light signal attached to the dashboard is automatically extinguished when the water gets below a certain level, so that a new supply may be

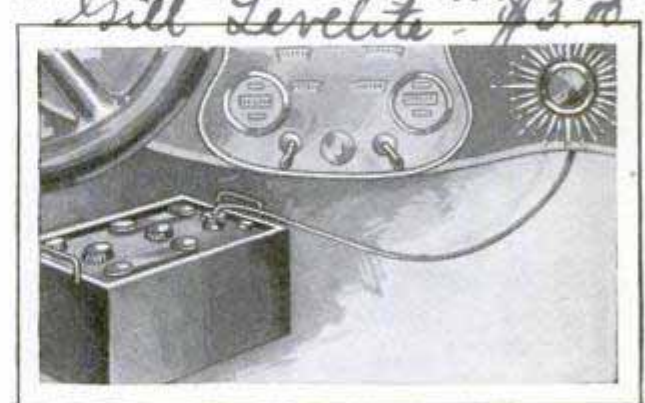

Battery Water-Gauge Light Installed on Dashboard; It Goes Out When Water Gets Too Low

obtained and trouble averted. The light also serves as a lamp for the instrument board and is easily installed.

*Bill Levelite - \$3.00*  
*Bill Huff, Co. Chicago*  
8300

749



Straightened Course of Chicago River Is Indicated by Dotted Lines

**TO TAKE KINKS OUT OF RIVER FOR TRAFFIC RELIEF**

To permit easier passage between the north and south sides of Chicago, the south branch of the river is to be straightened at a point in the railroad-terminal district where it now makes a sharp turn. For years, this twist has restricted street traffic producing a "bottle neck" situation.

The present number totals more than 45,000 annually, while trade-marks and designs bring the number up to 70,000. Loss of efficiency, due to crowded conditions and the fire hazard, is a serious feature of the situation. During the last fifty years, the office has turned in more than \$7,000,000 to the treasury and it is

**SCANTY QUARTERS HAMPER PATENT OFFICE WORK**

Failure to provide an adequate building for handling the enormous patent business causes a potential loss of millions of dollars annually to American industry, according to Thomas E. Robertson, commissioner of patents. He points out that, although the patent activities at the present time are 450 times greater than when the office was created, no greater space is now available for storing application files and copies of patents. When the first office was constructed, only 200 or 300 patents were issued yearly.

now practically self-supporting. Stored on the miles of shelving in the building are 50,000,000 copies of previously granted patents and thousands are added to this number each year. Applications which result in the grant of patents must be stored where they can be reviewed by officials of the office, and others.

Lead weighs only about half as much as tungsten.

**SAFETY INFLATER ELIMINATES TIRE GAUGE**

Employing a testing gauge while blowing up the tire is not necessary with an inflater which may be set for the required pressure and automatically shuts off the supply when the tire has received enough. A bell rings while air is passing and stops when the tire is properly filled.

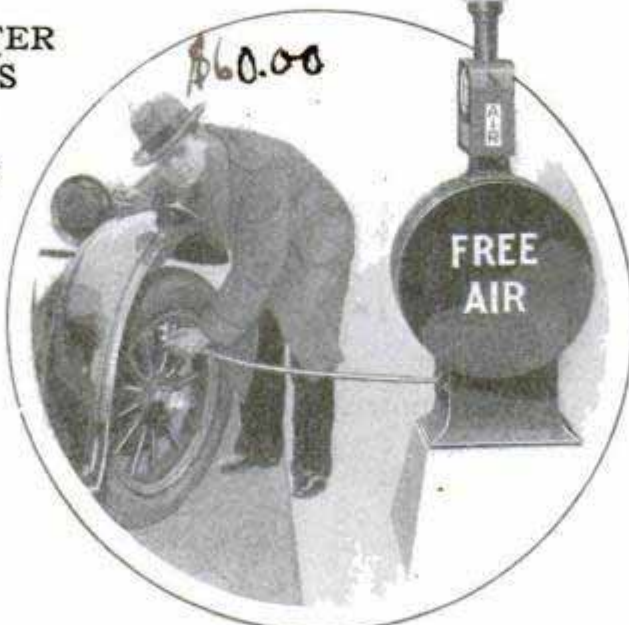

Insuring Correct Inflation without Use of Gauge; Bell Stops Ringing When Tire Is Filled

\$60.00

746

*Service Station Equipment Co  
Dayton, Ohio*

# TESTS FOR MOTORMEN TO ASSURE PUBLIC SAFETY



Testing a Candidate's Ability to Stand Strain

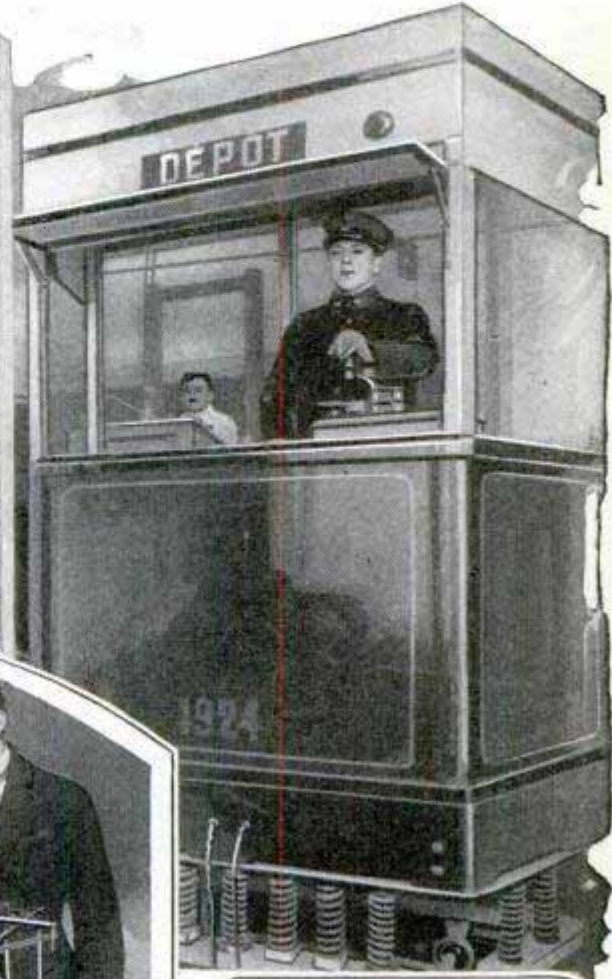

Above Is a "Dummy" Car Platform on Which Motor-men Are Tried, While the Examiner Records Their Reactions to Traffic Signals Suddenly Flashed in Front of Them

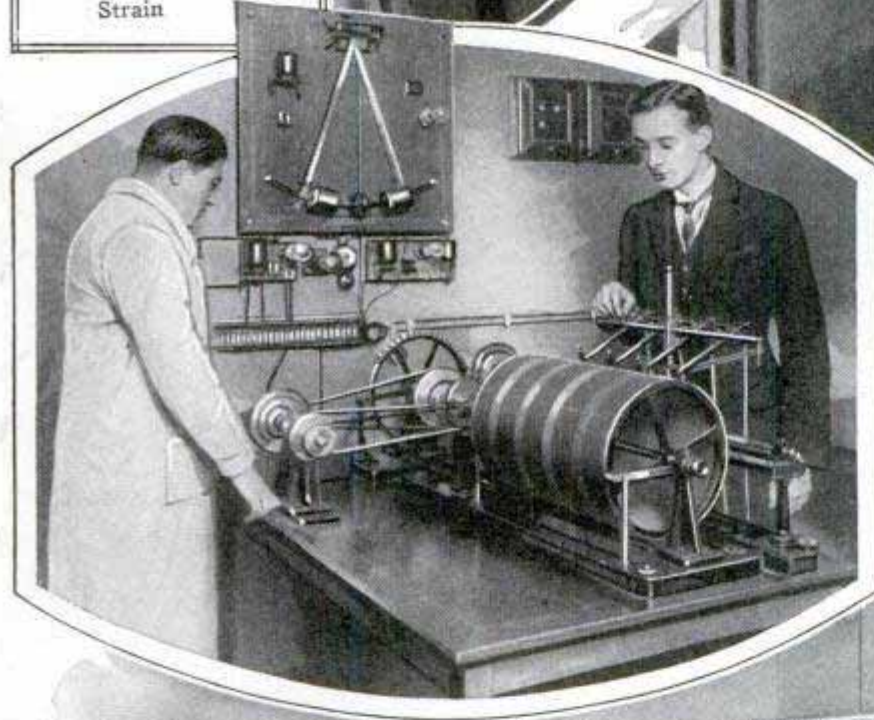

Measures of the Applicant's Excitement in Emergencies Are Made by the Apparatus in Insert, While the Lower Apparatus Tests His Judgment as to Speed and Distance

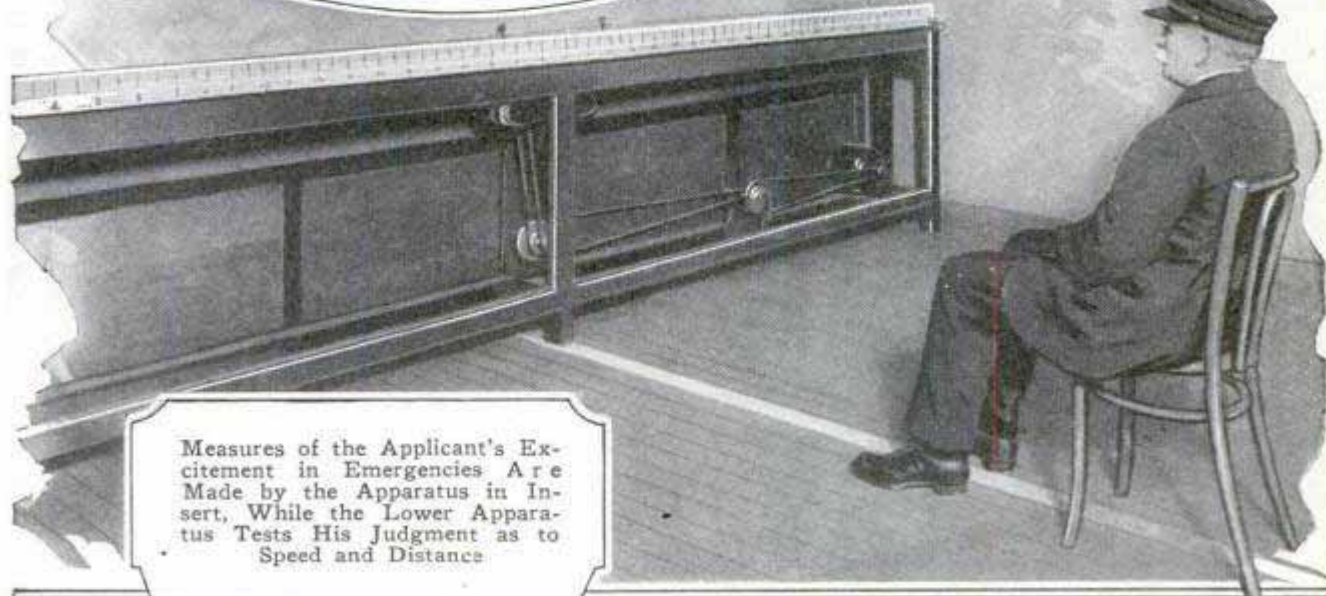



The Result of Four Months' Training at the Animal School; Wild Elk Broken to Harness and Hauling Dray

**BIG ELK BROKEN TO HARNESS AT ANIMAL SCHOOL**

772

Wild and vicious animals, difficult to train for show purposes, are sometimes sent to a special "school" in an Ohio city, where its manager accomplishes the seemingly impossible in educating the beasts. The success of his methods is demonstrated by the accompanying picture of a large elk which was broken to harness in less than four months and was used to haul a dray about the streets. It lost most of its antlers during its struggles, but was otherwise uninjured. A coyote has been taught to work with trained dogs, and several other animals are being trained.

**REDWOODS YIELD TANNING FLUID**

811

Redwood forests in California may prove to be a source of wealth not now figured on if the findings of a university investigator are substantiated. He has discovered that the reddish heart of the trees contains tannic acid in such amounts that the wood promises to be an important source of tanning materials used by the leather industries. In some cases, the yield ran from seven to eight per cent and one test showed a content of twelve per cent. The tannin is said to be inferior to that of the tan-bark oak of California, at present the mainstay of the tanning activities in the state, but the greater availability of the redwood may offset this disadvantage, it is believed.

*Emanuel Britz  
 Prof of Chemistry  
 Univ. of California*

**ELECTRIC STRETCHING MACHINE AIDS PHYSICAL CULTURE**

780

Beneficial results are said to be obtained from an electrical stretching board introduced at a recent exhibition. It can be operated by the person using it and has lengthwise and side motions intended to exercise and stretch parts of the body that are likely to need special treatment.

*Electrical and Industrial  
 Exposition, Grand Central  
 Palace, New York*

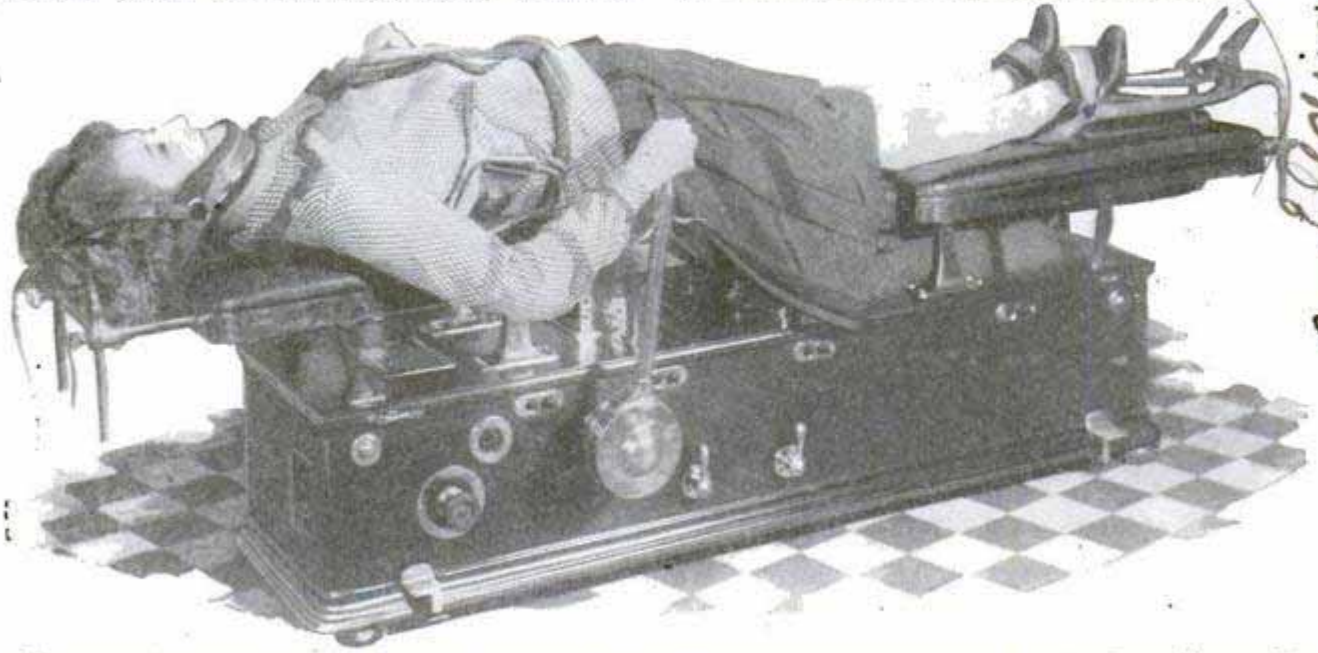

Demonstrating the Electrical Stretcher That Has Both Lengthwise and Side Movements for Exercising and Strengthening Muscles; the User Maintains Control of the Action

*Cannot locate maker  
 or inventor*



U. S. BUILDS FIRST CRUISER UNDER ARMS TREATY



Ready for the Construction of the First Cruiser Since the Limitation of Arms Treaty Was Signed; the Huge "Nest" in Which the "Pensacola" Will Be Built

Construction of the U.S.S. "Pensacola," the first man-of-war to be built according to the provisions of the Washington limitation of arms treaty, is now under way at the New York navy yard. The vessel will have a length over all of 585 feet six inches and a displacement of 10,000 tons, the limit fixed by the agreement. Its normal draft will be nineteen feet six and one-half inches, and the estimated speed, thirty-two and one-half knots. Its guns will not exceed eight inches in size, but the treaty did not limit the number of guns that may be provided. By an act of congress, in 1924, the president was authorized to undertake, before July 1, 1926, construction of eight scout cruisers, carrying protection and armament suit-

able to their size and type, to have the highest possible speed and the greatest desirable radius of action and to cost, exclusive of armament, not more than \$11,000,000 each. The keel was laid down on "Navy Day," October 27.

RAY'S OF ARTIFICIAL SUNSHINE AID DENTAL TREATMENT

Rays of artificial sunlight have been found helpful in various medical treatments and now a special lamp has been devised to administer the rays to the interior of the mouth in dental work. A tube is held between the patient's teeth and the lips closed while the operator manipulates the apparatus.



Sunlight Lamp for Dental Treatment; Artificial Sunshine Is Directed through Tube

*Exhibited at University of Washington*

*The Armore Lamp.*

664  
Dr. George Van...  
Yerkes Observatory, Williams Bay, Wis.

# Mars' Latest Visit Leaves Riddle of Life Unsolved

## Red Planet Probed by Watchers in Search for Clues That Life Exists on Its Surface

THE most intriguing mystery in the heavens—whether life exists on Mars—may be settled once for all within the next few weeks, when astronomers scattered throughout the northern hemisphere combine and compare the results of their latest observations of the big red planet. For two months they have trained their telescopes, cameras and spectroscopes on our nearest neighbor in the sky—nearest if you except our own satellite, the Moon—in a world-wide drive to solve once for all the question of whether man-made canals crisscross the planet, or whether the lines, which many have seen and some have photographed, are only an optical illusion that even fooled the cameras.

The occasion for the frenzied interest in Mars was its near approach to the earth, only 42,630,000 miles away, on October 27. It is true that this is several million miles farther than the distance to the planet in August two years ago, when it came within 35,000,000 miles of the earth, but on that occasion the planet was seen far down toward the southern horizon, not a favorable position for observers in the northern hemisphere. In spite of the difficulties two years ago of sighting through many extra miles of the earth's atmosphere, the astronomers definitely established that the canal marks were

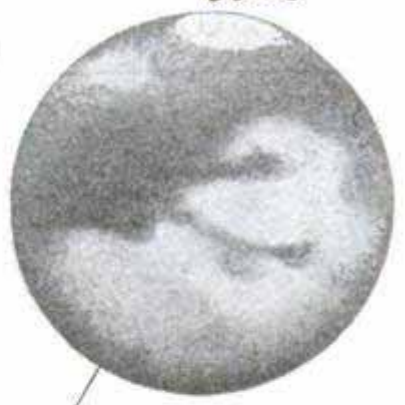

there, measured the temperature of Mars, weighed the oxygen in its atmosphere, and determined how much water a problematical Martian would have for daily drinking, bathing and shaving.

EXPRESS TRAIN 75 YEARS TO MARS

The establishment as a fact that Mars has both air and water proves that some sort of life may exist on the planet, but the Martian, if he does exist, resembles nothing we have ever seen, for the air he has contains one-third less oxygen than is found at the top of Mt. Everest, and the only man that ever reached that highest mountain peak in the world died there from lack of that vital element.

And the water vapor in the Martian atmosphere is only six per cent of that found over Pasadena, Calif., below Mt. Wilson observatory, where the measurements were made, a condition that would indicate a desert drier than the wastes of the Sahara, with its surface parched and cracked, while, as for the temperature recorded, it has a daily range, in the Martian tropics, of from around ninety degrees below zero at midnight to about sixty degrees above zero at noon.

To meet such conditions, lack of air, lack of water and tremendous temperature changes, the Martian would need a detachable skin or coat of fur, tremendous lung capacity to breathe the rarefied air, and an ability like the camel to go seven days without a drink. His colossal lungs would have to be housed in an enormous chest, yet it would be supported by spindlelike legs, for his total weight, as measured on earth, would be much less than that of one of our people, since Mars, with a diameter of 4,200 miles, is only about half the earth's size and hence the attraction of gravity is only a fraction as great.

Proof of the existence of air and water and at least some warmth, however, is not proof that life does exist, so science prepared to concentrate last fall on two things,

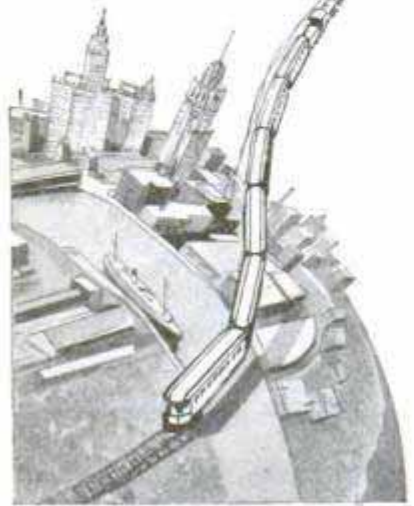

667

Four Drawings, at Different Times, Showing the Entire Surface of Mars, at Left, and Below, the Forty-Inch Lens of the Yerkes Telescope

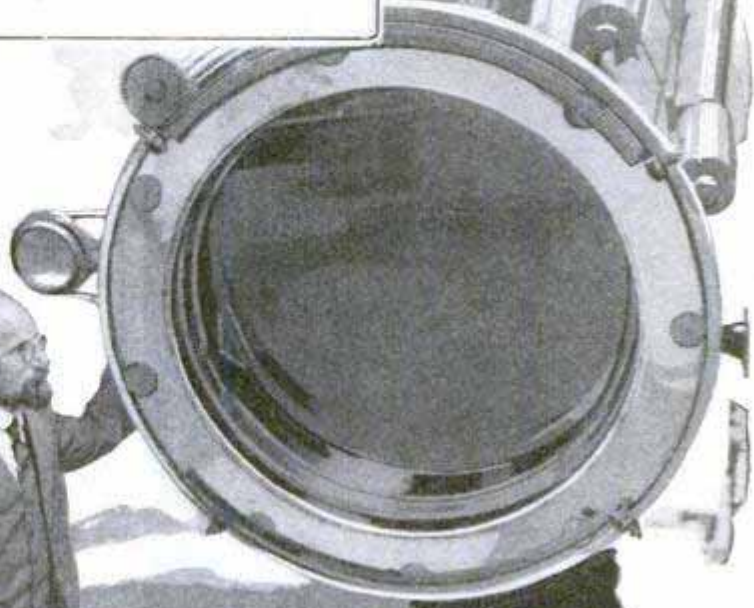
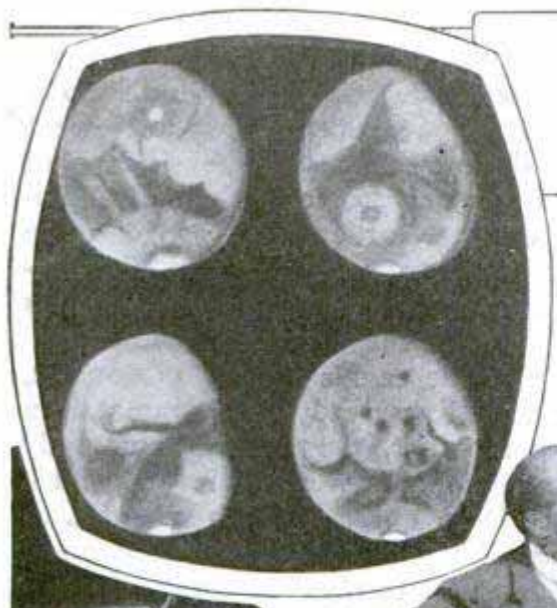

Above, Halves of Mars Photos, Taken by Ultraviolet and Infrared Light and Fitted Together to Show Thickness of Atmosphere



MARS' POLAR ICE CAP IN MAY



MARS' POLAR ICE CAP IN SEPTEMBER

Above and at Left Are Spring and Late-Summer Pictures Showing the Melting of Mars' Snow Cap

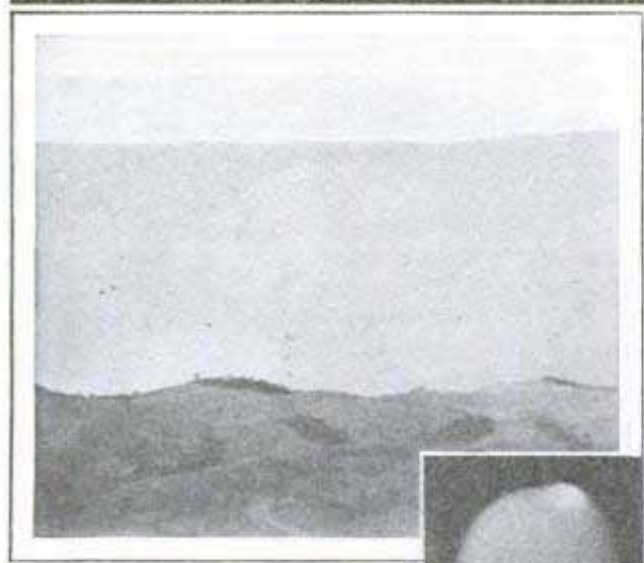

Valley of San Jose, Above, and Right, Mars, Photographed through Ultraviolet Filters

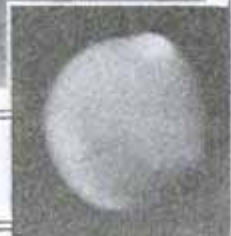

The Same Scenes by Infrared Light, Which Penetrates the Atmospheric Haze in Each

664

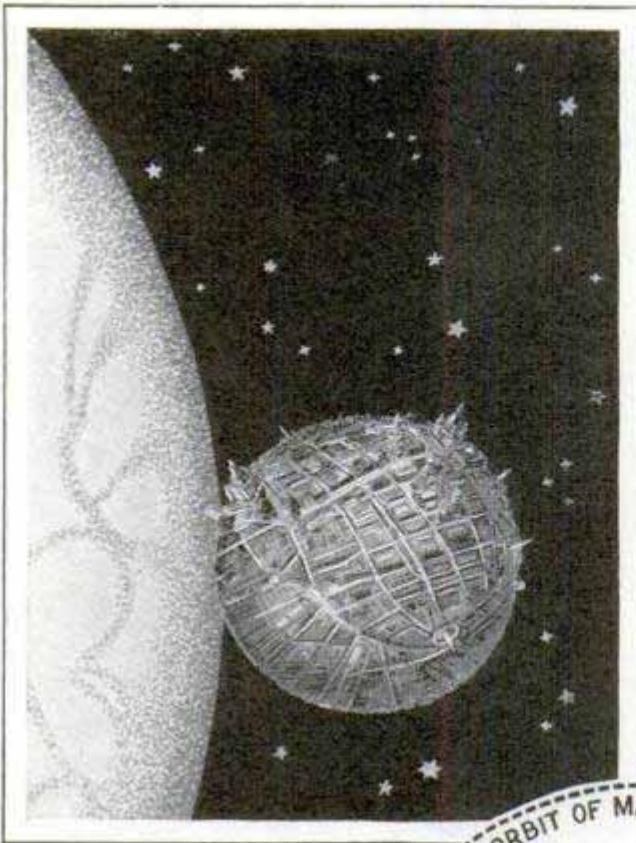

Mars' Smallest Moon, Ganymede, Only Seven Miles in Diameter, Would Just Accommodate a Good-Sized City, as the Artist Has Shown Above

the apparent spread of vegetation, and the mystery of the canals. The latter were for years a matter of doubt and their chief sponsor, the late Prof. Percival Lowell, was frankly accused of seeing things that didn't exist. The canals had first been discovered in 1877 by an Italian astronomer, Schiaparelli, while engaged in drawing the first map ever made of the planet. For a great many years he and Lowell were the only ones who claimed to have seen them. Lowell built an observatory at Flagstaff, Ariz., to help prove his theory, hoping that the rarefied air on the Arizona plateau would make better observations possible. He died in 1916 without having proved the canals existed, but the 1924 observations not only showed them to the observers,

but they were accurately photographed for the first time.

No sooner had that been done, however, than a new point was raised—were they really markings on the surface of Mars, answering Lowell's theory of irrigation ditches bordered by broad green fields, which stood out against the surrounding desert and hence made them visible, or were they optical illusions?

Many of the canals appear as doubles, two parallel lines, and H. J. Gramatzk, a German scientist, proved experimentally that they probably were optical illusions. That set Dr. Kuhl, a Munich scientist, to work and he proved the single channels were illusions, too! Gramatzk demonstrated the possibility that the double canals do not really exist by using two candles to project the shadow of a pencil. The shadow had dark edges, giving the same effect as is seen in the so-called double canals.

Dr. Kuhl's suspicions of the single canals, aroused by the questioning of the double ones, led him to try to measure them, with the surprising result that he found the supposed canals were much narrower than the finest lines that could be measured by any

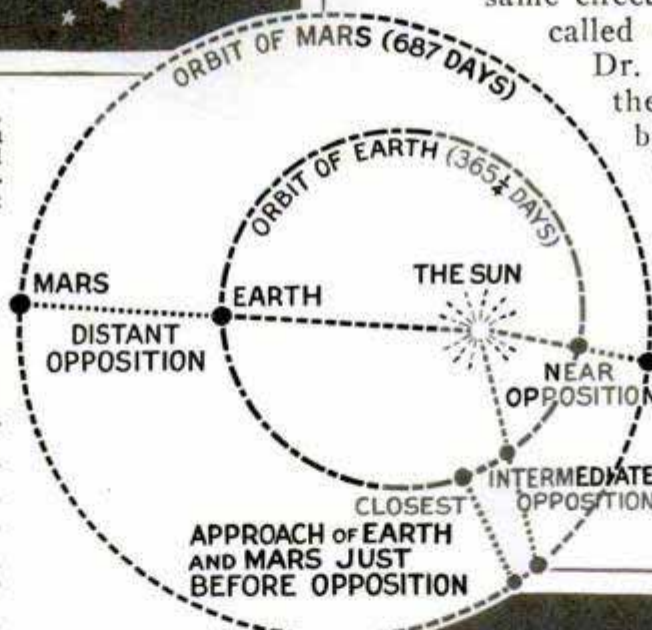

Map of the Orbits of Earth and Mars, Showing Why They Are Nearest at Certain Periods, and, at Right, a Sketch from a Photograph Showing Canals

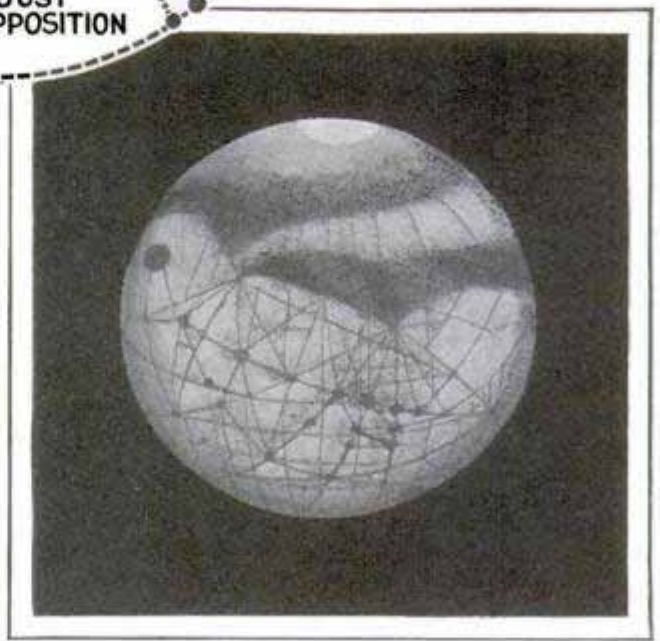

existing instrument, a fact that led to the conclusion they were just illusions, too.

This theory, however, has failed to satisfy everyone, so the investigation continues. The canals apparently are straight, laid out along geometrical lines, and all the single ones, at their points of junction, are surrounded by large dark dots that might be cities or intensively cultivated areas.

Under a large telescope, Mars presents a fascinating study. The temperature observations made two years ago give a definite picture of what a day on Mars is like. When the sun rises over an equatorial land there, the morning is bitterly cold. Slowly the ground gets warmer, more rapidly, probably, than would be the case on the earth because the atmosphere is so much less dense and its vapor content so slight, that there are few clouds to impede the sun's rays. At noon the heat in the areas which astronomers have named seas and marshes reaches close to sixty degrees above zero, and in other sections, which appear lighter, with a reddish or yellow tinge, to about forty-five degrees. As the afternoon progresses the temperature falls rapidly. The disk, as the astronomer watches, changes color, white fogs from the rifts and abysses, which, in contrast to the plains, are reddish and give the planet its peculiar brick-red color, even when seen with the naked eye, rise and spread over the surface. The land becomes gradually yellower the closer sunset draws near, and as the sun sinks below the horizon, the temperature falls far below zero. At the poles grim cold

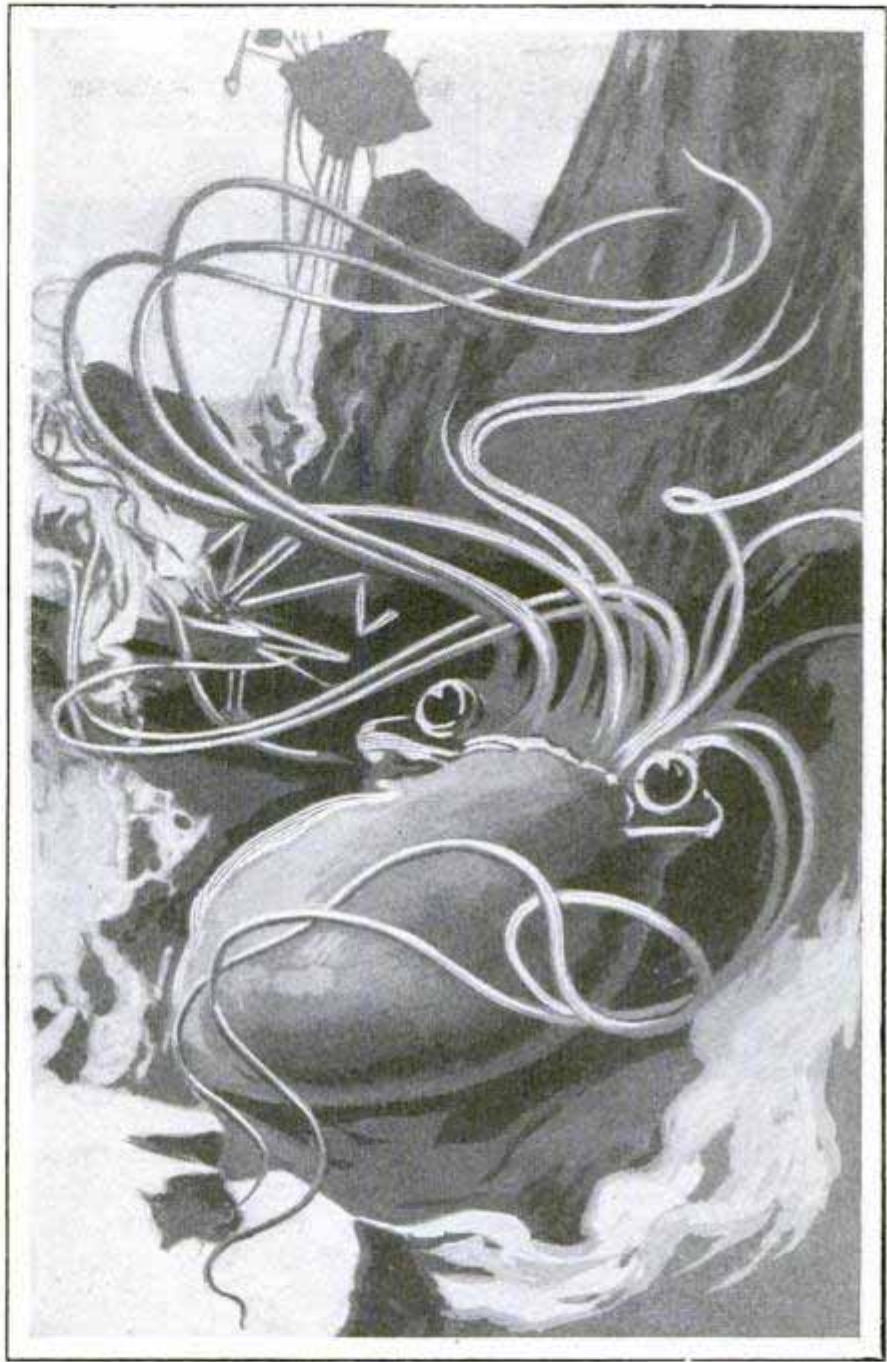

An Artist's Conception, from H. G. Wells' "War of the Worlds," of the Kind of Life the Planet Mars May Support

rules always, with an ice cap, much like those at our own north and south poles, always present. At the south pole, which, at the time of the opposition in August, 1924, when the observations were made, had summer, the temperature nevertheless was ninety-four degrees below zero. On the big ice cap, the melting of which could be followed distinctly, curious light spots were seen, whose changes pointed to violent atmospheric disturbances.

The periodical recession and advance of the Martian ice cap was accurately photographed many years ago. In our late spring it is at its greatest, extending

664  
12

well down from the pole, whereas by late September only a tiny white spot marks its position.

What a Martian Day Is Like Is Pictured by These Temperature Readings for Morning, Noon and Evening in Its Tropical Zone; the Midnight Temperature Is About the Same as at the Pole

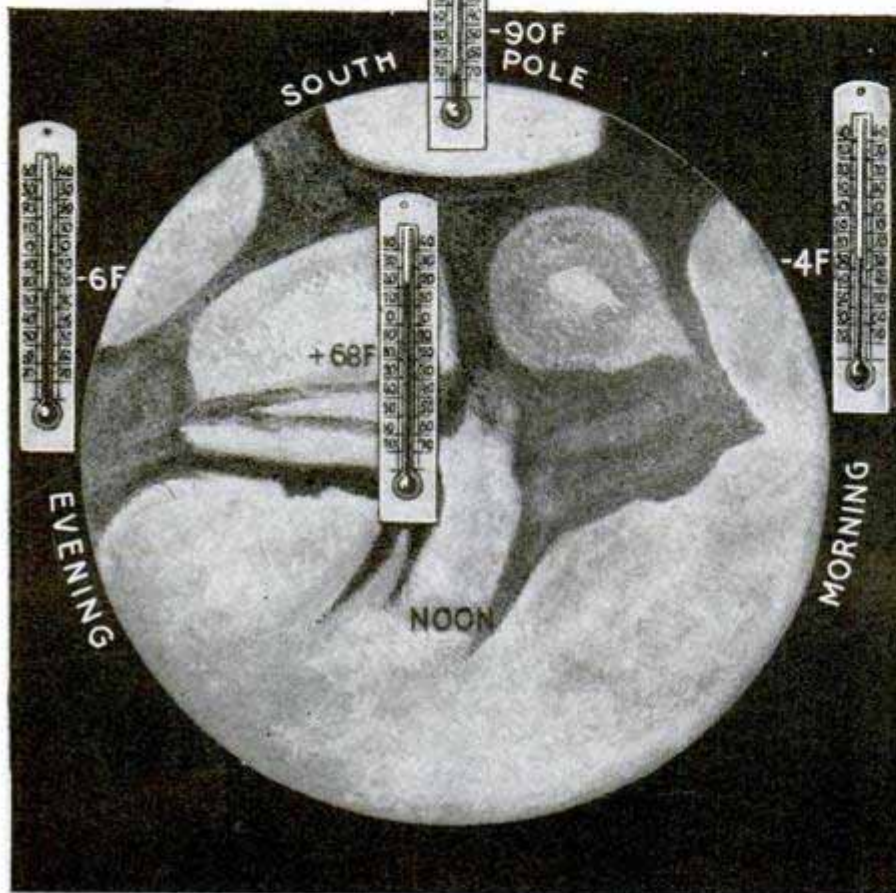

The way in which so much has been learned about the neighboring planet, if you can call an object more than 40,000,000 miles away a neighbor, is a story in itself. The discovery of its atmosphere was due to an ingenious idea conceived at Lick observatory and executed by Prof. Robert G. Aitken and W. H. Wright. From their station on Mt. Hamilton they took pictures of San Jose, Calif., lying in the valley thirteen miles away. One picture was taken through a color screen that passed only ultraviolet rays, and the other through a screen passing infrared rays, at the other end of the spectrum. Then they took similar pictures of Mars and found that the same effects were obtained, the atmosphere in one case blurring the image, just as it blurred the

Despite the very great range in temperatures the Martian world would not offer unconquerable obstacles to earthly explorers who had first become inured to our own north and south-pole extremes, though the cold on Mars exceeds somewhat anything they would experience on the earth. With such a large polar cap melting to supply water, it is even probable that sufficient moisture could be found to sustain them. The one insuperable difficulty to earthly men ever living on Mars is the scarcity of oxygen, but, while that bars them, it does not bar other forms of life, for insects and birds have been found as high up on Mt. Everest as man has ascended.

Life on Mars would at least have variety, for the planet has two moons to our one, and, curiously enough, one rises in the east and the other in the west! And one of them spins around Mars three times a day, so that it would be visible there both day and night.

image of the town, while in the other both showed clear. Finally, they cut the two pictures of Mars on a line drawn through the poles, pieced the half of one to the half of the other, and found that one picture was much larger than the other! The difference in size represented the thickness of Mars' atmosphere.

**FIND STRANGE TEMPLE IN INDIA  
THIRTEEN CENTURIES OLD**

Mysterious India has yielded another treasure to the historian in the ruins of a temple recently unearthed in Bengal. It is of a type distinctly different from that of other old structures, having been built of small bricks with mud as mortar. In spite of the ravages of time, the walls in some places were standing as high as 60 feet above the ground level, and the ornamentation of the temple was remarkably well preserved. Stone had been used sparingly, being confined mostly to the pillars

*at Baharpur*  
*archaeological Dept.*  
*Under direction of A. D. D.*  
*Provincial Government*

Tested at Annapolis  
65 of Washington

and pilasters, drain pipes and gargoyles in the shape of crocodiles' heads. The main part of the building occupied the center of a quadrangle where a mound, seventy feet high, remained. In plan, it resembled a huge Maltese cross, the arms of which were large staircases now hidden in the mound. The side walls of the stairway, and other parts of the structure, were decorated with figures of flowers, trees, rocks, snakes, animals and men.

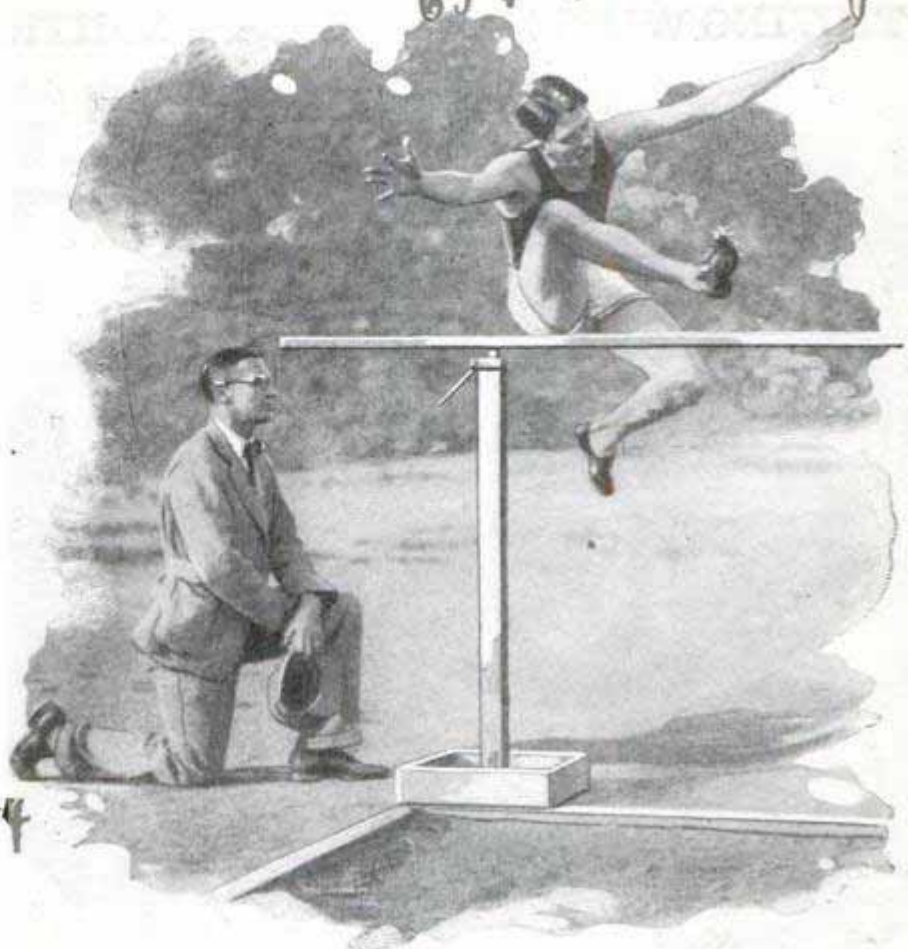

Clearing the Bar Is Necessary with This Type of Standard, or It Will Fall; Elevating Lever under Stick

**MACHINE ON BACK MAKES MAN FLY, LIKE A BIRD**

What appears to be a partly successful imitation of bird flight applied to transportation has been demonstrated in the curious apparatus devised by an Austrian inventor. The rig is strapped to his back and includes two upright propellers which, on revolving rapidly, raise the rider from the ground. On each side are wings that open and close like an umbrella. By means of the propellers, the height of ascent is regulated and the landing negotiated. The mechanism is driven by a gasoline motor and is said to have carried the inventor a third of a mile and to a height of 150 feet.

Herr Lutsch

Rear View of the Bird-Wing Flying Machine. Note Propellers on Each Side



**STRICTER TEST OF HIGH JUMPS IN NEW STANDARD**

Jumpers must clear the bar of a new standard clean, or it will fall off and the leap will not count. The crosspiece is so adjusted that it topples at the slightest blow and cannot bounce back on the pegs as sometimes occurs with other standards. The new rig has been tested by athletes at various schools.

**SINGLE-WIRE CABLE CARRIES FIVE MESSAGES AT ONCE**

Five telegrams can be sent at the same time at a speed of 1,200 letters in one minute on the single-wire cable to Germany. It stretches from Emden to the Azores, where it connects with the New York cable, forming the first direct telegraphic connection with Germany since the war.

Christian Science Monitor 10/20/26

Ben S. ...

769 **TILTING WINGS GIVE BETTER CONTROL OF AIRPLANE**

pilot sets the wings at their maximum angle—twenty-nine degrees for the upper and twenty-five for the lower wing—cuts off the power, and gently floats down,

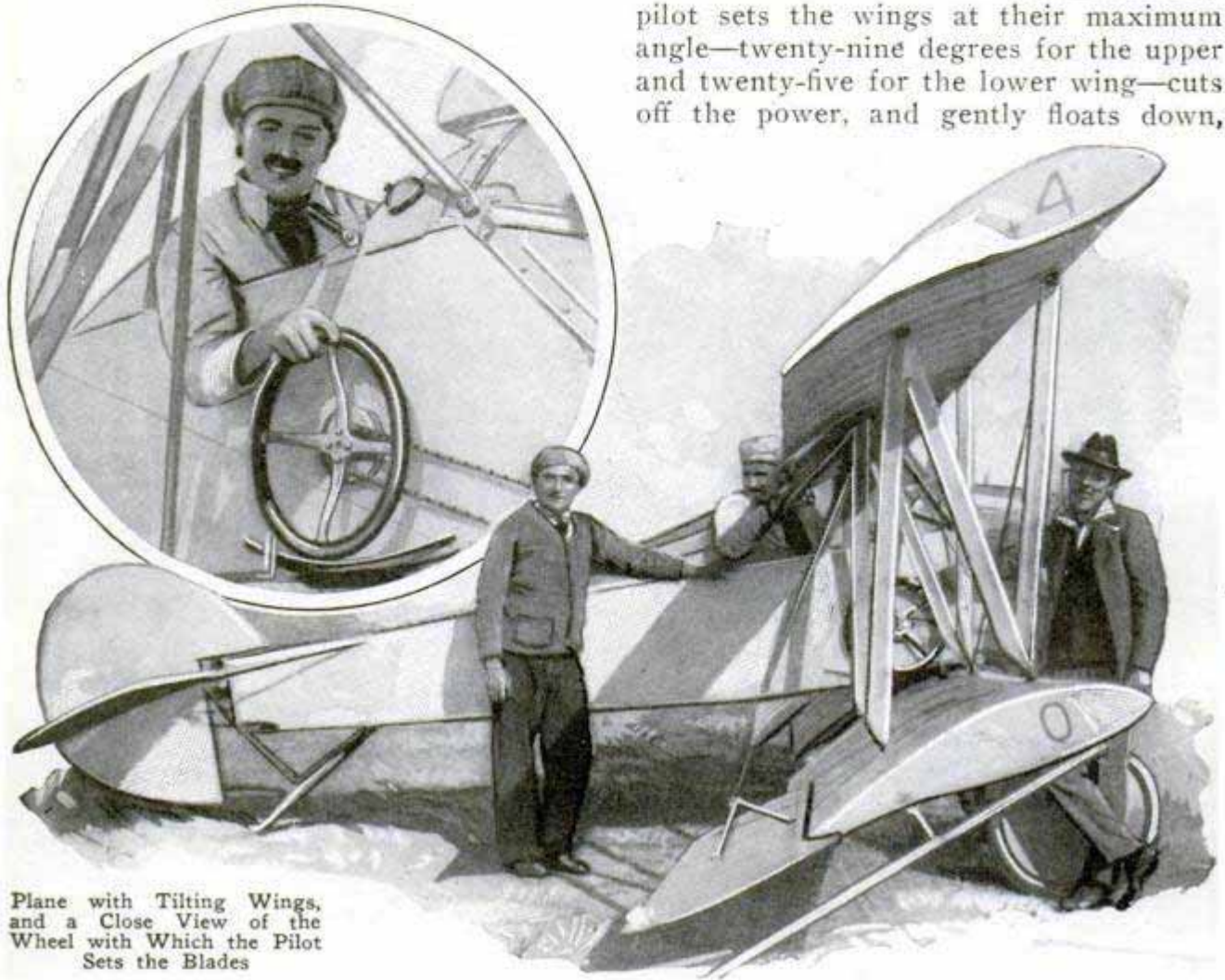

Plane with Tilting Wings, and a Close View of the Wheel with Which the Pilot Sets the Blades

*Paradena Calif.*

Designed to move in any direction or from one altitude to another with ease, yet to remain horizontal to the ground at all times, a biplane with movable wings has been built by A. A. Merrill, at the California institute of technology. It already has flown 1,100 miles. One of the most remarkable feats of the plane is its ability to land at a speed of less than five miles an hour. To accomplish this, the

much in the manner of a bird. The plane "takes itself off" the ground in the same manner. The pilot sets the wings at the desired angle and settles back comfortably and waits for it to leave the earth. Merrill claims his plane is stable under any and all conditions; gusts cannot upset it; it cannot be stalled to the point of losing control and it will not go into a dreaded nose dive unless the pilot so wills it.

*N.Y. Times 10/10/26*

**ORIGIN OF BIRTHSTONE TRACED TO ANCIENT EGYPT**

816 As early as 4000 B.C. an Egyptian priest wore a breastplate of twelve small stones or crosses, carvings of the period reveal, and this ornament is believed to have some relation to the plate worn by the High Priest Aaron as described in the book of Exodus. It was from this arrangement of stones that the idea of birthstones, one for each month in the year, is

believed to have been derived. In the first century A.D., Josephus mentioned that a special stone was dedicated to each month. The idea is further developed in the description of the foundation stones of the Holy City as recorded in the book of Revelation. Their order was used to determine the succession of the natal stones for the months of the year. The twelve stones are also in distinct relationship to the signs of the zodiac and, in this connection, had significance in astrologers' practices.



*Dea...  
Victoria B. West...  
Chicago*

*and*

**POPULAR MECHANICS**

**BURNING FLAME UNDER WATER  
MAKES STEAM SWIFTLY**

Promise of a more efficient way of generating steam is seen in a combustion method by which a flame is made to burn under water, transferring its heat directly and thus eliminating losses. (The system has been developed by English inventors and suggests the possibility of wide application on both land and sea. The apparatus is simple, requires about one-tenth the space of the ordinary boilers of a vessel and is said to generate steam within a few minutes after combustion. No smoke, soot or residue is formed, so that no funnels will be necessary and sea water can be used as no scale accumulates. The fuel is oil, although other materials can be employed, it is believed. Air is supplied to the flame under high pressure. The blaze is regulated by turning a wheel.)

**Submerged Combustion Ltd.  
FREEZER HOUSES ICE-CREAM  
AND CANDY STORE**

Built in the shape of a large ice-cream freezer, a refreshment store in a western city is a conspicuous wayside feature. Visitors are attracted by the huge handle which turns in realistic manner. It is counterbalanced to minimize vibration and is operated by a small electric motor.

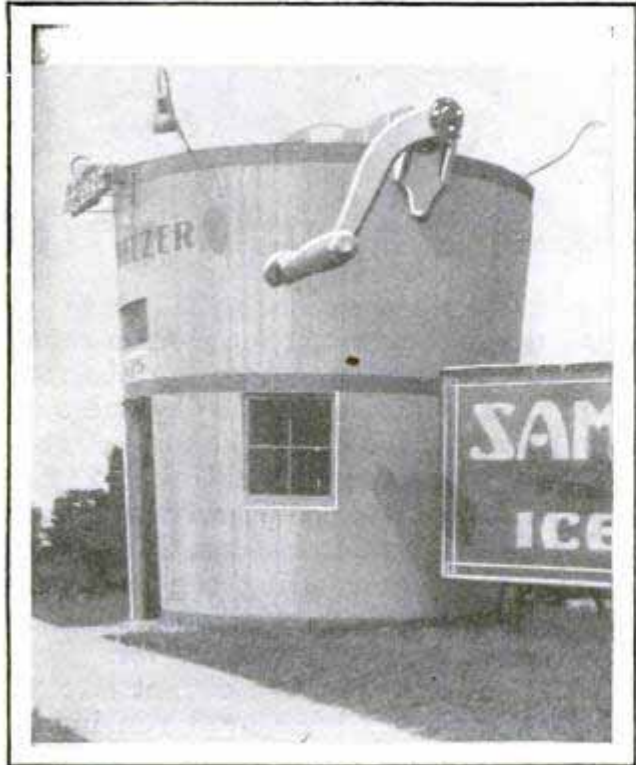

To Attract the Eye of the Hungry and Thirsty; Confectionery Store Built as Freezer

Cane Open for Use as Ukulele, and Closed as Walking Stick; Strings Are Tuned by Turning Coin in Slot



*Uke-Cane*

\$ 3.50

**UKULELE CONCEALED IN CANE  
IS TUNED WITH A COIN**

Walking stick and ukulele are combined in a novel and serviceable article introduced by an eastern inventor. The strings are behind a concealed cover in the cane, and they are tuned by inserting a coin in a slotted key and twisting it. A mandolin pick is used to play the instrument and best results are said to be obtained by resting the ukulele partly on a solid body.

**AFRICA SAND BLOWN TO FRANCE  
FALLS WITH RAIN**

Fine particles of yellow sand were found in rain that fell in southern France during severe storms not long ago. Apparently, the grains had been swept across the Mediterranean from Africa by the strong winds which blew steadily for more than two days. The carrying power of air currents is likewise demonstrated after severe volcanic eruptions. Some of the finer dust from such disturbances has been carried entirely around the world.

The sweetest bird singers have sober-colored plumage.

*757  
Morris Rothman  
364 Broadway, Daytime  
Chicago Music Co.*

*Chicago Daily News  
11/11/26*

738

# HOW FAR CAN YOU SEE?—UNCLE SAM GIVES ANSWER

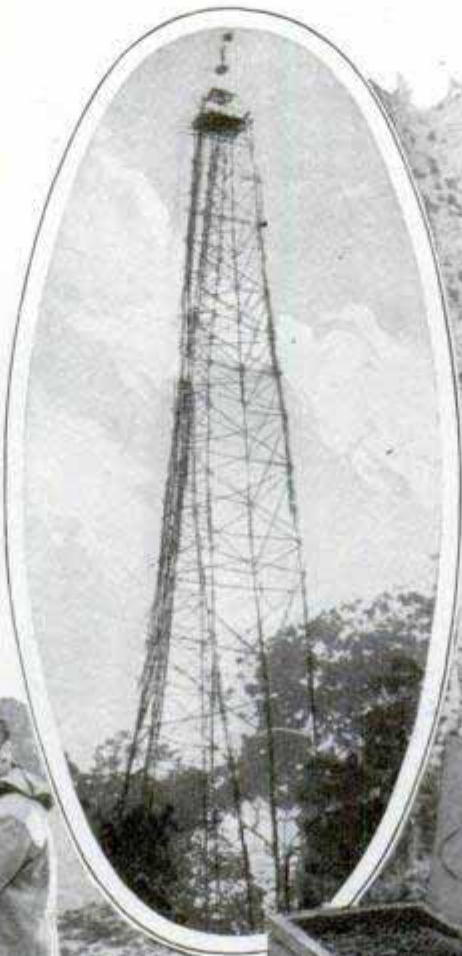

Fixing Your Location on the Map; Geodetic Engineers with Sun Reflectors and Telescopes; in the Center Is an Observation Tower, and at the Right, the Auto Light for Night Work

An ordinary automobile-headlight reflector holds the world's record for visibility of a low-candlepower light, according to a recent announcement of the coast and geodetic survey. Two such lights placed on a mountain top in Arizona were seen with the unaided eye by an observer on another mountain just a few feet less than 153 miles away. The long-distance sight was part of the regular work of the survey in accurately locating every part of the country, as a basis for correcting existing maps. Part of the location work is done by triangulation surveys, in which three points are used to

take bearings, from each to the other two, so as to fix their exact location in reference to one another. Accurate observations have been made in the daytime over even greater distances. The longest geodetic ray ever used in the United States was 192 miles, between observers stationed on Mt. Shasta and Mt. Helena, Calif. They worked in daytime, using sun-ray apparatus in which light was reflected from twelve-inch mirrors, the observers picking up the rays from the distant station. Even longer lines have been run in the Himalayas of India, one of them exceeding 200 miles, but there the observers

*any light*

*O. Anhard. Levassey,  
19 Avenue  
625 d'Orly, Paris, France*

simply sighted at the distant mountain peak as it stood out in quite distinct relief against the sky. Recently French engineers succeeded in linking the island of Corsica, birthplace of Napoleon, to the mainland by a triangulation survey in which several long rays, one of nearly 150 miles, were used. On one exceptionally clear night lights from projectors on five different mainland peaks were seen clearly and bearings taken from all of them. The bulbs used by the American surveyors are operated from dry cells.

**GOGGLES ARE HINGED TO WELDER'S HELMET TO SAVE TIME** 683

For welders, stonecutters, and others who use goggles, a combination of helmet and eye protectors has been devised. The goggles are hinged to the headpiece, which is of fiber material, worn as a cap and made secure by an adjustable strap at the rear. When not in use, the goggles are swung back and rest upon the top of the helmet. The wearer is spared the trouble of taking them off and searching for them again, and there is little danger of dropping or breaking the glasses. They can be adjusted to fit snugly. The entire outfit is light in weight and the material used resists both heat and electricity.



Combination Helmet and Goggles, Showing Hinged Support for Glasses Which Can Be Swung on Top

*Carter Lockard Co.  
125 E. 1st St. Peoria, Ill.*

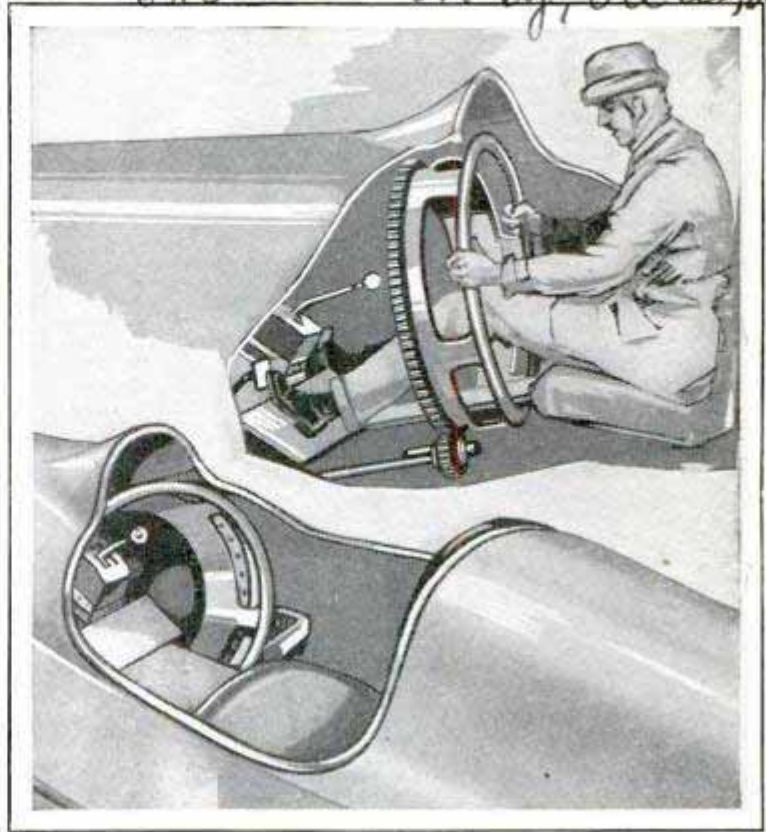

Steering Wheel and Part of Gear on Racing Car of Exceptionally Narrow Design to Decrease Wind Resistance

**AUTO RACE DRIVER SITS INSIDE OF STEERING WHEEL**

Reduction of wind resistance has become increasingly important in designing racing automobiles and to save a few square inches of head area, makers sometimes go to amazing lengths. An illustration of this is seen in a racer that appeared recently in France. It resembles a "knife on wheels." It was just engine-width and no more, and the steering wheel was fashioned so that the driver could sit with his legs through it, as though inside a hoop.

**MAGNETIC STREET-CAR BRAKES HELP PROMOTE SAFETY** 775

Electricity is not only used to propel street cars but to stop them. Magnetic brakes in the form of shoes suspended about two inches above the tracks have been devised. They are released by means of air pressure and are magnetized at the same time by electric current from the wires. In contact with the track, the shoes take a firm grip and are said to bring the car to a stop in one-third less the distance air brakes alone would do it.

*Harry Melrod Bldg  
Northville, Mich.  
808  
Albion  
Cal. 1926*

*Denver Public News  
Albion Cal. 1926*

*Dr. Roy A. Anderson  
San Francisco, Calif.*

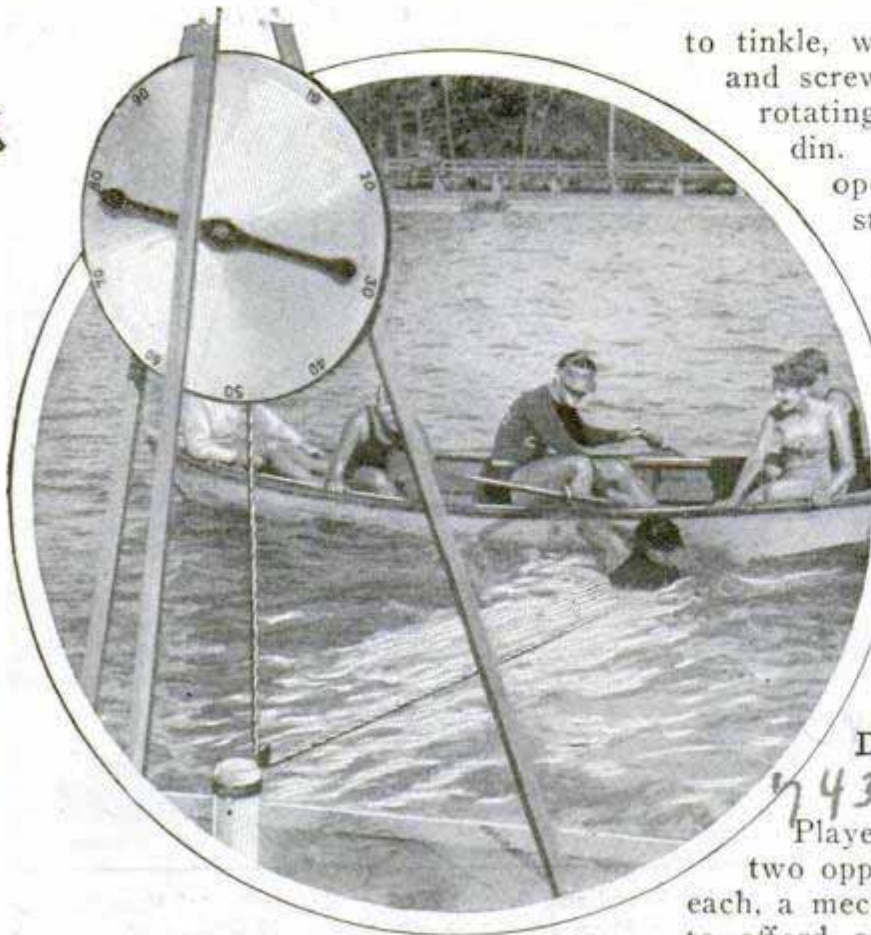

Measuring the Strength of a Swimmer's Strokes; Meter in Use on Pacific Coast Beach

### FORCE OF SWIMMERS' STROKES MEASURED BY METER

601

Like many other sports, swimming is being reduced to a fairly accurate science. In line with this development is a meter introduced on the Pacific coast for measuring the force of a swimmer's arm and leg strokes. It is mounted on a tripod and has a dial that registers up to 100 pounds. A line is attached to the swimmer, allowing plenty of slack for freedom of action. The pull on the cord as the stroke is made sends the arrow up to the figure giving the force of the movement.

### EFFECT OF NOISE ON WORKERS INVESTIGATED BY STUDENTS

800

Is the noise of the big city injurious to health and does it lower the efficiency of workers? Students at Colgate university are seeking answers to these questions by a series of tests in a laboratory under the direction of a psychology professor. To imitate the sounds of the streets, a noise-making machine is being used. It automatically blows a siren, causes a gong to ring at varying intervals and a smaller bell

to tinkle, while an assortment of nails and screws, crashing around inside a rotating six-sided box, adds to the din. The subject is a typewriter operator. The number of strokes made in a given time and the percentage of errors are recorded first without the noise and then with the racket. Tests will also be made to determine what physical effort was required to combat the strain of the noise. Other investigations are being made as to the effects of special wallboards and other materials for deadening sounds.

### DOLLS PLAY FOOTBALL AT TOUCH OF LEVER

743

Played on a miniature field with two opposing teams of eleven "men" each, a mechanical football game is said to afford participants opportunities for showing skill and enjoying some of the thrills of the real game. The figures are operated by means of a lever which causes the movable leg of each man to kick. A small round ball is used, and the field is so constructed that the ball always comes to rest at the kicking foot of the player. This is made possible by slight depressions at each of these points and high spots on the rest of the field. Two persons play



When Levers Are Manipulated, Doll Figures in Cabinet Perform a Game of Mimic Football

*Chester G. Ballard  
Amusement Co. of N. Y. City  
400 W. 45th St. New York*

*NY Herald Tribune*

*Chicago - L.A. - London  
S.A. - Paris - New York  
Columbia Hotel*

the game, one managing each team. One of the figures on each side plays a guard position between the goal posts to prevent a score. It moves back and forth under lever control when the opposing team kicks.

**MEMORIAL BRIDGE IS FEATURED BY CURVE**

Sentiment and skill are linked in a concrete bridge on the Victoria highway in California. It spans a rocky canyon at the summit of the Sierra Nevada, 6,000 feet above the floor of the Sacramento valley and not far from the scene of a tragic episode of pioneer days. The site overlooks Donner lake, where a party of emigrants were snowed in during the winter of 1846-47, suffering severe hardships and many deaths. The bridge has been dedicated to the memory of these early travelers, three of whom, then infants, are still living. The structure is considered interesting from an engineering standpoint because it describes a curve in crossing the canyon.

**ELECTRIC GRINDER FOR SKATES RUN FROM LIGHT SOCKET**

Adaptable to all kinds and makes of skates, with or without shoes, an electric sharpener operated from the lighting socket, is said to grind an accurate and well-finished edge in little time. A feature of the apparatus is that it permits lengthwise sharpening, producing the correct degree of concavity without the undesirable effects of cross-grinding.



*Ferrodo will Mfg Co,  
202 W. Indiana Ave.*

**STANDING ON SADDLES RIDERS LEAP HEDGE**

*548*

Cavalrymen of the Seventh Queen's Own Hussars showed their skill at horsemanship during a military carnival at Melksham, England, by performing a series of exacting drills. One of the

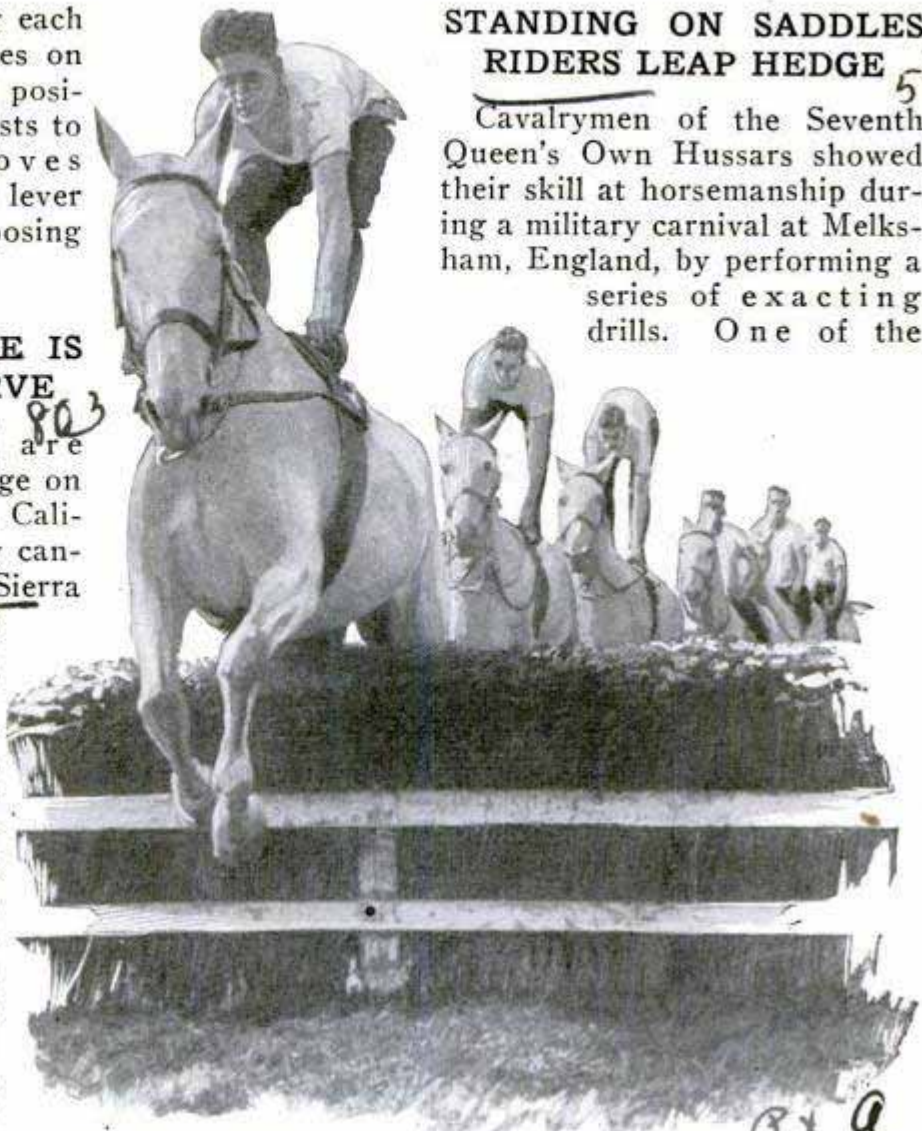

Matched in Color and Skill, Horses of the Queen's Hussars and Their Riders in an Exhibition Drill

stunts was to stand upon the saddles as the horses jumped over a hedge. Although grips were provided for finger-holds, the feat required steadiness and strength. The orderly line of mounts and men was not broken.

**WRONG COLOR OF WALLPAPER INJURIOUS TO HEALTH**

*7999  
A.C. Harin, paintmaker  
delegate to painters  
convention*

Illness and domestic discord may result from using the wrong color of wallpaper or paint in the home, according to an eastern manufacturer. Because of its vivid shade and its vibrations, red has an injurious effect on some nervous systems, it is said, leading to the provocation of quarrelsome natures and even more serious ills. Some colors are comforting and others are disturbing. Hence, in a home, care should be taken that the favorite color of one is not unpleasant to another.

524

# What Do Your Hands

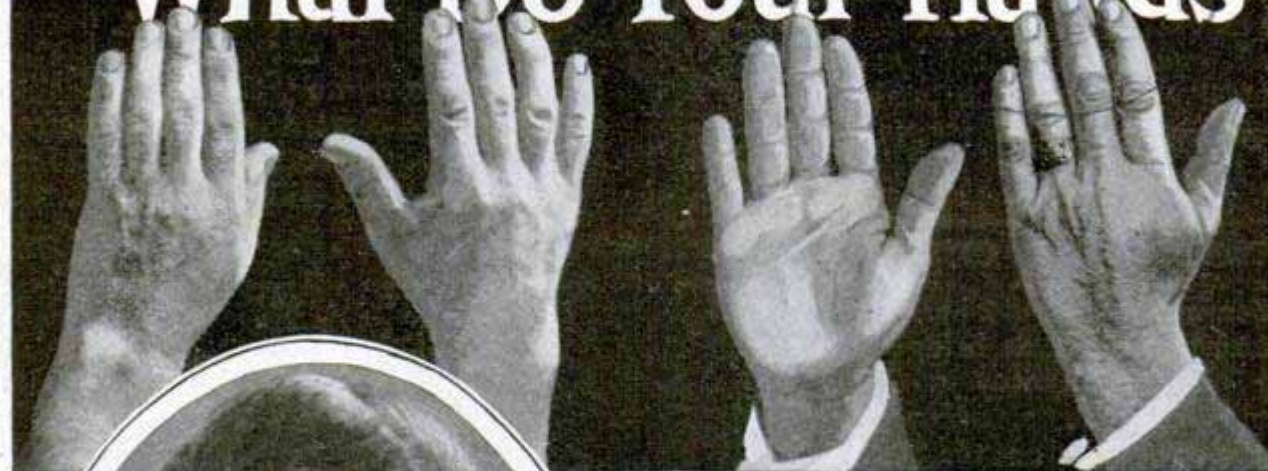

By FLOYD TAYLOR

one way he will try another; he will compromise and use diplomacy to gain his ends. A thumb set high up and close to the palm indicates a primitive mind, according to Dr. Blackford. She says the skilled man has a thumb set low, fixed on his hand so that it is easy for him to grasp things. An undeveloped, short, stubby thumb indicates to her low will power and low intelligence.

Dr. Blackford trained herself to be a physician. For years she was puzzled by her inability to understand people, to know what types they were and why they succeeded or failed. She finally gave up the practice of medicine and made a trip around the world to study racial types, returning to continue her studies in the United States. Since 1912, she has devoted herself to personnel problems of corporations, her clients including a large mail-order house, a life-insurance company, one of the best-known power companies, and a large textile firm.

She organizes personnel departments for such companies, where all the work of employing, paying, advising and discharging is done. Dr. Blackford declares that not more than two per cent of the men engaged by these personnel departments are discharged. Men employed are assigned to jobs which their physical characteristics indicate they are able to do. If a mistake is made, the case is studied again and the employe given some

Dr. Katherine M. H. Blackford, Who Applies Character Analysis to Fitting People into Right Work

**I**S your thumb pliable so that it can be bent back from the joint, or is it stiff and unyielding? The form of your thumb may indicate what work you are best suited for, and whether or not you are in the wrong job.

Dr. Katherine M. H. Blackford, who has studied character analysis for twenty years and since 1912 has been analyzing men and women to fit them to their jobs, says a man's thumb may tell her more about his character than he can himself in half an hour of talking.

The man with a stiff, unyielding thumb, she says, has a stiff and unyielding character. The man with the pliable thumb has more adaptability and a more flexible will. If he cannot get what he wants in

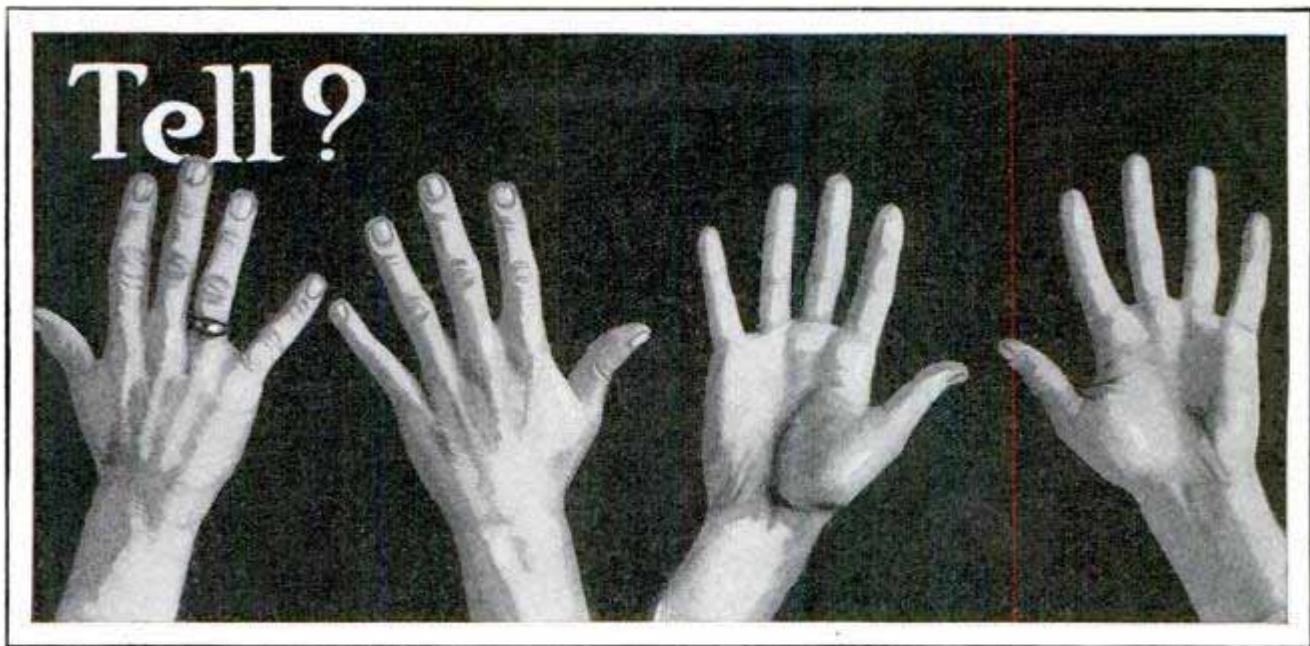

Across the Top, from Left to Right, Are Four Pairs of Hands, Those of a Laborer, an Assistant Sales Manager, a Bank Teller and an Engineer, All Showing Aptitude for Their Particular Work

other work. He is never discharged unless there is no job in the plant in which his abilities can be used to advantage.

Dr. Blackford insists there is some place in the world for every man; many have serious deficiencies, she admits, but all have special ability of some sort which can be used. Corporations employing hundreds or thousands of men save extraordinary sums by careful personnel work. A high employment turn-over is expensive; it can be avoided by placing the right man in the right job.

"Everything about a man counts in determining his abilities," Dr. Blackford says. "In physique, the convex structure is

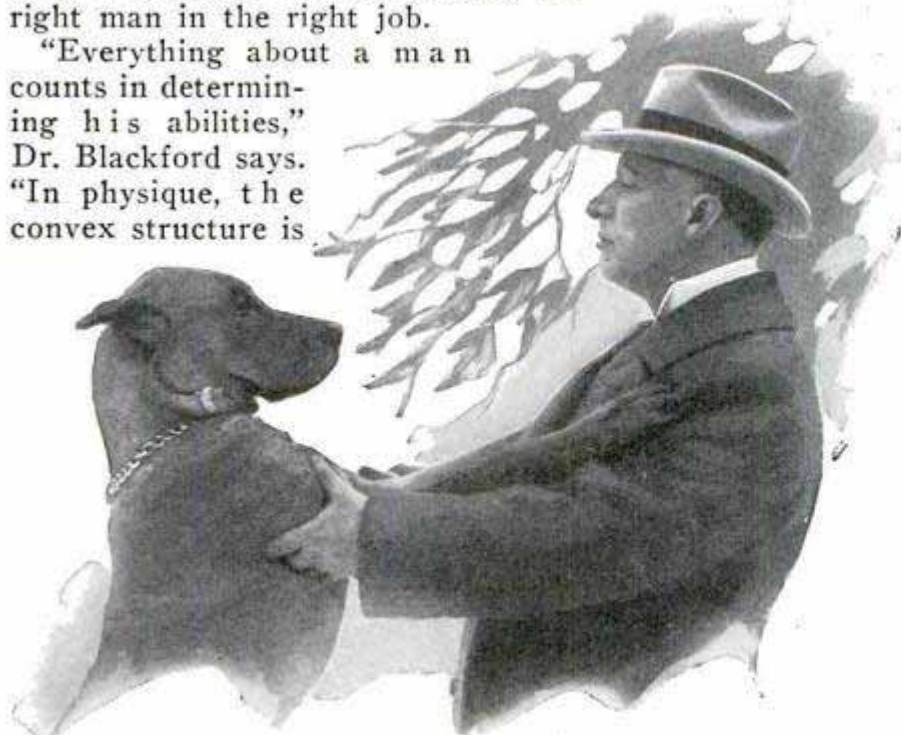

Gov. Al Smith, Being a Blond, Likes Variety and Change; His Large Convex Nose Indicates Energy, and His Long, Full Back Head Shows Sociability, Says Dr. Blackford

the positive principle and the concave the receptive principle. A tall man is not suited to stooping, so you will find most of the men handling shovels or construction jobs are short men. The short man is quicker in motion than the tall man.

"You will find that the majority of executives are stout. There is a direct relation between the desire for nourishment and the desire for money.

"Men who have raised pads at the ends of their fingers, just below the tips, are sensitive to their environment. The little mounds indicate that a man is more sensitive to pain and to all impressions.

"One man may be silken in texture, with fine hair, sensitive pads on his fingers and fine features. Another may be coarse like canvas. You use the silken man to do fine work and the canvas-like man to do work of heavy nature.

"Some work requires positive energy, the driving power to get things done, some requires a slow, enduring pace. If a man has high cheek bones and a nose which



Gen. Pershing's Convex Upper Face Shows Energy and Power of Observation; the Concave Lower Part Endurance and Tenacity, and the Length of the Head, from Chin Diagonally Backward, Indomitable Will

is convex when seen in profile, he has this positive energy. If he also has a high forehead and a large head and is a man of fine texture, he can best use his energy in mental work. If his forehead is low, his shoulders broad, his waist small and his texture coarse, he is best suited for physical work.

"The Anglo-Saxon has a high, long, narrow head. He is a pioneer and is progressive and ambitious. If you want a man with these qualities pick a high-browed man, with a long, narrow head. If you want a man to be cautious, careful, far-seeing, a man who will work slowly and thoroughly, find a square-headed man. If you need some one for dangerous work, who is optimistic and willing to take chances with his life, look for a round-headed man.

"You will find that a man who has a hard hand has a hard head. The man with a soft hand is impressionable. He can't see people suffer and be unhappy without feeling it."

Some years ago, Dr. Blackford was

called in by a cement company which had been producing inferior cement despite every effort to improve the product. Constant chemical tests are necessary to make good cement, and Dr. Blackford asked who was the company's head chemist. She was told by the president of the company that he was a man of exceptional ability. The chemist was called to talk to her. She noticed he had extremely short fingers.

"Can you ever make an experiment twice and get the same result?" she asked him.

He admitted he could not. She found he was a theorist able to convince others of his knowledge, but unable to do practical work. The company obtained a man of practical ability as head

chemist and the other was advised to find work as a teacher.

Dr. Blackford can tell the approximate age of a man by examining the skin on his hands. If a bit of skin on the back of a young man's hand is pinched between the fingers and lifted up it will snap back into position quickly when released. If he is old, it will fall back slowly.

"If a man comes to me and says he is forty when his skin indicates he is fifty," Dr. Blackford says, "I know either that he is fifty or that he has been living too fast."

A man of the brunet type who matures early mentally, according to Dr. Blackford, is likely to keep his youth physically until late in life. The blond lives faster than the brunet. He expends more energy; he doesn't conserve his strength. The blond is keyed higher and moves more rapidly. On a job which requires speed, a blond will do better work than a brunet. For fast work you would want a medium-sized compactly built blond, whose face, in profile, is convex.

Dr. Blackford points out that many men,



including some of the most famous in history, have been failures in one or more fields before they went into the work in which they ultimately found renown.

"Lincoln failed as a retail merchant," she says. "Grant failed as a farmer. Ford never earned more than \$150 a month until, at forty, he became an inventor and manufacturer. Hawthorne was a mediocre and poorly paid clerk until after he became a novelist, to name only a few out of many examples."

Going back to hands again, take the four pairs shown on the first pages of this story. The laborer's hands are typical, short and stocky with a heavy palm, fingers large and coarse, showing little sensitiveness.

The assistant sales manager's hands are those of an executive, with strong thumb, well balanced as a whole, with ability to grasp, and indicate a strong will.

The bank teller's hands are delicate, of fine texture, the crooked fifth finger indicating diplomacy, while the short nails show critical judgment.

The engineer's hand is in the analytic class, the thumb is flexible, showing intelligence, and the second joints are knotty. The raised pads at the ends of the fingers show the owner is a sensitive man.

Maj. Goodsell, Champion Single-Scull Oarsman, Can Easily Carry His Boat on One Shoulder; the Craft Weighs Eighteen Pounds and Is Almost as Fragile as an Eggshell



**OARSMAN'S SCULL FOR RACING WEIGHS EIGHTEEN POUNDS**

Lightweight equipment is an important factor in boat racing. This is illustrated in the fragile "shells" employed in rowing contests. A false move may send an oarsman's foot through the craft and, although one of the boats will easily hold a crew of eight men when on the water, the utmost care must be exercised in handling them to prevent damage. The scull illustrated weighs only eighteen pounds.

**POLICE-DOG AIDS PASSING OUT OF USE**

Of New York city's famous police-dog patrol, there are now but three members remaining from the original squad of thirty-five. The passing of the dogs is laid, not to their inefficiency or unreliability as home protectors, but to the difficulties of keeping them in good training. Few patrolmen to whom they were assigned understood dogs. They were first assigned to duty, in 1908, following an outbreak of robberies and other crimes in suburban districts. Within a month, they had been largely instrumental in bringing about a decrease of ninety per cent in the number of crimes in the suburbs. They were taught to catch fugitives by jumping upon them and holding them until the arrival of the patrolman.

**AUTO CHAINS QUICKLY MENDED WITHOUT TOOLS**



To simplify the task of mending the auto tire chain, easily inserted extra links which are quickly hooked in place and closed permanently by the weight of the car, have been introduced. No tools are needed for the attachment of the links.

*Johnson Motor Products Co. Inc. 308 N. Sheldon St*

*New York James 10/31/26*

739

many tenements of New York

# MODEL VILLAGES TO SOLVE ENGLISH HOUSING EVIL

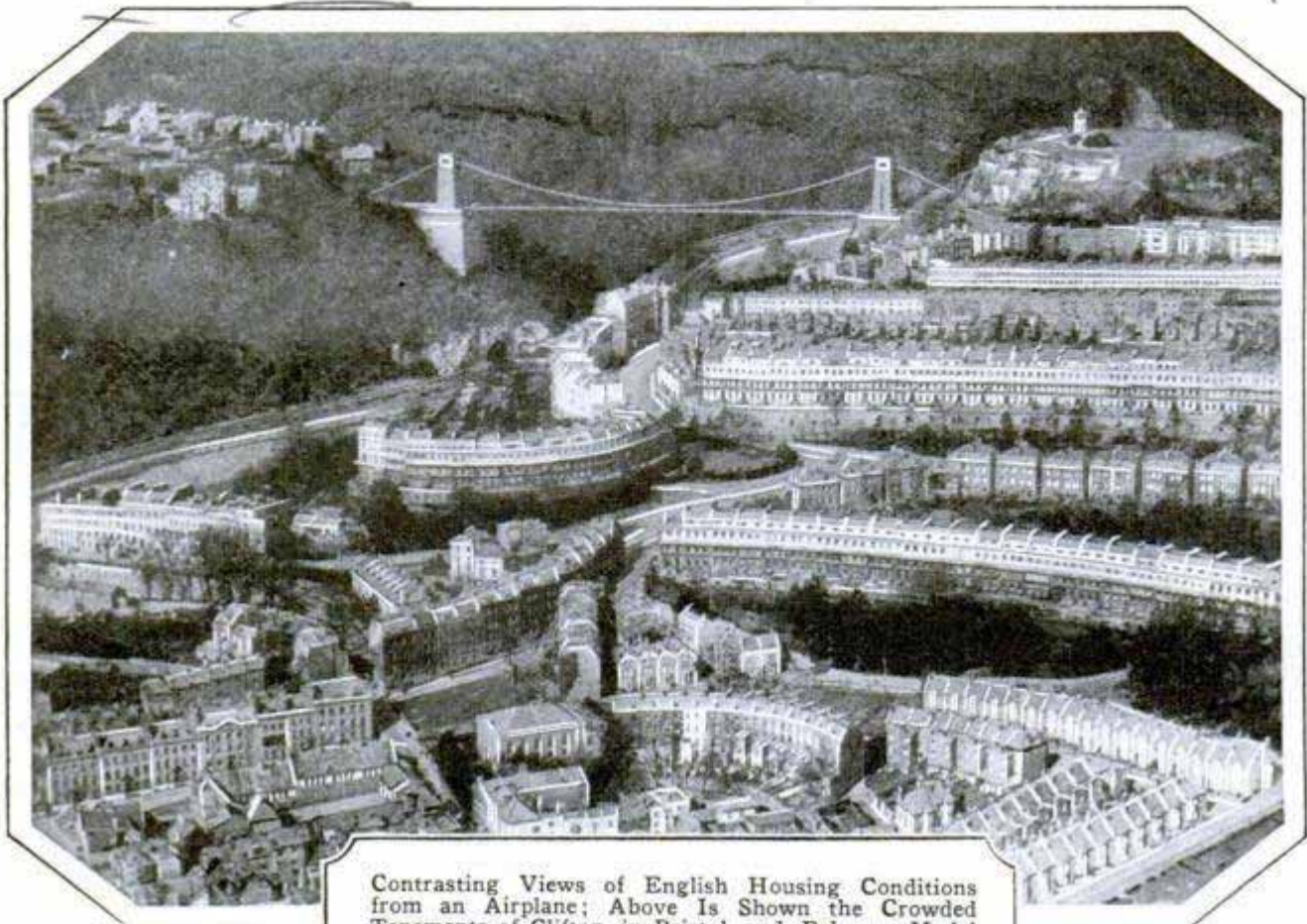

Contrasting Views of English Housing Conditions from an Airplane; Above Is Shown the Crowded Tenements of Clifton, in Bristol, and, Below, a Model Housing Estate near Rossington, Doncaster; Built in a Circular Plan, It Affords Light and Fresh Air, and Yard and Garden Space for the Cottage Dwellers

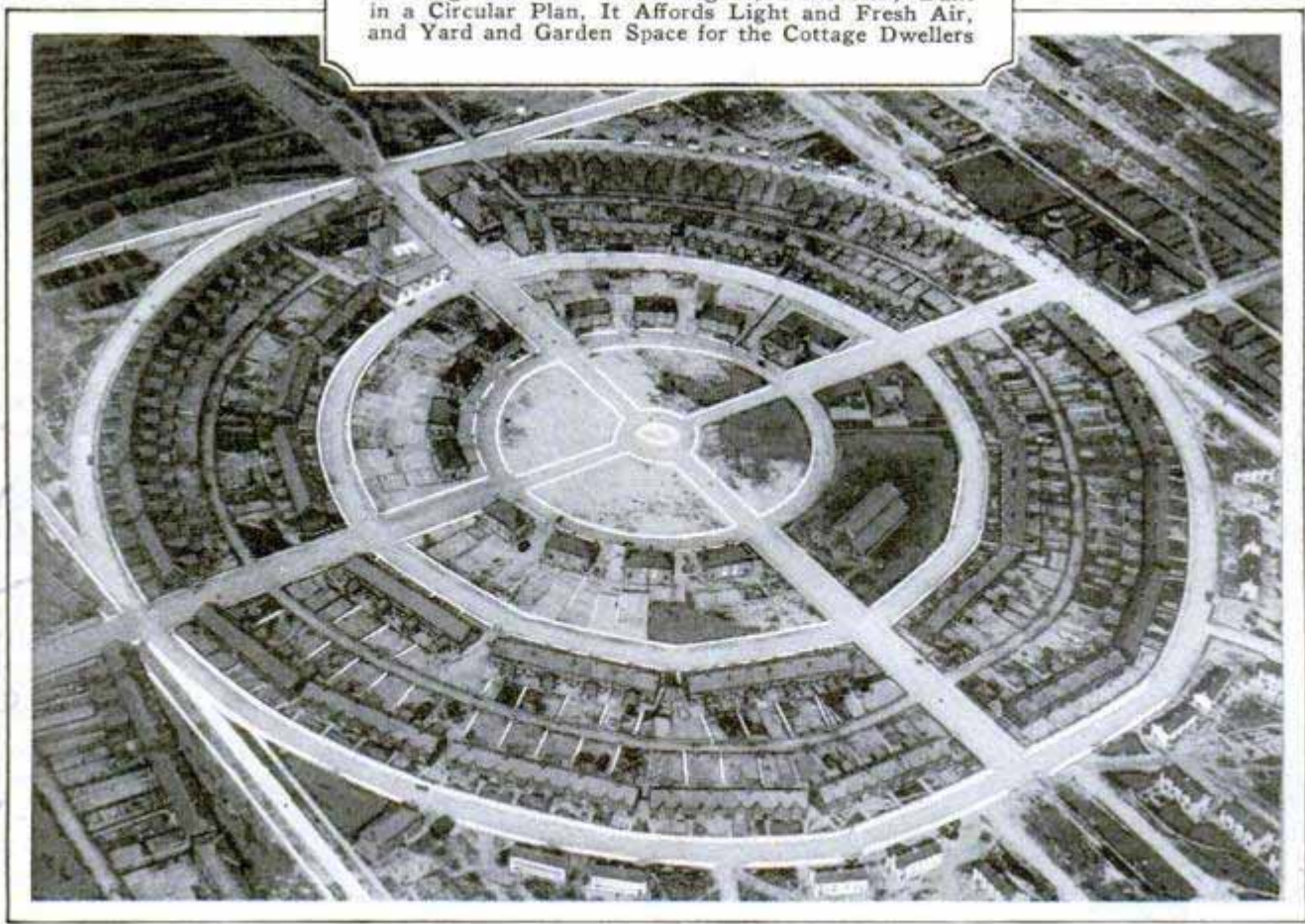

*Hoag, 205 Union League  
Los Angeles, Calif.*  
POPULAR MECHANICS  
TEAR GAS FAILS TO STOP  
BEARS IN YOSEMITE 823.

*Patent Pulp  
Sheffield, Norfolk, Eng.*

Depredations of bears in Yosemite national park upon the cabins of workmen and rangers, have become so serious that the national-park service is seeking a means of curbing them without injury. In an effort to discourage the bears, or put them to flight, experiments with tear gas were recently conducted in co-operation with the chemical warfare service. A small black bear was chosen as the victim for the experiment, and a heavy concentration of the gas was given him. It apparently caused the bear no discomfort whatever. He did not even blink. It previously has been demonstrated that horses and mules are indifferent to the gas, probably because they have no tear glands. Visitors to Yosemite find the bears among the most interesting of the park's wild life, and during the travel season they are well fed at the hotels and camps, as well as by visitors. By the time the hotels close the bears have become fat and lazy, and begin stealing slabs of bacon and other food, even though this may involve breaking a window or tearing a hole through a wall. With the apparent failure of tear gas, the park authorities are seeking other means of holding the bears in check without driving them out of the park.



Courtesy The Graphic  
Sample Hat and Flowerpots Made from the Pulp of Pine Wood at an English Factory

**HATS MOLDED OF WOOD PULP FOR ENGLISH MINERS**

Hats, flowerpots, dishes and many other articles are being fashioned from pine-wood pulp at an English factory. The material takes a wide variety of finishes and can be waterproofed. Helmets for miners are said to afford protection against falling rock. They are lighter than metal and not easily broken.

*made at Sheffield in Norfolk.*

**MIXER MAKES FOAM STREAM TO SMOTHER FIRES 771**

From a water hydrant and a pumping engine, a stream of fire-smothering foam is obtained through a mixer into which a powder is poured to form the thick substance. In contact with the water, it undergoes a chemical change which produces the foam. As much as 600 to 700 gallons can be delivered to the fire per minute, depending upon the water pressure. This system eliminates the use of special units of apparatus, and it can be put to work as quickly as a line of hose.



Pouring Foam Powder into the Mixer; the Smothering Stream Is Forced through Hose at Right

**BEES NEEDED TO HELP APPLE CROPS 815 IN MAINE**

If apple growers in Maine are to make money in the future, more bees must be raised in that section, according to experts. A small crop last season was ascribed to two main factors, cold damp weather during the blossoming period and the lack of sufficient pollination, due to the scarcity of bees.

*George C. Yeaton  
Portland, Maine*

*164 N. Clinton, Chicago*

*Noamite Child Corp.  
519 Turner St*

7.21

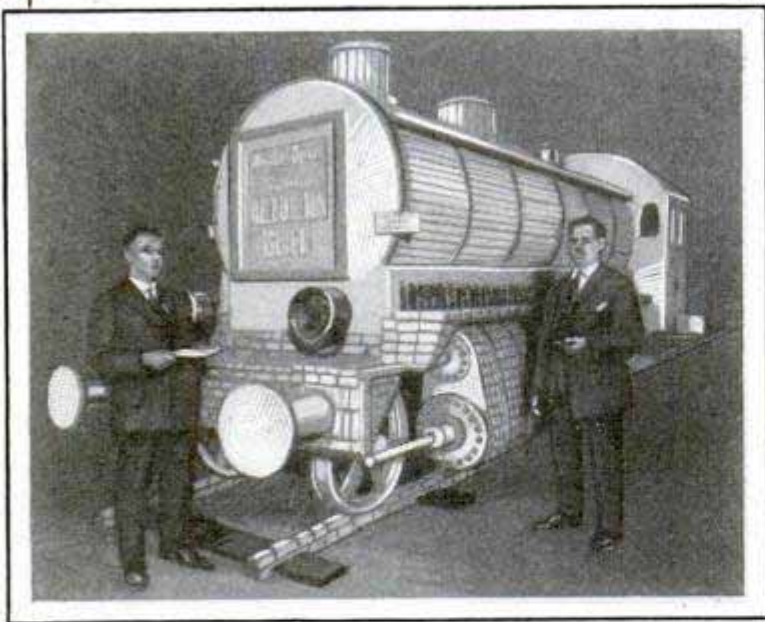

Model Locomotive Made of Soap Bars for a Berlin Exposition; Rails Are of Same Material

### LOCOMOTIVE MODEL IN SOAP FOR BERLIN SHOW

Thousands of cakes of soap of many different shapes and sizes were used at a Berlin Exposition in fashioning a large model locomotive. The rails, too, were of soap.

soap

### THIRTY BILLION TOOTHPICKS MADE YEARLY IN U. S.

Toothpick making, at first thought, would seem to be a rather insignificant industry, but six large factories are kept busy in the United States to supply the demand, and the business is a highly specialized one, demanding the services of skilled men and intricate machines. The picks require the choicest part of white-birch logs. What is left is made into other articles. Hence, the toothpick, as is often supposed, is not a by-product but yields material for other things. The ideal season for the mak-

790

ing of toothpicks is from December to April, when the sap is not running and can be more easily dried out, to prevent staining the wood. The bark of the trees goes for fuel, the "white sap," or cream of the log, is made into picks, and the "red heart" is used for other purposes. Logs are from six to sixteen feet long and are first cut into two-foot sections which are shaved to even cylindrical forms. They next go to the veneer lathes which shave them into long strips as wide as a toothpick is long. The strips are wound upon spools like ribbon and then passed through a chopper, a rapidly moving unit which has two sharp knives that cut out some 9,000

picks per minute. There are usually from twelve to sixteen of these machines to a battery. After they are cut out, the toothpicks are deposited in a huge steel oven where they are dried. The polish is applied by tumbling them about in a slowly turning steel cylinder, 110 feet in diameter. They are straightened by shaking, so they can be easily packed in the little boxes of which it takes some ninety-six to fill the ordinary shipping case.

Butyro  
698

### PUMP-LIKE CHURN MAKES BUTTER QUICKLY

One of the most recent modifications of the churn is a Parisian apparatus consisting of double-stroke pistons turned by a crank, a suction tube into which the cream is drawn and another outlet at the other side with an air valve. As the cream comes through and is mixed with air, the butter is rapidly formed and delivered in small chunks through the tube on the front of the churn. The apparatus can handle from 100 to 150 quarts daily and may be operated with a motor.

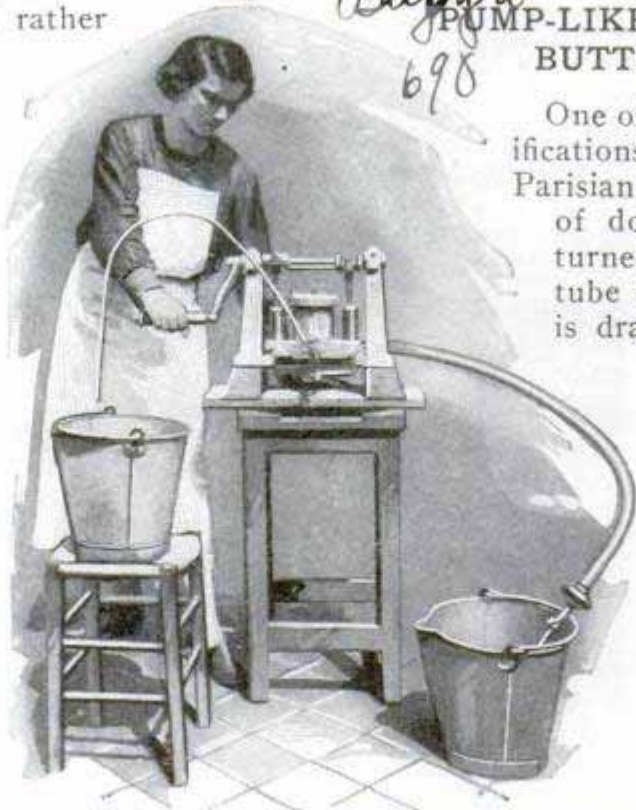

Pump Churn in Action; Butter Delivered at Right

N.Y. World.  
10/24/26

Chas. W. Kerpenchi  
Paris France

655 Conducted by Art Hoover,  
 Santa Monica, Calif.

HOW STUNT FLYING IS TAUGHT IN UNIQUE SCHOOL

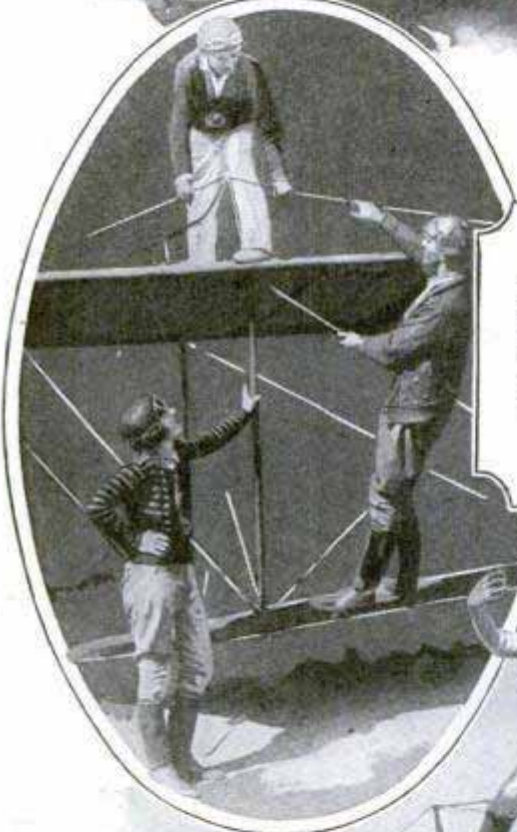
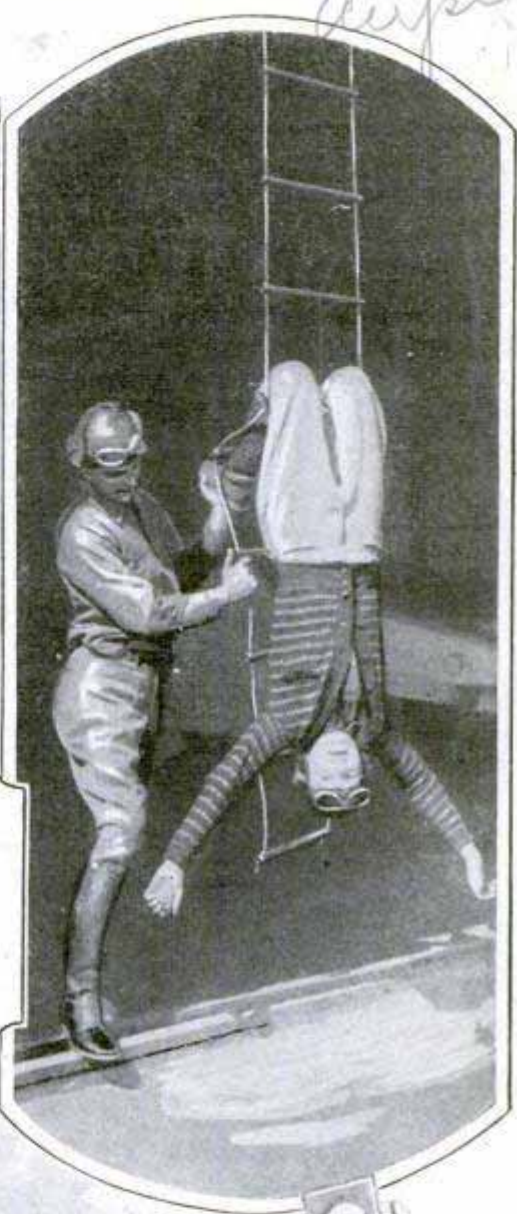
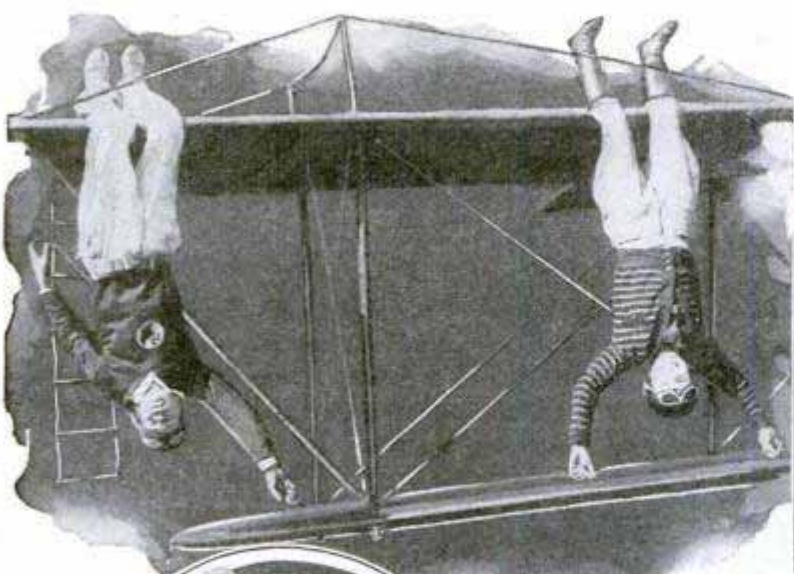

Otis Clark and Gladys Ingle Demonstrating the Correct Toe Hang; Left, Art Goebel Showing How to Balance on Wing Top, and, Right, the Ladder Hang

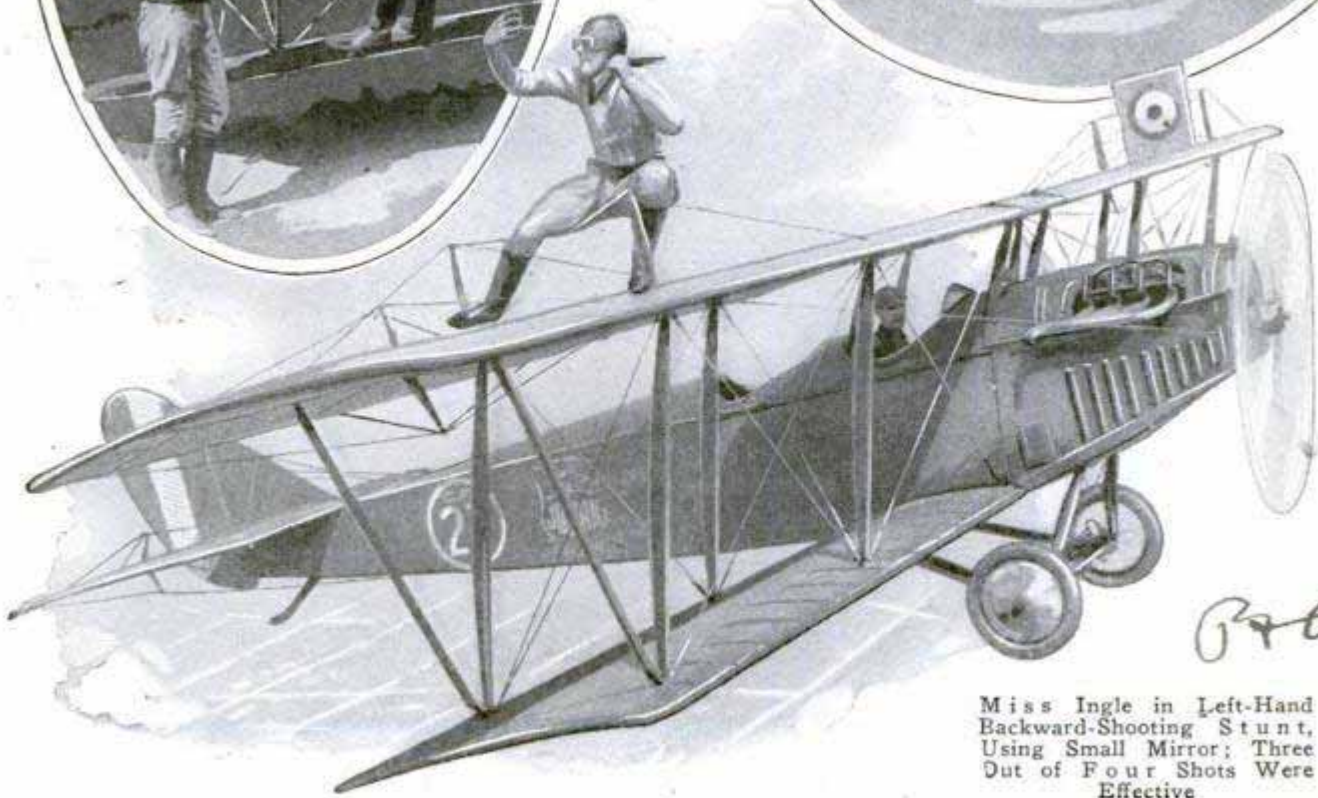

Miss Ingle in Left-Hand Backward-Shooting Stunt, Using Small Mirror; Three Out of Four Shots Were Effective



canal and other channels, according to records of government engineers. Their survey shows that Lake Superior, although not influenced by diversion elsewhere, reached a lower stage last year than at any other time of official record. The levels of lakes Michigan and Huron fluctuate almost as one body of water. They have been dropping ever since 1918. From about 1860, the level of Lake Michigan has undergone periodical changes, the charts indicate. One low mark was reached in 1872. A year of comparatively greater rainfall followed and the lake rose, reaching an unusually high stage in midsummer. After falling again for a few years, it reached another high level in 1886. Since then lower and higher stages have alternated up to the present time.

**COAL AS SUBSTITUTE FOR STONE USED IN BUNGALOW**

Walls of a bungalow erected by the chamber of commerce in Middleboro, Ky., are of bituminous coal, the chief product of the region, laid in mortar. No preservative or other protective finish was ap-



Kentucky House with Walls Made of Lumps of Coal; a Pleasing Contrast Was Gained with White Mortar

plied to the outer surface of the walls, for the coal is expected to resist the weather for an indefinite period.

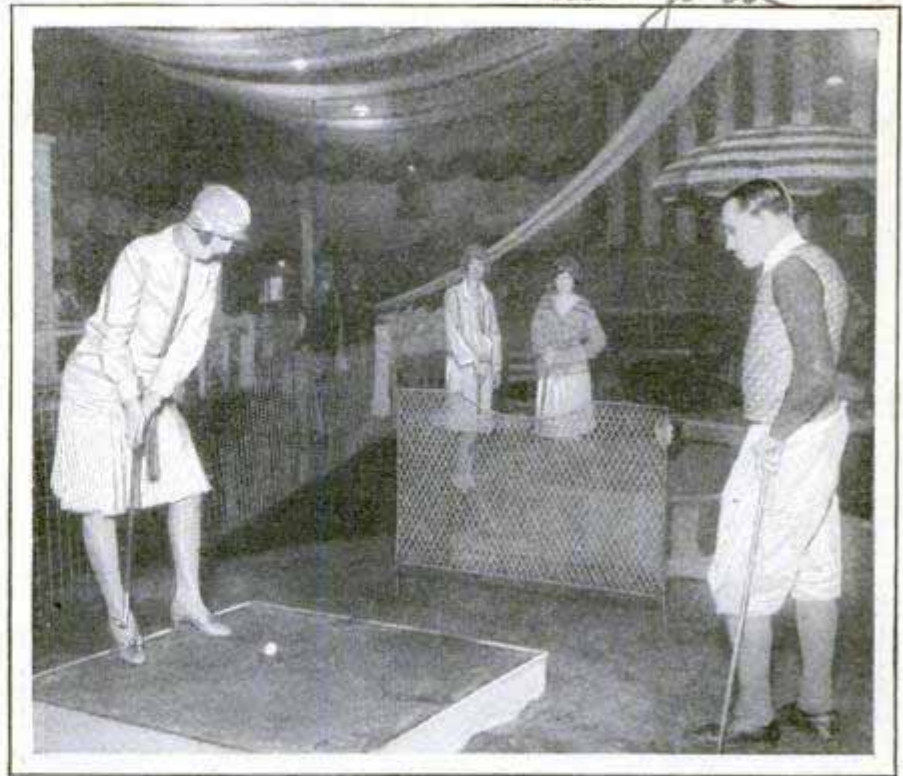

Teeing Off for the First Hole on the Indoor Course; the Play Affords Excellent Practice for the Outdoor Shots

**GOLF COURSE IN AN ARMORY HAS EIGHTEEN HOLES**

Golfers can enjoy many of the thrills of the regulation game in an eighteen-hole course arranged in a New York armory. Bunkers, traps and other features of the outdoor links are duplicated by carefully adjusted barriers, and there are said to be many opportunities for skillful shots.

**FIRELESS STEAM ENGINE HAULS STREET CARS IN JAVA**

Street cars in the city of Batavia, Java, are pulled by a locomotive run by steam from a storage drum, which is filled to a pressure of 600 pounds when the engine leaves the barns. This is usually sufficient to make the run, as the intense heat of the sun helps reduce losses. When it rains and the drum is cooled, an extra locomotive is sometimes needed to tow the other one in for another filling. The fireless and smokeless feature of the locomotive commends it for usage on city streets.

Gorillas sometimes attain an age of thirty or forty years.

*Chicago* 10/15/26 *Broadway & 87th Sts* *New York*

699



Huge Log Hollowed Out and Mounted on Trailer for Auto Trips; Three Men Worked a Month Cutting Interior of Section

### HOLLOW LOG ON AUTO TRAILER SERVES AS TOURIST'S HOME

To provide living quarters while on automobile trips, a western man fashioned a traveling bungalow from a huge log which was hollowed out to make room for folding beds, kitchen equipment and other features. The trunk measured nine feet four inches in diameter and, judging from the rings, was over 400 years old.

### UNDERGROUND QUAKE Milder Than One ON SURFACE

Earthquakes are felt more on the surface than below it, because the motion often resembles a wave. Below the surface of water, there is comparatively little action; at the top, the deep furrows and crests of the waves are in

their pedestals and, in some of the larger buildings, all the windows on one story were broken while no damage was done to those above or below, indicating that the structure had "bent" at a certain point as it swayed with the wavelike movement of the earth.

### COIN OF FIRST ROMAN REPUBLIC WEIGHS HALF POUND

741

About eight inches in circumference, a coin which was in circulation as long ago as the days of the first Roman republic has been found in the suburbs of Rome and is now in the possession of a New York jeweler. It is of metal closely resembling gold and, despite the wear of time, the figures on each side have not been obliterated beyond tracing.



Old Roman Coin, Showing Figures in Bas-Relief Partly Obliterated by Age

By J. J. Pardee '66

no record of owner

Professional Paper, 47-03,  
U. S. Geological Survey



# HOW ARMY IS PITTING ITS GUNS AGAINST PLANES

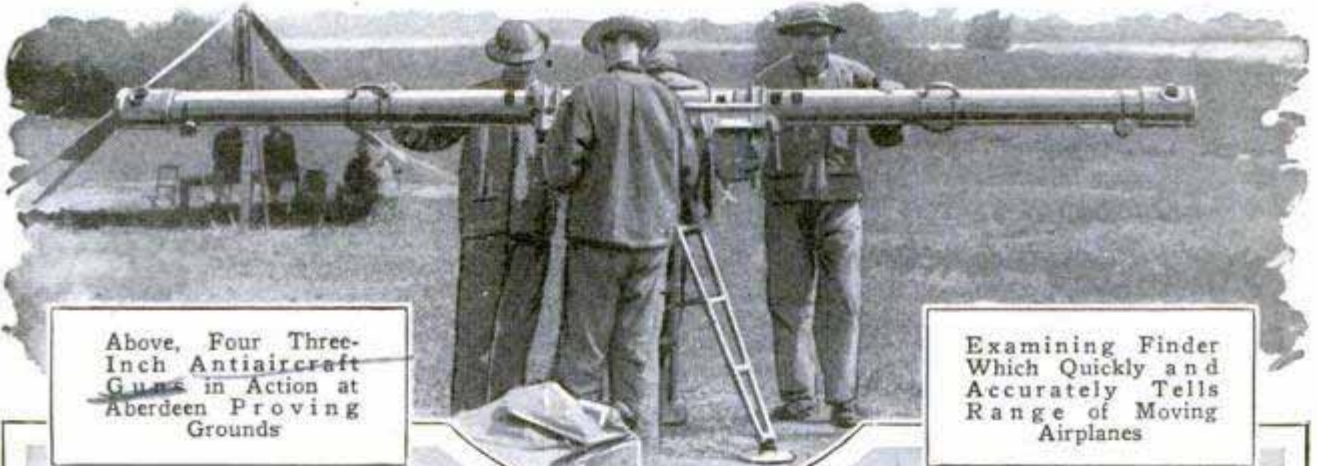
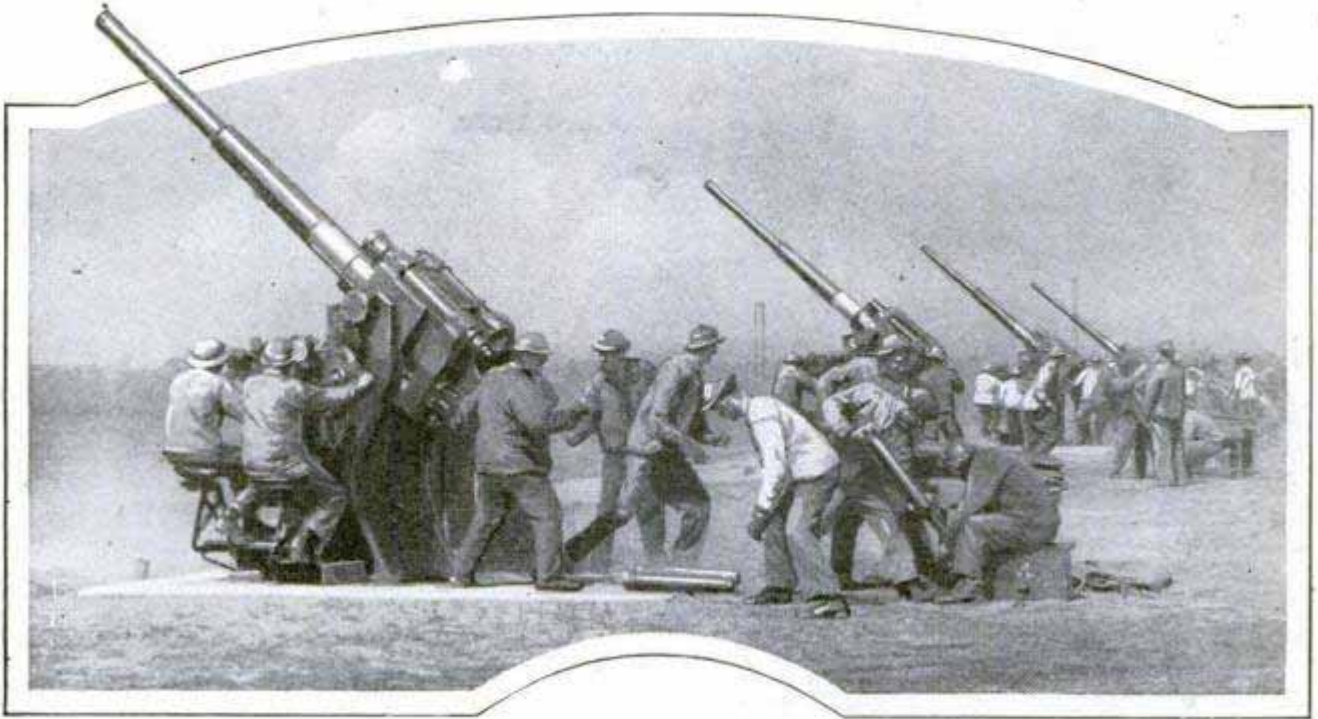

Above, Four Three-Inch Antiaircraft Guns in Action at Aberdeen Proving Grounds

Examining Finder Which Quickly and Accurately Tells Range of Moving Airplanes

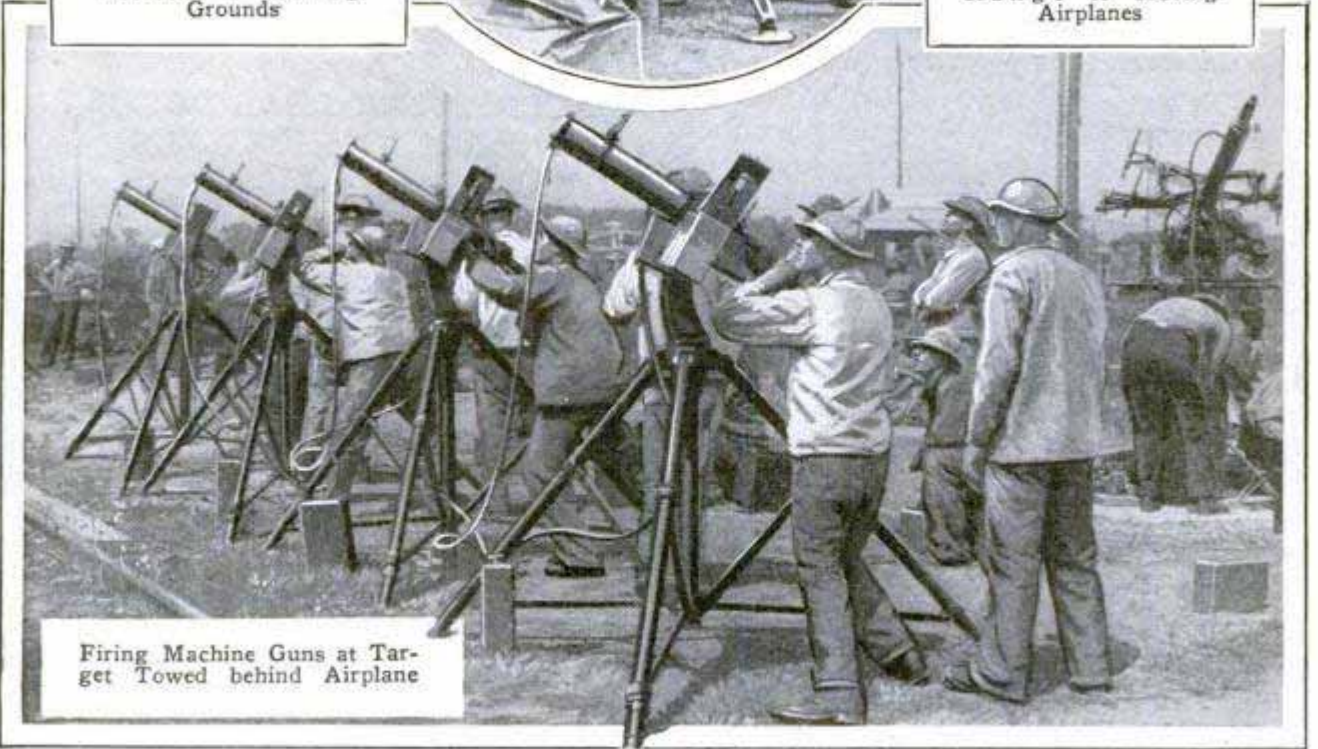

Firing Machine Guns at Target Towed behind Airplane

*00+a*

635

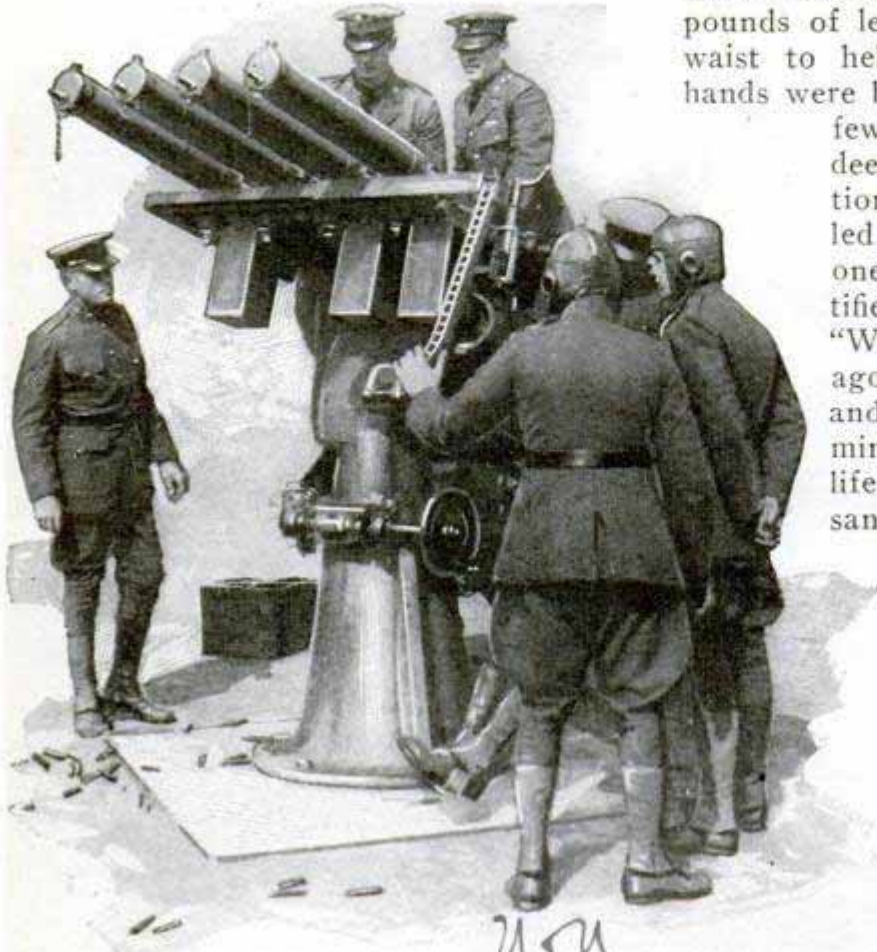

For Defense against Aircraft; the Four-In-One Gun Recently Tested at the Aberdeen Proving Grounds

**FOUR GUNS ON SINGLE MOUNT TO COMBAT AIRCRAFT**

One of the latest weapons devised to oppose aircraft is a battery of four machine guns, fired and controlled as one from a single mount. It can be manipulated for quick aiming and has long range. The gun was tested by army men recently at the Aberdeen proving grounds.

**SIX-MILE WALK ON SEA BOTTOM LATEST HIKING RECORD**

Walking on the ocean bottom across Hampton Roads to the naval base in two hours and fifty minutes, Klass Everts, a deep-sea diver, established a record in submarine hiking. He entered the water at eleven o'clock and emerged at 1:50, but little fatigued and complaining only that he had broken the lace of one of his iron shoes and that he had been deprived of his usual noon-day cigars. A launch accompanied him with air pump and life-line

rig and he kept in constant communication with the crew by telephone. Eighty pounds of lead were strapped about his waist to help weight him down. His hands were bare, an unusual feature, for few divers care to explore the deep without adequate protection for their hands. The walk led past the wrecks of old ships, one of which he partially identified as that of the steamer "Wyanoke," sunk several years ago. Anchors were also seen and one delayed him for several minutes while he untangled his life line. "I am now walking in sand," he called through the

phone. The next, he reported that he was up to his waist in mud. Hundreds of fish, large and small, were encountered. Some stopped to gaze at the intruder and then darted away as if they were shot out of guns. Near the naval base, Everts reported that he was walking on rocks, the first time such a formation was found at the bottom of Hampton Roads. Once he stepped into a deep channel and had difficulty in climbing up the steep sides. The distance covered was about six miles.

**CATERPILLAR REAR-DRIVE CAR RUNS AT HIGH SPEED**

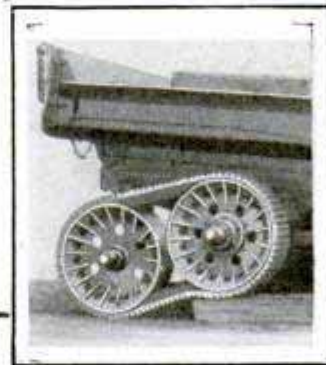

Speed of thirty-five miles an hour is claimed for an auto truck with a four-wheeled caterpillar drive at the rear. It is designed to combine the advantages of a fast carrier and one that will give maximum traction without injuring the surface of the road. A four-cylinder motor delivers seventy-two horsepower.

Some spiderwebs are so strong that birds are captured in them.

693

Norfolk, Va.

McNeil, Porter Co., 95 Crozier St. Akron, Ohio.

626 · W. Broadway  
114 E 16th St.  
33  
New York City

### ROLLER-BEARING RAILWAY CARS TO ELIMINATE JERKS

More than 100 cars on a western rail-  
road are being equipped with roller bear-  
ings for smoother riding and to permit  
operation of longer trains. Tests have  
shown that a twenty-one-car roller-bear-  
ing train could be started much more  
easily than a twelve-car standard train.  
Experiments with individual cars proved  
that the roller-bearing type required only  
a fraction of the tractive effort needed to  
start an ordinary coach. Engineers be-  
lieve that these bearings will remove what  
is known as "the hump in the road"—the  
tremendous power necessary to overcome  
the inertia of a standing train, and that  
passengers will be spared the shaking up  
that frequently attends a rough start.

82

### LAMP FOR TELLING FORGERIES SHOWS DIFFERENCE IN INKS

Telltale marks, too faint to be detected  
by the unaided eye, are said to be revealed  
plainly under a powerful lamp devised for  
exposing forgeries in checks and other  
documents. Much of its effectiveness lies  
in the fact that, if two different kinds of  
ink have been used in the writing, the dis-  
crepancy in colors and quality is shown.



Pitch Pipe with Sliding Mouthpiece Can Be Used on Several Different Instruments

### PITCH PIPE LIKE HARMONICA PRODUCES SEVERAL TONES

Tonal accuracy said to be impossible in  
ordinary instruments is afforded in a pitch  
pipe somewhat like a harmonica. On one  
side are indicated the tones and positions  
of the notes of the treble staff, and a slid-  
ing mouthpiece enables the user to select  
the one desired. The pipe is designed  
especially for vocalists and players of  
stringed instruments.

### PETROLEUM MADE BY CHEMIST YIELDS GASOLINE 668.

Petroleum has been produced syntheti-  
cally in the laboratory of a French chem-  
ist, according to reports. The product can  
be refined like the natural substance to  
yield gasoline, kerosene, various oils and  
other by-products, it is said. The process  
includes the use of secret agents. An  
initial step is to submit a mixture of hy-  
drogen and oxygen to great pressure and  
filter the resulting product with an agent  
that causes a transforming reaction.

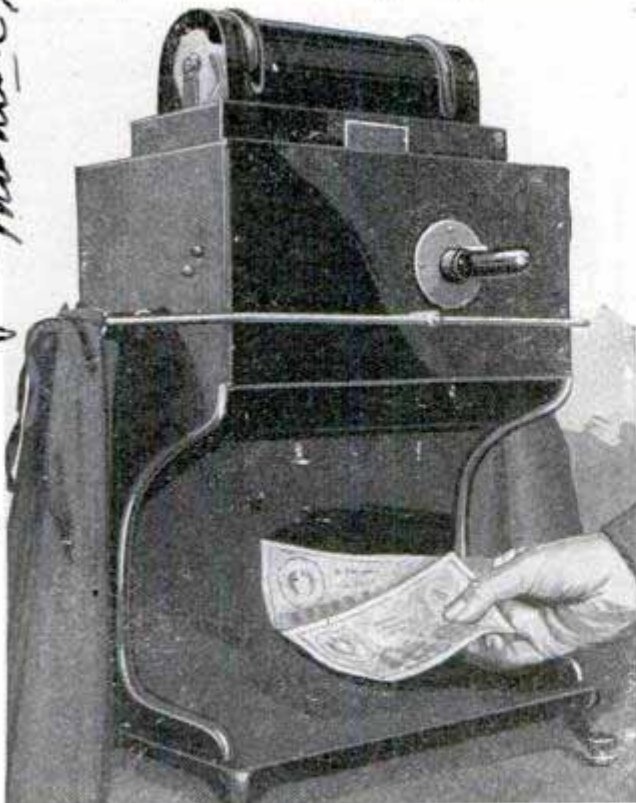

To Expose the Tricks of the Forger; Powerful Lamp Which Detects Differences in Inks

Mr. Swartz lampen Isesellschaft  
monax, Germany

Jackman, Wabach  
Chicago  
Lynn and Leahy

M. Audubert, Director  
of French National

*Lupino Lane  
film comedian*

*Lowell Observatory  
Flagstaff, Ariz*

*Hand games - a few July 23  
138 Elm St. Worcester Mass*

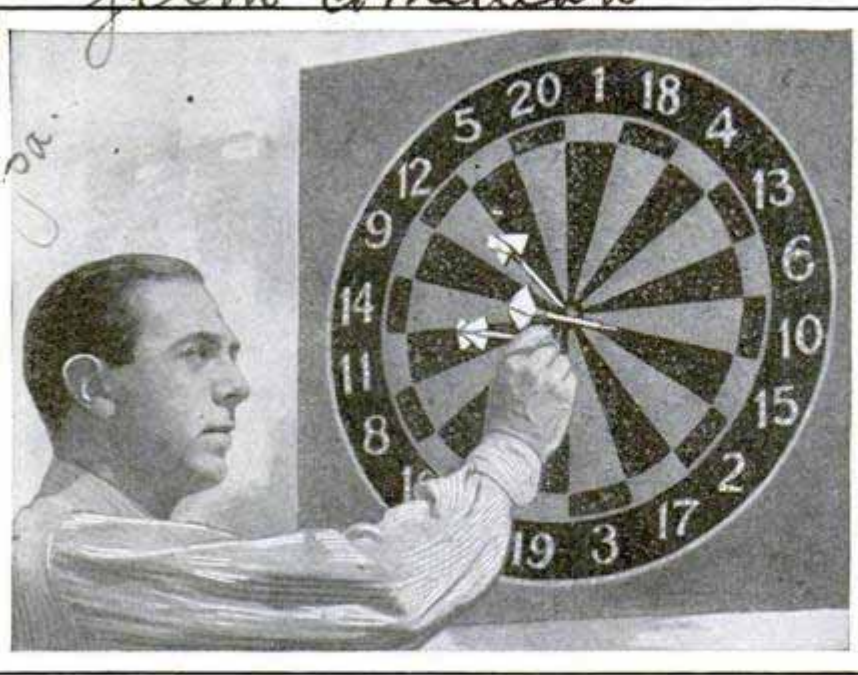

Hand-Dart Throwing, a Modification of Archery for Indoor or Outdoor Amusement; the Target Tells Value of Shots

### THROWING DARTS AT TARGET DEVELOPS STEADY HAND

Bowless archery has been added to the list of skill-developing games for indoor or outdoor amusement. It is played with a target and three small darts for each contestant. They have feathered guides and a sharp tip and are hurled at a distance of ten feet toward the target which is made of soft material. Scoring twenty points wins the game.

*Patrim Sorokin 202*

### RECORDS FOR LONG LIFE HELD BY POPES AND PRESIDENTS

According to the findings of a Russian economist, the presidents of the United States have averaged the longest life spans, their record being 69.9 years. Popes of the Roman Catholic church follow closely with an average of 69.6 years, and American millionaires are third with a record of 69.2. Scholars and scientists average 67.3 and writing men 64.4. The poorest showing was made by the hereditary monarchs of Europe with an average of but 53.6. While there are individual cases of long lives, the generally low record is believed to be due to the prevalence of intermarriage among the royal families. The showing made by the presidents and the popes is explained by the fact that both are elective offices, and men of mature years and good health are chosen for them. They

usually have made their own records and have not been hampered by the accident of birth from poor stock.

### MANY CHANGES IN JUPITER

<sup>662</sup> Within the last few months, remarkable changes have been observed on Jupiter. The phenomena are similar to those which occurred in 1919. The planet's south tropical belt had almost disappeared by last October, the telescope revealed, being replaced by a brighter and broader zone. The "great red spot," which had faded, showed considerable color again, becoming pink instead of a neutral gray.

### BAGGAGE RACK ON STREET CAR REDUCES CROWDING

<sup>632</sup> Quantities of luggage carried by tourists in Lausanne, Switzerland, have perplexed street-car officials. By attaching

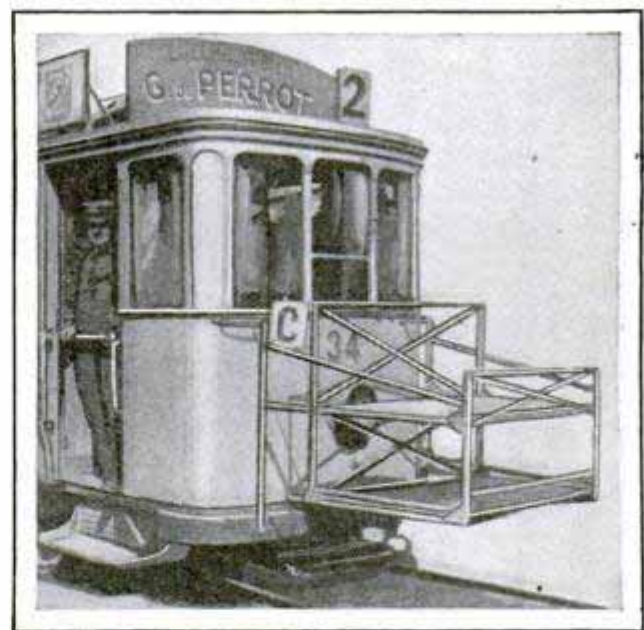

For Transporting the Passengers' Luggage; Rack on Rear of Swiss Street Car

a roomy rack on the outside for bags and bundles, more space is provided for passengers within, and there is less trouble in leaving or boarding the car.

*Stairway with  
235 Brookdale Ave  
Isleside, Pa.  
645*

**RULES FOR FIGHTING MOSQUITO**

Early in the season is the time to begin campaigns against mosquitoes, according to Maj. Edwin M. Skinner, of the Gorgas Memorial institute, and by following a few simple rules, citizens can do much to reduce the pests before they are on the wing, he asserts. Six preventive measures were cited as effective ways to combat the insects. First, take care that roof gutters are not sagged or choked. Cover cisterns tightly, so that the mosquito cannot deposit its eggs on the water. In this connection, the overflow and other openings should be protected with a fine-mesh screen. Tin cans or other containers likely to accumulate water should not be allowed on the premises. The basement should be kept free from water. Cellar screens should be left on until late in the fall so that the insects cannot get into the basements and hibernate, and, finally, tall grass and weeds should be cut down.

**SHOTGUN FOR ONE-HANDED MAN IS FIRED BY SPRING ROD**

Being crippled seems to increase the desire of some men for firearms, and many have overcome their misfortune to such a degree that they have shown considerable skill with ordinary guns. A special double-barreled shotgun built to the order of one crippled shooter is unique in the way it is fired. Besides the usual trigger, there is a sliding rod held in a forward position by a spring. It is actuated by pressing the end which is exposed under the forestock. This moves the trigger, firing the first barrel. Releasing the rod engages the trigger with the second - barrel mechanism for the next shot. The advantage of this arrangement is that the user's good hand is well forward to permit better control of the gun especially in rapid swings on clay birds or swiftly moving game.

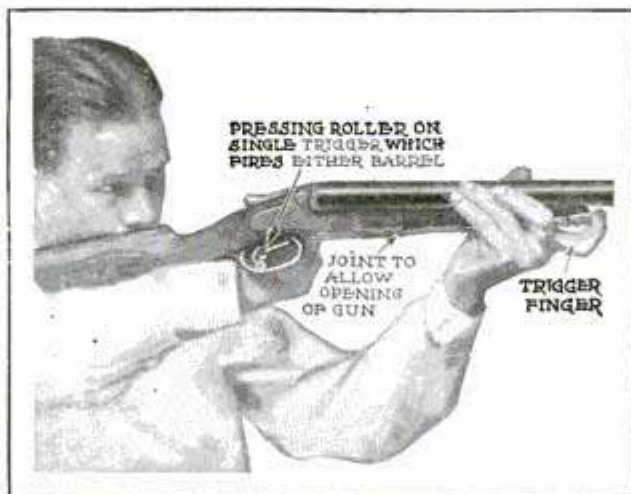

How Crippled Marksman Handles His Shotgun: Spring-Trigger Rigging Permits Easy Firing

*Levever Arms Co, Inc  
of the city N.Y*

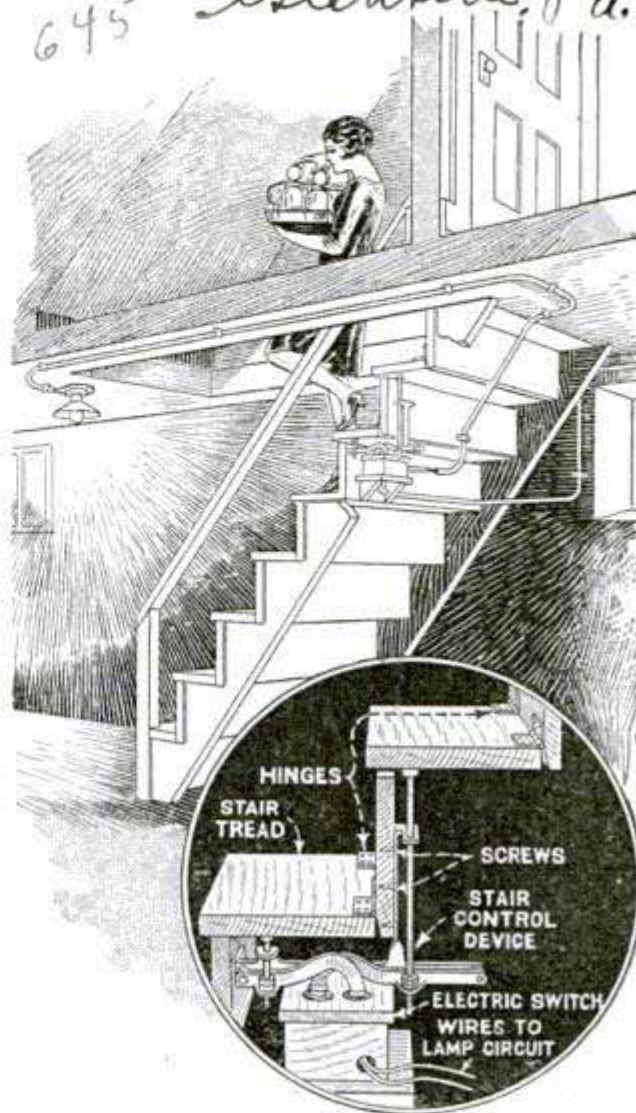

Drawing of Light Switch, Installed under Stairs, and Inset Explaining Details

**LIGHT CONTROLLED BY STAIRS ACTS AS BURGLAR ALARM**

A tread on the stairs presses a switch and turns on the electric lights by a recently introduced system to help illuminate the cellar and to eliminate the waste of current that occurs when the light is left burning by forgetting to press the button. The circuit is broken when the weight on the step is lifted. The installation can be rigged to serve as a signal, warning of the approach of an intruder. It is said to be easily put up and presents no fire hazard

# Weather Made While You

By PAUL D.



Shaking Dust and Soot from an Air Filter; Hundreds of Pounds Are Collected Yearly from a Single Large Building

**H**OMES, offices and factories will soon be cooled in summer just as they are now heated in winter, according to Prof. E. F. Miller, of the Massachusetts Institute of technology. "Shut the windows, turn on the electricity and keep cool," will be the rule during the scorching summer months.

"The increasing demands upon human energy in this age of swift progress and keen competition call for new measures for physical comfort and protection," says Prof. Miller. "Extreme summer heat slows human activity and lowers efficiency in all branches of endeavor, whether it be in factory, office building or home.

"The household furnace has overcome the cold of winter, but humanity still suffers from the summer heat. It seems likely that, within a few years, cool rooms in which to work and live will be considered just as much a necessity as warm homes and buildings are in winter.

"It is not a serious problem now to produce air-conditioning and cooling plants

for domestic purposes. These will consist of a refrigeration system in which air will be cooled and the moisture removed before it is put into circulation.

"The home-cooling and air-conditioning plant of the future will function with no more attention than the electric refrigerator. It also will be operated by electricity and will be equipped with thermostatic control, to maintain an even, comfortable temperature regardless of the heat outdoors."

Artificial weather is now a vital factor in more than a hundred kinds of business. It definitely started about twenty-five years ago in a printshop in Brooklyn, N. Y. A big color contract had

been accepted. The day was hot and humid. The ink wouldn't dry. To complete the job on time and with profit, the proprietors sought a way to control air conditions in the shop regardless of weather variations outside.

Today, weather is made to order for motion-picture studios, public buildings of all kinds, hotels, bakeries, candy shops, potteries, cigar and cigaret factories, chemical laboratories and scores of other



Useless Overheating Costs Coal Consumers Fortunes Every Winter; Approximately One Shovelful in Five Is Wasted by This Practice. The Remedy Lies in Intelligent Firing and Controlled Heating Systems

# to Order Wait

## PADDOCK

institutions. Almost every article we use has felt the touch of modified weather. It formerly took months to dry the many coats of paint on automobiles. Now, it can be done in a matter of hours, due partly to improved finishes and to efficient temperature controls and circulation.

A razor-blade manufacturer found that the rapidly moving grinding machines affected the air in such a way that moisture collected on the steel, rusting the product. He ordered apparatus that reduced the humidity in the plant and had no more trouble. A maker of metal pencils was bothered by unsightly marks found on nearly every holder after wrapping because the girls' fingers perspired. Air conditions in the room were modified by weather-making equipment, and the marks no longer appeared.

The interior temperature of an entire thirteen-story furniture store in Chicago has been raised from thirty-six degrees Fahrenheit to sev-



Manipulating Temperature and Ventilating Controls in London Town-Council Room; Each Member Can Adjust "Weather" to Suit Himself

enty degrees in thirty-five minutes by its efficient heating and ventilating system. A 4,000-seat motion-picture theater adds a luxury by cooling its air. By pressing a button, the entire auditorium can be pleasantly filled with a perfume in keeping with the picture on the screen, such as the fragrance of roses or lilies for a garden scene, and other appropriate odors. Apparatus supplied by a leading equipment manufacturer is furnishing 500,000,000 pounds of "conditioned" air every working day, enough for 20,000,000 persons to breathe.

The benefits of correct weather also are being enjoyed in homes. Dr. Willis L. Moore, former chief of the weather bureau, has not opened a window in his California house for two years. An efficient ventilating and cooling system has made it unnecessary. Engineers say that it is only a question of time when the majority of persons can enjoy better weather at home. Two factors promise realiza-

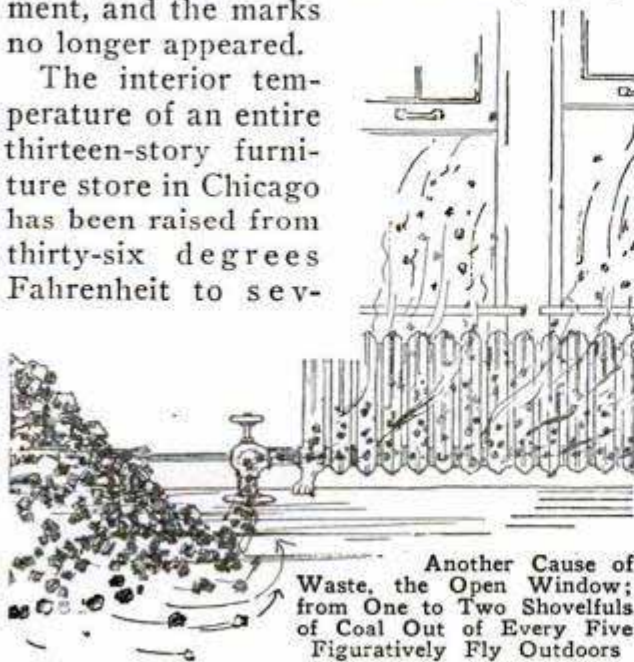

Another Cause of Waste, the Open Window; from One to Two Shovelfuls of Coal Out of Every Five Figuratively Fly Outdoors

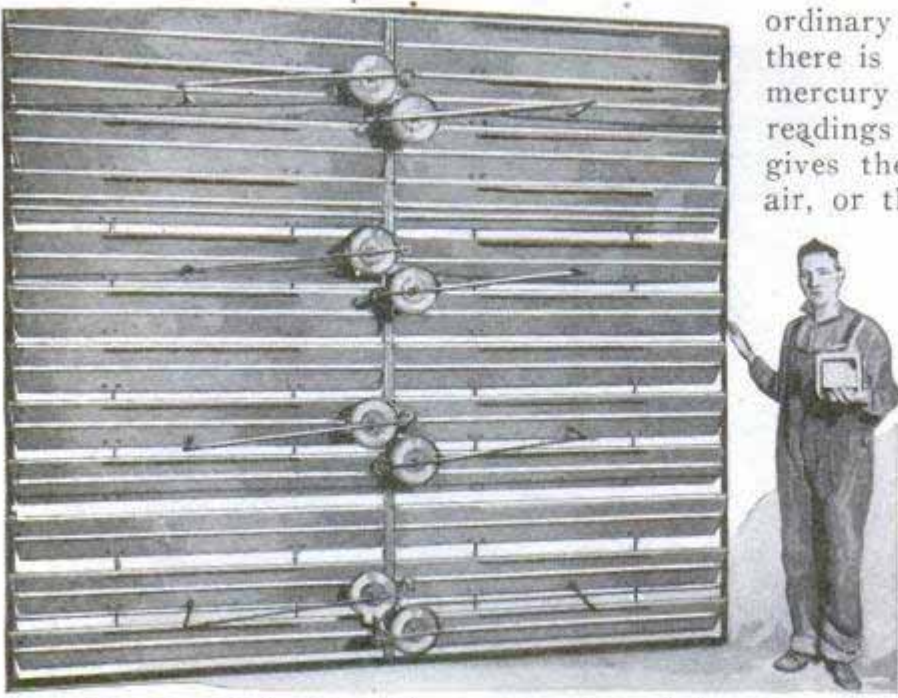

One of the Marvel Units of a Modern Heating and Ventilating System, a Set of Dampers, Controlled by Rheostats, to Regulate Air Conditions

ordinary instrument except that there is a moistened wick over the mercury bulb. Comparison of the readings on the two thermometers gives the relative humidity of the air, or the relation of moisture to the temperature. This factor is now considered vastly important to health and comfort.

Moist air reduces the amount of evaporation from the skin, and evaporation takes heat from the body and from the air, so that a cooling effect is produced. Hence, if the air is too dry on a cold winter day, the inside of the house may feel uncomfortable even at a high temperature,

tion of this dream—abundant electricity and well-insulated houses.

Only a few years ago, most persons thought of weather largely in terms of temperature, and they read the temperature from but one instrument, a common dry-bulb thermometer. But it is now known that there are really two temperatures that should be considered, the degree of heat and the quantity of moisture in a given volume of air or the temperature at which evaporation ceases. This is determined by a wet-bulb thermometer. It is essentially like an

because evaporation is in progress. Moistening the air permits lower temperatures for comfort, saving fuel and guarding health. In the same way, a hot moist day in summer is oppressive because of the blanket of wetness about the body, preventing evaporation and the removal

of heat. Besides the air's "wet and dry" temperature, its movement and cleanness are carefully regarded in modern heating and ventilating systems. These four factors, temperature, humidity, movement and cleanness, can now be controlled so accurately by "weather-

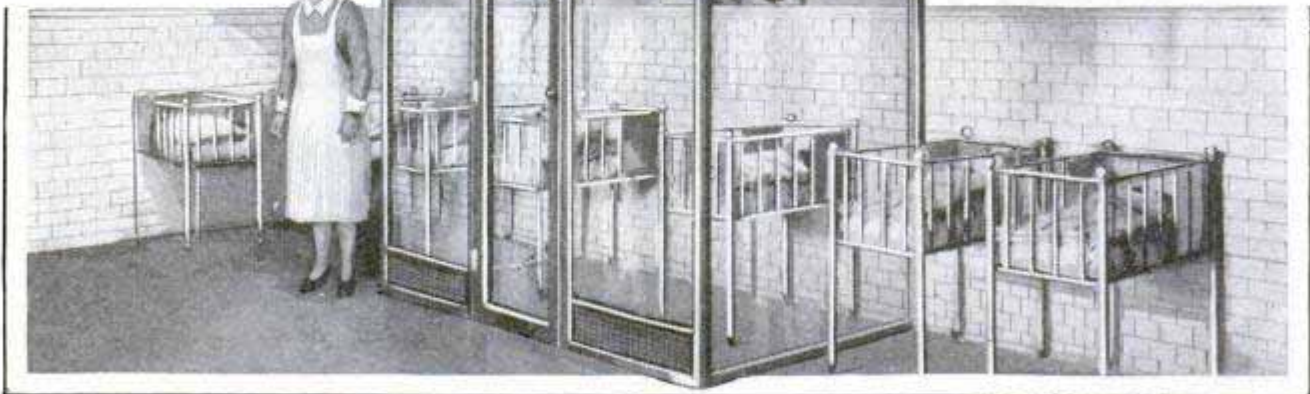
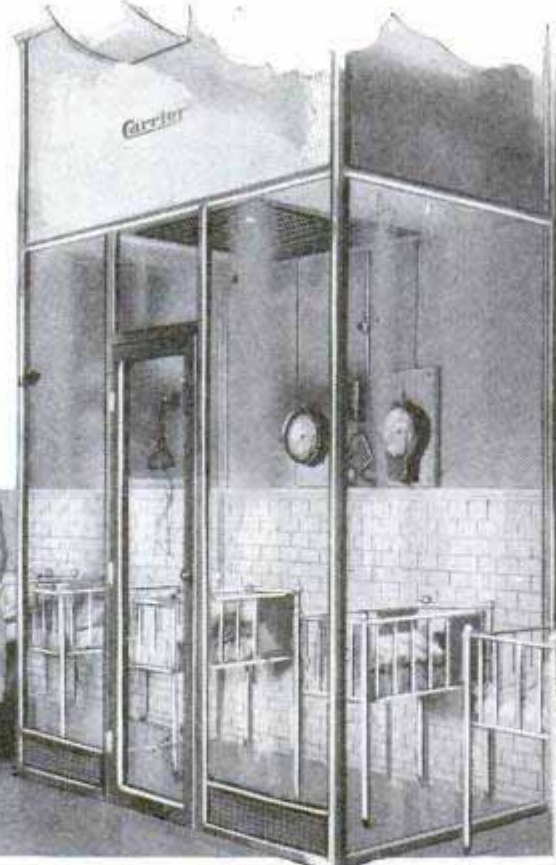

Where Weather Is Made to the Order of Exacting Physicians; a Glimpse in a Hospital's Baby-Incubator Room; Part of Control and Registering Apparatus on Wall



making" apparatus that, behind his walls, man can freeze, swelter or be comfortable any time of day and year almost without lifting a finger, for much of the apparatus works entirely by itself.

A visit to an "air factory" in a modern furniture store, for in-

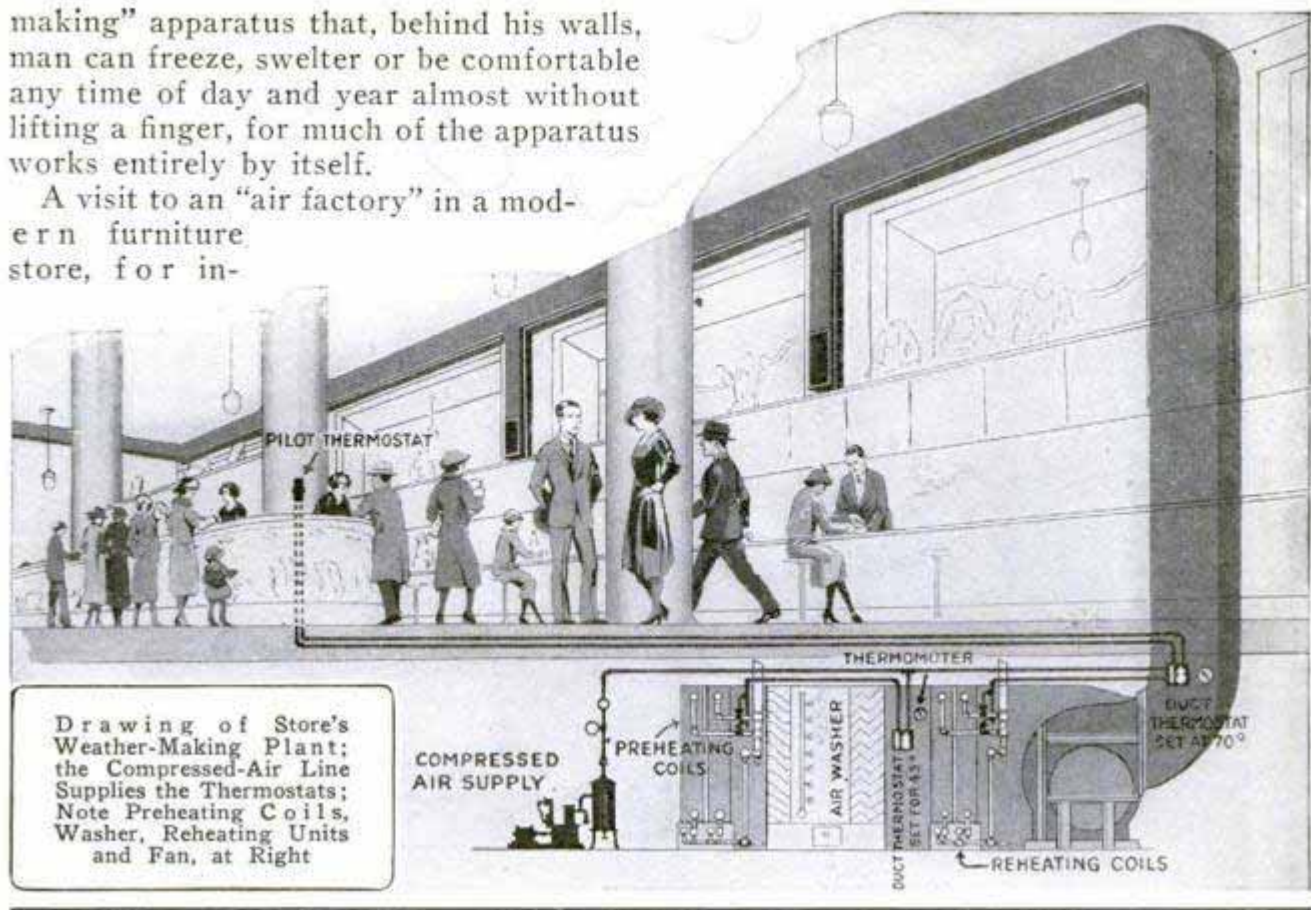

stance, leads to a curious room close to the roof where air is drawn through an opening in the outer wall, at the rate of several thousand cubic feet per minute, by a powerful fan turned by a twenty-five-horsepower motor. This wind is sucked through a rack of filters inclosed in a steel cabinet. On the air side, these screens are fuzzy with soot and dirt that has been trapped by the mesh and oil on the filters. A ton and a half of dirt that otherwise would have lodged in the noses and throats of customers, and on furniture, is collected every year from the 120 filters in this building. The screens are constantly being cleaned and bathed in an odorless oil. This absence of aroma is essential, as otherwise the building would be filled with an unpleasant smell.

Rid of much of its foreign matter, the air next gets a bath in a big spray tank, before it is sucked into the ducts that lead to all parts of the building. This cleans it further and also contributes moisture. Arrangements are provided for heating the air with steam before it strikes the wash water in winter and for reheating it afterward or removing excessive moisture. After the air has passed through the rooms, it is drawn out again by another

huge fan so that circulation is maintained. In some installations, a refrigerating unit is included. This consists of an assembly of ice-making machinery and cooling coils over which the air is passed to lower its temperature. Some of the refrigerating plants in large motion-picture theaters would freeze 300 tons of ice every twenty-four hours if applied for that purpose. No actual ice is made in the air-cooling process, however.

The whole system is often so well adjusted that thermostats can be set at a certain temperature and will keep an entire building at approximately that point throughout the year. In winter, heat is automatically turned on in case the interior gets too cold. In summer, the temperature can be largely governed by regulating the amount of moisture in the air.

These thermostats, the silent sentinels of the system, are what make operation with such efficiency and with so little human supervision possible. There are many types of the instruments, but, in general, they function by expansion and contraction caused by temperature changes, to actuate compressed-air or clockwork mechanisms that open or close valves directly controlling the heat.

470

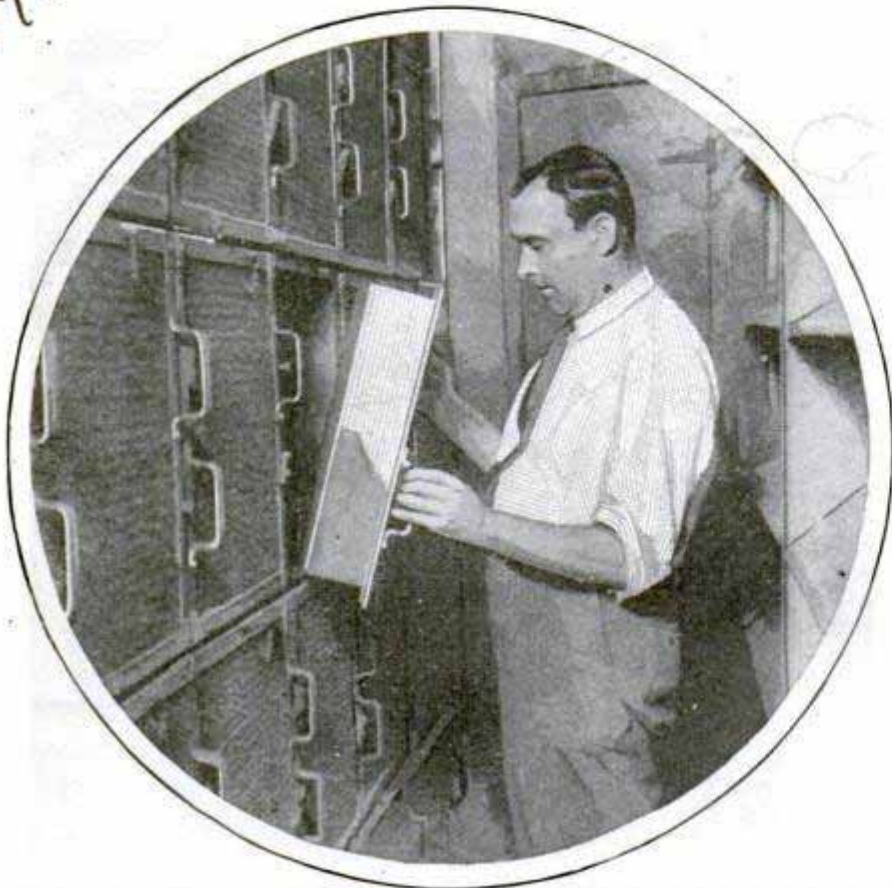

Removing a Screen inside a Filter Room; the Fuzzy Surface of the Other Screens Shows How Air Coming In at Right Is Being Cleaned

For instance, the temperature of the spray water in the air washer gets too cold. A unit in the controlling thermostat contracts. Compressed air, carried at about fifteen pounds' pressure, causes a valve to open, admitting steam to the spray-water heater. When the temperature reaches a certain point, the thermostat unit expands, the steam valve closes, and the heat is shut off. These vigilant regulators effect savings of thousands of tons of fuel annually, insure accurate and constant air conditions; in short, make it possible for the engineer to deliver the kind of weather wanted at any time. In some buildings, another marvelous instrument has been installed to aid in temperature control. It is an electrical apparatus which makes it possible for the engineer to remain in his office and yet determine the temperature in any room or section of the building simply by pressing a button. The instrument translates electrical resistance at different temperatures into degrees. Pressing the button completes the recording circuit to that room, and the reading is shown on a dial above.

What is the proper temperature for indoor comfort and efficiency? There are

many answers to this question, but tests have shown that satisfactory results are attained in offices that are kept at sixty-eight to seventy degrees Fahrenheit and in shops that are between sixty-five and sixty-eight degrees with the relative humidity at fifty. Considerably lower temperatures are needed where much physical effort is involved.

Raising the temperature two degrees reduced efficiency fifteen per cent in one shop, although the men were stimulated to do their best by a cash bonus. In a shell factory, accidents were sixteen per cent more numerous with the temperature at fifty degrees Fahrenheit than at sixty-

seven degrees and thirty-two per cent more numerous at forty-seven degrees. Numb fingers were largely responsible. Too much heat seemed to cause carelessness and inattention, for at seventy-seven degrees Fahrenheit there were twenty-three per cent more accidents than at sixty-seven degrees.

Lack of proper humidity in offices and homes is one of the big causes of colds in winter. A large insurance company, employing 6,700 persons, lost 62,233 days of work in one year because 2,824 cases of colds enforced absences. Dry air cracks the delicate lining of nose and throat, exposing the areas to injurious dirt and disease germs.

Hence, it is essential to supply moisture in heated rooms because air doubles its capacity for holding moisture for every eighteen degrees that it is heated. A hot fire will soon make the air too dry for health and comfort unless moisture is supplied. Humidifying apparatus is recommended by engineers, and they also advise using both a dry and wet-bulb thermometer for greater accuracy and safety in regulating the weather made to order for home, office or workshop.

**SOFT WOOD OF PALMETTO TREE  
USED FOR FURNITURE** 757

Impetus to the furniture and wood-working industry is forecast from the recent discovery of a method of utilizing the soft, pulpy wood of the sable palmetto tree, which grows in abundance along the southern coast. By a process developed at the Georgia school of technology, it is now possible to harden the fine-grained pulp and to effect a finish as smooth and glossy as that of the bird's-eye maple. The method is the result of two years' research and the work was made difficult because of the spongy quality of the wood, a good description of which is given in the story of the defense of Fort Moultrie, where the shots of the British fleet sank harmlessly in the soft logs. The wood, until now, has been useful for little else than dock piling. In preparing it for veneering, the section of the log is placed on a veneer lathe and unrolled in sheets, one tenth of an inch in thickness. These sheets are then subjected to a secret chemical process to harden the pulp, which is held together by the tough fibers. After being smoothed down, the veneer is applied in any finish desired. Samples have been prepared in walnut, mahogany, golden oak and green.

**FOLDING HOLDER FOR CYMBALS  
AMPLIFIES TONES** 745

Improved orchestral effect is the result claimed for a cymbal holder that is fitted to the rim of the drum and may be folded into a compact unit for the kit. It prevents the cymbals from swaying unduly when struck and has a metal cup which amplifies the tones. Pieces of felt attached to the cup help control the vibrations of the cymbals without destroying the natural quality of their clashing sound.



Amplifying Cup Visible on Top of Cymbal, Which Is Clamped to Drum So That It Cannot Sway

J. Schwartz Music Co., Inc.  
10 W 19th St. New York

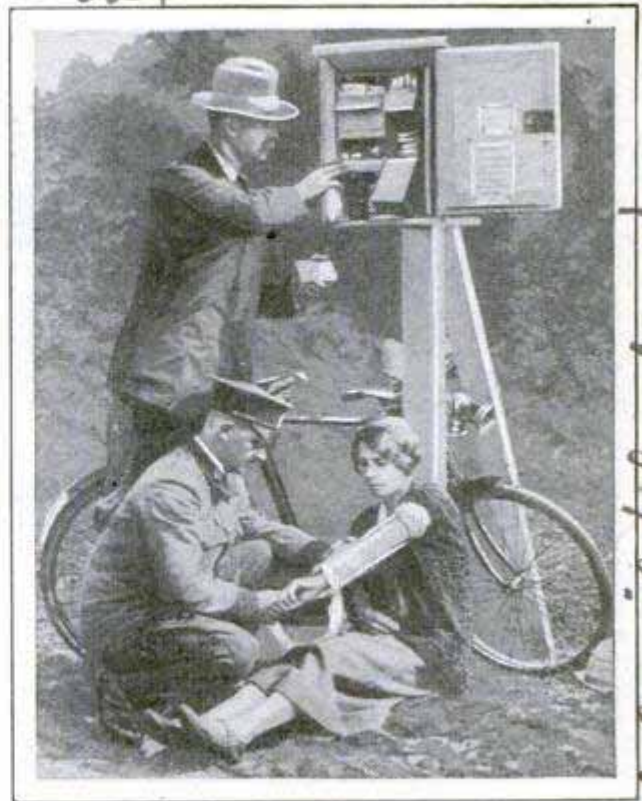

Attending an Accident Victim from Roadside First-Aid Station; Key to Cabinet Is Returned by Mail

**ROADSIDE FIRST-AID STATION  
SERVES FOR ACCIDENTS**

Bandages, dressings and other useful articles are kept in a cabinet by the side of an English highway for use in accident emergencies. Breaking a glass panel exposes the key which unlocks the box. The key is then dropped into a letter box and returned to an ambulance station.

**TWENTY-SEVEN YEARS  
USEFUL LIFE OF  
SKYSCRAPER** 779

Modern steel buildings will last several decades, but their period of usefulness is placed at only twenty-seven years by a New York authority. He declares that most of the structures of this kind are built not for perpetuity, as in ancient days, but with a view to replacement when their estimated usefulness is over.

at Sanildford - Cherry, Eng.

Chicago Daily News 10/28/26

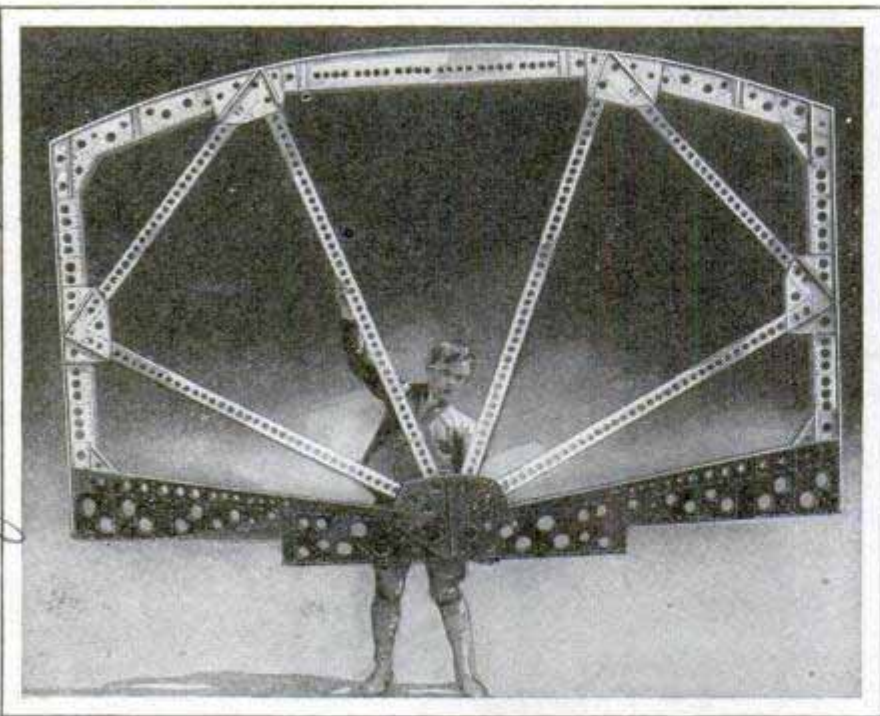

Demonstrating Light Weight of Metal Being Used for Huge Airplane; Whole Span Easily Lifted by One Man

**LIGHT METAL FOR AIRPLANE TO AID LONG FLIGHTS**

Since travel by air is largely a battle against gravity, experts are looking more and more to lighter and stronger materials to make possible longer and less expensive flights. Progress in this direction is illustrated in the metal that is being used to build a huge airplane in Germany for sea voyages. It is so light that one man can easily lift a fabricated span more than eleven feet wide. The plane is to have convenient and luxurious quarters for passengers.

**MAN-EATING CROCODILES CAUGHT WITH STICK**

Protected by the dense mangrove swamps near the ocean, the crocodiles of Borneo have flourished until the island has become known as the refuge of the largest and most ferocious creatures of this kind in the world. Some specimens that have been captured measure thirty-three feet in length. They lie almost submerged in quiet places along the rivers waiting for their prey and present a menace to unwary swimmers. Their jaws grow to be four feet long and they can deal a deadly blow with their tails. In

catching the crocodiles, natives attach a piece of meat to a short stick sharpened on both ends. This is fastened to a strong fibery leader, ten or twelve feet long, and the leader tied to a piece of rattan, forty or fifty feet in length. The bait is suspended over a stream and when swallowed, the sharp stick lodges firmly in the crocodile's stomach. The animal is located by the piece of rattan floating on the water. Armed only with spears, the natives tug at the rattan. An advantage of the fibery leader is that it slips between the crocodile's

teeth and is not often bitten through. The beasts have but one friend, a small bird that devours insects on their bodies, even picking morsels of food from between their teeth while they lie sleeping.

**SIDewise DRIVE FOR AUTOS SIMPLIFIES PARKING**

So that automobiles may be parked and removed with a minimum of effort in narrow spaces, an eastern inventor has de-

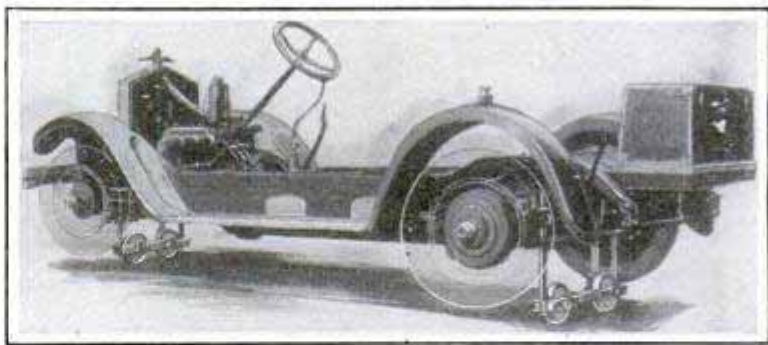

How the Auxiliary Wheels Are Lowered to Run the Car Side-ways for Parking

vised auxiliary wheels that permit the car to run sidewise. Without leaving his seat, the driver shifts levers to actuate a worm gear which causes an extra set of wheels to be forced downward raising the car, and another shift rolls it to or from the curb. When the auto is back in running position, the auxiliary wheels are drawn

*Wm. Victor P. Williams  
Parkmobile Corp.*

*Being built at the Harrier Yard at Mangell, Germany. See Friedrichshafen 480*

*Outdoor America  
Nov. 1916*

*William's Engineering  
Baltimore*

up out of the way. With this arrangement, an owner could build his garage in a narrow alley and drive the car in sideways while the lift feature serves the same purpose as jacks in raising it for repairs.

**HOT AIR USED TO PAINT PICTURES BY RADIO** 764

An improvement in the transmission of pictures by radio has been developed to eliminate the "freckled" appearance of the received picture from the dots and dashes drawn by the fountain pen of the recording apparatus. Instead of the pen, which had a habit of clogging up with dried ink whenever it remained idle a short time, the new recorder is a tiny jet of hot air, projected against a sheet of specially sensitized paper. The hot air develops the chemicals in the paper, and the attendant sees the picture gradually appear before him. A nozzle with an aperture only five-thousandths of an inch in diameter releases the air, which is controlled by a photoelectric cell. As the incoming current fluctuates, the air stream increases or decreases, causing a corresponding tone change in the picture.



The Pay-As-You-Enter Bus Appears in New York, Simplifying the Conductor's Task

**PAY-AS-YOU-ENTER AUTO BUS TO REDUCE ACCIDENTS**

So that the bus conductor can remain on the rear platform where he will always be in a position to help passengers on and off and thus reduce accidents, the motor coaches in New York city have been testing the pay-as-you-enter plan with good results. The scheme is said to have proved

satisfactory especially in congested districts, where patrons are tempted to enter or leave the bus while it is moving slowly. It was found that little extra delay was caused at the loading stations. The fare box is in one corner of the entrance platform where it does not obstruct the door.

Only about 30,000,000 of the world's available 450,000,000 horsepower from water is used.

**CARDBOARD DOLLS PLAY PART IN DESIGNING MACHINE** 676

A jointed cardboard manikin, carefully fashioned to correct scale, is used in a Chicago electrical works with drawings of machines so that the draftsmen can tell if they have allowed enough room for an operator, and if the equipment will be easily manipulated in different positions. The dummy is moved about into various postures in order to duplicate the working conditions as nearly as possible. Joints of the body are accurately located, allowing the figure to be bent forward and backward correctly.

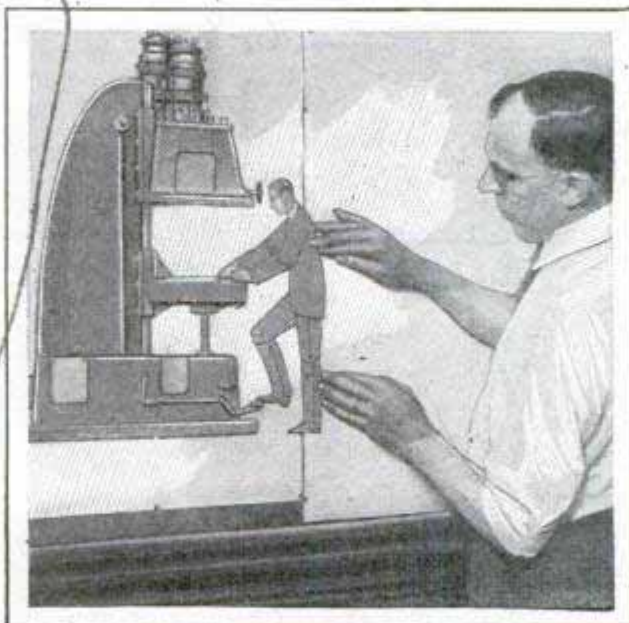

Cardboard Figure Can Be Moved to Represent Worker in Action at Machine

*Fifth Avenue Coach Co., City New York*

*J. D. Herck  
 Hawthorne Works*

528  
44

*in NY Herald Tribune*  
MECHANICS  
696  
10/17/26



Courtesy General Electric Co.

Silver-Tipped Skyscraper as It Appears at Night, Its Crest Flooded by Electric Lights

### LIGHTS ON TOP OF TALL TOWER EMPHASIZE ITS HEIGHT

Proportions of the 475-foot Book tower in Detroit, Mich., are accentuated at night by 128 floodlights and reflectors that bathe the top of the structure in colored radiance. Some of the lamps have amber glass and others a shade of rose. Eighteen projectors and fourteen reflectors are directed to shine on the roof. The lamps are of 500 and 200 watts and produce harmonious lighting on all sides of the tower.

☛To improve the appearance of floors, artistic borders in hardwood strips have been devised.

### BIRDS, BEASTS, INSECTS MAKE OWN WEATHER FORECASTS

The ability of birds and animals to foretell changes in weather, a fact that has been noted for centuries, is credited to unusual responsiveness to alterations in the atmospheric pressure. The same faculty is more or less common to diseased or delicate human bodies, notably sufferers from rheumatism. At sea level, the column of air extending upward from every square foot of surface weighs about one ton, and a change of a single inch in barometric pressure means a change of about seventy pounds in the weight of this air column. That amounts to a change of nearly half a ton of air pressure against the human body of average size. Apparently animals and birds are much more susceptible to such changes than human beings, and are accustomed to accept them as warnings of weather changes to come. John Gay, the eighteenth-century opera librettist, wrote, "When swallows fleet soar high and sport in air, He told us that the welkin would be clear." In Gay's time people did not know that swallows could fly high when the barometer was high, because the atmosphere was denser, and hence able to support the birds at a greater height. As the barometer falls, forecasting stormy weather, the air density is decreasing, and so the birds fly at lower altitudes.

### TUBE FOR GREASING MOTORS 6/8 REDUCES WASTE

Ball-bearing motors can be lubricated with a minimum of waste and trouble, and without removing the housing cap, directly from a collapsible tube holding enough grease for a year's supply. The old grease is flushed

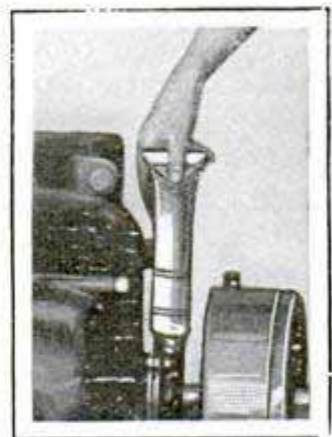

out with kerosene and the new injected after the housing plug has been taken out, less dirt being introduced in this way. The tubes are made in four different sizes for larger and smaller motors.

*The Fairbanks Morse Co.*  
902 S. Wabash

612.

251 S. Precinct Bldg.  
POPULAR MECHANICS

San Diego, Calif. 45

# ARE THE CONTINENTS DRIFTING IN A SEA OF ROCK?

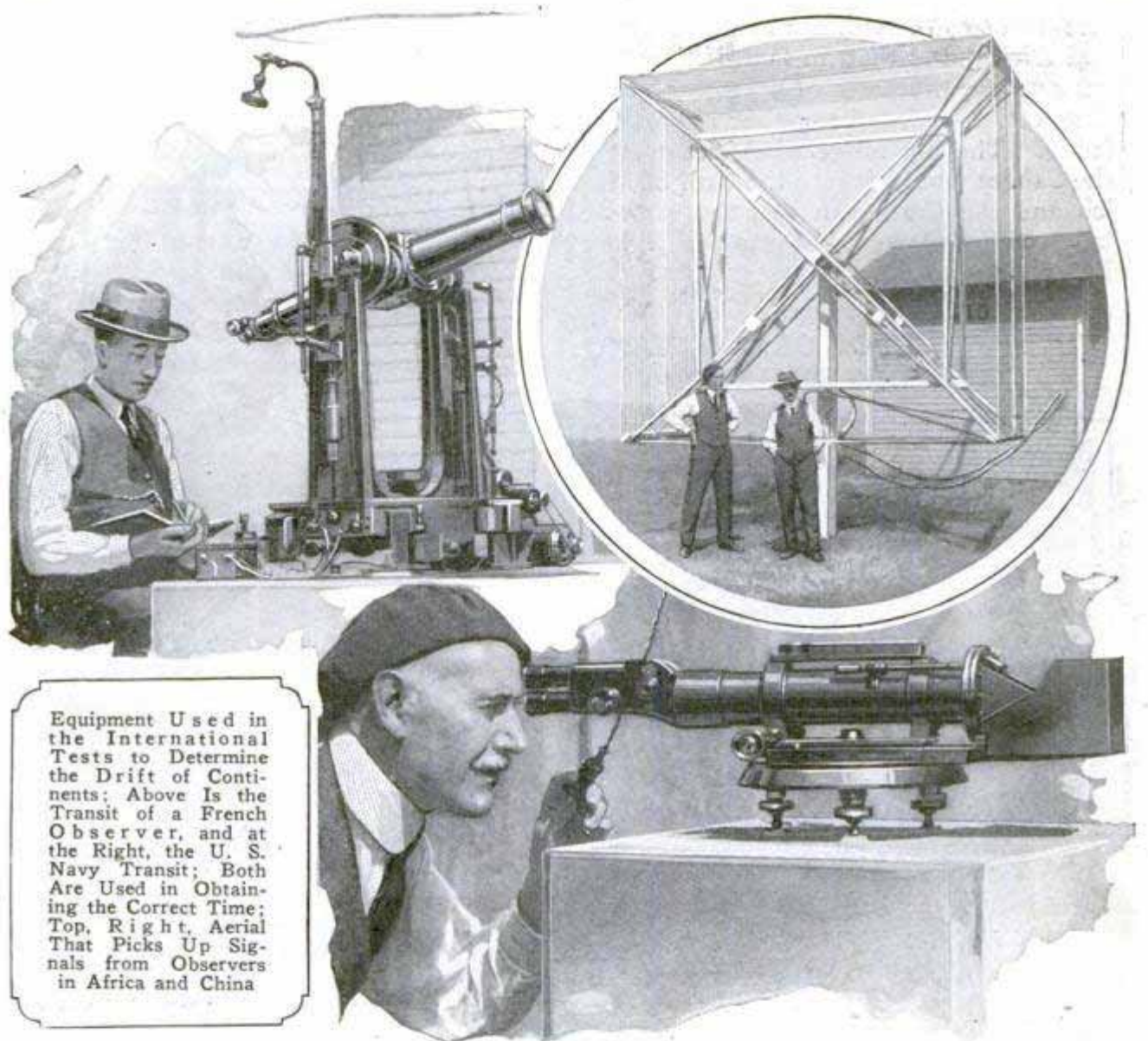

Equipment Used in the International Tests to Determine the Drift of Continents; Above Is the Transit of a French Observer, and at the Right, the U. S. Navy Transit; Both Are Used in Obtaining the Correct Time; Top, Right, Aerial That Picks Up Signals from Observers in Africa and China

To determine whether the parts of the world are adrift on a sea of rock and may eventually separate and recombine to form new continental groups, scientists the world over have started a series of ten-year experiments made possible by radio. With delicate instruments, and checking all data obtained by radio signals flashed around the world to the widely scattered observatories, they expect to settle definitely the momentous question. It is believed that North America is shifting north and westward and eventually will separate from South America, rendering a Panama canal unnecessary. By comparing observations to be made ten years from now with those made this winter, the theory can be confirmed or rejected.

If the world is shifting, then the longitudinal lines on present maps are wrong

and the location of cities and boundary lines incorrect. To determine whether errors exist, the observers simply check the stars at each station, determine from them the exact astronomical time at that point, and compare the results with similar checks at other points. Then, ten years from now, when the tests are repeated, if the different parts of the earth have shifted in relation to each other, the change will be apparent. The investigation is particularly important in view of the new theory evolved by Prof. John Joly, a distinguished scientist of Trinity College, Dublin, who believes that all the land above sea level once formed a single continent, and that over a period of millions of years it gradually broke up and the sections drifted apart to form separate continents. If you study a globe you can

see that the eastern coast line of North and South America bears a striking resemblance to the western coast of Europe and Africa, and that, in fact, if they were cut out like the parts of a jig-saw puzzle, they could be fitted together almost perfectly. The big bulge of Africa west of the Sahara would fit into the Gulf of Mexico and the Caribbean sea, the eastward bulge of Brazil, would fit into the Bight of Benin, and so on.

**TINY MODEL OF GRAND PIANO FITS IN THE HAND**

596

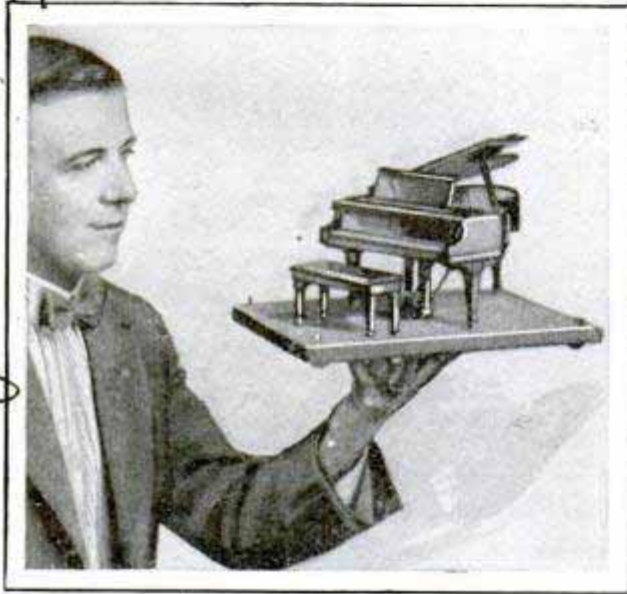

Almost Anyone Can Move This Piano, a Tiny Model Instrument Said to Be Accurate in Every Detail

One of the articles displayed on an "endless chain" of model products at the Sesquicentennial exposition was a replica of a grand piano constructed on a scale of one eighth of an inch to the foot. It is said to be accurate in every detail.

**AUTO SAWED IN TWO MAKES POWER PLANT**

By amputating the old auto and placing the engine upon a wheelbarrow arrangement for easy portability a practical means has been provided for driving the grain elevator, corn sheller, pumps and other units about the farm and shop. Power take-offs and caster spindles are

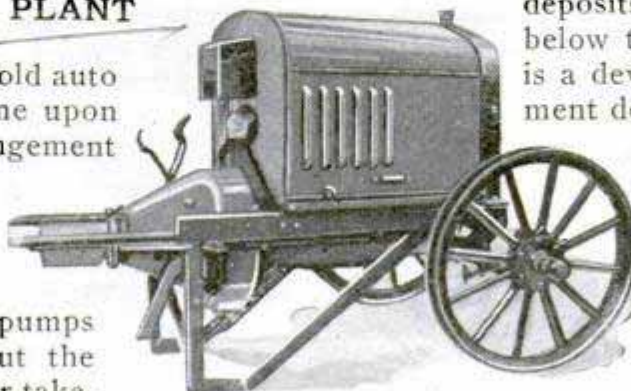

Old Auto Sawed in Two and Prepared for Service as a Power Plant

furnished to form a trailer to operate corn pickers, plows and other machinery when the legs and handles of the barrow rig are removed. The car is cut in two at the rear of the crankcase.

**LINCOLN'S EYE STRAIN IS SEEN AS AFFECTING HABITS**

607

Abraham Lincoln suffered from unequal balance between the muscles of the eyeballs, a western physician has declared, and this affliction, the doctor believes, partly explains some of the traits of the great president. His frequently slouchy postures are now believed to have been naturally caused by his attempt to bring his eyes into positions of comfort. He often read while lying down; in fact, this the doctor said, was the most satisfactory posture for the purpose, because the muscle which pointed his eyeball upward was stronger than that which pulled it down. Standing above an audience and looking down upon it as he spoke, fatigued him and he did not find it easy to watch a theater performance from an elevated position, because of the strain on his eyes, it is now believed. One of the stories told about Lincoln is that he had a premonition of his death from seeing a double image of himself on one occasion in a mirror. This "vision" is now thought to have been a manifestation of the president's imperfect eyesight.

**SECRET OF EARTH'S INTERIOR EXPLORED BY RADIO**

640

With the aid of a combination radio and camera apparatus, a western engineer has obtained photographs of metals far underground and has been able to locate ore deposits at considerable depths below the surface. The outfit is a development of an instrument designed to aid in finding pools of oil and gas as well as water. It was first tested on a steel building in Denver, Colo. Photographs were obtained, showing the beams and girders although they were hidden

Mr. William A. Sharpe  
Denver, Colo.

Weaver Piano Co. York, Pa.

S. E. Purty & Son, Sac City, Iowa

Mr. E. A. Merdian, Wash.

Woodbury Court 12501



from sight. At Crater, Ariz., the largest mass of a buried meteor, some 1,400 feet below the top, was located with the apparatus, and, in a New Mexico mining district, rich metallic veins and bodies of ore were detected. Three ancient tunnels that had been abandoned and sealed up were discovered along with gold and silver deposits. The instrument registers returning radio waves sent into the earth on a film.

**FLAG BRINGS WATER TO MINERS IN DESERT CAMP** <sup>599</sup>

Just as town and city residents hang out a card to inform the iceman a fresh supply is needed, so inhabitants of the mining camp of Quartz mountain in Nevada, have a way of ordering water. A flag bearing the chemical symbol of the liquid, "H<sub>2</sub>O," halts the tank wagons, which are driven from the supply fourteen miles away.

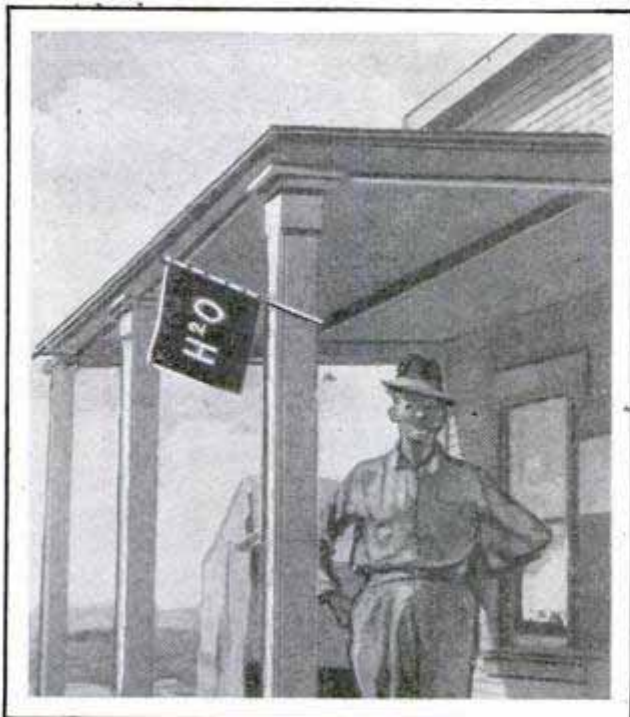

City Customs in the Desert; Water Flag Displayed to Give Notice That a Fresh Supply Is Wanted

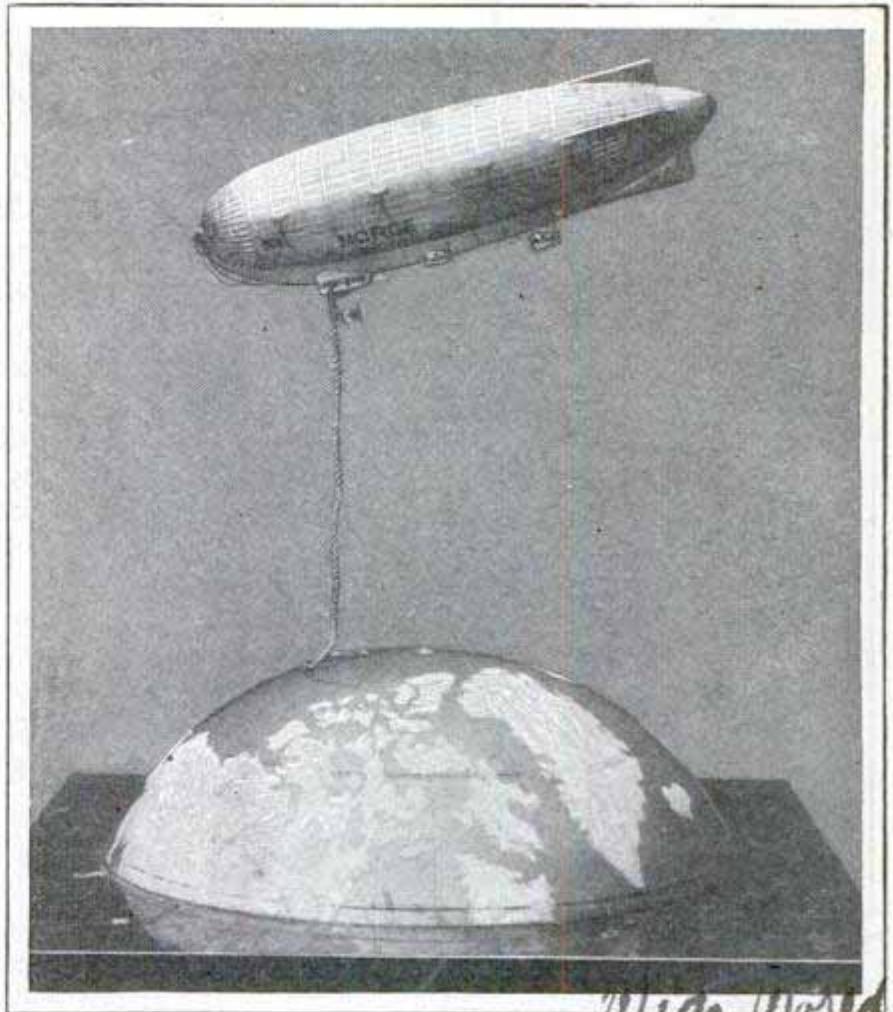

Presented to Commander Nobile by the Milan Automobile Club, a Gold Miniature "Norge" above the Globe's Top

**GOLD MODEL OF AIRSHIP NORGE CELEBRATES POLAR FLIGHT**

In memory of the first flight of a dirigible over the North Pole, a handsome trophy has been presented to Commander Nobile, the ship's designer, by the automobile club of Milan. It consists of a gold replica of the "Norge" above the top of the world, represented by a portion of a globe, incased in a base.

**INSECTS BLOWN OUT OF LIGHTS WITH FANS FOR MOVIES**

<sup>650</sup> Swarms of moths and other insects, attracted by the bright lights in the motion-picture studios, were once a problem in taking indoor scenes because they were likely to register on the film when passing before the camera. The difficulty has been eliminated by sweeping the rooms with "bug machines"—airplane propellers driven by electric motors which prevent their intruding in the picture.

*Metro. Soldwyn. Mayer*

538

2 Dayton, Ohio



Dard Hunter with Sample of Mulberry-Bark Paper, Made by South Sea Islanders

### PAPER FROM MULBERRY BARK USED FOR CLOTHING

Cannibals are not commonly thought of as proficient in any skilled art, but Dard Hunter, author and publisher, found that certain South Sea island tribes are expert at making a kind of paper from the bark of mulberry trees. They use the material in brightly colored patterns for garments and also as shrouds. Hunter, who prints his books by hand on paper which he makes in his

own one-man factory, has one of the world's most complete collections of ancient and modern paper.

### PAVEMENTS ON CHICKEN WIRE CAN BE ROLLED UP

To be laid over a twenty-mile stretch of sand thoroughfare near Corpus Christi, Tex., lengths of chicken wire coated with elastic asphalt are planned for an automobile highway. If the necessity arises the road could be rolled up and put away. The efficiency of this system was demonstrated during the World war, when Gen. Allenby used it in moving troops and trucks into Mesopotamia. The wire and its coating distribute the weight of vehicles so that they will not sink into the sand.

### BIG STORAGE-BATTERY ENGINE TO SPEED SWITCHING

Faster handling of trains and cars in the switching terminal is expected with a storage-battery locomotive that can haul seventy empty or thirty loaded freight cars at speeds of from eight to ten miles an hour. The battery weighs more than thirty-nine tons and is the equivalent of 1,579 ordinary six-volt batteries such as are used in radio. They furnish power enough to crank 1,600 automobiles simultaneously. The locomotive can be recharged with special apparatus at night when not working or, in an emergency, can be supplied with power while in operation from a small gas-engine generator in the cab. One charging is sufficient for a day's work.

Absence of noise and smoke and elimination of trolley wires are regarded as important features.

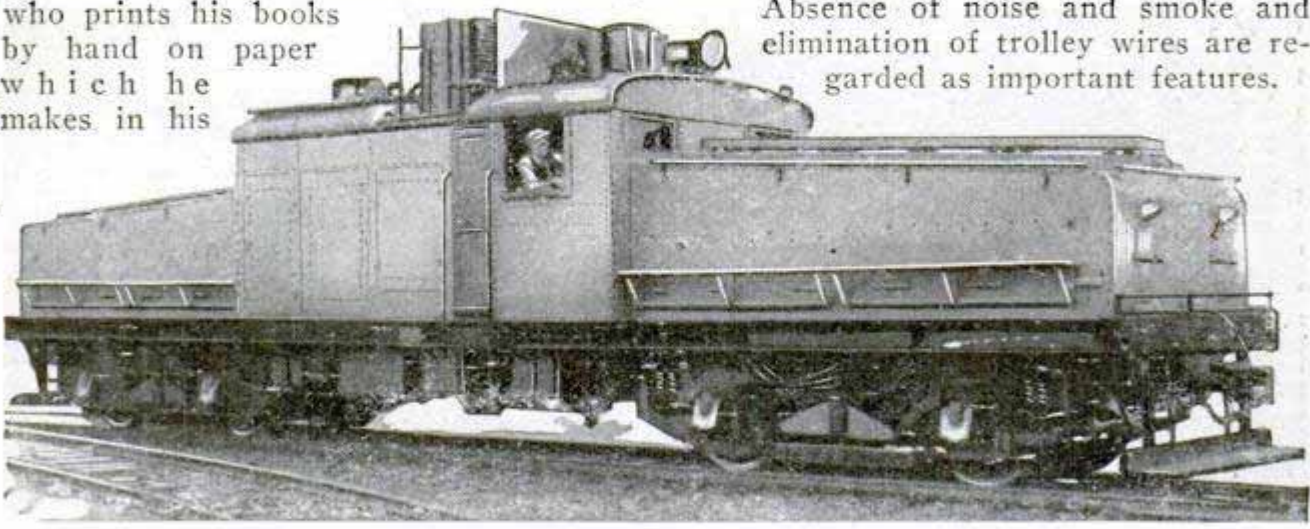

Huge Storage-Battery Locomotive for Railroad Switching Service; It May Speed Solution of Electrifying Big Terminals as Wires Will Not Be Needed over Switch Tracks

Built by General Electric Co. and Electric Storage Battery Co

for Chicago and Northwestern. to be used in freight yard switching

Antioch, Ohio

Sam Robertson City manager

593

**KITE CAMERA TAKES MOVIES  
OF TROOPS AT DRILL** 713

For the first time in the making of motion pictures, successful films of troop movements at long range were obtained from a kite at Camp Stanley, Tex., not long ago. The camera, wound up with a spring, was set and released at a height of seven feet while suspended from the kite string. A butterfly contrivance carried it to a height of 1,000 feet and, as the camera came in contact with the kite, the wings automatically folded up and the instrument was carried back by its own weight. It had been operating by the spring mechanism during the journey, the result being that a panoramic view in steadily diminishing proportions was obtained. For taking battle scenes, a balloon camera has been devised. It weighs sixty pounds, the kite instrument only twelve. A gas bag carries the camera to a height of 100 feet and fifty feet of film can be taken.



In Memory of World War Prisoners Who Died in Sweden; Unique Monument Erected at Trelleborg

*Preserves*  
**STORE EGGS ON TURNING RACK  
TO PREVENT SPOILING** 579

Contending that one of the chief causes of eggs spoiling lies in the common method of storing them upright, a German has designed a rack holding the eggs horizontally on cylindrical drums both inside and out. All that is needed to keep the eggs fresh is to give the apparatus a quarter turn every other day. A crank is provided for this purpose and a date index showing when the last turning was done helps eliminate mistakes and negligence. No chemicals or other preparations are used and, after candling, eggs have kept fresh for over a year. The apparatus is made in various sizes.

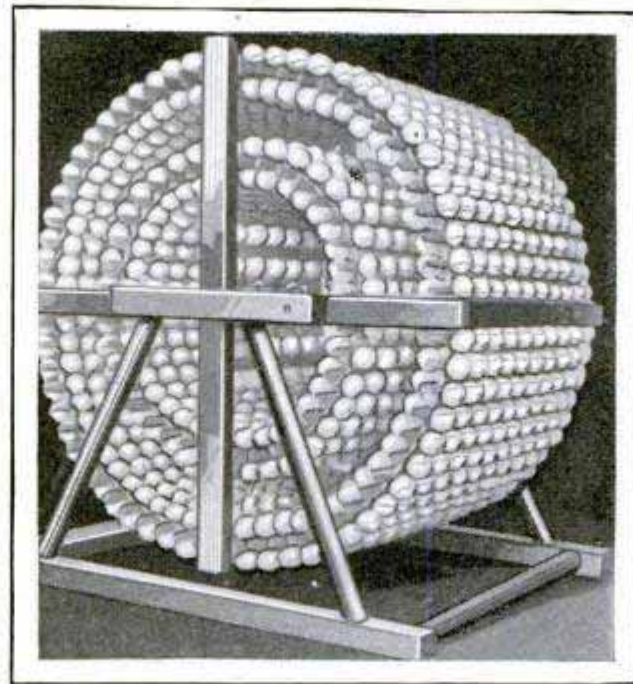

Storage Rack Filled with Eggs; It Is Turned Slightly Every Other Day to Prevent Spoiling

**SOLDIERS WHO DIED IN SWEDEN  
HONORED BY MONUMENT**

A world-war monument for Sweden seems incongruous at first thought since that country was neutral during the struggle, but a memorial has been erected and unveiled in Trelleborg to recall one of the tragic sidelights of the conflict. It is in honor of the prisoners who died in Sweden while being exchanged between Germany and Russia. A stone shaft, surmounted by a bird apparently grieving for its dead mate at the bottom, is the conspicuous part of the memorial.

*Mr - d mo - d industrie  
Bresden n, 30 Germany  
K. Fischer, Braunschweig 8/10*

50  
629

Vital Areas Protected from Bandits' Bullets; Berlin Policeman Wearing Flexible Chest Armor, and Metal Visor to Shield Head



### BULLET-PROOF POLICE ARMOR EXHIBITED IN BERLIN

Breastplate and a headgear that partly shields the eyes are conspicuous units of protective armor devised for German policemen. The coverings are quickly adjusted or removed and are arranged to guard the vital parts of the body without interfering with the wearer's movements.

### FIVE HUNDRED PATENTS A YEAR GRANTED TO WOMEN

Before the Civil war, less than half a dozen patents were granted women in one year, but the number has been steadily increasing until it is now above 500 annually. Their inventions cover almost the whole range of human activity and include a wide variety of articles from horse collars to windshield wipers. Most of them are within the scope of household appliances, but they include also articles for agriculture, manufacturing, mining, submarine warfare and fuel. As in the case of man's activity, necessity, as the mother

of invention, has inspired many of the devices. A Texas woman wrote the patent office that she was tired of stripping sugar cane for molasses by hand so invented an appliance that did the work better. Another woman, confined to her bed by illness during the hot days of summer, noticed how poorly the room was aired, and devised a ventilator on which she was granted a patent. A woman golf player became vexed when she had to recover balls that lodged in difficult places and arranged a special rake for the purpose. It was later modified for garden use and patented. Wives of farmers have devised a number of things not only to lighten kitchen work but to relieve the drudgery of farm toil. A Minnesota woman obtained a patent on a portable smokehouse, the invention being the result of her resolve to make the task, allotted to her, easier and more successful. Because she was tired of bending her back continually while doing the work, a Florida woman rigged a fertilizer distributor and wrote the patent office that the implement was the product of "Yankee laziness." Many firearms have been invented by women, the list including automatic pistols, bomb-launching apparatus, a cane-gun, etc. The decade ended in 1867 saw an increase of 677 per cent in the patents granted to women over the preceding ten years.

### SANDER FOR WOOD OR METAL RUN FROM LIGHT SOCKET

60

For smoothing wood or metal surfaces quickly and evenly, a portable electric sander can be operated on any alternating current from twenty-five to sixty cycles or with direct current of 110 volts. It is shaped somewhat like a plane and is equipped with a moving belt that

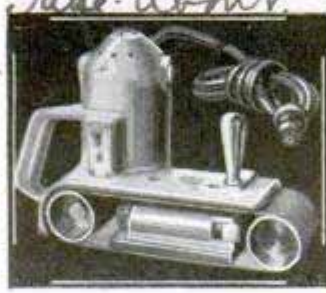

does the sanding. This may be changed, and so may the block with it, so that the sander can be applied to a wide variety of surfaces and materials. The right-hand side is clear so that the belt can be operated close to a baseboard or wall. The implement weighs but twelve pounds.

*Take about*  
*Washington*  
*Belvid.*  
62  
62  
Porter-Cable Machine Co  
Syracuse, NY

*New York Times*  
*10/17/26*

10/10/26

660 a.m. 7040

Elizabeth St. Chicago

**OSTRICH LEATHER  
MAKES FINE  
SHOES**

701

Because of the demand for their leather, ostriches are coming to rival cattle in some parts of South America, according to reports. The skin tans a beautiful shade of brown and the quill sockets, showing as a deeper shade, afford a pleasing contrast to the smooth surface. The leather is also being used for handbags, brief cases, show trimmings and other articles.

**ARCHER HOLDS BOW  
IN FEET FOR  
TRICK SHOTS**

643

Like the rifle marksman, the archer is able to demonstrate his skill by novel shooting positions. At an eastern meet, one contestant adopted a method used by some tribes of savages, that of holding the bow against the soles of the feet with the arrow between them, then drawing the string back with the hands and shooting. A stiff bow can be managed more easily in this manner, and steady aim is possible after practice.



Giving Archery a New Twist; Holding Bow against Soles of Feet for a Trick Shot

She Woke

9/25/26

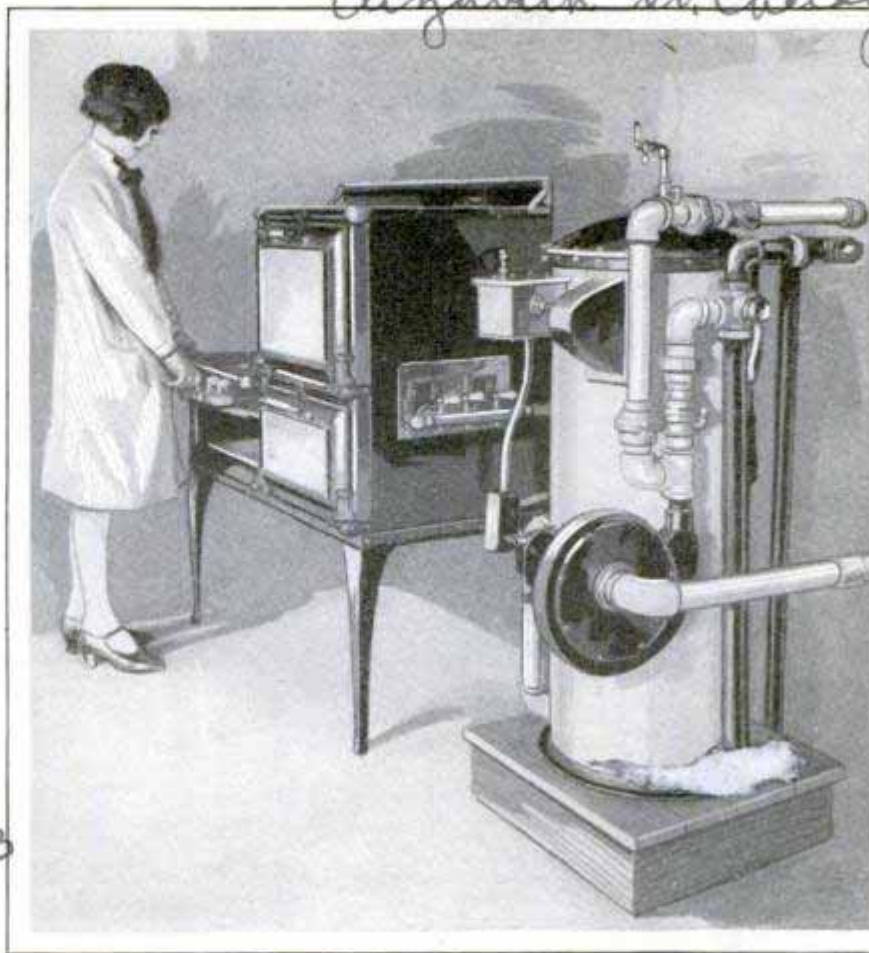

Gas-Generating Plant for Homes Not Served by City Supply; Outfit May Be Set Up Far from the Range

**HOME GAS-GENERATING PLANT  
REDUCES COOKING COSTS**

For homes in localities that are not supplied with gas but have electricity, a generating plant that uses gasoline is said to afford sufficient fuel for ordinary cooking at a cost less than ten cents a day. It consists principally of a tank containing wicking saturated with gasoline and through which air is forced to effect vaporization. A suitable mixture of gas and air is obtained, and to operate the outfit, it is only necessary to fill the tank once in six months, push an electric button, and the gas is soon ready for use. The tank may be placed in any convenient location, an automatic arrangement insures a constant supply of gas, and the fuel is said to have a heating value of 870 British thermal units. Safety is assured, the manufacturers assert, and the tank may be set up at some distance from the range and the gas piped to the burners.

☐The United States has a million and a half more automobiles than telephones.

can be seen at Economy Builders Co. Inc. 6407 Park Ave Chicago

# Things to

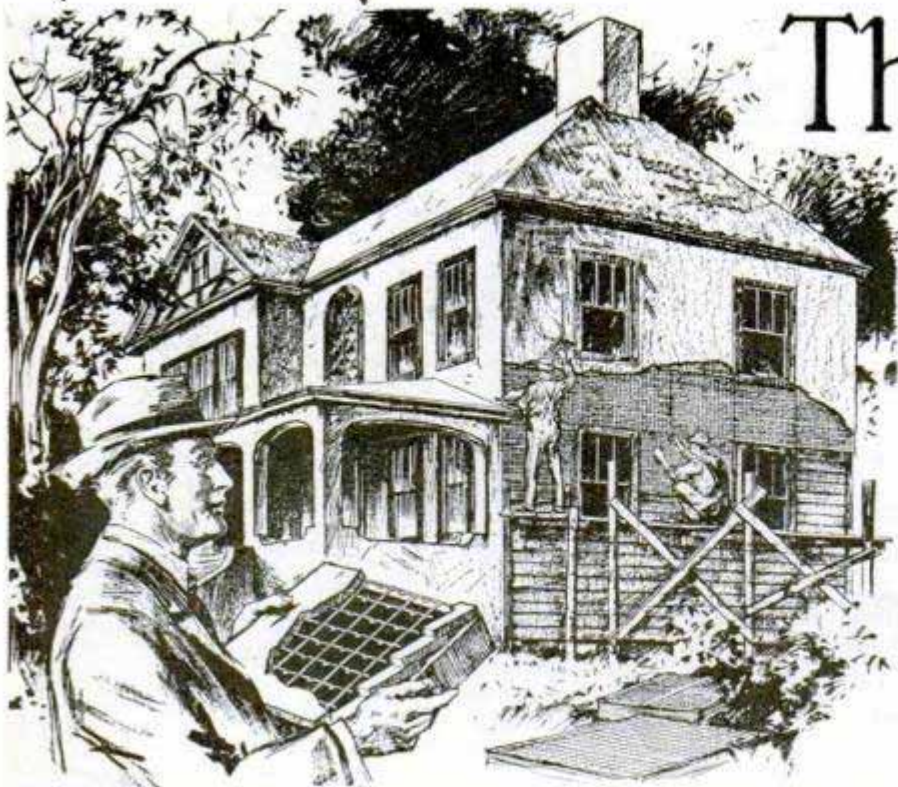

Metal Lath and Stucco. Applied over the Old Weatherboarding. Help Convert an Aged House to Smart and Modern Appearance

## By A CONTRACTOR

**T**HE trouble with building good houses is that the average buyer does not know whether they are well built or not and will buy a poorly built house that is all dolled up rather than a good house for the same or very little more money."

This was the verdict of a real-estate dealer who went on to tell many instances of cheaply built houses that had sold for good money in preference to well constructed ones, as well arranged and as sightly, but not fitted up to catch the eye of the buyer.

To begin with there are three grades of lumber. Most details of grading are unimportant to a house buyer, but there is one point that is vital. Go over the

lumber used in the house and determine if it was cut from a live tree or from a tree that had died on the stump or become overripe before cutting. Wood from a live tree is alive. When bent, it springs up to the point of breaking and snaps when broken. Wood from a dead tree will break like a piece of cheese and the ends will not show any fiber. Live lumber, properly painted, will last practically forever.

Dead lumber will not last a generation. It already has begun to decay and will not hold nails.

When you start building, the first thing to watch is the foundation. Concrete properly mixed will become stronger every year. Improperly mixed, it will gradually break up and your basement will be damp. Good concrete should have a full shovel of cement for every three shovels of sand and four shovels of gravel. See that this shovel of cement is as full as the shovels of sand and gravel. Then look well to the sand you use. It should be clean and sharp. Take a handful, when moist, and squeeze it in your hand. If it clings together take it to a faucet and let a small stream of water trickle through it.

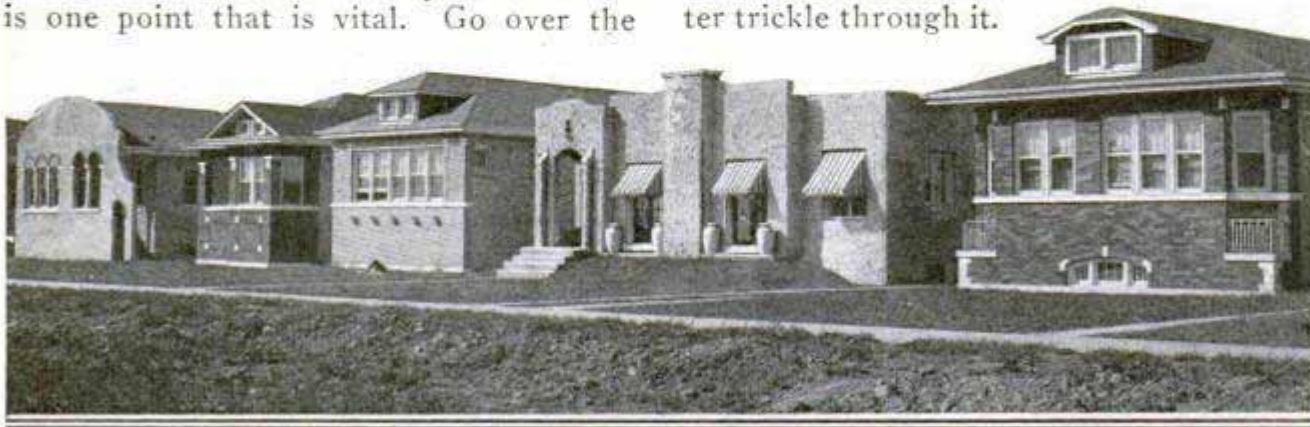

The Kind of House Your Neighbor Builds Influences the Value of Your Own; Here Is a Row of Bungalows, All Good in Themselves, but Spoiled by Unwise Mixture of Clashing Types

# Look For *in* Buying a Home

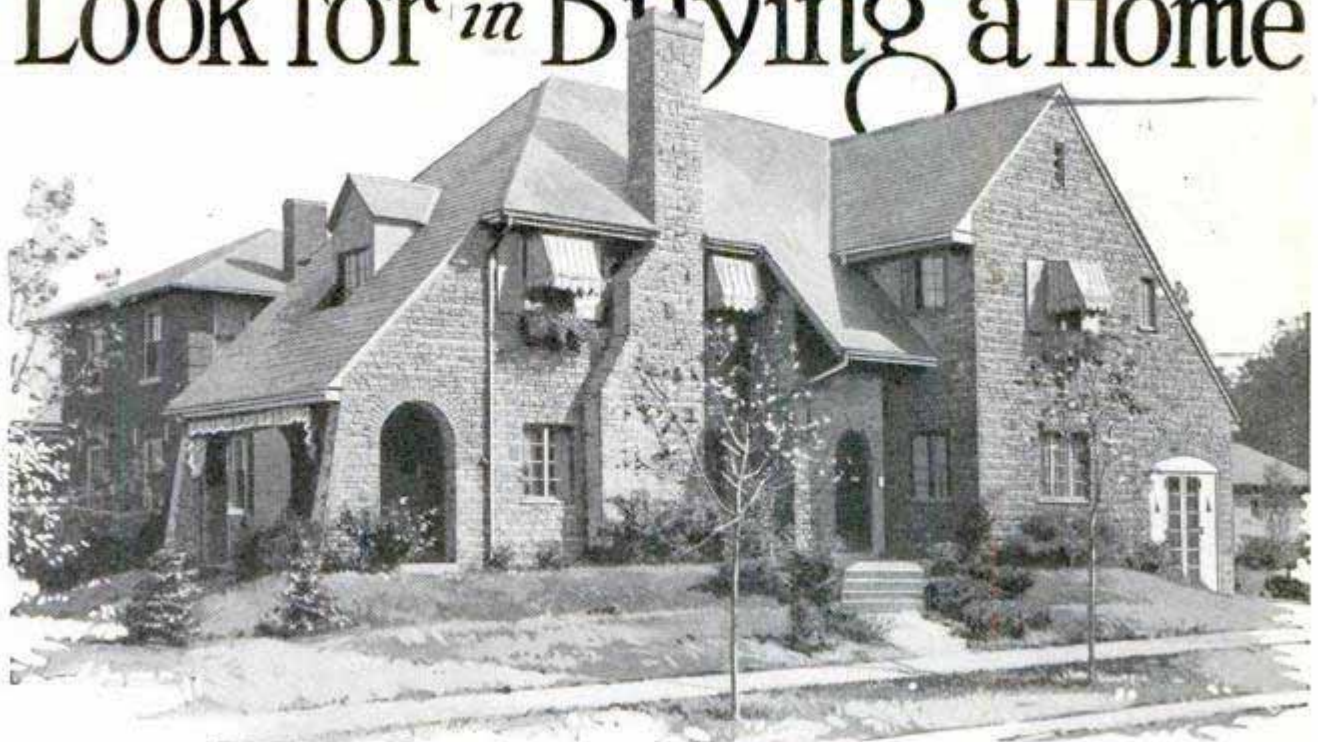

Skintled, or Staggered Brickwork, Relieves the Dull Plainness of Ordinary Laying, and Adds Charm to a House; Note the Convenience of the Built-In Garage, Which Is Easily Heated

If the water comes out clean, all right, if the water is discolored, the sand has not been properly washed and your concrete will not be as strong.

If you are having a wall poured, be sure it is not stripped of its form for at least two weeks, particularly if the weather is clear. Sun on green concrete will practically ruin it. In any case, see that the concrete is kept wetted down. It is a false notion that concrete dries out. The water does not dry out, at least not all of it. It unites with the cement in a chemical combination and, if there is not a proper amount of water present until this reaction takes place, the concrete will not become as strong as it properly should be.

If the house you are buying does not have a full basement, insist on having

a layer of waterproof paper between the courses of flooring. This will prevent the moisture from coming up into the house. Be sure that there is also a layer of paper between the inside and outside wall sidings and that it is properly placed around the window and door openings. This will save you tons of coal every year. The paper should be put under the window frames before they are nailed on and should have plenty of margin for laps.

See that the house was leveled up before plastering. Builders are prone to level a house when they are framing it and then forget that it may settle. If you wait until it is plastered, it may be too late, for any change of levels will crack the plaster



The Spanish Type House in the Foreground Is Good, and the Plain Bungalow Next to It Is Fair, but the Appearance of Both Is Lessened by the Incongruous Designs

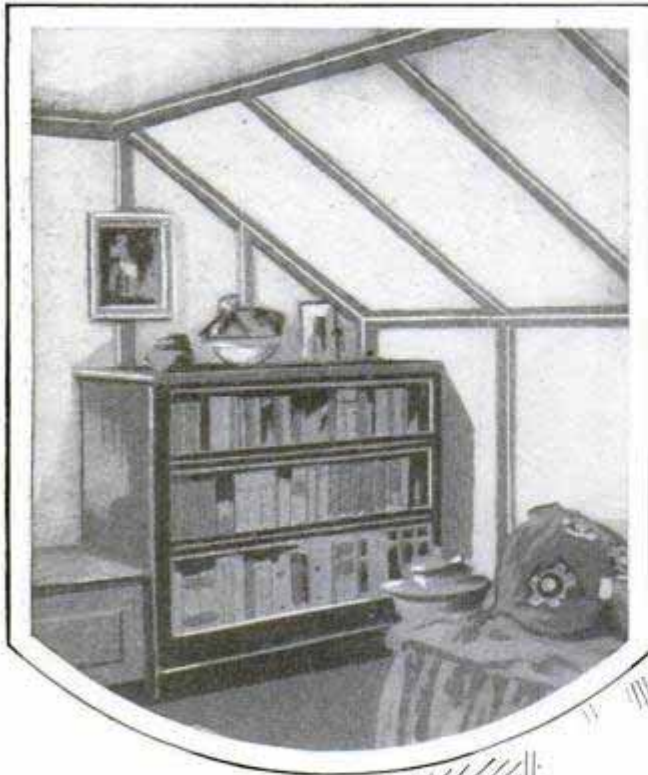

Wallboard Offers a Quick and Cheap Method of Making an Old Attic Attractive; at the Bottom Is an Example of Inferior Painting, Put On Just to Sell an Old House

and probably cause it to drop off. When you buy a house look into this matter. If it has not been done, don't buy the house. Rocking chairs will travel on a floor that is not level and, if you spill water, milk or any other fluid on it, it will run away from you instead of remaining to be wiped up.

Inspect the shingles. If the roof is steep, it will be all right if there is an exposure of five inches to the weather, but if it is flat, not more than four inches should be allowed. With many, shingles have come into disrepute. This is because people have used a cheap grade, cut thin and from poor timber, which will crack when dried out in the sun. A good shingle should be of live cedar, clear of knots, and the thick ends of five shingles put together should measure not less than two inches.

Shingles should be laid with galvanized nails. Blued steel nails will rust in two in a few years and the shingles will work loose. Shinglers do not like to put galvanized nails in their mouths and consequently advise against their use.

Nor should shingles be treated with anything containing free carbolic acid as it will attack the nails. It is not the exposed part of shingles that decays but that under the lap. If you are building a permanent home, dip the shingles in a stain, the major portion of which is boiled linseed oil, and your roof will last practically forever. When you buy a house, see what kind of siding is under the paint.

If it is cedar siding, or other wood, be sure it is placed with the grain vertical. The outside paint of a house suffers a heavy ordeal combating the summer's sun and the winter's frost, besides exposure to wind, rain, soot and sand. If the wood has a vertical grain, it offers a footing for the paint on which it can keep hold, but if there is

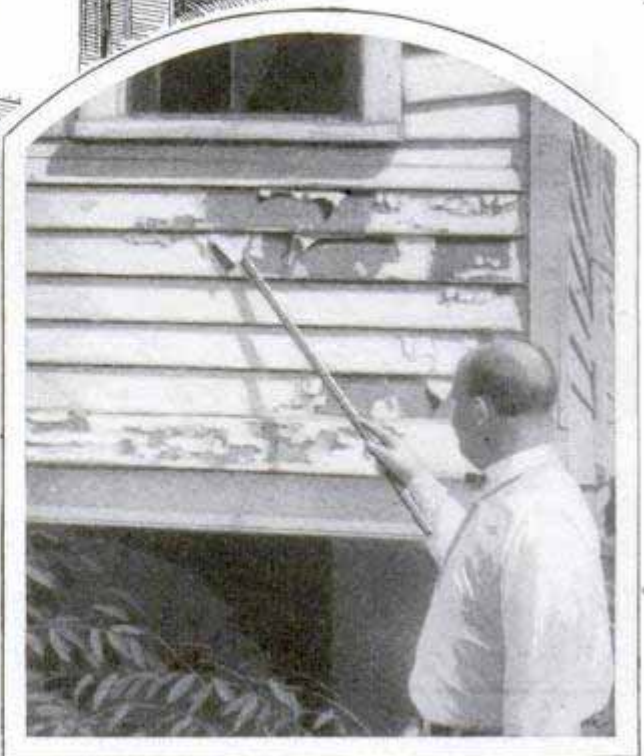
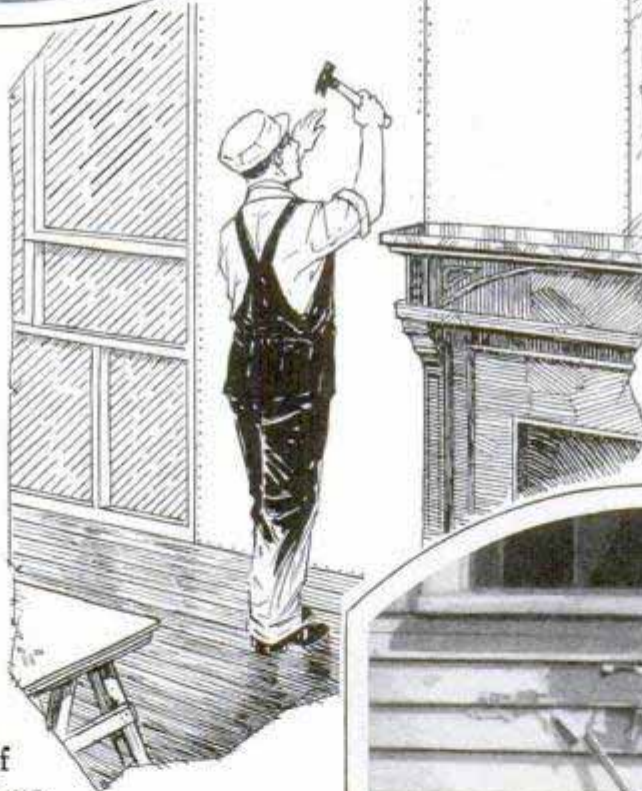



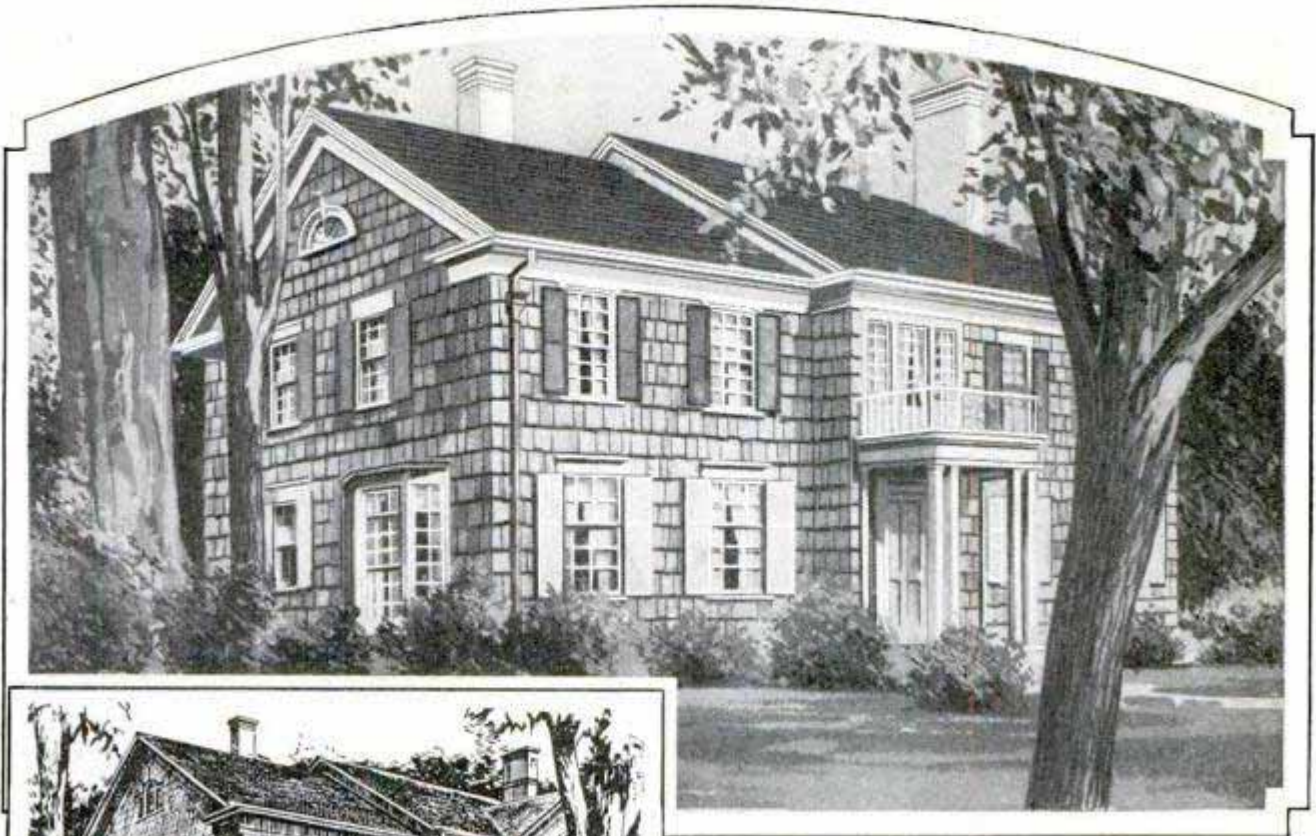

© Creso-Dipt Co., Inc.

Shingles Dipped in Gray Stain and Applied over the Old Walls Helped Remodel This House into the Pleasing Colonial Home Above

a slash grain, you will find the paint slipping at the end of the second year.

Coming to siding, brings up the subject of paint. There is only one real good base for outside work and that is linseed oil. It combines with the oxygen to form a hard surface. Linseed oil and paints made from it are more expensive, but though you may save half the money by buying cheap paints, they will not last.

As to inside finish, the first thing the average buyer asks is shiny hardwood floors. A shiny floor is the easiest and cheapest finish to obtain. The floor is laid, scraped, sanded, filled, wiped, sanded, shellacked, sanded again and then polished with wax. That makes a beautiful finish for a few weeks. But the first time a heavy chair is slid across it, however, there will be a scratch that nothing but refinishing will remove.

The good and permanent floor finish is wax, or oil. As soon as shellac is put on

wood, there is a new surface through which wax or oil will not go. So, if you use wax afterward, it means nothing more than a polish on the shellac, and any scratch cuts through and shows. If the shellac had been left off, the wax would have entered the pores of the wood and every additional coat would have made the floor harder and handsomer. But this is not a highly polished floor to start with and it will not be so for a number of years. Eventually it will have the color and polish of old country floors, but not at once.

Veneer hardwood floors are easier to take care of than tongue-and-groove hardwood floors thirteen-sixteenths of an inch thick. If a board is injured through any cause, it is easily removed from a veneer floor and another substituted. Also you will find the thick floors will "cup" or warp in damp weather, or if water is used on them.

When you look over your prospective house, take a straight stick with you, about four or five feet long, and lay it along the plastered walls. Put one end of it up near a door or window casing and see if the plaster recedes from the middle of the stick. If it does, the plasterer has "cheat-

ed" the wall, making it three-quarters of an inch thick at the openings where the grounds force him to do so and then scraping it away as soon as he has got away from the grounds. If this is the case, the plaster will be apt to crack and fall away from the lath.

See to it that your ceiling joists and studs are spaced sixteen inches apart. Where possible, unscrupulous builders will space them two feet. It is easy to knock on the plaster with your knuckle or a hammer and determine the location of studs and joists, and if you find them more than sixteen inches apart, don't buy the house, for ordinary lath will not stand the strain of so long a span and your plaster will come off. Also, if you can find a place where the plaster is exposed, see if the lath have been put on far enough apart so that the plaster was forced between them. This takes more plaster, and it will eventually fall off if not keyed on this way.

For a number of years driftwood gray has been a popular finish. This has been accomplished by the use of a number of different stains. If you contemplate buying a house with a stain finish, remember that unless the stain has a varnish, shellac or wax finish, it will show a greasy stain for every finger mark.

Look at the frames around the inside of your doors and windows. If they have mitered corners, find out how long they have been on and painted. In practically every case a frame with a mitered corner will shrink and the mitered joint open up, leaving an unsightly crack. Examine also how the door and window frames are nailed. If this has been done only along the inside edges and yet the outside edge lies flat against the plaster, you will be safe in buying, but if the frame is nailed along the outside edge, to hold it in place against the plaster, then the plastering has been cheated and, when the door frames shrink—as they surely will—they will pull apart at the joints and leave cracks.

Tile floors and drainboards are popular now, as a sanitary measure. Tile floors are fine in buildings and homes with plenty of help, but the prospective buyer of a small house would do well to consult some friend who has tiled floors before closing the deal. Tiled floors show dirt at once and are not readily cleaned. Tile drainboards around sinks also need to be cleaned frequently and it is well to remember that your fine china or glassware is never safe from chipping if you do not set it down with great care.

Look over the hardware. You know

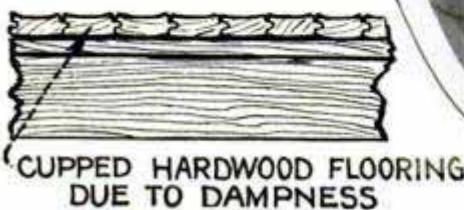
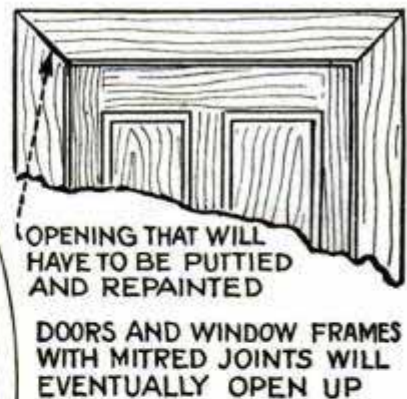
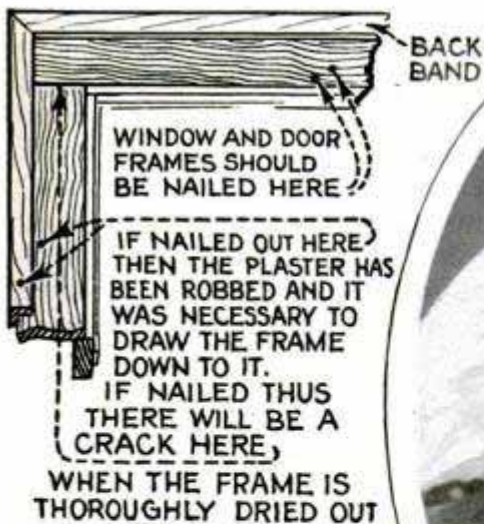

Here Are a Few Things to Look For When Buying a Ready-Built House; They Also Indicate Dangers to Avoid When You Plan to Build a New Home, for All Mean Trouble Later

what a nuisance it is to have the small screw that holds the doorknob come out and leave the knob in your hand. Good hardware will have the screw made of hard material so that the threads will not wear off and the screw drop out. Or, better still, they will be equipped with screw-on knobs which can be adjusted so that they will not rattle.

When you go out with a real-estate salesman, he will, nine times out of ten, take you to the back door, or leave you standing at the front door while he goes to the rear and lets himself in with a pass key. Usually, you will find an expensive burglar-proof lock on the front door while the other outside doors are fitted with ordinary locks which you can open with a piece of wire, or a pass key.

Look around the grounds and the builder's shed. If you see any box nails, don't tarry. They are too slim for house work, bend too easily and do not hold in the wood. But the worst thing about box nails is that the heads are made so thin that if they are driven home, as they should be, the heads break off and they have no holding power.

667

**AIR FAN FOR FURNACE HELPS COOL HOUSE IN SUMMER**

More heat in winter, better ventilation at all times and a supply of cool air in the summer are results claimed for a force fan for the hot-air furnace system. It is provided with louvers which automatically open or close to maintain balanced conditions. Loss of radiant heat in the cellar is reduced, interiors are warmed up more quickly, the manufacturers declare, and when the fan is operated in the summer, it causes cool air to circulate through the house from the basement.

Meat of the musk ox is said to taste much like beef.

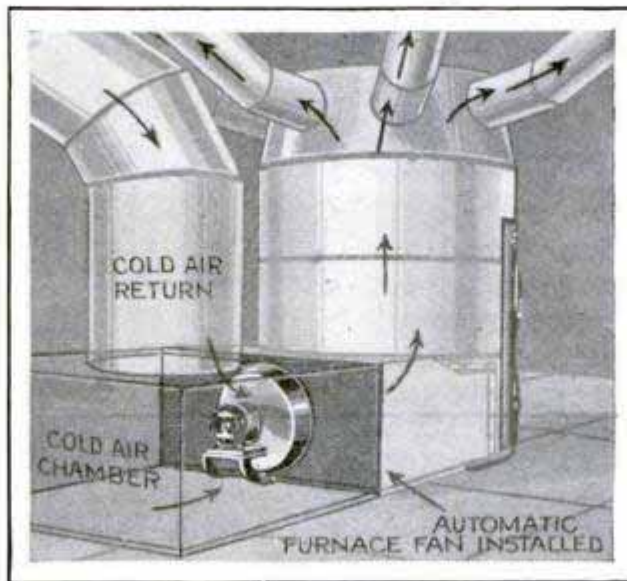

Drawing Illustrating Where Fan Is Installed and How It Circulates Cool Air in Summer

The Warm Air Furnace Co.  
6511 Cedar Ave.



Motion-Picture Card in Position for Changing the Faces, and Two of the Portraits Produced

**FACE IN CARD MOVES AS EDGES ARE PRESSED**

"Moving pictures" produced by squeezing the back of a small cardboard frame furnish a wide range of widely different faces in a new pocket novelty. As the back is shifted from side to side by the pressure of the fingers, a constant procession of faces form and disappear.

**CAN READ FORTY MILES AWAY IN SEARCHLIGHT'S BEAM**

740.

Beams from a 2,000,000,000 - candlepower searchlight, recently completed, are said to be so powerful that, on a clear night, a person at a distance of forty miles from it could read a newspaper by its light. This is regarded as a record in artificial illumination and the light is proclaimed to be the largest in the world.

no data on maker

*W. Adams*  
*720 Myerson Bldg. 7th St. N. W. Wash. D. C.*  
*Apex*  
*old*  
*R. Shure & Co. 200 Madison Franklin*  
*Bank Bros. 543 B Washington, N.W.*

58.  
 648. 305 Broadway

*Answers 10/2/26*  
**LUCK IN THE LABORATORY**  
 719

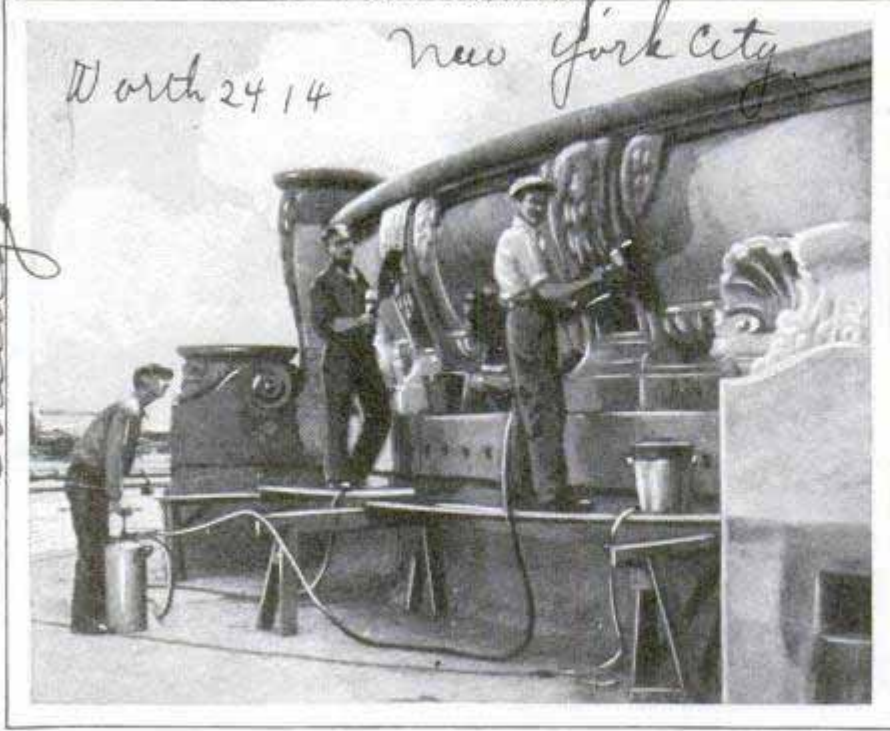

Workmen Coating the Exterior of the Buckingham Memorial Fountain with Waterproof Material to Protect the Marble

An element of luck often surrounds great discoveries. Dr. Alfred Russel Wallace was writing a treatise that developed approximately the same points when Darwin published his "Origin of Species." Marconi is the recognized inventor of wireless, but Sir Oliver Lodge had managed to send wireless messages across a laboratory before Marconi's findings were made known. Sir William Crookes stumbled upon the X-rays while making some photographs, but

**WATERPROOFING STONE ADDS TO ITS DURABILITY**

To prevent damage by water and freezing, the outer surface of the \$650,000 Buckingham memorial fountain in Chicago was treated with a liquid preparation having a paraffin base. A blowtorch was first applied to expand the material so that the liquid would penetrate the open pores to an effective depth. The process is said not to change the color of the marble but rather to intensify the delicate markings, and is intended to last for twenty years. Similar treatment was used on Trinity church, at Broadway and Wall street, in New York.

did not explore them further just then, intending to make a more thorough investigation later. His delay robbed him of a great victory. When he returned to England from Berlin, where he had been studying, the world was ringing with the name of Prof. Roentgen who had made public the discovery of the mysterious rays.

**HANDLE FOR ELECTRIC PLUG REDUCES SHOCK HAZARD**



For electric-cord plugs, an insulated handle simplifies attaching to sockets, prevents accidental contact with live wires and also helps preserve the cord. For connection to lamp sockets with shades it is not necessary to remove the latter.

**SUGAR PREPARED FROM WOOD BY ACID TREATMENT**

Production of sugar from wood on a commercial scale is considered a possibility as a result of a patented process developed by a German professor. Sawdust is treated with a forty-per-cent mixture of hydrochloric acid in special containers, causing the cellulose in the wood to be converted into glucose. It comes out as a grayish powder containing ninety-five per cent sugar and can be used directly for cattle feed and, after being refined, for human consumption.

**JEWELS IN INDUSTRY**

Jewels are usually considered as ornaments, but as bearings for watches and other small instruments they are in great demand, several million being used in the United States alone annually. Many are

*Lawson*  
*Hearborn*  
*Emb. H-14*  
*1251*  
*Prof. Friedrich Bergius*  
*Heidelberg University*  
*66*

*Tool Co. N.Y.*  
*Newark*  
*208 N. Wells Chicago*  
*625 N. 3rd*

*To be manufactured by International Sugar*

mined and cut in this country. Sapphires, for instance, are found in considerable quantities in Montana, while many come from Ceylon and Australia. While the usual color is blue, they are often found in all the hues of the rainbow. The Montana stone is said to be the best for bearings as it is less brittle. When the stones come from the mine, they are sorted, the more valuable ones being reserved for settings in rings and other jewelry. An efficient workman can turn, drill and polish as many as 100 sapphire bearings from small stones in a ten-hour day. In producing jewel bearings for some of the finer instruments considerably more time is required.

**SHOP COUNTER RECORDS  
SMALL-PART OUTPUT**

545

Accurate record of production of small parts is kept by means of a counter connected to a hopper through which the pieces may be passed to packing cases or storage bins. The small chute is tipped up sufficiently, as the articles slide down, to actuate the register. The arrangement eliminates errors and saves the trouble of mental calculations and counting. The unit is easily set up in any part of the shop.

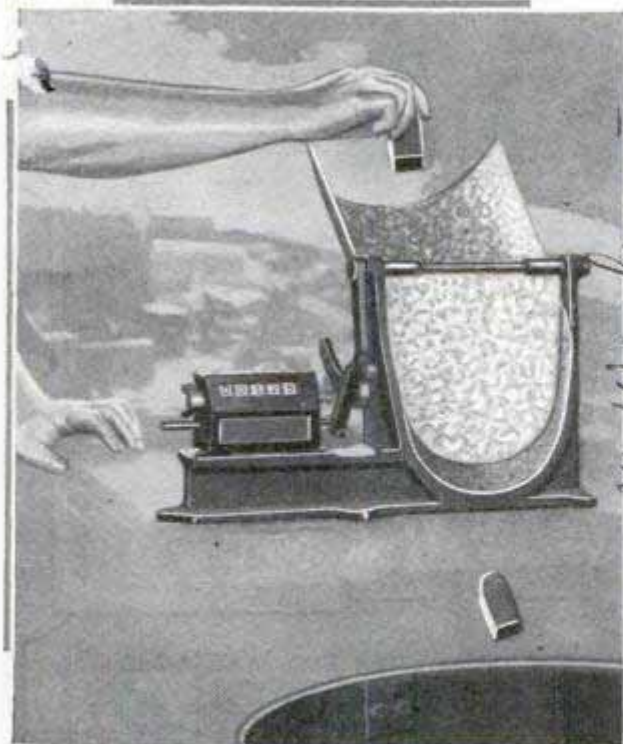

As Pieces Fall through Hopper, the Chute Tips, Registering the Count on Indicator at Left

Durant Mfg Co.  
655 Buffum St.

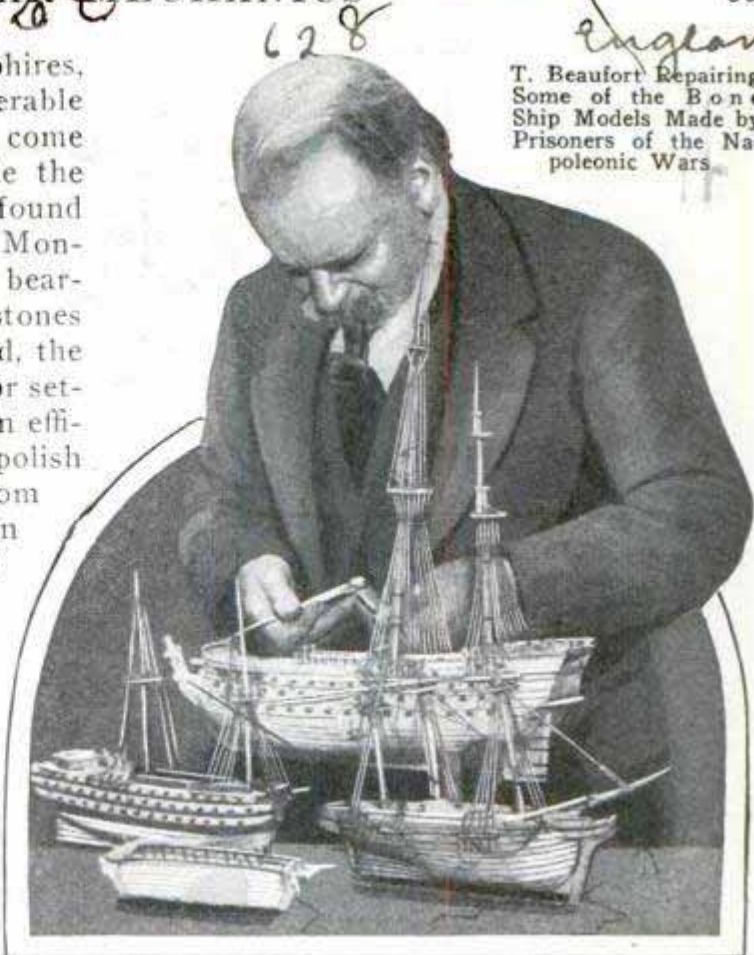

T. Beaufort Repairing Some of the Bone Ship Models Made by Prisoners of the Napoleonic Wars

**SHIP MODELS MADE OF BONES  
ARE VALUED HIGHLY**

Repairing the bone ship models made by prisoners during the Napoleonic wars, is the odd task of an English craftsman. The materials used in the replicas were obtained from the cookhouses. Some of the models are valued at sums ranging from \$1,250 to \$5,000.

**PICTURES OF BRAIN MESSAGES  
715 TAKEN BY WIRELESS**

Photographic records of messages sent to the brain by nerves are taken with an adaptation of radio apparatus by a European scientist. The instrument is fitted with an amplifier by means of which the nerve impulses are magnified and the impressions are translated into codelike dots and dashes on a photographic plate. The outfit is said to be so sensitive that it records the messages sent to the brain of a frog when the creature's skin is pressed or pricked, and it is being used to study the results of nerve stimulations in human beings, as in the case of a nerve fiber at the end of the finger being pricked with a needle.

Mr. E. A. Adrian  
Cambridge University

698

# The LATEST at European

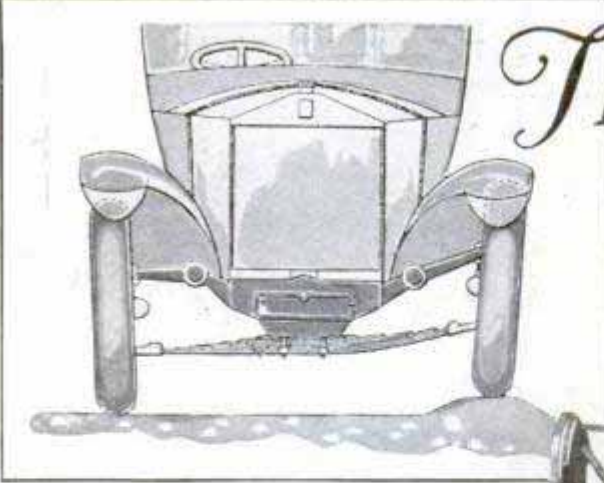

Built without a Front Axle, the Car Above Is Said to Have Unusually Easy Riding Qualities; at Right Is a European Type of Low Body

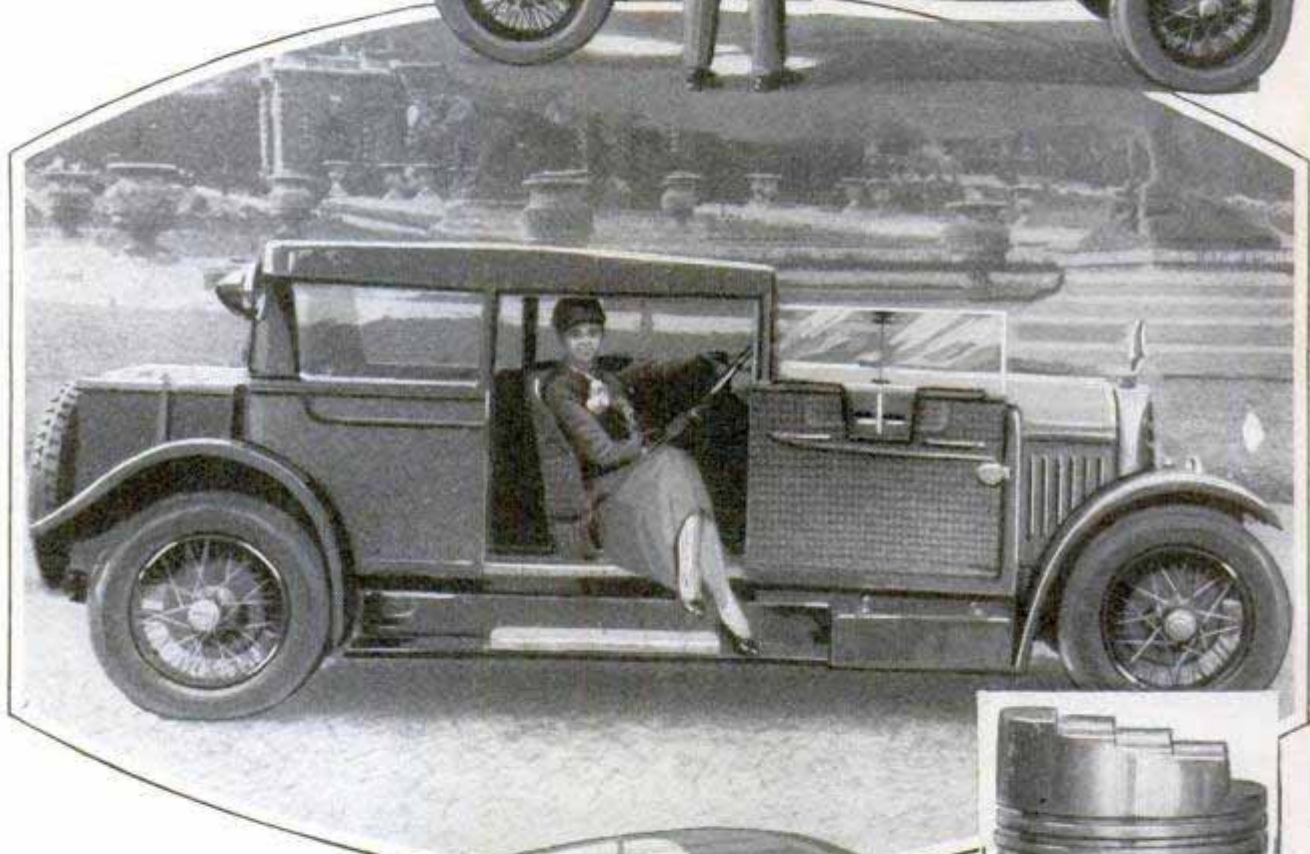
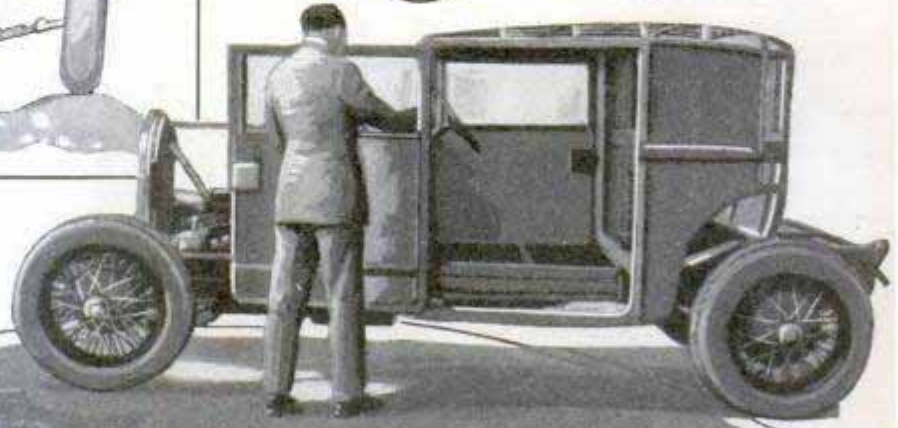

Exceptionally Wide Doors and Extremely Low Bodies Mark Many of the Custom-Built Coaches and Sedans Shown Abroad

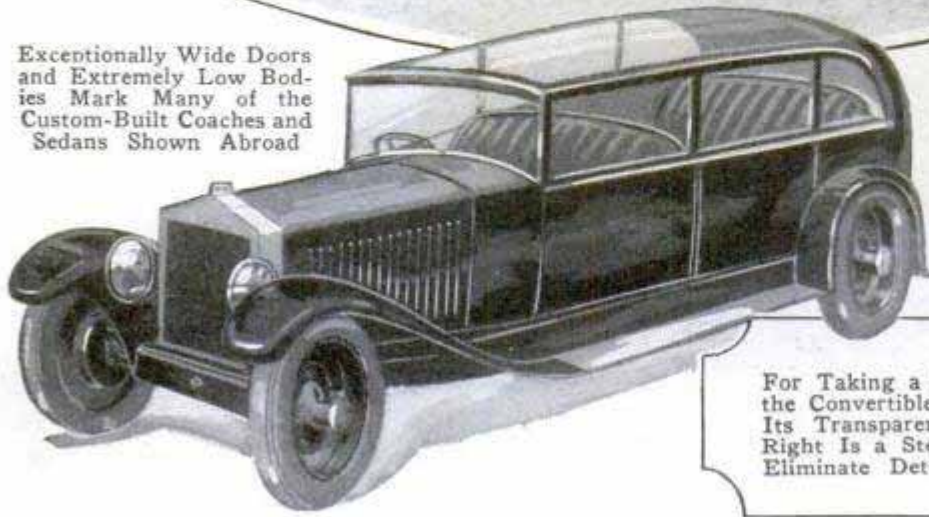

For Taking a Sun Bath or Sight-Seeing, the Convertible Touring Car, Above, with Its Transparent Top, Is Ideal; at the Right Is a Step-Top Piston, Designed to Eliminate Detonation at High Pressures

# THINGS seen Auto Shows

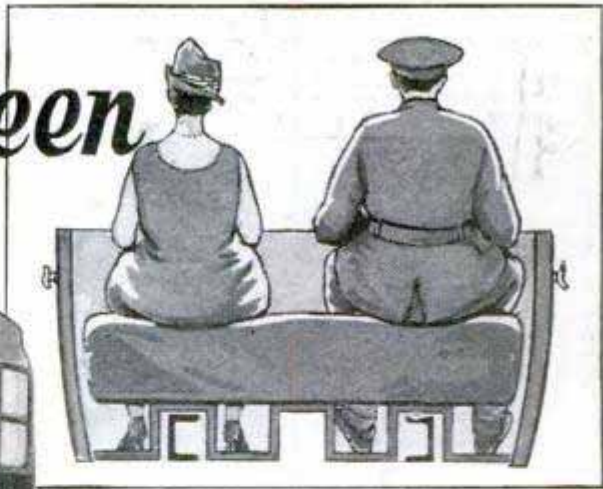

To Lower Floor Levels and Body Heights, Some European Designs Have the Floor below the Frame Members, the Passengers' Feet Resting on Either Side

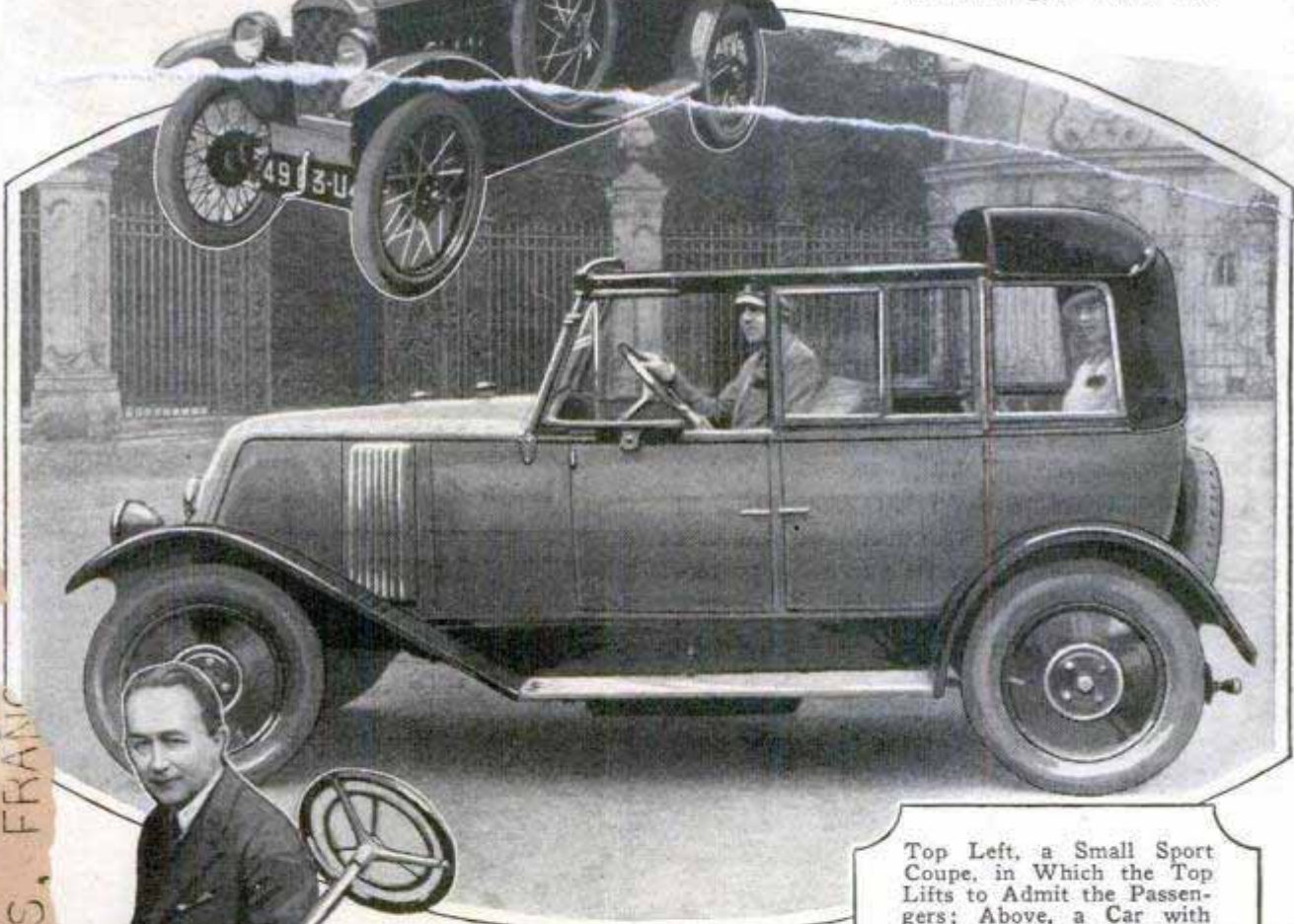
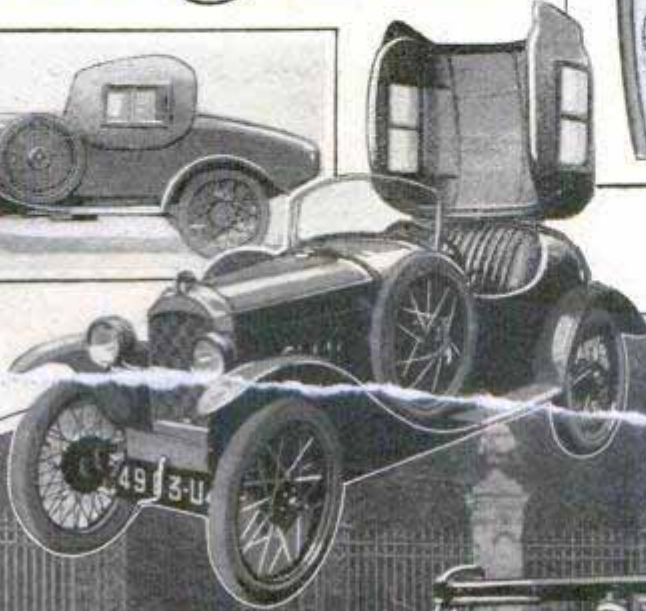
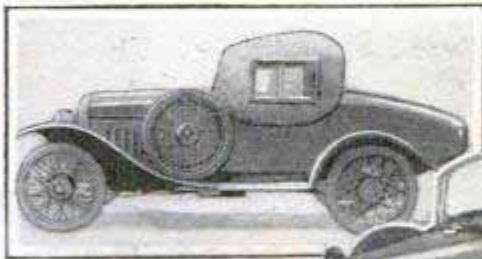

Top Left, a Small Sport Coupe, in Which the Top Lifts to Admit the Passengers; Above, a Car with Transparent Top, Which Rolls Back in the Fixed Section; Left, M. Costantinesco, with His Gearless and Clutchless Engine; the Sketch Below Shows How the Efficiency of Engines Has Increased

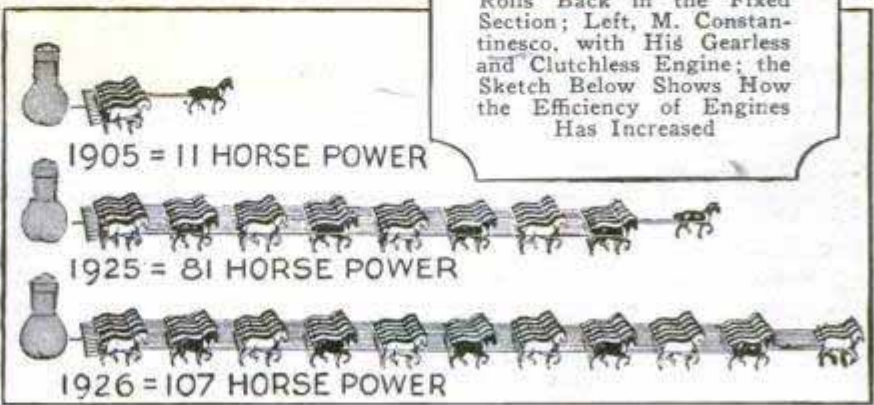

EXHIBITED AT PARIS MOTOR

PARIS, FRANCE

BATHROOM AND KITCHEN TILE  
MADE IN LARGE UNITS



Fitting Slab of the New Tile to a Wall; Its Qualities Permit Using It for Repairs

A new form of tile, specially adapted to refacing old plaster walls in bathrooms and kitchens, as well as for new jobs, is made in large sheets, ruled in tile pattern or with plain surface, which can be quickly installed with a minimum of joints. Although the material is guaranteed to be non-absorbent and unaffected by acids, and is cleaned without alteration in color, texture, or polish, it likewise is easily cut, so that slabs can be fitted to off-size rooms or irregular wall surfaces.

FIND MINERAL THAT EXPLODES  
IN MEXICAN MINE

An explosive mineral and crystals of gypsum the size of a post are among the rarities discovered by Dr. W. F. Foshag of the Smithsonian Institution during an expedition in Chihuahua and other states of northern Mexico. The strange mineral is called "Hillebrandite" and has been found in no other place in the world. Its discovery was marked by a series of explosions in the mine where men were extracting silver ore. They had the sound and effect of charges of dynamite, crack-

ing out great gaps in the tunnel. The action is believed to be due to high pressure, that is, the space in which the mineral was formed was insufficient for it and as soon as the tunnel gave it an outlet, it burst. The same mine also produced Ve-lardenite and Spurrite, other uncommon minerals. All three were found in great quantities. The gypsum was dug out of a cave in a silver and lead mine. The crystals measured up to six feet in length and between eight and ten inches in thickness.

METER TO MEASURE X-RAYS  
PROTECTS PATIENTS

A meter that registers the strength of X-rays being administered to patients, has been devised by a Florida physician. In the past, severe burns have been suffered from exposure to the substance, and the new instrument is expected to eliminate this risk.

*Sigmund Straus*

ARMOR EXPANDS WHEN STRUCK  
BY BULLETS

Lightweight metal prepared for armored-car construction is so resilient that it expands and stops bullets without letting them through. The force of their



Sample of the Metal after Bullet Bombardment; Missiles Dented but Did Not Penetrate Material

flight is taken up in the expansion of the material.

*American Armor Corp.*  
*33 W. 34th*

*Chicago - Santany Construction Co.  
355 Union Park Court - L. R. Bernier*

*Marietta Mfg. Co.,  
16th & Sherman,  
Indianapolis, Ind.*

*Black white every gray blue*

*The 1st of Feb*



*Balloon Co. 12 Rockland Ave.*

MAN-LIFTING KITES USED IN TAKING PHOTOGRAPHS

*Wphams Cur N. O. ...  
Worcester, Boston, Mass*

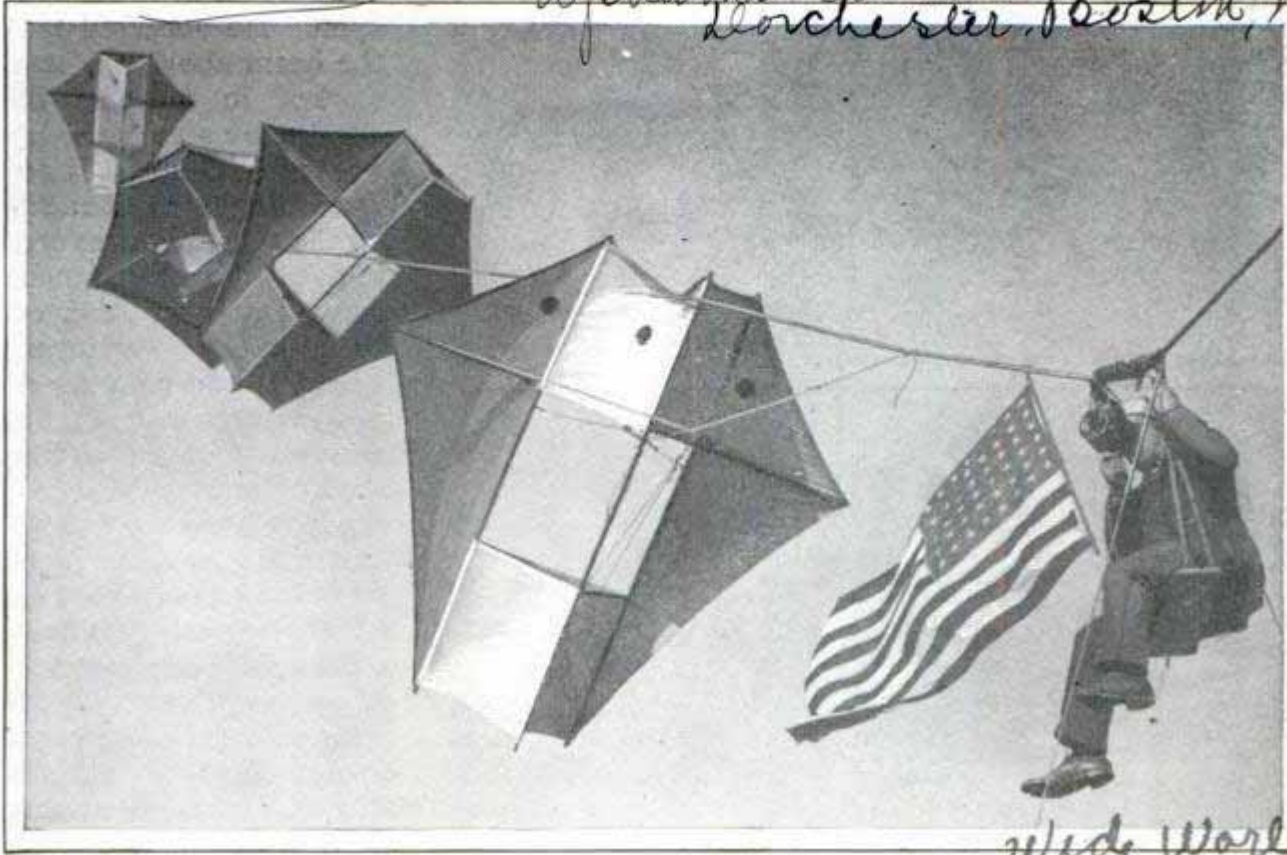

*Wide World*

Proving That Kite Flying Is Not Always an Idle Pastime; Supported by This Chain of Powerful Flyers, Photographer Was Able to Take Movies at Height of 150 Feet

That man-lifting kites can be made to serve a further practical purpose was demonstrated in an eastern city recently when a photographer was raised to an elevation of 150 feet, by a string of them, for taking motion pictures. Kites of this type have been carried on Arctic trips for suspending radio antenna and to aid in making observations.

after the great fire in Rome and, according to the historian Pliny, had room for 250,000, while some writers place its capacity at 485,000.

*Al Moffat for Xendergrams*

STADIUMS OF TODAY RIVAL THOSE OF ANTIQUITY 703

There are ten stadiums in the United States with a seating capacity of more than 50,000 persons each. The famous Greek amphitheater at Olympia, where the Olympian games were held, accommodated only 45,000, and the great Roman Colosseum at one time held 87,000, although some reports state that its original seating capacity was but 45,000. The Yale bowl holds 80,000, more than 140,000 persons were seated in the stadium at the Sesqui-centennial exposition in Philadelphia, and the stadium on Soldiers' field, Chicago, will accommodate 100,000. The ponderous wooden Circus Maximus was rebuilt

MAGNIFIER ON HAND STRAP LEAVES FINGERS FREE 652

To simplify the tasks of dentists, jewelers and others who frequently do delicate work, a magnifying glass supported on a band strapped about the hand, permits the full use of all fingers. It is sufficiently wide to help illuminate the object under examination as well as magnify it, and correct focus is easily obtained by moving the glass up or down on a sliding rod.



*Dentist - Trauman  
118 26th St  
New York*

Write our Bureau of Information if you wish to know who makes or sells any article described in this magazine. Send no postage; the service is free.

*N.Y. Times  
10/3/26*

*Cont. Max A. R. Brunner  
of manner 25, Alrededy  
of 25, Germany*

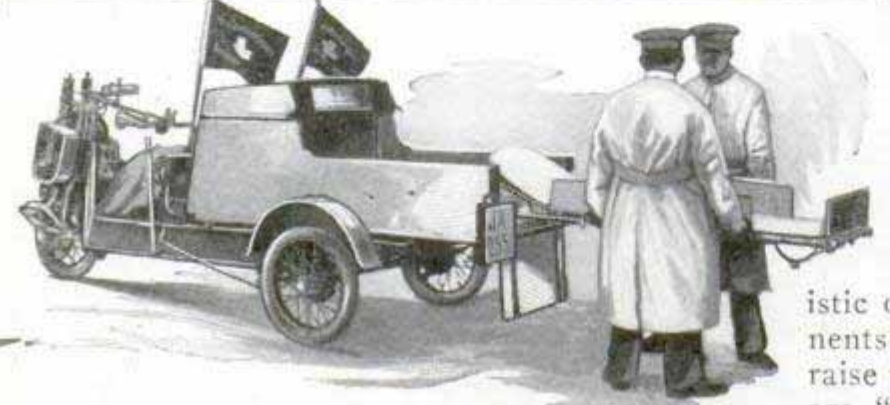
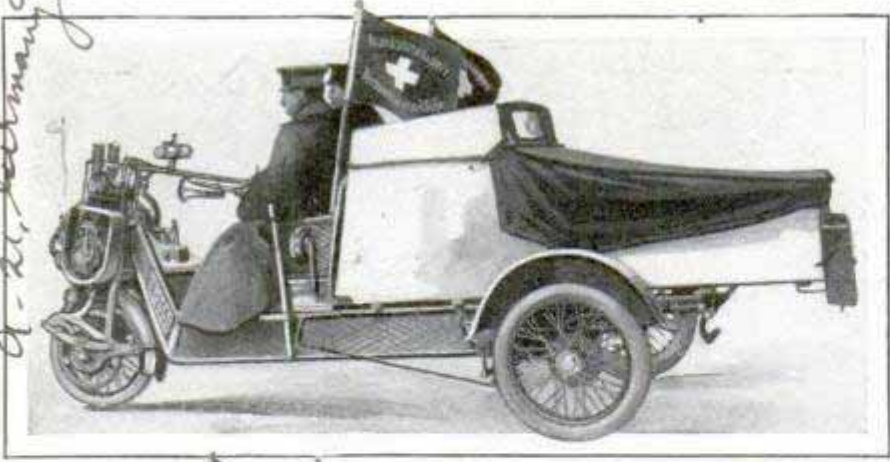

Tricycle Ambulance Covered and Attendants Removing Sliding Stretcher; Vehicle Is Intended for Use in Crowded Streets

**TRICYCLE AUTO AS AMBULANCE GIVES QUICK SERVICE**

High speed and ease of operation in crowded streets are advantages of a tricycle motor ambulance lately introduced in Berlin. There is a cot for one person at the rear. The vehicle has a front-wheel drive and is especially useful in minor accidents that do not require larger units.

**BOY IMPROVED STEAM ENGINE MODEL EXHIBIT SHOWS**

One of the most interesting exhibits among the patent models in Washington is a collection of miniature steam engines. Successive steps in the development of the giant of modern industry are illustrated in models of the engines made by Hero of Alexandria, by Newcomen and by Watt. There is also a replica of the early beam type upon which boys were employed to operate the cocks that turned the steam on and off. One of these boys, Humphrey Potter, instead of settling down like a

machine to the monotonous work, kept his eyes open. He observed that the beam above his head worked in unison with the cocks when he opened and closed them. Accordingly, he connected the two and after seeing that the arrangement worked properly, ran off to play. His employers began to notice a much greater regularity in the movement of the engine than before. This led to the discovery of the secret and the consequent adoption of the device on other engines. This "afterthought" is characteristic

of many inventions. Opponents of the patent system often raise the point that all inventions are "in the air," that the same suggestion sooner or later will come to a great many different persons and, hence, that the patent is simply a reward to the one who happens to arrive first.

**ROLLER RUN OVER HIDE TELLS EXACT SIZE OF CATTLE**

With a view to determining the amount of animal heat given off by cows, horses, sheep and other stock, in connection with



Measuring Cow with the Roller "Yardstick"

*Cont. Edwin Carise  
The Z...*

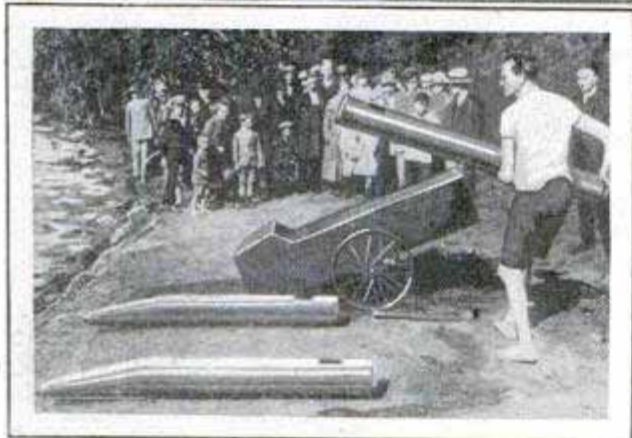
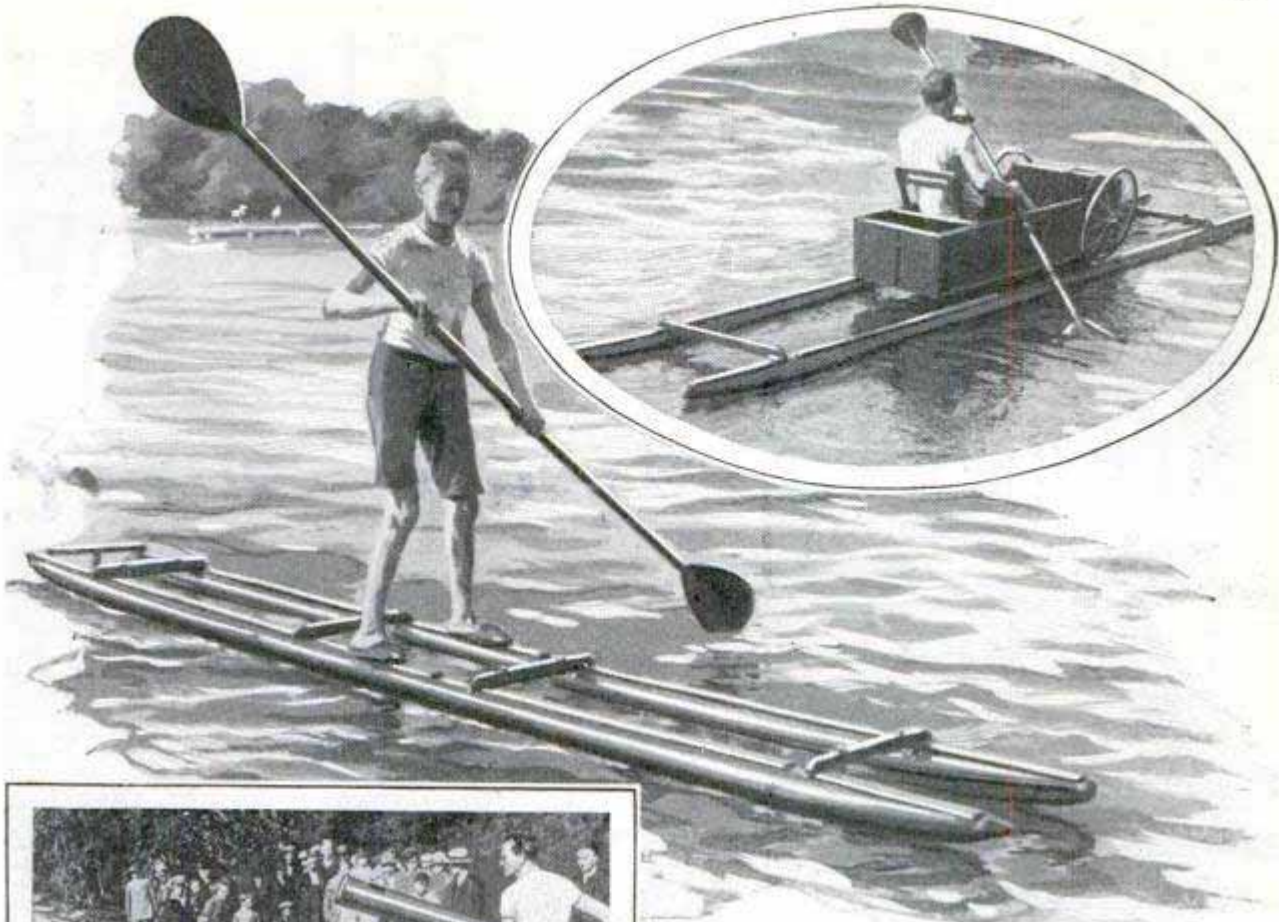

Stovepipe Boat as Single-Seater, a Pontoon, and Oarsman Assembling the Craft

**BOAT MADE FROM STOVEPIPE  
FOR WATER SPORTS**

Lengths of stovepipe formed into pontoons and made rigid by crosspieces, have been fashioned into a gliding boat for water sports by a German enthusiast. The craft is collapsible and can be hauled about in a box, which is fitted with wheels for land travel and adjusted as a seat when the boat is in use. Only a few minutes are required to take the outfit apart or assemble it.

649

**COLOR-MAKING NAVAL SHELLS**

Specially prepared dyes in containers fitted to the nose of shells fired from naval guns and scattered by means of a small detonating fuse have been adopted by ordnance experts to color the water the missiles throw up and thus enable the marksmen on different ships to determine which shots register. The coloring is distinguishable at from fourteen to twenty miles, and dyes the entire mass of water. Different colors are given to the participating ships.

studies of better stabling and feeding methods, investigators at the university of Missouri have been using an ingenious "yardstick" to measure the size of the animals. It is a brass roller of known area and has a chalk marker and a registering dial which counts the revolutions as it is drawn over the beast being measured. The chalk marks indicate the correct position for the instrument at each lining. The accuracy of the gauge is indicated by results obtained with a Holstein cow. The roller showed that it measured 42,635 square centimeters in area. After slaughtering, the hide was found to be 42,883 square centimeters.

*Columbus, Mo*

Names and addresses of manufacturers of articles described in this magazine will be furnished free by our Bureau of Information.

*Com. R. P. Esailer, Jr.  
Whitney*

1906

V. M. Argonne

# Contact with the Enemy



Signalmen Wigwag Code Messages. While Companions, with Glasses and Blanks, Record the Answers

**I**N the soft summer night, the United States fleet, accompanied by its aircraft carriers, was lurching through a western Pacific sea on the eve of a war game with the mythical empire of Karmania. Each ship was in possession of orders for the morning attack. It was recognized that the fleet was more than able to meet the enemy on the high seas, but also that it could not suffer a defeat, for the fuel supply would be so reduced by maneuvering and smoke making that, if defeated, it could never survive to safely reach the land.

Consequently, Admiral Seifert reasoned that the enemy, sure of victory or at least safety, would permit the Americans to

By G. K. SPENCER, 4225  
*dangerous line. San Diego*

attack his land defenses in order to still more deplete the fuel reserves, so that further action would be an impossibility for them, with the Karmanian fleet held at a home base and only its cruiser squadrons patrolling the seas. The admiral had decided to fight out the action instead of retreating to the Hawaii base.

The rain clouds passed, and with the coming of sunrise, an intense activity began. Air squadrons were now droning over the fleet. Knowing that the enemy had been informed of the approach of the Americans, no attempt was made at radio secrecy, for there was but one position on the island-base coast upon which a landing could be made. A string of brilliantly colored bunting suddenly sprang to the fore trucks of the "Colorado." The signal was:

"U. S. S. 'Holland' stand in to fleet center, with one squadron of destroyers escort, and stand by to launch tanks."

The "Holland," a submarine tender, stood in from her cruising station and began to launch overboard a great number of curiously box-shaped affairs. These were secured to the after decks of submarines. As rapidly as one submarine received its load, another cautiously came in to port or starboard.

The sea, after the night of rain, had cleared and, fortunately, was calm enough to permit sending the tanks overboard. The "Holland" aided this calm by pumping liberal quantities of oil on the water to quiet the slight choppiness which still prevailed.

When the work had been all but completed with the fleet still well out of sight of the enemy base, and with more than forty submarines running abreast on the

7706

Black Smoke Begins to Pour from the Destroyers as the Order Comes to Lay Down a Covering Screen for the Advancing Battle Fleet; Below, Gunners Serving the Bow Rifle of a Destroyer Wear Their Masks for Protection against Enemy Gas Shells When They Prepare to Attack Their Submarines

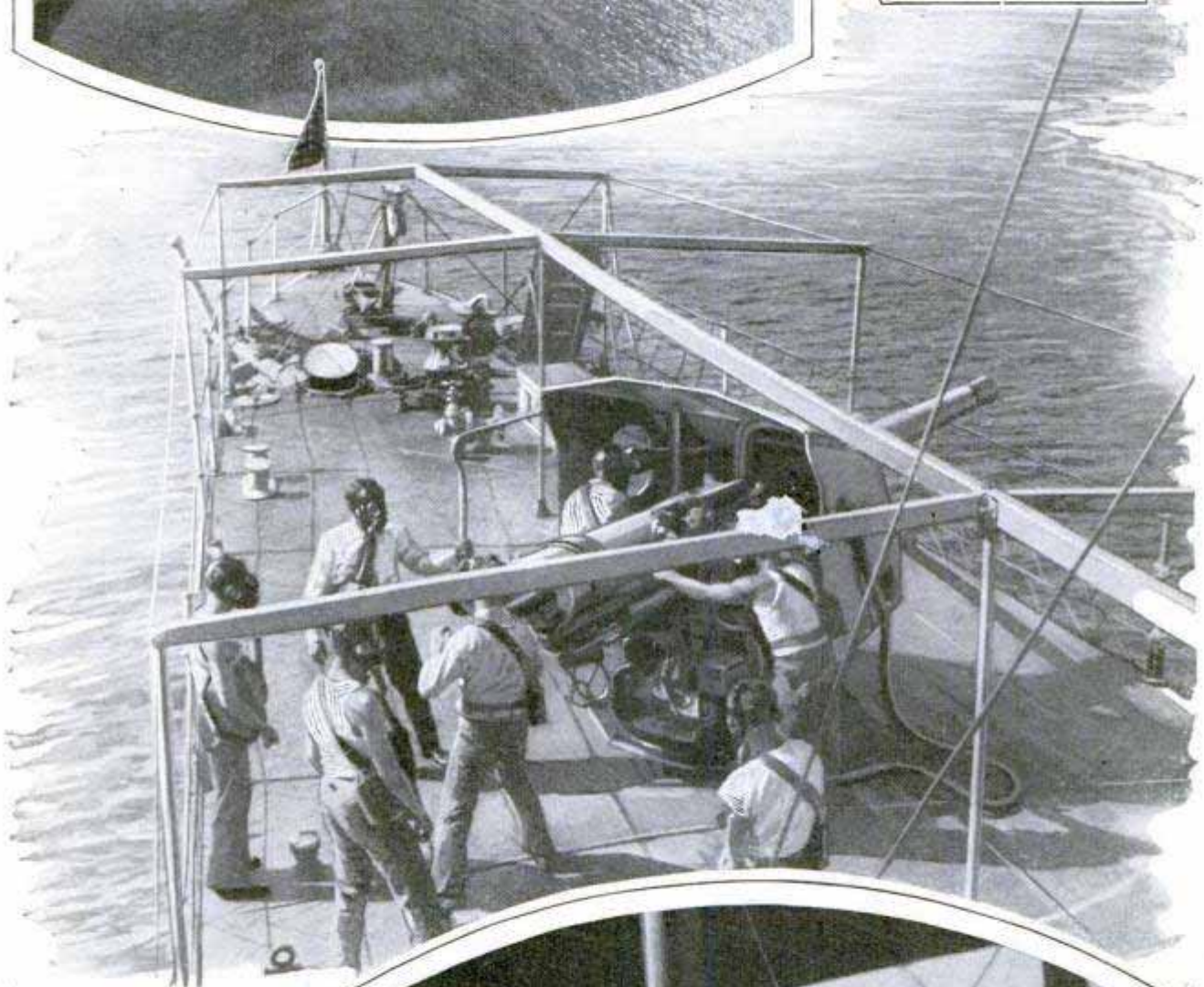
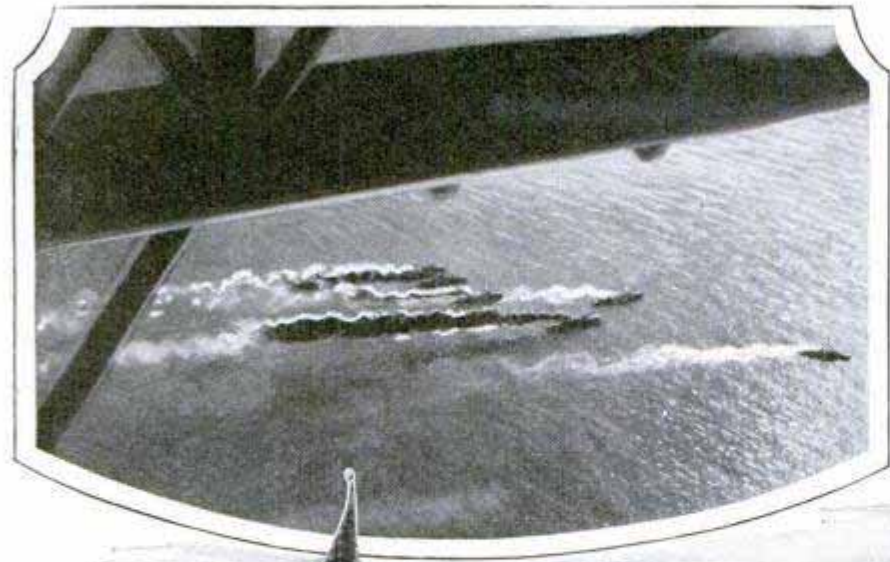

Closely Spaced, but Falling Short, the Enemy Shells Send Huge Geysers of Water Spurting into the Air; from an Aviator's Viewpoint the Battle Scene Is Spread Out Far over a Placid Sea, with Every Ship in View and the Course of Each Shell Made Plain; Even the Submarines Slipping Along Far below the Surface Can Be Seen from the Airplanes

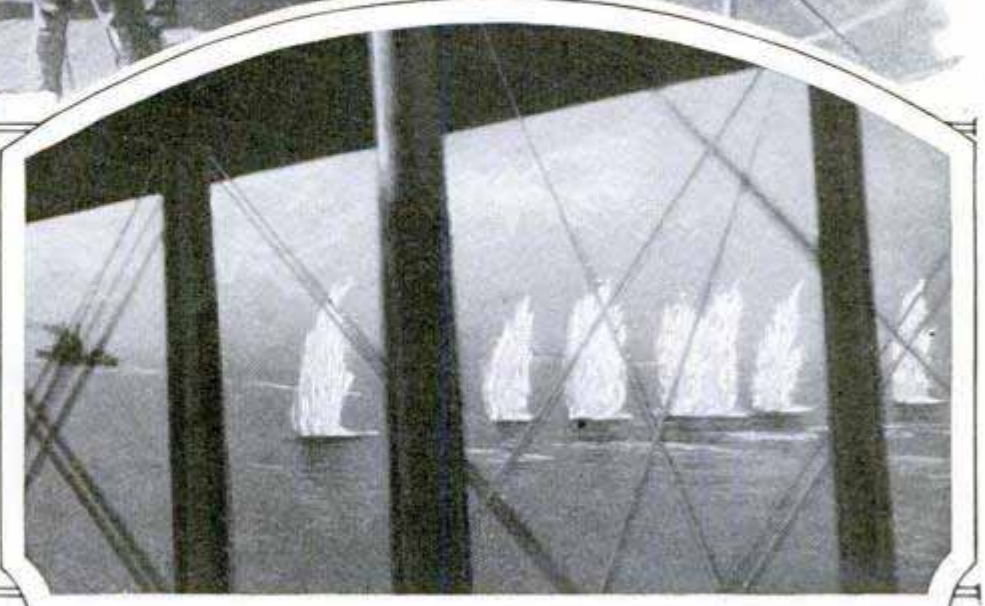

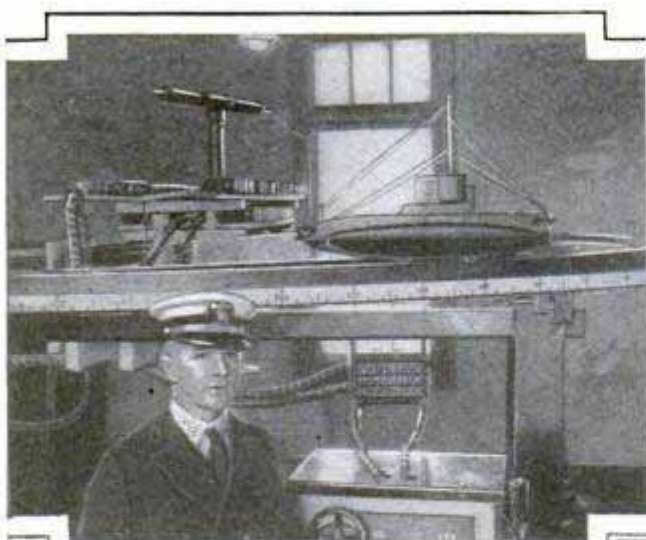

Above Is the Sound Apparatus Used to Teach Sailors How to Locate the Enemy's Position by His Propeller Noises; at Right Submarines Are Filling Their Tanks, and Below Are the Sound Detectors on Duty

surface of the sea, a flight of aircraft was observed far on the starboard bow. Immediately, it was pursued by the American planes, several of which dropped smoke pots and threw streamers of chemical fog between the enemy and the submarines.

Explosions also disturbed the surface of the sea, but the reports, received through submarine microphones by the fleet flagship, declared that the enemy was steadily retiring.

The American submarines never came to the surface, preferring to fight submerged and microphone their reports to the commanding admiral. Their duty was simply to prevent any approach by enemy submarine forces, while the aircraft performed a similar duty in the air.

At length, every submarine ordered to assist in the surface attack had been loaded with its tank.

"Comdesrons [commander destroyer squadrons] detach two squadrons to es-

cort advance of submarines," signaled the flagship.

"Comsubrons [commander submarine squadrons] detach two squadrons to escort submerged advance of submarines surface."

"Cruiser and battleship squadrons follow flagship in initial stages and await further orders stop begin firing as flagship hoists three-quarter speed cone."

"Turn pennant nine."

"Execute."

All ships made an abrupt turn to port of ninety degrees, and continued on the course. The same identical turn was made under water by the submarines and in the air by the aircraft.

Majestically, through the smoke still hanging low on the water's surface, the line of submarines, each with a "match-box" on its back, proceeded dead ahead.

"Enemy contact!" sang out a radioman. "Enemy contact!" a

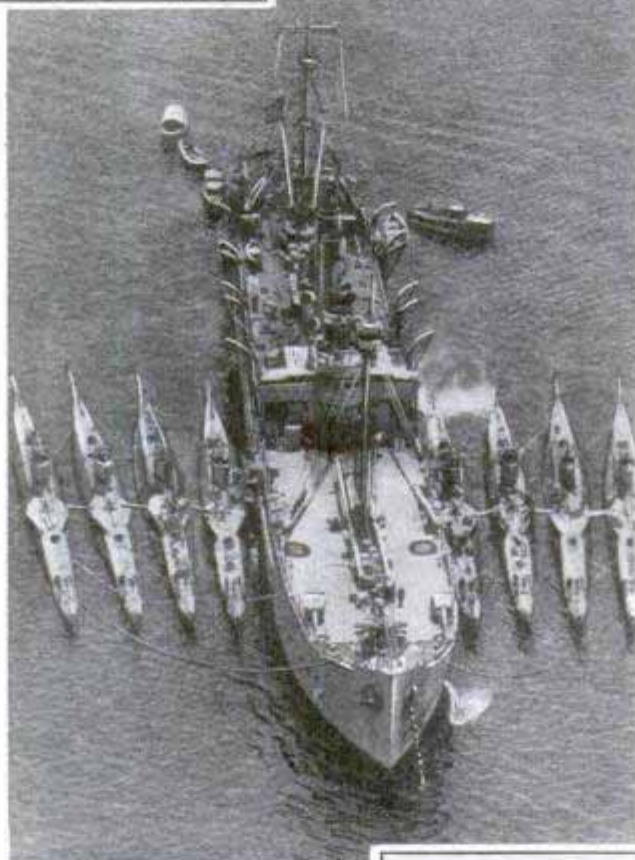

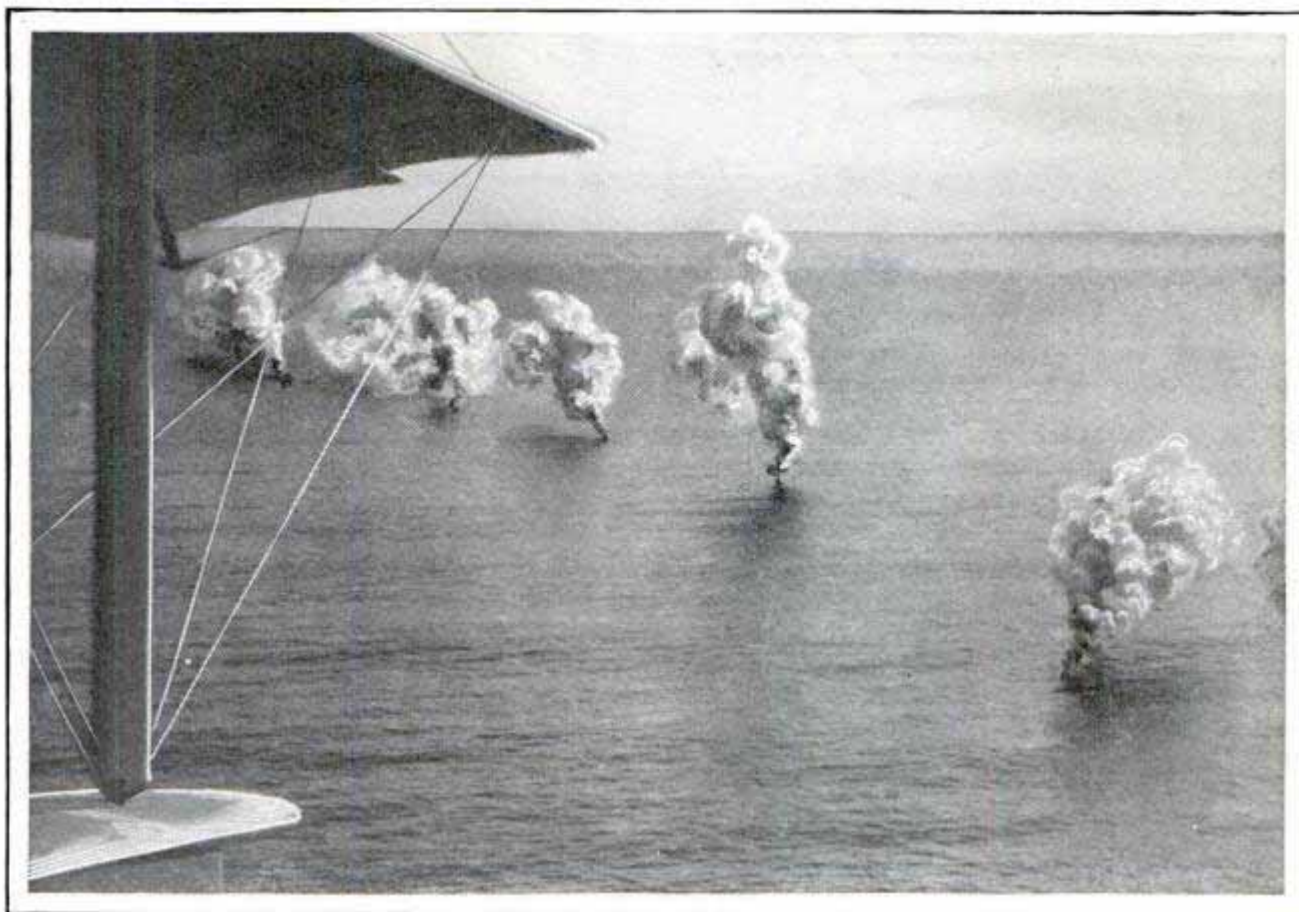

The Aerial Smoke Screen Goes into Action; the Flyers Can Drop Their Smoke Bombs Far Ahead of the Fleet and Spread a Protective Veil to Mask the Advance of the Surface Craft

quartermaster echoed to his bridge officer, who reported to the admiral. All ships began zigzagging, to throw off enemy gunners, and started firing. Long streamers of smoke fell about the fleet. Meanwhile, the American air forces were keeping the enemy aircraft away, while reporting the targets—"spotting."

The tank-loaded submarines, running on the surface with Diesel engines working at full speed, advanced steadily toward the distant coast, keeping well within the protecting smoke screen laid down by destroyers and aircraft. When there was barely enough water under the keels to permit them to submerge slightly, the squadron adjusted diving vanes and slipped beneath the sea. The ungainly tanks resting on their decks floated off and, on the instant, started their engines. With hardly a pause, the group of steel pillboxes, each carrying its armament of one-pounders and machine guns, proceeded to the distant beach.

A hundred yards off shore, the rapidly shelving sands came up and met them. Marine propellers ceased turning, caterpillar treads were thrown into gear, and

the ungainly steel forts lumbered up and out of the water, to sweep the waiting forces with a devastating fire. A new element in maritime warfare had been born—the amphibious tank.

Under cover of the attack, which swept up to the hidden gun pits inland, the battle fleet moved into position and began throwing shells high overhead, to wipe out the gun positions in the rear. Troop ships swung into place and dropped big motorboats. Landing parties piled aboard and followed the course of the tanks to the beach.

Led by the tanks ashore, the marine regiments, supported by their field guns, quickly consolidated positions and prepared a trench line to hold the beach. The objective had been taken and the war-game maneuvers were ended.

## NEW SUBSTITUTE FOR COCAINE

Synthetic cocaine that can be used as a local anæsthetic is reported from Germany. It is said to be a by-product from some of the intermediate substances used in the manufacture of artificial rubber.

### 681 DARK ROOM ON MOTORCYCLE SPEEDS PHOTOGRAPHY

Pictures are developed, while the cameramen return to their office from the



Inside the Motorcycle Dark Room, and Photographer Taking a Picture from His Elevated Platform; He Descends in Car to Develop It

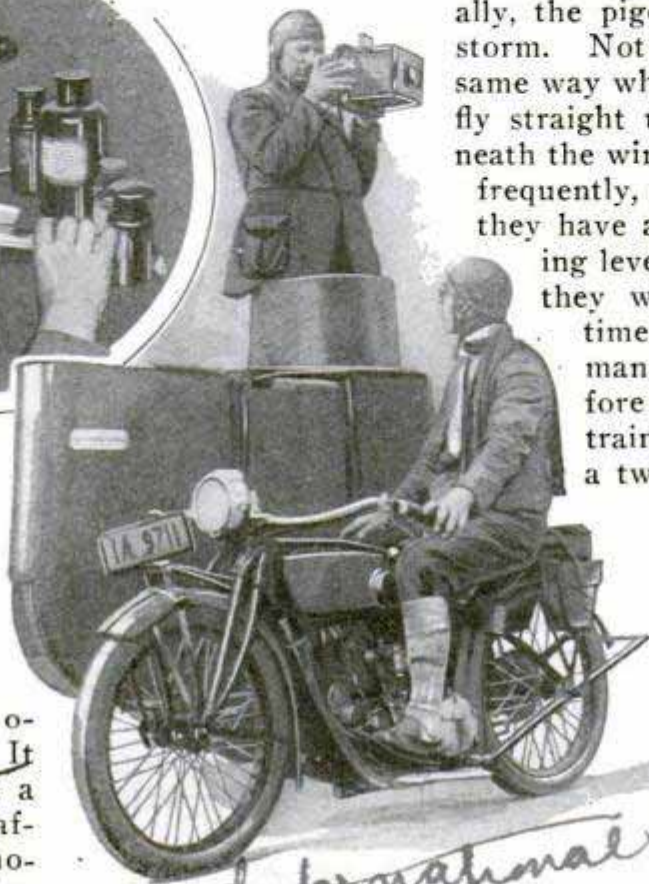

scene, in a motorcycle side-car studio introduced in Berlin. It is equipped with a conning tower, affording the photographer an elevated position for making exposures, and inside is a dark room with the necessary chemicals and accessories for developing the plates.

### SCHOOL FOR HOMING PIGEONS TRAINS THEM FOR WAR

Over 300 pigeons are enrolled in Uncle Sam's training school on the outskirts of Washington, D. C., where the birds are taught, with the aid of airplanes, how to develop speed and endurance, that they may be useful in carrying messages great distances. The course is carefully planned and the "pupils" are graded according to experience. The beginners in the two-year training period are known as "youngsters," and second-year birds are called "yearlings," while, after that, they boast the dignity of "old birds." The goal set for the pigeons is a speed of more than a mile a minute and an endurance of 500

miles. With a trainer, they are taken high in an airplane, tossed clear of the propeller and allowed to work their way back to the home roost. Some are dropped from an altitude of 10,000 feet. If a strong head wind is blowing, they will try to rise above it or will drop nearer the earth. Generally, the pigeon wins out against the storm. Not all the birds act in the same way when tossed out. Some will fly straight up, others will dodge beneath the wings of the plane and, more frequently, they will drop down until they have attained their favorite flying level of about 500 feet. Then they will circle about several times, and, in some mysterious manner, gain their bearings before starting homeward. The training progresses gradually, a two-mile schedule being the first task. This is pushed up to four miles and finally the pilot takes the candidate twenty-five miles from home with the expectation that the bird will arrive not long after his own return. After this accomplishment, the pigeon is advanced by stages to flights of fifty and seventy-five miles

and longer distances until it has completed a trip of 500 miles at the speed desired. The birds are assigned to various lofts according to their accomplishments. About 150 have flown the full 500 miles between daybreak and nightfall, the only period of the day when the pigeons will fly. Several have made the distance five and six times. The training school is conducted under the supervision of Chief Quartermaster Henry Kubec, U. S. N. Having watched the birds very closely, he says that, as a general rule, the pigeons return home by the easiest route.

### WATER CONTROLS HARDNESS OF CONCRETE 719.

Putting an extra gallon of water into a one-bag batch of concrete is about equivalent to taking out of the mixture fifteen pounds of cement and throwing it away, according to an associate of the American

Anacostia, D.C. 748

Minneapolis Tribune 10/24/26

Cloyd M. Chapman



society for testing materials. By regulating the amount of water, a more water-tight concrete can be prepared than if too much or too little water is used. Wearing qualities of the concrete are also largely dependent upon the quantity of water in the mixture. This refutes the common idea that the strength of concrete depends chiefly upon the amount of cement it contains. On the contrary, the cheapest ingredient is the one that controls the strength of the material. A sloppy mixture will be only about half as strong as one with one-fourth less water and the same amount of solids.

**MAGNET CHECKERS HOLD TO BOARD**

Accidental shaking of the checkerboard often seriously disturbs a game, but this is not likely to occur with a magnetized set. The pieces have a curved bit of metal on the underside and cling tightly to the board, which is of thin steel. When removed, they are placed on a square of metal in the box.

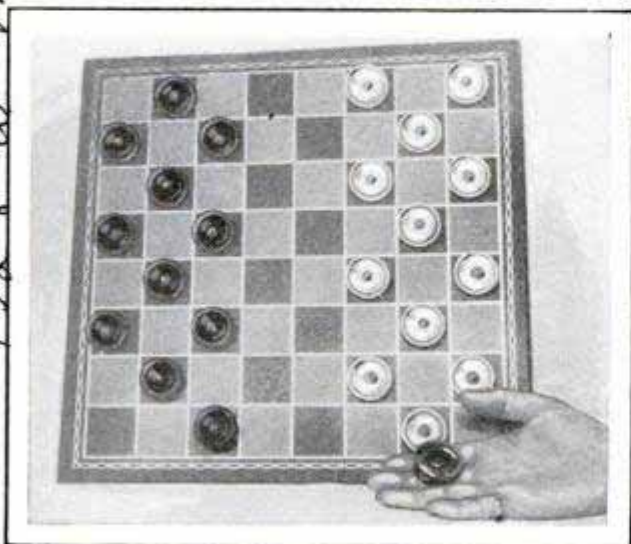

Magnetized Checkers Stick to Steel Board

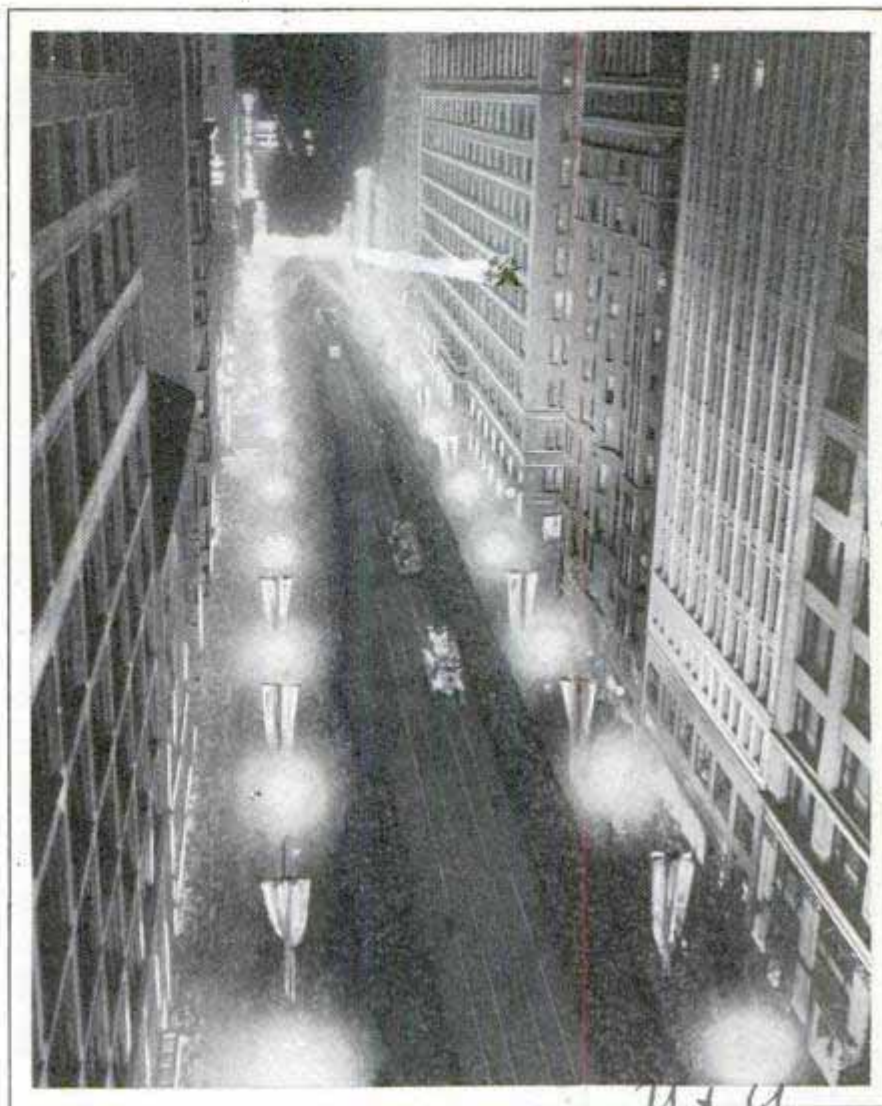

Chicago's State Street Gleaming with New Lights; One of the Old Lamps Is Visible near Second Flagpole at Right

**NEWEST STREET LIGHTS TURN NIGHT INTO DAY**

Special lamps and a type of support post in two sections, that can be taken apart to simplify inspection of the cables within, are features of the new lighting system in Chicago's State street, now one of the most brilliantly illuminated thoroughfares in the world. The globes stand erect instead of being suspended, a position intended to reduce burn-outs to a minimum. Each is sixteen and one-half inches long and six and one-half inches wide, said to be the largest ever used for street lighting. The standards also support the trolley-car wires, eliminating unsightly poles. The system consists of 140 lamps each of 2,000 watts, and cost about \$100,000.

☐ To every 220 persons in Canada there is one mile of railway.

1000  
 Special Supply Co.  
 132 & W. Monroe  
 Chicago

Convex Sign Co.  
 900 W. Lake  
 Chicago

designed and made by  
Lieut. J. M. Young  
Washington, D.C.  
605

not available to public

Miss Ethel Bartholomew  
Rt. 2, A. Hesperides,  
Lake Wales, Fla.

**LORGNETTES FOR ARMY MEN  
AID IN READING MAPS**



Raising His "Lorgnette," the Army Officer Obtains a Stereoscopic View of Map

To enable army engineer officers to read aerial and other maps more quickly, a stereoscopic instrument resembling a lorgnette has been introduced. It magnifies and reproduces perspectives, is compact and flat and easily carried in the kit.

**TINY PLANTS FINER THAN DUST  
SUPPORT SEA LIFE**

Too small to be seen by the unaided eye, the diatoms, minute plants of the sea, are regarded as vitally important even to man, for they constitute the basic food supply of many forms of life. The stomach of a young fish revealed the interdependence of the sea's creatures, a curious cycle that leads back to these tiny diatoms. The organ was filled with small herring, these, in turn, were gorged with water fleas and the fleas were full of diatoms. During the past ten years, Dr. Albert Mann, of the National Museum, has been study-

ing these small plants, the grass of the sea, and has prepared an interesting collection of them for the Smithsonian Institution. About 8,000 different kinds already are known. They assume marvelous geometric patterns and have the faculty of transforming within themselves inorganic matter into food. Occasionally, as many as 35,000 will be found in a quart of water. In handling the specimens, Dr. Mann has developed a glass-needle attachment to a microscope so that he can isolate single specimens on separate slides. Fossilized diatoms have been discovered in various parts of the globe where they were deposited on old sea floors. In California, such a deposit is twelve miles square and 1,400 feet deep. The earth is mined and used as a polish and combined with nitroglycerine to make dynamite. It is also serviceable as a filter.

**MODEL HOUSES OF BLUEPRINTS  
AID HOME BUILDER**

Blueprints mean little to the untrained layman considering a new home and, to make them more expressive, a young Minnesota woman has devised a way of fashioning models from the prints so that all the dimensions represented will be clearly visualized. The models are made in two types, one closed to show the exterior and the other arranged to be opened so that the floor plans may be revealed. The roof of this kind is lifted off, like a cover from a box, and, if desired, model

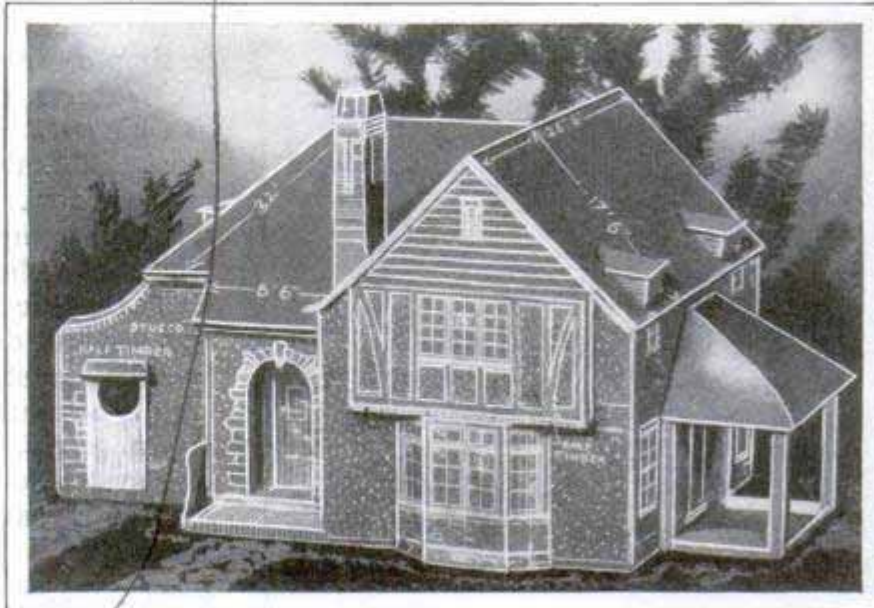

Blueprints Fitted into Three-Dimension Model of House

Scientific News Service  
Mechanical Institution  
659

Print Models Co.  
1334 La Salle

Miss Ethel Bartholomew  
Massachusetts

*Caution Service  
The Harragut  
Washington, etc.*

*Photomaton*

furniture may be set about to afford an accurate picture of the rooms as they will look when finished.

**RAILWAY TRACKS THAT TRAVEL**

An interesting fact of railway operation is the "creeping" of rails. One of the most remarkable instances of this is found on a line in New Jersey where the road runs over three miles of wet, spongy meadows. When a train passed the whole track sank under it. The effect was the same as if the train were going up-grade, and this caused it to push not only the rails, but the entire track before it. About sixty per cent of the traffic was eastward. It crept as much as thirteen feet in a single week. By means of heavier rails and longer ties, the movement of the track almost has been stopped.

**TRIGGER GAUGE FOR GAS TANKS REDUCES FIRE HAZARD**

Contents of gasoline or other tanks is quickly indicated to within one gallon by means of a triangular floating rod gauge that rests inside the tank when not wanted and springs into view by pressing a trigger release. The float buoys it up and the reading is taken from the graduations on the rod. It is easy to install and reduces fire hazard, as only the cap to the tank need be disturbed to take a measurement.

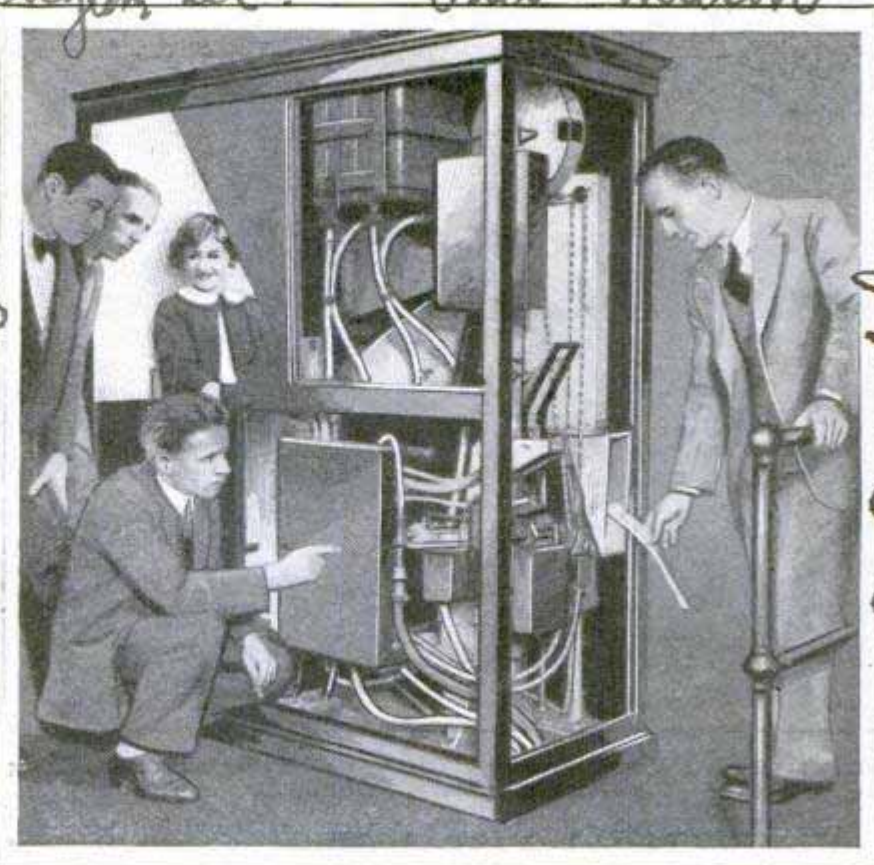
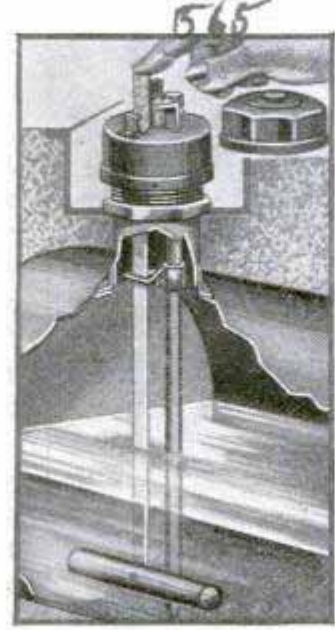

© Herbert Photos  
Panels Removed from Slot-Machine Camera to Expose Interior; Coin Aperture at Side and Film Delivery at Right

**SLOT-MACHINE CAMERA TAKES EIGHT PICTURES AT ONCE**

Eight photographs at one sitting, in the same or different poses, are taken for a quarter by a coin-in-the-slot camera recently introduced. The exposures are made directly on sensitized paper and a positive picture produced by a special chemical process. All eight are made and finished for delivery in as many minutes, and are said to be so clear that enlargements can be taken from them. A feature of the outfit is the temperature-control apparatus regulated by a thermostat for keeping the developing fluids at a nearly even point for efficient results. Since so many different poses can be taken in so short a time at such slight expense, it has been suggested that the camera may be of aid in making the identification photographs of criminals, and of messengers and other employes of banks and brokerage houses. Thousands of persons patronized the machine during the first five days it was exhibited on Broadway in New York. The majority of the patrons, it was observed, were men—a rather unexpected development.

*new girl  
M. Joseph  
Anatol  
Photomaton, Inc. 1659 Broadway  
Chicago agent: J. M. Hutton  
120 W. 20th St. New York*

*Automatic Gauge Truck Corp  
308 W. 20th St. New York*

546

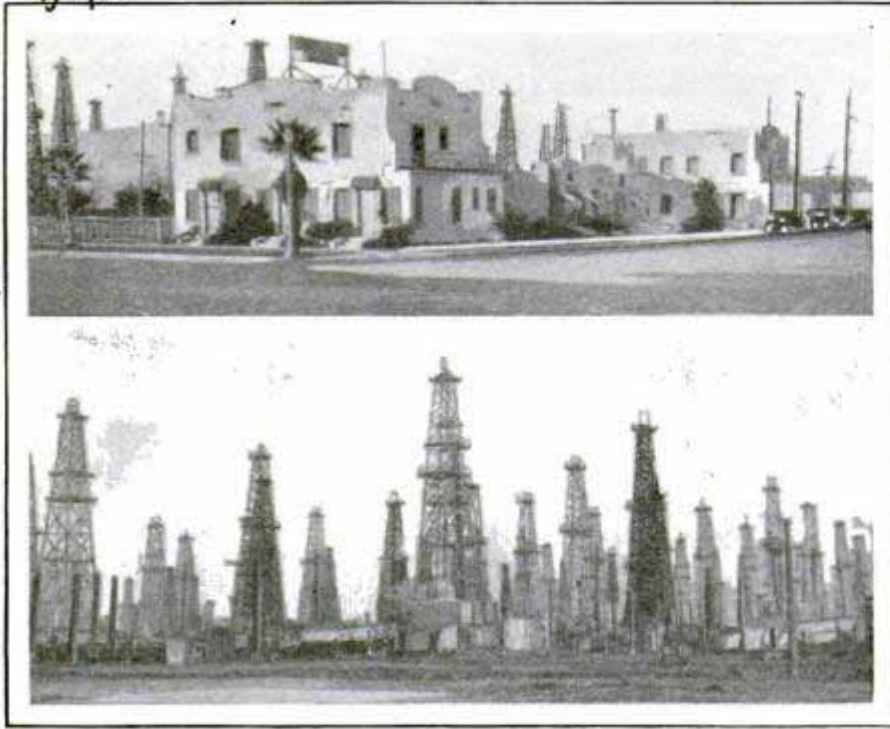

Glimpses of the Derrick "Army" Advancing on Huntington Beach, Calif.; A New Town Site Is Being Sought

**OIL WELLS TO OUST HOMES AND MOVE TOWN**

*Orange County*

Encroaching oil well derricks at Huntington Beach, Calif., already are within two blocks of the center of the town, and since most of the residents favor drilling in all sections of the community, a committee has been appointed to seek a new location for stores and houses. The rigs, in many cases, stand so close that it would be possible for a man to jump from one to another. Steel derricks are used to avoid fires.

**MEANINGS OF AUTO TERMS**

It is interesting to note that "chauffeurs" was the term applied to a band of brigands in France. These men seized travelers, carried them into captivity, and burned their feet in order to compel them to tell the hid-

ing place of their money. Gradually, the name came to be applied to men in charge of furnaces or boilers. Then, particularly by way of ridicule, the term became exclusively applied to the drivers of automobiles. Tonneau in French means "barrel." The back portion of the early automobile was round in shape and hence the name. Limousin was the name of an ancient province of France, wherein a designer of clothing turned out a kind of cloak that was taken up and worn by the inhabitants. The name was later applied to the covering of a carriage, and finally to the inclosed motor-car body. Chassis originally meant merely the framework of a wagon. The poppet valve is a name assigned to the English.

**PUFFBALL'S EXPLOSION SHOWS NATURE'S SKILL AS SOWER**

642

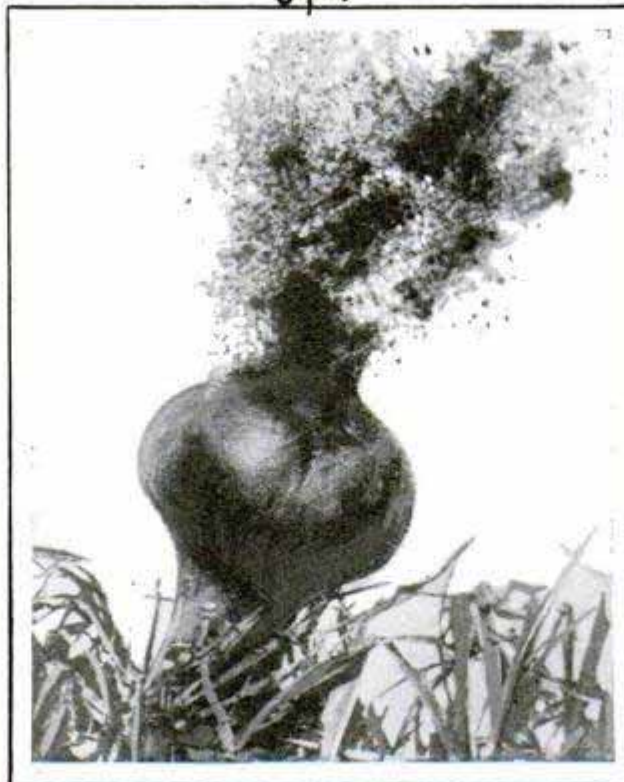

Photograph of Puffball at the Moment It Burst

How nature figuratively turns magician to effect the distribution of certain kinds of plants and other growths is illustrated in the case of the puffball, a variety of fungus. When the spores are ready for scattering, the ball bursts, not unlike a small volcano, as shown in the accompanying photograph, and the dust is carried to a considerable distance by the winds. A slight blow is sufficient to cause the "eruption" at the proper season.

*Em. Edwin Jarvis / Washington  
The Harragud 6/20*

*Elie W. Oche 9/25/26*

576

Sit still for five minutes, breathing normally, then take a deep breath. If you can hold it for forty-five seconds you have good vitality. Fair strength is indicated if you give up even at the end of twenty-five seconds, but if you can hold your breath no longer than fifteen seconds, surgeons would probably consider it inadvisable to operate upon you for fear of fatal result. The test, physicians hold, is an index of a person's power of recuperation and shows, to a degree at least, what reaction would follow the administration of an anæsthetic. Blood-pressure and red-corpuscle tests are also given to determine a patient's condition before an operation. The breath-holding experiment is a result of the war. Aviators who could not endure forty-five seconds were rejected by British and Canadian armies. The person who undergoes an operation is said to experience about the same bodily reaction as an aviator at a height of five miles.

*Auto*  
**AUTO TRUNK FITS UNDER SEAT WHEN FOLDED UP** 1553

Carried on the running board when in use, and fitting under the front seat when collapsed, a handy trunk for the automobile has space for traveling bags, extra blankets, cooking utensils, and other articles. Its cover is of waterproof material. Boards inside keep it in shape and knock down when the trunk is to be put away.

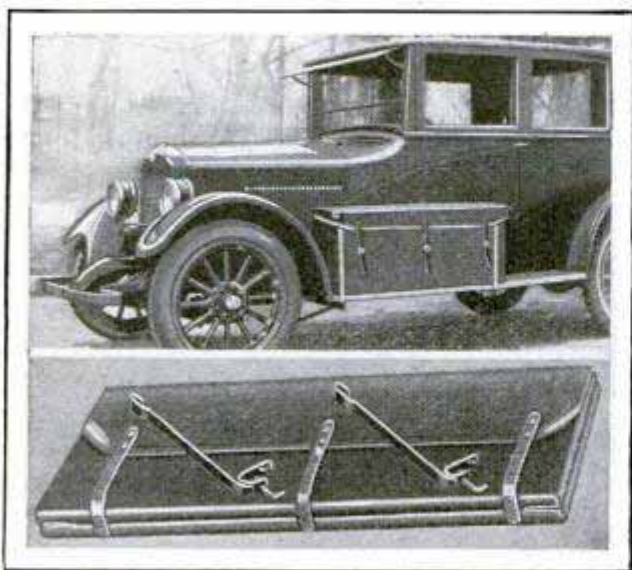

Auto Trunk in Service Position, and Folded Flat to Fit under Seat

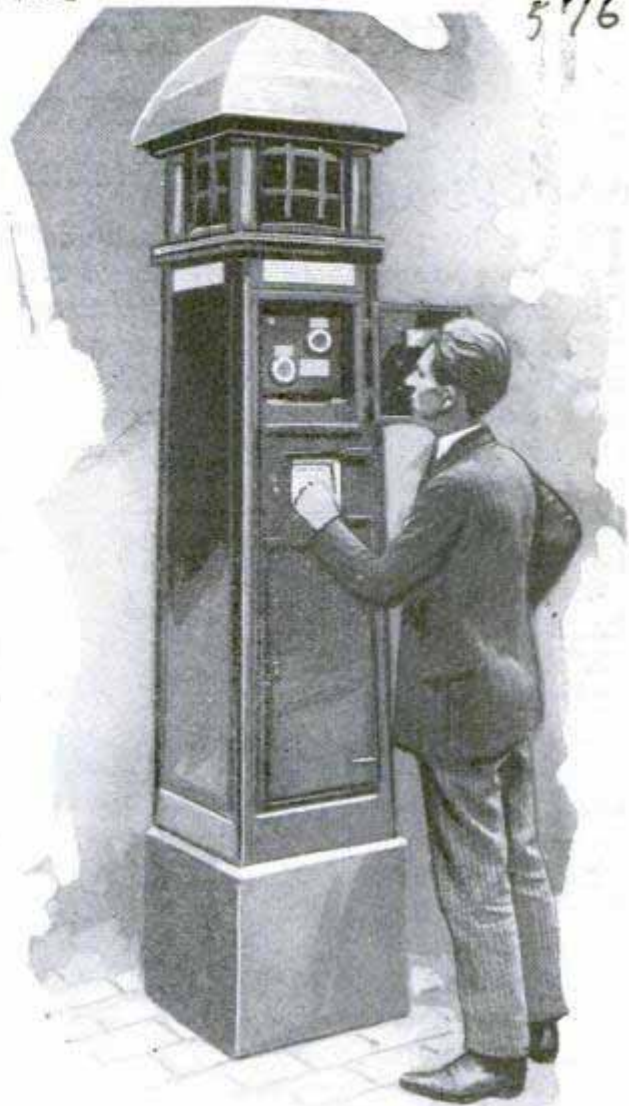

New Fire-Alarm Box in Berlin, with Telephone to Nearest Engine House

**BOX FOR FIRE ALARM RATTLES IF TAMPERED WITH**

False alarms are less likely to be turned in from a signal box introduced in Berlin, for the mechanism rattles instead of sending a call for the fire engines if tampered with. The box is lighted at night, is equipped with a telephone and also registers disturbances on the line, which may be cleared by adjusting a lever.

**SNAKES AND ANIMALS IN INDIA KILL THOUSANDS YEARLY** 459

More than 18,000 persons died from snake bites in India last year, according to official reports, while attacks from wild beasts caused 1,974 deaths. Of these, tigers were responsible for nearly 1,000 and the rest were assigned to wolves, bears, leopards, elephants, wild pigs, crocodiles and hyenas.

O. A. Zahner  
 812 Olive St.

Kansas City Post.  
 9/7/26

# Butterflies from the Cannibal Country Are Turned into Jewelry

*Road, Austin S.W. 9 London, Eng* By HAROLD T. WILKINS Esq. *4. Crowhurst*

IT is a long way from the fashionable shops of London to the wilds of New Guinea, from which come the beautifully colored butterfly wings now being fashioned into exquisite jewelry. A single sample of the rare Paradise butterfly, tailed and with wings of black, green and satiny gold, is valued at from \$150 to \$200.

In the uplands of New Guinea, the climate is cold, while the plains burn in torrid heat. The butterflies fly very high, and one species can be caught only by fixing a dead specimen on a leaf in the sun with wings outspread. The insects fly down to it, just as parrots do to a wounded mate. Acetylene flares are hooked on branches in the mountain country to lure other butterflies after dark, and they are also attracted by great bonfires made in the forests. Native Papuans and the cannibals of the Solomon islands are known to catch them in nets.

made of a web which trapped spiders will spin around sticks.

At the mouth of the Amazon river, stands a tower carrying a platform just beyond the tree tops. It is a moth and butterfly station where these insects are caught for the leading museums. At night

a powerful electric light attracts them and soon they literally envelop the platform in a fluttering cloud tinged with every color of the rainbow.

At an altitude of 2900 feet, an English collector and naturalist, H. S. Ländor, saw a vast number of splendid butterflies, one of which followed him for some days, attracted by the scent of some toilet soap.

Gold miners and ore prospectors vary the monotony of digging by exploring the woods around their claims, on the hunt for gorgeous butterflies. Wood cutters and "balata bleeders," roaming hundreds of miles in the

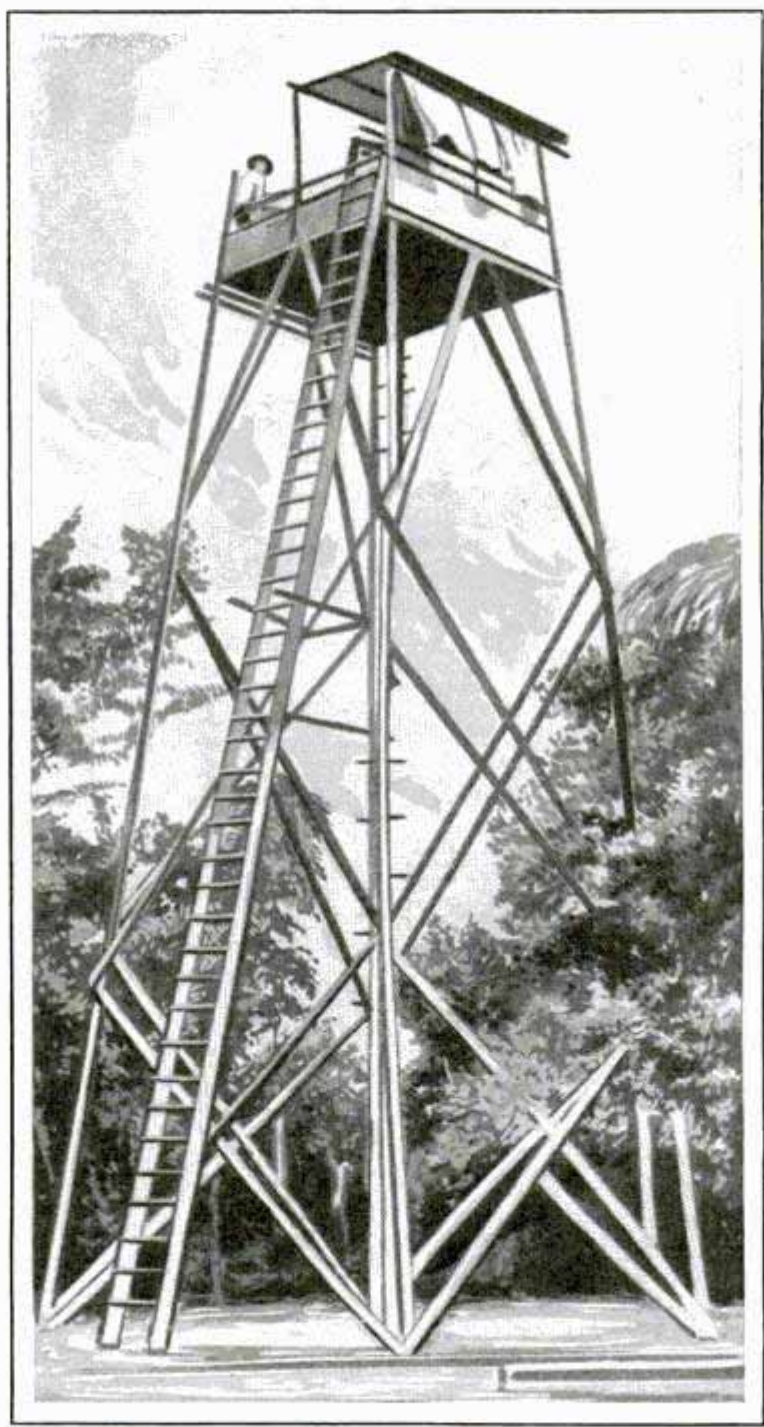

Butterfly-Trapping Tower Station at Mouth of Amazon River; at Night, Electric Light on Platform Lures the Insects



Designs Done with Butterfly Wings; the One at Left Is a Picture to Illustrate a Fairy Story, and at Right, a Locket; the Natural Bright Colors Are Carefully Blended



Imitating Stained Glass with Fragments of Butterfly Wings for a Novel Picture; Nearly 1,800 Wings Were Required; the Artist Is Placing the Tiny Pieces in the Window "Frame" to Complete an Elaborate Pattern; Little Painting Need Be Done on These Pictures but They Are Costly; a Single Rare Butterfly May Cost \$200

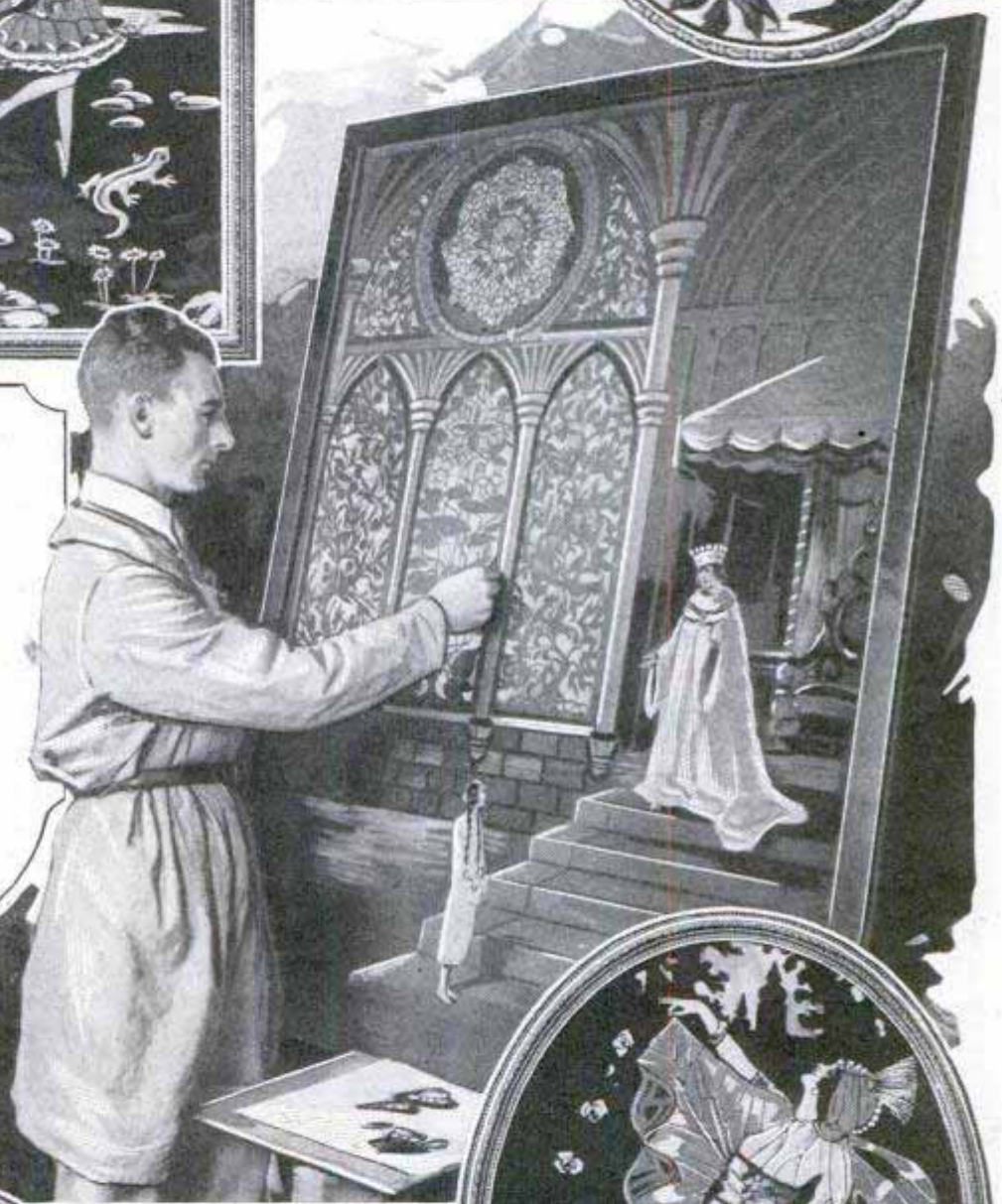

To Complete the Crinoline-Girl Design at Left, 120 Wings Were Fitted; in the Costume of the Persian Maiden, Right, Veins of the Wings Represent Folds of the Cloth; Butterflies from Equatorial Regions Were Used



vast forests of Guiana to tap the juice of the balata gum, collect butterflies for museums, private collectors and jewelers.

The uses of the butterfly's wings in art and industry will surprise many. The skillful jeweler can incorporate the lovely wings into rings and necklets, and in

dainty brushes, mirrors and combs. A few months ago, an English artist exhibited a picture of Catherine of Aragon looking through a cathedral window. All the colors of the rainbow illumine this window, which is about five feet square, and is composed of 1,800 tropical butterfly wings.

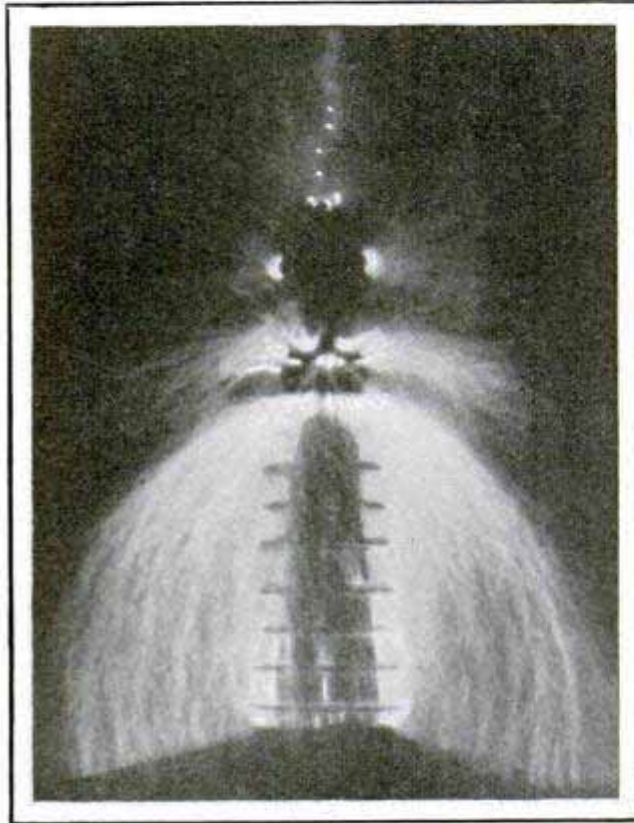

Photograph of High-Voltage Charge of Electricity as It Registered through Quartz Lens

PHOTO OF ELECTRIC SHOWER TAKEN WITH QUARTZ LENS

How a shower of electricity would look was pictured recently when a camera with a special quartz lens was exposed to ten consecutive tests of special high-voltage transformer equipment in an eastern testing laboratory. A pressure of 850,000 volts was used; and, while this was not sufficient to cause a spark to flash over the gap in the equipment, it was great enough to set up an electrostatic field which, after repeated exposures, the rapid quartz lens was able to record on the plate.

General Electric Co  
Schenectady, N.Y. 39

7/6 HOW SCIENCE AIDS INDUSTRY

How the chemist, with his test tubes and other laboratory apparatus, is influencing the development of industry is one of the romances of modern times. Artificial silk, a synthetic product, is becoming increasingly popular and its manufacture already constitutes an important economic factor in this and other countries. On the heels of this discovery comes the report that the scientists are approaching a method for the making of artificial wool. Processes have been developed for the fixation of atmospheric nitrogen with the result that products for fertilizing the soil can be obtained more cheaply. Another invention that is being applied to industry with important results, is the low-temperature carbonization of coal.

Auckland news 9/16/26

PEEP TUBE ON MOVIE CAMERA TO IMPROVE FILMS 7/14

Through a flexible tube attached to the motion-picture camera, the director is able to see the view as it will appear on the screen without interfering with the photographer. It is believed that this arrangement will reduce the retaking of film because of mistakes, as the director can instruct the players more effectively.



Director Inspecting View Before Film Is Taken; Flexible Tube Permits Criticism of Scene as Audience Will See It

Worked out by Norman Turog  
Director and Sen. Smith

Explained by Mr. H. V. Smith  
in address at Sydney Million Club.



## WONDER STORY OF SILK FROM WORMS TO FABRIC



A Few Scenes from the  
Eventful History of Silk  
in the Making



Feeding Mulberry Leaves to Silkworms; Picking Cocoons from Straw, Center; Reeling Fiber, Loading Silk from Steamer and Weighing Finished Article

Interesting steps mark the history of silk from the worm to the finished fabric. Japanese girls feed mulberry leaves to the worms, and the cocoons are carefully protected and placed in warm water when the silk filament is ready for removal. This simplifies the process of reeling the fiber into skeins of raw silk for shipment. Ocean liners, bearing the product from abroad, are met by fast trains which speed the consignments to the manufacturing plants in all possible haste to reduce expenditures for insurance and other costs. Cultivated for more than 4,000 years, the silkworm at times has been the victim of various diseases. In searching for a rem-

edy for one of their maladies, Pasteur, the great French scientist, made some of his most important discoveries, though his rabies treatment has overshadowed them.

### WHY WE "SEE" STARS 620

Stimulation of one of the nerves by a blow on the head is said to account for the common experience of "seeing stars" after a severe bump. This nerve carries the shock to the brain which interprets it as light, and when artificial stimulation is produced, as from a blow, the impression of a flashing light in the form of moving "stars" is conveyed to the brain.

*Auckland News*  
9/2/26

*Public Service Information  
24 North St.  
Boston*

### WEATHER MAPS SENT BY RADIO PROTECT NAVIGATION

353

Radio has reached out into the sea to further aid man in a process for transmitting to ships

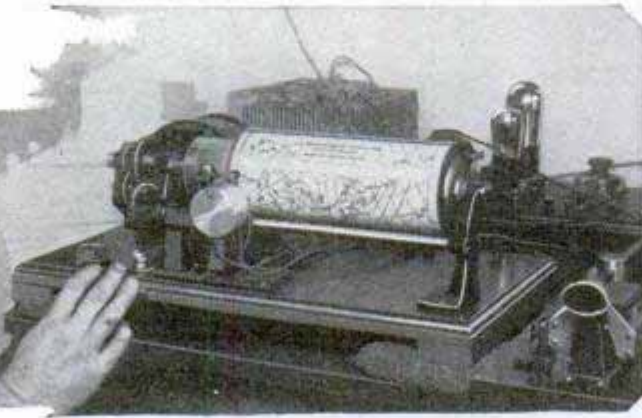

Copyright, Harris & Ewing

C. Francis Jenkins with Unit of Radio Apparatus for Transmission of Weather Maps; Copy on Cylinder Instead of Flat Surface

weather maps complete with high and low-pressure lines and other marks. Several vessels of the navy department already have been equipped with "radio-vision" outfits for receiving the charts. The method is an adaptation of that invented by C. Francis Jenkins for sending and recording photographs and moving objects by wireless. In the first tests, a 20,000-volt radio-telegraph transmitter at the naval radio station at Arlington, Va., sent the maps to ships cruising along the Atlantic coast. A photographic film of the chart, either a positive or a negative, was wrapped around a glass cylinder from the interior of which, as it rotated, a light shone upon a photoelectric cell. The lines on the map interrupted the light, thus changing the values for broadcasting purposes. The impulses were picked up on an ordinary radio receiving set. Its output was made to control a "blocked" electron tube in such a way that a "radio pen" traced the lines of the map on a piece of paper wrapped about a cylinder.

### LONG-DISTANCE PHONE BASED ON "BOOSTER" TUBES

Telephoning distances of 4,000 and 5,000 miles with ease and clarity is now an everyday occurrence, but few patrons realize what efficient aids have been sum-

moned to help carry their voices so far. The function of these unseen servants is to magnify the voice at various points along the line. For instance, on the toll circuit between New York and Chicago, there are sixteen such "booster" or repeater units. They build up the energy of the voice which ordinarily would be lost or greatly diminished in traveling over the closely spaced wires of the cable. Each of these stations is said to amplify the voice energy 200 times. The amount of energy handled is extremely small. It has been estimated that if conversation was carried on continuously for a period of ten years between the two cities, the accumulated energy

received by one of these repeaters would be about sufficient to light a fifty-watt lamp for only one minute. But one large repeater cannot be used, engineers say, because it would require more energy than the total amount of known energy in the world.

### SINK FOR SMALL APARTMENTS

#### 578 REDUCES BREAKAGE

Drainboard and sink are both equipped with a wooden latticework to reduce the likelihood of breaking dishes while covers

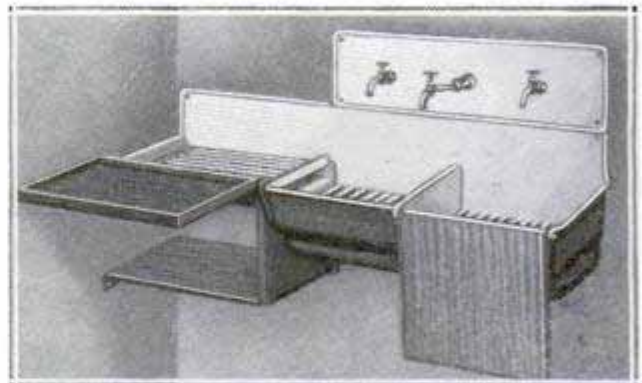

Compact Sink for Small Apartments; Wooden Bottoms Reduce Breakage and Shelves Afford Storage

are provided to conceal the basin and drainboard and afford extra shelf space for small apartments. The sink is of German design and is divided into two sections, for hot and cold water.

*Lehr. Schlingmann,  
Bremen, Germany*

*1819 San Francisco Washington D.C.*

*Utility News 10/11/26*

**INVISIBLE BLACK-LIGHT RAYS TO TRAP BURGLARS** 697

A new use for the invisible light rays at either end of the spectrum, the ultra-violet at one end and infrared rays at the other, is being tried out in laboratories, and offers a possible solution for the burglar-alarm question. The big drawback to present electrical-alarm systems is that the burglar may find the wires and discover methods of circumventing them. With the invisible light-ray alarm, the possibility of detection is removed. A light producing the invisible rays is placed at one side of the door, window or corridor to be protected, and on the other side is a photoelectric cell, connected to the alarm system in such a way that as long as the rays continue to strike it the alarm bell remains silent. As soon as a marauder passes between light source and electric cell, however, his shadow cuts off the flow, and releases the alarm.

**SPOTLIGHT ON RADIATOR IS OPERATED FROM DASH** 406

A spotlight mounted on the radiator of an automobile, but moved up and down and from side to side by a control lever on the instrument board, has recently been placed on the market. A flexible-cable connection terminates in a small lever on the dash, which is moved from side to side for both horizontal and vertical movements, being pushed in for the one and pulled out for the other. Another fitting, which is offered as a substitute, connects to the steering rod and automatically turns the light as the wheel is moved, so that the beam is always thrown in the direction in which the car is turning.

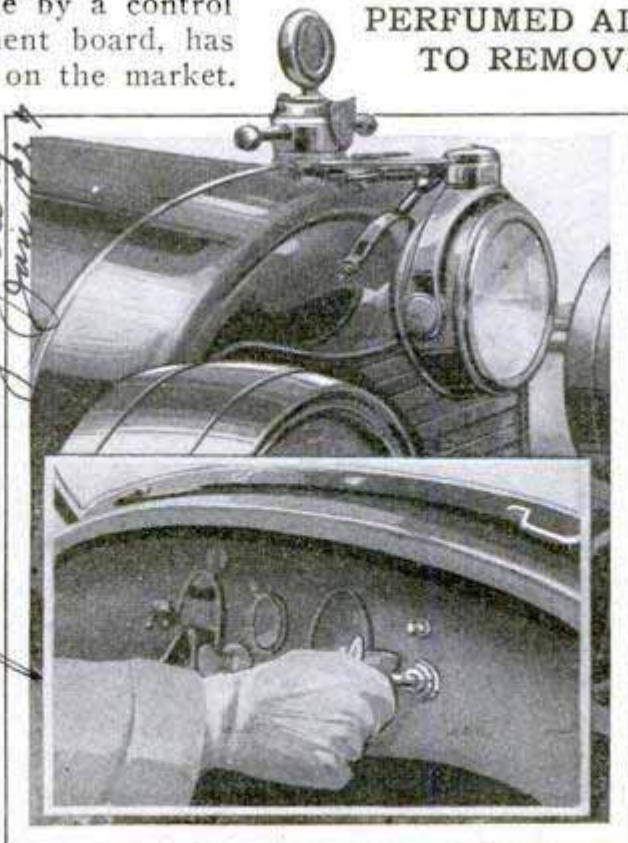

Auto Spotlight Mounted on the Radiator and Swung in All Directions by a Dash Control

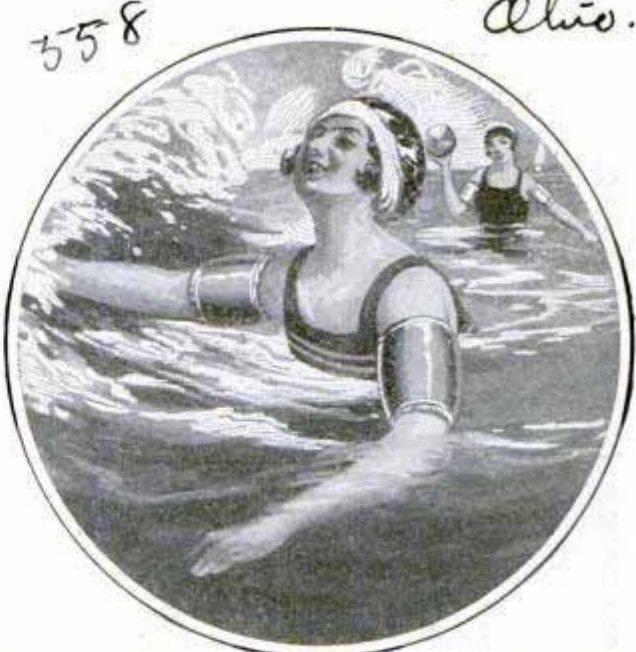

Swimmer Wearing Pair of Inflated Rubber Arm Bands; They Serve as Buoys but Do Not Impede Movements

**SLEEVE FLOATS FOR SWIMMERS REDUCE DROWNING RISK**

Wide rubber arm bands that can be inflated and are kept from collapsing by means of a valve, have been devised for swimmers. They are said to make sinking almost impossible and are especially helpful to beginners who are timid.

**PERFUMED AIR FOR HOSPITALS TO REMOVE DRUG ODORS** 694

Substitution of sweet, wholesome scents for the odors of chloroform and disinfectants that sometimes prevail in hospitals has been recommended as an additional way of improving conditions for patients. The use of soft color tints, such as gray, pink and green, already has proved beneficial as compared with monotonous white, and the perfumed ventilation is considered in line with this helpful change in coloring.

The Owl Lamp Co., 315 Montgomery St. R. 521

Will open Chicago factory Jan. 1st

American Hospital Association

## 695 MYSTIFYING TRICK LOCATES ANY CARD IN THE DECK

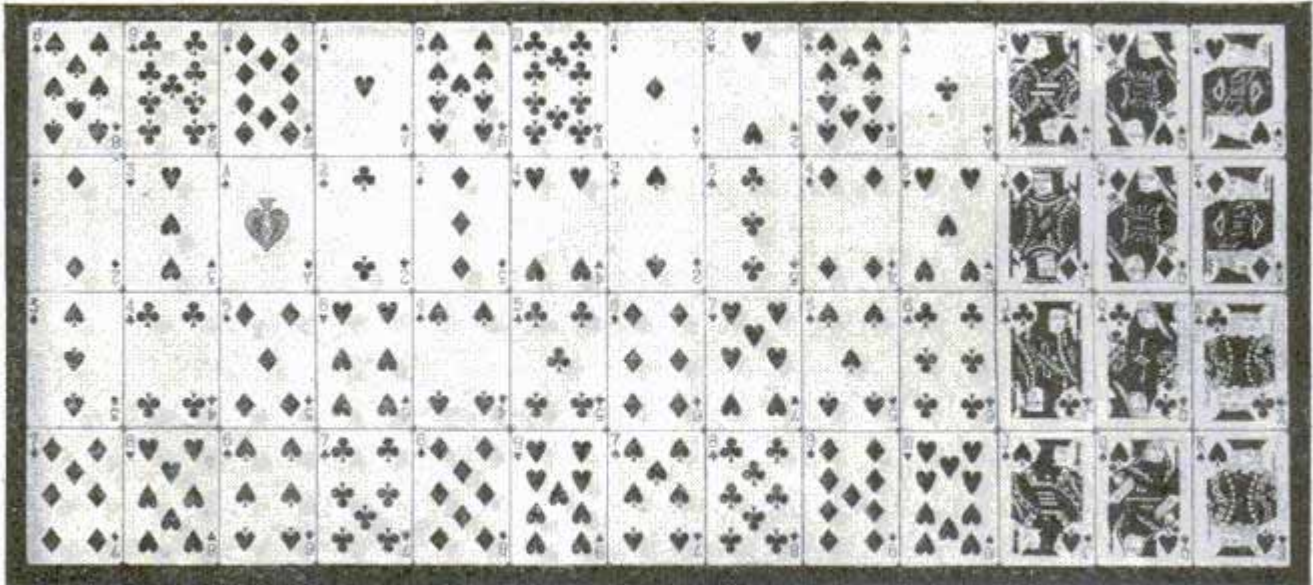

Prepare the Deck According to This Diagram, Then Either Turn the Cards Face Down or Gather Up the Deck by Starting at the Top Left, Keeping Them in the Same Order

A mystifying trick by which any playing card called is instantly located, can be performed with a deck arranged as shown in the illustration. The cards are laid out face downward, however, so that, before trying the trick in public, it is well to practice the trick with the cards face up, until you become familiar with its working. You will note that the three face cards of each suit are together at the right end of the rows. Memorize the order in which the face-card suits appear, hearts at the top, then diamonds, clubs and spades. After that is learned you consider the rows as ten cards each, plus the face cards, which are dealt with separately, as you already know their exact places in the layout.

To locate any other card called for, you multiply the value of the card by four, and, if it is a diamond, club or spade, add three, six or nine, as the case may be, to represent the face cards. If the card called for is a heart you do not add anything, but simply take the product of the card multiplied by four, and count down that number, beginning with the upper left-hand corner, and counting only the rows of ten. For example, if the six of hearts is called for, you multiply six by four, giving twenty-four, and find the card is the fourth from the left end of the third row. If the card was the six of diamonds, you would add three, representing the three diamond face cards, to twenty-four,

giving twenty-seven, and the card is the twenty-seventh down. Similarly the six of clubs would be twenty-four plus six and the six of spades twenty-four plus nine, or thirty-three cards down. When the product, plus the added number, is over forty you simply subtract the forty and use the remainder. Thus the ten of clubs gives forty-six—four times ten plus six for the diamond and club face cards. Subtracting forty, you will find the ten-spot is the sixth card in the first row.

Or the trick can be worked backward, by asking for a number and then naming the card. If some one asks you to identify the thirty-second card you know it is a heart because thirty-two can be divided by four, and, by dividing, you get eight, so it is the eight of hearts. If the number given is thirty-three it can not be divided by four, so the card is not a heart. Take off three, representing three face cards, and you have thirty, which likewise can't be divided by four, so it isn't a diamond. Subtract three more, leaving twenty-seven, and as that can't be divided by four it isn't a club. Subtract three more, giving twenty-four, divide that by four and you find the thirty-third card is the six of spades.

As soon as you have learned the system thoroughly, it isn't necessary to spread the deck out on the table. You can keep it piled, and yet give the location of any card in it.

8/26/26

of Elkhorn.

### SUBMARINE LIGHTS TO GUIDE SHIPS AND AIRPLANES

514

Powerful underwater searchlights, laid in lines to mark the sea routes, have been suggested as a means of safeguarding night travel by vessels, especially through rocky reefs or other dangerous passages. On busy lanes, a "rule of the road" could be established to keep ships going in one direction on one side of the lights and those coming in the opposite direction on the other side. The illumination would be a help in fogs and would also serve as a guide for airplane pilots, as the lamps would be visible at great distances.

### SEDAN FOR EIGHT PASSENGERS SERVES AS AMBULANCE

559

Seats are so arranged in a roomy eight-passenger sedan that some of them may be removed and converted into a stretcher, should it be necessary to use the car as an ambulance. Absence of a partition between the side doors permits removal of the cot, which has wheeled supports. When the car is adapted for passengers, the three single seats which are arranged between the main rear and front seats form the chief feature.

2670 of Michigan

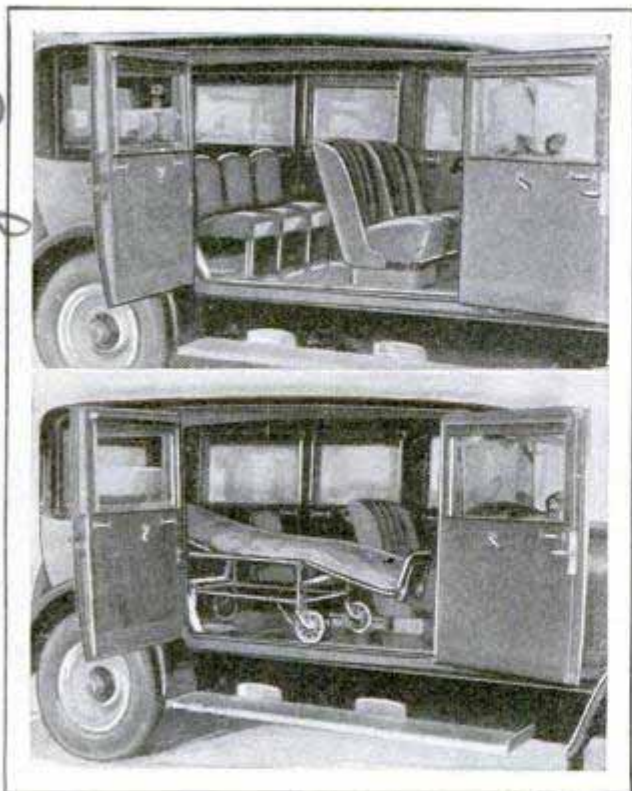

Seats Arranged for Eight Passengers and Adjusted as Wheeled Stretcher; Note Absence of Door Post

The Sayers & Scovill Co,  
Berl Sh. & Co. + O A. A.



To Perpetuate the Memory of a Servant to Man; Tablet in Honor of John F. Appleby

### MEMORIAL STONE TO INVENTOR OF BINDER-TWINE KNOTTER

Near Elkhorn, Wis., a memorial stone has been erected by the state historical society in honor of John F. Appleby, who invented the mechanical twine knotter used on grain binders today. He developed the attachment before enlisting in the Civil war, but did not put it to successful use until several years later, when wire was discarded as a means for tying bundles. He spent much of his time experimenting with the device on the Wisconsin farm where the marker has been raised in his memory.

756

### FIRE ALARM RECORDS FINGERS

Turning in false alarms has become such a sport in Berlin that the fire department has been experimenting with an alarm box which automatically registers the fingerprints of anyone who tampers with the signal. The recording unit is on the knob of the box. According to reports, the plan has succeeded in smaller cities and is expected to be adopted in Berlin.

d.w. Hans Schwanger  
of Berlin.

547

32 Union Square, N.Y.  
New York

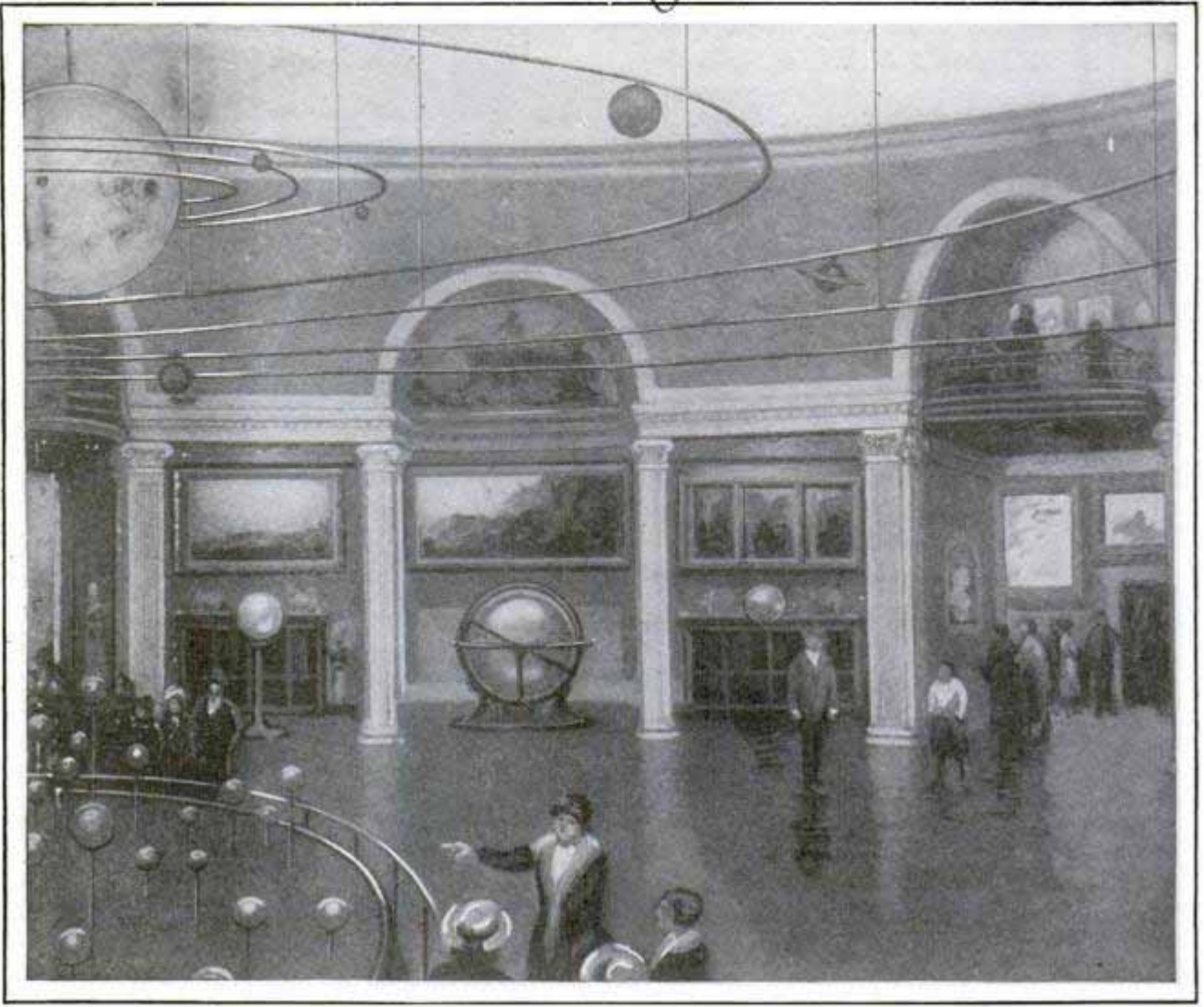

Miniature Indoor Universe, Planned for Astronomical Hall of the American Museum of Natural History, Will Enable the Layman to See the Sun, Stars and Planets Revolve

## To Reveal the Secrets of the Heavens at a Single Glance

**H**AVE you ever had a longing, as you gazed at the stars in the heavens on a clear night, to explore the mysteries that seem ever-present yet distant, inviting yet beyond comprehension unless you devoted long hours of study to them?

Imagine, then, an arrangement which would enable you to take in the whole universe at a single glance, an arrangement within the four walls of a museum which showed the relative placing of the sun, earth, moon, stars, and the rest of the planets, all correctly proportioned with respect to each other.

Plans now under consideration by the American Museum of Natural History in New York provide for such a planetarium where, unlike the technical observatory in

which the average man feels lost, laymen will have an opportunity to contemplate the array of stars and planets which have taken astronomers centuries to discover and catalog.

There will be a dome with the effect of the stars obtained through the use of a powerful lantern to throw slide pictures made from drawings based on photographs of the heavens. Complete representation will be effected by thirty-one slides closely fitted together.

If the system in vogue at similar so-called Uranias in Europe is adopted, a small telescope will be provided for visitors and a light will shine from the museum when the weather is ideal for star gazing. Popular lectures also may be given

641

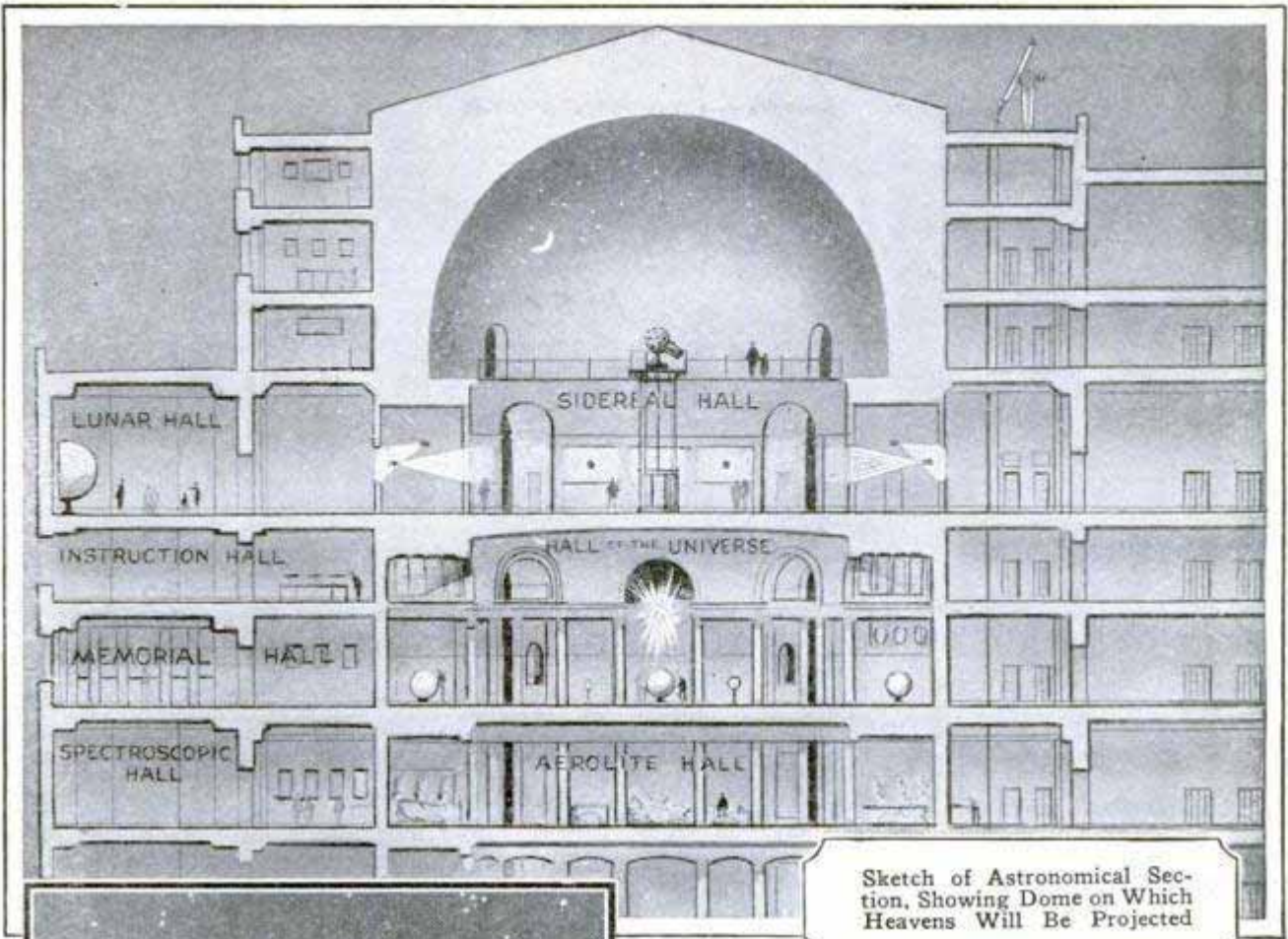

Sketch of Astronomical Section, Showing Dome on Which Heavens Will Be Projected



The Projection Lantern Above, One of the New Triumphs of Lens Making, Will Throw All the Main Features of the Sky on the Dome, as Shown at the Right, So That the Observer Will See the Glowing Stars, Moon and Planets Moving in Their Proper Orbits Overhead, While Lecturers Identify Them and Describe the Story of Their Life in Space

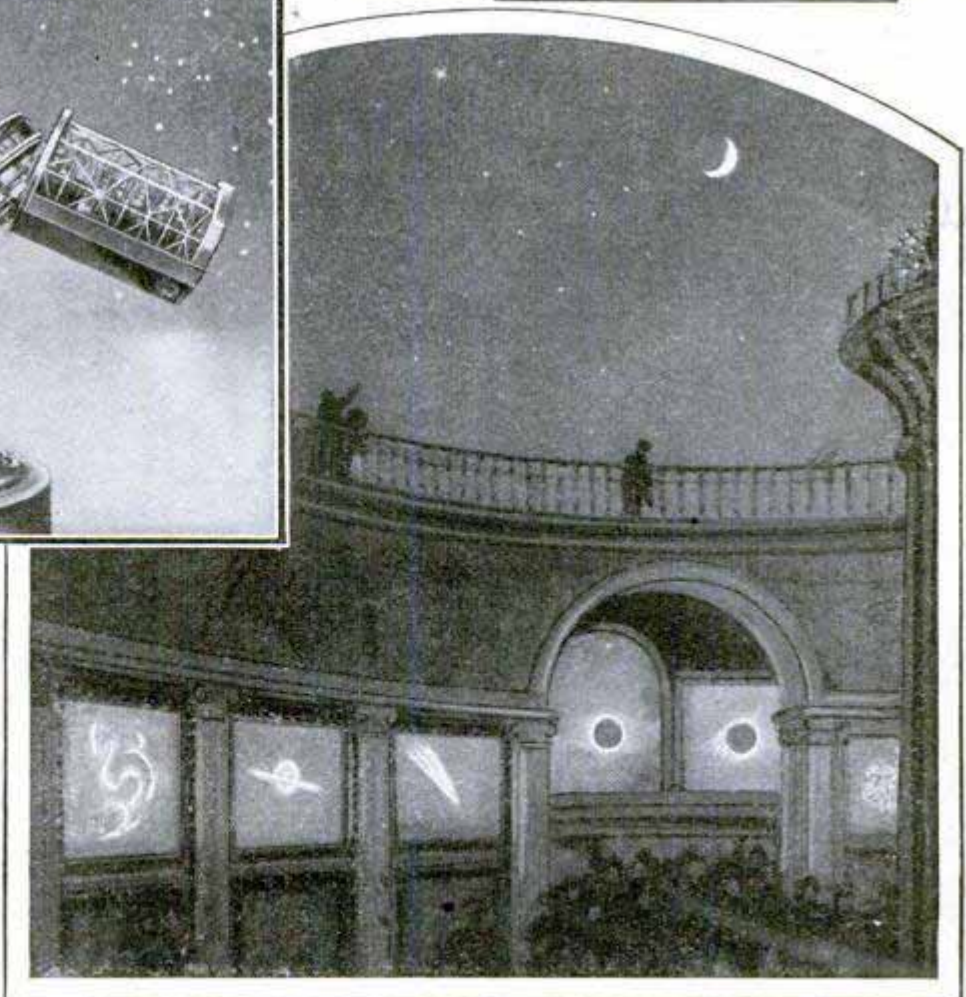

Collectors Convention  
 at Grand Central Palace

1610 Summer  
 POPULAR MECHANICS  
 Phila.

86  
 Novel Use of a  
 Collector's Tro-  
 phies; a Portrait  
 of Hans Lagerlof  
 of Sweden Done  
 Entirely in Stamps

692



**720**  
**PORTRAIT IN POSTAGE STAMPS  
 RIVALS WORK WITH BRUSH**

One of the exhibits at a collector's convention in New York city was a portrait done in bits of American and Swedish stamps. The pieces were arranged by colors in such a way that the features of the subject were realistically reproduced. The background was also made of stamps.

**720**  
**HEROES OF WORLD-WAR BATTLE  
 HONORED BY MONUMENT**

Among the shattered stumps and underbrush of Delville wood, in France, a

handsome memorial has been built in honor of allied soldiers who fell in battle there. On that spot was fought one of the most fiercely contested of all the engagements during the main battle of the Somme in the summer and fall of 1916. Troops from South Africa were chief contestants for the allies in the fighting around the wood.

**770**  
**IMITATION OF GOLD IS FOUND  
 IN NEW COPPER ALLOY**

Metal workers are investigating the possibilities of a new alloy of copper and beryllium, discovered recently, as it is believed to present an ideal material to be used as imitation gold. If such a substance has been found, it will have an important effect on the goldplating industry, authorities point out. About five percent of the alloy is beryllium. A desirable imitation should retain its brightness after long exposure to the air and to the heat of machines where temperatures of 750 degrees Centigrade are encountered.

**768**  
**NINETY THOUSAND LIVES TOLL  
 OF YEAR'S ACCIDENTS**

In 1925, the toll of human life taken by the automobile in America was at the rate of over two persons an hour for every day in the year, the total being 22,500, of whom nearly 6,300 were children under fifteen years old. These figures are taken from a report of Dr. Louis I. Dublin to the

*Chicago Daily News 10/26/26*



Tribute to Fallen Heroes amid the Shattered Stumps of a World-Battle Ground; the Memorial to the Men Who Fought at Delville Wood in France

*discovered by M. Es. Corson World  
 Address: 153 W. 4th place, New York*



*68* ... *Morrison. Bell m.v.*  
*on new at Bank of England.*

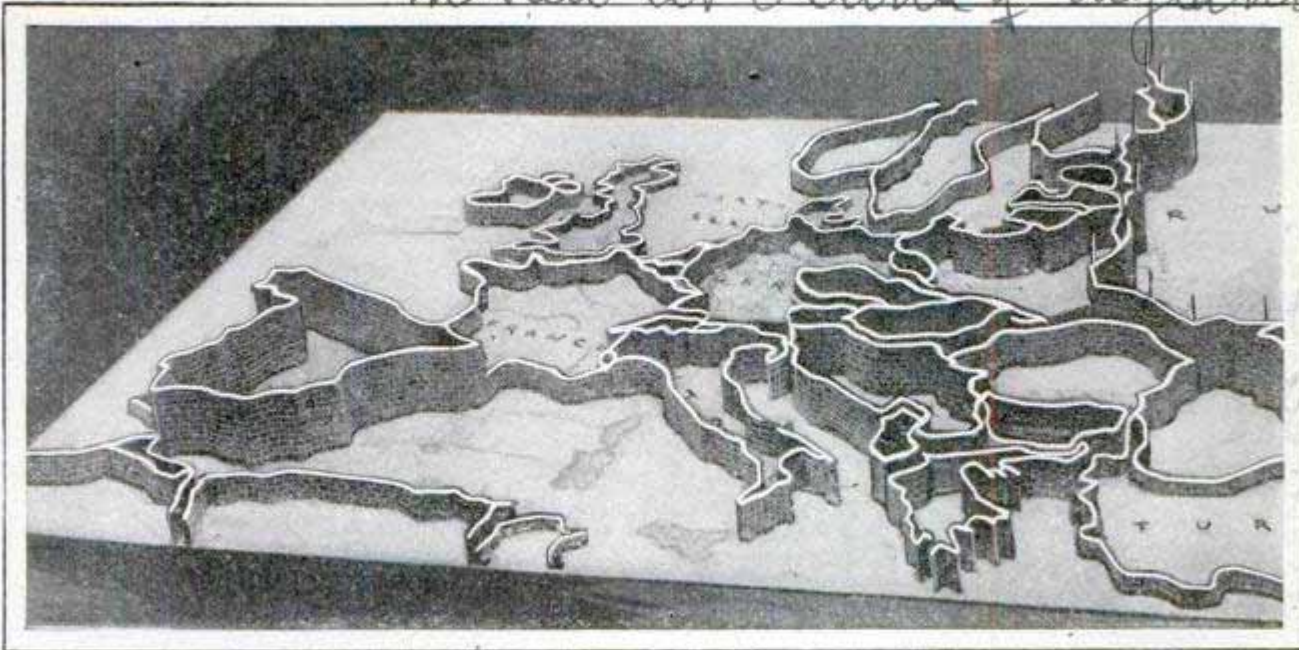

Courtesy Illustrated London News *16/9/26*  
 Tariff Conditions in European Countries at a Glance; Relative Height of Walls on Map Indicates Trade Restrictions in Various Sections; a Wire Barrier Surmounts the Russian Wall

National safety council, and indicate that, whereas the automobile death rates in England and in the United States were about the same in 1911, fatalities from this source now occur about two and one-quarter times as frequently in this country as in England. Government statistics showed that the rate of automobile deaths here was 76.2 per 100,000 population. In England and Wales, over the same period, it was 34.1 per cent. There was a decrease in the number of deaths from accidental falls, burns, drowning, steam-railroad and street-car accidents, the reports showed, the total number of accidental fatalities from all causes during the year being nearly 90,000. A survey of railroad conditions led to the conclusion that employment on the lines is now less than one-third as hazardous as it was twenty years ago and that, during the last thirteen years, employe and passenger fatalities have been reduced nearly sixty per cent—a very creditable showing.

*687* **EUROPE'S HIGH TARIFF "WALLS" SHOWN ON MODEL MAP**

National boundaries of countries in Europe were marked with walls on a model map to illustrate the comparative tariff restrictions imposed by different nations. The exhibit showed that Great Britain, northern Ireland, Holland and Tunis have the lowest walls, while Russia has the highest. A wire barrier was stretched on top to indicate that trade conditions are difficult under soviet rule.

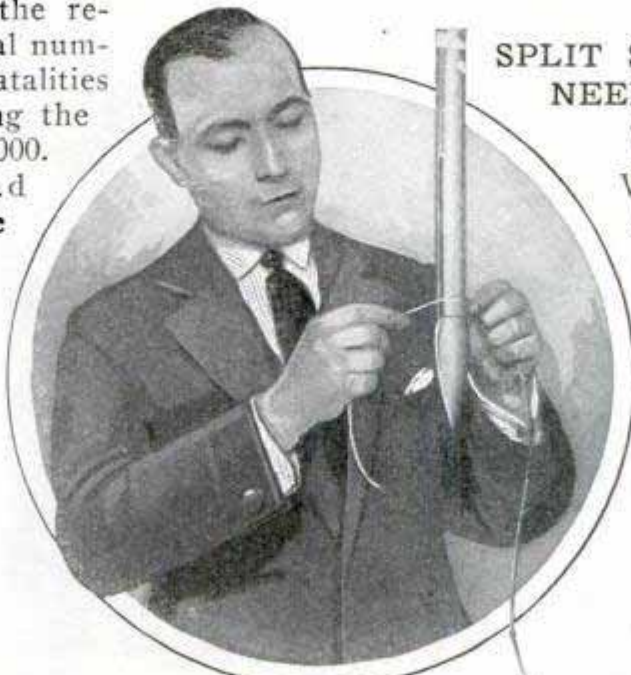

**SPLIT SEWING-MACHINE NEEDLE IS EASILY THREADED** *686*

With a fine split on one side a sewing-machine needle is said to be much easier to thread than the ordinary kind, particularly if the operator is hampered by imperfect eyesight. The slit is too small to permit the thread to become dislodged accidentally while sewing and the needle functions as any other.

Enlarged Photograph of the Split Needle, Showing How Thread Is Inserted

*A. W. Herbert, Pragerstrasse 16, Berlin W. 50*

S. Karpen & Sons.  
 88 636 W. 22nd St  
 Chicago.

POPULAR MECHANICS

STAGGERED SEATS IN AUTO BUS  
 AFFORD GREATER COMFORT

561 Greater ease and more privacy are afforded passengers in auto busses when the



How the Staggered Seats Afford More Room for Passengers and Diagram of Bus Interior

seats are set in staggered fashion so that the shoulders of two persons sitting side by side overlap but do not touch. The arrangement also to some extent increases the width of the aisle.

FIVE TOOLS COMBINED IN ONE  
 TO REDUCE KITCHEN LABOR

Three kinds of openers, a knife sharpener and a screwdriver are combined in a durable, all-metal implement for the kitchen. It removes the caps from milk bottles and the crimped tops of other containers or can be used for prying up the lids of coffee cans and fruit jars. The sharpening unit is attached at the side and work

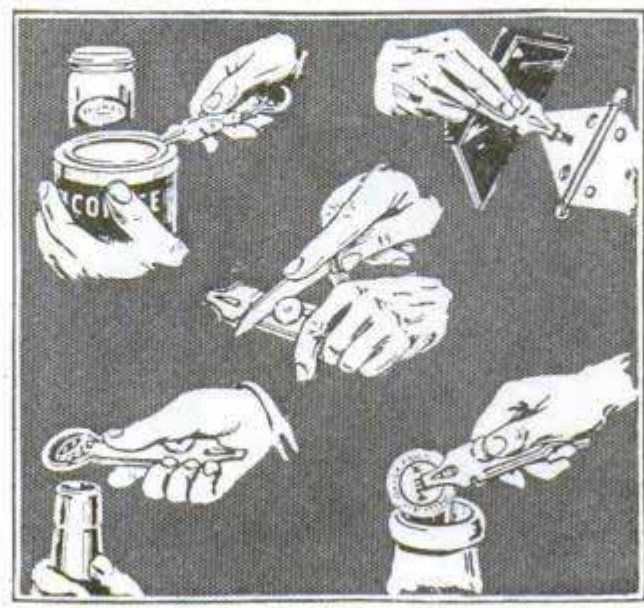

Drawing Illustrating the Various Uses of the Combination Tool; the Sharpener Shown in the Center

C. G. ...  
 Material Engineer  
 New York Navy Yard

can be done without fastening the tool to a table or bench as is necessary with most devices of this kind.

WAY TO SAVE AIRMEN'S EYES  
 SOUGHT BY NAVY

765 A new type of goggles to protect the eyes of aviators is being sought by the navy. The malady commonly suffered is snow blindness. It has little to do with the snow, since it may be encountered at almost any season and is produced by the reflection of the sun's rays from small particles floating in the air. The trouble is an old one, explorers in ice-bound regions having been bothered with it on many occasions. Only recently when Lieut. Comm. Byrd returned from his expedition to the Arctic, he reported that the sight of his right eye had been impaired during the flight to the pole. Another difficulty when flying at great heights is the unnatural angle from which the rays strike the eyes. According to scientists, men have become accustomed to light reflected from the ground and striking the lower part of the eye. At a great height, more light than usual shines in at the upper part of the retina and, being unaccustomed to this radiance, it becomes temporarily deadened and vision troubles follow. Added to this factor, the airman often must take off or land at morning or evening when he encounters the full light of the sun and has to battle against winds, dust and extreme changes of temperature.

The new goggles are to be designed to satisfactorily meet all these conditions. A type already tested is considerably larger than those now in use, and the glasses are bent to follow the contour of the average face. One of the most important problems is to find a glass which will keep out the injurious rays yet not rob colors of their true value.

Utility Manufacturers  
 160 N. Wells St  
 Chicago  
 37th & Broadway New York  
 180 New Montgomery St  
 San Francisco Calif

*10/26/26*  
**CHEMISTS TO SEEK  
 WAY OF MAKING  
 PETROLEUM** *63*

For many years, chemists have been searching for a way to make synthetic petroleum and now more thorough experiments than have yet been attempted are planned by the American petroleum institute under an endowment of \$500,000 established by John D. Rockefeller. The investigators will attempt to reproduce, as nearly as possible, the geological conditions believed responsible for the formation of petroleum.

*250 Park Ave New York*  
**SIEVE FOR CEMENT  
 HOLDS WATER** *669*

Contrary to an old proverb, it is possible to carry water in a sieve. At least some of the screens used in cement making are so fine that they will hold the liquid as shown in the photo. The sieves are employed in sifting materials for the cement after they have been burned. One test requires that seventy-eight per cent of the powder



Illustrating the Fine Texture of Screen Used in Sifting Cement Materials; Sieve Holds Water

should pass through a sieve that has 40,000 meshes to the square inch.

*Examined by Mr. V. L. Hudson  
 U.S. Bureau of Standards*

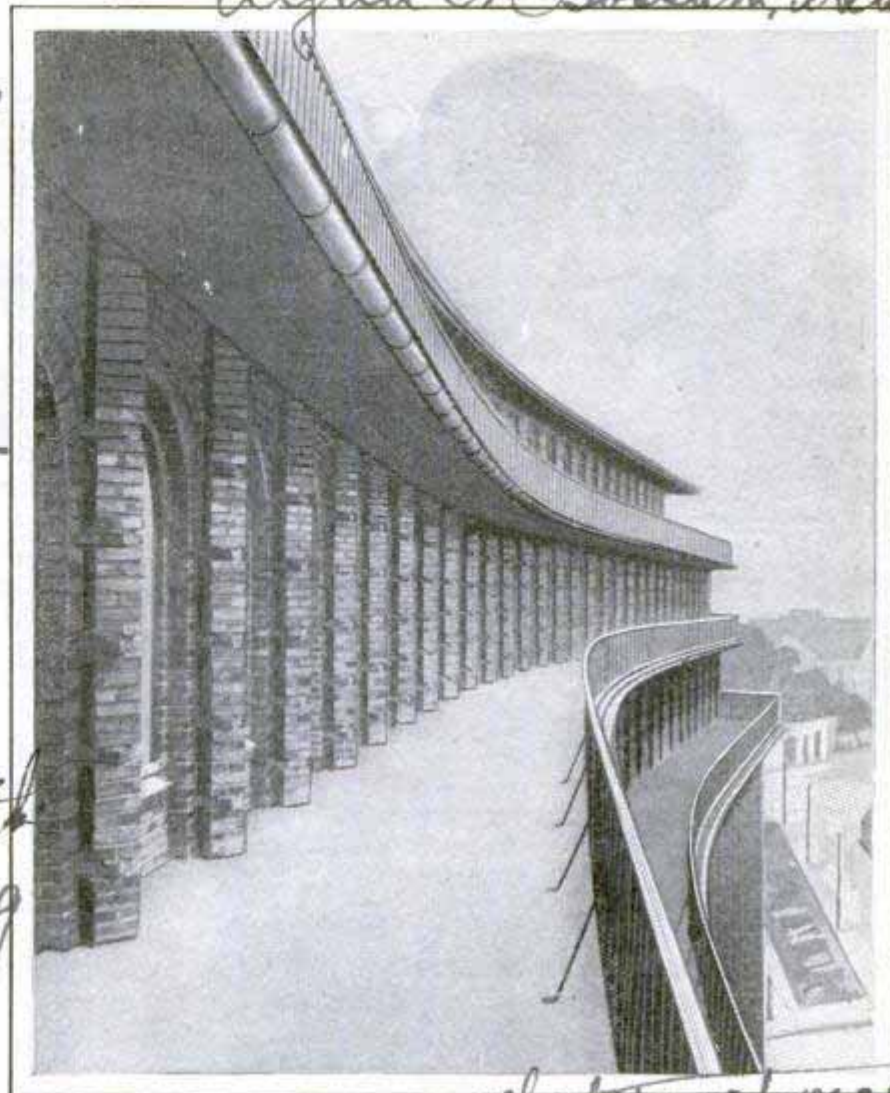

A Promenade for Persons on Each Floor; Sidewalks on Terraced Building in Hamburg, Germany, Afford Light and Fresh Air

**SIDEWALKS FOR UPPER FLOORS  
 OF BUILDINGS COMING**

In the so-called "stepped-in" style of modern office-building construction, architects see an additional development for city dwellers besides the increase in light. The terraces will permit the installation of separate sidewalks high above the one beside the pavement where workers may promenade during luncheon hours and thus enjoy the benefits of fresh air without riding to the street or ascending to the roof. In Hamburg, Germany, this innovation already has appeared. Curved recesses for the windows suggest the arches along a monastery cloister. The arrangement affords abundant light through office windows, and space that otherwise would be wasted is utilized.

Five or six miles a day is the usual rate of travel for icebergs.

*656. Suggested by Alfred C. Bossam, architect*

1621

# Shooting Trouble on Your

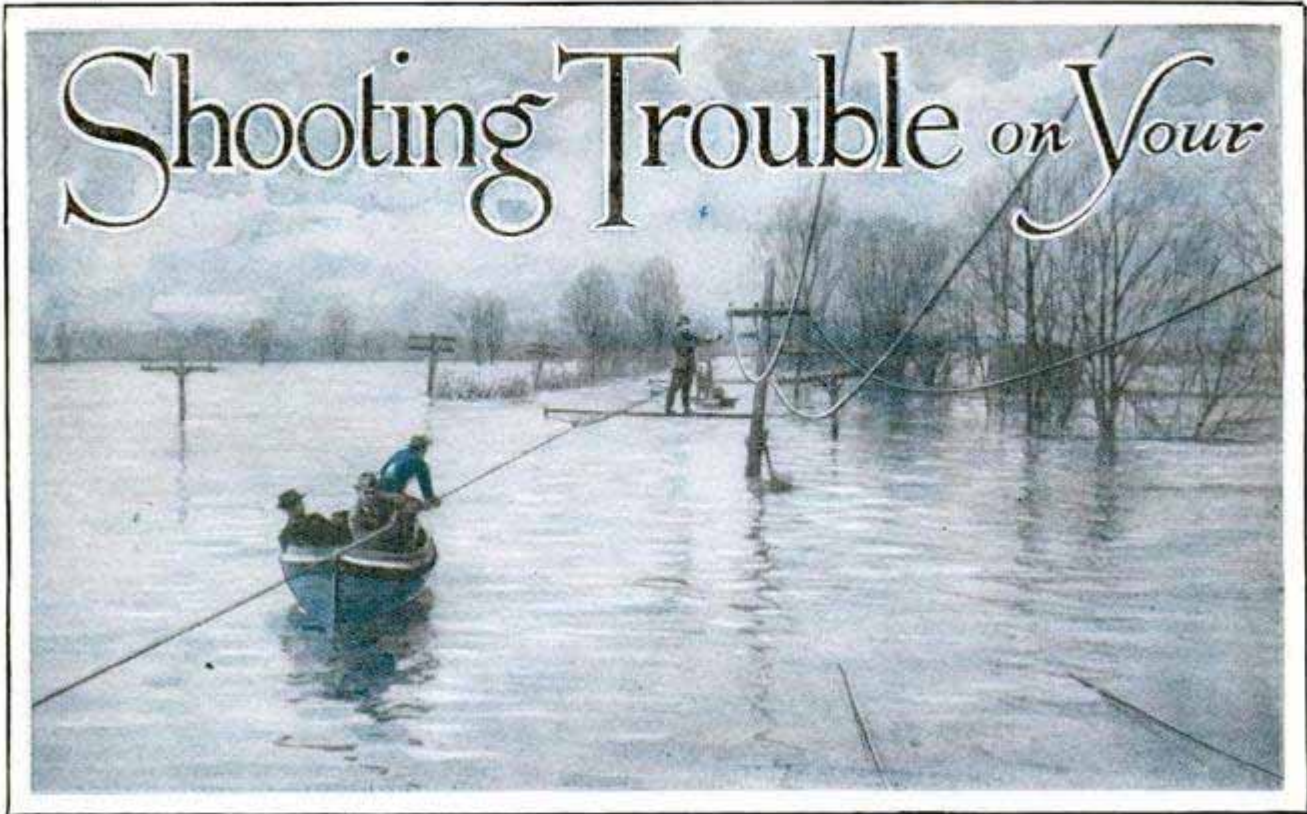

Linemen Using the Street-Car Trolley Wire to Pull Their Boat Along as They Restore Telephone Service While the Flood Waters Still Cover Farms and Houses

*Construction*

A TELEPHONE subscriber in New York is talking to a business friend in San Francisco. Every fifty miles along the line, from coast to coast, a trouble doctor of the telephone company is standing by to watch that the line is kept open, and if anything happens, to see that a new channel of communication is instantly switched into service.

In every telephone office in the land, hidden out of sight in some back room, is the surgery of a trouble man or men—one or two in small offices and a dozen or more in big ones. Out in the country along the long-distance wires are similar doctors, spaced never more than half a mile off from an even fifty miles apart. Sometimes the country-wire doctor's office lands in the village exchange, but just as often it is set down in the middle of a corn field or in a clearing in some mountain woods.

The country trouble shooter has the busiest life, for his patients are usually above ground, strung on poles where they are exposed to gales and sleet storms, to thoughtless hunters with a penchant for inflicting gunshot wound on glass insulators, and to such varied enemies as rats and squirrels.

The city-wire doctor hasn't so many varied diseases to treat, because most of his patients are already buried underground, in lead-sheathed cables carried through tile conduits. Left alone and undisturbed, with all joints properly soldered, trouble cannot develop in an underground telephone cable, but so long as cities grow and change, the conduits are never left alone long.

A new subscriber orders a telephone installed and the nearest manhole must be opened, the lead cable tapped and one of the extra pairs of wires, already installed for just that purpose, tapped and led into the house. With the connection made, short lengths of tubing, resembling radio spaghetti, are slipped over the new joints and the whole collection of cable wires, as many as 2,200 pairs in a big city cable, is bathed with melted paraffin to drive out the moisture and seal the joints with water and air-proof insulation. A big sheath of lead is then slipped over the cut and soldered to the lead cable.

Somewhere in the process a tiny air hole may be left, water seeps in, and sooner or later the trouble doctor, ceaselessly feeling the pulse of his miles of patients with delicate electrical apparatus, detects an

# Telephone Line

incipient case of disease that calls for a major surgical operation. A Wheatstone bridge is called into the diagnosis, and by measuring, to an unbelievably delicate degree, the exact resistance of the wire from the office to the scene of trouble, the doctor locates it within a matter of a few feet. The repair crew is dispatched to the scene, the defective joint opened, boiled out again with paraffin, and resealed, the whole operation often being completed before the subscriber even discovers that there is the least trouble on the line.

The streets of a big city are honeycombed with the lines of the various utility companies. Each knows where the other's property lies, and tries to miss it, but doesn't always succeed. A crew from the waterworks or the gas company, laying a new line, tries to save tearing up the pavement by boring a hole across the street beneath the ground. On the opposite side is a telephone conduit, carefully marked on the map, but through a mistake the boring auger is misdirected and drills through a lead-sheathed cable. Another job for the repair crew.

A workman wrecking an old building in Chicago last

**Exposed Overhead Wires, Long the Prey of Every Sleet and Wind Storm, Are Fast Being Replaced by Lead-Sheathed Cables**

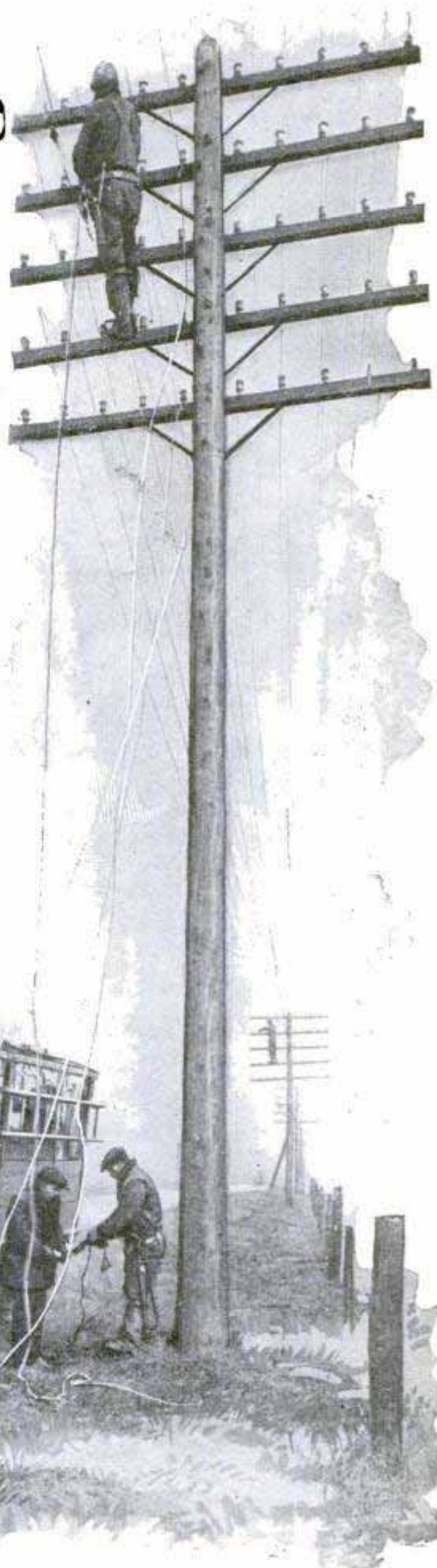



When Snow and Sleet Burden the Wires, the Linemen Must Maintain Constant Patrol

drag down hundreds of single wires and put the entire service out of commission, whereas the cable may be pulled down and lie on the ground without interrupting a single conversation.

But the aerial cable has acquired a new list of enemies all its own. Birds perch on it and some thoughtless hunter takes a shot and peppers the cable full of shot, causing a flock of short circuits. At a distance of thirty or forty feet, a shotgun pellet will penetrate the lead sheath and cause considerable damage. Trouble from this one source reached such alarming proportions in one district of southern Illinois a few months ago, that the telephone company was forced to enlist the aid of newspapers in half a dozen adjoining counties to print a general appeal to the public not to shoot birds on the phone wires.

Squirrels have a natural affinity for lead and love to try their teeth on it. Whenever overhead cables run through squirrel country the linemen get frequent calls to repair the damage they do. Sewer rats in the cities frequently eat their way through the lead in the underground conduits.

There was a time, a few years ago, when a tiny parasite which lived largely on a lead diet threatened to ruin the telephone-cable business, but investigators found a mate-

winter struck a pick into some hard object, and, in a blink, 2,000 phones in the business district went out of service. A big job for the repair crew—patching and reinsulating 2,000 pairs of wires.

For the main long-distance lines, cables, suspended from poles, are replacing the individual wires of the past. The worst damage from wind, sleet and other natural causes is thus averted. A sleet storm may

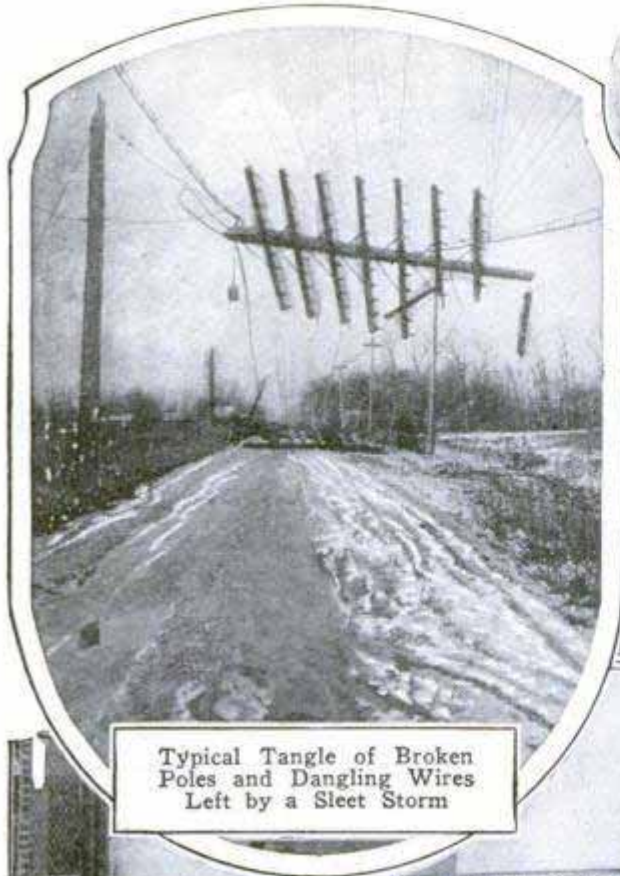

Typical Tangle of Broken Poles and Dangling Wires Left by a Sleet Storm



Lineman Using a Radio Set to Locate a Faulty Joint in a Buried Cable

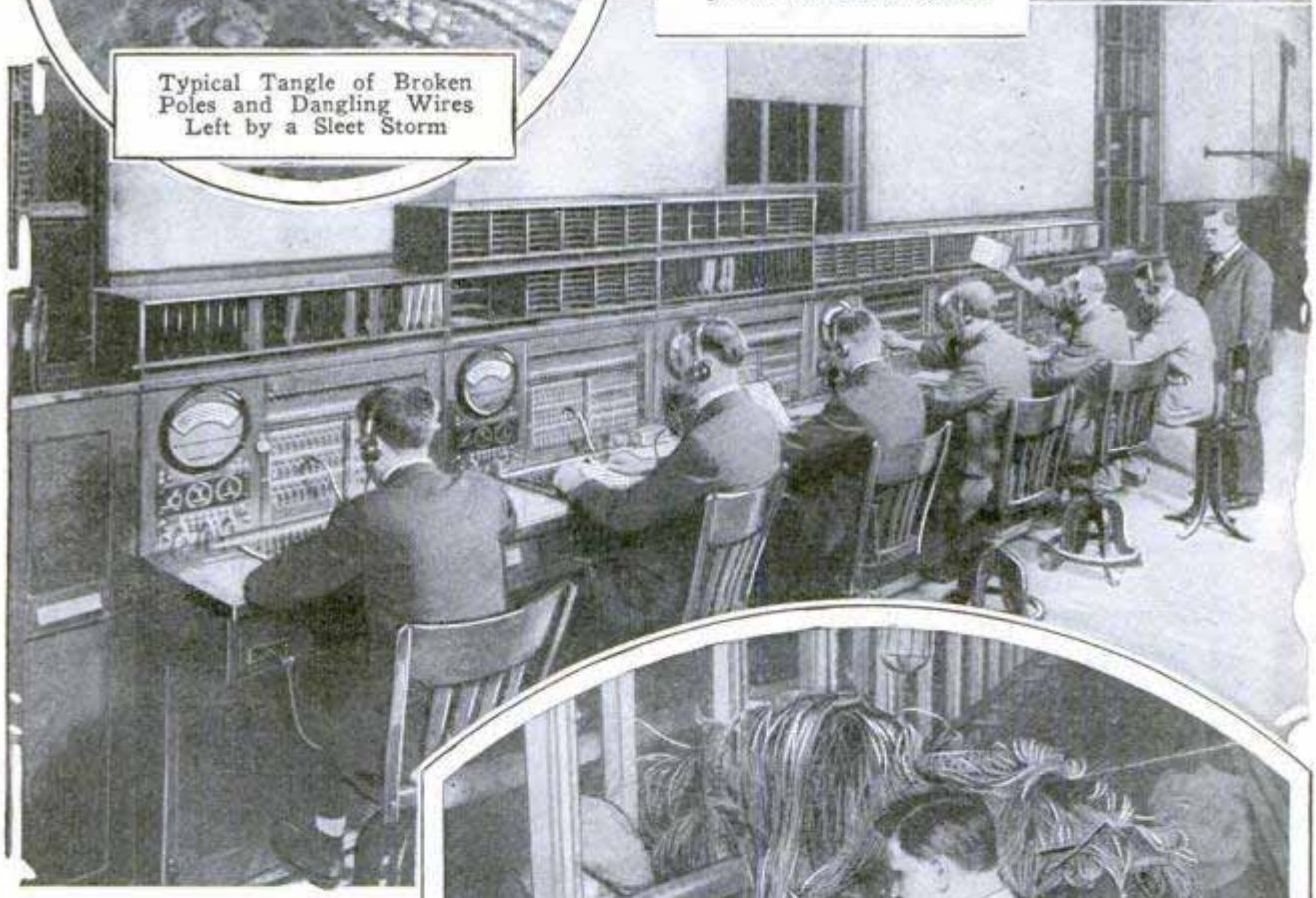

Above, a Long-Distance Test Panel in a Big Exchange, Where Experts Check the Condition of All Circuits, and, in Case of a Break, Determine Its Location; at Right, a Lineman Is Splicing 2,200 Pairs of Phone Wires in One Cable



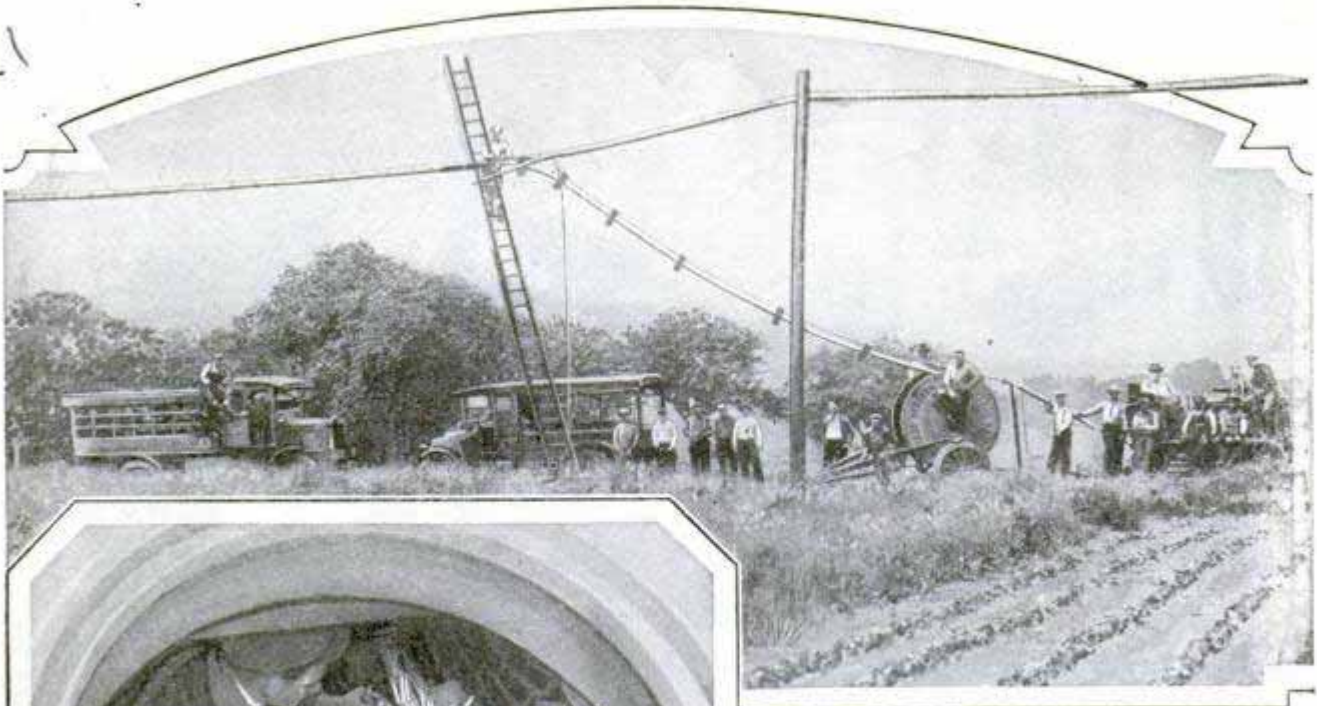

Stretching a Lead-Sheathed Cable, Above; Left, a Worker in a Manhole, Patching Wires beneath a City Street

leaving the equipment in a hopelessly tangled mess.

When that happens, it is cheaper to go into the district with new poles and new wire and erect an entire new system, than try to repair the old. Ice storms are the most destructive of all the natural foes of the telephone wire, since they usually extend over a considerable area. Damages of five to

rial the parasite didn't like and used it in the inner insulation, effectively curing the insect of the cable-diet habit.

The cost of keeping the nation's telephone lines working runs into untold millions each year. Every long-distance line is divided into sections, with their repair crews and trouble doctors, just as a railroad has dispatchers and section men to keep it open and in order. In the mountains and the northern states, where snow often buries the overhead wires in winter, the patrol crews, using snowshoes, skis and dog sleds, must be on constant watch. Near the end of winter sudden temperature changes may turn rain into sleet and freeze an ice coating over the wires. In one such disastrous storm northeast of St. Louis, a year or so ago, it was estimated that two tons of ice froze on single wires between poles, pulling the entire network down, breaking the poles off short and

ten millions in a single locality is not an unusual bill to pay for one of the nature freaks that leaves trees and wires coated with a charming film of ice.

Windstorms and tornadoes, while they wreak immense havoc, are usually confined to a smaller area. A tornado may sweep a path a quarter of a mile wide across a state or two, but even so damage is confined to a relatively small space.

To cope with storms, the country and suburban repair crews, mounted on motorcycles and automobiles, have an elaborate organization. At the first sign of storm each man knows what he must do, without waiting for orders from headquarters. He starts patrolling his section, and then calls in and reports conditions. If the lines are down and no report can be made, he begins repair work immediately, and the office, getting no report, sends help to the scene.



*A. W. Mr. Wehler*  
*634. no address given*  
*95.*

### HAWK DROPS SNAKE ON LINE THREE TOWNS GROW DARK

When the electric lights went out suddenly and left three Iowa towns in darkness, the "trouble shooters" immediately investigated while service was being restored from another generating station. Stretched across the high-tension lines and burned almost to a crisp was the body of a two and one-half foot snake. Since the poles were forty feet high, it was considered improbable that the reptile had climbed up. The linemen concluded that it had been dropped by a hawk.

### AIR ELEVATOR TO LIFT AUTOS REPLACES GREASE RACK

One of the advantages claimed for an auto lift that may be operated with air or water, is that it elevates the entire car at once, permitting access to all parts underneath and can be used at service stations too small to allow the construction of an inclined rack of the runway type. A frame of channel iron provides a support for the car and the lift itself is of simple design and easily operated.

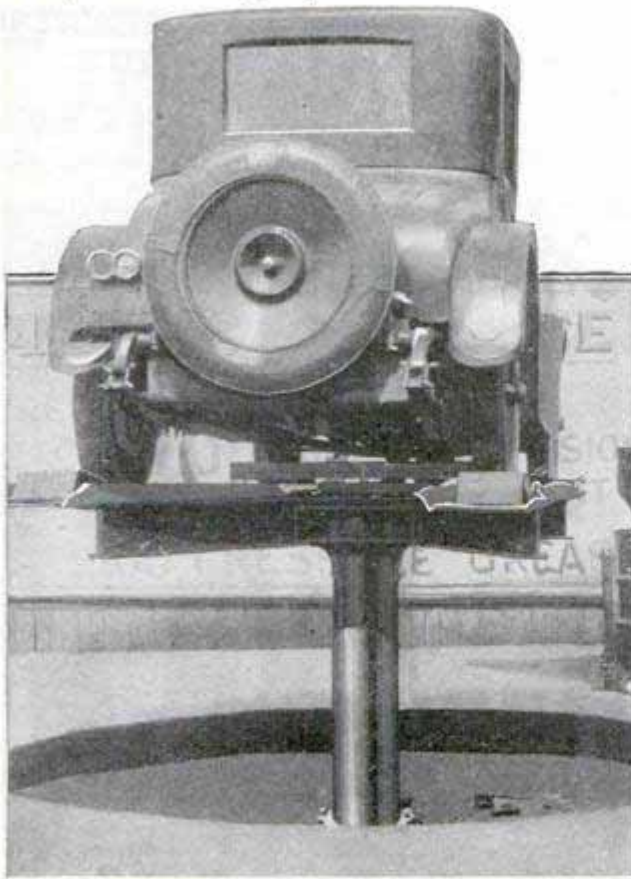

Car Raised on Lift for Inspection or Repair; It Rests on a Strong Platform of Channel Iron

*Cont. L. d. Thomas*  
*700 N. Esplanade*



Descending the Wire Fire Escape; Inset Shows the Grooved Block and Speed Regulator

### SAFETY FIRE ESCAPE ON WIRE HAS SPEED CONTROL

Persons slide safely down a wire in a fire escape consisting of a lifebelt attached to the wire by a wooden block, inside which is a curved groove. The strand passes through this slot and, to regulate the speed of descent, the occupant of the belt has but to adjust a thumbscrew on the block, which is done with a wingnut.

### OLD MINING PROBLEM SOLVED BY AN ACCIDENT

When a painter carelessly upset his bucket in the ore bins of a California mining company recently, he unwittingly exposed an improved method for precipitating the iron pyrites in the minerals, a process which is expected to yield the mining company as much as \$50,000 a year. The paint caused the "foam" on the bins to disappear and the effect was at first considered serious, as the foam had been thought necessary to separate mineral concentrates. Recoveries that day, however, ran twelve per cent higher than usual, for the paint contained linseed oil and kerosene, ingredients that proved effective agents in the process.

*at Catalina, Calif*  
*Owned by William*

6 14



Rare Specimen for Bronx Zoo, the Shoebill Stork from Africa; It Occupied a First-Class Cabin

**SHOEBILL STORK FROM AFRICA  
ADDED TO BRONX ZOO**

One of the best treated passengers on the steamer "Tymeric" was a rare shoebill stork from Africa, said to be one of the only five that have been captured in the last thirty-five years. It had a first-class cabin next to the captain's quarters on the bridge deck. The room was kept at a constant temperature of seventy-five de-

grees and the bird was fed regularly on fish. Except for two days of seasickness, it stood the voyage well and was in good condition when it arrived at the Bronx zoo. The specimen was caught, when a young chick, on the upper Nile and nursed until it could stand the trip to America.

674 **OUR "UNLUCKY" COIN**

Thirteen occurs in various combinations on the quarter dollar, not the Liberty piece, but no one considers it unlucky to possess the coin and there is really no mystery about the thirteen. It happens to be a repetition of the symbolism adopted for the flag and other insignia to represent the thirteen original colonies. The quarter's face shows thirteen stars surrounding the head, the words "quarter dollar" contain thirteen letters and, on the reverse side, there are thirteen stars above the eagle's head. The motto "E Pluribus Unum" contains thirteen letters, the lower part of the shield on the eagle's breast has thirteen stripes. In the sheaf held in the eagle's left claw are thirteen arrows and the olive branch in the other bears as many leaves.

*New York Times 10/3/26*

**FOLDING OUTFIT FOR DRAWING  
HAS SPACE FOR TOOLS**

585 Room for tools and matter to be copied is provided in a box under the board of a

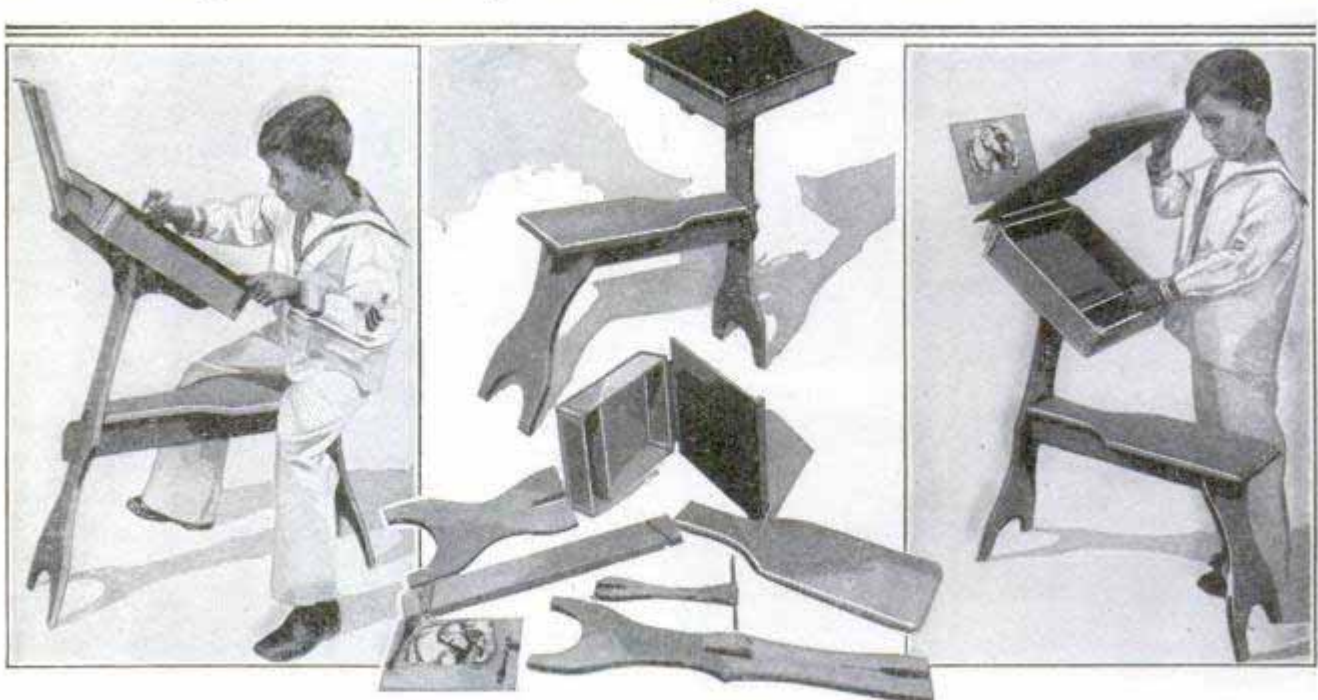

Junior Artist's Studio in One Unit; the Combination Drawing Board, Locker and Seat, and How Pieces Can Be Taken Apart and Reassembled; Holder for Copy at Top of Board

drawing outfit that can be knocked down when not in use and packed away in a small space. At the top of the board is a holder for fastening pictures or drawings.

EARS IN VAULTS  
FOIL ROBBERS

631

One of the latest means of foiling the burglar is an alarm system actuated by sound waves picked up by a sensitive microphone within a vault or other place to be protected. It is so adjusted that the ordinary sounds of traffic, voices and other disturbances do not affect it, but the sharp tap of a hammer or the boring of a drill will instantly start the mechanism. The vibrations are relayed to an electrical circuit which rings a gong or other signal, set where the alarm will receive immediate attention, but cannot be heard by the cracksman who probably will work on, unaware that he has fallen into a trap.

One of the advantages claimed for this arrangement is that it eliminates the complicated wiring required for many types of alarms, and it has been developed to such a point that false signals are not likely to be sent. This has been accomplished by careful balancing of the microphone to receive only the noise of chiseling or hammering, sounds that have a sharply defined wavelength.

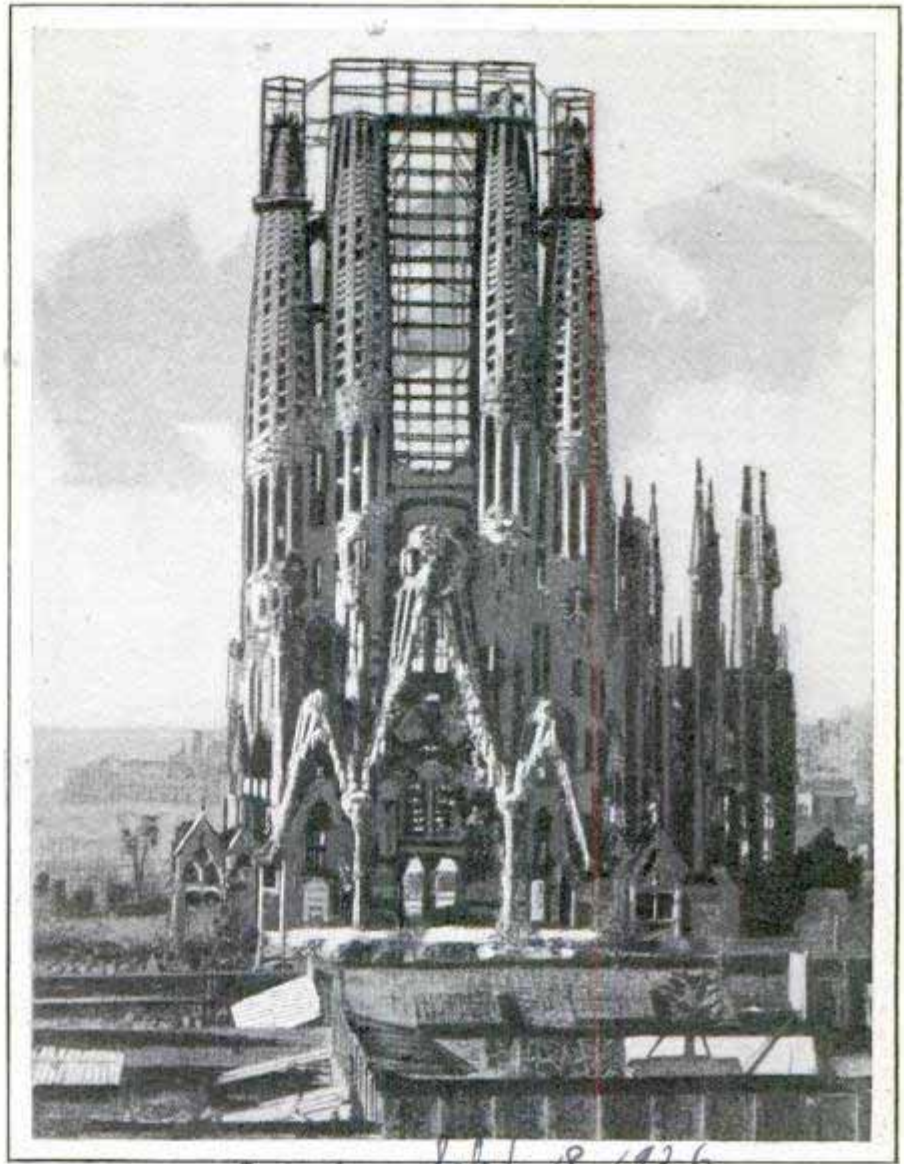
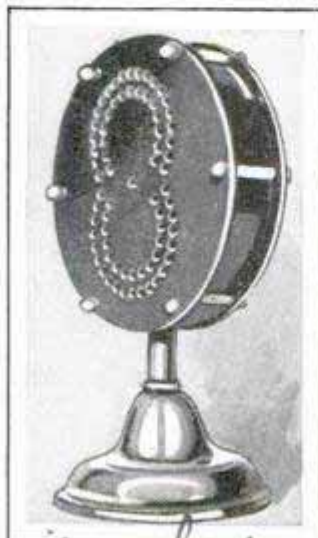

Courtesy The Sphere, *Q 639, Sept. 18, 1926*  
An Unfinished Dream in Stone; Weird, Curving Spires and Arches of the Barcelona Cathedral, Commenced Thirty Years Ago

DREAM CATHEDRAL OF CURVES  
SHOWS NEW NOTE IN ART

Eccentricity, some critics declare, is one of the outstanding characteristics in modern art and, to illustrate their point, cite the unfinished Barcelona cathedral, the dream of the late Antonio Gaudi. The designer cast aside many traditions and sought to achieve his effects through a continued arrangement of curved lines and masses. The spires, as commenced, have started to soar upward but are rounded and the open spaces in them are set in a winding line. Lavish ornamentation that follows the same tendency in curves is found in other parts of the structure, which was started thirty years ago. Caricatures of animals in wood and glass mark the work of other craftsmen.

*Underwriter Laborglone  
207 E. Chicago St.*

2040 *Stamp nail to 4540 Palmer St. Chicago*

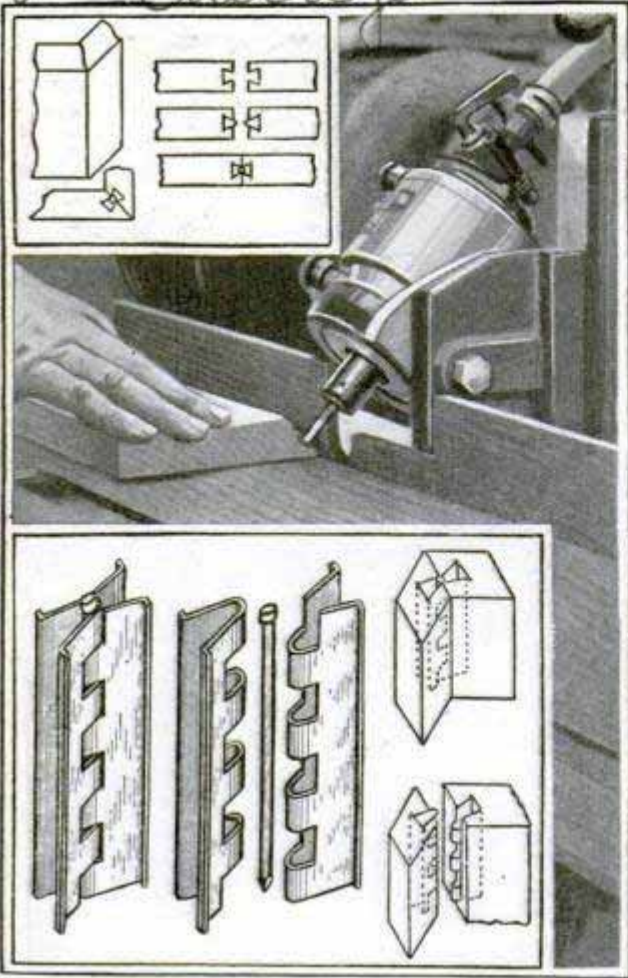

Diagrams Showing How Lock Joints Are Held Together with Nail, and Photograph of Slot Cutting

### LOCK-JOINT WOODWORK KEYS EASILY TAKEN APART

Construction of knockdown cabinets and other similar objects is simplified by the use of steel lock-joint keys that are held together with an ordinary finishing nail. They are inserted in slots which may easily be cut with a spindle routing machine, then dovetailed together and the nail driven in. To take the joint apart, the nail is withdrawn.

### OIL KEEPS DRIFT SAND OFF ROAD

641 Highway engineers in California and Oregon have been using a mixture of oil and asphalt on the slopes of sand dunes near the roads to keep the drifts from

blocking the thoroughfares. Laboratory tests have shown that oil containing from forty to fifty per cent asphalt is best suited to the work. It holds the sand particles together in a heavy mat after the more volatile oils have evaporated. It was found necessary to use not less than half a gallon to each square yard of area to be covered. Following the tests, six miles of highway in the dunes of Imperial county, Calif., have been treated.

### LESSONS IN FIRING DYNAMITE TAUGHT FROM AUTO TRUCK

575 To demonstrate correct methods of handling dynamite and similar explosives in clearing land and for other purposes, the state of Wisconsin sent out an auto truck in charge of two men who gave exhibitions and lessons in half of the counties of the state during a four months' tour. No attempt was made to teach land clearing or stump removal, but stress was laid upon ways and means of safeguarding lives and property. The employment of blasting equipment operated by electricity for long-distance detonating, proper ways to crimp caps, connect fuses and thaw out frozen dynamite were among the principal lessons. The truck was decorated with posters and the driver was dressed in the garb of a woodsman.



The Traveling Safety School the State of Wisconsin Sponsored, to Give Instruction in Firing Explosives

*California Highway Commission*

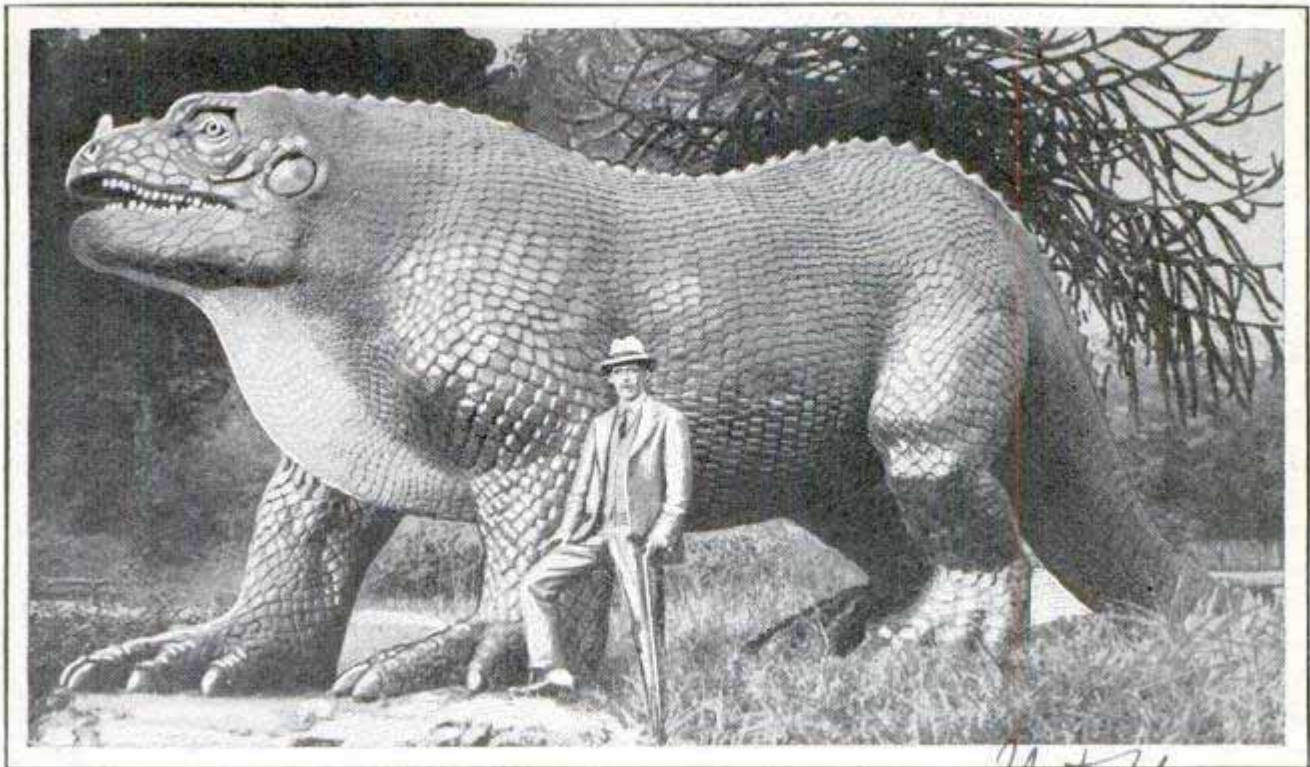

Are Monsters like This Still Alive? Col. H. F. Fenn Is Standing beside Replica of Prehistoric Beast, Such as His Expedition Will Hunt in Congo, Where Natives Declare Huge Creatures Can Be Found

**LIVING MONSTERS ARE SOUGHT IN WILDS OF CONGO**

Africa is a land of secrets, and one that has engaged the thought of explorers for many years is the possibility that in some of the remote wilds, huge beasts, long extinct in other parts of the world, are still in existence. Most of these suppositions are based on the tales of natives who declare that they have seen animals of enormous size and strange shapes in the jungles and lowlands bordering the Congo river. Under the leadership of Lieut. Col. H. F. Fenn, a British expedition plans a trip through the wildest sections of the Belgian Congo in search of monsters that may have survived in these fastnesses.

**LAND WIRE LAID BY AIRPLANE FOR EMERGENCY TELEGRAPH**

Successful stretching of six miles of telegraph wire from an airplane in eight minutes by Swedish engineers suggests a new field of usefulness for flying craft in war, forest surveys and emergencies of many kinds. One end of the wire was attached to a marker and when the plane reached the point where the connection was to be made, the cable was cut from the reel and, weighted, fell to the ground where it was

picked up and attached for sending a message. The actual laying of the wire took but six minutes. The connections were made in two.

**CLOTHING BAG ON AUTO SEAT HAS COLLAR POCKETS**

Attached to the back of the front automobile seat, a bag inclosing a hanger holds a suit of clothes and has pockets for collars, ties and other accessories. The cover fits securely over the contents, to keep out dust and prevent wrinkling.

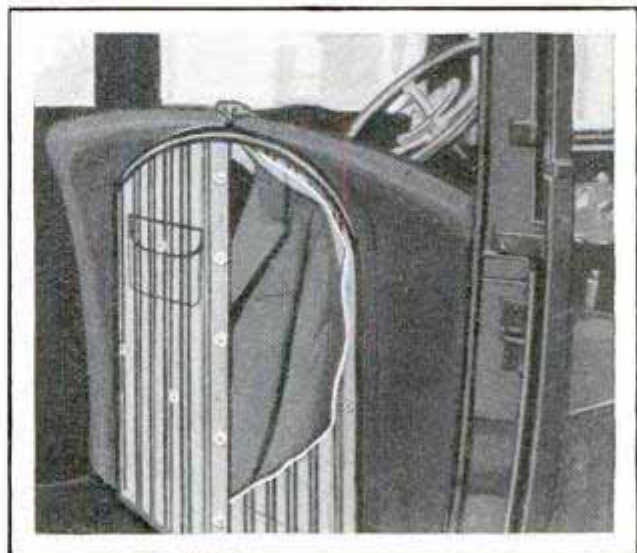

Suit Hanger Adjusted on Back of Automobile Seat; It Has Pockets for Collars and Other Accessories

*Capt. Edwin Jarvis  
The Harragut. 10 P*

*Cincinnati Auto Specialty  
Co. 312 Main St. 11-1*

390

# Do Animals Think?

## Brains Differ and Many Species Show High Intelligence, but Stage and Circus Tricks Are Seldom Based on Natural Aptitude

By J. EARLE MILLER

**T**O one who has spent a lifetime handling everything from elephants and lions to the proverbially silly geese, there is plenty of evidence that most animals have mental ability," says Albert E. Parker, superintendent of the Lincoln park zoo, of Chicago. But, he adds, the evidence on which the average person would base that claim—the clever tricks seen on stage and in the circus ring—is not worth considering. For stunts by the animals are usually based on tricks of the trainer.

Down in the bear pits at Parker's zoo is a big grizzly that probably would tip the scales at around a half ton, an inveterate peanut beggar. Most of the peanut feeders frequent the hill above the rear of the den, where they can drop the nuts without throwing them through intervening bars. The grizzly long ago learned to sit up and beg for them, and with a desire for more comfort, found he could

convert himself into an animate rocking chair by catching his rear paws with his front claws and rock back and forth on the tip of his spine. He learned that trick for himself—a sign of reasoning.

The animals in the lion house, which contains, in addition to a fine collection of jungle kings, a varied assortment of the cat tribes, including Royal Bengal and Siberian tigers, black leopards from Asia, spotted leopards and American mountain lions, are fed six days a week, four days on beef and twice each week on liver. The beef is accepted without much notice, but on the liver days—liver being a highly-prized delicacy—there is a terrific uproar as soon as the keeper enters the building with his baskets. That, to the uninitiated, looks like intelligence. As a matter of fact, however, it is merely well-trained noses that can smell liver fifty or a hundred feet away.

"It is hard to tell offhand," says Parker, "what is intelligence and what is not in trained animals, since a trick on the part of the trainer is more apt to be respon-

"Mustang," a Four-Footed Boxer Who Has Been Trained to Wield the Gloves, Sometimes Forgets in the Clinches and Starts to Use His Teeth

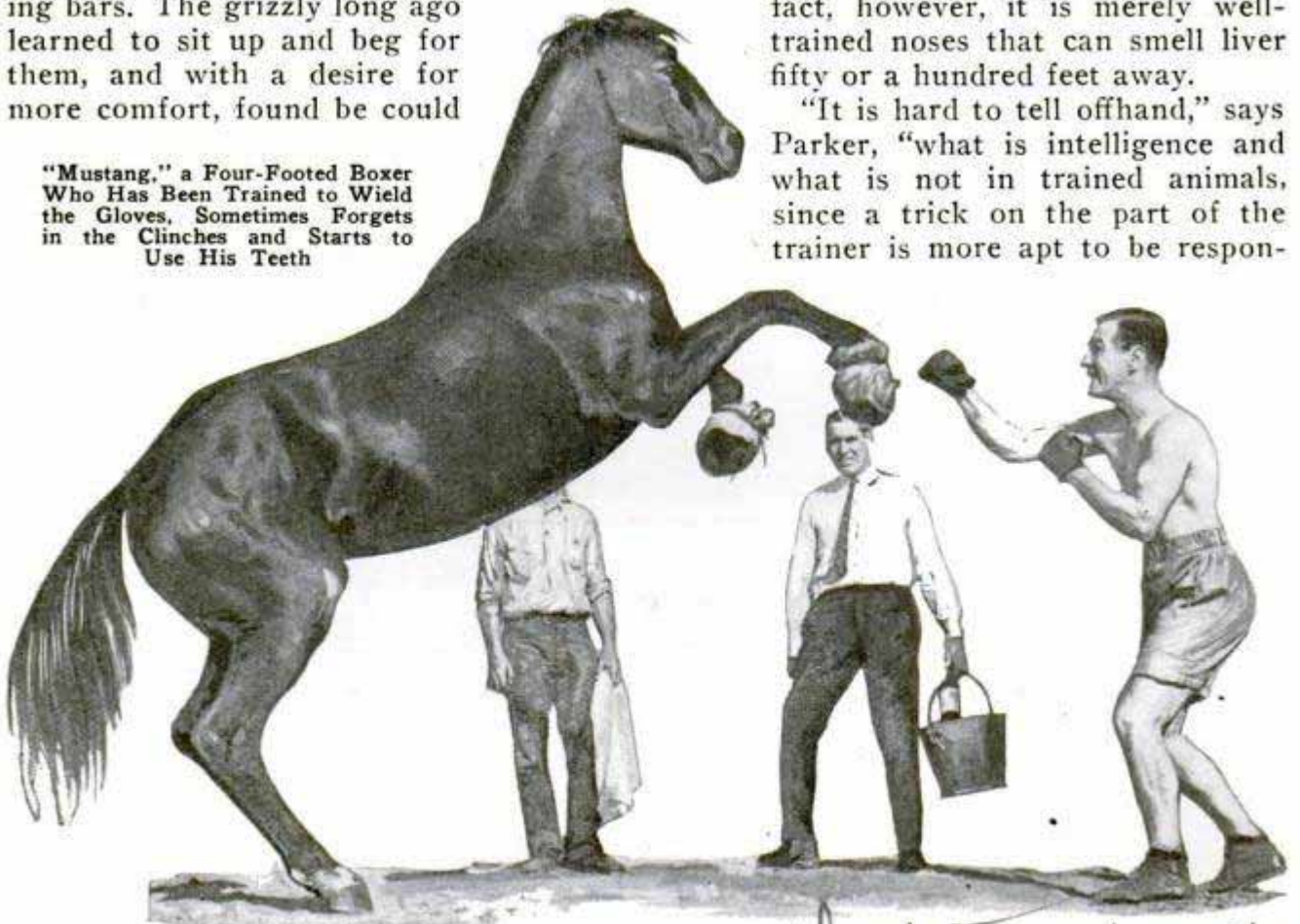

*International*

The Hippopotamus Is Probably the Hardest Animal of All to Train, Because It Is So Dumb That It Requires Months of Patient Effort to Get a Single Idea under Its Thick Skull

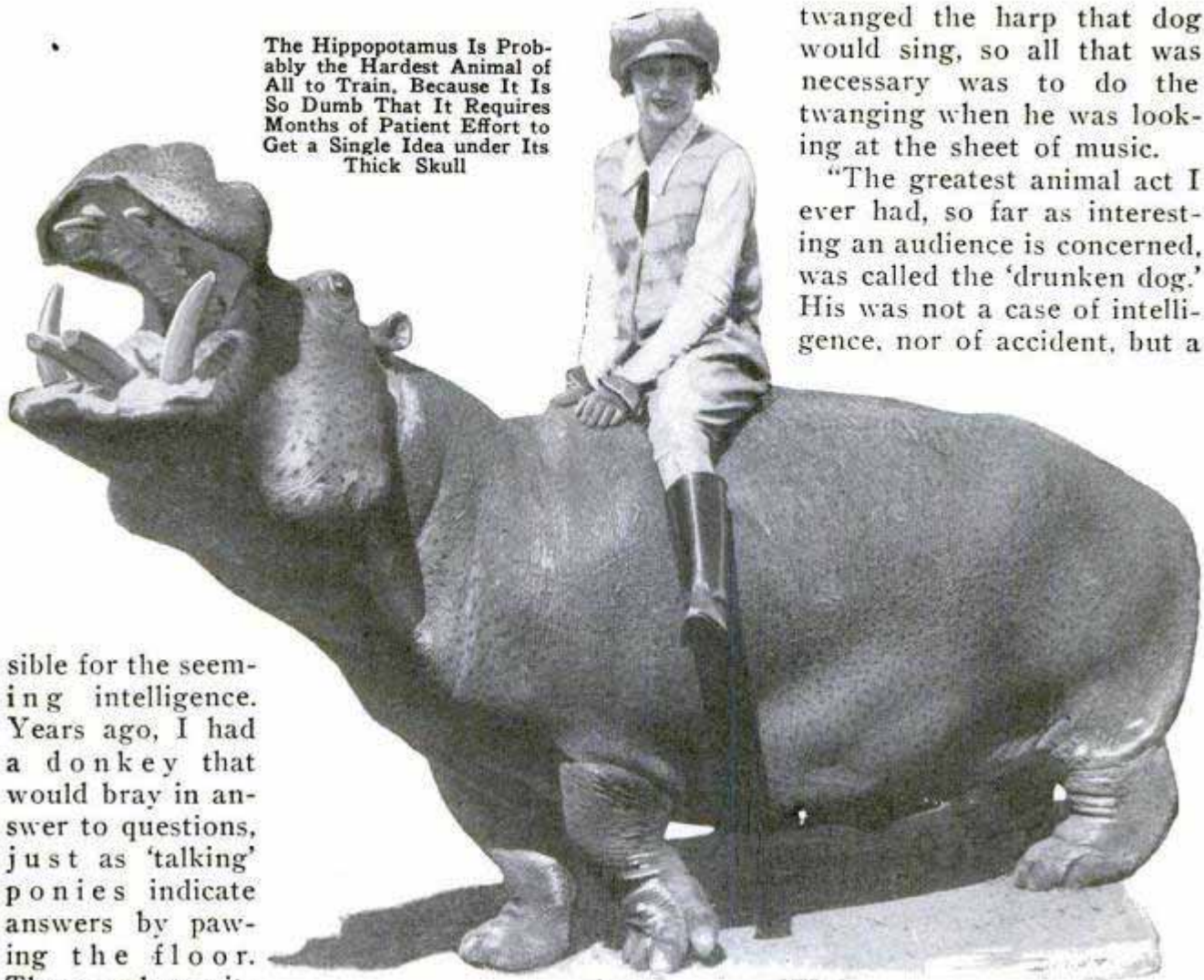

sible for the seeming intelligence. Years ago, I had a donkey that would bray in answer to questions, just as 'talking' ponies indicate answers by pawing the floor.

Those who witnessed our 'conversations' thought the donkey was wonderfully intelligent, whereas it was all a trick. One day I was sandpapering a board and, when the donkey heard the rasping sound, he started to bray. All I did to polish off the act was to glue two pieces of sandpaper to boards, making them easier to handle. A confederate, stationed behind a barrel, rubbed them together at the proper time and the donkey brayed.

"Another of my animal acts was a singing bulldog. When I held a piece of music in front of him, the dog threw back his head and began to howl. Then I would turn the paper over, show him the blank side, and he would remain quiet. Or, for variety, I would ask someone in the audience to lend me a newspaper, and demonstrate that it had no effect on the dog; he sang only to music. The secret was the accidental discovery that, like many dogs, his ears were extremely sensitive to certain sounds, notably that of a jews'-harp. So long as I or an assistant

twanged the harp that dog would sing, so all that was necessary was to do the twanging when he was looking at the sheet of music.

"The greatest animal act I ever had, so far as interesting an audience is concerned, was called the 'drunken dog.' His was not a case of intelligence, nor of accident, but a

trainer's trick. When the curtain went up, it disclosed an empty stage, with a small building, marked saloon, against the right wing. The dog came from the left, walking on his hindlegs, carrying a tin cup attached to one paw. He walked across the stage, entered the saloon, and in a moment reappeared, with his cup bubbling over with froth, while with a foolish expression, he ran his tongue over the outside of his jaw, as if licking off the last drops. He would walk a few steps, sit down and lick his jaw, get up and walk a few more, and then do the same performance over again.

"The explanation is simple enough. It takes about half an hour to teach a dog to walk on his hindlegs, and that was the hardest part of the act. The cup was tied to his paw, so he couldn't drop that. When he entered the saloon, I was waiting in the wings with a piece of paper smeared with bacon. I quickly rubbed that over his jaws and nose, filled the cup with cotton to represent froth, turned the dog



A Baby Elephant Taking a Pair of Lion Cubs Out for an Airing and "Snooky," the Chimp, as a Photographer; at Bottom Is Another Elephant Stunt. These Are Among the Most Intelligent Animals

around and started him back across the stage. Trying to lick off the bacon grease, of which he was fond, he would run his tongue around his jaw, and, finding it too difficult to walk on his hindlegs and reach the grease on his nose, he would squat down for a moment, and then get up and proceed a few steps, as I, having run around to the opposite wing, motioned him to come on.

"In another act a black leopard mounted a ball and rolled it across the arena. This performance was the result of an accidental discovery that he liked to climb on things and exercise his claws, so I built him a ball, covered it with canvas, and let him climb on. As he clawed, the ball rolled. If I walked toward him with the whip, he tried to back away, rolling the ball away from me, and if I backed up, he rolled it toward me. Most ball rollers, like juggling sea lions, are similar accidents.

"A good part of the work of training animals or birds for the stage or circus revolves around chance discoveries; you observe some peculiarity in your subject and then build your act around it. A friend of mine had a big chimpanzee he

was trying to train, and almost gave up in despair because of two peculiarities of the animal. One was that, when he stood up and walked, he threw out his chest in a striking manner, and the other that all the time he walked he kept waving one hand up and down.

"I was called upon for advice, and after watching the chimp solved the problem. We dressed him in women's clothes, his chest expansion adding to the illusion, shaved off his hair to give him a smooth face, painted it with clown-white, daubed on two big red spots for cheeks, and then tied a lace handkerchief to the waving hand. When he walked across the stage, waving his handkerchief at the audience, it brought down the house—a marvelous exhibition of intelligence, the audience believed. Later the trick was improved by walking the animal backstage before his act until he was fairly tired. The result was that, when he

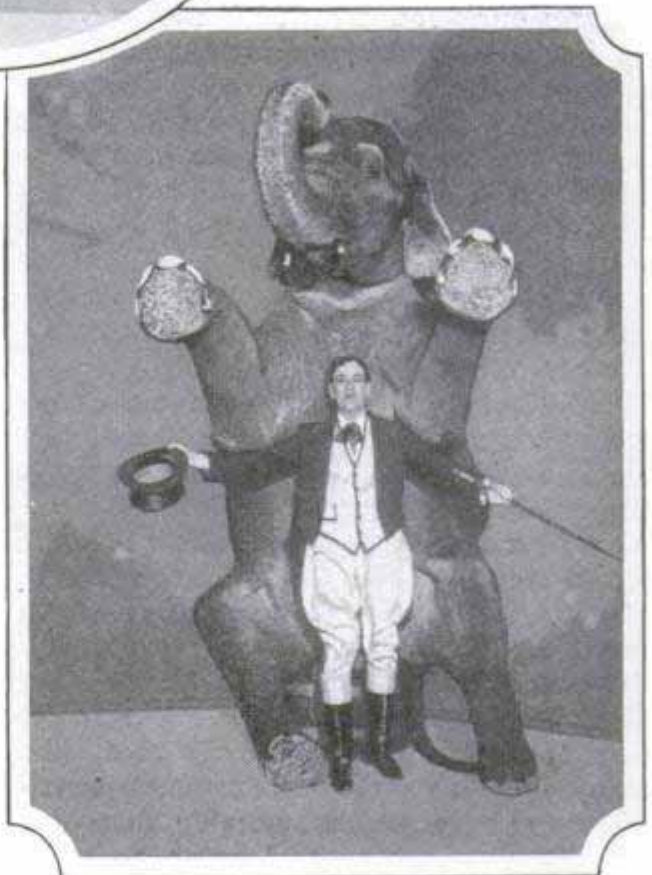
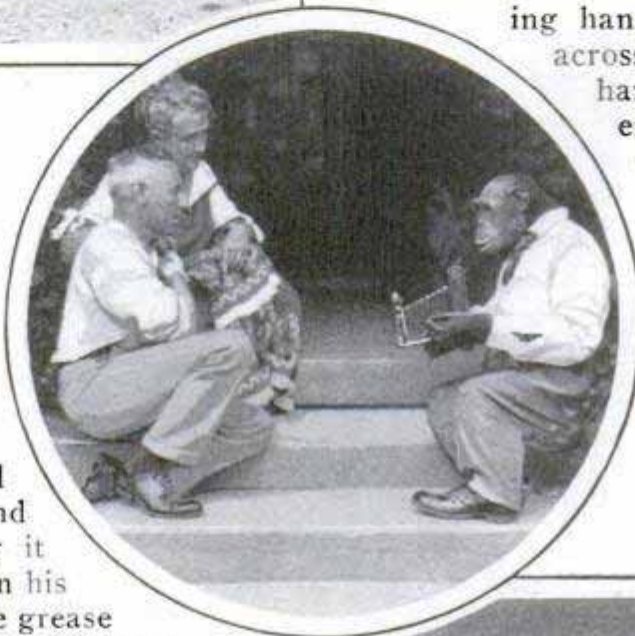



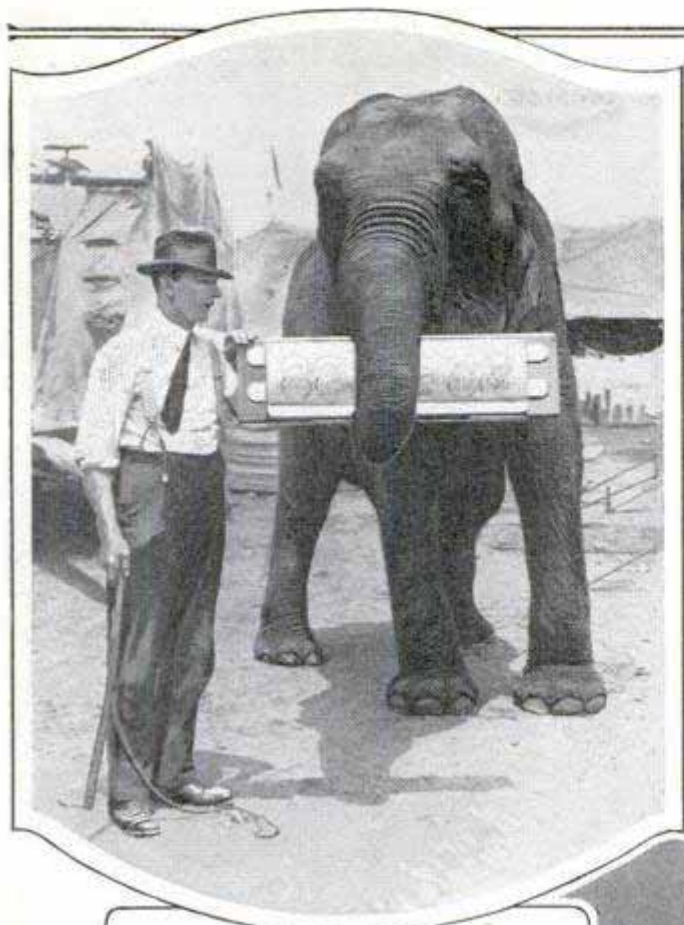

The Big Queen of a Circus-Elephant Herd, Tries Her Lung Capacity and Tongue on the World's Largest Harmonica

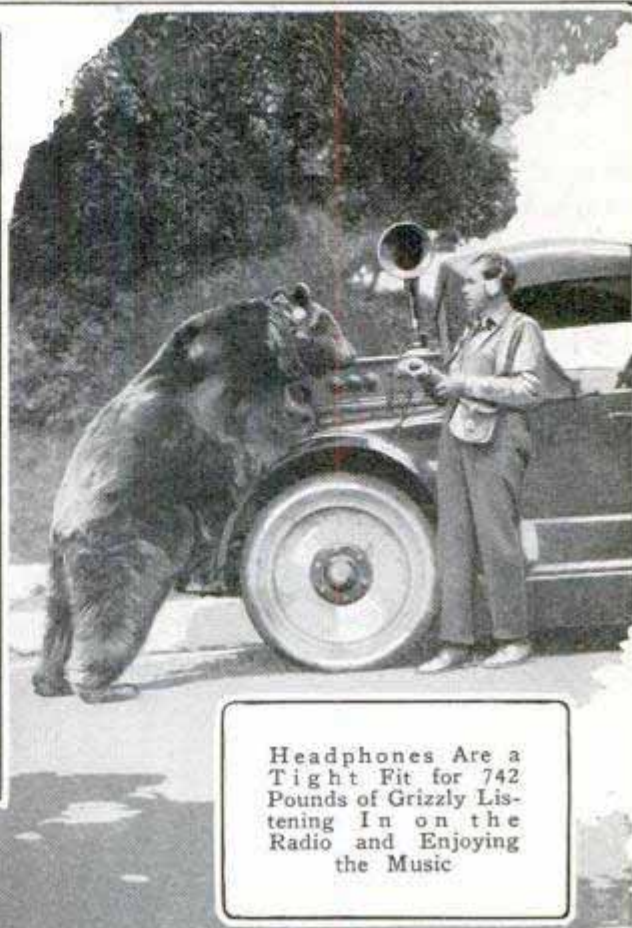

Headphones Are a Tight Fit for 742 Pounds of Grizzly Listening In on the Radio and Enjoying the Music



At the Left, in Shirt Sleeves, Is Superintendent Parker, of the Lincoln Park Zoo, with Billy, One of His Trained Chimpanzees, Who Dresses Himself, Rides a Velocipede and Shows Other Marks of High Intelligence; Above Is a Fighting Kangaroo Trying His Tail Spring at the Circus Winter Quarters

started across stage, he would walk a bit, then sit down to rest, all the time waving the handkerchief.

"One of the circus novelties in recent years has been a young hippo ridden either by a monkey or a boy. The hippo is very dumb, too dumb to train, but will let you place a load on his back, and will then follow a keeper around, particularly if the keeper holds out a bit of food. But take the keeper away, and the hippo wouldn't work, for he hasn't brains enough to be trained to go through an act alone.

"A hippo born in captivity, by the way, is better for that stunt than a wild one, for like most animals so born, it has not the intelligence of the native jungle beast. Animals, in their various grades of intelligence, run quite a lot like people. The fellow who has had everything brought to him during his life isn't apt to be quite as quick a thinker as the one who has had to scratch for a living. Animal trainers have found that it is cheaper to pay \$800 or \$1,000 for a jungle-born lion cub to train than to accept a cage-

born one as a gift. The jungle cub who has had to fight for his own living is far more intelligent.

"Training, by the way, has changed remarkably in recent years. The old days of whip and tackle have disappeared, principally because training has attracted a more intelligent class of men. About the most severe bit of training nowadays is to withhold a meal or two to sharpen the animal's wits. There again they are very much like humans—they think faster and better on an empty stomach than on a full one. And that, and not a desire to break them by starvation, is the real reason for depriving them of food. You can break an animal by starving it half to death, but you break its spirit, too, and that shows up in your act.

"The usual way is to withhold two or three meals, just enough to give a good appetite, and then teach the act. For example, if you want to train a donkey for a clown act in the ring, and the stunt is to teach him to bump the clown out of the circle, the usual way to go about it is

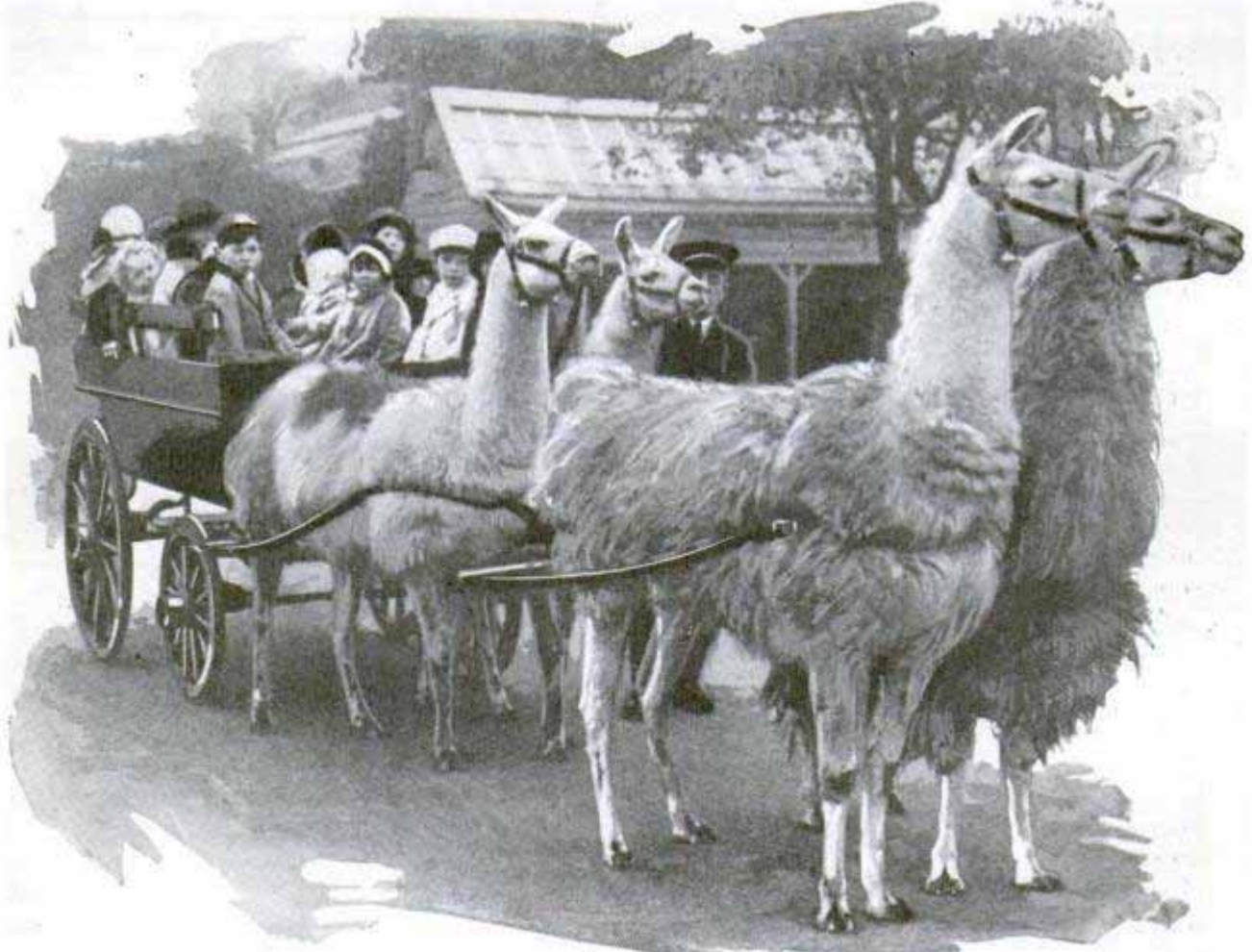

From Pack-Saddle Duty in the High Andes These Four Llamas Have Graduated to Harness and Cart in the London Zoo, Where They Are Used to Give the Visiting Children Short Rides

to start by missing feeding one day. Then the clown smears the back of an old suit with a mixture of bran and molasses, and lets the donkey approach to lick it off. When he arrives, the clown shoves back, bumping the donkey, and the donkey promptly returns the shove to reach the bran, whereupon the clown does his comedy fall. After that the donkey is rewarded with an apple or a lump of sugar. Eventually he associates the reward with the shove, and the bran mixture can be dispensed with.

"Such tricks take only time and painstaking care, and aren't particularly dependent on the animal's intelligence, except that some associate act and reward more quickly than others. All circus and stage tricks, however, become more or less automatic in the animal's mind. They go off well so long as they are performed in a certain rotation, but if the order is changed, the act will be a failure."

623

**COMPRESSOR FOR VALVE SPRING SIMPLIFIES AUTO REPAIRS**

One of the advantages claimed for a valve-spring compressor is that it is self-locking so that both hands can be used to remove collars or keys in dismantling the auto motor. A high ratio of leverage is obtained by means of an operating handle running on a roller against the main bracket. When using the compressor on heads, it is not necessary to remove inlet or exhaust manifolds, as the instrument is applied on the opposite side. It is adjustable to different engines.

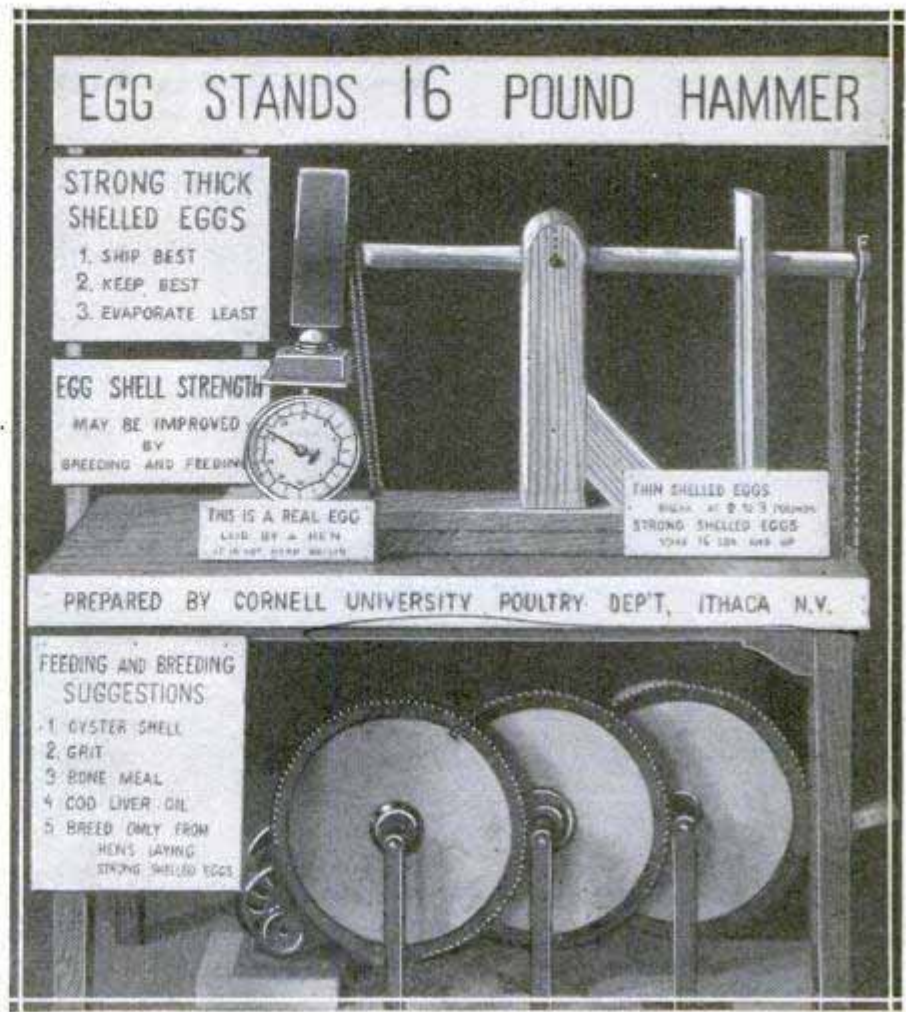

Geared Trip-Hammer Apparatus for Testing the Strength of Eggshells; Force of Blows Was Accurately Measured

**TEST STRENGTH OF EGGSHELLS WITH HEAVY HAMMER**

That eggshells are not as fragile as is commonly supposed has been demonstrated with a testing machine devised at Cornell university. A sixteen-pound hammer is so adjusted that it swings against an egg at the rate of three blows a minute. There was no breakage of the strongest shells at sixteen pounds. Eggs of this quality are considered better for shipping and are said not to spoil so readily.

**BATS AS AID TO APPLE CROP HELP DESTROY MOTHS**

Havoc wrought on apple crops by the codling moth can be greatly reduced by bats, according to one authority. Study of the creatures in the Yakima valley, Wash., showed that moths composed nearly ninety-five per cent of their food. In Texas, bats have been helpful in devouring malaria-carrying mosquitoes.

661 Mr. Charles A. Campbell  
San Antonio, Texas.

W. George E. Beaman,  
myr. & Elmwood St. Mass

WORLD CROSSED IN A STRIDE  
ON MERIDIAN LINE

551



One Step and He's across the World! The Row of Stones at Greenwich, Dividing East and West

Stepping across the earth from the west to the east side or vice versa is a simple matter at the royal observatory in Greenwich. A row of stones with a line carved down their center marks the official meridian where east touches west and on which official time and other calculations are based and furnished to the world.

SHOP-WINDOW DISPLAY TEST  
MADE ON SHOPPERS

609

What type of advertisement attracts the most attention from the pedestrian hurrying past the store window? In an effort to answer this and other questions relative to the effectiveness of shop displays, investigators of the business school at Columbia university made tests with stop watches on persons who halted before pictures, advertisements and other attractions placed in a New York City shop window. The observers were hidden and prepared tables giving the relative attention directed to the different exhibits. Only about one-third of the total number of persons watched glanced in passing. Only

Dr. H. K. Maxon

five per cent stopped for closer inspection. As a rule, women paid more attention to pictures of women, and men seemed more interested in advertisements featuring men. Of twenty pictures that drew the most notice, only half were of figures partly clothed. Children under ten years old showed the greatest interest in the displays. Colored persons of all ages paid less heed than did whites. A young man and a young woman used as decoys proved more effective in drawing a crowd than the window display alone. The time spent in looking at the exhibits varied from one-third of a second to a minute and a half, the average being about eight seconds. Upon the whole, men showed a greater tendency to pause than did women. The place chosen for the experiment was considered representative of a cosmopolitan city neighborhood. An average of eighteen pedestrians passed the window every minute.

SANITARY VENDER FOR BREAD  
PREVENTS DRYING

231

Bread is kept fresh and free from dust in a glass holder, which dispenses one or two slices at a time when a slide is pulled out at the bottom. The container is fur-

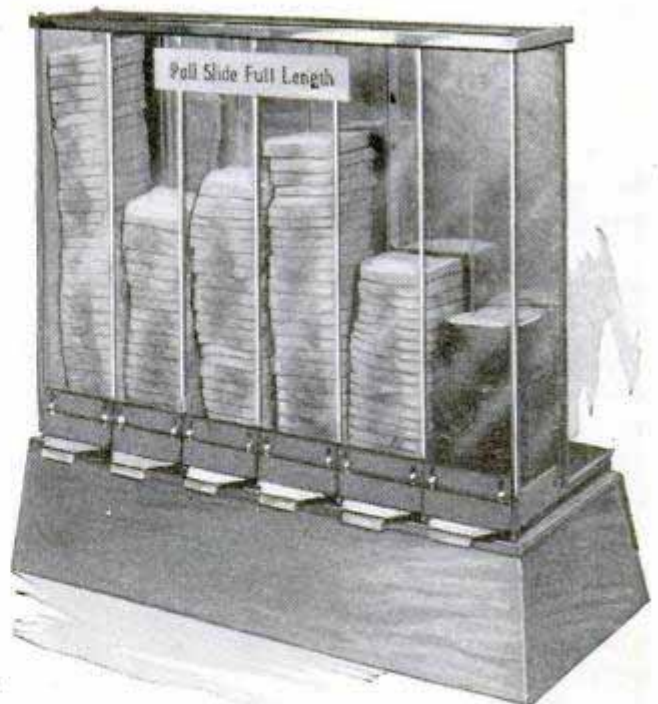

Safe from Dirt and Where Customers Cannot Handle It; Bread in Sanitary Restaurant Dispenser

nished in three, four or six sections, for large quantities or different kinds of bread.

Day Sickle Paints  
Lester Co. Lincoln

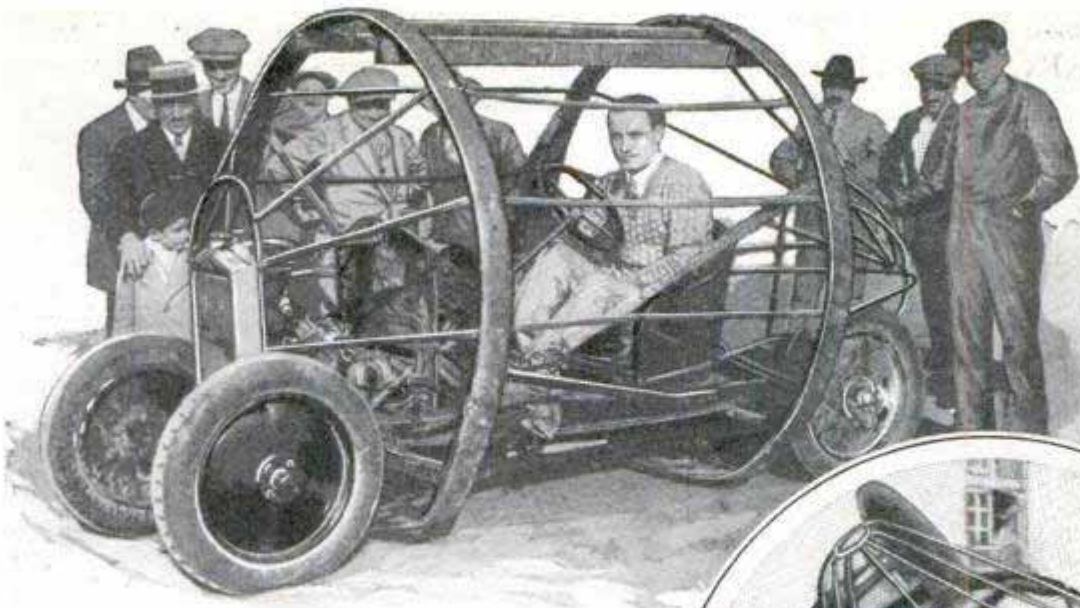

Driver in the Caged Auto, and Photo of the Somersault; the Occupant Suffered No Injury

**LOOP-THE-LOOP IN CAGED AUTO  
LATEST TRACK THRILLER**

*M. Mercier mauborg*

By constructing a cage of steel bands over the top of his lightweight racing car, a French autoist was able to perform intentional upsets and other stunts in comparative safety. While the car was speeding at fifty miles an hour, a twist of the steering wheel sent it turning over on one rim. It landed upside down, but the driver was not injured.

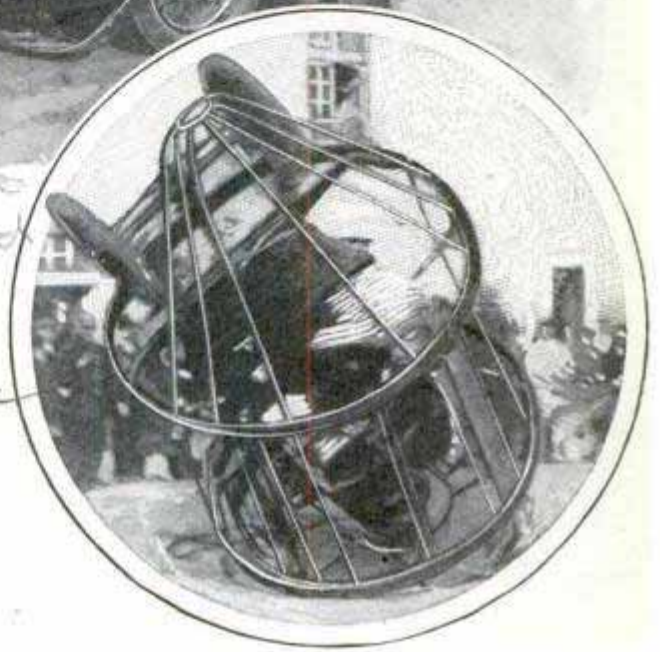

**METALS AS FUEL 710.**

Just as ordinary fuels are used, some metals are burned for the sake of the heat and light they produce. The essential difference in the process is that the products of the metallic combustion are not gaseous but solid. Under certain conditions the burning of aluminum yields sapphires and rubies instead of ashes. Magnesium is used to produce "star" fireworks. A shell packed with the metal and attached to a parachute is fired electrically high in the air. Pieces of this material were em-

ployed during the war. Aluminum has been found to be a good fuel for producing an intense heat for welding. In this field, the metal has assumed industrial importance in this country and abroad, the process being known as thermite welding.

**BULB ATTACHED TO DRY CELL  
CONVERTS IT INTO LAMP 557**

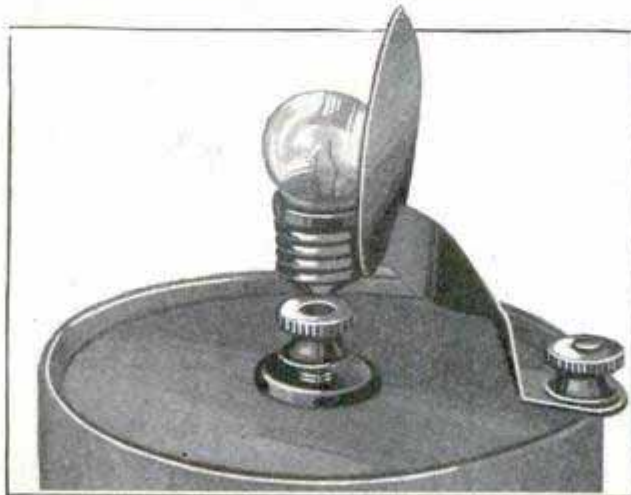

Bulb Attached to Dry Battery; Circuit Is Completed by Pressing Bracket against Center Post

Quickly attached to the ordinary small-voltage dry battery, an electric-light bulb has a reflector that may be turned to focus it anywhere. The fixture, which is patented, is connected to the negative post and the circuit completed by screwing up the nut on the positive post.

*Cml. Edwin Jarvis  
The Faragoys - 1st 100*

*John M. Abramson  
630 - 174 1st St.  
Brooklyn, N.Y.*

Walsh, Bishop's College  
Calcutta, India

3 E. 17th St  
New York  
2240

PAPER PETALS TELL WEATHER  
BY CHANGING COLOR

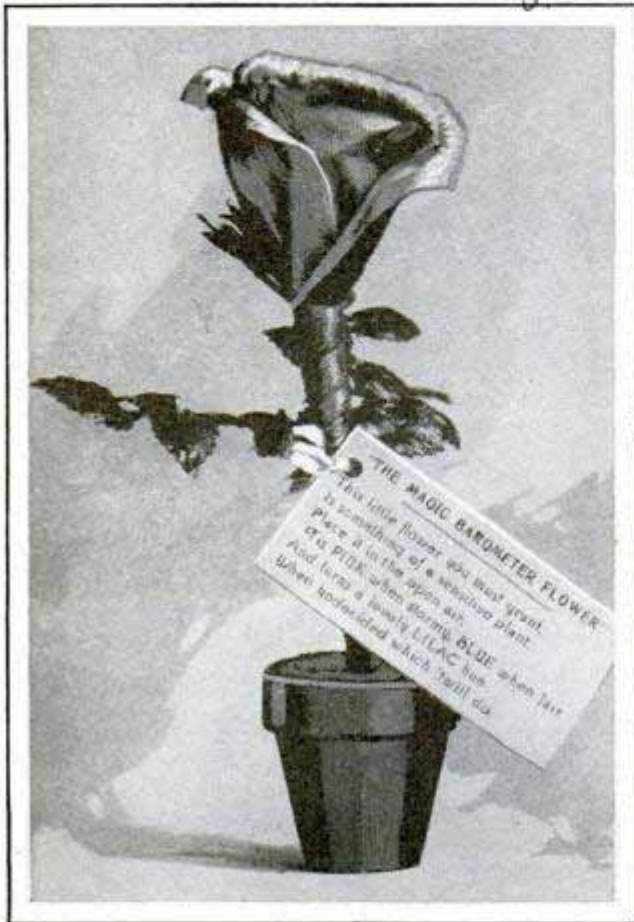

Chemically Treated Paper Petals of This Imitation Blossom Change Color to Indicate Weather Changes

Imitation flowers with chloride-of-cobalt treated petals, which change color with variations of the amount of moisture in the atmosphere, have appeared recently. They are an adaptation of the chemical hygroscope invented some fifty-five years ago. In dry weather, the flowers are bright blue, but when the air is moist, they change to a pink and assume a dull lilac hue during intermediate conditions.

WOOD-WHEEL SPOKE WASHERS  
PREVENT ACCIDENTS 556



Loose, squeaky or otherwise unsafe wooden wheels on autos or other vehicles are tightened with washer-shaped units snapped around the tenons of the spokes.

To adjust them, a small jack is centered between two spokes and screwed up until the felloes are lifted sufficiently to permit putting the tighteners in place.

CHILDREN LIVING IN WOLF DEN  
FOUND IN INDIA

Two little "wolf girls," one two and the other eight years old, were discovered near an isolated village in Bengal, British India, not long ago. They were running on all fours and uttering guttural barks. Persons who found them had difficulty in removing them from the wolf cubs with which they were living. It is supposed that the children had been abandoned by their parents and had been reared by the mother wolf. The younger one died soon after the rescue. The elder fought savagely against wearing clothing, which she tore off even after it was sewed on, refused to be washed and ate from a dish with her mouth in it. She neither laughs nor cries and prefers the company of dogs to that of other children.

ADJUSTABLE DIAL MARKS TIME  
FOR DEVELOPING PICTURES

Attached to a wall or shelf edge where it is easily seen, an adjustable timing dial for photographers indicates the period for leaving photos in the wash or fixing bath. Spacing of the hands on the dial is readily changed by loosening a screw in the center of its face.



SILICON IS NEWEST METAL

Not long ago, silicon sold for about \$225 a pound but the price is now fifty cents. The drop is largely due to the fact that the metal is produced electrically at Niagara Falls. It is dark, almost black in color, but shows bright when cut, like lead. It is found in abundance in nature, beach sand, for instance, containing about forty-seven per cent silicon.

Tucher Mfg. Co. 1172 Southwood Blvd  
Kansas City, Kans

Photo  
Pako Corp. 116 St.oughton  
Minneapolis, Minn  
Carbonium Colls. NY  
Magara Falls, NY

Minneapolis Tribune  
10/24/26

574 No data

PROGRESS OF TRANSPORTATION SHOWN BY MODELS

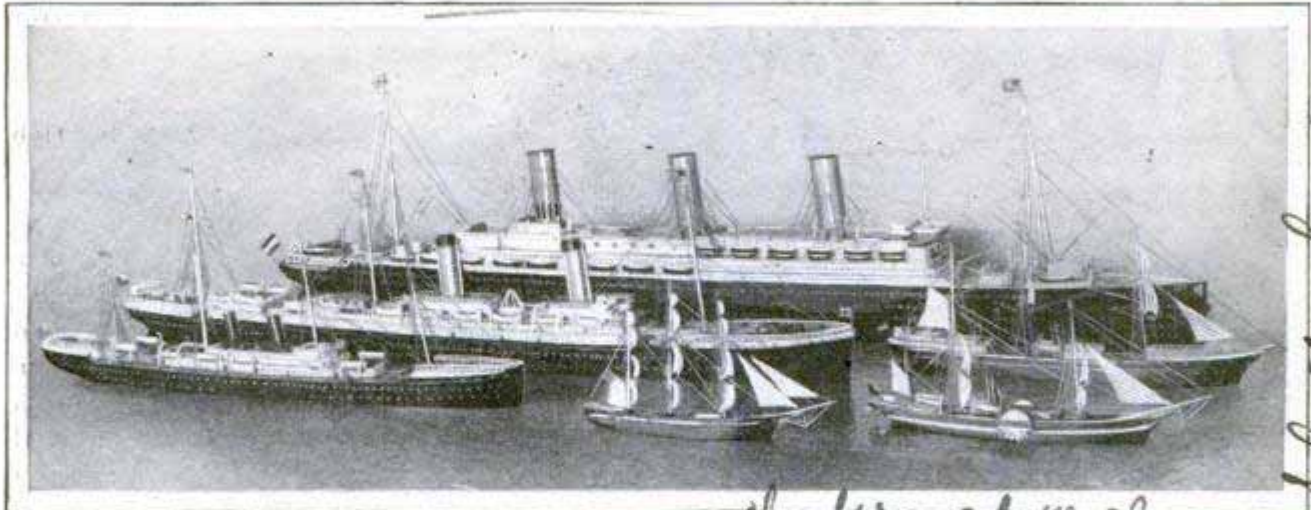

Maritime Progress of Several Decades Seen at a Glance; the Story of Shipping as Told by a Collection of Models from the Days of the Side-Wheeler to the Modern Liner

*International*

*St. Louis, Los Angeles, Calif.*

*Thomas Benton*

The great strides made in providing safe, comfortable and rapid means of travel across the Atlantic are seen at a glance in a collection of models shown in New York. The early years of steamer journeys are represented by a replica of an old side-wheeler, and a model sailing vessel recalls the years of voyaging between the old world and the new before steam was harnessed to ships. In the background is a realistic reproduction of a modern ocean liner.

than its mate when rounding curves. Driving and transmission parts are dust-proof and lubricated under pressure.

TRY NEW PRINCIPLES OF FLYING IN NOVEL DIRIGIBLE

Adaptation of new principles of flying and design, adds interest to the construction of a dirigible by a California inventor and engineer. The method of propulsion proposed for the ship is to remove the air pressure from the nose of the bag and transfer it to the rear, thus effecting a forward movement. The usual type of propeller has been discarded for a many-bladed disk to achieve this purpose. Plans call for a dirigible, 212 feet long and fifty-three feet in diameter. It will hold 242,000 cubic feet of hydrogen gas, and with a gross lift of 17,000 pounds will be able to carry thirty-five passengers. The outer envelope will be of a lightweight metal and the ship is expected to be twenty per cent lighter but will take a payload three times greater than other types of airships of the same dimensions.

695

*Equit*

SILENT GEAR FOR STREET CARS TO REDUCE WEAR

637

Quieter running and longer life for equipment are among advantages claimed for a new type of motor drive for street cars introduced in Switzerland. Instead of the usual arrangement of trucks, there is a middle one with four small wheels to carry the motors which drive two-wheel trucks at each end of the car by means of a transmission shaft similar to that of an automobile. The axles are arranged so that one wheel turns faster

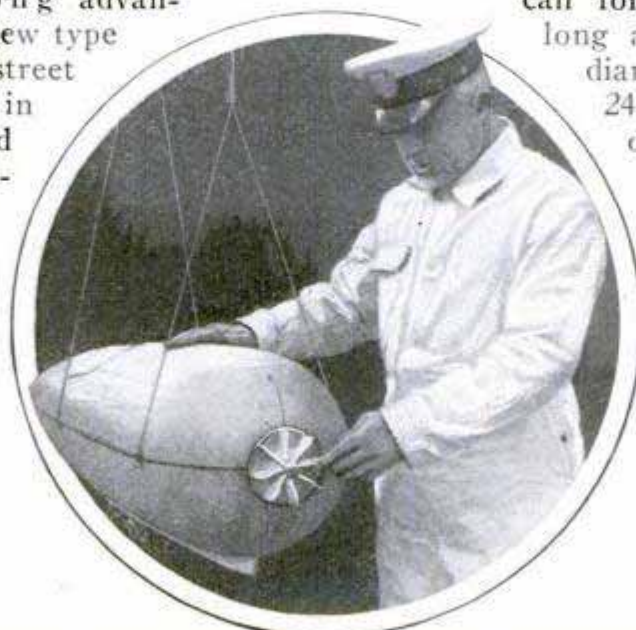

Model of New Style Dirigible with Its Revolving Nose Disk That Supplants the Ordinary Propeller

*Weekly News, New England Bureau of Science, the very best information from the U.S. Dept. of Science*

*Swiss car builder*

180

# New Ways to avoid



Tiny Washing Machine for Apartment Dwellers Is Operated by Faucet Water Power and Is Easily Stored on Shelf

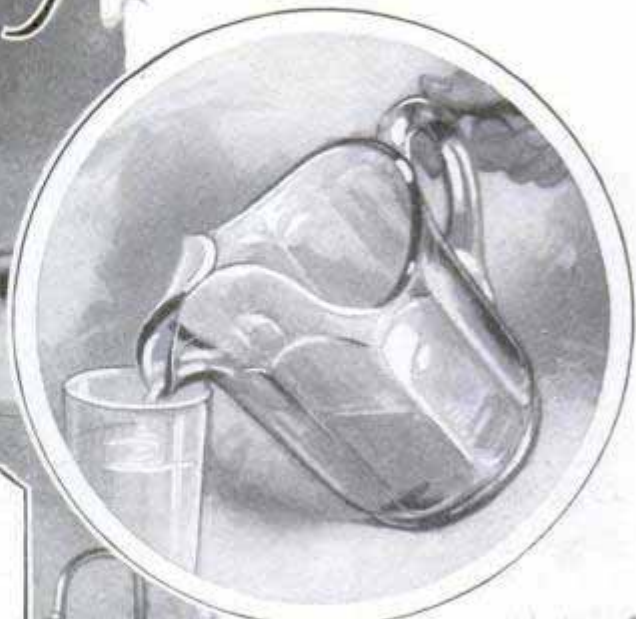

The Partly Closed Spout of This Pitcher Keeps Chunks of Ice from Slipping Out



Two Scrapers in One: Squeezing Handles Bends Blade for Curved Surfaces

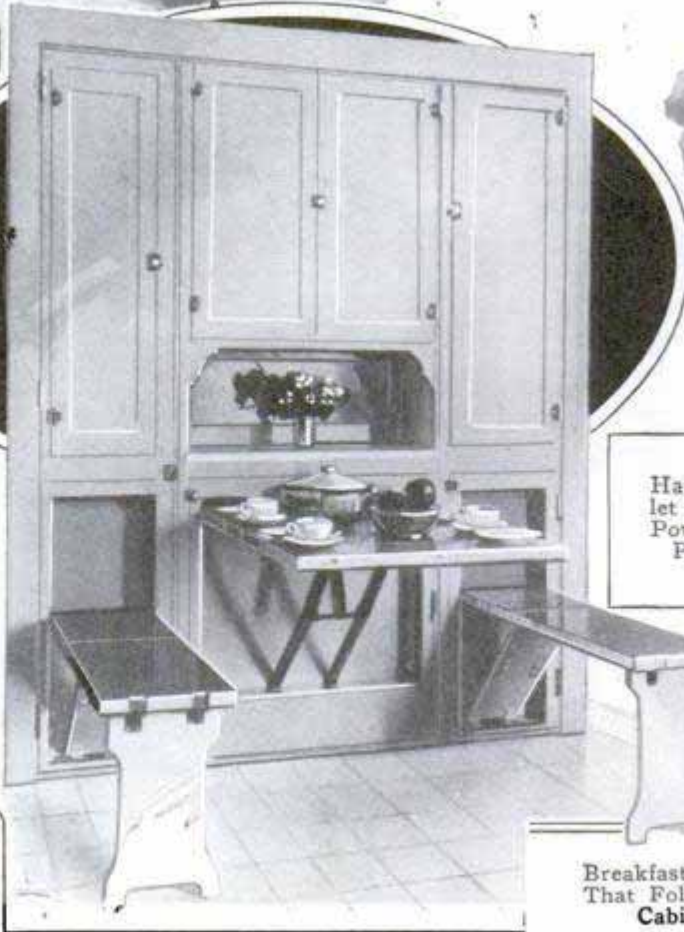

Handle of This Toilet Brush Carries Powder Released by Pressing Button

Breakfast Table and Seats That Fold into the Kitchen Cabinet as Panels



# Home Drudgery

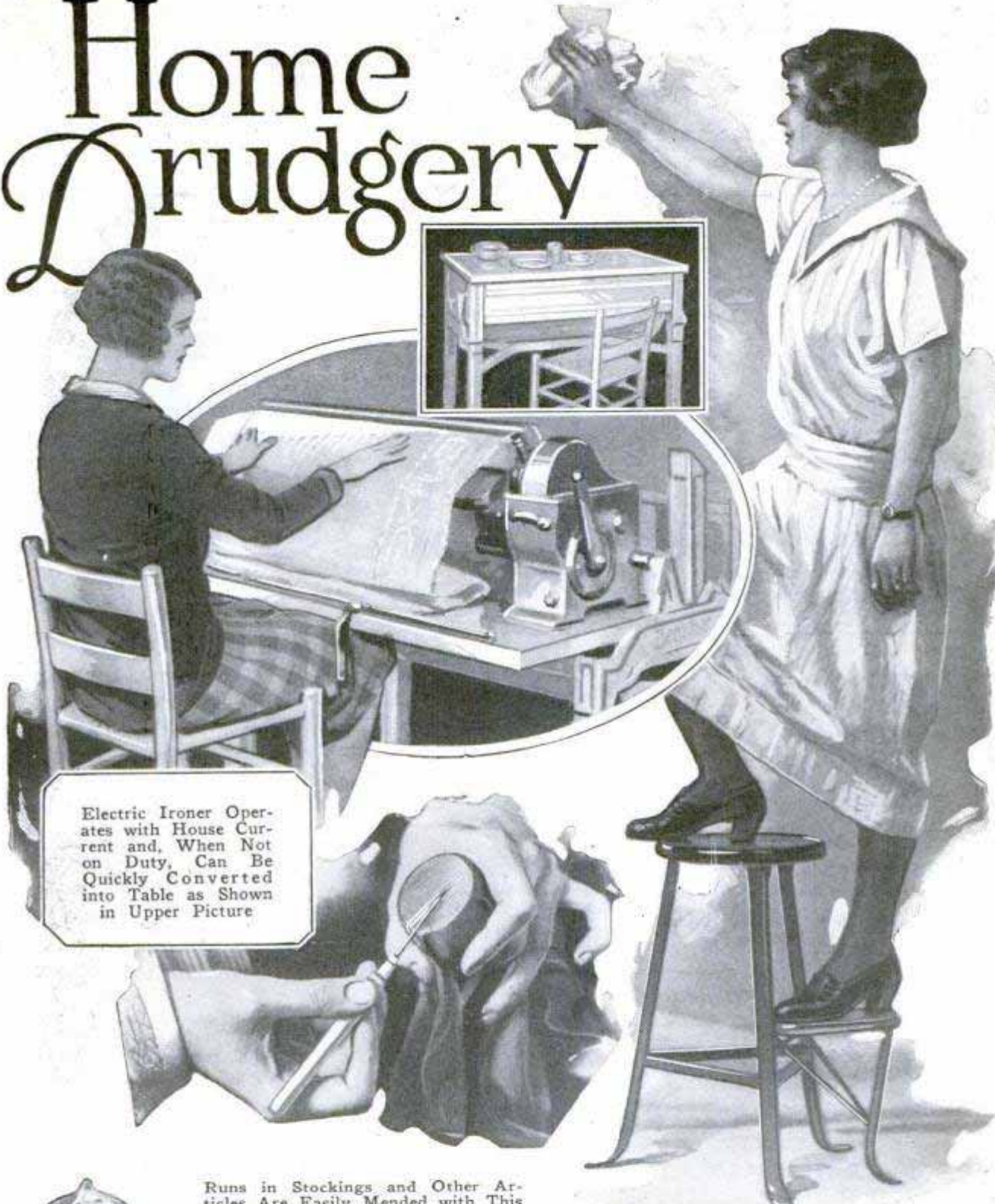

Electric Ironer Operates with House Current and, When Not on Duty, Can Be Quickly Converted into Table as Shown in Upper Picture

Runs in Stockings and Other Articles Are Easily Mended with This Little Needle Outfit

Useful for Many Tasks, This Stool, with Disappearing Step, Has Flat Feet So That It Will Not Tip, and Fits under the Sink



French Salad-Dressing Bottle Is Marked to Show the Proper Proportions of Oil and Vinegar to Be Mixed

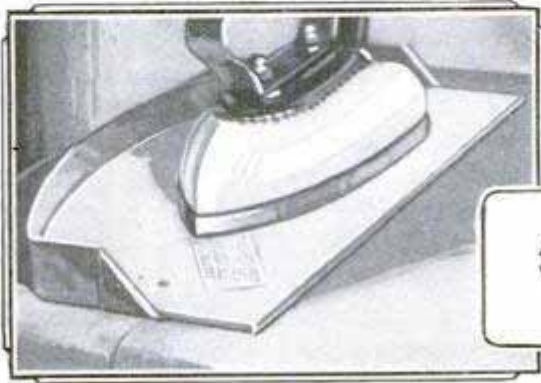

Asbestos Holder Prevents Flatiron from Falling or Burning

obtain it by addressing Bureau of Information, Popular Mechanics Magazine, Chicago.

Com. George A. Davis  
R. 900, 537 S. Dearborn

Chicago

HOUSES OF STEEL AND TURF  
CUT BUILDING COST

554

Cheap, serviceable houses are being constructed in Germany as a solution of the

a plan of action. There is also space for rope, chains and other equipment. The next car holds pieces of timber, ranging from wedges, to be used under the wheels or jacks, to square posts of various

No further information

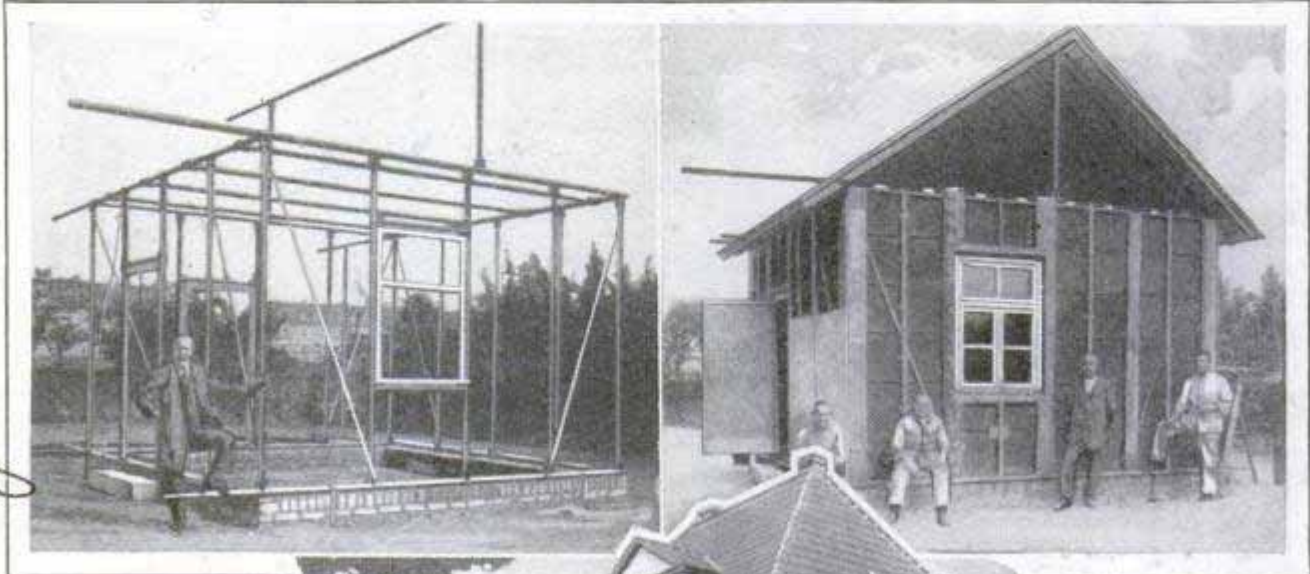

Two Stages in the Construction of the Steel and Turf Houses, and Completed Dwellings Showing Homelike Appearance

dwelling shortage, with a framework of steel and intervening wall spaces filled with turf. This material has proved satisfactory as insulation against heat, cold and wind. As no water is used in the building process, quick possession after completion is possible. As shown by the illustration, the finished house has an attractive appearance.

lengths for propping. Hand tackle has largely been discarded, but most wreck trains are equipped with many sizes of rope, pulleys and chains, strong enough to move a 100-ton weight. The

next car contains two or three sets of extra trucks, with wheels attached, to replace those that may be broken, for these are usually more severely damaged than others. Next to the locomotive, is the crane car on which swings a great steel arm, whose "muscles of chain" will raise fifty tons at a time and guide the load through the air, doing the work of 500 pairs of hands. The life of the wrecking crew is full of uncertainties. Weeks may pass without any call and then several wrecks may occur within a few hours. The train is always stationed near the shops where the men work when not on a wrecking job. They are obliged to reside near by so they can respond quickly.

WRECK TRAINS ALWAYS READY  
LIKE FIRE ENGINES

Always prepared for emergencies, the wreck trains maintained by large railroad systems are kept on switch tracks near the main line, and often the fastest locomotives are in the engine house with steam up ready for a rapid run to the scene of trouble. A train may consist of four or five cars and the track on which they stand is kept clear at all times. The rear car is generally occupied by the crew and officers who may hold a consultation on the way to a wreck to map out

(Fifty gallons of alcohol were produced from one ton of straw in England.

Com. Edwin Jansie  
11 Dearborn

10 p.

### HOW VOICES FROM SEA GUIDE SHIPS TO PORT

Great liners are being guided by means of a "leader cable," sunk in the ocean bed, the electric signals from which warn of dangerous channels. A message in Morse code is sent along the line and is received as a "musical singing note" in the "ear" of incoming vessels, a sensitive instrument hung over the sides for the purpose. The sound is conveyed by telephone to the navigating officers who are assured they are on the right course by following the directions from the cable voice. Experiments have been made with different-colored lights on the bridge illuminated by current sent through the cable, but, so far, the speech signals have been found more practical.

### BEEES ARE KEPT IN GLASS HIVE TO STUDY THEIR HABITS

Investigators at the Smithsonian Institution and visitors are able to watch how bees build their combs and store honey, for the swarm is housed in a glass hive which permits a close view of them at work. The 40,000 members of the colony go about their duties in apparent disregard of spectators. A glass chute leads to the food supplies outdoors and a ventilating system for the hive is provided.

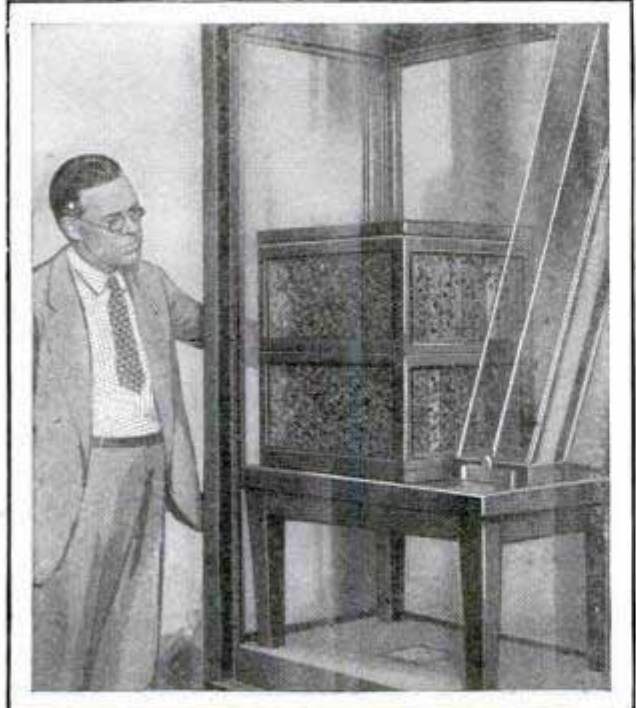

Bee Colony in Glass Home; the Chute at the Right Leads Outdoors; Traffic Rules Were Soon Enforced

*H. L. Lawton, in charge of hive*

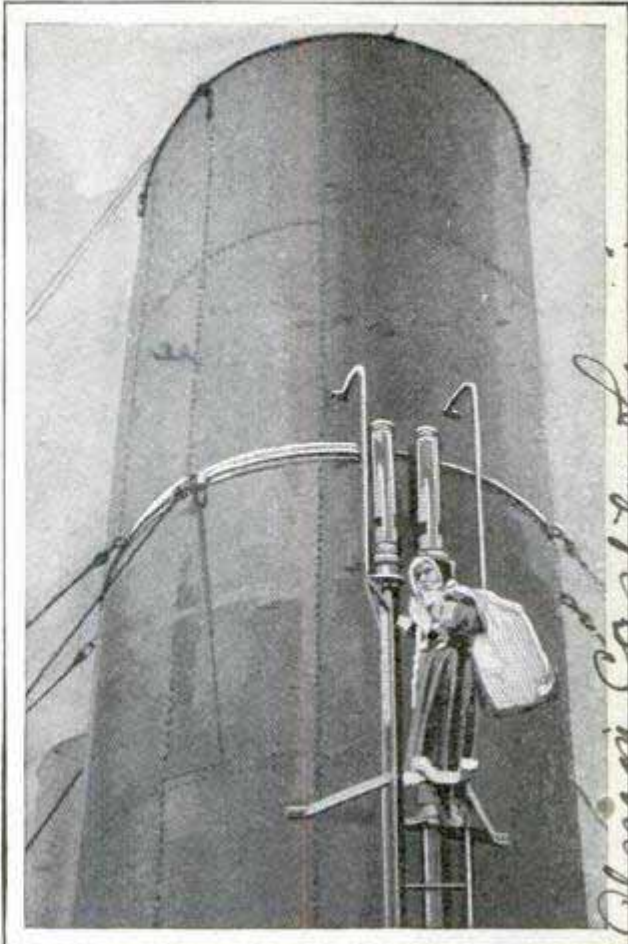

Proof That Santa Does Not Forget Ship Passengers; How He Got over the Top Is a Mystery

### STEEPLEJACK AS SANTA CLAUS CLIMBS LINER'S FUNNEL

Being far at sea does not prevent ship crews and passengers from observing Christmas in the traditional manner. The massive smokestack of the steamer "Arun-del Castle" tested Santa's ability as a climber, but the accompanying photograph indicates that he arrived safely with his pack of presents.

### PHONE AMPLIFIER IN SUBWAYS AIDS IN CALLING STATIONS

Guards in a New York subway are able to make themselves heard in announcing the stations, in spite of the roar of the trains, by speaking through an amplifying telephone arrangement. The transmitter is plugged into a slot conveniently placed, and the voice, greatly clarified and strengthened, comes out through receivers concealed in the roof of the car near the doors. Talking in an ordinary tone, the guard can be heard in all parts of the car and even on the station platform.

*Conf. Edwin Tarise  
The Harraguf*

*Arundel Castle liner  
Shipping World, 12/30/25*

1701

*news, coming in...*  
*Isardon Hotel,*  
*Washington, D.C.*

# The LATEST

*Written* By CORLEY McDARMENT *Isardon Hotel*  
*Washington, D.C.*

"MOTOR trouble!"

There lives no pilot so hardened to air work that his heart does not wobble just a little when the splutter of a gasping engine dies out completely and leaves him alone in the silence of space. No silence is so tragic as that of a dead airplane motor. The snap of a control wire or the crack of a wing spar cannot give a thrill like the death rattle of an engine. A motor literally talks to an aviator. Its steady hum is like honeyed words of good cheer, saying, "Be not afraid; I'm up here with you, and all's well."

But nothing on earth or above it is more useless than a dead engine. An aviator with a silent engine is just an unfortunate mortal floating around in the clouds with a seven or eight-hundred-pound chunk of iron strapped to himself, and it is like being in the middle of the ocean with a millstone tied to the left ankle.

As long as motors are as complicated as they are today, trouble will always occur. Much time, money and genius have been spent on designing simpler gas engines since the advent of the automobile, and since the rise of aviation, costly designs, born of experimental research, have followed one another feverishly in attempts to build a fool-proof aero engine. An auto engine may quit at any time, but the motorist is only delayed in his journey and can often rest beside the road while the car is being repaired. But an aviator's journey is too apt to be ended, sometimes forever, by the simple failure of an engine part.

If such troubles could be eliminated, it is estimated that the cost of commercial flying would be cut at least eighty-five per cent. The failure of a motor with the resulting "forced landing" so often costs the value of a whole airplane. One stump or a sapling can turn a \$50,000 airplane into a piece of junk. A pilot seldom is compelled to meet with stumps or saplings if his motor is working. Of thirty-five fatal airplane wrecks which took place in the U. S. Army Air Service, where more flying was done than anywhere else last year, eleven were known to be from motor failures.

A pilot who lives through an accident never says "motor trouble," except to the uninitiated, but he more often says: "I threw a 'con' rod," "my oil line broke," "the gas line clogged," or "lost my water." He seldom says "ignition trouble," but is more specific with such as, "broken distributor finger," "a short from the battery," or "the wire to number twelve cylinder came off."

Parachutes have done much to help locate specific causes of engine failure, especially when fire breaks out. As an example of a thrilling escape from a burning plane when a piston breaks, the following, taken from the official report of an aviator, who



Propellers of Large Bomber and Small Sport Plane

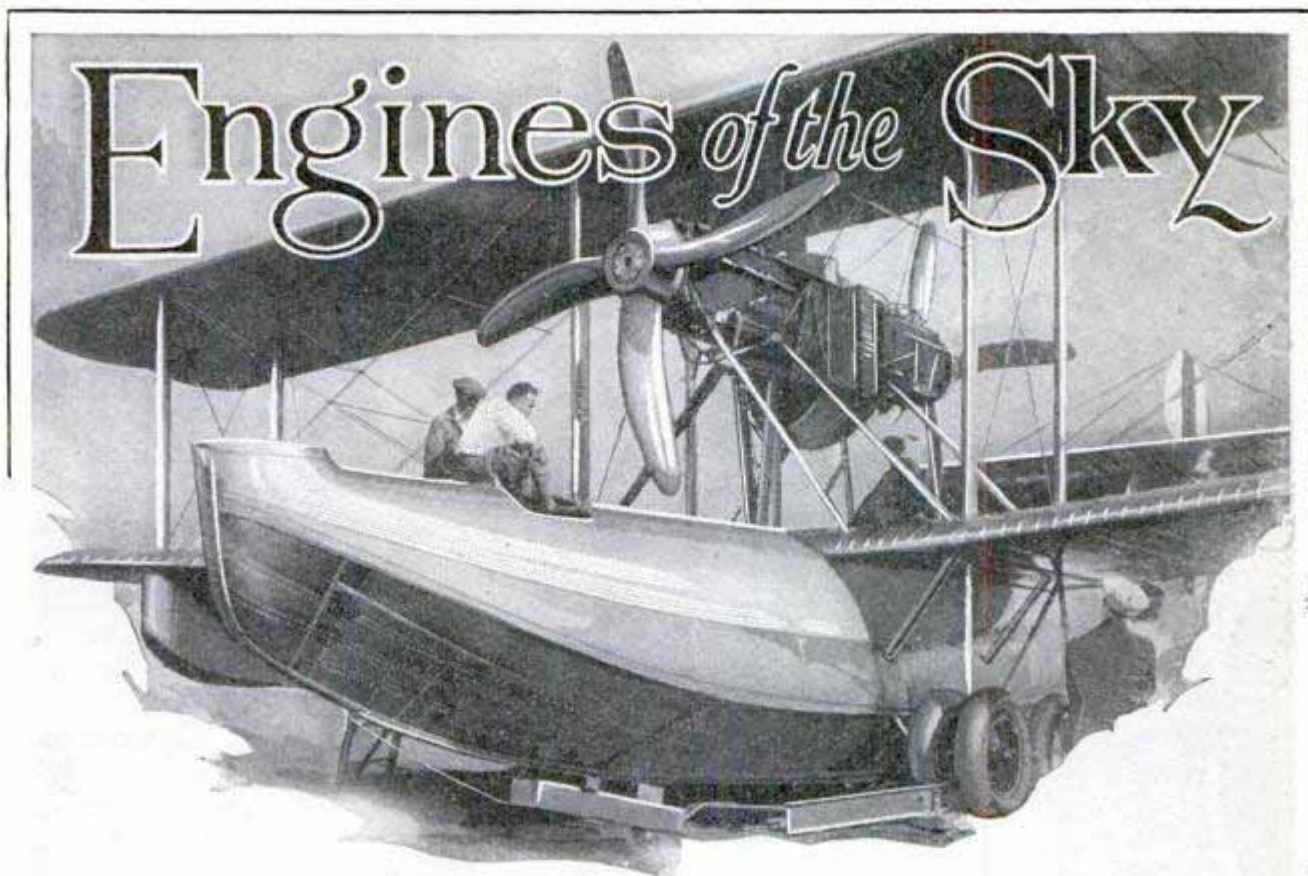

Tandem-Engine Mounting on a Huge Seaplane, with Two Four-Bladed Propellers, One Being Used to Pull and the Other to Push; This Ship Was Used in the Flight to Hawaii

jumped over Lake St. Clair, is quoted:

"I took off about 8:55 a.m. The motor spluttered as usual until the plane cleared the ground; then with motor wide open and running perfectly, I started to climb to join the formation, which was about one mile east of the field at about 1,000 feet. Just before getting in formation, they did a ninety-degree turn to the south. I banked around to join them and, as I did this, a lot of steam came back into my face clouding my goggles. I looked at the temperature gauge and it was about seventy-five. I opened the shutters and

throttled down a little. Then I noticed a tin-pan noise in the engine, as if it was greatly overheating. The formation then did a 180-degree turn and I pulled around to fall in and, as I did, more steam came into my face and I noticed a lot of smoke coming from the front lower part of the cockpit. I immediately put the machine in a dive, intending to land.

"As I pitched over into the dive, the front lower part of the cockpit seemed to burst into flames. The flames started licking me in the face, and knowing I was not very high and unable to see anything because my goggles were covered with steam and smoke, and also as the entire front part of the cockpit was in flames, I undid my belt, took off my gloves, stood up in the seat and dived over the left side of the fuselage. I pulled the rip cord and the parachute opened, and, shortly before I hit, I saw the plane strike, nose first, and I landed about 150 feet away."

Now, in this particular case, after the plane and motor were fished out and a board of officers examined the wreck, the conclusion was drawn that the fire was caused from a flash igniting the gasoline and fabric on the left side of the fuselage.

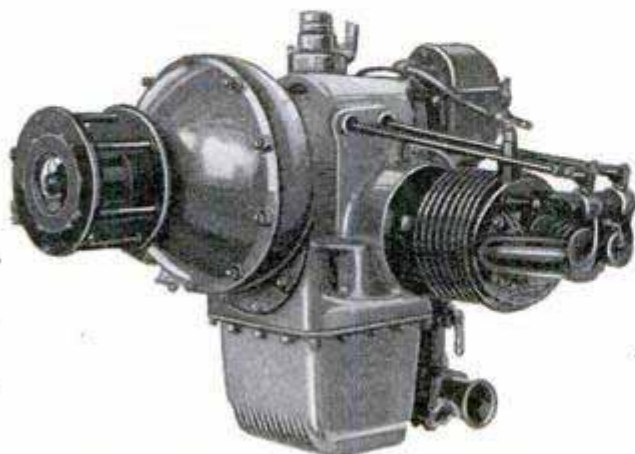

Tiny Two-Cylinder Engine for a Light Sport Plane; It Develops Twenty-Five to Thirty Horsepower

Wright-Morehouse - Wright Aeronautical Corp. - Peterson, J. L.

*Curtis Aeroplane + Motor Corp.  
74 Rail Buffalo, N.Y.*

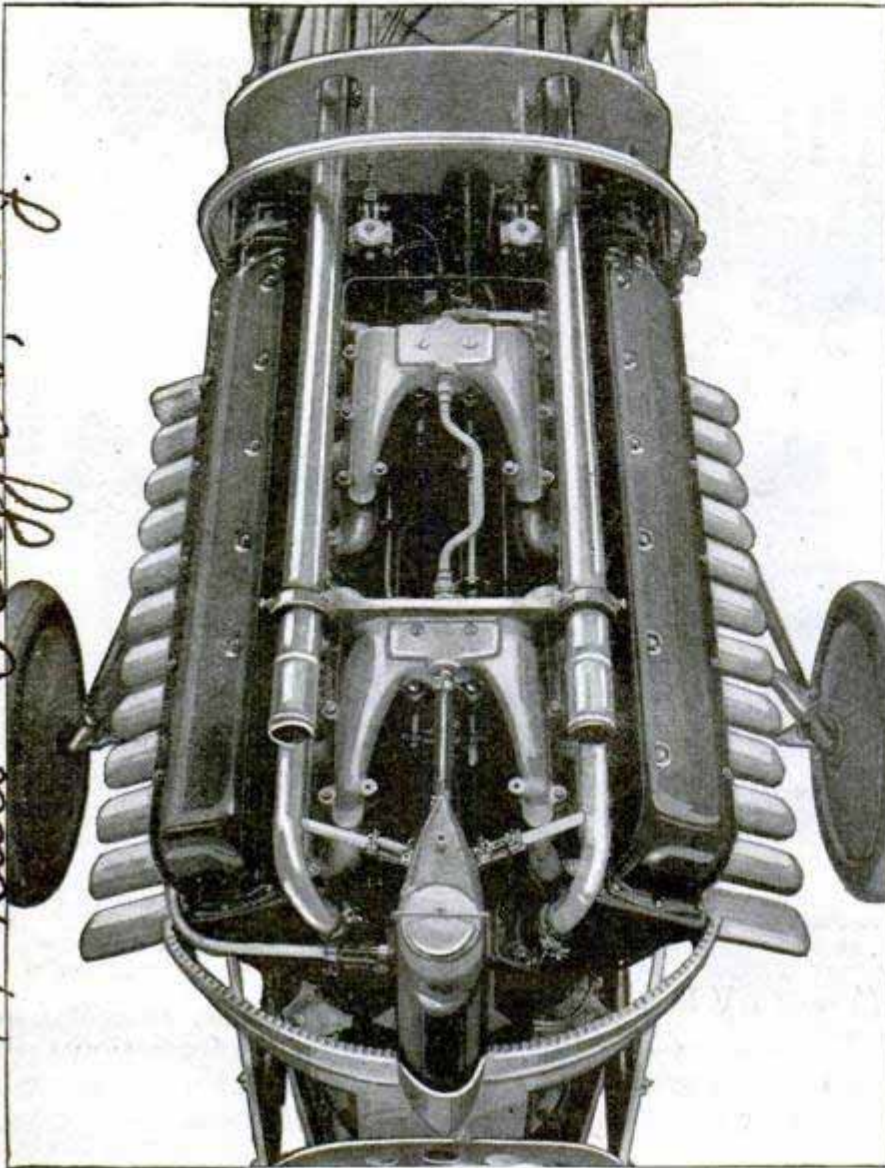

Looking Down on the Motor of the Curtis "Hawk," an Army Pursuit Plane  
Noted for Its High Speed and Fast Climbing Ability

does prevent the forced landings, and it is these that do the damage.

Ignition trouble used to be the big factor in engine failure, but with the generator systems, multiple magnetos and spark plugs that are uncanny in reliability, this menace has subsided somewhat. At present, there is less trouble with ignition than anything else. This is because it was once such a bother and hazard, and engineers set to work to overcome it, succeeding to a flattering degree.

Some of the more common causes of motor trouble are loss of water, oil, gas or breakage. Airplane motors run at such high speeds, and, during maneuvers, they are subjected to all sorts of centrifugal action. Great care has to be taken to keep the gyroscopic effect at the minimum, otherwise a motor could wrench itself free from its bed or bearings.

The flash was caused by a piston disintegrating, allowing the top end of the connecting rod to become free, which tore the cylinder walls and water jacket from bottom to top. This, in turn, caused the connecting rod on the opposite side to break. All this broke the crankcase and gasoline line between the two carburetors.

Such an accident is not one that can be remedied by airplane designers, and it does not directly concern motor designers; it is rather a problem of obtaining better metals. A metal lighter than cork and stronger than steel has been predicted for air use. Also, planes are now being designed with half a dozen motors, while flight can continue on two or three.

Of course, putting several engines in a plane is only beating the devil around the bush, so far as making engines fool-proof and reliable is concerned, but it certainly

Flexible water and gas lines have done much to eliminate loss of these liquids. But water, oil and gas are still lost in flight. The water hazard is being overcome in the latest engines by doing away with it entirely. The radial, air-cooled aero motor is gaining in popularity every day, and it is predicted that it will completely supplant the water-cooled type. Besides, it is much lighter in weight.

Oil leaks and holes are being made as large as is dared to prevent stoppage of the flow, but losing oil is far too common, and it is very serious. Zero oil pressure forced Lieut. Leigh Wade down in the North Sea on his flight between England and Iceland during the world flight. Oil can probably never be discarded as water has been, and the system is far from perfect. Loss of oil is more serious to a pilot than even the loss of gasoline, because the

Boeing Airplane to 330 W. Brown,  
 Scatter Wash.  
 Wallow Airplane  
 my C  
 Wichita, Kans.

SOME OF THE PLANES NOW BEING BUILT IN THE U.S.



TRAVEL AIR



CONSOLIDATED SEAPLANE

Consolidated Aircraft Corp  
 2050 Unwood Ave  
 Buffalo, N.Y.



SUPER-RHONE SWALLOW



BUHL-VERVILLE AIRSTER

Buhl-Verville Aircraft  
 Co - 2730  
 Scott Ave  
 Detroit



10-PASSENGER DOUGLAS

The Douglas Co.  
 Santa Monica  
 Calif



HUFF-DALAND KEYSTONE

Huff-Daland  
 Keystone Aircraft Co  
 Bristol Pa



THREE-ENGINED FOKKER

Fokker Aircraft Corp  
 110 E 42nd  
 New York



TWIN-MOTORED SIKORSKY



MARTIN MODEL 70

Wm L. Martin Co  
 16900 St. Clair Ave  
 Cleveland, O



THE IRELAND METEOR

Ireland Aircraft Inc  
 Garden City, N.Y.



BOEING MAIL PLANE



LINCOLN SPORT PLANE



LAIRD COMMERCIAL

E. M. Laird Co  
 Wichita, Kans.

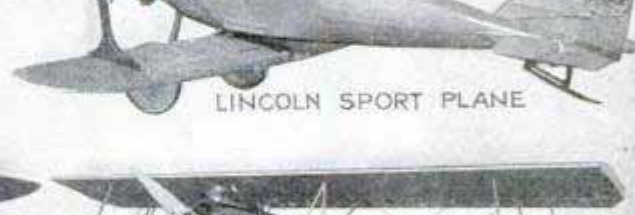

CURTISS LARK

Curtiss Aeroplane  
 & Motor Corp  
 74 Koll, Buffalo, N.Y.

Sikorsky Aircraft Corp  
 250 W. 57th, New York

1901

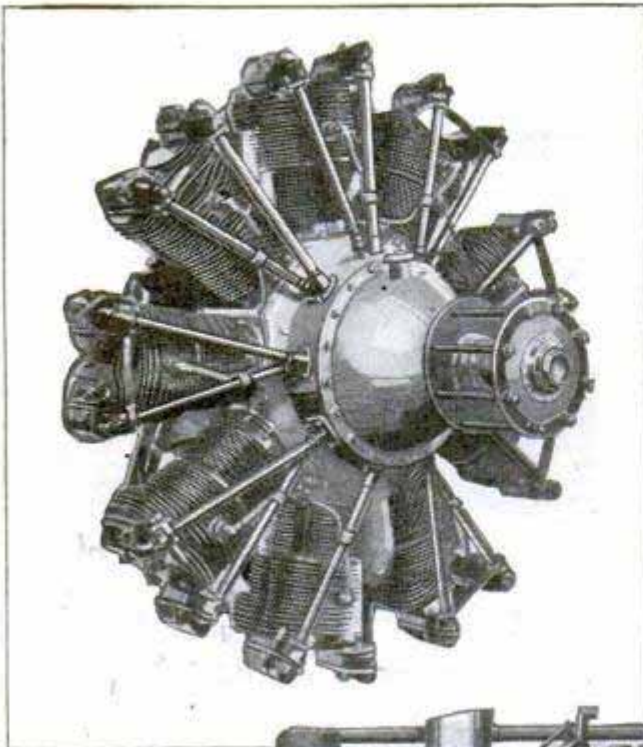

Air - Cooled Radial Engine; Engine, Radiator and Tanks of an Observation Plane; Bottom, End View of an Inverted Motor

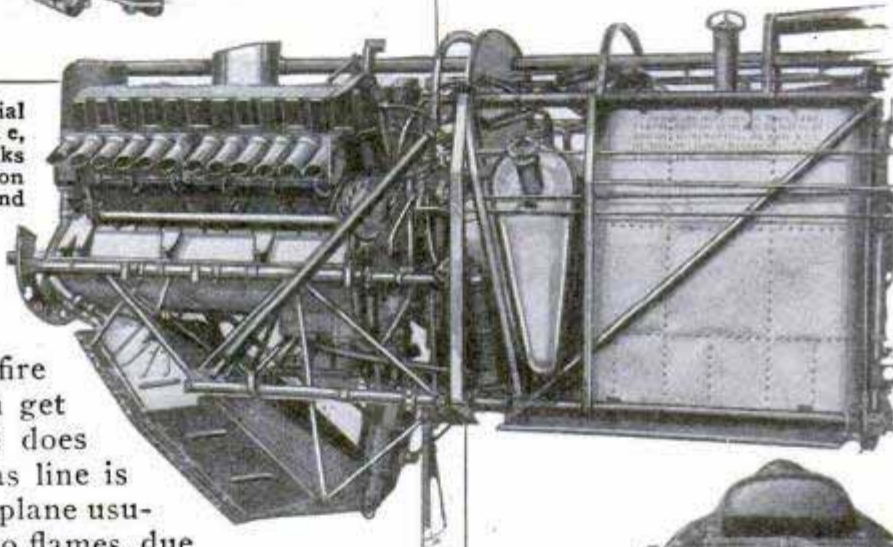

engine overheats and often catches fire before he can get down. If he does land and a gas line is ruptured, the plane usually bursts into flames, due to the gas touching the hot engine.

Insuring absolute gas supply to the cylinders is still a puzzle to designers. Gas lines frequently clog up even though the gasoline is strained through chamois skin. Pieces of solder from inside the gas tanks have caused clogging. The famous attempt of Hawker to fly across the Atlantic in 1919 was cut short in mid-ocean by this little thing.

As to whether the gravity or pressure feed is the best and most practical for the gasoline system is debatable. With gravity feed, the gas must be carried in the upper wing, or at least up where it affects the stability of the machine. The usual practice is to have the main tanks under pressure feed, and an emergency tank in the upper wing. Pilots always are expecting the gasoline pumps to quit, and they are not disappointed. Whenever an

engine stops in the air, and the pilot does not know what the trouble is, he automatically switches to the emergency gravity gas tank.

Another significant thing about motor failures is seen in the annual report of major accidents in the Army Air Service during the past year. Of 343 wrecks that were total, or so close to it that it makes little difference, 103 were caused by motor trouble. The other accidents ranged from sheer bad luck to just bone-headed flying. One crash was due to the pilot's attempting to show off before a crowd. In another case a cadet on his first solo flight, wandered over to a creek where some other boys were fishing and he got so interested that he forgot what he was

doing and hooked a wing in a tree.

But the hazards of the air are constantly being reduced, and during the last summer

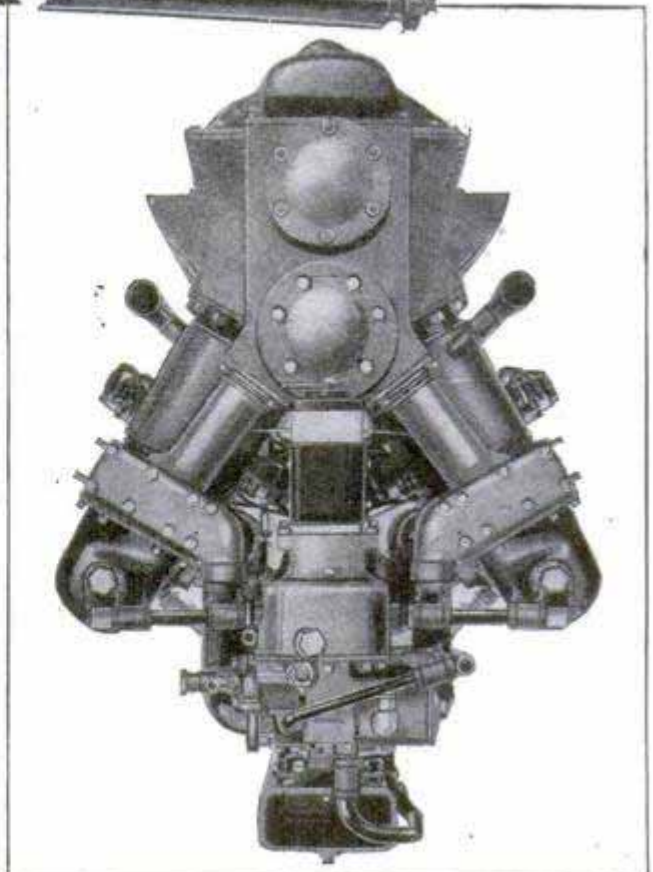



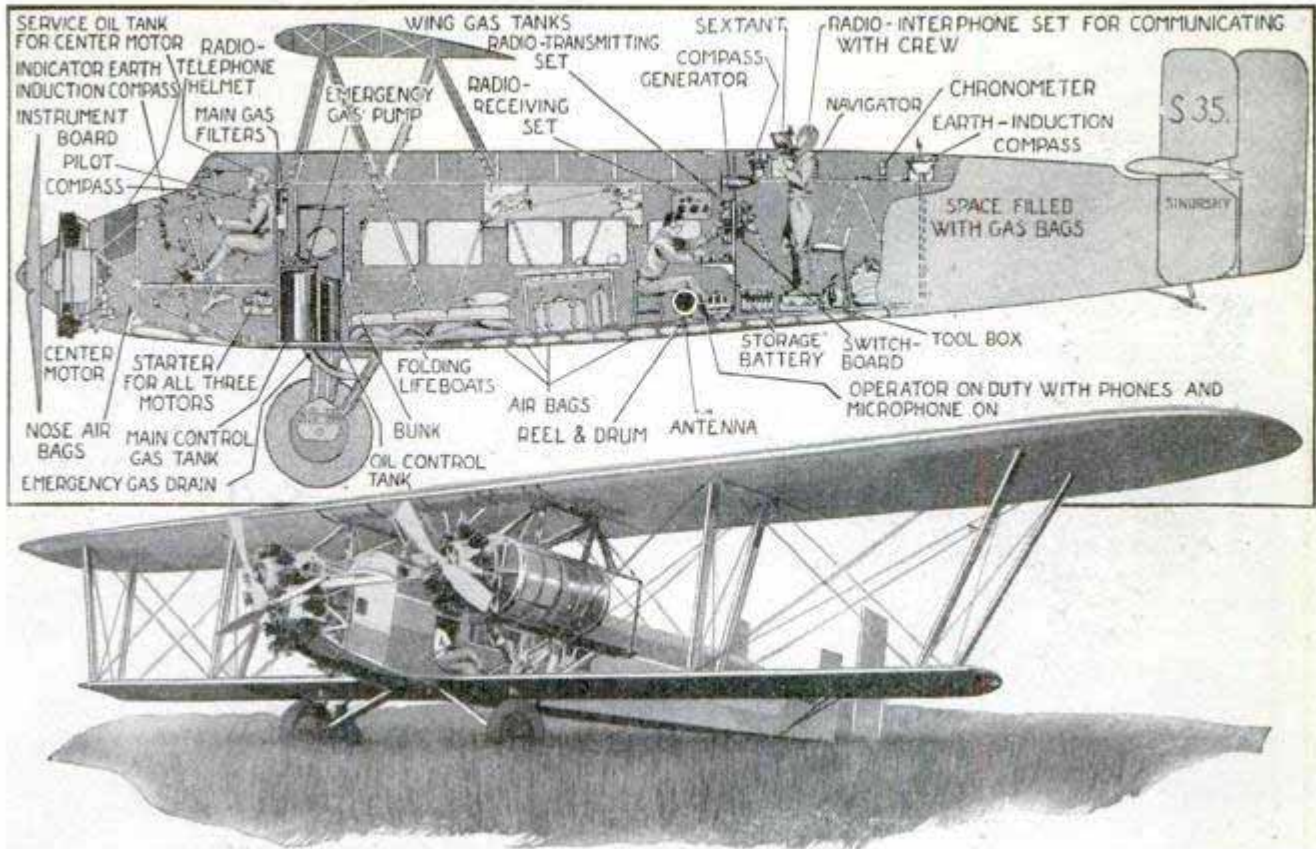

Photo and Diagram, Showing the Interior Arrangements of a Typical Big Plane; This Is Rene Fonck's Ill-Fated Three-Motored Sikorsky, Which He Hoped to Fly from New York to Paris

ten extensions of the air mail totaling 4,000 miles in length were put in operation, all financed by private capital. Many of these lines will provide passenger service in addition to carrying the mails.

Three individuals or concerns stand out in this hopeful development of commercial aeronautics, for the first time divorced from the spectacular flying of military machines and foolhardy showmen. First is Henry Ford. He has built a model airport at Dearborn. He has taken over the Stout metal-airplane factory and incorporated it in his own vast industrial enterprise. He is helping to finance the Aircraft Development Corporation, a group of aeronautic engineers seeking to perfect an all-metal dirigible airship.

National Air Transport, Incorporated, has a capital of \$10,000,000. Its members include such figures as Howard Coffin, of Liberty engine fame, and such names as Rockefeller, Davidson, Wrigley and Lamont. Col. Paul Henderson, who as second assistant postmaster-general perfected the illuminated airway for night flying and inaugurated the first through transcontinental service of the air mail, is general manager. The NAT is operating the 1,000-mile extension of the air mail

from Dallas to Chicago and it is also ready to take over the United States Air Mail, including the Chicago-New York service.

One of the most interesting figures in aviation today is a twenty-nine-year-old youth, Sherman M. Fairchild. Nine years ago at the age of twenty Mr. Fairchild was awarded a contract to build an aerial camera for the government. He built such a remarkable picture box that it became the official camera of the United States Army, Navy and Marine Corps, the Canadian, Brazilian and Japanese governments. In the face of skepticism from noted engineers, Mr. Fairchild took his camera and put it to work in civil use.

Mr. Fairchild, who is himself a pilot and aeronautical engineer, has designed a cabin monoplane with air-cooled engine which will retail at somewhere around \$4,000. He believes that the element of safety lies primarily in frequent and commodious landing fields and he is confident that private enterprise will develop such fields as the air becomes populated, just as the filling station and garage grew to meet the demand of the automobile. He insists that it is far easier to make a pilot of the family chauffeur than it was to make a chauffeur of the family coachman.

533

Inventor with Model Structure, Devised to Resist Earthquakes; the Arrangement Involves a Series of Braced Triangles

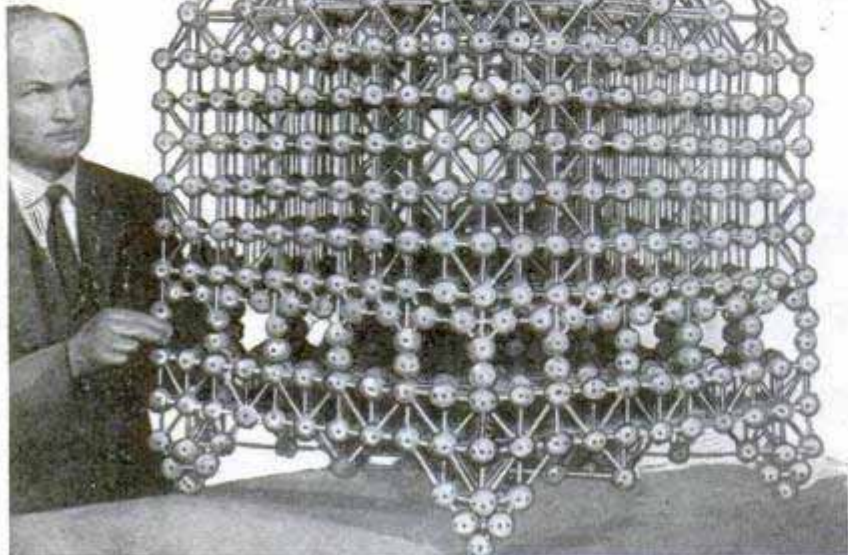

### NEW METHOD OF CONSTRUCTION TO RESIST EARTHQUAKES

Patterned after a system of building practiced by the ancients, a type of construction devised by a western inventor is intended to afford a means for erecting hotels, houses and other structures that will withstand earthquake shocks. A model of his plan shows a group of central supporting units braced by connecting props arranged in geometrical fashion.

### COIN TABULATOR AND CHECKER HELPS MAKE UP PAYROLL

Preparing money for the pay envelopes is often a laborious task, especially when the sums involve odd amounts. To simplify the work, a tabulator with keys that register different denominations from a nickel up to \$20, shows the number of coins and bills of different kinds that will be needed for the entire payroll. With a little practice, a sum such as \$17.35, for instance, could be registered in but two operations.



Tabulator to Simplify Making Up Payrolls; Pressing Keys Registers Number of Coins Needed

Pressing three keys at once would tabulate a \$10, a \$5 and a \$2 bill while two others in the cents column would register the quarter and the dime necessary to make up the total. When the payroll is completed, a quick computation checks its correctness.

### QUEEN OF FLOWERS

Although the rose is popularly regarded as the queen of blossoms, the botanist awards this distinction to the lowly daisy because of its structure. It represents about 250 flowers or florets with complicated arrangement of stamens and pistils, while the handsome

rose is much simpler, its petals being the showy garb of a flower in an early stage of development. The small rays of the daisy are not petals but whole flowers in themselves and the yellow boss also consists of individual flowers.

### SURGICAL OPERATIONS ON FISH

Most aquariums today have hospital tanks where sick fish are treated. Sea-water baths have been found beneficial to fresh-water fish when they become sick and sea fish are often greatly benefited by the fresh-water cure. A very serious affair is a puncture of the swimming bladder. This may be caused by taking the fish too suddenly out of water. It swallows a draft of air without having previously expelled the liquid contained in the bladder. For this operation, the fish is placed on an inclined plane so that the head remains under water. A gentle massage is applied around the gills to expel the air. If this does not suffice, the surgeon punctures the bladder with a needle.

*Denominator Adding Machine  
Brooklyn, N.Y.  
315-8444*

*Electric Traction  
P.H. Sub 916  
Index  
Zoological Gardens*

*J. A. Osits 9/4/26*

# Inexpensive Homemade Cone Speaker

By WALTER E. BURTON

**T**HE simple cone speaker shown in the photo, can be built by any radio experimenter for a few cents, and the tone qualities will prove a revelation when compared with the average horn speaker. The parts required are to be found in the average radio owner's equipment, as almost any type of horn unit will be suitable. A headphone of high resistance can be used, but a unit of the type designed for a phonograph or horn would be better as it will require the least changing.

The cone is of the free-edge type; that is, the vibrating member is supported in

to maintain its shape. The paper or parchment is laid out on a table and pinned to it in the exact center. A loop of string is placed over the pin, and a pencil placed in the other end of the loop. This loop of string acts as a guide when describing the circle. The circle should be 2 or 3 in. larger in diameter than the finished cone. A triangular segment is cut from the disk, the apex being at the geometrical center of the circle. The two edges of this section are then brought together, and glued with the aid of a narrow strip of the material, or they may be lapped and glued if preferred. The resulting cone will retain its shape indefinitely.

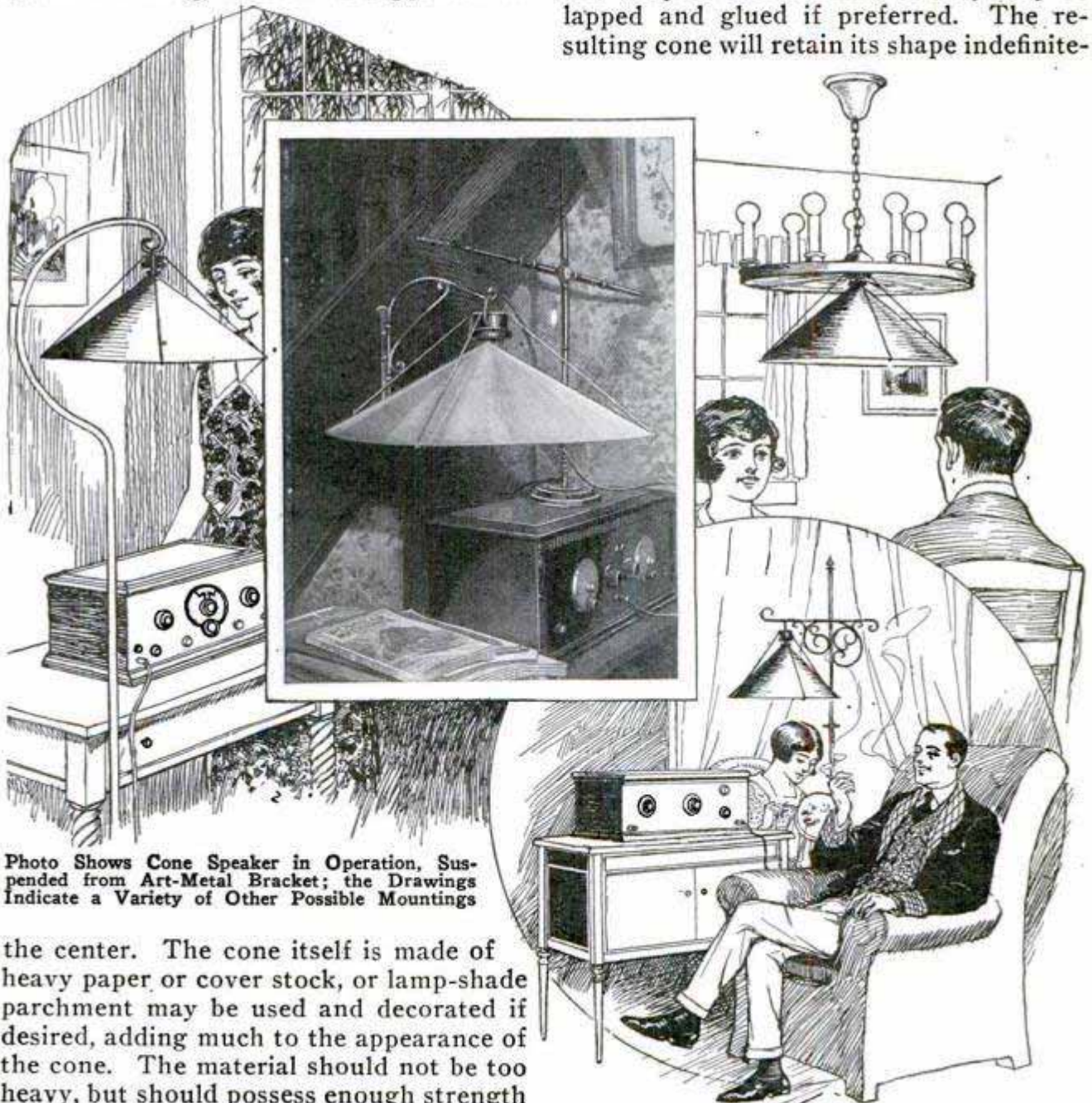
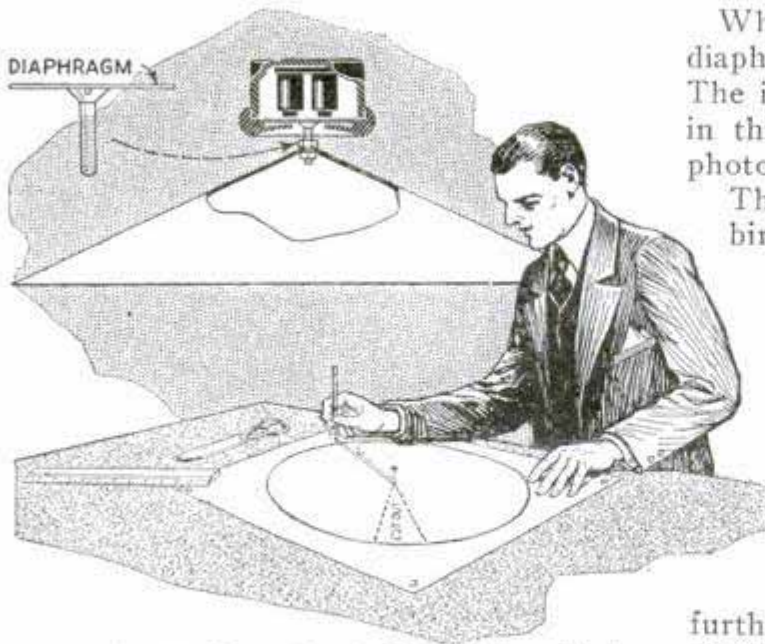

Photo Shows Cone Speaker in Operation, Suspended from Art-Metal Bracket; the Drawings Indicate a Variety of Other Possible Mountings

the center. The cone itself is made of heavy paper or cover stock, or lamp-shade parchment may be used and decorated if desired, adding much to the appearance of the cone. The material should not be too heavy, but should possess enough strength



Laying Out the Cone; Dotted Lines Indicate Section to Be Cut Out; Above, Diagram of Assembly

ly, unless subjected to severe strain. To further insure stability, the edges may be bound with a thin strip of metal, although this should not be necessary if the material is fairly heavy.

After completing the cone, prepare the diaphragm of the loud-speaker unit, so that a small flat-head brass machine screw, 1 in. long, can be soldered in the exact center of the diaphragm. The latter is usually coated with enamel, and a small area of this enamel must be scraped away so as to expose the metal for soldering. Be sure that the machine screw is exactly perpendicular to the diaphragm. The unit is then reassembled as shown in the sectional diagram, and is now ready for the cone. If the unit is of the type employing a mica diaphragm, the screw must be soldered or cemented to the central driving pin. Sealing wax may be used, but a soldered connection is better. The cone is fastened to the machine screw by means of two small brass nuts. A small hole, slightly less in diameter than the screw on the diaphragm, is made in the apex of the cone. One brass nut is threaded on the screw, the cone slipped in position and the remaining nut fastened on the inside of the cone, completing the assembly. The nuts should be screwed tightly in place, to prevent any slight movement that would interfere with the vibration of the diaphragm. If the unit is of the adjustable type, it may be regulated while in use, to obtain best results.

When assembled, the unit is suspended, diaphragm down, from a suitable support. The illustrations give several suggestions in this respect, the support used in the photo being a small art metal bracket.

The sketch at left shows the use of a bird-cage stand, and the others adaptations to light fixture and bridge-lamp stand. Any one of these makes a neat appearance, and if the cone is decorated, adds much to the appearance of the room. The strings passing over the unit terminate in small metal hooks at the edge of the cone, and are suggested to prevent the cone from swaying in air currents, and to further stabilize the assembly. A speaker of this type gives excellent results, reproducing voice and music with a full round tone and bringing out more of the low notes so often absent in horn speakers.

933- R. — Battery Tester  
**Pocket-Type Charge Indicator**

The pocket-type charge indicator shown in the illustration is about the size of the standard pocket voltmeter, and is now available for testing storage A-batteries of the 6-volt type. The direct-reading

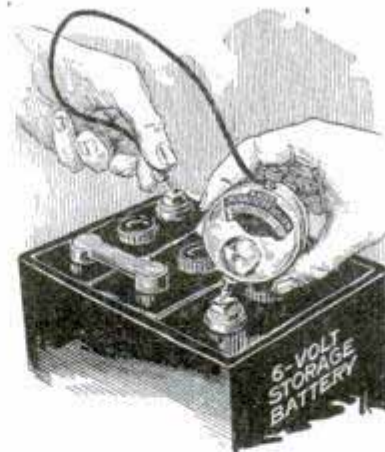

scale indicates when to start charging, when the charge is sufficient and when the battery should be taken off charge. The instrument is useful for checking storage batteries in console sets where space is limited, and does away with the danger of spilling acid as in tests with a hydrometer.

**Getting Rid of Lighting-Plant Interference**

Lighting-plant interference is caused by the ignition system or by sparking at the brushes. One remedy suggested is to try a piece of flexible metal tubing over the high-tension wire which runs from the spark coil to the spark plug. This

*Sterling Mfg. Co. 2801 Pruckard Av. Cleveland, Ohio*

metal covering should stop about  $\frac{1}{2}$  in. from the terminal and then be taped to prevent sliding along the wire and touching the terminal. The tubing also should be grounded (never to the frame of the lighting plant) by a wire carefully soldered to it and then connected to an iron rod, 6 ft. or so long, driven into the ground. If the trouble is caused by sparking at the brushes, this may be remedied by condensers, those from Ford coils being usable. Two of these should be connected in series across the line which goes from the lighting plant to the battery and house wiring, as shown in the illustration. The center point of the condensers is then grounded to an iron bar driven in the earth. A further precaution would be the use of inductance coils placed in the line in the manner shown in the diagram; these coils may be wound on a tube, 2 in. in diameter and 3 in. long, putting about 150 turns in each coil. The coil wire should be about the size of that going from the lighting plant to the battery. If these methods fail, as a last resort it might be well to cover the entire lighting plant with a metal shield, which should be grounded. The shield will prevent the plant wiring from acting like an aerial and transmitting interfering waves.

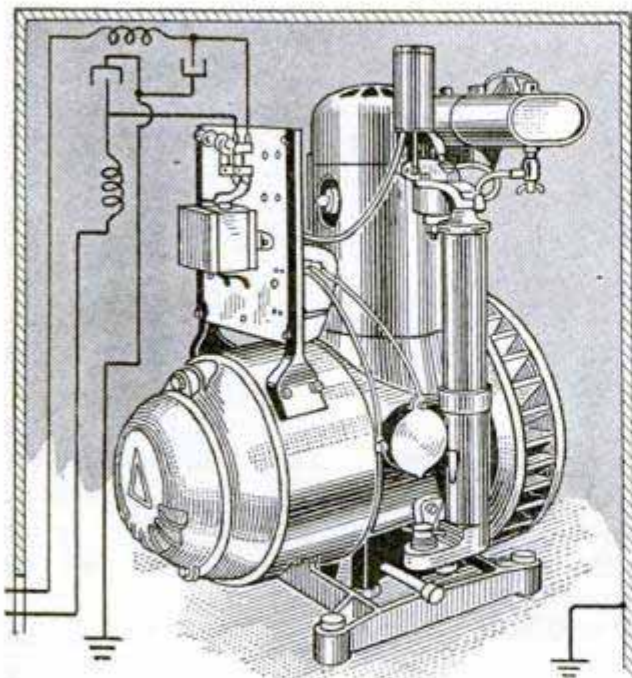

Lighting Plant, Showing Suggested Methods of Eliminating Radio Interference

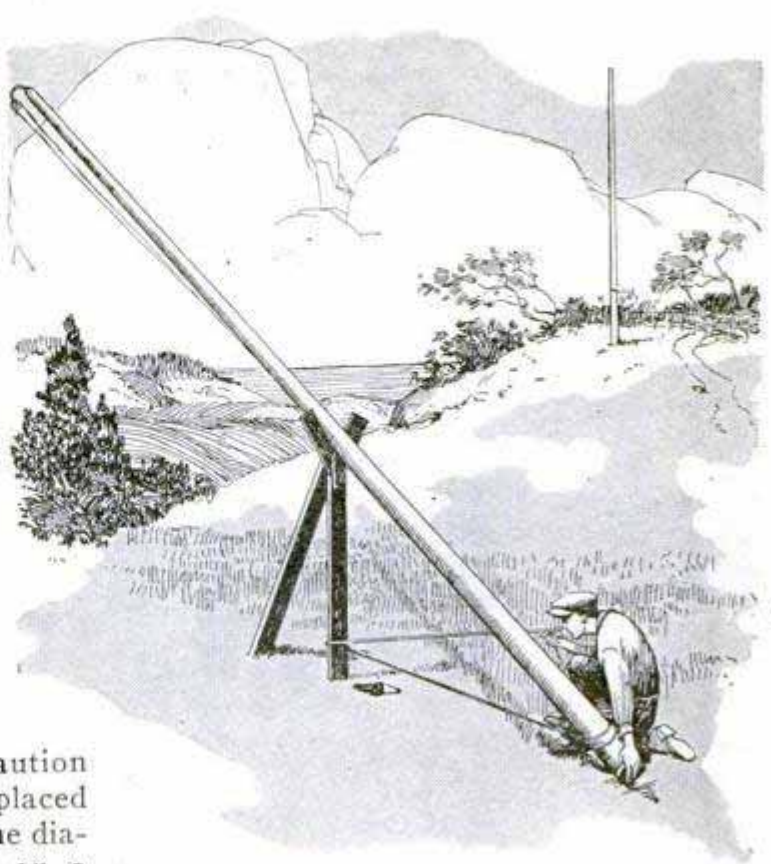

Aerial Mast Resting in Crotch, Ready to Be Raised

#### Tip on Raising Aerial Masts

Being confronted with the problem of raising two long and unwieldy aerial masts without assistance, I successfully employed the method indicated in the illustration after several others had failed. A 10-ft. post was sunk in the ground near the hole for the mast, well braced at the rear, and to its top were nailed two short pieces of scantling, forming a "Y." The small end of the pole was then laid in this crotch, a rope securely fastened near the butt end of the pole, and the rope looped around the post, near the ground, as shown, the loose end being held in the hand. By sliding the pole in the crotch, with the butt close to the ground, the snubbing effect of the rope, held tight in the hand, prevented slipping, and the pole was gradually hoisted in position. The ease with which the job was done was surprising after the energy expended in trying to raise it by other means. The crotched post was then removed to the site of the other mast and the operation repeated.—Bonar W. Balfour, St. Catharines, Ontario, Canada.

☐ Remove excess acid from the battery top with a cloth dampened with ammonia.

## Simple Coil-Testing Tool

A simple coil-testing tool for the radio experimenter, may be made from a phonograph needle and a clip from a discarded B - battery. The method of using the

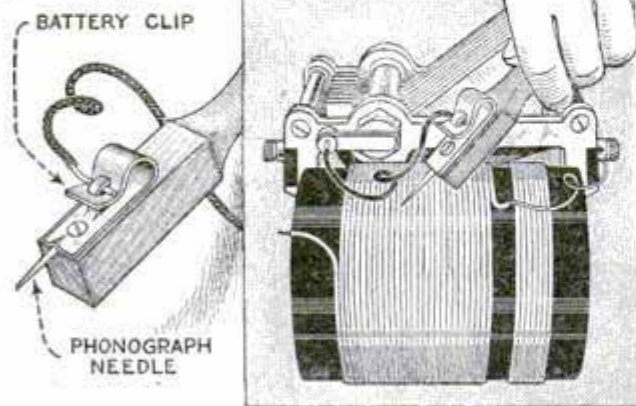

Details Showing Needle Mounted under Clip, and Right, Testing Coil to Determine Number of Turns

tool for determining the number of turns necessary to bring in the stations at the proper places on the dial, is clearly shown in the illustration.

Homemade coils can be matched with whatever condenser the builder may have on hand; the coil is wound with what is known to be more than the necessary number of turns. One of its ends is connected to the stationary plates of the variable condenser, the other being left unconnected. The coil-testing tool is now connected to the rotor plates of the condenser, and the sharp point thrust through the insulation of the coil at various places, while a station of known wavelength is being tuned in. When a place on the coil is found where a station of high wavelength comes in at a relatively high point on the dial, the surplus wire is cut off. The end of the coil is then connected to the rotor of the con-

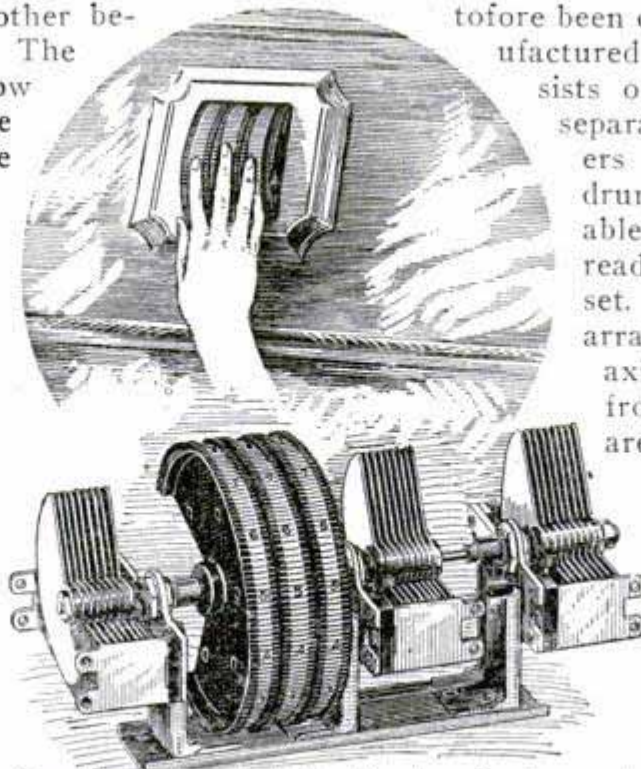

Drum-Type Control Unit, Showing Condensers in Parallel, Which Can Be Controlled with One Hand

denser instead of the test tool; this does away with the usual cut-and-try method.

Two of these tools connected with a short length of wire will be found useful in testing doubtful soldered joints. They are set to straddle the joint to be tested; if the set works better through the tools and connecting wire, the soldered joint is defective. The writer finds a wooden handle is quite satisfactory, but bakelite may be used if desired.—L. M. Curtis, Venice, Calif.

959-R

## New Condenser Has Bakelite Shaft

A new variable condenser has a shaft of clear bakelite instead of the common brass or steel type. The condenser is built into a U-shaped frame in such a manner that the shaft itself furnishes the insulation between the rotary and stationary plates. This design eliminates the side strips of insulating material and their supporting ribs, and permits the use of an all-metal frame that makes the condenser extremely compact and rigid.

## Drum-Type Control Unit Available

937-R for Home Builder

Centralized control units of the drum type are now available for the radio builder; this method of control has heretofore been confined to a few manufactured sets. The unit consists of two, three, or four separate variable condensers with tuning-control drums mounted on a suitable bracket, complete and ready for insertion in the set. The condensers are arranged on a common axis to be parallel to the front panel. The drums are grouped between the first and second condensers, which are rigidly mounted on a supporting bracket. All condensers are independent, and the drums are grouped so that all may be moved at once by the fingers of one hand.

Alden Mfg Co, Dept. D-14  
Springfield, Mass.

40 Paynter Ave.  
Eng Island City, N.Y.

# Simple Tungar Battery Charger

By F. L. BRITTIN

**T**UNGAR battery chargers are quiet, contain no liquid to spill, and have no vibrating elements to get out of order. They are always ready for duty and operate at low cost. While there are a number of good chargers of this type on the market, many experimenters prefer to build their own, saving a few dollars and at the same time gaining useful experience.

The instrument consists of a hardwood base, a socket of the standard porcelain type, a 2-amp. tungar bulb, and a two-voltage transformer. The bulb is the most expensive part of the instrument and retails for \$4. When purchasing it specify the type having the external anode connection coming up over the top of the bulb. If this type is not available, it is a simple matter to add the connection by winding a turn or two of No. 14 round tinned-copper busbar wire around the metal shoulder at the base of the bulb, soldering it to this metal band and bringing the free end up over the bulb as in the one illustrated.

The base is 1 by 7 by 8 in. in dimensions and a strip of bakelite, to carry 4 binding posts, is screwed to one of the 7-in. sides. Two

posts are for the output to the storage battery and the other two for the 110-volt 60-cycle a.c. supply. The transformer is wound to furnish 2 volts for lighting the filament of the bulb, in addition to the 15 volts to be rectified for the battery. The secondary of this step-down transformer therefore has two windings, one carrying 10 amp. at 2 volts, the other 2 amp. at 15 volts. Black stovepipe iron is used for the core laminations, and should be of such thickness that 58 laminations, including the shellac used for binding, will make a pile 1 in. high. The iron is cut into  $1\frac{1}{4}$  by  $3\frac{3}{4}$ -in. strips with heavy tinsnips and piled to make a hollow square, 5 in. on a side, the ends of alternate strips overlapping  $1\frac{1}{4}$  in. Any ragged edges on the strips should be trimmed off so that the core looks neat and regular.

You are now ready to build up the primary and secondary legs. Tear off one side and the lid of a cigar box, and nail a partition across it so as to make a compartment 5 in. long. Pile the strips for one leg of the core in this compartment, shoving alternate strips to opposite ends, so as to keep the ends even and

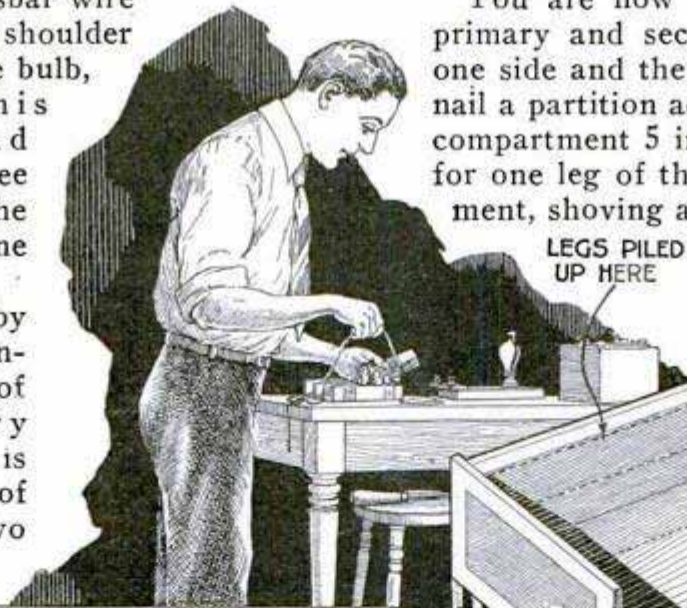

LEGS PILED UP HERE

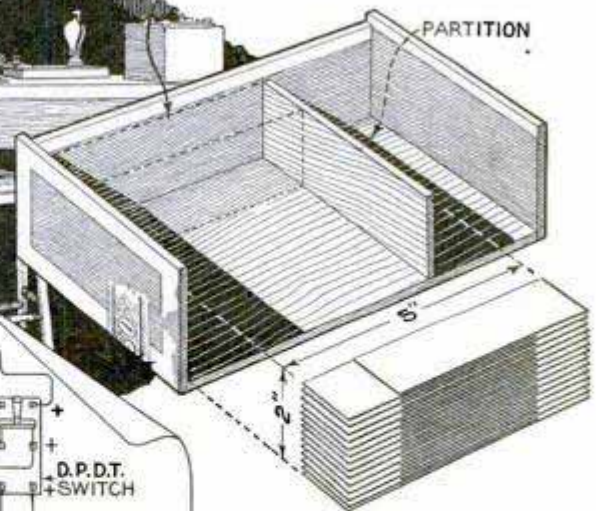

METHOD OF ASSEMBLING CORE

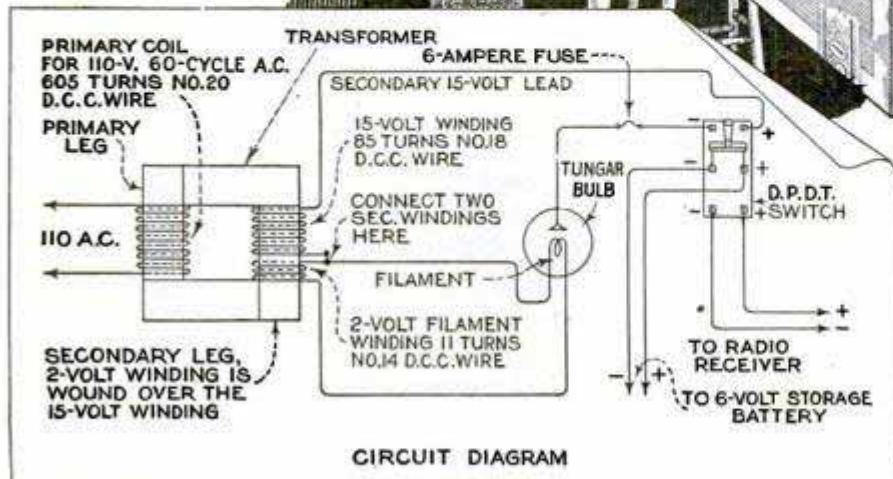

square. As each strip is laid in, coat it with shellac, and when the pile is 2 in. high, place a wooden block on it and clamp

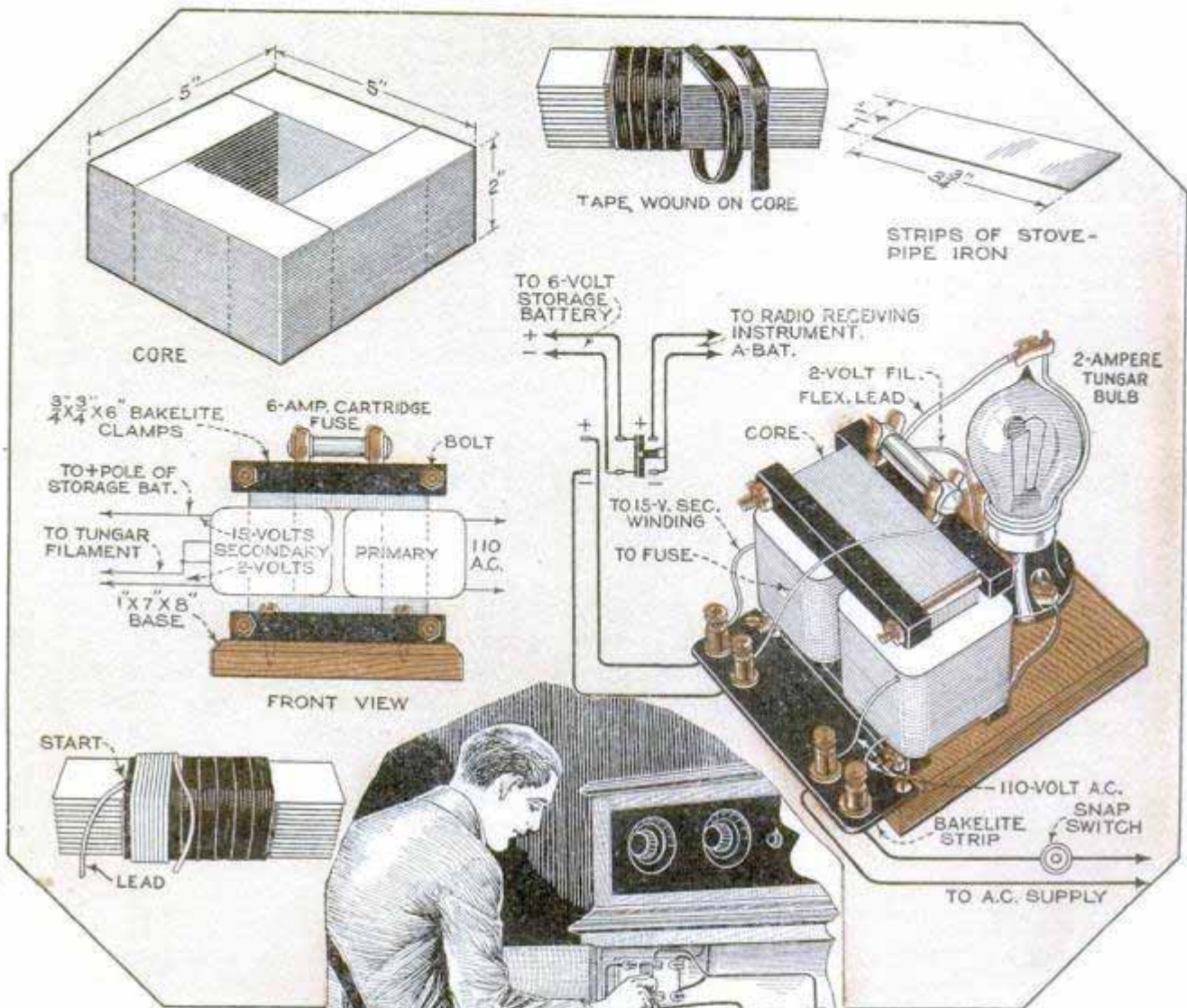

until dry. When dry, remove the leg and bind it with friction tape in the manner shown. Two legs are made in this manner, one for the primary and one for the secondary.

The primary coil consists of 605 turns of No. 20 d.c.c. wire. If any splices are required, make them as small and neat as possible and carefully solder the connection, insulating it with a piece of tape or spaghetti tubing. Leave a long starting end on the coil and bind it down under the first layer of turns to hold it firmly in position. Coat each layer of the coil, as it is wound, with shellac; if desired, two wooden spool ends may be made for the leg to facilitate even winding of the coil. Leave plenty of wire at the start and finish of the coil for leads. After the winding

Details of Home Charger; Completed Instrument with Wiring and, Below, Charger in Console

is completed, place the coil in a moderately hot oven and bake slowly and thoroughly. This baking process is important and should be carefully done to insure good results.

The secondary coil is then wound on the other leg, which should be wrapped with two layers of tape and one layer of empire cloth. This cloth may be obtained from any electrical shop. The 15-volt winding consists of 85 turns of No. 18 d.c.c. wire, and the 2-volt winding, 11 turns of No. 14 d.c.c. wire, is made over it. Shellac each layer as before, and leave long ends for connections. This coil is thoroughly shellacked, and then baked until completely dry.

Stand the two legs on end, and insert the side strips or laminations at one end,



then reverse and fill in the other end. Coat the entire assembly with shellac, and dry thoroughly. The top and bottom ends of the core should be clamped to prevent humming. To do this, use either regular iron transformer clamps, obtainable from electrical-supply firms, or the method shown in the illustrations. The clamps consist of four bakelite strips,  $\frac{3}{4}$  by  $\frac{3}{4}$  by  $6\frac{1}{2}$  in., which are bolted to the trans-

to connect the A-battery to the charger and turn on the snap switch in the 110-volt line. If the bulb does not glow when the current is turned on, turn off the current and disconnect the end of the 15-volt winding, where it is connected to the 2-volt coil, and connect it instead to the other end, that is, reverse the 2-volt connections. If the bulb still refuses to glow, it may be necessary to add one or two

#### MATERIAL LIST

1 hardwood base, 1 by 7 by 8 in.	$\frac{1}{2}$ lb. No. 18 d.c.c. magnet wire.
4 binding posts.	10 ft. No. 14 d.c.c. magnet wire.
1 6-amp. cartridge fuse, with mounting clips.	1 large roll electrical friction tape.
1 2-amp. tungar bulb.	1 empty cigar box.
1 porcelain socket.	1 d.p.d.t. switch.
1 strip bakelite, 3-16 by 2 by 7 in.	1 snap switch.
4 bakelite strips, $\frac{3}{4}$ by $\frac{3}{4}$ by $6\frac{1}{2}$ in.	10 ft. lampcord with wall-socket plug.
4 bolts, $4\frac{1}{2}$ in. long, with nuts to fit.	1 piece empire cloth, $2\frac{1}{2}$ by 8 in.
$1\frac{1}{2}$ lb. No. 20 d.c.c. magnet wire.	Stovepipe iron, wood screws, and shellac.

former, the lower ones being also screwed to the base, to support the assembly. One of the top strips serves as a support for a 6-amp. cartridge fuse, one end of which is connected to the anode terminal at the top of the bulb by means of a flexible wire terminating in a Fahnestock clip, and the other to the negative battery binding post on the base. Join the secondary coils, as indicated in the wiring diagram, by a well soldered connection, then tape and shellac the joint. Screw the bulb socket in position, and connect the 2-volt secondary leads to the filament terminals. The supply for the primary of the transformer can be connected with lampcord to a plug and inserted in a wall socket. A snap switch is placed in one side of this line and may be mounted at any convenient point near the set or inside the console. The d.p.d.t. switch mounted in the console is of the common porcelain-base type, and may be mounted at any convenient point. The 6-volt storage battery leads go to the center posts or "knife" of the switch. The charger leads go to one end, and the other end to the leads for the A-battery connections in the set. When wiring this switch, be careful to have all positive and negative posts connected just as shown in the diagram.

To operate the charger, first see that all connections are correctly made and the tungar bulb in position, with the clip at the top in place. Throw the d.p.d.t. switch

turns to the 2-volt winding, or five or six turns to the 15-volt winding, as the characteristics of the bulbs vary a little. When the instrument has been found satisfactory, solder the connections, and retape the coils. The ordinary 6-volt battery should be placed on charge overnight, and the charge continued through the following day, if the battery was low, until the hydrometer shows the correct reading. Keep the battery charged as near 1.280 as possible, and do not let the reading fall below 1.175 before recharging. Never charge a battery by guess, always use a hydrometer or similar tester. For average use a 6-volt 80-amp.-hr. radio battery will require recharging every week or ten days. This tungar charger is not designed to give a high charging rate, as it is always best to charge radio batteries slowly. Do not put the charger in a box, away from the air; if it is placed in a console, open the doors of the cabinet while charging to provide good circulation.

#### Testing Insulating Materials

Losses occurring in panel material, cabinets, baseboards and forms used in winding coils may be detected by placing the material between two r.f. coils in the set when the set is in operation and noting the variation in signal strength. If the insulating material is efficient, there will be no appreciable difference in this respect.

### Pilot Light for Battery Charger

The pilot light shown in the sketch is a visual reminder that the A-battery is on charge; in these days of silent chargers, one is likely to forget the charger is working. While this installation is intended

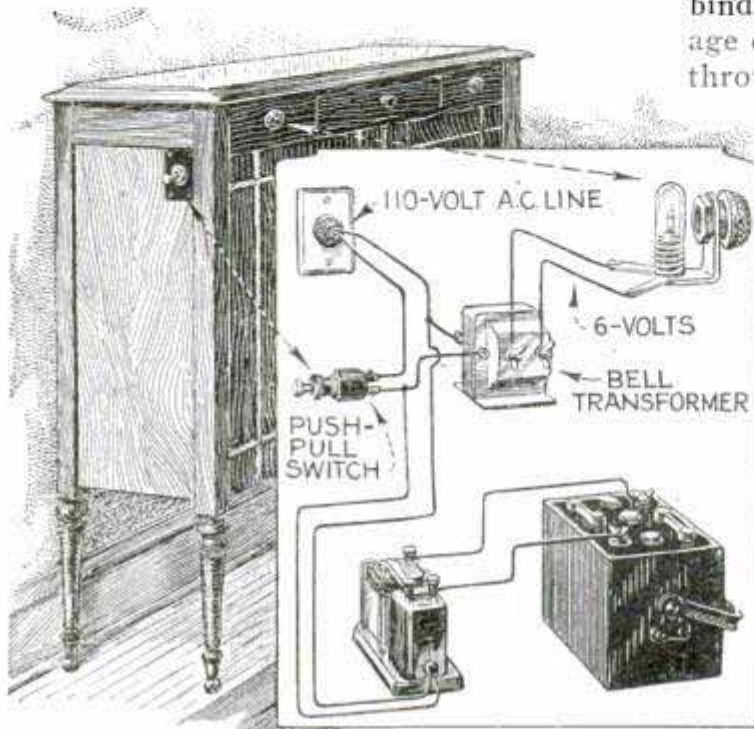

Radio Console, Showing Suggested Positions for Pilot Lamp and Switch; Insert, Detailed Wiring Diagram

for console cabinets, where provision is made for housing the storage battery, charger and B-batteries within the cabinet, it can also be adapted for use where the storage battery is placed in the basement. The materials required are usually to be found around the average workshop, or may be purchased from any radio dealer. The transformer is of the step-down type commonly used for doorbells, and must have a low-voltage tap of 6 volts. The push-pull switch is of the kind used for the A-battery supply on radio sets; and the small 6-volt lamp and bracket with colored glass bull's-eye is of the standard radio-panel type. This pilot lamp is mounted on the panel or cabinet so that it will be in plain view.

The switch is located conveniently either on the panel, or on the cabinet, in which case a hole slightly larger than required on the panel must be drilled in the cabinet. A small strip of bakelite is then drilled for mounting the switch, and screwed to the cabinet with the switch in

place. The step-down transformer is located inside the cabinet near the top, where it will be out of the way. Most of these transformers have two No. 14 insulated wires, about 6 in. long, for connecting to the 110-volt 60-cycle line. Lugs should be soldered to these leads, and binding posts provided for the low-voltage output. The supply line is brought in through the rear of the cabinet and should pass through a short-porcelain insulator. The lamp cord used should be long enough to reach a convenient baseboard receptacle, and an attachment plug is attached to the far end. The end of the cord inside the cabinet is bared of insulation for the length required to make connections, and a small lug is soldered to one of these ends. As chargers usually come with cord and plug attached, cut off the plug and leave just enough cord to make connections, then solder lugs to the ends of this cord. To make the connections, the wire having the lug, coming from the 110-volt line, one wire from the charger and one wire from the transformer are brought together and held

by means of a short brass machine screw thrust through the lugs and kept in place by a brass nut. A lock washer may be used to insure a tight permanent connection if desired. The remaining wire from the cord supplying the 110-volts is connected to one side of the push-pull switch; from the other terminal of the switch, a short flexible lead, terminating in a lug, is run to the transformer. The remaining lead from the charger is also connected to this lead from the switch. Finally connect the leads from the 6-volt terminals of the transformer to the pilot-light terminals, and the installation is complete. Make sure that all connections are tight, and wrap them with a double layer of friction tape. In operation, when the switch is in the on position, the charger is working and the pilot is lighted. In this way the charger may be left permanently connected, and a glance at the illuminated disk in the cabinet will suffice to tell whether the charger is in the circuit or not.—W. J. Langan, Freeport, Ill.

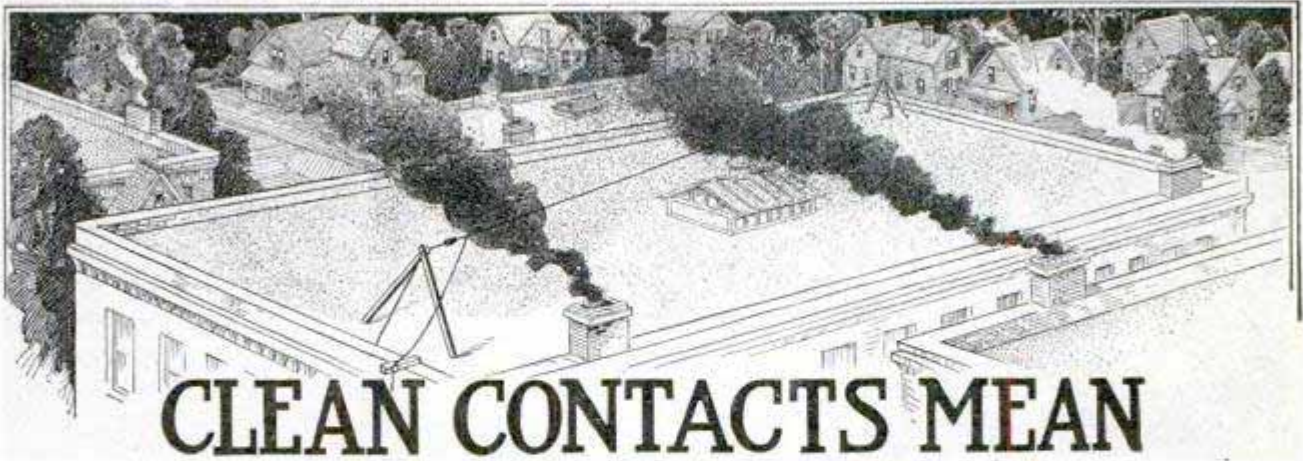

# CLEAN CONTACTS MEAN CLEAR RECEPTION

By IRA V. KELLER

**A**LL electrical contacts in a radio set must be clean, and kept so to insure good continuous reception. This is increasingly important in large cities and in manufacturing localities where the air is filled with soot, that not only settles on the aerial but filters into all parts of the set. One cardinal virtue of every well-built receiver is good soldered connections and these must be perfectly clean before the solder is applied. Merely butting two wires together and applying solder does not make a good joint; the connection must be mechanically strong enough to hold, even though solder were not used. The solder insures a permanent connection but does not itself make it.

Before proceeding further, it is well to know just what constitutes a well-soldered joint and how to make one. First, the iron preferably should be of the small electrical type if possible, although good work can be done with a plain one, heated by means of

a blowtorch or gas stove. Second, the iron must be tinned properly and kept tinned. A stand or rest for the iron can be made from a short length of busbar wire or from two crossed nails. Heat the iron and brighten the point with a file. Spread a bit of soldering paste on a sheet of copper, brass or tin that has been polished, and rub the

bright point of the iron over the fluxed surface. Solid wire solder is applied to the point of the iron during this rubbing process in the manner shown. This will coat the point with a layer of solder if the iron has been brought to the proper temperature, and this tinned surface must be maintained while the iron is in use. Electric irons are automatically heated to the proper temperature, but if the plain iron is used, care should be taken not to overheat it, or the tinned surface will be burned off. The quality and kind of



flux used are important in wiring a radio set. Rosin-core solder, or solder of the

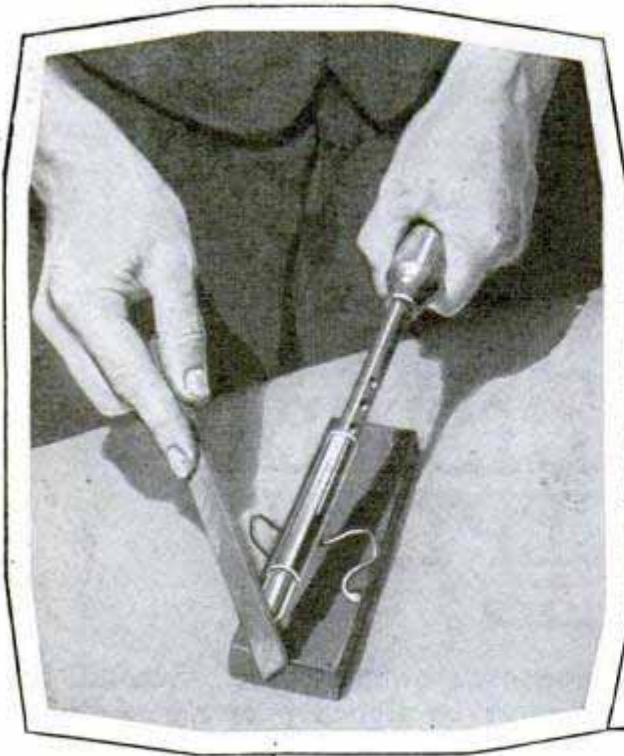

Top, Filing Tip of Soldering Iron; Center, Arrows Point to Contacts That Cannot Be Soldered; Bottom, Tinning Iron

acid-core type, is to be avoided. The former will run under the connections and cause poor contact and the latter will corrode. A simple soldering

paste, obtainable from any hardware or radio dealer, is preferable and should be used sparingly; a minute bit of the paste is applied to the surface to be soldered and then wiped off with the finger, as a very light film is all that is required. Anyone who has tried to solder a joint without using flux of some kind will know from experience that the molten solder will stubbornly roll off the wire unless some type of flux is used. The paste itself does not make the solder adhere, but it does remove an agent which otherwise would prevent the soft metal from sticking. This agent is an oxide, formed by the contact of the hot iron with the wire, so that the solder cannot reach the surface to be soldered, and is removed by the paste. Round tinned-copper busbar wire

makes a neat job, and is easily bent with a pair of wire-forming pliers. When two wires are to be connected, form a loop on one as shown, and clamp it tightly over the other for a good mechanical joint, before applying the solder. At binding posts, soldering lugs should be used, and it is well to watch carefully that no flux runs under the lug, making a poor contact. If this is suspected, it is best to remove the binding post, and sandpaper the lug and the shoulder of the post to be sure of a good clean contact.

So much for soldering. Next in importance are those contacts that cannot be soldered, and these are numerous in any set. In fact there are from 25 to 30 such contacts in every five or six-tube set, and these are indicated by arrows on the

photo of a six-tube set. Twenty-four are at the tube-prong contacts, and others at the jacks, switches and rheostats. Dirt on any one of these will be a fruitful source of noise, because many tubes have solder on

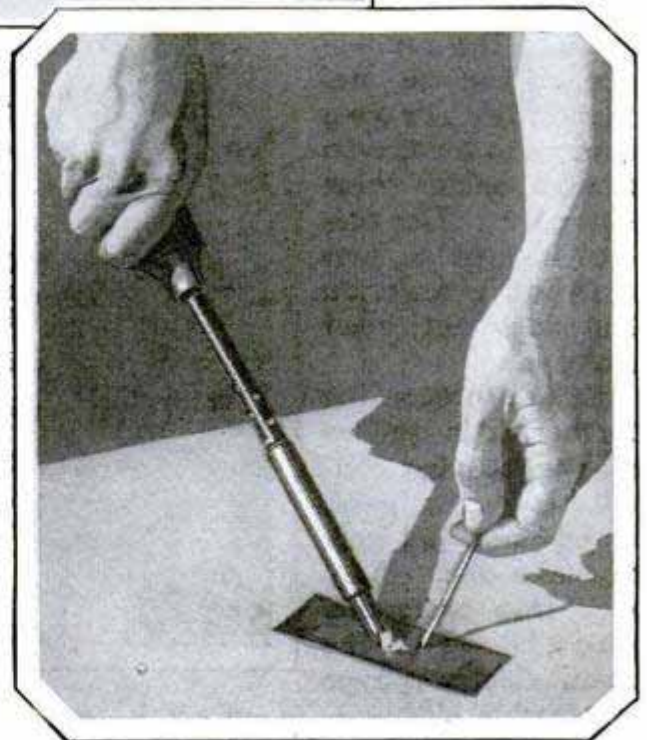
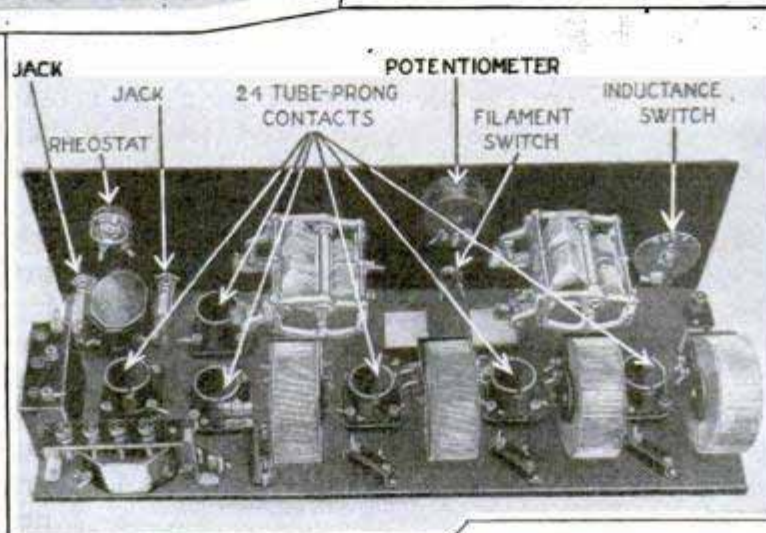

their base prongs, which rubs off on the socket contacts, oxidizes and forms a high-resistance, noisy connection. The battery switch will often accumulate dirt after continued use and should be taken apart and cleaned if possible; the same is true of the rheostats. Keep the tube prongs bright and shiny, cleaning both prongs on the tube, and the socket contacts also, with a bit of fine sandpaper. If the tube prongs are difficult to get at, use a pencil rubber; never use a coarse file or emery cloth. Spring contacts in jacks are treated with sandpaper in the same manner. The jack need not be removed from the set for cleaning, but care should be taken that the springs are not forced apart so as to prevent a good contact when the plug is inserted.

Next to be considered are the aerial and ground connections, where good, clean contacts are just as important as in the set. A ground clamp on a cold-water pipe is a general favorite, but the pipe should be filed bright before the clamp is applied. The aerial must have the least possible

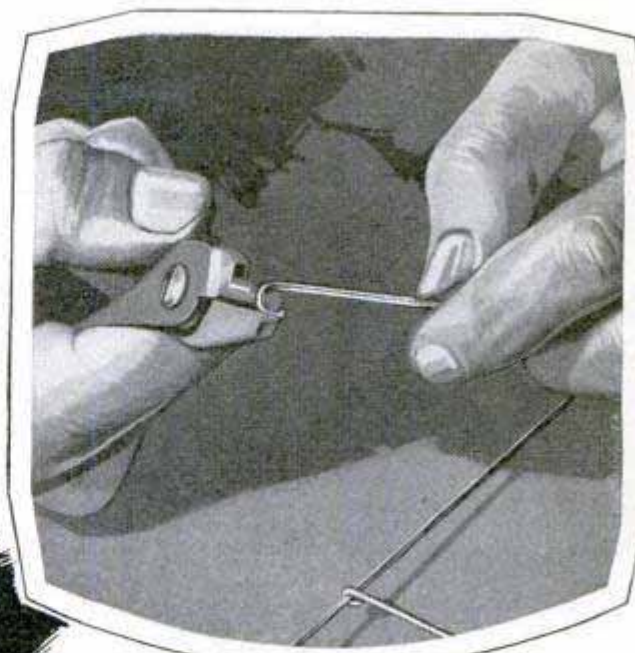

Above, Forming the Loop, Preparatory to Making Connections; Center, Ground Clamp and Aerial Wires; Bottom, Cleaning Jack Contacts

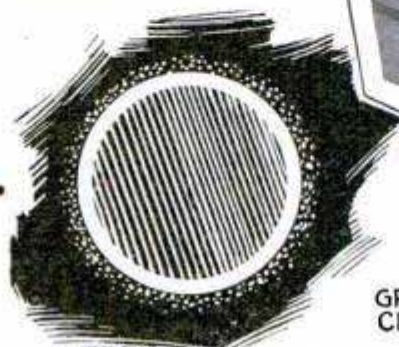

CROSS SECTION ENAMELED-COPPER WIRE



BARE WIRE BRAIDED



TINNED WIRE STRANDED



ENAMELED WIRE BRAIDED

DIRT AND CORROSION

CONTACT BETWEEN TWO STRANDS REDUCES EFFICIENCY

GROUND CLAMP

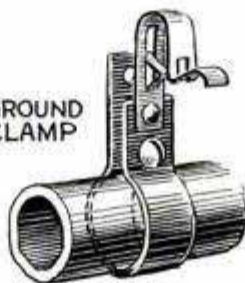

BAKED ENAMEL ON EVERY STRAND PREVENTS CORROSION AND DETERIORATION

BAKED ENAMEL, SOLID COPPER, AIR SPACE

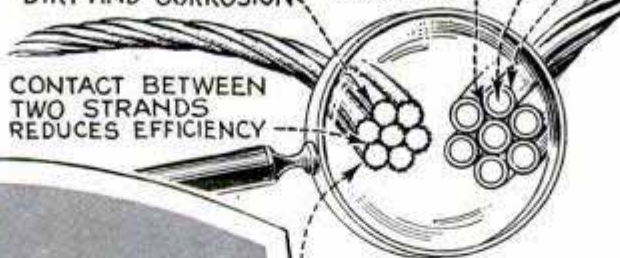

BARE COPPER AERIAL

leakage and resistance to the currents sent out by the broadcasting station if long-distance reception is to be obtained. Experience has taught that enameled-copper wire makes an ideal aerial, several types of stranded aerial wire being shown in one of the illustrations. In the cross section of a strand of enameled-copper wire the white band on its circumference

represents the enamel coating, while the small dots on the outside indicate dirt. The broadcast current penetrates through the dirt and enamel and travels on the surface of the copper wire, beneath the enamel. The copper, being a good conductor and free from dirt, permits the high-frequency radio wave to reach the instruments in the set, at its greatest possible strength. The magnified ends of plain stranded wire and of that covered with baked enamel, clearly illustrate the point. As the high-frequency radio current trav-

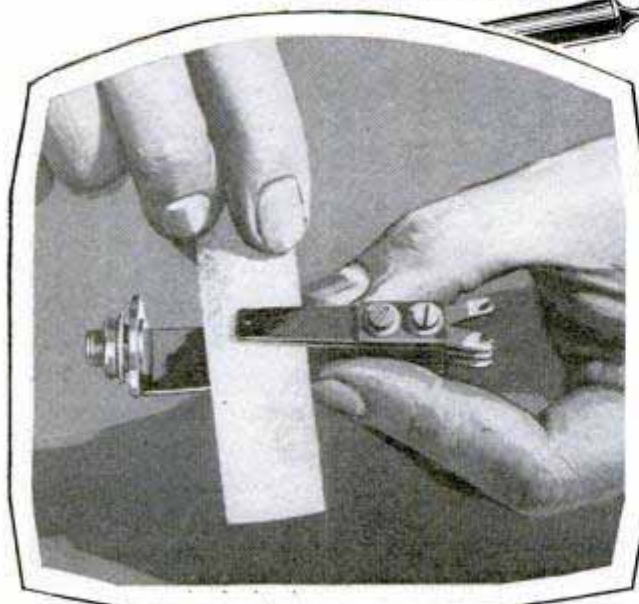

els mostly on the surface of the wire, a film of dirt and corrosion decreases the efficiency of the aerial by resisting the incoming current, which is very weak, even from local stations. It also allows current to leak to the ground instead of going to the instrument as it should.

Dirty insulators are another source of leakage, and must therefore be kept clean.

This is easy to do with glazed or glass insulators, but they should be inspected at intervals to be sure there are no cracks that will accumulate dirt and form a path of escape.

Briefly stated, distance reception is a matter of cleanliness, and frequent inspection of the entire set, including the ground and aerial installation.

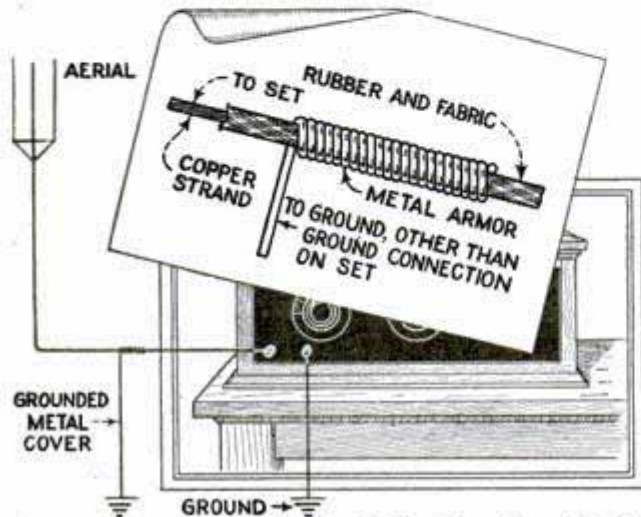

Armored Automobile-Circuit Cable That Proved Efficient Aerial, and Diagram of Installation

**Armored Aerial Minimizes Static**

The armored aerial shown in the illustration is easy to install and gives excellent results. As an experiment, I secured a 100-ft. length of single-strand armored automobile-circuit cable and rigged up an aerial with it for my five-tube set. After trying several different combinations, I discovered that, by connecting the copper wire in the center of the cable to the aerial post on the set and grounding the metal armor, much of the usual static disappeared. Distant stations came in with great volume and clarity. In the final hookup, a special lead was taken from the armor to an iron rod driven 5 ft. into the ground, and the regular ground to a water pipe. — G. C. Douglas, Raleigh, North Carolina.

**When Radio Set Works Better with the Gridleak Out**

If the set works better with the gridleak out, look for trouble in the grid condenser. Often, in a case of this kind, the grid condenser is defective and provides the necessary leakage to make the tube work; poor insulation, not bad enough to make an actual short circuit will cause this condition. If such is the case and a gridleak is placed across the condenser, the resistance is lowered to a point that will produce poor results. A new condenser should be substituted and several values of gridleaks tried until the one is found that will give the best results. Tube sockets made of poor insulating material will often provide a leak for the grid and produce the same results.

**Combination Easel and Wall Speaker**

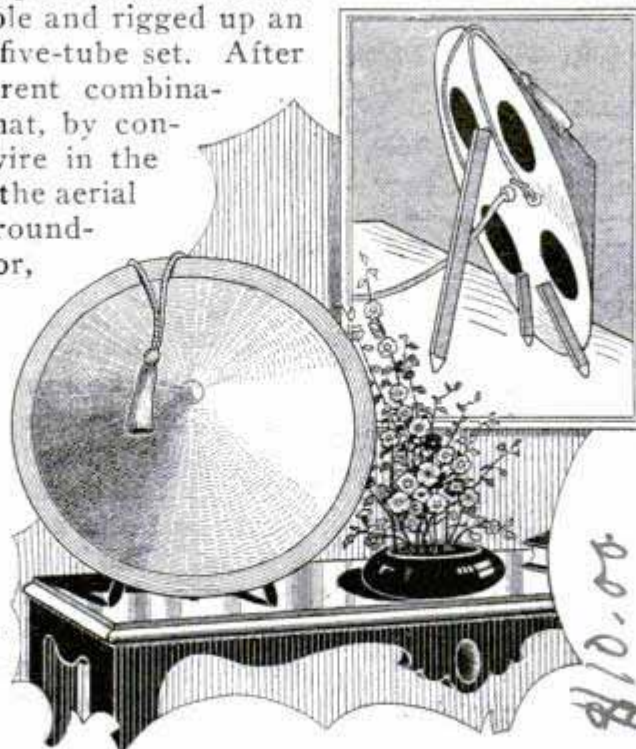

Cone Speaker That Can Be Mounted on Sturdy Easel, Or Suspended from Picture Molding

The combination easel and wall speaker shown has lately appeared on the market. The cone is 18 in. in diameter, its edge being heavily embossed, and the diaphragm is of heavy fiber. A steady easel, with rubber-tipped standards, is provided, and a gold cord with tassel is supplied for those who prefer to hang it from the picture molding. It is claimed that the speaker works perfectly in any position it is placed.

*Warc Radios Corp.*  
*Washington + 7th St*

# Fads and Novelties of Radio World

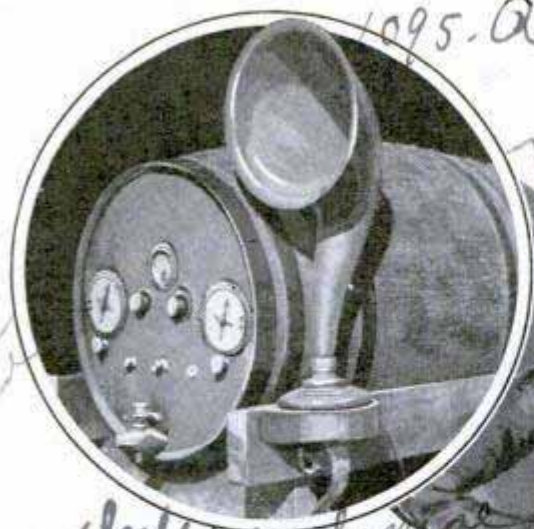

One of the Unusual Radio Sets That Attracted a Great Deal of Attention at the Los Angeles Radio Show; the Complete Receiving Set is Installed in a Keg



Above, Listening to Music Which Is Coming through a Loud Speaker in a Fountain, at the Fair Recently Held in New York City; Left, Set Built in the Hold of a Model Ship, the Copper-Wire Rigging Serving as Aerial

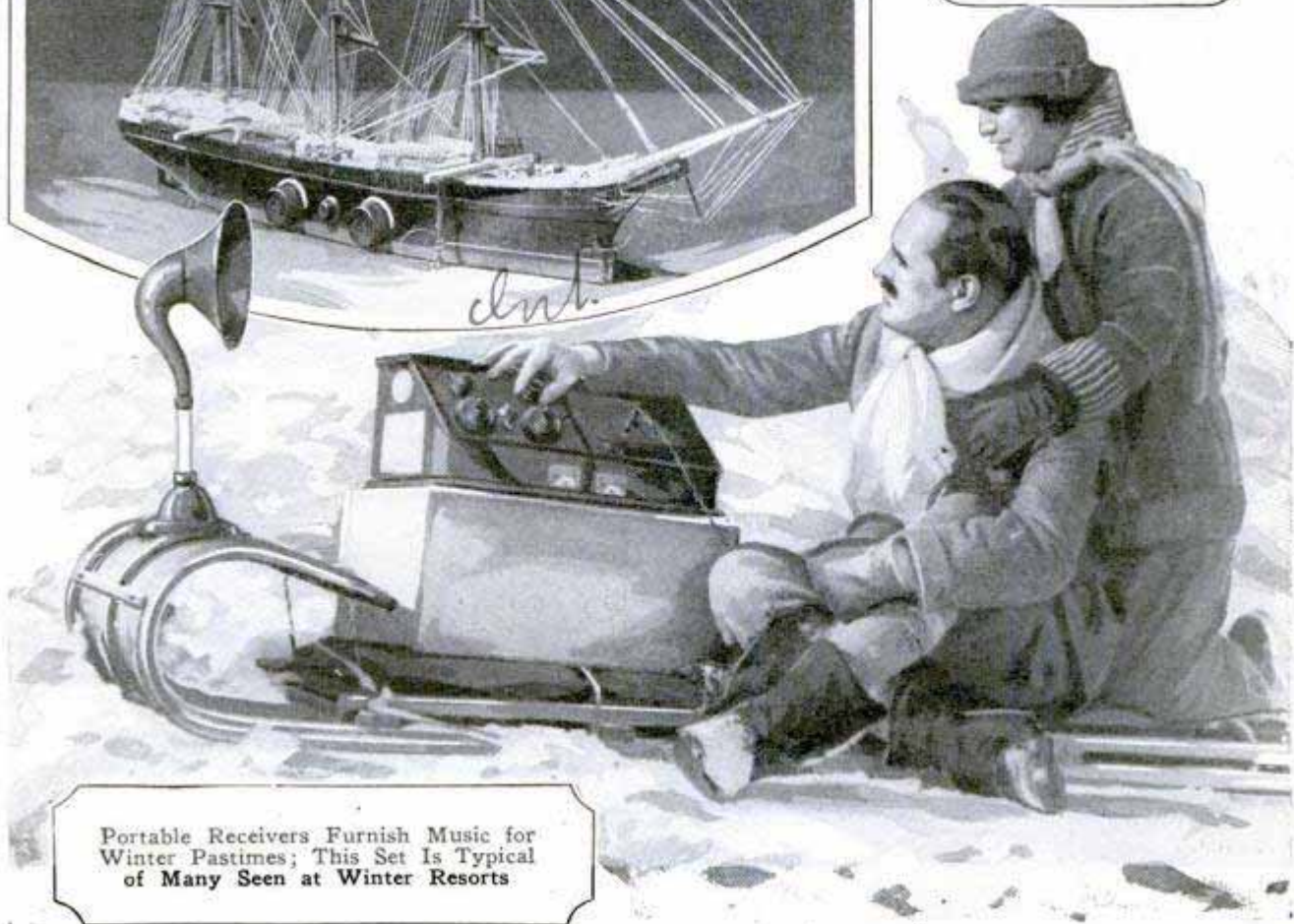
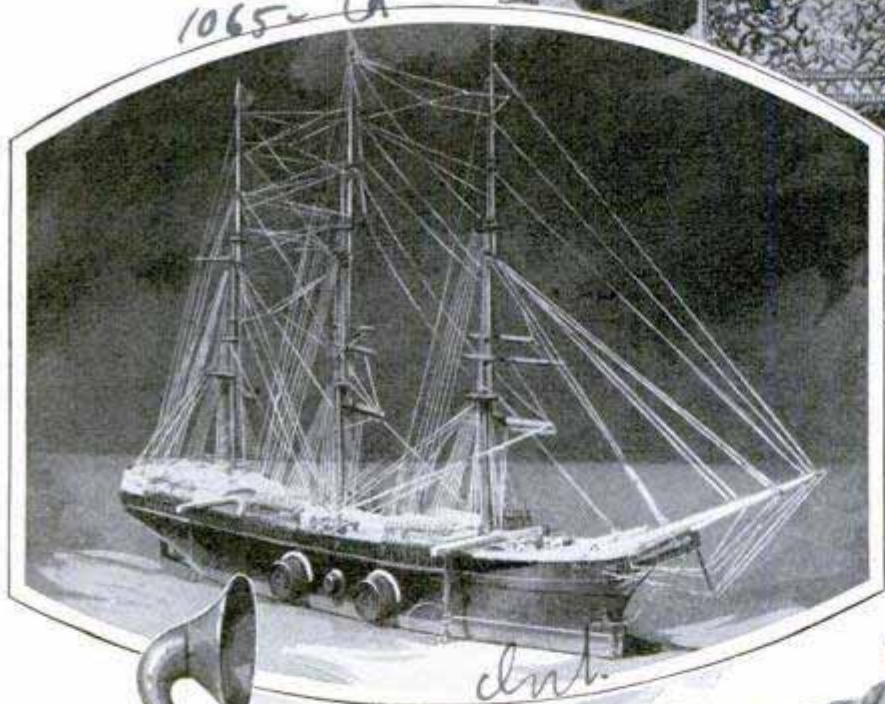

Portable Receivers Furnish Music for Winter Pastimes; This Set Is Typical of Many Seen at Winter Resorts

Howard Radio Co.  
 469 E. Ohio  
 Chicago

**This Seven-Tube Neutrodyne Operates from a Loop Aerial**

954-Q.

A seven-tube neutrodyne operating on a loop aerial is the outstanding feature of

markings are visible through a window in its center. These markings are calibrated in wavelengths, each receiver being tested with a specially built wave-registering instrument to insure accuracy and precision. A small electric light, concealed behind the panel, illuminates the dial markings, making them easily readable. To give smooth, free movement and

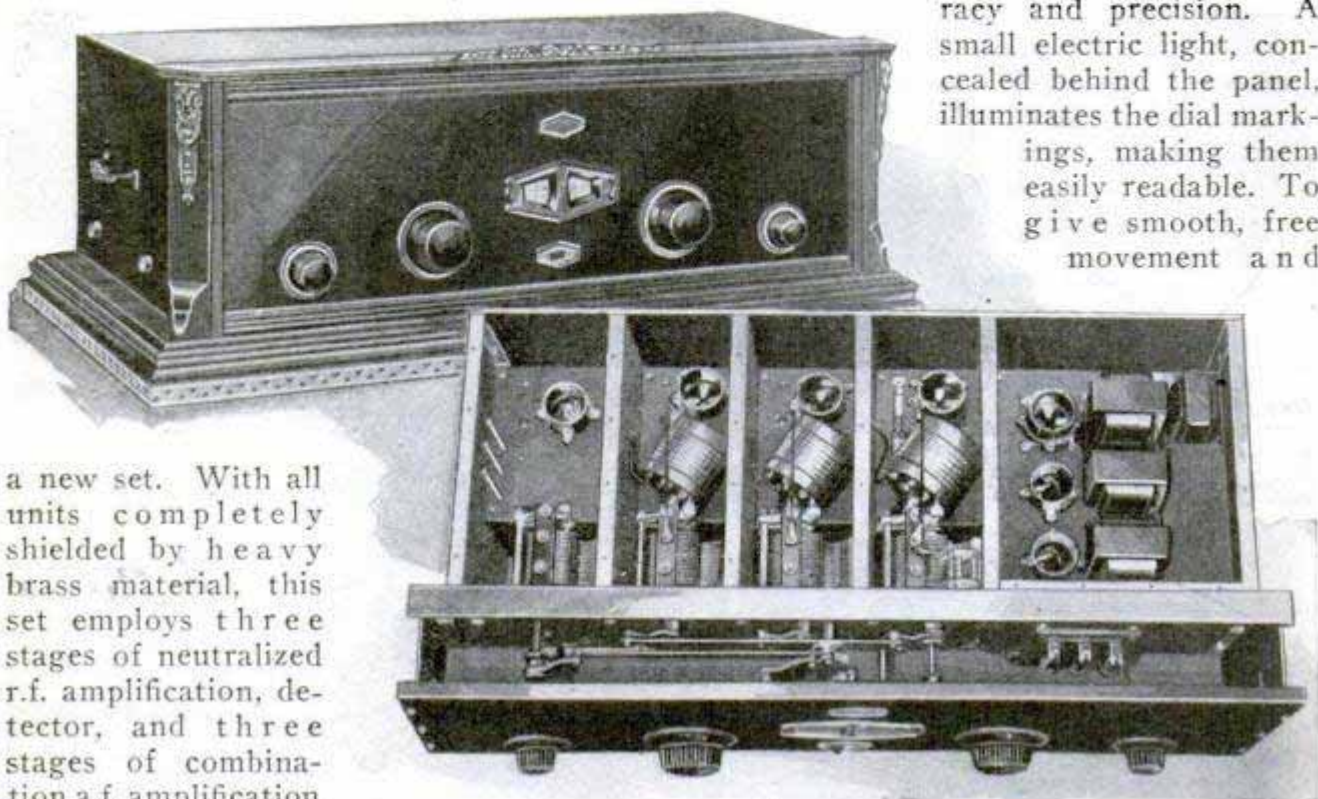

Above, Instrument in Cabinet Showing Tuning Controls and Windows for Dial Markings; Below, Interior View with Top Shield Removed

a new set. With all units completely shielded by heavy brass material, this set employs three stages of neutralized r.f. amplification, detector, and three stages of combination a.f. amplification of special design. It is also adapted for use with light-socket power devices, and is simple in design and attractive in appearance. The operating panel is made of aluminum, stained and grained to represent a rich walnut finish. A dual tuning control is used, and the panel is constructed in such a way that the dial

at the same time provide a hairline adjustment, the variable condensers are operated on two link-motion shafts which are controlled by the two tuning knobs. There are no gears to get out of mesh or wear out. The claim is made that the set is extremely efficient on long distance.

890-Q. **Handy Multi-Connector Plug**

A handy multi-connector plug, lately put on the market, has many uses for the radio experimenter. The sockets are mounted on the panel in the position shown and the combination makes an excellent phone or loud-speaker plug. Any number of parallel and series connections may be made by using several of these plugs. The contact points con-

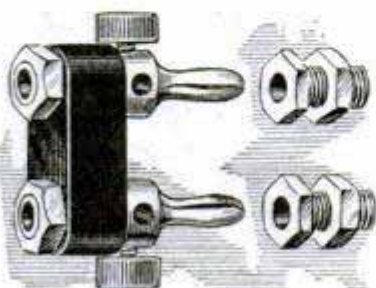

sist of springy prongs which are squeezed together as the plug is inserted, thus making a perfect sliding contact.

**Glass Bottles for Low-Loss Coil Forms**

Glass bottles, of the type used for pickles and olives, make ideal forms for winding low-loss coils, being highly efficient electrically and non-shrinkable mechanically. The start and end turns of the wire can be held in place with a bit of sealing wax. If desired, the finished coil can be treated with a thin coating of flexible collodion and then removed from the bottle. Coils of this type are very efficient and strong enough for average purposes.

General Radio Co  
 Cambridge, Mass



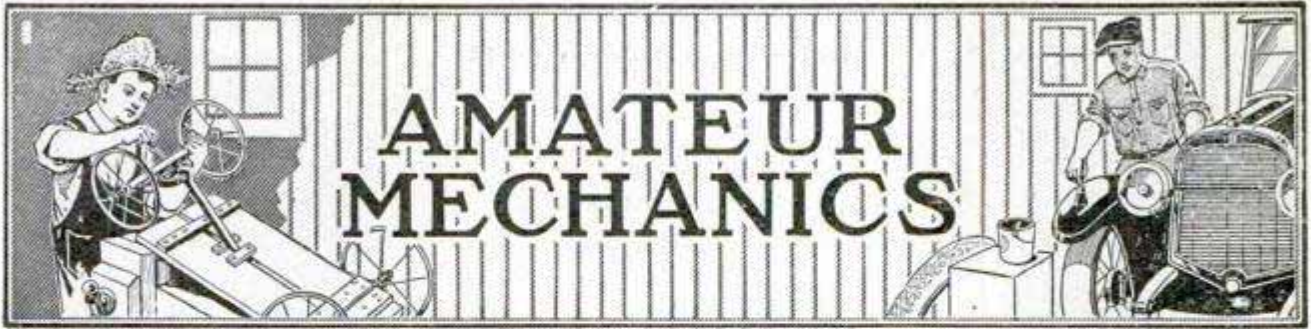

## The Art of Fancy Skating

By EARLE W. GAGE

SKATING has the greatest following of all winter pastimes, and is the real "King of Winter Sports." It is an art as well as a sport and gives healthful exercise to all the muscles of the body, bringing them into harmonious development. Every amateur skater dreams of that day when he may be able to accomplish the intricate figures of fancy skating and the fascinating waltz on ice.

First of all, it is important to have a place to skate, and if no natural rink is available near by, it is comparatively easy to construct one. The artificial rink may be anything from a small backyard affair, covering a few square yards, to a large and expensive rink, such as that recently completed at Montreal, at a cost of \$1,000,000. Yet there is a real art

in making skating rinks, and unless the proper rules are observed, trouble is sure to follow. The lay of the ground should first be considered. The surface should be level, or as nearly so as possible, for the more the ground slopes, the longer it will take to floor every part of the area, making a level rink. Clay land is the best, since it tends to hold the water until it freezes, gravel soil being next best, and sandy soil poorest.

It is necessary to throw up banks about the proposed rink. The best bank is one

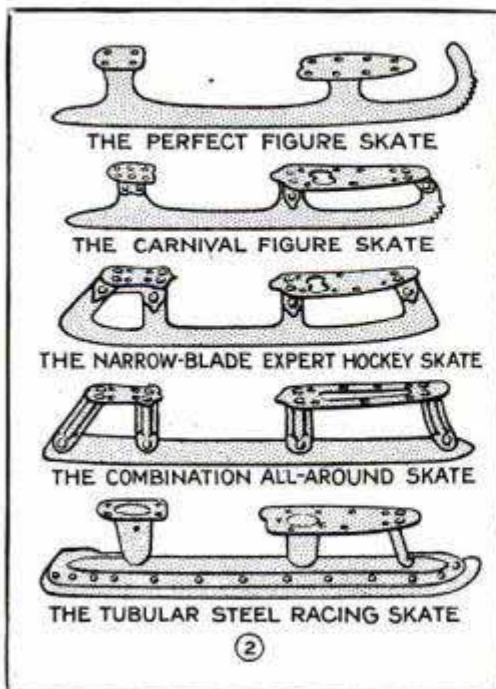

Various Forms of Skates, Each Type Being Adapted for a Particular Purpose; the Upper Two Are Popular Forms for Fancy Skating

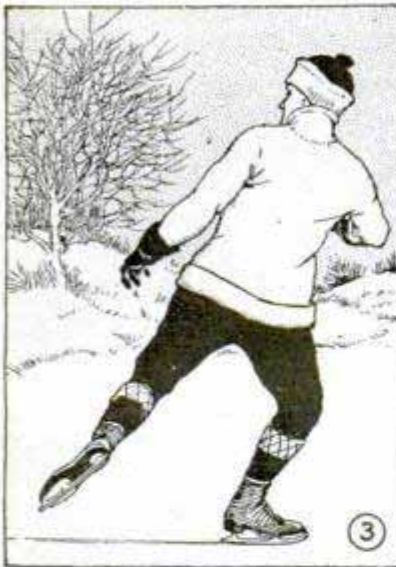

Fig. 3. Middle of Circle, Right Outside Backward; Fig. 5. Start of Right Outside Forward Circle; Center, Various Forms of Fancy Figures



which has been plowed up and tamped before freezing weather comes. One furrow should be plowed around and the dirt packed down with a spade or tamper to make it solid enough to close all air holes. Or, a board bank may be constructed of 2-in. planks, 10 or 12 ft. long, laid on edge after the loose surface has been scraped to let the plank rest on a solid foundation. The planks should be laid end to end around the rink, 2 by 4-in. stakes, about 36 in. long, being driven into the ground to a depth of 1 ft. at each intersection and nailed

to the planks. This serves to prevent the planks from moving under the pressure of the water. The dirt scraped from under them should be tamped around the planks at the bottom. If there is plenty of snow on a level piece of land,

it may be possible to scrape off the loose part, forming banks, over which water is sprayed, freezing them solid so as to hold the water poured into the rink. But this takes more time and is less satisfactory than the other method. After these steps have been taken, the rink is ready for freezing.

This calls for some time and cannot be hurried. The rink should not be flooded save in extremely cold weather, when an attempt may be made to bring the surface, after it has been properly prepared, up to level. The best way to accomplish this is to use a garden hose without a nozzle, spraying the bank particularly at its base. Do this night after night until there is no possibility of leakage. The surface may be frozen in the same manner, starting the work at the far end and working toward the water supply. Repeat this process until the ice is from 2 to 4 in. thick. Then, when the thermometer falls to from 8° to 10° above zero, connect the hose with a fine rose nozzle, and play the stream up in the air so as to have it come down in the form of a fine mist and freeze on striking the ice surface, which will not allow water to form in pools and cause rough spots. Skating may be started on ice 1 in. thick on the first night after spraying, additional sprinkling giving a smooth surface after the skates

have cut the surface. Continue to spray every night until the ice is 6 in. thick, when you will have a really nice rink.

It is possible to build an inexpensive rink on the lawn, if there is a level piece of ground, 20 by 40 ft., by building a clay-loam dike around the border, about 12 in. high by 12 in. wide at the top and with sloping sides. Such a rink will provide ample skating space for a dozen people, and will not injure the grass.

If the rink is con-



best scraper is made of sheet iron, about 4 ft. long by 3 ft. wide, and is formed like a large dustpan on runners, the edge being about 18 in. high at the back. The runners begin about 6 in. from the front of the scraper and continue along the bottom and up the outside of the back. Two men can push this over the surface of the rink and shave off the surplus ice. It is not necessary to sweep the rink for the



Diagrams Illustrating the Spread Eagle, Various Forms of Spirals and Methods of Making Jumps;

stantly used, it is necessary to shave off almost as much ice during the day as was put on the preceding night. This should be done before the rink is used and the process should be repeated several times during the day. The

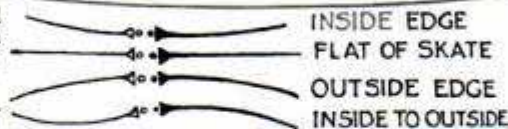

Cross Section of Rink and Dikes; Fig. 7. Position of Skaters for Dancing on the Ice

THE SPREAD EAGLE

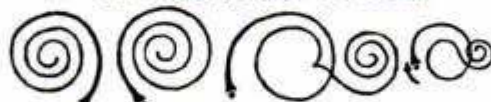

FORMS OF SPIRALS



FORMS OF JUMPS

JUMP FOLLOWED BY ONE-FOOT SPIN

PRACTICE METHOD

JUMP FROM BACK WARD THREE

water will absorb it. Sprinkling should be done regularly, say, from 6:00 a.m. to noon, and from 6:00 to 10:00 p.m., when the scraping is done, the water sprinkled being left to freeze all night.

A pair of good skates is the next item. There

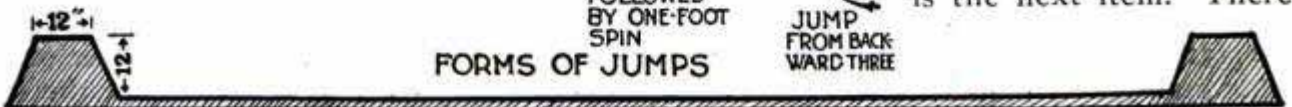

SKATING RINK

are a score or more styles to select from, each adapted to some particular use, such as general all-around skating, racing, hockey or figure skating. Practically the entire length of the racing skate rests on the ice, while but 4 to 6 in. of the curved hockey skate touches it, and this length is reduced to 1 or 2 in. in the figure skate. Each has a skating surface intended for practical use; the racing skate to secure the greatest speed in a straight course, longer and faster glides being possible with the long blade than with a shorter one. The 15-in. blade is the average for outdoor rinks. The blade is narrow, to assure an easy glide over the ice. The tubular skate, securely screwed to skating shoes, is probably the most popular one now used. This also may be had in several types, from the tubular hockey to the racing skate. It is essential, no matter what type is selected, that only the finest grade steel is used in making the surface. If the maker's name and guarantee are not stamped upon the skates, do not buy them.

There are three distinct styles of skating—English, American and continental. For several years the English style was accepted, but in more recent years the continental has gained in popularity until it is now universal. In this, the body sways with the direction of the stroke, the arms outstretched, indicating the forward movement, and the legs gracefully bent. In the English style such movement is not permitted. The arms are held motionless close to the body, the legs are unbent and there is a great rigidity of the body throughout. The American style is a combination of the two.

The beginner will learn more easily and quickly by having an experienced skater show him the stroke and body movements. A few simple rules should guide these. The toe of the propelling foot has to be turned outward, and the inner edge of the skate must be presented to the surface of the ice. The whole leg should be directed outward from the line of motion. The other foot has simply to be placed in the position for supporting the body and for running forward with the least possible resistance consistent with guiding the body rightly. The arms are swung from side to side, so that they are extended to

the right side, while the skater is running on his right foot, and to the left just after the stroke of the right foot is completed. This alternate swinging of the arms comes naturally to the skater in keeping his balance and little attention need be paid to it. Bear these rules in mind when learning to skate: Keep the weight of the body well in front, by leaning slightly forward; allow one foot to complete its stride before the next is begun; turn out the toes, and keep the ankles stiff and firm.

The skater should strive for long and finished strokes, not short, choppy ones. Put all the strength into every stroke, letting it carry you as far as it will. It is by the long, even strokes and the rhythmic swaying of the body that the good skater is distinguished from the beginner. In making a stroke with the left foot, let the body sway slightly to the left, and raise the right foot from the ice.

It is an easy matter to make a turn. When gliding forward with both skates on the ice, the two skates parallel, the slightest effort will incline them to the right or left, and the direction is instantly changed more or less in proportion to the degree of the muscular effort. It is much more difficult to make a stop. The usual method is to let the body lag behind the feet, and then to raise the toes of the skates, allowing their heels to dig into the ice until the friction overcomes the momentum. This requires some skill in balancing, and should not be tried until after the other strokes have been mastered. Another method is to turn abruptly half around and place the sides of both skates exactly at right angles to the line of motion, at the same time leaning over to the side toward which the turn is made.

In fancy or figure skating, very long, sure strokes are essential. Several figures are made while standing on one foot, and one would not be able to travel very far, or to cut many figures, using short, choppy strokes. Special skates are necessary, which are curved, sharp, and pointed at the end, in order to hold when one makes a sudden stop to do some intricate figure. It is absolutely essential that the body be held correctly, and here are the official standards followed by the best performers: Head erect, with eyes upon the ice seldom or never during the free skating,

and, in any case, not more than absolutely necessary; body upright, not bent forward or sidewise from the hips, shoulders thrown back, and chest expanded; arms, whether active or passive, should have free play from the shoulders, elbows slightly bent, hands with the palms downward or inward; skating leg always bent at the knee, to insure a springy rise and dip of the body; free leg poised or swung entirely from the hip, in the socket of which it should be turned outward and backward as much as possible, always separated from the skating leg; knee slightly bent, toe pointing down and out.

The beginner should select a few simple figures and master these before he tries any "tricks." First start on the large figures. There is a mistaken idea that skating these makes the execution of smaller figures more difficult; every professional first started on large figures

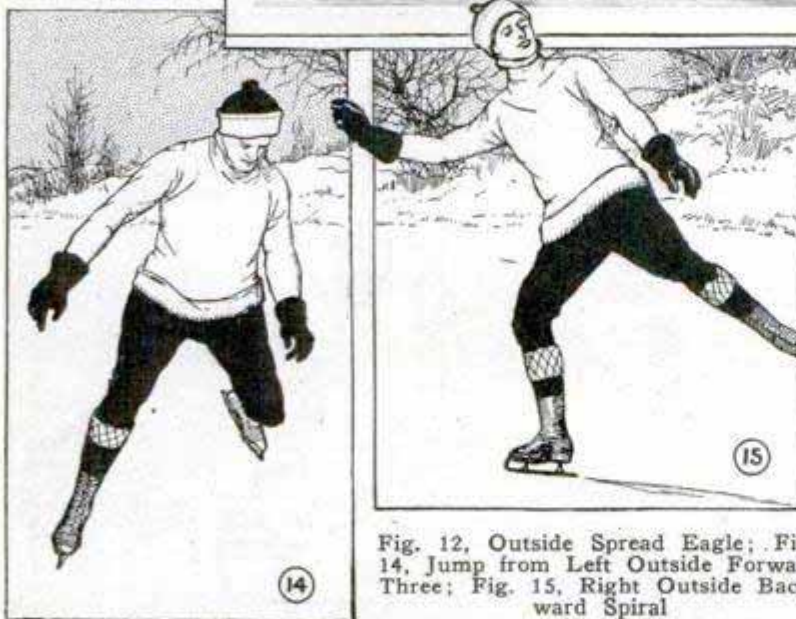
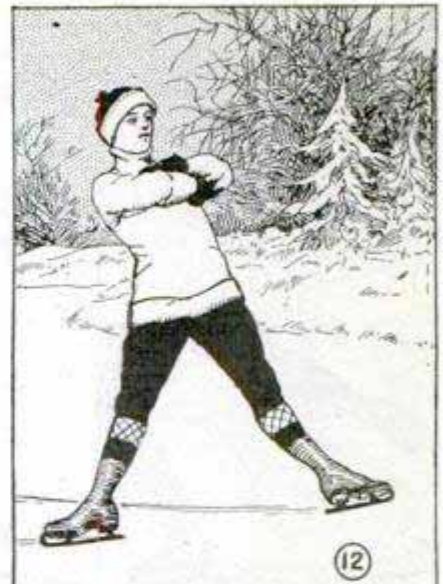

Fig. 12, Outside Spread Eagle; Fig. 14, Jump from Left Outside Forward Three; Fig. 15, Right Outside Backward Spiral

ing the skater more sure, easy and graceful when he comes to the smaller ones.

When walking, progress is made by means of the foot upon the ground, while in skating, all impetus comes from the foot just as it leaves the ground; while walking, we use the ball of the foot to steer and the body follows, and in skating, when the skater desires to turn, the shoulders and hips do the steering and the foot follows. Because skaters have not mastered this simple rule, they find it very difficult to make turns, which are fundamental in fancy skating.

before he tried small ones. The large figures aid in attaining good form, mak-

they find it very difficult to make turns, which are fundamental in fancy skating.

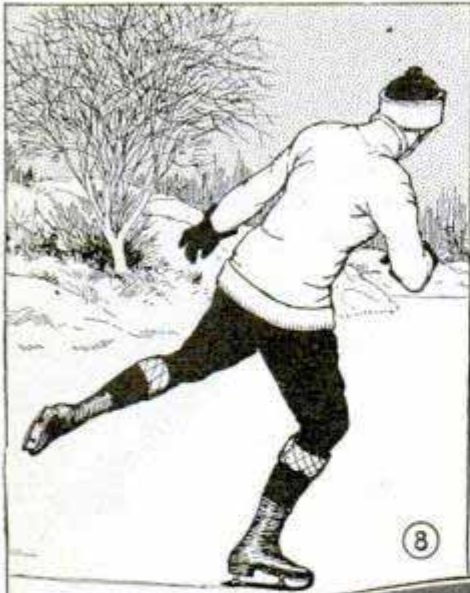

the first thing to learn in figure or fancy skating. This is effected by spread-eagling the feet, and comes with ease to those who are able to get into that posture. For the forward Mohawk, the skater proceeds on a right outside forward curve, and when he is about to effect the change to left outside backward, he thrusts back his left shoulder and brings forward the left leg in front of the right; then, turning the toes out as much as possible, he swings it around and behind the right and places it down on the outside back, and at the moment it touches the ice he takes up the right. The change from a back to a forward edge is made in the same manner, only in this the unused foot is thrown behind the foot on the ice and then swung around the latter and placed in front.



The knack of plain forward and backward strokes and turns may be acquired by the average beginner in a short time. But it is no easy task to become a good figure skater, and it requires long and painstaking practice. Only by tilting the skate is it possible to describe a circle. Only when wearing skates having a curved, sharp, and pointed end, is the skater able to make sudden stops and do figures.

Irving Brokaw, champion of America, advises that mastery of what is known as the "Mohawk" method of skating from forward to backward, or backward to forward, on an edge of the same character, is



Fig. 8, Approaching Turn, Right Inside Forward Three; Fig. 10, Start of Right Outside Forward Loop; Fig. 11, First Curve, Right Inside Backward Bracket

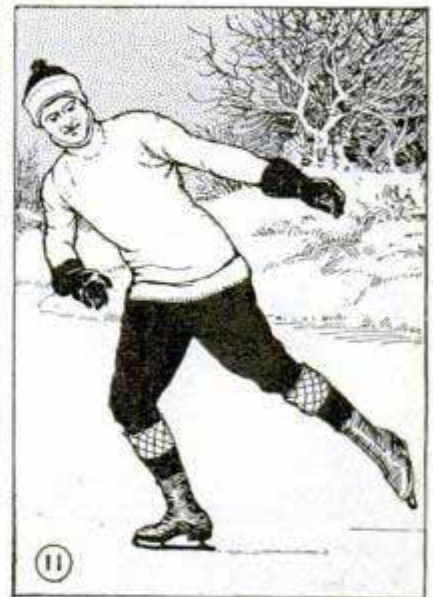

The outside Mohawks are more difficult than the inside ones, as with the inside

the feet must be turned out far less than with the outside ones. In making the Mohawk, the body is turned in the same way as in doing a "common bracket," also known as a "Mohawk on one foot."

The skater may go from outside forward to outside backward by simply bringing the left shoulder forward instead of backward and rotating the body in the direction of an ordinary three. It is necessary to make a jump, since the toes must be turned in at an extremely sharp angle just as, in the Mohawk, they are turned very much outward.

Three points should be borne in mind: Keep the skating or used knee bent at all times; carry the unused toe down and outward; learn to copy the correct skating positions found in rule books, which give the correct professional positions. The skater should aim to obtain power and control on both feet. Usually one foot is weaker than the other; practice most on the weak foot at the start until it becomes as strong as the other, for no person can be a good fancy or figure skater who is a one-legged skater.

There are two edges to every skate, the inside and outside edge. The inside edge is the one on the inner side of the foot, while the outside edge is that on the outside side of the skate. When the skater is moving on the right foot in a curved direction to the right he is on the outside edge, and when he is moving on the right foot in a curved direction to the left, he is on the inside edge.

"Spins" include artistic skating done on one foot, while "whirls" refer to those done on both feet. To make a spin, the skater starts very slowly, to se-

cure proper balance, and comes up to the flat of the skate, the used knee bent and arm outstretched, looking around in the direction of motion, holding head and shoulders bent slightly forward. Lean a trifle on forward part of skates, balance foot carried rather near the ice; come out of spin easily and without losing balance. If done in the proper manner, ringlet marks appear on the ice. This should be practiced both forward and backward, on right and left foot and all edges. There are several variations in this, as the drawing shows.

The two-foot whirls are made by starting on outside forward of one foot, turning by means of a three to other edge backward; bringing balance foot directly on ice about 18 in. from the other foot; arms outstretched at first and then quickly brought to sides, making the finish by remaining on one foot for several revolutions, while raising the other foot off ice.

The spread eagle makes a very pretty and artistic number. Not every skater can do this at first, although a few lessons will accomplish the art without great difficulty. Perseverance will

master it, unless the skater is bowlegged. It gives the easy and graceful bearing which every good skater wishes to acquire, and is of great assistance in executing Mohawks, threes, brackets, rockers, etc. It is essential that the head and body be held erect and the legs straight without being bent at the knee.

The spread eagle may be skated either on the inside or outside edge or in a straight line. Both legs must be turned directly outward from the hips, with heel pointing to heel, and muscles brought into play



which are not usually employed in skating. Until the muscles have developed, the beginner will have an ache in the calf of the leg. In the outside position the skater leans backward as far as possible, with legs wide apart, and in the inside, he leans forward, keeping whole body erect.

There are various methods of making spirals, and these afford the greatest test of graceful bearing that the skater can hope to attain. Much strength and power is needed to hold a position to the end of the large circle, so the beginner should start on simple spirals and gradually work up to the larger and longer ones as his experience and endurance permit.

Although jumps give the spectator the impression of agile action, spectacular and difficult, they are very hard on the skater, and call for much experience and practice. They may be made from threes, forward and backward, loops, brackets, rockers and counters, and should be prac-

ticed with either foot. A jump may be made from one foot to the other or on the same foot. Professionals do such spectacular stunts as jumping over a row of six or eight barrels, or over the backs of skaters, but the amateur will need considerable practice before he will feel safe in trying to span even a small box.

Waltzing on skates is one of the most popular pastimes of the winter, and is a delight both to performers and spectators. This art has little in common with its ball-room cousin, save the position of the partners, their simultaneous rotations, and their moving to the tune of music. The glides are long, in yards instead of inches, with smooth, circling movements. The step is nothing more than an ordinary forward outside edge on one foot, followed by a three-turn to the back inside edge on the same foot, and then a passing, with a gliding step, to the backward outside edge on the other foot.

### Lifting Valve-Rocker Arms



Tire Iron and Cross Link Facilitate Lifting Valve-Rocker Arms

An old truck-chain cross link, with the ends spread apart, may be used with a tire iron to lift valve-rocker arms on overhead-valve motors for the removal of the push rods. It takes little space, may be picked up in any junk yard and serves the purpose very well.—Richard C. Tarr, Gloucester, Mass.

### Making Paint Stick to Glass

Most of us know that it is next to impossible to make paint stick to glass permanently. It chips off soon after its application and several coats are worse than one. To make it stick, melt an ounce of clear rosin and, before it has cooled completely, dilute it with enough turpentine to keep it in a liquid state. After

mixing the paint to be used, pour it into this solution and there will be no trouble. The work takes only a few moments and the resulting job will be permanent.—L. H. Georger, Buffalo, N. Y.

### Automatic Chicken Feeder

A simple and efficient automatic feeder for small chicks may be made as follows: Take an empty tin coffee can, or other suitable can about 6 in. in diameter, and with a pocketknife cut three horizontal slits in the side, about  $2\frac{1}{2}$  in. in length, equal distances apart, and about 1 in. from the bottom. Then crush in the can above

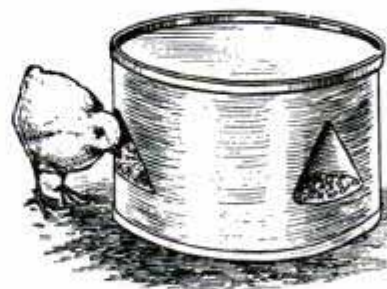

the slit sufficient to allow the chicks to feed. The sharp edges should be bent over to avoid injury. Altering a large can in the same way will make a good self-feeder for larger chickens.—F. J. Hiscock, Cody, Wyo.

☞ When paper sticks to a negative while printing, it can be removed by soaking both in hypo.



*Winter Holiday*  
*35 S Dearborn Chicago*

### Remedy for a Leaky Chimney

In the rooms immediately below the chimney there was occasional evidence of a leak during heavy rains. Repeatedly roof men made repairs which were intended to correct the trouble, but the leak persisted. Finally it was observed that no leak appeared during those months of the year when the heating system was operating, no matter how hard the rain. From this fact it was discovered that a few porous bricks in the chimney right at the roof line were causing all the trouble. The water was working its way into the bricks and completely around the flashing. When the chimney was in use, the heat apparently dried the water out faster than it could soak through the bricks. Painting the bricks at the roof line with a heavy roof paint remedied the trouble.—L. I. Thomas, Oak Park, Ill.

### Identification Tags on Umbrellas

Umbrellas are often lost and as they are not usually provided with identification tags, they are not returned to their owners. The tag shown in the drawing has

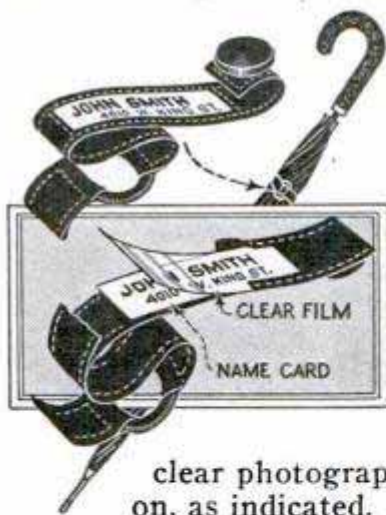

been found handy and it is not in the way. It is attached to the band used to tie up the umbrella. The band is cut out on the inside and a piece of paper covered with

clear photographic film is sewed on, as indicated. After the name is printed on it with ink the paper should be waterproofed by soaking it in linseed oil.

### Spooks in the Dark

Many spirit mediums use luminous paint in various ways in the production of scenes. Here is one of their tricks, which anyone can duplicate, and it will be the cause of much merriment as a practical joke, especially at Halloween time. The effect is that of a luminous face and hands



Luminous Paint Makes a "Glove Monkey" Appear as a Spook in the Dark

floating through the air and finally disappearing. The hands and face move about naturally, the hands making gestures and the head nodding in reply to questions. Get a "glove monkey," which is made to be operated by one hand. Cover the hands, face and ears with luminous paint, being careful to place black lines between the fingers on the hands. The eyes and mouth are also left black. Expose it to the light five minutes before demonstrating in the dark. It is covered with a black cloth or uncovered to make it disappear or reappear.—Bronaldo Murray, Sturgis, Michigan.

### Deflector for Auto Heater

The photo shows a deflector for an auto heater. It is easy to make and costs little. A piece of galvanized iron, 5 by 8 in., is used.

It is bent to the shape shown and fastened to the floor under the mat by means of screws and small nails. It keeps the stream of

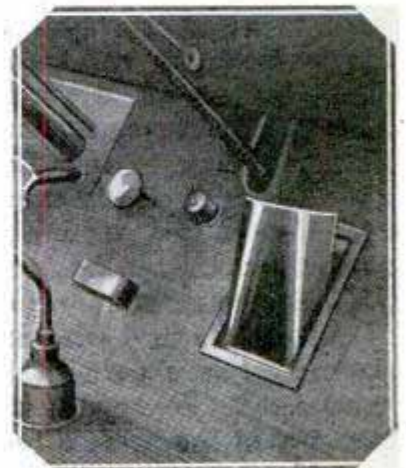

warm air from passing directly to the passenger's face and spreads it over the car.

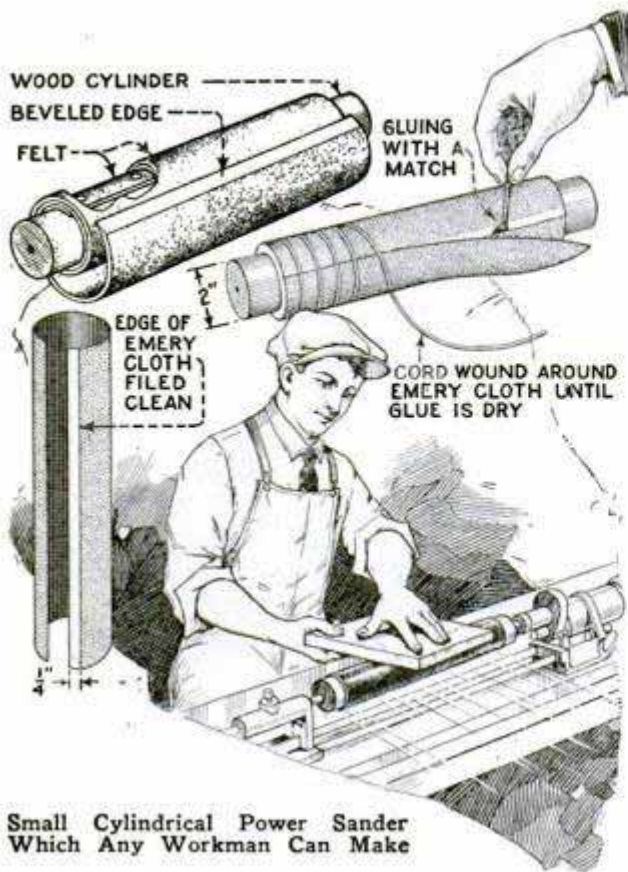

Small Cylindrical Power Sander  
Which Any Workman Can Make

### Power Sander for Home Workshop

Often it is necessary for the home mechanic to do some sanding in his shop and, if he has a lathe, a cylindrical sander can be made in a few moments. Turn down a roller, about 2 in. in diameter and 10 or 12 in. long. Tack a piece of felt cloth on, as shown in the upper left-hand detail, and bevel the edge of the felt with a wire brush or with a coarse file, so that there will be no ridge when the felt is wrapped around the roller in the direction opposite to that in which the lathe turns. This will prevent the felt from coming loose. A piece of emery cloth is cut out to fit snugly over the roll, allowing  $\frac{1}{4}$  in. for gluing, as shown in the lower left detail, and is filed clean, so that the glue will readily adhere to it. The inner side of the other edge of the emery cloth is stuck over the cleaned portion after the glue is applied, which can be done with a match. To keep the emery cloth on the roller until the glue is dry, wind some heavy cord around it, as shown in the upper right-hand detail. Be sure that the emery cloth overlaps in the same direction as the felt, in order to prevent it from being torn while sanding. The use of sandpaper instead of emery cloth is not advised, as it

tears quickly and has to be replaced so often. The felt provides just enough resiliency to protect the emery cloth and make the sanding operation easy.—E. R. Haan, Chicago, Ill.

### Paraffin Wax Keeps Paper Clean

I had occasion to make a chessboard recently and, having some heavy white drawing board on hand, I drew the squares and filled them in alternately with black India ink. While making the board, I knew that it would soil easily, but by the time the board was finished I hit upon an idea to prevent the white from showing dirt, or rather a way to prevent dust and dirt from collecting upon it, by rubbing it with paraffin wax. Now, after considerable usage, it is still in fine shape and as white as when I made it. I have found that this is an excellent method of keeping drawings and all sorts of cards clean that have to be handled much.—Edward H. Flaharty, Parco, Wyo.

### Novel Use for Drain Tile

The accompanying photo shows a novel use for drain tile. The two pillars on the porch and the pot in the center of the lawn are made of 18-in. glazed tile. The pillars have blocking inside, to help support the weight of the porch roof.—Gordon H. Sears, Holliday, Utah.



Glazed Drain Tile Can Be Used Successfully as  
Porch Pillars

**New Arrangement for Stamp Album**

Collectors of postage stamps are always on the lookout for new methods of arranging their specimens, so that their stamp albums may be made more interesting. Here is a novel scheme which does not require any change in the regular layout. Eliminating the half and one-and-one-half values of the present issue of United States stamps, select good copies of the precanceled kind bearing the post marks of the ten largest American cities. Mount these numerically, each bearing the name of a city according to its rank. Thus the one-cent stamp would stand for New York, the two-cent stamp for Chicago, and so on, until the tenth denomination, representing the tenth city in size. The whole set may be arranged accordingly. Previous issues, or those of foreign countries, may be mounted in the same order, arranging the stamps in the position the cities held at the time that the stamps were current.—Charles E. Forgette, Plattsburg, N. Y.

O. H. Caspary  
 146 E. Linden  
 St. Louis

**Powerful Tweezers Simply Made**

An unusual type of tweezers for light work, which has an extraordinarily firm grip, is shown in the illustration. It will be found especially useful when the pressure must be maintained for a considerable length of time. The tool resembles the conventional type, except that a link is passed over the legs. Holding the upper end of the link with the thumb, and drawing back on the lower end with the index finger, as shown, produces a powerful grip at the points.



**Baby Carrier for Small Autos**

Most baby carriers for the automobiles are made for larger cars and as I could not buy one that would be suitable in my Chevrolet touring car, I made the one shown in the illustration. A strip of 1/2-in. strap iron, bent to a rectangular form,

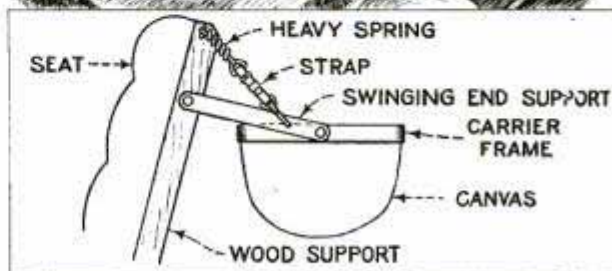
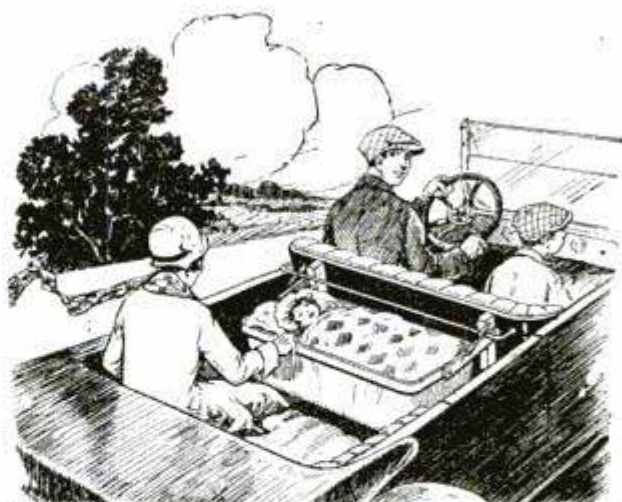

Homemade Baby Carrier Which Fits behind the Front Seat in Any Small Auto

about 14 in. by 2 1/2 ft., makes the frame for the carrier. The overlapping ends are drilled and fastened with screws. A 1/4-in. hole is drilled through the center of the ends, so that the frame can be pivoted on two supports, which are also made of strap iron. These supports are arranged so that they will swing a little on a vertical wooden support, and a heavy spring and strap hold them in position. Details of the construction can readily be seen.—Guy E. Clark, Everett, Wash.

**Reducing Labor of Hanging Clothes**

When clothes are hung on the line, one's back soon begins to ache from stooping so often to pick up the clothes

out of a basket and then to gather up the clothespins. To do away with this trouble, it is a good idea to provide a rack of suitable height for both the clothespin box and the clothes basket on a near-by fence or attached to the clothesline pole.—F. Ellis White, Brockton, Mass.

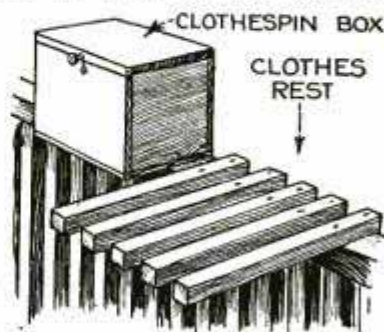

### An Improvised Pressure Shower Bath

Portable shower baths usually consist of a spray actu-

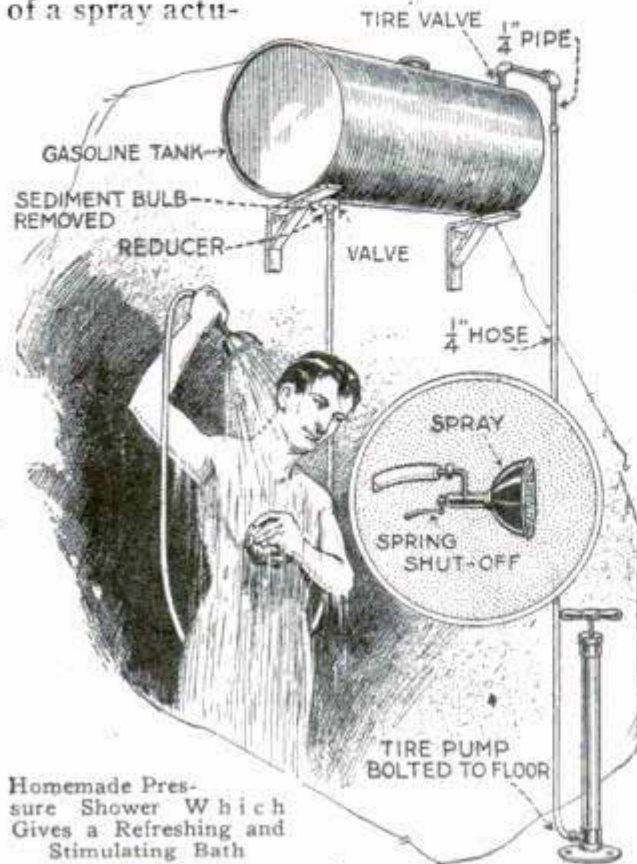

Homemade Pressure Shower Which Gives a Refreshing and Stimulating Bath

ated only by the fall of the water from overhead by gravity. These do not stimulate the skin and circulation like the needle baths, and a shower that will approach the qualities of the latter can be made by the home mechanic at slight expense. Arrange a shelf for a tank near or over the bathtub and low enough so that the tank can be readily filled with water. It is a discarded automobile gas tank of the kind that can be sealed so that it will withstand a few pounds of air pressure. Set the tank on the shelf and clamp it in place securely. Drill a hole in the top near one end and solder in a tire valve. Connect this with two elbows and two short pieces of  $\frac{1}{4}$ -in. pipe, so that one piece points down alongside the tank. Then remove the sediment bulb from the outlet underneath and substitute a shut-off valve and nipple, or reducer, as shown. Drill two holes in the foot of a tire pump, screw the latter to the floor beneath the air-valve inlet and connect the two with a  $\frac{1}{4}$ -in. rubber hose. Connect a sufficiently long piece of wire-wound pressure hose to the valve under the tank and fit the other end with a spring shut-off

valve, such as can be taken from a discarded farm-spray outfit. To the end of this attach a spray head. If possible, choose one of a shape that can be hooked over the upper valve stem when not in use and thus be held out of the way. To use the shower, remove the filler plug and pour in water until the tank is three-fourths full. Replace the plug with a rubber gasket to insure a tight seal. Force in air to several pounds' pressure with the pump. The tire valve acts as a check. When ready for the shower, open the tank valve and press the lever on the spring valve next to the spray head. The water will be forced down with enough pressure to give an exhilarating bath. When through, shut off the tank valve to guard against any leaking from the spray and hang the latter over the valve handle, as suggested.—L. B. Robbins, Harwich, Mass.

### Removing Stuck Lead from Tip of Refillable Pencil

When the lead becomes jammed at the end of refillable pencils and cannot be driven out, the only remedy is to drill it out. The main objection to this process is that, in the average household or office, a drill of the proper size is not at hand, and even if the regular twist drill of the proper size is used there is always the risk of enlarging the hole so that afterward the lead will wobble. For an emergency drill, get a large-size needle which will slip freely into the bore. Break off the end about halfway down the eye, as indicated, which will give you a two-pronged drill. The best plan is to hold the needle with a pair of pliers or drive it into the door casing, point first, and, after inserting the eye end in the pencil point, revolve the pencil between the fingers. Clean frequently as the drilling progresses.

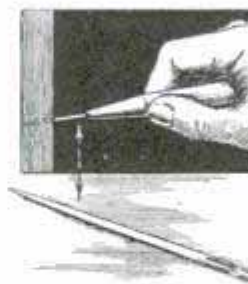

Commercial film is developed in the same manner as any other film; the resulting negative can be used for contact printing or enlarging, and if the prints are tinted, they make very attractive pictures that are a decided novelty.

# Make This Kicking-Mule Toy

By HERBERT C. MCKAY

EVERY child is familiar with Si Perkins and his mule "Maud." There are few toys that are simpler to construct than Maud and none that will hold the interest of the child longer. While the outlines of the various parts were made upon  $\frac{1}{2}$ -in. section paper, the exact proportions need not be followed closely. In fact, the whole design may be readily adapted to other forms of toys. Only Maud's reputation among the children led to her being adopted.

The material used should be plywood or, if this is not procurable, some soft, tough wood that does not split easily. The drilling and the strain incident upon operating the toy make easily splitting woods unsuitable. The parts should be sawed from the wood, sanded, drilled, enameled and varnished before assembly. A hard-drying varnish must be used, so that the parts will move smoothly without sticking; the joints should be free, yet no excessive

play allowed. The wood itself should not exceed  $\frac{3}{8}$  in. in thickness, and  $\frac{1}{4}$  in. would be even better. Fig. 1 is the body of the mule. Note that all limbs and appendages are lacking. The oval hole in the hip region is pierced for the tail. In addition, three holes are drilled for the pivot joints for hind and forelegs and ears. The harness and features are painted with enamel. The body color is a dun brown, the harness some bright color, such as yellow, the nose pink, the eye white and the other indicated features in black. Fig. 2



Cartoons © International Features Service

"Si" and "Maud," the Well-Known Kicking Mule, Will Keep the Youngsters Amused for Hours at a Time

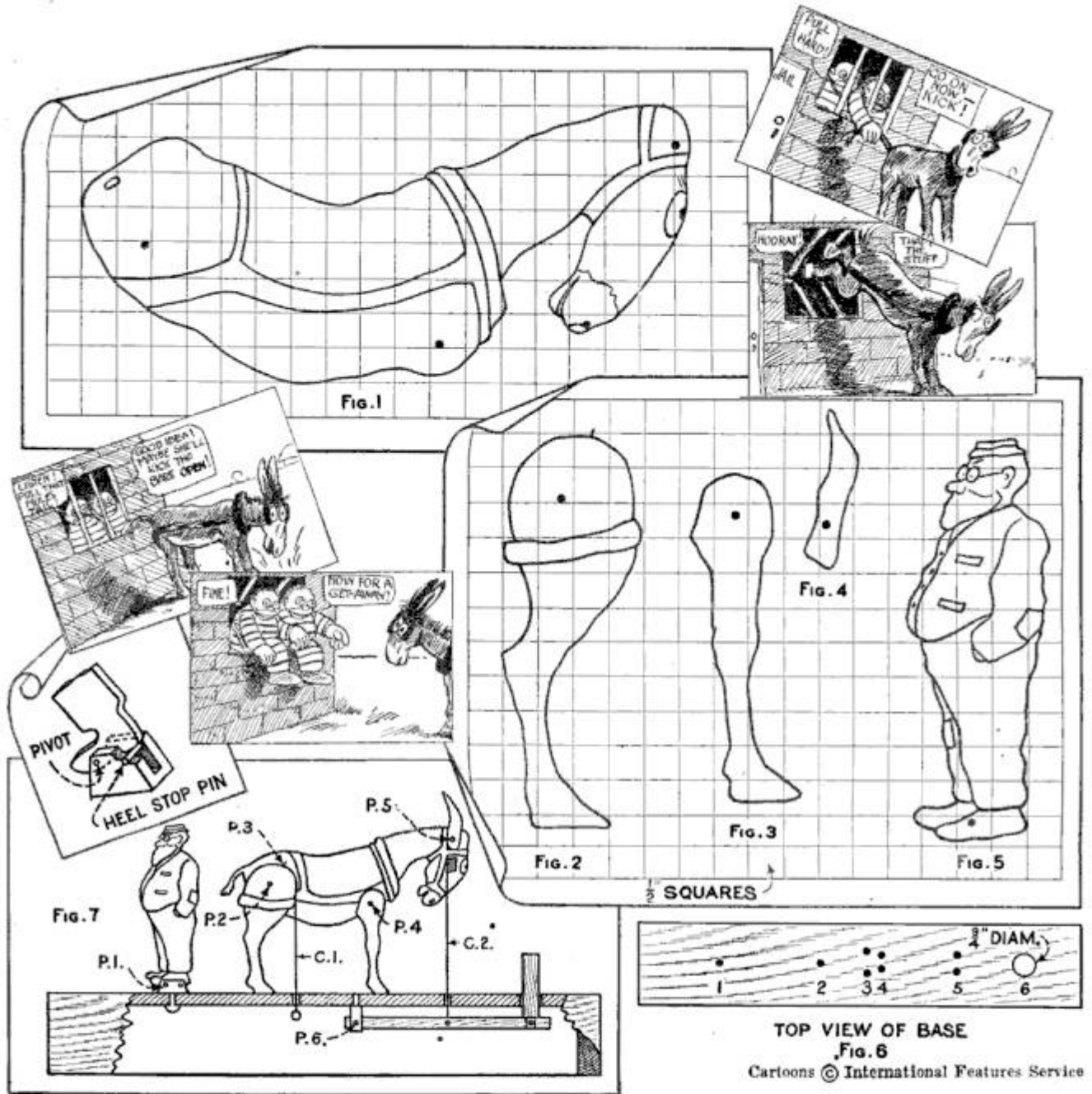

is the hindleg pattern. Two of these are needed. The color scheme is the same as for the body, although the feet may be painted white, if desired. The fetlocks are painted with short black strokes. A hole is drilled as indicated. An ordinary dressing pin, cut off about  $\frac{3}{8}$  in. below the head, is driven into the edge of the leg at the point shown. Fig. 3 is the pattern for the forelegs. They are drilled as shown and painted like the hindlegs. The ears, Fig. 4, are drilled and painted in some bright color. This is unnatural, of course, but will please the children.

Si himself is made as shown in Fig. 5. This is the most intricate figure to saw and color, but by following the pattern it will not be difficult. The coloring may be done according to taste, but bright and

inharmonious paints give the best effect. The outline about the hat has not been carelessly drawn. If a brim were left on the hat, it would be broken almost immediately. The general appearance of the figure is immaterial as long as it leaves a solid enduring form. In the original, eyes, beard and shirt collar were white, the shirt a light blue, the vest bright red with black polka dots, the trousers dark blue with green and yellow patches, the shoes black and the face a reddish orange. A hole is drilled in one foot, as indicated.

When these parts are completed, the base is made. This is a board, 5 in. wide and 2 ft. long, and is shown in Fig. 6. In this base nine holes are drilled. These holes may be identified by the numbers appearing directly below them. Their ex-

act spacing should be determined by placing the completed and assembled figures upon the base and then marking the base accordingly. No. 1 is for the screw which holds Si's support in place; No. 2 is a  $\frac{1}{16}$ -in. hole through which passes the kicking cord (C1, Fig. 7); No. 3 are for the screws which secure the lever supports; No. 4 for the screws which hold the forelegs in place; No. 5 are two holes for the bridle reins (C2, Fig. 7), and No. 6 is  $\frac{3}{4}$  in. in diameter, in which is placed the stump holding the bucket of oats.

The stump is a roughly round plunger, painted brown and gray, which will just slip easily into the hole provided. The top is shaped to represent a bucket or tub. This rests upon the end of the lever. The entire mechanism, as shown in Fig. 7, consists of two supports between which is pivoted the end of a long lever. These parts need not be made to dimensions, as the principle of action may be easily seen. A cord is fastened to one ear of the mule, below the ear pivot. This cord passes through one of the holes, 5, in the base, around and below the lever, up through the other hole, and finally is fastened to the second ear.

Further, a cord is fastened to the pin in one hindleg and taken through the hole, No. 2, in the base. There, it is passed through an ordinary button, back through the same hole and is fastened to the pin in the other leg. The button should hang about  $\frac{1}{4}$  in. below the base. Next, a semicircular support is cut from the plywood and screwed to the upper part of the base behind the mule. The exact position should be determined by trial. The figure of Si is secured to this support as shown.

His feet must be far enough above the base so that he will fall freely without digging his toes into it, and a stop pin pro-

vided under the heel, so he will stand upright, as shown in the detail. Small pieces of black paper glued to the bridle reins provide blinders, while several lengths of common cord, passed through the tail opening and tied, make the tail. Supports for the base complete the toy.

When the oat bucket is suddenly pushed, the bridle reins are pulled down, bringing the mule's head down while the ears remain perpendicular. This gives the appearance of the ears being laid back. At the same time, the hindquarters of the body, which is pivoted at P4, will rise, but since the cord C1 prevents the tops of the hindlegs from following, they will turn upon the pivot P2, and the heels will kick out and strike Si. Being pivoted at P1, he falls upon his face.

As soon as the pressure is released, a coil spring (not shown), hooked between the base and the lever, pulls the latter back into place, and Maud assumes her original position automatically. But Si must be helped to his feet again.

### Kink for Hanging Pictures

I had occasion to hang a number of pictures without aid, so I used the old plumb idea by hanging a string, weighted at the lower end, above the picture by means of a thumbtack. When the string crosses the picture at the center on both sides of the frame, the picture is correctly hung.—H. R. Wallin, Tampico, Mexico.



Using the Plumb Idea to Hang Pictures Straight on the Wall

¶ You can make your own auto polish at a big saving by adding 1 pt. of paraffin oil to 1 gal. of pure turpentine,  $3\frac{1}{2}$  oz. of citronella and  $1\frac{1}{2}$  oz. of cedar oil already mixed;

shake frequently while using the polish and dust the car well before applying. This polish is hard to beat.

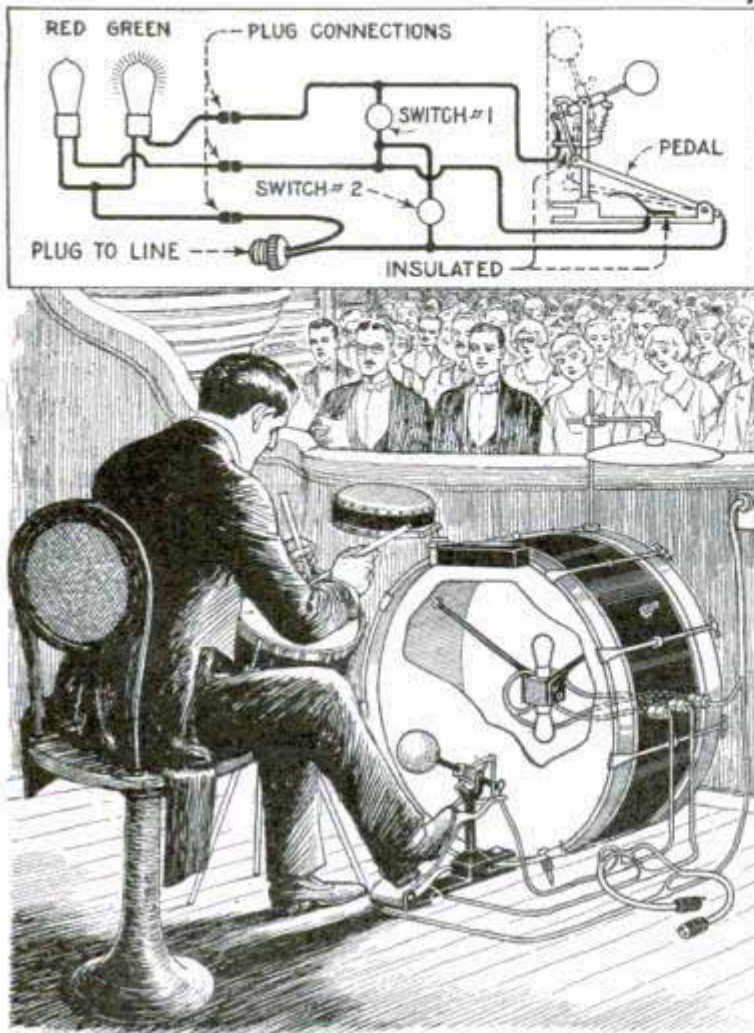

Colored Electric Lights Operated by the Pedal of an Orchestra Bassdrum Increase the Jazzy Effect of the Music

**Novel Lighting Effect for Jazz-Orchestra Bassdrum**

Many bassdrums have colored lights in them which flash on and off by the use of a thermostatic device. This control, however, causes the lights to operate at definite intervals. A variety of colors and unexpected flashes may be obtained by wiring the pedal into the circuit as indicated. When the pedal goes down, a connection is made which causes one color to show, and when it comes up again another connection lights up the second lamp. Various combinations may be produced by putting two switches into the circuit, as shown in the wiring diagram. If switch No. 2 is closed, one light will burn steadily and independently of the pedal. If switch No. 1 is closed, both lights will burn steadily. If both switches are open, the lights will alternate when the pedal is operated. If No. 2 is open and No. 1 closed, both lights operate to-

gether when the pedal is pressed and also when it is released. The effect produced is also dependent upon the drummer as he plays the music and can be varied by stopping the pedal before it comes up far enough to make contact. The lamps and sockets are suspended in the middle of the drum as indicated. There must be three electric wires on the inside to make connection with the three on the outside. This is done by the use of radio plugs. As shown in the wiring diagram, the contact springs must be insulated from the pedal.—J. L. Sevedge, Lafayette, Ind.

**Handy All-Purpose Stool**

For general use about the house, one will find the small stool shown in the photo quite convenient. Some of its uses are shown in the details. When placed on the seat of an ordinary chair, it brings the child up to his plate at the table. It is just right for a footstool and as a step to get at the window shade or the pantry shelf. It comes handy for grandma when she is getting into the car. With a cushion on it, it makes an excellent seat for a child as it takes up only a little space in the car. It makes a fine table for the children's tea party and when placed on a chair it can be used as a typewriter stand.—Leslie H. Phinney, Springfield, Mass.

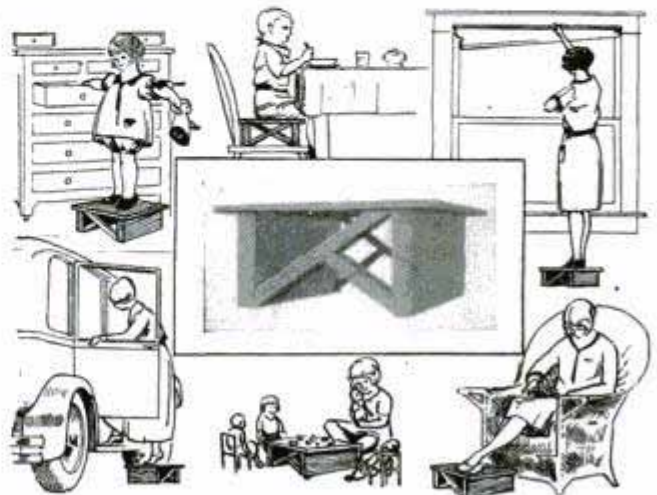

Small Wooden Stool of General Utility about the House and in the Automobile





# BUILD YOUR OWN SHIP MODEL

by  
J. EARLE MILLER

Preceding parts appeared in October, November and December

WITH the painting out of the way, the time it is drying can be filled in making the masts and yards of the boat. The "Half Moon" had three masts—a foremast rising from the forecastle, mainmast and a mizzenmast on the poop. In addition, the bowsprit, projecting from the beak, carried a sail in accordance with the custom of the time. Instead of the straight-pole masts of an earlier day, the masts were broken up into lower and topmasts, and the latter were surmounted by smaller poles carrying flags.

Each section of the masts tapers from butt to tip, and the yards taper from the center to the ends. There are several ways of making them, depending upon the tools and equipment available. For the average home-shop conditions, they can either be produced from dowel stock, or from squared spruce. If dowel stock is used, the taper can be put in by shaving the lengths down with a knife or scraper and finishing them smooth and round with various grades of sandpaper. Using spruce, the lengths should be squared to the dimensions of the mast butt or yard center, and the taper then planed on all four sides, after which the corners can be rounded off and smoothed.

The mainmast (lower part) is 9 in. long and  $\frac{7}{16}$  in. thick at the butt. To this length must be added 1 in. to be let into the hole bored in the deck. The top of the lower section is  $\frac{1}{4}$  in. in diameter.

Lay it out on a 10-in. length of dowel stock or squared spruce,  $\frac{7}{16}$  in. thick, tapering the length from 1 in. above the butt to the tip. The maintopmast is  $8\frac{3}{4}$  in. long,  $\frac{1}{4}$  in. thick at the butt and  $\frac{3}{16}$  in. at the tip, so that a very slight taper is required. The final section of the mainmast, the flagstaff surmounting it, is  $4\frac{1}{2}$  in. long,  $\frac{3}{16}$  in. thick at the butt, tapering to  $\frac{1}{8}$  in. just below the top, with a small ball, or truck, above. If the ball breaks off in cutting, it can be replaced by a bead, but it is more satisfactory to have it an integral part of the mast, since the flag halyard passes through a hole drilled in the ball.

With the three parts completed, the next task is to assemble them. For this purpose, the parts used are trestle trees, tops with their railings, and caps which are set on top of the lower mast and through which the topmast above passes. Details of these parts are shown in the sketches. Starting with the main, or lower, top, cut a disk of  $\frac{1}{8}$ -in. basswood,  $1\frac{3}{4}$  in. in diameter, and, through the center, drill a hole large enough to admit the lower masthead for a distance 1 in. below its tip. Slide the top of the mast and mark where its underside comes. Cut two lengths of basswood,  $1\frac{3}{4}$  in. long,  $\frac{3}{16}$  in. wide and  $\frac{1}{8}$  in. thick, and then cut two small notches in opposite sides of the mast, just below where the top is to rest, making them  $\frac{3}{16}$  in. wide, so that the trestle trees will rest in them. They should be cut to about half the thick-

ness of the trestle trees, or  $\frac{1}{16}$  in. deep. Slip the top on the mast, hold the trees in place, and mark on the underside of the top the outer line of the trees. Using these marks as the inner lines, lay out the two semicircular lubbers' holes shown in the drawings. With a small drill, bore a number of holes just inside the lines, and cut out the center with the knife. In the assembly, the lubbers' holes should come on either side of the mast, parallel to the length of the ship. Keeping their position in mind, drill three No. 60 holes in either side of the top,

$\frac{1}{8}$  in. from the outer rim, approximately  $\frac{3}{16}$  in. apart, and with the front hole back of a line drawn through the mast hole. These are for the topmast shrouds. Next lay out and drill six other holes, spacing them so the after ones on the sides fall between two shroud holes. These six are for the rail stanchions, and the drill used should be slightly smaller than the diameter of round radio bus wire.

Bend a length of bus wire around the outer edge of the top, so as to form a  $1\frac{7}{8}$ -in. circle and solder the ends together. This forms the rail. Next cut six pieces of bus wire,  $\frac{5}{8}$  in. long, and stick them in the six stanchion holes. As the latter are drilled  $\frac{1}{8}$  in. from the edge of the top, it will be necessary to bend the stanchions outward to meet the rail, which is soldered to them, after which the top and the trestle trees can be glued to the mast.

The cap on the tip of the lower mast comes next. It is cut from  $\frac{1}{4}$  by  $\frac{1}{4}$ -in. basswood and is  $\frac{3}{4}$  in. long. A hole is

drilled halfway through it, to take the tip of the lower mast, and another all the way through for the topmast. Owing to the danger of splitting the wood in drill-

ing these holes it is best to take a strip of  $\frac{1}{4}$ -in. wood, 1 in. or so wide and several inches long, and drill the holes first, then cut out the cap and shape it. The tip of the lower mast may be reduced in size, so that a smaller hole can be used for it. The upper top is  $\frac{1}{8}$  in. thick and  $\frac{3}{4}$  in. in diameter, and is drilled to slide down the top mast  $\frac{9}{16}$  in. below its tip. There are

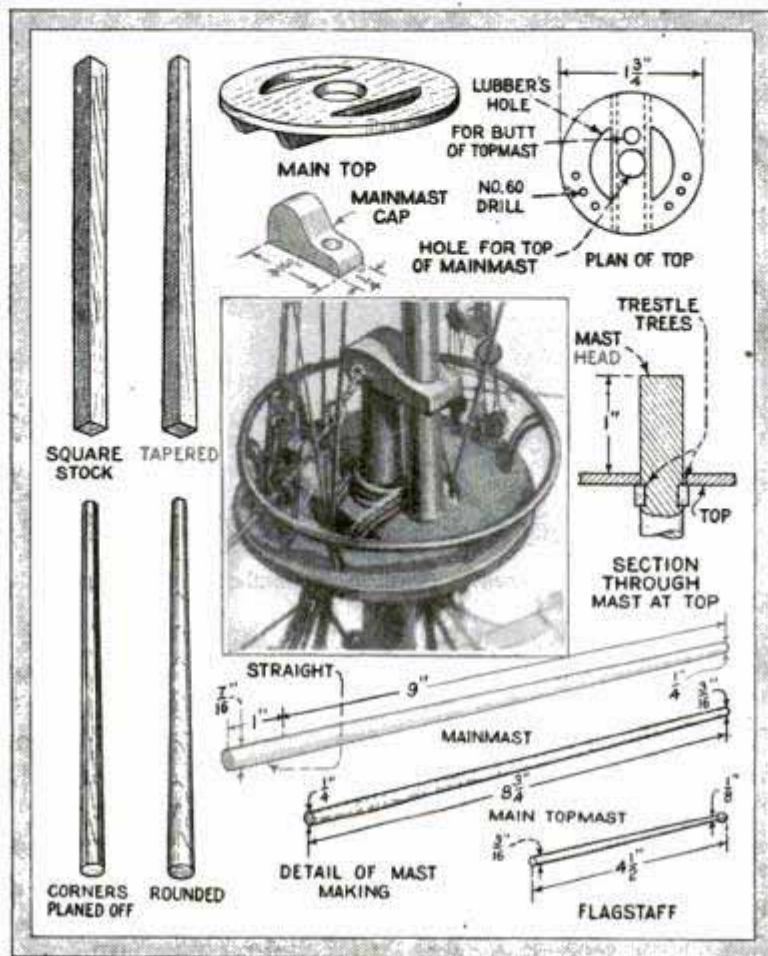

holes and no rails, but two  $\frac{1}{16}$ -in. holes are drilled, one on either side, through which the shroud lines pass. Owing to the small diameter of the top, no trestle trees are necessary. The maintopmast cap is made in the same way as that on the mainmast, and the flagpole is then glued in place. This completes the building of the mainmast.

The construction of the foremast is exactly the same. The lower mast is  $7\frac{1}{4}$  in. tall, from the deck line, and another inch is added to slip into the hole in the hull. It is  $\frac{5}{16}$  in. thick at the base and tapers to  $\frac{1}{4}$  in. at the tip. The foretopmast measures  $8\frac{3}{8}$  in., is  $\frac{3}{16}$  in. thick at the butt and  $\frac{1}{8}$  in. at the tip. The flag spar topping it is cut from  $\frac{1}{8}$ -in. stock,  $3\frac{13}{16}$  in. long, tapering to slightly over  $\frac{1}{16}$  in. in diameter just below the truck, or ball, which tops it.

The mizzenmast is a single stick, projecting 7 in. above the deck, 1 in. below it, measuring  $\frac{1}{4}$  in. through at the butt and  $\frac{5}{32}$  in. at the tip. It is surmounted by a

$\frac{3}{4}$ -in. solid top, with two small holes for the shrouds and by a cap holding a  $1\frac{3}{8}$ -in. flagpole,  $\frac{1}{8}$  in. thick at the base and  $\frac{1}{16}$  in. just below the  $\frac{1}{8}$ -in. truck.

The bowsprit is 7 in. long, plus 1 in. buried in the hull. It is  $\frac{5}{16}$  in. thick at the butt and  $\frac{5}{32}$  in. at the end, which is surmounted by a small knee, a cap and 2-in. flagpole. The stern flagstaff is 6 in. above the deck, and  $\frac{1}{2}$  in. enters the hull. It is reinforced by a second spar, projecting  $3\frac{1}{2}$  in. above the deck, the two being tied together by a cap like those on the masts. Both flagstaff and supporting spar are made from  $\frac{1}{8}$ -in. stock, the former ending in the usual truck. A No. 60 hole is drilled through the balls on each flagpole, to take the place of the block through which the flag halyard will run.

The yards come next, lower and topsail yards on the main and foremast, a bowsprit sail yard on the bowsprit, and a lateen yard on the mizzen. As stated before, they taper from the center to the ends and offer no difficulty in making, so only the following dimensions are necessary: The main lower yard is 8 in. long

and  $\frac{1}{4}$  in. thick in the center, tapering to slightly less than  $\frac{1}{8}$  in. at the ends; the main topsail yard is 5 in. long and  $\frac{3}{16}$  in. thick in the center; foremast lower and topsail spars are, respectively,  $6\frac{7}{8}$  by  $\frac{1}{4}$  in. in the center and  $4\frac{3}{8}$  by  $\frac{3}{16}$  in.; the

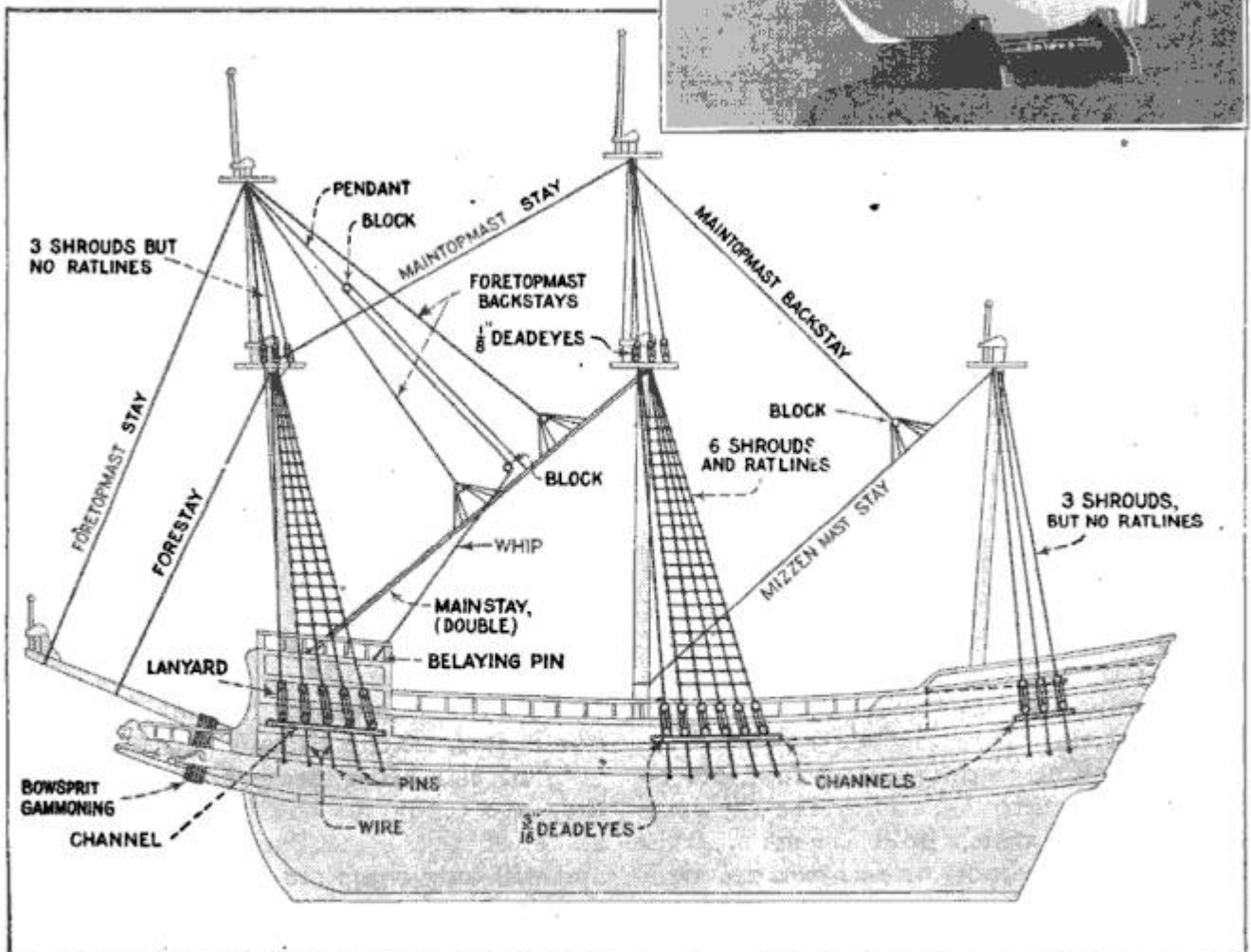
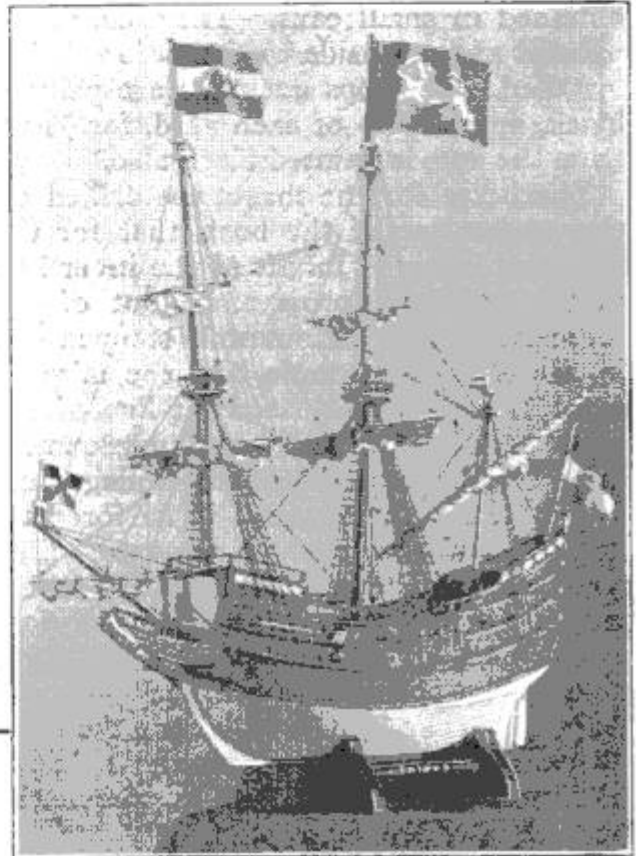

spritsail yard is  $5\frac{1}{2}$  by  $\frac{3}{16}$  in., and that on the mizzenmast is a long thin spar,  $10\frac{1}{2}$  in. over all and  $\frac{3}{16}$  in. in diameter at the center.

The dark, yellowish-brown furniture stain, known as golden oak, gives a good color for masts and yards, and can be obtained in small cans. They should be painted and set aside to dry before being installed. The tops and rails are painted black, and the tip of each yard, for  $\frac{3}{8}$  in. from the end, is painted black also.

The holes for the masts are drilled on the center line of the boat, that for the foremast being  $\frac{5}{8}$  in. aft of the inner line of the bulwark across the front of the forecastle. The mainmast is stepped  $4\frac{3}{16}$  in. aft of the forecastle, and the mizzenmast  $\frac{1}{2}$  in. back of the front line of the poop deck. Both main and mizzenmast have a slight rake backward, leaning some 5 or 6° from the vertical. The foremast has about the same rake forward. The two holes for the stern flagpole are drilled just inside the bulwark, so that the pole will project in the same plane as the stern lines. The bowsprit is stepped in a hole drilled into the hull  $\frac{1}{2}$  in. above the floor of the beak, and at such an angle that it will pass approximately 1 in. above the head of the lion figurehead.

In assembling and mounting the masts, it should be noted that the topmasts are forward of the lower masts, and the flag-staffs forward of the topmasts. It is not necessary to glue the masts in place, since the shrouds and rigging will brace them, but the bowsprit should be glued.

You are now ready to start the rigging, which looks exceedingly difficult, but actually only requires time and patience. Rigging of a vessel is divided into two parts, standing and running. The standing rigging includes the shrouds, stays and backstays of the masts, the fixed lines which are permanently installed and tarred as protection against the weather. The running rigging includes all the movable lines, the blocks and tackle by which the yards and sails are handled.

The standing rigging comes first, starting with the shrouds. They are the sets of side braces which hold the masts, and to which cross lines, or ratlines, are tied to form the rope ladders by which the sailors climb to the yards. Each shroud is

set up with a pair of deadeyes, circular fasteners, each with three holes, with a lanyard laced back and forth between them, serving to tighten each shroud. The deadeyes for the lower shrouds are  $\frac{3}{16}$  in. in diameter and those for the upper shrouds  $\frac{1}{8}$  in. They can be purchased from professional model-makers' supply companies, or made at home. In the latter event, the best material is the black-celluloid knitting needles sold in ten-cent and department stores. If they are used, they should be cut up in lengths of  $\frac{1}{8}$  in. for the lower deadeyes and  $\frac{1}{16}$  in. for those on the upper shrouds, and drilled according to the sketch on page 156. A No. 58 drill will do for the larger ones, and a No. 60 for the smaller. It is recommended that deadeyes and blocks be purchased.

The shroud lines should be of strong linen. No. 6 linen fishing line, which can be obtained at a sporting-goods store at about 30 cents for a 25-yd. card, is best for the lower shrouds. The upper shroud lines, and most of the running rigging are made from black-linen button thread. A 100-yd. spool will be enough.

Starting on the lower mainmast, which requires six shrouds on either side, pass the end of the fishline up through one lubber's hole in the lower top, around the mast, and back down through the hole; bring the end down 1 in. or so below the level of the bulwark, and cut off the piece, making two shrouds. Now withdraw the section, and, using it as a guide, cut five more pieces the same length. Pass the ends of three lengths up through the lubbers' hole on either side, around the mast and back down through the hole, giving the six shroud ends on either side.

Next take one of the  $\frac{3}{16}$ -in. deadeyes, pass the end of a shroud around it in the groove provided for the purpose and seize the end to the shroud by wrapping it with fine steel "hair" wire. Cut a 3-in. length of the wire and twist one end around a second deadeye. Then turn both deadeyes so that the center hole of the upper one is nearest the shroud and the center hole of the other nearest the wire, and they are ready for the lanyard. This is made of the black-linen button thread, and will only come out right when put on the proper way. The object is to have three straight and parallel lines on the

*made by Cooper and Aft Co, Inc, Huntington, N.Y.*

*Order at me 415 Madison Ave New York*

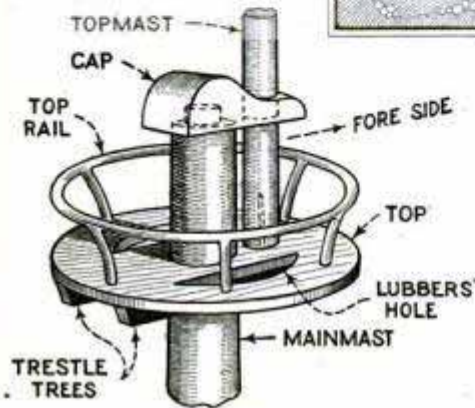
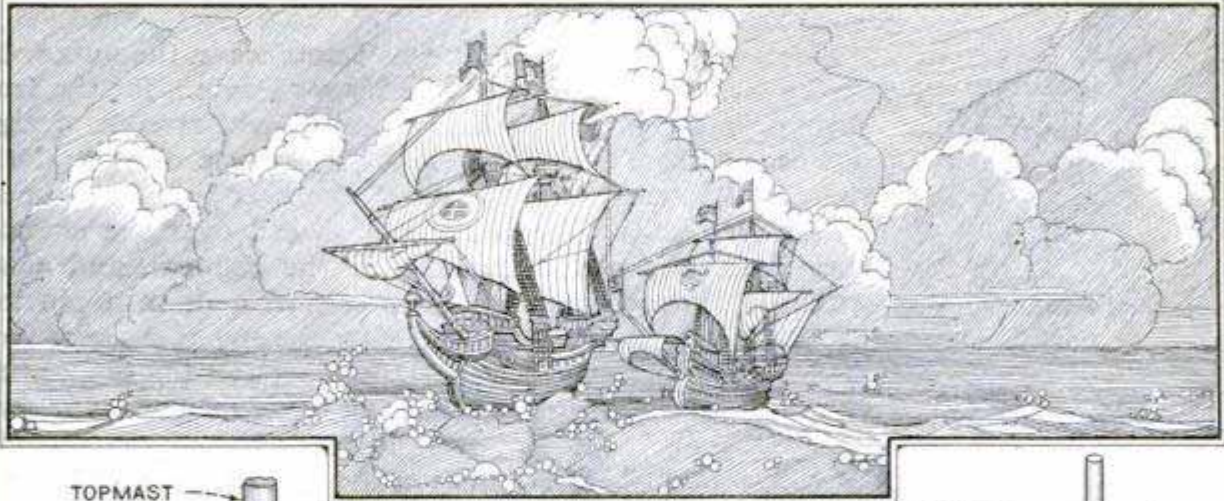

VIEW OF MAINTOP

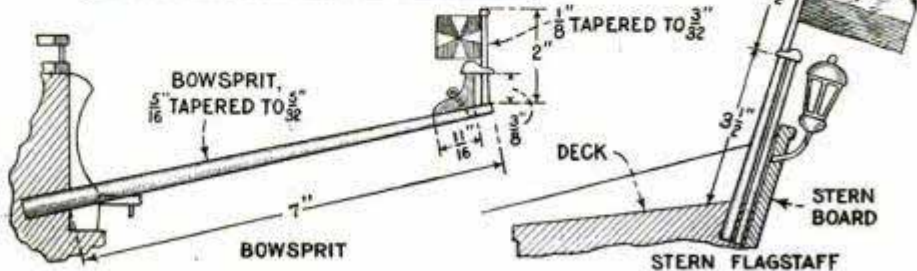
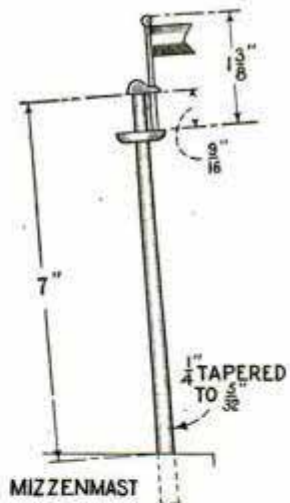
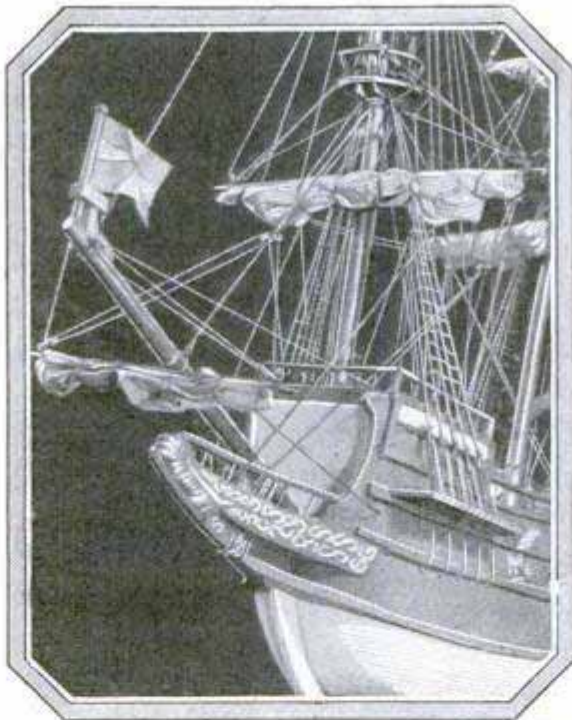
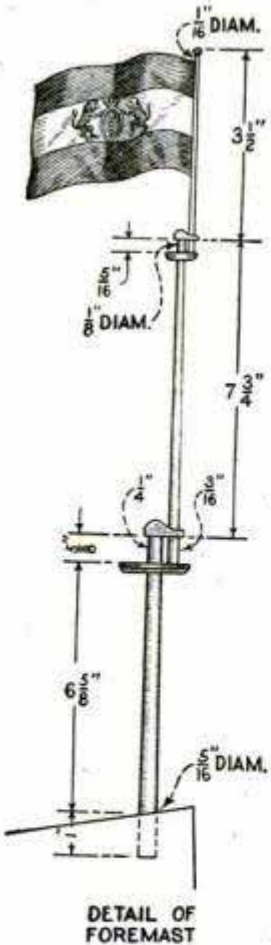
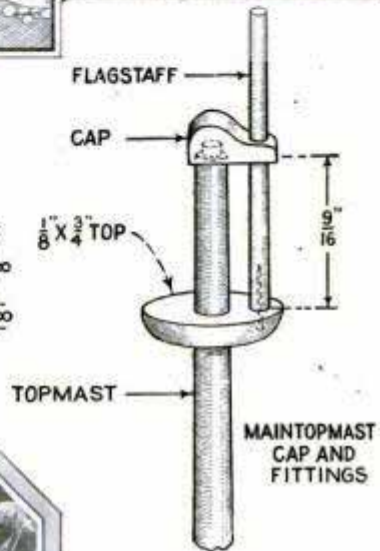
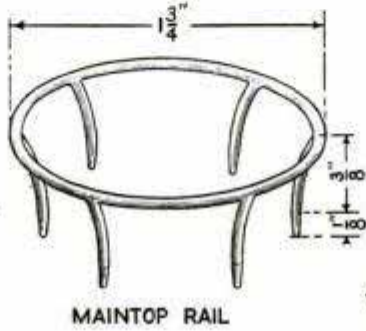

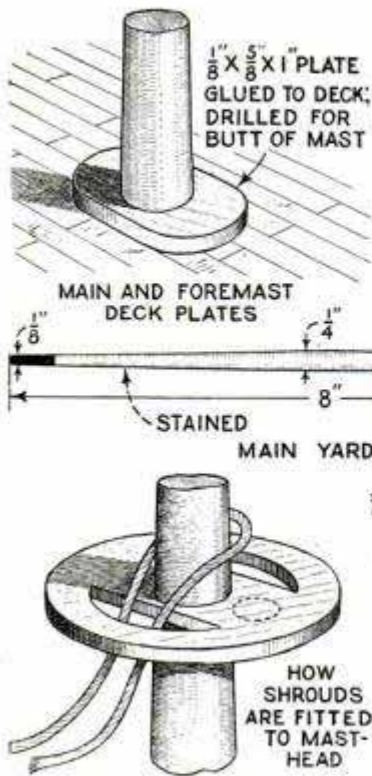

which it is knotted around the shroud, over the wire seizing on the shroud end.

Next, with a knife, cut six small notches in the outer edge of the mainmast channel. The forward notch, for the front shroud, is so placed that the shroud will stretch straight downward from the mast top, and, because of the rake of the mast, bring it slightly aft of the rear line of the mast butt. The other five are equally spaced over the channel. Just above the next strake below the channel, and alined with the shroud, beneath the first notch, drive a pin into the hull, and twist the end of the wire from the lower deadeye around the pin, adjusting it so that the lower deadeye will come just above the top edge of the channel. Drive the pin the rest of the way into the hull. Next pull in or let out the lanyard until the top deadeye comes on a line with about the center of the deck rail, and then

tie the end around the shroud and cut off the excess thread.

Find the other end of the same shroud, catch a deadeye in the bight of the cord, and then, holding it alongside the completed shroud, draw it taut and adjust the deadeye until it comes even with the first one. Next make it secure, as on the first shroud,

front face of the deadeyes, the center line being the longest. Tie a knot in one end of a 10-in. piece of button thread, making the knot big enough not to slip through the deadeye hole. Then pass the other end through one of the side holes in the deadeye fixed to the shroud. The knot side will then be the back side of that deadeye. Next pass the end of the lanyard through the corresponding side hole of the deadeye on the end of the wire. The side which it enters will then be the front side of that deadeye. Coming out the back of this lower deadeye, the lanyard goes diagonally up the back to the hole in the center of the upper deadeye, entering from the back. Coming out the front, it is threaded as shown in the drawing, and the end left loose to tighten and "set up" the shroud later, following

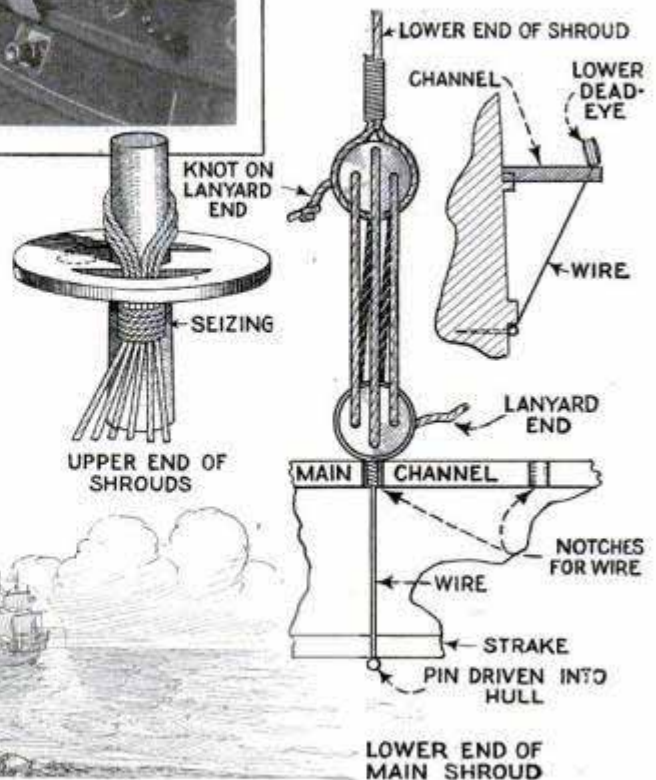

with wire seizing, and then proceed to set up the lower dead-eye and lanyard like that already completed. The rest of the shrouds are set up in the same way, taking care to adjust them so that the masts are held upright and in line. The foremast takes five shrouds to the side and the mizzen three. The odd shroud on each is wrapped once around the mast, with an end passed down each side through the holes in the top.

The fore and maintopmasts each take three shrouds on each side, using the 1/8-in. deadeyes. The topmast shrouds are made of the button thread, and the lanyards of a smaller size of black-linen thread, small enough to pass through the deadeye holes. Instead of a wire from the lower deadeye, attach 6-in. lengths of button thread, poke the ends (known as futtock shrouds) down through the shroud holes in the top, pass them through the lower shrouds, and knot them to a wire ring fastened to the lower mast. For this purpose a No. 60 hole is drilled through the mast, an eye bent in a short length of wire, using the nose of a small pair of pliers or a small nail to form it, both ends of the wire passed through the hole, and an eye formed on the opposite side of the mast by placing a nail, or the end of a scribe, between the wires and then twisting the ends together, after which the ends are clipped off close to the eye. The fishline lower shrouds should then be painted black, to represent tar.

The shrouds on the lower fore and main-

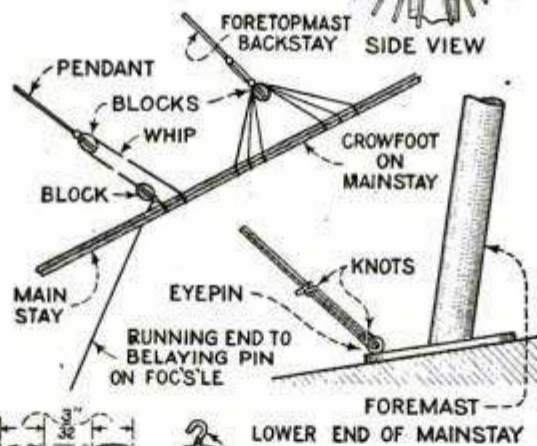
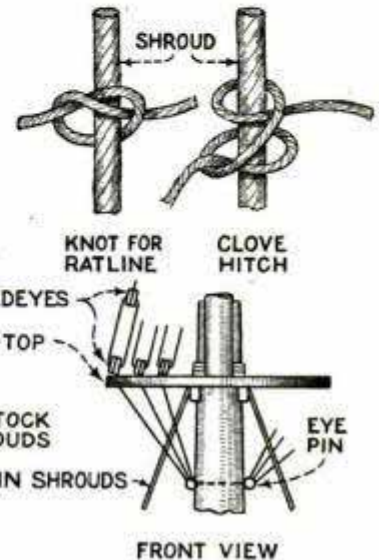
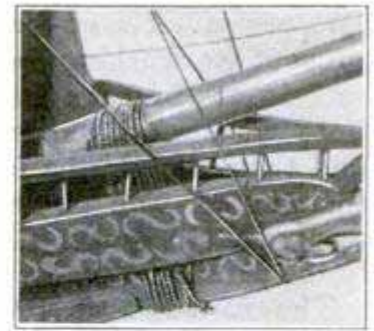

masts require ratlines in order that the sailors may climb to the tops. None are required on the mizzen or topmasts. The ratlines are made of button thread, and are easy to install, though patience is required in tying so many knots.

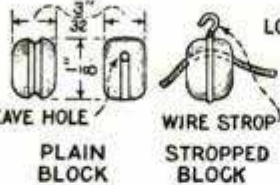
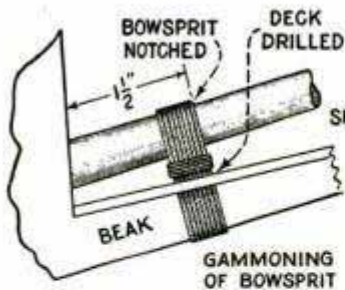

There is some question whether ratlines were attached to all shrouds in Hudson's day, but the more modern practice is to leave them off the forward shroud, or "swifter," and this saves quite a few knots, so that method was followed in this model. Knot one end of a piece of the thread around the second shroud, just above the rail and then, using the simple overhand knot shown (a clove hitch is correct, but is difficult to make so small), tie it to each successive shroud. As the knots are drawn tight, pull the shroud lines close together, and then expand them to their proper distance. In this way a taut ratline with no droop is obtained. After the ratline is knotted to the last shroud clip off the end, but leave about a

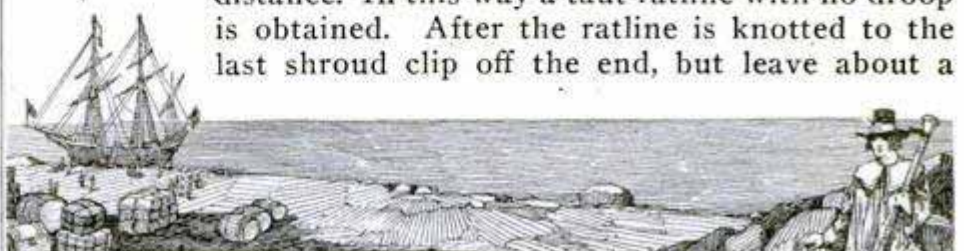
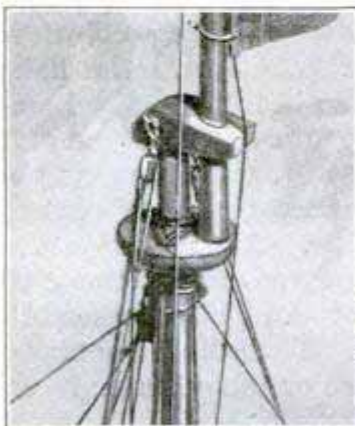

quarter of an inch beyond the knot to prevent its working loose. After all the ratlines are in place coat shrouds and ratlines with white shellac, allow it to set, and then clip off the loose ends close to the knots. The shellac fixes the knots firmly and prevents their working loose in the future.

The fore-and-aft stays for the masts come next. Start with the mainstay, which is the heaviest on the model. With the knife, cut a small groove around the mainmast just below the top. Cut a 24-in. piece of the linen fishing line, knot the middle around the mast, and pass the two ends, from opposite sides, through a small eye, made of a pin and driven in the deck  $\frac{1}{4}$  in. back of the foremast. Pull the stay taut and knot the ends, then knot them again around the stay itself, about  $\frac{5}{8}$  in. above the eye, as shown in the detail sketch. This prevents the knots from working loose, and gives extra cord to enable taking up the stay at any time in the future, if necessary.

The mizzenmast is stayed to the mainmast by another piece of the linen line, one end being knotted around the mast just below the top, and the other around a groove cut in the mainmast,  $1\frac{1}{4}$  in. above the deck. The forestay runs to the bowsprit, being knotted around a groove cut in the latter above and just forward of the head of the lion figurehead.

Button thread is used for both the fore and aft stays of the topmasts. The foretopmast is stayed to a wire eye fastened around the knee which supports the flagstaff on the tip of the bowsprit, and the maintopmast stay runs from the top of the maintopmast to the foremast head, being knotted around it just above the lower top, and beneath the cap. The foretopmast backstays, of which there are two, are fastened to the mainstay, the strain being distributed by "crowfeet," made of the light thread used for the upper shroud lanyards. The stay itself is knotted around a block, through which three lengths of the fine thread pass, their ends being knotted along the stay, as shown in the standing-rigging sketch. Running down between the two foretopmast backstays is a "pendant," a short length of light thread carrying a block at the end. One end of a longer piece of the same

thread is tied to the mainstay midway between the crowfeet, and the other end passed around the block on the end of the pendant, then through a block seized to the mainstay as shown in the detail, and the running end carried down to a belaying pin on the forecastle pin rail. The blocks are the same as used in setting up the running rigging. The only remaining stay is the maintopmast backstay running from the maintopmast down to the mizzenmast stay, to which it is attached with another crowfoot, as shown in the rigging sketch.

This completes the standing rigging, with the exception of the bowsprit gammoning. Owing to the system of stays, all the strain of all the masts eventually falls on the bowsprit, so extra-strong construction is necessary to carry the burden. Cut eight small notches, as close together as possible, in the top surface of the bowsprit, starting about  $1\frac{1}{2}$  in. from the butt. Directly beneath them, either drill eight small holes in the beak floor on either side of the bowsprit, or cut a narrow slot  $\frac{1}{2}$  in. long through the flooring. Take a couple of feet of the linen fishline and, starting underneath the beak, push the end up through the slot, over the bowsprit, letting it lie in the first notch; down the other side and through the slot in the beak floor, on that side of the stem. Thence it goes around the stem, up the first side, and so on, until eight lines have been passed around. Draw it as taut as possible, bearing down on the bowsprit until every stay is tight, and then knot the ends beneath the stem, shellac and trim them close, after first painting the cord black to represent the tarring.

(To Be Continued)

### How to Bleach Glue

Often it is necessary to have a colorless glue. To obtain this, dissolve the flake glue in water by the heating method and then add one part oxalic acid and one part zinc oxide, the two together making a quantity equal to at least one per cent of the mass of the glue. After every trace of color has disappeared, strain the glue through a piece of doubled cheesecloth or similar material. The whole operation should take no more or less than an hour. —L. H. Georger, Buffalo, N. Y.



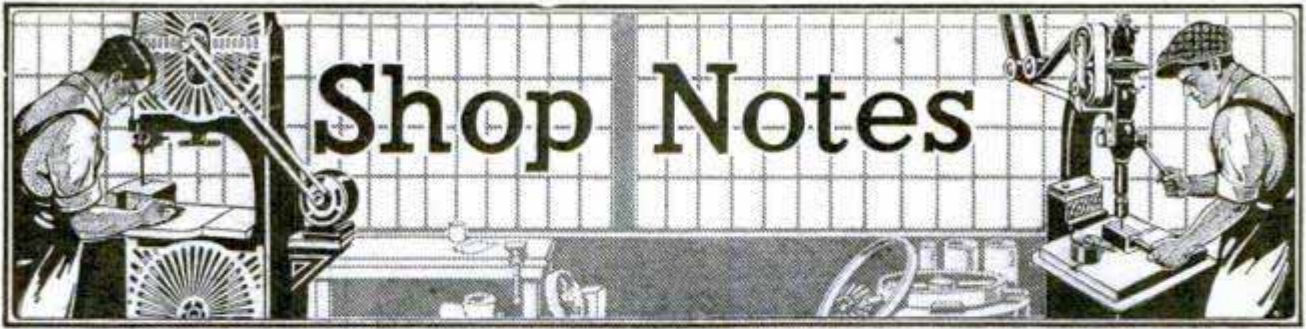

All Shop Notes published in 1926, in book form—Fifty Cents—from our Book Department

## Making Artificial Ice on the Farm

By RALPH W. McPHERSON

**T**HERE are few streams or ponds near the Borreson farm in Saunders County, Nebraska. Then, too, it is just far enough south to prevent reliance on Jack Frost for any great length of time. The ice harvest is always uncertain, and always expensive where a long haul is necessary. Yet the heat of July and August always finds ice in the cave at Borreson's.

Ten or twelve years ago, all the farmers in this neighborhood became excited about making their own ice. All of them tried various means to freeze water from

their own wells. For various reasons most of them gave it up in disgust. When the water froze in the containers, they couldn't get it out. Often, in freezing, the containers were broken to pieces. All in all, it was voted a failure.

But it is a real hardship to do without ice in this community, where dairying is

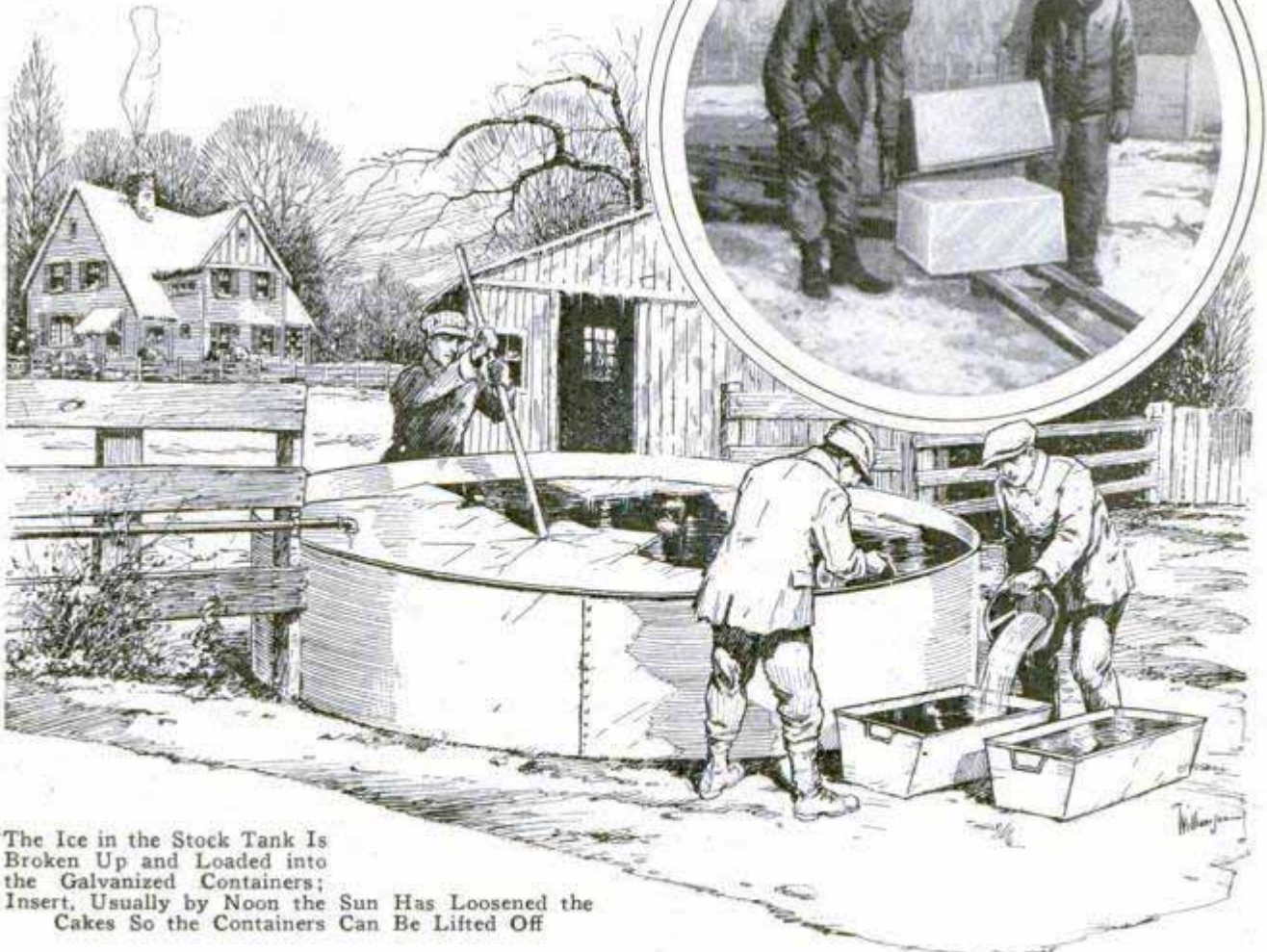

The Ice in the Stock Tank Is Broken Up and Loaded into the Galvanized Containers; Insert, Usually by Noon the Sun Has Loosened the Cakes So the Containers Can Be Lifted Off

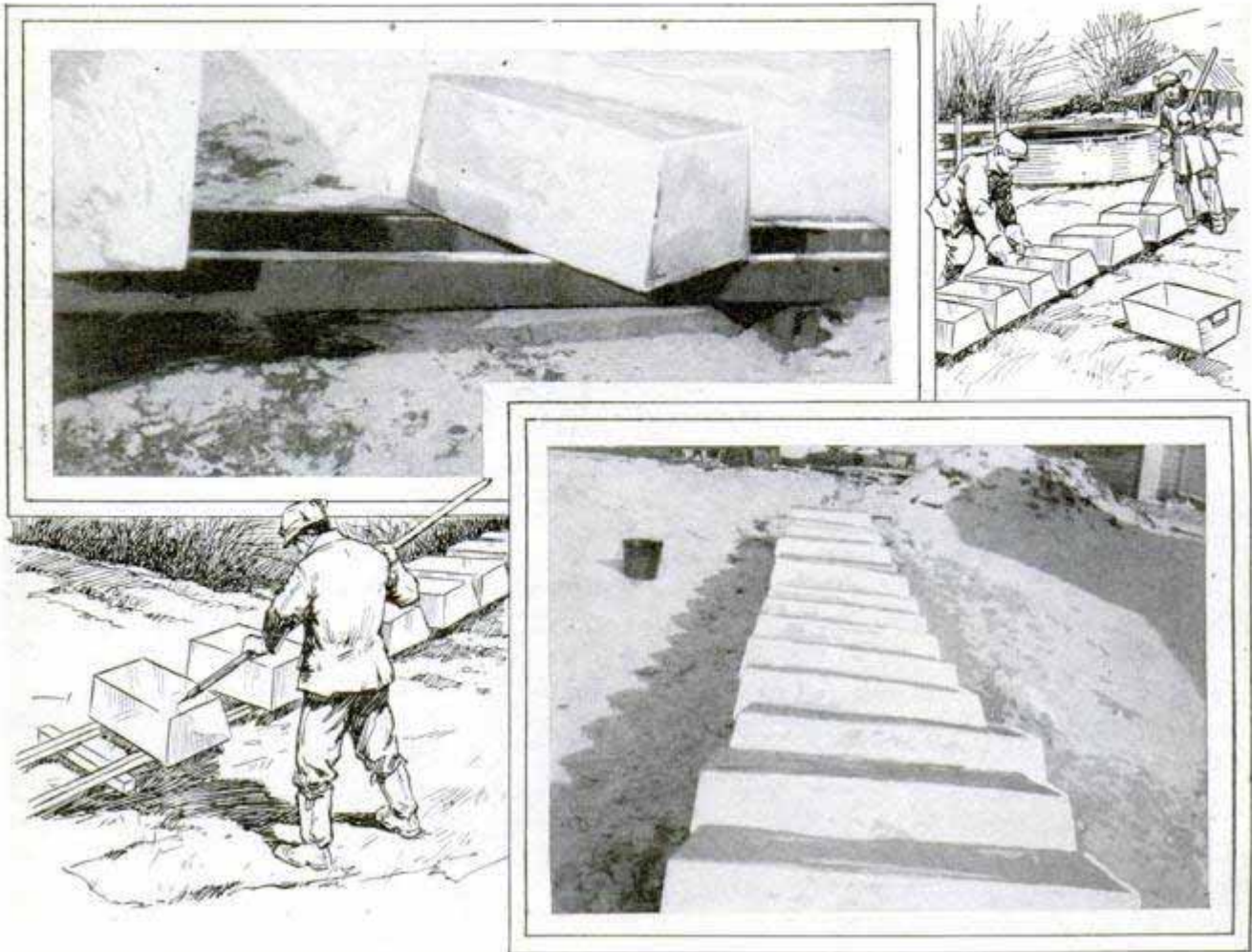

Upper Left, the Racks Are High Enough So That the Air Can Circulate Below the Containers; Right, a Line of Cakes on the Way to the Ice Cave

one of the main money makers. Mr. Borreson did without it for two summers. Then he decided that he was somehow going to figure out a way to have ice. He had tried wooden containers before and was convinced they could not be successfully used. In the first place, the water soaked into the fibers and froze so firmly there that it was next to impossible to dislodge the ice. The wood also cracked easily under the pressure of expansion.

To correct these two evils, he set about making metal containers. He used a heavy-gauge, galvanized sheet metal. These he patterned after a cake tin, narrower at the bottom and with flaring sides. Around the top he riveted strap-iron bands, with strong handles at each end that would permit handling with large mittens on.

Experimenting with these containers, he found that the flaring top to a certain extent resisted the pressure exerted by the freezing water, and that the metal of the container was sufficiently elastic to

allow for the rest of the strain. The greatest difficulty was that it took the well water too long to freeze. On his next attempt, he cleaned out one of the large stock tanks and filled it with water which he allowed to stand overnight. In the morning there was about two inches of ice on the tank. This he broke up and placed in his containers, filling them with the cold water from the tank. The next morning, his pans contained solid cakes of ice. The broken pieces of ice from the tank had hurried the freezing and at the same time had relieved the pressure so that the containers were not bulged.

Borreson now has eighteen of these pans in use. In freezing weather they are placed on a rack made of two-by-fours which is raised about 1 ft. off the ground. It is but a moment's work each morning to break the ice in the tank and fill the pans. The next morning, the ice cakes are ready, and the pans are slid out into the sunlight and turned bottom up. Ordinarily by noon, the sun's heat has

loosened the ice from the metal and the cakes will drop out into the rack. In this respect, he says, it is important that the containers be filled no farther than within 1 in. of the top, which leaves room enough to jar the cakes loose.

If the weather is too cold to loosen the ice in this way, a couple of kettlefuls of boiling water will turn the trick. Pour the water down the sides and ends first. In the first attempt, the boiling water was poured over the bottom. There was a boom and the bottom of the container burst. The boiling water had caused the formation of steam inside which exerted enormous pressure.

The racks are so arranged that the ice is easily slid right into the ice cave, which is really a cellar dug out beneath the milk house. One man can easily swing the cakes down the chute and into position. They are stored with top and bottom up alternately, so that the flares will fit snugly together, and packed in sawdust.

Water is piped to the house and milk-house. These pipes run through the ice cave, which means ice-cold water all summer long. For the household, there need be no hesitation in using the ice direct, for it is as pure as the water in the well.

"Oh, yes, there's work to it!" Mr. Borreson said. "If there had been a pond or river within reasonable distance, I never would have stayed at it until I made it work. But now the womenfolks wouldn't let me go back to the old way of putting up ice if I could. It's wonderful for them to have that absolutely clean ice whenever they want it. And really I don't notice the work much. It is just an added chore—a few minutes each day while the ice weather is on."

#### When to Clean Flues

All coal-sooted flues contain sulphur and this causes iron to rust rapidly in the presence of moisture. It is advisable to clean the flues as soon as possible, especially where some of the connections are iron. As soon as the fire is allowed to go out, one should do the work and not leave it until ready to start again, as the soot cakes and is much more difficult to clean out the longer it remains.—Geo. G. McVicker, North Bend, Nebr.

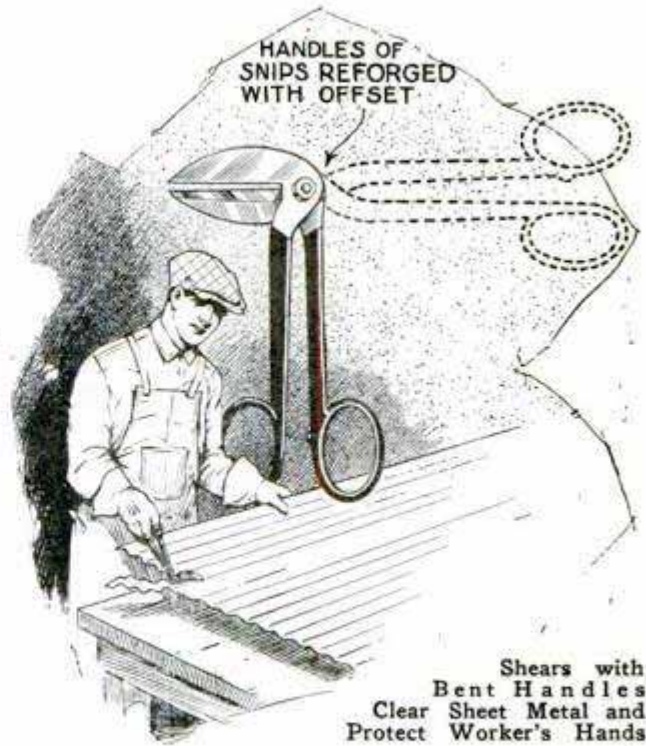

#### Altered Snips Cut Heavy Sheet Iron Easily

Shears, reforged to the shape shown, far from being awkward, as might at first glance be suspected, have been found better, more rapid and less troublesome in use than the straight type for cutting heavy sheet metal. To make these shears, an ordinary pair is taken apart and the handles are reforged, or bent, just behind the joint as indicated. These shears are especially desirable in cutting across corrugated metal. The worker's hands are protected and the job can be done more rapidly.—G. A. Luers, Washington, D. C.

#### Holster for Service-Station Attendant

With the tool holster shown in the photo the auto-service station attendant is al-



ways ready for small jobs as his tools are at hand. The holster contains a pair of pliers, a screwdriver, valve cores and two tire gauges. Besides saving

steps for himself, the worker pleases the customers by quick service.—Carlton Groat, The Dalles, Oreg.

### Red Lead Better than White for Priming Wood

For the last 20 years or more the customary practice, and the usual advice to

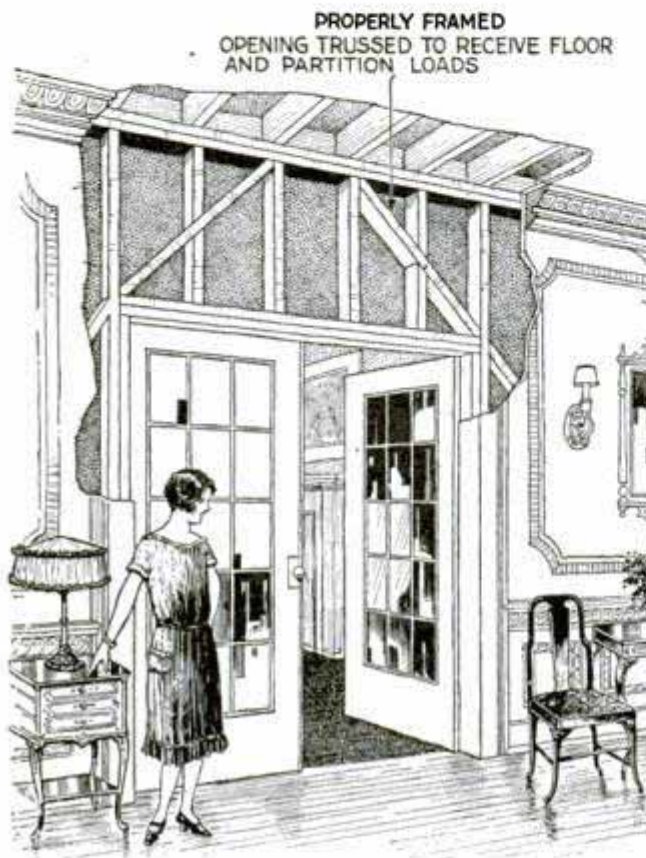

benefited greatly by being primed with red lead before the finish coats are applied.—L. H. Georger, Buffalo, N. Y.

### Frames for Wide Door Openings

Two methods of framing wide door openings are shown in the accompanying drawing. The door at the right is improperly framed and will sag, causing the

IMPROPERLY FRAMED FLOOR  
JOISTS WILL CAUSE DOOR  
FRAME TO SAG, MAKING  
DOORS STICK AND  
THE PLASTER CRACK

Correct and Incorrect Methods of  
Framing Wide Door Openings; That  
Shown at the Right Causes the Doors  
to Stick in Their Casing and the  
Plaster to Crack

all painters, is to use white lead and oil as a priming coat on wood for screens and doors, and other outside fittings. Red lead and raw linseed oil, properly mixed and applied, and allowed to dry well, will produce a better film, which is extremely hard and more elastic than any other material. The reason red lead is found better than white, is that it is highly oxidized and its density very great, so that it works in with the oil and makes a better filler and pore sealer.

It is particularly good for use on sappy and pitchy hardwoods, such as yellow pine, cypress, spruce and all green stock. It prevents resinous matter from seeping through the paint. Most other primers will allow wood to change in dimensions, and this alternate shrinking and swelling is very hard on any paint, but when red lead is used as a base the wood is waterproof and so its moisture does not change. On many finishes where varnishing has to be done, red lead will help preserve the finish. Porch floors will be

doors to stick in the casing and the plaster to crack. On the left, the door frame is correctly braced to prevent these troubles, the diagonal braces taking the floor and partition loads and distributing them evenly to the studding.

### Improved Snubbing for Unloading Tanks

The usual method of unloading a large tank from a truck is to roll it down on skids, a rope being passed around the circumference and the

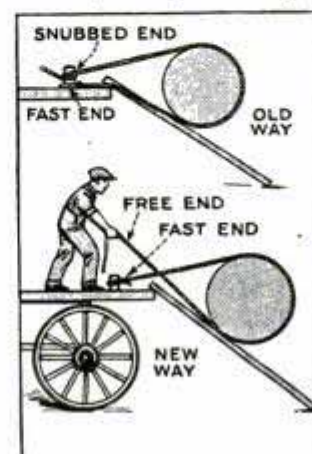

free end snubbed as shown at the top of the illustration. A better method is to fasten the upper end of the rope, using the free lower end without a snubbing post as shown below. The advantages of this method are apparent; in

the first case, the rope travels with the tank, the necessary braking friction being obtained by a few turns about the snubbing post, while in the second, these sharp bends are eliminated, as the tank must slide on the rope as a brake drum does in its brake band, furnishing its own friction and lessening the wear on the rope.—E. M. Love, Alhambra, Calif.

### Assembly of New-Type Ford Transmission Bands

Transmission bands with a detachable ear can be more readily assembled with some kind of tool which will pull and guide the bands around the transmission drums. Such a tool can be made as shown in the drawing. A piece of steel phonograph spring, about 3 ft. long, was annealed, drilled and slotted at one end with a file, so that it could be attached to the projecting studs on the band. One end was bent back and riveted. The opposite end was fitted with a file handle, which was done by sawing the handle lengthwise and riveting the spring to it. In use, the threading tool is inserted from the left side of the transmission, is pushed around the drum, and the transmission band is hooked into the elongated slots and pulled



Handy Tool Made from Spring Steel Is Helpful in Inserting Transmission Bands

down through the transmission. The tool should be made so that the natural curve of the spring will conform to the drum.

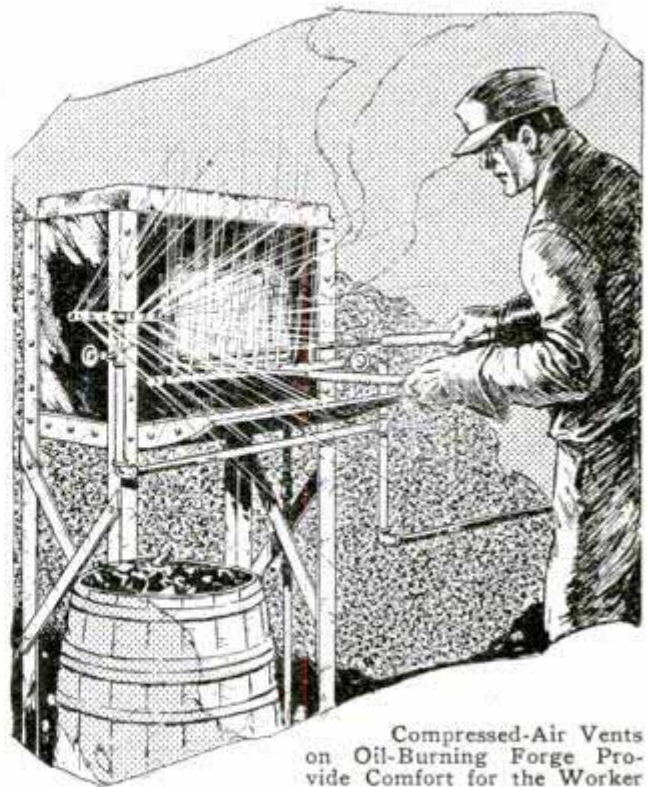

Compressed-Air Vents on Oil-Burning Forge Provide Comfort for the Worker

### Protection for the Rivet Heater

Heating rivets in an oil-burning forge is a hot job, but, with the compressed-air attachment shown in the drawing, the discomfort is lessened considerably by an upward blast of cool air that deflects the heat of the furnace from the worker. Pipes, below and on the side of the forge, are perforated with a number of small holes, through which the air is forced out in the directions indicated. As a further protection, two sections of hose are slipped over the handles of the tongs.

### Applying Acid to Solder Jobs

While working on a large job of soldering on galvanized iron, with muriatic acid as a flux, trouble was experienced with the brushes used in applying the acid. The employment of a medicine dropper overcame most of the difficulty. It did not spread the acid so much as the brush does, but applied it to the edges and inside of the joints, making much better and neater work possible. By taking advantage of the bubbling of the acid, it could be spread over a large area with ease when desired. The dropper was found to be easier to use and more economical, as it was not affected by the acid and there was less acid wasted.—Reuben Jensen, Silverton, Oreg.

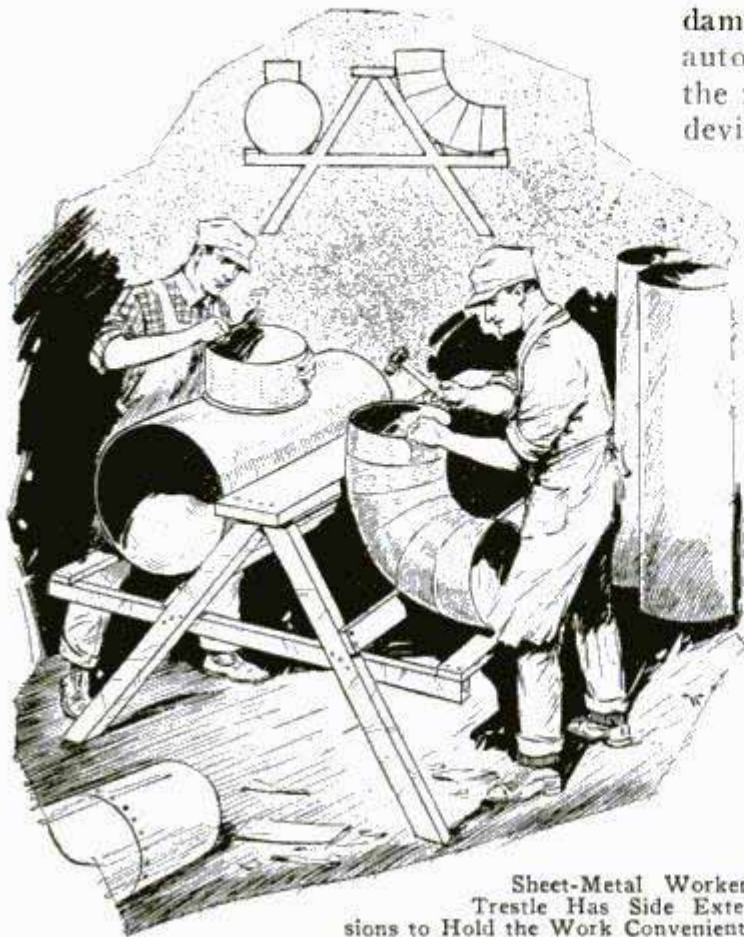

Sheet-Metal Workers' Trestle Has Side Extensions to Hold the Work Conveniently

### Trestle for Sheet-Metal Work

The trestle shown in the drawing is somewhat similar to the form ordinarily seen in metal-working shops, but its use is quite different. The extensions on the sides adapt it to holding work of various shapes. It is made slightly higher, the crosspieces are placed two-thirds the height and the long side sections are nailed on in the positions indicated. It is evident that this trestle has considerable advantage over the flat-top bench.

### Furnace Feed for Combustible Waste

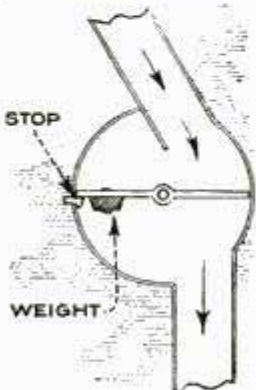

to the material and rate of flow. The waste accumulates on one side of the

A semi-automatic feed for the burning of fine combustible waste like sawdust, which will prevent a constant, excessive stream of cold air from entering the fire-box, can be made as indicated in the illustration, the details being varied according

damper until the balance is upset, when it automatically dumps down the pipe onto the fuel bed. It is advisable to locate this device a few feet above the automatic stokers if such are used. One side of the damper should be weighted to make it slightly heavier than the other; then, with stops set in the side of the pipe, it will come back into its horizontal position after dumping and close the pipe until another load has accumulated.—Chas. F. Goldthwait, Waterbury, Conn.

### Cotter-Pin Drill Jig

To drill a hole in the bolt for cotter pins without a guide is unsatisfactory. One of the simplest methods of drilling for cotter pins is to use the jig shown in the drawing. It consists of a cast-iron or steel block, with  $\frac{3}{8}$ ,  $\frac{1}{2}$ ,  $\frac{5}{8}$ ,  $\frac{3}{4}$  and 1-in. holes drilled in the end. At right angles to each hole, and near the edge, holes are drilled and tapped for a  $\frac{1}{4}$ -in. setscrew. At spaces starting 1 in. from the edge of the block,  $\frac{1}{8}$ -in. holes are drilled in line through the holes larger than the  $\frac{1}{2}$ -in. size, while  $\frac{7}{32}$ -in. holes are drilled through the smaller holes in the same way. The drill-guide holes are drilled at  $\frac{1}{4}$ -in. intervals. In use, put the bolt in the cotter hole, measure until the correct drill hole is found and then proceed to drill the bolt through the hole.

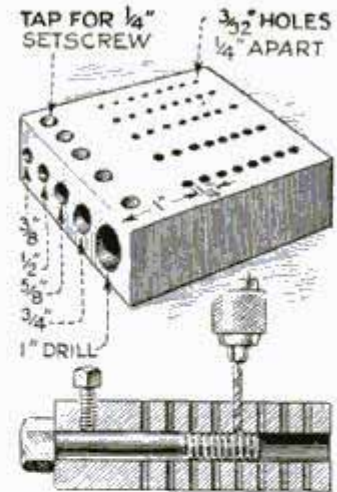

### Razor Edge on Planes

To put a razorlike edge on planes, chisels, etc., grind them on a carborundum wheel in the regular way, and, instead of finishing on a whetstone, do it on a cloth buffing wheel using a little tripoli or putz pomade. A plane iron sharpened in this way will cut hair.

# How to Adjust Your Auto Headlights



AS the result of a study conducted by the bureau of standards, during the course of which 400 cars of 58 different makes, employing 47 varieties of lighting devices, were tested, it is stated that 75 per cent of the headlights on automobiles are improperly focused, or aimed, and would throw a dangerous, or at least a very troublesome glare in the face of approaching drivers. Anyone who drives much at night will know that this statement is not exaggerated in the least.

There is no excuse for this condition. The

adjustment of auto headlights, while not a job to be done carelessly, is really a very simple one, and one that any driver who takes pride in having everything about his

car in first-class condition should learn to do. Even if the driver cares very little whether the other fellow is bothered by his headlights or not, properly adjusted lights will save a lot of trouble on his own account, since he will not continually be called upon to dim his lights during the course of a long night drive, but can go through with the bright lights on, with



Adjusting the Lamps Sidewise So as to Center the Spots on the Marks Made on the Wall



Top, Loosening the Lamp Adjustment; Center, Aiming Lamp; Below, Measuring Height of Lamp Center

the assurance that they will trouble no one.

The first thing to do is to put the headlamps in the best possible condition. Take off the lenses and clean them with a stiff brush and hot soapy water. Dirty lenses will absorb a lot of light that would be more usefully employed lighting the road. Be sure the lens is thoroughly dry before replacing it. Next examine the reflector; if it is dirty or tarnished, it should be carefully polished. Use only clean cotton or chamois, with a polisher composed only of powdered lampblack and alcohol. Never, under any circumstances, use a gritty polish for the reflectors, or you will ruin them. Their silvered surfaces should never be touched with the fingers, since these are "salty" and will leave tarnish marks that are practically impossible to remove. Next replace blackened bulbs, and see that these do not wobble in the sockets; if they do, pinching the socket

slightly with a pair of pliers will correct the fault.

To focus the headlamps, select a spot where the car may be placed on a level surface, 25 ft. away from a vertical wall or the garage door. Measure the height of the center of the left headlamp and make a mark on the wall, exactly opposite this lamp, at the same height. An ordinary stick will do for taking the measurement, if a rule is not at hand. Do the same with the right headlight. The marks should be in the form of crosses, the horizontal bar of the cross representing the height of the headlamp center, and the distance between the vertical bars the center-to-center distance of the head-

lamps. Another way to make the marks is given in the heading illustration, where the height of the headlamp centers is shown by a long horizontal line on the garage door, with cross marks to represent the distance between the centers of the lamps.

If the car can be fully loaded while the test is being made, this is all the marking





required, but, as this is seldom practicable, it is necessary to make allowance for the loading of the car, which causes the beam to be tipped up. If the wheelbase of your car is from 100 to 110 in., and it is a touring car, make a horizontal mark on the wall 8 in. below the one already there, and continue the vertical lines until they cross the lower line. If the car is of the same wheelbase but is a sedan, the second line should be 7 in. below the first; if a coupe, 6 in., and so on, according to the table shown on page 169.

Now cover up the right headlamp, switch on the bright lights and focus the left headlamp until the most concentrated spot of light you can get appears on the wall. The

upper illustration in the center of this page shows the kind of spot that should be aimed at. Some lamps have a simple ratchet back of the reflector and the bulb is focused by moving the socket back or forward, one notch at a time, until the best spot on the wall is obtained. Others have a screw in the back of the lamp housing that may be turned with a

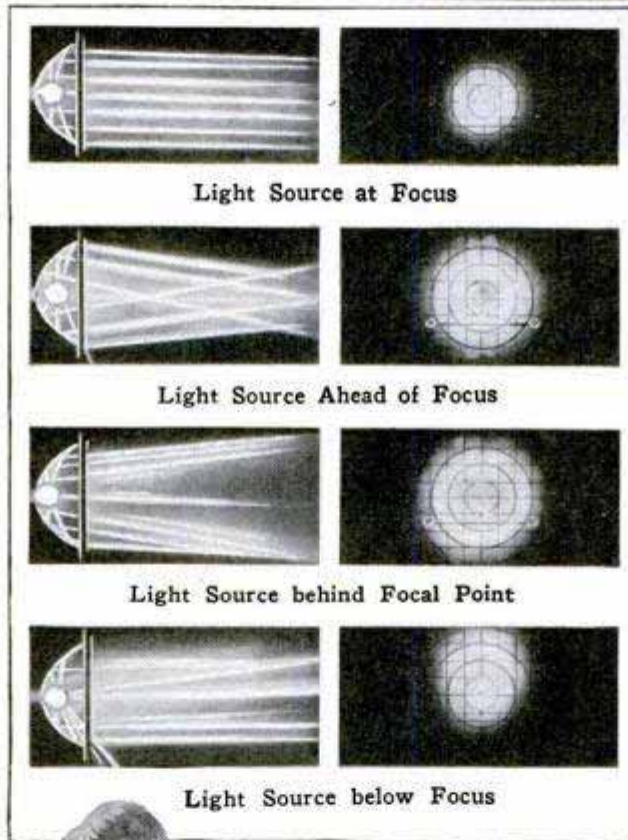
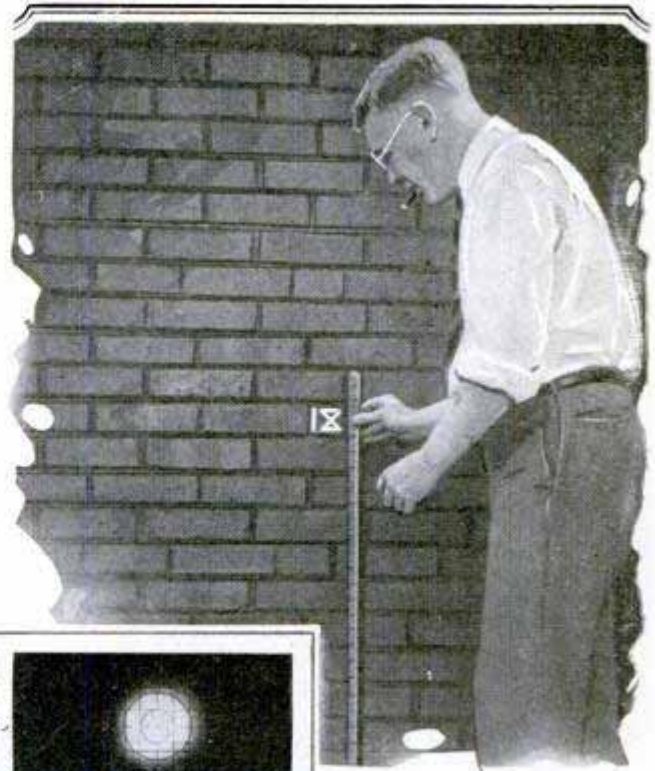

Top, Marking Center Height on Wall; Left, Correct and Incorrect Focusing; Bottom, Marking Center-to-Center Distance

screwdriver to advance or withdraw the bulb. Still others have a knob instead of the screw in the lamp housing, while some cheap lamps have a simple setscrew binding the socket in place, and the setscrew must be loosened to adjust the bulb and tightened again to hold it in place. What-

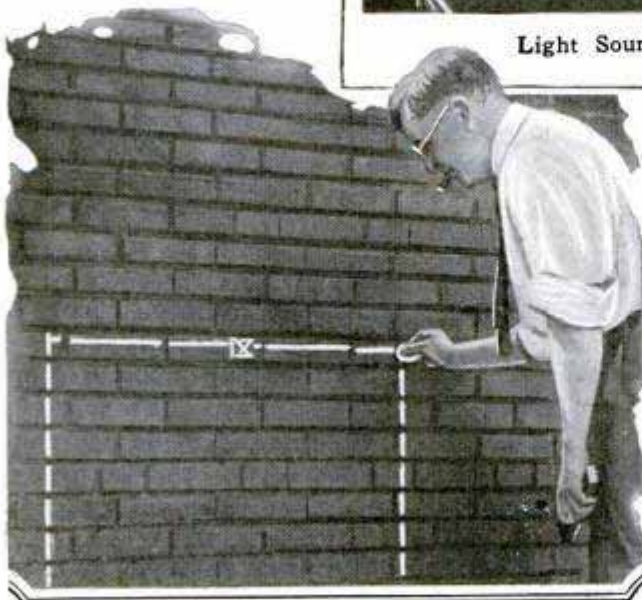

ever the form of adjustment, the purpose of all is the same. There is only one spot in the lamp where the bulb is at the proper focus, and if the bulb is not placed at that spot, much of the efficiency of the light is lost. Tests have shown that a variation of even  $\frac{1}{16}$  in. in the position of the bulb means a loss of 68 per cent of the candle-power available; so it pays to have the lamps focused properly. When the left lamp has been focused, treat the right one in the same manner, covering up the left one while doing so. All this is done with the lenses removed.

Now replace the lenses, taking care to have the part marked "top" in its proper position. Lenses are usually marked so that the word "top," molded in the lens, reads correctly when viewed from the front of the car. Next, center the pattern produced by the beam from the lamps on their corresponding marks on the wall or door. This is effected by means of the adjustment usually incor-

porated in the lamp bracket or at the base of the lamp. When the beam patterns have been centered sidewise, tilt the beam downward until the top edge of the pattern just falls on the lower of the two horizontal lines on the wall—the one that was marked to allow for the loading of the car. Ford cars, previous to 1926, have no adjustment to permit the tilting or sidewise movement of the lamp, so the bracket itself must be bent to accomplish this. The heading illustration shows approximately what the beam pattern should be when properly adjusted, and you will notice that the top edge of the beams just strikes the horizontal line. There is only one line showing here, because the car was artificially loaded while the lamps were being adjusted.

Since it is not possible to make lamp bulbs that are perfectly uniform, and since, as stated previously, a variation of even as little as  $\frac{1}{16}$  in. may lower the efficiency of the light 68 per cent, it follows that every time a new bulb is inserted in the lamp, the light should be focused again. It is not usually necessary to re-

aim the headlights when a new bulb is inserted, but it would do no harm to check the aiming, since, if the new bulb filament is below the focus, it will have the effect of tilting the beam upward slightly. The pictures on page 167 show a perfectly focused lamp and the spot it produces; a lamp in which the bulb is ahead of focus; one in which the bulb is behind the focus, usually seen imme-

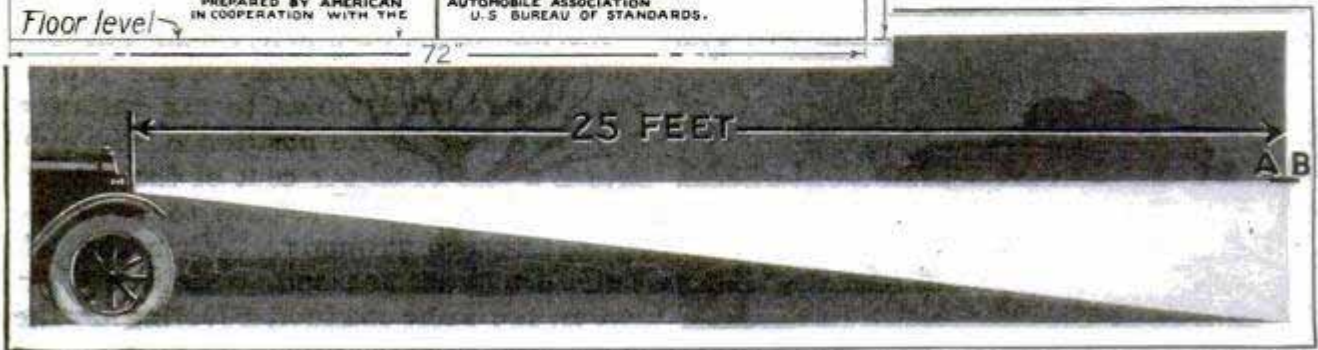
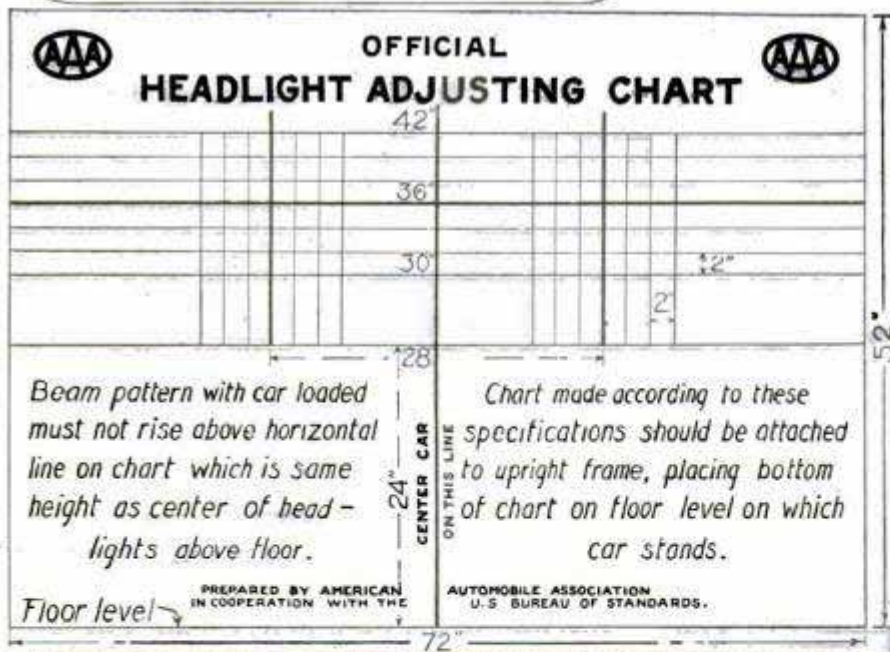

Above, Cleaning Reflector; Center, Official Focusing Chart; Below, Properly Aimed Beam Does Not Rise above Horizontal

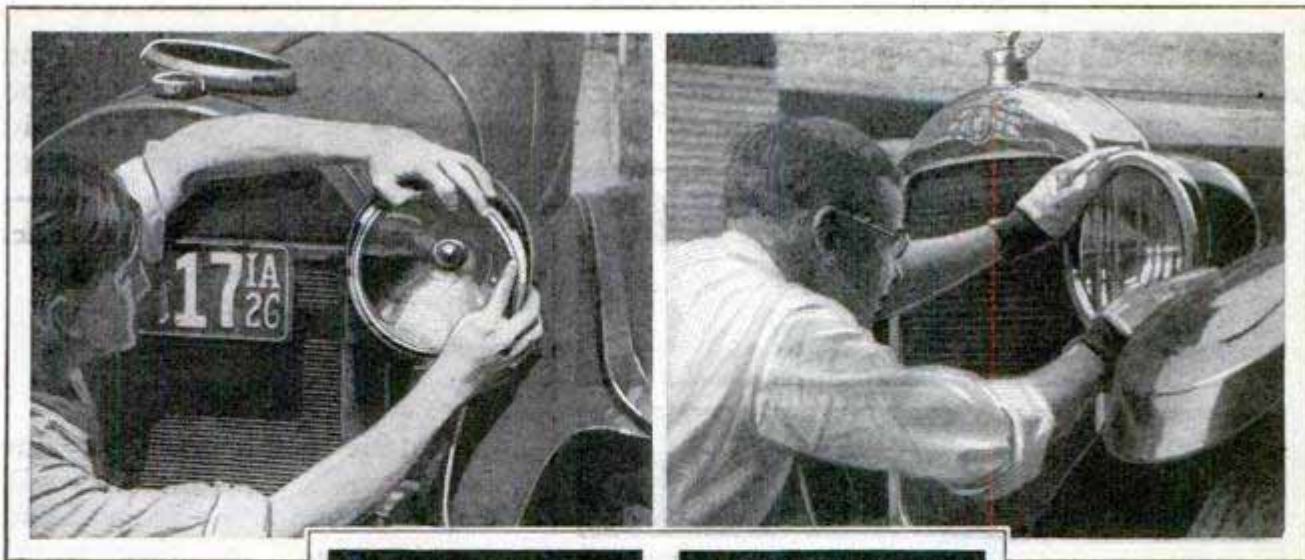

diately by the presence of a black spot in the center of the area of light on the wall, and one where the bulb filament or light source is below the point of focus. On this page is shown how the

lenses affect the beam coming from the lamp. The lens on the left has vertical flutes in the glass and the pattern produced is shown below. In the lamp at the right the beam is bent by means of a horizontal prism, and the pattern shown below is a more desirable one than the one at the left, because the rays from different sections of the lamp are spread. On page 170 two other beam patterns are shown. Both of these are from lamps properly adjusted, the difference in the patterns being due to the different types of lenses employed.

This is all there is to adjusting the headlamps, and it is a small job after all, when the added comfort in driving is considered together with the efficiency of the driving lights.

There are a few more points in the care of headlamps that might be mentioned. When replacing the rims at any time, see that the drain hole is at the bottom, and that the wicking around the edge of the rim, which keeps the casing tight against moisture, is in good condition. A little grease placed around the inside of the



Rays through Lens with Vertical Flutes, and Right, with Horizontal Prism

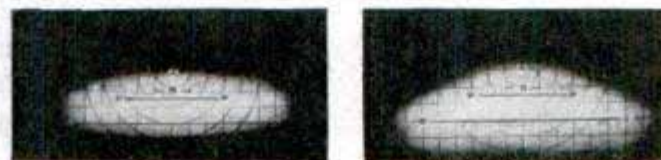

Top, Left, Renewing Gasket; Right, Adjusting Lens; Bottom, Two Patterns Produced by Lenses

rim will make it easier to remove it the next time, and help to prevent rust at this vulnerable spot. When replacing two-filament bulbs having a bright and dim filament, either the bulbs or the

plug connectors may be placed wrong side up. Check this by seeing that the lower 21-cp. filament burns when the switch is turned to "bright."

The simple steps may be summed up as follows: Clean the lamps; focus the bulbs; center the light spots on the marks; replace the lenses and tilt the lamps to allow for the loading of the car.

For the headlights, use only standard 21-cp. bulbs, since all approved headlighting devices are designed for use with bulbs of this candlepower. "Daylight" or blue bulbs of 21-cp. are available, but if these are used in the headlights, it may be found necessary to have the charging rate of the generator increased somewhat,

WHEELBASE	TOURING	SEDAN	COUPE	ROADSTER
100-110	8"	7"	6"	5"
110-120	7"	6"	5"	4"
120-130	6"	5"	4"	4"
130-140	5"	4"	3"	3"

since these bulbs consume about 50 per cent more current than the clear ones. Incidentally, many drivers have the impression that the blue bulbs give a better

and more natural light than the clear ones, but tests have shown that, under ordinary conditions, there is no advantage in vision, while, where the illumination require-

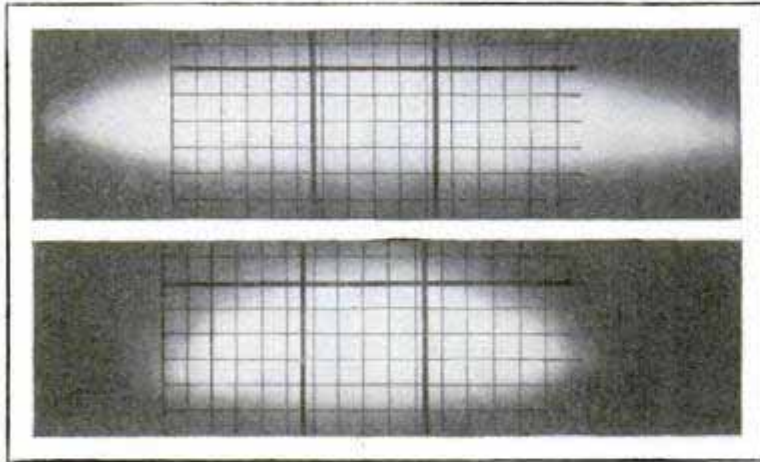

Pattern from Lamps Properly Adjusted, but Employing Different Types of Lenses

ments are most severe, as on wet roads or in haze or fog, the light from the standard clear bulb is much better than that from the blue one. Incorrect voltage at the lamps, sometimes the cause of poor headlighting, may be due to an over or undercharged battery or to poor contacts.

### An Auger Chuck

The square, tapering end of the shank of carpenters' augers, which so nicely accommodates them to a bit stock, very effectually prevents their use in the chucks ordinarily found on machine tools and woodworking machinery. However, a



split taper bushing used in conjunction with a No. 2 Morse-taper sleeve in the manner illustrated, holds the augers satisfactorily. It will be found that with this taper sleeve, the square end of the auger enters the recess into which the drill tang ordinarily fits, and is thus dogged against rotation, while the bushing holds the auger in correct alignment. The writer makes these bushings out of close-grained wood, preferably apple, hornbeam or beech. The shanks of augers are forged and are not quite uniform in diameter,

hence, if the hole in the bushing is a few thousandths of an inch smaller than the largest diameter of the auger shank, the natural resiliency of the wood will hold the auger tight and true, taking up the variations of the shank.—Herbert A. Freeman, Willimantic, Connecticut.

### Eliminating Static on Line Shafts

A static eliminator for line shafts in mills and factories will keep the employes from being shocked and from the serious consequences which might result. To make it, get an iron tee,  $\frac{3}{4}$  in. in diameter, and a piece of  $\frac{3}{4}$ -in. threaded pipe. Flatten one

end of the latter and drill holes in it, as shown. Fasten this unit onto some convenient bearing on the line shaft with two machine screws. Take a round carbon rod out of an old dry cell, scrape the surface smooth so that it will fit into the round hole in the tee; then connect a light coil spring to the carbon rod and to the tee. This exerts a pressure and keeps the rod against the shaft. The end of the carbon rod is connected to the ground, which results in the complete elimination of static.—Develle Thatcher, Kansas City, Mo.

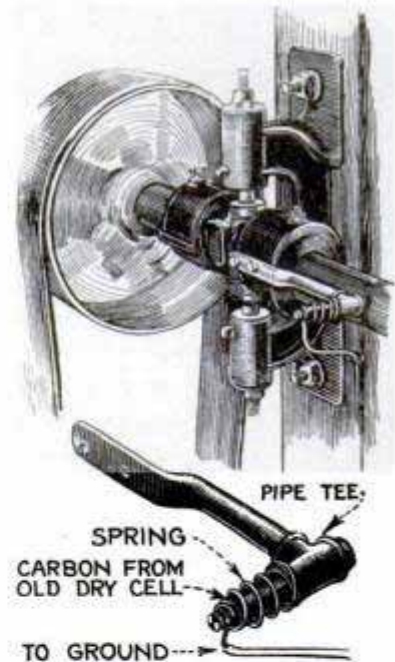

### Attachment for Milling Hexagon on a Shaft

Most small shops have only inexpensive attachments to take the place of a well-equipped milling machine and therefore every idea that facilitates the work helps. One job, which is not uncommonly called

for, is the milling of six splines or a hexagon on the end of a shaft. I have found that very good division of the shaft for milling can be done with the use of a

### Sandbag Pulls Hay Fork Back

Dairy barns are usually longer than they are high, and when hay is unloaded

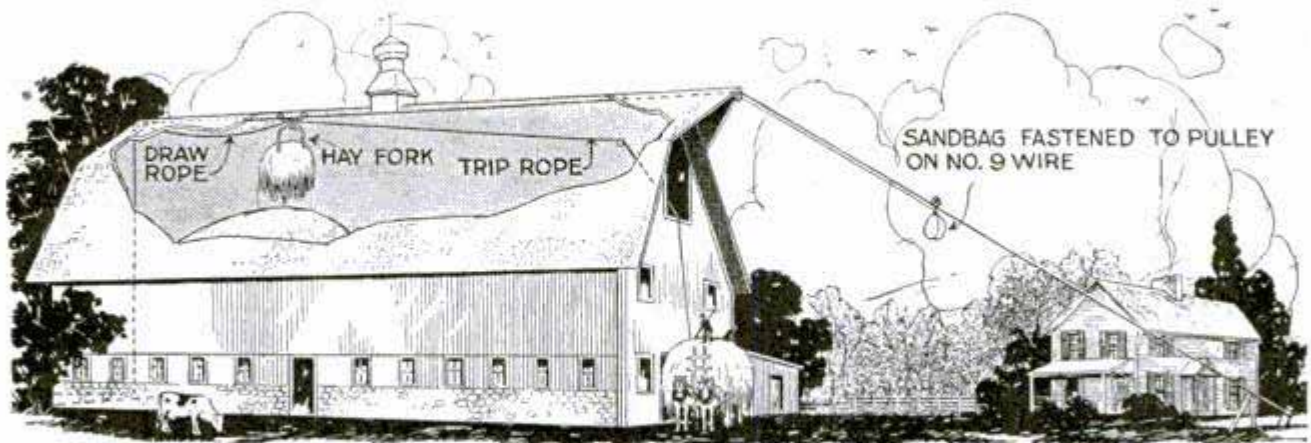

Sandbag Fastened to a Pulley on Wire, Which Is Run from the Barn Gable to a Stake in the Yard, Pulls the Hay Fork Back the Entire Distance in a Long Dairy Barn

hexagon nut. Fasten the nut on the shaft some distance from where the milling is to be done. Sometimes the end of the shaft is threaded so that a nut can be screwed up snugly against a shoulder. If not, a larger nut may be slid over the shaft and wedged securely. Before taking the first cut, level one side of the nut by rotating the shaft and clamp it in this position. After the cut is made, all that is to be done for each new cut is to level succeeding sides of the nut as before by rotating the shaft.—S. J. Gee, Salt Lake City, Utah.

### Threading Short Lengths of Pipe

It is usually almost impossible to thread the ends of short pieces of pipe with an ordinary stock and die. Having to thread a number of such lengths, and also some ells, which I could not hold securely in the pipe vise, I used the method illustrated. The handle of the die stock was put into a vise and the pipe was threaded by screwing it into the die with a wrench. Pipes up to 1½ in. are easily threaded in this way.—Thos. J. Johnson, Cuero, Tex.

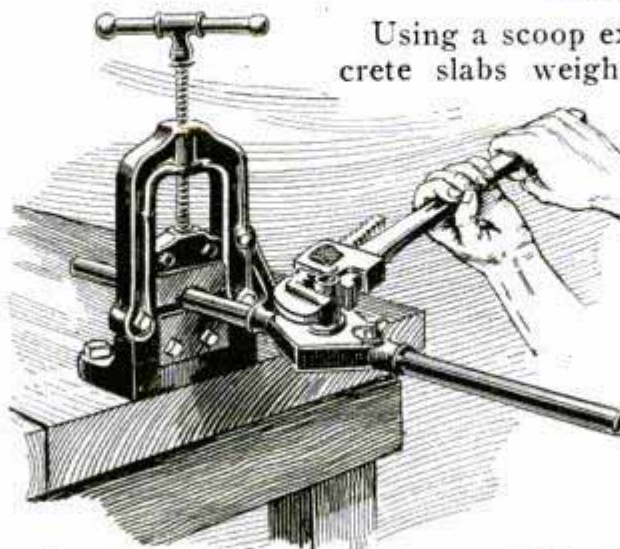

Method of Threading Short Lengths of Pipe

through an end door into the loft, it is difficult to pull the fork back. A sandbag is sometimes used to pull the fork out but in long lofts the sandbag reaches the ground long before the car has been brought back. The drawing shows how one farmer overcame this difficulty. He stretched a length of No. 9 wire from the gable of the barn to a stake some distance from it, fastened the sandbag to an ordinary hay-fork pulley and attached this pulley to the draw rope on the fork. The sandbag is pulled up the wire when the bundle of hay moves into the barn and, when the fork is dumped, it slips back down the wire with the car and fork.

### Scoop Excavator Is Used to Smash Concrete Slabs

Using a scoop excavator to tilt up concrete slabs weighing several tons each and shattering them by letting them fall, was the novel plan hit upon by a road-building contractor to get rid of about a mile of old pavement. After the slabs were smashed, the pieces were picked up by the machine and loaded into trucks for disposal.—Geo. F. Paul, Chicago.

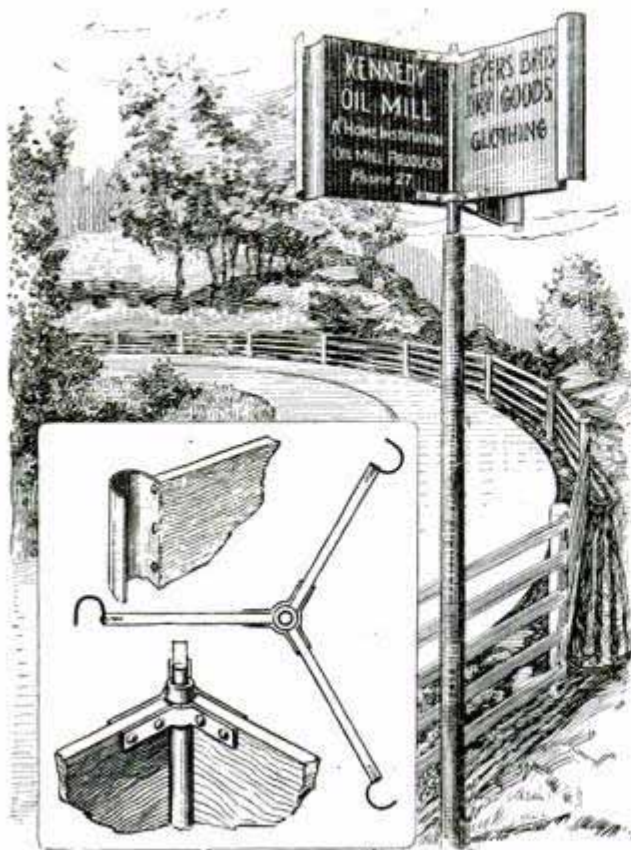

Novel Rotating Signboard Keeps Moving Almost Continuously in a Slight Breeze

### Novel Revolving Sign

As it is always in motion, the sign shown in the drawing will attract considerable attention. It consists of three signs, each about 2 ft. square and made of 1-in. wood. They are fastened to a piece of 1½-in. pipe, 2½ ft. long, with small strap-iron brackets, and on the outside end of each board a vane is fastened. The vanes are made of tin, each being 2 ft. long and 8 in. wide, and bent to a semicircular shape. The sign is pivoted on a rod, so that a slight breeze will keep it in motion.—Thos. F. Johnson, Cuero, Tex.

### Brushes Placed in Oil Keep in Condition

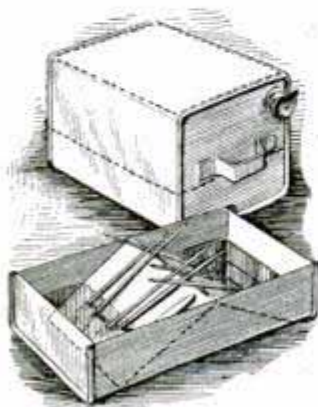

Paintbrushes can be kept in good condition by leaving them, when not in use, in a container of the kind shown in the illustration. It is made from a 5-gal. oilcan. This is cut in two. One of the sides is also cut off

and bent to form a suitable angle, then set in the container as shown. The container is filled with lard oil to a height of about 1 in., or so that the bristles will be covered when the brushes are laid in the oil. As the weight of the brushes is supported mainly by the center piece, the hairs will not turn up and spread.—Jos. E. McLaughlin, Chicago, Ill.

### Strengthening Riveted Plates by Special Countersinking

Sheet metal or thin plate can generally be joined to heavier plate by means of round-head rivets, and the strength of the plate increased. In pressure members, such as tanks, boilers and various other constructions, strength is essential, and a weak joint may break open if strained. But, in many instances, tubular pieces and other members, where an inner piston moves on the surface of the work, or where some part bears, round-head rivets cannot be used. Under such conditions, where countersunk rivets must be used, it will be found that the method shown in the illustration is far superior to the usual riveting, which is shown below. The recessed rivet, which draws the plate adjacent to it into the counter-

sunk area, develops the full strength and more than normal bearing strength of the plate. To make this joint, the heavy plate is drilled and countersunk through the thin plate, this hole being one-half to two-thirds the body diameter of the rivet. A tool of the shape shown is used to set the thin plate down into the countersink in the heavy plate and then the rivet is driven in the usual manner.

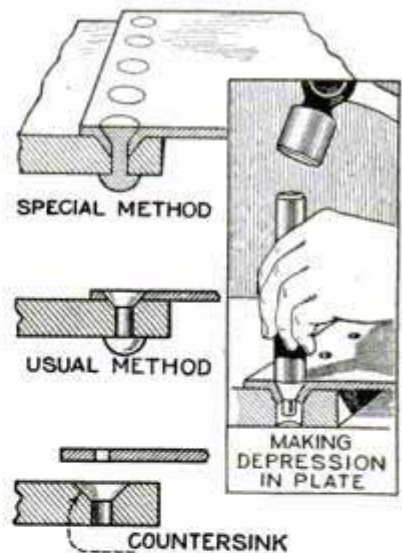

Caliper a bored hole at several points in its length as the size at the opening may be misleading.

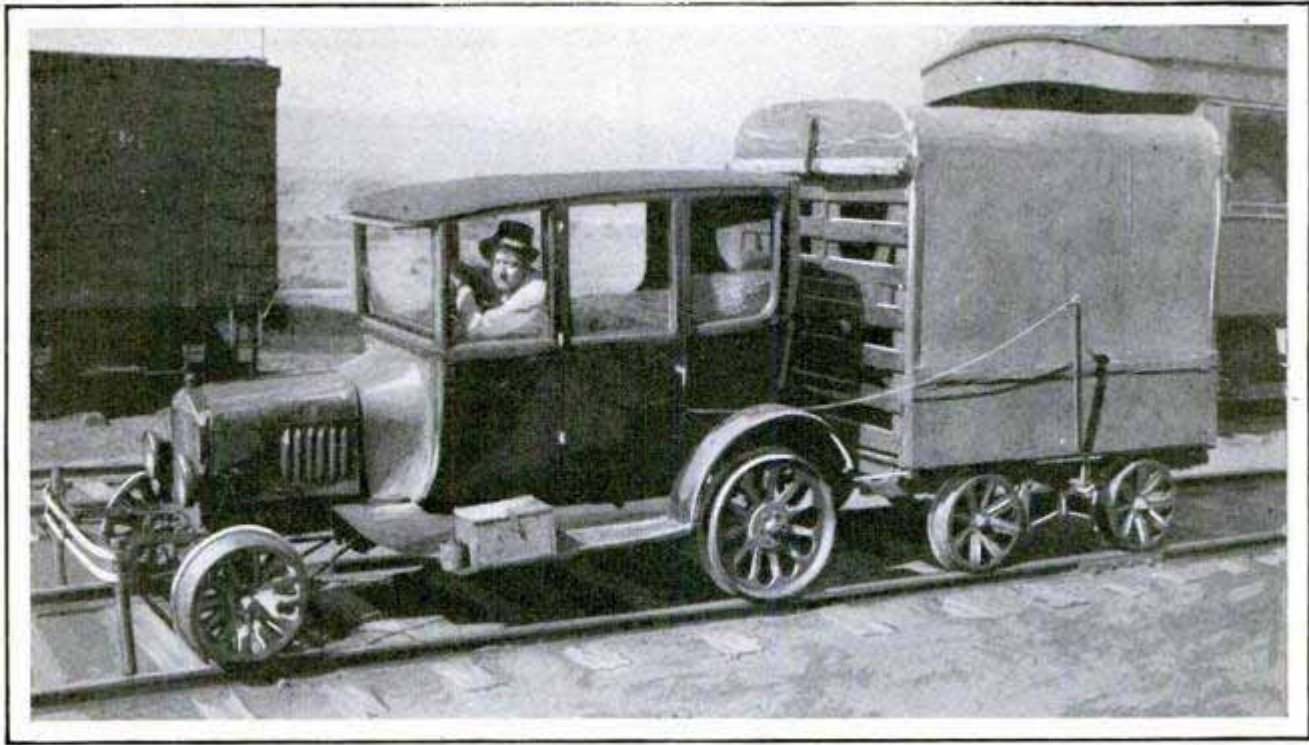

Handcar Wheels Attached to Automobile Enables It to Run over Railroad Tracks with Considerable Speed; Lengths of Hose Hanging from Bumper Brush Away Small Obstructions from Rails

### Auto Used for Train Service

Since automobile busses are hauling so many passengers and much express, the railroads have found it unprofitable to run passenger trains over some of their branch lines the year around. One western railroad simply put handcar wheels on a Ford sedan and a top on an ordinary pushcar, making a passenger and express train out of the two. The pushcar carries the express and mail for small towns along the line and the trip is made in one hour as the line is only 30 miles long. This speed is better than that of regular trains. The steering gear is disconnected and the front spindle bolt is clamped so that it cannot turn. Two short lengths of hose, running down to the rail from the bumper, serve to brush off small stones and weeds that might cause derailment if they were not removed.—Carlton Groat, The Dalles, Oreg.

### Air Compressor Made from Old Motor

By transforming the two center cylinders of a four-cylinder gasoline engine into pumps and using the outer ones to furnish power, a garage owner of St. Paul, Minn., has constructed an efficient, compact air compressor at little cost. An old discarded motor was purchased for a few

dollars and put in running order with odds and ends around the shop. The valves of the two center cylinders were bolted down to their seats and the push rods operating them were removed. Pipe connections were made with the spark-plug holes of the center cylinders and joined with a tee. A Y-coupling was joined to the tee, one side of the former being fitted with an intake check valve and the other with an outlet check valve. An old water-heater tank served as a radiator. The compressor runs at approximately 500 r.p.m. and easily supplies an air pressure of 125 pounds.—Jesse A. Leason, St. Paul, Minn.

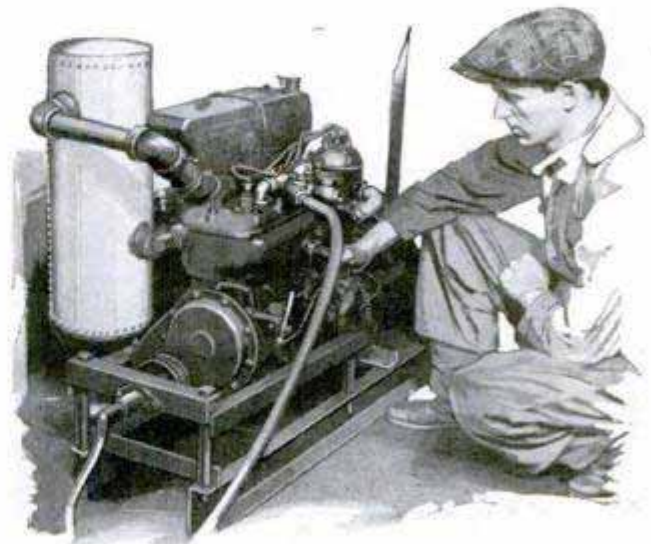

Efficient Motor-Driven Air Compressor Made from Old Automobile Engine



Small Wire Hook, Slipped over Railing, Holds Paint Pot in Handy Position

### Paint-Pot Hanger

Two painters had the job of painting the railing of a very long porch. They decided that it would be a hard and tiresome task to carry the pail as they proceeded. A stiff piece of large wire, which would not bend easily, was obtained and shaped as shown. This held the pail securely to the railing as they went along.—Charles Latour, Plattsburg, N. Y.

### Improved Baseboard and Shoe

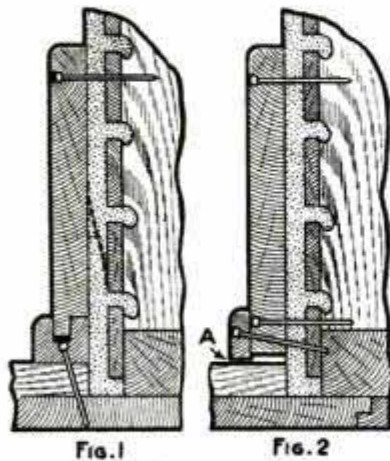

Fig. 1

Fig. 2

The accompanying drawing shows an improved baseboard and shoe. The advantages of this over the old form are quite obvious. The groove, into which the tongue of the baseboard fits tightly, prevents cracks of the kind indicated by the letter A in Fig. 2, caused by the baseboard shrinking or the floor

settling. In case the plastering has been dubbed off as indicated by the dotted line in Fig. 1, the grooved shoe will keep the bottom edge of the base in proper alignment with the surface of the plastering, while, when the plastering is dubbed off and a shoe of the kind shown in Fig. 2 is used, the lower edge of the baseboard must be blocked out, in order to keep it in a true position.—H. H. Siegele, Emporia, Kans.

### Shock Wrench for Grinde:

The handiest kind of wrench to keep around an emery or polishing wheel is a shock wrench like the one shown in the illustration. The nuts used to tighten the wheels on the spindle can be manipulated more readily with a wrench of this type than with the solid kind usually employed. The principle is the shock, or knocking action, which tightens or loosens the nuts as the belt on the machine is pulled around. The wrench consists of a body cut to form a handle, which is drilled out at the end to take the hexagon ring and slotted to clear the pin that is driven into the ring. To loosen a nut the pin is at the top and the far side of the belt is pulled. To tighten the nut the opposite procedure is followed.—Harry Moore, Montreal, Canada.



### Analysis of Pump Troubles

If the pump handle rises slowly when released, it is an indication that the water is leaking through the valve to the pipe below. The check valve may be worn or some obstruction may have lodged between the valve and its seat. The remedy is to draw out the cylinder, remove the valve and clean the seat. If the leather is found worn, it should be replaced. If the handle jerks back, as if a spring were attached to it, the cylinder is too far from



the water supply or the water supply is shut off by some obstruction. Perhaps the screen has become filled with clay or gravel, or it may be that the suction pipe is too small for the size of cylinder used, but if the pump worked satisfactorily previously, this is not likely to be the case. The remedy generally consists in drawing out the suction pipe and cleaning the pipe and point screen. If the handle works up and down without apparent resistance and without delivering water, or a very small quantity, the leathers are worn out and must be replaced. However, this trouble may also be due to something being lodged under the valve. Air bubbles discharged with the water are caused by a leaky joint or a cracked pipe in the suction line, and can only be remedied by drawing out the pipe and repairing it.—C. C. Hermann, Moline, Ill.

### Smoke Escape for Workshop

Having an open tuyere in a small farm workshop, the owner was troubled by smoke which did not escape readily and filled the whole interior in a short time, making the air unfit for inhalation. The farmer eliminated this trouble by constructing the simple smoke escape illustrated in the drawing. He removed some roof boards at the ridge and nailed a few lengths of 2 by 4-in. wood lengthwise on the rafters as shown. The roofboards were nailed over these,

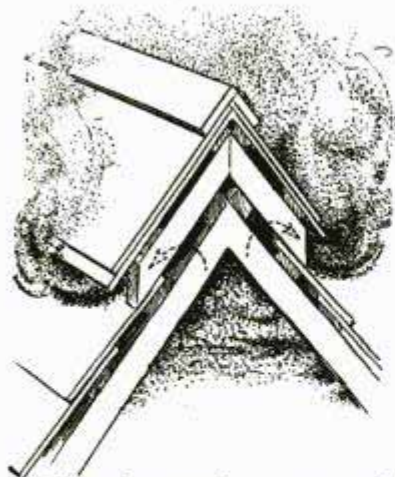

which formed a sort of inverted trough over the ridge to prevent rain and snow from entering.

### Truck for Moving Shop Trays

While there are various forms of shop trays used

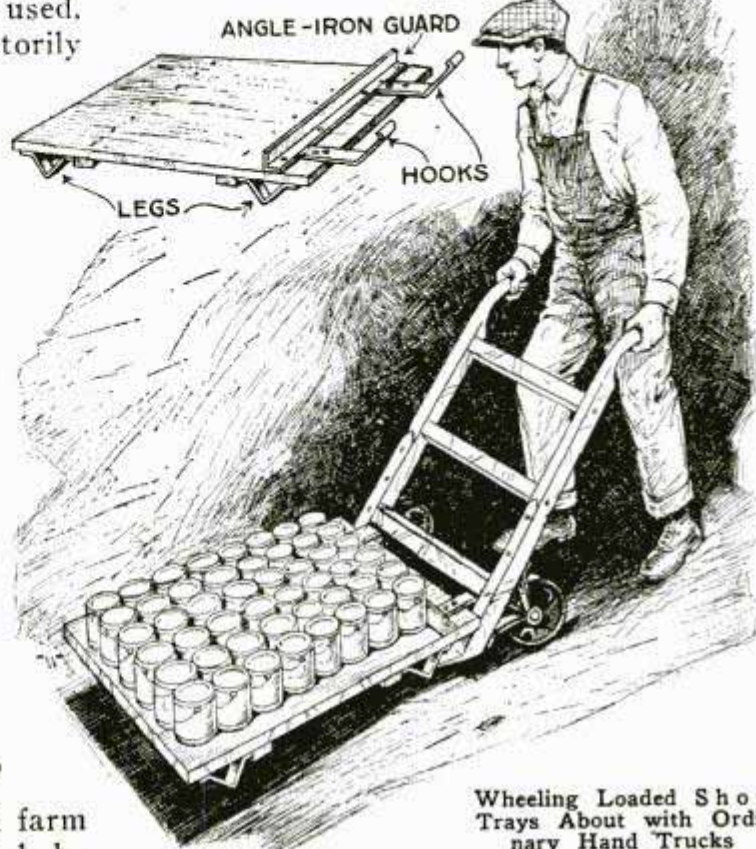

Wheeling Loaded Shop Trays About with Ordinary Hand Trucks

for the removal of parts from the machines where work on them has been done, the tray shown in the drawing will be found unusually handy because it can be moved with a hand truck. It has four legs, about 4 in. high. On one end two small hooks are fastened and these engage with a crossbar on the truck, while the lift heel of the truck bears against the bottom of the tray. As a means of handling material rapidly, this method has been found to be a decided improvement. Of course, the load has to be within the capacity of the hand truck.—G. A. Luers, Washington, D. C.

☐ Chamois skin, moistened in water to which a few drops of kerosene have been added, can be used to clean the windows of the automobile as perfectly as desired; it is only necessary to go over them afterward with a clean dry cloth.

IN accordance with the editorial policy of this magazine never to accept compensation in any form for what appears in our reading pages and also to avoid the appearance of doing so, we are obliged to omit the name of the maker or the seller of any article described. This information, however, is kept on file and will be furnished free, by addressing Bureau of Information, Popular Mechanics Magazine, Chicago.

422

# This May Be Your Home

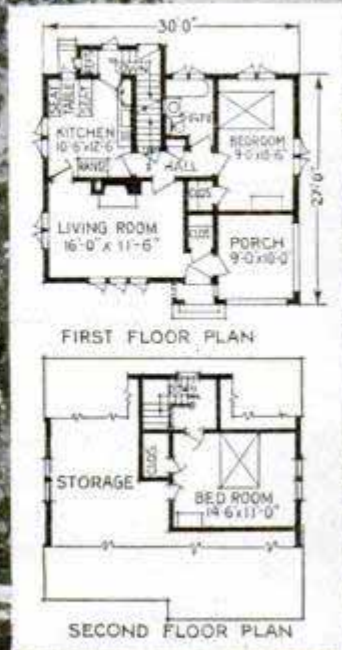
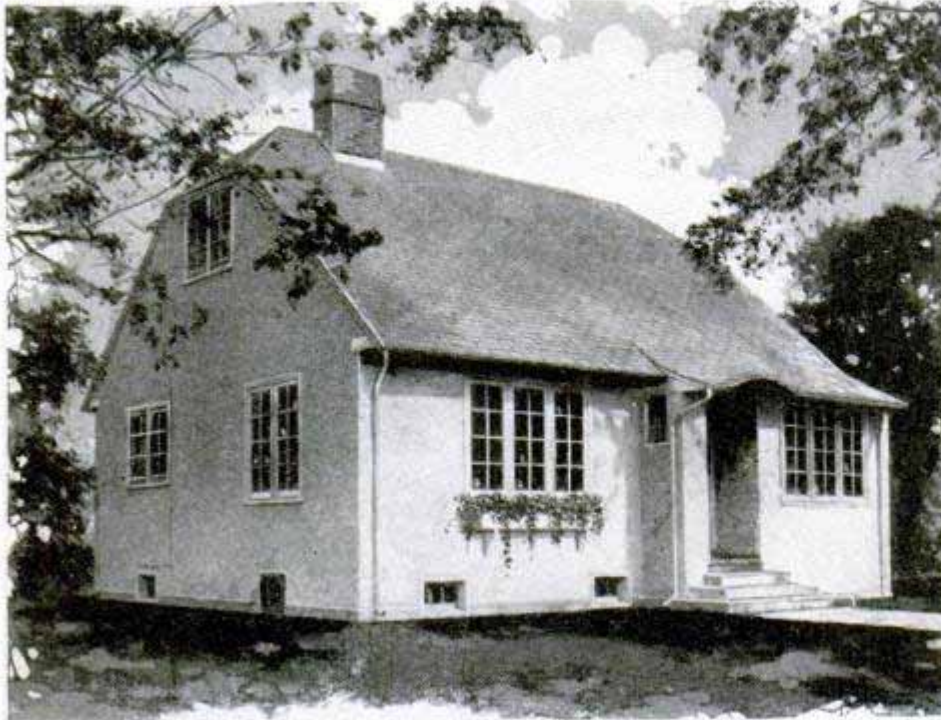

Copyright, Architects' Small House Service Bureau

Plan No. 3A2

**Q**UESTIONS regarding home building addressed to this magazine will be answered by The Architects' Small House Service Bureau of the United States, Inc., controlled by the American Institute of Architects and endorsed by the United States department of commerce. Inclose 10c and self-addressed envelope. Blueprints, specifications and material list for the house shown here may be obtained at nominal cost. Inclose self-addressed stamped envelope for reply. If further information is desired, send 5c and stamped envelope for a 24-page booklet explaining how the Small House Service Bureau functions and showing 12 sample plans. A new booklet, entitled "Fifty Ways to Lower Home Building Costs," illustrated by ten bureau houses actually lived in, and showing how as much as \$1,000 can be saved on a home, may be obtained for 20 cents.

**T**HE average three or four-room bungalow can be convenient and comfortable to live in, but is seldom distinguished for its architectural beauty.

This design provides three principal rooms on the first floor and a fourth room under the roof, combining usability, economy of building and fine appearance in an unusually successful manner. The plan is practically rectangular. This is a form that produces lower costs, but, on account of the clipped gable ends and the eyebrow treatment of the roof over the entrance, the design does not tend toward a box-like appearance such as many square houses have. The porch can be inclosed or left open as may be desired.

On the first floor there are three principal rooms with bath and three large closets. The kitchen is equipped with dining alcove, with built-in seats and table. The refrigerator stands in the rear entry and is equipped for outside icing.

The living room is made inviting by a fireplace opposite which there is a group of three windows.

The second story may be left incomplete for the time being or fitted with an additional room. If the fireplace is placed on the end wall of the living room, two rooms may be obtained in the attic.

Construction is wood frame on continuous masonry foundations. The exterior finish is stucco, but siding may be used. A 40-foot lot would be required. This house should face north or west, but may be reversed.

## Home Builders' Questions

**Q.** The foundation of my home is concrete and the inside is rough. I would like to fix this up in better shape and also make it lighter. Will you please advise the proper way to do this? **A.** Plaster the walls with white Portland cement.

**Q.** How do you thin varnish when it becomes thick? **A.** Do not add oil or other varnishes or liquid driers. Add only pure turpentine. Warm both the turpentine and thick varnish before mixing and let the mixture stand over night before using.



See demonstration at hardware dealers'.  
Try the  
"YANKEE"  
Ratchet.

## No need to hold chuck

to keep it from turning back on ratchet movement. The famous "Yankee" Ratchet is smooth, powerful, silent; as easy-working as the stem-wind of a watch, yet unbreakable.

See "Yankee" No. 2100—the finest bit-brace ever made. Try it—and you will appreciate the economy of paying a little more to own a tool of this kind.

**No. 2100**

*Hard Rubber Handles.* Unbreakable. Do not warp, shrink, crack or bind. Top handle steel-clad, ball bearing. Sweep handle caps held by patented "Yankee" method, preventing excessive handle play.

*"Yankee" Finish.*—Nicked and finished in keeping with the perfection of its construction.

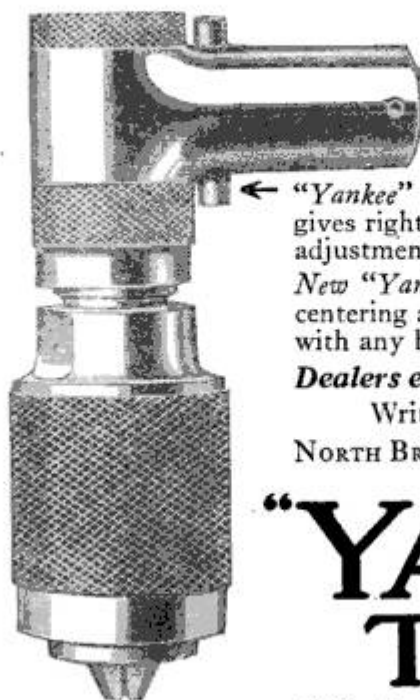

← *"Yankee" Ratchet Shifter.*—A finger-touch gives right or left ratchet, or rigid. Positive adjustment. Dust-proof. Moisture-proof.  
*New "Yankee" Chuck.*—Ball bearing. Quick centering and accurate. Won't loosen in work with any bit; round, square taper,  $\frac{1}{2}$  in.

*Dealers everywhere sell "Yankee" Tools*  
Write us for "Yankee" Tool Book  
NORTH BROS. MFG. Co., Philadelphia, U. S. A.

**"YANKEE"  
TOOLS**  
*Make Better Mechanics*



## Pathfinders

*An Advertisement of  
the American Telephone and Telegraph Company*

CHRISTOPHER COLUMBUS discovered America, thus adding a new world to the old. Alexander Graham Bell discovered the telephone, giving the nations of the earth a new means of communication. Each ventured into the unknown and blazed the way for those who came after him.

The creating of a nation-wide telephone service, like the developing of a new world, opened new fields for the pathfinder and the pioneer. The telephone, as the modern American knows it, has



been made possible by the doing of a multitude of things in the realms of research, engineering and business administration. Its continued advancement requires constant effort in working upon a never-ending succession of seemingly unsolvable problems.

Because it leads the way in finding new pathways for telephone development, the Bell System is able to provide America with a nation-wide service that sets the standard for the world.

# One Cent *per* mile

*America's lowest  
cost power trans-  
portation*

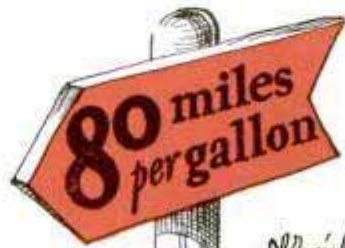

**T**HE Harley-Davidson Single — new-type motorcycle — costs barely one cent per mile to operate! No wonder thousands upon thousands of people are adopting this amazingly low cost and dependable means of transportation. The cost is actually lower than street car or bus fare! Only one-seventh the cost of operating a low priced motor car!

The Single is easier to ride and control than a bicycle—safe. Parks in 2x8 foot space — convenient. Travels 80 miles on a gallon — economical. Powerful, dependable, Ricardo-head motor.

Easy to buy, too. Your Harley-Davidson dealer offers a convenient Pay-As-You-Ride plan. Price, complete with 3-speed transmission and full electric equipment, f.o.b. Milwaukee, only **\$235**

See your dealer for a demonstration and send us the coupon for literature.

**The** HARLEY-DAVIDSON MOTOR CO.  
DEPT. P MILWAUKEE, WIS.  
**HARLEY-DAVIDSON**  
[ **New-Type Motorcycle** ] **Single**

Com-  
fort-  
able

Safe

HARLEY-DAVIDSON MOTOR CO.  
Dept. P, Milwaukee, Wis.

Interested in your Single; send catalog and my dealer's name.

Interested in your dealer proposition; is my territory open?

Name \_\_\_\_\_

Address \_\_\_\_\_

City \_\_\_\_\_ State \_\_\_\_\_

# BUILD YOUR 1928 MODEL RADIO SET NOW!

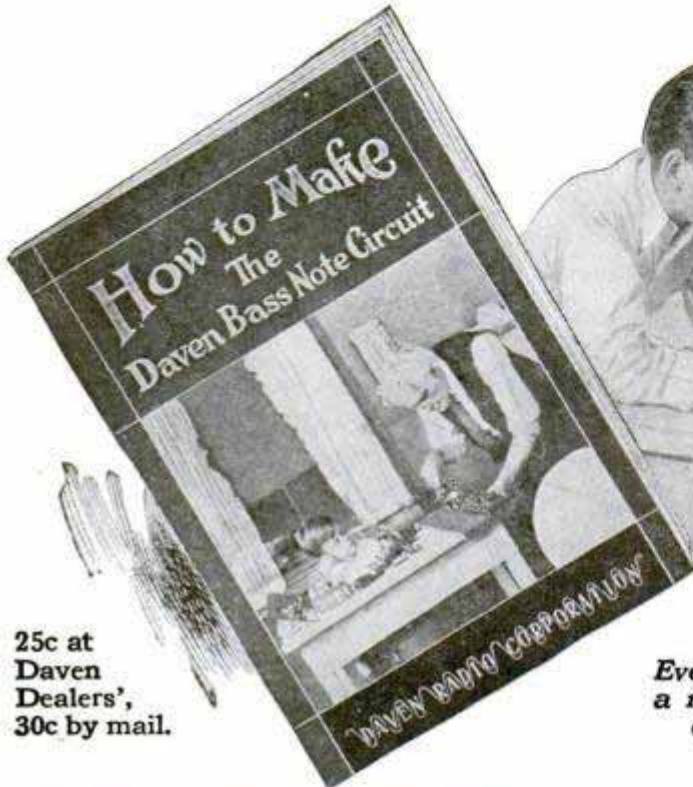

25c at Daven Dealers', 30c by mail.



*Even if you can't drive a nail in straight, you can build this set.*

**T**HE DAVEN BASS NOTE SET—the “hook-up” that all radio fandom is talking about—and building! The pure-tone circuit that will be the feature of next year's leading factory-built sets. The set that will open your eyes—and ears!—to the new possibilities in radio! The set that will be the talk—the envy—the *model*—of your neighborhood!

You—no matter if you never tried set building before—can build this set—easily, quickly—and equal the job of an expert. This new Book does the trick! Simple as A B C. Shows everything life-size. Numbers every wiring connection. Mistakes are practically *impossible* with such charts as these!

Get this Book. Build the first 1928 *model* set in your neighborhood. And learn the great big difference the Daven Bass Note Circuit makes in radio. Get this Book at your Daven Dealers, or write us—but *don't* put it off!



### FACTORY BUILT DAVEN BASS NOTE SETS

If you are not interested in set building, but want the new completeness of reception, the easy 2-dial tuning, the sharp selectiveness that the Bass Note Circuit brings, you will be interested to know that we have bought a controlling interest in the Port Manufacturing Company of Newark. Write for Free Folder showing and describing complete Daven Bass Note Sets. Address,

Port Manufacturing Co.,  
Radio Set Division of  
Daven Radio Corp.  
161 SUMMIT ST. NEWARK, N. J.



### THIS RESISTOR DOESN'T CHANGE

The Daven Glastor, the new *Transparent Resistor*, is noiseless and enduring. Complete range of resistances.

### NEW RESISTOR FOR BELIMINATORS

The Daven *Hi-Duty Glastor* especially designed to carry the highest currents known to radio.

# DAVEN

## BASS NOTE CIRCUIT

For COMPLETE Radio Reception



### New 8th Edition Daven Manual

This valuable book, newly revised, explains Daven Amplification in full detail, and shows how to apply Daven Amplification to any set. Get the Manual at your dealers', 25c—30c by mail.

Complete Daven Catalog Free on Request.

*"The Sine of Merit"*  
**DAVEN RADIO CORPORATION**  
TRADE MARK *"Resistor Specialists"* REGISTERED  
161 SUMMIT STREET NEWARK, N. J.

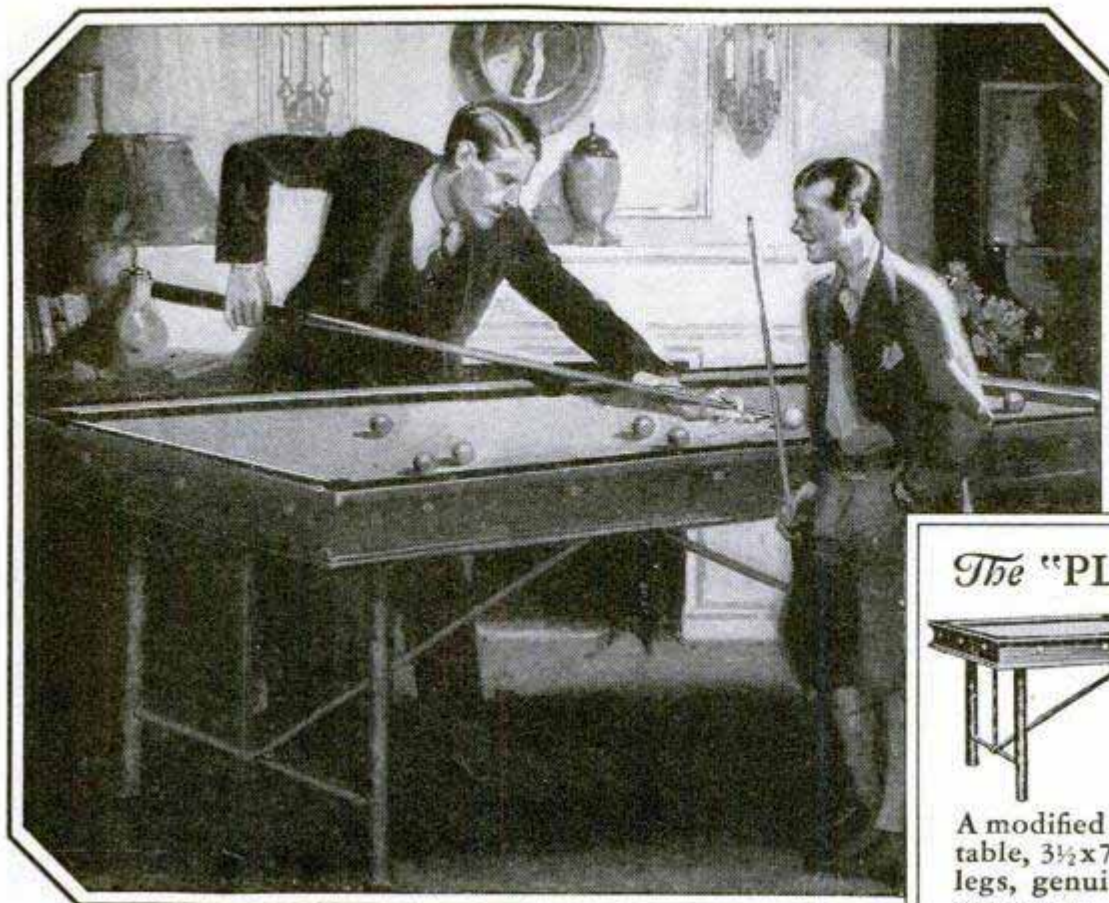

*For Real  
FUN  
at Home  
Play  
Billiards*

## \$26<sup>50</sup> Brings this Wonderful Billiard Table to Your Home

**T**HINK of it! A genuine standard type, slate bed billiard table—a table with accurate angles, junior regulation cushions, fully equipped, beautifully constructed and finished, for \$26.50 cash—with the balance in small monthly payments.

Picture the fun you could have those long winter evenings with a real billiard table in the house—the thrills, laughter, excitement with a billiard tournament in progress every night.

Family, neighbors, friends—everybody can play and there isn't a better, more wholesome form of entertainment a home could offer. And it is good exercise.

This remarkable Brunswick Table, the "Playmate," isn't a toy. It's a modified standard slate bed billiard table. Read the description at the right. Then fill out and mail the attached coupon for full details, prices, etc. Do it today.

**BRUNSWICK-BALKE-COLLENDER COMPANY**

*Established 1845. Branches in All Principal Cities in U. S. and Canada*

**Play  
Billiards**

### *The "PLAYMATE"*



A modified standard billiard table, 3½ x 7 ft. with folding legs, genuine slate bed to assure an absolutely level playing surface, cushions, balls and angles scaled to scientific proportions providing all the playing qualities of a regular professional size table.

The Playmate is designed especially for small homes where extra space or a special room is not available. It comes completely equipped—ready for play.

**Price \$26<sup>50</sup> Cash**

*Balance in small  
monthly payments*

At a slight extra cost interchangeable cushions may be had making the table suitable for either carom or pocket billiards. Smaller tables for pocket billiards only, sizes 2½ x 5 ft. and 3 x 6 ft., may be had at still lower prices.

The Brunswick-Balke-Collender Company  
Dept. H-143, 623 S. Wabash Avenue  
Chicago, Ill.

Gentlemen: Please send me full descriptions, prices and terms on Brunswick Home Billiard Tables.

Name.....

Street.....

City.....

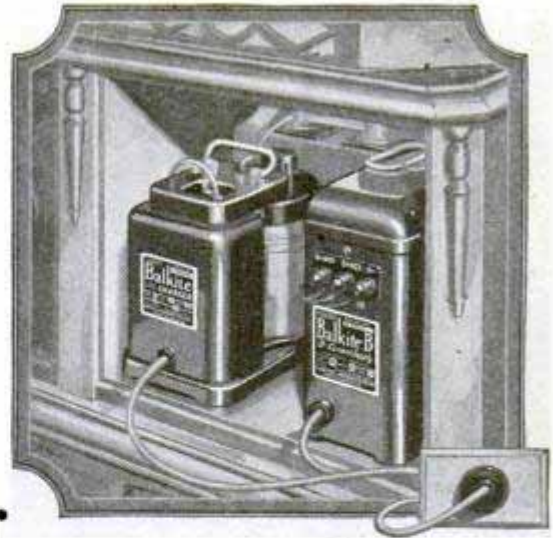

Silent, infallible,  
permanent radio power  
*from the light socket* with Balkite "B"  
and the Balkite Charger



#### Balkite Trickle Charger

MODEL K. With 6-volt "A" batteries can be left on continuous or trickle charge thus automatically keeping the battery at full power. In effect converts your "A" battery into a light socket "A" power supply. Charging rate about .5 ampere. Over 200,000 in use. Price \$10. West of Rockies \$10.50. (In Canada \$15.)



#### Balkite Combination

When connected to the "A" battery supplies automatic power to both "A" and "B" circuits. Automatically controlled by the filament switch on your set. Will serve any set now using either 4 or 6-volt "A" batteries and requiring not more than 30 milliamperes at 135 volts of "B" current—sets of 8 tubes or less. Price \$59.50. (In Canada \$83.)

Over 700,000 radio set owners are now using Balkite Radio Power Units because they provide silent, permanent power from the light socket. They are noiseless in operation and can be used during reception. They employ no tubes. They have nothing to wear out or replace. They are based on the same Balkite principle now commonly used in railway signaling, hospital lighting, and other systems where power must be infallible.

One way of equipping your radio set with Balkite is to add Balkite "B" and the Balkite Charger. Balkite "B" eliminates "B" batteries entirely and supplies "B" current from the light socket. It is the proved "B" power supply. Balkite "B"-W at \$27.50 serves sets of 5 tubes or less requiring 67 to 90 volts, Balkite "B"-X sets of up to 135 volts and 8 tubes and Balkite "B"-Y any standard set.

The Balkite Charger, with both high and low charging rates, used as a trickle charger automatically keeps your "A" battery always fully charged. In effect it makes your battery a light socket "A" power supply. Its high rate provides a ready reserve for heavy duty use.

Add these Balkite Units now and enjoy the last word in radio convenience and economy. Ask your dealer.

[Balkite "B"-W \$27.50; "B"-X \$42; "B"-Y \$69; Balkite Charger \$19.50. West of Rockies \$20; In Canada "B"-W \$39; "B"-X \$59.50; "B"-Y \$96; Charger \$27.50]

FANSTEEL PRODUCTS CO., Inc., North Chicago, Illinois

*Listen to the Balkite Radio Symphony Concerts with Walter Damrosch and the New York Symphony. Balkite Hour, Saturday nights, 9 P. M., Eastern Standard Time. Stations WEAf, WEeI, WGR, WFI, WCAE, WSAI, WTAM, WWJ, WGN, WCCO, KSD, WDAF, WOC.*

FANSTEEL  
**Balkite**  
Radio Power Units





### Handiest tool in your Work Shop

Perhaps you have never thought of the special advantages of using LePage's Liquid Glue. It is always ready for immediate use. No weighing, soaking or heating is required. The quality is always the same. It "sets" slowly enough so that you have plenty of time to place the joints together exactly as they should go. Slow setting also allows LePage's to penetrate the wood, increasing the strength of the joint. LePage's Liquid Glue is equal in strength to any animal glue. Buy a can for your workshop. It is the easiest, quickest, handiest form of Glue. Insist on LePage's.

#### Recipe for Making LEPAGE'S Gesso

To make one cup of LePage's Gesso, you need 1 gill can of LePage's Glue, 1 1/4 cups whiting, 3 teaspoons linseed oil and 3 teaspoons varnish. Place whiting in mixing bowl and pour in slowly in this order. LePage's Glue, linseed oil, and varnish. Mix until smooth. All ingredients obtainable at nearest hardware store.

# LEPAGE'S GLUE

*Bottles, Tubes, Cans*

# Household furniture you can make yourself

LEPAGE'S New Books  
*will show you how*

Now with the coming of long winter evenings, come two new LePage's Craft Books to show you how to make simple, attractive and useful pieces of household furniture, and how to improve your craftsmanship.

"LePage's Work Shop Book" contains complete directions for making a taboret, footstool, hanging book shelves, book trough, end table with book trough, and a number of simple things which perhaps your boy would like to make. The printed directions for making, step by step, are supplemented by dimension drawings and illustrations made from photographs of the finished pieces of furniture.

LePage's "Practical Suggestions for the Home Work Shop" will help you come closer to equalling the skill of the trained cabinet-maker. It tells you how to make strong joints with glue, and with glue in its most convenient form—LePage's Liquid Glue.

These books also show you how to cover up small defects in your craftsmanship. Now and then a tool will slip and an error is made. Or there are holes to be filled where nails or screws have been countersunk. Or the edges of a joint are not exactly even. A simple new way to repair these defects is with the use of LePage's Gesso instead of putty. LePage's Gesso will stick to any surface—wood, metal, glass, etc., and will stand 1000 lbs. breaking strain as explained in the books. It can be sandpapered, planed and painted or stained just like wood. We give you in the small panel below a simple formula for making LePage's Gesso, but of course we tell you more about it in the books themselves, together with practical information on decorating your finished articles with Gesso.

### Send 10 Cents for These NEW LEPAGE'S Books

THE practical and useful help of these two books is yours for only 10 cents. Just write your name and address on the coupon below, tear the coupon out and mail it to us today with 10 cents in coin or stamps, and we will at once send you a copy of each, postage paid. Address LePage's Craft League, Dept. RR-4, Gloucester, Mass. Tear out the coupon now so you will not forget it.

#### MAIL THIS COUPON

LePage's Craft League, Dept. RR-4, Gloucester, Mass.

Gentlemen: Enclosed you will find 10 cents (coin or stamps) in payment for "LePage's Practical Suggestions for the Home Work Shop," and LePage's Work Shop Book. Please send a copy of each to:

Name.....

Street.....

City..... State.....

# WURLITZER

TRADE MARK REG. STEREO  
THE WORLD'S LARGEST MUSIC HOUSE



## Try Any Wurlitzer Instrument in Your Own Home

**EXAMINE IT**, show it to your friends, play it as much as you wish. An ample free trial—no obligation to buy. We make this liberal offer because we want you to see for yourself this superior quality of Wurlitzer instruments, the result of 200 years' experience. Noted musicians praise them for unusual tone quality, artistic workmanship and ease of playing. They are used in the finest bands and orchestras throughout the country.

### Easy Payments

If you decide to buy, payments are arranged in small monthly sums. A few cents a day pays for your instrument. Special offers on complete musical outfits.

## SEND FOR New Catalog

The greatest musical catalog ever published! Over 3,000 articles—every known instrument described and illustrated; many of them shown in full colors. Gives you lowest prices and all details of Free Trial, Easy Payment plan. All sent FREE—no obligation. Send coupon below.

Clip and Mail

**THE RUDOLPH WURLITZER CO., Dept. 1771**

120 W. 42nd St., New York 117 E. 4th St., Cincinnati  
329 S. Wabash Ave., Chicago 250 Stockton St., San Francisco  
Send me, absolutely free, new illustrated catalog, with prices and details of Free Trial, Easy Payment plan. No obligation.

Name \_\_\_\_\_

Address \_\_\_\_\_

City \_\_\_\_\_ State \_\_\_\_\_

Instrument \_\_\_\_\_

(State Instrument in which you are interested)



**here's the  
trick for  
close quarters—**

The No. 151 Starrett Hacksaw Frame. Take a good look at it—and then think of all the tight corners you've tried to use a hacksaw in. For repair jobs on the car—getting at fender and body bolts, Ford bands, etc.—around the radio set, odd jobs of pruning and—well, there's a whole flock of odd jobs of cutting around the average home for which this frame is just the trick.

Ask your hardware dealer to show you the No. 151. And write us for descriptive matter and a free copy of Catalog No. 23 "AP."

**THE L. S. STARRETT CO.**

*World's Greatest Toolmakers*  
Manufacturers of Hacksaws Unexcelled  
Steel Tapes—Standard for Accuracy  
ATHOL, MASS.

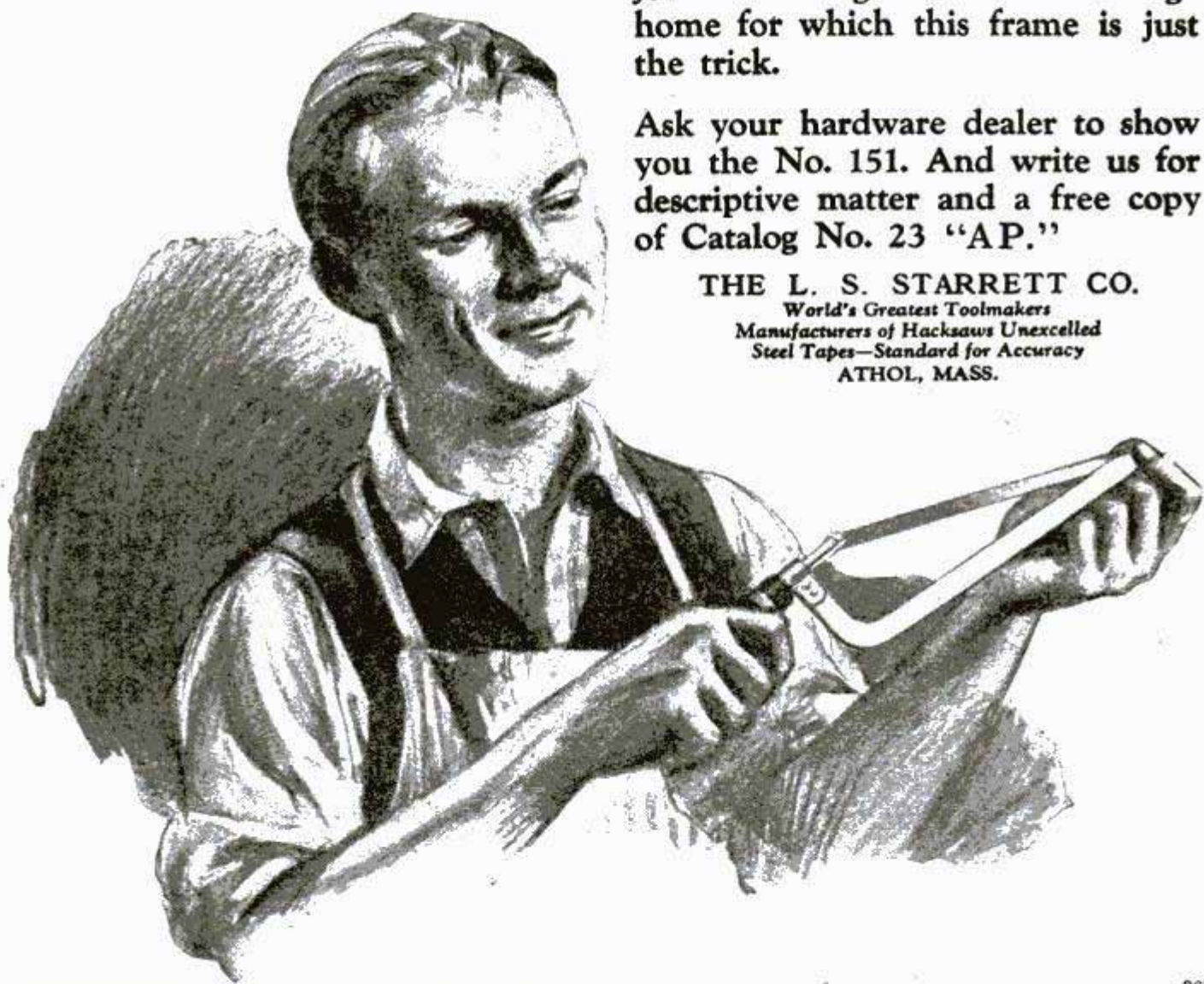

**Use Starrett Tools**

**Look**

**sent on**

Adjusted to the Second  
Adjusted to Temperature  
Adjusted to Isochronism  
Adjusted to Positions  
21 Ruby and Sapphire Jewels  
25 Year Gold Strata Case  
Your choice of Dials  
(Including Montgomery R. R. Dial)  
New Ideas in Thin Cases

**Approval**

**The 21 Jewel  
Santa Fe Special**

We will send this famous watch, express prepaid, for you to examine, to inspect, to admire, to approve, without one penny advance payment. Examine the watch and be convinced it's the best watch buy you ever saw. Just a small payment down, the balance in easy MONTHLY payments. You use the watch while paying for it.

**Save 1/3 to 1/2 of Your Money**

By purchasing this Famous Santa Fe Special Watch. Not only are you saving money from the present day prices of watches, but you can still secure the "Santa Fe Special" Watch, at the same low prices and terms that have made our watches famous.

**Ladies' Wrist Watches**

Artistic, dependable ladies' wrist watches — perfect timepieces, beautiful hand engraved cases in white or green gold. Send for New Watch Book and see the new shapes and designs. Sent on approval and sold on payments.

**Write for "Santa Fe" Watch Book**

Clip the coupon, fill out and receive the FREE WATCH BOOK just off the press. All the newest watch case designs in white or green gold, fancy shapes and thin models are shown. Read our easy payment offer. Wear the watch 30 days FREE. Watch sent for your examination and approval without a penny down. Nothing to risk. See the watch before you buy. Write for New Book Today and Select Your Watch. Mail Coupon.

**SANTA FE WATCH COMPANY**

16 Thomas Building, Topeka, Kansas  
(Home of the Great Santa Fe Railway)

**A LIMITED OFFER!**

With every Santa Fe Special, a beautiful gold chain or strand of exquisite pearls. Write while offer lasts.

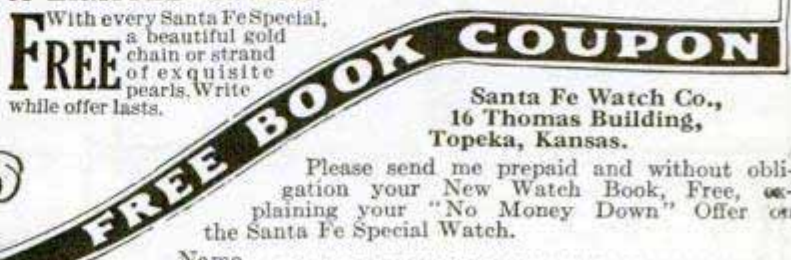

Santa Fe Watch Co.,  
16 Thomas Building,  
Topeka, Kansas.

Please send me prepaid and without obligation your New Watch Book, Free, explaining your "No Money Down" Offer on the Santa Fe Special Watch.

Name.....

Address.....

State.....

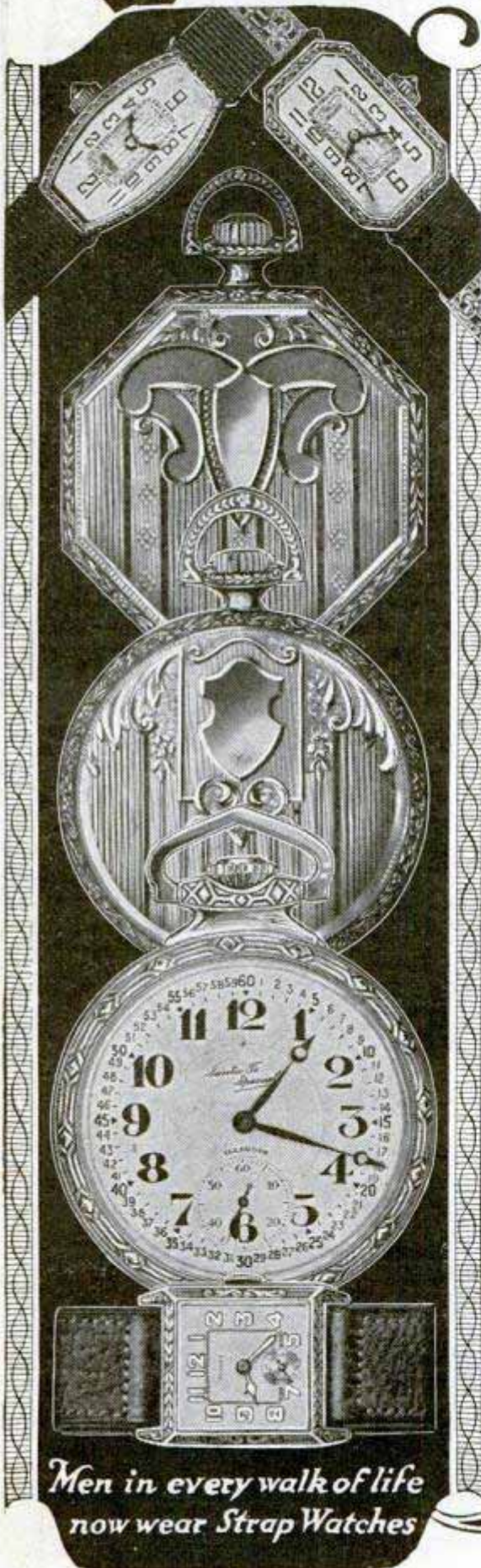

**Men in every walk of life  
now wear Strap Watches**

Double Keen  
Double Clean



### Make The Twice-Over A Once-Over

**T**HE Gem Double Life Blade gives a double-clean shave in half time! Its double-keen shaving edge gets the hair at the dermal line the first stroke! Double-heavy, double-reinforced, double-durable—it keeps giving brand-new shaves long after other blades have expired! Made of better tempered steel, it leaves you in a better temper after the shave! Sold everywhere.

*P. S.—Your money does double-duty when it buys the Gem de Luxe Razor. And to make sure that every Gem owner is double-happy, our service department will make good for any frame that isn't 100% perfect—no matter how long it's been in use. Send it to*

GEM SAFETY RAZOR CORPORATION  
Brooklyn, N. Y.

# GEM

Double Life  
BLADES

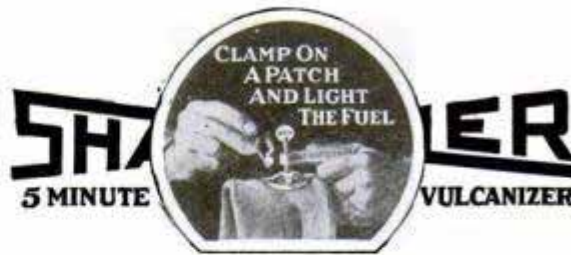
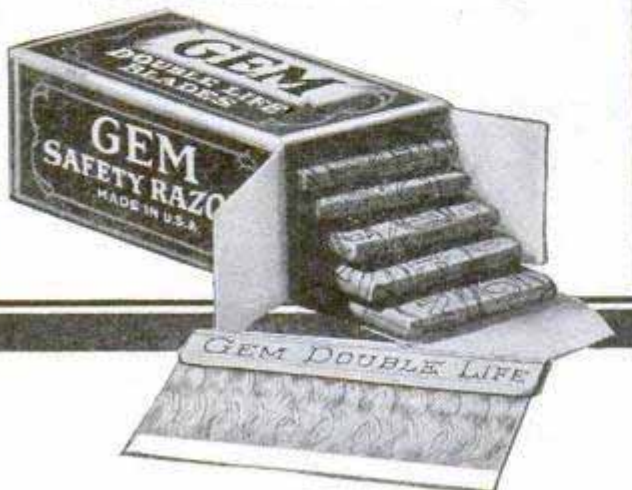

## You Need This!

*It's the Easiest Way to Fix Punctures*

You can't help but make a perfect puncture repair with this handy little Shaler 5-Minute Vulcanizer—it's so simple and easy to use. In an emergency, when you get stuck on the road with a "flat," you can depend on it to make a heat-vulcanized repair that will last, in just a few minutes.

The Shaler costs so little that you should carry it in your car—always. After you use it once you'll know why motorists used fifty million Shaler patches last year.

You can get complete outfit wherever auto supplies are sold for only \$1.50. Slightly higher in Canada and far West.

C. A. SHALER CO., Waupun, Wis., U. S. A.

## Starts Cold Motor

**INSTANTLY;** New QUICK-START electric-heat primer, for FORDS and others. Principle adopted by Lincoln, Packard, Chrysler. Three devices in one.

**GREATEST GAS SAVER YET INVENTED**

Prevents carbon. Saves battery; saves oil. **Agents:** Quick-selling year-round article. Bigger margin of profit for you. Special FREE Deal. Write **W. C. Kutsche, Inventor.** Electric Superstarter, Dept. 7A, Grand Rapids, Mich.



## REMINGTON

PORTABLE TYPEWRITER  
Dealers and Branches Everywhere

## NEW! A BIG HIT!

The Little  
Checkwriter  
with the  
Big Protection



**Salesmen!**

At last! A checkwriter at everybody's price! Sells for \$12.50. Does more than larger machines costing hundreds! Our salesmen cleaning up!

**The Arnold Features**

1. Pocket size convenience.
2. Handsome nickel plated aluminum.
3. Light weight. Easy to operate.
4. Prints and cuts characters in acid proof ink.
5. Unlimited capacity. Low cost. Easy to ink.
6. Guaranteed for 5 years. Nothing to get out of order.

**FREE SAMPLE OFFER!** Salesmen! Here's the biggest selling proposition of the year for you. Wonderful opportunity with very liberal commissions to district managers and salesmen.

**THE ARNOLD CHECKWRITER CO., Inc., Dept. 18**  
FLINT, MICHIGAN

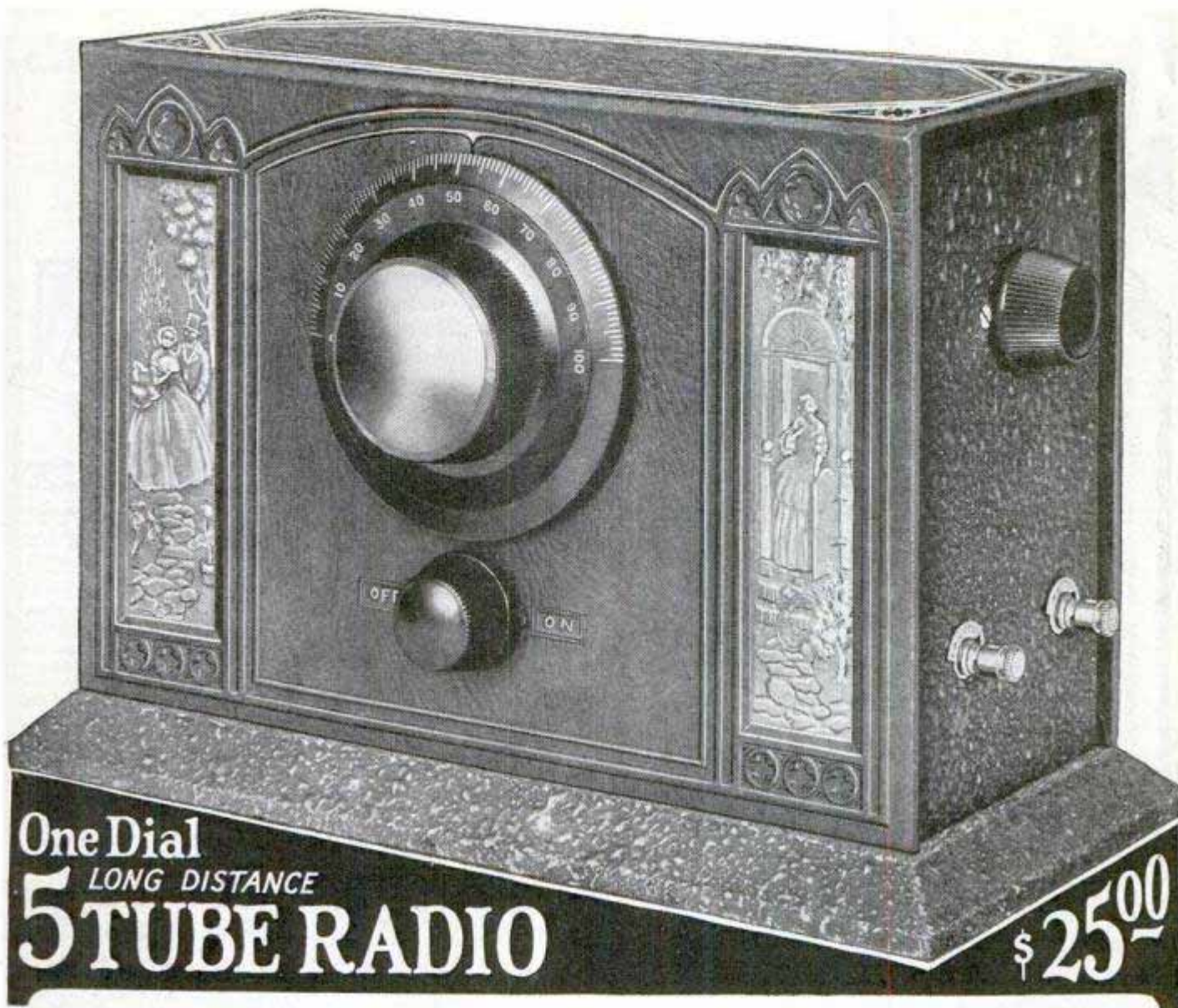

**EVERYBODY**, including experienced radio engineers, said—it cannot be done. But we did it—produced a high grade, long distance single dial control radio to operate a loud speaker to retail for \$25.00—and yet allow liberal discount to agents.

This marvelous instrument is the result of five years' hard work by an organization of trained radio engineers. It is no experiment—thousands are in use—the results speak for themselves.

### There Will Be a Radio in Every Home

Thousands have been waiting for just such a radio—a real long distance, powerful instrument—but at a price they can afford.

It is here, and live, wide-awake salesmen will recognize their opportunity immediately—they won't lose a single minute writing for full information.

Just as there are 100 Fords to one high-priced car, just so will there be 100 Vikings to every \$75.00 and \$100.00 radio—think what this means to men who get in on the ground floor right now.

### A \$25 Radio Which Will Equal a \$75 Radio

Put a Model 599 Viking, which retails for \$25.00, alongside any radio retailing for \$75.00 and even more. Compare them for ease of tuning—only one dial to

tune on the Viking—distance received, volume and tone. The results will make any man say, "I'll save that \$50.00."

Radio is today the biggest and quickest selling line—thousands are being sold—salesmen have made unheard-of profits. But here is a far greater, a far more interesting radio proposition than anyone ever dreamed of.

**Agents Wanted**  
**Make \$100.00 a Week**

### You Should Make \$100.00 a Week Easily

You can't help it—many will make more. Some will control a county—others will control many counties. We have the liveliest radio selling plan of today—instruments of all prices—a radio price to fit every pocket book.

Any man who will follow our teaching cannot help but add big money to his present income and start to do it immediately. If you want more money here is your chance, but you'll have to act quick—others will jump at this chance.

### Sell Radio in Your Spare Time—Evenings

You don't even have to give up your present position. The only time radio can be sold is in the evening—by demonstration. So here is a chance to add to your present income. During the past five years we have trained 4364 men in this very profitable business.

You'll be the first one with a real low priced long distance radio—your price will startle everybody—the results will be even far more startling. Once you demonstrate you're sure of a sale. No one can think of investing \$75.00 to \$100.00 in a radio when this instrument will equal the results and your retail price is only \$25.00. Just think of the advantage you have. Sell a radio for only \$25.00, and yet make a handsome commission.

### Territory is Going Fast— Better Write Today

Someone is going to get the big profit on the sale of these instruments in your community—is that someone going to be you? Write today for our 100 page book which fully describes not only this wonderful instrument but also a full line of radio at all prices. It's FREE for the asking.

### Use This Coupon

H. A. Fischer,  
118 W. Austin Ave., C  
Chicago, Illinois.

I am interested in selling your 5 tube set in this territory. Please send me your 100 page radio book, FREE.

Name.....  
Address.....City.....  
County.....State.....

**SEND FOR 100 PAGE FREE BOOK**

# Agents

**\$75 to \$200 a week with GRIPSIT**

**If You Want Big Money**

and want it now, here is your opportunity.

Be an agent for the Gripsit stropper—the most wonderful razor blade sharpener ever invented.

**These are the selling arguments that will get you the business—**

1. Gripsit is a remarkable new device that enables anyone to strop a safety razor blade to hair splitting keenness in a few seconds.
2. A quick, smooth, perfect shave every day.
3. One good blade will last for months and may be used over and over again.
4. A saving of \$5 to \$10 a year in blade expense.

As an extra inducement to help you sell every man in your community, we are giving **FREE a SILVER-PLATED GENUINE GILLETTE RAZOR and BLADE** with each outfit.

**Here's Your Big Offer**—Beautiful 14 Karat gold plated stropper—with pig grain Keratol case. Specially prepared Newshell strop of finest quality. Complete outfit packed in attractive box. Retail for only **\$1.50**. Big profit for you on every sale. This amazing outfit, including **FREE GENUINE GILLETTE Razor and Blade**, sells on sight. No experience necessary. All you have to do is to show Gripsit. It demonstrates itself. This is positively the greatest money-making proposition ever offered. Don't wait till tomorrow but write immediately for full particulars. We will send you chart showing how you can make \$75 to \$200 a week.

If you are now employed, write for special spare time proposition. No matter what your occupation is, you can add many dollars to your weekly pay envelope.

**GRIPSIT CORPORATION**  
Dept. AL, 405 Broadway  
CAMBRIDGE, MASS.

Exceptional opportunity for district managers or crew organizers.

## Shoot the Best Gun

The **NEW BENJAMIN** is the finest air rifle ever made. Unlike all others. Has amazing accuracy—shoots hard and far. It's the original American genuine **AIR** operated rifle. One to six pump strokes compress air to any desired degree of power. Same force as in air drills and air hammers except you control the shooting force. Never loses force—no springs or levers to get out of order. Makes crack shots quickly, inexpensively. Gives years of delightful recreation with utmost safety. At your dealer's, or sent postpaid for \$5.00.

### Shoot 5 Days FREE

We give you five days, ammunition supplied, to test the **NEW BENJAMIN**. If in this time you don't believe it to be the finest air rifle you've ever seen or used, and if you don't believe it is the one and only air rifle for you, return it, postpaid, and your money will be refunded at once.

## The NEW BENJAMIN AIR RIFLE

America's Original Air Rifle

**\$5** at your dealer's or sent postpaid direct from factory on **FREE Trial** as above if dealer does not handle it—write for our wonderful offer.

### Get This Book and Details FREE

**BENJAMIN AIR RIFLE & MFG. CO.**  
645 N. Broadway, St. Louis, Mo.

Please send your amazing offer and free copy of "The Shooter's Art," telling how to become a crack shot, how to hold, aim, and handle guns and guide others in use of guns.

Name \_\_\_\_\_

Address \_\_\_\_\_

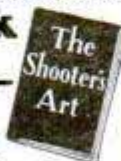

## New and Used Auto Parts at 30 to 80% Saving

Our stock of new and used replacement parts is the largest in the world. No matter what you need, write to us for prices. You will save from 30 to 80% and parts can be obtained from us which it is impossible to get elsewhere.



### Get Our Big Parts Book—FREE

Our Big 80-page Parts Catalog is the largest book of its kind ever issued. Everything for the automobile at cut prices—less than regular wholesale.

An enormous volume of business and quantity purchases make our low prices possible. Nationally advertised products. All new except where specified—Timken Axles and Bearings—Brown-Lipe Transmissions—Pistons—Rings—Hayes and Firestone Wheels—Rims—Tires—Tubes—also a complete line of Accessories. If it's for an auto, you will find it listed in our big parts Book.

Write Today for Your Copy—It's FREE

## WARSHAWSKY & CO.

World's Largest Replacement Parts House  
1915-35 So. State St., Dept. PM-1, CHICAGO, ILL.

## MAKE YOUR FORD Into The "LARK"

**\$5.00** Red-I-Kut life size patterns

Class—Snap



Famous sure-fit **RED-I-KUT** life-size patterns and picture instructions show how you can easily convert your Ford into this Fast, Saucy, Sport Car as thousands have done, with easily obtained materials. No need to lay up the car. Rear seat folds, making 4-passenger car. Send 10c coin for actual body photo

and new manual of other distinctive sport body patterns from \$5.50 up—"RKO" Set "Spring-Le" irons, Tops and Windshields. ORDER RIGHT NOW.

**KUEMPEL COMPANY, 80 Kuempel Bldg., GUTTENBERG, IOWA**

## "Best Pen I Ever Had—and costs less!"

That's what users of the Postal say. New filling method—easiest ever devised. Holds 4 times usual amount of ink. Transparent (always know how much ink you've got!). Unbreakable. Only \$2.50! Sent C. O. D. Order now and try it! Money back if you don't like it.

**Postal Pen Co., Inc., Dept. P. M. 1, 25 W. 43rd St., New York City**

## Women Simply Can't Resist This Fast-Selling Line of Smart Fabrics

Show women this exquisite display of dress goods, silks, wash fabrics and you can't keep them from buying. Men and women agents needed to devote full or spare time. Good commissions. Average \$40 to \$85 a week. 1,000 samples furnished. Write quickly.

**THE NATIONAL IMPORTING COMPANY**  
Dept. N-6, 569-573 Broadway, New York City



## MOTORCYCLES

### LESS THAN HALF COST



Ace, Indian, Cleveland, Harley-Davidson, Henderson Motorcycles and Sidecars, new, used and rebuilt. **Rider Agents Wanted.** Write for FREE trial offer, agent's free outfit and big bargain bulletin. **New American Bicycles** in different styles and colors. Write for illustrated catalog giving our money saving prices.



**AMERICAN MOTOR CYCLE CO.**  
2047 W. Chicago Ave., Dept. 135 Chicago

# Own this TYPEWRITER!

## GENUINE UNDERWOOD TYPEWRITER

Now is the time to get your typewriter! Be up-to-date—know the pleasure and convenience of having one in your own home. You'll be amazed at the uses everyone in your household will find for this real Underwood rebuilt typewriter.

**ONLY \$3.00 DOWN AND it's yours**

**Every One Can Use a Typewriter**

Every member of the family will use and enjoy it! Act now and get this ace of writing machines! Don't send a cent—but do get our big special offer—our valuable book on typewriters and typewriting—*free*. You can learn to write on this standard-keyboard machine in one day. A week after the expressman has brought it, you'd feel *lost* without it. A trial will *prove* it—and doesn't cost you a penny!

### Send No Money Now

We don't want a penny now. Nor any money at all unless this proves the typewriter bargain of your life. The trial is *FREE*. If you buy, our easy terms make it a pleasure to pay. There's no excuse now, for not

owning a typewriter—and the finest make! We include all tools, cover, etc., all complete, all ready to write. Write us now. Deal direct; we are the largest factory of the kind.

If you know typewriters, you know the perfect work and the ease and speed of an Underwood. If you have never owned a typewriter, start with the finest! You can try this one at our risk. But, the time to act is *NOW*. Don't miss out on this present bargain offer. Don't do longer without the convenience of a typewriter.

### Free Trial Offer

Our plan gives you the opportunity of a *thorough trial* before you buy. You run no risk whatever. You start to pay for your typewriter *after* you have found it the only machine for you! But get the facts before this lot of machines is all in use. Clip the information coupon before you turn the page. It will pay you! Note the very useful book you will receive *free*! Write for full particulars at once.

## EASY TERMS FREE!

### Pay Like Rent

You pay only \$3 down you get the machine. The balance is divided into such small monthly payments that you will never miss them. We have made it very easy for you to own a typewriter now.

**FREE!** Get our typewriter book free: Lowest prices and terms. We also give free with each machine a typewriter manual giving valuable instruction for learning rapid typing, useful pointers for all who use a typewriter, business forms, social correspondence, work for others, etc. Also all tools *FREE*. Clip coupon *NOW*.

Mail to SHIPMAN-WARD MFG. CO.  
2121 Shipman Building, Chicago

Please send me full offer, with Typewriting Manual *FREE*, prices, terms, etc., and full information about your *FREE* course in touch Typewriting. All without obligation; this is *NOT* an order!

Name \_\_\_\_\_

St. or R. F. D. \_\_\_\_\_

P. O. \_\_\_\_\_ State \_\_\_\_\_



**BOTH TOOLS \$1.00 DOWN**



**A Sensational Offer!**

**Electric Drill and Saw**

Look! A SpeedWay Portable  $\frac{1}{4}$  H. P. Electric Drill and a SpeedWay Portable Electric Hand Saw can now be yours for a trivial down payment.

**Easy Terms—Free Bits**

Pin a \$1.00 bill to this coupon. Mail it today! We will ship both Drill and Saw to your home postage prepaid. We include two drill bits free.

**SpeedWay Quality**

This SpeedWay  $\frac{1}{4}$  inch Drill will drill holes in steel faster than any tool you have ever used. Likewise the Saw is a sturdy, compact tool. Both tools noted the world over for high quality workmanship.

**Send in the Coupon**

Don't hesitate! This special offer is limited. We guarantee satisfaction—or your money back. Act now!

**ELECTRO MAGNETIC TOOL CO.**  
 Dept. 21, 1830 S. 5<sup>th</sup> Ave., Cicero, Ill.

Gentlemen: Here is my \$1.00 bill. Send me the SpeedWay Electric Drill and SpeedWay Hand Saw as advertised. When delivered I will pay the postman \$10.00 and remit to you the balance of \$20.00 in two payments of \$10.00 per month. Don't forget to include 2 drill bits free.

Name.....  
 Address.....

**TIME IS MONEY**



**Star Blades Save Both**

When you buy hack saw blades to do your cutting jobs, there are two important factors involved—

**TIME and MONEY**

A blade that will cut twice the number of times and twice as fast without breaking or losing teeth is saving both time and money.

Star Hack Saw blades meet these requirements.

**STAR HACK SAWS**

Let us send you samples of this blade free

**CLEMSON BROS., Inc., Middletown, N.Y.**

**PARKS**

**WOODWORKING MACHINES**

*Cabinet Shop Special*

**\$290**

*with Motor*



You ought to have this handy Parks in your shop. It is a compact, complete machine designed just like a big production outfit at one-fifth the cost. Includes 8-inch circular rip and cross cut saw with polished cast-steel saw table, 16-inch band saw with tilting table for bevel-sawing, 6-inch jointer, and motor operating from any light socket. Just plug in and go to work! Fits in a corner of your basement. Does any kind of cabinet and joinery work. Add lathe, shaper and other attachments any time at small cost. For the man who does "odd jobs" in his off time this Parks is a big money maker. Turn out as much as a four-man shop working by yourself.

Write for circular and Parks complete catalog of handy woodworking machinery.

**The Parks Ball Bearing Machine Co.**  
 1500-1540 Knowlton St. Cincinnati, Ohio  
 Canadian Factory: 298 Notre Dame East, Montreal, Can.

**CALCULATIONS**



In Office, School, Store and Shop can be instantly made with the Midget Slide Rule. It gives the answer to any problem involving fractions, mixed-numbers, decimals, whole-numbers, roots, powers, Logs, and Trig. Functions. Thousands of these rules are used by Accountants, Engineers, Clerks, Students, etc. It is the most versatile calculator ever invented. If you have any figuring to do, order a Midget Slide Rule on trial. Made of aluminum with figures on white celluloid. Size 4". Price with Instruction Book, \$1.50. Leather Case, 50c extra. Catalogue Free. Sent C. O. D. if desired. Your money back if you are not satisfied.

**GILSON SLIDE RULE CO., Niles, Mich.**

**TOOL CASES**



for Machinists, Repairmen and Tool Makers; none better; thirty styles. Quartered Oak and all metal. Ask for booklet "BUILT FOR SERVICE"

**The Yarder Manufacturing Co. TOLEDO, OHIO**

**Tight Handles—Send for booklet "HOW TO KEEP TOOL HANDLES TIGHT"**

Fayette R. Plumb, Inc., 4857 James St., Philadelphia

**REDUCED PRICES ON ENGINES**

Now—big sale on most practical farm engine ever built—the famous OTTAWA. Low cash prices—easy terms—on all sizes  $1\frac{1}{2}$  to 7 H-P. Each engine pulls big surplus of power. Easy starting. You must be satisfied or money refunded. 30 day trial. 10-year guarantee.

**FREE BOOK** —"How to Know Better Engines." Write today for your copy. A post card brings it.

**OTTAWA MFG. CO.**  
 631 D King St., Ottawa, Kan.  
 Desk 631 D Magee Bldg., Pittsburgh, Pa.



# Make \$25<sup>00</sup> to \$40<sup>00</sup> a day Winter and Summer



## No Dull Seasons No Lay-Offs Your Own Boss

The American Universal Electrically Driven Floor Surfacing Machine offers you an opportunity of a lifetime to get into something for yourself, be your own boss, build up a real business, and make big money for you the year 'round—Winter and Summer.

Do like thousands of others have done. Accept this wonderful opportunity to get behind an electrically driven American Universal Floor Surfacing Machine and build up a big, profitable business of your own.

An American Universal Floor Surfacing Contractor

**Makes \$25 to \$40 a Day**

**Every New Floor Must Be Surfaced—Every Old Floor Needs Resurfacing**

There is surfacing work to be done in every new and old business or residence in your vicinity. If you are willing to don a pair of overalls you can make from \$25 to \$40 a day every working day in the year. Men from all lines of business have accepted this opportunity and are now making real money. All started with one machine, but many are now operating six or more machines and have become floor surfacing contractors on a large scale.

**No Experience Necessary** Any intelligent man can learn to operate the electrically driven American Universal Floor Surfacing Machine in a very short time. It actually does in a day the work of six men scraping by hand and does much better work than can be done by hand. Write now for particulars. Let us tell you how you can become an American Floor Surfacing contractor. You can secure this information absolutely free without any obligation on your part.

**The American Floor Surfacing Machine Company**  
Originators of Floor Sanding Machines  
523 South St. Clair Street, Toledo, Ohio



## Makes Old Ford a Tractor

We furnish everything for converting Ford Auto Chassis with Engine into a handy Farm Tractor. Just right for truck growers, small farms, nurseries, etc. Pulls 16' Plow, Discs, Seeds, Cultivates; Runs Belt Machinery. We also build Garden Tractors and Cutter Bar Mower Attachments.

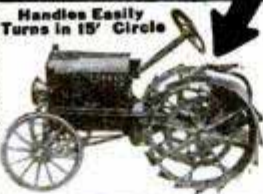

Write for Free Particulars.  
SHAW MFG. CO., Dept. F Galesburg, Kan.

\$25 to \$45

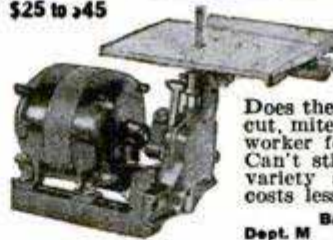

## GET THE NEW IDEA BATES MOTOR SAW — 6 SAWS IN 1 —

Does the work of band-saw, rip-saw, cross-cut, miter, bevel and scroll-saw. A wonder worker for the home shop. Direct drive! Can't stick! Cuts 2" wood. Most amazing variety saw ever invented. Does more, costs less! Not a toy. Write for circular.

BATES MOTORCRAFT COMPANY  
Dept. M 28 N. Clinton CHICAGO, ILL.



**WADE AMATEUR MECHANICS, REPAIR SHOPS, INVENTORS, STUDENTS**  
**BENCH LATHE**  
A real machine tool for the home work bench—capacity 4" dia. x 12" length. For Metal—Wood—Composition Materials. Turning—Facing—Boring—Drilling—Winding—Thread Cutting. Accurate—Strong—Quiet—Compact. Slide-rest has travel entire length of bed. Leadscrew inside bed. No. 1 Lathe, plain headstock, \$28.00. No. 2 Lathe, back-gear headstock, \$58.00. Extra for lathes with 18 inches between centers, \$7.00. Complete line of accessories at equally low prices. Write for free catalog.

THE GEROLD CO., Dept. P-30, 120 Liberty St., New York



**CRESCENT WOODWORKING MACHINERY**  
High in quality, moderate in price. Ask for circulars describing bench machines for the small shop. If you are interested in the larger machines we can supply you with Band Saws, Saw Tables, Self Feed Rip Saw, Shapers, Jointers, Variety Wood Workers Planers, Planers and Matchers, Disk Grinders, Cut Off Table, Swing Cut Off Saws, Borers, Hollow Chisel Mortisers, Tenoner, Universal Wood Workers. Ask for circulars.

The Crescent Machine Co., 93 Columbia St., Leetonia, Ohio

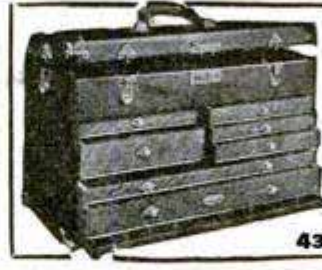

**Tool Cases for Toolmakers and Machinists**  
Are shown in our New 1927 Catalog. Write today for a copy. Thirty sizes and styles shown. One to suit your needs.

*A. Gerstner & Sons*  
437 Columbia St., DAYTON, OHIO



**SEND NO MONEY** Genuine Full Cut Diamonds, No Chips  
Terms (6 Months to Pay)—Outside U. S., Cash with Order  
**No. 6132.** Solid Gold Men's Initial or Emblem Ring. 2 Genuine Diamonds 4-100 ea. 14-Kt. White Gold Top. Emblem (any lodge) or any initial (Old English) Yellow or White Gold inlaid in Genuine Hope Ruby or Black Onyx.  
**No. 6598** Any initial (raised gold) or Eastern Star, Rebecca, Mason, Shrine, K. of C. emblem if desired.  
Send number of ring, size of finger, initial or emblem desired, and ring will be sent for inspection.  
Ask for Free Jewelry Catalog



Ladies' Ring Genuine Black Onyx with Genuine Full Cut Diamond. 14-Kt. White Gold. \$15

This Reg. Trade Mark Guarantees you genuine diamonds.

**\$25 Buffalo Jewelry Mfg. Co., "The Mail Order House"**  
Dept. P (or at Your Jeweler's) 501 Washington Street, Buffalo, N. Y.

# WITTE Log Saw

Wico Magneto



**LOW PRICE  
EASY TERMS**

COMPLETE outfits, everything you need when you go into timber. No extras to buy. Saws 15 to 25 cords a day. Cheapest to operate—runs all day at cost of 2c an hour per H.P. Burns any fuel with big surplus of power for any work. USE IT FOR OTHER WORK. Completely equipped with WICO magneto, speed and power regulator, throttling governor and 2 fly-wheels so can be used for any other jobs—pumping water, grinding grain, etc.—an all-purpose outfit that will work every day in the year. Only 3 minutes to change from log saw to tree saw—10 seconds to clamp to tree. Fastest felling ever known. Fells trees from any position.

## Lifetime Guarantee

**FREE BOOK** Simply send name today for NEW catalog, lower prices special offers, and how to make money with these rigs. Tells all about engines, sawing outfits and pumps.

### WITTE ENGINE WORKS

6744 Witte Building KANSAS CITY, MISSOURI  
6744 Empire Building PITTSBURGH, PA.  
6744 Witte Building SAN FRANCISCO, CALIF.

**"3 HOURS SHIPPING SERVICE"**



# Mechanics Proud of CORNWELL Hand Forged Tools

MORE than 100,000 mechanics throughout the United States are proud of their Cornwell Tools and use no others...Cornwell Tools accomplish results where other tools fail...You can put them to any test...Use them in shop or home and get your money back if you are not absolutely satisfied that they are the finest tools you ever saw...The widespread use of Cornwell Tools is the astounding evidence of their quality.

### Tools of Amazing Strength

Chisels, rivet busters, punches, wrenches, screw drivers, pry bars, socket wrenches, universal joints, pliers—for use in garage, shop or anywhere where strong tools are required...Nothing like them in the world—if you ever saw tools as good as these, return your order and get your money back.

### Test These Tools at Our Risk

Try any test described in booklet...If the tools fail or show the slightest harm, we will instantly replace them or give you your money back...Can any guarantee be stronger than this?



**Mail  
Coupon  
Today**

**CORNWELL QUALITY TOOLS CO.,  
Dept. G, Cuyahoga Falls, Ohio**

Send me illustrated booklet with prices on full line of Cornwell Hand-Made Tools.

.....Occupation  
Name.....  
Address.....  
City..... State.....

# They know how to "hold their Youth"

The distinctive trait you will notice in using Crescent-Smith & Hemenway Wrenches, Pliers, and other tools is that the Crescent hardening process keeps them like new for a lifetime of service.

Get Crescent-Smith & Hemenway Tools at hardware or accessory stores.

**CRESCENT TOOL CO.**

210 Harrison Street  
Jamestown, N. Y.



# CRESCENT and Smith & Hemenway TOOLS

*Made and guaranteed by the  
originators of the Crescent Wrench*

## Measures ANYWHERE!

Inside or Outside—quick and accurate—the rule for you. Sliding action for speed and durability. Any length 2 to 8 ft., 20c per lineal foot. At dealers or sent postpaid.

Dealers and Agents: request attractive proposition

**Interlox** Master Rule Mfg. Co.  
813 East 136th Street, NEW YORK

## BURN YOUR NAME ON TOOLS

# WITH THE ARKOGRAF

PROTECT YOUR TOOLS FROM THEFT  
Write with electricity any name or design on the hardest and finest tools and instruments, or any metal, like writing on paper with pen or pencil.  
**Complete Outfit \$3.50**—Prepaid Anywhere  
Interesting illustrated circular free. Write today. Agents wanted.  
ARKOGRAF PEN CO., 1171 E. Stark St., Portland, Oregon



# "Red Devil" Glass Cutters

DON'T risk breaking glass with an inferior glass cutter. Better be SAFE and use a Red Devil Cutter. No. 48 has 6 honed wheels—a sharp one always ready. Ask your Dealer.



**LANDON P. SMITH, INC.**  
106 Coit St., Irvington, N. J.

"It's all in the Wheel"

**30  
DAYS  
FREE  
TRIAL**

# 7 Tube Set

## Single Dial Radio

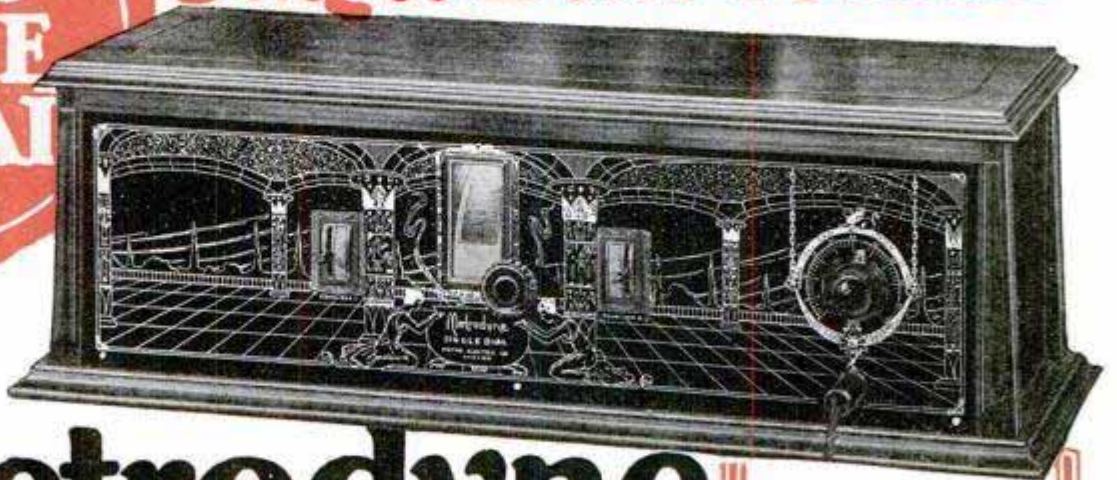

# The Metrodyne

**ONLY ONE DIAL TO TUNE**

**Retail Price**

**\$75**

**Completely Assembled**

**BIG DISCOUNTS  
TO AGENTS  
AND DEALERS**

Wonderful offer direct from the factory! The world's greatest radio. A perfect working, single dial control, 7 tube receiver. And just to prove our claims, we will ship it to your home for 30 days' free trial. Test it under all conditions. Test it for distance, volume and tonal quality — and if you are not convinced that it is the best single dial set you ever heard, return it to the factory. We don't want your money unless you are completely satisfied.

### BIG PROFITS TO AGENTS AND DEALERS

Our Agents and Dealers make big money selling Metrodyne Sets. You can work all or part time. Demonstrate the superiority of Metrodynes right in your home. Metrodyne Radios have no competition. Lowest wholesale prices. Demonstrating set on 30 days' free trial. Greatest money-making opportunity. Send coupon below—or a letter—for our agent's proposition.

### Metrodyne Super-Seven Radio

A single dial control, 7 tube, tuned radio frequency set. Approved by America's leading radio engineers. Designed and built by radio experts. Only the highest quality low loss parts are used. Magnificent, two-tone walnut cabinet. Artistically gilded genuine Bakelite panel, nickeled piano hinge and cover support. All exposed metal parts are beautifully finished in

24-k gold. Easiest set to operate. Only one small knob tunes in all stations. Dial is electrically lighted so that you can log stations in the dark. Volume control regulates reception from a faint whisper to thunderous volume, 1,000 to 3,000 miles on loud speaker! The Metrodyne Super-Seven is a beautiful and efficient receiver, and we are so sure that you will be delighted with it, that we make this liberal 30 days' free trial offer. You to be the judge.



**6  
Tube Set  
\$48.50**  
RETAIL PRICE  
Completely  
Assembled

### METRODYNE SUPER SIX RADIO

**ON 30 DAYS' FREE TRIAL**

Wonderful 6 tube, long distance radio set. Approved by America's leading Radio Engineers. Easy to operate. Dials log easily. Tune in your favorite stations instantly on the same dial numbers every time. No guessing. 30 days' free trial.

Mr. Howard of Chicago said, "With 5 Chicago Stations on the air I tuned in 17 out-of-town stations, including New York and San Francisco on loud speaker very loud and clear."

We are one of the pioneers of radio. The success of Metrodyne sets is due to our liberal

**30 Days' Free Trial Offer,** which gives you the opportunity of trying before buying.

**MAIL THIS COUPON**   
or send a postal or letter. Get our proposition before buying a radio. Deal direct with manufacturer—  
**Save Money.**

**METRO ELECTRIC COMPANY**  
2161-71 N. California Ave., Dept. 141, Chicago, Illinois

### Mail COUPON Below!

Let us send you proof of Metrodyne quality

C. J. Walker, Mariposa, Calif., writes: "Received my Metrodyne Single Dial set O. K. I believe that these one-dial sets are going to be excellent sellers. I had no trouble in tuning in stations enough to satisfy anyone, so you will please send me another set."

Roy Bloch, San Francisco, Calif., writes: "Very often we travel from New York to the Hawaiian Islands quickly—from station to station—by means of the little tuning-knob which operates the electrically-lighted dial. The Metrodyne Single Dial Set is much easier to operate than any radio set I've ever seen."

We will send you hundreds of similar letters from owners who acclaim the Metrodyne as the **greatest radio set in the world.** A postal, letter or the coupon brings complete information, testimonials, wholesale prices, and our liberal 30 days' free trial offer.

**METRO ELECTRIC COMPANY**  
2161-71 N. California Ave., Dept. 141  
Chicago, Illinois

Gentlemen:

Send me full particulars about Metrodyne 6 tube and 7 tube sets and your 30 days' free trial offer.

Name.....

Address.....

If you are interested in AGENT'S proposition, place an "X" in the square

# LOFTIS BROS. & CO.

108 N. State St. Chicago, Ill. Dept. H-894  
Christmas Catalog Free: 132 Pages of bargains in Diamonds, Watches, Silverware, Clocks, Ivory Goods, and gift articles for all occasions.

## Diamonds

GENUINE - GUARANTEED

CASH OR CREDIT

**Quality Gifts**

The Quality Christmas Gift is the most prized of all. Every article we sell is of finest grade. You always get the best value from Loftis. Satisfaction guaranteed or money back. The Diamond Rings shown here are exquisite creations in Solid 18-karat White Gold, set with sparkling blue white Diamonds of fiery radiance. Any ring sent for your free examination on request.

**Credit Terms:** Pay one-tenth down balance in weekly, semi-monthly, or monthly terms at your convenience. All goods delivered on first payment. Our References: Any Bank in the U. S. A.

**Special Christmas Bargain**  
Beatrice Diamond Dinner Ring, 8 perfectly matched blue white Diamonds and six blue Sapphires. Beautifully engraved and carved, solid 18-k white gold—\$125 a week **\$3.25** a week

**19-Jewel A-justed Waltham No. 846—14-k white gold filled; assorted patterns, \$42.50 \$4.25 down and \$1.00 a week**  
We carry all standard makes of Railroad Watches—guaranteed to pass a \$1.00 test. Credit at Cash Prices.

**Wedding Rings**  
No. 824—The "Elite" 18-k white gold \$7.50  
Set with 3 Diamonds, \$22.50; 5 Diamonds, \$32.50; 7 Diamonds, \$42.50; 9 Dia's, \$52.50; 12 Dia's, \$67.50. All platinum, \$25. With 3 Diamonds, \$50; 5 Diamonds \$70; 7 Diamonds \$80; 9 Diamonds, \$100; circled by Diamonds, \$200.

**Wrist Watch No. 16—14-k white gold. High grade 15-Jewel movement, \$14.85. \$1.48 a week down and \$1.00 a month**

**Cushion Strap Watch, nickel, 6 Jewels—high grade movement, \$9.95**  
Leather strap. Special



# BIG BOOK of AUTO SUPPLIES

**Mailed Free—Postpaid**  
We want every car owner to have our Big New Complete Book of Auto Accessories. Write for a Free copy and see for yourself what you save.

**TIRES TUBES & AUTO SUPPLIES**

## NEW LOW TIRE PRICES

Every tire brand new stock and fully guaranteed. Prices also cut on Tubes, Batteries, Heaters, Winter Tops, Water Pumps, Radiators, Windshield Cleaners, Carburetors, Spotlights—all Repair Parts, Tools, etc. No matter what you need, this New Book will save you money. Send for it.

# BROWN LYNCH SCOTT CO.

816 MAIN ST. MONMOUTH, ILL. [8]  
WE SHIP IN 10 HOURS—BLS OR REFUND 5 PER CENT

# Tire AGENTS

## Tire WANTED

Use and introduce MELLINGER CORD TIRES 15,000 MILES GUARANTEED  
Lowest Wholesale Prices in America. Shipped prepaid on approval. Make big money all or part time. No capital or experience. Sample sections furnished.

**YOUR TIRES FREE!** Simply send name today for valuable FREE BOOK; tells how thousands have gone into big business. SPECIAL AGENTS' OFFER. Wholesale Prices and FREE SAMPLE KIT. Write nearest address.

**MELLINGER TIRE & RUBBER CO.**  
Dept. 415, Kansas City, Mo., Dept. 415, Philadelphia, Pa., Dept. 415, Oakland, Calif. WRITE NEAREST OFFICE



# SHAW MOTOR ATTACHMENT

## MAKES YOUR BIKE A MOTORCYCLE!

A high grade 2 1/2 H. P. motor attachment quickly clamped on any bike frame. Speed 4 to 40 miles an hour. 90 to 125 miles per gallon of gas. Special Low Price Now! Write today for Complete Description and Special Low Prices on SHAW Motor Attachments and the SHAW Complete Motorbicycle.

**SHAW MANUFACTURING COMPANY**  
Dept. 37 Galesburg, Kansas



# OIL BURNER BOILS 50 GALLONS

## IN LESS THAN AN HOUR

Use indoors or outdoors to suit convenience; burns with terrific, silent, blue flame; boils maple syrup, apple cider, fats, etc., in half the ordinary time.

**BUY DIRECT AT FACTORY PRICES**

No other compares with this wonderful Improved Kerosene Gas Burner. Indispensable for dairies, farms, homes, etc. Simplest scientific, popular priced burner ever constructed. No Soot, Smoke, Spill or Noise. Write for descriptive catalog.

**HOME MFG. CO., Dept. 33, 28 E. Kinzie St., Chicago, Ill.**

# MOTORCYCLES

**RELIABLE STANDARD MAKES** that you can DEPEND on. Enjoy the glorious experience of going where you like—when ever you like. The price is within your means—35% to 50% less than others. These machines are lightly used, thoroughly overhauled or rebuilt. Send for catalog.

**MYEROW BROS.,**  
15 Berkeley St. Boston, Mass.



# Make \$60 to \$100 A WEEK

## New 300 Candle Power Lamp—Burns 96% Air

Introduce wonderful patented invention. Burns only 4% fuel—cheap kerosene or gasoline. Uses less than wick lamps. Greatest advancement in lighting of the age. Table lamps, wall lamps, hanging lamps, lanterns. Powerful, brilliant, soft, restful white light—like daylight. Brighter than a score of wick lamps. No smoke—No Soot—No Odor.

**FREE Outfit Offer** Easy to earn big money. No experience—no capital required. Work all or spare time. Simply take orders. We deliver and collect—pay you big commission same day. Vivian of Minn. made \$400 in 39 days. Green of N. Y. made \$33 in one day. Hundreds making \$10 to \$40 a day. Get territory quick. Big season now on. Write today for Free catalog and special agents offer.

**The Akron Lamp Co., 101 Lamp Bldg., Akron, O.**



# Catch Fish!

Eels, Mink, Muskrats with our new folding galvanized **STEEL WIRE TRAP.** Write for our FREE TRAP OFFER and Bargain Catalog. \$1 Box of our famous Fish Bait FREE to introduce our traps.

**WALTON SUPPLY CO., 3500 JUNIATA AVE., ST. LOUIS, MO.**



# STOP FORD CRANKSHAFT END-PLAY!

**C-A ADJUSTABLE BEARING** corrects and prevents end-play without removing motor. Eliminates many troubles. Easy to install—simply drop pan. Only \$3.75. Ask your dealer or sent prepaid by **ADJUSTABLE BEARING CO., Dept. P, 405 Virginia Ave., Indianapolis, Ind.**



# Big Money

Made by agents selling our wonderful Facial Soap, Perfumes, Toilet Articles, Spices, Extracts, etc. Free cake of soap and agents' terms mailed to any address.

**LACASSIAN CO. Dept. 455 ST. LOUIS, MO.**





# Club Feet

**Treated Without Plaster Paris Casts**

Two photos, taken 11½ weeks apart, and mother's letter, show how McLain Sanitarium helped Elizabeth Ahern.

*My daughter was born with a Club Foot. She suffered agony with plaster casts before we took her to McLain's. I think there is no hospital like McLain's and I advise parents with crippled children to go there. My child is cured.*

MRS. WM. D. AHERN, Livingston, Montana.

McLain Sanitarium (established 1898) is a private institution devoted to the treatment of crippled children and young adults. No surgical operation requiring chloroform or general anaesthetics. Plaster Paris not used. Patients received without delay. Parents retain full charge of children if desired.

**WRITE FOR FREE BOOKS** "Deformities and Paralysis," and "References," which show and tell of McLain Sanitarium's facilities for treating Club Feet, Infantile Paralysis, Spinal Diseases and Deformities, Hip and Knee Disease, Wry Neck, Etc. Also illustrated magazine, "Sanitarium News," mailed free every 60 days.

**McLAIN ORTHOPEDIC SANITARIUM**  
902 Aubert Ave., St. Louis, Missouri, U.S.A. KR730

**Beautiful HOUSES \$900 and BUNGALOWS CAN BE BUILT FOR AND UP**

This and many others in my new book, Building Plans for Modern Homes, will save you hundreds of dollars. One of the most complete and comprehensive books of plans ever published by any architect. New edition just off the press. Nearly 600 floor plans and photographs of Colonial houses, bungalows, etc., costing from \$200 up; gives sizes and cost to build. Sent postpaid for \$3.00.



**FREDERICK H. GOWING ARCHITECT**  
101 Tremont St., BOSTON, MASS.



**Lighting Fixtures READY TO HANG**  
(Direct from the Manufacturer)

Completely wired, including glassware. Send for New Catalogue No. 27. Just reduced prices. Special proposition to DEALERS.

**ERIE FIXTURE SUPPLY CO.**  
STA. A ERIE, PA.

# AGENTS

**NEW! GRAB THIS FREE OUTFIT QUICK!**

STAY-PREST Trousers Presser—wonderful new invention—looks efficient, and it is. That's why 250,000 have been sold already.

**My First Week I Made \$93**

"Since then I have earned over \$100 every week," says S. L. Patterson, of Iowa. Many others making big money. No wonder! Millions of interested prospects. A quality product. Puts lasting crease in trousers. Takes out bagginess—smoothes entire surface—demonstrates in 40 seconds. Sells quick to every man.

**FREE Selling Outfit**

Your profits paid in advance. Simply write orders. We deliver and collect. Test it without cost. Full time or side line. Send postcard for offer of free demonstrator. Join the big money-makers. Write today.

**THE GETGEY-JUNG COMPANY**  
A-121 G. & J. Bldg. Cincinnati, Ohio

# Play the HAWAIIAN GUITAR and be Popular!

Play all the latest hits just as the Hawaiians do. Be the most popular member of your set. Get in on all the good times. Entertain your friends—or play professionally. Be in demand everywhere. We will help you.



**\$15 HAWAIIAN GUITAR with Genuine Seal Grain Fabrikoid Cover FREE when you enroll**



This sweet-toned, mellow Hawaiian Guitar would cost you at least \$15 in any music store without the Genuine Seal Grain Fabrikoid Case. We can afford to give you the entire outfit free when you enroll, including picks, steel playing bar, etc., because we make them in huge quantities in our own factory. Nothing to buy—everything is furnished.

**Learn in Spare Time at Home**

You study in spare time—when you like—as long as you like. And even if you don't know one note from another, our method is so simple, plain and easy that you begin a piece your first lesson. In half an hour you can play it!

**Famous Native Hawaiians Teach You**

You receive expert instruction from such world famous players as Kolomoku, Kalaluki, Ferara and Seville. They quickly teach you the secrets of this fascinating instrument.

**Complete Conservatory Course.** You get 52 complete printed lessons. Nothing is omitted. Pictures explain every move. And no matter how little you know about music when you begin, no matter if you have never touched a musical instrument, you can positively learn to play by our plain, easy, picture method.

**Only 4 Motions to Learn**

Then you can play any music—popular songs, classical, old-time melodies, native Hawaiian airs—or real jazz—separately or with accompaniment. You'll never be lonesome after you learn to play on this beautiful Hawaiian Guitar.

**Pay as You Play**  
We make it easy for you. You start any time—with a small first payment—then pay while learning. Write for liberal offer.

**Our Written Guarantee**  
We guarantee in writing to teach you. 45,000 successful students. And we coach and advise you after graduation—no extra cost.

**Other Courses** under famous teachers—Tenor Banjo, Violin, Mandolin, Banjo Ukulele and Ukulele.

**FIRST HAWAIIAN CONSERVATORY OF MUSIC, INC.**  
9th Fl., Woolworth Bldg., Dept. 248, New York, N. Y.  
Approved as a Correspondence School Under the Laws of the State of New York

**ACT! Mail This Popularity Coupon NOW!**

**FIRST HAWAIIAN CONSERVATORY OF MUSIC, Inc.**  
9th Fl., Woolworth Bldg., Dept. 248, New York, N. Y.

Please mail full information about your 52-lesson Hawaiian Guitar Course. I am not obliged to enroll unless I want to.

Name \_\_\_\_\_  
Address \_\_\_\_\_  
City \_\_\_\_\_ State \_\_\_\_\_

# LUMINOUS PAINT

**Make Your Watches, Clocks, Etc., Visible by Night**

The very latest discovery in the scientific world. Hitherto, practically unobtainable except at an exorbitant price, we have at last succeeded in producing this remarkable LUMINOUS PAINT, which, applied to the surface of any article, emits rays of white light, rendering it perfectly visible in the dark. **THE DARKER THE NIGHT, THE MORE BRILLIANT IT SHINES.** Quite simple to use. Anyone—you can do it. A little applied to the dial of your watch or clock will enable you to tell the time by night. You can coat the push buttons or switch plates of your electric lights, match boxes, and innumerable other articles; make your own Luminous Crucifixes, Luminous Rosaries, etc. Small bottle, price 25c. Larger sizes, 50c and \$1 postpaid. **JOHNSON SMITH & CO., Dept. 802, RACINE, WIS.**

## Serpent's Eggs Exploding Cigarettes

Box contains 12 eggs. When lit with a match, each one gradually hatches itself into a snake several feet long, which curls and twists about in a most life-like manner.

Price per box, 10c postpaid, 3 for 25c.



Roll your own and save money. Makes them better and quicker besides saving more than half. Use your favorite brand of tobacco. Neat, useful and handy. Pocket size, weighs 1/2 lb. Made entirely of metal, nickel-plated. Price 25c postpaid.

## MIDGET BIBLE

**GREAT CURIOSITY**  
Smallest Bible in the World. Size of a postage stamp. 200 Pages. Said to bring good luck to the owner. A genuine work of art. Must be seen to be appreciated. Make good money selling them to friends, church acquaintances, etc. **PRICE 15c each, 3 for 40c, 12 for \$1.35, 100 for \$7.50.** Also obtainable in Leather Binding, with gold edges. **Price 50c each, 3 for \$1.25, \$4.50 per doz.** Magnifying Glass for use with Midget Bible, 15c.



## STAGE MONEY

With a bunch of these bills, it is easy for each person of limited means to appear prosperous by flashing a roll of these bills at the proper time and peeling off a genuine bill or two from the outside of the roll, the effect created will be found to be all that can be desired. **Prices, postpaid: 40 Bills 20c, 120 for 50c, or \$3.50 thousand postpaid.**

## Wonderful X-Ray Tube

A wonderful little instrument producing optical illusions both surprising and startling. With it you can see what is apparently the bones of your fingers, the lead in a lead pencil, the interior opening in a pipe stem, and many other similar illusions. A mystery that no one has been able to satisfactorily explain. **Price 10c, 3 for 25c, 1 dozen 75c. Johnson Smith & Co.**



## Good Luck Ring

Quaint and Novel Design

A VERY striking and uncommon ring. Silver finish, skull and crossbone design, with two brilliant, flashing gems sparkling out of the eyes. Said by many to bring Good Luck to the wearer, hence its name, Good Luck Ring. Very unique ring that you will take a pride in wearing. **ONLY 25 CENTS.**

# JOHNSON SMITH & CO.

Dept. 802

RACINE, WIS.

A De Luxe Edition of our new 1927 CATALOG mailed on receipt of 25c. Handsome binding. Bigger and better than ever. Only book of its kind in existence. 550 pages of all the latest tricks in magic, the newest novelties, puzzles, games, sporting goods, rubber stamps, unusual and interesting books, curiosities in seeds and plants, etc., unobtainable elsewhere. Remit by Stamps, Coin, Money Order, Check, etc. Unused U. S., Canadian and Foreign Stamps also accepted.

# BLANK CARTRIDGE PISTOL

Protection against Burglars, Tramps & Dogs

Prices  
**50c**  
**\$1.00**



Well made and effective; modelled on latest type of Revolver; appearance all in all is enough to scare a burglar. When loaded it may be as effective as a real revolver without danger to life. It takes standard 22 Cal. Blank Cartridges obtainable everywhere. **Price 50c, superior quality, \$1.00 postpaid. Blank Cartridges, by express, 50c per 100 Holster (Cowboy type) for Blank Cartridge Pistol, 50c Johnson Smith & Co., Dept. 802, Racine, Wis.**

## BOYS! BOYS! BOYS! THROW YOUR VOICE

Into a trunk, under the bed or anywhere. Lots of fun fooling the teacher, policeman or friends.

**THE VENTRILO**

a little instrument, fits in the mouth out of sight, used with above for Bird Calls, etc. Anyone can use it.

**Never Fails. A 16 page course on ventriloquism, the Ventrillo, ALL FOR 10 CENTS**



Everything about the Ku Klux Klan told in a clear, fearless manner. Book tells all—How it started and was oppressed in 1871—The New Ku Klux Klan—How Organized—How Members are Enrolled—Oath of the Klan—Questions for Candidates—Creed—Objects of the Order—Obedience—Fidelity—Pledge of Loyalty—Ku Klux Klan and the Masons—The Jews—The Masons—Real K. of C. Oath—The Negro Ku Klux Klan, etc., etc. Latest and most complete book on the Klan published. **Price 35c, Postpaid.**

## Popular Watch Charms

**JUST LIKE ORDINARY CIGARETTES. BUT SUCH REAL STARTLERS!** The box contains ten genuine cigarettes of excellent quality. They appear so real, but when each cigarette is about one-third smoked, the victim gets a very great surprise as it goes off with a loud BANG! A great mirth provoker yet entirely harmless. **Price 25c per box.**

**15c**  
ONLY  
3 for 40c; \$1.35 doz.

Very pretty little curiosities and decidedly novel. Fitted with Magnifying Lenses that enlarge the picture to a very surprising degree; in fact, it seems almost incredible that a clear picture could be possible in such a small compass, and how sharp and distinct they show up when you look through. Come in assorted views—Actresses, views of Panama Canal, Lord's Prayer in type, etc.

## Mystic Skeleton

A jointed figure of a skeleton 14 in. in height, will dance to music and perform various gyrations and movements while the operator may be some distance from it.

10c & pd.

## Novelty Badges



**Kissing Permit 10c Garter Inspector 10c**  
Two very novel metal badges, nickel plated, that you can wear, giving you fun out of all proportion to their trifling cost. **10c, each badge, 3 for 25c, or 75c per doz. postpaid anywhere.**

## MAGIC FLUTE

Wonderfully Sweet Toned and Musical



The Magic Flute, or Humantone, is a unique and novel musical instrument that is played with nose and mouth combined. There is just a little knack in playing it which, when once acquired after a little practice, will enable you to produce very sweet music that somewhat resembles a flute. There is no fingering, and once you have mastered it you can play all kinds of music with facility and ease. When played as an accompaniment to a piano or any other musical instrument, the effect is as charming as it is surprising.

## LOOK 35c LOOK

Wonderful instrument. Greatest thing yet. Nine separate articles in one. Everybody delighted with it. Odd, curious and interesting. Lots of pleasure as well as very useful. It is a double Microscope for examining the wonders of nature. It is also an Opera Glass, a Stereoscope, a Burning Lens, a Reading Glass, a Telescope, a Compass, a Pocket Mirror, and a Laryngoscope—for examining eye, ear, nose and throat. It is worth all the cost to locate even one painful cinder in the eye. Folds flat and fits the pocket. Something great—you need one. Don't miss it. Sent by mail, postpaid. **Price only 35c or 3 for \$1.00**

## HOT DOG! SENSATIONAL NEW NOVELTY

It is made of rubber like a small balloon. Contains a curious chemical that acts in a most remarkable way. Squeeze the deflated balloon with the hand and it suddenly becomes quite warm and fills itself up with air. It is SELF-BLOWING. Play all sorts of jokes with it. Lay it on a chair; place it secretly underneath anyone; underneath anyone's pillow; drop it in someone's pocket and after a short time, when friction causes the chemicals to act, a large and superbly colored balloon develops. Each Hot Dog in a small box. Quite harmless, but loads of fun. **15c, each, 3 for 40c., \$1.35 doz. postpaid.**

## Female SEX Indicator Male Sex Indicator

Hold the MAGIC INDICATOR over a man's hand—instantly it moves in a straight line, backward and forward. Hold it over a woman's hand and it describes a complete and continuous circle. The same action can be obtained over a letter written by a man or woman, etc. It is fascinating; baffling. We have never been able to figure out how it's done, but we've never seen it fail. Many novel and entertaining feats may be performed with the Sex Indicator. For example, similar results can be obtained with animals, cats, dogs, rabbits, over birds, chickens, canaries, etc. Also used to predetermine the sex of chickens and birds, etc. In fact it is sold as a patented egg tester in Europe. **Price 25c, or 3 for 85c. pd. JOHNSON SMITH & CO., Dept. 802, RACINE, WIS.**

## COMIC CELLULOID BUTTONS



These Comic Celluloid Buttons provide subjects for pleasant jokes and amusing conversation and thus smooth the way to a more familiar acquaintance and cordial friendship. There are seventy different titles altogether, all very wittily worded and quite unobjectionable. Wear one and see the effect. All four Buttons illustrated above will be sent postpaid to any address for **ONLY 20c** or a dozen, all different, for **45c**.

## SURPRISE SOAP

You've heard of people turning green with envy but they haven't turned half as green as the fellow who unwittingly uses this soap. It is an exact duplicate of an ordinary piece of soap. Secretly it contains a chemical which acts like a dye as soon as it comes into contact with water. **PRICE 15c postpaid.**

## KEYLESS LOCKS

These clever locks cannot be opened unless you know the combination. No key necessary. For your locker, bicycle, tool chest, mail box, thousands of uses. Shackle and tumblers nickel plated. Weighs trifle over one ounce. Small, yet strong. Secret and full instructions with each lock. **PRICE 25c** or 3 for **65c** postpaid.



## Every Boy His Own Toy Maker

Greatest boys' book written. Tells how to make a Pinhole Camera, a Canoe, model Railroad, a Telephone, Boomerang, Telegraph Instrument, Box Kite, Talking Machine, Microscope, Electric Motor, Electric Door Bell, Water Wheel, Paddle Raft, a pair of Skis, a Dog Sled, Bird House, Rabbit Yard, etc. 64 pages, 150 illustrations. **PRICE 10c** postpaid; 3 for **25c** postpaid.

## INVISIBLE INK

The most confidential messages can be written with this Ink, for the writing **Makes No Mark.** Cannot be seen unless you know the secret. Invaluable for many reasons. Keep your postals and other private memorandums away from prying eyes. Great fun for playing practical jokes. **Only 15c a Bottle; 3 for 40c.**

## REAL PISTOL

Shoots Blank Cartridges



## Miniature Watch Charm Pistol

Exact reproduction of a real pistol; actually fires **REAL BLANK CARTRIDGES** of miniature size. Illustration is actual size.  $1\frac{1}{4}$  inches long, with ring at end for attaching to watch chain. Looks like a regular pistol. Break-open type; illustration shows position for loading. Made entirely of high grade steel, nickel plated, octagon barrel, handsomely engraved handles, complete in box with cleaning rod. **PRICE \$1.75.** Also furnished with **pearl handles, \$2.50.** **BLANK CARTRIDGES, 50c** per box of 25. **JOHNSON SMITH & CO., Dept. 802, RACINE, WIS.**

## RESURRECTION PLANT



One of the most wonderful plants known. Possesses the strange power of turning in a few minutes from an apparently lifeless, dry herb to a **BEAUTIFUL**

**LIVING FERNLIKE PLANT** of a dark green color. Simply place the plant in saucer of water, it will open up and start to grow in 20 minutes. When taken out it will dry up and go to sleep until placed in water again. Fine house plant—summer or winter. **10 cents each or 3 for 25c., 75c per doz., postpaid.**

## Microphone Transmitter Button



You can easily make a highly sensitive detectophone by using this Transmitter Button to collect the sound waves. You can build your own outfit without buying expensive equipment. It is simple and inexpensive. You can install an outfit in your home and hear conversations being held all over the house. You can connect up different rooms of a hotel. This outfit was used by secret service operatives during the war. It is being used on the stage. It is ultra-sensitive and is the greatest invention in micro-phones. You can mount the button almost anywhere—card board boxes, stove pipes, stiff-ale cans, on the wall behind a picture frame, etc. Button is so light and small it cannot be detected. Persons can be overheard without suspecting it. You can listen in on conversations in another room. A deaf person in the audience can hear the speaker. Connected to phonograph, piano or other musical instrument, music can be heard hundreds of feet away. Button may be used to renew telephone transmitters; often makes an old line talk-up when rickety lines will. The ideal microphone for radio use; carries heavy current and is extremely sensitive. Amplifies radio signals. Countless other similar uses will suggest themselves. Experimenters find the Button useful for hundreds of experiments along the lines of telephones, amplifiers, loud speakers, etc. Many fascinating stunts may be devised, such as holding the button against the throat or chest to reproduce speech without sound waves. \$5.00 is given to anyone who sends in a new suggestion for the use of the Button providing the manufacturers find it suitable for use in their literature. **PRICE \$1.00 POSTPAID ANYWHERE.**

Send remittance (Postage Stamps accepted) for all articles listed on above and previous page to

## MAGICIAN'S OUTFIT

Apparatus and Directions for a Number of Mysterious Tricks Enough for an Entire Evening's Entertainment

**ANYONE CAN DO THEM 75c**



It is great fun mystifying your friends. Get this Conjuror's Cabinet, and you will be the cleverest fellow in your district. It contains the apparatus for seven separate tricks, including The Disappearing Rose, that, when placed on the lap of your coat, vanishes from sight at will; the Magic Vase and Ball Trick (a Wooden Ball is placed inside, and upon replacing the lid has disappeared and is found in someone else's pocket); The Magic Nail with which you can apparently cut your finger almost in two; the Wonderful Card Trick (a card is placed in an envelope, and when opened an entirely different card altogether is found); The Disappearing Coin Box (a coin is placed in the little wooden barrel, and when opened again, is found to have vanished entirely, or can be made to change into a coin of another denomination); The Famous Dissolving Penny Trick; The Glass Goblet and Vanishing Coin Trick (a coin is dropped into a glass of water, and when the water is poured out the coin has vanished). With the tricks described above we send full printed instructions for performing each trick, so that anyone can readily perform all the tricks to the great amusement of their friends or the public. Any boy of ordinary intelligence, with this Cabinet of Tricks in his possession, can give a perfect entertainment not inferior to some regular magicians. Besides the tricks contained in the Cabinet, there are many other feats and illusions fully explained with full printed instructions, for which you easily make or procure the necessary apparatus. This unexcelled Cabinet of Tricks for **ONLY 75 CENTS POSTPAID TO ANY ADDRESS.**

## Great Fire Eater

Most Sensational Trick of the Day!

With the Fire Eater in his possession any person can become a perfect salamander, apparently breathing fire and ejecting thousands of brilliant sparks from his mouth, to the horror and consternation of all beholders. Harmless fun for all times, seasons and places. If you wish to produce a decided sensation in your neighborhood don't fail to procure one. We send the Fire Eater with all the materials, in a handsome box, the cover of which is highly ornamented with illustrations in various colors. **Price of all complete only 30 cents, postpaid.**

## SQUIRT ROSE

25c



**A REAL STARTLER.** This is the most popular of all squirt tricks. The flower in your coat looks so fresh and sweet that everyone is tempted to inhale the delightful perfume. Then is the moment to press the bulb. Geewh! Slickens! Don't they jump? There is a very long rubber tube that easily reaches to the pocket of your coat or trousers, and the bulb is large enough to make a dozen shots with one loading. **PRICE 25c** each, or 3 for **65c** postpaid.

## PISTOL, OPERA & FIELD GLASS

PRICE POSTPAID, \$1.00



It is made in the shape of and looks like a regular Automatic Pistol. No one is likely to stop and ask you whether it is real or not. Thus it is likely to prove itself very handy in an emergency. On pressing the trigger it opens up, as shown in the illustration at the right, revealing nine most useful articles: Opera and Field Glass, Telescope, Mirror, Magnifying Glass, Burning Lens, Reading Glass, Sun Dial, Sun Compass, etc. In the handle of the revolver there is a piece for various pocket necessities, such as First Aid Articles, Buttons, Pins, etc. The Pistol is of sheet metal, blind finish, that can be carried comfortably in pocket. **PRICE \$1.00.**

## SURPRISE MATCHES

More fun than fighting with your wife. Look just like ordinary matches. Put up in boxes just like regular Safety Matches. As the victim tries to light one he gets quite a surprise. **PRICE 10c** per box, 3 boxes for **25c**, or 12 for **75 cents.**



## SEEBACKROSCOPE

By merely placing this clever instrument to your eye, you can see what is going on behind your back, and sometimes you see very interesting things when no one thinks you are looking. Why it is just like having eyes at the back of your head. **PRICE ONLY 25 cents, postpaid, 3 for 50 cents.**



## NEW BOOK ON ROPE SPICING

A most practical hand book giving complete and simple directions for making all the most useful knots, hitches, rigging, splices, etc. Over 100 illustrations. All about wire rope attachments, lashing, blocks, tackles, etc. 37 Heraldic Knots illustrated. Of great value to mechanics, riggers, campers, boatmen. **Price 20 cents postpaid.**



## The "Little Giant" Typewriter

A First Class Writing Machine For \$1.50

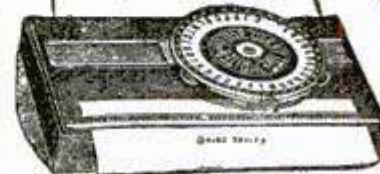

A perfect little typewriter for \$1.50. There are thousands of persons who would like to use a typewriter but whose needs and business do not warrant the expense attached to the purchase and use of a fifty or seventy-five dollar machine. To such persons we confidently recommend our Little Giant. It is strongly made, but simple in construction, so that anyone can quickly learn to operate it, and write as rapidly as they would with pen and ink. The letters of the alphabet most frequently used are so grouped as to enable one to write rapidly, the numerals 1 to 10, and the punctuation marks being together. With this machine you can send your best girl typewritten love letters, address envelopes, make out bills, and do almost any kind of work not requiring a large, expensive machine. With each typewriter we send a tube of ink and full printed instructions for using the machine. **Price complete \$1.50** by mail postpaid to any address in the world.



# OXO-GAS OIL BURNERS

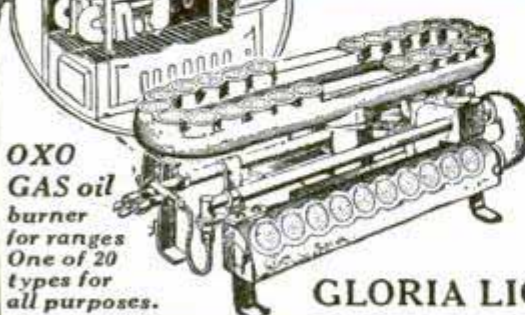

**OXO GAS** oil burner for ranges One of 20 types for all purposes.

**For Furnaces, Ranges, Heating Stoves, Etc.**

OXO-GAS, the cheapest, cleanest, most efficient fuel known to science, is made from kerosene or distillate, and air, mostly air. Burns with a pure blue flame of high heating intensity, as silently as city gas. *Over a million in use.* Manufactured by the oldest (est. 1906), highest rated and most responsible corporation. *Ask any bank. Send for Catalog* illustrating and describing twenty different distinctive designs of oil burners for *Furnaces, Cook Stoves, Heating Stoves, Base Burners, Hot Water Heaters, etc.*

**Agents Wanted** Some choice territory for OXO-GAS agencies still open to thoroughly responsible parties. Your own locality may yet be unassigned.

**GLORIA LIGHT COMPANY, 111-1 N. May St., Chicago, Ill.**

## NEW VEST POCKET ADDING MACHINE

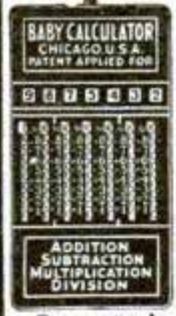

**ADDS, SUBTRACTS, MULTIPLIES, DIVIDES**  
Does work of \$300 machine. Guaranteed 5 years. **NOT A TOY.** Made of steel and indestructible. Million dollar capacity. Fits in pocket. Will not make mistakes. So simple child can operate it. Instructions furnished. Everybody should carry one for figuring.

**FREE TRIAL \$2.50 Total Cost**

**SEND NO MONEY**—Just name and address. We will ship Calculator immediately. (On delivery pay postman \$2.50 (Plus few cents Postage). (If outside U. S. send cash). If not satisfied after 10 day trial you get your money back. **THOUSANDS OF SATISFIED USERS.** This is lowest priced practical calculator made. "Why pay more for inferior imitations?" Order from this ad.

**Mail Coupon Today—**  
**BABY CALCULATOR SALES COMPANY**  
Dept. 41, P. O. Box 1118, CHICAGO, ILL., U. S. A.

- I am enclosing \$2.50—send adding machine prepaid.
- Send Adding Machine C. O. D. \$2.50 plus postage.

Name.....  
Address.....  
City..... State.....

**AGENTS** Write for big commission and territory proposition.

Information on any book free. Write Popular Mechanics Press, Chicago, Ill.

## TYPEWRITER PRICES REDUCED



**ON ALL STANDARD MAKES**  
Big bargains, easy payments on late model Underwoods, Royals, L. C. Smiths, Remingtons, etc.—perfect machines expertly remanufactured by the "Young Process", guaranteed like new for five years. Shipped direct from our factory to you at big saving.

Our big illustrated catalog sent free and without obligation to buy. Write for yours today.  
**Young Typewriter Co.,** Dept. 1101, 654 W. Randolph St., Chicago, Ill.

## AGENTS 500% PROFIT GENUINE GOLD LEAF LETTERS

**\$** guaranteed to never tarnish. Anyone can put them on stores and office windows. Enormous demand, large profits. Paul Clark says: Smallest day \$28.70. R. L. Reel made \$920 in two months. Write today for free sample and liberal offer to general agents.  
**METALLIC LETTER CO., 433-B N. Clark St., CHICAGO**

**"Independent" GOLD POINT \$2**  
Lever, Self-Filler Stylopen  
"Makes Writing a Pleasure"  
Jumbo, \$3.50; Red, \$3.00; Black  
**J. C. ULLRICH & CO., 161 Washington St., N. Y. Est. 1884 Agents Wanted**

## I OFFER YOU

\$100 a week! Do you want it? Would you like to have a steady income of \$100 a week—over \$5000 a year? Then let us tell you how you can make this big money in the easiest work imaginable. We are now ready to appoint 700 Representatives in all parts of the country. You can be one of them and by simply doing what we suggest



**HUDSON Coach**  
You can be one of them and by simply doing what we suggest

## \$100 A WEEK

you can clear \$100 a week. Christopher Vaughn made \$125 in one week. G. M. Collum cleaned up \$250 one month in his spare time. Fred Wilson cleared \$44 in three days' time.

### Hudson Coach Given

You can do as well as any of these Representatives whether you are experienced or not. We furnish everything you need to start. We show you how to make every minute pay you amazing profits. You can work spare time or full time. Write today. Let us prove that you can make \$100 a week and get a new Hudson Super-Six Coach in addition to your large earnings.

**THE AMERICAN PRODUCTS CO., Dept. 7004, Cincinnati, O.**

**AUTO FREE — Write today for details**

# Newest Invention! SPORS Pen

No wonder it's so easy to make \$20 a day when you can distribute this new unbreakable self-filling Fountain Pen with these latest improved inventions.

**IMPORTED** GUARANTEED FOR TWO YEARS  
—WRITES LIKE A \$7 PEN.

Your Sample Pen Costs You ONLY **65¢** for **\$1.25** Sells for

**FREE**  
SILK NECK RIBBON TO MATCH WITH EACH LADIES' STYLE PEN

**FREE**

## There Are Dollars to Be Made

almost every time you turn around. Fountain Pens are always in demand. Nearly everyone uses them, especially when they can get a Fountain Pen like ours for only \$1.25 that writes as good as a pen selling for three and four times this price.

## Money Back Guarantee

If you cannot make at least \$10.00 a day, all you have to do is to return unsold goods to us any time within 60 days and we will refund your money at once.

Could we give you a guarantee like this if we had any doubt that the average person cannot make at least \$10 a day?

**7**  
BEAU-TIFUL COLORS:  
Red, Green, Yellow, Purple, Mahogany and Green Molot

WRITES AS SMOOTH AS A PENCIL ON ANY KIND OF PAPER. & GROOVES FOR INK TO FEED. EXTRA POINTS COST ONLY 15¢.

**WHAT TO GET FOR CHRISTMAS?**

Do you realize that people all over the United States are asking that very question? Wondering what they should get for Susie or Bill or Mother or Dad or Brother? Show them these new style unbreakable SPORS pens, which come in different colors in either the ladies' or men's style and a sale is made every time. These pens are put up in beautiful holly boxes all ready for the customer to send out before Christmas.

**BARREL AND CAP MADE OF THE BEST AND STRONGEST MATERIAL WHICH WILL LAST PRACTICALLY A LIFETIME**

**STRONG ATTACHED CLIP**

Biggest improvement ever thought of in pen history. Small air tight place for point keeps ink from drying and will write the instant it touches the paper without first shaking the pen.

**60-DAY TRIAL**

Money back if not pleased. A perfect pen for every need under all conditions—for any kind of paper.

**F. SPORS & CO.,**

299 Main St., Lesueur Center, Minn.

- Send me one Spors pen, 65c c. o. d., plus postage.
  - Send me 12 Spors pens, \$6.42 c. o. d., plus postage.
  - Send me 36 Spors pens, \$18 c. o. d., plus postage.
  - Send me catalog, no obligation on my part.
- Mark X opposite proposition interested in.

Name.....

Address.....

City..... State.....

# PATENT

## Protect Your Ideas

### Take the First Step Today

If you have a useful, practical, novel idea for any new article or for an improvement on an old one, you should communicate with a competent Registered Patent Attorney AT ONCE. Every year thousands of applications for patents are filed in the U. S. Patent Office. Frequently two or more applications are made for the same or substantially the same idea (even though the inventors may live in different sections of the country and be entirely unknown to one another). In such a case, the burden of proof rests upon the last application filed. Delays of even a few days in filing the application sometimes mean the loss of a patent. So lose no time. Get in touch with me at once by mailing the coupon on the opposite page.

### Prompt, Careful, Efficient Service

This large, experienced organization devotes its entire time and attention to patent and trade mark cases. Our offices are directly across the street from the U. S. Patent Office. We understand the technicalities of patent law. We know the rules and requirements of the Patent Office. We can proceed in the quickest, safest and best ways in preparing an application for a patent covering your idea. Our success has been built on the strength of careful, efficient, satisfactory service to inventors and trademark owners located in every state in the Union.

### NO CHARGE for Information On How to Proceed

The booklet shown here contains valuable information relating to patent procedure that every inventor should have. And with it I will also send you my "Record of Invention" form on which you can sketch your idea and establish its date before a witness. Such evidence may later prove valuable to you. Simply mail the coupon and I will send you the booklet, and the "Record of Invention" form, together with detailed information on how to proceed and the costs involved. Do this NOW. No need to lose a minute's time. The coupon will bring you complete information entirely without charge or obligation.

My Patent Law Offices  
Just Across  
Street From  
U.S. Pat. Office



Above is a view of my drafting and specification offices where a large staff of experienced experts are in my constant employ. All drawings and specifications are prepared under my personal supervision.

# NEWS

*Inventors*  
*Write for these* **Free**  
**Books**

**Strict Secrecy Preserved**

All communications, sketches, drawings, etc., are held in strictest confidence in strong, steel, fireproof files, which are accessible only to authorized members of my staff. Feel free to write me fully and frankly. Your case will have my personal attention. It is probable that I can help you. Highest references. But **FIRST**—clip the coupon and get my free book. Do **THAT** right now.

**Clarence A. O'Brien**

*Registered Patent Attorney*

Member of Bar of: Supreme Court of the United States; Court of Appeals, District of Columbia; Supreme Court, District of Columbia; United States Court of Claims. Practice confined exclusively to Patents, Trade marks and Copyrights

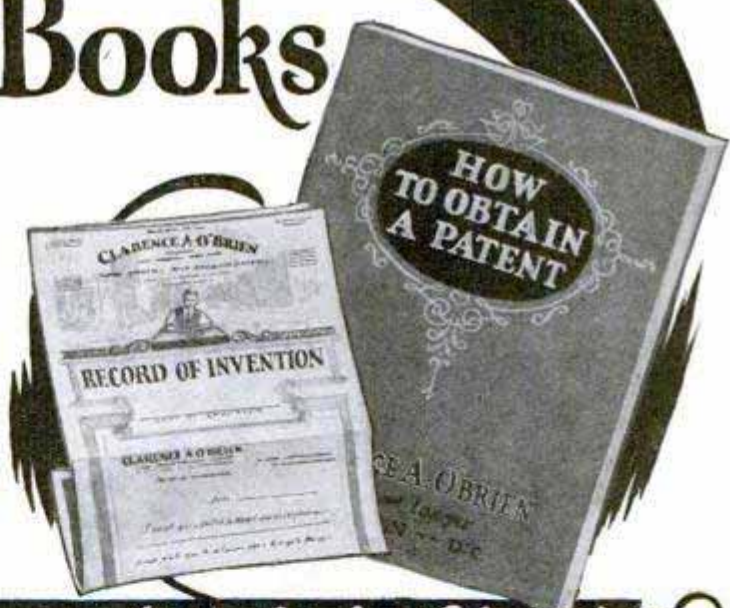

**Clip this Coupon and Mail it Now!**

**CLARENCE A. O'BRIEN, Registered Patent Attorney**

70-S Security Savings and Commercial Bank Bldg., Washington, D. C.

Please send me your free book, "How to Obtain a Patent," and your "Record of Invention" form without any cost or obligation on my part.

Name.....  
*(Important: Write or Print name clearly.)*

Address.....

# PATENTS TRADE-MARKS AND COPYRIGHTS

## Have You An Idea?

### Our Offer: FOR THE PROTECTION OF YOUR INVENTION YOUR FIRST STEP

Before disclosing an invention the inventor should write for our blank form

#### "RECORD OF INVENTION"

This should be signed and witnessed and returned to us together with model or sketch and description of the invention for

#### INSPECTION and INSTRUCTIONS

*No Charge for the Above Information*

### Our Four Books Mailed Free to Inventors

*Our Illustrated Guide BOOK*

#### How to Obtain a Patent

Contains full instructions regarding U. S. Patents. Our Methods, Terms, and 100 Mechanical Movements illustrated and described.

#### Our Trade Mark Book

Shows value and necessity of Trade Mark Protection. Information regarding *Trade Marks and unfair competition in trade.*

#### Our Foreign Book

We have Direct Agencies in Foreign Countries, and secure Foreign Patents in shortest time and lowest cost.

#### Progress of Invention

Description of World's Most Pressing Problems by Leading Scientists and Inventors.

*We Regard a Satisfied Client as our best advertisement, and furnish anyone, upon request, lists of clients in any state for whom we have secured patents.*

*Highest References—Prompt Attention  
—Reasonable Terms*

## VICTOR J. EVANS & CO.

### PATENT ATTORNEYS

Main Offices: 956 9th St., N. W., Washington, D. C.

*Opposite U. S. Patent Office*

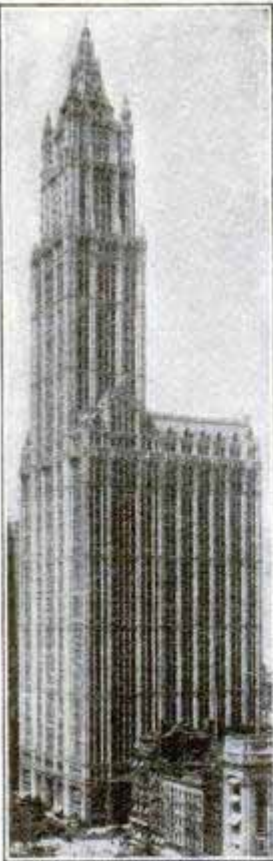

Our New York Office  
Suite 1007 Woolworth Bldg.



Our Philadelphia Office  
Suite 714-15 Liberty Bldg.



Our Washington Office  
Victor Building



# PATENTS TRADE-MARKS AND COPYRIGHTS

## IMPORTANT

TO HAVE YOUR CASE MADE SPECIAL AND AVOID DELAY YOU SHOULD HAVE YOUR CASE MADE SPECIAL IN OUR OFFICE to secure protection, save correspondence and secure early filing date in Patent Office. To secure special preparation of your case send \$25.00 on account with model or sketch and description of invention.

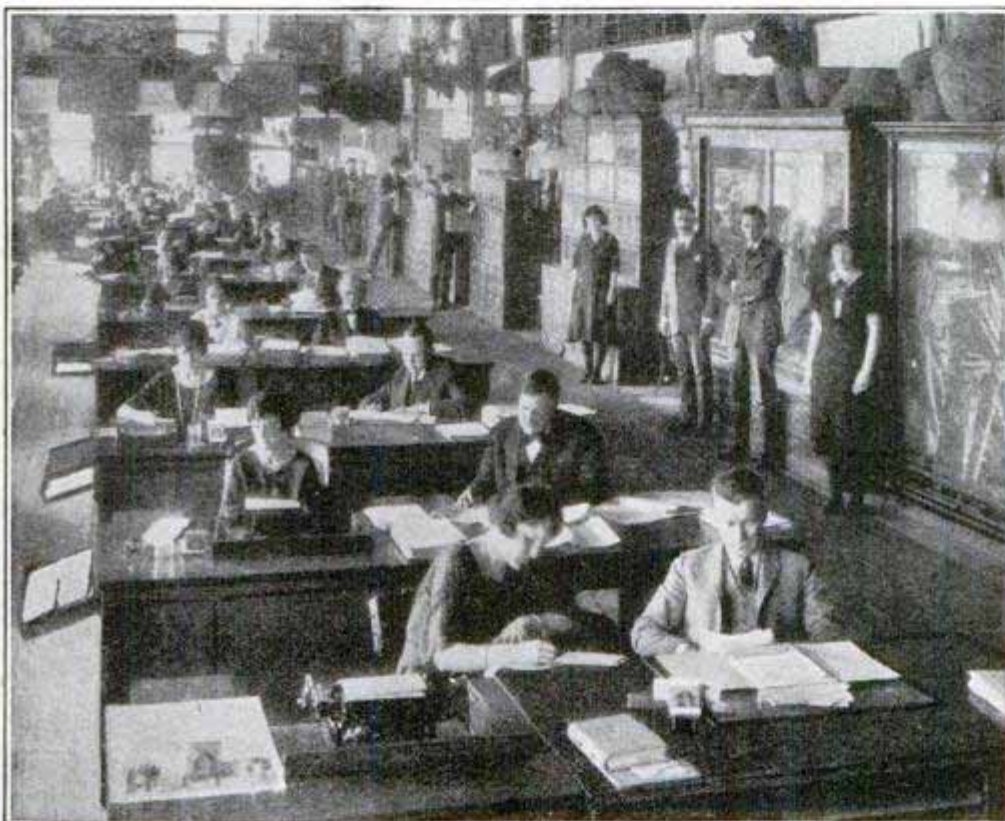

MAIN OFFICE, VICTOR J. EVANS & CO.—VICTOR BUILDING, WASHINGTON, D. C.

*Our Lawyers Practice in all U. S. Courts and defend Clients in Suits involving Patents, Trademarks and Copyrights*

All Communications and Data Strictly Confidential. Interference and Infringement Suits Prosecuted

OUR ORGANIZATION OFFERS PERSONAL SERVICE By Experienced Patent Lawyers, Solicitors and Draftsmen

**FREE  
COUPON**

**VICTOR J. EVANS & CO.  
PATENT ATTORNEYS**

NEW YORK OFFICES  
1007 Woolworth Bldg.

CHICAGO OFFICES  
1114 Tacoma Bldg.

PHILADELPHIA OFFICES  
714-715 Liberty Bldg.

PITTSBURGH OFFICES  
514 Empire Bldg.

SAN FRANCISCO OFFICES  
Hobart Bldg.

MAIN OFFICES: 956 9th Street, N. W., WASHINGTON, D. C.

Gentlemen: Please send me *Free of Charge* your books as described on preceding page.

Name .....

Address .....



Our Chicago Office  
Suite 1114 Tacoma Building



Our Pittsburgh Office  
Suite 514 Empire Building



Our San Francisco Office  
Suite 1010 Hobart Building

# P·A·T·E·N·T·S

Just as it is important that you protect your idea with a patent, so it is imperative that your patent covers your invention completely. The one best way to assure this is to retain a reliable, experienced patent attorney

**MUNN & CO.**  
**PATENT ATTORNEYS**  
*Associated since 1846 with the Scientific American*

1572 SCIENTIFIC AMERICAN BLDG.  
*24 West 40th Street, New York*

523 SCIENTIFIC AMERICAN BLDG.  
*Washington, D. C.*

1312 TOWER BUILDING  
*Chicago, Ill.*

520 VAN NUYS BUILDING  
*Los Angeles, Cal.*

655 HOBART BUILDING  
*San Francisco, Cal.*

*Ask for free copy of "Patents—A Book of Facts Every Inventor Should Know" and for "Inventor's Diary." Send for it NOW.*

# INVENTORS PROTECT YOUR IDEAS

Before disclosing your invention send for our Evidence of Invention Blank. This should be signed and witnessed and returned to us with a model or sketch and a description of your invention for our *Inspection and Instructions* which are free.



Also send for

Our guide book "**How to Get Your Patent**" which is sent free upon request. This book includes full instructions regarding U.S. Patents, Trade Marks, our Terms, Methods, etc.

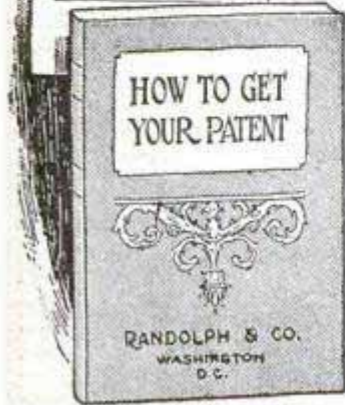

*Terms Reasonable Best References*

### WRITE TODAY

RANDOLPH & COMPANY  
300 Victor Bldg., Washington, D. C.  
Please send me FREE OF CHARGE your Evidence of Invention blank and your guide, "How to Get Your Patent."

Name.....

Street.....

City..... State.....

## RANDOLPH & CO.

300 Victor Bldg. Washington, D. C.



## PATENTS

Send us sketch or model for advice and exact cost of patent. Our book "**How to Obtain a Patent**" sent free. It tells how to apply for Patents, Trade Marks, Foreign Patents, Copyrights, etc.; gives information on Patent Procedure; tells what every inventor should know. Thousands of inventors, who are our clients, are our reference.

**CHANDLEE & CHANDLEE, 25 Years' Experience**  
473 7th St. Washington, D. C.

## PATENTS

Trade Marks, Copyrights, Patent Litigation Handbook with illustrations, 100 mechanical movements. Sent free on request.

**ALBERT E. DIETERICH**  
formerly member examining corps U. S. Patent Office  
**PATENT LAWYER and SOLICITOR**

621-A, Ouray Bldg.  
27 Years' Experience Washington, D. C.

# 1000 NEEDED INVENTIONS!

Here is the most remarkable book ever offered to inventors. One Thousand needed inventions listed and described. Arranged as follows: General Problems; Automotive; Mechanical; Electrical; Chemical; Radio; Marine. Separate chapter on the Ten Most Needed Inventions. This book may give you one idea that will win you a fortune. Nothing else like it has ever been published. Compiled at enormous expense. Edited by Raymond Francis Yates, formerly Managing Editor of a leading scientific magazine. Over 100 pages, durably bound. Send no money. Pay postman only \$1.00 plus postage on arrival. Money back after 10 days' examination if desired. Limited edition. Write NOW.

**BUREAU OF INVENTIVE SCIENCE**  
DEPT. 31 ROCHESTER, NEW YORK



United States Capitol

# PATENTS

**Don't Lose Your Rights To Patent Protection**

Before disclosing your invention to anyone send for blank form "**EVIDENCE OF CONCEPTION**" to be signed and witnessed. As registered patent attorneys we represent hundreds of inventors all over the United States and Canada in the advancement of inventions. The form "Evidence of Conception," sample, instructions relating to obtaining of patents and schedule of fees sent upon request.

## LANCASTER & ALLWINE

480 Ouray Bldg. WASHINGTON, D. C.

*Originators of forms "Evidence of Conception."*



# PATENTS

**Booklet Free**      **Highest References**  
**Promptness Assured**      **Best Results**

Send drawing or model for preliminary examination of Patent Office records.

## ALL BUSINESS GIVEN PROMPT AND PROPER ATTENTION

Listed Patent Lawyer in the latest editions of the Rand-McNally Directory of Bankers and Attorneys, of Chicago, Ill.; The Baggott & Ryall Directory of Attorneys, New York City; The Lawyers Guaranteed Directory, Detroit, Michigan; The Lawyers and Bankers Quarterly, published by the Legal Directory Publishing Company of St. Louis, Mo.; the American Lawyers Annual, Cleveland, Ohio.

**WATSON E. COLEMAN,**  
 REGISTERED PATENT LAWYER

Victor Building, 724 Ninth Street, N. W.  
**WASHINGTON, D. C.**

## INVENTORS

who derive largest profits know and heed certain simple but vital facts before applying for Patents. Our book *Patent-Sense* gives those facts; sent free. Write

**LACEY & LACEY**  
 Established 1869  
 646 F St., Washington, D. C.

## Have You An Invention?

If so the WORLD PROGRESS will send you upon request sample copy Free containing SUGGESTIONS TO INVENTORS as to Inventions Needed. We invite manufacturers to address us regarding inventions they want.

Subscription for one year 60 cents

**WORLD PROGRESS PUB. CO., Inc.**  
 Room 203 Victor Bldg.      WASHINGTON, D. C.

## BLUE BOOK ON PATENTS

AND PRIORITY RECORD BLANK GRATIS.

**MONROE E. MILLER, PATENT LAWYER**  
 411-2 Ouray Building,      WASHINGTON, D. C.  
 ELECTRICAL AND MECHANICAL EXPERT



## GEARS ALL KINDS SMALL

The most accurate made and prices reasonable. We carry a complete line of gears in stock for immediate shipment. Can also quote on special gears of all kinds. Send us your inquiries.

WRITE FOR CATALOGUE 10

**CHICAGO STOCK GEAR WORKS**  
 105-109 S. Jefferson St., CHICAGO



**GEARS AND PARTS OF MODELS**

Inventors and Mechanics  
 Send 2 cent stamp for  
 Gear or Material Catalogs  
**COLBURN GEAR & MFG. CO.**  
 98 Holmes St., Quincy, Mass.



## BOW LEGS and KNOCK-KNEES UNSIGHTLY

Those afflicted with BOW LEGS should wear the "PERFECT LEG FORMS" and overcome this deformity. Trousers hang perfectly straight. Made of the highest grade Aluminum. Sanitary, Light and Durable. Easy to put on or off. Send for booklet showing photos of men with and without the "PERFECT LEG FORMS."

**PERFECT SALES CO.**  
 140 N. Mayfield Ave.      Dept. 5      Chicago, Ill.

## TOBACCO OR SNUFF HABIT CURED OR NO PAY

Any form QUICKLY conquered. NO LONG WAITING. Costs small sum if it cures. Harmless. Sent on approval.  
**DR. C. M. SIMPSON, 204 W. 44th St., CLEVELAND, OHIO**

## PIMPLES

Cleared up—often in 24 hours. To prove you can be rid of Pimples, Blackheads, Acne Eruptions on the face or body, Barber's Itch, Eczema, Enlarged Pores, Oily or Shiny Skin, simply send me your name and address today—no cost—no obligation. **CLEAR-TONE** tried and tested in over 100,000 cases—used like toilet water—is simply magical in prompt results. You can repay the favor by telling your friends; if not, the loss is mine. **WRITE TODAY.**  
**E. S. GIVENS, 429 Chemical Bldg., Kansas City, Mo.**

# PATENTS

## To the Man with an Idea

I offer a comprehensive, experienced, efficient service for his prompt, legal protection and the development of his proposition.

Send sketch, or model and description, for advice as to cost, search through prior United States patents, etc. Preliminary advice gladly furnished without charge.

My experience and familiarity with various arts frequently enable me to accurately advise clients as to probable patentability before they go to any expense.

*Booklet of valuable information and form for properly disclosing your idea free on request. Write today.*

**Richard B. Owen, Patent Lawyer**  
 9-303 Owen Bldg., Washington, D.C.  
 41-E Park Row,      New York City

**TRADE-MARKS**  
 REGISTERED

**FREE!**

**This**  
**84 PAGE**  
**RADIO**  
**BOOK**

**SAVE 1/3 to 1/2**



**RADIO**  
**1927**  
**CATALOG**

**RANDOLPH**  
**RADIO CORP.**  
180 NORTH UNION AVENUE  
CHICAGO, O. ILLINOIS

**The World's Largest**  
**Exclusive Radio Mail Order House**

will send you—**FREE**—this wonder catalog of radio bargains containing over 2000 items of everything in **RADIO**, including all the **latest Sets, Kits, and Parts**, at rockbottom prices that **Save you 1/3 to 1/2**

**5-TUBE SETS AS LOW AS \$24.90**  
**LATEST 1927 MODELS**

Table and Console models with built-in loud speakers. Beautiful, genuine mahogany and walnut cabinets. 5-6-7- and 8-tube sets at amazingly low prices.

**SEND FOR BOOK TODAY**

We cannot begin to tell all about this wonderful Radio Book. Simply send letter or postal, and this **wonder radio catalog** containing over 2000 radio bargains will come to you **absolutely free**. Write Today.

**RANDOLPH RADIO CORP.**  
180 N. Union Ave., Dept. 213, Chicago, Ill.

## DEAFNESS IS MISERY GOOD HEARING A JOY



Millions of people know that, but Multitudes of persons with defective hearing and Head Noises are again enjoying conversation, go to Theatre and Church because they use Leonard Invisible Antiseptic Ear Drums, which are Tiny Megaphones fitting in the Ear entirely out of sight. No wires, no batteries, no head piece. They are Unseen Comforts and inexpensive. Write for booklet and sworn statement of the inventor who was himself deaf.

A. O. LEONARD, Inc., Suite 161, 70 5th Ave., New York

**WHITE FLAME**

**BURNERS** make your old kerosene lamps and lanterns give a brilliant white light better than electricity or gas. Doubles your light. Saves oil. **NO MANTLE TO BREAK.** Guaranteed Safe and Reliable. Delights every user. Send now for complete sample postpaid 50 cents, stamps or coin. 3 for \$1.25. Money Back if Not Satisfactory. Live Representatives Wanted. Exclusive Territory.

**WHITE FLAME LIGHT CO., 68 Clark Bldg. Grand Rapids, Mich.**



## NEW DISCOVERY

**AUTO STROP BLADE RENEWER—FOR AUTO STROP BLADES ONLY—Positively Makes Dull Blades New.**  
25¢ Postpaid—Agents Wid.—MFKerys—Box 9—Long Beach, Calif.

**EASY \$100 a Week**

**FUGO**  
**FIRE EXTINGUISHER**

Unusual opening for live agents in every locality. Make \$5000 or more a year—**easily**. Fugo—the instantaneous automatic fire extinguisher—is needed and wanted in every home, store, theatre, garage, shop, school, automobile, etc. Cheapest fire protection available today. Within reach of all.

**1 Qt. Size \$5.00 2 Qt. Size \$7.50**

Recharged in a jiffy.

Amazing 30-second demonstration clinches sale—each one sold sells others. Territory going fast. Write at once for wonderful proposition that will **MAKE YOU BIG MONEY.**

**THE NATIONAL FORMETAL CO.**  
6535 Metta Ave., N. E. Cleveland, Ohio



## Health and Strength Thru **RenuLife** VIOLET RAY Treatments at Home

Thousands of chronic sufferers have found new health, radiant vitality, energizing vigor with **RenuLife**, the health-giving Violet Ray Generator that drives poison and waste tissue from your blood. Read what they say:

### Crippled 14 Years

"RenuLife Violet Ray has put me on my feet after being a cripple for 14 years. I had rheumatism from my hips down to my feet. Everyone is surprised how good I can walk now—thanks to the RenuLife Generator."

### Paralysis Victim

"I had an attack of paralysis and my entire left side was afflicted. It also left me with very little desire for food, therefore my strength wasted quickly, but after persistent application of your Violet Ray, I am gaining continually."

### Didn't Know What a Night's Rest Was

"I had neuritis in both my arms and sciatica in my left limb, and suffered so much I didn't know what a night's rest was. After taking fifteen treatments with RenuLife I sleep much better, and whereas my limb was so painful I could only sit for about fifteen minutes, now I can sit as long as I please."

### Could Scarcely Breathe

"My son had Chronic Bronchial Asthma. Every time we had rainy or foggy weather these attacks came on. He could scarcely breathe. Since taking RenuLife Ozone treatments he has had but one slight attack."

### Free Book and Treatment Offer

RenuLife operates from any light socket and is as gentle and soothing in its action as a ray of sunshine. You can easily give yourself health treatments with the RenuLife Generator in your own home. Remember over 85,000 of these instruments are in use. *RenuLife is a wonderful time-tested product backed by a rigid guarantee.* Prove this to your own satisfaction now by trying RenuLife free in your own home! Make yourself the sole judge of RenuLife merit.



Check any ailments on which you want information.

- |                                          |                                    |                                            |
|------------------------------------------|------------------------------------|--------------------------------------------|
| <input type="checkbox"/> Asthma          | <input type="checkbox"/> Dandruff  | <input type="checkbox"/> Nervousness       |
| <input type="checkbox"/> Bad circulation | <input type="checkbox"/> Deafness  | <input type="checkbox"/> Neuralgia         |
| <input type="checkbox"/> Blackheads,     | <input type="checkbox"/> Dyspepsia | <input type="checkbox"/> Neuritis          |
| Pimples                                  | <input type="checkbox"/> Eczema    | <input type="checkbox"/> Prostatic Trouble |
| <input type="checkbox"/> Bronchitis      | <input type="checkbox"/> Hay Fever | <input type="checkbox"/> Rheumatism        |
| <input type="checkbox"/> Catarrh         | <input type="checkbox"/> Insomnia  | <input type="checkbox"/> Skin Disorders    |
| <input type="checkbox"/> Colds           | <input type="checkbox"/> Lumbago   | <input type="checkbox"/> Sore throat       |
| <input type="checkbox"/> Constipation    | <input type="checkbox"/> Pain      | <input type="checkbox"/> Sprains           |

Any others? \_\_\_\_\_

**RENULIFE ELECTRIC COMPANY**  
103 RenuLife Building, Detroit, Michigan

- Without obligation, please send me details of your **FREE TRIAL PLAN**, in accordance with your offer in Popular Mechanics.
- Please send **FREE Book**.

Name \_\_\_\_\_ (Please Print)

Address \_\_\_\_\_

Town or City \_\_\_\_\_ State \_\_\_\_\_

**AGENTS WANTED—Write to Salesmanager**

# Going to Build Remodel or Repair?

**DON'T** think of building a new home or repairing an old one without a copy of our free woodwork catalog.

To those who contemplate building or remodeling, this book is a valuable work of reference. In it are found the latest ideas and most advanced styles for everything in millwork. It illustrates and describes windows and sash of all kinds, including porch and storm sash, doors, frames, mouldings, screens, porchwork, stairwork, hardwood flooring, interior finish, cabinet work—in fact, practically everything in manufactured millwork. Every article in the book shows a low money-saving price direct to you.

## FREE ESTIMATES

Send us your lumber and millwork bills for a free estimate. Let us quote prices on your material and tell you the exact amount of freight. Then compare our prices with others. This service costs you nothing and places you under no obligation whatever.



**CHICAGO MILLWORK SUPPLY CO., 1444 W. 37th St., Chicago, Ill.**  
PLEASE SEND ME YOUR FREE BOOK

Name \_\_\_\_\_ St. No. \_\_\_\_\_  
Town \_\_\_\_\_  
State \_\_\_\_\_  
Occupation \_\_\_\_\_

**Book is Free**

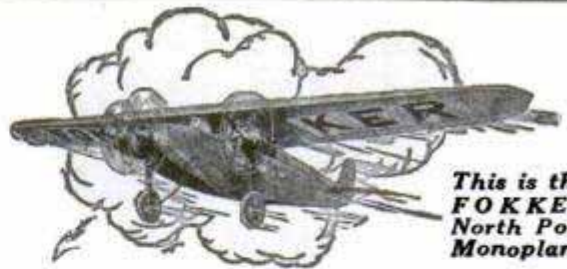

This is the **FOKKER North Pole Monoplane**

## Build and Fly 3 ft. Models of Famous Aeroplanes!

There's no fun like building your own Model Aeroplane. It's the most interesting job you ever tackled. Shows you how big machines are built. You can fly it too, right from the ground under its own power. Any bright boy can do it; Ideal Scale Drawings and Building-Flying Instructions show you how, and Ideal Model Aeroplane Construction Outfits contain everything needed. For 25c we will send you the complete plans for any one of the following famous Aeroplanes:

### Every Boy's Airplane

The finest idea in Model Airplanes. Looks like a real one; clips together easily and quickly, ready to fly in 2 hours. **Complete Outfit Only \$6.00**

**FOKKER North Pole Monoplane;** Curtiss JN4 D-2 Training Plane; DeHavilland "Round-the-World Flyer"; N C-4 Naval Seaplane; Bleriot; Nieuport or Taube Monoplane; or Cecil Peoli Racer. Send 25c now and get plans for the one you want to build. (All 8 plans for \$1.50.)

Catalog Model Aeroplanes, Flying Toys, Parts and Supplies, 5c postpaid.

**Ideal Aeroplane & Supply Co.**  
408 West Broadway, New York



Ask your Dealer for Ideal Model Aeroplane Construction Outfits.

## Adana Automatic Self-Inking PRINTING MACHINE

**\$11**

### Complete Plant



**THIS** massively constructed Printing Machine is the most wonderful of its kind. There are now over 10,000 users of these plants, many saving enormously in their own work, others making an excellent living.

Will print any class of matter from a **CHEMIST'S LABEL** to an **ILLUSTRATED MAGAZINE**

including Perforating, Creasing and Box-making. The finest malleable iron and mild steel used in construction. Simplicity to the extreme. No special skill required. Large numbers of boys are producing their School and Scout Magazines. Printers' metal type, case, complete accessories, and excellently illustrated instructional book included. **POSTAGE \$3 EXTRA.** Write for illustrated particulars in two colors and samples of work and catalogue.

**THE "ADANA" AGENCY (Dept. PA)**  
34 King Street, Twickenham, Middlesex, England

Printers should write for particulars of new system of supplying First-Class Founders' Type

## A SCHOOLBOY CAN NOW "KEEP BOOKS"



Bookkeeping troubles made so easy with a So-Easy Loose Leaf Outfit. Binder, 200 sheets ruled to use in your business, A-Z index. Price **\$3.00. SPECIAL for 10 Days.** Send \$2.50 for book. I will include samples of 60 stock forms and "How to Find Errors in Trial Balances."

**B. MOHLER, Box 453, CHICAGO, ILL.**

## MEN \$10-\$15-\$20 a Day Commissions Paid Daily

Profitable new field for men who are conscientious and dependable. **NO EXPERIENCE NECESSARY.** My plan pays biggest commissions in this line, in advance, with extra bonus for producers. **Act Now**  
**Full or part time \$45 to \$100 weekly**

## Sell Better Quality All Wool Tailoring \$31.50

Our astonishing values in tailored-to-order, all-wool suits and overcoats positively sell on sight. We want earnest men **AT ONCE** who are anxious to **Make Money** and will help them to establish a steady, big-paying repeat business. No capital required.

We furnish handsome large swatch samples and complete instructions—**FREE.** Write at once.

**W. Z. GIBSON, Inc., 161 W. Harrison Street, Dept. A-516 Chicago**



Information on any book free. Write Popular Mechanics Press, Chicago, Ill.

## Direct at Factory Prices

Sample \$1.18 3 for \$3.00 Postpaid

**Hand Forged Razor Steel Blades** Send for our 100-page **FREE** List and "HOW TO USE A RAZOR."

**Maher & Grosh Co.**  
106 A St., Toledo, Ohio



### A Genuine \$2 Knife for \$1.18 Postpaid

Handy shaped Blade makes this knife best for mechanics, sportsmen and farmers; light but strong; re-sharpened easily. Stag handle. German silver finish; blades file tested, hand forged from razor steel and warranted.

No 57

# \$351<sup>00</sup> CLEARED ~ IN ONE DAY

So writes W. H. Adams of Ohio in August 1925. V. A. Marini of California reports \$11275 sales in three months. Jacob Gordon of New Jersey \$4000 profits in two months." Alexander of Pennsylvania "\$3000 profits in four months." Ira Shook \$365 sales in one day. Bram bought one outfit April 5 and 7 more by August 28. Iwata, bought one outfit and 10 more within a year. Mrs. Lane of Pittsburg says "sold 8000 packages in one day. J. R. Bert says "only thing I ever bought that equaled advertisement." John Culp says:

"Everything going lovely. Crispette wrappers scattered all over town. It's good old world after all." Kellog, \$700 ahead end of second week.



## WE START YOU IN BUSINESS

Furnish secret formulas, raw material, and equipment. Little capital required; no experience needed.

## Build a Business of Your Own

No limit to the sale of Crispettes. Everybody likes them. It's a delicious food confection. Write for facts about a business that will make you independent. Start now, in your own town.

## Profits \$1000 a Month Easily Possible

Send postal for illustrated book of facts. It contains enthusiastic letters from others—shows their places of business, tells how and when to start, and all information needed. Free. Write now!

**LONG-EAKINS COMPANY**

128 High Street

Springfield, Ohio



## New Plan! makes it easy

\$50<sup>00</sup> to \$100<sup>00</sup> Weekly

Selling Shirts Direct to Wearer. No capital or experience needed. Spare or full time. Established 1885. Represent a real manufacturer.

## WRITE FOR FREE SAMPLES

MADISON SHIRT MILLS, 562 BROADWAY, NEW YORK

## \$2000 IN 3 MONTHS

80c PROFIT on \$1 order; started with ad costing \$21, sold over 2000 orders in 3 months. Will send you ad, letters and tell you how I did it free. Quincy Co., 721 Quincy Bldg., Chicago.

## NO JOKE TO BE DEAF

— EVERY DEAF PERSON KNOWS THAT

I make myself hear, after being deaf for 25 years, with these Artificial Ear Drums. I wear them day and night. They stop head noises and ringing ears. They are perfectly comfortable. No one sees them. Write me and I will tell you a true story, how I got deaf and how I make you hear. Address



Medicated Ear Drum

**GEO. P. WAY, Artificial Ear Drum Co. (Inc.)**  
80 Hoffman Bldg., 2539 Woodward, Detroit, Mich.

# Great *New* Invention for seekers of Health Power Beauty



Elco Health Generators at last are ready for you! If you want more health—greater power to enjoy the pleasures and delights about you, or if more beauty is your desire—write! Ask for the book on these inventions which has just been prepared. It will be sent to you without cost. It tells you how Elco Health Generators aid you in leaving the lethargy and hopelessness of bad health and weakness behind forever. Re-vitalize yourself. Bring back energy. Be wholly alive. Write today!

10 Days Free Trial—Write for FREE BOOK



These great new inventions generate High Frequency Violet Ray, Mechanical Vibration, Medical Electricity and Ozone. Combined or separate.

They operate on the electric light in your home or on their own motive power at less than 50 cents per year. Elco Health Generators are positively the only instruments which can give you in one outfit Electricity, Violet Ray—Vibration and Ozone—the four greatest curative agents. Send coupon below. Get the Free Book NOW!



### For All These:

- |             |                 |
|-------------|-----------------|
| Rheumatism  | Asthma          |
| Gout        | Hay Fever       |
| Lumbago     | Sore Throat     |
| Neuralgia   | Catarrh         |
| Sciatica    | Deafness        |
| Headache    | Insomnia        |
| Neuritis    | Pain            |
| Nervousness | Development     |
| Circulation | Skin Disease    |
| Weakness    | Pimples         |
| Paralysis   | Scalp Disorders |
| Eye Trouble | Obesity         |

## MAIL the COUPON for FREE Book!

Do not put this paper down without sending the coupon. Don't go on as you are with pains and with almost no life and energy. You owe it to yourself to be a better man or woman. You were put here to enjoy life—not just to drag through it. So do not rest another day until you have put your name on the coupon here. That will bring the whole story of these great new inventions. Do it today—now.



**Lindstrom & Company**

30 West Lake Street, Dept. 93-51, Chicago, Ill. Please send me your free book, "Health—Power—Beauty" and full information on your 10-day Free Trial Offer.

Name.....

Address.....

Agents Wanted

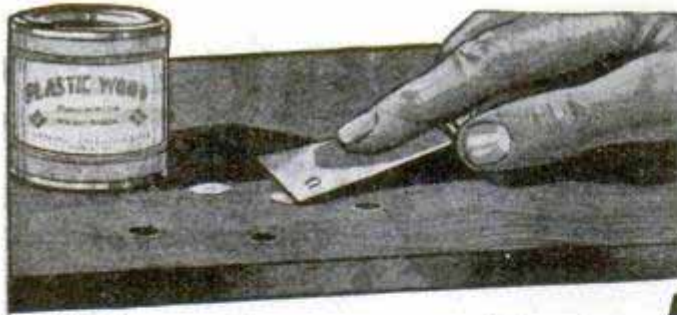

# Wood in a Can!

Literally true of **PLASTIC WOOD**

Try **PLASTIC WOOD** for filling old screw holes, making casters solid in a chair, repairing furniture or wherever wood needs replacing.

As it comes from the can **PLASTIC WOOD** can be moulded in the fingers and pushed into holes and cracks. It hardens on exposure to the air and can be whittled, planed, sand-papered or turned on a lathe.

**PLASTIC WOOD** will adhere to metal or tile as well as to wooden surfaces—takes paint, stain and varnish—nails and screws will not split it. There is nothing like

## PLASTIC WOOD

FOR SALE AT PAINT AND HARDWARE DEALERS

1/4 lb. can ..... 35c      1 lb. can ..... \$1.00

If unable to buy **PLASTIC WOOD** send the enclosed coupon with 35c.

**ADDISON-LESLIE COMPANY,** S-2  
Canton, Mass.

Please send me a trial quantity of **PLASTIC WOOD** for which I enclose 35c.

Name .....

Address .....

**\$6**  
**CASH WITH ORDER**



17" Over all, 4" Swing, 11" Centers.  
Shipping weight 13 lbs. Bed is machined and lathe well built. Also made in larger sizes.

**SYPHER MFG. CO., Dept. L, Toledo, O.**

# You Can Make Big Money In This New Business

File saws automatically by machine. Do better work than the hand filers and turn out 3 and 4 jobs to their one. Every carpenter, contractor, meat market, woodworking shop, factory and home has year around business for you. 50c and more for filing saws—\$1.50 for retooling. You can handle ALL kinds of saws with the

## FOLEY AUTO MATIC FILER

—hand, band, back, panel, circular, and meat saws. Here's what Wm. Barnett, 143 Villard Ave., No. Milwaukee, says: "I am having good success with the **Foley Saw Filer**. It has paid for itself twice in the three months since I got it." You too can have such a comfortable business. Start getting it now by writing for complete information.

**FOLEY SAW TOOL CO.**  
211 Bldg., 914 East Lake Street  
MINNEAPOLIS, MINN.



**Write Now!**

**SAVE 1/2 ON PLUMBING & HEATING SUPPLIES**

**CATALOG FREE**

90 pages, Beautifully Illustrated—Warranted high quality or money back. Get our Catalog before you buy.  
**STANLEY PLUMBING SUPPLY CO., Inc.**  
1000 Spring Garden St. PHILA., PA.



# MOVIES In Your Home



Our marvelous, practical **Movie Machines** sell as low as \$3.75 post-paid, and use same size film as big theatres. We also have wonderful films at lowest prices—with a new film exchange service.

**Don't Miss This!**  
Write NOW for Free Catalogue.  
**PARAMOUNT MANUFACTURING CO.**  
Dept. MD, Boston, Mass.

Don't go into the woods without the **CEEBYNITE** a **Taylor Compass**



If your Dealer cannot supply you, write

**Taylor Instrument Companies**

ROCHESTER N.Y.

Canadian Plant, Tycoo Bldg Toronto

There's a Taylor Thermometer for Every Purpose

# Do Wonderful Chemical Tricks and Experiments with **CHEMCRAFT** Junior!



Make ink, dye cloth, test water and soil. Puzzle your friends with **Magic Chemical Tricks**: write secret letters with invisible ink, pour blue, brown and black liquid from a pitcher of water, make magic writing paper.

It's all easy with this wonderful **Craft**. Always sold for 50c, but if you send us the names and addresses of five boys, we will send you **CHEMCRAFT JUNIOR** for only **25c**

**BIG BOOK FREE!**

**Chemcraft** Chemist Club Magazine: full of experiments, stories and chemical news. Just write for it—it's free.

**The Porter Chemical Co.**  
113 Summit Ave. Hazletown, Md.





## Why Don't You Play a Hohner Harmonica?

Anyone may quickly learn to play real music on a Hohner Harmonica with the aid of this Free Instruction Book.

See how easy it is! Read the simple directions, look at the charts and pictures, take your Harmonica, hold it as shown and *blow-draw, blow-draw*. In a short time you will master the scale; and when you can play the scale you will soon be playing favorite melodies to the delight of yourself and friends

Get your harmonica today and be sure it's a Hohner. And ask for the Free Instruction Book. If your dealer is out of copies, write M. Hohner, Inc., Dept. 181, 114 East 16th St., New York.

"Tune-in" on Your Radio for the "Hohner Harmony Hour" Musical Programs.



## YOU NEED SARGENT PLANES

See them at your hardware dealer's. For booklet write Sargent & Company, Manufacturers 49 Water Street New Haven, Conn.

## Diamonds Here at 60% of Market Price

Free Bulletin lists diamonds as low as \$60 per carat, also Gems of Finest Quality at higher per carat charges, but proportionately Low Bargain Prices. This 3/4 less 1-16 carat correctly cut diamond, a snappy blazing solitaire at \$68.50. This 75 year oldest largest Diamond Banking Firm in all the world lends money on diamonds. Thousands of unpaid loans and other bargains. Many from big cash deals direct with European Diamond Cutters. Must sell NOW.

### WHY PAY FULL PRICES Costs Nothing to See

Any Diamond sent for absolutely free examination at our risk. No obligation. No cost to you. Latest Listings—Unpaid Loans. Sent Free. Describes Diamond Bargains in Detail, gives cash loan values guaranteed. Explains unlimited exchange privilege. Write Today for your copy of Diamond Bargain List. Postal card will do.

Jos. De Roy & Sons, 1952 De Roy Building Pittsburgh, Pa. Only Opposite Post Office



\$68<sup>50</sup>  
3/4-1/16  
Carat  
Correctly  
Cut

# Sensational Typewriter Offer



## The World's Only Ball Bearing Typewriter

NEVER has there been such a typewriter bargain on as easy terms! A genuine Silent Ball Bearing L. C. Smith at a 40% savings!

### Only the L. C. Smith has all these features:

Ball bearings (636 of them) at all points of wear. All the writing visible all the time. Non-shift carriage. 2-color ribbon. All the latest operating conveniences. Beautiful—renewed.

If you decide to keep it only \$3<sup>00</sup> DOWN BALANCE EASY TERMS

## Guaranteed 5 Years

Money cannot buy a better typewriter. U. S. Government bought 50,000. The choice of railroads, big corporations like the Standard Oil Co., etc., because of its exclusive ball bearing feature. Easiest running, longest wearing of typewriters.

## Send No Money!

Just mail coupon. Without delay or red tape, typewriter will be shipped you. Use it 10 days. See how speedy and easy it runs—the perfect work it turns out. If not delighted, return at our expense. You'll want to keep it. You can, for \$3 down and \$5 monthly. Now is the time to buy. \$3 worth of extras free. Send coupon now before offer is withdrawn.

\$40 SAVED by Using this Coupon  
SMITH TYPEWRITER SALES CORP.  
111-360 E. Grand Ave., Chicago

Ship me the L. C. Smith, F. O. B. Chicago. On arrival I'll deposit \$3 with express agent. If I keep machine, I'll send you \$5 a month until the \$66.70 balance of \$69.70 price is paid; the title to remain with you until then. I am to have 10 days to try the typewriter. If I decide not to keep it, I will repack and return to express agent, who will return my \$3. You are to give your standard 5-year guarantee.

Name.....  
Address.....  
City..... State.....  
Employed by.....



**Charge it!**

**Full Year to Pay**  
All transactions strictly confidential  
**10 Days Free Trial**

NO. MA1  
\$72.50

**A FULL YEAR TO PAY**

Pin only \$1 to your order, and your choice comes to you parcel-post prepaid on 10 Days Free Trial. Then pay postman only \$1 more on delivery, and after free trial pay balance in 12 equal monthly payments. Satisfaction guaranteed or money back.

**FREE**

**"Royal Book of Gems"**

Thousands of special values in genuine diamonds, watches and jewelry illustrated. Your copy sent immediately on request.

**No Red Tape—No Delay**

**Look Prosperous Wear Genuine Diamonds!**



**MA3**—Lady's wrist watch latest style solid 14 K gold, highest grade 17 ruby and sapphire jewel movement, lifetime guarantee. Featured at **\$22**



**MA2**—Beautifully hand engraved wedding ring, 18 K white gold, with 5 genuine blue white diamonds. Featured at **\$29.50**

**Royal Terms make buying easy**



**MA4**—Fiery blue white diamond—best quality 18Kt. white gold—artistically carved, hand pierced, lady's mounting. Featured at **\$49.50**



**MA5**—Three perfectly matched blue white diamonds set in a beautifully hand pierced mounting—18Kt. white gold—latest creation. Featured at **\$36.75**



**MA6**—Something he will like and use. Famous Elgin strap watch, 20 year guaranteed green gold-filled case, radium dial—accurate time-keeper. Featured at **\$24.50**

Established 1895

**ROYAL DIAMOND & WATCH CO.**  
Address Dept 1754 170 Broadway, N.Y.

Information on any book free. Write Popular Mechanics Press, Chicago, Ill.

**AGENTS!**

**EXPERIENCE UNNECESSARY**



Science has finally produced it. An instantaneous metal cleanser—neither sloppy liquid nor messy paste. Dry magic floss. Touch it to nickel, copper or brass. The metal shines bright and clean instantly! No hard rubbing! Lightning Silver Cloth does same for Silverware. Lightning Furniture Floss instantly cleans and puts high lustre on Furniture. No liquid! Lightning Products all approved by Good House-keeping Institute. Agents making up to \$30 a day!

**AMAZING DISCOVERY ABOLISHES METAL AND FURNITURE POLISH**

Imagine! Touch tarnished articles with a Lightning Polishing Cloth or Floss and you make them bright as new. Demonstrations positively astonishing! Every one a sale! Agents collect real money on every call.

**Makes a Sensational Demonstration!**

Everybody Buys These Products. Housewives buy the Lightning Silver Cloth and Furniture Floss. Autolets buy Lightning Polishing Floss. Sell all three to stores and offices in big quantities. Nothing else like them. Sure big, quick MONEY GETTERS.

**Sample Free!** Exclusive territory. Real cooperation. Triple profit. Answer this ad at once. Make big money. Easy! Quick! Don't delay. Write NOW! FREE test sample and proposition by return mail.

**C. L. LIGHTNING PRODUCTS CORP., 1773 Greenleaf Ave., Chicago**



**EDWARDS WILL SAVE YOU MONEY ON**

**METAL ROOFS**

We own our own steel mills, roll our own sheets, make them into high-grade REO METAL SHINGLES, Sidings, Ceilings and Roofings of every type and style for every kind of building. We control every operation from the raw material to the finished roof and we sell direct from our factories to the user. Not a dollar to divide with anybody but the customer! You get better value for less money.

**OUTLAST THREE ORDINARY ROOFS**

EDWARDS METAL ROOFS are weather-proof, lightning-proof, fire-proof! The galvanizing bends with the metal. No tools required.



**LOW-COST ALL-METAL GARAGES**

Any size. Any style. Portable. Ready to erect. Complete with frames, doors, sash and hardware. Ornamental, durable, economical. Blue-prints and complete instructions FREE.

Write today. Get our low prices and Free Samples. Ask for Roofing Book No.150 or for Garage Book No. 150

**THE EDWARDS MFG. CO.**  
100-150 Butler St. Cincinnati, O.



**PLUMBING - HEATING WATER SYSTEMS**

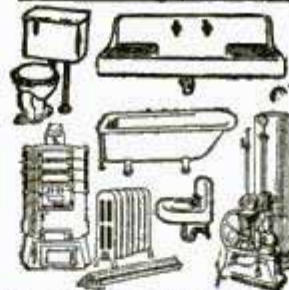

**SAVE UP TO 40%**

Wonderful bargains—everything guaranteed. Full line of plumbing and heating supplies. Hot water, steam heating plants and fixtures and water systems at big savings.

**Install Them Yourself**

Finest materials all brand new and perfect. Tell us your wants and mail us a rough sketch of your rooms.

**SEND FOR PRICE LIST**

**B. KAROL & SONS CO.** 800 S. KEDZIE AVE. Dept. 20 CHICAGO

**MOTORCYCLES**



Price \$10 and up purchased through our Co-Operative Plan for as low as \$1.00 down and \$1.00 per week

Indians Harley-Davidsons Ace Henderson and Clevelands

*Motorcycles shipped to all parts of the world*

**WALKER-INDIAN CO., 188 Mass. Ave., BOSTON**

**You—and This New Machine Can Earn \$500 a Month**



**Operate a Tire Repair Shop**

70,000,000 Tires in use. America's greatest opportunity for men with small capital. We furnish everything—\$100 and up. Easy payments. We train you FREE right at home. Start making money at once. Write today for Free Book of Opportunity.

**Haywood Tire Equipment Co. 1344 S. Oakley, Chicago**

**FREE Crafts Course**



Active Dealers and Salesmen Wanted

**THE Red Jacket HOME WORK SHOP IS SENT ON TRIAL**

**FREE Blue Prints**

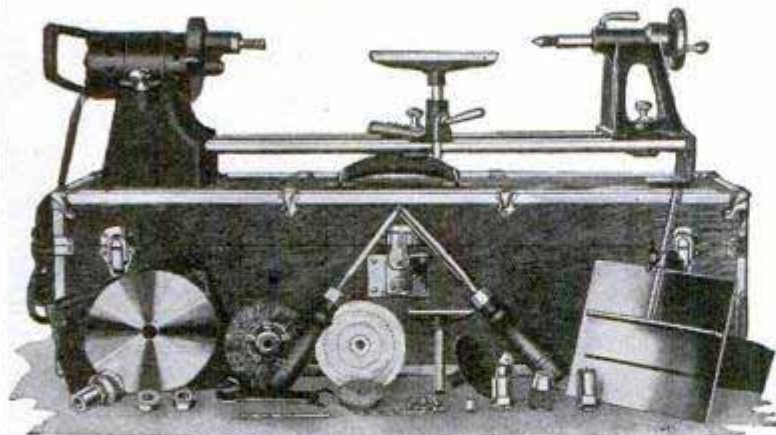

**ONLY \$10.00 DOWN**

**GENUINE ELECTRIC TOOLS (NOT-A-TOY)**

**THE WACO PRECISION LATHE**

A chest full of electric tools that make you an accomplished workman. Designed by a master for the private use of tool lovers and men who want to build, construct, invent and create at home. You will be able to make everything— attractive odd furniture, toys, home and garden improvements, all around manufacturing, repairing.

Complete equipment consists of the powerful Red Jacket Motor, with direct drive to an accurate wood turning lathe (capacity 9 in. x 32 in.); a bench saw; scroll and jig saw; and all accessories for both portable and stationary power drilling, buffing, grinding and cleaning. Attaches to light socket, and gives you complete private tool and machine shop.

Created for "handy" men. So compact, reliable and efficient that you can accomplish any job with it, and so inexpensive that anyone can own it. Unconditionally guaranteed. Our literature is interesting and fascinating, and explains everything. Don't delay. Learn all about the Red Jacket Home Work Bench now.

**BUY ON YOUR OWN TERMS—ONLY \$10.00 DOWN**  
**Liberal Cash Discounts—Ten and 20 Payment Plans**  
**SPECIAL CRAFTS COURSE FREE TO OWNERS**  
**Everything Explained in Our Literature. Ask for It**

**WACO TOOL WORKS, 2915 So. Wabash Ave. Chicago, Illinois**  
 Manager, Dept. 101: Please send me particulars about 10-day free trial, free blue-prints and \$10 down payment.

Name.....  
 Address.....

**SIMONDS HACK SAW BLADES**

Write for your FREE copy of Hack Saw-ology  
**SIMONDS SAW & STEEL CO., FITCHBURG, MASS.**  
 CAL. 30-40



**KRAG CARBINE STYLE**

22 inch Barrel, 5 shot Box Magazine. The choice of hundreds of Big Game Hunters. Barrel slightly used and refinished, other parts NEW. First class serviceable condition. Shipping weight, 13 lbs.

**PRICE \$15 F.O.B.**

**HAND GRENADE BAG**

**45c** Made of fine quality canvas. Size 10x10 inches inside. Suitable for School Bag and hundreds of other purposes. Terms strictly cash. No C. O. D. Shipments. *Catalog Free on Request.*  
**W. STOKES KIRK**  
 1627-P.M. North 10th St. Phila., Pa.



**30 Days' Free Trial**

Select from 44 Styles, colors and sizes, famous Ranger bicycles. Delivered free on approval, express prepaid, at Factory Prices. You can easily save \$10 to \$25 on your bicycle. Prices \$21.50 and up. **\$5 a Month** on any Ranger if desired. Parents often advance first deposit. Boys and girls can easily earn small monthly payments. Pay as you ride. Best quality, at factory prices, express prepaid. Lamps, wheels and equipment, low prices. Send **No Money, do business direct with makers.**



**Mead CYCLE COMPANY**  
 DEPT. 110 CHICAGO  
 Write today for free Ranger Catalog, factory prices and marvelous easy payment terms

**Austin's Blue Flame Kerosene Oil Fired Steam Boiler**



will operate your food cookers, heat your homes, run your small steam engines. Inexpensive to operate. Price complete \$150 F.O.B., Chicago, Ill.

**Manufacturers of kerosene fired stoves—Ranges—Heaters—Hot-dog stands—Coffee Urns.**

If you want to burn kerosene oil, write us for catalog.

**AUSTIN WELDING WKS.**

Dept. 1, 551-555 W. Quincy Street, CHICAGO, ILL.

**\$5,000 A Year**



Without previous experience selling Surety, the original powdered hand soap, direct to users and dealers. We assure your success. Everyone everywhere demands SURETY, the GENUINE product. Don't waste your time on something inferior but write today for FREE SAMPLE and exclusive territory.

**SURETY MANUFACTURING CO.**  
 26 W. Washington St., Dept. 12, CHICAGO

**150 TO 300 MONTHLY FROM ONE DAY BATTERY CHARGING**



Start a Big Profit-Making Business of your own—"One Day Battery Charging." Requires small space and practically no investment. Anyone can successfully operate. Charges batteries in 1/2 the usual time at 1/2 the cost. **Every car owner a customer.** The HB One Day Battery Charger will pay for itself on easy monthly payment plan with practically no expense to you—and bring you a handsome profit besides. Write for full particulars in Bulletin M. NOW!  
**HOBART BROS. CO. Box M-17 TROY, OHIO**

**30 DAYS FREE TRIAL**  
 ON ABSOLUTE MONEY BACK GUARANTEE

**ONLY \$16 MONTHLY—MORE THAN PAID BY INCREASED PROFITS**



Fastest Cutting

**Saws Fifteen Cords a Day!**



**ONLY \$39**

**Men—  
Let Me Send You My  
Greatest LOG SAW Offer!**

It's easier now than ever before to own this fastest-cutting, easiest-moved, most powerful Log Saw. Now, you can make big money sawing firewood, stove-bolts, ice, shingle timber, etc. Write today for full details of this most wonderful offer. Know how easy it is to make big money sawing fifteen cords of wood a day with no hard work.

**350 Saw Cuts a Minute— Make BIG MONEY—**

nearly six each second. Just think of it—now you have a log—in a few seconds it's all sawed up into lengths you can use—without any hard work! The OTTAWA has balanced crank shaft, power force feed, friction clutch.

Wood selling at \$3 a cord brings owner \$45 a day. Saw your own wood—go into the wood business. Don't let the lack of ready money stop you. Remember, we sell on very easy terms. More in use than all others combined.

**Puts the OTTAWA Working for YOU!**

I average \$20 profit a day with my OTTAWA. —J. Schill, New York. "My OTTAWA has earned \$700 for me." —S. Graham, Wisconsin. "I can make more money with the OTTAWA than by farming." —D. Goff, Missouri.



**OTTAWA 4.H.P. LOG SAW**



**30 Days to Try**—one whole month to use the OTTAWA at your own sawing. Shipped on trial only—backed by 10-year guarantee. Prove to yourself how easy you can saw 15 cords or more a day—at a cost of 1 1/4¢ a cord.

**To Save You Freight**—and get your machine to you a few days after you order, I ship from: Ottawa, Kan.; Pittsburgh, Pa.; St. Paul, Minn.; Albany, N. Y.; Memphis, Tenn.; Indianapolis, Ind.; Pueblo, Colo.; Ft. Worth, Texas; Portland, Ore.; San Francisco, Cal.

**FREE** Send me your name and address on postcard today, so I can send you my wonderful new edition of the "Wood Sawing Encyclopedia." Educational, instructive. Be sure to investigate—will help you to make big money.



**HARRY OVERMAN, Pres. OTTAWA MFG. CO.**  
1742-P Wood St., Ottawa, Kans. Room 1742-P, Magee Bldg., Pittsburgh, Pa.

**A Home and Income for You in Sunny Florida**

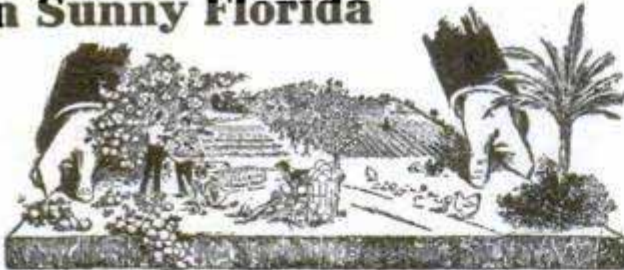

**Be Independent—Own a Grapefruit and Orange Grove—A Truck or Poultry Farm. Increase Your Income**

**THE RIGHT LAND IN THE RIGHT LOCATION AT THE RIGHT PRICE WE HAVE IT—Any Size Farm**

These splendid lands are suburban to Tampa, the metropolis of South Florida. Here you find the most healthful, the most delightful climate in North America. For fifteen years we have been right here helping develop Hillsboro—the banner agricultural County of Florida, and we are still here to serve you and to help you obtain the farm you want, on very easy payments extending over 2 or 3 years' time to suit.

**\$300.00 to \$500.00 Per Acre Profit**

This is not an unusual return for truck farmers in the Famous Tampa district. All kinds of vegetables can be grown. Big prices are paid for early potatoes, Winter cabbage, Bermuda onions, tomatoes, celery and dozens of other vegetables during the Winter and early Spring, when the north is covered with ice and snow. Strawberries, Melons and other small fruits, also yield large profits.

**Write for Facts About Sunny Florida. IT COSTS YOU NOTHING TO LET US PROVE TO YOU** that we have the land you want—in the location you want—at a price you can afford to pay and on the easiest terms you can imagine. Let us show you. Fill out and mail us the coupon today and receive our large descriptive book FREE!

**NORTH TAMPA LAND CO.**

404 Zack Street Tampa, Florida

Coupon for **FREE** Book on Florida

**NORTH TAMPA LAND CO.**  
404 Zack St., Tampa, Fla.  
Please send me your large illustrated Book, "The Call of the Southland," on choice Citrus Fruit and Truck Farms suburban to Tampa, Florida.

Name.....  
St. No.....  
City.....  
State.....

Please mention Popular Mechanics

**AGENTS AND SIGN MEN**

Now Making \$50.00 to \$100.00 and Up Per Week Selling Our **GOLD LEAF SIGN LETTERS**



For store and office windows, board signs, trucks and glass signs. We also make to order script signs and business emblems singly or by the thousands. A permanent business. No capital or experience required. Big demand in every city. Samples and Literature Free.

**CONSOLIDATED SIGN LETTER CO.** 69X W. Van Buren CHICAGO, ILL.

25¢ **CLASS FREE PINS CATALOG** 25¢

Design shown made with any equal amount lettering, 2 colors enamel,



Silver Plate 25¢ ea; \$2.75 doz. Sterling silver 40¢ ea; \$4.00 doz.

**BASTIAN BROS. CO.** 728 Bastian Bldg. Rochester, N.Y.

**Palmolive Shaving Cream**

"5 New Delights for Men"

**STOP CHASING RAINBOWS**

Become a distributor of our World Famous Products. Goods used up between trips. Every item in daily demand. Repeat business assured. We back you with 50 years' experience and unlimited co-operation. Our products backed by \$10,000,000 Company are known and used everywhere.

**A FEW DOLLARS WILL START YOU**

All you need is a desire to work and make good. We show you how. Any average man, satisfied with \$35.00 to \$50.00 a week to start, can establish an income for life with us.

**THE J. R. WATKINS CO., Dept. 33, Winona, Minn.**

**WRITE FOR INFORMATION TODAY**

# FREE Kalamazoo Book of Factory Prices

**NOW READY**



Ranges \$37<sup>75</sup> up

## Save 1/3 to 1/2

New FREE book quotes **Reduced Factory Prices**. Introduces sensational **5-Year Guaranteed Bond** on Stoves, Ranges, Furnaces. 200 styles and sizes. Beautiful porcelain ranges and combination gas and coal ranges in soft grey and delft blue. Mahogany porcelain enamel heating stoves. Cash or easy terms—as low as \$3 down, \$3 monthly. 24 hour shipments. 30 day **free** trial. 360 day approval test. Satisfaction guaranteed. 26 years in business, 600,000 customers. Write today for your copy of this FREE book.



Pipe or Pipeless Furnaces \$59<sup>95</sup> up

**KALAMAZOO STOVE CO., Mfrs.**  
391 Rochester Ave.  
**KALAMAZOO MICH.**

## "A Kalamazoo Direct to You"

Trade Mark Registered

Dries in minutes

**Speed!**

**VALSPAR BRUSHING LACQUER**

use it in a few minutes. Send 20c for sample and literature.

With Valspar Lacquer you can finish furniture in any color and

Colors: Red, Green, etc. **VALENTINE & COMPANY, 458 Fourth Ave., New York**

## STA-LOK CUFF LINKS

To open—just lift the knob—a handsome Christmas Gift for any man

Genuine gold filled Sta-lok Cuff-Links. Will not pull open accidentally. Will stand any strain and are permanently guaranteed. In beautiful gift box. Send \$1 cash or money order.

**NATIONAL JEWELERS, 56 North Fitzhugh St., Rochester, N. Y.**



## A Motor Boat—for half the cost!

The Super Elto clamps on any open boat—gives

all motor boating pleasures at amazingly small cost. Powerful, speedy, reliable. Light and portable. Write today for intensely interesting catalog!



Elto Outboard Motor Co.  
Ole Evansville, Ind.  
Dept. 225 Mfrs. Home Bldg.  
Milwaukee, Wis.

**The Super Elto**

"Starts With a Quarter Turn"

# "I Raze You!"

Welcome news! Here's Barbasol in my hand, and I hold a *straight* shave, *full* satisfaction, and *four* of a kind. No brush. No rub-in. No after-smart. No trouble. Try Barbasol—3 times—according to directions. 35c and 65c tubes.

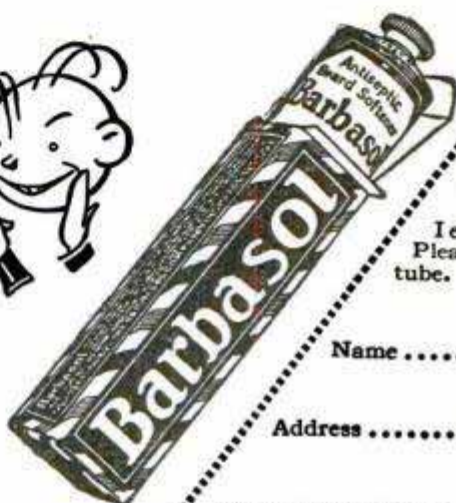

The Barbasol Co.  
Indianapolis Ind.

Enclose 10c. Please send trial tube.

Name .....

Address .....

P-M-1-27

**For Modern Shaving**

## BE PRESIDENT OF YOUR OWN COMPANY

CONCEIVE that of all methods present or past, the Nestler Rubber Fusing Process (U. S. Pat. No. 1,354,992) alone, produces a positive fusion or welding of new and old rubber! —The first and only practical and successful method of re-rubbing a tread worn tire, is here—a simple, quick, inexpensive process that makes tires new again and cuts tire costs in half!

Each year since 1917 thousands of tires have been successfully Nestlerized annually by ourselves and licensees. Due to increased demand caused by high tire prices we have decided to issue a limited number of additional licenses. License rights will include protected territories, free instruction, and full cooperation. 17 million cars and 34 million tires replaced annually constitute a limitless opportunity for business and profit.

The demand for territories is great and prompt action is vital. A printed proposition with full facts and detailed information is now ready. Write for it TODAY.

**NESTLER RUBBER FUSING CO., Inc.**  
DEPT. P1  
245 W. 55th Street, New York City



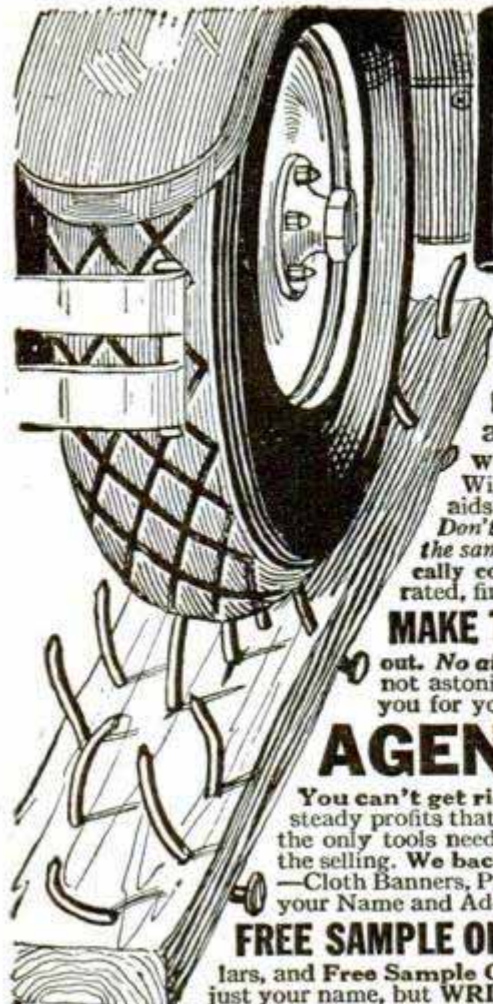

# No More Punctures PROTECT YOUR TIRES IN ONE MINUTE

**Tires Hammered Full of NAILS, Leak No Air**

**GALACITE**—a Scientific, Viscous, Pneumatic Cement (*not a liquid*) **SEALS PUNCTURES** instantly and automatically the moment they occur. One application made in a minute, without taking tire off wheel or rim, does the

**work.** Seals slow leaks and porous tubes. Will not injure tire or tube. On the contrary, Galacite aids in preserving rubber, often doubling tire life. *Don't confuse Galacite with anything else ever intended for the same purpose.* It is new, different, clean, and scientifically correct, manufactured by a long established, highly rated, financially responsible concern.

**MAKE THIS TEST:** Take a hammer—drive as many nails into a tire as you wish—then pull them out. *No air will escape. No pressure will be lost.* If you are not astonished and delighted with results, we will even pay you for your time and trouble.

## AGENTS—Big, Quick Profits

You can't get rich in an hour—but you can make immediate-sure-steady profits that are amazing. A hammer and hand full of nails are the only tools needed—*no lengthy arguments*—a demonstration does the selling. We back our agents with powerful advertising helps—Cloth Banners, Posters, Newspaper Ads, and Circulars printed with your Name and Address. **The price per tire is very low.**

**FREE SAMPLE OFFER.** Get the facts and get them now. RUSH your name to us for full particulars, and **Free Sample Offer.** Territory is going fast. Send no money, just your name, but **WRITE TODAY.**

**C. F. Johnson & Company, 19 W. Jackson Blvd., Chicago, Ill. Dept. 435**

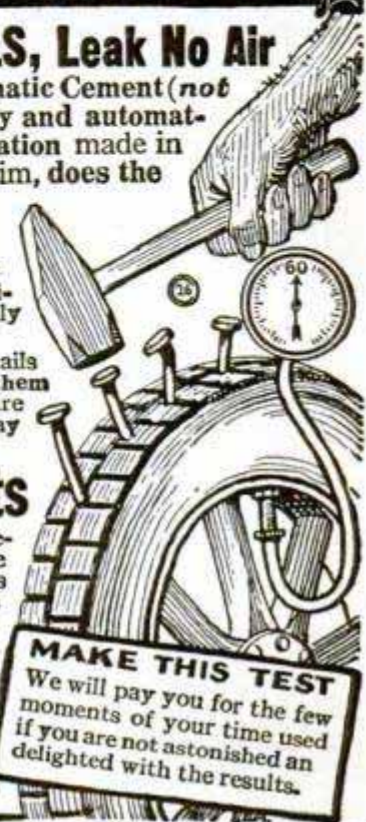

**MAKE THIS TEST**  
We will pay you for the few moments of your time used if you are not astonished and delighted with the results.



**BUILD BUSINESS WITH AIR!**

Only \$12 monthly for a few months brings the best business builder and advertisement your shop can have if you sell to the car owner. Tire Stores, Garages, Battery Shops, Filling Stations are making big money with the new low-priced HB Automatic Air Compressor—priced \$75 to \$100 less than similar equipment on the market. Ask for bulletin AC 6—Tells all about it. **HOBART BROTHERS CO., Box M172, Troy, O.**

**FREE** 1000 Illustrations **ELECTRIC FIXTURE CATALOG!**



Write today for your copy. Save 50% direct from Manufacturer. No Middleman's Profit. **OUR SPECIAL: 8 Room Electric Set, ready to hang, \$24.50—Other bargains.**

**UNITED LIGHTING FIXTURE CO.**  
83 Flatbush Ave. Dept. P, Brooklyn, N. Y.





**MOVIES IN YOUR HOME**

Write for interesting catalog of movie machines and films—Low Prices.

**PILGRIM CO., DEPT. 117, MEDFORD, MASS.**



**Do Your PRINTING**

Cards, stationery, circulars, tag, labels, paper. **Complete Outfits, \$8.85 up, Job Presses \$11 up, Rotary \$149.** Card Cutters, \$3. Save money. Print for others, big profits. All easy rules sent. Write for catalog presses, type, paper cards, ink etc. **THE KELSEY CO., P-37, Meriden, Conn.**

# Making It Easy to Build Things!

Men everywhere find it easy to build things of wood with Boice-Crane Machines. New 64-page illustrated booklet explaining how to perform many wood-working operations sent postpaid upon receipt of 10c. Also shows complete line of Boice-Crane Circular Saws, Jig Saws, Band Saws, Mortisers, Jointers, Lathes, Drills and explains our money-back guarantee.

**14' Band Saw**  
Table 12"x14" tilts 45 degrees. Saws 7" stock. Uses blades 3/8" to 1/2" wide. Bronze bearings.

**Handisaw Model 2**  
Does ripping, mitering, grooving, sanding, grinding and drilling with ease and accuracy. Table 10"x13". Saw 7" dia. Cuts 2 1/2" stock. Dados 3/8"x5/8". Cuts moulding.



**8' Bench Lathe**  
Does turning, drilling, sawing, sanding, grinding and jig sawing in wood or soft metal. Swings 8". Capacity between centers 19". Metal-working model fitted with compound slide rest. All Boice machines driven by 1/4 to 1/2 h. p. motor attached to light socket. Machines sold with or without motor. Send 10c for Booklet NOW.

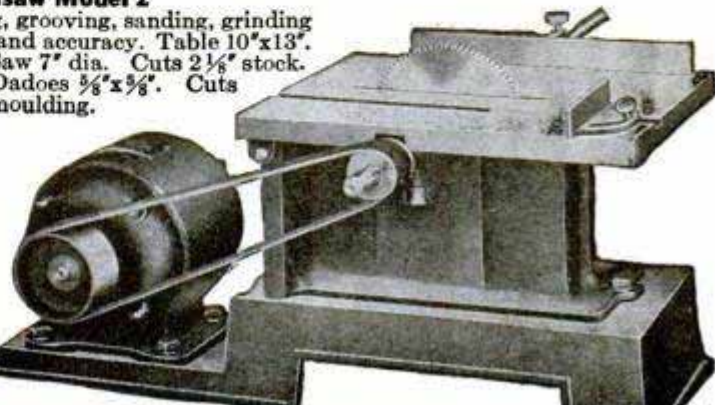

**W. B. & J. E. Boice**  
Dept. P. M., I-C, Toledo, Ohio

# What I Will Do!

Yes, only \$1 will bring your choice of these Big Bargains for your approval and 15 DAY TRIAL. Simply pin \$1 bill to this ad, indicate your selection and mail it TODAY. If you can duplicate your selection for less money elsewhere, send it back and your \$1 will be refunded. If satisfied, pay balance in 10 equal monthly payments. NO RED TAPE - PROMPT DELIVERY. DEALINGS CONFIDENTIAL.

**B80--** Ladies 18K White Gold Ring, beautifully designed, AA 1 Blue-white Diamond. \$50 \$4.90 a Month.

**B81--** Ladies hand-engraved 18K White Gold Birthstone Ring set with 2 Blue-white Diamonds. Any birthstone furnished. \$25. \$2.40 a Month.

**B82--** Ladies hand-carved 18K White Gold ring, with 3 Blue-white Diamonds. \$45. \$4.40 a month.

**B83--** Gents 14K Solid Gold hand-engraved Ring with AA1 Blue-white Diamond set in White Gold square-top \$42.50. \$4.15 a Month.

**B84--** 14K White Gold Wrist Watch: 4 Blue, white Diamonds; 4 Blue Sapphires. Guaranteed 15 Jewel movement. \$42.50. \$4.15 a Month.

**B85--** Famous Bulova Gents Strap Watch 14K Gold filled case, guaranteed 15 Jewel movement. \$28.50. \$2.75 a Month.

**B86--** 12 size 21 Jewel Illinois Victor Watch; 14K Green Gold filled case. Price \$45. \$4.40 a Month.



8000 Big Bargains in Diamonds, Watches and Jewelry shown in the catalog. Send for it Today--it's FREE.

**L.W. SWEET Inc.**  
DEPT. 67-F 1660 BROADWAY NEW YORK

## Guaranteed to Start Coldest Motor Instantly

Astounding new invention for all cars. 1 Quick-start free to Distributors. Drawing Account and Traveling expenses guaranteed Exclusive Agents.

QUICKSTART MFG. CO., 805-A Station C, OMAHA, NEB.

## CUT WINTER FUEL THE EASY WAY



The farmers best helper for 40 years. Thousands save money and backaches every year. YOU CAN TOO. Send for free catalog showing low prices. Address Dept. 115. FOLDING SAWING MACHINE CO., 2633 S. State St., CHICAGO, ILL.

## AMERICAN SCROLL SAW

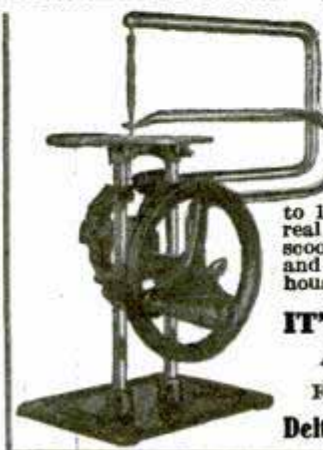

It's Easy to Build Things When You Use This Saw

You will like its sturdy, mechanically correct construction; the ease of operation; the smooth, absolutely square cut. Cuts fibre, bakelite, wood up to 1" and metal up to 1/4" thick. A real tool to make your radio sets, scooters, cabinets, experimental work and lots of useful things around the house, etc. Can be motor-driven.

IT'S A REGULAR TOOL And the Price Is Right

For details write to Dept. A-116

Delta Specialty Co. 858 Third Street MILWAUKEE, WIS.

# "I Made \$1,000 a Month from the New Food Sensation Greaseless Doughnuts"

That's what Thomas Minch did with Brown Bobby. You, too, can cash in big on this sensational new food product. Think of it! Actually a Greaseless Doughnut!

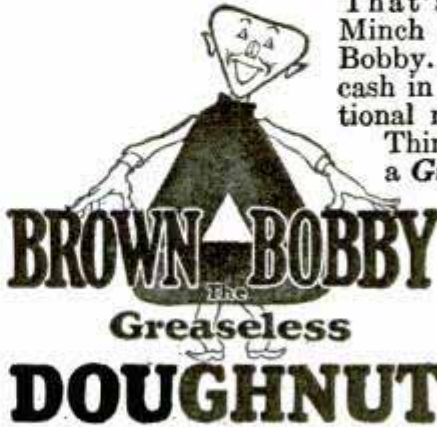

Mrs. Nelson, Rockford, Ill., makes Brown Bobbys at home. "Sold 90 doz. last week. Will sell 3 times that many this week. Wonderfully easy."

Fair Store, Chicago, says: "It's a great money-making device." "The demand for Brown Bobby is beyond my wildest expectations," writes Jas. O'Connor, Chicago. Hundreds of others are meeting equal success. Your opportunity is here. Write!

## Big Profits for YOU!

Millions of greasy doughnuts are sold daily, hard as they are to digest. What a mammoth market for Brown Bobby! Cooked without a trace of grease to a golden brown—crisped to a feathery lightness—Brown Bobby is positively the food sensation of the age. No one thought a doughnut could be made without grease. But WE did it. And YOU can get in on the first easy profits.

## Simple, Easy, Sure

Get this! With one simple, inexpensive, electrically operated machine, you can turn out a full dozen Brown Bobbys every 3 minutes—cost, less than 1c each. No baking skill required. Just add water to our patented "Mix." No bother. No boiling grease. No odor. A child can do it. Big money for women making Brown Bobbys at home. Tremendous opportunities in every town for a thriving business on a surprisingly small investment. Wherever there are hungry people, Brown Bobby is a sure hit. In lunch rooms, drug stores, wherever food is sold Brown Bobby offers a chance for amazing profits. Special openings for Brown Bobby Specialty Doughnut Shops in every town.

Write Quick! Be the first in your locality to get the first easy profits. Whatever your present line-up, let us present you a plan that will be feasible and full of opportunity for a steady, paying business. Just mail the coupon! Get the facts now. Profits are waiting.

## FOOD DISPLAY MACHINE CORP.

28 E. Jackson Blvd., Dept. 13-51, CHICAGO, ILL.

Food Display Machine Corp., Dept. 13-51  
28 East Jackson Blvd., Chicago, Ill.

Gentlemen: Please send me the plan by which I can cash in on Brown Bobby, the Greaseless Doughnut. It is understood that this obligates me in no way whatever.

Name.....

Address.....

IMPORTANT! If you will write us brief details of your present business and future plans, we will gladly outline a Brown Bobby business plan to fit your individual case.

# Greater Distance, Finer Selectivity, Greater Power with These AERO COIL Supersensitive Units!



## Tuned Radio Frequency Kit Price \$12.00

Will positively improve the performance of any receiver. Patented Aero Coil Construction eliminates radio frequency losses and brings tremendous improvement to volume, tone and selectivity. The antenna coupler has variable primary. Uses .00035 condenser. 8 page color circuit layout and instruction sheet for building the supersensitive 5 tube Aero-Dyne receiver packed with each kit. Extra copies, 75c each. Instructions include insert showing how to wire up for Power tube if desired.

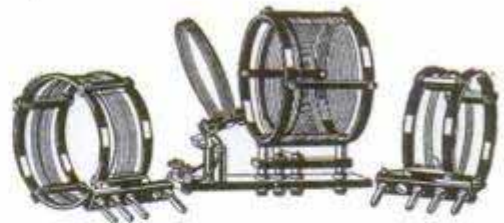

## Low Wave Tuner Kit Price \$12.50

Completely interchangeable. Adapted by experts and amateurs. Range 15 to 130 meters. Includes three coils and base mounting, covering U. S. bands 20, 40 and 80 meters. You can increase the range of this short wave tuner by securing coils No. 4 and 5. Combined range of 25 to 550 meters. Both interchangeable coils fit same base supplied with short wave kit and use the same condensers. Coil No. 4 price, \$4.00; Coil No. 5, \$4.00.

**GET THESE COILS from your nearest dealer. If he should be out of stock, order direct from the factory.**

**AERO PRODUCTS, Inc. Dept. 107, 1772 Wilson Ave., Chicago, Ill.**

**PROVED!**  
40,000 Radio Users Demonstrate Reliability and Wonderful Performance

**\$12.50**  
40,000 in Use



**FERBEND "B" ELIMINATOR** Complete  
Replaces "B" Batteries. Operates direct from socket on 110-120 volt A. C. lighting circuit. Delivers up to 100 volts.

Second successful year. Constant flow of unsolicited testimonials prove its splendid performance. Amazingly low in price—high in value. Equal to any "B" Eliminator, regardless of price—not only in operation, but in workmanship, quality, durability and appearance.

Ask Your Dealer—or Send Direct Shipment made direct on receipt of price, or C. O. D. if preferred. Use for 10 days to convince yourself—if unsatisfactory write us within that time and purchase price will be refunded.

SEND ORDER TODAY.

**FERBEND ELECTRIC CO.**  
415 W. Superior Street  
Chicago, Ill.

The FERBEND "B" Eliminator is approved and passed by the Right laboratory tests of Radio News and Popular Radio.

**100 SCALE PLANS**  
for building old and modern ship models. Free catalog of plans, books, prints, maps and other things that smack of the sea.



SEA ARTS GUILD, 405-A Eleventh Avenue, MILWAUKEE, WIS.

# A touch and it's done

all you need is heat—and Kester Metal Mender. It's ready to use and with it you can do your own soldering at home as well as an expert. Full directions with each can, enables anybody to solder.



**KESTER METAL MENDER**  
CHICAGO SOLDER COMPANY  
4201-362 Wrightwood Ave., Chicago, U. S. A.  
Est. 1899

**SM**

## 220 & 221 AUDIO TRANSFORMERS

Do you know that the unofficial report of the largest telephone manufacturing company in the world set S-M 220s up as the very finest they have ever tested? Do you know that a large manufacturer building reproducing equipment for new theatres standardized on 220s and 221s after going over the entire market? Do you know that the maker of the finest electrically cut phonograph records stopped looking for reproducing equipment when his laboratory reported on the 220s and 221s? Do you know that every important magazine has recommended them?



S-M type 220 audio transformer is designed for all stage use in ordinary or power amplifiers, with all standard tubes. S-M 221 is an output transformer, to be used between your power tube and loud speaker. It's guaranteed to improve quality and handling power—unconditionally, with any set or speaker. Both types are priced at \$6.00.

Prices 10% higher west of the Rockies.

**SILVER-MARSHALL, INC.**  
840 West Jackson Blvd., Chicago, U. S. A.

### When You Want a BLOTORCH

That gives 400° more heat—  
That's 100% safe—send for

**TURNER MASTER No. 45**  
Only \$7.75, postpaid

TURNER BRASS WORKS, Industry Ave., Sycamore, Ill.

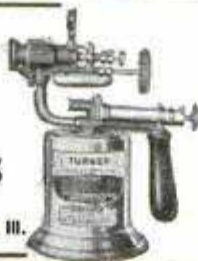

## FREE RADIO CATALOG

LATEST  
IN  
HOOK-UPS  
AND  
RADIO

NEW 1927 EDITION—FREE 164 PAGES  
Greater bargains than ever before in  
standard sets, parts, kits and supplies.  
The parts you want, at big savings. Special  
prices on sets, tubes, batteries, etc.  
Write today for free Guide. Please include name  
of another radio fan.  
The BARAWIK Company 540-551 Monroe St.  
CHICAGO, ILL.



THIS 68 PAGE  
RADIO  
CATALOG  
**FREE**

Contains 75 Radio "Hook  
Ups," 300 Illustrations, 630  
articles, 8 page Log Book of  
all U. S. Broadcast Stations.

"Build your own with 'RASCAL' Parts"  
RADIO SPECIALTY CO., 98 E. Park Place, New York, N. Y.



TO those accustomed to ordinary reproduction, the Tower Cone guarantees a refreshingly new quality of service—real beauty of tone, deep, rich and clear, with a volume truly delightful. Such quality of reproduction—a notable forward-step in the acoustic art—is directly due to the scientific features of design only found in Tower.

*On Sale from Coast  
to Coast*

TOWER MFG. CORP., Boston, Mass.



# THOUSANDS OF RADIO SET OWNERS need these improvements

THE U. S. Navy the Signal Corps and 69 makers of leading standard sets use the variable resistance controls made by Central Radio Laboratories. These improved controls should be used on your set if you want the last word in quality for fine reception. Yet, owing to our huge output the cost is no more than for many inferior devices.



### Modernize Your Old Set with Centralab Modu-Plug

Tone volume is, as you know, the one big improvement in this year's best sets. You can enjoy this improvement with your present receiver for only \$2.50. Modu-Plug is especially for that purpose. It provides full tone volume control from a whisper to maximum, simply by adjusting the small knob on the plug. Matches the speaker impedance to the set. Attaches instantly without tools.

Standard type Modu-Plug replaces present speaker plug. Cord type fits sets not equipped with jacks. Either type, at dealer's, or mailed direct. . . . . **\$2.50**



### Centralab Radion M With "A" Battery Switch

Here is the variable resistance guaranteed always smooth, noiseless and permanent in adjustment. Tapered to control oscillation and volume, it also has a positive, quick acting "A" battery switch. One knob replaces two. Turning knob to right lights tubes, then increases volume. To left decreases volume, then cuts off batteries. Resistance is 0 to 500,000 ohms. You cannot imagine the great improvement until you try it. Adapted to all circuits. **\$2.30**

At dealer's, or mail direct, . . . . .

### Centralab Rheostat S

Where your old design rheostat overloads, heats-up and quickly becomes noisy on new style tubes using increased current, Centralab Ribbon-type Rheostats will operate smoothly and permanently quiet. Insulated metal discs hold rigid a smooth flat resistance surface instead of wires, insuring even regulation and no dead spots. Every set using this rheostat is improved. 2 resistances for 5 to 10 tubes, at dealer's, or mail direct, **\$1.25**

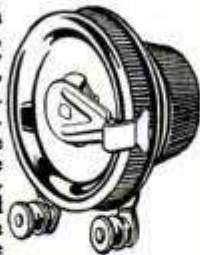

We make variable resistances for both the U.S. Navy and Signal Corps and for 69 makers of leading standard sets

**SEND NO MONEY** — If your dealer isn't supplied, order direct from us. Send no money. Simply pay postman on delivery, plus few cents postage. Install and test for 10 days. Then if you are not more than pleased and delighted with the wonderful results, return the goods to us and your money will be refunded. **10 DAYS' FREE TRIAL!**

CENTRAL RADIO LABORATORIES  
30 Keefe Avenue Milwaukee, Wis.



Please Mention Popular Mechanics

# FREE

## NEW 1927 Radio Catalog

WRITE TODAY TO

## Chicago Salvage Stock Stores

509 S. State St. Dept. PM Chicago, U. S. A.

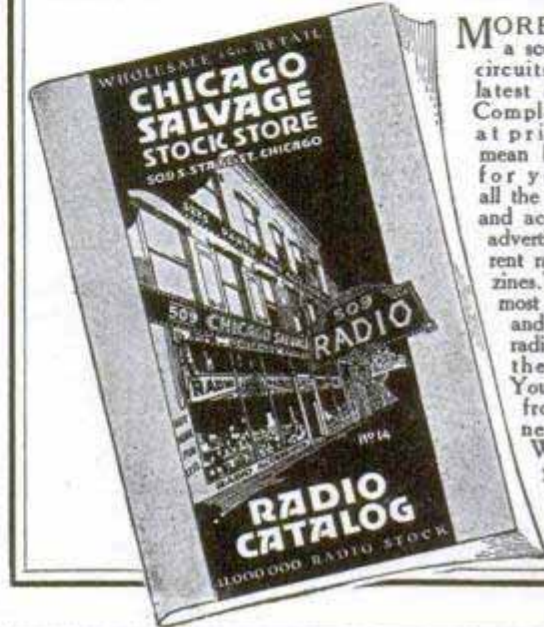

MORE THAN a score of new circuits—all the latest and best. Complete parts at prices that mean big savings for you. And all the latest parts and accessories as advertised in current radio magazines. The largest, most complete and up-to-date radio stock in the world. Yours to choose from in this new catalog. Write for your copy.

### \$20,000 — Specialty Salesman — \$20,000

Want State distributors at once. No investment. Call on merchants, banks, wholesalers and manufacturers only. \$20,000 a year easily possible on greatest merchandising plan ever conceived. Unit of sale, small profits tremendous. Man capable of handling executives only kind considered. Wire or write today. Aerial Electric Co., 128-36 W. Kinzie St., Chicago

# "B" BATTERY ELIMINATOR

Only **\$7.95**



### MONEY-BACK GUARANTEE

No more worry with "B" Batteries! Hook up a Roll-O "B" Battery Eliminator and forget battery troubles forever. This wonderful new invention means better reception, sharper tuning. Gives you more real pleasure from your set.

Completely Equipped—No "Extras" to Buy  
Operates perfectly on direct or alternating current, giving up to 90 volts current, and using the full wave of the power supply. Simple directions enclosed—anyone can plug it in to any kind of set up to six tubes. Constant voltage gives set more power. Costs no more than set of good "B" Batteries. Solidly built in beautifully finished metal case, with genuine Bakelite top.

### SEND YOUR ORDER NOW

Don't blame your set because run down "B" Batteries won't let it work right. Order your Eliminator NOW. Write name and address on a piece of paper, pin a dollar bill to it, and mail it TODAY. Pay postman balance (\$8.95 plus a few cents postage) when he delivers your Eliminator. Use it ten days. If not more than satisfied, return it and get your money back. Roll-O Trickle Charger, for either "A" or "B" Batteries, only \$3.95 (plus few cents postage). Send \$1.00 with order—balance C. O. D. Satisfaction guaranteed or money refunded.

THE ROLL-O RADIO CO.  
Dept. R-3 Third and Sycamore, Cincinnati O.

Send **\$1.00**

# 30 Days Free Trial

Just Out -  
1927  
Model

Yes Sir!  
You can put a new 1927 Westingale Radio in your home and use it to your heart's content on 30 Days' Trial. Listen to music, concerts, news, sports, market reports from stations all over the country. Compare it with old style 3 or 4 dial sets costing more, then if not convinced that Westingale gives you the greatest Radio satisfaction and the best value for your money, you don't have to keep it.

New ONE  
Dial Radio

\$57<sup>00</sup>

Retail Price

Big Discounts  
to Agents

NOW! Westingale offers the last word in Radio. Either 1 or 2-Dial Control — easiest to tune and years ahead in powerful reception and tone. Newest period type cabinets, two-tone walnut finish. The front panel embossed in dull gold with artistic Spanish Galleon design. Unbeatable for performance, appearance or price.

2-Dial, 5 tubes \$47<sup>00</sup>

1-Dial, 5 tubes \$57<sup>00</sup>

Where else can you get so much for the money on 30 days trial? Why pay more? Why take chances? Why not have the NEWEST Radio when you can try them at our risk. Before you buy get our Free Catalog and 30 Day Trial Offer

Westingale Electric Co.  
Department 130  
1751 Belmont Av., Chicago, Ill.



**AGENTS WANTED**  
BUY at COST

Your own Radio Free. Get demonstrator set on 30 Days' Trial—make \$100 a week easy. Full or spare time. Big discount on first set placed in each locality. Be first—write today for dealers' discount and full details.

## Simplified Radio Blueprints

Blueprints for the most popular sets described in Popular Mechanics Magazine can be obtained for a charge just sufficient to cover the cost of production and mailing. The sets for which blueprints are available are:

Simple One-Tube Receiver	April 1926	15c
Two-Tube, Loud Speaker Set	July 1925	10c
Three-Tube, Cockaday Receiver	April 1925	10c
Three-Tube, Low-Loss, Short-Wave Set	Oct. 1925	10c
Three-Tube, Loud Speaker, Loop Set	Dec. 1926	15c
Three-Tube, 15 to 550 Meter Set	Nov. 1926	15c
Four-Tube, Loop Set, for Car or Home	Aug. 1926	15c
Five Tube, Browning-Drake Set	May 1926	15c
Six-Tube, Self-Contained Receiver	July 1925	10c
Six-Tube, Counterphase Receiver	Feb. 1926	15c
Six-Tube, Portable, Loop Set	June 1926	15c
Six-Tube, Perfect-Tone Receiver	Nov. 1925	10c
Eight-Tube, 1927 Model Superheterodyne; this set of blueprints includes drilling templates and extra photos	Oct. 1926	75c
B-Battery Eliminator	Mar. 1926	15c
Non-Radiating Unit	May 1926	15c
Simple Tube-Tester and Chart	July 1926	15c

Address the RADIO DEPT.  
Popular Mechanics Magazine  
200 E. Ontario St., CHICAGO

Back numbers of the magazines describing the construction of the sets can be obtained from our Circulation Department, price 25 cents each.



## RADIO DRILL

This drill was designed particularly for the amateur experimenter and manufacturer of radio equipment and is adaptable for any work within the range of its capacity.

It is equipped with a swinging adjustable table, ball thrust spindle, chuck capacity 0 in. to 1/4 in., and has belt-shifter on tight and loose driving pulleys.

Manufactured by  
H. & D. MACHINERY CO.  
P. O. Box 2 Whitman, Massachusetts.

\$12.00



## RADIO BOOK FREE

Tells how you can make big money in world's newest and greatest field. Presents lifetime opportunity in Radio. Right now we want live agents and dealers in every locality, \$60 to \$100 a week easy.

**40% TO 60% PROFIT**

**FREE** Simply send name for this big illustrated book explaining liberal profit proposition and how to get latest radio goods at wholesale. Also prices on parts, sets and accessories and amazing special offers—all free. Write today.

**STANDARD RADIO CO.** 1402 Walnut Street  
KANSAS CITY, MO.



5 Tube Set  
only \$39<sup>50</sup> RETAIL



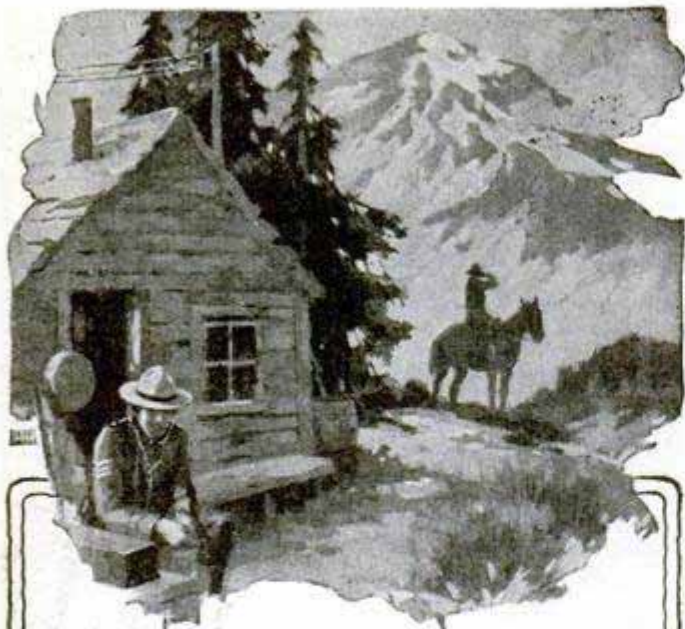

## The "Mountie" isn't lonely any more

WHEN the supply ship steams south from the last outpost of northern civilization in September, not to return until the following July, loneliness will never again beset the lives of the Royal Canadian Mounted Police who patrol that vast, wild area.

Radio is now brightening the long winter nights with music, special programs, messages and greetings from their "home folks." And in the receiving sets of the "Mounties" is the best equipment obtainable. The batteries they use *must* be dependable. They *must* serve until new supplies are brought in a year later.

Ask Any Radio Engineer

**BURGESS BATTERY COMPANY**

GENERAL SALES OFFICE: CHICAGO

Canadian Factories and Offices:  
Niagara Falls and Winnipeg



# BURGESS RADIO BATTERIES

## IT'S A WONDER!

### Works So Easy



## Press-to-Feed Electric Soldering Iron

A great invention. Indispensable for all kinds of soldering work. Convenient, simple, economical. One hand does the work of two. Made with removable tip— $\frac{3}{8}$ " and  $\frac{3}{4}$ " round, making it adjustable for light or heavy work. Trigger Press-to-Feed attachment takes all sizes of solder wire. Operates on either D. C. or A. C. 110 to 115 volts, 50 watts. Attachments are made to fit all leading makes of electric soldering irons. Price complete with Press-to-Feed attachment... **\$3.50**  
Attachment only..... **1.50**



### Radio Work

requires this iron. Gets into tight places with ease. Speeds up radio set building.

### Agents

Press-to-Feed is a necessity for industrial and domestic uses. Big profits selling this wonderful iron to factories, homes, auto mechanics, etc. Order a sample. Quantity discounts on request. Write to

**ILLINOIS STAMPING & MFG. CO.**  
220 N. Jefferson St., Dept. 21, CHICAGO

# 2000 RADIO BARGAINS Here

## The Guide to Radio Prices and Radio Quality

Our vast resources and radio experience have been utilized to assemble in one gigantic institution, the best and newest things in radio. The Randolph catalog is the great radio market place—a masterpiece of merchandising that befits our house—

## The World's Largest Exclusive Radio Mail Order House

Catalog Contains Over 2000 Items, from the most beautiful, fully equipped console radio set, down to the smallest part or tool, for the set builder—kits, parts and supplies of every type and style. All beautifully illustrated and interestingly described. Also valuable data of today's most fascinating and most wonderful achievement—RADIO.

## 5-TUBE SETS AS LOW AS \$24.90—Latest 1927 Models

All Randolph sets are sold at amazingly low prices. No matter what kind of set you want—no matter how little you want to pay—you can select YOUR SET AT YOUR PRICE from the Randolph catalog. **WE SAVE YOU MONEY** Because we handle radio exclusively and sell a tremendous volume of everything in radio, we can concentrate our buying power for the benefit of our customers.

**SEND FOR BOOK TODAY** We cannot begin to tell all about this wonderful Radio Book. Simply send letter or postal and this bargain catalog of guaranteed radio sets and supplies will come to you absolutely FREE.

**RANDOLPH RADIO CORPORATION**  
180 N. Union Ave. Dept. 212 Chicago, Ill.



Save  
 $\frac{1}{3}$  to  $\frac{1}{2}$

# A&B Battery \$2 Charger ONLY

## SATISFACTION GUARANTEED



Charges any type of storage A or B battery, using a few cents worth of ordinary house current, either alternating or direct. Cannot injure battery. Complete directions enclosed. Anyone can operate it. No expensive "extras" to buy. Why pay \$10.00 to \$15.00 for a charger when you can get this splendid GUARANTEED R. B. Charger by mailing us two dollars (bills, money order, check or stamps) plus ten cents in stamps or coin to pay mailing costs. Charger will be sent postpaid. If you are not satisfied, return within five days and we will refund your money. Order at once—TODAY.

**R. B. SPECIALTY CO.**  
Dept. F-1 308 East Third St., Cincinnati, O.

**American RADIO** Now—  
**50% DISCOUNT ON RADIO!**  
BIG NEW 1927 CATALOG—FREE

Dealers, Agents, Set Builders—get our big 1927 Catalog—225 nationally advertised lines. Lowest prices in America! Largest, most complete stock. Radio's latest developments. It's FREE—send for your copy now. American Auto & Radio Mfg. Co., Inc. 1424 McGee St., Kansas City, Mo.

# SOLDERALL

METAL IN PASTE FORM

The only convenient metal solder

Every Electrical Connection needs Solderall for perfect reception

**25¢**

The SOLDERALL CO., NEWARK, N.J.

# Auto Owners Wanted

To introduce and use HYDRO INSURED TIRES. Hydro Agents make money selling the only tires in the world insured for one year against all road hazards regardless of mileage. HYDRO TIRES sell fast because they have no competition in price; no rival in quality; no imitation in appearance and no equal in the insured protection to the user. Insurance Policy with every tire. Are made by the only tire factory in America selling its own product through authorized Salesmen—Agents. We offer opportunity of lifetime to establish profitable tire business of your own. No capital required. Sales kit and advertising helps furnished. Exclusive territory granted. Write today for catalog and complete information about the Hydro Agency Plan.

## HYDRO INSURED TIRES

The Most Beautiful Tire in America

HYDRO-UNITED TIRE CORPORATION, Address Dept. PM 11, POTTSTOWN, PA.

# World's Lowest Priced Shock Absorber

Marvel Shock Absorber and Spring Control for all cars

Checks rebound and cushions downthrow—a proven advantage over strap controlled shock absorbers which check rebound only. Easily installed in a few minutes on front and rear springs.

Send check or M. O. We pay postage

**MARVEL PRODUCTS COMPANY, 4225 Lorain Avenue, Cleveland, Ohio**  
Makers of Patented Shock Absorbers for many years.

**PERFORMANCE GUARANTEED EQUAL TO ANY DEVICE AT ANY PRICE.**

For Chevrolet, Star & Ford **\$3.80** per complete set of 4 All other cars \$4.60

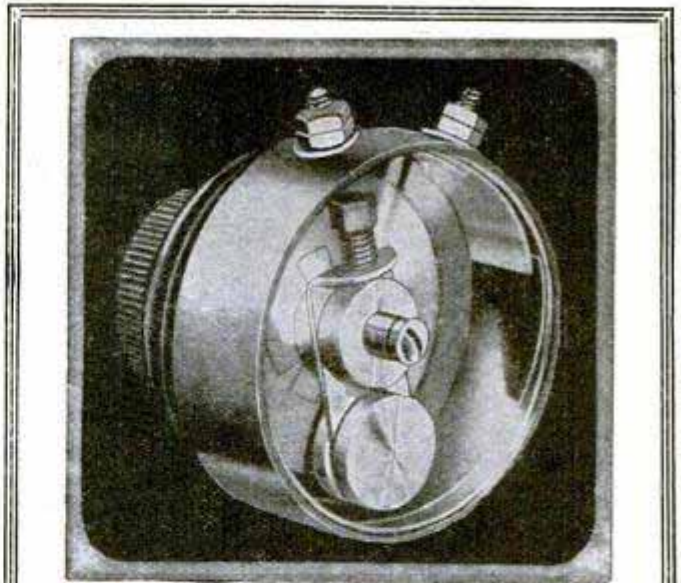

## Note the difference!

INSTALL **FROST-RADIO** Super Variable Resistance Units in your new set and note the difference! Nearly all of the new radio circuits call for one or more of these new non-inductive high resistance units. They are smooth and noiseless in operation and give any degree of resistance from zero to maximum without steps or jumps. Type 880 (2 terminals) is supplied in resistances of 50,000, 100,000, 200,000 and 500,000 ohms; type 890 (3 terminals) in 400, 2,000, 50,000, 100,000, 200,000 and 500,000 ohms. Both types, list \$1.25 each. Your dealer has them.

**HERBERT H. FROST, Inc.**

160 N. LaSalle Street

New York

CHICAGO

Los Angeles

# RADIO PANELS OF GENUINE BAKELITE

Cut, drilled and engraved to order. Send rough sketch for estimate. Our New Catalog on Panels, Tubes and Rods—all genuine Bakelite—mailed on request.

**STARRETT MFG. CO.** 524 S. Green St. Chicago, Ill.

The man who studies gets ahead. Popular Mechanics Press will advise you what books to read to advance in your trade, 200 East Ontario Street, Chicago, Illinois.

# Famous MARWOOD Now Sold on Easy Terms

1 Dial 6 Tube **\$43<sup>85</sup>**

**Get Agents Price—Save 50%**

Great news! Now own a famous Marwood at the world's lowest price for real quality—and pay on easy terms. The only Radio sold direct on easy terms—proof that the Marwood MUST be a wonder. A year ahead with 4 big exclusive improvements—Super-Selectivity, Power-Tube Volume, New Easy-Tuning Principle, New Tone Quality. Save half—and get a Radio that can't be beat at ANY price. It's a beauty—figures etched in gold.

## 30 Days Free Trial

Both Models Shipped  
**Complete With All Accessories**

We trust you. Prove the Marwood the best buy in America. Don't buy a Radio till you get our easy terms, 30 Days' Free Trial, Agent's Confidential Low Prices, Free Radio plan, new Catalog. Agents—Write quick for territory. Make big, easy spare-time money.

6 Tube 3 Dial **\$36<sup>85</sup>**

**MARWOOD RADIO CORPORATION**  
1747—A56 Morse Ave., Chicago, Ill.

# Make FURNITURE at Home

You Can Do It in Spare Time—It's Easy

THE simple designs in furniture are, after all, the most attractive. And the best of the easily-made styles have been gathered into "Popular Mechanics Furniture-Making Books." These books are filled with pictures that show you how the finished piece looks, and how to lay out, saw, and put together the various parts. You are also told how to finish your furniture in the most attractive ways. Nowhere else will you find instructions more clear. Nowhere else will you find such a marvelous assortment of simple designs to select from. Think of it! 142 different designs, including all the pieces of furniture and the different styles of lamps you need to make your home a pleasant place to live.

142 Pieces

Complete Instructions and Designs



## Popular Mechanics Furniture-Making Books Tell How to Make These 142 Pieces of Furniture and Lamps



You can make any of these pieces

Only Simple Tools Needed

- Settee
- The fuming of oak
- How to make black wax
- 40 styles of chairs, beginning with the Egyptian style made 500 years before Christ
- Piano bench
- A shaving stand
- A waste paper basket
- A cigarette pedestal
- A princess dresser
- A sideboard
- A window seat
- A plant stand
- A bedside medicine stand
- A hall chair
- A side chair
- An arm chair
- A book case
- A lamp stand
- Extension dining table
- An oak-bound cedar chest

- A dresser for child's playroom
- Arts and crafts oil lamp
- China closet
- An oak bedstead
- A footstool
- A library set in pyro-carving
- A grille with pedestals to match
- A lady's writing desk
- A telephone stand and stool
- An oak medicine cabinet
- Home-made mission chair
- A lamp stand and shade
- A porch chair
- A tabouret
- A Morris chair
- A mission book rack
- A substantial library table
- A mission candlestick
- A low-back mission chair
- A magazine stand
- A lawn swing
- A portable table
- A combination billiard table and davenport

- Easily made book shelves
- A blacking case tabouret
- A Roman chair
- A roll top desk
- A pyrographer's table
- A piano bench
- A library table
- A princess dresser
- A sewing box
- A fern stand
- A wardrobe
- An oak table
- A book trough
- An oak serving table
- An umbrella stand
- A chafing-dish buffet
- A writing desk
- A music rack and book stand
- A dictionary and magazine stand
- A leather back arm chair
- A wall shelf
- A pedestal
- A magazine rack
- A hall tree

- One-light portable lamp
- Two-light portable lamp
- Four-light chandelier
- Dining-room dome
- Reading lamp
- Parlor or den lantern
- Lantern
- One-light portable shade for droplight
- Four-light chandelier
- One-light bracket
- Piano lamp
- Nevel post lamp
- Electric candle sconce
- One-light bracket
- Droplights
- Reading lamp No. 1
- Reading lamp No. 2
- Square dining-room dome
- Mission chandelier
- Desk light
- Droplight No. 3
- Chandelier
- Hexagonal library lamp
- Hexagonal dome
- Lamp No. 1
- Lamp No. 2
- Lamp No. 3
- Lamp No. 4
- Conventional patterns
- The butterfly design
- The pyramid design
- An oak buffet
- Oak stain
- A plain oak hall clock
- A rocking chair

- A curved back arm chair
- A plate rack
- A tool for marking dowel holes
- A magazine table
- A waste paper basket
- A writing desk
- A couch with cushions
- Shade for dining room
- How to bend wood
- A smoking stand
- A china closet
- A leather-covered footstool
- Arts-crafts mantel clock
- A music stand
- Wall case with mirror
- A table for the den
- A burlap-covered seat
- A quarter-sawn oak settee
- A screen
- A mission book rack
- A round extension table
- An arm dining chair
- A hall bench
- A sewing table
- A side chair
- Another piano bench
- Another screen
- A folding card table
- A magazine stand
- A tabouret
- A porch swing
- A foot warmer
- Plate rack
- A mission sideboard

## IDEAL BOOKS For Manual Training Courses

Men and boys, alike, find these books to be marvels of simplicity and fascination. Boys just starting manual training courses, will find in these books instructions and designs that will make their work both interesting and profitable, for the pieces so clearly described may be readily sold at a good profit.

33 Lamps to Choose From



Save Half the Cost of Furnishing Your Home

It's Fun to Make Things. It's Profitable to Make Furniture and Lamps

This valuable set known as "Popular Mechanics Furniture-Making Books," includes the five volumes of which thousands have been sold:

1. Mission Furniture and How to Make It, Book 1
2. Mission Furniture and How to Make It, Book 2
3. Mission Furniture and How to Make It, Book 3
4. Lamps and Shades in Metal and Art Glass
5. Arts-Crafts Lamps and How to Make Them

Send No Money

Don't send a penny (if you live in the U. S.). We want you to have these valuable books in your hands before you make any deposit. When the postman hands them to you, pay the postage, and deposit \$4.95 for the five books. If you are not delighted with your purchase, we will promptly refund the entire purchase price. Nothing could be fairer than that. Just write a postal and say, "Send me the Popular Mechanics Furniture Making Books." Single books, \$1 each.

POPULAR MECHANICS PRESS  
Room 101, 200 East Ontario St., Chicago

# Build a \$100 SHIP MODEL for \$4.98 in 3 Hours

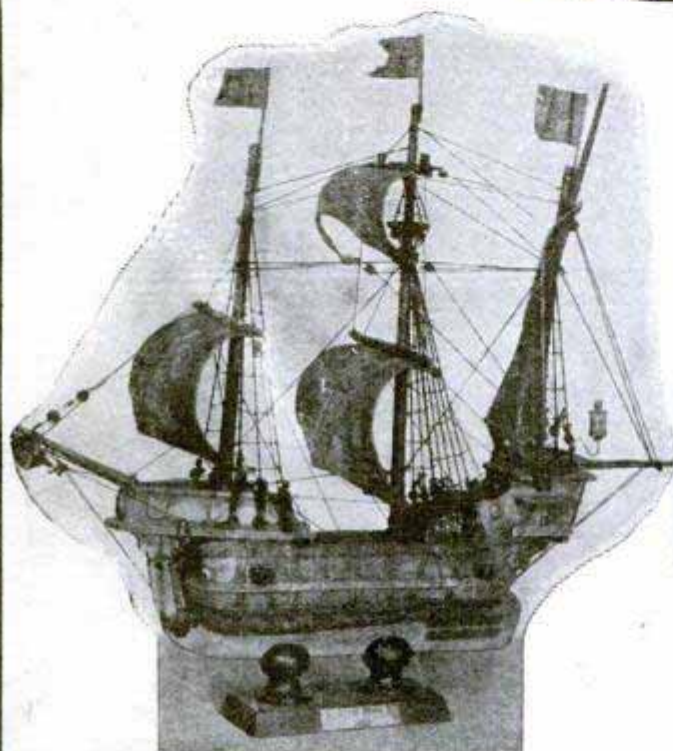

**SANTA MARIA—COLUMBUS' FLAG SHIP**  
Size: Height 25 in. Width 11 in. Length 27 in.

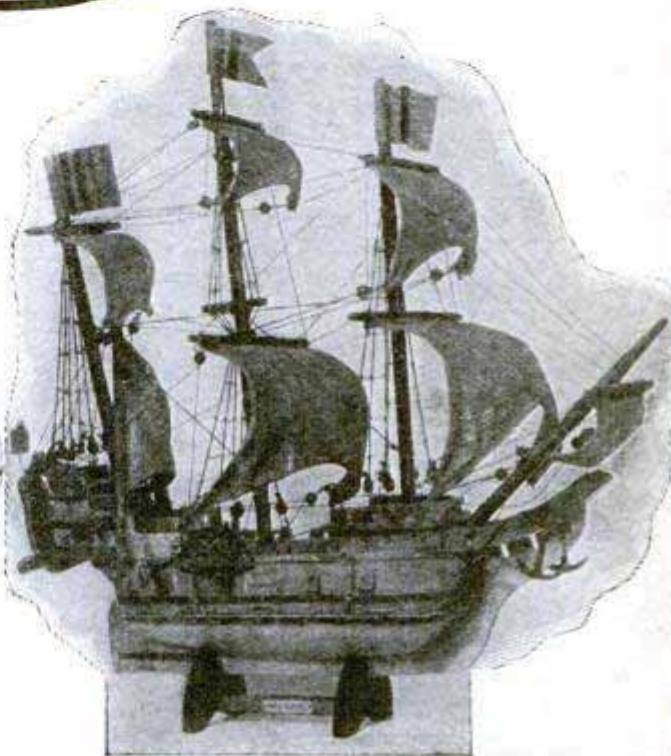

**MAYFLOWER—LANDING OF THE PILGRIMS**  
Size: Height 25 in. Width 9 in. Length 27 in.

ANY SCHOOL BOY CAN PUT PARTS TOGETHER IN 3 HOURS

**The WORLD'S LARGEST BUILDERS of SHIP MODELS Will Help You**

by supplying every part (no paint); all parts are cut and fitted, ready to put together; no tools are needed other than a small hammer. Here is a partial list of parts we send you for the SANTA MARIA MODEL—space does not permit describing MAYFLOWER parts—hull, keel (2 pieces), rudder, rudder support, 6 hawse pipe rings, 6 cannon, 6 port shutters, 9 shields, front and poop deck sides and railings, upper deck with decorated stern, colored picture for stern, trimmings for stern and after upper deck, rear balcony, steps and door, 2 side balconies, railings, cabin and roofs, 2 rigging channels, anchor, lamp and bracket, crow's nest, bowsprit, and yard arms, fore mast and fore yard arms, mid-mast (2 pieces), top sail and main sail yard arms, rear mast and yard arms, gib sail, top sail, main sail, fore sail, lateen sail, 55 blocks and falls, 3 flags, 18 bumping strips, 4 rudder strip supports, stand and brass name plate, enough rigging for all blocks and falls and yard arms, sufficient wire, brads, staples and glue. Hull and all parts are of wood. Shipping weight, 6 lbs. Canadian orders must be accompanied by money order for four dollars and ninety-eight cents, and enough postage for parcel post.

**ABSOLUTELY NOTHING TO BUY  
EXCEPT PAINT**

**ORDER AT ONCE AND HAVE IT  
READY FOR XMAS; MAKES A  
WONDERFUL GIFT**

**WE ALSO SELL COMPLETED  
MODELS—DEALERS, WRITE FOR  
PRICES ON COMPLETED MODELS  
AND KNOCKDOWN KITS. USE  
YOUR LETTERHEAD**

**MINIATURE SHIP MODELS**  
3216 Baring Street Philadelphia, Penna.

#### MINIATURE SHIP MODELS

3216 Baring Street, Philadelphia, Penna.

Please send me the completed parts of your Ship Model

..... cut and fitted, ready to be  
put together. I will pay postman \$4.98, plus postage (a few  
cents).

Name.....

St. or R. F. D.....

City.....

State.....



**Ready for You!**

**THIS** Handy Pocket Catalog is fresh from the press—it is the 1927 edition. It tells you about the many fine King instruments. There you will find full information on the new King French Horn, our latest and greatest achievement. Then too, you can learn of the new Improved Proportion King Trombone; of the already famous Giant King Sousaphone.

You will find much of interest and profit in this catalog.

Send the coupon now.

**KING Band Instruments**

**THE H. N. WHITE CO.**  
5211-83 Superior Avenue, Cleveland, Ohio

I am interested in \_\_\_\_\_ Instrument

Name \_\_\_\_\_

Address \_\_\_\_\_

City \_\_\_\_\_ State \_\_\_\_\_

# No Joke to be Bald



**Grow New Hair Quick**

## Let Me PROVE It To You FREE

What I accomplished on my own head, pictured above, I believe I can do for you, provided you are under 45 years of age and loss of hair was not caused by burns or scars. Anyhow, I must succeed or you pay nothing. No apparatus—my home treatment is simple, quick and inexpensive.

**Send No Money** Just your name and address and I will mail you full information with PHOTOGRAPHS, NAMES and addresses of men and women who have successfully used my treatment for dandruff, falling hair and particularly for baldness. Write Now. A postal will do.

**VREELAND'S,** 1351 Euclid-Windsor Bldg. CLEVELAND, OHIO

## DON'T WEAR A TRUSS

**BE COMFORTABLE—**

Wear the Brooks Appliance, the modern scientific invention which gives rupture sufferers immediate relief. It has no obnoxious springs or pads. Automatic Air Cushions bind and draw together the broken parts. No salves or plasters. Durable. Cheap. Sent on trial to prove its worth. Beware of imitations. Look for trade-mark bearing portrait and signature of C. E. Brooks which appears on every Appliance. None other genuine. Full information and booklet sent free in plain, sealed envelope.



MR. C. E. BROOKS

**BROOKS APPLIANCE CO.,** 107 State St., Marshall, Mich.

**One Year**

**To Pay**



**No. CS2 - Price \$62.00, \$2 Down and \$5 a Month**

This big cluster of seven best grade sparkling blue white diamonds is set in **SOLID PLATINUM** in this solid white gold ring. Guaranteed to stand any test.

18 KARAT

**No Red Tape**

**10 Days Trial**

**SEND NO MONEY** You pay \$2.00 to postman after you get this ring. If you keep it, pay only \$5.00 a month for 12 months. If you are not satisfied after seeing the ring, return it in 10 days and we will return your money—every cent. You take no risk in ordering this beautiful, flashing diamond cluster ring. Pay for it in monthly installments, like putting money in a bank.

### Cluster Looks Like \$600 Solitaire

You now can buy this gorgeous ring at the wholesale price. Compare it with similar rings at \$100.00. We guarantee it to stand any test or comparison. It is the greatest bargain ever offered by any Diamond Importer. We will give you 8% more than you paid for it when you exchange it for a larger diamond ring.

### WRITE FOR JEWELRY CATALOGUE

This beautiful diamond cluster ring is a sample of the unexcelled values we offer our customers. A thousand and one other selections are shown in our catalogue. Brings our store into your home.

### STERLING DIAMOND & WATCH COMPANY

(Diamond Importers—\$1,000,000 Stock—Est. 1879)  
1540 Broadway Dept. 2234 New York, N. Y.

Length over all 30 in.; between centers 14 in. Swing over bed 7 3/4 in. Includes counter shaft. Bronze taper bearings. Weight 60 lbs. No. 11 Lathe, 40 in. over all; 24 in. centers, 7 3/4 in. swing. Price \$75.00. Time Payments if desired.

**\$60**

**The Sypher Mfg. Co., Dept. D, Toledo, Ohio**

# Foot Pains Stopped in five Minutes



If your feet pain and ache, if they tire easily or feel cramped, if they burn or itch, if your legs ache with throbbing, twitching pains, I want to send you free and postpaid my new book "**Foot Health**." It tells how foot troubles may be corrected easily, quickly and permanently at home by an entirely new method that uses no arches, braces, cushions, bandages or any other device to be worn in the shoe or on the foot, without special shoes or tiresome exercises. Yet foot pains are stopped almost instantly, weak fallen arches raised and strengthened, the foot muscles invigorated, the circulation in the feet and legs improved, and the cause of foot troubles permanently corrected. Write for this free book now and learn how easy it is to have strong, sturdy, self-supporting feet free from aches and pains.

**DR. F. H. GRIFFITH, Foot and Leg Specialist,**  
Suite 3151, Davidson Building Kansas City, Mo.

# Merry Christmas and a Healthy New Year



•BUY•  
•CHRISTMAS•  
•SEALS•

THE NATIONAL, STATE and LOCAL TUBERCULOSIS ASSOCIATIONS of the UNITED STATES

Please Mention Popular Mechanics

## STOP THAT LEAK WITH SMOOTH-ON No. 1

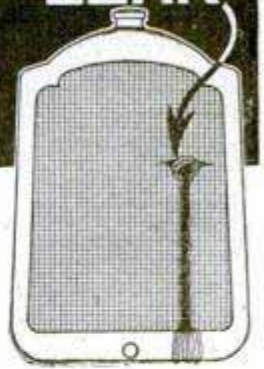

YOU can apply Smooth-On with radiator full or empty, hot or cold, without removal from the car and without putting inside anything that clogs the circulation.

Merely roll the Smooth-On into a stiff putty, press it against and into the leak with your thumb or pack it into the defect with a knife blade or screw-driver, and scrape off the excess. The leak will stop instantly, and the repair is permanent. For a few cents and in a few minutes you will have avoided all the delays and expense of a professional repair job that couldn't be any better.

**Bursting Water Jackets.** Water jackets of automobile, stationary or marine gas engines which have developed long or short cracks or have even had pieces broken entirely out from freezing can be made thoroughly and lastingly serviceable by similar repair, or by applying Smooth-On under straps or a plate.

Smooth-On No. 1 can be used in a hundred ways in the household, and it often saves from \$50.00 to \$100.00 on the first job.

Keep a can of Smooth-On No. 1 with your tool kit and some day when caught with a repair job you will thank yourself for your forethought.

Get Smooth-On No. 1 in 7-oz., 1-lb. or 5-lb. tins at any hardware store or if necessary direct from us.



Write for  
**FREE BOOK**



Do it with **SMOOTH-ON**

SMOOTH-ON MFG. CO., Dept. 37,  
574 Communipaw Ave., Jersey City, N. J.

Please send the free Smooth-On Repair Book.

# FREE

This booklet tells how to stop not only water leaks in radiators, bursted water jackets, and at loose hose connections, but also how to stop gas leaks from the tank, gasoline lines and exhaust system, and oil leaks at gaskets and at cracks in crank or gear case. It also tells how to make headlight posts, nuts, hub caps and bolts and grease cups stay tight, and shows dozens of simple money saving Smooth-On repair jobs.

Sent free if you return the coupon

SMOOTH-ON MFG. CO.  
Dept. 37, 574 Communipaw Ave.  
JERSEY CITY, N. J.

Name.....

Address.....

P.M. ....

**WE PAY FREIGHT**  
**5 ROOMS AND PORCH** \$**548<sup>00</sup>**  
**BATH INCLUDED**



**Others \$375<sup>00</sup> up**  
**BUILD YOUR OWN HOME**  
**Save \$300 to \$800**  
**AND MORE**  
 Buy all materials direct from manufacturer—saving four big profits! Guaranteed materials. Factory-cut. No waste. 40% less labor. Most remarkable money-saving prices ever offered!  
**HANDSOME BIG FREE!**  
**CATALOG**  
 Prices include all lumber, millwork, roofing, lath, hardware, paints, nails. Plans furnished FREE. Freight paid east of Mississippi and North of Mason-Dixon line, also Minnesota, Iowa, Missouri.  
 Write for catalog now  
**LEWIS MFG. CO., Dept. 121, BAY CITY, MICH.**  
 Send Postcard

**MAINE HUNTING SHOES**

**\$3.40**



Send old leather top rubbers (any make) and we will attach our 1927 Hunting Rubbers, repair and waterproof tops, put in new laces and return, postpaid, for \$3.40. Same guarantee as new shoes. With heels, \$3.65.

Send for Catalog of Maine Hunting Footwear and other specialties

**L. L. Bean, Mfr.**

**22 Main Street**  
**FREEMPORT, MAINE**



**Agents!**  
**\$20 a day**

- Meat Tenderer
- Mince Knife
- Cleaver
- Ice Tool
- Food Chopper
- Fish Scaler
- Nut Crumbler

**HANDIEST TOOL IN THE KITCHEN.** Housewives all say "Just what I want." The *Ideal Fiber Cutter* is a real household aid. Tested and Approved by Good Housekeeping. Two minute demonstration sells it—**100 PER CENT PROFIT.** Boorem, Pennsylvania says, "Have bought my home and car

with Cutter profits." Bassett, Washington, new agent, writes, "Made \$7.50 in 2 hours today." You can do as well. No experience needed. Work spare or full time. Write for details.

**THE TYLER COMPANY, M-7 Muncie, Indiana**

**Big 3-ft. Telescope**

Only **\$1<sup>85</sup>**

Makes people and objects miles away seem close. Brings new pleasures to home, farm, camp, travel, sport. See moon and stars as never before. New Ferry "Wonder" telescope has 5 sections—over 3 ft. long open, 12 in. closed. Fully brass bound. Powerful lenses.

**FREE! Yes, Absolutely FREE!** Hand-some leatherette covered Carrying Case, light, strong, complete with strap. Handy for farmers, auto tourists and hikers.

**5 Sections**  
**8-Power Lenses**  
**Thousands Delighted!**

"I am delighted with the 'Wonder' telescope. Today I have been watching submarines 3 miles off the coast."—Phillip Brush. "I can see across the Mississippi 3 miles and see people fishing."—M. L. Thorn. "I am nearly 80 years old and if I could not get another would not take \$10.00 for it."—A. R. Walker. "I can tell time on the church clock 5 miles away."—Edward Foster. "Could tell color of aeroplane 4 miles away."—Mrs. L. M. Yarbrough. "I saw a Light House 18 miles away."—Clyde Scribner.

**Send No Money**

Send name and address and Ferry Wonder 3-ft. Telescope with free Carrying Case will come by return mail. Pay postman special bargain price of \$1.85 plus a few cents postage. Satisfaction guaranteed or your money back. Supply limited.

Order Today! **FERRY & CO., Dept. 1771, CHICAGO**



Adjusted to Second, to Temperatures, to Isochronism, to Position; 21 Ruby and Sapphire Jewels; 25 Year Gold Strata Case.

**21 Jewel BURLINGTON**

A masterpiece—so accurate that the men's watch is in use on practically every vessel of the U.S. Navy. And the Burlington line is complete—with styles and designs for everyone.

**Write!** This aristocrat among watches is sent on approval and sold direct on easy payments at rock-bottom prices. Write now for the free Burlington Book picturing in colors the most complete assortment of watch styles and designs ever shown under one cover.

**BURLINGTON WATCH COMPANY, Dept. 13-51**  
 19th Street and Marshall Blvd. Chicago, Ill.

**Avoid Typhoid**

spread only by improper sewage disposal

You can now have the convenience and health protection of modern bathroom and toilet for your country home or camp with



**San-Equip**

**SEPTIC TANKS**

Solve the problem of sewage disposal safely and economically. For water toilets without sewers. Design follows U. S. Public Health Service. No failures. Easily installed.



**Before You Decide**

write for San-Equip folders and free plan sheets. Give us the brief details of your problems and we will do the rest. No obligation.

**Chemical Toilet Corporation**  
 854 Free St., Syracuse, N. Y.  
 Makers of sanitary waterless toilets

**NEW PRACTICAL  
DIESEL ENGINE BOOK**

The importance of the Diesel engine in its various applications to Marine, Locomotive, and Stationary operation can scarcely be overestimated. Every progressive engineer and student of mechanical engineering will realize the necessity of extending his knowledge into this field.

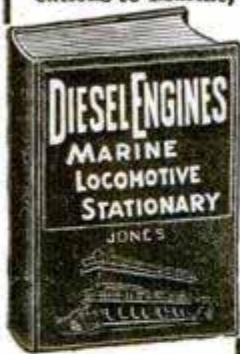

This up-to-the-minute book by D. L. Jones, Chief Machinist, U. S. Navy, is extremely practical, complete and in simplified language. Deals thoroughly with installation, operation and maintenance.

565 pages (6x9)—340 Illustrations.  
Pay postman \$5.00 on delivery.  
**Popular Mechanics Press**  
200 E. Ontario St. CHICAGO

**Helpful IDEAS for Home Owners**

In these two practical books, you will get 502 ideas that will be helpful in making your home a better place to live in—a home to be proud of. The ideas are for the making, improving and repairing of the devices needed about and in the home. The books are:

1. Home Mechanic's Handbook No. 1
2. Concrete Handbook No. 1

These books tell how to make most everything, from door stops to a refrigerator, and from a concrete sidewalk to a lawn fountain.

**Send No Money** Simply write a postal and ask that Popular Mechanics two Homeowner's books be sent C.O.D. When the postman delivers the books to you, hand him \$1.00 plus the few cents postage.



**POPULAR MECHANICS PRESS**  
Popular Mechanics Bldg. Room 611 Chicago, Ill.



**259 Discoveries  
For Lathe Operators**

This book contains the experiences of 106 successful operators in the U. S. and in the principal foreign manufacturing countries. 83 articles tell how to make special lathe tools and attachments. 33 on gauges and indicators. 23 on special devices for holding work. 9 special lathe centers. 29 on how to do unusual jobs. 28 on boring and drilling. 11 on thread cutting.

**212 Illustrations** The pictures make it easy for a beginner. Every article is written so anyone can understand it, and every kink has been thoroughly tested.

**Send No Money** Just write a postal. Popular Mechanics Lathe Handbook and Drilling and Thread Cutting Handbook will be sent C. O. D. Pay postage and 98c for the 2 books.  
**POPULAR MECHANICS PRESS**  
Room 27, Popular Mechanics Building, Chicago, Ill.

**NEED A BETTER GRIP ON MATHEMATICS?**



SEND for a copy of "Mathematics for the Practical Man," only \$1.50. By common sense methods it removes the mystery and difficulties so that algebra and even calculus are made simple.

Assuming your knowledge is limited to arithmetic you quickly and easily gain a working knowledge of Algebra, Geometry, Trigonometry and Calculus. Simply pay postman when he hands you the package.

**Popular Mechanics Press**  
Room 101  
200 E. Ontario Street, Chicago

**Grab This New**

**Live Seller Quick**

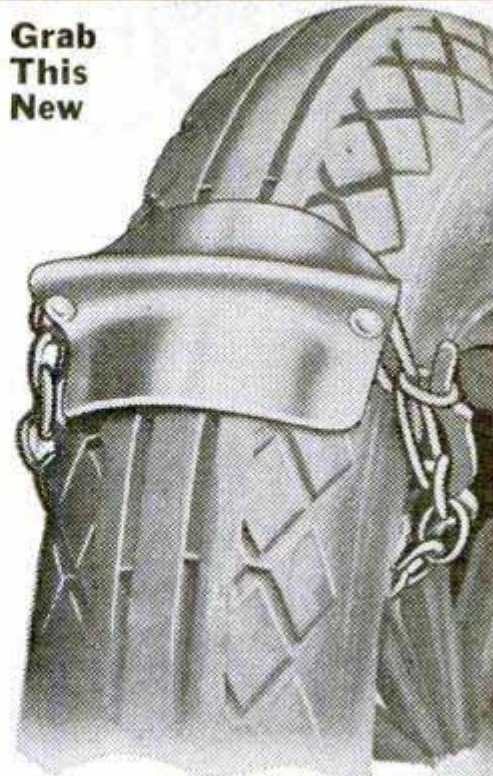

**Amazing New Invention!**

EVER since I got stuck in mud up to the axles about a year ago and paid \$25 for towing, I have been experimenting in the perfection of a device which could be quickly locked on the rear wheels to afford powerful traction sufficient to force any car or truck out of mud, sand or snow. The result is my patented

**Gets-U-Out Pressed Steel Tire Lug**  
(Patented—Nothing Like It)

**It Gets You Out of Mud, Sand, Snow**

Two on each rear wheel does the trick in a jiffy. And it's so simple to slip them on and off, a woman driver can do it easily. Sturdy construction, with nothing to get out of order, my Lugs will last for years. On the market only 30 days, yet hundreds of car owners are already using them successfully.

**J. J. Andrest, of Minnesota, says:**

"Your Lugs have never failed to pull my heavy 2-ton truck out of deep mud, sand or snow."

**\$75 to \$150 Weekly Easy**

I don't care if you've never sold before, you'll positively coin money—full or spare time—with this new, year round specialty. And it isn't necessary for you to spend your bank roll either. Sells in Sets of 4 at a low price, with 100% profit to you. Every car owner buys.

**Guarantee**

I hereby agree to refund the full purchase price if my LUGS fail to force any car or truck from mud, sand or snow.

ART BENSON

**FREE SAMPLE OFFER**

Just clip and mail the FREE OFFER COUPON—NOW—and cinch your territory on this whirlwind seller. Act quick.

**ART BENSON, Gen. Mgr.**  
**Chicago Tire Lug Company**  
733-338 W. 47th St.  
CHICAGO, ILL.

**TIRE LUG CO.,**  
733-338 W. 47th St.  
CHICAGO, ILL.

I want to get my share of the big money to be made with your new GETS-U-OUT PRESSED STEEL TIRE LUG. Send me the facts without obligation about my profit and your FREE SAMPLE OFFER.

**FREE OFFER COUPON—MAIL NOW**

Name.....  
Address.....  
City..... State.....



# You Can Play This Pan-American Clarinet!

YOU can learn to play every popular melody in a few weeks on America's most popular instrument—the Clarinet! PAN-AMERICAN Clarinets are beautifully toned for home, school, church, solos, piano accompaniments, or bands and orchestras.

**Price \$40.00**  
Easy Payments

A small amount down, and the balance in small monthly payments gives you a PAN-AMERICAN Zylind Clarinet. Endorsed by professionals. Beautifully finished. Latest key mechanism.

Send coupon for complete information and catalog of PAN-AMERICANS—America's most popular line of band and orchestra instruments.

**Send No Money**  
Mail Coupon

THE PAN-AMERICAN BAND INSTRUMENT & CASE CO.  
Dept. G-4, Elkhart, Indiana  
Yes—Send me complete information on a Pan-American Clarinet, or.....instrument.

Name.....  
Address.....  
City..... State.....  
My local Music Dealer is.....

## FREE TRIAL

PAN-AMERICANS are Factory Guaranteed, and can be had on FREE TRIAL. Write today.

Ask for PAN-AMERICAN Catalog of

- Saxophones
- Flutes
- Trumpets
- Piccolos
- and all other band and orchestra instruments.

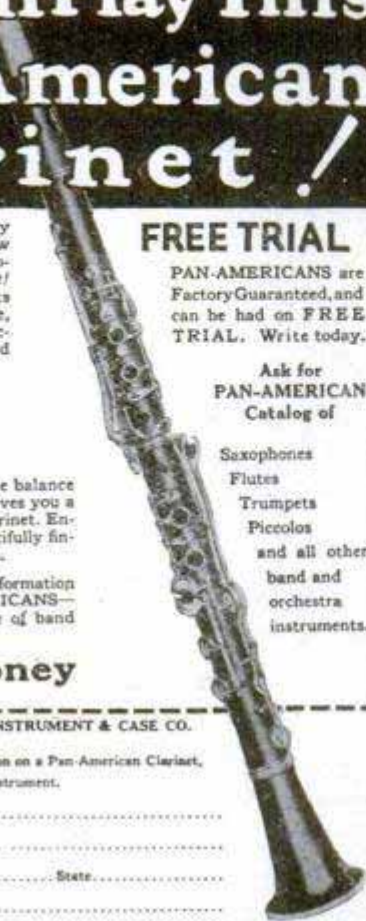

# FORDS

no freezing no boiling!



## Great Gas Saving

No need for winter fronts, summer pumps, or gas savers. The wonderful Airlock does all three. An absolutely genuine article which prevents freezing or boiling in any climate running or standing. It fuelizes and decarbonizes besides. Installed like a motometer. Makes an amazing demonstration. Sells like machine guns fire. Agents with Fords make \$50 daily. Free trial always. Address

**AIRLOCK PRODUCTS**  
Box 588 Burnett, California  
Send me Agents free trial offer of your sensational Airlock.

Name.....  
(Print plainly)

Address.....



## American Poultry Journal

Oldest, Largest and Best

**9 MONTHS' TRIAL 25 cts.**

1 Year 50c 3 Years \$1 5 Years \$1.50

Averages over 100 pages per issue—tells how to feed, house and breed; how to secure high egg production; how to hatch and rear poultry successfully. Established 1874. Only 25c for 9 mos. Stamps accepted.  
American Poultry Journal, 14-523 Plymouth Court, Chicago

## Do Your Own Hatching

Trust your hatching to time-tried and tested

**"SUCCESSFUL"**  
Incubators and Brooders

Used by the big money-makers who stay in business year after year. Poultry Lessons free to every buyer. Eastern customers will be served quickly from our Eastern Warehouse.



34 Years Making Good

Catalog Free  
Des Moines Incubator Co 689 Second Street, Des Moines, Iowa

## FREE Book HOW TO FEED AND CARE FOR CHICKS

Gives Money Making Secrets of Poultry Raising. Tells how to hatch, care for and feed chicks until fully grown. Gives plan of Poultry and Brooder Houses. Describes Miller's "IDEAL" INCUBATORS with Patented Egg Turning Traps. Oil and Coal Burning BROODERS. Eggs for hatching—Baby Chicks—BARGAIN PRICES. WRITE TODAY!  
J. W. MILLER CO., Box 12, Rockford, Ill.



## RAISE BELGIAN HARES

NEW ZEALAND REDS—Chinchillas—Flemish Giants  
**MAKE BIG MONEY**—We supply stock and pay you following prices for all you raise: Belgian Hares \$2 each—New Zealand \$3 each—Chinchillas \$4 each—Flemish Giants \$5 each. \$2-page illustrated book, catalog and contract, also copy of Fur Farming magazine, tells how to raise skunk, mink, fox, etc., for big profits, all for 10c. Address

OUTDOOR ENTERPRISE CO., Box 25, Holmes Park, Mo.

## HOW A BOY BUILT UP A GREAT SQUAB FARM

Started small in backyard when at school with no money, now has \$30,000 plant, ships to New York 150 bbls. squabs yearly, receiving \$75 to \$100 a barrel. You can do the same. Send for this book. Price is fifty cents but we will mail it to you for the names and addresses of four of your friends and your own name and address. Write today to  
Plymouth Rock Squab Co., 634 A St., Melrose High., Mass.

## WONDERFUL POULTRY BOOK 40 BREEDS

The Nation's Great Poultry Manual tells about Mrs. Berry's success. Blood-Tested, Pure-Bred Poultry, Hatchery, Feeding, Housing, Diseases & Remedies. Makes LOW PRICES on best Fowls, Eggs, Chicks, Supplies. Pullets lay at 4 months. Send only 5c to help mail.  
BERRY'S POULTRY FARM, Box 29, Clarinda, Iowa

## 68 BREEDS Valuable New Poultry Book Free—100 Pages.

Fine Pure-bred Northern raised chickens, ducks, geese, turkeys, eggs, baby chicks, incubators & brooders at lowest prices. America's great Industry. My 45th year.  
W. A. Weber, Box 28, Mankato, Minn.

## PLANS for Poultry Houses

All styles, 150 illustrations; secret of getting winter eggs, and copy of "The Full Egg Basket." Send 25 cents.  
INLAND POULTRY JOURNAL, Dept. 74, Indianapolis, Ind.

## 64 BREEDS Most Profitable chickens, ducks, turkeys and geese.

Choice, pure-bred northern raised. Fowls, eggs and incubators at low prices. America's great poultry farm. At it 34 yrs. Valuable 100-page book and catalog free.  
R. F. Neubert Co., Box 908, Mankato, Minn.

## FOY'S BIG BOOK, in Colors

A complete guide to successful Poultry and Squab Raising. Low prices on CHICKS, Breeding Stock and PIGEONS.  
Write Today! FREE!  
FRANK FOY, Box 18, Clinton, Iowa





# Yours

## a rich farm like this with 35 years to pay

**M**ILLIONS of dollars profit are earned every year by American farmers on the rich lands of Western Canada. Low priced land is the secret of their success.

Now you, too, can buy rich farm lands at an average of \$15 an acre. Think of the profits you can earn with the average 3 year yield of 17.5 bushels of wheat to the acre; land where stock, hogs and dairy farming thrive

### 35 YEARS TO PAY

Pay only 7% down. Then use the land free one year, after two years of profit pay the balance in 34 equal annual payments. Pocket your profits—we don't want them. This big railway wants man power—farming power, to reap the golden harvest of this fertile soil. Taxes are low. Lands are close to good markets, schools, churches, etc. The climate is favorable; the roads are good; freight rates are low. Stop paying the penalty of high priced lands. Come to Canada where every farmer profits. Investigate now.

### You Cannot Buy Until You Investigate

We will not sell you land until you see it. Special low fare (single fare plus \$2) trips available. Let us arrange details. Mail the coupon for full information. No obligation.



**C. A. VAN SCOY**  
Supt. of Colonization, Dept. 501  
Canadian Pacific Ry. Depot Winnipeg, Canada



The farm home of J. S. Samis

### Read What These Farmers Say:

I started with \$600—now I have 960 acres improved, stocked and paid for.  
J. S. Samis, Alberta

Come here and give your children a chance to do well; own your own home and prosper.  
Mrs. L. F. Pinkerton, Alberta, Canada

I farm 960 acres; raise thoroughbred hogs and cattle. Raised 19,000 bushels of wheat, oats and barley this year. Come to Canada.  
F. J. McLoy

C. A. Van Scoy, Supt. of Colonization  
Dept. 501, Canadian Pacific Ry. Depot  
Winnipeg, Man., Canada

I am interested in learning more about:

- Prairie Provinces of Canada
- Irrigation Farming in Sunny Alberta
- Business and Industrial Opportunities in Western Canada.

My Name.....

Address.....

Town.....State.....

### BUCHSTEIN'S FIBRE LIMB



Send for Catalog Today

is soothing to your stump—strong, cool, neat, light. Easy payments. Braces for all deformities.  
**D. BUCHSTEIN CO.**  
610 3rd Ave., So.  
MINNEAPOLIS, MINN.

### ENVELOPES, \$2.75. LETTERHEADS \$3.75 A THOUSAND

Your return address on corner and good envelopes. 1,000—\$2.75, 5,000—\$10.00, 10,000—\$17.50. No. 10—\$1.00 extra. Letterheads, \$3.75 a thousand, 5,000 at \$3.25, 10,000 at \$3.00 per thousand. Write copy plain. **SAMPLES FREE.** A. Mohler, Box 453, Chicago, Ill.

## MAKE THINGS AT HOME—SAVE MONEY \$1350



### PARTRIDGE WOOD TURNING LATHE

Buy the finished parts. Build bed at home. A real tool. 6" swing. Weight 16 lbs. Make radio parts, floor lamps, toys and numerous other practical and valuable articles. Also made in sizes to swing 8", 11", 13", 16" diameters.

### IDEAL XMAS GIFT FOR FATHER OR SON

We also manufacture Saw Mandrels, Emery Grinders, Polishing Heads, Foot Presses.  
Send today for descriptive circular.

**E. O. PARTRIDGE, Dept. PM-1, 2039-49 W. Lake Street, CHICAGO, ILL.**

f. o. b.  
Chicago

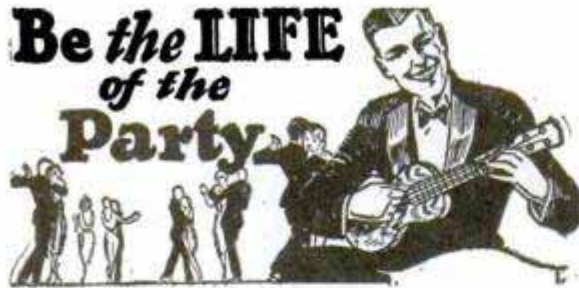

**Be the LIFE**  
of the  
**Party.**

## Play a Tune in 10 Minutes

*Popularity—new friends—money-making opportunities come to those who can play!*

Now you can pick up your favorite stringed instrument and play a tune almost instantly. No knowledge of music needed. No expensive lessons. No weeks of tiresome practice. Play tunes from the start. Surprise and astonish your friends. Amazing new invention makes it easy to play Ukulele, Banjo, Mandolin, Tenor Banjo, Guitar, Mandolin.

Trixie Friganza, famous Mandolin Star wrote: "I played in 3 minutes and never touched a stringed instrument before." John A. Cruser: "I was skeptical about anyone playing tunes instantly but have changed my ideas completely." W. G. Matthis: "Your advertisement didn't tell the half of it." Mrs. A. Kamen: "My friends and I play wonderful tunes. The more we play the more we like it." J. G. J. J. J.

### ASTONISH Your Friends

You have always wanted to play. Do not delay—it is so easy—so wonderfully easy that we guarantee success or it costs you nothing.

### SEND FOR FREE BOOK!

More popularity—more fun from life—new friends—money-making opportunities. If you want to play tunes at once—send today for a free book about **Ferry E-Z Playing stringed instruments**. Soon you, too, can know the joy of making your own music. E-Z Playing Instruments are sold complete or the Player can be attached to your own stringed instrument in a jiffy. Send the coupon today.

**FERRY & CO., Dept. 9771, Chicago, U. S. A.**

-----Mail coupon today-----  
**FERRY & CO., Dept. 9771, Chicago, U. S. A.**  
 Send free book telling how I can get more fun out of life, make more friends, have greater opportunities for getting ahead by learning to play my favorite stringed instrument in 10 minutes. No obligation.  
 Name.....  
 Address.....  
 City..... State.....

## RESHAPE YOUR NOSE!

You can safely reshape your nose to beautiful proportions with **ANITA NOSE ADJUSTER**—painlessly, comfortably. Results speedy and guaranteed. Physicians praise it highly. No metal to harm you. Winner of Gold Medal, 1923. **FREE BOOKLET** Write for it today.  
**THE ANITA CO., Dent A-12, ANITA Building Newark, N. J.**

# STOP USING A TRUSS

Do Away With Steel And Rubber Bands



**FREE TRIAL**  
 TRADE MARK  
 PATD APRIL 6 1909  
 Inner surface is made adhesive to secure the PLAPAO-PAD firmly to the body, keeping the PLAPAO continually applied and the pad from slipping. No straps, buckles or springs attached. Soft as velvet—easy to apply.  
 It's the Non-Slip-ping, yet Non-Rigid Pad and What is Within It That Counts

## FREE to 5,000 Truss Sufferers

To the extent of 5,000 sufferers who may apply I will send, ABSOLUTELY FREE, a sufficient quantity of the Plapao to positively convince them that this is the only logical, common-sense way of treating rupture. Plapao is a highly astringent medication placed within the Plapao-Pad and being absorbed through the skin, creates a wonderful feeling of relief and at the same time tends to strengthen the weakened muscles and thus permanently close the rupture opening. The process of recovery is natural, so you'll have no use for a truss—you can throw it away forever! Old and young have testified under oath that the Plapao-Pads cured their rupture—many of them long-standing, aggravated cases—without delay from work. Patent allowed in U. S. and foreign countries. Awarded Gold Medal at Rome and Grand Prix at Paris.  
**Send No Money**—for a sufficient quantity of the Plapao is sent without charge to enable you to give it a thorough test; you pay nothing for this trial now or ever. Write for it and full information today. Address: Plapao Laboratories, Block 1427 St. Louis, Mo.



# Deafness

Perfect hearing is now being restored in all cases of deafness caused by Catarrhal troubles, Relaxed or Sunken Drums, Thickened Drums, Roaring or Hissing Sounds, Perforated, Wholly or Partially Destroyed Drums, Discharge from the Ears, etc.

## Wilson Common-Sense Ear Drums

require no medicine but effectively replace what is lacking or defective in the natural ear drums. They are simple devices, which the wearer easily fits into the ears where they are invisible.

**Free Book on Deafness**  
 Soft, safe and comfortable. Write today for 168-page book on deafness giving full particulars and many testimonials. The hearing of thousands of grateful users has been restored by these "little wireless phones for the ears."

**WILSON EAR DRUM CO., Incorporated**  
 256 Todd Building LOUISVILLE, KY.

# HAIR GROWS!

when our Vacuum Cap is used a few minutes daily. Sent on 60 days' FREE trial at our expense. No drugs or electricity. Stops falling hair, cures dandruff. A postal brings illustrated booklet.

**MODERN VACUUM CAP CO.**  
 558 Quincy Denver, Colorado

\$

**150 TO 300 MONTHLY FROM ONE DAY BATTERY CHARGING**

Charge batteries in 1/2 the time required by others and get the business. Latest method recommended by the leading battery companies and approved by the U. S. Bureau of Standards. **BIG YEAR ROUND PROFITS.** Best paying business in automotive field. Requires no special experience, uses small space. **30 DAYS' FREE TRIAL** at our risk under absolute money back guarantee. Write today for bulletin X, giving full particulars.

**Hobart Bros. Co. Box M171 Troy, Ohio**

**30 DAYS FREE TRIAL**  
 ON ABSOLUTE MONEY BACK GUARANTEE

ONLY \$16 MONTHLY—MORE THAN PAID BY INCREASED PROFITS

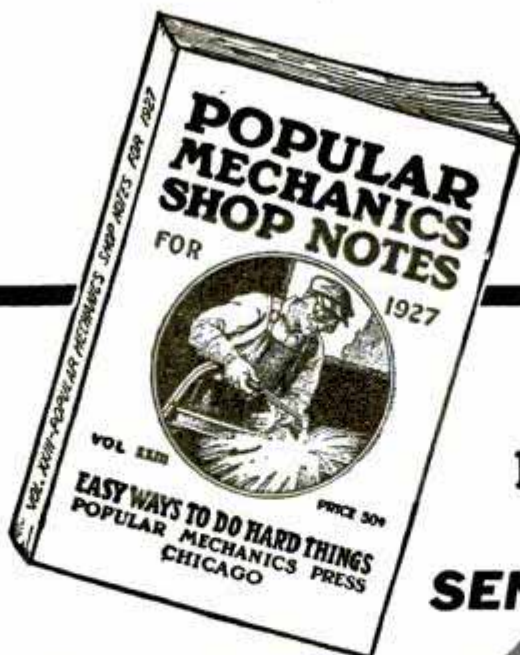

**479  
ARTICLES**

**JUST OUT**

**374  
PICTURES**

**SEND NO MONEY**

# SHOP NOTES for 1927

This announcement will be welcomed by thousands because they have learned that each yearly issue of Shop Notes contains dozens of short cuts that save time and money. Every article is written by some man who has tried the idea and found it worth money. The variety of subjects covered is one reason why so many buy Shop Notes each year. In many ways the 1927 issue surpasses previous numbers. The following brief list will give you an idea of the variety of subjects covered.

## SOME OF THE SUBJECTS

Auto Repairing  
Battery Care and Repair  
Lapping Bushings  
Bracing Fence Corners  
Novel Cab Stands  
Cleaning Lantern Chimneys  
Outside Hay Chute  
Repairing Air Compressor  
Durable Nests for Poultry  
Boxes for Cream Cans  
Shop Tools  
Electrical Equipment  
Homemade Elevator Wings  
Cleaning Enamel  
Concrete Working Ideas  
Carpenters' Shortcuts  
Fitting Made Easy

Ventilation Flues  
Tool Boxes  
Printers' Helps  
Making a Blowtorch  
Garage Equipment  
Irrigation Canals  
Jewelers' Kinks  
Draftsman's Kinks  
Lathe Operator  
Electroplater  
Cabinet Worker  
Lumber Yard Management  
Mechanical Drawing  
Farmer's Helps  
Micrometers  
Sheet Metal Working

Painter's Equipment  
Motorist's Helps  
Storekeeper  
Pattern Making  
Drainage  
Outdoor Air Press  
Workbench  
Welding  
Plumbing  
Using Spindle Drills  
Making Grinders  
Raising Vertical Piping  
Cutting Wallboard  
Rubber Stamp on Thimble  
Pin Stamping  
Service Station Attendant  
Lettering

## 6,000 IDEAS ON ALL SHOP WORK

There are now 16 volumes of Shop Notes available. And this unrivaled library of shop helps may be had for a special price of \$7.50. If you do not have the back numbers of Shop Notes, you should purchase the entire library. The following are now available:

1908, 1912, 1913, 1914, 1915, 1916, 1917, 1919, 1920, 1921, 1922, 1923, 1924, 1925, 1926, 1927

**Amateur's Guide—Professional's Handbook** Both amateurs and professionals find Shop Notes of wonderful value. The articles are so clearly written and so thoroughly illustrated that even a boy can follow them. Teachers of Manual Training should have the complete library.

## SEND NO MONEY

Don't send a penny. Just fill in the coupon with your name and complete address, indicate whether you want the whole library or the special offer of 1927 Shop Notes and Lathe Handbook for 98 cents. When the books are delivered to you, pay the postage and deposit price of books with postman.

**POPULAR MECHANICS PRESS**  
200 E. Ontario St., Room 101, Chicago, Ill.

### SPECIAL OFFER COUPON

POPULAR MECHANICS PRESS,  
200 E. Ontario St., Room 101, Chicago, Ill.

Send me, as per your special offer, the following books. I will pay postage and the price of books when they arrive. My money will be refunded if I am not satisfied. (Check what you want.)

1927 Shop Notes and Lathe Handbook, 98c  Complete Shop Notes Library (16 vols.) \$7.50

Name.....

City..... State.....

Street and No.....

# PLUMBING and HEATING



ALL-CAST PIPELESS FURNACE

home. Kinks and Wrinkles and Savings that will surprise you. With our simplified plans and new easy method, you can do the installing. We loan tools FREE. Our Bonded Guarantee is backed by Million Dollar Plant and 50 Years in Business.

## HARDIN-LAVIN CO.

Established 1876  
107-17 West Pershing Rd., Chicago, Ill.  
MAIL THE COUPON NOW!

### HARDIN-LAVIN COMPANY,

107-17 West Pershing Rd., Chicago, Ill.

Gentlemen: Please send me your FREE BARGAIN CATALOG with special wholesale prices. I am interested in:

- Water Supply System
- H. W. Heating Plant
- Stm. Htg. Plant
- Pipeless Furnace
- Warm Air Furnace
- Bathroom Outfit

NAME.....

ADDRESS.....

P. O. .... STATE.....

### Buy at Wholesale—Save Half

Send coupon for FREE bargain catalog. Explains our new easy method and shows everything in highest grade Plumbing Outfits, Heating Plants, Water Supply Systems, Pipe, Fittings, etc. For 50 years we have been saving our customers hundreds of thousands of dollars and now we have made arrangements so that you can BUY ON EASY TERMS.

### FREE PLANNING SERVICE

Send us a rough sketch of your rooms and we will figure the wholesale cost of Heating Plant or Plumbing Outfit designed especially for you.



## Can YOU do This?

Can you beat time to music? Can you hum a tune? Could you walk up to the piano and pick out "Home, Sweet Home" with one finger? Anyone who can do these things can quickly master a

# BUESCHER

## True Tone Saxophone

With the three lessons given on request with each new Buescher Saxophone you can teach yourself, quietly, at home. No one need know until you are ready to "do your stuff." Then, will you be Popular!

Free Trial. Easy Terms.

Send to Buescher's for any band instrument you choose on six days' trial. Take it Home. See what you can do. Then pay a little each month while you're learning. Satisfaction guaranteed. Write today for literature, prices and terms. Mention favorite instrument.

BUESCHER BAND INSTRUMENT CO.  
Everything in Band and Orchestra Instruments  
1893 Buescher Block Elkhart, Indiana

## Wait Just a Moment, Mr.!

Before You Light That Cigarette, Cigar or Pipe—Or Take a Chew of Tobacco—

### REMEMBER THIS:

That no man can escape the bad effects of tobacco. Its active principal—nicotine—is a deadly poison which, in time, is simply bound to injure your health—perhaps seriously.

Most tobacco users realize this. But when they try to quit unaided they find it next to impossible because of the almost unbreakable hold the habit has on them.

Thousands of inveterate tobacco users have found it easy to quit with the aid of the



### Keeley Home Treatment For the Tobacco Habit

A sane, scientific Treatment based on the prescription of Dr. Keeley, who founded the famous Keeley Institute for liquor, drug and tobacco addicts more than 50 years ago. Quickly and completely banishes all craving for tobacco in any form. Contains no habit-forming drugs. No bad after-effects. Not a tobacco substitute. A wonderful tonic. Improves appetite and digestion.

**Money-Back Guarantee** If, after taking this Treatment according to directions you can honestly say you have not been benefited, we will refund your money.

**MAIL COUPON** for FREE BOOK which gives plain facts about the injurious effects of tobacco and tells how easy it is to quit with the aid of this remarkable treatment.

### THE KEELEY INSTITUTE

Dept. P. M.-1 DWIGHT, ILL.

The Keeley Institute, Dept. P.M.-1, Dwight, Ill.

Send without obligation your free booklet telling how to rid myself of the tobacco habit.

Name.....

Address.....



## Don't Be a Slave

Be independent and make big profits with the

## BEISSER KEY MACHINE

You can start a business of your own, no experience necessary. Only machine that will cut ALL KINDS of keys perfectly. No hand filing required. Also first keys by number without need of taking locks apart. Write Today for Full Particulars.

BEISSER KEY MACHINE CO.  
407 Fort Street, East Detroit, Michigan

# PIMPLES

ANDRE'S ACNE CREAM is Excellent for all Skin Troubles no matter how severe or chronic. Pimples, Blackheads, Eruptions on face or body. Eczema, Barbers' Itch, Scales, Crusts, Pustules, Enlarged Pores, Oily, Shiny or Itching Skin. Lightens Freckles, softens and whitens the skin. Immediate Results. Write for full particulars.

Andre & Co., 4029 Cottage Grove Av. Suite 451, Chicago, Ill.



Speed Lathe \$1050

complete with spur center and adjustable rest. Longer bed \$1.00 per additional foot.

7" swing, 24" metal bed, 3 speed cone pulley.  
JEFFERSON MFG. CO., FAIRFIELD, IOWA



# Do This To An Old Tire and Make \$150 Every Week!

Simply Drive Nails Into an Old Tire in Front of Big, Interested Crowds and Make from Ten to Twenty Sales an Hour! This is Absolutely the Most Startling, Spectacular, and Thrilling Demonstration You Ever Saw! Just Think—No Matter How Many Nails You Drive Into an Old Tire It Won't Puncture—It Won't Leak a Bit of Air—You Can Pull the Nails Out and Drive Right Away!

Mr. O. S. Nelson of Mitchell, South Dakota, a chemist of unusual ability, has discovered an amazing new way to make any tire puncture proof! So startling is this new invention, so marvelously successful, that salesmen are piling up big, liberal commissions for just a few hours' work. Every auto owner, whether he drives a Ford or a Cadillac, is interested—he detests the fuss and bother of changing tires on the road and mending tubes.

## Punctures Sealed While You Drive

This wonderful new, scientific discovery is called Aer-Pruf. An old tire, after being treated with Aer-Pruf, was punctured with 857 nails without a single leak! Aer-Pruf seals punctures instantly while you are driving, so that you never know you have a puncture. Not only that, but it seals slow leaks, valve leaks, and porous tubes. It prevents rim cuts and broken side walls. It doubles tire mileage because it prevents driving with partly flat tires—the biggest cause of tire trouble. It has no injurious effects on casing or

tube. Will last the lifetime of the tube.

J. O. Bright sold fourteen sets in two hours—profit \$29.40, or over \$100 a day! W. R. Woock started out with demonstration samples. Then he secured some good territory and writes that he disposed of 700 sets in only three weeks' time.

We grant you Exclusive Territory Rights so that you can appoint sub-agents who will earn a splendid income for you. A good sub-agent should make you, at the very least, \$5 a day clear. If you appoint only three sub-agents, your profits from their work would be \$15 a day—\$400 a month—\$4,800 a year! And that is besides your commissions on your own work!

## FREE Sample Offer

Right now we are making a big special offer to send you a FREE Sample Set of Aer-Pruf and to pay you for the time required to test the sample if you are not amazed and delighted with it! You never before heard of such an unusual offer! Investigate this offer today. Just send the request blank for full details.

## AER-PRUF MFG. CO.

A-3187 Logan Bldg.

Mitchell, South Dakota



Frank Ryman says, "Have punctured all four of my tires at least four hundred times and they still stand up." Buford Houska says, "One of my Aer-Pruf treated tires was punctured 150 times by actual count on a long trip. It is still standing up under full pressure."

## Makes Old Tires Like New

Aer-Pruf doubles Tire Mileage, making an old Tube practically as good as new. C. A. Anderson says, "My old tires had to be pumped up every day until I had them treated with Aer-Pruf. They stayed up after that."

Aer-Pruf goes wherever the air goes, sealing up any and every leak—big and little punctures, slow leaks, valve leaks, and porous tubes.

Aer-Pruf Mfg. Co.  
A-3187 Logan Bldg.,  
Mitchell, South Dakota.

Please send me full details of your  
FREE Sample Offer.

Name.....  
Address.....  
City..... State.....

## Practical Tools for Practical Men

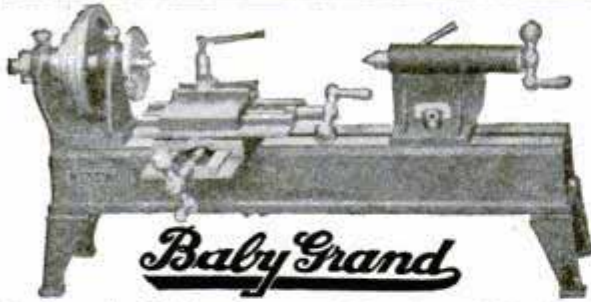

Equipped with back-gear head or plain head as shown. Arranged for wood turning, metal turning or both. A practical machine for skilled mechanic or amateur: for shop or home. Made with same precision and quality materials as large lathes. Has 6" swing; 12" or 18" between centers; speed 180 to 1750 R. P. M. Quantity production explains its low cost.

### Baby Grand Drills and Grinders



Both are thoroughly practical tools of high quality. Drill capacity 0" to 3/8" drills. Wide speed range. Comes equipped with chuck as shown. Grinder wheels 4" dia.; 3/8" face. Comes complete as shown.



Write today for prices and complete information on Baby Grand Tools.

### The Watson Mfg. Co.

101 Watson Bldg.

Toledo, Ohio

## Serve Humanity by Selling Renulife VIOLET RAY Health Generators

Renulife High Frequency Electrical Treatments are used in over 85,000 homes, physicians' offices and hospitals to combat disease.

Andrews made \$1,000 commission the first month. Johnson made \$10,000 the first year. Mrs. Knowlton averaged \$60.00 per week part time work selling Renulife Violet Ray Generators. Our new campaign is in full swing. We can turn over splendid territory to dependable men and women. The use of Renulife Violet Ray Generators for giving beauty treatments in the home as well as combating disease is growing with amazing rapidity. Renulife operates on a scientific principle, supplies life-giving oxygen, improves circulation of blood, sweeps away fatigue poisons from the system. Easy to sell. Write today for full details. **Act now — big national advertising campaign is under way.** Address — Sales Manager,



**RENULIFE ELECTRIC COMPANY**  
104 Renulife Bldg. DETROIT, MICHIGAN

## PATENTED SUBANTENNA!

The  
One  
Great  
New  
Thing  
In  
Radio

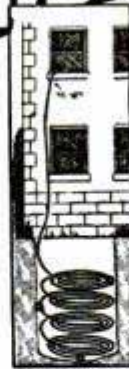

### Amazing New UNDERGROUND ANTENNA

**Eliminates All  
INTERFERENCE**

**Gets Distance Clearly.**

Here you are, "Distance" fans! Install this new type underground "pick up system." Get distant stations loud and clear like local. SUBANTENNA banishes STATIC

and all other air noises. Lets the broadcast come through clean.

**Uses Filtered Ground Waves.** Power line leaks, arc-light crackles, STATIC and all air noises are filtered out from the broadcast and grounded by SUBANTENNA before the broadcast reaches the set. The greater distance and clarity of your set will amaze you.

**Nothing Else Like It.** Not just a wire. Consists of special composition wire differently insulated and sheathed in a lead jacket and containing a series of three "building up" coils. Nothing else will do what SUBANTENNA does. Nothing else in the world like it.

**FREE TRIAL OFFER!** We want you to test SUB-ANTENNA. We want you to enjoy the thrill of loud, clear DX reception when your old aerial will give you nothing but STATIC and crackles. Write at once for FREE TRIAL OFFER and scientific explanation of SUBANTENNA. Write NOW!

**CLOVERLEAF MANUFACTURING CO.**  
2716-H So. Canal St. CHICAGO

### Own a CORONA

The portable typewriter built like an office machine. Has four-row keyboard and big-machine features throughout. Write to



L. C. Smith and Corona Typewriters, Inc.  
112 E. Washington St., Syracuse, N. Y.

### THIS BOOK FREE

Tells you how to make \$150 to \$300 monthly profit in cold weather with practically no investment. Tells how to get the equipment on 30 days trial and on easy monthly terms that let it pay for itself with a handsome profit besides. Write for book MS-7, THE HOBART BROTHERS CO. Box M173 Troy, Ohio

**Keep Your Shop Busy  
While Others Are Low**

## \$100 WEEKLY

Hundreds making it. Selling marvelous auto invention—all cars. One size—fits all cars. Easily demonstrated Pocket size. Installed in 3 minutes. We guarantee sale. Send for free introductory sample offer and Crew Managers proposition.

**MAE AUTO PRODUCTS COMPANY** **FREE**  
DEPT. 501, 6355 BROADWAY, CHICAGO **Introductory**  
**OFFER**

Books on all subjects are sold  
by Popular Mechanics Press,  
200 E. Ontario St., Chicago, Ill.

# Swear Off Tobacco

## Tobacco Habit Banished Let Us Help You

### Quick Results

Trying to quit the tobacco habit unaided is often a losing fight against heavy odds, and may mean a serious shock to your nervous system. So don't try it! Make the tobacco habit quit you. It will quit you if you will just take **Tobacco Redeemer** according to directions.

It doesn't make a particle of difference whether you've been a user of tobacco for a single month or 50 years, or how much you use, or in what form you use it. Whether you smoke cigars, cigarettes, pipe, chew plug or fine cut or use snuff—**Tobacco Redeemer** will positively remove all craving for tobacco in any form in a few days. Your tobacco craving will usually begin to decrease after the very first dose—there's no long waiting for results.

**Tobacco Redeemer** contains no habit-forming drugs of any kind and is marvelously quick, scientific and thoroughly reliable.

### Not a Substitute

**Tobacco Redeemer** is in no sense a substitute for tobacco, but is a radical, efficient treatment. After finishing the treatment you have absolutely no desire to use tobacco again or to continue the use of the remedy. It helps to quiet the nerves, and will make you feel better in every way. If you really want to quit the tobacco habit—get rid of it so completely that when you see others using it, it will not awaken the slightest desire in you—you should at once begin a course of **Tobacco Redeemer** treatment for the habit.

### Results Absolutely Guaranteed

A single trial will convince the most skeptical. Our legal, binding, money-back guarantee goes with each full treatment. If **Tobacco Redeemer** fails to banish the tobacco habit when taken according to the plain and easy directions, your money will be cheerfully refunded upon demand.

### Let Us Send You Convincing Proof

If you are a slave of the tobacco habit and want to find a sure, quick way of quitting "for keeps" you owe it to yourself and to your family to mail the coupon below or send your name and address on a postal and receive our free booklet on the deadly effect of tobacco on the human system, and positive proof that **Tobacco Redeemer** will quickly free you from the habit.

**Newell Pharmacal Company**  
Dept 300, Clayton Station, St. Louis Mo.

### Free Book Coupon

**NEWELL PHARMACAL CO.,**  
Dept. 300, Clayton Station, St. Louis, Mo.

Please send, without obligating me in any way, your free booklet regarding the tobacco habit and proof that **Tobacco Redeemer** will positively free me from the tobacco habit or my money will be refunded.

Name.....

Street and No.....

Town..... State.....



Tobacco Tells on  
Nervous System



Tobacco Ruins  
Digestion



Tobacco Stunts  
Boy's Growth



Tobacco Robs  
Man of Vitality



Tobacco Steals  
from You the  
Pleasures, Com-  
forts, Luxuries  
of Life





# DEVITT 8" COMBINATION SAW

## 13 TOOLS IN ONE

Saw table raised, showing Emery wheel, saw guard and drill attachment.



Planer attachment on saw table.

Showing Sanding disc attached.



Table tilted for beveling.

Dado head attached for grooving.

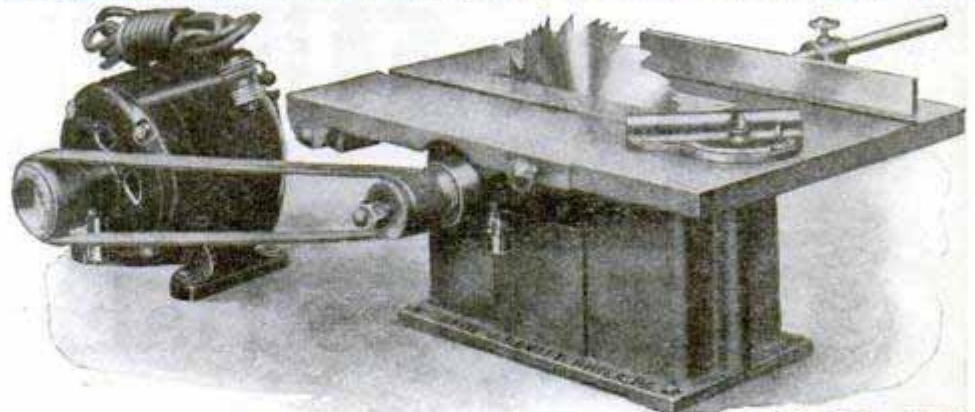

**\$35**  
F. O. B. Phila.

YOU save a great deal of money, time and space by buying a Devitt 8" Combination Saw. Why buy special tools for beveling, grooving, buffing, etc.? The Devitt Combination Saw will rip, cross cut, bevel, miter, groove, mortise, tenon, drill, rabbet, grind, buff and polish. The attachments are easily and quickly adjusted. The saw and motor when set up ready for work occupy very little room. The 1/4 H. P. 60 cycle 110 volt A. C. motor can be run from a light socket and provide power for other purposes when the saw is not in use. A cut up to 2 1/4" can be made with the 8" Combination Saw without planing. The ideal machine for shop, factory or home, complete with attachments: 12"x16" table, 8" Combination Saw, iron pulley for saw table, 12" ripping fence, adjustable cut off miter gauge, motor-specifications as above, 1 1/4" endless leather belt, wood pulley, 8 ft. cord and plug, 6" buffing wheel, 3/4" 3 jaw drill chuck, 5" emery wheel, 8" sander, saw guard, and 2" dado insert. \$35.00 F. O. B. Phila. Height 16", shipping weight, 100 lbs. (Planer attachment to fit on table top will smooth pieces up to 2' wide, \$12.00 extra F. O. B. Phila.)

Write for our beautifully illustrated 4 page circular.

**PAUL J. DEVITT** 1102 South 2nd Street PHILADELPHIA, PA.

**Blancke Agent Makes \$3000 in 1 Month**  
SALES INCREASES Guaranteed

Ford Mileage to 43.8 miles on 1 Gallon of Gas  
**\$15 a DAY GUARANTEED to DISTRIBUTORS**  
Blancke Thermostatic Carburetor Control in official Tests increased Ford mileage 110% per gal. of gas. 250,000 satisfied users recommend the Blancke Control because of large mileage increase. Strongest Guarantee in Automotive Industry Backs Sale of Blancke Controls Sensational demonstration. Order wired by Waite of Alberta, "Ship 1000 Controls. Get ready another 2000." Clyde Jones, Ark., writes, "Sold 63 Controls today." Phillips Vickery, Ga., says, "Sold 108 Controls in 1 day."

Blancke Plan and Guarantee gives every user Agent new Ford Car Free by time his present Ford is worn out

**GET 1 FREE TO INTRODUCE**  
Blancke Plan starts you in a business that pays you from \$450.00 to \$3000.00 per month. No experience needed. Exclusive territory. Write today for Free Control and amazing Distributor's Plan. Cadillac and Deleo Light use as Standard Equipment Thermostatic Carburetor Control under Blancke License.  
**BLANCKE AUTO DEVICES CO.**  
Dept. 805-A, 157 E. Erie Street, Chicago, Illinois

### THE WOTEN GASOLINE ENGINE

Air-cooled—Water-cooled. One H. P. in 20 pounds. Handiest little engine ever made. Ideal wherever power is needed. Also the Metalumen Model Airplane Engine, one-half H. P. in 3 1/2 pounds. The market demands them in thousands. Generous agency propositions on request. Complete line of small gasoline and steam engines, battery chargers, etc. Catalogue Free.



**DYNAMIC MANUFACTURING CO.**  
First Nat'l Bank Bldg., Dept. 7, CHICAGO

### SAY! LISTEN!

A New Pair of Pants Matched to Your Coat and Vest



Just doubles the life of your suit. We can match almost any suit. 70,000 patterns. Sample is sent for your O. K. before making. All made to measure. Send piece of cloth or vest for matching.

**ACME PANTS MATCHERS**  
Dept. A-23 20 W. Jackson CHICAGO  
Enclose return postage if vest is sent



## Everybody is Playing The "JAZZITHA" The one string Hawaiian Guitar

Play all the popular melodies at once and surprise yourself and friends. No lessons or knowledge of music necessary. The music is written in numbers. The Jazzitha is 19 inches long, nicely finished in lacquer. Comes with pick, bar and ten song leaflet and **FREE 3 Extra strings worth 25c**

Send no money—Pay Postman \$1.47 plus postage on delivery. **MAKES AN IDEAL GIFT**  
IMPORTANT:—No C. O. D.'s to Canada or foreign countries, send money order (only) for \$1.75—this includes postage.

**THE JAZZ STUDIOS, 2512-41st Avenue Dept. 560 Long Island City, N. Y.**  
Please print your name and address plainly.

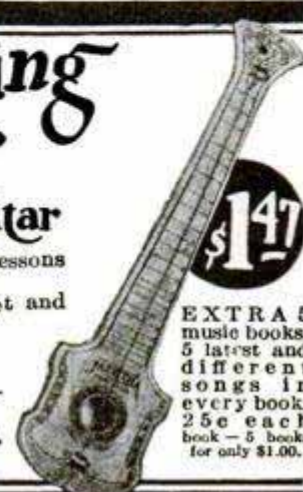

**\$1.47**  
EXTRA 5 music books, 5 latest and different songs in every book, 25c each book — 5 books for only \$1.00.

*At home—by mail—you can learn*  
**Massive Stage Illusions**

Guarded Secrets of the Orient  
 The Great Hindoo Mango Tree Illusion  
 The Great Chinese Ghost Illusion, and  
 over 150 BIG effects in real professional

# Magic

*taught by the great master  
 who mystified Europe!*

So amazing, so mystifying is the Magic power of this great Master, Dr. Harlan Tarbell, B. Sc., FSD, D.N., that Europe called him "the miracle man".

AND NOW—think of it!—YOU have the marvelous opportunity of learning these Magic Secrets—at home—by mail—direct from this great master.

You'll be astonished at how, through the able teaching of this great Master, YOU will soon master—impromptu effects, parlor tricks, and even massive stage illusions. You'll be taught famous mysteries of Europe, China, and of the Ancients. Great secrets will be revealed to you.

## *Guarded Secrets of the Orient*

Yes, even those great mysteries the Hindu Fakir guards so jealously—all this and MORE will you be taught and soon master with this great renowned teacher who mystified Europe and whose original ideas are used by famous magicians the world over. The great Dr. Tarbell will initiate you into the innermost mysteries of this time honored profession. Your friends will be amazed at the great Magic Powers you will soon acquire. Yours friends will envy you. Magnetic popularity will be yours.

## **Earn \$250 to \$1000 a Month**

There's big money in Magic for YOU. Yes, and the best part is that you do not have to give up your present position or business. You can make nice money entertaining on the side, or under the guidance of this great Master, you can become a real, professional magician, make big money and enjoy fame and glory.

**Write Today**— mail that coupon NOW and learn of the great limitless opportunities in store for YOU!

**Tarbell System, Inc.,** Studio 93-51, 1920 Sunnyside Ave., Chicago

## **Mail This Coupon NOW!**

- Tarbell System, Inc., Studio 93-51
- 1920 Sunnyside Avenue, Chicago, Illinois
- Gentlemen: Without any obligation send me your free literature and information all about your wonderful "Tarbell Course in Magic." Also tell me about your great Special Price Offer and Easy Payment Plan—offered NOW for limited time only.

Name.....

Address.....

Age.....

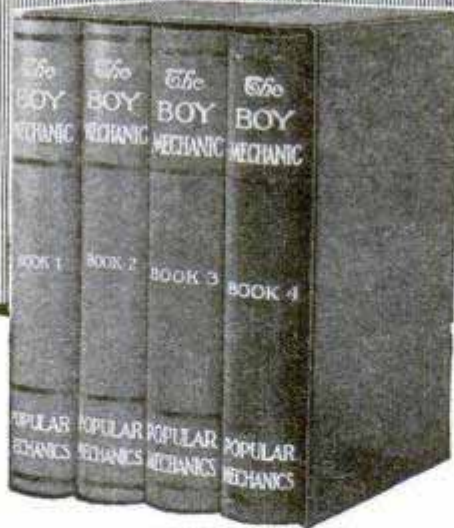

**3,849**  
Ideas

**3,917**  
Pictures



## It's Fun To Make Things

Let the other boys wonder how you can make so many interesting things. Make your own motor sled. Make your own radio. Make your own skis and snowshoes. You can learn how to make almost anything that any boy could want by following the pictures and the simple directions in

## The Boy Mechanic Library

And just think of it, there are nearly 4,000 separate articles in the four beautiful volumes! Some of the most fascinating subjects are listed below.

### How To Make Things—How To Do Things

- |                  |                       |                     |
|------------------|-----------------------|---------------------|
| Boats            | Carpentry             | Electrical devices  |
| Winter sports    | Painting              | Photography         |
| Camping          | Toys                  | Music               |
| Ice boats        | Fishing               | Outdoor games       |
| Water sports     | Fruit growing         | Stoves              |
| Toboggans        | Entertainments        | Furnaces            |
| Tents            | Automobile            | Wireless            |
| Skis             | House decorations     | Tricks              |
| Indian snowshoes | Drafting              | Puzzles             |
| Skating          | China painting        | Bicycle             |
| Gymnasium        | Decorative metal work | Flowers             |
| Wind wagons      | Furniture making      | Hunting             |
| Motor sleds      | Farming               | Kites               |
| Radio            | Poultry               | Metal working tools |
| Magic            | Models                | Secret locks        |
| Trapping         | Laboratory helps      | Swings              |
| Pets             | Household helps       | Sleds               |
| Leather work     | Wood working          | Power devices       |

Learn how to make things to sell. Learn how to make things to enjoy yourself. Buy the complete library, including Book 1, Book 2, Book 3 and Book 4.

**SEND NO MONEY** Four Books for only

Simply sign your name and address to the attached coupon and mail it at once. When the postman delivers the books to your door, pay him the price of the books and the few cents postage. That is all.

**\$7**

POPULAR MECHANICS PRESS  
Popular Mechanics Building, Room 101, Chicago, Ill.

..... Mail The Coupon Today .....

Popular Mechanics Press,  
Popular Mechanics Building, Room 101, Chicago, Ill.

Please send me at once C. O. D. The Boy Mechanic Library comprising Book 1, Book 2, Book 3, and Book 4. I will pay the postman \$7 and the few cents postage.

Name.....

City.....State.....

Street No. or R. F. D.....

If you want individual books at \$2 each, check the numbers of the books you want: 1  2  3  4



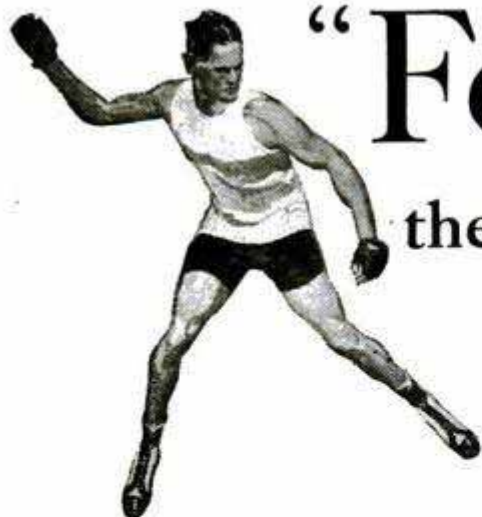

# "Footwork

the secret of power and speed"

*says a world's champion athlete  
in a booklet written for boys*

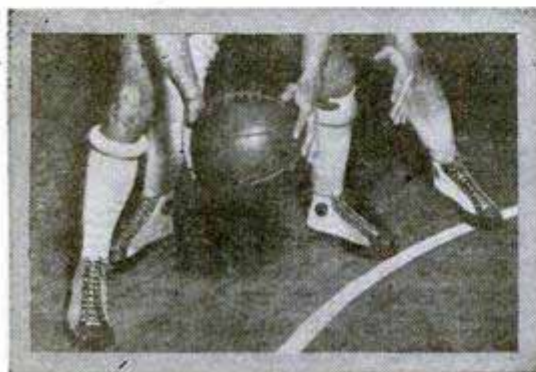

On the handball court or the basketball floor—indoors and outdoors—fast, sure play depends on footwork. And Keds are built for speed! There's a model for every kind of sports wear

**I**NDOORS and outdoors—on the hard wood of the gymnasium floor as well as on the grass or clay of the tennis court—in every game where you have to cover ground *fast*—the saying of this great player holds good: "Shoes must be exactly right."

It's no wonder that this great athlete plays in Keds! And that most champion players in many sports—championship teams from coast to coast—choose Keds.

This new Keds special basketball shoe has a sure grip on the

fastest floor. Its sole is non-slipping, light and springy. It is specially built to absorb shocks that tire muscles.

Keds uppers are light, too. But they're strong, to protect against strains. And there's the special Feltex innersole to keep your feet always cool and comfortable.

Here's a shoe that's built for speed!

Ask for Keds by name. But be sure the name Keds is on the shoe. There's a model for every kind of sports wear, indoors and out. Keds come in all popular styles at prices from \$1.25 to \$4.50.

United States Rubber Company

## Keds

Reg. U. S. Pat. Off.



### "SPRING-STEP"

This new special Keds basketball shoe is just what he's been looking for, says one of America's most famous basketball coaches. The diagram shows you why. The "Spring-Step" has a tough, sure-gripping sole and is shaped to fit your feet. Comes in white with black trim

*They are not Keds unless the name Keds is on the shoe*

No. **125**

Bench Lathe  
Complete as  
Illustrated  
Price \$40

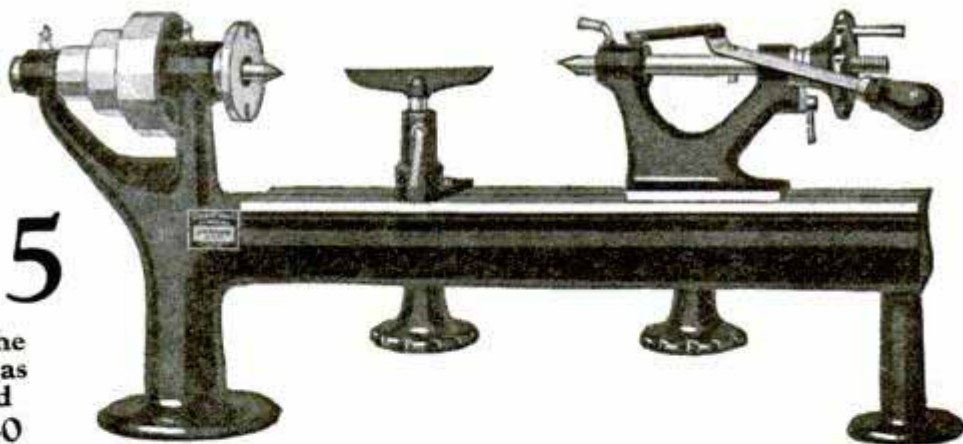

This bench lathe  
makes your home shop  
a real workshop

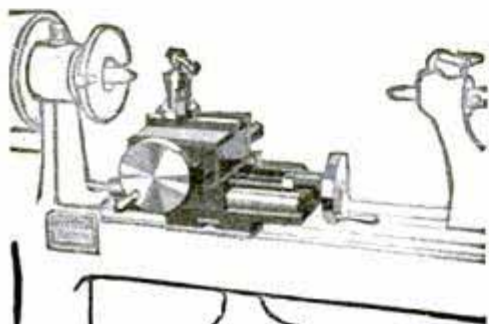

No. **132** Slide Rest  
Price \$17.50

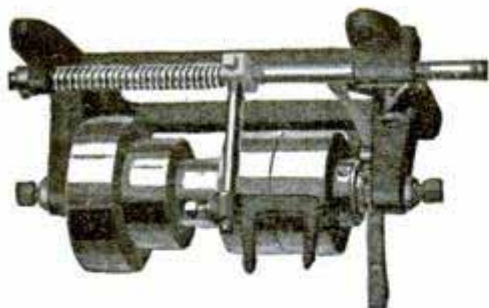

No. **130** Counter Shaft  
Price \$12

**Bench Lathe No. 494**

This lathe has the same construction as No. 125 above, but is slightly larger. Length over all, 31 inches; height, 11 1/2 inches; swing, 7 inches; extreme distance between centers, 18 inches. Net weight, 36 pounds. Price, \$44.00.

**T**HERE are many turning and boring jobs you could do yourself if you had a bench lathe. Make your workshop more complete by adding to it this Goodell-Pratt Lathe. It enables you to do professional-looking work. Over-all length of this bench lathe is 25 inches; height, 11 1/2 inches; swing, 7 inches; extreme distance between centers, 12 inches. It weighs only 30 pounds. Price, \$40.

This lathe has a milled bed and a tail stock with milled base. Live spindle has a cone bearing to take up wear. The tail stock has both screw and lever feed. Cone pulley has 3 steps—1 1/2, 2 1/2, 3 1/2 inches in diameter. The lathe is finished with black and red enamel. All working parts are beautifully polished.

A complete line of attachments is available to fit this lathe. Among them are a slide rest, lathe tools, compression check and collets, milling attachments, turret attachments.

**400-page book of tools FREE**

A postcard will bring you the 400-page pocket-size book of all the famous 1500 Goodell-Pratt tools. In this book are shown and described many tools you will want to outfit your workshops completely. Every tool shown is beautifully made and finished by skilled toolmakers. Just let us know where to send your copy of the book. It is FREE.

GOODSELL-PRATT COMPANY

GREENFIELD, MASS., U. S. A.

*Toolsmiths*

Makers of Mr. Punch

**GOODSELL-PRATT**  
**1500 GOOD TOOLS**

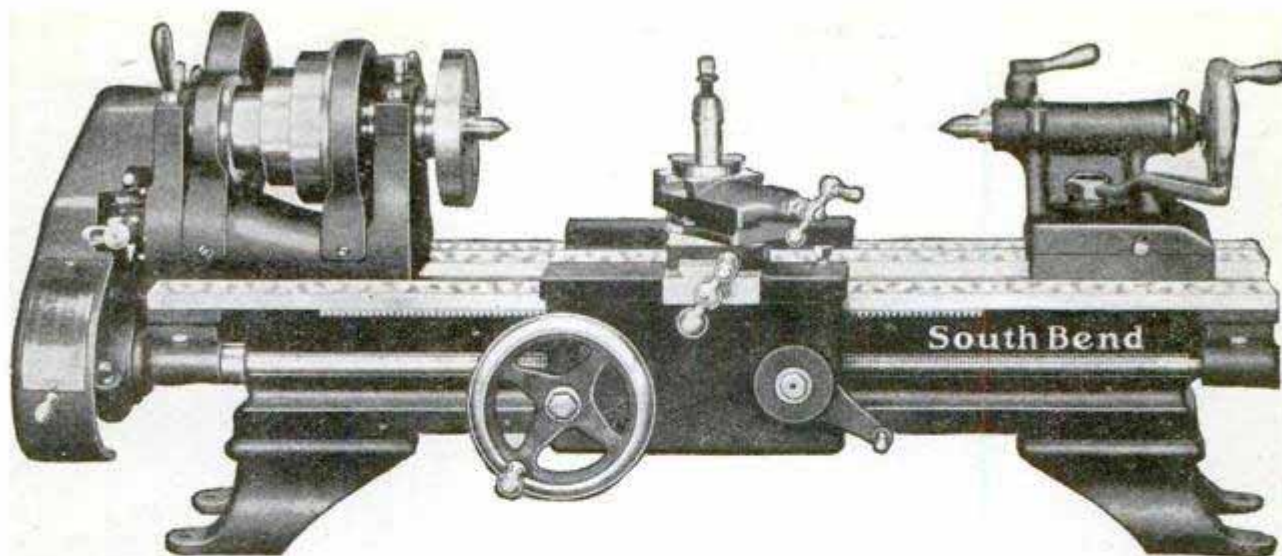

**9 in. x 3 ft.  
Back Geared  
Screw Cutting**

**Bench  
Lathe**

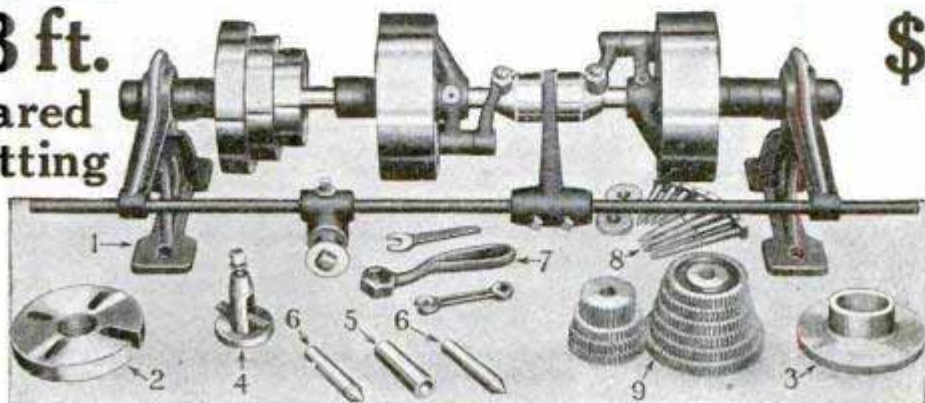

**\$150**

**Price  
Includes  
Counter-  
shaft and  
Equipment**

**THE 9-in. South Bend Back Geared Screw Cutting Bench Lathe is a precision tool capable of turning out accurate machine work of all kinds within its capacity.**

### Brief Specifications

**BACK GEARED HEAD STOCK** with 3 Step Cone gives six changes of spindle speeds.

**GROUND HEAD STOCK SPINDLE** is made of special carbon steel. Has  $\frac{3}{4}$ -inch hole its entire length for machining long bars and rods through Collet and Lathe Chucks.

**PHOSPHOR BRONZE SPINDLE BEARINGS** are hand scraped to perfect bearing, adjustable for wear.

**COMPOUND REST** is graduated 180 degrees and can be clamped to operate at any angle required.

The Compound Rest Feed Screw and the Carriage Cross Feed Screw are both equipped with Micrometer Graduated Collar reading in thousandths of an inch. **PRECISION LEAD SCREW** is  $\frac{3}{4}$  inches in diameter, 8 threads per inch. The finest precision thread gauges, taps, etc., can be made to meet the most exacting requirements.

**POWER FEED** to the carriage, by clamping the split nuts on the lead screw.

**SCREW THREADS** can be cut as follows, either right or left, including  $11\frac{1}{2}$  pipe thread: 4, 5, 6, 7, 8, 9, 10, 11,  $11\frac{1}{2}$ , 12, 13, 14, 16, 18, 20, 22, 24, 26, 28, 30, 32, 36, 40, with the change gears supplied with the lathe.

This lathe can be driven from overhead countershaft or can be Motor Driven.  $\frac{1}{4}$  H. P. Reversing Motor required connected direct to light socket.

Write for Bulletin 22-J for Detailed Description

**SOUTH BEND LATHE WORKS**

617 East Madison St.

South Bend, Indiana

*Easy Payment Plan if Desired*

### Attachments

Draw-in Collet Chuck  
Graduated Taper Attachment  
Milling and Keyway Cutting Attachment  
Electric Grinding Attachment  
Electric Mica Undercutter  
Turnstile Bed Turret  
Thread Indicator  
Adjustable Thread Cutting Stop  
Step Chuck and Closer  
6-in. 4 Jaw Independent Chuck  
4-in. 3 Jaw Universal Chuck  
Drill Chuck, etc.

### The New Line of South Bend Lathes

In the past 20 years over 35,000 South Bend Lathes have been built and are giving satisfactory service in all lines of work. There is a South Bend Lathe for every job—from 9" to 24". The most popular sizes are listed below.

Size	Quick Change	Standard Change
9" x 3'	\$ 258.00	\$ 228.00
11" x 4'	308.00	268.00
13" x 5'	387.00	337.00
16" x 6'	521.00	461.00
18" x 8'	693.00	628.00
21" x 10'	1032.00	949.00
24" x 12'	1437.00	1338.00

For complete details write for illustrated Catalog No. 87 sent postpaid on request

**SOUTH BEND LATHES**

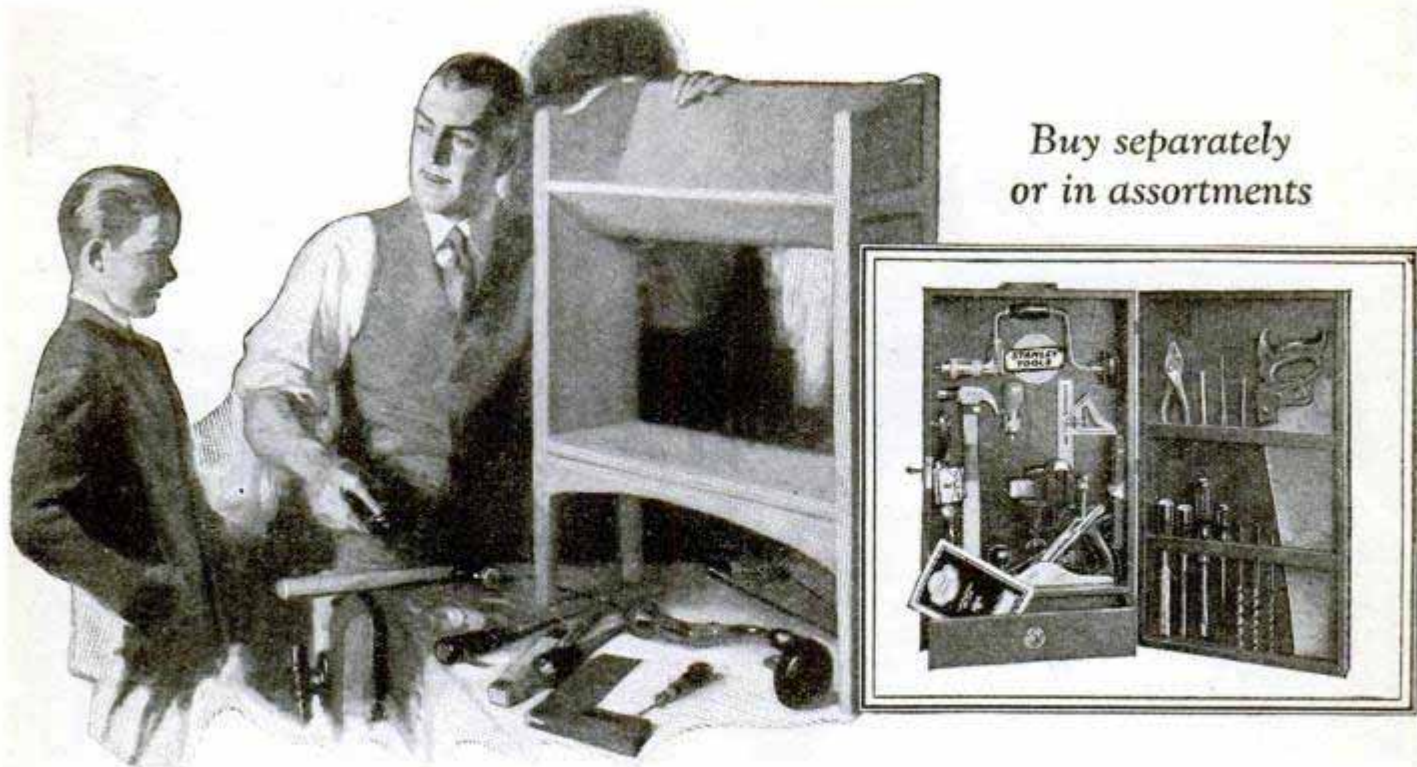

*Buy separately  
or in assortments*

## To men who love their books!

**A**RE your books and magazines scattered about the house where they may become damaged and where the bindings may crack and break? You can easily make a book or magazine stand—and think of the fun you will get out of it. Thousands of men find woodworking an absorbing as well as a most useful hobby.

Of course you realize the importance of using good tools—the amateur user needs them even more than the professional. Nothing is more discouraging than to have a tool go wrong when you are in the midst of an interesting job. Most carpenters use Stanley Tools because they know from first-hand experience that the Stanley name stands for design, balance, and durability. And Stanley Tools are the first

choice in thousands of manual training classes.

You can buy Stanley Tools separately and so collect your own set. For your convenience in buying there are also complete sets of Stanley Tools at a wide variety of prices from \$15 to \$95. Or there are assortments in strong cardboard boxes containing directions for making your own tool chest. Price \$2.15 to \$20.

**IMPORTANT** — For only 10c (to cover cost of printing and mailing) we will send you a plan sheet which gives full directions for making a bookstand like that shown above. Ask for Plan No. 11.

Ask your hardware dealer for a copy of Stanley catalogue No. 34-D. It shows the most complete line of woodworking tools on the market. If he cannot supply you write direct to The Stanley Works, New Britain, Conn.

The best tools are the cheapest to use  
Ask your hardware dealer



---

# STANLEY TOOLS

---

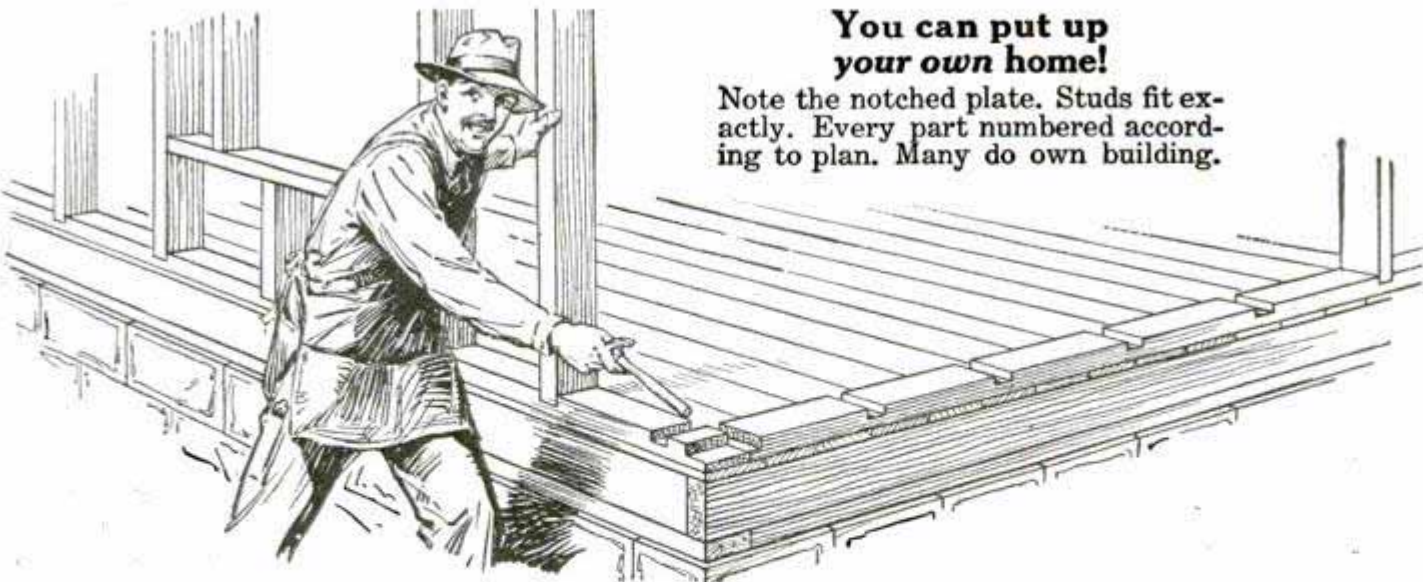

**You can put up  
your own home!**

Note the notched plate. Studs fit exactly. Every part numbered according to plan. Many do own building.

## Buy Your Home "Plan Cut" Direct from Mill—Save Up to \$2000

**Parts come all sawed and fitted—As easy to build as swinging a hammer! Saves 30% labor and 18% lumber waste!**

Now you can have the home of your choice—planned by skilled architects—at a price within your reach, and build it yourself if you want to!

Through the Gordon-Van Tine Plan-Cut system, we furnish lumber and material already measured, sawed, beveled and notched at the mill. All that is necessary is to nail it together!

Every part fits. Every measurement has been made. Roof pitches all figured. Rafters cut and notched. Joists and studs sawed to proper length. Stairwork and cupboards ready to put up. The only sawing to be done is siding and finish.

Whether you do it yourself or hire a carpenter, you save hours of carpenter-time—the average is about 30 per cent. And you save errors, mistakes and blunders. Only one way to build, and that is the right way!

**Send Us Your Bills to Figure**

We sell lumber and material at wholesale prices for any job. Send us your material bills for free estimate.

### Stronger, More Solid Construction

The Gordon-Van Tine Plan-Cut system gives you a stancher, tighter-built house. Every joint and angle meet perfectly—the parts are all cut to steel-gauge measurements. And they go together as accurately as the girders on a steel skyscraper.

### No Waste—No Extras

There is no waste lumber—no kindling wood when you are thru. Nor are there any extras. We furnish material according to a specified list. You buy your house at a guaranteed price, and know in advance exactly what it will cost.

### Wholesale Prices

By buying direct from mill you get *wholesale prices*. We cut material in our modern mills, located at the source of supply, sell to 200,000 customers, with but one small profit. So we can sell you *guaranteed highest quality material* at factory prices.

### Charming Homes

Our plans are the latest word in modern home-building. These homes have been designed by skilled architects. We furnish complete blue-prints and full instructions. Every home has been proved and tested by repeated building. Write for Free Book and latest wholesale prices!



**Home 623  
5 Rooms  
\$1201**



**Home 633  
5 Rooms  
\$1795**

An impressive 5 room home, with bath. Compact—can be built on narrow lot.

Beautiful Colonial Bungalow. Large living room, with fire-place. Two bedrooms.

**Send for  
This  
Book  
TODAY!**

**Book of  
100 Plans  
FREE!**

Shows photos, floor plans, specifications, prices of 100 homes, 3 to 10 rooms; Bungalows, Colonial, city and country homes. Write!



Gordon-Van Tine Company  
898 Case Street, Davenport, Iowa  
*Satisfaction Guaranteed or Money Back.*  
Please send me Book of 100 Home Plans.

Name.....

Address.....

# Gordon-VanTine PLAN·CUT Homes



# CROSLEY

BETTER COSTS LESS

# RADIO

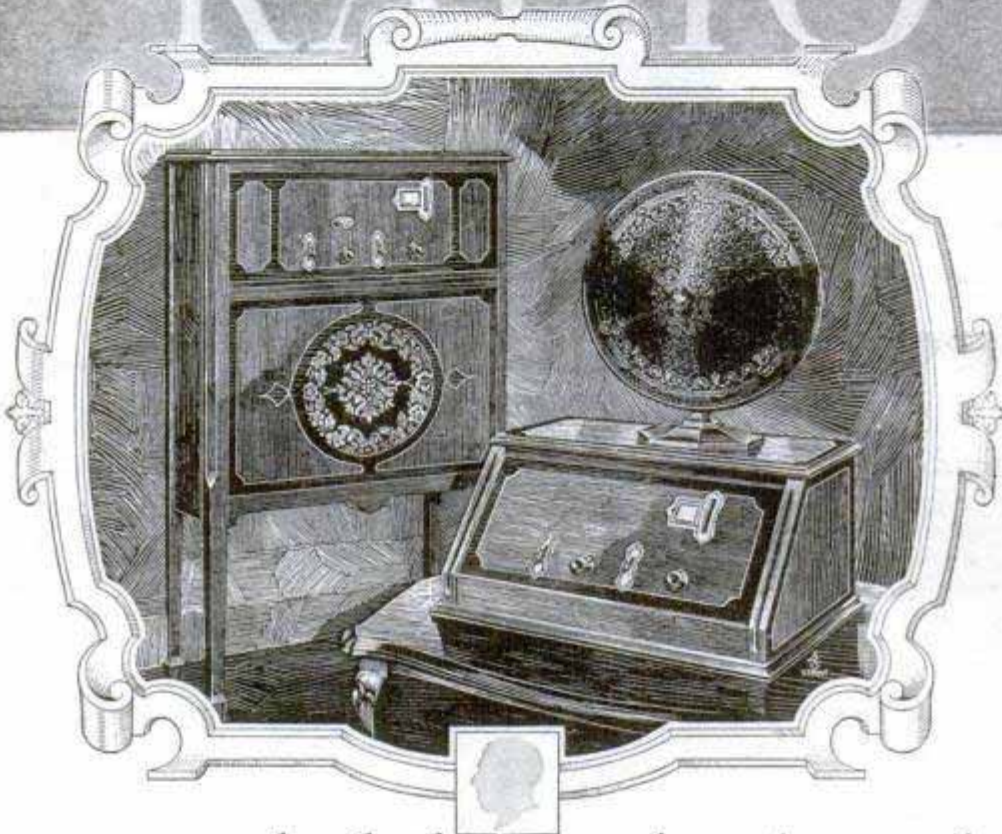

## Amazing single dial control *and* reproduction

### THE 5 tube 5-50

Such a success! Enthusiastic owners report amazing performance—a drum dial delivering stations loud, clear, sharp; each an almost imperceptible turn of the drum apart. Write station letters on the drum; return to them at will. This marvelous receiver containing these advanced ideas in radio (some of them exclusive to Crosley), including metal shielding and power tube adaptability indicates Powel Crosley, Jr.'s genius in lowering prices by mass production methods.

# \$50.

Prices slightly higher west of the Rocky Mountains

### THE SUPERMUSICONE

Listen to this wonder reproducer of broadcasting! Then you'll understand why it is the biggest selling loud speaker on the market EVERYWHERE, and the most imitated. Its shape, however, is NOT the secret of its wonderful performance. Its delightful tone and the fidelity of its reproduction is achieved solely through the Crosley patented actuating unit. Avoid imitations. There is only one genuine MUSICONE. Smaller model, 12-inch cone, \$12.50.

# \$14.75

### THE 5-75 CONSOLE

This set includes ideas for radio reception perfection NOT found in any other radio. Marvelous exclusive Crosley "Crescendon" and "Acuminators" increase volume on distant stations and bring in programs entirely passed by and missed on ordinary one dial control radios. Console is 40 inches high with ample room for batteries and a genuine Crosley Musicone is built in. Radio chassis same as in the 5-50 receiver. Beautifully finished two-tone mahogany cabinet, rose gold fittings.

# \$75.

Write Department 15 for Illustrative Literature

Crosley manufactures radio receiving sets, which are licensed under Armstrong U. S. Patent No. 1,113,149, or under patent applications of Radio Frequency Laboratories, Inc. and other patents issued and pending.

## THE CROSLEY RADIO CORPORATION

CINCINNATI, OHIO. POWEL CROSLEY, Jr., President

# 30 DAYS FREE IN YOUR HOME

Tested and approved by all of Radio's Highest Authorities



Send Coupon for Amazing Special Offer!

Unless Trial Proves Your Miraco the Most Selective, Clear est Toned and Most Powerful Distance Getter Among Sets up to \$10 Tubes, Don't Buy It!

BEAUTIFUL-BIG-POWERFUL ultra Selective **MIRACO** ultra

Retail LIST Price **\$49.75** GET SPECIAL OFFER **only 29.75** one year GUARANTEE

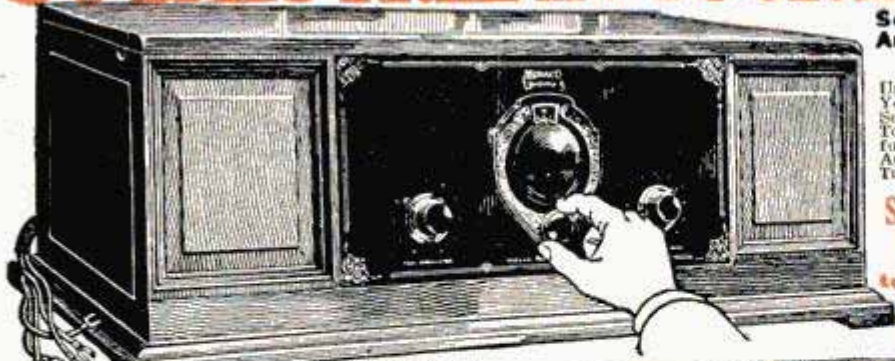

Built like—to look like—and perform like \$200 sets

## Real Single Dial Control! Magnificent Big Powerful Miraco "Unitune-5" Get Special Offer and Amazing Low Price!

The celebrated Miraco Ultra-5—U.S. Navy type circuit, had also been adapted to Single Dial Tuning—without sacrifice of selectivity, volume, clearness, power, tone, or distance getting qualities! In the magnificent big Miraco Unitune-5, above shown, you turn one vernier knob for stations everywhere. Beautiful hand-rubbed, piano hinged, solid walnut cabinet, 28 in. long, 15 in. deep, 10 in. high. Sloping Bakelite panel is walnut finished to match. Also offered on 30 days free trial!

## Coast to Coast and Foreign Reception Certified by Miraco users

**MIRACO RADIO GETS 'EM COAST TO COAST** Notice! Enormous tales of the celebrated Miraco's fine Bee-bee's (resulting from delighted users) are highly gratifying. Here is a list of some of the most recent and up-to-the-minute improvements such as new, more efficient, and only on much higher priced sets. Miraco's this year are still better—more beautiful—more selective—more powerful for tomorrow than ever before.

## USER-AGENTS WANTED... WRITE!

Reports from users everywhere leave little to be said. These are only a few of the many in our files and which we receive daily. Send coupon for plenty of additional proof and testimony of nearby users.

**HAS NO EQUAL FOR TONE, VOLUME, DISTANCE.** Northwood, Wis. N.J. Miraco best packed set I ever saw shipped. Words cannot express the wonderful tone quality, volume and distance. First night received 41 stations on loudspeaker. Up to last night, the 15th day, I have received exactly 100 stations. Farthest is KGO, Oakland, Calif., on loudspeaker. Also Puerto Rico, Cuba and Canada. Francis B. Lee.

**TONE QUALITY PLEASES EVERYONE.** Philadelphia, Pa. Everyone that hears the Miraco is very pleased with tone, distance, etc. Stated in during International Day of the Girl, Oct. 10, 1934, Oakland, Calif.; C.H. Mexico City, Mex.; G.W. Cuba, etc. Stated in during International Day of the Girl, Oct. 10, 1934, Oakland, Calif.; C.H. Mexico City, Mex.; G.W. Cuba, etc. Stated in during International Day of the Girl, Oct. 10, 1934, Oakland, Calif.; C.H. Mexico City, Mex.; G.W. Cuba, etc.

**WISCONSIN HEARS COAST TO COAST.** Racine, Wis. I got station 250 London last Wednesday night. My Miraco. Heard a choir singing and announcements. Have also heard P.R., Havana, Cuba, etc. Stated in during International Day of the Girl, Oct. 10, 1934, Oakland, Calif.; C.H. Mexico City, Mex.; G.W. Cuba, etc.

**UTAH ENJOYS COAST TO COAST PROGRAMS.** Helper, Utah. The Miraco sure can't be beat at any price. Coast to coast it sure does and more. I have had stations in date 150 stations and they all come in wonderfully. Monte Giles.

**MIRACOWNS AGAINST 3 OTHER NAMES.** Pearland, Texas. I tried three other makes and the Miraco is the best of them all. Received KFI, Los Angeles, Calif., on loudspeaker. O. H. Richards.

**COAST TO COAST LOUD AND CLEAR.** Guthrie, Minn. We loved our 30 stations and our 1500 miles on the loud speaker the first night—our first experience tuning a radio. The third night we got WJAZ, Jacksonville, Fla., and here you have ever heard. O. R. Wolf.

**MIRACO BEATS A SUPER EIGHT.** Cobalt, Ontario, Canada. Miraco is one of the best radios in all the north country. There is a man here who has a big Super eight and our Miraco outperforms some \$300 sets. Bakely, Ga. I am well pleased with my Miraco. Does better than machines that cost \$200 or more. F. D. Tison.

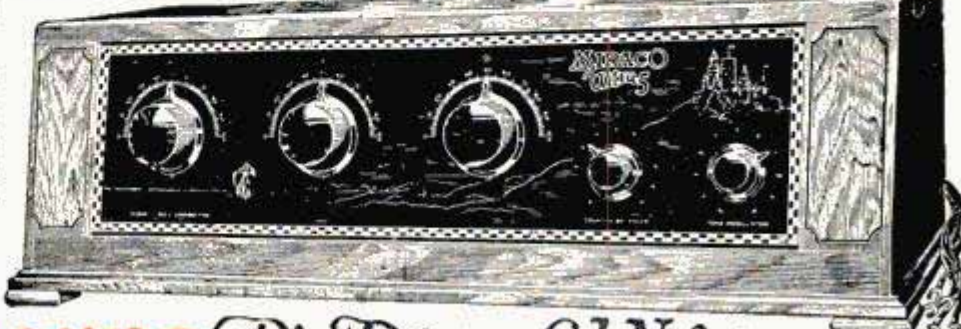

## Big Powerful New Unitune 5 MIRACO ultra 5

Solid Walnut Cabinet 28 in. long 27 in. long

TRADE MARK REGISTERED

ULTRA-SELECTIVE LONG DISTANCE 5 TUBE SETS EASY ON BATTERIES

Why run down your costly batteries burning 6, 7 or 8 tubes when users everywhere report that powerful, big Miraco sets actually are unsurpassed (even at 2 to 4 times the price) for razor-edge selectivity, extreme long distance reception, clear natural tone, quiet easy tuning and powerful loud speaker volume—combined with great savings in use of battery current.

**Be Convinced—At Our Risk!** Enjoy a big, powerful Miraco 30 days in your home. Compare it with highest priced sets. Then decide. Your verdict final. Remember, this offer is made direct to you by a famous big Radio Corporation—one of America's oldest, reliable makers of fine sets. Many thousands of satisfied customers. Postal or coupon brings testimony of nearby users and plenty of proof.

**Factory Prices Save You Up to 1/3!** Save or make a lot of money on

Compare its construction with highest priced sets—study this picture

Note the neat sturdy high-class construction; wide spacings between parts eliminate losses and interference. All wiring concealed under genuine Bakelite base panel. (M) Flexible wiring prevents broken or loose connections. Push-type sockets for the new tubes. (A) (B) (C) — "Duoformers" — famous exclusive Miraco Ultra low loss, self shielded and matched coils — one of the Miraco secrets of selectivity with powerful volume on long distance stations. (D) "Counter balancer" — patented feature, NOT a rheostat or potentiometer. Controls condensers on all wave lengths, reduces "B" battery consumption and further increases selectivity, distance range, clarity, power and volume. (E) (F) Shielded transformers of famous make evenly amplify all notes; beautiful tone quality. (G) Tone Modulator — regulates volume, switches current off or on. (H) (I) (J) Low Loss Straight Line Frequency Condensers — highest grade — equipped with ball bearings. Solid brass plates. Evenly separate all stations. (K) Connect E-Z Cable for attaching batteries. (L) Genuine Bakelite front panel. And many other latest features of costliest sets. Literature describes them fully, send for it!

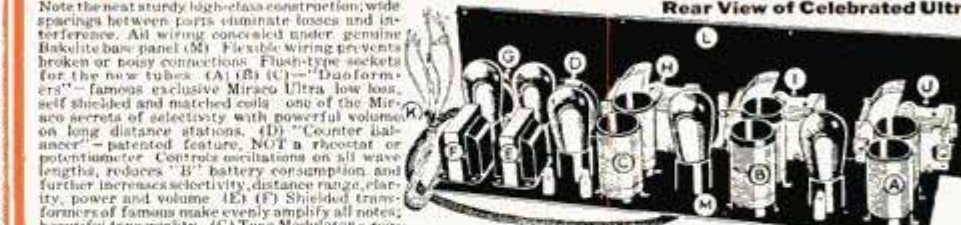

AGENTS! Write for DEALERS! proposition, Nation-wide popularity, superior performance, amazingly low prices, make Miracos easy to sell. This Coupon is NOT an order

**All the Proof you want is waiting for You!** Coupon or postal brings reports from hosts of users in your vicinity and elsewhere proving that Miraco sets at rock-bottom money-saving factory prices, outperform sets costing up to four times as much. You can also buy speakers, tubes, batteries, etc., at big savings from us! Get our proposition before spending money elsewhere.

**MIDWEST RADIO CORPORATION** Pioneer Builders of Sets Cincinnati, O.

407-8 Miraco Building Without obligation, send free literature, testimony of users, AMAZING SPECIAL OFFER and full particulars of your big money-saving factory-price proposition on Guaranteed Miraco sets and all radio supplies. ( ) User ( ) Dealer

NAME ADDRESS

Send coupon for Amazing Special Offer!

This Coupon is NOT an order

# Thorola

A New Idea  
in Radio

The **Only** Receiver  
with Horn and Cone  
Speaker Combination

Used with Batteries or  
Power Operated



Thorola Console  
Model 58  
\$125



Thorola Cabinet  
Model 57  
\$60



Thorola  
Model 4  
Horn Speaker  
\$25

Thorola  
Model 4  
Cone Speaker  
\$20



Prices slightly higher  
west of Rockies



\$185

## Thorola DeLuxe Console MODEL 59

THE advances recently scored in sound recording have for some time been available in radio broadcasting. It remained for Thorola to make them available in radioreception. This is accomplished by the combination of both Horn and Cone—an exclusive Thorola feature. Elusive, delightful tonal qualities that have long been waiting to be brought out, are now made audible through Thorola.

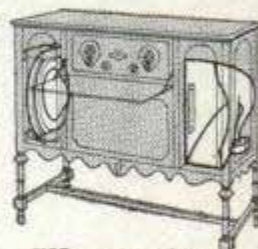

Illustrating  
the New Idea  
in Radio  
Cone and Horn  
Speakers Operat-  
ing in Unison

Your dealer will gladly demonstrate the  
Thorola—preferably in your home

REICHMANN COMPANY

1725-39 West 74th Street

Chicago, U. S. A.