

POPULAR MECHANICS

MAGAZINE

WRITTEN SO YOU CAN UNDERSTAND IT

REG. U.S. PAT. OFF.
REG. D. TRADE MARK GREAT BRITAIN No. 410435

REG. U.S. PAT. OFF.



SEE PAGE 963

ATKINS

SILVER STEEL SAWS

Mr. Happy Man says:

**“Look for the ATKINS
Name on the Blade”**

IT guarantees the only Cross Cut Saw made of “Silver Steel” to hold its edge longer—the only “Segment Ground” Cross Cut Saw to cut faster and easier—the only Cross Cut Saw packed with the BLUE STICK for protection of the teeth.

Save time, money and labor by looking for the ATKINS name when you buy a saw. Write for the ATKINS “Cross Cut Saw” booklet; it gives full information, including complete instructions for filing and setting Cross Cut Saws. It's FREE.

E. C. ATKINS & CO. Estab. 1857
Dept. P, INDIANAPOLIS, U. S. A.

*Leading Manufacturers of Highest Grade Saws
for Every Use; Saw Tools, Saw Specialties and
Machine Knives*



A WARM HOUSE
IN THE MORNING

HARDIN-LAVIN PIPELESS FURNACE

ALL-CAST SAVE HALF-INSTALL YOUR OWN

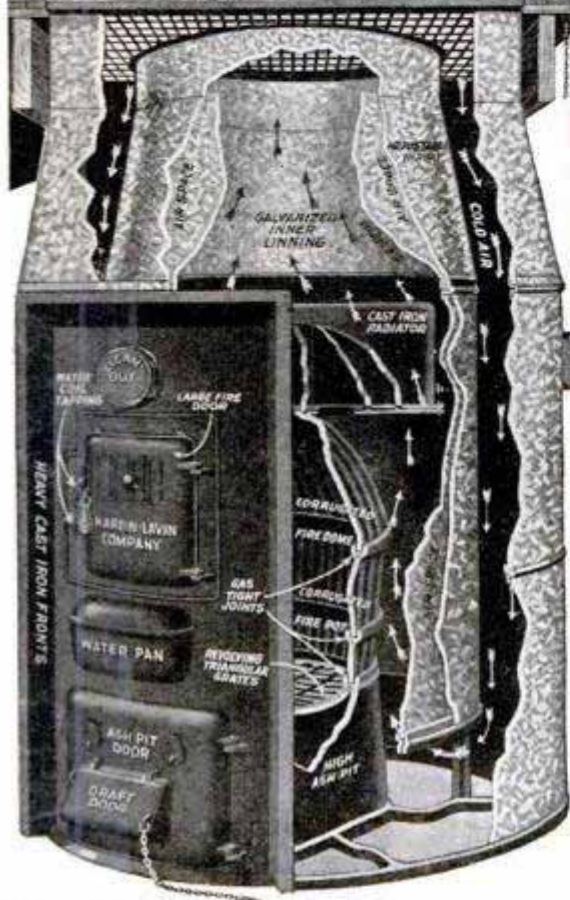

The Hardin-Lavin Company, ever since the firm was founded 50 years ago, has specialized in the sale of only the very highest grade HEATING and PLUMBING outfits and supplies.

We now offer a new improved model, all-cast pipeless furnace at a remarkable low wholesale price.

Burns Any Fuel, Needs Less Attention

This superior, all-cast pipeless furnace burns any kind of fuel with equal satisfaction. Designed to give the utmost in heating results. No other pipeless furnace will give you more heat from the fuel used than will this new model. Hardin-Lavin.

Heats the Whole House

Insures quick as well as economical heating. It has specially designed firepot that keeps the fire just as hot at the outside edges as at the center. Forever does away with the inconvenience of a stove and gives you a complete pipeless furnace heating plant at less than the cost of the average heating stove.

Special
at
\$62.95

For 5 Room
Size

heavy galvanized casing incloses the furnace. Ample air return insures good circulation. You get wholesale price and bonded guarantee. Order today and save.

	Firepot	Capacity	Special Price
PM-88	18 in.	10,000 ft.	\$ 62.95
PM-89	20 in.	14,000 ft.	72.75
PM-90	22 in.	18,000 ft.	86.80
PM-91	24 in.	28,000 ft.	99.25
PM-92	28 in.	40,000 ft.	132.95

Double Casing — No Heat Lost

A double air-and-asbestos-insulated heating stove. You can do the installing yourself without previous experience. We send clear instructions that anyone can understand. A house equipped with this heating plant is comfortable in any weather, clean and attractive at all times and much more easily salable.

HARDIN-LAVIN "Furnaceola" SMALL—BEAUTIFUL—EFFICIENT THE NEW HOME HEATER



Furnace Heat for Homes and Stores without Basements

\$67.50

The Hardin-Lavin "Furnaceola" represents the latest development of a strictly high class furnace that can be set on the first floor and yet heat the whole house to a uniform temperature. Designed to take the place of old style, inefficient heaters in homes, stores, offices, churches, etc., where there is no basement.

Furnace Heat, Stove Economy

Constructed just like a high class furnace. Circulates moist air to the farthest corner of every room in any weather. The "Furnaceola" has heavy outer jacket, open bottom and top, for rapid air circulation. Holds fire full 24 hours under test. Burns any fuel. Can be equipped extra with magazine for burning only hard coal. Will heat 6 or 7 good-sized rooms with no more fuel than old style stove. Size: 47 inches high over all. Floor space occupied 22x22 inches. Takes 7-in. stove pipe.

PM-1061—Cast iron dull finish	\$67.50
PM-1057—Grain mahogany porcelain enameled	74.50
PM-1058—Grain walnut porcelain enameled	74.50
PM-1059—Full blue porcelain enameled	74.50
PM-1060—Full gray porcelain enameled	74.50

Shipping weight 315 pounds. Stove pipe extra.

Grade A Quality Guaranteed Plumbing Outfits

—at **WHOLESALE!** We help you plan and install. Send us your blue print or rough sketch of room arrangement and we will figure without obligation the exact cost of bathroom, kitchen and laundry plumbing; heating plant, water supply system or complete equipment.

Deferred Payments—In addition to highest grade goods at wholesale and the many other Hardin-Lavin advantages of easy installing features, free plans, etc., we have now also made arrangements so that you can **BUY ON EASY TERMS**. Nowhere else can you find this complete combination of quality goods, wholesale prices, exclusive features, and budget plan of payment.

Bonded Guarantee Protects You

Every system or fixture is backed by our bonded guarantee, million dollar plants and 50 years' reputation for highest quality goods at lowest possible prices.

Mail Coupon Today

We are helping thousands to save money and make money. Our free Bargain catalog explains how. Send for your copy today. Our outfits are cut to fit the exact job. Installing plans, diagrams and complete instructions free so that any handy man can do the installing.

All orders are shipped from our Chicago plant the day they are received. It means a lot to know that you will get prompt service and square dealing.

FREE Bargain Catalog

Gives illustrations, complete descriptions, sizes and wholesale prices on heating outfits of all kinds, water supply systems, complete bathroom outfits and plumbing supplies, fittings, pipe, etc. All at wholesale.

HOT WATER HEATING PLANT CUT-TO-FIT GUARANTEED

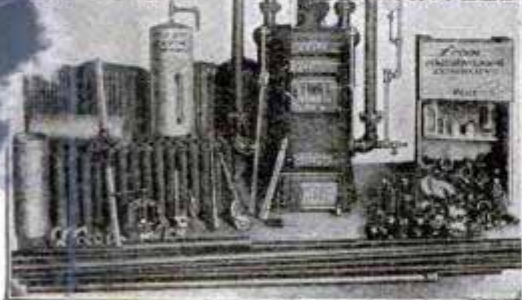

Hot Water Heating Plant as low as \$200.00 complete.

EST. 1876
HARDIN-LAVIN COMPANY
When in Chicago visit our new plant at 107-17 W. PERSHING ROAD CHICAGO, ILL.

Hardin-Lavin Company,
107-17 W. Pershing Road, P. M.-12-26
Chicago, Illinois.

Gentlemen: Please send me your free bargain catalog with special wholesale prices and easy terms. I am interested in:

- Hot Water Heating Plants
- Steam Heating Plants
- Pipeless Furnace
- Warm Air Furnaces
- Water Supply Systems
- Bathroom Outfits

NAME

ADDRESS

CITY.....STATE.....



The phone never rings for Jim —perhaps it's *comedones*

TIME after time Jim answers the phone only to say, "Here, Walter, it's for you." And that's the way it is with everything so far as Jim is concerned. He's usually neglected—seldom counted in—often counted out. He never thought to blame it all on *comedones*.

* * *

Many young men suffer from *comedones*—the scientific term for blackheads. Skin can't be clean-looking, fresh, wholesome, if these disfiguring formations are present. What's more, you may not even be conscious of comedones. But your friends notice them.

Tear off, sign and send



Use at Home
after Shaving

Pompeian Massage Cream helps you overcome comedones. It gives you a clean, clear, ruddy complexion. It gets into the pores where comedones form, rolls out all dirt and oily secretions, and stimulates a healthy circulation, keeping skin clean, pores open.

Try this treatment: After you shave, spread Pompeian Massage Cream generously on your face and rub. Continue to rub until cream rolls out. Note how dark the complexion looks. That's the dirt that was in your pores.

Don't let comedones form. Use Pompeian Massage Cream every day—especially when engagements demand that you look your best. To get the full benefit, use Pompeian Massage Cream regularly at home after shaving. Your face will feel and look like a new dollar. 60c jar at all drug stores.

THE POMPEIAN LABORATORIES
Dept. 3, Cleveland, Ohio

Gentlemen: I enclose 10c (a dime, coin preferred) for a special trial tube of Pompeian Massage Cream.

Name

Street Address

City State

**SEND FOR
10-DAY TRIAL
TUBE**

For 10c we will send a special trial tube containing sufficient cream for many delightful massages. Positively only one trial tube to a family on this exceptional offer. Use this coupon now.



For Men!

Popular Mechanics Magazine

200 E. Ontario Street, Chicago, U. S. A.

H. H. WINDSOR, Founder

H. H. WINDSOR, Jr., Editor and Publisher

London: Hachette & Cie.,
16-17 King William Street, Charing Cross, W. C. 2

Paris: Hachette & Cie.,
111 Rue Reaumur

Melbourne: Gordon & Gotch
509-513 Little Collins St.

ISSUED MONTHLY

SUBSCRIPTION:

SINGLE COPY, 25 CENTS

In United States and its possessions, also Canada, Cuba, and Mexico, per year, postpaid - \$2.50

To all other countries in the Postal Union - 3.00

All subscriptions are discontinued at expiration. Please examine the date printed on your wrapper.

Entered as Second Class Matter Sept. 15, 1903, at the Post Office at Chicago, Illinois, under Act of March 3rd, 1879.

Entered as Second Class Matter at the Post Office Department, Canada.

Published monthly by POPULAR MECHANICS CO.

Copyright, 1926, by Popular Mechanics Co.

Copyright in Australia. Copyright in France

Vol. 46

Contents for December, 1926

No. 6

Article	Page	Article	Page
Accidents		Fence—cone-shaped bases for posts	989
annual loss from accidents in U. S.	937	Field Glasses—as spectacles	977
deaths in air accidents the past year	896	Fire—half of deaths from occur in homes	914
Advertising		Fire Engine—with water tank	984
pattern of lighted windows for holiday display	928	Fishing—hook holder on rod	929
street-car straps carry ads	998	Flowers	
twenty-four-foot rooster advertises farm	993	Chinese use roses for flavoring	939
Air		fashioned in iron	959
from well harnessed to aid diggers	938	Fog—coal strike in England helped clear air	951
thirty miles up hotter than boiling water?	930	Furnace—electric man fires and removes ashes	952
Airplane—built like seagull	942	Gauge—metal rule for fitting corks	883
Archæology		Golf—balls collide on drive	928
dig up city where Abraham offered sacrifice	950	Gun	
seek fabled "City of Brass" in Sahara	965	bullet cleans rifle barrel	910
Architecture—library roof in tile mosaic	954	flintlock fired in honor of Daniel Boone	886
Art—Roman art copied in arch for American troops	989	Hammer	
Astronomy—day lengthened as moon recedes from earth	962	has steel "backbone" to keep head on	992
Automobile		pulls nails without bending	968
small racing to run on Norwegian railroads	893	Hanger—garment, folds up	992
three-wheel auto first in six-day race	931	Heater	
Automobiles—Driving		hot water for auto	993
barriers and hairpin bench add thrills to race	962	that burns gasoline, serves as fireplace	965
new motorist more careful than experienced one	968	Horse	
safety signals urged for drivers	954	six horses defeat elephant in pulling contest	987
Automobiles—Equipment and Supplies		too small to wear shoes	938
auto awning keeps out sun and diverts rain	911	Household Devices	990
cylinder-head lifter fits spark plug holes	940	House Plan	1056
emergency brake horn switch	908	Hurricane—terrors from the tropics	888
gauge for motor cylinders	978	Ice—auto motor runs cutter	944
lost auto license rack aids motorists	914	Ice Cream	
mud grips fit on auto tires	945	from crude oil	960
rear-wheel runs pump	951	sandwich carrier	1000
sidewalk periscope on auto	939	Ice Storms—costly beauty of	995
sliding front seat for auto	937	Jewelry—when people marry shown by survey of	992
winker for stop lights	960	Kite—eighty-five-foot dragon kite has blinking eyes	908
Automobiles—Fuel—grain dust used as	961	Light—shadow effects show way to place lights	985
Automobiles—Lubrication—oilier with signal light	894	Lighthouse—cottage built as affords wide view	967
Automobiles—Tires		Lighting	
chemicals raise mileage	975	most dangerous freak	953
spare of wood blocks costs less than rubber	962	strikes road	929
Automobiles—Wheels—two-piece rim on auto wheel	941	Lizards—gigantic in Malay	952
Aviation—concrete ears are airplane defense	955	Loading and Unloading—tractor outfit saves hand	964
Belt—guards street worker against motor accident	994	shoveling	968
Birds		Lock—without key opens at touch	968
nest sought for centuries found in Alaska	961	Locomotive	
wonderful traits of	906	noise ended with gun silencer	974
Blind—lighted armband for gives night protection	969	run by turbine	894
Boats and Boating—cars preferred to motor on royal craft	883	Mail Box—twelve foot	937
Bridge—of old type and bamboo in Japan	906	Memorial—stone arch honors war heroes	916
Buddha—figure of disclosed in cave-in	945	Microphone—for home detects thieves	976
Building		Models	
quake-proof	940	of opera scenes	977
sawed in two to dry moisture	984	woman carves ship	906
Camera—as large as auto used as ad	910	Money	
Christmas Trees—where they get their names	952	Chinese coin to burn for offerings for dead	917
Circus—when white tops are laid away	898	queer things used as money centuries ago	941
Cotton—auto picker protects plants	967	Mosquitoes—airplane war on	983
Crime—new war on	918	Motion Picture Camera—rod supports as substitute for tripod	962
Diving—helmet for shallow diving	986	Motorboat—super-speed boat	955
Door—knocker rings bell and lights lamp	913	Mountain—seek through frame resembles paint	893
Drawing—machine draws billion of curves	999	Mountain Climbing	
Electric Fan—painter wears at work	927	cable road to Alpine peak	924
Electric Lamp—held in mouth	914	in your car	932
Electricity		Muff—and handbag combined	927
generator could light a million homes	958	Numbers—magic lure of	979
map-made lightning bolt	881	Parachutes—to land mail on non-stop flights	993
		Pencil—telescope as ruler	955

Air Valve Searchlight - 976
Sun made Target for airplane runners

Auto accident 928
gauge 978
two bookburns 988

gun 994
bullet cleans rifle barrel 910
flintlock fired in honor of Daniel Boone 886

hammer 992
pulls nails without bending 968
hanger—garment, folds up 992
heater 993
that burns gasoline, serves as fireplace 965

horse 987
too small to wear shoes 938
household devices 990
house plan 1056
hurricane—terrors from the tropics 888
ice—auto motor runs cutter 944

ice cream 960
from crude oil 1000
sandwich carrier 995
ice storms—costly beauty of 992
jewelry—when people marry shown by survey of 908
kite—eighty-five-foot dragon kite has blinking eyes 985
light—shadow effects show way to place lights 967
lighthouse—cottage built as affords wide view 953
lighting 929
most dangerous freak 952
strikes road 964
lizards—gigantic in Malay 968
loading and unloading—tractor outfit saves hand 974
shoveling 894
lock—without key opens at touch 937
locomotive 916
noise ended with gun silencer 976
run by turbine 916
mail box—twelve foot 976
memorial—stone arch honors war heroes 977
microphone—for home detects thieves 906

models 977
of opera scenes 906
woman carves ship 917
money 941
chinese coin to burn for offerings for dead 983
queer things used as money centuries ago 962
mosquitoes—airplane war on 955
motion picture camera—rod supports as substitute for tripod 924
motorboat—super-speed boat 893
mountain—seek through frame resembles paint 924
mountain climbing 932
cable road to alpine peak 927
in your car 979
muff—and handbag combined 993
numbers—magic lure of 955
parachutes—to land mail on non-stop flights 927
pencil—telescope as ruler 979

generator could light a million homes 881
map-made lightning bolt 917
chinese coin to burn for offerings for dead 941
queer things used as money centuries ago 983
mosquitoes—airplane war on 962
motion picture camera—rod supports as substitute for tripod 924
motorboat—super-speed boat 893
mountain—seek through frame resembles paint 924
mountain climbing 932
cable road to alpine peak 927
in your car 979
muff—and handbag combined 993
numbers—magic lure of 955
parachutes—to land mail on non-stop flights 927
pencil—telescope as ruler 979

generator could light a million homes 881
map-made lightning bolt 917
chinese coin to burn for offerings for dead 941
queer things used as money centuries ago 983
mosquitoes—airplane war on 962
motion picture camera—rod supports as substitute for tripod 924
motorboat—super-speed boat 893
mountain—seek through frame resembles paint 924
mountain climbing 932
cable road to alpine peak 927
in your car 979
muff—and handbag combined 993
numbers—magic lure of 955
parachutes—to land mail on non-stop flights 927
pencil—telescope as ruler 979

[Continued on Page 4]

Corks Only for 983

Peat Fibre Used for Carpet 905

Cover on 987

DRAKE'S PRACTICAL MECHANICAL BOOKS

THEY WILL RAISE YOUR PAY—

ORDER ON 5-DAY TRIAL

The books listed below will perfect you in your chosen trade—pave the way to the big positions. Written in non-technical language—easy to read and understand. *Every book covers its subject completely. An entire course of instruction condensed into one volume.* Your choice sent postpaid—you benefit 5 days—money refunded in full if not entirely satisfactory. Order direct from this page.

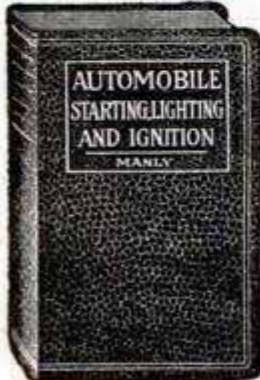

Automobile Books

Automobile Starting, Lighting and Ignition, by Manly... 700 pp. \$3.00
Brookes' Automobile Handbook. \$2.00
Ford Motor Car, Truck and Tractor, by Manly... Cloth \$1.50
Automobile Battery, Care and Repair, by Manly... Leatherette \$2.00
Motorcycle Handbook, by Manly \$1.50

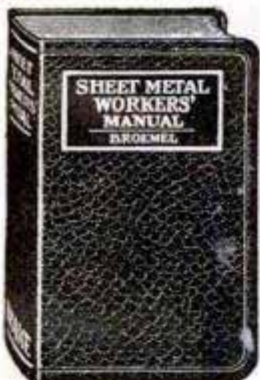

Shop Practice Book

Sheet Metal Workers' Manual... \$2.
Oxy-Acetylene Welding and Cutting... Cloth \$1.
Slide Rule and Logarithmic Tables. \$2
Handbook for Millwrights... Cloth \$2
Machine Shop Practice... Cloth \$2
Mechanical Drawing and Machine Design... Cloth \$2

ORDER DIRECT FROM —ON OUR MONEY—

The books listed above are only a part of our catalogue, which you will receive by filling out and mailing us the attached quick action order direct from this page. Each book wanted and send in with prepay postage and send the books on order.

FREDERICK J. DRAKE & CO.
PUBLISHERS

1008 Michigan Ave.,
Drake Books Are For Sale at A

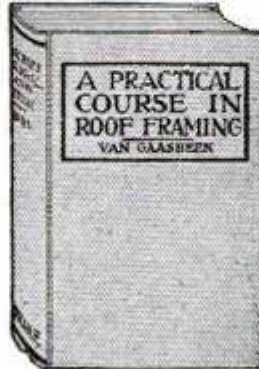

Carpentry Books

Cloth Binding
Modern Carpentry, 2 vols. \$3.00
The Steel Square, 2 vols. \$3.00
Modern Estimator... \$1.50
Timber Framing... \$2.00
Builder's Architectural Drawing... \$2.00
Concretes... \$1.50
Practical Bungalows... \$1.00
Roof Framing, by Van Gasbeek... \$1.50

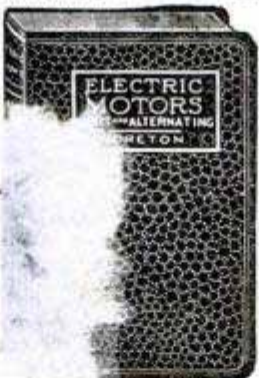

Electrical Books

Wiring and Automatic Switching, 300 pp. Leatherette \$2.50
Electricity... \$2.00
Wires and Descriptions. \$1.50
Magnet Winding... \$1.50
D. & A. \$1.50



Painting and Decorating

Ross Crane Book of Home Furnishing and Decoration... Cloth \$3.00
House Painting Methods with the Brush and Spray Gun, by Vanderwalker. Cloth... \$2.00
Interior Wall Decoration, by Vanderwalker... Leatherette \$4.00
The Mixing of Colors and Paints, by Vanderwalker... Cloth \$2.00
A Show at Sho' Cards... Cloth \$4.00
Sign Painting, by Atkinson... Cloth \$4.00
Strong's Book of Designs, Leatherette \$4.00
Modern Painter's Cyclopaedia. Cloth \$2.00
Automobile Painting... Cloth \$1.50
New Hardwood Finishing... Cloth \$1.50
Wood Finishing, Plain and Decorative... Cloth \$2.00
Owen's Paint Guide... Cloth \$1.00

Steam Engineering

Swingle's Handbook for Steam Engineers and Electricians. Leatherette... \$4.00
Examination Questions and Answers for Marine and Stationary Engineers. Leatherette... \$2.00
Steam Boilers... Leatherette \$2.00
Swingle's Catechism of Steam, Gas and Electrical Engineering. Leatherette \$1.50

Modern Languages

By Prof. P. S. Allen, U. of Chicago
French without a Teacher... Cloth \$1.25
Spanish without a Teacher... Cloth \$1.25
German without a Teacher... Cloth \$1.25
Everyday French... \$1.25
Everyday Spanish... \$1.25

FREDERICK J. DRAKE & CO.
1008 Michigan Avenue
Chicago, Ill.

GENTLEMEN:—Please send me free, postage paid, your illustrated catalogue which lists and describes 200 Practical Mechanical Books for Home Study.

My name is

and my address

Mail Coupon For Free Catalogue
Your Guide to Home Study

Home-Study Training

*That
Leads to
Successful
Careers—*



Are Successful Men Born or Made?

"Born with mind but not with wisdom; born with intellect but not with knowledge; born with power to discern, but not born to discretion and sound judgment; born with adaptabilities but not with abilities; born, it may be, with wealth, but not born to success. Wisdom, knowledge, discretion, judgment, ability, character—these are *attainments*, not bestowments or inheritances." — *The Kansas Banker*.

Genius and inspiration were once credited with playing an important part in building a successful career. —What part *do* they actually play in the making of success?

William Livingston, President of the Dime Savings Bank, Detroit, has this to say:

"Genius is supposed to be some peculiar capacity for spontaneous accomplishment. If so, it is one of the rarest things in the world. I have been studying business and human beings for more than sixty years, and I've never yet seen anything permanently worth while that was accomplished on the spur of the moment. The man who expects to win out in business without self-denial and self-improvement and self-applied observation stands about as much chance as a prize fighter would stand if he started a hard ring battle without having gone through an intensive training period."

How You Can Measure Your Chances for Success

We are all looking forward to successful careers. If an employe, you want a better position. That is the first step up. If an employer, you want to improve the business you manage.

Business cannot pay you for ideas and plans which you do not deliver, and this applies to owner and employe alike. Neither can Business pay you for *learning* business.

If you desire success, your day must be filled with achievement—doing things. Contemplation, analysis, acquiring the experience of others, must come *after* the gong rings at night.

Broadly speaking, everyone who reads these words falls into one of three groups; in fact, this analysis really constitutes a measuring stick by which you can measure the degree of success which you will probably enjoy:

Group 1—Those who are making no effort to increase their business knowledge and ability aside from the limited experience which comes as a result of each day's work.

Group 2—Those who, more or less consistently, are reading constructive literature pertaining to their specialties or field, but who follow no organized plan.

Group 3—Those who consistently follow a definite, well-organized, step-by-step plan, which embraces not only the best experience in their specialty, but also shows the relationship of their job to the fabric of business as a whole.

Send for the LaSalle Salary-Doubling Plan—Today

During fifteen years, LaSalle Extension University has been furnishing men with an organized plan of self-development—in every important field of business endeavor. The proof that such a plan wins out is evidenced in the fact that during only six months' time as many as 1,248 LaSalle members reported salary increases totalling \$1,399,507. The average increase per man was 89 per cent.

The details of the LaSalle *salary-doubling plan* will be sent you for the asking. Whether you adopt the plan or not, the basic information it will place in your hands, without cost, is of very real and definite value. And it's FREE.

Balance the two minutes that it takes to fill out the coupon against the rewards of a successful career—then clip and mail coupon NOW.

LA SALLE EXTENSION UNIVERSITY

The World's Largest Business Training Institution

Dept. 1264-R

Chicago

I would welcome details of your *salary-doubling plan*, together with complete information regarding the opportunities in the business field I have checked below; also a copy of "Ten Years' Promotion in One," all without obligation.

- Business Management
- Modern Salesmanship
- Higher Accountancy
- Traffic Management
- Railway Station Management
- Law—Degree of LL.B.
- Commercial Law
- Industrial Management Efficiency
- Banking and Finance

- Modern Business Correspondence and Practice
- Modern Foremanship and Production Methods
- Personnel and Employment Management
- Expert Bookkeeping
- Business English
- Commercial Spanish
- Effective Speaking
- C. P. A. Coaching

Name.....

Present Position.....

Address.....

PLUMBERS & STEAM FITTERS



A new set—just out! A practical, illustrated, Reference Library and Study-Course for Master Plumbers, Journeyman and Apprentice Steamfitters, Gas Fitters and Helpers, Sheet Metal Workers, Draughtsmen, Master Builders, Engineers and all Building Trade Students. This valuable set of handy, pocket-size Guides explains in practical, concise language and well-done illustrations all the principles, advances and short cuts of the Plumbing and Heating trade—based on modern practice. Contains careful, detailed instructions on how to figure and estimate various jobs. Use FREE COUPON below to examine, without obligation, this valuable work.



INFORMATION

Guides give complete instructions and practical modern data on the following important subjects:

- MATHEMATICS—symbols, arithmetic, mensuration, trigonometry, tables.
- PHYSICS—specific gravity, pressure, expansion, hydraulics, pumps.
- MATERIALS—iron, steel, copper, brass, lead, tin, antimony, bismuth, zinc, asphaltum.
- SHEET METAL—lead, tin, plate, galvanized, brass, bronze.
- PIPE—wrought iron, steel welded, threads, tests, tubes.
- TOOLS—square, level, plumb bob, scriber, caulking, tap borer, pipe threading, torches, fire pots, etc.
- SOLDERING—soft soldering, tinning.
- JOINT WIPING—preparing joint, wiping, judging solder.
- BENDING—distortion, tools used, hot and cold bends.
- BEATING—lead flashing, gutter corners, etc.
- SANITATION—cold water supply, siphonage, air pockets, circulation, etc.
- HOUSE DRAINAGE—sewer, drain, stacks, traps, venting.
- SEWAGE DISPOSAL—purification, cesspools, septic tanks, filter beds, disposal.
- FIXTURES—bath, lavatory, shower, urinal, kitchen, storage tanks.
- PIPE FITTINGS—hubs, spigots, laying length, cast soil fittings.
- ROUGHING IN—layout for work, drainage, piping methods.
- ACCESSORIES—valves, cocks, valve grinding, floats, tubing, thread fitting.
- SOIL PIPE—joints, packing, caulking, wrought pipe, tools.
- SCREWED PIPE FITTINGS—dimensions, forged, malleable brass, bends, joints, flanges.
- DRAINAGE FITTINGS—recessed joints, properties of.
- PIPE FITTINGS—threading offsets, elbows, pipe bending, assembling.
- HEATING AND VENTILATION—steam, low pressure, vapor systems, vacuum, hot water, circulation, furnaces.
- REFRIGERATION—ammonia compression, management of machines, various methods.
- WATER SUPPLY—wells, city main, pumps, piping methods, tanks, repairs.
- GAS AND GAS FITTING—producers, meters, fittings, pressure, flow, underwriters requirements.
- SHEET METAL WORK—geometry, problems, patterns, mitering, bench machines, wiring, burring, edging, tucking.
- BRAZING—Heating methods, brazing copper, lead burning.
- WELDING—oxidation, various methods, blow pipe, thermit.
- BLACKSMITHING—Forges, firing, fluxes, anvil work, forming, swedging, tempering.

AUDELS PLUMBERS & STEAMFITTERS GUIDES-4 Vols. \$6
 1670 Pages—3642 Trade Illustrations

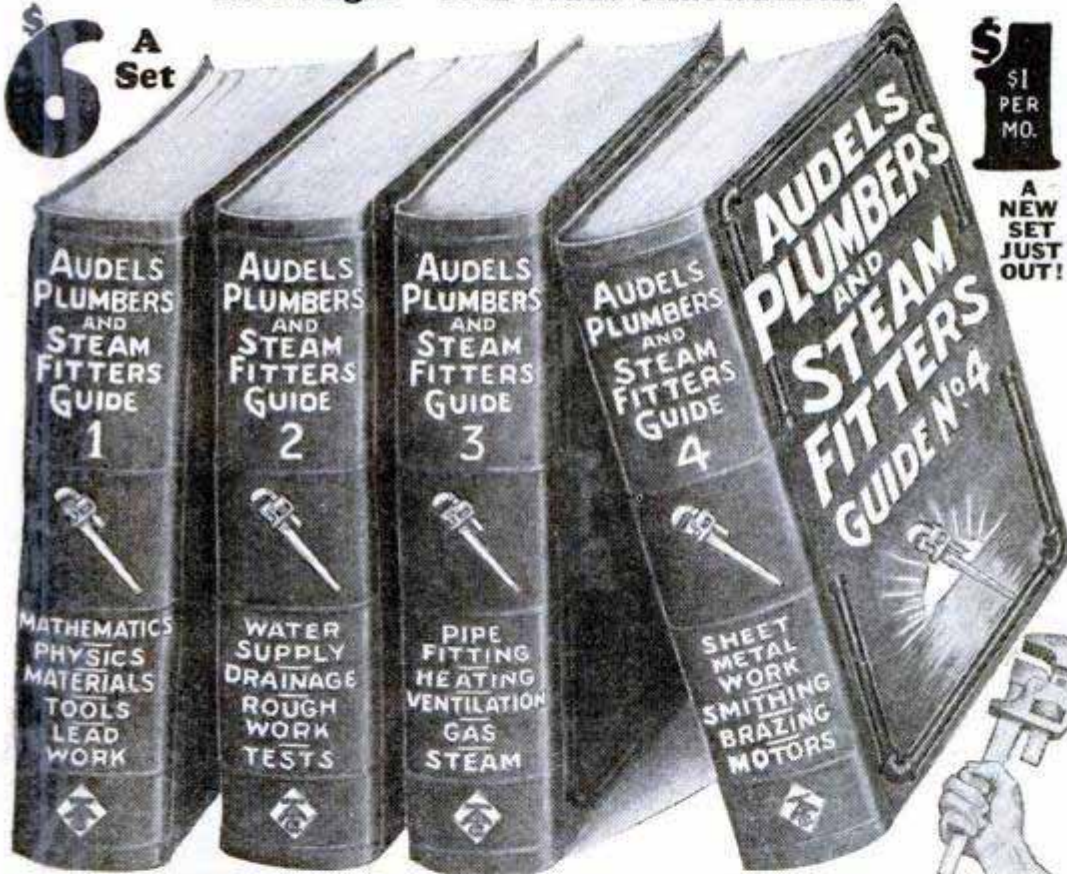

Pocket Size—Easy to Carry and Read
 FLEXIBLE BINDINGS—GOLD EDGES

These great self-educators teach the plumbing, heating and steamfitting trade in an easy step-by-step manner. There are thousands of practical examples, covering the entire trade—as well as new methods, new ideas, efficiency plans, short cuts, time and money saving suggestions. A practical and valuable Daily Helper on every plumbing job. Every point made clear with easily read text and clear illustrations and diagrams.

Complete Course for Home Study and Reference



Audels Plumbers and Steamfitters Guides give you, at a low price COMPLETE inside trade information and instruction. You can gain a thorough, practical knowledge of the trade by half an hour a day of easy reading. The definitions, tables, diagrams, descriptions, explanations, rules, sketches and illustrations will be found easy to follow and to apply to daily work.

Send No Money—Nothing to Pay Postman!

Send coupon now—today! Not a cent to pay until you have examined books. No obligation unless satisfied. This is your big opportunity for advancement.

FREE EXAMINATION COUPON

THEO. AUDEL & CO., 65 W. 23d St., New York.

Please send me (postpaid) for free examination, AUDEL'S PLUMBERS and STEAMFITTERS GUIDES, 4 numbers. If satisfactory, I will send you \$1 within 5 days and \$1 monthly until \$6 is paid.

Name.....
 Address.....
 Occupation.....
 Reference..... 12T30



NOW
Absolutely
FREE!

GET THE FACTS!

About the Tremendous Money-Making Opportunities in the WORLD'S BIGGEST BUSINESS!

Find out how you can get into this gigantic Auto Business! Think of it—7 Thousand Million Dollars paid to Auto men every year for upkeep alone! See why there are so many Tremendous Opportunities for the trained Auto Man to get Big Raises in Pay QUICK!—opportunities waiting for YOU! My Free Book shows why. My Free Lessons show how you can take advantage of these wonderful Opportunities.

Be an Auto Expert

If you want to boost your pay quick, Mail the Coupon now. Be an Auto Expert. It's the one Business for the red-blooded, ambitious man who wants to make real money! I will help you do it. Get all the particulars about my lifetime Employment at Service and my lifetime Consultation Service—both of which I include Free of Extra Charge.



I'LL PROVE That I Can Put YOU in Line for the BIG PAY JOBS—QUICK!

Clip coupon now! I'll send you absolutely FREE OF CHARGE—with positively no obligation on your part—3 "JOB-WAY" Auto Lessons and Jobs and my big, new Auto Book also! I want you to see for yourself—just why B. W. Cooke "JOB-WAY" Training is bringing so many men BIG Money in such remarkably quick time. I want you to see what it can do for you!

Find out how I train you **AT HOME!**

Don't sell your time for low pay! You don't need to! Get all the Facts! Find out how you can become a Big Pay Man in amazingly quick time! These 3 FREE Lessons show you why you can stay home; keep your present job! They prove that you don't have to leave your doorstep—that you can Master every branch of Auto work right in your own home. Send Coupon while I can still offer you these 3 Lessons absolutely FREE!

See How You Can Earn up to \$150 a Week

If you're earning a cent less than \$60 a week, clip coupon now! Get the proof. See for yourself how easily you can master Auto work right in your own home—and how quickly you can get in line for the big Auto Jobs that pay up to

\$10,000 a year and more—or in a Money-Making Auto Business of your own. Remember—these lessons and Jobs come to you absolutely FREE of charge and without any obligation on your part whatever.

ACT QUICK! My Big New Auto Book Also FREE!

Coupon brings this startling, revolutionary, new Auto Book, also absolutely Free! Shows how hundreds of men have reached Big Pay in amazingly QUICK Time! Shows what you can do!

Send Coupon at ONCE!

Learn how men without a day's previous auto experience, and only common schooling become Garage Owners, Superintendents, Managers and can earn up to \$150 a Week and more! See why hundreds of men have found "JOB-WAY" to be such interesting, practical Training!

I stand ready to give you absolute proof. Clip COUPON NOW and I'll rush your Lessons to you Absolutely Free!

MAIL THIS COUPON NOW!
Send 3 AUTO Lessons and 1 BOOK FREE
B. W. COOKE DIRECTING ENGINEER Dept. 916
CHICAGO MOTOR TRAINING CORPORATION,
1916 Sunnyside Avenue, Chicago, Illinois

Dear Sir: Send me absolutely FREE and without any obligation on my part, 3 "Job-Way" Lessons and Jobs. Also your Auto Book FREE and full particulars of your 5 Outfits Offer.

Name.....
Address.....
Town.....
State.....

Coupon Brings Full Details of my 5 OUTFITS OFFER

Includes Tools, Tool Bag, Electrical Test Bench and Radio Receiving Set—all Equipment. Also 303 Wiring Diagram Charts, also Socket Wrench and Ignition Wrench Sets.

B. W. Cooke
Directing Engineer
Chicago Motor Training Corporation
1916 Sunnyside Ave.
Dept. 916 CHICAGO



Show Card Lettering

Learn at Home

HERE is the very course you need if you want to get a good paying position as a Show Card Letterer or Sign Letterer, or have a business of your own. This course is complete and practical and specially arranged to meet the needs of the student who studies at home. It was written by E. L. Koller, Principal of the School of Art of the International Correspondence Schools, member of the American Federation of Arts, and The National Society of Craftsmen.

Mr. Koller has had twenty years' teaching experience, and his success in training other men and women is an indication of what he can do for you. J. L. Wood, a clerk, made more than \$100 "on the side" before he had completed his course and also won \$125 in prizes. Harry William Lord writes that he has more than doubled his salary as a result of studying this I. C. S. course in spare time. William Whitman, a wagon builder, now has a signing business of his own and is earning nearly three times as much as he did before enrolling with the International Correspondence Schools.

There is no doubt that Show Card Lettering and Sign Lettering offer a real opportunity to ambitious men and women. Just mark and mail the coupon and we'll gladly send you a booklet telling all about the I. C. S. course in Show Card Lettering, or any other subject in which you are interested.

INTERNATIONAL CORRESPONDENCE SCHOOLS

Box 5614-E, Scranton, Penna.

Without cost or obligation on my part, please tell me how I can qualify for the position or in the subject before which I have marked an X:

SHOW CARD LETTERING

- | | |
|---|--|
| <input type="checkbox"/> ILLUSTRATING | <input type="checkbox"/> CARTOONING |
| <input type="checkbox"/> Business Management | <input type="checkbox"/> Salesmanship |
| <input type="checkbox"/> Industrial Management | <input type="checkbox"/> Advertising |
| <input type="checkbox"/> Personnel Organization | <input type="checkbox"/> Better Letters |
| <input type="checkbox"/> Traffic Management | <input type="checkbox"/> French <input type="checkbox"/> Spanish |
| <input type="checkbox"/> Business Law | <input type="checkbox"/> Stenography and Typing |
| <input type="checkbox"/> Banking and Banking Law | <input type="checkbox"/> Business English |
| <input type="checkbox"/> Accountancy (including C. P. A.) | <input type="checkbox"/> Civil Service |
| <input type="checkbox"/> Nicholson Cost Accounting | <input type="checkbox"/> Railway Mail Clerk |
| <input type="checkbox"/> Bookkeeping | <input type="checkbox"/> Common School Subjects |
| <input type="checkbox"/> Private Secretary | <input type="checkbox"/> High School Subjects |

TECHNICAL AND INDUSTRIAL COURSES

- | | |
|---|--|
| <input type="checkbox"/> Electrical Engineering | <input type="checkbox"/> Architect |
| <input type="checkbox"/> Electric Lighting | <input type="checkbox"/> Architects' Blueprints |
| <input type="checkbox"/> Mechanical Engineer | <input type="checkbox"/> Contractor and Builder |
| <input type="checkbox"/> Mechanical Draftsman | <input type="checkbox"/> Architectural Draftsman |
| <input type="checkbox"/> Machine Shop Practice | <input type="checkbox"/> Concrete Builder |
| <input type="checkbox"/> Railroad Positions | <input type="checkbox"/> Structural Engineer |
| <input type="checkbox"/> Gas Engine Operating | <input type="checkbox"/> Chemistry <input type="checkbox"/> Pharmacy |
| <input type="checkbox"/> Civil Engineer | <input type="checkbox"/> Automobile Work |
| <input type="checkbox"/> Surveying and Mapping | <input type="checkbox"/> Airplane Engines |
| <input type="checkbox"/> Metallurgy <input type="checkbox"/> Mining | <input type="checkbox"/> Agriculture and Poultry |
| <input type="checkbox"/> Steam Engineering <input type="checkbox"/> Radio | <input type="checkbox"/> Mathematics |

Name.....

Street Address.....

City..... State.....

The International Correspondence Schools are the oldest and largest correspondence schools in the world



848X-009-D11H



THEN CHOOSE AVIATION!

Easy to Become An Aviation Expert

\$50 to \$100 a Week

Are you eager for a life of constant thrills, constant excitement and fascinating events? Do you crave adventure, popularity, admiration, and the applause of great crowds? Then why not get into the Aviation Industry—the greatest adventure since time began—the greatest thrill ever offered to man?

Think what Aviation offers you. Thrills such as you never had before! The praise and plaudits of the multitude. Ordinary salaries from \$75 to better than \$400 a week! And a chance to get in on the ground floor where rewards will be unlimited!

Aviation is growing so swiftly that one can hardly keep track of all the astonishing new developments. Air-mail routes have just been extended to form a vast aerial network over the entire U. S. Airlines and airplane factories are springing up all over the country. Men like Henry Ford are investing Millions in the future of commercial Aeronautics in America! The possibilities are so tremendous that they stagger imagination!

Everything is set for the greatest boom in history. The fortunes that came out of the automobile industry and out of motion pictures will be nothing compared to the fortunes that will come out of Aviation! There is just one thing holding it up:—lack of trained men! Even in the beginning thousands will be needed—and generously paid. The opportunities open to them cannot be over-estimated. Those who qualify quickly will find themselves on the road to undreamed of money—success—popularity—and prominence!

Get into this thrilling profession at once while the field is new and uncrowded. Now—by a unique new plan—you can quickly secure the basic training for one of these wonderful high salaried jobs, at home, in spare time. Experts will teach you the secrets—give you all the inside facts that are essential to your success. And, the study of Aviation is almost as fascinating as the actual work itself. Every Lesson is chock-full of interest—and so absorbing that you actually forget you are studying. But best of all are the ultimate rewards you are fitting yourself to gain!

Send for FREE Book

Send the coupon for our new, free book, just out—"Opportunities in the Airplane Industry". It is vitally interesting, reads like a romance and tells you things about this astonishing profession you never even dreamed of. This book is so fascinating it could easily sell for a dollar. We offer a limited number FREE. Write for yours today.



American School of Aviation
Dept. 1359, 3601 Michigan Ave., Chicago, Ill.

Fascinating—Daring—Big Paying

Prepare Now for One of These Positions

- Aeronautical Instructor \$60 to \$150 per week
- Aeronautical Engineer \$100 to \$300 per week
- Aeronautical Contractor Enormous Profits
- Aeroplane Repairman \$60 to \$75 per week
- Aeroplane Mechanician \$40 to \$60 per week
- Aeroplane Inspector \$50 to \$75 per week
- Aeroplane Salesman \$5000 per year and up
- Aeroplane Assembler \$40 to \$65 per week
- Aeroplane Builder \$75 to \$200 per week

AMERICAN SCHOOL OF AVIATION,
Dept. 1359, 3601 Michigan Ave., Chicago, Ill.

Without any obligation please send me FREE book "Opportunities in the Airplane Industry." Also information about your course in Practical Aeronautics.

Name.....

Address.....

City..... State.....

LEARN

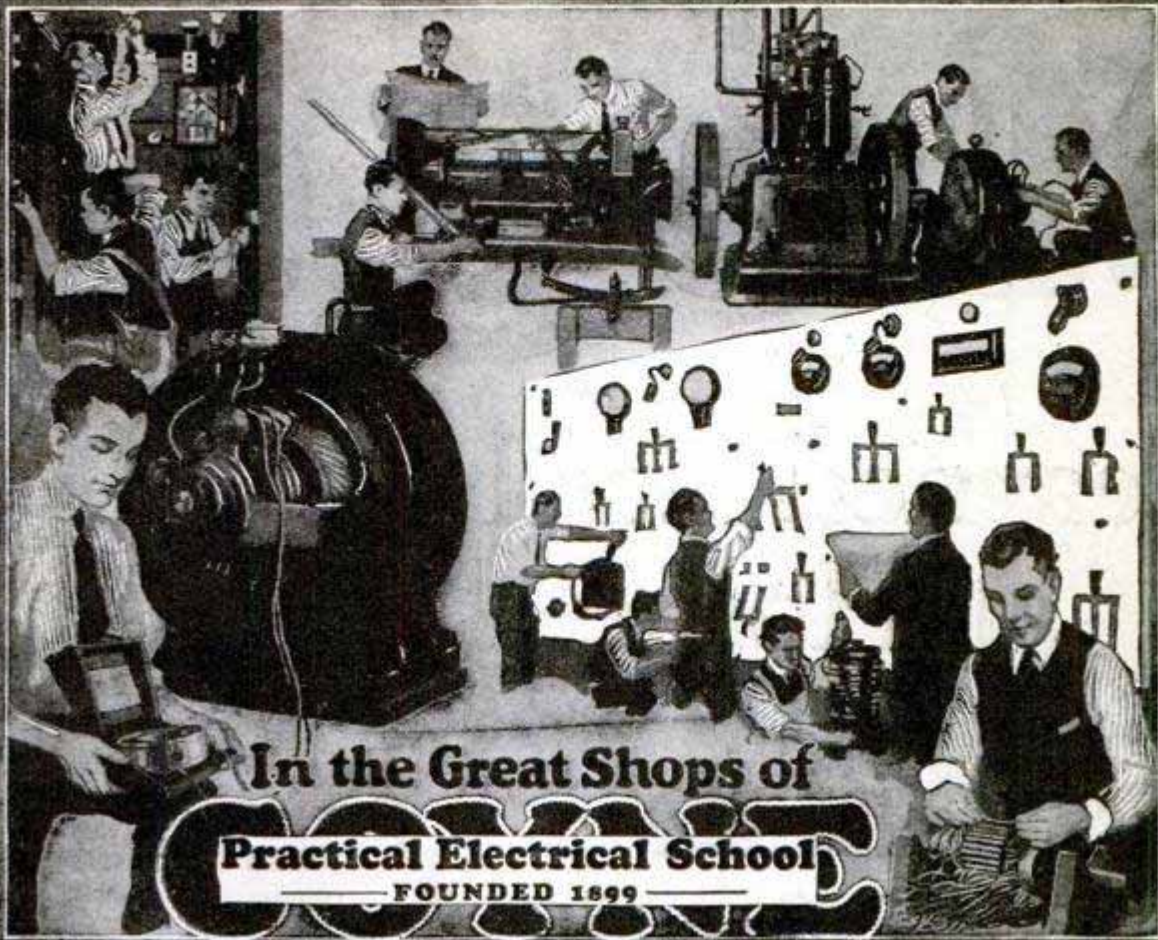

ELECTRICITY

In the Great Shops of
COYNE
 PRACTICAL ELECTRICAL SCHOOL
 FOUNDED 1899

MAKE \$200 to \$800 A MONTH

EARN BIG PAY!
Make \$200 to \$800 a Month

Why work for small pay. Why be satisfied to make \$25.00 or \$30.00 or even \$40.00 a week in a disagreeable job where you never know when you might get fired. Do pleasant work. Be an ELECTRICAL EXPERT and earn \$200.00 to \$800.00 a month or go in business for yourself and earn up to \$10,000 a year.

All Practical Work, No Books

I train you on actual Electrical Machinery. I don't teach you a lot of useless theory. My training gives you useable knowledge on the same kind of machinery you will find in Power Houses, Plants and industrial businesses.

Free Railroad Fare to Chicago

For a short time I'll pay your Railroad Fare to Chicago, and besides I'll include Free my two big Courses, Auto and Radio Electricity.

My Big Free Book Tells Complete Story

I haven't space here to tell you the advantages of my training but I'll send ABSOLUTELY FREE my big new book with over 150 actual photographs and success stories of my graduates. It tells you all about my employment service after graduation and how you can earn your expenses while attending my school. **FILL OUT THE COUPON NOW AND MAIL IT AT ONCE.** You owe it to yourself to get the facts.

H. C. Lewis, Pres.
Coyne Electrical School
 1300-1320 W. Harrison St.
 Dept. 96-72 Chicago, Ill.
 Dear H. C.—I sure want to get all the facts. Send me that big handsome 12x15 inch book. Of course I'm under no obligations and it doesn't cost me a cent.

COYNE Founded 1899 H. C. Lewis, Pres.
ELECTRICAL SCHOOL
 Dept. 96-72
 1300-1320 W. Harrison St. Chicago, Ill.

Name.....
 Address.....
 Town.....
 State.....

IN 3 MONTHS

MagiC

Learned Easily
at Home

**Astonish
Your Friends!**



Dr. Harlan Tarbell
Master of Magic
who has mystified
magicians as well as
laymen with his mar-
velous magic.

Gain the magnetic popularity that makes you the center of any crowd. Business and social success is assured the man who can perform mystifying tricks. You can earn big money on the side or as a professional, as well as being the most popular person in your crowd. Why envy others' skill? You can learn Magic yourself, quickly and easily.

**The First
and Only
Course
in Magic**
ever offered to the
public teaching
**Real Professional
MAGIC**

read
what the Great
Madame
Hermann says:

My Dear Dr. Tarbell: I have read with interest your course in Magic. It is the most original and perfect work of its kind I have seen. I highly recommend it.

-A. Hermann

**Earn \$250 to
\$1000 a Month**

even sleight of hand, generally supposed to require long practice, is NOW made simple to learn. For Dr. Harlan Tarbell, one of the really Great Magicians, has finally opened up the secrets of his profession in a completely illustrated course offered at a merely nominal cost. Through the wonderful Tar-

bell system you will be able to mystify and entertain your friends. After that Dr. Harlan Tarbell takes you through the entire maze of sleight of hand, card tricks and elaborate stage diversions. The apparently superhuman doings of the accomplished magician becomes as simple as ABC.

Mail This Coupon NOW!

Tarbell System, Inc., Studio 13-59
1920 Sunnyside Avenue, Chicago, Illinois
Gentlemen: Without any obligation send me your free literature and information all about your wonderful "Tarbell Course in Magic." Also tell me about your great Special Price Offer and Easy Payment Plan—offered NOW for limited time only.

Name.....

Address.....

.....Age.....

Great Special Offer!

There is a tremendous demand for magic entertainment. Clubs, Lodges, Charity and Social affairs—all will pay high fees to the man who knows Magic. Dr. Harlan Tarbell really gets as high as \$250 for a half hour's work right now. Opportunity everywhere to make money aside from your regular occupation. Salesmen find it a tremendous asset. Find out all about this unprecedented opportunity to learn Magic. Learn about the great Special Price and Easy Payment Offer we are making Now, for a limited time only. The coupon brings full details without any obligation. **Mail it TODAY.**

Tarbell System, Inc.
1920 Sunnyside Ave., Studio 13-59 Chicago, Ill.

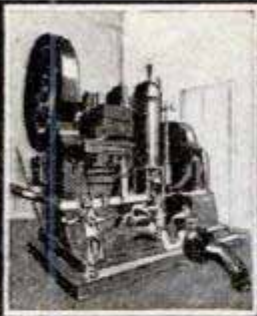

Be a Machine Draftsman—earn \$60 to \$150 a week



Be a Structural Draftsman—earn \$60 to \$200 a week



Be an Architectural Draftsman—earn \$60 to \$150 a week

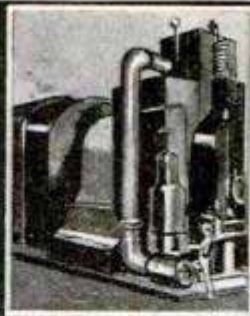

Be an Electrical Draftsman—earn \$60 to \$125 a week



Be an Auto Draftsman—earn \$60 to \$125 a week

3 Drafting Lessons **FREE!** Actually

to prove you can LEARN AT HOME, IN YOUR SPARE TIME!

We have invented a new, simplified way to teach Drafting—the first real improvement in Drafting home-instruction in history. We want you to see it, try it—without one penny of cost or obligation. We want to show you how we get away from the copying methods used in the past. See how we make you think, solve problems, do actual drafting room jobs from the first lesson!

Draftsman Wanted \$60 to \$125 a week!

FREE Job Service

Our employment department will help place you in a good job. Demand exceeds the supply. No charge for nation-wide employment service. Read want-ads for Draftsmen every day in Chicago Tribune or any big city paper—see the opportunities for yourself—and get ready for them.

MAIL COUPON TODAY!

Win Success Through Drafting

Drafting is easy, fascinating work. Short hours. Big pay. And the Draftsman is always in line for promotion for executive positions. This training is Complete. It includes high-school subjects (if you need them) and all the Engineering and Mathematics required of Drafting Experts.

A New, Rapid, Easier Training

70,000 fine jobs advertised this year. Get ready to fill one. Get out of the rut. Make something of yourself. Plan your future in Drafting. Even if you have only common schooling, even if you know nothing of Drafting, we guarantee to make you a real Draftsman or to refund your money! Special surprise offer right now to the first 500 men who answer this ad—reduced price, easy terms. Coupon brings complete information.

Coupon Brings Three Lessons Free!

Get them. Test your own ability to learn Drafting and get ready for a fine job and big pay. Coupon also brings surprise offer, and complete information about your opportunities for success in Drafting.

Mail It Today!

Complete Costly Drafting Outfit GIVEN!

You need a fine outfit like this to do precise, neat Drafting. Not one penny of extra charge for this complete, valuable, high grade outfit. Imported instruments. Table, board, mahogany-edge T square, triangles, ink, thumb-tacks, etc., everything you will need. Retail value \$20. Coupon brings this Free Offer.

CHIEF DRAFTING ENGINEER, AMERICAN SCHOOL,

Dept. D-974 Drexel Ave. & 58th St., Chicago

Rush 3 Free Drafting Lessons. Surprise offer, complete information, money-back guarantee, etc., to prove I can become a real draftsman at home in spare time.

Name.....

Street No.....

City..... State.....

CHIEF DRAFTING ENGINEER AMERICAN SCHOOL

Dept. D-974

Drexel Ave. & 58th St., CHICAGO



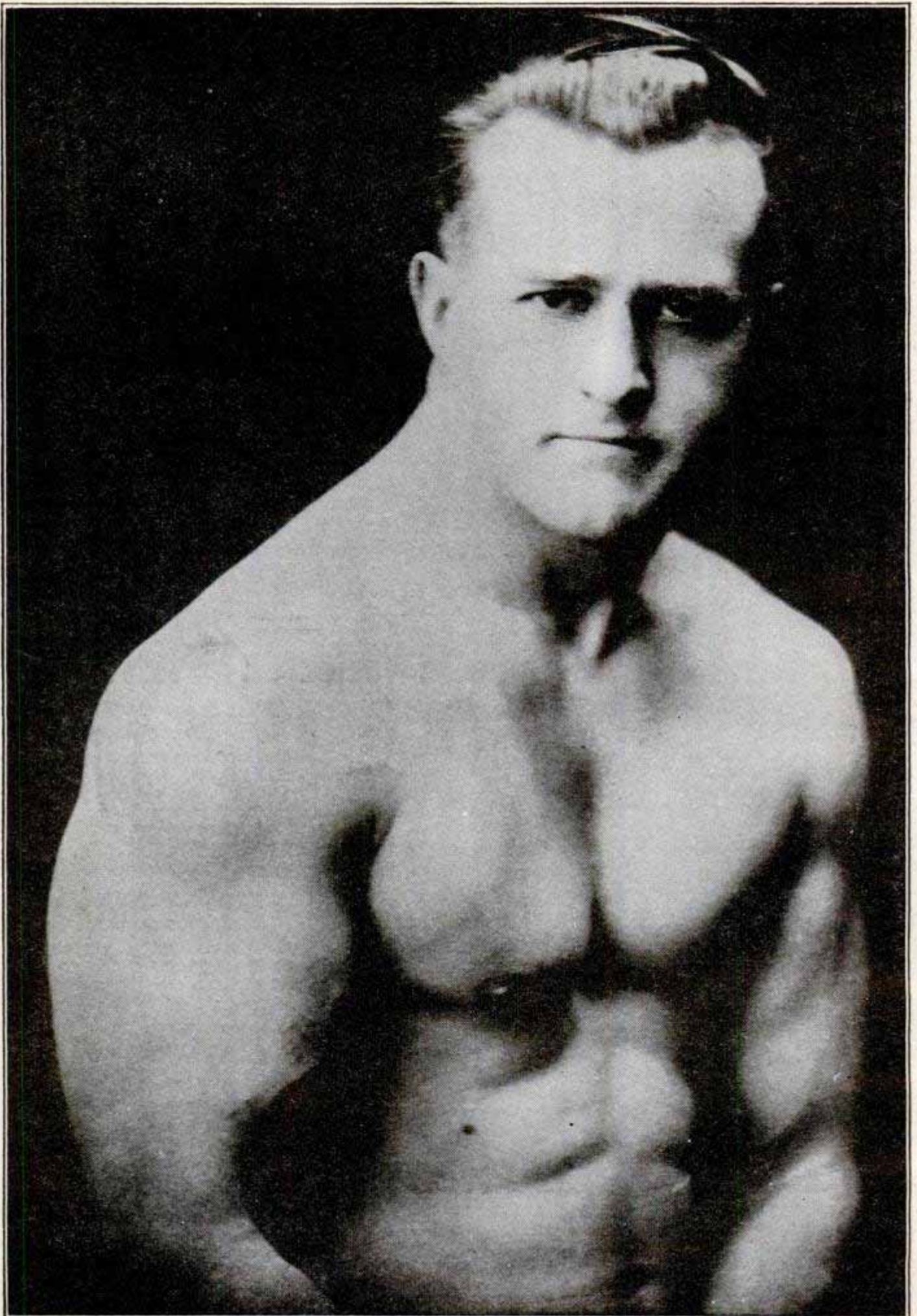

EARLE E. LIEDERMAN, *The Muscle Builder*
Author of "Science of Wrestling," "Muscle Building," "Secrets of Strength," "Here's Health," "Endurance," etc.

I Walked Over 3000 Miles

**to Shake Hands With Earle E. Liederman!
Read How I Who Was Doomed To Die
Gained Health and Strength.
By Chas. Todd.**

I didn't take this long hike from San Francisco to New York to win a bet—no, fellows, I took this long jaunt because I wanted to meet Earle E. Liederman face to face, shake him by the hand and let him see what a wonderful job he did for me. I wanted him to see the wonderful muscles he built for me—I wanted him to know of the endurance I attained from taking his course.

I was doomed to die—so the doctors said. Think of the agonized suffering which I went through. I was told that I would never be strong and healthy and that if I exerted myself I would quickly go to the great beyond. Think of it, fellows? Death was playing tag with me, dogging my very footsteps and the odds of me living a full, natural life were 1,000 to 1 against me—I fooled them all.

Earle E. Liederman Came to My Rescue

Mr. Liederman never heard of me, but I heard of his method of body building and determined I couldn't lose by writing him. As the situation was at that time, I didn't think Liederman could give me health any more than anyone else, but I decided in my desperation that I had nothing to lose and everything to gain and like a drowning man grasping at a last straw, I wrote and told him all my health troubles.

I Received the Greatest Surprise of My Life

Lickety split, by return mail, Mr. Liederman personally communicated with me and gave me my first ray of hope—he said he could help me! He also wrote that he would give me all the dope on getting healthy and strong by mail, just as he does every day for thousands of others. But, because my case was such an exceptional one, he would have to ask me to work closer with him than his ordinary run of students. I told him I was at his mercy and that his orders would be law and that I would follow his advice to the letter.

A Miracle In Thirty Days

After following Liederman's instructions the first thirty days, a miracle happened. I noticed a wonderful change in my breathing. My blood tingled and my entire appearance surprised everyone who knew me. No longer did I see my friends nudging each other and shake their heads as if to say, "It's too bad, he's going fast." No! I fooled them all. I got well and strong and became a fine specimen of physical manhood. I never dreamed that I would be able to swim, run, jump or do anything that my heart desired. After a few short months, I was fearlessly able to throw caution to the winds.

After the foundation for my health was laid, the rest came easy. I added real healthy muscle around my bones, I acquired that springy step which bespeaks the healthy person. My eye sparkled like crystal. My body just tingled with energy—I was pep from head to foot. I lost my slump—I acquired a feeling up and down my spine which made me know that I had real healthy life in me and many more happy, healthy years to look forward to. Yes, I lived and am living now for the first time. That is why I hiked from 'Friseo—I wanted to show Liederman what a wonderful man he made out of me—I wanted to prove to myself that my strength and endurance were real.

It's a Cinch to Enjoy Life

Don't care who you are or what your health ambitions are, I Liederman can do for you what he did for me. If you add muscles to your arms, legs or chest, Liederman will give you one solid inch on your arm and two inches on your chest in the first thirty days. I know this guarantee means what it says because he did it for me. I asked Mr. Liederman to announce to the world about my case because I wanted to show the makers of health and strength to enjoy the great system of muscular development.

He will send you his big 64 page book telling all about it and he will gladly send it to you free—read the book in which Mr. Liederman tells you all about the system of muscular development.

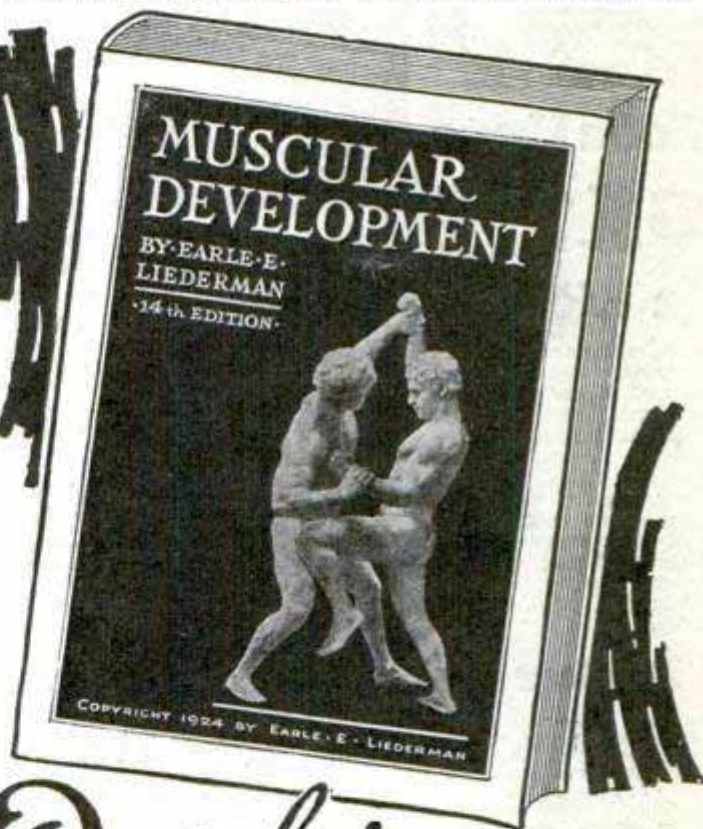

Send For My New
64 Page Book

"Muscular Development"

IT IS FREE

It contains forty-eight full-page photographs of myself and some of the many prize-winning pupils I have trained. Many of these are leaders in their business professions today. I have not only given them a body to be proud of, but made them better doctors, lawyers, merchants, etc. Some of these came to me as pitiful weaklings, imploring me to help them. Look them over now and you will marvel at their physiques. This book will prove an impetus and a real inspiration to you. It will thrill you through and through. The book is yours. I want you to have it with my compliments. Keep it. This will not obligate you at all, but for the sake of your future happiness and health, do not put off. Send today—right now before you turn this page.

EARLE E. LIEDERMAN

Dept. 2012 305 Broadway New York City

It
Is
FREE
DON'T
SEND ONE
PENNY
—
YOUR
NAME
AND
ADDRESS
ON A
POSTAL
WILL DO

EARLE E. LIEDERMAN,
Dept. 2012, 305 Broadway,
New York City.

Dear Sir: Without any obligation on my part whatever please send me a copy of your latest book, "Muscular Development."

Name.....

Address.....

City..... State.....

(Please write or print plainly.)



Over \$10,000 a Year
C. V. Champion of Illinois counts it a "red letter day" when he first read this remarkable book — "Modern Salesmanship." He says "It enabled me to learn more, earn more, and BE MORE!" To-day he is president of his company and his earnings exceed \$10,000 a year!



\$1,000 in 30 Days
W. Hartle spent ten lean years in the railway mail service before "Modern Salesmanship" put him on the road to big pay. He has earned more in a week than he formerly earned in a month — averaged over \$1,000 for thirty days!



\$13,500 First Year
A. H. Ward was formerly a Chicago clerk, earning \$25 a week. Within one year he increased his earnings over \$1,000 a month—or to \$13,500 a year! The book—"Modern Salesmanship"—proved the first rung in his ladder to Success!



\$7,286 Last Year
F. G. Walsh was a clerk earning \$1,000 a year, and trying to support a wife and three children. He had to do something. N. S. T. A. training built up his income last year to \$7,286—an increase of over 700 per cent.

-and They Started By Reading This Amazing Book!

Now—For a Limited Time Only—This Remarkable Man-Building, Salary-Raising Volume Is Offered FREE to Every Ambitious Man! If You Ever Aspire to Earn \$10,000 a Year or More, Read It Without Fail.

Where Shall We Send Your Copy FREE?

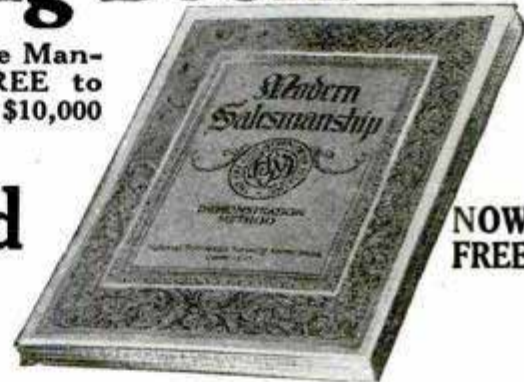

NOW FREE

A BOOK! Just seven ounces of paper and printer's ink—but it contains the most vivid and inspiring message any ambitious man can ever read! It reveals the facts and secrets that have led hundreds of ambitious men to the success beyond their fondest expectations! So powerful and far reaching has been the influence of this little volume, that it is no wonder a famous business genius has called it "The Most Amazing Book Ever Printed."

This vital book—"Modern Salesmanship"—contains hundreds of surprising and little-known facts about the highest paid profession in the world. It reveals the real truth about the art of selling. It blasts dozens of old theories, explains the science of selling in simple terms, and tells exactly how the great sales records of nationally-known star salesmen are achieved. And not only that—it outlines a simple plan that will enable almost any man to master scientific salesmanship without spending years on the road—without losing a day or dollar from his present position.

What This Astonishing Book Has Done!

The achievements of this remarkable book have already won world-wide recognition. The men who have increased their earning capacities as a direct result of reading "Modern Salesmanship" are numbered in the thousands. For example, there is E. E. Williams of California who was struggling along in a minor position at a small salary. "Modern Salesmanship" opened his eyes to things he had never dreamed of—and he cast his lot with the National Salesmen's Training Association. Within a few short months of simple preparation, he was earning \$10,000 a year! Today he receives as much in 30 days as he used to receive in 365!

And then there's J. H. Cash of Atlanta. He, too, read "Modern Salesmanship" and found the answer within its pages. He quickly raised his salary from \$75 to \$500 a month and has every reason to hope for an even more brilliant future. And still they come! W. D. Clenny of Kansas City commenced making as high as \$850 a month. F. M. Harris, a former telegrapher, became sales manager at \$6,000 a year. O. H. Malroot of Massachusetts became sales manager of his firm at a yearly income of over \$10,000 a year!

From \$15 a Week To \$7,500 a Year!

"A few years ago I was working in a shop for \$15 a week. When my factory friends heard of my intention to become a salesman they laughed at me. Today these fellows are still working in a shop and I am making \$7,500 per year. I can only speak words of praise for N. S. T. A. for it offered me a position which I took and raised me from a \$15 a week job in the shop to \$7,500 a year as a salesman."
C. W. Birmingham, Ohio

\$100 a Week Increase!

"When I took up the National Salesmen's Training Association Course, I was selling shoes for \$35 a week. Now I am earning an average of \$135 a week. I attribute this remarkable progress to N. S. T. A. Training."
James Jacobsen, Kentucky

A Few Weeks—Then Bigger Pay

There was nothing "different" about these men when they started. Any man of average intelligence can duplicate the success they have achieved—for their experience proves that salesmen are made—not born, as some people have foolishly believed.

Salesmanship is just like any other profession. It has certain fundamental rules and laws—laws that you can master as easily as you learned the alphabet. And through the **National Demonstration Method**—an exclusive feature of the N. S. T. A. system of SALESMANSHIP training—you can acquire the equivalent of actual experience while studying. Hundreds of men who never sold goods in their lives credit a large portion of their success to this remarkable training.

Free to Every Man

If we were asking two or three dollars a copy for "Modern Salesmanship" you might hesitate. But it is now FREE. We cannot urge you too strongly to take advantage of this opportunity to see for yourself what salesmanship has done for others—and what the National Salesmen's Training Association stands ready and willing to do for you. Find out exactly what the underlying principles of salesmanship are—and how you can put them to work for you. No matter what your opinion is now, "Modern Salesmanship" will give you a new insight into this fascinating and highly-paid profession. Mail the coupon now!



Dept. W-12, N. S. T. A. Building, Chicago, Ill.

National Salesmen's Training Assn.,
Dept. W-12,
N. S. T. A. Building, Chicago, Ill.

Without cost or obligation you may send me your free book, "Modern Salesmanship."

Name.....
Address.....
City..... State.....
Age..... Occupation.....



"The Boss Didn't Even Know My Name"

"He said my face was more or less familiar and he remembered seeing me around, but he didn't even know my name until the I. C. S. wrote him that George Jackson had enrolled for a course of home study and was doing fine work.

"Who's George Jackson?" he asked. Then he looked me up. Told me he was glad to see I was ambitious. Said he'd keep his eye on me.

"He did too. Gave me my chance when Frank Jordan was sent out on the road. I was promoted over older men who had been with the firm for years.

"My spare-time studying helped me to get that job and to keep it after I got it. It certainly was a lucky day for me when I signed that I. C. S. coupon."

How much longer are you going to wait before you take the step that will bring you advancement and more money?

It takes only a moment to mark and mail this coupon and send it to the International Correspondence Schools at Scranton. Isn't it better to do this today than to wait a year or five years and then wish you had?



Mail the Coupon for Free Booklet

INTERNATIONAL CORRESPONDENCE SCHOOLS
Box 5618-E, Scranton, Penna.

Without cost or obligation, please tell me how I can qualify for the position or in the subject before which I have marked an X:

BUSINESS TRAINING COURSES

- | | |
|--|---|
| <input type="checkbox"/> Business Management | <input type="checkbox"/> Salesmanship |
| <input type="checkbox"/> Industrial Management | <input type="checkbox"/> Advertising |
| <input type="checkbox"/> Personnel Organization | <input type="checkbox"/> Better Letters |
| <input type="checkbox"/> Traffic Management | <input type="checkbox"/> Show Card Lettering |
| <input type="checkbox"/> Business Law | <input type="checkbox"/> Stenography and Typing |
| <input type="checkbox"/> Banking and Banking Law | <input type="checkbox"/> Business English |
| <input type="checkbox"/> Accountancy (including C.P.A.) | <input type="checkbox"/> Civil Service |
| <input type="checkbox"/> Nicholson Cost Accounting | <input type="checkbox"/> Railway Mail Clerk |
| <input type="checkbox"/> Bookkeeping | <input type="checkbox"/> Common School Subjects |
| <input type="checkbox"/> Private Secretary | <input type="checkbox"/> High School Subjects |
| <input type="checkbox"/> Spanish <input type="checkbox"/> French | <input type="checkbox"/> Illustrating <input type="checkbox"/> Cartooning |

TECHNICAL AND INDUSTRIAL COURSES

- | | |
|---|--|
| <input type="checkbox"/> Electrical Engineering | <input type="checkbox"/> Architect |
| <input type="checkbox"/> Electric Lighting | <input type="checkbox"/> Architects' Blue Prints |
| <input type="checkbox"/> Mechanical Engineer | <input type="checkbox"/> Contractor and Builder |
| <input type="checkbox"/> Mechanical Draftsman | <input type="checkbox"/> Architectural Draftsman |
| <input type="checkbox"/> Machine Shop Practice | <input type="checkbox"/> Concrete Builder |
| <input type="checkbox"/> Railroad Positions | <input type="checkbox"/> Structural Engineer |
| <input type="checkbox"/> Gas Engine Operating | <input type="checkbox"/> Chemistry <input type="checkbox"/> Pharmacy |
| <input type="checkbox"/> Civil Engineer | <input type="checkbox"/> Automobile Work |
| <input type="checkbox"/> Surveying and Mapping | <input type="checkbox"/> Airplane Engines |
| <input type="checkbox"/> Metallurgy | <input type="checkbox"/> Navigation |
| <input type="checkbox"/> Steam Engineering | <input type="checkbox"/> Agriculture and Poultry |
| <input type="checkbox"/> Radio | <input type="checkbox"/> Mathematics |

Name.....
Street.....
Address.....

City..... State.....

Occupation.....

Persons residing in Canada should send this coupon to the International Correspondence Schools Canadian, Limited, Montreal, Canada.

Wrestling Book

Learn at Home 10c



Men, Boys be perfect physically. Learn right in your own home from WORLDS CHAMPIONS how to be an expert WRESTLER. Learn secret trick holds, blocks, breaks and pinning holds. Learn how to defend yourself against bigger, stronger men. Learn Jiu-Jitsu. Also most wonderful course in PHYSICAL CULTURE ever discovered. The world renowned FARMER BURNS AND FRANK GOTCH are authors of these splendid lessons. Learn to be a real athlete. You can if you'll try. Have a beautiful attractive body that all will admire. Surprise your friends, and the "bully" with your great ability. Learn to protect yourself, your mother, sister or sweetheart. Have perfect health, ability.

Only 10c

Send only 10c coin or stamps, for 82 page book, ILLUSTRATED, giving full particulars. Tells the secrets of the big Champions; gives many tricks, holds and other valuable information. A costly book which we send for only 10c—the cost of packing and postage. Don't miss it. Don't delay. SEND TODAY—THIS MOMENT. State your age.

Farmer Burns School, 1779 Railway Exchange Bldg., Omaha, Neb.

Music Lessons

UNDER MASTER TEACHERS

At Home

A Complete Conservatory Course By Mail

Wonderful home study music lessons under great American and European teachers. Endorsed by Paderewski. Master teachers guide and coach you. Lessons a marvel of simplicity and completeness.

Any Instrument Write telling us course you are interested in—Piano, Harmony, Voice, Public School Music, Violin, Cornet, Mandolin, Guitar, Banjo or Reed Organ—and we will send our FREE CATALOG with details of course you want, under master teachers. Send NOW.

University Extension Conservatory, 339 Siegel-Myers Bldg., Chicago, Ill.

LEARN WATCHMAKING

and become independent. We help you secure a position.

Easy to learn. Send for FREE CATALOG.

ST. LOUIS WATCHMAKING SCHOOL, Dept. 5, ST. LOUIS, MO.

BART SUPPLIES

Quality art materials at lowest prices. Save on everything you need. Convince yourself—send today for catalog.

BART SUPPLIES, 425 Eastis Bldg., MINNEAPOLIS, MINN.

LAW

THIS BOOK FREE!

Study at Home

Become a lawyer.

Legally trained men win high positions and big success in business and public life. Greater opportunities now than ever before. Earn \$5,000 to \$10,000 Annually!

We guide you step by step. Degree of LL.B. LaSalle law graduates practicing in every state. We furnish all text material, including 14-volume Law Library. Low cost. Easy terms. Valuable, interesting 96-page book free. Send for it NOW.



LaSalle Extension University, Dept. 1264-L, Chicago

**RADIO
NEEDS
TRAINED
MEN!**

I Will Train You At Home To Fill a Big Pay Radio Job



"I give you all this apparatus so you can learn quickly at home the *Practical Way*"

J.E.S.
FREE OF EXTRA COST



If you're earning a penny less than \$50 a week, clip coupon now. Send for AMAZING FREE BOOK, "Rich Rewards in Radio." Why go along at \$25 or \$35 or \$45 a week, when you could earn \$50 to \$250 in the same six days, as a Radio Expert? Hundreds of N. R. I. trained men are doing it—why can't you?
Earn \$50 to \$250 a Week—Radio Experts in Big Demand

Radio needs trained men. Get into this new live-wire profession of quick success. It's the trained men, the Radio Expert, who gets the big jobs of this profession—paying \$75, \$100, \$200 a week and up. Every day N. R. I. trained men are taking good places in the Radio field—men just like you—their only advantage is TRAINING. You can prepare just as they did by new practical methods. Our tested clear training makes it easy for you. Big Free Book contains all the proof.

You Learn Quickly In Spare Time

So sure am I that I can train you successfully for a better future in this new Big-Pay profession that I guarantee your training with a money-back bond. Lack of experience or education won't hold you back—common schooling all you need to start. You can stay home, hold your job, and learn quickly and pleasantly in your spare time. My practical, helpful methods enable you to start RIGHT AWAY toward one of the bigger Radio jobs paying \$50 to \$250 a week. No delay, no losing time from work—no scripping or scraping to get your training.



Operates WMAQ
"Accepted a position with the Chicago Daily News Station WMAQ. MY INCOME PRACTICALLY DOUBLED. I handle all consultation, also do operating. Your course taught me the theoretical and practical knowledge that makes my work easy." Keith Kimball, Station WMAQ, Chicago, Ill.

You Get All of This

All instruments shown here and others sent to all my students free of extra cost under short time special offer. Clip coupon now—find out all about this big unequalled offer while you still have time to take advantage of it. This training is intensely practical—these instruments help you do the practical work. You learn workmanship and get added confidence in your ability.



\$70 in one Day for T. M. Wilcox
"In business for myself—RECENTLY MADE \$70 in ONE DAY. I was an electrician of rich experience, occupying a splendid position as telephone superintendent when I enrolled with you, believing it would open up greater opportunities. Estimate Radio worth tens of thousands of dollars to me in next few years." T. M. Wilcox, Belle Island, Newfoundland.

World Famous Training That "Pays for Itself"

My Radio course World-Famous as the training that "pays for itself." Make more money QUICK when you take up this practical course. Work on millions of antennae, receiving sets, offers you big chance to make spare time cash while you're learning. I'll show you how. My students don't wait a year to increase their income—they report QUICK INCREASES as a result of this course—often two or three weeks after starting. Howard Luce, Friedens, Pa., made \$320 in 7 weeks during spare time. D. H. Suitt, Newport, Ark., writes: "While taking the course I earned in spare time work about \$900. These records not unusual—these men a few of hundreds."

Your Satisfaction Guaranteed

We who know the results this practical tested training gets, stand behind it all the way with a signed guarantee bond that we give you when you enroll. Get started today! It's your big chance for one of the bigger Radio jobs—mail coupon NOW for my Big FREE BOOK and proof! No obligation.

Get This FREE BOOK

Most amazing book on Radio ever written—full of facts and pictures—tells all about the great new Radio field, how we prepare you and help you start. You can do what others have done—GET THIS BOOK. Send coupon today—no obligation.

J. E. Smith, President
NATIONAL RADIO INSTITUTE
Dept. PT-7, Washington, D. C.



MAIL THIS COUPON TODAY
J. E. Smith, President
NATIONAL RADIO INSTITUTE
Dept. PT-7, Washington, D. C.
Dear Mr. Smith—Without obligating me in any way, send me your free book, "Rich Rewards in Radio" and all information about your practical, home-study Radio Course.

Employment Service To All Graduates
Originators of Radio Home-Study Training

Name.....Age.....
Street Address.....
Town.....State.....



DRAWING *is a way* to FORTUNE

Ali Hafed, a Persian farmer, sold his acres to go out and seek his fortune. He who bought the farm found it contained a diamond mine which made him fabulously rich. Ali Hafed overlooked the great opportunity at his door to go far afield in search of wealth—which illustrates a great truth.

DO YOU LIKE TO DRAW?

If you do it is almost a certain indication that you have talent, a talent which few possess. Then don't follow Ali Hafed's example and look farther for fortune. Develop your talent—your fortune lies in your hand!

Earn \$200.00 to \$500.00 a Month and More

Present opportunities for both men and women to illustrate magazines, newspapers, etc., have never been excelled. Thousands of publishers buy millions of dollars' worth of illustrations every year. Illustrating is the highest type of art—pleasant work, yielding a large income.

THE FEDERAL COURSE IS A PROVEN RESULT GETTER

It is the only Home Study Course which has been built by over fifty nationally known artists—Sid Smith, Neysa McMein, Norman Rockwell, Clare Briggs, Charles Livingston Bull and Fontaine Fox among them.

FREE—"A ROAD TO BIGGER THINGS"

If you like to draw you should read this free book before deciding on your life's work. It tells about illustrating as a highly paid, fascinating profession and about the famous artists who have helped build the Federal Course. Just tear out this ad, write your name, age, occupation and address in the margin, mail it to us and we will send you your copy of the book and the sample lesson free. Do it right now while you are thinking about it.

Federal School of Illustrating

12136 Federal School Bldg. Minneapolis, Minn.



Young outdoor men wanted

Interesting, vigorous outdoor work in a growing organization where merit wins advancement. Good starting wages. Permanent positions and a real future for men who make good. Our present field force of Davey Tree Surgeons cannot meet the increasing demand. So we are selecting now, to enter our employ, a few sturdy, clean young men, thorough Americans, single, between 20 and 30 years old, free to travel, industrious, with good practical education, and able to give good references. Write for qualification blank to serve in place of personal interview.

The Davey Tree Expert Co., Inc.,
638 Federal Bldg., Kent, Ohio.

FREE—if you act NOW

Bishop's ELECTRICAL DRAFTING and DESIGN —Free With This Pay-Raising Set

For a short time only we will give every subscriber to Croft's LIBRARY OF PRACTICAL ELECTRICITY a copy of Bishop's ELECTRICAL DRAFTING AND DESIGN—absolutely FREE. This book tells you everything you want to know about reading and constructing all kinds of electrical drawings and diagrams. It comes to you FREE with

The Croft Library of Practical Electricity

A combined reference library and home study course 8 volumes, 3000 pages, 2100 illustrations, flexible binding \$1.50 in ten days and \$2.00 monthly for nine months—only 7 cents a day.

The man who gets anywhere in any line of endeavor is the man who KNOWS. And generally the more he knows the more he earns.



For the man who wants to know there is nothing better than these eight volumes packed to the covers with sound, helpful information on every phase of electricity from first principles to central station work.

SEE IT FREE—No obligation to Purchase

By just filling out and returning the coupon below you will have, at no cost to you whatsoever, a practical, useful set of books for 10 days' Free Examination. We take all the risk—pay all charges. You assume no obligation—you pay nothing unless you decide to keep the books. Send the coupon NOW and see the books for yourself. When your first payment of \$1.50 is received we will send you your free copy of Bishop's ELECTRICAL DRAFTING AND DESIGN.

FREE EXAMINATION COUPON

McGRAW-HILL BOOK CO., Inc., 370 Seventh Ave., New York

Send me for 10 days' free examination the Croft Library of Practical Electricity. If satisfactory I will send you \$1.50 in 10 days and \$2.00 monthly until the special price of \$19.50 is paid. If not wanted, I will return the books at your expense. On receipt of my first payment of \$1.50, it is understood that I am to receive, free of charge, a copy of Bishop's ELECTRICAL DRAFTING AND DESIGN.

Signed

Address

City and State

Position

Employer

P.M. 12-1-26

ELECTRICITY

Complete Study Course and Pocket Library \$10



SHIPPED FREE

A set of **HAWKINS GUIDES** is a true friend to the electrical worker. It tells you how to do any job the right way—without guessing or taking chances.

Hawkins Guides put all the facts about modern electrical engineering at your finger tips. Therefore your chances for advancement in the electrical field are unlimited.

HAWKINS GUIDES DOUBLE YOUR VALUE



Electricity is king!

It is the ruling force of today—transportation, communication, light, heat, power—indeed every modern activity is dependent on electricity. Industry is crying for electrical men that know their jobs!

Hawkins Guides teach you all you need to know about electricity in easy, step-by-step lessons. Daily spare time reading of the Guides will greatly increase your value to yourself and your employer in a few weeks. Hundreds of our friends have written us and told us this!

ing of the Guides will greatly increase your value to yourself and your employer in a few weeks. Hundreds of our friends have written us and told us this!

READERS OF HAWKINS GUIDES KNOW HOW



"You can't stump him on an electrical job." "He certainly knows his business." "Certainly have to hand it to him for knowing how." —These are the things employers say about our friends who are readers of Hawkins Guides. No matter what question or problem comes up the Ready Reference Index enables you to give an expert answer at once.

HAWKINS STARTS YOU WHERE OTHERS LEFT OFF

Why should you work at low wages when easy reading of **HAWKINS GUIDES** will give you the money-making knowledge of the expert? Easy daily reading of the Guides will teach you in a few months what it has taken the expert a lifetime to learn!

With **HAWKINS GUIDES** in hand you have a running start to success in the electrical field. You will actually begin where others left off!

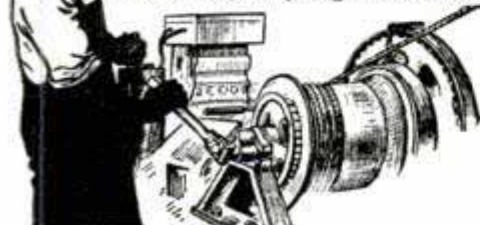

NOW!

This coupon is your golden opportunity. Tear it out—send it now!

FOR EXAMINATION!

REAL ELECTRICAL EDUCATORS

"Hawkins Guides at \$10 is the best investment I have ever made. Am able to take up almost any electrical job and have never gone to an electrical school."—B. Roessler, Oenaville, Texas.

AS EASY AS A. B. C.

"Everything in Hawkins Guides is very plain and anybody can read and understand them as easy as A. B. C."—J. Knight, Tobyhanna, Pa.

OTHER ENTHUSIASTIC READERS SAY

"Worth ten times their price." "Helped me to two raises in four months." "Better than a school of instruction." "Studied them when I was laid up and got further ahead than if I had been on the job."

Hawkins Guides Explain These Points So You Can Easily Understand:—

Magnetism—Induction—Experiments—Dynamoes—Electric Machinery—Motors—Armatures—Armature Windings—Installing of Dynamoes—Electrical Instrument Testing—Practical Management of Dynamoes and Motors—Distribution Systems—Wiring—Wiring Diagrams—Sign Flashers—Storage Batteries—Principles of Alternating Currents and Alternators—Alternating Current Motors—Transformers—Converters—Rectifiers—Alternating Current Systems—Circuit Breakers—Measuring Instruments—Switch Boards—Wiring—Power Stations—Installing—Telephone—Telegraph—Wireless—Bells—Lighting—Railways. Also many Modern Practical Applications of Electricity and Ready Reference Index.

Hawkins Guides—10 POCKET SIZE NUMBERS

Each number easy to carry around and read in spare time. Big type and clear diagrams. Easy to study and learn. Durable, flexible binding—gold edges. 3,500 pages—4,700 illustrations. Shipped free for examination. Pay only \$1 a month if satisfied. Price of set, complete, \$10.



EXAMINE GUIDES FREE!

Let the Guides themselves demonstrate their practical value to you—as a study course, reference work and complete electrical library. You are the judge. Simply send this coupon. No obligation unless you are entirely satisfied. Tear out on dotted line—fill in—mail it NOW!



FREE EXAMINATION COUPON

Theo. Audel & Co., 65 W. 23rd St., New York City

Please send me (postpaid) for my approval **Hawkins Electrical Guides**, 10 numbers (price \$1 each). If satisfactory I will mail you \$1 in 7 days and further mail \$1 monthly until purchase price of \$10 is paid.

Name

Address

Occupation

Employed by

12T30

Play the HAWAIIAN GUITAR and be Popular!

Play all the latest hits just as the Hawaiians do. Be the most popular member of your set. Get in on all the good times. Entertain your friends—or play professionally. Be in demand everywhere. We will help you.



\$15
HAWAIIAN GUITAR
 with Genuine Seal Grain
Fabrikoid Cover
FREE
 when you enroll



This sweet-toned, mellow Hawaiian Guitar would cost you at least \$15 in any music store without the Genuine Seal Grain Fabrikoid Case. We can afford to give you the entire outfit free when you enroll, including picks, steel playing bar, etc., because we make them in huge quantities in our own factory. Nothing to buy—everything is furnished.

Learn in Spare Time at Home

You study in spare time—when you like—as long as you like. And even if you don't know one note from another, our method is so simple, plain and easy that you begin a piece your first lesson. In half an hour you can play it!

Famous Native Hawaiians Teach You

You receive expert instruction from such world famous players as Kolomoku, Kalaluki, Ferara and Seville. They quickly teach you the secrets of this fascinating instrument.

Complete Conservatory Course. You get 52 complete printed lessons. Nothing is omitted. Pictures explain every move. And no matter how little you know about music when you begin, no matter if you have never touched a musical instrument, you can positively learn to play by our plain, easy, picture method.

Only 4 Motions to Learn

Then you can play any music—popular songs, classical, old-time melodies, native Hawaiian airs—or real jazz—separately or with accompaniment. You'll never be lonesome after you learn to play on this beautiful Hawaiian Guitar.

Pay as You Play

We make it easy for you. You start any time—with a small first payment—then pay while learning. Write for liberal offer.

Our Written Guarantee

We guarantee in writing to teach you. 45,000 successful students. And we coach and advise you after graduation—no extra cost.

Other Courses under famous teachers—Tenor Banjo, Violin, Mandolin, Banjo Ukulele and Ukulele.

FIRST HAWAIIAN CONSERVATORY OF MUSIC, INC.

9th Fl., Woolworth Bldg., Dept. 248, New York, N. Y.
 Approved as a Correspondence School Under the Laws of the State of New York

ACT! Mail This Popularity Coupon NOW!

FIRST HAWAIIAN CONSERVATORY OF MUSIC, Inc.
 9th Fl., Woolworth Bldg., Dept. 248, New York, N. Y.

Please mail full information about your 52-lesson Hawaiian Guitar Course. I am not obliged to enroll unless I want to.

Name _____
 Address _____
 City _____ State _____

LEARN BY DOING
 Every phase of all branches of
ELECTRICITY
 taught by
Actual Practice
 In America's foremost institution for trade training
No Books Used
 Individual Instruction Start Any Day
 Write for FREE 64-page catalog
THE NEW YORK ELECTRICAL SCHOOL
 44 West 17th St., New York City

Anyone CAN LEARN

No talent or experience necessary. Fascinating work. Pays big money. Complete instruction book tells about: Alphabets, Colors, How to Mix Paints, Show Cards, Window Board and Wall Signs, Ready made letters, Gilding, Tricks of the Trade, also gives 100 Alphabets and Designs. Book bound in flexible int. leather-gold edges, and four half bearing Show Card Pens. Sent postpaid \$3.00. (C.O.D.) 10c ex.

Gilvie Pub. Co., 57 Ross St. Dept. 50, N.Y. City

EARN MONEY IMMEDIATELY—WE FURNISH EQUIPMENT TO START!!

LAW High-Grade Instruction
 By Correspondence Prepares You for the Bar—Est. 1892

University Methods. Standard Text-Books. Approved by Bench and Bar. Graduates practicing in every state. Send today for Free Catalog and Rules for Admission to the Bar. CHICAGO SCHOOL OF LAW, 802 Reaper Block, Chicago, Ill.

GOVT. POSITIONS

\$35 TO \$75 WEEKLY

- | | |
|------------------------|----------------------------------|
| () Railway Mail Clerk | () Meat Inspector |
| () P. O. Clerk | () Special Agent (Investigator) |
| () Forest Ranger | () Stenographer-Typist |
| () File Clerk | () Immigrant Inspector |
| () Matron | () City Mail Carrier |
| () General Clerk | () U. S. Border Patrol |
| () Chauffeur-Carrier | () Typist |
| () Skilled Laborer | () Seamstress |
| () Watchman | () Steno-Secretary |
| () Postmaster | () Auditor |
| () RFD Carrier | |

Mr. Ozment, Dept. 111, St. Louis, Mo.
 Send me particulars about positions marked "X"
 —salaries, locations, opportunities, etc.

NAME _____
 ADDRESS _____



I Can Teach You to Sing Like This!

—Eugene Feuchtinger

I do *not* mean I can make a Caruso out of every man—
or a Mary Garden out of every woman,—but

*I can teach you in a few short months a basic
secret of voice development which Caruso dis-
covered only after years of persistent effort*

HERE IS THE SECRET! This is a picture of the human throat, showing the all important Hyo-Glossus muscle. Biographers of the great Caruso tell us of his wonderful tongue control. Caruso himself speaks of it in his writings, as the basic secret of vocal power and beauty. But tongue control depends entirely on the development of your Hyo-Glossus muscle.

The Hyo-Glossus muscle in your throat can be strengthened just as surely as you can strengthen the muscles of your arm—by exercise.

Professor Eugene Feuchtinger, noted vocal scientist, famous in Europe before coming to America, was the first man to isolate and teach a method of developing the Hyo-Glossus.



If you are ambitious to sing or speak, or merely improve your voice for social or business purposes, here is your opportunity. If you suffer from stammering, stuttering or other vocal defect, here is a sound, scientific method of relief. Under the guidance of Prof. Feuchtinger himself, you can practice these wonderful, silent exercises in the privacy of your own home. For this method of training is ideally adapted to instruction by correspondence.

Free Book Send today for the Professor's book, "Physical Voice Culture." It will open your eyes to the possibilities of your own voice. It will indeed be a revelation to you. Get it without fail. Mail coupon.

Perfect Voice Institute 1922 Sunnyside Ave. Studio 93-59 Chicago

100% Improvement Guaranteed

Thousands of men and women have already received the benefits of the "Physical Voice Culture" method. If you will practice faithfully, your entire satisfaction is guaranteed. In fact, if your voice is not doubled in power and beauty, your money will be refunded. You alone are to be the judge.

PERFECT VOICE INSTITUTE

1922 Sunnyside Ave., Studio 93-59 Chicago

Please send me FREE, Professor Feuchtinger's book, "Enter Your World." I have put X opposite the subject that interests me most. I assume no obligations whatever.

Singing Speaking Stammering Weak Voice

Name

Address

Age

BOYS



Drawn from actual photograph of student doing spare time electrical work

Learn Electricity Make Big Money

How would you like to earn two or three dollars every evening after school and prepare yourself for a fine big job at the same time? Here's the opportunity of a lifetime for you fellows who like Electricity. Begin right now to prepare yourself for a regular man's size job in this fascinating field. Your chances for a big success are simply wonderful—the pay is big (thousands of men earn \$70 to \$200 a week) and advancement comes swift and sure.

I Will Train You at Home

With my easily earned, spare time Electrical Course I will train you at home like I have trained hundreds of other boys who are now big successful men. It will not interfere with your school work and you can earn more than the small cost of the course doing odd electrical jobs in your spare time. The Course pays for itself. I will show you how to get this work and how to do it. Some of my boy students make \$10 to \$15 a week this way.

Tools, Apparatus and Radio Course—Given Without Extra Charge

Send me the coupon below and I will tell you all about the big outfit of tools, apparatus and instruments and a new Radio Course that I am giving to my students for a limited time. I will send you my big interesting Electrical Book and a sample lesson, too—all Free. You will be tickled with the things I will send you Free. Mail the coupon right now.

L. L. COOKE, Chief Engineer
Chicago Engineering Works
Dept. O19 CHICAGO

Look What This Boy Is Doing

"Although the School term is coming to a close, and I am pretty busy with my examinations, I manage to keep up with my electrical studies and work."

"I guess I forgot to tell you I am now in business for myself. Am doing fine, but owe it all to you. If it had not been for your Course, I, being under age, could not have secured my license in this town. But I got it, and now have all the work I can do, averaging \$20 to \$30 a week, thru spare time work."

"I went out on a job tonight after school, on which I made \$3 and brought home another on which I made \$2.50—\$5.50, for 4 hours' work and no material furnished by me."
ROGERS SMITH,
1215 Chestnut St.
Greenville, N. C.

Use This "FREE BOOK" Coupon

L. L. COOKE, Chief Engineer,
Chicago Engineering Works,
Dept. O19 2150 Lawrence Avenue, Chicago

Send me your Big Outfit Offer, your big Electrical Book, Sample Lesson and particulars of your Electrical Course and Extra Radio Course. This will not obligate me in any way.

Name.....
Address.....
This Coupon only for use of boys 15 years old or more.

\$25.00 DRAWING COURSE for \$2.98



Haven't you often wished that you could draw cartoons, illustrate some idea, sketch some pretty face, etc.? You can do all of these things. One of America's most famous Cartoonists and Illustrators has developed a great, simple system for success in all branches of Commercial Art. This system has revolutionized the entire theory of drawing. It means that drawing can be as easy for you as writing—much simpler than learning shorthand, bookkeeping or typewriting. We are now placing this original system for learning Drawing, Art and Cartooning, consisting of 34 lessons with over 500 illustrations, within reach of every one. If you will devote a few hours each week to the Course WE ABSOLUTELY GUARANTEE that you will learn to draw and draw well before you have half finished the Course. If we fail to make this claim good, we will refund every cent paid us. By eliminating a large office force for answering correspondence, expensive catalogs, etc., we are enabled to make a price of \$2.98, the cheapest price ever known for a high-grade, home study course. Many have sent us letters similar to that of Rob't P. Davis of Detroit, who wrote: "I can't see how you ask so little, when others with inferior Courses get from \$20 to \$60 for theirs. It is more than I expected." Learn to draw. It is a big asset, no matter what field you are in.

Send No Money

Just order the course, and \$2.98 on arrival pay postman plus a few cents postage, payment in full for the entire Course and Free Drawing Outfit. If not entirely satisfied, return within five days and we will REFUND MONEY. Address:

FREE: If you order the course at once, we will include a drawing outfit, consisting of artist's pencils, pens, paper, erasers, thumb tacks, etc., enabling you to go to work without any additional cost.

LEDERER SCHOOL of DRAWING, Dept. 2480-Z, Chattanooga, Tenn. Orders from outside the U. S. A. are payable \$3.28 cash with order.

LEARN WATCH REPAIRING



You can learn by our modern and original system of instruction every part of the Watch Repairing Trade at home as good or better than at a shop. You can earn money while learning and secure a well paying position or start in business after completing our course of instruction. Good watch repairers are always in demand and earn from \$50 to \$75 per week. For particulars apply to the Wisconsin School of Watch Repairing 166 Mason St., MILWAUKEE, WIS.

MUSIC LESSONS FREE



IN YOUR OWN HOME

Write today for our FREE booklet. It tells how to learn to play Piano, Organ, Violin, Mandolin, Guitar, Banjo, etc. Beginners or advanced players. Your only expense about 2c per day for music and postage used. American School of Music, 51 Lakeside Bldg., Chicago

Book on Law Free



Write today for this new book. It tells you how a law training will shorten your road to success. It also carries a vital and inspiring message to every ambitious man! Find out about the opportunities that await the law trained man. Find out how you can learn law right in your own home. No obligations. The book is absolutely FREE. Write Today now while we are making a special reduced tuition offer.

American Correspondence School of Law
3601 Michigan Ave., Dept. 1359 Chicago, Illinois

IF YOU STAMMER

Write for my free book "Millard's Advanced Natural Corrective Course" and a free copy of my speech magazine. 10,000 cases successfully treated. Est. 24 years. Largest school for stammerers in world. Millard Inst. of Normal Speech, 2317 Millard Bldg., Milwaukee, Wis.

Learn Photography at HOME

Earn \$3,000 to \$10,000 a year. Prepare quickly during spare time. Also earn while you learn. New easy method. Nothing else like it. Send at once for free book, "Opportunities in Modern Photography" and full particulars. Special offer open now International Studios, Inc., Dept. 1359, 3601 Michigan Ave., Chicago, U. S. A.



Thousands Have This Priceless Gift - and Never Discover It!

MANY men rob themselves of success, popularity, achievement and position which could rightfully be theirs if they would uncover the priceless gift which nature gave them. They go through life timid, self-conscious fearful and retiring instead of using this natural gift of powerful speech to dominate and control others and become leaders among men. Seven men out of every nine have this gift. You can now find out for yourself, by means of this amazing FREE test, if you are one of these.

No sane man would deliberately and knowingly throw away a chance to become an outstanding, influential and important figure occupying a high-salaried job. Yet, without knowing it, thousands of men are neglecting a priceless gift which would bring them influence, position, popularity, power, leadership and money.

Nearly every man has in him the knack of powerful and convincing speech. This magic power is that thing which often rises up within you and demands expression, but is never heard because you lack the confidence in your ability—you get "stage fright."

Now Easy to Become a Powerful Speaker

What 15 Minutes a Day Will Show You

- How to address business meetings.
- How to propose and respond to toasts.
- How to make a political speech.
- How to tell entertaining stories.
- How to write better letters.
- How to enlarge your vocabulary.
- How to develop self-confidence.
- How to acquire a winning personality.
- How to strengthen your will-power.
- How to be the master of any situation.

I don't care what work you are now doing. I don't care what may be your station in life. I don't care how timid and self-conscious you now are when called upon to speak. If you will give me just 15 minutes each day in the privacy of your home I will make you an accomplished and powerful speaker in a few short weeks or it will not cost you a single penny. You need not have a college education nor any previous voice training. By this amazingly easy method you have only a few simple, easy-to-remember principles to learn. Then you will see how really easy it is to have the power of effective, convincing speech.

Why Powerful Speakers are Picked for Important Jobs

If you will take particular notice, you will find that the big, important, high-salaried jobs invariably go to the men who are powerful talkers. Often you will see a man of this type forge ahead in business at an amazingly fast rate, while men of even greater ability stand tied to one small job. That is the reason you are often astonished to see a man jump over the heads of many superiors into a job among the big leaders. It is the power and ability to speak with force and conviction that flashes men from obscurity and low wages to prominence and high salaries.

Amazing Book Free—Mail Coupon

If you will fill in and mail the coupon at once, you will receive a remarkable new book called "How to Work Wonders with Words." This book gives you an amazing test by which you can determine for yourself in five minutes whether you are one of the seven men out of every nine who possess the "hidden knack" of powerful speech, but do not know it. Decide for yourself if you are going to allow 15 minutes a day to stand between you and success. Thousands have found this to be the biggest step forward in their lives. If it has played such an important part in the lives of many big men, may it not be yours? Then mail the coupon at once.

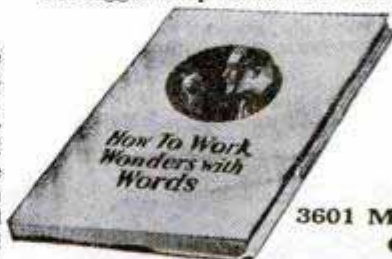

NORTH AMERICAN INSTITUTE

3601 Michigan Ave., Dept. 1359
CHICAGO, ILL.

North American Institute,
3601 Michigan Ave., Dept. 1359, Chicago, Illinois.

Please send me FREE and without obligation my copy of your famous book, *How to Work Wonders with Words*.

Name.....

Address.....

City.....State.....

Money-Making Tools



To those who enroll in near future—tools **FREE** of any extra cost whatever. Also a drafting table! Act now!

I need YOU with 100 firms BEGGING ME to send them more DRAFTSMEN. Many offer to take BEGINNERS, at \$50 a WEEK. Graduates can start at \$90 and \$100! GET BUSY!



Drafting is the BIG field, men. Every industry you can name BEGINS with the draftsman. Without mechanical drawings—by the thousands—every shop in the land would be STOPPED.

In fact, it is the SERIOUS SHORTAGE of draftsmen that brings this offer: *I will furnish all instruments, supplies, even to the table, to those who start now!*

PAY AS YOU GO Don't give me the excuse that you have no ready money for this golden opportunity. I am not so interested in cash; I want your application. I want at least 200 men to start *right now*. I want them ready to recommend by Spring! We will get a flood of letters saying "send us draftsmen," from every sort of industrial and engineering concern, and we must make good.

The first week's pay envelope of many a Dobe-trained draftsman has held enough to cover the entire cost of the course! Most students learn evenings, keeping on with their old work until ready to step into somebody's drafting room. The first month equips you to take on simple drafting jobs on the side. It helps you learn; I gladly permit this.

Well-Paid Positions Every Way You Turn

A draftsman soon forgets the days when he used to wonder where to get a job. Instead, he asks "What line of work interests me most?" And "What part of the country suits me best?" Twenty of my graduates went to Florida this year; three are in Japan; last month one wrote me from Ceylon. And I wish we had the count of how many Dobe draftsmen have become chiefs!

Positions loom up almost as soon as you are enrolled in a Dobe class! We receive requests *daily* for junior men—for men only partly through our course. "We'll take a *beginner*," some concerns write us, "so long as he is a Dobe-trained man and has begun *right!*"

IT'S EASY and interesting to learn drafting. For drafting isn't "drawing"! You don't need any "talent." A draftsman uses tools for every line and every curve. You couldn't make them crooked if you tried! That's why drafting is so easily learned—and so interesting. *For you do everything by rule.* So, I guarantee to make *anyone* a finished draftsman; if you can read and write, you can learn this line. One of my students is 51 years old; another is just seventeen. *But they'll all be making a grown-up salary by Spring!*

WARNING! The special offer of tools is for immediate action. Don't expect me to hold it open indefinitely. Clip the coupon *now* for free book: *

CHIEF DRAFTSMAN DOBE, Div. 83-59
1951 Lawrence Avenue
Chicago

Special Tool Offer

Send me **FREE** and **POSTPAID** Successful Draftsmanship Book and material telling all about your home course, terms, etc.

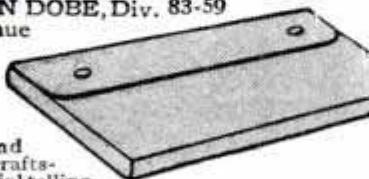

Name.....Age.....
Address.....
P. O..... State.....

ELECTRICITY

Practical-Technical TRAINING

Free

Great demand for practical-technical electricians and engineers. Fascinating work. Rapid advancement. Thousands of positions open. Finlay trained men earn \$10 to \$25 a day and more. Send today for latest catalog, beautifully illustrated, explaining One and Two year courses in Electrical Engineering. Also 12 weeks course in Practical Electricity. Degrees and certificates of efficiency awarded.

Courses to suit your needs

Finlay condensed method now in 24th successful year trains head and hand. Completely equipped shops and laboratories. Faculty of trained experts. Students assisted to positions.



EARN \$10 to \$25 A DAY

FINLAY ENGINEERING COLLEGE
114 Finlay Bldg. Kansas City, Mo.

Learn to Mount Birds



Learn at home by mail, to mount birds, animals, game heads; tax furs, make rugs and robes. Complete lessons. Easily and quickly learned by men, boys and women.

FREE Write today for Free Taxidermy Book. Tells all about it. Every Sportsman, Hunter, Trapper and Nature lover should know this wonderful fascinating art. Save your trophies. Big profits guaranteed. Our school is 20 years old—100,000 graduates. Investigate today. Write for Free Book.

Northwestern School of Taxidermy 9779 Elwood Bldg., Omaha, Neb.

Learn to PAINT SIGNS and SHOW CARDS

We quickly teach you by mail, or at school, in spare time. Enormous demand. Big future. Interesting work. Oldest, foremost school. **EARN \$50 TO \$200 WEEKLY** John Vauson, N. Y., gets \$25 for single show card. Crawford, B. C., says: "Earned \$200 while taking course." Send today for free information, samples and guarantee.



DETROIT SCHOOL OF LETTERING
150 Stimson Ave. Est. 1899 Detroit, Mich.

Learn Furcraft



Learn by mail, evenings at home, to Renew, Repair and Make-up all kinds of fur garments. Learn glazing, ironing and storage. Big demand, big need for your service in every neighborhood. \$3 an hour in your spare time or a real business now and a fur shop later. We teach you secret processes. Earnings start in 30 days. Uncrowded field for men and women. **FREE BOOK**—Send now for free book giving details. No obligation.

Northwestern Fur Co. 1779 Sunderland Bldg. OMAHA, NEBRASKA



"BECOME A LIGHTNING TRICK CARTOONIST"

Send \$1.00 for Laugh Producing Program of 23 Trick Drawings with Instructions. Catalog of Chalk Talk Supplies Free. **BALDA ART SERVICE, Dept. 1, Oshkosh, Wis.**

Comedies, Dramas, Musical Comedies and Revues, Minstrel Choruses, Songs, Blackface plays. Everything for Burnt Cork Shows and All Amateur Entertainments. Monologs, Dialogs, Speakers. **PLAYS** Vaudeville Acts How to Stage a Play Make-up Goods CATALOGUE FREE

T. S. DENISON & CO., 623 So. Wabash, Dept. 9, CHICAGO

Learn Watchwork, Jewelrywork and Engraving

A fine trade commanding a good salary, and your services always in demand. Address **HOROLOGICAL, Dept. P, Bradley Institute, PEORIA, ILLINOIS**, for our latest catalog.

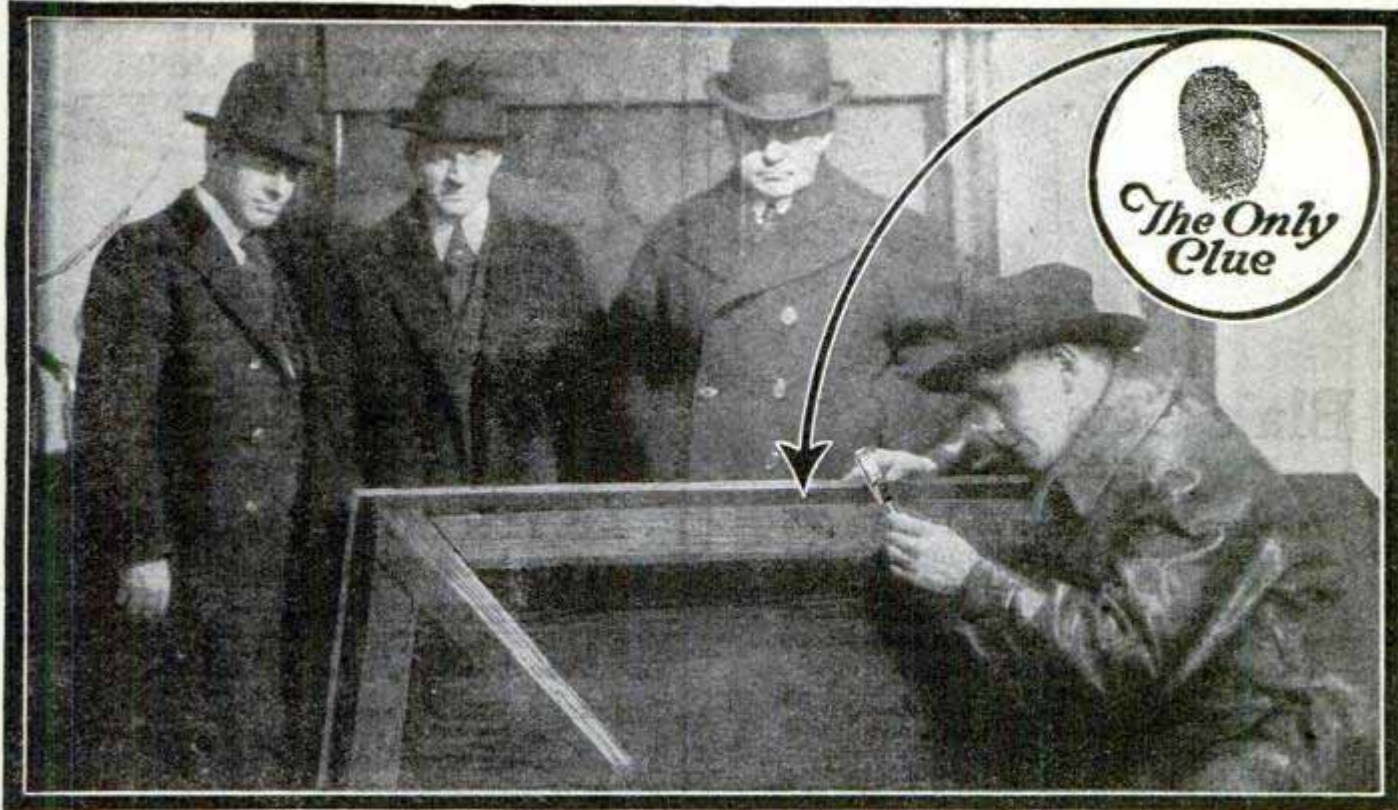

\$500 REWARD for TWO HOURS WORK

WARREN BIGELOW, the Finger Print Detective, was making his usual review in the morning newspapers. He had just finished reading the press reports of the daring robbery of the offices of the T—O—Company when the telephone on his desk rang. Central Office was calling, asking him to come immediately to the scene of the robbery.

Although he drove his high powered roadster rapidly and arrived very shortly at his destination, he had plenty of time to consider the main features of the case as reported by the press. The job had undoubtedly been done by skilled cracksmen and robbers of uncommon nerve. Sixty-five hundred dollars in currency—the company pay-roll—were gone. Not a single, apparent clew had been found by the police.

Finger Print Expert Solves Mystery

On his arrival, Bigelow was greeted by Nick Austin, Chief of Detectives, who had gone over the ground thoroughly.

"Hello, Warren. Here's a job that has us stumped. I hope you can unravel it for us."

By this time, the district officers and the operatives from Central Office had almost given up the investigation. After hours of fruitless efforts, their work was at a standstill. They were completely baffled.

With lively interest and a feeling of relief they stepped back to await the results of the Finger Print Detective's findings. They were plainly awed at his quiet, assured manner. The adroit old Chief himself was manifestly impressed at the quick, sure way in which Bigelow made his investigation.

Almost immediately Bigelow turned his attention to a heavy table which had been tipped up on its side. Examination of the glossy mahogany showed an excellent set of finger prints. The thief might just as well have left his calling card.

To make a long story short his prints were photographed and taken to Central Office, where they were matched with those of "Big Joe" Moran, a safe blower well known to the police. Moran was subsequently caught and convicted on Bigelow's testimony and finger-print proof. Most of the money was recovered. In the meantime the T—O Company had offered a \$500.00 reward, which was given to Bigelow—his pay for two hours' work.

Learn At Home in Spare Time

Could you imagine more fascinating work than this? Often life and death depend upon decisions of finger-print evidence—and big rewards go to the **Expert**. Thousands of trained men are now needed in this great field. The finger print work of governments, corporations, police departments, detective agencies and individuals has created a new profession. Many experts regularly earn from \$3,000 to \$10,000 a year in this fascinating game. And now you can easily learn the secrets of this new Science in your spare time—at home. Any man with common school education and average ability can become a Finger Print Detective in a surprisingly short time.

Free Course in Secret Service

For a limited time we are making a special offer of a **Professional Finger Print Outfit, absolutely Free, and Free Course in Secret Service Intelligence**. Mastery of these two kindred professions will open a brilliant career for you.

Write quickly for fully illustrated free book on Finger Prints which explains this wonderful training in detail. Don't wait until this offer has expired—mail the coupon now. You may never

see this announcement again! You assume no obligation—you have everything to gain and nothing to lose. Address

UNIVERSITY OF APPLIED SCIENCE

Dept. 13-59, 1920 Sunnyside Avenue, Chicago, Illinois

UNIVERSITY of APPLIED SCIENCE, Dept. 13-59 1920 Sunnyside Av., Chicago

Gentlemen: Without any obligation whatever send me your new, fully illustrated, FREE book on Finger Prints and your offer of a FREE course in Secret Service Intelligence and the Free Professional Finger Print Outfit.

Name.....

Address.....

Age.....

Why don't You be a Finger Print Expert?



Blair Gets 225% Increase!

The future didn't look so good for Thomas J. Blair, Jr., Bluefield, West Virginia, when he enrolled for LaSalle training in Higher Accountancy. He was then assistant bookkeeper in a general store in a small country town.

Three years later, he had a different outlook. "I am now head of the accounting department of a large corporation," he writes, "and the two raises I have received within the last nine months make my total salary-increase since starting LaSalle training 203%." More recently he reports a business change which brings his total increase up to 225%."

Send for Free Book

"Accountancy, the Profession that Pays"

Blair got his start with the aid of just such a coupon as you see below this text.

He learned—from LaSalle's 64-page book, "Accountancy, the Profession that Pays"—of the splendid opportunities in this highly profitable profession. He was shown just what he must do to take advantage of them. He saw his chance. He took it! Swift promotion was the natural result.

A copy of the book which has meant so much to Mr. Blair will be mailed you for the asking. Thousands of men have found in this book their means of escape from deadly routine and have started, thru its aid, toward incomes paying \$3,000, \$5,000, \$10,000, even \$20,000 a year. Whether or not you choose the Accountancy way, the book is well worth your reading—and the coupon brings it to you free.

Balance the two minutes that it takes to fill out the coupon against the rewards of a successful career—then clip and mail the coupon NOW.

— — — Find Yourself Thru LaSalle! — — —

LA SALLE EXTENSION UNIVERSITY

The World's Largest Business Training Institution

Dept. 1264-HR Chicago

I would welcome details of your salary-doubling plan, together with copy of "Accountancy, the Profession that Pays," also a copy of "Ten Years' Promotion in One," all without obligation.

Higher Accountancy

Training for positions as Auditor, Comptroller, Certified Public Accountant, Cost Accountant, etc.

Other LaSalle Opportunities

LaSalle opens the way to success in every important field of business. If more interested in one of the fields indicated below, check and mail now.

- | | |
|--|--|
| <input type="checkbox"/> Business Management | <input type="checkbox"/> Personnel and Employment Management |
| <input type="checkbox"/> Modern Salesmanship | <input type="checkbox"/> Banking and Finance |
| <input type="checkbox"/> Traffic Management | <input type="checkbox"/> Modern Business Correspondence and Practice |
| <input type="checkbox"/> Railway Station Management | <input type="checkbox"/> Expert Bookkeeping |
| <input type="checkbox"/> Law—Degree of LL.B. | <input type="checkbox"/> C. P. A. Coaching |
| <input type="checkbox"/> Commercial Law | <input type="checkbox"/> Business English |
| <input type="checkbox"/> Industrial Management | <input type="checkbox"/> Commercial Spanish |
| <input type="checkbox"/> Modern Foremanship and Production Methods | <input type="checkbox"/> Effective Speaking |



Name.....

Present Position.....

Address.....

PREPARE FOR AN ART CAREER

—thru the *only* school operated as a department of a large art organization. Commercial Artists trained the "Meyer Both Way" earn as high as \$10,000 per year. We today have hundreds of students who had previously studied in other art schools. Why? Because your instruction is based upon our everyday experience in meeting the art needs of leading advertisers. Home study instruction. Write for illustrated book telling of the success of our students.

MEYER BOTH COMPANY

Michigan Ave. at 20th St., Dept. 16, Chicago, Ill.

ELECTRICAL

Course for men of ambition and limited time. Over 4000 men trained.

Condensed course in Theoretical and Practical Electrical

ENGINEERING

including the closely related subjects of Mathematics and Mechanical Drawing taught by experts. Students construct motors, install wiring, test electrical machinery. Complete course

IN ONE YEAR

Prepare for your profession in the most interesting city in the world. School established 1893. Send for catalog

BLISS ELECTRICAL SCHOOL
422 Takoma Ave. WASHINGTON, D. C.



LEARN WATCH REPAIRING

Be a watchmaker—you can learn this profitable trade by correspondence in a few weeks in your own home by the DeSelms Chart System. After you complete the course you will know a watch from A to Z. You will know just what the matter is and how to repair one. When you graduate you will be a practical watchmaker and repairer and competent to fill any position. Positions for our graduates. Ask for our Free Book. It explains our system and terms.

THE DeSELMS WATCH SCHOOL
LOGANSPORT, INDIANA



Learn Advertising at HOME

Some of the highest paid men in the world are advertising men. You can learn easily and quickly at home during your spare time. Bigger opportunities now in advertising than ever before. Constant demand for our graduates at big pay.

Send for FREE Book. Giving interesting information and vital facts—just what you want to know about advertising. Write today!

PAGE-DAVIS SCHOOL OF ADVERTISING
Dept. 1359 3601 Michigan Ave., Chicago, U. S. A.

Welding

Become a Welding Expert! Then earn top wages or go into business for yourself. We train you at Home, in your Shop, or on the Job. "Kerr's Training Course for Welders" is a thorough course in practical experience, covering all metals. It trains you in WHAT TO DO and HOW TO DO IT. Write at once for terms and enrollment card. (State if you have the use of a welding outfit.)

KERR'S WELDING SCHOOL Dept. 2, 752 N. Broadway
LOS ANGELES, CALIF.

LEARN PIANO TUNING AT HOME

Send for FREE copy of the 28th ANNIVERSARY EDITION of our book "Winning Independence." Read how students master TUNING with our Tune-A-Phone, and WHY our graduates head the profession in all parts of the world. With Bryant's patented devices, tools, charts, and lessons, one learns quickly and easily. Low tuition, easy terms, Diploma granted. MONEY-BACK GUARANTY. \$10 to \$25 a day, exceptional opportunities, and an idea! profession await you.

BRYANT SCHOOL OF TUNING (71) Bryant Bldg., Augusta Michigan



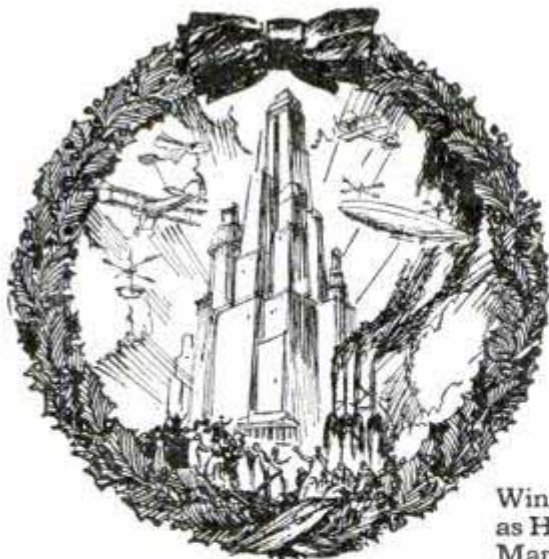

A Great Bargain a 40% saving on The New 1926 ENCYCLOPAEDIA BRITANNICA

NOW the inspiration and daily usefulness of the magnificent NEW Britannica can enter any home for Christmas *without slightest hardship of cost.*

A startling innovation in publishing makes it possible to offer you this newest Britannica in the New Form at a saving of 40% as compared with the regular Cambridge Issue.

A Part of Progress

This NEW Britannica—just published—gives every reader a bigger share in the wide-world progress of recent years. The special articles—inspiring—illuminating—come from the world's most famous men and women. Twenty-two Nobel Prize

Winners, industrial leaders such as Henry Ford, inventors such as Marconi, explorers such as Nansen and Stefansson—the greatest teachers, statesmen, physicians and naturalists—all gather in the NEW Britannica to inform you of the opportunities of today.

What Christmas gift could possibly fill your life with such a clear, inspiring light as this new THIRTEENTH EDITION Britannica!

For All Ages

On wireless, motion pictures, astounding inventions, discoveries and explorations *all ages* read the new Britannica with a feeling of thrilling adventure.

For business and professional men here is breadth and depth of knowledge.

Women find the THIRTEENTH EDITION absorbing reading—a wealth of information on household efficiency, children's rearing, civic affairs, literature, art and social service.

Now You Can Save 40%

In addition to the Easy Payment Plan by which you pay for the NEW Britannica out of income you can now, by prompt action, obtain the popular-priced NEW FORM (32 volumes

bound as 16). This splendid NEW FORM is little more than half the cost of the famous and standard Cambridge issue. In contents—type and illustrations—the NEW FORM is exactly the same as the Cambridge, but vast savings are made possible by the use of special opacity paper, the use of the same plates as the Cambridge issue, and by binding 2 volumes in ONE.

This NEW FORM is the lowest in price that can ever be obtained. No home this Christmas need be without a New Britannica. The certain demand this season for the NEW FORM, and the limit of its present supply, require quick action on your part. The Coupon you send by mail TODAY will bring by return mail all information—the Easy Payment Plan that makes this Christmas your happiest and easiest to pay for.

Send for this FREE 80-Page Book FREE

It outlines vast world changes that the NEW Britannica gives in detail; shows specimen pages, many in color; pictures the two issues; gives full details of the New Form (at a saving of 40%) and also the Easy Payment Plan; helps your decision in time for Special Christmas offer. Send Coupon Before Mail Closes Tonight; have all details in time before Christmas.



Use This Coupon for FREE Booklet

THE ENCYCLOPAEDIA BRITANNICA, Inc.

342 Madison Avenue, New York

PM6-L2

Please send me, by return mail, without any obligation on my part, your free 80-page Specimen Book of the new 1926 ENCYCLOPAEDIA BRITANNICA (Thirteenth Edition). Also full particulars of the NEW FORM (40% saving) and your easy terms of payment.

Name.....

Address.....

City.....State.....

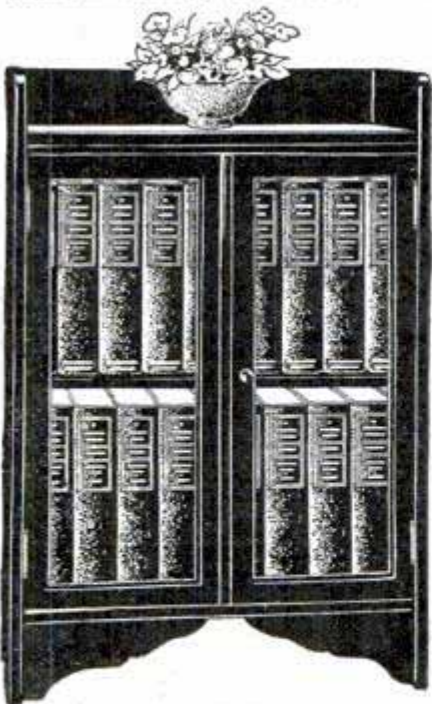

Tear out and mail this coupon TODAY



High School Course in Two Years!

You Want to Earn Big Money!

And you will not be satisfied unless you earn steady promotion. But are you prepared for the job ahead of you? Do you measure up to the standard that insures success? For a more responsible position a fairly good education is necessary. To write a sensible business letter, to prepare estimates, to figure cost and to compute interest, you must have a certain amount of preparation. All this you must be able to do before you will earn promotion. Many business houses hire no men whose general knowledge is not equal to a high school course. Why? Because big business refuses to burden itself with men who are barred from promotion by the lack of elementary education.

Can You Qualify for a Better Position

We have a plan whereby you can. We can give you a complete but simplified high school course in two years, giving you all the essentials that form the foundation of practical business. It will prepare you to hold your own where competition is keen and exacting. Do not doubt your ability, but make up your mind to it and you will soon have the requirements that will bring you success and big money. **YOU CAN DO IT.**

Let us show you how to get on the road to success. It will not cost you a single working hour. Write today. It costs you nothing but a stamp.

American School

Dept. H974, Drexel Ave. and 58th St., Chicago

American School

Dept. H974, Drexel Ave. and 53th St., Chicago

Send me full information on the subject checked and how you will help me win success.

- | | |
|-----------------------------|---------------------------|
|Architect |Business Law |
|Building Contractor |Lawyer |
|Automobile Engineer |Machine Shop Practice |
|Automobile Repairman |Mechanical Engineer |
|Civil Engineer |Shop Superintendent |
|Structural Engineer |Employment Manager |
|Business Manager |Steam Engineer |
|Cert. Public Accountant |Foremanship |
|Accountant and Auditor |Sanitary Engineer |
|Bookkeeper |Surveyor (& Mapping) |
|Draftsman and Designer |Telephone Engineer |
|Electrical Engineer |Telegraph Engineer |
|Electric Light & Power |High School Graduate |
|General Education |Wireless Radio |
|Vocational Guidance |Undecided |

Name.....
Address.....

STUDY at HOME

Teachers, authors, students and all who wish a broader outlook may start any day courses in Psychology, Art, Government, Economics, History, Literature, Education, Religion, Foreign Languages, Sciences and other subjects. These courses yield credit toward a Bachelor degree.

The University of Chicago

107 Ellis Hall Chicago, Illinois

Here's the Career for YOU



Get into Motion Picture Camera Work, Portrait and Commercial Photography. Learn at home. Big money while learning.

Earn up to \$250 a week

Hundreds of positions pay \$75 to \$250 a week. Or open your own studio. Easy, fascinating work.



CAMERA FREE

to students. Your choice of real Motion Picture Camera using professional film or 5 x 7 View Camera, anastigmat lens.

Write for big Free Book on Professional Photography. Explains amazing opportunities.

NEW YORK INSTITUTE OF PHOTOGRAPHY

12 W. 33d St., New York, N. Y., Dept. 49

Note: If you prefer to come to our studios for instruction, write for Catalog R-49 to nearest address: 10 W. 33d St., New York, or 630 So. Wabash Ave., Chicago.



PIANO JAZZ

By Note or Ear. With or without music. -short Course- Adult beginners taught by mail. No teacher required. Self-instruction Course for Advanced Pianists. Learn 259 styles of Bass, 684 Syncopated Effects, Blue Harmony, Oriental, Chime, Movie and Cafe Jazz, Trick Endings, Clever Breaks, Space Fillers, Sax Slurs, Triple Bass, Wicked Harmony, Blue Obligato, and 247 other Subjects, including Ear Playing. 133 pages of REAL Jazz, 25,000 words. A Postal brings our FREE Special Offer.

Waterman Piano School, 1826 W. Adams St. Los Angeles, Cal.



Wonderful, new device, guides your hand; correct your writing in few days. Big improvement in three hours. No failures. **Complete outline FREE.** Write C. J. Ozment, D-34, St. Louis, Mo.

Learn RADIO

At Home-By Mail

\$3,000 to \$10,000 a Year. How to build, repair, install, sell radios now, quickly learned. Simple, easy home-study plan. 1000-mile set free with course. Low cost, easy terms. Send now for free big book on radio opportunities.

RADIO ASSOCIATION OF AMERICA
4513 Ravenswood Ave. Dept. A-12 Chicago, Ill.

Skin Troubles

Cleared up—often in 24 hours. To prove you can be rid of Pimples, Blackheads, Acne Eruptions on the face or body, Barbers' Itch, Eczema, Enlarged Pores, Oily or Shiny Skin, simply send me your name and address today—no cost—no obligation. **CLEAR-TONE** tried and tested in over 100,000 cases—used like toilet water—is simply magical in prompt results. You can repay the favor by telling your friends; if not, the loss is mine. **WRITE TODAY.**
E. S. GIVENS, 428 Chemical Bldg., Kansas City, Mo.



"Can he really play?" a girl whispered. "Heavens, no," Arthur exclaimed. "He never played a note in his life."

They Laughed When I Sat Down At the Piano But When I Started to Play!—

ARTHUR had just played "The Rosary." The room rang with applause. Then to the amazement of all my friends, I strode confidently over to the piano and sat down.

"Jack is up to his old tricks," somebody chuckled. The crowd laughed. They were all certain that I couldn't play a single note.

"Can he really play?" I heard a girl whisper to Arthur.

"Heavens, no," Arthur exclaimed. "He never played a note in all his life. . . ."

I decided to make the most of the situation. With mock dignity I drew out a silk handkerchief and lightly dusted off the piano keys. Then I rose and gave the revolving piano stool a quarter of a turn. The crowd laughed merrily.

Then I Started to Play

Instantly a tense silence fell on the guests. I played the first few bars of Beethoven's immortal Moonlight Sonata. I heard gasps of amazement. My friends sat breathless—spellbound! I played on.

A Complete Triumph!

As the last notes of the Moonlight Sonata died away, the room resounded with a sudden roar of applause. I found myself surrounded by excited faces. Everybody was exclaiming with delight—

plying me with rapid questions . . . "Jack! Why didn't you tell us you could play like that?"

. . . "Where did you learn?"—"Who was your teacher?"

"I have never even seen my teacher," I replied. "And just a short while ago I couldn't play a note."

"Quit your kidding," laughed Arthur, himself an accomplished pianist. "You've been studying for years. I can tell."

"I have been studying only a short while," I insisted. "I kept it a secret so that I could surprise you folks."

No Teacher Needed

Then I told them the whole story.

"It seems only a few months ago that I saw an ad of the U. S. School of Music mentioning a new method of learning to play which only cost a few cents a day! The ad told how a woman had mastered the piano in her spare time at home—and without a teacher! The method she used required no laborious scales or exercises. It sounded so convincing that I filled out the coupon requesting the Free Demonstration Lesson.

"It arrived promptly and I started in that very night to study it. I was amazed to see how easy it was to play this new way. I sent for the course and found it was just as easy as A. B. C.! Before I knew it I was playing all the pieces I liked best. I could play ballads or classical numbers or jazz, with equal ease! And I never did have any special talent for music!"

Play Any Instrument

You too, can now learn music—right at home—in half the usual time. You can't go wrong with this simple new method which has already shown almost half a million people how to play their favorite instruments. Forget that old-fashioned idea that you need special "talent." Just read the list of instruments in the panel, decide which one you want to play, and the U. S. School will do the rest.

Send for our Free Booklet and Demonstration Lesson

Thousands of successful students never dreamed they possessed musical ability until it was revealed to them by a remarkable "Musical Ability Test" which we send entirely without cost with our interesting free booklet and Demonstration Lesson.

Right now we are making a Special offer for a limited number of new students. Sign and send the convenient coupon now—before it's too late. Instruments supplied when needed, cash or credit. U. S. School of Music, 712 Brunswick Bldg., N. Y. C.

U. S. School of Music, 712 Brunswick Bldg., New York City.

Please send me your free book, "Music Lessons in Your Own Home," with introduction by Dr. Frank Crane, Demonstration Lesson and particulars of your Special Offer. I am interested in the following course:

Have you Instrument?.....

Name.....
(Please write plainly)

Address.....

City.....State.....

PICK YOUR INSTRUMENT

- | | |
|------------------|---------------|
| Piano | Clarinet |
| Organ | Flute |
| Violin | 'Cello |
| Drums | Harmony |
| and | and Com- |
| Traps | position |
| Banjo, | Sight Singing |
| Tenor, | Ukulele |
| Plectrum | Harp |
| or 5-String | Cornet |
| Mandolin | Piccolo |
| Saxophone | Guitar |
| Hawaiian | Trombone |
| Steel | |
| Guitar | |
| Voice and Speech | Cul- |
| ture | ture |
| Automatic Finger | Con- |
| Control | trol |
| Piano | Accordion |

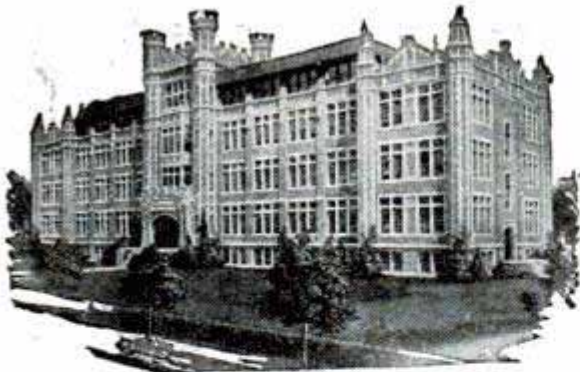

Go to High School at Home

You can secure a high school education right at home by studying the splendid new courses recently prepared by the International Correspondence Schools.

These courses are equivalent to the courses given in resident high schools. They have been specially arranged for men and women who wish to meet college entrance examinations, to qualify for a business position, or to make up the education they missed when forced to leave school too soon.

The College Preparatory Course, the High School Commercial Course and the High School English Course include English, algebra, ancient, medieval, modern and U. S. History, history, physiology, literature, geography, Latin, bookkeeping, drawing, geometry, shorthand, physics, chemistry, salesmanship, advertising, civics, trigonometry, economics, American business law, corporation finance, money and banking, business and trade economics, etc. A diploma is given at graduation.

The lessons are easy to understand and you will make rapid progress because you will be *in a class by yourself* and you will study under the guidance of instructors who are sincerely interested in helping you to get ahead and achieve the bigger things of life.

Just mark and mail the coupon and we will gladly send you interesting free booklets describing the High School Courses of the International Correspondence Schools or any other subject in which you are interested.

INTERNATIONAL CORRESPONDENCE SCHOOLS Box 5619-E, Scranton, Penna.

Without cost or obligation, please tell me how I can qualify for the position or in the subject before which I have marked an X:

- College Preparatory Course
- High School Commercial Course
- High School English Course
- High School Vocational Course
- High School Agricultural Course

- | | |
|--|---|
| <input type="checkbox"/> Business Management | <input type="checkbox"/> Salesmanship |
| <input type="checkbox"/> Industrial Management | <input type="checkbox"/> Advertising |
| <input type="checkbox"/> Traffic Management | <input type="checkbox"/> Better Letters |
| <input type="checkbox"/> Business Law | <input type="checkbox"/> Show Card Lettering |
| <input type="checkbox"/> Banking and Banking Law | <input type="checkbox"/> Stenography and Typing |
| <input type="checkbox"/> Accountancy (Including C.P.A.) | <input type="checkbox"/> Business English |
| <input type="checkbox"/> Nicholson Cost Accounting | <input type="checkbox"/> Civil Service |
| <input type="checkbox"/> Bookkeeping | <input type="checkbox"/> Railway Mail Clerk |
| <input type="checkbox"/> Private Secretary | <input type="checkbox"/> Common School Subjects |
| <input type="checkbox"/> Spanish <input type="checkbox"/> French | <input type="checkbox"/> Illustrating <input type="checkbox"/> Cartooning |

TECHNICAL AND INDUSTRIAL COURSES

- | | |
|---|--|
| <input type="checkbox"/> Electrical Engineering | <input type="checkbox"/> Architect |
| <input type="checkbox"/> Electric Lighting | <input type="checkbox"/> Architects' Blueprints |
| <input type="checkbox"/> Mechanical Engineer | <input type="checkbox"/> Contractor and Builder |
| <input type="checkbox"/> Mechanical Draftsman | <input type="checkbox"/> Architectural Draftsman |
| <input type="checkbox"/> Machine Shop Practice | <input type="checkbox"/> Concrete Builder |
| <input type="checkbox"/> Railroad Positions | <input type="checkbox"/> Structural Engineer |
| <input type="checkbox"/> Gas Engine Operating | <input type="checkbox"/> Chemistry <input type="checkbox"/> Pharmacy |
| <input type="checkbox"/> Civil Engineer | <input type="checkbox"/> Automobile Work |
| <input type="checkbox"/> Surveying and Mapping | <input type="checkbox"/> Airplane Engines |
| <input type="checkbox"/> Metallurgy | <input type="checkbox"/> Navigation |
| <input type="checkbox"/> Steam Engineering | <input type="checkbox"/> Agriculture and Poultry |
| <input type="checkbox"/> Radio | <input type="checkbox"/> Mathematics |

Name.....
 Street Address.....
 City..... State.....

**QUIT WISHING
AND WAITING
EARN**

\$3500 to \$5000 a Yr.

DOING MECHANICAL WORK FOR DENTISTS

Three Months' Training Will Qualify You for Success

Hundreds More Dental Mechanics Needed Now and Demand Is Increasing

YOU LEARN BY DOING

We train each student individually—no classes whatever—using the tools of the trade and you learn on regular dental work. But we do not make the **serious mistake of depending on practical work alone.** You are given definite theoretical training as well.

FREE R. R. FARE—OTHER ASSISTANCE

Besides providing the best of training at the lowest possible cost and refunding the student's R. R. fare to our nearest school, we secure jobs for those who need to earn while learning. Free Tools and Materials, Easy Terms. For full information just write today for Free Bulletin No. 2.

BODEE DENTAL INSTITUTE

Established over 30 years

New York	Philadelphia
1755 Broadway	1305 N. Broad St.
Buffalo	Brooklyn
501 Washington St.	85 Court St.

STATEMENT OF THE OWNERSHIP, MANAGEMENT, CIRCULATION, ETC., REQUIRED BY THE ACT OF CONGRESS OF AUGUST 24, 1912, of Popular Mechanics Magazine, published monthly at Chicago, Ill., for October 1st, 1926. State of Illinois, County of Cook, ss.

Before me, a notary public in and for the state and county aforesaid, personally appeared H. H. Windsor, Jr., who, having been duly sworn according to law, deposes and says that he is the editor and business manager of the Popular Mechanics Magazine and that the following is, to the best of his knowledge and belief, a true statement of the ownership, management, etc., of the aforesaid publication for the date shown in the above caption, required by the Act of August 24, 1912, embodied in section 411, Postal Laws and Regulations, printed on the reverse of this form, to wit: First. That the names and addresses of the publisher, editor, managing editor, and business manager are: Publisher, Popular Mechanics Co., 200 East Ontario St., Chicago, Ill. Editor, H. H. Windsor, Jr., 200 East Ontario St., Chicago, Ill. Managing Editor, L. K. Weber, 200 East Ontario St., Chicago, Ill. Business Manager, H. H. Windsor, Jr., 200 East Ontario St., Chicago, Ill. Second. That the owner is: (If owned by a corporation, its name and address must be stated and also immediately thereunder the names and addresses of stockholders owning or holding one per cent or more of total amount of stock. If not owned by a corporation, the names and addresses of the individual owners must be given. If owned by a firm, company, or other unincorporated concern, its name and address, as well as those of each individual member, must be given.) L. B. Windsor, 200 East Ontario St., Chicago, Ill.; H. H. Windsor, Jr., 200 East Ontario St., Chicago, Ill.; Lina B. Windsor and Henry H. Windsor, Jr., Executors of the Estate of Henry H. Windsor, deceased, Chicago, Ill. Third. That the known bondholders, mortgages, and other security holders owning or holding 1 per cent or more of total amount of bonds, mortgages, or other securities are: (If there are none, so state.) None. Fourth. That the two paragraphs next above, giving the names of the owners, stockholders, and security holders, if any, contain not only the list of stockholders and security holders as they appear upon the books of the company but also, in cases where the stockholder or security holder appears upon the books of the company as trustee or in any other fiduciary relation, the name of the person or corporation for whom such trustee is acting, is given; also that the said two paragraphs contain statements embracing affiant's full knowledge and belief as to the circumstances and conditions under which stockholders and security holders who do not appear upon the books of the company as trustees, hold stock and securities in a capacity other than that of a bona fide owner; and this affiant has no reason to believe that any other person, association, or corporation has any interest direct or indirect in the said stock, bonds, or other securities than as so stated by him. H. H. WINDSOR, Jr., Editor and Business Manager. Sworn to and subscribed before me this 29th day of September, 1926. J. GRAHAM, Notary Public. (My commission expires June 17, 1928.)

DON'T STAMMER

Quick, easy, complete cure guaranteed. Information, diagnosis, phonograph record and catalog free. America's foremost school. Est. 1894. Act before it is too late.
153 Stinson The LEWIS INSTITUTE Detroit, Mich.

BE AN ARTIST

WE CAN TEACH YOU DRAWING in your own home during your spare time. Twenty-five years of successful teaching proves our ability. Artists receive large salaries.

Write Today for Art Year Book

SCHOOL OF APPLIED ART
ROOM NO. 2 BATTLE CREEK MICH.

They Gave Me the Ha-Ha! When I Asked for a Dance

*—but When I Stepped
on the Dance Floor—*

By Fred Kennedy

HOW the boys laughed! Ha! ha! ha!
They had just seen me ask Mabel for a dance.
They stared—amazed at what they considered
“my nerve.”

“Why, Fred can't dance, can he?” I heard one of them
whisper excitedly.

“No; he never danced a step in his life!” came the reply.

Even Mabel, the girl I had
asked to dance, looked at me
rather questioningly. “You
really know how to dance, don't
you?” she asked.

Just then the music started.
For answer I tightened my arm
around her and swept her out on
the dance floor in a graceful waltz.

An instant change came over
my friends' faces. I heard gasps
of astonishment. “Look at Fred
dance!” “Where did he learn?”

I kept on dancing—did all the
latest steps—glided through all
the newest figures. The music—
the soft lights—my lovely partner
—all seemed to intoxicate me,
seemed to thrill me. I danced as
I had never danced before!

A Complete Triumph

When the music stopped, my
friends all congratulated me.
“Fred, you're a wonder,” they declared. “Where
did you learn to dance like that?” “You dance like
a professional!”

I told them—told them about Arthur Murray,
America's foremost dancing instructor—told how I
had taken his famous course in dancing.

“But isn't that course terribly expensive, Fred?”
some one questioned. “Arthur Murray teaches so
many of those high society people.”

“Not expensive at all,” I replied. “I didn't take
personal lessons. That isn't necessary. I took his
new Home Study course, which costs only a few
cents a day!”

Learn to Dance at Home

This story is typical and it shows you just the
chance you've been looking for—a chance to become
an accomplished dancer right in your own home at a
small cost.

No matter how poorly you dance now—no matter
if you've never been on a dance floor in your life—



If You Can Do This Step

Arthur Murray will make you a
finished dancer in 10 days

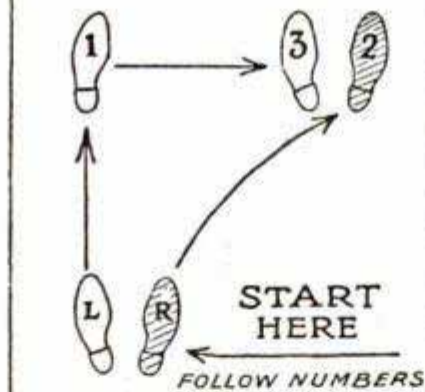

Arthur Murray's new method
makes you a finished dancer in ten
days or you don't have to pay a
penny for the lessons.

Just think! In ten days' time
you'll be able to do the Charle-
ton, the French Tango, the Ritz
Fox Trot, the Debutante Waltz,
and all the other smart new steps.

This method of learning dancing
is so simple and easy to understand
that you can do any of the latest
steps in one evening, right in your
own room, without music or part-
ner. And in ten days' time you

will be ready to take your place as the best dancer
in your set!

Five Lessons FREE

To prove that Arthur Murray can make you a fin-
ished dancer in ten days' time, he is willing to send
you five lessons from his remarkable course *absolutely
free!* Just send the coupon (with 10c to cover cost of
printing and mailing), and these valuable lessons will
be forwarded at once. Also a free copy of his new book, “The
Short Cut to Popularity.”

Don't wait—you owe it to yourself to clip and mail this
coupon NOW. Arthur Murray, Studio 677, 7 East 43d St., N.Y.

ARTHUR MURRAY, Studio 677,
7 East 43rd Street, New York City.

To prove that I can learn to dance at home in ten days
you may send the FIVE FREE LESSONS. I enclose 10c
(stamps or coin) to pay for the postage, printing, etc. You
are to include free, “The Short Cut to Popularity.”

Name.....

Address.....

City.....State.....

OWN an Auto Repair Shop



ALL YOU NEED Is a FEW TOOLS and 8 Weeks' Training

Why not be your own employer? Why not get for yourself not merely a part of the money you earn, but all of it? McSweeney graduates who own their own garages all over the country are making big money. Thousands of splendid locations are

open everywhere. 20,000,000 car owners are clamoring for BETTER repair service—the kind of workmanship that only TRAINED Auto Mechanics can deliver.

Be Your Own Boss—Profits \$7500 to \$20000 Weekly

In every state new repair shops owned by McSweeney trained men are taking business away from old garages operated by men who don't know how—unskilled, half-baked mechanics. No other business offers such wonderful opportunities as this—the biggest industry of them all. Learn by my PRACTICAL training, by working with real tools on real equipment. No schooling required; no book study. No extras of any kind to pay for. My eight weeks' training includes everything.

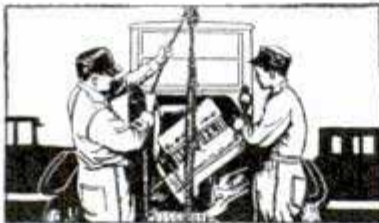

70,000 JOBS Open Yearly

for men who prefer to work for Big Wages instead of going into business for themselves. Earn from \$60 to \$125 a week and more. Thousands are doing it after finishing my training. Take advantage of my great Special Offer. I have taught thousands of auto mechanics; I can teach you.

YOUR R. R. FARE and 8 WEEKS' BOARD FREE

Don't miss this remarkable opportunity. Save one-third Now. Your money back if not perfectly satisfied. Send the coupon TODAY for my Short Time Reduced Price Tuition Offer and Big Book FREE.

McSWEENEY

AUTO, TRACTOR AND ELECTRICAL SHOPS
9th & Walnut Sts., Dept. LV-14 1815 East 24th St., CINCINNATI, OHIO Dept. LV-14 CLEVELAND, OHIO

Mail This Coupon to Either Address Above
Please send your Big Free Book and Special Offer.

Name.....

Address.....

City..... State.....

Old at 23

OLD AGE depends on OSSIFICATION or hardening of the arteries. An excess of starchy foods such as oats, wheat, rice, potatoes, etc., is one cause of the encrusting of the inner walls of blood vessels, producing malnutrition, **HIGH BLOOD PRESSURE**, homeliness, **OLD AGE** and **DEATH**.



DOMESTIC animals, horses, cattle, sheep, etc., eating grains (herbivora) are **SHORT** lived. **WILD** animals, eating mostly animal food (carnivora) are frequently **LONG** lived, (100 years).

Observe the deposits inside old water pipes and kettles. Similarly an excess of calcareous substances from starchy foods with earthy matter from water, clog the arteries.

Watch the people who consume large quantities of starchy foods, bread and water! They look **HOME-LY** and **prematurely old**, are **STIFF** and **AWKWARD** in their movements, and their skins are often rough and scurfy. Suitable animal food, fruit and vegetables produce an appearance of youthfulness, grace, and refinement in coarse-looking starch-eaters.

For quick proof try only **aged persons, who have exhausted their reserve power**. Send for statements of **ELDERLY** people who have experienced a wonderful change to youthful activity after only 10 days' trial of the new system of **UNDILUTED** waterfree nutrition.

The injurious effects of water, table salt, cereals, fat, butter, sugar, etc., are explained in our booklet; also the one common underlying cause of all disease.

Write us for particulars of Government Bulletins, describing experiments on convicts, hens, cows, etc. Deficient feeding produced disease, whereas **FULL NUTRITION** corrected e. g., paralysis, blindness in hens, rats, etc.; beriberi, skin affections, etc., in men.

From sworn statements:—**PARALYSIS**. Age 61. Right hand and leg helpless three years, restored in three weeks. **ARTHRITIS**. All joints swollen from lime deposits. Knees and wrists locked immovable for eight months. Blind for two years. Can now see, walk, do home work. **CATARH**, hay fever, and asthma, improved from the first meal. **GALLSTONES**. Age 80. Cholic every week for years, but not one attack since instruction over four years ago. **TUMORS**. Age 40. Dissolved within a year. **GOITRE**. Collar reduced 17 to 15 inches normal size. **UTERINE HEMORRHAGE**. Age 60. Bedridden three years. Now does housework. **ECZEMA**. Age 69. Skin cracked, scaling, normal in three months. **PYORRHEA**. See Reprint from "Dental Digest." **PREGNANCY**. Age 30. No nausea, no swollen feet nor constipation, delivery painless. **Waterfree Meals**. Educational Booklet 10c. **BRINKLER SCHOOL OF EATING**, Dept. 42-M, 136 West 72nd St., New York.

MEN WANTED TO LEARN

Motion Picture Projection

\$2,000 to \$4,000 a Year

Quickly learned. Short hours, big pay. Best equipped school in Michigan. Projectionists for Movie Houses and Road Shows.

MOVIE OPERATORS SCHOOL

61 Sproat Street,

DETROIT, MICHIGAN

YOU CAN OIL PAINT

Amazing new method teaches men or women to earn after first lesson. OIL PAINT photos — portraits, landscapes or art subjects. Earn \$18 to \$30 and more a week. OIL PAINT OUTFIT GIVEN. Send now for free illustrated book. PICTORIAL ART STUDIOS, Inc., Dept. MP, 2731 No. Clark St., Chicago

ADDING MACHINE

Fits Vest Pocket

SEND NO MONEY

A marvelous calculator. Does the work accurately and quickly as a \$300 machine. Invaluable to anyone who uses figures. Don't carry pad and pencil. This startling invention will solve all problems in a minute. Business men, students, professional people, all need this **HANDY HELPER**.

Don't send money, just name and address. Pay postman only \$2.95 plus few cents postage. Try it for 10 days. Your money back if not satisfied.



Counts To 1 Billion

Results in plain sight **PRICE** all the time -- clears instantly. Made of steel and brass, in handsome case, fits vest pocket; weight only 3 oz. Send for yours now -- you'll save time and money.

\$2.95

Reliable Adding Machine Corp., Dept. 49
184 W. Washington St., Chicago, Ill.

AGENTS

Here's a dandy chance to make money. Everybody wants one. Fine profit. Write for new offer.

3 ELECTRICAL LESSONS actually FREE!



to prove this home-training will prepare you for a good job and a raise in pay!

Get these three lessons. Look them over. Test your own ability to master Electricity at home in spare time. See for yourself how every fact has been simplified. See what thousands of men have paid millions of dollars for, to help them earn **BIGGER PAY**. Uncover some of the mysteries of Electricity, and see why millions of men are so fascinated by it. Don't send a penny, don't enroll—just mail the coupon.

Go Into ELECTRICITY!

Thousands of jobs open at \$60 to \$125 a week. My training prepares you to fill them. Superintendents of Power Plants Wanted. Chief Electricians Wanted. Electrical Experts Wanted in Radio, Electrical factories, Auto Plants, Telephone and Telegraph Systems, etc.

Training Built by 23 Noted Engineers

This is not a one-man, one-idea school. 22 famous Engineers and Executives of the following corporations and universities helped me make Dunlap-training complete and up-to-date.

1. General Electric Co.
 2. Commonwealth Edison
 3. Crockey-Wheeler Co.
 4. Cutler-Hammer
 5. American Tel. & Tel. Co.
 6. Westingh. El. & Mfg. Co.
 7. Western Electric Co.
 8. Underwriters Lab., Inc.
 9. Columbia University
 10. Dartmouth College
 11. Massachusetts Inst.
 12. Lehigh University
 13. University of Vermont
- AND MANY OTHERS

I Will make this Contract with You!

Read it. This million dollar institution stands back of this agreement to **PREPARE** you to fill a well-paid Electrical Job, and then to help you **FIND** the job—or to refund the small amount charged for your training!

7 Costly Electrical Outfits Given!

I send you absolutely without extra cost, as a part of this training, 7 costly outfits of standard size tools and materials, so you learn Electricity **BY DOING** actual Electrical jobs. One of these outfits is a \$10 Electric Motor—a real motor and generator, the same type as the big fellows in a power plant. I send it to you "knockdown" and have you wind the field and armature and assemble it. *That's the way I teach every branch of Electricity!* House-wiring, Electric Light, Radio, and Motor outfits included.

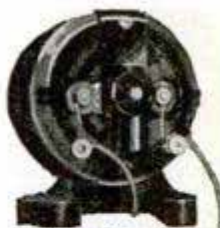

\$10 Motor Given



AMERICAN SCHOOL
—the Million Dollar Educational Institution



When you enroll for my home-training in **ELECTRICITY** I agree to give you:

1. Complete training, including Electrical Engineering, Ignition; Radio, etc.
2. Seven outfits of standard tools and materials, including a \$10 motor.
3. I WILL HELP YOU GET A GOOD JOB AND A RAISE IN PAY.
4. —or I will refund every cent of your money.

AMERICAN SCHOOL
By Chief Engineer Dunlap

Free Job Service!

for **STUDENTS** and **GRADUATES**. This **JOB SERVICE** keeps in touch with great Electrical employers all over America. The day you enroll, this Job-Service Department registers you, finds out what kind of job you want, where you want to work, etc. And when you apply for the job you want, we back you with our recommendation and help you make good in it after you get it.

WRITE Me Immediately!

If you have reached the point where you realize **YOU MUST** train and specialize to get anywhere, *write me immediately!* I will show you the wonderful opportunities, the enormous salaries, the many openings waiting in this billion dollar industry. I'll tell you about the most sensational combination **TRAINING-AND-JOB** offer ever made, which is practically a guarantee of your success. Mail coupon and get 3 Free Electrical Lessons and complete information.

CHIEF ENGINEER DUNLAP, Electrical Division

AMERICAN SCHOOL Drexel Avenue and 58th Street
Dept. E-974 CHICAGO

3 Electrical Lessons actually FREE

Chief Engineer Dunlap, Electrical Division
AMERICAN SCHOOL
Drexel Avenue & 58th Street, Dept. E-974 CHICAGO

Send me your combination **TRAINING-AND-JOB** offer, 3 Free Electrical lessons, facts about opportunities in Electricity, etc.

Name

St. No.

City.....State.....

DO YOU LIKE TO DRAW?

HAVE you a liking for drawing, for sketching people and scenery and putting your thoughts upon paper? Would you like to turn your talent for drawing into money? It is a fascinating and immensely profitable hobby to be able to sketch quickly and easily the people you see about you, pretty scenery, trees and old houses.

DID YOU EVER THINK what a pleasant and profitable profession is open before anyone with a talent for drawing? Commercial Artists and Illustrators make big incomes, the work is extremely interesting and enjoyable and is exceptionally well paid. Many artists engaged in this work make from \$5,000 to \$10,000 a year and more drawing for newspapers and advertisers. Huge prices are paid for Illustrations, Cartoons and Designs for Advertisements and Posters. Editors, publishers and advertisers are always looking for new and interesting drawings and are willing to pay good prices for them.

OPPORTUNITIES ABOUND in this wonderful profession for anyone who has a liking for drawing. No profession offers such opportunities today as does Commercial Art and Illustrating. The tremendous increase in advertising and illustrated publications has created such a demand for competent artists that the field of commercial art and illustrating is a real gold mine for the man or woman who likes to draw.

LEARN AT HOME There is no need for you to leave your home in order to study this delightful and absorbingly interesting art. You can study anywhere under our resultful system of correspondence instruction with which you have the help and guidance of artists high in their profession.

If you are FIFTEEN years of age or over

Copy this Sketch

→
and send it to us for
Free Criticism

and let us judge for you whether you have a talent for Drawing. The criticism is entirely free to persons FIFTEEN years of age and over. Age must be stated on your sketch. No sketches will be accepted from anybody under FIFTEEN years.

2 ILLUSTRATED BOOKS

FREE

Let us also send you an actual Specimen Lesson Book, Number from our Course of Instruction as supplied to regular students.

Twenty-five of Instruction to regular students.

This Lesson Book is en-

titled "How I Do My Work" and has been written and illustrated by eight prominent artists. Each artist explains in simple language the working methods which he uses in his own studio. This Book contains forty illustrations of which fourteen are in color.

"Drawing for Pleasure and Profit" is another book which we will send you free. It is an unusual publication of real value to anyone with a liking for Drawing and gives you hundreds of very interesting facts about Illustrating, Commercial Art and Cartooning. We will send you these two books absolutely FREE when returning your sketch.

THE NORTH AMERICAN SCHOOL OF DRAWING

(Incorporated)

517 Curtiss Bldg. Buffalo, N. Y.

2 BOOKS FREE





TRAVEL ON "UNCLE SAM'S" PAY ROLL

RAILWAY POSTAL CLERKS \$158 Month First Year Raise to \$225 Month

Many other U. S. Government Jobs Open to Men and Boys 18 up

Post Office Clerks
Rural Mail Carriers

City Mail Carriers
Clerks Customs and Internal Revenue Service

These are steady positions. Strikes, poor business conditions, lockouts or politics do not affect them. U. S. Government employees get their pay for full twelve months every year. There is no such thing as "HARD TIMES" in the U. S. Government Service.

ALLOWANCE FOR HOTEL EXPENSES

Railway Postal Clerks now get \$1900 the first year, being paid on the first and fifteenth of each month. \$79.16 each pay day. Their pay is increased \$100 and \$150 a year. The maximum is \$2700 a year. \$112.50 each pay day. They get extra allowance for hotel expenses when away from home.

PAID VACATIONS

Railway Postal Clerks, like all Government employees, are given a yearly vacation of 15 working days (about 18 days). When on runs they usually work 3 days and have 3 days off duty or in the same proportion. During this off duty and vacation, their pay continues just as though they were working. When they grow old, they are retired with a pension. As Railway Postal Clerks are continually traveling, they have an excellent chance to see the country. They are furnished with a railroad pass.

City Mail Carriers—Post Office Clerks

Clerks and Carriers get \$1700 the first year on regular and automatically increase \$100 a year to \$2100 with further increase to \$2300. They also have 15 days vacation. Examinations are frequently held in the larger cities. City residence is unnecessary.

What Will You Earn 5 Years from Now?

Compare these conditions with your present or your prospective condition, perhaps changing positions frequently, kicking around from post to pillar, no chance in sight for PERMANENT employment; frequently out of a position and the year's average salary very low. DO YOU EARN \$1900 EVERY YEAR? HAVE YOU ANY ASSURANCE THAT A FEW YEARS FROM NOW YOU WILL GET \$2700 OR MORE A YEAR, EVERY YEAR?



Get Free List of Positions

Fill out the coupon. Tear it off and mail it today—now, at once. DO IT NOW—This investment of two cents for a postage stamp may result in you getting a U. S. Government Job.

FRANKLIN INSTITUTE,
Dept. D-174,
ROCHESTER,
N. Y.

Rush to me entirely free of charge 32 page book with (1) a full description of the position checked below; (2) Specimen coaching; (3) a list of U. S. Government Jobs now obtainable.

- Railway Postal Clerk (\$1900-\$2700)
- Post Office Clerk (\$1700-\$2300)
- City Mail Carrier (\$1700-\$2100)
- Rural Mail Carrier (\$2100-\$3300)
- Clerk in Government Offices . (\$1140-\$1860)
- Bookkeeper (\$1320-\$2040)

Name

Address

Use This Coupon Before You Mislaid It—Write or Print Plainly

MAIL COUPON TODAY



Earned Over \$200 While Studying Cartooning

Many of our graduates are now winning satisfying financial rewards in the fascinating field of Cartooning. Even some of our students sell some of their work before finishing the Course. Here's proof! Read this enthusiastic letter:

"I have made more than \$200 making advertisements of all kinds while studying the course under the guidance of the Washington School. But what I admire more is the scientific methods used by the school directors. Such methods develop skill and talent in the artist in such a wonderful way that I daresay there is not in America any better school of Cartooning." *H. P., San Lorenzo, Porto Rico.*

You Can Learn Cartooning At Home

It's easy to learn Cartooning! Through our amazingly simple method, you, too—without any apparent talent at all—can easily learn to draw comics that sell—and quickly prepare yourself for this pleasant, big-pay profession! Personal instruction from capable and experienced instructors. Study where you please and whenever you please. Lessons are easy to master. And in almost no time you should be making good money drawing salable cartoons!

Mail Coupon for Free Book

Learn more about the wonderful money-making opportunities in cartooning, and how this method makes it easy for you to learn. Read about our students—their success—what they say—how easy it was—actual reproductions of their work—how they made big money while studying. Booklet entirely free. Send for it NOW. Washington School of Cartooning, Room 3012-D, 1113-15th St., N. W., Washington, D. C.

Washington School of Cartooning,
Room 3012-D, 1113-15th St., N. W.,
Washington, D. C.

Please send me without obligation, your illustrated FREE BOOKLET on Cartooning.

Name.....
(State whether Mr., Miss or Mrs.)

Address.....

City.....State.....

If under 16 years, please state age.....

BIG POULTRY BOOK and New POULTRY BULLETIN FREE



Worth Hundreds of Dollars. Shows how Big Men in Poultry Grew Rich—How Many Started Small, Now Worth Thousands. You can do same if you follow methods outlined in FREE BOOK. Now is the time to make money with poultry. FREE BOOK and New Bulletin tells what to do each month. Mention variety of poultry you like. Write today without fail. AMERICAN POULTRY SCHOOL, Dept. 70, KANSAS CITY, MO.



Every Boy His Own Toymaker

Greatest boys' book ever written. Tells how to make a Steam Engine, Telephone, Magic Lantern, Boats, Kites, Balloons, electrical and mechanical toys, traps, fishing tackle, sleds, stunts, diving board, Bird Houses, etc. Fully illustrated 10c, 200 kinds. Iron, Wood and Wire Puzzles. Sample leader and Catalog 10c. WESTERN PUZZLE WORKS, SAINT PAUL, MINNESOTA.

MAKE MUCH MONEY Making and Selling Your Own Goods, Formulas by experts. Manufacturing Processes. Trade-Secrets. All lines. All kinds. Catalog, special circulars free. **W. THAXLY COMPANY, Washington, D. C.**

No Better Christmas Present for \$2.50

than a year's subscription to

Popular Mechanics Magazine Containing 4500 Pictures and 3600 Articles

Much of it Interests Everybody

Most of it Interests Anybody

All of it Interests Somebody

Order through your Newsdealer or address the Publisher

POPULAR MECHANICS COMPANY

200 East Ontario Street, CHICAGO, ILL.

Easy now to get your **STEAM ENGINEER'S (OR ELECTRICIAN'S) LICENSE!**

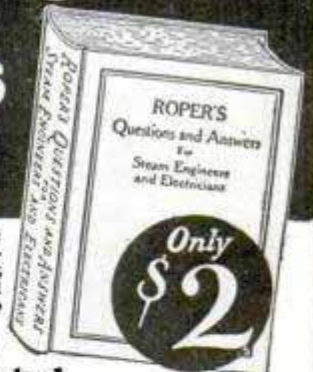

"Roper's Questions and Answers for Steam Engineers and Electricians" is a big help to the man about to qualify as steam or electrical engineer. Just revised and up to the minute. The standard work.

This book answers all questions likely to be asked

Fully covers scope of questions given by boards in stationary and marine examinations. Special sections on Diesel engine, new boiler and engine room devices, and electrical apparatus.

Sent on 5 DAYS' APPROVAL—Send no Money Over 350 pages concise information. Handy pocket size volume, in black leatherette. Pay postman only \$2.00, plus few cents postage. Money refunded if you return within 5 days.

CATALOG of Mechanical and Engineering Books FREE

All standard works on Machine Design, Mechanical Drafting, Auto Mechanics, Painting, Paper Hanging, Wood Finishing, etc. Send for it now.

DAVID McKAY CO., Pub., Dept. 212, 604 S. Washington Sq. Philadelphia, Pa.

DAVID McKAY COMPANY, Pub., Dept. 212, 604 S. Washington Sq., Philadelphia, Pa.

Send me "Roper's Questions and Answers" with your free catalog. I will pay postman \$2.00 plus postage. You to refund if I return book in 5 days.

Check here if you wish catalog only.

Name.....
Address.....
City.....State.....

A FRANTIC CALL FOR MEN WHO CAN READ BLUE PRINTS

OF BUILDINGS

Leads Quickly to Jobs Paying \$4,000 to \$12,000 a Year

See how easy it is to get in the building game. Nowhere else does such simple training count for so much. Nowhere else can a man make \$4,000 to \$12,000 a year so quickly and so easily. Nowhere else are there so many countless thousands of openings as there are with contractors, builders, and real estate firms, who are constantly calling for men who can read blue prints. Six billion dollars a year is spent for building. Trained men are at a premium in this gigantic industry. Untold thousands are needed at steady salaries far above the scale wage.

90 DAYS EASY TRAINING PUTS YOU IN THE 6 BILLION DOLLAR BUILDING FIELD

NO longer is it necessary to start at the bottom of the building trades and spend years to work up. Now you can get three years' training in three months. There are no barriers to your success in the great outdoor building field. You do not need more than a common school education. We train you at home, in spare time, by the fascinating blue-print method with lessons that are as easy to read as your newspaper.

These tested plans come to you from one of the oldest and largest schools of building construction and superintendence in the country. This course is endorsed by leading contractors and master builders. These tested, practical plans and lessons are the kind of training that puts men in \$5,000 to \$15,000 jobs and in profitable building and contracting businesses of their own. You learn from actual blue print plans—from practical building experts—you learn how to read all the plans, estimate the costs and supervise the entire construction of a building—you learn everything a contractor has to know when he undertakes the construction of a building.

Amazing opportunities are open to you when you know blue prints, plans, estimating and construction. There is building superintending—the best outdoor profession on earth—that pays handsome salaries and often a bonus for efficient work. Clifford Scholl went from clerk to Ass't. Superintendent at 49% increase in salary in 8 months. Thousands of builders and contractors need men like Clifford Scholl.

IF YOU LIVE IN OR NEAR CHICAGO

Visit our School for Builders, open day or evening. Thousand men attend each year. Enter any time. You can get the same training at home, by mail. Same plans; same lessons; same instructors. The Coupon brings all facts Free.

Every Job Must Have A Contractor

The building field is wide open for men who want to go into business for themselves. Henry Mehl, Pa., a policeman, now owns his own contracting business. Burgert, Ill., stepped into a foremanship at 200% increase in salary. Busch, Kan., writes, "I have been offered \$300 a month several times." Boyes, Can., writes, "Your school has increased my wages 40% already." Patrick, Mich., says: "My salary has been increased 92%." Marchand, La., writes, "I am getting along fine. My salary is now increased 196%."

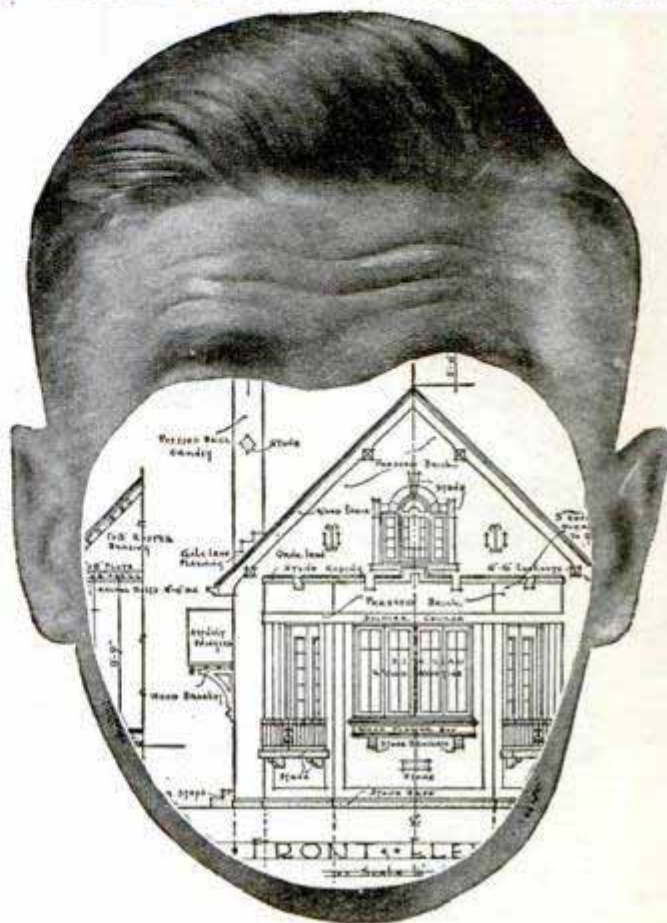

If you really want more money—if you hope to own a business of your own—get into the building business . . . no matter what your job is now. No overcrowding in this tremendous field—room for thousands every day. Why buck competition in crowded industries where only a few men can succeed?

Clerk or carpenter—office man or bricklayer—salesman or superintendent—it makes no difference. You can get into the building business quickly . . . easily. Or if you are in it at present, get this training now, that you must have for success.

FREE Trial Lesson

Simply mail the coupon below for an intensely interesting free book "How to Read Blue Prints," and full information. See what fascinating fun this first trial lesson is. Get these facts before you. See what amazing opportunities open up for you in the Six Billion Dollar Building Field. Don't wait or delay. Act now. Simply mail the coupon below.

Chicago Technical School for Builders

Dept. W-10, Chicago Tech Bldg.,
118 E. 26th St., Chicago



Chicago Technical School for Builders,
Dept. W-10, 118 E. 26th Street, Chicago, Ill.

Send me, without obligation, your free book, "How to Read Blue Prints" and full details of the course and the opportunities in the Building Field. It is understood that no salesman will call on me.

Name.....

Address.....

City..... State.....

Age..... Occupation.....

DETROIT

Is the Logical Place to Learn ^{the} Automobile Business

You want to earn more money. You want to fit yourself for a better job or a business of your own. The automobile business is your opportunity. **Thousands** of trained men are needed **right now**. Come to Detroit now and learn this business right. Then go out, a trained man. **Earn Big Money.**

Three-quarters of all the cars are made right here. Study autos where they are made. Learn at the "Old Reliable" **Michigan State**—endorsed by the auto makers. They approve our courses of training because they are complete and because our instructors are experts. We know how to **train you right**, and that is what you want.

Learn in a Few Weeks—START NOW!

Without any previous experience—just a liking for mechanics—you can learn the automobile business in a few short weeks here at the "Michigan State." Take a full Automotive Course in 12 weeks. Or our great **Master Course** in 30 weeks. Or specialize in any one of its money-making branches; you can be an Auto Electrician; a Tire Expert; a Battery Service Man; a Repair Man; a Welder; a Machinist. Course includes training in Garage Management, Business Methods and Selling. Classes always open. You need make no special arrangements—start at once—now. The cost is low and terms easy. Any man, anywhere, can afford it.

Earn While You Learn

If necessary we can assist students to secure part time work to earn money each week. Or students who wish to take our evening course will be assisted to full time day jobs. Ask for details, and when writing please explain your circumstances fully.

We Help to Get Jobs

"Michigan State" trained men are wanted, in Detroit, in your home town, in garages throughout the country. We place many of our graduates directly. This Employment Service is absolutely free. L. T. Middlebrooks (Cal.) writes: "Getting the best pay I ever received and all credit to the M. S. A. S."

Work on These Great Cars—Some of the NEW Chassis Recently Received

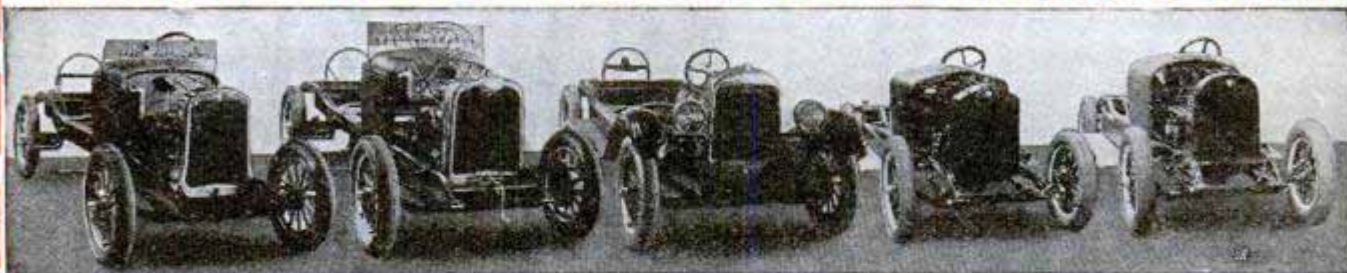

Oldsmobile

Oakland

Jewett

Essex

Hudson

The chassis in this picture are the latest models, just received. Our location in Detroit, the Automobile Center of the World, and our reputation for giving Quality Training only, brings us the close co-operation and endorsement of the

automobile manufacturers. This means much to you. You always find the latest and most up-to-date equipment at the "Old Reliable" Michigan State. Our equipment is continually being improved and is now better than ever.

100,000 Trained Men Needed Now

Where can you find such an opportunity as this? The Auto Business has grown to be the biggest business in the world. Its volume is more than steel or railroad industries. A hundred thousand more trained men are needed. The field is getting bigger all the time. Green men can't draw the good pay. But trained men can. E. J. Asbury (W. Va.) says, "I am clearing \$50 a week just at home. Haven't even got a shop yet."

QUALITY TRAINING ONLY

Note that we don't promise to put you on top of the world in a few weeks. We know the **great need** for skilled men, and the wonderful future ahead of you if you get started now. But we know it takes work. It takes real knowledge. And that we can give you. Then start in a good job and advance to big money. Auto knowledge means steady work, wherever you want to go, at good pay, and a certain future. **Send the coupon for Big New Book and find out for yourself.**

MICHIGAN STATE
312 Auto Bldg. Detroit, Michigan

Learn Autos Where Autos Are Made

The AUTOMOBILE CENTER

Learn at the School

Endorsed by ^{the} Manufacturers

The auto makers are the best judges of an auto school. They know how training should be given. They know the "Michigan State" training is right. That is why they endorse this school. The auto makers helped outline our courses, they furnish us equipment, they employ our graduates. When they say you will make no mistake in coming to the "Michigan State" their advice is worth a lot to you.

Detroit Trained Men Earn More Money

Detroit trained men get preference every time and get jobs quickly. Customers will go miles out of their way to take their jobs to a Detroit trained man. It brings you business, jobs, success, highest pay. The "Michigan State" diploma is a valuable money-making asset.

Get Into the Auto Business NOW!

Be a skilled repair man. There are over 20,000,000 cars in the U. S. A. alone. What a chance for the trained man! Car owners search for reliable repair shops. Garage owners advertise for competent mechanics. They don't want green men. But the skilled auto man always has a job.

More good garages, battery shops, tire shops, welding shops and electric service stations are needed. Open a shop any place, right at home where your friends are; or in some other town or at country cross-roads. **Make Big Money.**

Home Study Course

For those who cannot come to Detroit for their training, we have a special Home Study Course. This course covers the same subjects in detail as our Residence Course. You get the same practical training with the exception of the actual work on the cars. The knowledge you gain in the first week or two in the Home Study Course should enable you to get a job in a garage right away. This is your big opportunity. Don't delay. Under New Plan the Home Study Course is FREE to students who later take the Residence Course. Say which course you prefer.

Business Management

The former Packard service manager trains our students in the business end of running a garage. This training is worth \$100 alone, but it costs you nothing extra. Another one of the big advantages of Michigan State training. All students get this Business Course without extra charge.

SEND COUPON NOW

Get all the interesting facts. Mail the coupon for Big FREE Catalog and information concerning your future that you must not fail to get. It's illustrated with photos of school equipment and factory production included in our weekly inspection trips, also hundreds of letters from our successful graduates. It tells you how you can get a good paying job—how you can go into business for yourself with little capital. Mail the coupon or send us a post-card today. Write now. (We do not enroll colored students, except for our Home Study Course.)

BIG BOOK FREE



Send for it Today

Mail Today!

Michigan State Automobile School, 312 Auto Building, Detroit, Michigan

Send me free and without obligation complete information about Detroit training to make the most money. Also send me FREE, your BIG NEW BOOK.

Name.....

Street or R.F.D.....

City..... State.....

I am interested in { 12 weeks' Auto Course
20 weeks' Master Course
Home Study Course

AUTOMOBILE SCHOOL
3729 Woodward Ave. Detroit, Mich.

The Automobile Center



\$250 For His First Story

Yet He Is Only One of Hundreds Now Being Trained for Success as Writers by New "Copy Desk" Method.

NO better evidence of the remarkable success of this new course in writing could be offered than the following letter from Porter Wylie, Jr. He says:

"I am an insurance man, not a writer, but I received \$250.00 for the first article I ever wrote. Your Course taught me really to see what I looked at. I know at last why Writing is the most fascinating calling in the world."

A Fascinating Career

Yet Mr. Wylie is only one of many who have already turned their training into cash as a direct result of their studies with the Newspaper Institute of America.



What so many others are doing—you can do. By devoting only your spare time—right in your own home—you can quickly master the fundamentals of profitable writing, and start to carve out a real career.

Your Writing Ability Tested—FREE

If you are ambitious, if you really want to write—you should mail the coupon at once for our FREE Writing Ability Test and information about the opportunities in the newspaper and magazine field. The test costs nothing and will place you under no obligation. So don't put it off. Mail the coupon NOW!

NEWSPAPER INSTITUTE OF AMERICA
Dept. 712, 25 West 45th St., New York City

Please send me your free Writing Ability Test and information on opportunities in writing.

Name.....
(Please state whether Mr., Mrs. or Miss)

Address.....

City..... State.....

Stop Making Mistakes in English

Wonderful new way to improve your English. No rules to learn. No hard study. Grammar, spelling, punctuation, and expression, taught in 15 minutes a day—at home. Self-correcting feature makes it fascinating as a game. Write today for Free Book "How to Speak and Write Masterly English." Address



SHERWIN CODY SCHOOL OF ENGLISH
512 Searle Building Rochester, N. Y.



Test Your Art Ability, FREE

Do you like to draw? Our simple scientific Art Ability Questionnaire will tell if your talent is worth developing and how much training you will need. Your true score given. Commercial artists make big money. Learn at home, in spare time, with the Federal course. Write today for your Questionnaire, giving age and occupation.

FEDERAL SCHOOL OF COMMERCIAL DESIGNING
623 Federal Schools Bldg. Minneapolis, Minn.

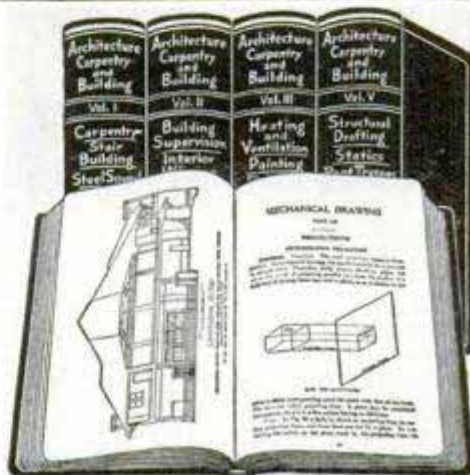

Brain Tools

For Architects, Draftsmen, Carpenters, Contractors, Builders and all who expect to build

Men who work with their hands know that headwork gets them more money.

Brain tools make the tools in your tool box at least twice as effective, and the best brain tools you can get are good books—not just any books, but books which tell you the things you want to know, and do it instantly. Carpenters make themselves contractors by learning how to estimate correctly. Contractors are able to handle bigger and more profitable jobs by learning how the big fellows do it, and architects and those who want to enter this highly paid profession earn more money by having facts and figures at their finger tips. This brand new set of five handsomely bound books covering all phases of architecture, carpentry and building, enables you to get authoritative, specialized information in a moment. No tedious long hours of reading—no hard grinding study, but instant reference to the vital facts. You don't waste a minute—the new jiffy index puts before your eyes, without wasted time, the things you want to know.

The most complete work of its kind we have ever published; nothing has been overlooked. Use of tools—building construction, heating, lighting, plumbing, architectural drawing, blueprint reading; in short the most comprehensive and easily understood work of its kind.

These Books Sent FREE

Yes, this is true. We ship them to you without a penny of down payment. When you get them, look them over carefully—note how easy it is to find what you want to know—test the index in any way you want to and then, if after 10 days you agree that you have at hand a veritable mine of invaluable information, send only \$2.00 and keep the books. After that send us only \$3.00 per month until the small total of \$24.80 is paid. For a short time we will include with each set a complete portfolio of the five basic orders of Architecture. These 58 beautifully illustrated plates are drawn to scale and carefully figured. Size of each 11x15 inches. You'll thank the day you sent for your set.

Learning Means Earning

and here you have at hand information gathered from hundreds of experts, all for so small a sum you'll never miss the money. Use these books as others have done and you'll get many times their price in a few months. One job alone may repay you several fold. Send for your set today.

FREE EXAMINATION COUPON

AMERICAN TECHNICAL SOCIETY
Dept. G-919, Chicago, Ill.

You may send me, entirely without obligation, this handsome set of 5 volumes—Architecture, Carpentry and Building. I am to have full ten days in which to look them over and decide if I want to keep them. After which I will either send them back or send \$2.00 down and \$3.00 per month until the special price of only \$24.80 has been paid. Please include FREE the portfolio of 58 handsome plates.

Name.....

City..... State.....

Reference.....

Don't Pay Me a Cent If I Can't Give You a *Magnetic Personality* -5 Days FREE Proof!



NO matter how lacking you are in qualities of leadership, no matter how colorless, timid, unsuccessful and discouraged you may be, I GUARANTEE to so magnetize your personality that your whole life will be completely transformed!

I can give you poise that banishes self-consciousness, charm that makes you irresistibly popular, personal power that will indelibly influence the minds of others and amaze your friends.

I'll make you a fascinating force in social life, a powerful, dynamic, commanding figure in your profession. You'll become more popular, more prosperous, more gloriously successful than you ever dreamed possible!

Let me send you the proof—absolutely free! If within 5 days you do not experience a decided change in your personality, if you do not find yourself making new friends with ease, if you do not discover yourself already on the way to social popularity, business success and personal leadership—just say so. Tell me my principle of personal magnetism can't do every single thing that I said it would do. And you won't owe me one penny!

What Is Personal Magnetism



What Is Sex Magnetism?

What is that magnetic, powerful influence that draws one man to one woman—forever, irresistibly? What is that strange never-failing spark that awakens love? What is it, in man or woman, that seems to draw and fascinate—the hypnotic power that no one can resist?

You have it. Everyone has it. *But do you use it?*

What is this marvelous force that raises the sick to glowing, vibrant health, the timid to a new confident personality, the unsuccessful to positions of wealth and astonishing power?

You have it—everyone has it—but *not one person in a thousand knows how to use it!* It is not a fad nor a theory. It is simply you, yourself—your manner—your own marvelous personal force, released and magnified a hundred fold in an amazingly clear-as-crystal, scientific way! More necessary than good looks. More valuable than money. For without it a salesman is handcuffed! Without it a business man is powerless to command! No actor, no teacher, no orator, no statesman can long hold his audience spellbound without this supremely influential magnetic force!

Personal magnetism! How easy to release it! How wonderful its results! No long study or inconvenience. Not the slightest self-denial. Just a simple, clear, age-old principle that taps the vast thought and power resources within you, releases the full sweep of your magnetic potentialities and makes you almost a new person from what you were before!

Personal Magnetism is not hypnotism. Hypnotism deadens. Magnetism awakens, inspires, uplifts. Personal Magnetism is not electricity. It is *like* electricity in one way—while you cannot see it, you can observe its startling effects. For the moment you release your Personal Magnetism you feel a new surge of power within you. You lose all fear. You gain complete self-confidence. You become almost overnight the confident, dominant, successful personality you were intended to be—so fascinating that people are drawn to you as irresistibly as steel is drawn to a magnet!

The Facts Are Free

The fundamental principles of Personal Magnetism have been put into an extra large volume under the title of "Instantaneous Personal Magnetism." It is bound in beautiful dark burgundy, with the title gold embossed. Its scope is as broad as life itself. "Fires of Magnetism," "Sex Influences," "The Magnetic Voice," "Physical Magnetism," "The Magnetic Eye," "Oriental Secrets," "Rapid Magnetic Advancement," "The Magnetic Mind," and "Magnetic Healing," are only a few of the subjects covered in this amazing book. A magnificent book that tells you just how to cultivate the magnetic influence of your nature.

You *can* sway and control others. You *can* command success. You *can* influence people to do the things you want them to do. Through this amazing book you gain the key to a magnetic personality in 5 days—or you don't pay one penny! That is my free offer to you.

Send Coupon Today

You must see this wonderful volume—examine it—let it influence indelibly your own personality. You send no money with the coupon—you pay no C. O. D. You get the book first. If you aren't stirred and delighted in the 5-day period, return it and it costs you nothing. Otherwise keep it as your own and remit \$3 in full payment. You are the sole judge. You do not pay unless you are absolutely delighted. And then only \$3.

You simply can't delay! Clip and mail the coupon NOW.

Ralston University Press, Dept. 13-W, Meriden, Conn.

RALSTON UNIVERSITY PRESS DEPT. 13-W, MERIDEN, CONN.

All right—I'll be the judge. You may send me the volume "Instantaneous Personal Magnetism" for 5 days' FREE EXAMINATION in my home. Within the 5 days I will either remit the special low price of only \$3.00 or return the book without cost or obligation.

Name

Address

City State

5 BIG REASONS WHY L.L. COOKE TRAINING Has Helped So Many Men Into Big Pay Jobs in Electricity



**What's
Your
Future?**

Do you want to make more money than you ever made before? Are you interested in getting into a **real** profession, with **real** opportunities and a **real** future? Then clip the coupon on the opposite page. Let Chief Engineer Cooke, world famous as "The Man Who Makes Big-Pay Men," tell you how he has doubled the pay of thousands of men. Get the facts about his amazing way of training, backed by 10 years of sensational success. It costs nothing to investigate. And it may mark the turning point of your life!

**1 100%
Practical**

"Mr. Cooke, once I did not believe in correspondence schools, but your Course is different. Your training is so plain and practical that anybody after studying it could go out and take any job in which electricity is concerned. **I know, for I did it.**



"Your course got me a fine electrical job soon after I started, and I made good at it. In fact, although I had no previous experience, my pay was doubled after only six weeks on the job."

R. P. Zimmerlin,
55 Salisbury St.,
New Bedford,
Mass.

**Recommended by
10 Thousand
Boosters!**

2

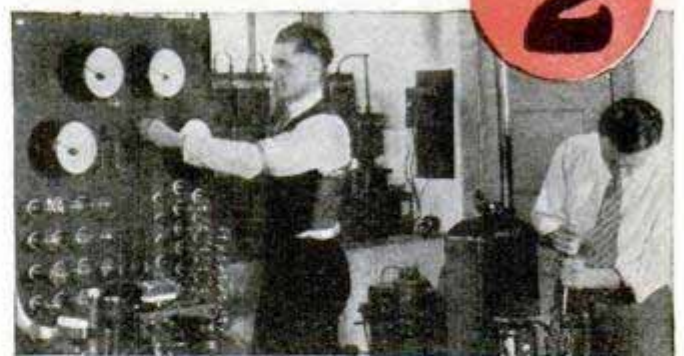

"If it hadn't been for you, Chief, I wouldn't be where I am today. I operate the only battery and ignition Service in this town, and my earnings run as high as \$65.00 A DAY. You don't know how proud it makes me to have that Cooke Diploma hanging in my office. And believe me, I lose no opportunity to tell the other fellows all about it. I am, as always, a booster for your Course."

Jacob Lantz, 1223 First Ave.,
Hillsboro, Ore.

Chief Engineer Cooke's Training is *not* something new and untried. For 10 years, men have been winning quick promotion and bigger earnings in Electricity by his simple, practical method. Maybe he can help you as he has already helped 10,000 others. Find out TODAY. Send the Coupon below for your FREE copy of "The Vital Facts about Electricity."



L. L. Cooke,
Chief Engineer

3

Results Immediately in Increased Pay

"I enrolled, as you know, only six months ago, but already I am making \$350 a month in Farm Lighting Work. How's that for quick results, Mr. Cooke? Your Course has done wonders for me. A few months back the other fellows laughed at me when I decided to become a Cooke trained Man. They don't laugh now. Just think what I can accomplish by next year at the rate I am going—and I owe it all to you. My thanks cannot be expressed in words."

H. H. Guthals, R.F.D. 1,
Talmadge, Nebr.

Only One Course —Training Men for Big Pay Jobs in ELECTRICITY

Chief Engineer Cooke trains men for one profession, and only one—Electricity. So don't confuse his training with others of a similar name or with schools which conduct dozens of courses. It pays to get your training from specialists. The L. L. Cooke Course represents the lifetime experience of Mr. Cooke and more than 50 other electrical engineers who helped him prepare it.

And the thousands of successful Cooke Trained Electrical Men all over the world prove that the Chief's way of training men for the big-pay jobs in this big pay field must be the right way.

Get the Facts Now— in This Great FREE Book!

"The Vital Facts" tells you everything you want to know about the opportunities in Electricity. It's a big book with over 150 pictures, 100 true stories of electrical success and descriptions of 43 different electrical fields you can enter. And it's Free to every reader of Popular Mechanics who will clip and mail the coupon below.

Send for the Chief's book today. No obligation, of course—and the book will be mailed to you, not delivered by an agent. Learn about this wonderful pay-raising training by reading "The Vital Facts." Your copy is ready. Address:

L. L. COOKE, Chief Engineer,
L. L. Cooke School of Electricity,
Owned and Operated by
Chicago Engineering Works, Inc.
Dept. 19, 2150 Lawrence Ave., Chicago, Ill.

Low Price— costs only a few pennies a day

"I have often wondered how you can give so much in service and instruction for the low price you ask for your Course, Chief. I was making only \$16.50 a week when I enrolled with you. Before I finished the Course I was a foreman at \$50.00 a week. Then I started in business for myself and now often clean up that much in a single day."

Chas. A. Finch, Mgr.,
Middletown Electric Co.,
Middletown, N. Y.

5

Easy to Read —Easy to Understand

"Your training is the cause of all my success. When I enrolled with you I didn't know a thing about Electricity and was only making \$18.00 a week. But your clear, easy way of teaching pulled me through and gave me a thorough knowledge of electrical work. Now I make over \$100.00 a week and am going up all the time. Cooke Training gets all the credit."

J. E. Ritch,
102 Bencil St.,
High Point, N. C.

FREE BOOK COUPON



Chief Engineer Cooke,
Dept. 19, 2150 Lawrence Ave.,
Chicago, Ill.

Send me at once your FREE Book "The Vital Facts about Electricity," and full particulars of your training that helps men into Big-Pay Jobs. This does not obligate me in any way and I am not to be annoyed by salesmen or agents.

Name.....

Address.....

City..... State.....

**These books make promotion sure
—Free book if you order now—**

FOR a short time only we will give every subscriber to the New Library of Power Plant Practice a copy of Maujer and Bromley's **FUEL ECONOMY IN BOILER ROOMS**—one of the most helpful engine-room books ever written. The book tells you hundreds of important points about boiler-room practice. You can read it easily and understand it without any trouble at all. This book—that comes to you **FREE**—will help you day in and day out. You get it **FREE** with

**Power Plant Practice 9 volumes—3978 pages
—3777 illustrations
A Combined Home-Study Course and Reference Library**

These practical books bring the big-pay job within your reach. They make it possible for you to know power plant work as it is practiced by the highest paid engineers.

The library covers the entire field—boilers—valve setting—engine operation—turbines—injectors—foundations—electrical machinery



— combustion — refrigeration — fuels — governors — boiler stresses — fire tubes — feed water treatment — selection of boilers and engines — pumps and pump governors — steam traps — condensers — piping, etc.

Every page is packed with the kind of information that the power plant man needs in his daily work.

If you want to get ahead in your work—If you want to pass an examination for an engineer's license—If you want the big pay that comes with increased knowledge—get these books.

Sent free—no money down—7c a day

FREE EXAMINATION COUPON

McGraw-Hill Book Co., Inc., 370 Seventh Ave., New York. Ship to me, charges prepaid, the nine volumes of the Power Plant Library, price \$19.50. If satisfactory, I will send \$1.50 in ten days and \$2 a month until the special price of \$19.50 has been paid. If not wanted, I will write you for shipping instructions. Upon receipt of my first payment you are to send me free, Maujer and Bromley's Fuel Economy in Boiler Rooms.

Name.....
Address.....
Position.....
Company..... P. M. 12-1-26

Learn How to BOX

JIMMY DeFOREST BOXING COURSE

Teaches by mail the same System he taught Champion JACK DEMPSEY



In 20 weeks, under the System of Jimmy DeForest, World's Greatest Trainer and Maker of Champions, you will master the priceless knowledge that made Jack Dempsey his millions, and fortunes for a host of other Jimmy DeForest-trained ring stars. Every 6 months 30 are selected from all classes and recommended to leading promoters for boxing engagements. That's how pupils are brought to the front at once. Boys who were once rank amateurs are today earning big money; weaklings have been made strong, courageous; men have learned the art of self-defense. Send today for the now famous book, "The Golden Age of Boxing," greatest book of its kind ever written; full of valuable information, photos of great fighters and pupils who became successes over night. Enclose 10c to cover cost of mailing, etc. Write now.

JIMMY DeFOREST BOXING COURSE 347 Madison Ave., Box 612, NEW YORK CITY

Learn



Aviation

At Home in your spare time.
Be an expert Airplane Engineer.

Earn \$3,500 to \$10,000 a Year

Practical course—takes only a few months. Write for special offer on free airplane parts and free catalog.

**WESTERN AIRPLANE CORPORATION
Dept. M-12 Menadnock Block CHICAGO**

\$20,000,000 DAILY WAGES Paid to AUTO MECHANICS

Learn in 8 Weeks

Ten thousand men have been qualified by my practical, easy-to-learn Shop Method of teaching with real tools on real equipment. I guarantee your money back if I fail. No book study.

I Pay Your Railroad Fare to my training shops and Board You 8 Weeks FREE

My eight weeks' course is complete. No extras to pay for. This offer is limited. Save one-third while it lasts. Act promptly. Mail the coupon today. Remember "Mac" is one of the world's largest operators of Auto and Tractor Training Schools.

Get your name on the payroll of America's biggest industry and be fixed for life. Auto Mechanics "who know their stuff" are in demand everywhere—never so many jobs as right now waiting for trained men to fill them. No apprenticeship. No education required.

Wages \$75 to \$150 Weekly are paid to thousands of auto experts. Others make more as owners of garages and repair shops. What man of 16 or 60 could ask for a Bigger Opportunity?

Write today for my remarkable special reduced tuition offer that includes free board and railroad fare.

Ask for My Big Book — Tells Everything

MAIL THIS COUPON FOR MY GREAT OFFER

**McSWEENEY Auto, Tractor and Electrical SCHOOLS
Cleveland, Ohio, Dept. LW-14, Cincinnati, Ohio**

Please send your Special Offer and Big Illustrated Book.

Name.....
Address.....
City..... State.....

McSWEENEY SCHOOLS
Auto, Tractor and Electrical
Cleveland, O., Dept. LW-14, Cincinnati, O.

AUDELS ENGINEERS & MECHANICS GUIDES

EXAMINE FREE!



\$12
Complete Set
8 Guides

For Every

Engineer
Mechanic

Machinist
Electrician

Fireman; Oiler
Engineer Student

THIS Master Set is a gold mine of daily, practical helps for workers in every branch of engineering. A self-educating study course for the student; the standard reference work for the chief. Thousands of rules, tables, calculations and diagrams make it easy to read and learn. Latest inside information on theory and practice of modern engineering for reference study and review. Thousands of new short-cuts that make the job easier. Examine free! Pay \$1 a month (less than 4c a day) if satisfied that this set will help you to a better job—or make your present job easier.

AUDELS STANDARD LIBRARY

With Questions and Answers That Solve Your Problems

EASY TERMS

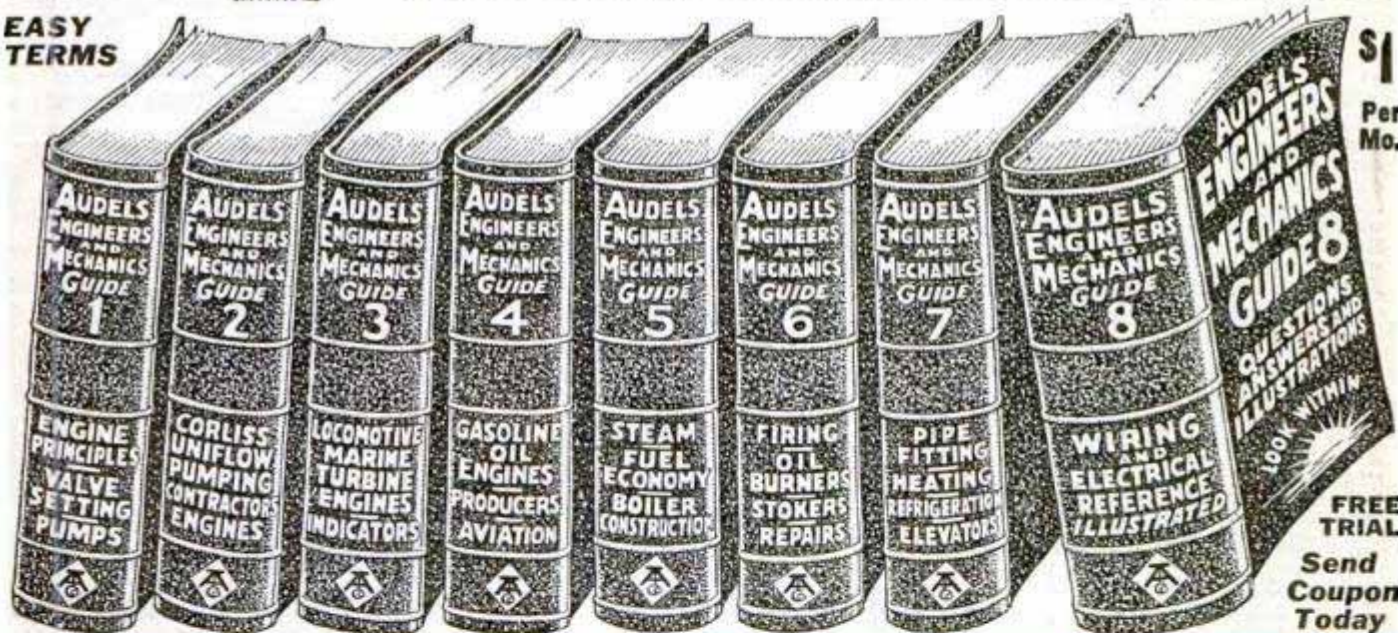

8 GUIDES—8754 PAGES—4750 ILLUSTRATIONS—POCKET SIZE

8 pocket numbers with Ready Reference Index, 8754 pages, 4750 illustrations. Easy to read. Highly endorsed. A good help in securing Engineer's License. Price \$12; terms, \$1 per month. Free Trial.

INFORMATION:— In A Handy Form. Answers to Your Questions and Problems. Here is a partial list of the subjects covered:—**Engine Principles, Valve Setting, Pumps, Corliss Engines, Uniflow Engines, Pumping Engines, Contractors Engines, Locomotives, Marine Engines, Turbine Engines, Gas Engines, Oil Engines, Indicators, Producers, Aviation, Steam, Fuel Economy, Boiler Construction, Firing, Oil Burners, Stokers, Boiler Repairs, Pipe Fitting, Heating, Refrigeration, Elevators, Dynamos, Motors, Lighting, Wiring, Electrical Diagrams, Radio, Electrical Reference and Calculations.**

FREE BOOK—FOR LIMITED TIME.

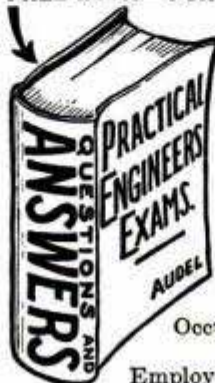

While the edition lasts, "Audel's Answers" will be included with each set of Audel's Guides. Contains special information for those who want to go before the board to get a license. Makes Engineers exams easy. Send this coupon at once.

THEO. AUDEL & CO., 65 West 23rd St., New York City.

Send me AUDELS ENGINEERS AND MECHANICS GUIDES, 8 numbers, \$12 and "Audels Answers" for free examination. If satisfactory, I will send you \$1 in 7 days, then \$1 monthly until \$12 is paid.

Name

Address

Occupation

Employed by..... 12T30

NOW FREE



B. W. COOKE
Directing
Engineer



CLIP COUPON
5
BIG OUTFITS
Free
OF EXTRA COST

EARN up to \$150 a Week!

If you're earning a cent less than \$60 a week, *clip coupon now*. Get the **PROOF** that you can be on your way to **BIG PAY** as an Auto Expert **QUICK!** See for yourself how fascinating this training is—how easily you can master Auto Work right in your own home—and how **quickly** you can get in line for the **big Auto Jobs** that pay up to **\$150 a week and more**—or a Money-Making Auto Business of your own! Remember these Instruction jobs come to you **ABSOLUTELY FREE** and without obligation. *Clip coupon now.*

I'll train you AT HOME Get these free instruction Jobs now. See how thorough, how complete "JOB-WAY" Training is—includes all Electrical work—Ignition, Starting, Lighting—all Mechanical, also Welding, Brazing, Vulcanizing—also Business Course, Salesmanship, Advertising—How to keep simple Books—also Students' Magazine, also 5 working Outfits. Nowhere else can you get this original genuine, copyrighted B. W. Cooke "JOB-WAY" Training.

This Big Auto Book Also FREE Coupon brings this startling, revolutionary Auto Book, too, absolutely Free! Shows how hundreds of men have reached Big Pay in amazingly quick time! Shows what you can do. Send for it now!



TO PROVE that "JOB-WAY" is "PAY-RAISE" Training

Clip coupon now. I'll send you absolutely **FREE OF CHARGE**—with positively *no obligation* on your part—6 "JOB-WAY" Instruction **JOBS!** and my big book. I want you to *SEE for yourself* just why "JOB-WAY" Training is bringing so many men **Big Money** in such *remarkably quick time*. I want you to see how men *without a day's previous auto experience*—and only *common schooling* become Garage Owners, Superintendents, Managers, and earn up to **\$150 a week and more!** I want you to see why Hundreds of men have found "JOB-WAY" Training to be such interesting, most practical money-making training!

That's why I make you this unusual offer—with absolutely *no strings on it* and *not a single penny's charge*. Clip coupon now and I'll rush your jobs to you *absolutely Free!*

Coupon Brings Full Details of My 5 OUTFITS OFFER

Includes Tools, Tool Bag, Electrical Test Bench and Radio Receiving Set—all Equipment. Also 303 Wiring Diagram Charts, also Socket Wrench and Ignition Wrench sets.

Be An Auto Expert

The World's Biggest Business Needs You!

There are so many tremendous Opportunities in this gigantic Auto Industry that I want every ambitious man *who really wants* to make more money, to have these 6 Instruction Jobs, just to see how easily and quickly I can boost his pay way up. Just think! Seven thousand Millions of Dollars are paid to Auto men every year for *upkeep alone*—**Nineteen Million Dollars a day!** Think what that means to you—the Big Pay Opportunities open to you as an auto expert! It's the one field for the man who wants a **BIG pay check!** Learn all about it now!

Act Quick!

Don't delay a minute. Send coupon right now while I can still make you this special offer of 6 Auto Instruction Jobs absolutely free—as well as my Big Auto Book, free too! Act now!

SEND ME LESSONS and BOOK FREE

B. W. COOKE, 1916 Sunnyside Ave., Dept. 916A, Chicago
Send me absolutely FREE and without any obligation on my part, 6 Auto Instruction Jobs. Also your Auto Book FREE and full particulars of your 5 Outfits Offer.

Name

Address

Town

State

B. W. COOKE Directing Engineer
Chicago Motor Training Corporation
1916 Sunnyside Ave. Dept. 916A CHICAGO, ILL.

Classified Advertisements

WORLD'S BEST WANT AD MEDIUM

Advertisements in this section, 30 cents per word, each insertion, minimum 10 words, payable in advance. To be inserted under proper classification in January issue, copy should be in our office November 18th.

ADVERTISING AGENCIES

A TEN Dollar Ad may put your proposition over. \$10 pays for a 4 line 24 word classified ad one Sunday in 10 of the largest newspapers. Reach over 7 million readers. Minneapolis Tribune, Buffalo Courier, St. Louis Post-Dispatch, Pittsburgh Press, Indianapolis Star, Atlanta Journal, Detroit Free Press, Birmingham News, Cincinnati Enquirer, Little Rock Gazette. Free catalogue showing other lists of newspapers and magazines sent on request. Ankrum Advertising Agency, 22 West Jackson Blvd., Chicago. Largest classified advertising agency in the world.

ADVERTISING: Over 25 years' experience building up advertisers. We prepare, plan and place magazine, newspaper and classified advertising. Also folders, circulars and letters. Describe briefly your proposition, send your recent advertising matter, proofs of ads, etc. We will send you "Advertising Simplified," latest book of rates and valuable information. Ask Dun's, Bradstreet or any publication about us. Charles H. Touzalin Agency, 708 Union Trust Bldg., Chicago, Ill.

ADVERTISE in the classified section of newspapers and magazines, to secure help, money, or to sell. 24-word advertisement in nine big Metropolitan papers \$10.00. Nearly two million circulation. Many other bargain lists. Write for Free 58-page Directory No. 26, Brinckerhoff Advertising Agency, 37 W. VanBuren, Chicago.

ADVERTISE in 24 Big Sunday Newspapers—24 words \$15.00. 300 Rural Newspapers, 28 words \$10.00. 100 Big Weekly Newspapers, 24 words \$5.00. Lists and consultation free. National Advertising Service, Richmond Hill, N. Y.

ADVERTISE in 24 Big Sunday Newspapers, 24 words \$15.00. Excellent for securing Agents, Salesmen, and Business Opportunities. Catalog listing 1,000 leading Dailies, Weeklies, Mail Order Magazines, Everything. Free. Wade Advertising, Baltimore Bldg., Chicago.

ADVERTISING—All newspapers and magazines; publishers' lowest rates. Largest classified agency on Pacific Coast. Rate sheet free. Baum, 815-333 West Second, Los Angeles.

ADVERTISERS International Manual, new edition. Inside information for Advertisers & Publishers' Rates. 50c Postpaid. Economies Publishing Co., Dept. 53, 1475 Broadway, New York.

ADVERTISE—Newspapers, Magazines, Country papers—classified (Want Ads)—display space. Free catalog. Martin, 37B West 39th, New York.

SIX Word Line—355 rural weeklies \$3.55. Admeyer, 4112-M Hartford, St. Louis.

ADVERTISING in all magazines and newspapers at publisher's lowest rates. Write for Rate Book. Taylor's Advertising Service, 314-16 Brown Bldg., Rockford, Ill.

FOR ADVERTISERS

GUARANTEED Lists—agents, mail order buyers, others, secured through our own advertising or copied from original letters. 500, \$2.25; 1,000, \$4.00. Price list free. Club mailing. Demuth Co., Englewood, N. J.

HEADQUARTERS for mailing lists of every description. Mail Order Buyers, Agents, Opportunity Seekers, Juveniles, Tradespeople. Cooperative Mailing \$3.00—1,000. Particulars Free. Field Co., 1145 East 99th St., Cleveland, Ohio.

ADVERTISERS' Manual; New edition. Inside information for advertisers. Postpaid 50c. Economies Publishing Co., Dept. 53, 1475 Broadway, New York.

ADVERTISING 222 magazines 8c word; \$6.00 inch; \$45.00 page. Sample 10c. Diamond Advertiser, Norton, Mass.

IDEAS, Sales Letters, Advertising. Ad-sales Service, 103 Broadway, Peoria, Ill.

SILVER quarter gets 2 good classified ads and replies plus list 55 southern country papers. Write Wilson, Box 243, Michigan City, Ind.

I WRITE letters, folders, booklets, complete followup for manufacturers, mail order dealers. Long experience. Write for details. L. Taylor, 314-16 Brown Bldg., Rockford, Ill.

ADVERTISE in a Magazine That Pulls and get your share of business. Worth subscribing for on account of highly instructive mail order articles. Sample free. Gilbert Sales Co., Pub., Milford, Conn. Dept. E.

CUTS engraved, \$1.00 or higher. Wineholt Sales Co., Woodbine, 4, Penna.

ADVERTISE in 300 country newspapers, 28 words, \$10.00. Keator, Hartford Bldg., Chicago.

ILLUSTRATIONS, Cartoons Drawn to Order. McCalip, Box 162, Peoria, Ill.

25 WORDS 88 magazines; \$1.00. Thrice \$2.00. Smith's Service, 1194, Wenatchee, Wash.

ORIGINAL Letters rented. Information free. Wineholt Sales Co., Woodbine, 4, Penna.

CUTS, Drawings \$1.50. Window Cartoons, 6. \$1.50. GPO. Bx471, New York.

SALES PROMOTION

\$50 TO \$50,000 Daily Sales Developed During 28 years for clients by our direct mail plans, copy, campaigns. One product, 1923, an idea; this year \$100,000 orders booked. Fifty year old concern desired 50 national representatives in 1925; we produced 40 in three months. 700 dealers in 10 months at \$3 each, for another. Ten years Sales Promotion Manager Larkin Co. Submit sales problems for free diagnosis. James C. Johnson, 118A Woodbridge Ave., Buffalo.

WE Write Sales Letters, Booklets, Pamphlets, etc. Complete Service for Advertisers. Consultation Free. Arbor Business Service, 245 West 112th Place, Chicago.

SALES creating letters written. G. W. Anderson, Box 1244, Phoenix, Ariz.

AUTOMOBILE SUPPLIES

BIG Sale on Auto Supplies. Malco Automatic Windshield Wipe \$2.85. National 5" Spotlight \$1.95. Diamond Ford oilers 98c. High Pressure Gun and Hose \$2.85. High Pressure Alemite Fittings \$1.00 Doz. Exhaust Cut-Outs, all cars, \$2.00. Gilmore "Bull Dog" Bounce Absorbers \$6.75 pair. Fulton Accelerator for Fords 85c. Jewell Dash Lamp Caps 75c. For Hub-O-Disk a cap made of heavy steel, \$1.95 set. Ford Arvin Heaters \$1.65. Smart Drum fog lights \$3.75. Jewell Stop Lights \$1.95. Mail orders daily. Schuck Auto Supply, 1922 Westlake, Seattle, Wash.

REBUILT Magnetos, 4 cylinder. Simms, Bosch, Left and Right hand rotation. Suitable for trucks, tractors. Price \$14.75. Guaranteed. Simms Magneto Co., 2724 S. Michigan, Chicago.

USED Auto Parts for Any Car. Allen's Parts Co., 2001 So. 9th, St. Louis, Mo.

ARE Profits slipping away? Hold them by repairing tires profitably on our Vulcanizers. Costs little and operates economically. Adams-Barr, Columbus, Ohio.

SAVE 40-80%. New and Used Automotive Parts, 2,000 models. Bankrupt supplies, 5,000 bargains. Sport shields, \$3.00, roadster tops, \$10.00, complete touring, \$15.00. Wheels, radiators, generators. Brightman Auto Exchange, 321 Windsor Ave., Hartford, Conn.

SERVICE data blue print chart—34 by 48 inches specifying valve and ignition timing; valve, piston, ring and bearing fitting dimensions. Chart covers eighty 1926 automobile engines. \$1.50 postpaid. C. T. Schaefer, 2641 Russell Ave., St. Louis, Mo.

BATTERY Tester and Inspector. Regular \$50.00 value; \$32.00. Battery Shop Equipment and Supplies at Wholesale. Adams-Barr, Columbus, Ohio.

BARGAINS on Radiators. All standard makes radiators furnished at bargain prices. State Make and model. We guarantee satisfaction. Independent Radiator Co., 1119 Wabash Ave., Chicago.

MAGNETOS, Starters, Generators, Ignition systems, spark plugs, part, timing chains, repairing. Melner Magneto Co., 1759 E. 21st St., Cleveland, Ohio.

SELF steering Automobile Leaders. Write Britzius Mfg. Co., Dover, Minn.

VULCANIZING Auto Tires is a Paying Business. We have Plants near you from \$50 up. Catalog Free. Instruction Book \$1. Equipment Exchange, 108 East 11th, Los Angeles, Calif.

AUTO Emblems. Any Lodge. Write. North Central Distributors, Dept. J, Ashland, Ohio.

65 MILES on 1 Gallon—Wonderful Gas Saver. All autos. 1 free. Critchlow, 805-X, Wheaton, Ill.

AUTOMOBILES

PATENTS. Time counts in applying for patents. Don't risk delay in protecting your ideas. Send sketch or model for instruction or write for Free book "How to Obtain a Patent" and "Record of Invention" form. No charge for information on how to proceed. Communications strictly confidential. Prompt, careful, efficient service. Clarence A. O'Brien, Registered Patent Attorney, Security Bank Building (directly across street from Patent Office), Washington, D. C. See pages 170 and 171.

FOR FORD OWNERS

FORD Rebuilt Parts. We are forced to salvage a great many used Ford cars through our used car department and we have complete units and parts of every description that we can sell at ridiculously low prices—complete rebuilt motors, \$35.00; Front Axle System, complete with front spring, \$9.00; Rear Axle Assembly complete, \$15.00; Frames, \$1.50; new 1918-19 Fan Belts 10c each. These are just a few of our bargains. Send in your wants. We can take care of you. C. F. Van Sicken Motors Company, 6047 Cottage Grove Avenue, Authorized Ford Dealer, Chicago, Ill.

PUT a "Bingo Timer" on your Ford. Guaranteed best made. Thousands in use. Requires no oil. No more trouble. All Dealers or direct with full particulars—\$1.50. Agents make big money. United Machinery Company, Cincinnati, U. S. A.

STOP Fords Overheating. Use "Welco" fan. \$1 postpaid. Welco Products, 3344 Altamont, Cleveland, Ohio.

65 MILES on 1 gallon—Wonderful Gas Saver. All autos. 1 free. Critchlow, 805-Y, Wheaton, Ill.

FORD lamp door opener, postpaid, \$1.25. Peter La-Vold, Virginia, Wis.

UNDERSLING with "RKO" Swing Lo Irons. See "Red-1-Kut" ad page 180.

MOTORCYCLES, BICYCLES AND SUPPLIES

OVERSTOCKED Used Motorcycles. 1923 Indian Chief \$95.00. 1923 Harley Davidson \$95.00. 1923 Henderson DeLuxe \$120.00. Two hundred others; write for free list. Myerow Brothers Co., 15 Berkeley St., Boston, Mass.

GOOD Second Hand Parts for Indian, Harley, Henderson, Ace and Excelsior Motorcycles. No Junk. Ship C.O.D. No Lists. J. B. Dahl, 3661-63 Archer Ave., Chicago, Ill.

1923 HARLEY-DAVIDSONS, \$168; 1922, \$118; 1921, \$111; 1920, \$85; 1919, \$65; 1917, \$50; 1916, \$45; 1915, \$40; 1914, \$35. Guaranteed. Money refunded if not satisfied. Circular free. Wisconsin Cycle Sales Co., 726 National Ave., Milwaukee, Wis.

DON'T buy a Bicycle Motor Attachment until you get our prices. Shaw Mfg. Co., Dent, 27, Galesburg, Kans.

SEND for Bargain Bulletin. All makes of rebuilt motorcycles at lowest prices. Used parts half-price. Send Stamp. Ash Motor Corporation, Rochester, N. Y.

NEW and used Motor Cycle Parts. Tower Cycle Co., 3604 Kingsland Ave., Pine Lawn, Mo.

AVIATION

LEARN to Fly; \$100.00 including Solo. We guarantee to solo you regardless of the number of flying hours required. Our instructors are ex-army aviators and air-mail pilots with wide experience. Our training equipment is the best obtainable. Our course requires about two weeks, depending on the individual. No bond required, no charge for breakage. Eight years without an accident. 76 students graduated in 1925. Commercial aviation is a rapid growing industry. Don't delay! Enroll now in one of the oldest and best known flying schools in America. Write for booklet, Robertson Aircraft Corporation, operators of the United States Air Mail, St. Louis-Chicago, Lambert-St. Louis Airport, Anglum, Mo.

PATENTS. Time counts in applying for patents. Don't risk delay in protecting your ideas. Send sketch or model for instruction or write for Free book "How to Obtain a Patent" and "Record of Invention" form. No charge for information on how to proceed. Communications strictly confidential. Prompt, careful, efficient, service. Clarence A. O'Brien, Registered Patent Attorney, Security Bank Building (directly across street from Patent Office), Washington, D. C. See pages 170 and 171.

TEN lessons in the air of twenty minutes each will make you a pilot by our advanced method of training. This, together with our five weeks' shop course at \$100.00, makes America's oldest aircraft factory the most popular flying school. Work after class hours guaranteed. Special Winter evening course, including shop work, field and flying, \$190.00. Employment furnished during the day, paying \$20.00 to \$40.00 per week. Heath Airplane Company, Chicago, Ill.

NEW Fur-Lined and Sheepskin-Lined Flying Suits, Water Proof, Electrically Heated, \$75.00 and \$60.00. Sheep-Lined Moccasins \$5.00; Goggles, Genuine Non-Shatterable, \$2.50; Helmets \$2.50 to \$7.00; New Production Nitrate Dope, 5-gallon Cans \$9.50. Everything for Aviation—Ships, Motors, Spares, Equipment, Flying Instructions. Write for Catalogue. Nicholas-Beazley Airplane Company, Marshall, Mo.

AIRPLANES, Motors, Supplies; 100 H.P. Gnome Rotary Motors \$75. Florida; 28 H.P. Lawrence Motors \$125; Curtiss 90 H.P. \$500; tan leather helmets \$3.75 and \$5.00; non-shatterable goggles, Oval \$2.50; wide-vision \$4; temperature gauges with 12 ft. tubing \$7.50; leather breeches \$12.00; leather coats \$18.50, or sheep-lined \$23.50; airplane cloth 65c yd.; dope \$2.50 gal.; aerial camera \$100. Logan Aircraft, 716 W. Superior, Cleveland, Ohio.

HEATH propellers won first place in speed and efficiency at the Philadelphia air races. Each propeller individually designed for the particular work to be done, as laid out by America's oldest aeronautical engineers. Heath propellers on your sled or boat will give you the kind of results you are wishing for. Propeller circular 4c; motorcycle biplane circular 4c. Heath Airplane Company, Chicago, Ill.

COMPLETE Scale Plans, with Building-Flying Instructions for following 3-ft. Model Aeroplanes, 25c each postpaid; Fokker North Pole Monoplane; JN4D-2; DeHavilland; NC4; Bleriot; Niuppout or Taube Monoplanes; Cecil Peoli Racer. Complete 48 pp. catalog 5c; listing hundreds of parts and supplies for experimenters. Ideal Aeroplane Co., 165½ Spring Street, New York.

AIRPLANE, boat, sled propellers. Build speedy "Aerodrive" sleds, boats from our blueprints of either type, priced at \$1. Fine leather helmets only \$3. Aircraft supplies list 5c. Everything aeronautical! Ostergaard Aircraft, 4269 North Narragansett, Chicago.

DURABLE 24" model airplane; flies 300 ft. \$1.25 Postpaid. Marx Model Aircraft Co., 608 East 8th, South Salt Lake, Utah.

MOTORS—90 horse OX5. New, \$300; Used, \$100 to \$200; 28 horse Lawrence, New, \$125. Propellers \$3 to \$25. Aviators' Leather Coats, used, but good \$5.00 to \$10.00. Smith Machinery Co., P. O. Box 153, Houston, Texas.

FOR Sale—new T-M Government Scout Biplane, complete, ready to fly, original crate, \$450.00 takes it—worth \$3,800.00. Stored San Diego, Calif. Harry E. Skinner, 428 Webster Ave., Chicago.

AERO Dope Sheets give specifications 159 different airplanes 16 to 4,000 horsepower and 76 aeronautic motors; span, weight, power, type, area, etc. Postpaid, \$2. Send now and get posted. Aero Sales Company, Box 3690, Portland, Oreg.

TYPE-L8 Simms Magneto Clockwise rotation, also one Anti-Clockwise, as used on Government Curtiss OXX6 and others. Lightweight. Suitable for any 8 cylinder motor. Never used. List \$125. Bargain at \$29.50. M. Moser, 1219 North Shore Ave., Chicago, Ill.

PARACHUTES, new and used for air-planes, specify weight. Thompson Bros. Balloon Co., Aurora, Ill.

EARN \$3,500 to \$10,000 a year. Prepare for flying. Complete ground course in mechanics of aviation. Write for free catalog. Western Airplane Corporation, Desk K-12, Monadnock Block, Chicago.

AERONAUTICS! Are you keeping pace with the new developments? "Aeroplane Engines in Theory and Practice," by Rath-bun describes engines fully. Used as a text in Government Schools and includes all makes. For Mechanician, builder and flyer. Send no money. Just order on a postal. When postman hands you book, pay him \$2.50 and postage charges. Popular Mechanics Press, Room 812, 200 E. Ontario St., Chicago.

TEN hours flying instruction for \$125. No charge for breakage. Training starts day you arrive. Indian Lake Aviation Company, Russell's Point, Ohio.

BIG Special Christmas Offer. Curtiss Pulitzer Racer construction set, Aero Digest, Year's Subscription, Scientific Air glider, \$6.00. Send 5c for Big Model Airplane, Boat and Supply Catalog. W. Phipps Co., 367 Wilson Ave., Brooklyn, N. Y.

SCOUT airplanes for sale; the famous Spad airplanes, single seaters, similar to the T. M. Scout, uncovered and without motor \$200.00 each f.o.b. our warehouse at San Antonio, Texas. Robertson Aircraft Corp., Anglum, Mo.

THE American School of Aviation announces a new correspondence course in Mechanics of Aviation. A thorough training in Practical Aeronautics. American School of Aviation, Dept. 1841, 3601 Michigan Ave., Chicago, Ill.

MOTORS: Curtiss OXX-6 Class A (under Fifty Hours) for Plane, Sea-Sled, Motor boat, etc., \$275.00. All Motor and Plane Spares at Best Prices. Send for Catalogue. Monumental Aircraft Co., 339 N. St. Paul Place, Baltimore, Md.

AIRPLANES. How to build them and be sure they will fly. Learn the two most powerful influences on the stability and operation of an airplane. Get our free information, blue prints and propeller literature. Crawford Airplane Mfr., 2225 American Ave., Long Beach, Calif.

LEARN Aviation at America's foremost school. Earn your tuition if you lack the cash. Send 25c to Box 502, Peoria, Ill., for full particulars.

THREE foot model aeroplane. Price \$1.00. Circulare free. Aero Shop, 3050 Hurlbut Ave., Detroit, Mich.

BOOKS AND PERIODICALS

WE buy, sell, rent used educational matter. Send 25c for magazine and big list, and other money-making ideas. None free. Home Magazine, Dept. P, Box 912, Nashville, Tenn.

PRACTICAL Psychology Teaches Hypnotism, Personal Magnetism, Magnetic Healing, Auto-Suggestion, Cure Habits and Disease. Easy Lessons. Send for Booklet, 4 cents stamps. Fernando, Dept. M, Springfield, Mass.

HYPNOTISM easily learned. Lessons guaranteed. Postpaid \$1.10. Smith Pub. Co., Dept. 3, Springfield, Mass.

FREE—Send for my Newthought, Self-culture, Occult, Mystic and Scientific book literature. Martens Publisher, Burlington, Iowa.

SCIENTIFIC Books. Send for descriptive circular. Levi Bryant, 543 East 47th St., Chicago, Ill.

COURSES: Professions and Trades. Write Public Correspondence Association, Box 326, 601 E. 36th St., Chicago, Ill.

WHERE'D Cain Get Wife? 15 pages, 20c. Jabe Studio, Kansas City, Mo.

CURIOUS Books, Unique Novelties, Stunning Pictures. Samples, 10 cents Prepaid. Linds, 214 W. 34th Street, New York.

HYPNOTISM easily learned. Guaranteed lessons \$1.00 COD. Wineholt Assn., Woodbine, 21, Penna.

SAVE money on your magazine subscriptions. Catalog free. Zenith Book Co., Box 188, St. Paul, Minn.

PITMANIC Light-Line Shorthand Book, 25c. Marr, Teacher, Nashville, Tenn.

HALF-PRICE. New-old books. Psychology, Encyclopedias, Business, History, etc. Phipps, Library, 1014 Belmont, Chicago.

BOOKS: Write for our sales and exchange plan. Kilburn, Spring Valley, Minn.

NATIONAL Fun Review—snappy, humorous magazine. Whole year 10c. Sadny, 299 Willis Ave., New York.

FUNNY White Mule—America's greatest magazine, including snappy pocket novelty, 10c. White Mule, Beaver Dam, Wis.

SHOP Notes for 1927. Get your copy now. Only a limited edition. Contains all the articles published in the Shop Notes department of Popular Mechanics Magazine during 1926. Send No Money. Just write a postal and we'll send 1927 Shop Notes and any one of the other following numbers: 1908, 1912, 1913, 1914, 1915, 1916, 1917, 1919, 1920, 1921, 1922, 1923, 1924, 1925, 1926. Pay postman 98 cents and the postage when he hands you the two books. Popular Mechanics Press, 200 E. Ontario St., Room 812, Chicago, Ill.

PICTURES AND POSTCARDS

TRUE-BLUE friends everywhere. Exchange postcard, stamps, etc. Year, \$1; half, 50c; quarter, 25c. Hundreds listings, 10c. Ed Ericson, Elroy, Wis.

SEND Christmas Greetings by air mail. Something new. Red, white and blue special air mail envelopes, 10 for 25c. Globe Service Co., 223 Palisade Ave., Jersey City, N. J.

ART Pictures, Books and Novelties. Catalog 10c. Howard Sales Co., Dept. 15, 1188 Folsom St., San Francisco, Calif.

JOIN Live Postcard Club; Membership lists including Catalog, 10c. Harvey Teeple, Decatur, Ind.

220 ART and bewitching beauty pictures, including Rudolph Valentino photograph, 25c coin. Smith's Novelties, M9145-47 South Bishop St., Chicago.

25 BEAUTIFUL Hand-Tinted Personal Xmas Cards and Envelopes, 4x5. Name in raised Gold Letters. Postpaid \$1.85. Samples Free. Maguire's, Al, Boulder, Mont.

75 BEAUTIFUL Art Pictures and Bathing Beauties 25c (coin). Photo Sales Co., 3242 Riehton, Suite 400, Detroit, Mich.

GAMES, ENTERTAINMENTS AND PLAYS

MYSTIFY and fool your friends. Be popular. Great fun! Ventriloquism made easy by new scientific method. Send only \$1 for complete professional course. Guaranteed. Whittle Institute Ventriloquism, Bloomfield, N. J.

VENTRILQUIZM taught almost anyone at home. Small cost. Send 2c stamp today for particulars and proof. George W. Smith, Room S-126, 125 N. Jefferson Ave., Peoria, Ill.

100 LIGHTNING Chalk Talk Stunts \$2.00. Cartoonist, 2925 Euclid, Kansas City, Mo.

SEND for Modart. A fascinating game for the whole family. Plays High Score, Baseball and other games. Complete outfit \$1.00. Toohy Mfg. Co., Box 505, Troy, N. Y.

CRYSTAL Gazing explained. Stamp brings Circular. Waldmann, 1450 First Ave., New York.

PLAYS, musical comedies and revues, minstrel music, blackface skits, vaudeville acts, monologs, dialogs, recitations, entertainments, musical readings, stage handbooks, make-up goods. Big catalog free. T. S. Denison & Co., 623 S. Wabash, Dept. 11, Chicago.

NOVELTIES, CURIOS, ETC.

BOYS sell the aeroplane propeller wheels. Something new. Made of wood 12 inches long. Everybody wants one on their car. Sell for 50c. Send 6 cents postage for one. Aero Shop, 3050 Hurlbut Ave., Detroit, Mich.

MAGIC TRICKS, BOOKS AND JOKER NOVELTIES

MAGIC—Tricks, Books and Supplies. For Amateurs as well as the great professionals. Anyone can learn through our instructions. Feature Acts in Mind-Reading, Spiritualism, Rope Ties, etc. Large illustrated Professional Catalog, 20c. Chicago Magic Co., 140 So. Dearborn St., Dept. B, Chicago, Ill.

BOOKS, Magic, Mysteries, Magic Tricks, Novelties. Catalog Free. Singer, 555, Hancock, Wis.

FOR something different, send 10c for "Fun-Magic-Mystery." New 80-page Book of 500 Tricks. Also contains Catalog largest line Magic Tricks and Supplies in South, at lowest prices. Send 10c today! Lyle Douglas, Station A, Dallas, Texas.

BREAKING Pencil with Dollar Bill. Fifteen Other Tricks, Bargain List, Catalog, Rebate Coupon, all for 25c. Chesters Magic Store, 403 North State, Chicago.

250 MAGIC Tricks and Big Catalogs 25c. Midwest Novelty, Dept. X, 7609 Drexel, Chicago.

FRENCH—Oriental Novelties, Books, etc. Catalog, Sample 10c. Marelle Company, 81 E. Madison, Chicago.

ILLUSTRATED Magic Catalog 6c. Lynn's, 105 Beach, Jersey City, N. J.

BOOK 125 card tricks 30c. Catalogues free. Geo. R. Moritz, Remsen, Iowa.

BIG Package Magic containing Book exposing Modern Escapes, Illusions, Mind-reading, Gambling Secrets, sample tricks, illustrated catalog, all for 25c. Acme Sales Co., 939 W. Exchange, Akron, Ohio.

CARD tricks. Coin tricks. Hypnotism. Ventriiloquism. 64 page books. Complete guides, 10c each. Geo. Fenner, 2401 Jefferson, Louisville, Ky.

FREE with \$25 order die box. Send 20c for our large catalogue of tricks, wigs, sensational escapes. Oaks Magical Co., Dept. 548, Oshkosh, Wis.

SEVEN Magical Delusions and Catalogs—25c. Gilmagic, Morgan Park, Ill.

WONDERFUL Bargain in Magic Tricks and Illusions. Famous Needle Trick only \$1.50, sample trick 20c. Get our free catalog. F. & R. Co., Dept. F, Hoboken, N. J.

STAMP COLLECTING

JUST What Every Stamp Collector Wants. Free. The new 1927 Scott Price List is just out, brimming full of wonderful bargains. Hundreds of Scott Seal packets, sets, and dime sets of guaranteed genuine stamps. Many attractive new packets and sets that every collector, advanced or beginning, should know about. Prices that make every item a real bargain. Also describes the complete line of Scott Albums, from 60 cents to \$55.00; catalogues, hinges, tongs, magnifying glasses, watermark detectors, millimetre scale and perforation gauge and all other accessories needed by the collector. This big illustrated price list of more than 80 pages is free for the asking. Write for it now. Scott Stamp and Coin Co., 1 West 47th Street, New York, N. Y.

ARABS! Bandits! Head-Hunters! Egypt (sphinx); Malay (tiger); Tunis (Arab); Turkey (sacred mosque); Belgium (battle between angel and "old horns"); Congo (head hunter)—All of these mysterious and remarkable stamps are contained in our Famous Phantom Packet—55 fine varieties (to approval applicants only) for 8 cents. Nothing like it; order at once! Pacific Stamp Co., Box 138, Helena, Mont. Extra! Send us, with your order for the Phantom Packet at 8c, the names of three friends who collect stamps; we will give you, free of charge, a scarce set of 11 dif. Albania—bandit land! Supply limited; write immediately!

500 DIFFERENT Stamps for 25c! Big Collection 500 Different Stamps from Bosnia-Herzegovina, Crete, Epirus, Hong Kong, Iceland, Kenya and Uganda, Liberia, Malta, Nyassa, Tanganyika, Wallis and Futuna, Zanzibar, and other "hard" countries. Catalogue value \$10.00. Price only 25c to Approval Applicants! Special Bargains: 1,000 different 79c; 15 triangle stamps 49c; 100 Africa 50c; 100 Asia 60c; 100 Balkan States 35c; 100 British Colonies 25c; 100 French Colonies, 30c; 100 Portuguese Colonies 50c; All 8 packets for \$3.00! Illustrated Lists Free. Loma Stamp Co., 2221 Madison Ave., San Diego, Calif.

ANCHERS \$\$\$ Outfit—only 12c! Fine triangle stamp; set German stamps with (pre-war) value forty million dollars (interesting!); perforation gauge, mm. scale; small album; airmail set; scarce stamp from smallest republic on earth; newspaper set; packet good stamps from Travancore, Johore, Dutch Indies, etc. Entire outfit for 12c to approval applicants! (Nice pocket stock book, value 25c. with every order!) Ancher Stamp Co., 148 1/2 Clerk St., Jersey City, N. J.

\$1.00 FREE. Black U. S. Postage. Given Away with each order. Pioneer Stamp Album with 500 illustrations, 150 different stamps from 40 countries, Syria, Lebanon, Hejaz, Liberia, New French Colonies, British, Portuguese Colonies, South Africa, Australia, 500 hinges, 36 page illustrated catalogue. All for 15c. Big Commission to Agents for the Best approval sheets of stamps ever offered. Write for sample outfit. Hussman Stamp Co., Dept. M, 620 Olive St., St. Louis, Mo.

FREE! Berry's Unused Hundred! 100 different, beautiful stamps—all unused!—from far-off countries, which would cost you over \$1.00 if purchased from approval sheets. Included are: Albania, Antioquia, Bosnia, Herzegovina, Chad, Dahomey, Cuba, Flume triangle, Latvia, Nyassa giraffe, etc. This fine packet absolutely free to approval applicants enclosing 4c postage! Big lists also free. Write today! M. P. Berry, Wrentham, Mass.

FREE—A Monstrous Menagerie! The ferocious tiger; the kangaroo, leopard, oxen, camel, ant-eater, snake, caribou, swan, giraffe, flying horse, screaming eagle, wild elephant, etc. This wonderful packet of hard-to-get stamps—all containing pictures of curious birds, beasts and reptiles—free to approval applicants enclosing 5c postage! Big illustrated lists also free. Write today! Mystic Stamp Company (Dept. 8), Camden, N. Y.

FREE—New Issue Packet with Order. Zanzibar, Abyssinia, Travancore, Herzegovina, Quelimane, Mozambique, Menagerie Collection, Album, Hinges; 10c. Liberty, 3974 Arsenal, St. Louis, Mo.

WANTED. U. S. Match and Medicine, Narcotics and Newspaper Stamps. Wineholt Stamp Co., Woodbine, 26, Penna.

FREE Hungry Charity No. 565 to 567 and a surprise packet given to those requesting for my 1, 2, and 3c approvals, and also my 50% discount. Chas. W. Schmidt, P. O. Box 4832, Frankford Station, Philadelphia, Pa.

STAMPS, 100 varieties, Africa, Brazil, Peru, Cuba, Mexico, etc., 10c. 50 different U. S. 25c; 1,000 mixed, 40c; 1,000 hinges, 10c. List free. C. Stegman, 5941 Cote Brillante, St. Louis, Mo.

500 DIFFERENT only 25c (regular price 50c). many unused, from British, French, Italian and Portuguese Colonies, Chile, Flume, Guatemala, Persia, Siam, etc., to all approval applicants. Big bargain lists free. Victoria Stamp Co., London, Can.

200 DIFFERENT U. S., Cat. \$13.25 only \$3.95. Ask for Approvals. Wineholt Stamp Co., Woodbine, 26, Penna.

SPECIAL Newfoundland Catalogue. Every stamp illustrated. Send 10c for a copy. Will credit you this on your first order. Try these—38 Newfoundland postage, all different face, (Cat. \$5) for \$1. Rev. Butler, St. Georges, Newfoundland.

STAMPS Free—Ask for money-saving approvals. John P. Borresen, Cedar Falls, Iowa.

STAMP Album Free! Spaces for 1,200 stamps, with purchase of 100 different unused stamps for 25 cents. B. Nagle, 1101 Marion Reading, Pa.

COLLECTORS secure Russian stamps direct from source: Philatelic International, I. Tverskaja Jamskaja 3, Moscow, U. S. S. R. American Branch P. O. Box 388, San Francisco.

25 DIFFERENT—Africa, Asia or Australasia, 10c. Lufbery, Port Orange, Fla.

STAMPS Free, 102 different including Hong-Kong. Postage 2c. Fine approvals to adults giving bank, dealer or business references. List Free. Stamp Bought, Payn Stamp Co., 945 Grande Vista Drive, Los Angeles, Calif.

BORNEO, Malay, Liberia and 105 other Different Foreign Stamps, Hinges and Lists with Approvals 9c. 55 Different United States, including Commemoratives, 10c. Fennell Stamp Co., Dept. M, St. Louis, Mo.

1,000 DIFFERENT Stamps Free. For particulars write Stamp Sales Co., 736 West 24th St., Milwaukee, Wis.

FREE—12 scarce Azerbaijan to collectors requesting Illustrated Price List and approvals. Penn's Stamp Co., Greensburg, Pa.

100 DIFFERENT 5c; with Album and Hinges, 10c. Carlton Bain, 80 Magazine, Cambridge, Mass.

FREE. Good Set to Approval Applicants Sending Postage. J. Maxfield, Box 315, Amsterdam, N. Y.

\$5.00 GOOD catalogue value for only \$1.00. R. W. Pelton, Meriden, Conn.

QUALITY Collections, Refund Guarantee. 1,017 different 90c; 2,011 \$2.85; 3,000, \$8.90; 500 face different British Colonies, \$3.30; 500 French Colonies, \$3.60; 500 Portuguese Colonies, \$5.20. R. W. St. Benno, Glen Ellyn, Ill.

DANZIG Stamps free. Interesting Packet from Danzig with big catalogues free for 2c. Midland Stamp Company, Toronto, Canada.

100 DIFFERENT 5c. Price List Free. Hollub, De Land, Fla.

FINE Approval Selections at 60% discount. 100 stamps free for 3c postage. Write Now. Wineholt Stamp Co., Woodbine, 26, Penna.

\$10.00 FOR 25c. A choice assortment of 500 all different stamps guaranteed to catalogue over \$10.00, offered to approval applicants for only 25c. Edgewood Stamp Co., Dept. C., Milford, Conn.

To approval applicants enclosing 10c for our Marvel Packet of 55 different from Gabon, Togo, etc., we will send—absolutely free—a genuine scarce South African triangle stamp! Curhan Stamp Co., Gloucester, Mass.

LOOK—50 Different Unused French Colonials, 8c to approval applicants. Want lists filled. Stamp Shop, 515 West 175th, New York.

INTERESTING one and two cent approvals, loose leaf books. Reference necessary. Ogden Stamp Shop, Baidwinsville, N. Y.

200 DIFFERENT, 20c; 500 Different, 45c; 1,000 Different, 95c. Price list of Packets and Sets Free. Set of Picture Stamps Free with First Order. N. Newstead, 1451 Broadway, New York.

100 STAMPS free. Postage 2c. The Philatelist, 830 Fern Place, Johnstown, Pa.

16 ARMENIA, 16c; 11 Albania, 11c; 3 Abyssinia, 6c; 10 Azerbaijan, 20c; 26 Alenstein, \$1.00; 6 Angola, 6c. Frederick Jackson, Dos Rios, Calif.

FOREIGN Revenues, Telegraphs, Locals, envelopes, rails, etc., pretty, different, cheap. Stamped Marine Policy free to applicants with references. Vanderhoof, 1114 Logan, Denver, Colo.

200 STAMPS 15c, 15 Africa, British or French Colonies 10c. Fine stock for approvals. Harvey Teeple, Decatur, Ind.

1,000 DIFFERENT stamps, 80c; 2,000, \$3.50; 3,000, \$10.00. Fred Onken, 630 79th Street, Brooklyn.

STAMPS, 100 different 20c. Bargain packet list with order. Tiptop approvals. Reference required. J. M. Ryan, Box 2004, Louisville, Ky.

FREE—100 different to approval applicants. John Cooley, Fort H. G. Wright, N. Y.

105 DIFFERENT, one dime. Also particulars how you can get 1,000 different or cash premium free. Duplex Service, W. Farmington, Ohio.

500 DIFFERENT, 24c; 1,000, 59c; 2,000, \$2.39. Price List free. Wineholt Stamp Co., Woodbine, 26, Penna.

STAMPS—2,000 varieties \$3.75. R. O. Humphrey, 34 Van Houten Ave., Passaic, N. J.

10 NYASSA Camels and Giraffes 9c to approval applicants. Patapose Stamp Co., 4811 Ferndale Ave., Baltimore, Md.

100 DIFF. revenues, \$3.00 value—27c. Oscar Hartman, 3803 Humboldt, Denver, Colo.

1,000 HINGES and Confederate Bill 8c. only to real applicants for approvals. Pettet Bros., 962 S. Boulevard, Atlanta, Ga.

START a Stamp Collection—70 different stamps from 70 different foreign countries, including Africa, Asia, Australia, Europe, West Indies, etc. Our pamphlet which tells "How to make a collection properly," and price list of albums, packets and sets all for only 16 cents. Queen City Stamp Co., Room 36, 604 Race St., Cincinnati, Ohio.

AUCTION Sales Catalogue free. Wineholt Stamp Co., Woodbine, 26, Penna.

PRECANCELS, 110 diff., 25c. M. Grosser, 1824 N. Harding Ave., Chicago, Ill.

EXCHANGE stamps, postcards, etc. Interesting booklet, 10c. Ed Erickson, Elroy, Wis.

109 DIFFERENT, Abyssinia, Azerbaijan, etc. 10c to Approval Applicants only. Floyd Marsh, 524 Hamilton Ave., Indianapolis, Ind.

108 STAMPS, Chad, etc., album, 4c to approval applicants. Hill, Leonard St., Waltham, Mass.

SELLING out 1,000 Foreign Stamps 20c; 3,000 for 50c. Craven Stamp Co., Thompsonville, Conn.

FREE. Harding Precancel Catalog Two Dollars. Ralph Mack, Goshen, Ind.

105 DIFFERENT and bargain list 4c. Walter Oliver, Williamsville, N. Y.

THOUSANDS Different Stamps—1c Each! Big Lists Free! Supreme, 2335-7 S. Turner, Chicago.

110 DIFFERENT Stamps, many unused, high values, free to collectors requesting our Net Approvals. Postage 2 cents. Christensen, Milwaukee, Wis.

BARGAINS: Scott's Postage Stamp Catalogue \$2.00; 1,000 different Foreign 94c; English Hinges, 1,000, 10c; 1,000 Unused Foreign, 50c; 1,000 used 35c; 50 dif. U. S. 10c; Album, holds 4,000 stamps, 70c; Album, holds 1,000, 16c. Request Sunflower Approvals. Price List. Sunflower Stamp Co., Hutchinson, Kans.

FREE Gifts. Send for list. Puritan Syndicate, Schenectady, N. Y.

THREE Sets Persia, 1915 Cat. \$14.64, only \$1.99. Order today. Wineholt Stamp Co., Woodbine, 26, Penna.

BUY collections without purchasing duplicates. Write Farley Stamp Co., Auburn-dale, Mass.

25 FRENCH Colonials Free. Approvals. J. D. Shaw, 668 Lincoln Ave., Hawthorne, New Jersey.

SEND \$1.00 for my Approval Sheets of Foreign Stamps. Fine. 200 British Colonies, all different, \$1.25. C. Taylor, 15 Cross St., Newport, R. I.

500 MIXED U. S. and foreign stamps 15c. Glenwood Stamp Co., 30 Athol Street, Springfield, Mass.

BIG premiums to approval applicants. Noecker, 1261 N. 10th, Reading, Penna.

U. S. 16 cent Airmail Stamp to Approval Applicants giving references. 2c postage. Jones, 828 South Williams, Denver, Colo.

150 GOOD Mixed Foreign stamps, 3 cents. Stanton, Niantic, Conn.

BEST one cent approvals in America. F. P. Hand, 1117 So. 60th St., Philadelphia, Pa.

110 NEW Europe All Different, a wonderful collection cataloging several dollars, free to collectors requesting our Net Approvals. Postage 2 cents. Badger Stamp Co., Milwaukee, Wis.

24 VARIETIES Cuban stamps, 10 cents. List of 6,000 low-priced stamps free. Address Chambers Stamp Co., 111P, Nassau St., New York City, N. Y.

500 DIFF. Asiatic, So. Amer., African, etc., album, perf. gauge, hinges, list. All for 40c. Oroo Stamp Co., 12 Geary 206, San Francisco, Calif.

COVERTCO Packet, 250 varieties unused and used stamps 15 cents. Covert Stamp, 39 State, Rochester, N. Y.

20 UNUSED stamps free. All different. Postage, 2c. P. M. Fisk Stamp Co., Toledo, Ohio.

1,000 ALL different stamps \$1.00. New price list of all United States stamps free. Voorhees, 7 South Dearborn St., Chicago.

500 DIFFERENT Stamps, Egypt, Sudan, Syria, Lebanon, Allanites, Palestine, Iraq, Arabia, Persia, Somalia, Eritrea, Abyssinia, Alexandria, Port Said, British, French, Portuguese Colonies, etc. Value \$40, post free \$3. Bazar Agency, Box 20, Port-Tewfik, Egypt.

PACKET of 23 stamps, no two countries alike. Packet hinges. Set of \$1 and \$2 U. S. Rev., all for 5c. P. M. Miami Stamp Co., Toledo, Ohio.

FREE! Loose Leaf Postage Stamp Album at rate of 8 pages each month given with subscription to monthly Journal. Send 2c stamp for prospectus. United Stamp Co., Marquette Bldg., Chicago, Ill.

STAMPS, 100 all different. Postage 2c. Lists free. P. M. Quaker Stamp Co., Toledo, Ohio.

300 DIFFERENT Germany, 75c; 25 Luxembourg, 25c; 6 Haiti, 7c; 40 Denmark, 12c; 23 Epirus 30c. Frederick Jackson, Dos Rios, Calif.

105 CHINA, etc. 2c. Album (500 illustrations) 3c. Bullard, Sta. A, Boston.

STAMPS on approval 1/4c up. Free premium. Herbert Keigwin, Middletown, N. Y.

SESQUICENTENNIAL Specialty! "Exhibition," "Charity," "Coat-of-Arms," "Pictorial," "Airmail," "War Sufferers," six wonderful sets; packet beautiful British, French, Portuguese Colonies; 100 different foreign. Big value, 15c, to approval applicants. Deering, 38 Fairmount, Marlborough, Mass.

STAMPS—1,000, 25c; 500 different, 35c; 1,000, 90c; 2,000, \$3.75. Album holds 2,000 stamps. 60c. Micheal, 4444 Clifton, Chicago.

100 DIFFERENT U. S. stamps 40c; no cut squares. Approvals all countries; send reference to M. L. Cook, 527 West 46th Street, Chicago, Ill.

STAMPS sent on approval at 70% discount. Reference required. Emory Renoll, Hanover, Pa.

FREE! 25 different United States with 60% discount approvals to reliable parties. Seidenberg, Baroda, Mich.

UNITED STATES— Send on approval. Send me your want list. Ref. Please. M. Hanna, New Kensington, Pa.

1,000 MIXED U. S. and Foreign Stamps 25c. Phil. Lunsted, Cape Cottage, Me.

FREE 40 Czecho Slovakia Stamps to approval applicants. 2c Stamp. Lightbown's, Osborne Rd., Southsea, England.

FREE. 200 different stamps to approval applicants. Auburn Stamp Co., 767 Irving, Syracuse, N. Y.

50 VAR. Scandinavians 10c. Gronberg, Box 5441, Philadelphia, Pa.

UNITED STATES and Foreign Money, Medals, Catalogue and Villa Bill 10 cents. Alexis Mengelle, Colorado Springs, Colo.

TRIANGULAR Stamps—One Nyassa, one Liberia and one Flume for 5c. Eight Portuguese Colonials added for good measure. Crowder Company, Waverly, Baltimore, Md.

200 DIFFERENT stamps 10c; 1,000 Hinges 10c. R. H. Carlton, 380 W. So. Temple, Salt Lake, Utah.

RARE COINS

UNITED STATES Commemorative Half Dollars in uncirculated condition at bargain prices. Columbian, 69c; Alabama, \$1.13; Lincoln, \$1.23; Pilgrim, \$1.23; Grant, \$1.23; Missouri, \$1.89; Monroe, \$1.13; Maine, \$1.33; Huguenot, \$1.23; California, \$1.23; Vancouver, \$1.23; Stone Mountain, \$1.23; Lexington, \$1.13; Sequoi, \$1.23. White Cent and bargain Price List 10c. Arey, Box 483, Muskogee, Okla.

50,000 COINS, medals, bills. Retail catalogue free. Illustrated books showing prices paid 10c. Nagy, 8P South 18th, Philadelphia.

40 OLD coins all different \$1.00, 100 different Germany War Coins \$2.00. Alabama Half-Dollar, Uncirculated, \$1.25. Stone Mountain Half-Dollar Uncirculated \$1.00. Claud Denney, Box 315, Dallas, Tex.

CALIFORNIA gold Quarter 2c. Half 5c; 1827 dime 40c; 1857 5c, 15c; 1775 Colonial shilling 40c. A. Wylie, Wheaton, Ill.

8 DIFFERENT Coins 25c. Half Dime 15c. Brooks, 2725 1/2 Live Oak, Dallas, Tex.

RARE Coins, Bank Bills, Stocks, Bonds, Bought and Sold, 3 different Bills, 2 Coins and Price List 10c. Geo. Best, Cedar Rapids, Iowa.

OLD Money Wanted. Will pay \$100.00 for 1894 Dime, 8c. Mint, \$50.00 for 1913 Liberty Head Nickel (not Buffalo). Big premiums paid for all rare coins. Send 4c for Large Coin Folder. May mean much profit to you. Numismatic Co., Dept. H, Fort Worth, Tex.

GET Profit and Pleasure in collecting Old Coins. Send 10c for Large Illustrated Coin Catalogue. You'll be delighted with it. Send for it right now. B. Max Mehl, Numismatist, Mehl Bldg., Dept. P, Fort Worth, Texas. Largest Rare Coin Firm in the U. S.

TWO different medals 25c; coins bought. Durso, 25 Mulberry, New York City.

UNITED STATES, Large Cent, two-cent bronze, three-cent nickel and Bargain List, 25c. Fifteen dates large cents, \$1.00. George Coffin, Greenwood Mountain, Me.

CALIFORNIA gold, 3/4 size, 27c; 1/2 size, 53c; three-cent-piece and catalogue, 10c. Norman Shultz, Box 746, Salt Lake City, Utah.

\$2 to \$500 Each Paid for hundreds of Old or Odd Coins. Keep All Old Money. It may be very valuable. Send 10 cents for Illustrated Coin Value Book, 4x6. Get Posted. Guaranteed Prices. We Buy and Sell. Clarke Coin Office, LeRoy, N. Y.

OLD Coins, Large Fall Selling. Catalogue quoting prices paid for coins, ten cents. William Hesslein, 101A Tremont Street, Boston, Mass.

FOR BOYS

BOYS and Girls, Earn Xmas Money. Write for 50 sets St. Nicholas Christmas Seals. Sell for 10c a set. When sold send us \$3.00 and keep \$2.00. No Work—Just Fun. St. Nicholas Seal Co., Dept. 43PM, Brooklyn, N. Y.

WOODWIN Electric Motor, high speed from one dry battery. Postpaid one dollar complete with starting switch, fan and grooved pulley. Ritter Manufacturing Co., 314 Washington Street, Brooklyn, N. Y.

ENTERTAINMENT for Boys! Our latest Movie Machines and durable Steel Toys are just the thing for real play. Catalogue Free. D. F. Elder & Co., Dept. C, Chelsea, Mass.

LIST free, boys magazines, fourth subs. prices. Spencer-Kiln Agencies, West Los Angeles, Calif.

FILMS for Toy Machines, 200 feet \$1.50 Postpaid. Dixie Film Co., Box 2042, Memphis, Tenn.

CAMERAS AND PHOTO SUPPLIES

PHOTOGRAPHIC equipment and accessories of every description are listed and illustrated in our 228-page catalogue. It will pay you to secure a copy which is issued free, as our prices are low. We also deal in used goods which are sold under the same guarantee as new goods. Ask for our Bargain Book. Central Camera Co., Dept. E112, 112 S. Wabash Ave., Chicago, Ill.

STATUETTES from Your Films. Send us any negative or picture with \$3.00 and we will make you Enlarged Statuette, and Artkraft Base. Instructions on Trick Photography 25c. Catalog free. Matusek's Studio, 1518 W 21st St., Chicago.

MODERN Photography in all its branches now taught by mail. New Successful Method. Students earning \$300.00 while learning. Big opportunity. Write for particulars and unusual offer open for short time. Dept. 3431, International Studios, Inc., 3601 Michigan Ave., Chicago.

KODAK Films—Special trial offer; your next kodak film developed, 5c—prints, 2c each. Moser & Son, 1917 St. James Ave., Cincinnati.

LEARN Filmless Photography. New discovery. Instructions and samples \$1.00. Satisfaction guaranteed. Sample photos 10c. Koch's Studio, Colbran, Colo.

BIG Money Saved on Photographic Lenses and Apparatus—goods exchanged; repairing done. Ralph J. Golsen, 1128 Argyle St., Chicago, Dept. P.

FILMS Developed. Special Trial Offer. Any Size Kodak film developed 5c, prints 3c each. Trial 6x10 Enlargement in handsome folder 40c. Overnight Service. Roanoke Photo Finishing Co., 209 Bell Ave., Roanoke, Va.

CALENDARS from Your Films—Send us any negative with 25c and we will make for you a 1927 calendar with the picture from your film artistically mounted. Frank Scobie, Photographer, 68C Sleepy Eye, Minn.

HAVE You a Camera? Write for Free sample of our big magazine, showing how to make better pictures and earn money. American Photography, 110 Camera House, Boston, 17, Mass.

MAKE \$75 to \$250 weekly; Motion Picture, Portrait and Commercial Photography. Camera Free. For Special offer, write New York Institute of Photography, Dept. 49A, 10 W. 33rd St., New York.

UNEXCELLED Gloss Prints. Trial Offer. Your Kodak Film Developed and printed only 10c. F R B Photographers, Dept. "C," 1503 Lincoln Ave., Cincinnati, Ohio.

KODAK Film—Special Trial Offer—Your next roll developed 5c, prints 3c each. Beautiful 6x10 mounted Enlargement 40c. Sameday Service. Fleet Photo Service, 1210 G. N. W., Washington, D. C.

KODAK and Graflex Bargains. Ray, 296 5th Ave., New York.

MOTION PICTURES

FILMS: \$3.00 per reel up. Comedy, Western, Cartoon, Drama, Serial, Educational, Special Features. Best Movie Stars. Free List. Toy Film 200 Feet Postpaid \$1.50. Dixie Film Co., Box 2042, Memphis, Tenn.

NEW and Rebuilt Projectors for Theaters, Schools, Churches, Traveling Shows. Supplies and Complete Theater Equipments. Bargain Prices. Free Catalog. Monarch Theatre Supply Co., Memphis, Tenn.

NEW 150 Spring Motor Movie Camera, \$37.50. Negative Film 2 1/2 cents foot. Printer \$25. Movie Developing Outfit \$25. Movie Projector \$20. Comedy Film \$5. Drama \$2. Lantern slides 20 cents. Twin Arc Movie lamp \$25. Ray, 296 5th Avenue, New York.

MOVIE films, 1,000 ft. reels. Complete stories, \$2.50 each; shipped anywhere on receipt of remittance with order. Independent Films, 177 Golden Gate Ave., San Francisco, Calif.

FILMS—\$3.00 Up. Exchange Privilege. Projectors, Supplies. Lowest Prices. Howard Leiber, 623 W. 170th St., New York.

BARGAINS: Machines, Stereopticons, Films, Supplies. National Equipment Co., Duluth, Minn.

\$\$\$ FOR Ideas. Photoplay Plots revised, criticized, copyrighted, marketed. Send for free booklet. Universal Scenario Company, 244 Security Bldg., Santa Monica and Western Ave., Hollywood, Calif.

SEND \$2.00 for startling new Cinemeter. Gives exact exposure for all Movie Cameras or lenses. Fits pocket. Free Bargain List of Motion Cameras. Bass Camera Company, 109 North Dearborn Street, Chicago, Ill.

LARGEST Concern in the Country Handling Home Movie Films and Toy Machines. Western, 730 S. Wabash, Chicago.

25-VOLT, 30 Ampere Mazda Lamps, \$2; Motors cheap. Ray, 296 5th Ave., New York.

SCENERY TO RENT

WORLD'S Most Beautiful Settings for operas, plays, minstrels. Amelia Grain, Philadelphia.

EDUCATIONAL AND INSTRUCTION

YOU can have a business profession of your own and earn big income in service fees. A new system of foot correction; readily learned by anyone at home in a few weeks. Easy terms for training; openings everywhere with all the trade you can attend to. No capital required or goods to buy, no agency or soliciting. Address Stephenson Laboratory, 1 Back Bay, Boston, Mass.

ARTIFICIAL Marble sanitary flooring instructions, ornamental casting, concrete, plaster, papier-mache decorations, garden furniture, statuary, Rubber-moulds, 17 years instructing the public; particulars and illustrations free. Chris. Mahler, Huntington, N. Y.

\$115-\$400 MONTHLY paid—Ry. Station—office positions. Free passes, experience unnecessary. Write Baker, Supt., (ABT) Star Bldg., St. Louis, Mo.

USED educational matter. Lowest prices; terms. Catalog free. Mention Subject. Fred Goetz, 440-A Sansome, San Francisco.

USED Educational Matter bought, sold, exchanged. Bargain Catalogue Free. Handling, 799 Broadway, New York.

USED educational matter of all kinds. Sold on repurchase basis. Big saving. Money-back guarantee. List free. (Courses bought.) Lee Mountain, Pisgah, Ala.

ARE You Interested in Writing short stories, poems, songs, photoplays, For Profit? Then send for our new edition of actual letters from prominent editors, who want your manuscripts. It's Free if you send for it Now. Address M. Mendelsohn, Editor, Dept. 102, Writer's Digest, 22 E. 12th St., Cincinnati, Ohio.

MEN wanting forest ranger positions. \$1,500-\$2,400. Write for particulars and list Natl. forests. Mokane, A-21, Denver, Colo.

EARN \$25 weekly, spare time, writing for newspapers, magazines. Experience unnecessary. Details Free. Press Syndicate, 981 St. Louis, Mo.

SALESMANSHIP—Condensed Course Covering Entire Subject two dollars. Benjamin Rosenberg, 334 Albany Ave., Brooklyn.

DRAFTING taught—by Structural Engineer. Kasdorf, 1063 Holton, Milwaukee, Wis.

PORTRAIT Drawing taught by mail. One lesson and particulars 25c. O. Heuser, 4356 N. Lincoln St., Chicago, Ill.

SONG Poem Writers—write Ray Hibbele, D15X, 2104 N. Keystone Ave., Chicago.

BACKWARD children trained and cared for. Wilson Schools, Dayton, Ohio.

INSTRUCTION books, all kinds. Catalogue free. Wineholt Book Co., Woodbine, 4, Penna.

SHOCARD writers, Artists, Pressmen—Mix 500 beautiful colors (proportions). Prepaid \$1.00. Art Publishers, 2033-37 College, Indianapolis, Ind.

SEE New York Institute of Photography Advertisement under Trade and Technical Schools.

DOUBLE Entry Bookkeeping mastered in 60 hours with 8 keys; guaranteed; diplomas. International Bookkeeping Institute, Dept. 8, Springfield, Mo.

YOU need a better grip on mathematics? Tell us to send you a copy of "Mathematics for the Practical Man" only \$1.50. By common sense methods it removes the mystery and difficulties so algebra and calculus are made simple. Assuming your knowledge is limited to arithmetic you quickly and easily gain a working knowledge of Algebra, Geometry, Trigonometry and Calculus. Simply pay postman when he hands you the package. Address Popular Mechanics Press, Room S12, 200 E. Ontario St., Chicago, Ill.

RADIO OUTFITS AND SUPPLIES

NEW 600-Mile Radio without Batteries. Only \$2.95 postpaid. The ideal Christmas Needs no tubes or batteries. 250,000 satisfied customers. Order your radio from this adv. Crystal Radio Company, Wichita, Kans.

500-MILE "Pocket" Radio, \$2.00. No Tubes nor Batteries required. Useful and practical; loudspeaker volume. Order direct today. Spencer Laboratories, 118 Atlas, Akron, Ohio.

RADIOS—Five tube sets \$22.50 delivered. Tubes 95c. Literature Free. Agents Wanted. Seminole, 427 East 16th, New York.

SAVE 33 1/2% on all your radio supplies! Order by mail. Eliminate the storekeeper's profit. We handle only guaranteed quality products. Write for price list now. Midwest Engineering Supply Co., Dept. M, 3318 W. Harrison St., Chicago, Ill.

\$10.00 FOR all Part of a "B" eliminator using a 201A tube; 50H chokes \$2.00. 30H chokes \$1.75. Write for list. Radio Parts Sales Co., Box 24, Orange, N. J.

CROSLEY Radios and Loudspeakers; new, guaranteed, latest models at greatly reduced prices. J. Noid, 27 Chestnut St., Schenectady, N. Y.

GUARANTEED 5-Tube Sets (No Howling), \$29.50. Standard Radio Co., Monroe, Wis.

LONG Distance "Pocket" Radio, \$1.95 Postpaid. No Tubes, No Batteries, Compact and useful; not a toy. Order direct. Spencer Radio, 116 Atlas, Akron, Ohio.

RADIO Accessory Agents—We manufacture a first class quick selling Radio "B" device with two year guarantee. Thousands in use. Write. Kimley Electric Co., 2663 Main St., Buffalo, N. Y.

BUY one Power tube and receive one Standard tube "Free." Write. C. J. Allgey, 106 Lafayette St., Glendale, N. Y.

RADIO Balking? Valuable information, stamp. John M. Fisch, Sigourney, Iowa.

TRADE AND TECHNICAL SCHOOLS

GET a Foreman's Job in any trade. Train yourself to earn more money. Become an expert Blue Print Reader. You can do it in spare time. My training will give you advancement in a few weeks. Write now—tell me what trade you want—I will send my plan at once. Carroll Rumsey, 165 Drexel Bldg., Philadelphia, Pa.

LEARN to Paint—Best Paying trades—in a few weeks. Paperhanging, Interior Decorating, Sign Painting, Auto Painting, Show Card Writing. Send for Free Catalog. Chicago, Painting School, 144 West Austin Ave., Chicago.

TELEGRAPHY—Both Morse and Wireless—taught thoroughly and quickly. Tremendous demand. Big salaries. Wonderful opportunities. Expenses low; chance to earn part. School established fifty years. Catalog free. Dodge's Institute, Fern St., Valparaiso, Ind.

LEARN Bricklaying at home or in school run by contractors. Catalog free. Associated Building Employers, F400, A. B. E. Building, Grand Rapids, Mich.

FOREMANSHIP. Approved short course. Easy terms. Write for information. Industrial and Commercial Institute, 2207 Arlington Avenue, Middletown, Ohio.

MAKE \$75 to \$250 weekly; Motion Picture, Portrait and Commercial Photography. Camera Free. For Special offer, write New York Institute of Photography, Dept. 49A, 10 W. 33rd St., New York.

MEN wanted to learn machine and tool making. We give you actual practice. G. & L. Machine Works, 1926 So. Wabash Ave., Chicago.

BUSINESS OPPORTUNITIES

PROFIT of \$600 to \$1,000 goes into pockets of each distributor of Bows Seal-Fast line Automotive Products. One of the finest, cleanest manufacturing and sales organizations in the U. S. A., with highest grade financial and bank references showing unusual record of growth, has several openings in good territories. Must show proof of capacity to handle systematic distribution of products of excellent merit, backed by constant national advertising. No answer wanted unless complete details of past record and present standing are given. If you are the right man we have the foundation of a growing, independent and highly profitable business for you. Address: Sales Manager, Bows Seal-Fast Corporation, Indianapolis, Ind.

EARN \$8.00 at home by learning Photo-Retouching. Write, American Art Studio, Auburn, N. Y.

HIRE yourself as Boss! \$250 a week easily made making these Big-selling Specialties. 300% to 900% Profit. Investment Small. No machinery needed. Let me show you how to make Heetit the New German anti-freeze preparation for Radiators; Fibro-seal Guaranteed Puncture Proof; Para-ulkine, no-cement Instant Weld Patch; Super-Radiolyte, 20-minute Battery charging Liquid, and 30 other big money-makers in the House-hold, Food Beverage and Toilet Specialty lines. Valuable Literature Free! Miller, Chemist, 1706-C Jetton, Tampa, Fla.

100 QUICK Profit, Honest, Guaranteed Workable Mail Order Plans and complete instructions including detailed working specifications of plans that have made fortunes. A high-class, complete publication, finished in 1926. Covers all departments of the mail order business. Also teaches you clearly to originate plans of your own and put them into immediate operation. The only work of its kind ever published. Written by fully competent and reliable authority. Mail Order Service, Box 93, Omaha, Nebr.

START a manufacturing business of your own. Earn \$100 weekly. Make your own products. Formulas, toilet articles, perfumes, soap, extracts, etc. We furnish everything and show you how. Valuable catalog free. National Scientific Laboratories, 1934W Broad, Richmond, Va.

PATENTS. Time counts in applying for patents. Don't risk delay in protecting your ideas. Send sketch or model for instruction or write for Free book "How to Obtain a Patent" and "Record of Invention" form. No charge for information on how to proceed. Communications strictly confidential. Prompt, careful, efficient service. Clarence A. O'Brien, Registered Patent Attorney, Security Bank Building (directly across street from Patent Office), Washington, D. C. See pages 170 and 171.

LEARN Furcraft—Big Profits Waiting in Every Community. Easily Learned at Home in Your Spare Time. Get into a High-Grade Business for Yourself. Uncrowded Field. No Peddling or Soliciting. We Teach You How. Be First. Write Today for Illustrated Booklet. It Is Free. No Obligation. Northwestern Fur Co., Suite 9779, Sunderland Building, Omaha, Nebr.

\$750,000.000 MAIL order business in 1925. Many grow rich in this great trade. Sell merchandise, information, patented articles various preparations. Breniser's Famous Mail Order Handbooks tell how. Eleven brochures \$3. One book with complete catalog, 25c; none free. Breniser, (Established 1900), 1607 Sansom, Philadelphia.

MAKE—Sell Your Own Goods. Formulas by experts. Manufacturing Processes. Trade-Secrets. All kinds. All lines. Catalog, circulars free. B. Thaxly Co., Washington, D. C.

MIRRORS Resilvered at Home. Costs Less 5 cents per square foot; you charge 75 cents. Immense profits, plating like new; brassy, worn-off autoparts, reflectors, tableware, stoves, etc. Outfits furnished. Details Free. Sprinkle, Plater, 127, Marion, Ind.

COLOR Christmas Cards at home. Light pleasant work, pays good money. Send \$1 for trial outfit containing 24 beautiful cards and envelopes to match. Cards when colored usually retail 15c 20c each. Arts & Crafts Company, 3668 S. Michigan Avenue, Chicago.

NEW Mail Order Business. For Particulars Send Name and address only. R. Kelly, 304 Empress Theatre Building, St. Louis, Mo.

MAIL-ORDER Business Plan—Begun on very few dollars, builds to big enterprise; entirely new idea; no newspaper or magazine advertising; exclusive goods; unusual opportunity; send for circular. The Wholesale Company, 473-5 So. Arlington, Akron, Ohio.

GUARANTEED Mail-Order Idea. Successful. Double Income. Legitimate. Stamped envelope brings information. W. E. Johnson Co., P-5428 South Wells, Chicago.

ARE You Old at Forty? See our advertisement on page 68 of this issue. The Electro Thermal Company, 2164 Main Street, Steubenville, Ohio.

BUILD Up your business charging batteries. The Scioto Battery Charger does it economically and costs only \$50 to start. Azams-Barr Co., Columbus, Ohio.

MAKE Big Money Safe and Lock Expert. Wayne Strong, 3705 1/2 Lan Franco St., Los Angeles, Calif.

ENTER a new business. Earn \$3,000 to \$6,000 yearly in professional fees making and fitting a foot specialty, openings everywhere with all the trade you can attend to; easily learned by anyone at home in a few weeks, at small expense; no further capital required, no goods to buy, job hunting, soliciting or agency. Address Stephenson Laboratories, (1) Back Bay, Boston, Mass.

\$3,000 TO \$5,000 Yearly. Want it? Others are making it. Send check or money order today for our invaluable books "How to Sell Real Estate," \$3.00—and "How to Conduct Real Estate and Insurance Business," \$1.50. Absolute satisfaction guaranteed. Free circulars. Realty Book Co., Dept. 52, Cleveland, Ohio.

CHRISTMAS novelty sold merchants. Exclusive territory to financially responsible representatives. Big demand. Big money. Consolidated, 67A West Van Buren, Chicago.

SELL your Pictures. All kinds. List of 90 buyers \$1.00. Start now. Address Wilson, Box 243, Michigan City, Ind.

MAKE Money at Home—spare or full time. Our new book, containing 20 Money-Making Plans sent postpaid, 50c. Crittenden, 4122 West 21st Street, Chicago.

OPERATE money-making mail-order business in spare time. Write for free particulars. Triangle Mail Order Service, 600 Blue Island Ave., R31, Chicago.

MAIL order Booklet, where to buy Books, Novelties, Specialties, 10c. Harvey Teeple, Decatur, Ind.

CAPITAL secured for invention, any business proposition. Inexpensive, reliable method. Interstate Service, Elizabeth, N. J.

MANUFACTURE New, Fast-selling, novelties, toys, auto, toilet and agent's specialties. Free Bulletin describes reliable plans, patterns, processes, commercial information. Manufacturer's Bureau, 1129A, East 31st, Kansas City, Mo.

BEING first to invent a pocket device (1,488,376) for immediately withdrawing the poison of snakes, animals, insects, etc., from the wound, would like to hear from those financially interested. Stephen O. Bryant, Bethany, Mo.

SELL or make Art Novelty—beautiful gift. Sample 50c. Graeme Studios, 541 N. Michigan Blvd., Chicago.

65 MILES on 1 Gallon—Wonderful Gas Saver. All autos, 1 free. Critchlow, 805-Z, Wheaton, Ill.

EARN \$15.00 Daily. Qualify as an Expert Automobile Refinisher, Retrimmer, Cleaner, Interior Decorator. Make automobile specialties. Modern Trade Practice Quickly Learned at Home—Endorsed Everywhere. DeWilde, Sheboygan, Wis.

ENORMOUS Profits Manufacturing Candy. Details for Stamp. Haffitzel, 7377-J, Lincoln, Neb.

INCH Display Advertisement 100 Magazines Year \$32. Wood's Popular Service Co., Atlantic City, N. J.

I WILL Start You in business, supplying plan and first stock for only \$1.00. Satisfaction or your money back. Liebig's, Beaver Dam, Wis.

MONEY—French Cleaning. Garment Dyeing. 378-Page Chemical Receipt Book \$3.00. A. Barnes, Helena, Ark.

JUST Out—United Big-Mail Directory 16c. Wetzel, Valhalla, N. Y.

START spare time Mail business. Sample circulars 10c. Kentucky Agency, Covington, Ky.

SHERIDAN'S Directory. Latest. Largest and Best Buyer's Guide. Wholesale Supply Sources for Thousands of Articles, \$1.00. S. Van Auken, 34 Richton, Detroit, Mich.

CONSULTOR advises you confidentially to achieve success. Box 74, Brooklyn, New York.

NEW Money Making Schemes. 100 Business Ideas and Plans. Endless array of opportunities for ambitious people to establish profitable business. Price Postpaid \$2.00. Circular free. Colonial Mail Order Co., Box 369, Morristown, New Jersey.

MINIATURE Die - Casting Machines \$56.00. 318 Reed St., Erie, Pa.

SIGNS and Showcards Easily painted with Letter Patterns. Large variety of Styles and Sizes. Write for free samples. John Rahn, 2120 Neva Ave., Chicago.

RESPONSIBLE manufacturer wants competent men to manage office and salesmen, \$300 to \$1,500 necessary; will allow expenses to Trenton if you qualify. Address Manager, 536 Forst Richey Bldg., Trenton, N. J.

MAIL Order News contains latest money-making schemes, opportunities and suggestions showing big profits. Complete instructions how to start profitable Mail Order Business of your own. Everything explained. Sample copy of this big magazine 25c. None Free. Established 23 years. Mail Order News, 360 Bristol Bldg., New York.

PATENTS Procured; Trade Marks Registered—A Comprehensive, experienced, prompt service for the protection and development of your ideas. Preliminary advice gladly furnished without charge. Booklet of information and form for disclosing idea free on request. Richard B. Owen, 30-Owen Bldg., Washington, D. C., or 41-R Park Row, New York.

MECHANICS, painters, carpenters, start furniture refinishing, painting, handyman shop on nearly nothing; winning plan brings customers quickly. John Braceland, 1439 So. Ninth, Philadelphia, Pa.

SCHEMER, Alliance, Ohio, 36p monthly, prints mammoth \$-getters. Subscriber reports \$25,000 from three; another \$10,000 from one. Try your luck. Year, \$1.00; 3 months, 30c.

DELAWARE Incorporator. Charters; Fees Small; forms. Chas. G. Guyer, 901 Orange St., Wilmington, Del.

MAKE Money at Home—making toys. We show you how. Send \$1 for complete working drawings and instructions. DeKalb Designing Co., Decatur, Ga.

I MADE \$30 a Week Home. French Breadmaking. 15 years' experience; Free Booklet tells. Ashbrook 67, Marengo, Ohio.

UNPATENTED Ideas Can Be Sold. I tell you how and help you make the sale. Free particulars (Copyrighted). Write W. T. Greene, 810 Jenifer Building, Washington, D. C.

SELL Pro-Tex-Chex. A Check Protector. Sample 25c Postpaid. Goldstein Bros., Santa Cruz, Calif.

WE Start You in Business, furnishing everything; men and women, \$30.00 to \$100.00 weekly operating our "New System Specialty Candy Factories" anywhere. Opportunity lifetime; booklet free. W. Hillyer Ragsdale, Drawer 4, East Orange, N. J.

MAKE toys and novelties at home. Big profits. Instructions and illustrations, 25c. Astrolite Company, Sharpsburg, Pa.

SMALL fortunes being made in uncrowded Baby Chick Industry. \$3,000 to \$5,000 first year not unusual. Business keeps growing; unlimited demand. Valuable booklet explains fully, tells what to do, how to do it. Send 25c to cover mailing, etc. Limited supply—Write Now! Wellington J. Smith Co., 551 Davis-Farley Bldg., Cleveland, Ohio.

CHEMICAL Expert will furnish Formulas and Trade Secrets. All lines. Lists Free. W. L. Cummings, Ph. D., 228 Gordon Ave., Syracuse, N. Y.

600 WAYS to Make Money; 3,700 Formulas—Plans. "Encyclopaedia Business Opportunities." 3 Volumes \$1.25. Catalog Free. Ideal Book Shop, Park Ridge, Ill.

MARBLE mixing instructions, covering wood or cement flooring 1/2 inch thick, fireproof, waterproof, low cost, sanitary, all colors. Particulars and illustrations free. Marble and flooring samples 12c. Chris. Mahler, Huntington, N. Y.

LEARN the collection business. Good income, quick results. Interesting booklet, "Skillful Collecting" free. National Collectors Assn., Long St., Newark, Ohio.

EARN \$10 daily silvering mirrors, plating and refinishing metalware, autos, chandeliers, bedsteads, headlamps. Outfits furnished. E. Decie Laboratories, 1133 Broadway, New York.

DON'T gamble in mail order business. Be sure. Free circular puts you wise. MacRae, M40 Oregonian Building, Portland, Ore.

DEALERS—Buy Battery Shop Equipment and Supplies at Wholesale. Get circular No. 131. Adams-Barr, Columbus, Ohio.

TATTOOING Supplies. Illustrated Book free. Manufacturer's Prices. "Waters," 965 W. Putnam, Detroit.

CHRISTMAS novelty sold merchants. Exclusive territory to financially responsible representatives. Big demand. Big money. Consolidated, 67A West Van Buren, Chicago.

NOW that you have read all these offers, send 25c for Detailed Information. (None free.) "How" and "What" to Sell by Mail; through Agents; or Direct! We want 100,000 Representatives! Opportunity is knocking—Answer! Surety Service, Dept. 12, 551 Harvard St., Rochester, N. Y.

WANT More Money? Start Little Mail Order Business. Samples and Plan Free. Mailing Charges 10c. Suydam, 10748 112th St., Richmond Hill, N. Y.

TELEGRAPHY

TELEGRAPHY—Both Morse and Wireless—taught thoroughly and quickly. Tremendous demand. Big salaries. Wonderful opportunities. Expenses low; chance to earn part. School established fifty years. Catalog free. Dodge's Institute, H St., Valparaiso, Ind.

CHEMISTRY

FORMULA by Richards means the best. Your chemical problem solved and working process furnished \$5.00. Write me. W. Stedman Richards, Consulting Chemist, Box 2402, Boston, Mass.

EXPERIMENTERS' laboratory apparatus. Chemicals. List 5c. Chemical Apparatus Co., 4402 West End, Chicago.

FORMULAS AND TRADE SECRETS

FORMULAS. Guaranteed Best Chemical Science can devise. Stamp brings big bunch valuable literature describing Latest Reliable Processes for Manufacturing All Lines. Don't Buy till you've received these Profitable Propositions. No recipe-book Trash. 29 years giving satisfaction. Miller Chemist, 1706-U Jetton, Tampa, Fla.

SPECIAL formulas for Manufacturing and Business purposes. Any one you want, including full manufacturing instructions and where to get all supplies, sent for \$5. Satisfaction guaranteed. Announcements of latest formulas for quick-selling seasonable products sent monthly without charge. Write today. National Information Bureau, 316E Shepherd Building, Grand Rapids, Mich.

MAKE Chili Bricks in Your Community. Sell stores, markets, restaurants, hotels. Manufacture in your kitchen. 200% profit. 5 oz. brick makes 12 dishes fine Chili-Carne. Wonderful opportunity. New Idea. Secret process. Full instructions \$1. Sample brick 35c. Keeps for weeks. Mexican Chili Co., Box 738, Houghton, Wash.

SELF-SHAVING cream without razor. Formula 25c. "Erie," Waukegan, Ill.

500 VALUABLE Formulas, 25c. Circular Free. Harvey Teeple, Decatur, Ind.

BIG Money. Ten guaranteed formulas. Novelty selling plan, dollar bill. M. Lidenberg, Fergus Falls, Minn.

ANY Formula. Dependable, individual attention. Reasonable. No lists. Boyd Hayes, Pegram, Tenn.

MAKE—Sell Your Own Goods. Formulas by experts. Manufacturing Process, Trade Secrets. All kinds. All lines. Catalog, circulars free. B. Thaxly Co., Washington, D. C.

CONCRETE Waterproofing Processes, making Hard, Light Colored Dauppproof concrete building blocks. Concrete Machine Co., 5 Main St., St. Louis, Mo.

NEW specialty formula \$1.00. C. Stevens, 702 Umatilla, Portland, Ore.

SAWDUST. Chemicals makes Sanitary Flooring. Directions \$1.00. Universal Supply Co., Auburn, N. Y.

20c—ANY Formula—20c. Dime Information Bureau, Colorado Springs, Colo.

EASY money maker, just like I use myself; why not you? Particulars for red stamp. W. P. Stump, Hemet, Calif.

3,000 FORMULAS and Recipes for \$1.00. Worth while Formulas, Trade Secrets, etc. 368 pages. E. Kephart, 415 East 73rd, New York City.

START a manufacturing business of your own. Earn \$1.00 weekly. Make your own products. Formulas, toilet articles, perfumes, soap, extracts, etc. We furnish everything and show you how. Valuable catalog free. National Scientific Laboratories, 1934W Broad, Richmond, Va.

10,000 FORMULAS. Write for Free descriptive folder on Henley's famous Formula Book. Elite Trading Co., 311 5th Ave., New York.

10,000 FORMULAS. A real Gold Mine of money-making ideas. Tells how to make almost everything under the sun. You can make and sell cosmetics, muckage, anti-freeze solutions, battery solutions, beverages, cheese, chewing gum, cleaning preparations, extracts, hair preparations, inks, bluing, leather polish, mirrors, perfumes, polishes, typewriter ribbons, carbon paper, washing powders, liquid soap, and hundreds of other profitable articles. Send No Money. Just write a postal for "Henley's 20th Century Book of Formulas." Pay postman postage and \$1. Popular Mechanics Press, 290 E. Ontario St., Room 812, Chicago, Ill.

500 FORMULAS including Luminous Paint—Renewing Dry Batteries—Resilvering Mirrors—Gas Tonic, Puncture Plugger, 25c. Catalog Free. Ideal Book Shop, Park Ridge, Ill.

AGENTS WANTED

I WANT a Partner. Someone to take care of my business in your locality. Make \$15.00 daily; show samples; distribute Teas, Coffee, Spices, Extracts, things people eat. I furnish everything complete, including world's finest super-sales outfit. Highest quality products; lowest prices; big permanent repeat business—quality guaranteed by \$25,000 Bond. With the person I select as my partner, I go 50-50. Get my amazing offer of Chrysler closed car, "free." Write or wire today. C. W. Van De Mark, Dept. 100M, 117 Duane Street, Cincinnati, Ohio.

CHRISTMAS Specialty. Beautifully tinsel art cards, 14x22 inches, all reading "Christmas Greetings, Best Wishes for the New Year"; worth \$3.00; anyone can sell one or more quickly at \$1 or more, each, to nearly every store; cost you 50 cents each; 10 or more 35 cents; 100, 30 cents; 1,000, 25 cents, delivered; active men sell 50 to 100 a day. Write quick for free literature to Consolidated Co., 65-M West Van Buren St., Chicago.

NECK chains—now is the time to sell them for Christmas. Two hand-made bead chains twenty inches for less than the price of one. Send \$1.00 get two chains—sell one for \$1.50. J. A. Weber, 4311 Ravenswood Ave., Chicago.

AGENTS: \$11.80 Daily in Advance, Introducing New Insured Hosiery for Men, Women, Children. Must wear or replaced free. Nylon made \$395 one month; Edwards, 460.60; Mrs. Bonq, \$425.45. Why not you? Even spare time should pay \$3.00 an hour. 57 styles, 39 colors including latest "Silk to the Top" ladies' hose. No experience needed. We furnish samples. Silk hose for your own use free. New Plan. No matter what you are now doing, write quick. Macehee Hosiery Company, Card 25612, Cincinnati, Ohio.

AGENTS—\$11.80 Daily in Advance (Sworn Proof) Introducing New Insured Hosiery. Guaranteed one year. No capital or experience required. Your pay daily. Monthly bonus besides. We supply samples. Silk hose for your own use free. M. H. Mathews, Card 58612, Cincinnati, Ohio.

GREETING Cards—All Kinds, Fancy, Silk-Gelatine, English, German, Spanish, Klees Company, 1710 Undercliff Avenue, New York.

SALESMEN Selling to Men. We have logical side line for you that will sell along with any other line you may now be handling and probably make more money for you, provided you are now selling to men. Get full facts at once by addressing Salesmanager, 844 West Adams, Dept. 628, Chicago.

SALESMEN: Write your name and address on a postal and mail to us. We'll show you sure earnings of \$20.00 a day. Will you risk one minute and a one cent stamp against \$20.00? Mind you, we say we'll show you. Address Dept. 1952, William C. Bartlett, Inc., 870 W. Adams St., Chicago.

DIXIE Two-Color Sign Cards—300% introducing, then \$5 establishing local agency. Sample and catalog, 6c. Camer, 1125 Royal, New Orleans.

REAL Money selling a great new Health Invention generating Violet Ray, Vibration, Electricity and Ozone. Exclusive Territory now open. Write today. Lindstrom & Co., 30 W. Lake St., Dept. 93-59, Chicago.

BIG money-making opportunities; No peddling, Particulars free. Elite, 38 Elizabeth St., New York.

CAN you sell an article everyone needs, actually worth \$2.00, for 97c; give away an article everyone wants; retail price 50c, and still make over 100% profit? Eureka Co., Dept. A, Fairfield, Iowa.

REPEATER Corn Killer 1 1/2c. Sample 25c. Moves, 1231P Clay, Paducah, Ky.

AGENTS. Write for free Catalog. 100 Sure Sellers. House Dresses, Hosiery, Underwear, Shirts, Blankets, Flannels, Novelties, Etc. Economy Sales Co., Dept. 526, Boston, Mass.

PATENTED Pocket Chair. Big money being made by agents everywhere; sells on sight to motorists, campers, tourists, football fans—wherever chairs are needed. Folds to pocket size. Weighs 1 1/2 lbs. Indestructible. Send for sample. Glasvin Import, 96 Fifth Ave., New York.

65 MILES on 1 Gallon—Wonderful Gas Saver. All autos. 1 free. Critchlow, 805-J, Wheaton, Ill.

AGENTS Wanted, Full or part time, to sell on liberal commission, new Thermostatic Automatic Carburetor Control Attachment, for Ford cars. Increases mileage 100 per cent. No holes to drill. Attached in 2 minutes. Does automatically exactly what Ford Manual instructs driver do by hand. Cadillac now using Thermostatic Carburetor Control under Blanche license. Write at once. Blanche Auto Devices Co., Dept. 805-T.X., 157 E. Erie St., Chicago, Ill.

SENSATIONAL 2 for 1 Offer. "Bonds Clothes" are big sellers. Suit and overcoat or two suits for \$29.50. Dress and business clothing made to fit and fit to wear. Latest designs. Venetian lined. \$65 to \$150 weekly. \$5.00 profit. Free outfit includes large double swatch samples (11"x28"). John Bond Tailoring Co., Dept. D12, Jackson and Desplaines, Chicago. Satisfied customers from coast to coast for 37 years.

FOR Christmas. Our Luminous Crucifix shines in the dark and makes a wonderful Christmas present. Our agents always clean up with this Crucifix at this time. W. G. Hannan Co., Dept. B, 2539 S. State St., Chicago.

AGENTS: It's a winner. Combined cigarette and match case. Black grain finish leatherette. Holds Package cigarettes and box matches. Sells on sight. Big profits. Write for details. All-in-One, Dept. A-12, 2810 Portland, Minneapolis, Minn.

AGENTS wanted: To sell the new "Wonderlamp" magnetic trouble light that every motorist will buy on sight. No experience necessary, either full or spare time (evenings). \$5.00 an hour easily made. Wonderful Christmas Gift. If you want to make real money send stamp for particulars. Wonderlamp Company, No. 919 Fisk Bldg., New York City.

START a manufacturing business of your own. Earn \$100 weekly. Make your own products. Formulas, toilet articles, perfumes, soap, extracts, etc. We furnish everything and show you how. Valuable catalog free National Scientific Laboratories, 1934W Broad, Richmond, Va.

AGENTS Rubber Specialties, house dresses, undergarments, sleeping apparel combined to insure large earnings for you. B. & G. Manufacturing Co., Dept. 993, Pittsburgh, Pa.

WRITE for free catalog to sell Nationally Advertised Radio in your own locality. Dept. 5, Harry Berg Co., 394 Hennepin, Minneapolis.

MILLIONS of billfolds are sold every Nov. and Dec. for Xmas presents. Samples sent prepaid. Agents wanted. Get my combination billfolds, check book, and lodge card holder, \$1.50 prepaid. Send all orders to F. E. Williams, Hotel Roslyn, Los Angeles, Calif.

WOMEN—\$2 an hour spare time; new idea sanitary necessity; sells on sight; every woman buys; new feature never before used; designed by physician; revolutionizes old uncomfortable methods; pay every day; no deliveries, no collections, no experience or capital required. Particulars mailed in plain envelope. Don't delay; write Mrs. Mary P. Coleman, Meriden, Conn.

AGENTS—Big money in spectacles wholesale prices. Snoddy Co., St. Louis, Mo.

GENUINE Gold Leaf Letters anyone can put on Store windows. Guaranteed to never tarnish. Large Profits. Enormous Demand. Free Samples. Write today. Metalite Letter Co., 438-D North Clark, Chicago.

"LIQUID-LEATHER" Fills Holes in Shoes, Rubbers, Tires, Dries Instantly. Pliable, Waterproof. Just Imported from France. Tube Retail 75c—Cost 35c. Sells Housewives. Sub-Agents. Nulife Leather, Hartford, Conn.

REFLEX Golf Sticks sell! \$15.00 a day easily made by agents. Every golfer eager to buy golf's greatest and newest invention. Improves any player's game. Highly endorsed by prominent professionals. Write for details. The Reflex Manufacturing Co., 18 West Seventh St., Cincinnati, Ohio.

MAKE and Sell "Waterless Hand Soap"; "Metal Polishing Cloth"; "Rainshed Windshield Wiper." Three Guaranteed Formulas \$1.00. Formula Catalog Free. Clover Laboratories, Dept. H, Park Ridge, Ill.

AGENTS \$72 a week—Biggest line Guaranteed Cutlery ever offered. Knives, Razors, etc. We give exclusive territory. Extra commission. Big money for spare time. Write for Samples. Novelty Cutlery Co., Dept. 831, Canton, Ohio.

WE Have a Real Proposition. No Classing. Big Profits. Repeats Year Round. Complete Plan and Sample 25c. Fadco Sales Service, Windfield, Pa.

A PERMANENT Position and Good Income is open to man or woman handling our goods in your locality. Established 35 years. No experience or capital. Full or part time. Dignified work. Write Employment Dept., Winter Company, 19 Winter Bldg., Washington, D. C.

AGENTS—Biggest money makers ever offered. Sell offices, homes Bestufone, which makes both hands free while telephoning; Midget Collapsible Garment Hangers, Wonderful Holiday sellers and Everin Keypurse to hold change and keys. G. Kalina Company, 1308 Avenue N, Brooklyn, N. Y.

DISCOVERED! Diamond Rival—Rajah Gems astound Jewelry world and defy detection. Set in artistic Sterling Silver mountings copies of highest priced platinum designs. Sell like wildfire at popular prices. Salesmen and Agents unique selling plan means enormous profits for you. Write immediately for details. Rajah Company, Dept. X12, Salisbury, N. C.

AGENTS make \$40 to \$80 weekly selling typewriters re-manufactured like new by the "Young Process." Lowest prices and easiest terms ever offered. Big Commission—no investment—real opportunity to start in business for yourself. Write Today. Young Typewriter Co., Dept. 575C, 654 W. Randolph St., Chicago, Ill.

NEWEST Invention. Abolishes kinks, snarls and automatically coils telephone and iron cords. Housewives, companies buying 5 to 50, \$3.40 outfit Free. Never-knot, Dept. B12, McClurg Bldg., Chicago.

STARTLING new invention, you'll be surprised when you see the improved clips for hanging ornaments on Christmas trees, agents making big money, mail ten cents for box of 100. Universal Novelty Company, 6734 N. Bouvier St., Philadelphia, Pa.

ADD Water to our concentrates and produce high quality foods, beverages, flavorings, toilet, auto and agent's specialties. We furnish labels, containers and concentrated products ready to dilute. Permanent, profitable, exclusive proposition. Deady-Barter Co., Station E-4, Kansas City, Mo.

DIFFERENT Oil Burner sells for \$35. Does the work of \$300 outfit. Flame control adapts it to store or furnace use. Greatest opportunity for agents in years. Big profit. Write for literature. Home Economy Burners, Inc., 312 Marcellus St., Syracuse, N. Y.

MARVELOUS New Invention, 400% Profit. Liquid Quick Mend for hosiery and fabrics. Tremendous demand. Over hundred other fast sellers. J. E. Johnson Co., Dept. 448, Chicago, Ill.

BIGGEST Little Thing Out. Universal Household Device, day in day out and year round where chairs are used. Big money making Harvest to Agents. Sample post paid 50 cents. Write for particulars. Jos. Bouska & Son, Bridgeport, Wash.

PATENTS. Time counts in applying for patents. Don't risk delay in protecting your ideas. Send sketch or model for instruction or write for Free book "How to Obtain a Patent" and "Record of Invention" form. No charge for information on how to proceed. Communications strictly confidential. Prompt, careful, efficient service. Clarence A. O'Brien, Registered Patent Attorney, Security Bank Building (directly across street from Patent Office), Washington, D. C. See pages 170 and 171.

MAKE beautiful radiator covers with adjustable metal Over-Tops. Beats high-priced covers. Several needed every home, apartment, office, having hot water or steam radiators. Fast sales. Hire others. Big profits surprise you. Interior Arts, Inc., 4523 No. Clark, Dept. 21, Chicago.

MAKE \$60 to \$100 weekly taking orders for non-generating, life-time guaranteed oil burner; only \$15. We deliver, collect and pay you daily. Heat King Oil Burner Co., 230 Reliance Bldg., Kansas City, Mo.

TEN Dollars a Day six days a week selling McNeess Products. The repeat business does it. Qualify for Resident Manager and add as much or more to your own earnings. A Big opportunity for a real worker. Write Furst-McNeess Co., 506 Sunlight Bldg., Freeport, Ill.

AGENTS—Men—Women: Big profits selling Veripure Vegetable Soap—wonderful new soap for toilet, bath, etc. Write today. Veripure Laboratories, Box 999-C, Chicago.

THE best tooth-paste for Pyorrhea is ZI-O-Dine. Every tube guaranteed. Taste and cleansing qualities wonderful. Fifty cent tubes. Agents wanted. Iodine Products Co., Laurel, Miss.

WOULD \$100.00 per week interest you? Millions of photos all over the country just crying to be made into beautiful artistic medallions. We have new plan. Lowest Prices. Speedy Service. Experienced agents losing money every day they put off writing us. Art Medallion Co., Department C, Corner Campbell and Jackson, Chicago, Ill.

AGENTS: 100% profit selling our low-priced beautiful and attractive Felt Rugs. Easiest and surest way of doubling your money. Perfect color combinations win instant admiration and insure quick sales. Excellent opportunity to build substantial business. Eastern Mills, Everett, Mass.

AGENTS—Demonstrators—To sell the **Christman Ejector Fork**—The latest in kitchen utensils—Sample 50c. The Christman Manufacturing Co., 301 Anthe Bldg., Covington, Ky.

AGENTS—To sell Catholics—Wonderful Proposition. United Religious Goods Co., 201 United Bldg., Covington, Ky.

AGENTS, Sell office supplies. Dignified work. Meet big business men. Pay daily. Catalog free. Mohler, Box 453, Chicago.

SELL Pocket Adding Machines. Sample \$1.40 C.O.D. Wineholt Distributing Co., Woodbine, 54, Penna.

AGENTS make real money. Sell headlight shade for all autos. No rust. No rattle. Guaranteed. Makes night driving safe. Headlight Shades Co., Yankton, S. D.

SPLENDID profits selling self-threading Needles. \$50 weekly easy; sell at sight. Write for details. Henco Co., Dept. 23, 246 Fifth Ave., New York.

AGENTS Coin Money. Household specialties. One agent sold 161 one day. G. L. Erwin, 2113 Harrison St., Chicago, Ill.

WANTED—Men and women, sell self-threading needles. Blind men thread them. Sale in every home. Pay \$3 a day. Experience unnecessary. Send 10c for sample needle and particulars. Southern Sales Company, Box 168-PM, Mt. Pleasant, Tenn.

\$50.00 WEEKLY, pleasant work, applying gold initials on automobiles. \$1.45 profit every \$1.50 job. Experience unnecessary. Free samples. Raico Monograms, 1043 Washington, Boston, Mass.

2 WONDERFUL Inventions. Startling plan gives customer Free Gold Plated device making old phonograph sound like Orthophonic Victrola. Other abolishes needles. Bradley sold 36 in 36 calls. Ever-play, Desk B12, McClurg Bldg., Chicago.

CHRISTMAS Novelty sold stores day or evening. Every store a prospect. Clean up big in December. Active agents make \$25.00 per day. Consolidated, 65A West Van Buren, Chicago.

HANZO "Removes the grime—in half the time." Unique sales plan nets you \$2.50 every ten minutes. Free samples, advertising circulars. Staple article used by millions. Grab this coin-coaxer. Free sample waiting. Hanzo Company, 765 Waveland Ave., Chicago.

GOLD Sign Letters. \$9.75 for Thousand. Non-Tarnishable. Free sample. Catalogue. Atlas Sign Works, 438 Broadway, Denver, Colo.

MAKE Big Money Selling Our Christmas Greeting Cards. Write Today. Buchanan, 63 Court St., Boston, Mass.

CANVASSERS, men and women, to take orders for calendars. Write for particulars. L. Bohden, 103-17 Jerome Avenue, Ozone Park, Long Island, N. Y.

EARN \$45 to \$85 extra a Week. Selling beautiful Shirts. Commission in advance. We deliver and collect. Write quick. Fashion Wear Shirts, Dept. S-942, Cincinnati.

\$31.00 PROFIT—with \$1.50 Outfit—Big Money—Easy Work. Selling Gold Monograms for Automobiles, Luggage, Windows, Wagons. No Experience. No License. "Samples Free." NuLife Monograms, Hartford, Conn.

\$25.00 DAILY in advance, showing colored slickers and raincoats. \$6.50 raincoats \$3.95. Outfit free. Prompt delivery. Super Built Garment Co., Box 453, Chicago.

START a manufacturing business of your own. Earn \$130 weekly. Make your own products. Formulas, toilet articles, perfumes, soap, extracts, etc. We furnish everything and show you how. Valuable catalogue free. National Scientific Laboratories, 1934W Broad, Richmond, Va.

65 MILES on 1 Gallon—Wonderful Gas Saver. All autos. 1 free. Critchlow, 805-1, Wheaton, Ill.

BUY our absolute necessity 2c—sells 25c. We undersell all. Seven samples 30c. Catalog free. Mills Sales Co., 13 E. 16th St., New York.

AGENTS \$13 daily in advance. Bonus besides. Introduce finest line guaranteed hosiery you ever saw. 126 styles, colors. Spare time satisfactory. Auto furnished. No experience needed. Credit given. Samples furnished. Wilknit Hosiery Co., Dept. 1431, Greenfield, Ohio.

CHICAGO Diamond Expert overvalued our Mexican Blu-Flash Gem 3,000%! The Diamond's Only Guaranteed rival! Greatest spare-time, side-line agent's article known! Amazing profits! \$5 pocket sample case Free! Write quick! Mexican Gem Company, Box P7C, Monterey, Calif.

TAKE orders for guaranteed Bed Spreads. Every woman buys, no competition, outfit free. Household Supply, J1603 Michigan, Chicago.

THANCO Vanilla—Bottle Yourself! Concentrated; add water; free labels. Crushes competition! 500% profit! Immense seller, homes, bakeries, stores. Write Thomas Manufacturing Company, Indianapolis, Ind.

FRENCH and German giftwares, novelties and specialties. Agent wanted. J. Keiser, Schnelsenweg 5, Hamburg, Germany.

AGENT Makes \$57 a day driving nails in tire! Amazing discovery heals all punctures—one tire was punctured 837 times without a leak. Send for Free Sample Offer. O. S. Nelson, T3713 Logan Bldg., Mitchell, S. Dak.

WANT a plan that will sell 9 out of 10? A nationally known line of 200 articles. Write for particulars and \$8.00 free sample case. H. Smith, Mgr., 1223 Wabash, Chicago.

MAKE \$20 daily selling merchants \$1.00 changeable letter display signs. 75c profit every sale. Maze Manufacturing Co., Norwood Station, Chicago.

SELLING Like Blazes! Eleven piece toilet goods assortment at \$2.25 with two piece carving set Free to your customers. 100% profit. Davis Products Co., Dept. 56, 1321 Carroll, Chicago.

BIG Profits! Great Demand! Rich's pure fruit Concentrated Soft Drinks. Every home, store, soft drink dealers buys. \$10.00—\$25.00 Daily easy. Sample free. Sol P. Rich Co., 622 S. Sangamon, Chicago.

DUO Double Strength Extracts in immense demand. Build big permanent business. Also mighty attractive line toilet preparations, household specialties, etc. Duo Co., EX-1, Attica, N. Y.

\$5,000 A YEAR—Selling Perry Photo Medallions. Big demand. Ready sales. 400% to 600% profits. Any photo copied perfectly on Medallions, Mirrors, Compacts, Jewelry, etc. Guaranteed likeness. Investigate. Free catalog and full details on request. Write Today. S. Perry Photo Novelty Corp., 1793 Jerome Ave., New York.

AGENTS—500% profit selling genuine gold window letters; Scripts. Experience unnecessary. Free sample. Premier Letter Co., 121 N. Francisco, Chicago.

AGENTS: Make \$500.00 before Xmas. Pay Daily. No investment. Rhinestone initial Buckles and novelties. Big Xmas and all year sellers. Exclusive territory. Chaton Novelty Co., 606 Blue Island, Chicago.

SELL Sanitary Rubber Goods, Stepins, Shadow Skirts. Every woman buys. Free Sample offer. American Rubber Products, Dept. 208, Pittsburgh, Pa.

RAINCOATS—Full line, all prices. Also leather and sheep-lined coats. Big catalog free. Commissions 25% with bonus. Hydro Raincoat Co., 718 Independence, Chicago.

SELL Radium Water Generators. Entirely new fast seller. Repeat orders sure. Permanent income. Ask why today. Radium Refinery, 2209 Broadway, Oakland, Calif.

AGENTS—Big Seller—\$20 Daily Easy selling Taylor Caps—made-to-measure; every man buys; some want 2 or 3 caps. Samples Free and Cap free to agents. Write quick for fast money making proposition. Taylor Cap Manufacturers, Dept. O-6, Cincinnati, Ohio.

AGENTS \$180 month. Auto furnished. Introduce Jennings Guaranteed Hosiery. Finest line silks. Pay you daily. Extra bonus besides. New plan. No experience needed. Credit given. Samples furnished. Jennings Hosiery Co., Dept. 2031, Dayton, Ohio.

AMAZING Large Cash Commissions Introducing Beautiful \$3.95 and \$4.95 Fit-to-Measure Guaranteed Shoes. Actual Samples Furnished. Wire for your territory. Style Arch Shoe Co., Dept. 107-M, Cincinnati, Ohio.

AGENTS—\$240 month. Startling new invention. Self-wringing mop. Push button and its wrung. Hands never touch water. New selling plan. Low priced. Territory given. Write quick. Details free. National Products Co., Plan 231, Dayton, Ohio.

AGENTS: \$16 day. Distribute \$2.25 household articles free to ten thousand new customers for our guaranteed goods. Part time satisfactory. Write for samples today and start quick. Jennings Co., Sample 631, Dayton, Ohio.

BIG Profits. Sell "No-Splash" 4-Strainer Water Filters. Fast sales, lowest prices; send for 6 dozen, \$1.80 postpaid. Jones Mfg. Co., 243E2 Franklin St., Boston, Mass.

AGENTS—Here's just the opportunity you've been looking for. \$100 a week; free automobile; exclusive territory. Write today for particulars. American Products Co., 6325 Monmouth, Cincinnati, Ohio.

GREATER Profits—Year Round sales. Complete guaranteed line dress and work shirts, overalls, workpants, lumberjacks, leather vests, playsuits. \$10—\$25 daily easy. We show you how. Complete Outfit Free. Nimrod Shirt Co., Dept. 8, 4922-28 Lincoln Ave., Chicago.

REAL Selling Sensation! Tremendous earnings whole or part time! Patented Hot Water Bottle Combination Invention needed everywhere. Big commissions. Extra bonus. We deliver. Write C1014, Lobl Corp., Middleboro, Mass.

SURE Seller to every merchant—no gamble—big profits—steady repeater—free sample and exclusive territory. Embossed Show Card Co., 9464 Euclid, Cleveland, Ohio.

MIRRORS Resilvered at Home. Costs Less 5 cents per square foot; you charge 75 cents. Immense profits, plating like new; brassy worn-off autoparts, reflectors, tableware, stoves, etc. Outfits furnished. Details Free. Sprinkle, Plater, 128, Marion, Ind.

AGENTS: Why not sell Paintographs? Once shown always sold. Beautiful and novel. No competition. Popular Holiday Gifts. Sure repeaters. Our men are cleaning up. You can too. Write for free particulars today. Bradfords, St. Joseph, Mich.

AGENTS, something new. 8 tools in one. Fine leather case. Fits hip pocket. Use it every day. Big seller. Details free. Novelty Cutlery Co., Chest 231, Canton, Ohio.

AGENTS, Mail Dealers, Demonstrators, Dollar bottle perfume, and dollar book both 25c. Cost you 10c. Samples of both and particulars 25c. You won't believe your eyes. Vauty, 155 W. 21st, New York.

FREE Adding Machine to "Live-Wires" accepting our Dollar-a-Minute Agency. Improved 2-lb. Calculator. Adds, Subtracts, Multiplies, Divides. Work equals \$300.00 machines. Retail \$15.00. Big demand; large profits. Write quick for protected territory. Lightning Calculator Co., Dept. F, Grand Rapids, Mich.

NO Dull Times Selling Food. People must eat. Federal distributors make big money; \$3,000 yearly and up. No capital or experience needed; guaranteed sales; unsold goods may be returned. We furnish you with sample case, license and Free Samples for customers—Sure repeat orders. Exclusive territory. Ask now! Federal Pure Food Co., A297 Archer, Chicago.

SALESMEN—Here's the double income line—1 call, 2 sales. Helix Hosiery, lingerie, guaranteed. Low prices, generous commissions. Write for result producing plan. Helix Co., 213-D Fourth Ave., New York.

NEWEST Craze! Onyx Ring—Interchangeable Monogram or Emblem. Retail \$4.50. Your profit \$2.25. Demand so big agents needed everywhere for tremendous Christmas business. Also complete line Auto and Wall Emblems. Get free sample—bonus plan. Crafts, Dept. PM12, 3314 Lawrence Ave., Chicago.

WE pay \$48 a week, furnish auto and expenses to introduce our Soap and Washing Powder. Buss-Beach Company, Dept. A42, Chippewa Falls, Wis.

GENERAL Agents Wanted to Sell Postcards. No Talking required. Big Profits. Sample and Selling Plan 10c. Herman Studio, 706 Calhoun St., Ft. Wayne, Ind.

OPEN Toilet goods shop anywhere. We furnish everything. Liebig's, Beaver Dam, Wis.

GET posted—Good prices paid for butterflies, insects. See Sinclair display advertisement, page 68.

AGENTS—Best seller; Jem Rubber Repair for tires and tubes; supercedes vulcanization at a saving of over 800 per cent; put it on cold, it vulcanizes itself in two minutes, and is guaranteed to last the life of the tire or tube; sells to every auto owner and accessory dealer. For particulars how to make big money and free sample, address Amazon Rubber Co., Philadelphia, Pa., Dept. 505.

LAST Call! Fall in. Here's a Money Maker! Supreme Shirts give 100% satisfaction. Proposition, Kit Free. Supreme Shirt Co., 276-M Fifth Ave., New York.

SELL men's neckwear; wonderful proposition. Astor, 318-M Broadway, New York.

OUR latest neckwear and lingerie line is unequalled for making money. Write for details. Public Service Mills, 725-F 51st St., Union City, N. J.

BIG earnings. Square Deal Policy, sell "Spikes Quality Shoes" direct to ladies. Big values, snappy styles, \$1.00 up. Money Back Guarantee. Protected Territory. Write! Spikes Shoe Company, Dept. 420, Cincinnati.

PEARLS Make Ideal Christmas Gifts; Every Woman Customer; Write Hanover Trading, 925-F Broadway, New York.

MAKE—Sell Your Own Goods. Formulas by experts. Manufacturing Processes. Trade-Secrets. All kinds. All lines. Catalog, circulars free. B. Thaxly Co., Washington, D. C.

WE Pay \$50 a Week and Expenses and give Ford Auto to men to introduce poultry and stock compounds. Imperial Co., D-23, Parsons, Kans.

AGENTS—Clean up on Eyeglass Cleaner. Carried in vest pocket. Sells itself. Steady repeater. Sample 2c, refunded first order. Philip Amendt, 441 Maple Ave., Phillipsburg, N. J.

75c PROFIT on \$1.00 Sale. Auto, Furniture and Glass Cleaner. Your Name on Label. Exclusive Rights. Free Sample. Mfg-E, 213 Griswold, Detroit, Mich.

FREE: Large Wholesale Specialty Catalog, showing latest best sellers from all parts of the world. Spors Co., Leveur Center, Minn.

GET Pay Every Day; Distribute nationally known Food Products to established users. Now is the best time to make permanent connection bringing \$2,000 to \$5,000 a year. Write the J. R. Watkins Company, Box 27, Winona, Minn.

PORTRAITS, photo-pillow tops, frames, sheet pictures, medallions, merchants' signs, food products, photo jewelry, guaranteed hose, toilet requisites, luminous crucifixes. Catalog 50 specialties free. 30 days' credit. Jas. C. Bailey Co., Dept. C12, Chicago.

STARTLING Selling Plan! \$1.25 premium free to every customer on \$2.00 sale of 8 ounce Vanilla, 6 ounce Shampoo and 4 ounce Lemon Lotion. Details and samples free. C. I. Togstad, Dept. 18T, 29 S. Clinton, Chicago, Ill.

\$50,000. PICTURE Man Friedman made canvassing. Beginners can make \$100.00 weekly with my sales talk. Experienced men make more. Free book. "Profits in Portraits" explains. Samples Free. Picture Man Friedman, Dept. 8B, 541 W. Lake, Chicago.

AGENTS—Mescio Corn and Callous Remover will build you a steady repeat business. Send today for pocket-size trial outfit. The Moss Co., 307 Searle Bldg., Rochester, N. Y.

STARTLING Invention. New Shock Absorber for Fords retails at \$3.00. Big profits easy. Exclusive distributors wanted. M & M Mfg. Co., 21 Station C, Omaha, Nebr.

AGENTS—Make a dollar an hour. Sell new kind of sharpeners. Sharpens all knives and tools quickly. Demonstrating sample free. Premier Mfg. Company, Dept. 62, Detroit, Mich.

100 MORE active men to introduce Chieftain Guaranteed Tailored Shirts (3 for \$1.95). Latest novelties, colors. Dickman, Illinois, in 3 weeks made \$589; Sinton, Texas, in 12 days, \$219.60; Bend, Iowa, in 16 days, \$334.80. Why not you? No experience or capital needed. We deliver and collect. Full working outfit Free. Cincinnati Shirt Company, Secy. 15816, Cincinnati, Ohio.

START a manufacturing business of your own. Earn \$100 weekly. Make your own products. Formulas, toilet articles, perfumes, soap, extracts, etc. We furnish everything and show you how. Valuable catalog free. National Scientific Laboratories, 1934W Broad, Richmond, Va.

MANUFACTURE Very Latest, Biggest-selling Advertisements yourself—No Machinery; Investment small—All lines. Stamp brings Valuable Interesting Literature explaining how others sell your products and big bunch lists Guaranteed Formulas. 300 to 1,200% profit to you. Reliable Information Only. No "Master Formula" trash. Miller, Chemist, 1706-V Jetton, Tampa, Fla.

"AGENTS" Big Money Selling New Household Cleaning Set. Washes and dries windows. Sweeps, scrubs, mops. All complete only \$2.95. Over half profit. Write Harper Brush Works, 132 Third St., Fairfield, Iowa.

65 MILES on 1 Gallon—Wonderful Gas Saver. All autos. 1 free. Critchlow, 805-V, Wheaton, Ill.

AUTO owner tire agent wanted each locality to use and take orders for hand-made Mellinger cord and balloon tires; guarantee bond 15,000 miles; shipped prepaid on approval; get your tires free; no capital or experience required; make \$100 to \$300 weekly. Write for wholesale prices and sample kit. Address Mellinger Tire Co., Dept. 400, Kansas City, Mo., or Dept. 400, Philadelphia, Pa., or Dept. 400, Oakland, Calif.

AGENTS \$1 Retail \$3. Your Profit \$2. Wonderful pocket Adding Machine with Magic Writing Pad. Particulars Free. Typewriter Supply, 905 Hersh Bldg., Pittsburgh, Pa.

ONLY 1 Sale Daily Means \$135 per Month Profit! Full or spare time. New \$5,000 Accident and Sickness Policy, \$25 Weekly Benefit, Premium \$10 yearly. Tremendous demand—amazing profits. \$100,000 guaranteed with State. Write quick for territory and special contract. Underwriters, Dept. 702, Bunnell Bldg., Newark, N. J.

AGENTS—N-R-G Laundry Tablets, the old reliable moneymaker for live agents. Millions sold—200% profit—sales waiting for you. Clothes washed spotlessly clean in 10 minutes without rubbing. Free samples. N-R-G Company, 230 W. Superior, Chicago.

CALIFORNIA Rosebuds selling like hot cakes. Agents coining money; new stuff. Big profits. Catalog free. Mission Factory PM, 2328 West Pico, Los Angeles, Calif.

MAKE \$75 to \$100 Every Week. Just taking orders for the Longwear line of men's and women's guaranteed all leather shoes at factory prices. Selling like wildfire. Write for samples. Longwear Shoe Company, Dept. F, Minneapolis, Minn.

FREE Ties or a Beautiful 31 Piece Monogrammed Dinner Set, or both, with each order for full box of our Guaranteed Hosiery; Ladies All Silk Hosiery 25c; over 35 Hosiery and Neckwear Styles; from 37% to 117% commission, 10% Bonus; over 50 colors. State experience and give three references to see Samples. We deliver. S. Q. S., Desk H, Lexington, Ky.

A BUSINESS of Your Own—Making Sparking Glass Name and Number Plates, Checkboards, Signs. Big Book and Sample Free. E. Palmer, 512 Wooster, Ohio.

AGENTS—New Plan, makes it easy to earn \$50.00 to \$100.00 weekly, selling shirts direct to wearer. No capital or experience needed. Represent a real manufacturer. Write now for Free Samples. Madison Company, 566 Broadway, New York.

GET Our Free Sample Case—Toilet articles, perfumes and specialties. Wonderfully profitable. La Derma Co., Dept. A, St. Louis, Mo.

DO you want good live agents—fellows who can get the business? Ask me how others are doing it. I'll gladly render the necessary assistance without cost to you. Address, M. L. Rund, Mgr. Classified Advertising, Popular Mechanics Magazine, Chicago.

AGENTS wanted—To sell Ray-O-Lite cigar and gas lighters. Big earnings. Sample 50c. Rapid Mfg. Co., 799-E Broadway, New York.

OVER 100% Profit, Self Lighting Gas and Cigar Lighters; Everybody interested, repeat business. Sell individuals, dealers, subagents. Particulars Free. P. Bernhardt, 127 West 30th St., New York.

MILLIONS stolen. Remarkable new \$5.00 Check Protector stops forgery. Inks, protects two colors. Sensational sales, profits. Write. Safety Devices Corp., Grand Rapids, Mich.

AGENTS—Clever Invention! Inkspoon makes every pen a fountain pen. Fast office seller; big profit, demand increasing everywhere. Exclusive territory offered. Sample free. H. Marul Company, Tribune Bldg., New York, N. Y.

BECOME Your Home Town's Leading Business Man. You can make \$100.00 weekly selling our guaranteed food products, paints, oils, shirts, hosiery, etc., direct to consumer in towns and country. Every article a repeater. No experience necessary. Exclusive territory for men and women. Loverin & Browne Co., 1615 S. State St., Chicago.

DISTRIBUTORS, Salesmen, Energetic Men wanted every city to job Easy-Mend; new household product, thru agents and stores; can earn \$3,500—\$5,000 yearly; whirlwind seller; repeats 8 to 20 times yearly; successful campaign, sales talks, circulars free; few dollars capital starts you. Facts sent free. Thos. Barnett, Pres., 1811-B Mondamin, Des Moines, Iowa.

REMNANT Store, Bethel, Ohio. Greatest Dry Goods Bargains on Earth. Agents and Dealers.

WILLIAMS' No-Water Hand Soap, in tubes, has taken Auto owners by storm; washes dirtiest hands perfectly clean without water; easy demonstration makes quick sale. 150% profit. Williams Co., Dept. 265 Montclair, N. J.

PRIVATE Brand Toilet Articles, Food Products, Household Specialties. We pack these goods for you under your private label. With your name on goods you get all the repeat business. Appoint sub-agents to work with you. Highest Quality Merchandise. Over 200% profit. Write immediately for our attractive offer. Supply Department, National Scientific Laboratories, 1904W Broad, Richmond, Va.

\$320 PROFIT First Three Days' Sales for Zindel, Illinois, with Morey Quick Action Auto Rim Tool. Profit \$2 tool. Exclusive territory for hustling agents. Earn \$10 to \$50 cash daily, \$75 to \$300 weekly year round. M. Morey Rim Tool, Biltsfield, Mich.

SELF Threading Needles find sales in every home. Fine side line; big profits; easily carried. Sample free. Prentice-Lee, 145 East 23rd St., New York.

\$60-\$200 A WEEK. Genuine Gold Letters for store windows. Easily applied. Free samples. Liberal offer to general agents. Metallic Letter Co., 438-B North Clark, Chicago.

AGENTS Wanted. Pocket Puzzles—200% Profit, Sample and Catalog Free to Agents. Western Puzzle Works, Saint Paul, Minn.

WANTED: Local and State Representatives for famous ready made Artistic Signs, price tickets, etc. No competition. Full protection. Large profits. For particulars write Artistic Signs, 799R Broadway, New York.

BIG Money and Fast Sales. Every owner buys Gold Initials for his auto. You charge \$1.50; make \$1.35. Ten orders a day easy. Write for particulars and free samples. American Monogram Co., Dept. 40, East Orange, N. J.

AGENTS: 500% profit. "Happy Home Make Shampoo" builds your own big business. Martin of Indiana made \$75.00 in one day. Missouri man made \$750.00 one month. Exclusive territory. Geo. A. Schmidt & Co., Dept. P, 236 W. North Ave., Chicago.

NEW \$3.50 Automatic Adder. Fast seller—Big Profits. Exclusive territory for live-wire sellers. Bassett Company, 1458-C Hollywood Ave., Chicago.

AGENTS—Sell Pure Linen Imported luncheon sets; big commission in advance. We deliver; a great new money maker for men or women agents. Belfast Linen Co., 6431 S. Dearborn, Chicago.

"AMAZING New Cleaner." Cleans Everything. Sells like wildfire. Quick Repeater. 300% Profit. Miller, New York, made \$1,000 in 6 weeks. Beck, Illinois, \$98.00 in 2 days. Premium sales plan and Free Samples make selling easy. Work full or spare time. Write quick. Bestever Products Co., 1945E, Irving Park, Chicago.

PERFUMED Beads from California. Fast Sellers. No Competition. License unnecessary. Big margin. Hire subs. Clean up. Mission, 519PM, 2328w. Pico, Los Angeles, Calif.

MOCCASIN Manufacturer Wants Agents Everywhere to sell a complete line of moccasins to wearers. Entire new line. No competition, repeat orders. Get details. Daley Moccasin Co., Fort Covington, N. Y.

\$16 A DAY Easy—I start you in auto accessory business; no investment; no experience necessary. Landin, 3433 Montrose Ave., Chicago.

CAN you sell Ford size tires at \$3.50 each? Write for plan. Details free. American Accessories Co., Station 231, Cincinnati, Ohio.

START a manufacturing business of your own. Earn \$100 weekly. Make your own products. Formulas, toilet articles, perfumes, soap, extracts, etc. We furnish everything and show you how. Valuable catalog free. National Scientific Laboratories, 1934W Broad, Richmond, Va.

WE Start You Without a Dollar. Soaps, Extracts, Perfumes, Toilet Goods. Experience unnecessary. Carnation Co., Dept. 2480, St. Louis.

65 MILES on 1 Gallon—Wonderful Gas Saver. All autos. 1 free. Critchlow, 805-M, Wheaton, Ill.

AGENTS—Make a dollar an hour. Sell Mendits, a patent patch for instantly mending leaks in all utensils. Sample package free. Collette Mfg. Co., Dept. 404, Amsterdam, N. Y.

GOLD Leaf Window Letters and Script Signs. No experience; 500% profit. Samples free. Consolidated, 69U—West Van Buren, Chicago.

AGENTS—Send for Free Sample "Fret-not" Washday Wonder. Big Profit. You don't have to talk; if she doesn't buy at sight, leave sample. Exclusive territory. Credit given. Empire Specialties Co., 1549 N. Wells, Dept. 101, Chicago.

AGENTS make \$100 week placing advertising Cigar Lighters with glass front. Every dealer wants one. Write for free plan. Drake Mfg. Co., Dept. M, Milwaukee, Wis.

AGENTS—Sell 5c fast selling candy specialties to stores. Big profits. Lorrac Products Co., Albany, N. Y.

MANUFACTURER lamb wool polishers, dusters. Newhall, 338 Broad St., Lynn, Mass.

SELL by mail! Big Profits! Books, Formulas, Novelties, Bargains. Particulars Free. Elfen, 523 South Dearborn Street, Chicago.

AGENTS make \$3.00 an hour taking orders for our 40 Fascinating Kitchen Specialties. No competition. Write Quick. General Products Co., Dept. 7-K, Newark, N. J.

GIVE Away finest laundry soap Free. You'll make \$10 daily easy by new selling plan. Big repeat business. Write quick. Wolverine Soap Co., 28 Wolverine Bldg., Grand Rapids, Mich.

AGENTS—Steady Income. Large manufacturer of handkerchiefs and dress goods, etc., wishes representative in each locality. Factory to consumer. Big profits, honest goods. Credit given. Send for particulars. Freeport Mfg. Co., 59 Main St., Brooklyn, N. Y.

POLMET—The Wonderful Polishing Cloth that cleans all metals without liquid, paste or powder. Approved by "Good Housekeeping" and "Modern Priscilla"—sells fast at 25c. Sample free. Gale & Co., Inc., 15 Edinboro St., Boston.

AGENTS—Stamping names on Pocket Key Protectors; sample Check with your name and address. 25c. Stamping Outfits. Emblem Checks, Check Fobs, Name Plates. Hart Mfg. Co., Desk 2, 303 Degraw St., Brooklyn, N. Y.

BIG Money Monogramming automobiles. \$1.40 profit on \$1.50 sale. Particulars and samples free. Evans Products Company Midian Avenue, Windsor, Conn.

AGENTS—Here's a New One. "Best-ever Powdered Hand Soap." Sells like wildfire. Marvelous Discovery. Removes grease, paint, ink, oil, in fact anything from the hands. Cannot harm skin. 150% Profit. Great Repeater. Agents simply coin money. "Free Samples Get the Business." Write immediately. Bestever Products Co., 1937 E. Irving Park, Chicago.

NEW Wonderful Seller. \$1.40 profit on every \$1.50 sale, monogramming autos; free samples. Monogram Co., B99, Worcester, Mass.

MAN in each town to plate auto parts, reflectors, bathroom fixtures, refinish beds mirrors, chandeliers; by new method. No capital or experience required. Simple plan of manufacturing at home starts you in big money-making business. Outfit furnished. Free particulars and proofs. Gun Metal Co., Ave. H, Deatur, Ill.

INSTANT Weld. Repairs largest punctures without cement or heat. Lenn's—profit one day, \$56. Write quick. Free sample; territory going fast. Tourists' Pride Mfg. Co., Desk T, Minneapolis, Minn.

YOU Can Make Good Durable Paint and Varnish 40c per gallon. Write Dept. 2 Emmelmann Bros. Mfg. Co., Indianapolis, Ind.

65 MILES on 1 Gallon—Wonderful Gas Saver. All autos. 1 free. Critchlow, 805-W, Wheaton, Ill.

REPLATE brassy worn-off Automobile parts. Reflectors, Bath Room Fixtures, Worn Spoons, Forks, etc., with pure silver. Looks like new. Use U-Kan-Plate Polish. Positively no mercury. \$1.00 half pints. Post Paid. Satisfaction Guaranteed. Agents wanted. Dept. A, U-Kan-Plate Co., Philadelphia.

\$1 PER hour selling Dirt-Solve Washing Powder. Big repeater; exclusive territory. Premiums for customers. Sample free. Goodspeed Products Co., Rutland, Vt.

AUTOMOBILE Specialties. Guaranteed formulas for all latest money makers. Lowest prices. Write for free lists. Murphy, Chemist, Tujunga, Calif.

FURNITURE refinishing, polishing, painting, handyman shop; wonderful profits; start yours on nearly nothing. John Braceland, 1457 So. Ninth, Philadelphia, Pa.

McDONALD Polishing Cloth cleans gold, silver, nickel. Sample, terms, 15c silver. Daniel McDonald, 18 Agawam St., Lowell, Mass.

AGENTS, both sexes, we manufacture and control new household article. Fast seller. Big profits. Exclusive territory. Write now. Connolly, 123 Liberty St., New York.

AGENTS: Big Money Monogramming by Transfer method. Catalog Showing Over 50 Styles and Particulars Free. Motorists' Accessories Co., Mansfield, Ohio.

FREE Sample. "Rain Shield Wiper." Retail \$1.00—Cost (25 cents). Sold Clear and Rainy Days. No Cloth—No Paste—No Attachment. (1) Rub keeps windshield clear 48 hours. Experience Unnecessary. NuLife Corporation, Hartford, Conn.

EARN \$10 daily silvering mirrors, plating and refinishing metalware, autos, chandeliers, bedsteads, headlights. Outfits furnished. E. Decle Laboratories, 1133 Broadway, New York.

ALL-YEAR-ROUND profitable business selling wonderful new water softener and cleaner. Removes grease, oil, ink and dirt quickly. Every home and business place a live prospect. 100% profit. Big repeat orders. Exclusive territory. Write for free sample. Seacoast Laboratories, Sea Bright, N. J.

PENNANTS and Pillows: Colleges, Schools, Clubs, Lodges. Students and agents get busy. American Pennant Co., 66 Hanover St., Boston, Mass.

KLEENZIT Kleening Pencil—New, different, instant appeal to housewives and tailors. Sell like hot cakes. Removes spots from clothes without leaving marks or rings. 50c seller—big profit. Agent's sample 25c. Write quick. Exclusive territory. Argyle Specialty Co., Dept. P, Argyle, Wis.

AGENTS: Our gold-eyed Needle Cases are wonderful sellers; immense profits; \$50 to \$300 weekly; proof and particulars free; sample outfit 15c; factory prices. Paty Needle Co., 231 Davis Square, Somerville, Mass.

HIGH-GRADE SALESMEN WANTED

WANTED—Tailoring Salesmen, make \$60 to \$125 per week. Biggest merchants in many towns have started with our line. We are the largest made-to-measure tailoring house in the country, furnishing elaborate sample equipment, including 500 all-wool fabrics. You make your own profits from \$8.00 to \$15.00 on each order. Guaranteed absolute satisfaction, perfect fit, best workmanship, or no sale. Write for our line and all accessories to be sent free. Tell us all about yourself. Address N. O. Perry, Sales Manager, Box 483, Chicago, Ill.

SALESMEN—Become Independent. Own Your business, experience unnecessary selling our \$7,500.00 Accidental Death; \$50 Accident; \$25 Sick Weekly Benefits—\$12.50 Yearly. Other Amounts proportionate. Guaranteed steady income from renewals. \$250,000 Deposited Insurance Department. Universal Policy, Dept. A, 30 Clinton St., Newark, N. J.

MAGIC Moving Window Salesman. It's Real changeable letter system has actually boosted users' sales 200% to 400%. None but dead dealers indifferent. If you can spot a winner, get the facts and begin pocketing \$100 weekly. Display Products Company, P. O. Box A5123, Gateway Station, Kansas City, Mo.

SALESMAN: Manufacturer of established line guaranteed tools offers profitable connection to men with mechanical and some sales ability; part time men considered; two average sales daily net \$50.00 weekly; advance commission. Write for free catalogue and money making plan. J. G. Woods, Inc., 37 West 29th St., New York, N. Y.

MAKE \$100 Weekly in spare time. Sell what the public wants—long distance radio receiving sets. Two sales weekly pays \$100 profit. No big investment, no canvassing. Sharpe of Colorado made \$955 in one month. Representatives wanted at once. This plan is sweeping the country—write today before your county is gone. Ozarka, Inc., 431 N. LaSalle Ave., M, Chicago.

START a manufacturing business of your own. Earn \$100 weekly. Make your own products. Formulas, toilet articles, perfumes, soap, extracts, etc. We furnish everything and show you how. Valuable catalog free. National Scientific Laboratories, 1934W Broad, Richmond, Va.

SALESMEN—Sideline—Pick up big commissions selling plain and advertising Toy Balloons for World's Largest Balloon Factory. Pioneer Rubber Company, Willard, Ohio.

SALESMEN, go into the office accessory and supply business. We furnish complete lineup. Build a permanent business that pays big money. Write for particulars. Davis Company, 10 Tremont, Boston, Mass.

SALESMEN—New line, New Field, \$6.50 profit every sale; sell Radium health products. A scientific, drugless treatment needed in every home. The \$2,500,000,000 spent yearly for health assures you a permanent and profitable business with no dull seasons; experience unnecessary. Exclusive territory. Write Radiumized Applicator Co., 1303-P Fillmore, Buffalo, N. Y.

SALESMEN—Tremendous Repeater. Used by Millions. \$20 profit on ten \$3.50 sales. Merchant's repeat orders build permanent business. Auto Bonus. Territory. Full or Side Line. Hustlers wanted only. Elcor Products, Dept. L-10, Washington, D. C.

COLLECTS Money from the Dead-Beats. Retail \$5.00—Cost \$1.00—Profit \$4.00. "New Method." Every Storekeeper, Doctor buys quickly. Wonderful Money Getter, Federal Association, Hartford, Conn.

GREAT neckwear line now free! Features finest quality neckwear at factory prices. Collect big commissions daily. Write for Free tie offer and Free outfit. Nawco Neckwear, Desk 12-B, Covington, Ky.

MR. BRUSH Salesmen—Old Established New York Brush Manufacturers require services of men in all territories to sell their extensive line of Sanitary Twisted in Wire Brushes. We pay larger commission than any other Brush House in the country. Write immediately for proposition. Wire Grip Sanitary Brush Corporation, 15 Mercer Street, New York.

SALESMAN—Trunks, bags and suitcases sell everywhere. Excellent sideline; commission basis. Write us today for proposition. Appomattox Trunk & Bag Co., Petersburg, Va.

BIG profits! Permanent trade! Gift Day everyday! Liberal free goods, bonus awards, selling quality toiletries of distinction. Le-Maire Perfume Co., 3330 Carroll Ave., Chicago, Dept. 609.

MAKE money selling advertising novelties and calendars. Select line of quick sellers. Fine sideline. Write today. William Miller Son Co., Charlestown, N. H.

SALES manager to distribute faultless automatic sash holders. Salary \$5,000 a year and bonus. Address Faultless Sash Holder Co., Inc., Indianapolis, Ind.

LITTLE Wonder Pencilknife, safetyclip, nailcleaner, fits on pencil. Samples 10c. Klees Company, 1710 Undercliff Avenue, New York.

LITTLE Wonder Pencilknife, Clip, Eraser, Cigarcutter, Nailcleaner, Letteropener, made of finest Sheffield steel, fits on pencil. Sample and catalog of 20 best agents' specialties for 10c. Klees Co., 1710 Undercliff Ave., New York.

SIDELINE men calling on retail cigar stores, billiard balls, confectioners, drug stores. Compact samples. Big commissions. Harlich Mfg. Co., 1413-A W. Jackson Blvd., Chicago.

SALESMEN: Want \$6,000 this year? Write us today. Strong retail line, nationally advertised. Company established 26 years. Liberal advances to producer. Continental Co., 1300 Liberty Bldg., Cleveland, Ohio.

START a manufacturing business of your own. Earn 100 weekly. Make your own products. Formulas, toilet articles, perfumes, soap, extracts, etc. We furnish everything and show you how. Valuable catalog free. National Scientific Laboratories, 1934W Broad, Richmond, Va.

BECOME Your Home Town's Leading Business Man. You can make \$100.00 weekly selling our guaranteed food products, paints, oils, shirts, hosiery, etc., direct to consumer in towns and country. Every article a repeater. No experience necessary. Exclusive territory for men and women. Lovrin & Browne Co., 1600 S. State St., Chicago.

\$100-\$200 WEEKLY. Retailers' live-wire specialty. \$40 weekly guaranteed against corn. Reliable house. Guarantee dealers turnover or money back. Pay you to investigate. Appleton Specialty Co., Cedar Rapids, Iowa.

TAKE orders for coffee, sugar, flour, meats, canned goods, staple groceries also paints, radio sets, tires, auto and tractor oils. No capital or bond required. We deliver and collect. Permanent business. Big pay. Write at once. Hitchcock-Hill Co., Dept. 50, Chicago.

\$60-\$200 A WEEK. Genuine Gold Letters for store windows. Easily applied. Free samples. Liberal offer to general agents. Metallic Letter Co., 438-A North Clark, Chicago.

CALIFORNIA Rosebuds selling like hot cakes. Agents coling money. Absolutely new. Big profits. Catalog free. Mission Factory SP, 2328 West Pico, Los Angeles, Calif.

CALENDAR salesmen: Our line is the only one that covers entire field. Calendars—Fans—Signs—Pencils—Blotters—Aluminum—Wood—Celluloid. Remembrance advertising for every merchant. Full or part time. Dept. 226, Model Calendar Co., South Bend, Ind.

ANY Salesmen Can Sell Them! Merchants everywhere use punchboards. Someone sells them, why not you? Collect big commissions daily. Newest, largest, elaborate catalog sent upon request. Lincoln Sales Co., 9 So. Clinton, Chicago, Dept. D.

FOUR \$7.50 sales to merchants net you \$20.00 daily. Sayers Systems, 2803 Sheffield Ave., Chicago, Ill.

NEW patented fire-prevention device. 40,000,000 users. Now ready to be marketed through country distributors only. Low prices. Easily sold. Very profitable. Samples on approval. Reitz Manufacturing Co., Box 271, Shamokin, Pa.

UNUSUAL Proposition—350% to 500% profit for you. World's Best Furniture and Automobile Polish supplied in bulk. Bottles at wholesale—labels Free! Exclusive territory. Write! Hyde Co., Rowan, Iowa.

HELP WANTED

WORK for Uncle Sam. Get Government Jobs. Men—women, 18 up. Commence \$95 to \$158 month. Steady work. Short hours. Paid vacation. Pull unnecessary. Common education sufficient. Candidates coached without leaving home. Full particulars and 32 page book—Free. Write immediately. Today sure. Franklin Institute, Dept. D3, Rochester, N. Y.

MEN to train for locomotive firemen on railroads nearest their homes—everywhere; beginners \$150—\$250 monthly; promoted, locomotive engineer, \$3,000—\$4,000 yearly. Best paying positions on railroads. Railway Association, Desk M1, Brooklyn, N. Y.

MEN, 18 up, wanting to qualify for U. S. Mail Service positions, \$142 to \$225 monthly, write immediately for free particulars. P. Bradford, 112 Bergen Ave., Jersey City, N. J.

WANTED—Boys and Men, 16 up. \$25.00 to \$60.00 week. Many positions. Become Automobile Repairman. Work interesting. Easily learned. Sample lessons—Free. Write today sure. Franklin Institute, Dept. D400, Rochester, N. Y.

We can use 25 men at once. Salary while learning Rubber Tile Floorlaying. This is your chance to learn a big pay job. Big demand for mechanics right now. Easy to learn. Write for information. Wm. Youde, Manager, 4341 W. Harrison St., Chicago.

GET posted—good prices paid for butterflies, insects. See Sinclair display advertisement, page 68.

50 MEN age 18 to 30. Steady work days; able to train 3 hours a night at trade. Ambitious to learn. Good wages. Send application American Building Trades, Hearst Square, Chicago.

RAILWAY Mail Clerks, Men 18-35. \$158-\$225 Month. Travel—See Country. Common education sufficient. 25 coached free. Write immediately. Franklin Institute, Dept. D16, Rochester, New York.

MEN wanting to prepare for forest ranger or railway mail clerk examinations Write Mokane, A-23, Denver, Colo.

DR. KNOLL'S mystery secrets now revealed. Your radio active life currents can create amazing results quickly. Get these secrets now. Copy \$1.00, satisfaction guaranteed. Dr. Wm. F. Knoll, 29 No. Ashland Blvd., Chicago.

FIREMEN, Brakemen, Baggage-men, (white or colored), sleeping car, train porters (colored), \$150—\$250 monthly. Experience unnecessary. 819 Railway Bureau, East St. Louis, Ill.

RAILWAY Mail Clerks, \$158 Month, 25 coached free. Write immediately. Franklin Institute, Dept. D16, Rochester, N. Y.

MEN, 18-45. Become regular Mail Carriers, \$1,700—\$2,100 year. Sample coaching free. Write immediately. Franklin Institute, Dept. D16, Rochester, N. Y.

EARN \$10 daily silvering mirrors, plating and refinishing metalware, auto, chandeliers, bedsteads, headlights. Outfits furnished. E. Decie Laboratories, 1133 Broadway, New York.

MEN Wanted—prepare as firemen, brakemen, colored train or sleeping car porters, wire for application blank; experience unnecessary; first class roads, no strike. Name position wanted. Railway Institute, Dept. 35, Indianapolis, Ind.

RAILWAY Mail Clerks, \$158 Month, 25 men, 18 up, coached free. Write immediately. Franklin Institute, Dept. D16, Rochester, N. Y.

DON'T prepare for any Civil Service Examination without seeing our catalogue. Free. Columbian Correspondence College, Washington, D. C.

BECOME a Landscape Architect. Uncrowded profession of wonderful opportunity for money-making. Easily mastered by mail. Earn while you learn. Write for book. American Landscape School, 56-E, Newark, N. Y.

SILVERING Mirrors, French Plate. Easily learned; immense profits. Plans free. Wear Mirror Works, Excelsior Springs, Mo.

ALL men—women wanting Government Positions, \$140—\$225 monthly, should get our "Exam. Coaching" immediately. Write, Ozment, 101, St. Louis, Mo.

U. S. GOVERNMENT wants men, \$1,700—\$1,900 and up at start. Railway Mail clerk examination coming. Let our expert (former Government examiner) prepare you for this and also Rural Carrier, Post Office, Customs, Internal Revenue, and other branches. Write today for free booklet. Dept. 8, Patterson Civil Service School, Rochester, N. Y.

We Start You in Business, furnishing everything. Men and women, opportunity to earn \$85 to \$100 weekly operating Ragsdale's original "New System Specialty Candy Factories" anywhere; wholesale or retail. Big commercial candy book free. W. Hillier Ragsdale, Drawer 350, East Orange, N. J.

BUSINESS SERVICE

CAPITAL Seekers: Gathering Funds, Limited edition, Free booklet. Act. Dickinson Co., 29 South LaSalle St., Chicago, Ill.

WHAT have you to manufacture or sell? Have facilities, finances, and selling organization. Automotive accessories preferred. Leo J. Schiltzer, Box 1280, Paterson, N. J.

MAKE "Em Pay—My system will make them pay their bills. Write for the acid test. Literature free. Burleigh L. Horr, Horr Omelia Block, Rhineclander, Wis.

REPRESENTATION in Washington, D. C. Mail address, information, Anything, Anytime. Service, 223 Victor Bldg.

TYPEWRITERS AND SUPPLIES

TYPEWRITERS, all standard makes, thoroughly re-manufactured by the famous "Young Process" and shipped direct from factory to you on 10 days' trial. Guaranteed 5 years. Easy monthly payments. Write today for free catalog. Young Typewriter Company, Dept. 575C, 654 W. Randolph St., Chicago.

TYPEWRITERS, adding and calculating machines at less than half manufacturer's price. Bargains. Free Guarantee. Ford Company, 45 E. 28th St., New York.

SIMPLEX Typewriters \$1—\$5. Remingtons \$12. Demeo, 114 Ford St., Providence, R. I.

UNDERWOOD Typewriters—only \$3.00 down. Easy monthly payments. Low prices at less than manufacturers. 10 days' free trial. Rebuilt, all worn parts replaced. Just like a new machine. 5-year guarantee. Write for a big free catalogue B-151. Shipman-Ward Mfg. Co., 1519 Shipman Bldg., Chicago, Ill.

100 TYPEWRITERS Free. Overstocked. Rent rebuilt Underwood or Remington \$3.00 month. If you pay its value in rental, we give machine free. Particulars free. Pittsburgh Typewriter Exchange, 945 Hersch Bldg., Pittsburgh, Pa.

TYPEWRITERS, all standard makes, \$10 up. Fully guaranteed. Free trial. Write for complete illustrated lists. Northwestern Typewriter Exchange, 121 N. Francisco Ave., Chicago.

TYPEWRITERS: Wholesale, \$15.00 up. Dictaphones. Millereo, 2805 Kellogg, Wichita, Kans.

TYPEWRITERS—all makes; real values; guaranteed. Typewriter Bargain House, Ada, Okla.

HIGH grade Carbon Paper and Typewriter Ribbons at lowest prices. Write for Particulars and price list. Nelson Carbon & Ribbon Co., Elmhurst, Ill.

PRINTING, ENGRAVING AND MULTIGRAPHING

PUBLISH Your Own Magazine or House Organ. Our standardized service at one-fifth ordinary prices. Samples and particulars free. Evans Printing Company, Grand Rapids, Mich.

250 WATERMARKED letter heads, (8 1/2 x 11), envelopes, bill heads, cards, \$1.25 each; combination \$4.50. Pfleger Bros., Hackensack, N. J.

BUSINESS and Personal Cards at special prices. Samples for Stamp. Business Card Specialty Shop, P-552, Jackson, Mich.

ACQUAINTANCE—Offer: our superline, colorprinted letterheads and envelopes, half price—1,000, \$2.90; 500 \$1.65; 200, 95c. Regular grade, \$2.00 thousand. "Tool of Hundred Uses," price everywhere \$1.00, given free with first order. The Backlund Co., Detroit Lakes, Minn.

150 BOND letterheads and 150 envelopes printed \$1.50. Lehman Sales Company, Box 249, Duluth, Minn.

PRINTING: Letterheads, Envelopes, Cards, Blotters, Sales Letters Written, Revised, Multigraphed, Quality Work, Prices Low. Empire Letter Company, Syracuse, N. Y.

HIGH grade commercial Printing at lowest prices. Samples free. Massanetta Paper Co., Harrisonburg, Va.

250 BOND Letterheads or Envelopes, \$1.00. Glenwood Art Press, Govans, Baltimore, Md.

5,000 WATERMARKED Bond Letter Heads \$10.00. Other printing reasonable. Samples on request. Harlem Press, 132 W. 26th St., New York.

5,000 LOTS 5 1/2 x 8 1/2 Circulars, \$10.00; Ad. Slips, \$5.00; 3 1/2 x 6 Four-page Folders, \$13.75. All Printing Lowest Prices. Elegant Samples Free. Good's Printery, Harrisonburg, Va.

GUMMED Labels, with name, Business and address, 500—30c; 1,000—50c. P. Wetzel, Valhalla, N. Y.

"NEARGRAVUREMBOSSO"—(type embossed) 250 Letterheads \$3.85 postpaid. Samples, Solihdays, Knox, Ind.

\$3.00 DELIVERED, 500 Watermarked Bond Letterheads, 8 1/2 x 11, and 250 envelopes, money with order. Job Printing Specialty, National Printing Company, Goshen, Ind.

500 MULTIGRAPH Letters with Printed Head \$2.35. Samples. Carlsons, 8743 Essex Ave., Chicago.

CIRCULARS 5,000 5 1/2 x 8 1/2 \$10. 5,000 3 x 6 \$5.50 3 1/2 x 6 four-page folders, \$14. Postpaid. Samples. Garrison Press, Harrisonburg, Va.

225 BOND letterheads, envelopes, bill-heads, cards, \$1.25 each. Combination, \$4.00. Economic Press, Leonia, N. J.

DISTINCTIVE—Artistic Business Stationery that Creates Confidence. 1,000 Letterheads or Envelopes \$3.00. Samples. Moulton Printing Company, 1410-P East 8th, Kansas City, Mo.

MULTIGRAPH typewriting business correspondence, two dollars thousand. Hamermill Bond Letterheads, four dollars. Mavera Corporation, Monmouth, Ill.

We print Stationery, Booklets, Catalogs, Circulars. Samples. Commercial Press, Batavia, Ohio.

PERSONAL Stationery: 100 Envelopes and 200 Sheets exquisite bond paper, each with your name and address, \$1.00 Postpaid. Brookside Press, 146 Mt. Joy Place, New Rochelle, N. Y.

1,000 LETTERHEADS or Envelopes, \$3.00. Sent Prepaid. Samples Free. Monitor Press, Morrisville, Pa.

YOUR Name and Business address imprinted on Pencils; most resultful advertising. Samples free. Direct-prompt service. (No agents.) S. Mustai & Co., 10-12 Lincoln St., Yonkers, New York.

QUALITY Book Printing at reasonable prices. Cloth, Board, Paper, Bindings. Meador Publishing Company, 27 Beach, Boston.

QUALITY Printing! Reasonable Prices! Send for Free Standardized samples and prices. Folders, Circulars. Catalogs our specialty. Ernest Fantus, 525 South Dearborn, Chicago.

PRINTING OUTFITS AND SUPPLIES

PRINTING Outfits—Presses, type supplies, type novelties. Send stamp for catalogue. Model Press, York, Penna.

COMPLETE printing outfits, presses, type, ink, paper, supplies. Write for Catalog. Kelsey Company, G-11, Meriden, Conn.

PRINTING Presses—Type Supplies. Bargains. Foster, 4342 North Robey, Chicago.

PRE-USED Printing Presses, Type supplies. List for 2c stamp. Popular Bargains, Richland, Pa.

USED Presses, Type, Supplies. C. H. Whitfield, Balletine, Norfolk, Va.

DUPLICATORS AND DEVICES

PORTABLE "Stencils-Duplicator," 8x11 \$7. Copies like \$150 mimeograph. F. Gerwin, Dale, Okla.

YOU can make 50 to 100 copies of a letter, notice, etc., at a cost of three cents on a Heyer Quality Duplicator. Write for free trial offer. The Heyer Duplicator Co., 14 S. Wells St., Chicago, Ill.

ADDING MACHINES

NEW \$3.50 Automatic Adding Machine. Adds. Subtracts. Multiplies. Absolutely accurate. Capacity \$999,999.99. Fully guaranteed. 75,000 pleased users. Makes adding easy, positive, quick. Eliminates Mistakes. Saves Time. Postpaid \$3.50. Bassett Co., 1458 B Hollywood Ave., Chicago.

FREE trial, Marvelous Calculator, Adds, Subtracts, Multiplies, Divides automatically. Work equals \$300.00 machines. Five year guarantee. Price only \$15.00. Write today for free trial offer. Special: \$3.00 Pocket Calculator, only \$2.00 cash. Lightning Calculator Co., Dept. E, Grand Rapids, Mich.

RUBBER STAMPS

YOUR Name and address on two line rubber stamp 25c. Brush & Co., Auburn, Nebr.

MAILING LISTS

SELECT new accurate statewide list 10,000 prosperous North Dakota farmers, \$30.00 complete, \$4.00 thousand. Cash with order. Automobile lists, addressing, mailing. Business Service Co., Bismarck, N. Dak.

99% GUARANTEED Mailing lists. Accurate, Reliable, Guaranteed. The kind that produces business; compiled for every possible business or individual. Lists of every kind of any business or individuals compiled for your individual needs anywhere. Catalogue and information on request. National List, 847 Broad, Newark, N. J.

1,000 LIVEWIRE Agents, Salesmen, Opportunity Seekers, Mo. Beginners. Addresses printed on gummed paper \$3.00. Geo Wargo Service, 811X Porter, Streator, Ill.

100, 1026 MAIL Buyers 50c. Earl Coy, R. R. 8, Dayton, Ohio.

1,000 NAMES, \$1.00. Mention Classification. Wineholt Sales Co., 4, Woodbine, Penna.

ADVERTISERS, 10,000 Agent Names, 98% correct, only 1c each in thousand lots, Month old, price-list free. Yorton, B-373-PM, Syracuse, N. Y.

MAIL Order List \$2.20 thousand. Western Supply, 1617 12th Ave., Rockford, Ill.

150 NAMES 50c. Coulter, 427 East 16th, New York.

FOR SMOKERS

SEND 10c, Silver or Stamps, for sample package 20 fine cigarettes. Large pocket tin Special Blend smoking tobacco also sent for 10c. Direct-to-Smoker. French Tobacco Company, Dept. 31, Statesville, N. C.

HOMESPUN Tobacco—Guaranteed. Chewing five pounds \$1.50; 10—\$2.50. Smoking, 10—\$1.50. Pipe free; pay when received. United Farmers, Bardwell, Ky.

100 REGULAR 5c Cigars, \$3.50 C.O.D. Wineholt Mail Order, Woodbine, 77, Penna.

"AGITATOR" Hand Made Cigars. Selected stock. \$3.00 per box—"Cut Rate" \$2.00 per box. Parcel Postpaid. Manufactured by Schrier Bros., Athens, Pa.

NATURAL Leaf Smoking Tobacco. Aged in bulk, two years old, mellow and sweet; 5 lb. \$1.00; 10, \$1.75. Satisfaction guaranteed. Farmers' Union, Mayfield, Ky.

TOBACCO: Kentucky Sweet Leaf. Mellow with age. Fine flavor. Smoking, 15 lb. \$1.50. Chewing, \$2.25. Pay when received. Ernest Choate, Wingo, Ky.

BOATS AND LAUNCHES

REVERSE gears, propellers, and other equipment bought, sold, exchanged. Wm. H. Baker, Pond St., Quincy, Mass.

BUILD Your Own Boat during your leisure time this winter; plan now. 55 models, new designs. Send 25c for complete catalog. Brooks Boat Co., Inc., Rust Ave., Saginaw, West Side, Mich.

BOAT Building Plans for amateurs. Rowing, sailing, speed, cruising. Free catalog. The Rudder, 9 Murray Street, New York.

GUARANTEES Waterproof Joints—Stanzall Waterproof Joint Glue. Used for making boat models and for general use. 30c for ¼-lb. trial size. L. W. Ferdinand & Co., 152 Kneeland St., Boston, Mass.

ALL materials needed to build Hudson's "Half Moon" described October Popular Mechanics, \$10.00. Hull readycut; blueprint included. Other models also. Roy Hancock, 323 Douglas Ave., Portsmouth, Va.

MAKE 16' Rowboat; blueprint 30c. Weesho-Uco, 31st Office, Detroit.

RAZORS AND BLADES

RENEW your old safety razor blades quickly and easily. Make new blades better. Apply Nura to your strop or stropper, and see the difference. Nura makes blades last indefinitely. Straight razors seldom, if ever, need honing. Stop buying blades. Will not injure Strop. Guaranteed. Send 50 cents, no stamps. Nura Co., Box 342, Rochester, N. Y.

SAFETY Razor Blades—2 Doz. \$1.00, postpaid. Double edged. For Gillette and similar razors. Guaranteed good as any on market. Owl Supply Co., 3509 Ohio, St. Louis, Mo.

GILLETTE style razor and dozen blades 55c. Autostrop razor, with strop, blade, 50c. Coulter, 427 East 16th, New York.

FINE Razor with free strap \$1.77 C.O.D. Mervin Wineholt Co., Woodbine, 99, Penna.

LETTER SPECIALISTS

MONEY—producing letters, booklets, circulars. Proof. Bartels, 504 52nd Street, Milwaukee, Wis.

FOR THE HOME

MEN! Women! Earn \$1 an Hour at Home, Weaving Colonial Rugs, genuine fluff rugs, fancy fabrics, from new and other materials. Home weavers always busy. You learn in 30 minutes. We guarantee it. Looms now at reduced prices. Liberal Pay-As-You-Weave terms. Solve Your more-money problem by writing for Free Loom Book today. Union Loom Works, 480 Factory St., Booneville, N. Y.

GRANDFATHER'S Clock Works, \$5.00. Build your own case; Instructions free; make good profits selling your friends. Clock works with chimes for old or new cases. Write for full particulars. Clock Co., Ruffner St., Philadelphia.

TEXAS Orchard Run Pecans 5 lbs., \$1.10; 10, \$2.00. Postage collect. Langham Bros., Melon, Texas.

AUSTRALIAN Hulless Popcorn. Pops out crisp, crunchy popcorn, no tough hulls. 5 pounds \$1.25 C.O.D. plus postage. Postal Corn Co., Bevidere, Ill.

CEDAR chests only \$11.65—"Red-1-Kut" complete with rich copper trim—you assemble and save half—send for pictures. Kuempel Furniture Company, Guttenberg, Iowa.

SHIP Models, by Capt. E. A. McCann. Instructions and full-scale drawings for making models of Pirate Pelucea and Spanish Galleon. 150 pages—only book of its kind. \$2.60 postpaid. Sea Arts Guild, 405W 11th Ave., Milwaukee, Wis.

DIAMONDS, WATCHES AND JEWELRY

WATCHES—all well-known makes at practically wholesale prices. Including Ingersoll, Elgin, Waltham, Illinois, New Haven and many others. Guaranteed new movements, latest models, priced from \$1 up. Free examination. Write for our price on watch desired and compare with usual retail price. No obligation. Progressive Supply Co., 2025C Fifth Ave., New York.

GENUINE Diamond pin with three best silk knitted neckties only \$1.25. Richard Importing, East Orange, N. J.

WATCH REPAIRING

ALL makes of Watches repaired by experts. Write International Watch Service, Box 5P, Fordham Station, New York.

ANTIQUES, WAR RELICS AND INDIAN GOODS

CURIOS—Relics For Sale. Everything in Curios. Send for lists. Museum, Springfield, Ind.

BOW, Arrows, \$1.60; Beaded Headbands, Necklaces, \$3.00; Fobs \$1.00; Dozen Arrowheads, \$2.50; Birchbark Canoe and Catalogue, 25c. Chief Flying Cloud, Dept. M, Harbor Springs, Mich.

INDIAN deer killing bows \$2.50. Hunting arrows 75c. Cow boy lassoes \$3.50. Thousand article catalogue 10c. Indian-craft P. Company, 466 Connecticut, Buffalo, N. Y.

SEND 5c for fine, new list Indian relics, antique firearms. F. E. Ellis, Webster Groves, Mo.

FOR Dens. Relics from Europe's battlefields; also medals. Illustrated catalogue 2c, with Sample War Photos. International, 1889 Albany Ave., Brooklyn, N. Y.

PHONOGRAPHS AND RECORDS

RECORDS, latest numbers thirty cents each. Write for catalogue. Pleasing Sound Phon. Co., 204 East 113th St., New York, N. Y.

BUILD your own Phonograph. We furnish everything. Catalog sent free. American Phonograph Co., 4116 West 24th Place, Chicago, Ill.

OLD records exchanged. Particulars Free! National, 4110 24th Place, Chicago.

MUSIC AND MUSICAL INSTRUMENTS

WONDERFUL Music Bargains. Theater pianists, teachers, orchestras, church soloists, everybody, 27 fine pieces, perpaid, \$1. State preferences. Fine for Christmas. Sample 2c; circulars free. Hubbard's Bargain Music, Riverside, Calif.

I BUY, Sell, Publish Songs. Chester Escher, 455 Wayne St., Jersey City, N. J.

BANJO-UKE, \$1.97 C.O.D. Worth \$6.00. Instructions free. Wineholt Studios, Woodbine, 99, Penna.

PIANO Jazz: Teaches Ear Piano Playing, Negro Harmony. All styles of bass, Novelty effects, etc. Circulars Free. "Piano Bill," Ossington, Toronto, Canada.

VIOLINS—Genuine handmade masterpieces. Get Details. John Lehto, 935 14th, San Pedro, Calif.

REAL Jazz Piano lessons. Latest Hits, taught quickly at home. Booklet and Sample Lesson Free. Address Studio, 7 United Schools of Popular Music, P. O. Box 1959, Boston, Mass.

SONG Poem Writers—write Ray Hibeler, D1, 2104 N. Keystone Ave., Chicago.

DOLLARS to Cornetists—Trombonists! High notes, attack, tonguing made easier. Full instruction \$1.00. Paul D. Placide, 628 East 29th St., Baltimore, Md.

SONG Writers Attention!—Have been very successful helping amateur song writers. I can probably help you. Write Samuel Speck, 1367 Broadway, New York.

I WANT song poems—a different proposition. Richard Broughton, Sioux Falls, S. Dak.

LEARN Tenor Banjo Playing. Little method. Complete instructors (3 books) \$1.00. Quince, 430 So. Broadway, Los Angeles, Calif.

SONG Poem Writers Address Monarch, 1472 Broadway, Dept. 104, New York.

HANDMADE Violins. Expert Repair Work. Fifty Years Experience. W. C. Blanchard, Violin Maker, Hopkinton, Iowa.

PLAY Piano by Ear. A Sound System. Write for Free Booklet. You'll be glad you did! Boucher's Harmony Studio, 127 Metcalf St., Ottawa, Can.

SHARPS and Flats—Free. Very interesting. Send for it Today. Harry L. Alford, 192 No. State St., Chicago, Ill.

VIOLINS, Deep, Mellow, Soulful—on credit. Easy terms for wonderful instrument. Get details today. Gustav F. Henning, 2424 Gaylord St., Denver, Colo.

"MUSIC Composed" to words. Bauer Bros., (formerly of Sousa's Band), Oshkosh, Wis.

WRITE Songs. Big money and reputation. Write for information. J. Gordon Pub. Co., 201 N. Hoyne Ave., Chicago.

CORNETISTS—Trombonists—Saxophonists—Clarinetists. Get "Free Printers." Name instrument. Virtuosi School, Buffalo, N. Y.

I WANT Song Poems. Casper Nathan, 3544 N. Racine, Chicago.

SONG Poem Writers—Stamp brings "Song Writers' Guide." Wm. Van Beaver, 81-1239 Elm St., Green Bay, Wis.

PATENT ATTORNEYS

PATENTS. Time counts in applying for patents. Don't risk delay in protecting your ideas. Send sketch or model for instruction or write for Free book "How to Obtain a Patent" and "Record of Invention" form. No charge for information on how to proceed. Communications strictly confidential. Prompt, careful, efficient service. Clarence A. O'Brien, Registered Patent Attorney, Security Bank Building (directly across street from Patent Office), Washington, D. C. See pages 170 and 171.

LACEY'S Patent Sense. Valuable book free. See ad page 174.

PATENTS—Write for our Guide Books and "Record of Invention Blank" before disclosing inventions. Send model or sketch of your invention for Free Inspection and Instructions. Terms Reasonable. See advertisement on pages 172 and 173. Victor J. Evans & Co., 934 Ninth, Washington, D. C.

INVENTORS—My Book Inventor's Manual, telling what every inventor should know, sent free upon request. Hartwell Balcom, Registered Patent Lawyer, Barrister Building, Washington, D. C.

OBTAIN your patent through us; we finance the application. Patents Bureau, Times Bldg., St. Louis, Mo.

PATENTS Procured. Prompt Service. Personal, careful and efficient service. Highest references. Moderate fees. Send sketch or model for actual search and advice. George P. Kimmel, Master of Patent Law, 55P Legal Bldg., Washington, D. C.

PATENTS Procured: Trade Marks Registered—A comprehensive, experienced, prompt service for the protection and development of your ideas. Preliminary advice gladly furnished without charge. Booklet of information and form for disclosing idea free on request. Richard B. Owen, 30-Owen Bldg., Washington, D. C., or 41-R Park Row, New York.

"INVENTORS' Guide" sent free on request; this book contains illustrations of patented inventions and gives valuable information and advice for all who have original ideas or improvements. Frank Ledermann, Registered Attorney and Engineer, Woolworth Bldg., 1712, New York.

UNPATENTED Ideas Can Be Sold. I tell you how and help you make the sale. Free particulars (Copyrighted). Write W. T. Greene, 807 Jenifer Building, Washington, D. C.

PATENTS. Booklet free. Highest references. Best results. Promptness assured. Send model or drawing for preliminary examination. Watson E. Coleman, Patent Lawyer, 644 G. Street, Washington, D. C.

INVENTORS: Send sketch or model for advice and exact cost of patent. Ask for our Free book: "How to Obtain a Patent." Tells what every inventor should know. Established twenty-eight years. Highest references. Prompt service. Reasonable charges. Chandler & Chandler, 474 Seventh, Washington, D. C.

MILLIONS spent annually for ideas! Hundreds now wanted! Patent yours and profit! Write today for free book—tells how to protect yourself, how to invent, ideas wanted, how we help you sell, etc. American Industries, Inc., 500-Victor Bldg., Washington, D. C.

INVENTORS having ideas to patent: Write for Booklet explaining Co-operative Plan for handling your applications. Tells how to sell and safeguard your inventions at lowest cost. Ralph Burch, Patent Lawyer, Jenifer Bldg., Washington, D. C.

MONROE E. MILLER, Ouray Bldg., Washington, D. C. Patent Lawyer; Mechanical, Electrical Expert. Booklet and Priority Record blank gratis.

RICHARD E. BABCOCK, Patent Lawyer, Washington Loan & Trust Bldg., Washington, D. C. Booklet.

ESTABLISHED 1864. Milo D. Stevens Company. Free Booklet, Patents, Trade-Marks, Copyrights. Offices, Monadnock Block, Chicago; Barrister Building, Washington, D. C.

PATENTS, Trade-Marks, Copyrights, and Patent Litigation. Write for advice and instructions how to proceed, costs, etc. Hand Book with illustrations of 100 Mechanical Movements sent free on request. Albert E. Dieterich, Patent Lawyer and Solicitor, 621-B Ouray Bldg., Washington, D. C.

PATENTS—Send for form "Evidence of Conception" to be signed and witnessed. Form, fee schedule, information free. Lancaster and Allwine, Registered Patent Attorneys in United States and Canada, 221-Ouray Bldg., Washington, D. C.

"INVENTOR'S Advisor," the valuable Patent book with 139 mechanical movements and illustrations, sent free upon request. MM. Labiner, Patent Attorney, 3 Parkrow, New York.

INVENTORS—Write for our Guide Book, "How to Get Your Patent" and Evidence of Invention Blank. Send model or sketch of your invention for our prompt examination and instructions free. Randolph & Co., Dept. 430, Washington, D. C.

PATENTS—Trademarks obtained. Information free. O. A. Michel, Registered Attorney, Box 624-B, St. Louis, Mo.

PATENTS, Trade-Marks, Designs. This firm has 27 years' experience and gives expert personal service at reasonable rates. We properly protect your invention. Write for free information and exact cost of procuring patent before proceeding. John B. Thomas & Co., 302 F St., N. W., Washington, D. C.

U. S. AND foreign patents, trademarks; moderate rates, 22 years' experience. George C. Heinicke, 32 Union Square, New York; registered in U. S. and Canada.

PERCY S. WEBSTER, 203 Saving and Loan Building, Stockton, California. Long established organization. Patent booklet free.

FOR INVENTORS

PATENTS. If you have an invention which you wish to patent you can write fully and freely to Munn & Co., for advice in regard to the best way of obtaining protection. Please send sketches, or a model of your invention and a description of the device, explaining its operation. All communications are strictly confidential. Our Handbook on Patents is sent free on request. This explains our methods, terms, etc., in regard to Patents, Trade Marks, Foreign Patents, etc. "Scientific American" contains Patent Office Notes, Decisions of interest to inventors and particulars of recently patented inventions. Munn & Company, Solicitors of Patents, 1523 Scientific American Building, 24 W. 40th St., New York; 524 Scientific American Bldg., Washington, D. C.; 1313 Tower Bldg., Chicago, Ill.; 666 Hobart Bldg., 582 Market St., San Francisco, Calif.; 521 Van Nuys Building, Los Angeles, Calif.

PATENTS. Time counts in applying for patents. Don't risk delay in protecting your ideas. Send sketch or model for instructions or write for Free book "How to Obtain a Patent" and "Record of Invention" form. No charge for information on how to proceed. Communications strictly confidential. Prompt, careful, efficient service. Clarence A. O'Brien, Registered Patent Attorney, Security Bank Building (directly across street from Patent Office), Washington, D. C. See pages 170 and 171.

WANTED: Specialties of electrical or mechanical nature, patented or not, that can be marketed through automotive accessory, hardware, electrical trades. If specialty meets Delta quality standard, will buy outright or manufacture on royalty basis and market it through our established channels under nationally known Delta trademark. Send full information and drawings. Delta Electric Company, Marion, Ind.

INVENTORS—Write for our Guide Books and "Record of Invention Blank" before disclosing inventions. Send model or sketch of your inventions for our free inspection and instructions. Terms reasonable. See advertisements on pages 172 and 173. Victor J. Evans & Co., 157 Ninth, Washington, D. C.

INVENTIONS Perfected, Ideas Developed, Models, Tools, Dies, Experiment. John Zoltan, 833 Lyman Ave., Oak Park, Ill.

FOUNDRY and Machine Shop wants to purchase outright or on royalty, rights to manufacture useful patented articles. John E. DuBois, DuBois, Pa.

ATTENTION: Sell your ideas yourself. Manufacturers list, any article, \$1.00. Clarence Knol, 1018 Watkins St., S. E., Grand Rapids, Mich.

REDESIGNING. Selling and Promoting Patents, High grade Model making and Drafting service at reasonable rates. All our work is strictly confidential and guaranteed. L. C. Johnson Engineering Works, 3405 North Clark St., Chicago, Ill.

LACEY'S Patent Sense. Valuable book free. See ad page 174.

SUCCESSFUL Patent selling through co-operation. Particulars free. Chartered Association American Inventors, Barrister Building, Washington, D. C.

WILL buy improved invention. Write W. L. Kendig, 416 N. Duke Street, Lancaster, Pa.

IDEAS for ten inventions. Enquiries answered. Mrs. R. Harvey, 2731 Rose St., Victoria, B. C.

PATENTS Wanted, cash or royalty basis, send description. Box 126, Dowagiac, Mich.

WILL buy improved invention. Write W. L. Kendig, 416 N. Duke Street, Lancaster, Pa.

EDWARD C. SASNETT, Formerly a Principal Examiner United States Patent Office. Strictly Personal Service. McGill Building, Washington, D. C.

PATENTS Procured: Trade Marks Registered—A comprehensive, experienced, prompt service for the protection and development of your ideas. Preliminary advice gladly furnished without charge. Booklet of information and form for disclosing idea free on request. Richard B. Owen, 30-Owen Bldg., Washington, D. C., or 41-R Park Row, New York.

PROTECT your patents, trademarks in case of infringement. Guaranteed by strongest bonding company, surplus \$4,000,000. Patent & Trademark Protection Co., Drawer 1345B, St. Louis, Mo.

I SELL Patents. Established in 1900. The only man in America who has spent the past 25 years exclusively at this work. An experience highly valuable to you, if you have a good patent to sell. Charles A. Scott, 773PM Garson Avenue, Rochester, N. Y.

PATENTS Wanted—We buy and sell practical patents. Big opportunity, undeveloped field. Describe briefly. M. Okamura, Box 1290, Honolulu, Hawaii.

UNPATENTED Ideas Can Be Sold. I tell you how and help you make the sale. Free particulars (Copyrighted). Write W. T. Greene, 806 Jenifer Building, Washington, D. C.

I AM in touch with hundreds of moneyed men and manufacturers who wish to buy good inventions. Write Hartley, 38 Court St., Bangor, Me.

MAIL copy of patent or description of invention. Central Sales Agency, Independence, Mo.

GET your own patents. Legal blanks, complete instructions \$1. Cutting Sons, Campbell, Calif.

INVENTORS Universal Educator—contains 900 mechanical movements; 50 perpetual motions. Tells how to obtain and sell patents. Suggests new ideas. Explains how to select your attorney and avoid patent sharks. Price (revised edition) \$1.50 postpaid. Albert E. Dieterich, 621-Ouray Bldg., Washington, D. C.

INVENTIONS developed to commercial basis. Non-infringing devices designed. Basic claims suggested. A. Papini, Leonia, N. J.

PATENTS FOR SALE

WINDOW—So constructed that the upper and lower sashes may be swung inwardly when access to their exterior is desired. C. Veri, 5 Farnham Ave., Garfield, N. J.

OUTRIGHT or Royalty. Electric hair curlers. No. 1,400,305. Marie Miller, 26 W. Erie St., Chicago, Ill.

SLIDE Saxophone. Slide plays for harmonica. Aquatic aeroplane, parachute and airship. F. C. Bender, 306 Wilson Ave., Brooklyn, N. Y.

METALLIC Slide for Extension Tables. Chas. T. Schilling, 715 W. Beaver Ave., State College, Pa.

OUTRIGHT or royalty—grain heading machine attachable to any Wagon to secure power for operation. W. H. Dean, Grand, Okla.

OUTRIGHT, new shock absorber for vehicle springs. Patent pending. J. Lenn, Newburgh, Ind.

MR. MANUFACTURER—I have a gas-fired boiler that saves over \$40.00 monthly on gas bills. Need somebody to help me pilot the ship. Endorsed by Architects' Association of North America. Any fair offer considered. Betts, 2509 North Spaulding Ave., Chicago, Ill.

HAND Drill, compressed air cylinder drive, crankless, gearless, powerful, very simple. Patent Pending. P. Miller, 1190 Booth St., Milwaukee, Wis.

NOVELTY. Keeps Hat from blowing away. Louis Pichler, 670 E. 102nd, Cleveland, Ohio.

FOR Sale Patent on Shoe Finishing and Ornamenting Tool and Stitch Remover. Best device of its kind yet invented. Practical, simple and efficient. Will outright or place on royalty. For full particulars address Anthony Dobry, 730 Orange Ave., Fort Pierce, Fla.

FOR Sale, Outright or Royalty Patented Mail Bag Catcher for use on mail cars. To anybody interested in such a patent please write to Medrick Houle, Cheever, N. H.

PATENT No. 1,279,233, Drinking Fountain. Will sell Outright or Royalty. P. T. Bockmier, Garfield, Wash.

PATENT No. 1,583,724 Shoe Shining Cabinet. Hands Do Not Touch Polish Cans. No Mechanism. Unlimited Possibilities. Frank Lisi, 6041 Woodland Ave., Philadelphia, Pa.

U. S. PATENT No. 1,940,071—Hobby Horse for sale, Canadian Patent allowed and German applied for. Nick Schleich, 1612 Third Ave. North, Great Falls, Mont.

PAY patent fees; get 1/2 interest. W. Morris, 1816 12th, Washington, D. C.

FOR Sale—Patent on new style Goggle for acetylene and electric welding. Safe and reliable. Protects eyes from light. Sell outright or place on royalty. For full particulars address N. C. Hall, West Marion, S. C.

TOBACCO Dispensing Device. U. S. Patent No. 1,600,133. Automatic match container. Movable bottom. Pocket size. Exceptional merit. Outright or Royalty. Pedersen & Andersen, 1116 Central Ave., Alameda, Calif.

TO manufacturer direct Pat. No. 1,571,570. J. N. Buron, 1214 Santa Barbara St., Santa Barbara, Calif.

WHY let your patents lie idle? Tell our two million five hundred thousand readers about it! The majority of our readers are especially interested in new ideas and inventions. Ask me to tell you how other inventors successfully sold their patents. M. L. Rund, Mgr., Classified Advertising, Popular Mechanics Magazine, Chicago.

ENGINEERING

ENGINEERING Data: Pocket loose-leaf Transformers, and distribution diagrams. Send for circular. C. Homan, 193 Berkeley Place, Brooklyn, N. Y.

SURVEYING INSTRUMENTS

LARGEST stock of new and used surveying instruments in the country direct from factory. Satisfaction guaranteed or money refunded. Wissler, 619 N. Broadway, St.

MODELS AND MODEL SUPPLIES

PATENTS. Time counts in applying for patents. Don't risk delay in protecting your ideas. Send sketch or model for instruction or write for Free book "How to Obtain a Patent" and "Record of Invention" form. No charge for information on how to proceed. Communications strictly confidential. Prompt, careful, efficient service. Clarence A. O'Brien, Registered Patent Attorney, Security Bank Building (directly across street from Patent Office), Washington, D. C. See pages 179 and 171.

SPECIAL machine builders, tool and die makers, inventor's models, production work of all kinds. Dept. L. Quality Hardware & Machine Co., Ravenswood and Thorndale Avenues, Chicago, Ill.

DIES—For less than half others charge. Write us. McConnell & Co., Springfield, Ill.

MODELS, Designing, Drafting, Patterns, Castings, Machine Work, Nickelplating, Enameling, Experimental Work. Send for Circular. Acme Model & Mfg. Co., Washington, D. C.

QUALITY models made of inventions. Estimate free. Nortwed's Model Machine Shop, Ethan, S. Dak.

HAGSTROM Model & Tool Works, Makers of fine models, dies, tools and light manufacturing. Kansas City, Mo.

PATTERNS and Models made. Light Manufacturing. H. W. Hathorn, Mason City, Iowa.

MODELS, Experimental work, tools, Dies, Stamping, Production Work. Most effective; least cost. Great Lakes Tool Manufacturing, 3947 Lake Street, Chicago.

MODELS, Tools and Dies, and General Manufacturing, new invention, our specialty. Logan Machine & Manufacturing Co., 126 S. Clinton St., Chicago, Ill.

HULIT & Co., General Model Makers, 625 W. Jackson, Chicago, Ill. Specializing in high-grade model work on inventions of merit. Complete Equipment, Experienced Workmen.

WE make working models for inventors and do experimental work and carry a complete stock of brass gears and model supplies. Send for catalogue. The Pierce Model Works, Tinley Park, Ill.

LET our experience be your guide. Models that are models; Tools and equipment for economic manfg. Patterns of all types; manufacturing in all branches. Satisfaction guaranteed. United Machinery Company, Cincinnati, U. S. A.

FOR MECHANICS

1,000 AGENTS wanted. One in every town and city to handle following products—Rust remover Rustprotector, Metalhardener, Weldingplates, Cutting oil, Metal Rags and Waste cleanser. Every factory needs them. G. A. Himmelsbach, P. O. Box 254, Far Rockaway, N. Y.

"BLUEPRINT Reading" is a compact book telling how to read Machine blueprints. Send No Money. Just pay postman postal charges and \$1. Popular Mechanics Press, Room 812, 200 E. Ontario St., Chicago, Ill.

MANUFACTURING

METAL-CRAFT—Eventually—Metal-Craft. Competent Engineers, Designers and Producing Organization await your commands on dies, stampings, die-casting, deep pressing, screw-machine and wire products. Plating. Enameling. Burnishing. Assembling. Wrapping and Packing to your specifications. Large completely equipped plant which guarantees prompt, efficient service. It is not the quality of raw materials alone, nor the precision in manufacture, and not just the service rendered that has given Metal-Craft the good reputation they bear—but all of these, as a constant certainty, in Combination. Estimates promptly furnished. Metal-Craft Manufacturing Company, Chicago, Box 259-W.

OPPORTUNITY Wanted. We have a fully equipped factory and machine shop and over fifty years' experience in manufacturing electrical, mathematical and mechanical instruments. What have you that we can manufacture, either in complete instruments, or parts, where low operating expense and exceptional facilities are essential? Gray Instrument Co., 64 1/2 W. Johnson Street, Germantown, Philadelphia, Pa.

OUR factory will make your models, manufacture your articles as well as build your tools, dies and fixtures. Standard Die & Specialty Co., 1932 Austin Ave., Chicago, Ill.

PATTERNS, wood and metal. Models, tools and dies. Brass, bronze, aluminum and iron castings. Screw machine work, production work of all kinds. Write Modern Machine & Pattern Co., Terre Haute, Ind.

MACHINE Work and Screw Machine Products by well equipped shop. Cincinnati Automatic Machine Co., Cincinnati, Ohio.

INVENTIONS developed and manufactured. Any material. Models, instruments, tools. Lowest prices. Established twenty years. Swanberg, 5124 N. Kildare Ave., Chicago.

MANUFACTURE New, Fast-selling, novelties, toys, auto, toilet and agent's specialties. Free Bulletin describes reliable plans, patterns, processes, commercial information. Mfg. Bureau, 1129-A East 31st, Kansas City, Mo.

MANUFACTURING Models, Dies, Stampings, Brass Work, one or thousands. Baum's Metal Specialties, Kansas City, Mo.

WOOD articles manufacture. Model supplies; patterns, lumber, mouldings, tools. The Woodcraft, 105 West, 100 Street, New York.

A CAPABLE American Inventor—Improving, Designing, Inventing of Ideas, Inventions and Patents. Address H I P, 722 Mace St., Greensburg, Pa.

WIRE goods made to order. Cooley Mfg. Co., 530 N. Western Ave., Chicago.

WE design and build special machinery, tools, dies, jigs and fixtures. Experimental work. Light stamping, quantity production. Reliable Machine Co., 400 West 23rd St., New York City.

MINIATURE Die - Casting Machines \$50.00. 318 Reed St., Erie, Pa.

MACHINERY, TOOLS AND SUPPLIES

LATHE screw cutting nine inch swing, long bed, thirty-five dollars. Yankee half inch bench drill, fifteen dollars. Other bargains. Gaines Bros., Box Four Eight One, Gainesville, Tex.

LATHE with screw cutting attachment at a bargain. R. Jaegermann, 5815 Easton Ave., St. Louis, Mo.

SURPLUS Machinery from our plant at extremely low prices. Lathes, Drill presses, Shapers, Milling machines, Hack saws and small tools. Ask for list. Electro Platers Supply Co., 547 Considine Ave., Cincinnati, Ohio.

16" SMITH and Mills Crank shaper, \$300.00; 20"x10" Bradford engine lathe, \$375.00; 10" Drill press with chuck, new, \$19.25; No. 60 Heald auto cylinder grinder, \$750.00; Geared chain hoists, one ton, \$27.50; 1/4 H.P. New motors \$15. Write for complete machinery and supply catalog. Cincinnati Machinery Supply Co., 218 E. Pearl St., Cincinnati, Ohio.

BENCH Speed Lathes—7" Swing, 24" Bed, 3 speed Cone. Price \$10.50 Complete. Jefferson Mfg. Co., Fairfield, Iowa.

CONCRETE Building Block Machines and Molds. Catalogue free. Concrete Machine Co., 5 N. Main St., St. Louis, Mo.

OTHERS have successfully sold their machinery through our columns—so can you. Ask me for proof. M. L. Rund, Manager, Classified Advertising, Popular Mechanics Magazine, Chicago.

ELECTRICAL

BUILD Your Own Battery charger, power transformers, Tesla apparatus; special designed for the home work shop. Particulars free. Albert Deibig, Electrical Engineer, 1690 Park Ave., New York.

BURGLAR Alarm Equipment. Electricians install alarms. Complete 100-pound alarm outfit, instructions, and advertising matter furnished. Must have car and some capital. Mercantile, Bank and Poultry house systems. We build, Gongs, Relays and Parts. Midnight Burglar Alarm System, 3218 Cambridge Street, Toledo, Ohio.

BOOKS—Electrical, Mechanical, Industrial, Electric Toys, Fractional hp. motors. Catalogue 10c. Manhattan Co., 333b W. Manhattan Blvd., Toledo, Ohio.

ELECTRICAL Kinks on all phases of practical electricity. 47 ideas on wiring, 45 on making electrical devices, 19 on lighting, 5 on transformers, 5 on motors, 8 on generators, 11 on switches, 22 on testing, 12 on repairing, 11 on battery manufacture and repair, 5 on telephones, and 9 on electricians' tools. 214 articles. 162 pictures. Send no money. Just write postal for "Electrical Kinks." Pay postman postage, and \$1.50. Popular Mechanics Press, Room 812, 200 E. Ontario St., Chicago, Ill.

ENGINES, MOTORS AND DYNAMOS

HERE is your opportunity to obtain grinders and buffers, brand new; they are full 1/4 H.P., 110 volt, AC, 60 cycle, with cord and plug, with 6" emery wheel on one side and 6" buffer on the other, enclosed dust proof motor. We only have a limited number left at \$15.75 each. Cash with order. Brand new 1/4 H.P., 110 volt, AC, 60 cycle, motors with pulley at \$10.00 each. Immediate shipment. General Distributing Co., Security Storage & Van Co., Duluth, Minn.

MOTORS—New GE 110 or 220 volt 60 cycle Single Phase 1/4 HP, \$11.90; 1/2 HP, \$28.53; 1 HP, \$38.50. Mail \$3 check or money order. We will ship COD anywhere. Motor Specialties Co., Crafton, Penna.

GOVERNORS for Auto Engines. Let us show you how to make a power plant for the shop or farm. A. C-S Governor Co., 215 W. Manchester, Los Angeles, or Springfield, N. Y.

ALTERNATING current motor bargains, single and three phase. All sizes, all kinds, both new and rebuilt. Send for new price list. Guaranteed makes only. General Electric, Wagner, Westinghouse, Century. Motors bought, repaired exchanged. Hyre Electric Co., 615 H.Z. So. Dearborn St., Chicago.

NEW Wonder Electric Drilling-Buffering-Grinding Outfit, complete with 1/4 H.P. A. C. motor. Introductory Offer \$12.45. New 1/2 H.P. 32 volt Farm Plant motors \$17.50. New 1/4 H.P. 110 volt A. C. Wash Machine Motors \$7.75. Greatly reduced prices on 1/2 and 1 H.P. single phase Motors. Send remittance with order. Satisfaction Guaranteed. Acme Tool Co., 627 West Washington, Chicago.

STEAM engines One H.P., \$18; 1/2, \$12. Boy's wonderful Christmas presents. James Chambliss, Bessemer, Ala.

1/4-HORSE alternating and direct current used motors, \$6.50. Groove pulleys, 30c Flat, 45c. 1/4 Horse, 32 V., 8,000 speed motors, 1/4 Horse, 3,000 speed, 110 V., direct current, \$3.75 each. Also other bargains. Queen City Electric Co., 1736 Grand Ave., Chicago, Ill.

DO you want an electric lighting plant on your farm, with your gasoline engine and one of our 1,000 Watt, 32 volt, Westinghouse generators? You can have electric lights in your house, barns, etc., at a very low cost. Run your washing machine, cream separators, etc. The cost of the above generators are \$48.00 each. Write for bargain catalog on engine driven lighting plants. General Distributing Co., Security Storage Bldg., Duluth, Minn.

BLACKSMITHS

BLACKSMITHS. Make More Money in Job Shop or Factory Doing Hard Jobs Easy. Be a Master Machine and Plow Blacksmith and Expert Tool Dresser and Tempering to a Standard with Collard Tempering Charts. All for One Dollar. Samples Free. W. M. Toy, Sidney, Ohio.

BENDING MACHINES

THE famous Hossfeld Wrenchless Universal Bender is the last word in bending machines; bends metal, cold or hot, into most any conceivable shape, including Eye-bolts and Automobile Spring Eyes. Bends up to 1" bars or 1 1/4" Pipe cold. Used by the largest corporations, yet so inexpensive that even a farm shop need not be without one. Send for Circular. Hossfeld Mfg. Co., Box 344, Winona, Minn.

FOR SALE—MISCELLANEOUS

ADDRESSOGRAPHS. Letter Folders, Multigraphs, Envelope Sealers, Duplicators, less than half price. Guaranteed. Pruitt Co., 117 No. Market, Chicago.

MOUNTED Wolfskin Rugs. Open Mouth's \$17 each. Satisfaction guaranteed. Strange's Taxidermy Shop, Clarkson, Wash.

ALMONDS—5 lb. \$2.00 prepaid. Cotton-Route No. 2, Box 570 Pasadena, Calif.

HASSLER Shock Absorbers (new), \$14.00. G. J. Myers Codorus, Pa.

BUY—Exchange—Sell! Many of our readers have for sale or exchange the article you are looking for—and lots of them are looking for the very items you want to turn into cash. Get together! Let our two million five hundred thousand readers know your wishes—they'll help you! Send your ad today to M. L. Rund, Manager Classified Advertising, Popular Mechanics Magazine, Chicago.

WANTED—MISCELLANEOUS

MAIL us your discarded Jewelry, Gold, Crowns and Bridges, Watches, Diamonds, Silver, Platinum, and old False Teeth. Money promptly mailed. Goods returned if offer refused. United States Smelting Works, (The Old Reliable), Dept. 71, Chicago.

HAVE You a new Correspondence School Course we could take and sell through big National Advertising Campaign? Leading Correspondence School may buy your idea outright or pay fair royalty. Write Today! Your material held in strictest confidence. Box MFJ, care Popular Mechanics Magazine, Chicago, Ill.

REAL ESTATE, FARM AND ORCHARD LANDS

720 ACRES of grass land at \$7.00 per acre. \$2.00 per acre down, balance in 5 years at 6% annually. W. E. Campbell, Bellevue, Tex.

35 ACRES Edge Village. Only \$900 with Horse, Tools and Poultry; city markets, delightful 5-room house, good barn, granary, poultry house; wire-fences, fruit, woodlot. 25 acres level fertile crop land. Only \$900, part cash. Details in Illus. Catalog Supplement. Copy free. Strout Agency, 255-P, 4th Ave., New York City.

POULTRY Land \$3 down \$5 monthly buys 40 acres Southern Mo. Price \$200. Send for list. Box 22-N, Kirkwood, Mo.

OREGON Homesteads (late opening) and lands offer exceptional opportunities. Map and details \$1.00. Frank Thompson, Sheridan, Ore.

SELL your property quickly for cash, no matter where located. Don't pay big commission. Particulars free. Real Estate Salesmen Co., Desk B, Lincoln, Nebr.

PECAN-Orange-Fig Groves "On the Gulf" Monthly payments. Guaranteed care. Big, quick returns. Suburban Orchards, Dent, M. Biloxi, Miss.

OZARK land; ten acres near White River and proposed Dixie Dam, \$100; \$5 monthly. Alvin Zimmerman, 1800 N. Fifth, Kansas City, Kan.

POULTRY

KEEP Chickens? Tell us the breed and how many and we'll send you free a copy of the most interesting poultry journal ever published. Poultry Item, Box 71, Sellersville, Pa.

DOGS AND PETS

REGISTERED German Police dogs. Write for particulars. Springdale Farms, Scottville, Mich.

RAISE guinea pigs. Pay better than poultry or rabbits; easy to raise; little space required. Particulars and booklet how to raise free. Cavies Distributing Co., 3102 Grand Ave., Kansas City, Mo.

FOX Terriers, Collies, Bulldogs. Puppies \$10.00. Chas. Smiley, Judson, Ind.

SMALLEST Boston stud. Cards. Puppies: Christmas. "Sentree," Gardenia, Royal Oak, Mich.

BEAUTIFUL Fox terriers. Write, Curtis Matz, Carmi, Ill.

CANARIES—Ida Conley, Hinton, Okla.

HUNDRED Hunting Hounds. Fur Finders. Catalogue, Kaskaskennels, B57, Herrick, Ill.

ENGLISH Shepherd Puppies. Blacks and Browns. Guaranteed to Heel. H. W. Chestnut, Chanute, Kans.

PEDIGREED Pups High Class, Police, Airedales, Collies, Chows, Danes, Wire Hair, Maplewood Kennels, Medway, 3, Mass.

BEAUTIFUL registered Bull Pups, \$15. Bulldogs, 501 Rockwood, Dallas, Texas.

FOXES, raccoons, muskrats, skunk, ferrets, rabbits, squirrels, mink, opossums, B. Tippman, Caledonia, Minn.

RABBIT Sale—Pedigreed. \$2.00 up. Illustrated book, 10c. Malkranz Rabbitry, New Bethlehem, Pa.

PERSONAL

HOW Is Your Health? Our Medical Staff Will Answer Any Health Question, in English You Will Understand. 25 cents. Longevity Research Laboratories, 92 Chestnut, Fairhaven, Mass.

ASTROLOGY—Stars tell Life's story. Send birthdate and dime for character reading. M. Kleman, 90 Adelaide St., Winnipeg, Manitoba.

HERB Doctor Book, 10c. Contains over 250 valuable herb medicine recipes for home use. Shawnee, 145 West 112th St., Chicago.

WONDERFUL uses can be made of roots, herbs, flowers, etc. Interesting 96-page booklet containing 250 recipes, some of them the cherished secrets of Indian medicine men and old Herbalists. Free. Box 29P, Station L, New York.

ASTROLOGER will read your life. Test predictions for one year, 20c, dimes or stamps. Send year and birthdate. Money back, if dissatisfied. G. Niemeyer, 621 McConnell Terrace, Atlantic City, N. J.

FORTUNE Telling Chart. Send 10c. Elmer Gutknecht, 445 Idaho St., Milwaukee, Wis.

TOBACCO or Snuff Habit Cured or no pay. \$1.50 if cured. Remedy sent on trial. Superba Co., N3, Baltimore, Md.

WONDERFUL health book for only 10c (publisher's price \$1.00). Appreciated by every reader, sick or well. Teaches health the natural way, also suggest reliable self treatment of disease. Address, Author, Box 437, Seattle, Wash.

UNUSUAL Horoscope Consisting of Extensive four page Special Horoscope, and Astro Analysis. Send 50c and birthdate. Money returned if dissatisfied. Prof. Bolles, Box 125, Cranford, N. J.

FORTUNE telling and character reading, by numbers, palmistry, chiromancy, oraculum, astrology, horoscope, kabala, tea leaves, and cards. All in one 250-page book, illustrated. Easy to learn. Send no money. Write a postal for "Fortune Telling and Character Reading." Pay postman postage and \$1.25. Popular Mechanics Press, Room 812, 200 East Ontario St., Chicago, Ill.

MISCELLANEOUS

BARBER Shears, Corrugated Clipper, grinding, 50c Pair. Perfect work, 25 years experience. Send prepaid, 24 hour service. Fuller, 420 S. Main, Lima, Ohio.

MIRRORS Resilvered at Home. Costs Less 5 cents per square foot; you charge 75 cents. Immense profits plating autographs, reflectors, tableware, stoves. Refinishing metalware, etc. Outfits furnished. Write for information. Sprinkle, Plater, 288, Marion, Ind.

BARREL Lots Slightly Damaged Crockery, Hotel Chinaware, Cookware, Glassware, etc. Shipped Direct from Factory to Consumer. Write for Particulars, E. Swasey & Company, Portland, Maine.

GET posted—good prices paid for butterflies, insects. See Sinclair display advertisement, page 68.

ARTIFICIAL Eyes. Booklet free. Denver Optic, 559 Quincy, Denver, Colo.

PENNY legitimate coin operated scales. Peanut, Gum and Match machines. E. A. Barr Co., Shamokin, Pa.

WOLF and Coyote Exterminator Capsules—With formula and instructions; got 9 coyotes one night, brought \$121.50; free circular. George Edwards, Livingston, Mont.

CAN You Draw? Make money at home. Something new. No canvassing. Sample and particulars 10c. "Straley," 1017 W. Mulberry, Springfield, Ohio.

SAFETY First! Bathes, sea travelers; carry Pneumatic Swimming Belt, pocket life preserver. Booklet free: "Universal," 309 3th Ave., New York.

CREAMY Fudge—Secret—Delicious, easy, make money, 25c. Donnell, 414 Summit St., Ann Arbor, Mich.

MEXICAN made pistol holders, cartridge belts; horse hair goods, lariats, sombreros. List free. Ingersoll Leather Co., 307 Fannin, Houston, Texas.

1 PAIR Fine Cotton Blankets, only \$1.99 C.O.D. Satisfaction Guaranteed. Mervin Wineholt Co., Woodbine, 99, Penna.

ALL-WOOL Yarn for sale from manufacturer at bargain. Samples free. H. A. Bartlett, Harmony, Me.

LOCKSMITH—Safe opening taught by mail. C. I. Mitchell, Temple, Texas.

HYPNOTISM and Auto Suggestion. Learn how to hypnotize other people, yourself and animals. Learn clairvoyance, mind reading and telepathy. Clearly explained in "Practical Lessons in Hypnotism and Auto Suggestion." Send no money. Pay postman postal charges and \$1.25. Popular Mechanics Press, Room 812, 200 East Ontario St., Chicago, Ill.

HARRIS Tweed, cream of Scotch Home-spuns direct from Makers. Suit-lengths by Post, \$2.00 per yd. Samples free on stating shades desired. Newall, 270, Stornoway, Scotland.

TRAPPERS, any burrowing animal without smoking, digging or trapping. No fake. Get's them every time. Method fully explained 25c. McKelvey Cortright, Box 261, Middletown, N. Y.

BEST Yet Cement Mends wood, glass, ivory, dishes, etc. Stronger than glue. Resists heat. Agents wanted. Big profit. Particulars free. Trial can 10c. Moser Brothers, Richland Center, Wis.

WEEDS—Cut them with cutter bar on Shaw Garden Tractor. Also plows, cultivates and runs belt machinery. Low prices. Immediate delivery. Shaw Manufacturing Company, Department C, Galesburg, Kans.

TATTOOING—learn tattooing, with my outfits. Send for circulars; they explain everything. Sergt. Bonzey, 367 South Main, Providence, R. I.

I CATCH from 45 to 50 foxes in from 4 to 5 weeks' time. Can teach any reader of this magazine how to get them. Write for particulars. W. A. Hadley, Stanstead, Quebec.

CUTS anybody can make. Simple, cheap process. \$1. Specimens, particulars, 2c stamp. M. Day, Windfall, Ind.

HOMEOPATHIC and Biochemic preparations sent postpaid to all parts of the world. Manual and booklets free. Halsey Bros. Co., 645 St. Clair St., Chicago, Ill. Established 1855.

AMATEUR Cartoonists: Make money in spare time with new cartoon selling plan. Write Smith's Service, PM1194, Wenatchee, Wash.

NEW salesboards, bargains, write Interstate Company, Box 700, Minneapolis, Minn.

LOCKSMITHING. 500 tricks of the trade; how to make keys; how to open locks and safes; safe drilling; how to set combinations; key-cutting tables; umbrella work; everything you should know to become a lock expert. Copiously illustrated. Only complete book on subject sold at reasonable price. Send No Money. Just write a postal for "Locksmithing." When postman hands you book, pay \$1.50 and postal charges. Popular Mechanics Press, 200 East Ontario St., Room 812, Chicago, Ill.

Scatter-brained!

No wonder he never accomplishes anything worthwhile!



HIS mind is a hodge-podge of half-baked ideas. He thinks of a thousand "schemes" to make money quickly—but does nothing about any of them.

Thoughts flash into and out of his brain with the speed of lightning. New ideas rush in pell-mell, crowding out old ones before they have taken form or shape.

He is Scatter-brained. He pities himself, excuses himself, sympathizes with himself. And the great tragedy is that he has every quality that leads to success—intelligence, originality, imagination, ambition.

His trouble is that he does not know how to use his brain. His mental make-up needs an overhauling.

It is a known fact that most of us use only one-tenth of our brain power. The other nine-tenths is dissipated into thousands of fragmentary thoughts, in day dreaming, in wishing.

What can be done about it? Find out by means of Pelmanism; then develop the particular mental faculty that you lack. You can develop it easily; Pelmanism will show you just how; 550,000 Pelmanists, many of whom were held back by your very problem, will tell you that this is true.

Pelmanism is the science of applied psychology, which has swept the world with the force of a religion. It has awakened powers in individuals, all over the world, they did not dream they possessed.

Among those who advocate Pelmanism are:

- T. P. O'Connor, "Father of the House of Commons."
- The late Sir H. Rider Haggard, Famous Novelist.
- General Sir Robert Baden-Powell, Founder of the Boy Scout Movement.
- Judge Ben B. Lindsey, Founder of the Juvenile Court, Denver.

- Frank P. Walsh, Former Chairman of National War Labor Board.
- Jerome K. Jerome, Novelist.
- Gen. Sir Frederick Maurice, Director of Military Operations, Imperial General Staff.
- Sir Harry Lauder, Comedian.
- Baroness Orczy, Author.
- Prince Charles of Sweden.

—and others, of equal prominence, too numerous to mention here.

A remarkable book called "Scientific Mind Training" has been written about Pelmanism. It can be obtained free. If you are made of the stuff that isn't content to remain a slave—if you have taken your last whipping from life—if you have a spark of Independence left in your soul, write for this free book. It tells you what Pelmanism is, what it has done for others, and what it can do for you.

Let Pelmanism help you find yourself. Mail the coupon below now—while your resolve to do something about yourself is strong.

THE PELMAN INSTITUTE OF AMERICA

Approved as a correspondence school under the laws of the state of New York

19 West 44th St. Suite 612 New York City

The Pelman Institute of America, 19 West 44th St., Suite 612, New York City.

I want you to show me what Pelmanism has actually done for over 550,000 people. Please send me your free book "Scientific Mind Training." This places me under no obligation whatever.

Name.....

Address.....

City..... State.....

The Smartest Gift for the Daintiest Miss



No. 15. Orange Blossoms \$1.50 per pair



No. 12. Two Strands of Pearls \$3.00 per pair



No. 17. (The Pearlastic worn in the picture.) One Strand with Alternating Pearls.....\$2.50 per pair



No. 37. Forget-Me-Not \$2.75 per pair



No. 19. One Strand of Pearls \$2.00 per pair

Indestructible pearls, mounted in lovely designs on shirred elastic—such are the new pearlastics (Patented) which lend elegance to evening or daytime wear and bridal outfits. Inexpensive, charming gifts, cannot be cheaply imitated, beautifully boxed. All colors. Satisfaction guaranteed.

Order by number and state colors wanted. 10% discount on half-dozen pairs or more. Send no money. Pay the postman!

NAMBROOKS CO. Dept. 512, 132 Nassau St. NEW YORK CITY



"Learning to Fly"



Send Dollar Bill for "Learning to Fly"—complete course by Murphy McHenry. "Learning to Fly" is direct—simple—practical—non-technical. If you are planning to take flying lessons, you should have this fundamental information first. "Learning to Fly" is written by recognized, licensed pilot, and contains accurate description of actual experiences in an airplane. Be prepared for future important developments in civil aviation.

Course is sent complete, postpaid, for \$1. Send coupon today. Pin

AIRWAY SCHOOL San Mateo, Calif. Dept. 3
AIRWAY SCHOOL Dept. 3, San Mateo, Calif.

Gentlemen: Enclosed find One Dollar for which please send me, postpaid, Murphy McHenry's course in aviation logic, complete.

Name.....
Street, Number.....
City..... State.....



How, after 12 years hard work as railroad brakeman, I got into real estate, and now make more in a month than I used to make in a year.

By **L. C. CLARKE**
(Address furnished on request)

FOR TWELVE YEARS I was a brakeman on the Mohawk Division of the New York Central.

During that time my wages averaged exactly \$638.40 a year.

Then I got started in the real estate business, and during the past year I made one sale that gave me a commission of \$4,500, which is more than I made on the railroad in seven years of hard work.

And I don't feel that I have done anything wonderful—anything the other fellow can't do if he will, I simply got into the right kind of business—a business of big opportunities—a business where big money is made.

You—who are reading these words—can do what I have done if you have a mind to. You don't need education, experience, capital or influence. I didn't have any of these things.

I had to leave school when I was thirteen, so I had mighty little education. I had no real estate experience. I never earned more than just enough to keep me out of the poorhouse, so I had no capital. And, as for influence, where would a \$50-a-month brakeman get any?

And you don't have to go to a big town to succeed. I am located in a little New York State town of only 3,000 population.

Of course, I'm pretty enthusiastic about the real estate business. I think it's the greatest business in the world. It has more advantages and bigger opportunities than any other business I know of. It is as permanent as the earth itself. It is almost unlimited in its possibilities—about ten million properties are always on the market. It is easy to learn. You don't need capital to get started, as you

do in almost any other business. The business can't grow smaller—it keeps getting bigger and bigger as population increases. And you can get started in the business right at home in your spare time. When I realize that I have an independent, enjoyable business of my own, a good home, two automobiles, and every convenience and comfort a sane man could want, I sometimes find it hard to believe that I'm the same fellow that put in twelve long years of hard work as a railroad brakeman.

Now if you are kicking about what I used to kick about—long hours, hard work and poor pay—if you want to get into a business where you can have the biggest kind of an opportunity to make good—simply send your name and address to American Business Builders, Inc., Dept. 44-Z, 18 East 18 Street, New York, and they will send you, *without cost or obligation*, a copy of their free book, "How to Become a Real Estate Specialist."

In five minutes after you start reading this fascinating book, you will agree with me that you have at last struck the best business opportunity that ever came your way—an opportunity to learn a splendid, money-making business and get started—right at home—in your spare time—without capital or experience—in a safe, sound, independent business of your own.

So get busy, if you want to grab something big. If you are ambitious to make something of yourself—get ahead—make more money—this is one chance you can't afford to let slip out of your grasp. It costs you nothing to find out what there is in this for you. You take no risk. So, mail the coupon at once. Take my word for it, you will never regret the day you sent for this free book. And some day you may do just what I did—put through a deal that will put more money in your bank account than you ever saw in one pile before.

I Made \$4,500 in One Sale

Free Employment Service

Real estate corporations, sub-division operators, auctioneers, realty bond houses, building and loan associations, insurance companies and others requiring trained representatives (men or women) should register at once for our free employment service. Address—Business Development, Dept. 44-Z, 18 East 18 St., New York.

Buy and Sell Real Estate

Anyone wishing to buy any kind of real estate, anywhere, write at once (on postal card only) requesting Free Requirement Blank. Owners, wishing to sell, write at once (on postal card only) requesting Free Listing Blank. Address—National Real Estate Exchange, Dept. 44-Z, 18 East 18 St., New York.

American Business Builders, Inc.,

(Authorized Capital \$500,000)

Dept. 44-Z, 18 East 18 Street, New York



Send me—without cost or obligation—your new, free illustrated book, "How to Become a Real Estate Specialist."

Name.....

Address.....

The World's Only Ball Bearing Typewriter



636
Ball
Bear-
ings

L. C.
Smith
Silent
Model
No. 8

FREE 10 DAYS

BEFORE buying any typewriter, try this L. C. Smith 10 days free. Test it in your home or office where no one will urge you to buy. See how easily it operates, the perfect work it turns out. Money cannot buy a better typewriter. Recognized for 20 years as the world's *easiest running, longest wearing* typewriter.

Only \$3⁰⁰_{Down}
Balance Easy Terms

Guaranteed 5 Years Ball bearings at all points of wear. All the writing always visible. All the latest operating conveniences. Beautiful. Re-Newed.

SEND NO MONEY Just mail the coupon. No red tape. No obligation. We will promptly ship you this splendid machine. If a trial does not convince you it is the finest machine you ever used, return it to us at our expense. You can keep it for \$3 down and \$5 monthly until our Special Price of \$69.70 has been paid.

FREE—By acting now you receive Complete Touch Typewriting Course, Tools, Waterproof Cover, Operating Instructions. Now is the time to buy. Never has such a typewriter bargain on as easy terms been offered. We may never be able to offer it again. Send coupon now—before offer is withdrawn.

\$40 SAVED by Using this Coupon
SMITH TYPEWRITER SALES CORP.
9C-360 E. Grand Ave., Chicago

Ship me the L. C. Smith F. O. B. Chicago. On arrival I'll deposit \$3 with express agent. If I keep machine, I'll send you \$5 a month until the \$66.70 balance of special \$69.70 price is paid; the title to remain in you until then. I am to have 10 days to try the typewriter. If I decide not to keep it, I will repack and return to express agent, who will return my \$3. You are to give your standard 5-year guarantee.

Name.....

Address.....

City.....State.....

Occupation.....

Employed by.....

**\$10 TO \$20
A DAY**

LEARN TO PAINT

A real trade with a Big Future. Paperhanging, Decorating—Graining—Marbling—Sign Painting—Show Card Writing—Auto Painting.

PAY BEST WAGES

of all Trades everywhere and more steady work—Write today for my Big Free Catalog and Special Offer.

HARRY GLICK, President
CHICAGO PAINTING SCHOOL
Dept. M-148 West Austin Ave., Chicago

10,000 OIL BURNERS AT HALF PRICE for Your Stove or Range

ACT promptly and you can end the dirt and drudgery of coal forever. For 10,000 new, improved Oliver Oil Burners are to be sold at half price as part of gigantic advertising campaign. 30-Day Free Trial Offer. Agents Wanted Everywhere. Write Oliver Oil Burner Corp., W-131 Oliver Bldg., St. Louis, Mo.

How to Straighten Bow and Knock-kneed Legs!

Improve your personal appearance by using the new patent "Lim-Straitner," Model 18. Corrects now Bow and Knock-kneed legs safely, quickly and permanently at home. No costly operation or discomfort. Is worn at night. Easy to adjust; its result will save you soon from further humiliation and will improve your personal appearance 100 per cent. Write today for copyrighted Physiological and Anatomical book and experience of others without obligation. Enclose a dime for postage.

M. TRILETY, Specialist Dept. 1421L
BINGHAMTON, N. Y.

PIMPLES

ANDRE'S ACNE CREAM is Excellent for all Skin Troubles no matter how severe or chronic. Pimples, Blackheads, Eruptions on face or body. Eczema, Barbers' Itch, Scales, Crusts, Pustules, Enlarged Pores, Oily, Shiny or Itching Skin. Lightens Freckles, softens and whitens the skin. Immediate Results. Write for full particulars.

Andre & Co., 4029 Cottage Grove Av. Suite 451, Chicago, Ill.



See the World
in an Officers
Uniform ~

Be a Ship's Officer
Salary Up to \$350⁰⁰
a month and expenses
Learn Navigation

In 24 Short Weeks
Many Opportunities in Our Fast
Growing Merchant Marine

Prepare now to become an officer in Great Lakes, Coastwise or Foreign trade. See the world. Have plenty of excitement, fun, action and adventure. Also big pay. Men trained in navigation command salaries up to \$350 a month and expenses. Our graduates are now holding high-paid positions on ships sailing to all corners of the world.

Our remarkable course, prepared by an old sea captain and endorsed by U. S. Navy and high shipping officials, now ready for your use at home. Teaches entire subject of Navigation with higher mathematics. Everything reduced to simple arithmetic.

Learn more about this wonderful opportunity. Just the life for a red blooded man. Write quick for free book telling all about course and successful students.

Get FREE BOOK

WORLD TECHNICAL INSTITUTE
Dept. 10, 925 15th St., N. W., Washington, D. C.

Send me your FREE book telling about the opportunities on the sea and about Captain Sheppard's plan to teach me navigation in 24 short weeks.

Name.....

Address.....



WARNING! You can't become an ELECTRICAL EXPERT in one month!

I have trained 16,000 men in my big schools. And I know how long it will take you to become an *electrical expert*. I know that you need THOROUGH training to get a *good* job. And I have proved that my way of teaching electricity is the right way to train you to get one of those big-pay jobs *quicker*! I don't promise you a big-pay electrical job 30 days after you enroll for my course. But—

I will absolutely guarantee that when you complete my electrical course you can become a REAL Electrical Expert, thoroughly trained and capable of holding down a high-salaried job. And I'll help you land that job!

I wouldn't dare print such a guarantee unless I could back it up. But everybody knows that National's Electrical Course is thorough and complete. Nationally famous instructors train you. You use as few books as possible. You work right with the instructors on a half-million dollars' worth of new electrical equipment. *You learn by doing.*

I Help You All Through Your Life!

It may take you six months or a year to learn Electricity. But when you enroll for my course you are entitled to stay in this big school all your life! You can take part of my course and come back years later to take the rest, at no extra cost. You can stay in any department until you have mastered it thoroughly. I don't rush you through half-trained. I'll always help you to learn more and earn more. National stands behind you all through your life!

When you graduate from National you know your stuff! I'll help you get a job and your superior training will quickly get you bigger pay than other men who have merely learned a smattering of electricity. California is undergoing a tremendous hydro-electrical development. Los Angeles is the center of the West's Big Pay electrical jobs.

With National Training You Know MORE than Other Men

How can you hope to be a foreman or superintendent—or hold any other big-salaried electrical job—unless you know *more* than the other men? Isn't it ridiculous to expect to learn electricity in three or four months when leaders in the electrical industry say it takes years?

My Free Book Tells the Truth

Don't be misled by promises. Get my free book of facts. It tells the *Truth* about the electrical industry. Learn about my sensational Lifetime Scholarship—the greatest proposition ever offered any man who seriously wants to learn electricity *right* and earn real money. My course may cost you a few dollars more but you'll agree that it's worth thousands of dollars more.

Every statement I make here is backed by 22 years' experience teaching men like you. I *guarantee* my training. And if you want to be a real Electrical Expert instead of a "half-baked dud," you'll mail this coupon for my free book and learn the facts before you decide.



Mail Coupon Now for

FREE
Electrical Catalog
 It tells how you
 too can win a
 big pay job
 Quickly

National
 Electrical School
 Dept. 501
 Santa Barbara & Figueroa Streets
 LOS ANGELES, CALIFORNIA

I am interested in the Big-Pay Opportunities of the Electrical Industry. Send me your FREE 64-page illustrated catalog.

NATIONAL ELECTRICAL SCHOOL

Dept. 501

Santa Barbara and Figueroa Streets
 Los Angeles, California

MAIL THIS "SUCCESS COUPON" NOW

Name.....
 Address.....
 City..... State.....

DRAFTING



Learn at Home

DRAFTING is one of the best professions a young man can choose because it pays good salaries and it is the stepping stone to even better positions. Many leading architects, mechanical engineers and electrical engineers got their start at the drafting board.

There is no easier way to learn Drafting than through the home-study courses of the International Correspondence Schools. The practical value of these courses is shown by the success of I. C. S. students and also by the fact that employers are constantly writing us for trained men. We receive more calls for I. C. S. draftsmen than for graduates of any other course.

F. E. King was "a poorly paid clerk" when he enrolled for the I. C. S. Drafting Course. By study, industry, and perseverance he became Chief Draftsman of the U. S. Steel Furniture Company, of Syracuse. He is now earning more in a day than he used to earn in a week.

A. J. Hutchins became Chief Draftsman for the American Strawboard Company and increased his salary 300 per cent—also as a result of I. C. S. Training.

There is no doubt that Drafting offers a real opportunity to ambitious men and it will pay you to investigate it. Just mark and mail the coupon and we'll gladly send you a booklet telling all about the I. C. S. courses in Drafting or other subject in which you are interested.

INTERNATIONAL CORRESPONDENCE SCHOOLS
Box 5615-E, Scranton, Penna.

Without cost or obligation on my part, please send me one of your booklets and tell me how I can qualify for the position or in the subject before which I have marked an X:

- | | |
|---|--|
| <input type="checkbox"/> Mechanical Drawing | <input type="checkbox"/> Sheet Metal Worker's Course |
| <input type="checkbox"/> Draftsman's Course | <input type="checkbox"/> Sheet Metal Pattern Drafting |
| <input type="checkbox"/> Boilermaker's Course | <input type="checkbox"/> Boilermaker's Laying Out |
| <input type="checkbox"/> Structural Drafting | <input type="checkbox"/> Ship Drafting |
| <input type="checkbox"/> Architectural Drawing | <input type="checkbox"/> Illustrating and Designing |
| <input type="checkbox"/> Mechanical Engineer | <input type="checkbox"/> Machinist |
| <input type="checkbox"/> Electrical Engineer | <input type="checkbox"/> Toolmaker |
| <input type="checkbox"/> Civil Engineer | <input type="checkbox"/> Iron and Steel Worker |
| <input type="checkbox"/> Steam Engineer | <input type="checkbox"/> Patternmaker |
| <input type="checkbox"/> Structural Engineer | <input type="checkbox"/> Foundryman |
| <input type="checkbox"/> Architectural Engineer | <input type="checkbox"/> Automobile Mechanic |
| <input type="checkbox"/> Surveyor | <input type="checkbox"/> Architect's Blueprint Reading |
| <input type="checkbox"/> Concrete Builder | <input type="checkbox"/> Electrician |
| <input type="checkbox"/> Contractor and Builder | <input type="checkbox"/> Apprentice Trades |
| <input type="checkbox"/> Business Management | <input type="checkbox"/> Salesmanship |
| <input type="checkbox"/> Traffic Management | <input type="checkbox"/> Advertising |
| <input type="checkbox"/> Bookkeeper | <input type="checkbox"/> Business English |
| <input type="checkbox"/> Private Secretary | <input type="checkbox"/> Civil Service |
| <input type="checkbox"/> Spanish and French | <input type="checkbox"/> Common School Subjects |
| <input type="checkbox"/> Mathematics | <input type="checkbox"/> High School Subjects |

Name.....
Address.....
.....

LEARN WATCHMAKING AND ENGRAVING
BY OUR PROFIT-SHARING PLAN
OUR GRADUATES SUCCEED
One of our low students started in a very small way—now doing over \$30,000 a year. Another in Wisconsin, over \$10,000 the first year. Day or night classes. Call or write for FREE BOOK
Chicago School of Watchmaking, Dept. 2301, 4844 Lincoln Avenue, CHICAGO



WHY NOT spend Spring, Summer and Fall gathering butterflies, insects? I buy hundreds of kinds for collections. Some worth \$1 to \$7 each. Simple outdoor work with my instructions, pictures, price-list. Send 10 cents (not stamps) for my illustrated Prospectus before sending butterfly.

MR. SINCLAIR, DEALER IN INSECTS,
Dept. 6, Box 1424, San Diego, Calif.

SCIENCE FINDS NEW DRUGLESS GLAND STIMULANT

Science has discovered a new method of applying a positive-nature force. The method is wholly different—a tremendous step forward in regaining prostate gland health. Amazing effects produced in thousands of men, many beyond sixty.

"A hundred years ahead of modern medicine," writes a New York physician. Doctors and osteopaths are using and prescribing it. No drugs, medicine, massage or violet rays. Absolutely safe.

Does what Gland Tablets can never do. Directly stimulates prostate gland and often restores it to normal size and functioning in six days! Also tones up entire system, usually routes constipation and piles. Bladder weakness and frequent painful urination relieved in most cases. These results are unconditionally guaranteed.

Scientist's FREE Book, "Why Many Men Are Old at Forty," explains these amazing facts. This book is now FREE. No obligation at all. Simply ask for FREE Book.

THE ELECTRO-THERMAL CO., 2164 Main St., Steubenville, Ohio
Western Address: Suite 21-G, 303 Van Nuys Building, Los Angeles, Calif.

→ An Xmas Gift For "Him" ←
Get an Exerciser at Half Price—Make Him Happy!

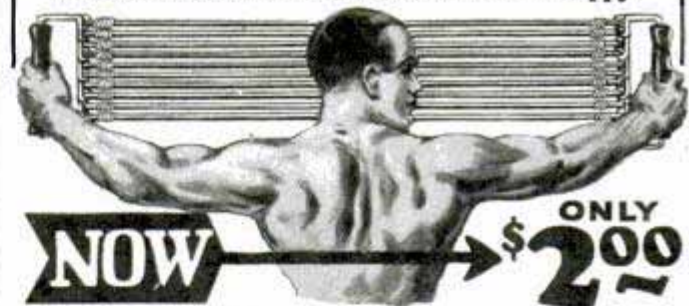

Giant Chest Expander

and Progressive Exerciser

Use This Money Saving Coupon

Be a muscular Marvel. Have the muscles of a super-man. Become strong for your health's sake or to astound your friends with extraordinary feats which only men of giant strength can do.





Free instructions. The Giant Chest Expander and Progressive Exerciser is made with new, live springy rubber so as to give it long wear and great resisting qualities. Sold with a guarantee to give entire satisfaction or money back. Made two ways, either

5 Cables or double strength 10 Cables
for **\$2** The double strength exerciser has resistance of over 200 lbs. for **\$4**

Send No Money Send at once and get your Giant Exerciser at the present low introductory price. This price is made so low because we want everyone to enjoy muscles and strength at the lowest possible cost. Don't pay more—order from us—get the most for your money. Use coupon now



PROGRESSIVE EXERCISER CO.,
4012 Langdon Bldg.,
Broadway and Duane Street, New York
Please send me your 10 cable Progressive Exerciser for \$4.
(Check the Exerciser you want.) It is understood that if I am not satisfied with this Exerciser, I will return it within 5 days and get my money back.
Name.....
Address.....
City..... State.....

<p>BRICK LAYING</p>  <p>\$14.00 A DAY</p>	<p>ELECTRICITY</p>  <p>\$75 A WEEK</p>	<p>AUTO PAINTING</p>  <p>\$50.00 To \$125.00 A WEEK</p>	<p>STRIPING</p>  <p>\$2.00 AN HOUR</p>	<p>PLUMBING</p>  <p>\$300.00 A MONTH</p>
---	---	--	--	---

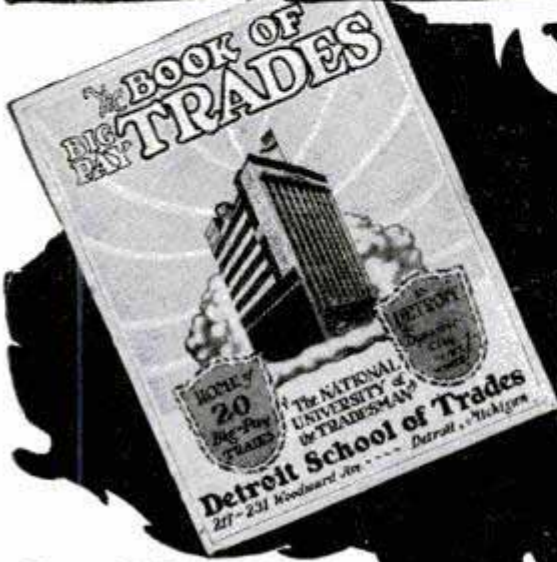

YOUR OPPORTUNITY

Learn One of these

BIG PAY TRADES

QUICK

Don't spend months in school or digging through dry books. Here you learn by doing with tools on actual jobs—you learn right—and you learn quick. Before you know it you're ready for big pay right here in Detroit.

DON'T Work At a Hard Low-Pay Job Another Day!

Get out of the grease—leave the rut forever—say "Good bye" to low pay. Take your choice of the clean, big pay jobs and start earning \$50 to \$100 a week right from the start in a real trade.

Get This New Big Pay Book
The Most Amazing Door to Quick Big Money You've ever seen. Twenty trades. Pick the one you are best suited for. Work at a job you like. Learn your trade, quick. This book is free.

Steady Work in Detroit's Big Plants
Scores of Big plants, body plants, auto plants, wheel makers, tool makers, designers, finishers, strippers—hundreds of real estate developments and new buildings—plenty of work inside or outside—at big pay. Steady work the year around for men who know their trades.

BIG PAY JOBS GALORE
Not Enough Men

The Detroit School of Trades teaches 20 big pay trades. It is called the "National University of the Tradesman". You don't have to learn some old, low-pay, worn-out business. Send for the book, look through, pick the money you want in the trade you want to learn. Then come here, we'll teach you how and help you get a job. Over three hundred of our men now working in one body plant. Hundreds of others in other plants. Hundreds more needed.

Think of These Facts
Hansen made \$183 for one week's work in bricklaying. Brooks jumped from \$35 a week to \$65.85 the first week he left school. Augustine was making \$6.00 a day—learned plastering and makes \$12 a day. Hundreds double their pay. You can do as well. Remember it doesn't cost you a penny for this book. Risk one postage stamp now on what may be the opportunity of a lifetime. Read it, be convinced. Come and see. Succeed for yourself. Send coupon at once. Don't delay. The National University of Trades can do big things for you.

DETROIT SCHOOL OF TRADES
DEPT. 1226A DETROIT, MICHIGAN

Come and Work In Dynamic DETROIT

A great city—big—throbbing with life—growing—filled with opportunity—crying for men to take big pay for doing the jobs that need doing. Building trades booming. Automotive trades—real trades—always good—get into the spirit of a big city, fastest growing most dynamic in America—do big things with big men—succeed with success in this City of Wonderful Opportunity

CHOOSE In This Great School We Teach These Big-Pay Trades

- Bricklaying--\$1.50 to \$1.65 per hour
- Plastering--\$1.50 per hour
- Plumbing--\$1.25 to \$1.75 per hour
- Carpentry -- \$60.00 to \$125.00 per week
- Electrical--\$10.00 to \$14.00 per day
- Sign Painting--\$1.00 to \$2.00 per hour
- Paper Hanging--\$10.00 and up per day
- Interior Decorating--\$10.00 to \$14.00 per day
- Plan Reading and Estimating--\$70.00 to as high as \$250 a week
- Auto Mechanics--\$1.00 to \$2.00 per hour
- Auto Painting--\$9.00 to \$12.00 per day
- Auto Trimming--\$9.00 to \$14.00 per day
- Metal Finishing--\$10.00 per day
- Acetylene Welding--\$1.00 to \$2.00 per hour
- Tool Making--\$70.00 to \$200.00 per week

FREE Send Coupon **10-DAY**

THE STATE OF MICHIGAN

protects you. The great Detroit School of Trades is supervised by the Michigan State Board for vocational education and conforms in every respect to the standards and requirements laid down by this organization, just the same as a State University or Endowed College.

Detroit School of Trades, Dept. 1226A Detroit, Mich.

Send me Free and without obligation your big new book of BIG PAY TRADES. I am interested in

the _____ trade

Name _____

Address _____

City _____ State _____

BIG PAY for Ornamental Iron Draftsmen

GET INTO this new business where hundreds of architects, engineers and factories designing and making ornamental iron and bronze *simply cannot get men who can do this work.* Beginners get \$65.00 a week. Good men easily command \$500 a month. To trained ornamental iron draftsmen the way is open to become salesmen, estimators, partners in the business—because they are too valuable to let go.

Work on Big Jobs

Modern office buildings, apartments, theatres, stores, stations, etc., require hundreds of thousands of dollars' worth of ornamental iron and bronze, for entrances, store fronts, lobbies, elevator doors, stairways, etc. \$200,000 of this material went into the building shown here.

The big jobs demand MEN WHO KNOW, and pay the price for them. The ordinary draftsman cannot do this work,—but he can easily learn, and put himself in line for the BIGGEST PAY earned by draftsmen in any field.



Be the Man Who KNOWS

Learn at home in spare time. The American Institute Course gives you a thorough training in *everything* the ornamental iron draftsman must know. It is practical from A to Z. No books, or higher mathematics, no previous experience necessary. Your work is done just as it would be in the drafting room, and is criticized by draftsmen with 22 years' experience in this field. *We help you get a good position without charge, as soon as you can qualify.*

Get This Book

Look into this—now! Don't wait a day. The sooner you start the sooner you'll be a high-priced draftsman. Get full details of the tremendous opportunities in this field, and what amazing strides you can make, if you start with the right training. Mail the coupon NOW, giving age and occupation.



American Institute of
Ornamental Iron and Bronze

3009 Hennepin Ave., Minneapolis, Minn.

Please send book "KNOWLEDGE Your Greatest Asset."

Age..... Occupation.....

Name.....

Write your address plainly in margin

Foot Pains Stopped in five Minutes



If your feet pain and ache, if they tire easily or feel cramped, if they burn or itch, if your legs ache with throbbing, twitching pains, I want to send you free and postpaid a new book "Foot Health." It tells how foot troubles may be corrected easily, quickly and permanently at home by an entirely new method that uses no arches, braces, cushions, bandages or any other device to be worn in the shoe or on the foot, without special shoes or tiresome exercises. Yet foot pains are stopped almost instantly, weak fallen arches raised and strengthened, the foot muscles invigorated, the circulation in the feet and legs improved, and the cause of foot troubles permanently corrected. Write for this free book now and learn how easy it is to have strong, sturdy, self-supporting feet free from aches and pains.

DR. F. H. GRIFFITH, Foot and Leg Specialist,

Suite 3151, Davidson Building Kansas City, Mo.



Your Candy Store

YOU CAN BE YOUR OWN BOSS—and have a profitable business of your own—MANY started with SMALL CAPITAL in the CANDY business and made MILLIONS—This book shows ALL DETAILS HOW TO START—Send \$1.00 for "CONFECTIONER'S GUIDE" to SMITH CANDY CO., 8441 Paxton Ave., Chicago

MINNEAPOLIS LEGS ARMS



Largest Artificial Limb Center in the World

More limbs and braces shipped daily than from any other city. Write: MPLS. ARTIFICIAL LIMB CO., 242 S. 4th St., MINNEAPOLIS, MINN.

WHAT IS A BAR BELL?

A BAR BELL is simply a long-handled dumb-bell. It has many advantages over a pair of dumb-bells. For instance, it is far easier to handle a 50-lb. bar bell than two 25-lb. dumb-bells. Again, with a bar bell you can do certain back and leg exercises where it would be awkward to handle a pair of dumb-bells. The bar bell became

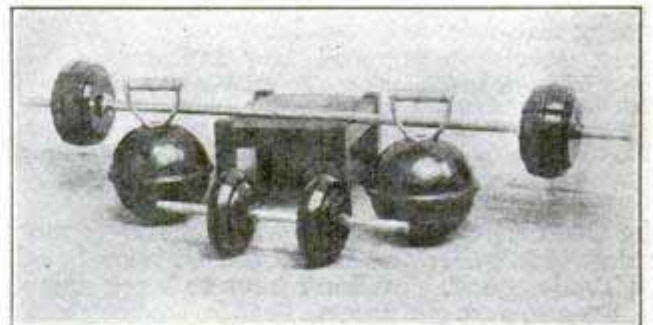

One of the Milo Bar Bell Sets

The Greatest of All Body Builders

when the adjustable feature was added—for then it became possible to employ the progressive method of exercise which has proven to be the only way in which a man of below average physique can gradually but steadily improve his build, his muscular development, and his stock of organic vitality until he becomes a physical superman—the very pattern of health and beauty.

USE COUPON FOR FREE BOOKLET

THE MILO BAR BELL CO., Dept. 500 2747 N. Paltherp St., Philadelphia, Pa.

Gentlemen: Please send me, without obligation on my part, your free booklet entitled "Health, Strength and Development and How to Obtain Them."

Name.....

Address.....

City..... State.....

O. C. MILLER
Director of
Extension Work
American
School

Be a real

Draftsman!

Prepare at Home for a well-paid Drafting Job!

Before you put your time and money into any kind of training, make sure there are plenty of jobs to be had when you're ready for them. That's why men go into Drafting. 70,000 jobs advertised in 12 months. Big salaries. Fascinating, easy work, short hours, and unlimited opportunities for advancement to executive positions.

Drafting Made EASY for You **NO-PROFIT PRICE**

We have developed a new one-step-at-a-time method which makes Drafting principles easy to understand. Even men with only common schooling make rapid progress with this instruction. Right from the very beginning you do actual Drafting room jobs. And by a wonderful new system you learn **without** copying, you see **why** every step is done and so you become a **Draftsman**, not a tracer.

Real Draftsmen **SPECIALIZE!**

The big money in Drafting goes to men who specialize in Machine Design, or Electrical Drafting, or Architectural Drafting, or Structural, or Automotive. It isn't enough merely to know general Drafting practice. You must know how to calculate and design and plan original work, to fill the kind of a Drafting position that pays \$60 to \$125 a week. The American School, for 29 years a leading institution teaching Engineering by home-study methods, now includes this specialized training in the complete Drafting course.

—EASY TERMS

This wonderful, more complete, simplified, rapid, up-to-date instruction in Drafting offered at very low tuition easily within reach of the untrained man who needs it. Small monthly payments make it easy for you to prepare for a fine Drafting position at a big increase over your present salary.

Training backed with nation-wide **Free Job-Service**

The American School now offers its students and graduates, without cost, the services of an efficient Employment Department which keeps in touch with the employers of Draftsmen all over the U. S. We have placed hundreds of men in good Drafting positions.

Look into this opportunity. Get my free book, Job and Raise offer quick! Let me show you how to turn part of your spare time into real training for a real job.

Mail
Coupon
Today!

O. C. Miller, Director of Extension Work,
American School, Dept. D-974-A Drexel Ave.
& 58th St., Chicago.

Please send me Free Drafting Book, Job and Raise offer and complete information about preparing for a fine Drafting Job at home in spare time.

Name.....

St. No.....

City..... State.....

O. C. MILLER
Director of Extension Work

American School

Dept. D-974-A
Drexel Ave. and 58th St.
CHICAGO

Complete Professional Outfit Given
These standard quality, full size instruments, board, table, triangles, T Square, ink, protractor, etc., given without extra charge to every student.



Learn at Home to Make Clever SHOW CARDS

A Profitable Business of Your Own for full or spare time. Earn \$25 to \$50 a week in spare time. Double your pay. Practical method of home instruction makes learning easy.

Why work for low pay? Clever "sales-increasing" display material is always needed by progressive business enterprises of every description. \$10 to \$20 is often paid for a single attractive show card. Skilled Show Card Writers command high salaries—right from the start.

Prepare now. No special ability needed. Learn at home in your spare time through a most complete and practical method. We develop your originality and teach you how to make attractive show cards, just like a professional. We give all of your work personal attention through the mail. Scores have learned Show Card Writing this quick, easy way and are now making more and more money each week. SO CAN YOU.

Take advantage of the wide range of money-making opportunities always open in the Show Card field. Make original Show Cards for your own employer or work for several merchants at the same time. Establish a profitable business of your own. Show Card experts earn up to \$110 a week—and more if you're ambitious.

Send for FREE Book

Get busy. Boost your pay. Don't delay your preparation for this uncrowded, lucrative profession. Write today for our big Free Book, full of illustrations. Gives complete details of our practical home-study course. Mail coupon now! Washington Show Card School, Dept. 3012-D, 1117-15th St., N. W., Washington, D. C.

Washington Show Card School, Dept. 3012-D
1117-15th Street, N. W., Washington, D. C.

Please send me FREE and without obligation, a copy of the new 32-page book, "Quick Success In Show Card Making."

Name.....

Address.....

City..... State.....



Deafness

Perfect hearing is now being restored in all cases of deafness caused by Catarrhal troubles, Relaxed or Sunken Drums, Thickened Drums, Roaring or Hissing Sounds, Perforated, Wholly or Partially Destroyed Drums, Discharge from the Ears, etc.

Wilson Common-Sense Ear Drums

require no medicine but effectively replace what is lacking or defective in the natural ear drums. They are simple devices, which the wearer easily fits into the ears where they are invisible.

Free Book on Deafness

Soft, safe and comfortable: Write today for 168-page book on deafness giving full particulars and many testimonials. The hearing of thousands of grateful users has been restored by these "little wireless phones for the ears."

WILSON EAR DRUM CO., Incorporated
205 Todd Building LOUISVILLE, KY.

Fibre-Lite Limbs

BRACES AND TRUSSES

DO NATURE'S WORK. GREAT INVENTION. EASY TERMS. AGENTS WANTED
WRITE FOR FREE FIBRE SAMPLE. WORMAN CO. 252-P HENNEPIN AVE. MINNEAPOLIS, MINN.

TOBACCO OR SNUFF HABIT CURED OR NO PAY

Any form QUICKLY conquered. NO LONG WAITING. Costs small sum if it cures. Harmless. Sent on approval.
DR. C. M. SIMPSON, 200 W. 44th St., CLEVELAND, OHIO

HAIR GROWS!



when our Vacuum Cap is used a few minutes daily. Sent on 60 days' FREE trial at our expense. No drugs or electricity. Stops falling hair, cures dandruff. A postal brings illustrated booklet.

MODERN VACUUM CAP CO.
558 Quincy Denver, Colorado

Big Money in Poultry



Eggs Turn into Dollars FAST!

Make \$1,000 a Year in Spare Time—Easy

Lots of room for YOU in the poultry business. 85% of the people of this country live in cities. EVERYBODY eats eggs and poultry meat—but only 15% produce them. Why not let the "other fellow" pay YOU the fancy prices? Easy to get started in back yard, on vacant lot or farm. We GUARANTEE success if you follow our methods. We show you how to feed for eggs, in winter, when eggs are high in price; how to cut feed bills; how to keep flocks healthy; how to tell laying hens. PAY-BIRDS, from loafers. Our course, produced by eighteen famous experts, endorsed by 30 leading agricultural schools, gives you thousands of sure, proved, tested Methods that make PROFITS CERTAIN. FREE book tells what we're doing for others—and what we can do for you.

Others Say:

"You have opened up to me a pleasant and profitable way of gaining an independent living."
Seldon Anderson, R. I.

"When I enrolled for your course, I knew nothing about poultry keeping. I am now successfully operating a commercial poultry farm."
W. J. Warthen, Conn.

"Your course was a splendid investment. I recommend it for both beginners and experienced poultrymen."
Y. W. Ow, Hawaii.

MAIL COUPON TODAY

Mail this now

The National Poultry Institute
Washington, D. C. Dept. 411

I am interested in your plan on "How to Raise Poultry for Profit." Send me your FREE book, without obligation on my part.

Name.....

Address.....



Like a Pleasure Trip

—yet worth countless dollars to you

12 happy weeks in Chicago—then *Big pay for life*. Read how the Greer Shop plan starts you into wonderful future in either Electrical or Auto Engineering—by *actual experience*. Send coupon below *now* for Big Free Auto or Electrical Book and offer.



Yes, Shorty, I had a wonderful time in Chicago, and I'm all signed up for a real man's size job at man's size pay. Don't you wish you had gone, too?



Scene in radio department. Here you can fit yourself for commercial operator's license if you wish. We teach code as well as theory. Thoroughly practical from start to finish—as is the entire Greer training.



View of part of the interior of the bungalow for practicing house wiring—right in the Greer Shops. You learn here by real experience—with an expert always at hand to show you how.



One of the first lessons in the Automotive shops is on this "split chassis." Every working part shows. Just an example of the equipment that makes Greer training so simple, easy and practical.



Using the "Weaver Crane" in the Automobile repair department. Here you learn about all up-to-date auto equipment—by actually using it. Real experience on all makes of cars, under supervision of an expert.

ELECTRICAL ENGINEERING

Learn how to earn \$65 to \$200 per week. Now is the best time you will ever have to get into this fascinating field. Inside work through the worst weeks of winter—in the big cheery Greer Shops. And at the end of 12 weeks you'll certainly have the laugh on the fellows who couldn't decide—who act as if they're afraid to leave home.

Practical Men Needed

The demand for electrical men is growing faster and faster. More and more railroads are being electrified. Everywhere power companies are reaching out farther. They have now actually started the tremendous task of *electrifying the farms*. Think what these developments mean to you! With this Greer training you will be a valuable man. You will get bigger pay

than you probably ever dreamed—and for work that you'll thoroughly enjoy. Don't wait. Get full information *quickly*. Send coupon below.

Actual Experience Here

You learn in the big Greer Shops by really using the sort of equipment that you'll find out on the job. Individual instruction by experts.

On our floors are over 200 motors, of various makes and sizes. Complete armature and stator department. Rotary converters, alternating current generator, high tension line, automatic telephone panel—all here in our shops for your use. Course in practical radio fits you for commercial operator's license.

You will enjoy our big illustrated electrical book. Send the coupon today—*now*.

AUTOMOTIVE ENGINEERING

If interested in autos, trucks or tractors, by all means get our big, free, auto book *at once*. The coupon below will bring it by return mail. You will find it full of valuable information about making your start in the auto business. Read letters—in this book—from some of the 50,000 men, who are now successful and happy—thanks to Greer training.

Real Auto Experience

You learn in the Greer Shops by *actual doing*—first on the marvelous shop equipment, and later on customers' cars, left for overhauling and repairing. Always under supervision of an efficient, friendly instructor. Every step is made simple and

easy. Individual instruction. You go ahead as fast as you are able. No one is held back by some one else being slow.

Learn Any Branch

After you have the general training needed, you may specialize in any branch you wish, such as vulcanizing, trouble shooting, starting and lighting storage batteries or general repairing. There is great demand for men who *really know*. Hundreds of Greer trained men now own their own shops. You can do the same if you wish—starting on a small scale, as soon as you finish this training.

Don't miss this chance by waiting. Send the coupon *now* while you have it before you.

Greer College of Automotive & Electrical Trades

CHICAGO, ILL.

FREE Employment Service

Our employment department is ready to help you—while in training and *for life*. Day and evening classes. Low cost. Easy terms.

ERWIN GREER, President, Greer College—
Dept. 1201, 2024 S. Wabash Ave., CHICAGO.

Please send me your FREE BOOK and offer for Electrical Automotive course
It is understood I am not obligated in any way

Name

Address



FREE RAILROAD FARE TO CHICAGO IF YOU ACT PROMPTLY

Don't envy the plumber-be one!



I CAN TEACH YOU HOW TO MAKE FROM \$10 TO \$50 A DAY EVERY DAY OF THE YEAR AS A PLUMBER

Ray Smythe

Plumbers rank at the top of wage earners—they get top pay. A trained plumber can be on the job every working day of the year—he doesn't starve one week and feed on the fat of the land the next. He has a steady income—a steady job. He can start a shop of his own and earn \$50 and more.

LEARN IN TEN WEEKS

Here in the Universal Plumbing School we can positively teach you plumbing in 10 weeks—training that should enable you to secure a plumber's certificate and to earn a plumber's income.

NOT A CORRESPONDENCE SCHOOL

Strictly a tool-using school. You work with tools—materials. Become expert in lead work—plan

reading and all other parts of the trade. We have been teaching practical plumbing and putting men on the highway to success for years. Oldest successful shop-school.



WHAT I HAVE DONE FOR OTHERS I CAN DO FOR YOU

Let me tell you the whole interesting story. Write your name and address in the coupon and mail today.

Get my catalog—chuck full of pictures and straight-from-the-shoulder facts. You'll be surprised at low tuition fee offered for short time. No obligation whatever.

Mr. Ray Smythe, Pres., Universal Plumbing School, The Kansas City School of Plumbing, 2030 Troost Ave., Kansas City, Mo. Send me your catalog telling about school and big money making possibilities.



STOP USING A TRUSS

Do Away With Steel And Rubber Bands



Inner surface is made adhesive to secure the PLAPAO-PAD firmly to the body, keeping the PLAPAO continually applied and the pad from slipping. No straps, buckles or springs attached. Soft as velvet—easy to apply.

It's the Non-Slipping, yet Non-Rigid Pad and What is Within It That Counts

PATD APRIL 6 1909

FREE to 5,000 Truss Sufferers

To the extent of 5,000 sufferers who may apply I will send, ABSOLUTELY FREE, a sufficient quantity of the Plapao to positively convince them that this is the only logical, common-sense way of treating rupture. Plapao is a highly astringent medication placed within the Plapao-Pad and being absorbed through the skin, creates a wonderful feeling of relief and at the same time tends to strengthen the weakened muscles and thus permanently close the rupture opening. The process of recovery is natural, so you'll have no use for a truss—you can throw it away forever! Old and young have testified under oath that the Plapao-Pads cured their rupture—many of them long-standing, aggravated cases—without delay from work. Patent allowed in U. S. and foreign countries. Awarded Gold Medal at Rome and Grand Prix at Paris.

Send No Money—for a sufficient quantity of the Plapao is sent without charge to enable you to give it a thorough test; you pay nothing for this trial now or ever. Write for it and full information today. Address Plapao Laboratories, Block 1427 St. Louis, Mo.



Don't Let Anybody BULLY YOU

Learn Scientific Tricks of Physical Mastery

By a few simple tricks you can have any assailant at your mercy quick as a flash. The astounding secrets of self-defense, used by the New York Police, are revealed in the marvelous, officially recognized system—

Captain Wallander's Course All Complete In Physical Training Manual By Capt. A. W. Wallander

Commander Physical Training, New York Police

A complete course in physical culture. Scores of gripping action photos showing just how to throw a bigger man and overpower him—disarm a hold-up thug—build up muscle—keep in fighting trim. Hundreds of health hints, too; care of the feet, prevention of colds, correct posture, walk without fatigue. This is the genuine book used by the New York Police, now available TO YOU. Easy to Learn Let Capt. Wallander give you his great secrets and detective tricks. You'll hardly believe that such valuable knowledge could be learned so easily.

ALL YOURS IN WORLD'S MOST AMAZING COURSE

In Physical Culture and Police circles this volume is world famous. Send immediately for your copy. DON'T SEND MONEY NOW. Send coupon today. When volume arrives, pay the postman \$1.97, plus few cents postage. If you are not satisfied return volume and get money back. \$1.97

SIEBEL PRESS, 34-B W. 20th St., New York.
Send me Capt. Wallander's Physical Mastery Course as contained in the "Physical Training Manual."
Name.....
Address.....
City..... State.....
(82.25 U. S. Cash with order outside the U. S. A.)

A Sure Way to Earn

\$10 to \$20 a Day
or
\$3,000 to \$6,000
A Year and More!

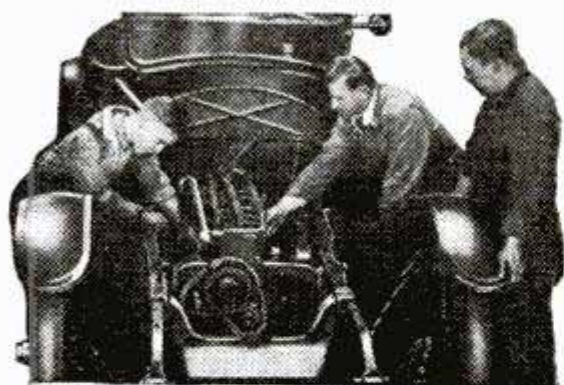

Ten dollars a day in the Automobile business means full \$60.00 a week (plus extra time). And as you can work every day in the year, as many hours as you please—you can net from \$3,000 to \$6,000 a year—and even more. Those in business for themselves can earn from \$10,000 per year up.

Why These Big Salaries?

Because the automobile industry cannot find enough skilled men. It is estimated that not one so-called auto-mechanic in ten, now employed in service stations, repair shops and garages (especially in and around greater New York) know thoroughly the fundamentals of automotive construction and repairing—but they are kept busy because more capable men cannot be obtained.

How to Get a Big Salary

You know as well as anybody that every man drawing a big wage or salary must know what he is doing. In the automobile business this is particularly true—as wages and salaries always depend upon what the employee can earn for his employer.

And no one can earn these big incomes unless he knows automotive construction and repairing—in all its branches—from A to Z.

The Sort of Training Necessary

There are as many grades of automobile training schools as there are grades in the public schools or universities.

No man—however bright—can be thoroughly trained in automotive mechanics—short of three months.

The average automobile owner does not want an untrained, impractical man experimenting and fooling with his car—any more than you would want a surgeon novice to cut off your leg.

Where to Get Proper Training

Select a well-known, long established automotive school with a reputation for efficient training. A school where guarantees mean that when you receive your certificate of ability—you will be able to intelligently repair and properly re-assemble in quick time any standard make of automotive vehicle. New York City is the best place to be trained—because in New York City, Brooklyn, Jersey City, Newark, Hoboken, and scores of other manufacturing and residential cities—within commuting distance, there are more automobiles and trucks—per thousand population—than in any other section of the world.

Besides, in this territory practically all cars and trucks are operated 12 months in the year; therefore, more repairs and more overhauling are required. And, in this section, car and truck owners demand the best and quickest service possible and are willing to pay the costs. This is why skilled automotive mechanics can make more net money in New York territory than in any other section.

Est. 1909 **Stewart** 17 Yrs. Ago
Automobile School
225-227 West 57th Street
(At Broadway), New York City

The School to Train You!

If you want a thorough and practical, scientific training—under the constant guidance of the best staff of instructors that can be obtained, investigate the services rendered by the *Stewart Automobile School of New York City*.

The Stewart School is more than a school, in fact it's an institution ranking with the technical departments of the leading universities. When you graduate from this institution, you will know all about the different types of engines, transmissions, brakes, differentials, steering gears, timing, carburetors, battery repairing and battery rebuilding, starting, lighting and ignition systems, tire repairing, etc. In fact you will thoroughly understand all about every standard make of automotive vehicle and how to keep it in service.

The Stewart System Easy

Stewart Instructors have perfected the "personal instruction" policy of this school. Each beginner is studied, his individual characteristics noted, then he receives his instruction in the way that will be most valuable to him and easiest to grasp. The course of training is thorough, no one is rushed and every point is driven home. The complete catalogue (which you will receive as soon as you send in the attached coupon) contains a guarantee that you can remain until you are entirely satisfied.

Decide Now

If you are not earning at least \$50 to \$75 or more a week—with a business of your own in sight—this message is intended for you. It is now possible for any average man, regardless of education or experience, to be trained at the Stewart Auto School for a big-pay job quickly. There is a crying demand for good men right now—but you must act quickly.

FREE BOOK—Send For It

You can open up the way to newer and better things by a mere scratch of the pen or pencil. You can take advantage of the great opportunities in the rapidly expanding automobile business, the largest, fastest growing and best paying industry in America. Latest statistics show that there are more automobiles than telephones in the U. S. This is amazing. *Investigate now.* It costs you nothing and *does not obligate you* to buy anything. *But find out—investigate.* Send the coupon for our new big FREE book, which explains all details. Send it now!

Special low rates for room and board for out of town students gladly arranged.

STEWART AUTOMOBILE SCHOOL
225-227 West 57th Street, New York, N. Y.

Please send me your free book that describes your school and the opportunities in the Automobile Business. I am under no obligation.

Name.....

Address.....

City.....

State..... Age.....

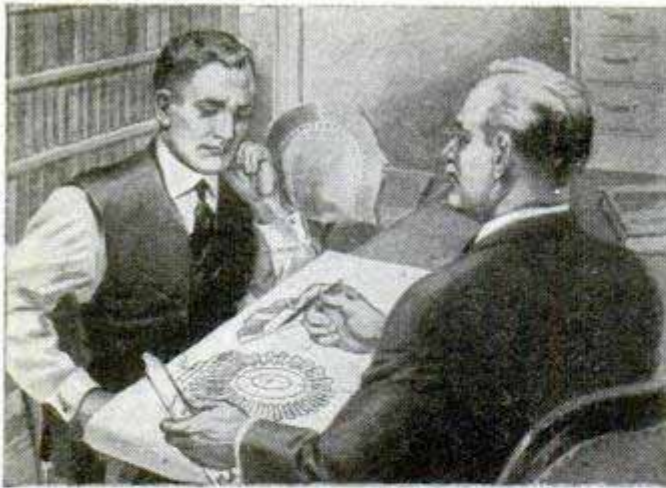

Mechanical Engineering Learn at Home

MECHANICAL Engineering embraces the design, construction and operation of machines and machine tools.

It is a profession which offers almost unlimited opportunities for advancement to men who combine natural mechanical ability with special technical training.

For this is The Age of Machinery. Almost every convenience, luxury or necessity which we enjoy today depends on machinery for its production or adaptability to our needs. Every new invention multiplies the opportunities for competent designers, builders, erecting engineers, etc.

One of the best ways to train yourself to secure a position as a Mechanical Engineer is through the home-study courses of the International Correspondence Schools.

These courses are complete and up-to-date, and they are especially arranged to meet the needs of the student who studies at home.

They are also particularly helpful because they are written by well-known mechanical engineers who have had years of practical experience in this field and who know the quickest, best way to solve every problem.

Just mark and mail the coupon and we'll gladly send you Free Booklets describing the I. C. S. courses in Mechanical Engineering or any other course in which you are interested.

Mail the Coupon for Free Booklet

INTERNATIONAL CORRESPONDENCE SCHOOLS
Box 5616-E, Scranton, Penna.

Without cost or obligation, please send me one of your booklets and tell me how I can qualify for the position or in the subject before which I have marked an X:

- | | |
|---|--|
| <input type="checkbox"/> Mechanical Engineering | <input type="checkbox"/> Toolmaking |
| <input type="checkbox"/> Mechanical Course | <input type="checkbox"/> Blacksmithing and Forging |
| <input type="checkbox"/> Drafting | <input type="checkbox"/> Patternmaking |
| <input type="checkbox"/> Mechanical Drawing | <input type="checkbox"/> Foundrywork |
| <input type="checkbox"/> Complete Shop Practice | <input type="checkbox"/> Machine Shop Practice |
| <input type="checkbox"/> Electrical Engineering | <input type="checkbox"/> Architects' Blueprints |
| <input type="checkbox"/> Electric Lighting | <input type="checkbox"/> Contractor and Builder |
| <input type="checkbox"/> Radio | <input type="checkbox"/> Architectural Draftsman |
| <input type="checkbox"/> Railroad Positions | <input type="checkbox"/> Concrete Builder |
| <input type="checkbox"/> Civil Engineer | <input type="checkbox"/> Structural Engineer |
| <input type="checkbox"/> Surveying and Mapping | <input type="checkbox"/> Chemistry <input type="checkbox"/> Pharmacy |
| <input type="checkbox"/> Metallurgy <input type="checkbox"/> Mining | <input type="checkbox"/> Airplane Engines |
| <input type="checkbox"/> Steam Engineering | <input type="checkbox"/> Agriculture and Poultry |
| <input type="checkbox"/> Architect | <input type="checkbox"/> Mathematics |

BUSINESS TRAINING COURSES

- | | |
|--|---|
| <input type="checkbox"/> Business Management | <input type="checkbox"/> Salesmanship |
| <input type="checkbox"/> Industrial Management | <input type="checkbox"/> Advertising |
| <input type="checkbox"/> Personnel Organization | <input type="checkbox"/> Better Letters |
| <input type="checkbox"/> Traffic Management | <input type="checkbox"/> Show Card Lettering |
| <input type="checkbox"/> Business Law | <input type="checkbox"/> Stenography and Typing |
| <input type="checkbox"/> Banking and Banking Law | <input type="checkbox"/> Business English |
| <input type="checkbox"/> Accountancy (Including C. P. A.) | <input type="checkbox"/> Civil Service |
| <input type="checkbox"/> Nicholson Cost Accounting | <input type="checkbox"/> Railway Mail Clerk |
| <input type="checkbox"/> Bookkeeping | <input type="checkbox"/> Common School Subjects |
| <input type="checkbox"/> Private Secretary | <input type="checkbox"/> High School Subjects |
| <input type="checkbox"/> Spanish <input type="checkbox"/> French | <input type="checkbox"/> Illustrating |

Name.....

Street Address.....

City..... State.....



and, perhaps you, too, due to the lack of money, time and education necessary to master a trade, wonder what to get into *quickly* and make the most out of. Haven't you overlooked the very thing you are looking for? 60,000 Moler graduates know Modern Barbering is easy to learn, *quick* to earn, *clean* and FASCINATING! FIND OUT! Write for catalog "B-12."

Address the Branch
of the MOLER SYSTEM OF COLLEGES nearest you.
(Street address not needed)

- | | | |
|------------------|------------------|---------------------|
| Chicago, Ill. | Detroit, Mich. | Fargo, N. D. |
| New York, N. Y. | Denver, Colo. | Memphis, Tenn. |
| St. Louis, Mo. | New Orleans, La. | Dallas, Tex. |
| Kansas City, Mo. | Omaha, Nebr. | Houston, Tex. |
| Cincinnati, Ohio | Milwaukee, Wis. | San Antonio, Tex. |
| Cleveland, Ohio | Atlanta, Ga. | Toronto, Ont., Can. |

Health Food Directory — How to select the proper foods for gaining weight; reducing; building vitality; disease resistance; constipation; building muscle, etc. Rates and tabulates standard branded foods. No other book like it. 150 pages of valuable information. Special price 25c. postpaid. 1 limited edition.
Macfadden Publications, Inc., Dept. P.M.12, 1926 B'way, N.Y. City

RHEUMATISM

Now Conquered by Violet Ray

New, scientific, painless treatment stops pain almost instantly. Used and endorsed by doctors, hospitals, and thousands of home users.

10 Days FREE Trial

VIOLETTA is an invention for producing genuine violet rays. Test their marvelous curative power in your own home. Why suffer rheumatism, neuritis or other distressing pains when you can try this new, better way to health, beauty, vigor, 10 days free? Send now for Free Trial Offer and Free Book telling all about Violet Rays, the many ailments treated and the amazing results obtained by thousands of sufferers.



VI-REX COMPANY, 2304 Warren Ave.
Dept. 1231-A Chicago, Illinois

Learn to Mount Specimens like These

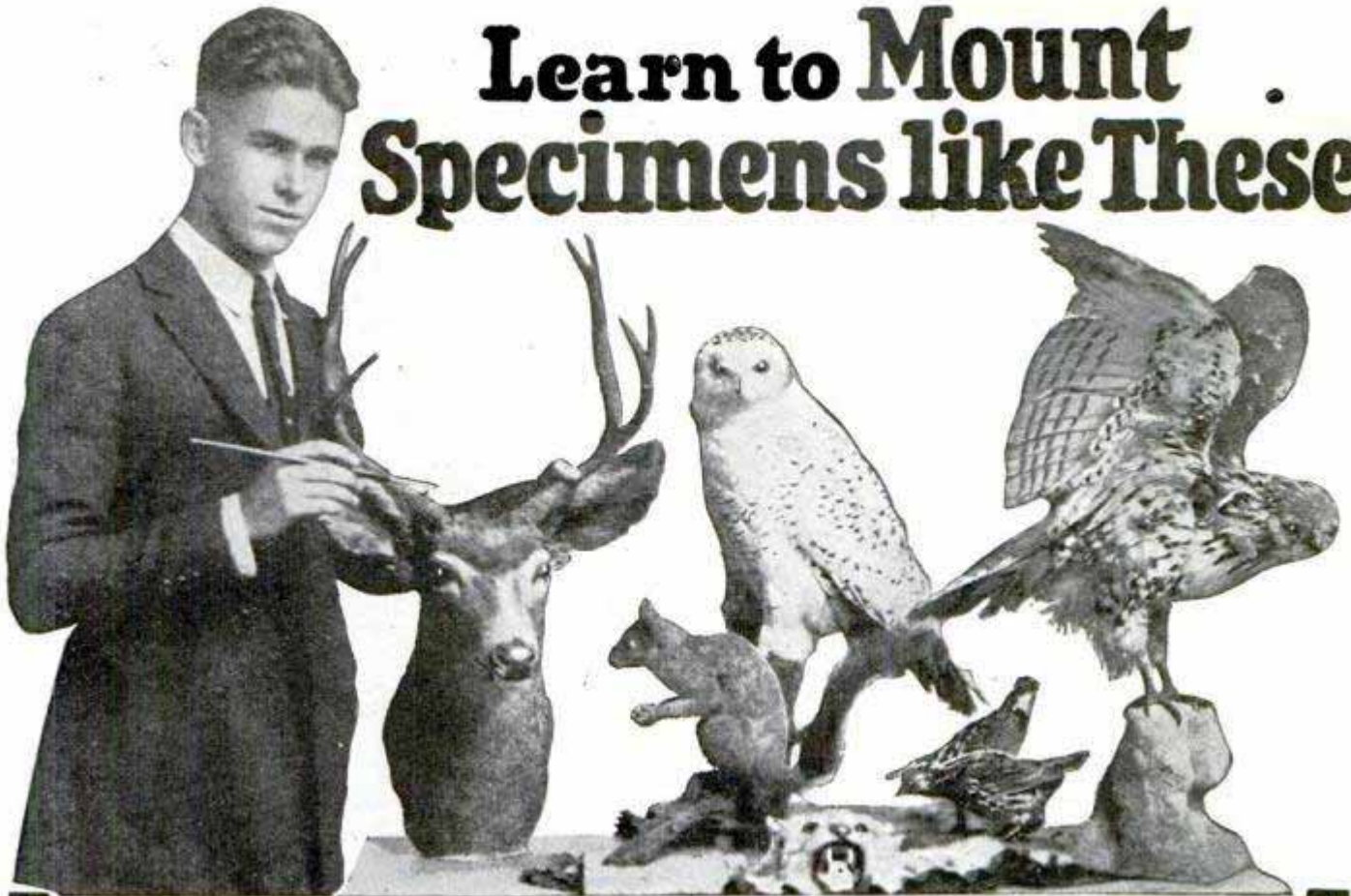

LEARN to mount and stuff all kinds of game, animals, birds, fish—tan furs and skins, make beautiful rugs, robes, etc. You can learn *easily and quickly* during your spare time by mail. *Great sport and lots of fun.* Lessons are easy and intensely interesting. Latest museum methods. This school is 20 years old, high class and reliable, and has 75,000 graduates. *Success guaranteed.* Don't delay, but start to learn this extremely fascinating art NOW.

FREE Beautifully illustrated book, "How to Mount Game." Explains the secrets of taxidermy. Dozens of photos of mounted specimens. Tells how you can learn this great art, no longer a secret, right in your own home during *spare time*. Tells how to become a taxidermy artist, how to save your own splendid trophies, how to beautify and decorate your room and home with nature's choicest art. Tells how young men and boys can make the **BIGGEST MONEY** from their spare time. Don't delay. Clip coupon now. Send **TODAY** for this Free Book.

Make Big Money—

Taxidermy is the most profitable OF ALL spare time work. Sell your mounted specimens. Mount trophies for your friends, hunters, trappers and fishermen. Have a side business of your own. Be independent. Have plenty of spending money—for athletic goods, radio, books, traps, and for vacations. Here is your opportunity. Don't delay. Send the coupon right NOW.

Free Book Coupon

Northwestern School of Taxidermy
8779 Elwood Bldg., Omaha, Nebr.

Send me, absolutely free, your illustrated book, "How to Mount Game." Also tell me how I may learn to be an expert taxidermist easily and quickly by mail. No obligation.



Name _____

Address _____

BETTER HANDWRITING

Quickly and easily learned by children and adults. Perfect penmanship assured. Write for information, or send price 98c today.
VIC. HANSEN WALLACE, IDAHO

WANT WORK AT HOME?

Earn \$18 to \$80 a week **RETOUCHING** photos. Men or women. No selling or canvassing. We teach you and furnish **WORKING OUTFIT** given with each enrollment. Limited offer. **Write today.**
Artcraft Studios, Dept. 50, 3900 Sheridan Rd., Chicago

PATENTS

Booklet Free Highest References
Promptness Assured Best Results

Send drawing or model for preliminary examination of Patent Office records.

ALL BUSINESS GIVEN PROMPT AND PROPER ATTENTION

Listed Patent Lawyer in the latest editions of the Rand-McNally Directory of Bankers and Attorneys, of Chicago, Ill.; The Baggott & Ryall Directory of Attorneys, New York City; The Lawyers Guaranteed Directory, Detroit, Michigan; The Lawyers and Bankers Quarterly, published by the legal Directory Publishing Company of St. Louis, Mo.; the American Lawyers Annual, Cleveland, Ohio.

WATSON E. COLEMAN,
REGISTERED PATENT LAWYER

644 G Street, N. W., Opp. U. S. Pat. Office
WASHINGTON, D. C.

MEN

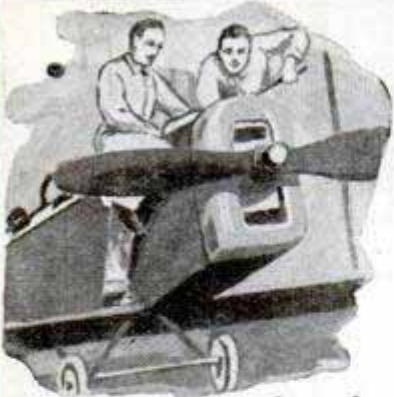

Airplane Mechanic
\$85⁰⁰ to \$125⁰⁰ a week

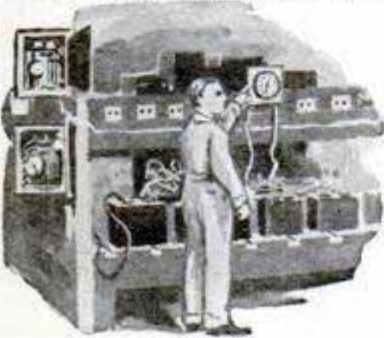

Batteries \$300⁰⁰ a month

**Get This New
72-Page
Book
Today

FREE**

**TELLS
ABOUT
SEVEN
GOOD
TRADES**

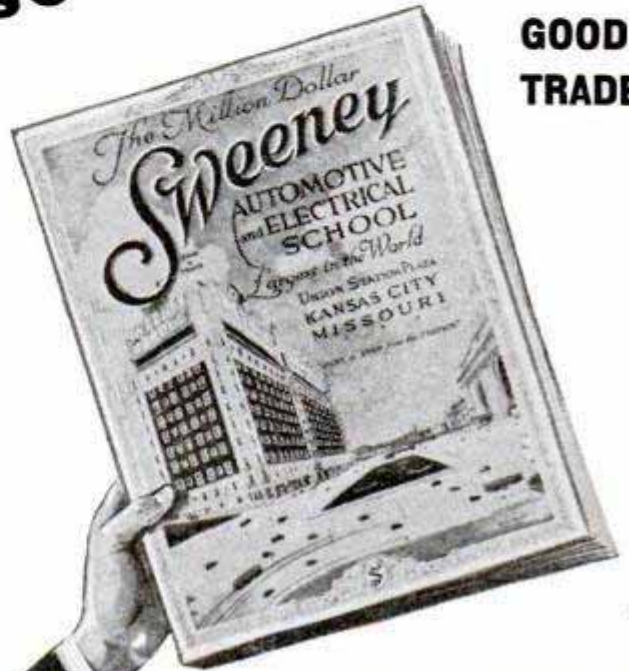

**The first
step to a
big pay
job ..**

**Sweeney
Flying School**

teaches flying with skilled instructors, fine planes, a great flying field, all equipment. All the time in the air necessary to make you a skilled pilot. If you want to be a pilot, fit yourself for government mail or commercial service, exhibit at fairs, etc., here's your chance. SWEENEY GROUND SCHOOL is a thorough course in practical airplane mechanics. You don't have to take flying unless you want to. Airplane mechanics are in great demand. Five men on the ground needed to keep one man in the air. Learn by doing. Construction and repair of planes—all about motors—re-covering wings, etc. Mechanics and engineers earn from \$50 to \$125 a week. Riggers earn \$50 to \$75.

E.J. Sweeney,

President

The Million Dollar
Sweeney Trade School

You work on latest type equipment and become a skilled man in a great new business. Mechanics and ground men always assured of interesting, profitable, steady work.

Sweeney
Aviation—Automotive
3231 SWEENEY BLDG.

WANTED

THE MILLION DOLLAR SWEENEY SCHOOL



with over 65,000 graduates, trains you in a good trade. What appeals to you? Auto repairing—bus line driving—garage—repair shop—tire shop—welding—radio broadcasting—auto painting, or does opportunity call you FROM THE AIR? Do you want to be a pilot—or airplane mechanic? Write me today—GET THE FACTS—about wages—profits—opportunities and HOW THE SWEENEY SYSTEM is equipped to give you successful training. Auto Mechanics make \$50 to \$100 a week. Learning is easy by the Sweeney System of Practical Training. Use tools not books. Be an auto mechanic—driver—truck driver—repair man—tire man—demonstrator. Own your garage or repair shop. Run a welding and vulcanizing shop. You can learn these trades separately or in a combined course.



Here's proof that Sweeney School is the recognized authority. Telegram from Oklahoma: "Need teacher auto mechanics. Salary \$1600. Wire reply." Another from Arkansas: "Can you recommend teacher? Wire answer."

Sweeney System "Learn by Doing"

If you are mechanically inclined, if you like to work with tools, you will learn under the "SWEENEY SYSTEM" by actually doing the work on the most complete gas engine and electrical equipment. Over \$200,000 invested. \$50,000 Radio Station

WHB. You'll get dirty and greasy, but you'll learn through the SWEENEY SYSTEM OF PRACTICAL TRAINING that fits you for the big pay jobs waiting for Sweeney Trained Men.

Send for This Big FREE Book

That's the first step. It obligates you to nothing but gives all the facts. Tells all about different mechanical trades. Shows how men LEARN BY DOING. How we teach with TOOLS—not books. Tells all about wages and opportunities. Fully illustrated; pictures of men at work. Takes you through the million dollar school—one of the sights of Kansas City—on Union Station Plaza—right by the great Liberty Memorial. Men come from all over the world to this school. Read letters from happy graduates, making good. Special section devoted to flying—pictures of planes and hangars and Sweeney Students at work. Clip coupon—or postcard will do—but DON'T PUT IT OFF. This book costs me a dollar but I send it absolutely free. No colored students accepted.

RADIO STATION WHB

EMORY J. SWEENEY, President
3231 Sweeney Bldg., Kansas City, Mo.

Please send me your FREE 72-page catalog and full details of your courses leading to BIG PAY JOBS. I am interested in

- () Flying
- () Airplane Mechanics
- () Auto Mechanics
- () Welding and other trades
- () Batteries
- () Vulcanizing

Please mark X opposite subject in your mind.

Name.....Age.....

Address.....

Town.....State.....

MARK X IN SUBJECT THAT INTERESTS YOU

mey
—Electrical School
KANSAS CITY, MO.

"THERE'S MONEY IN IT"

AT HOME LEARN TELEGRAPHY AT HOME

MORSE AND WIRELESS



TEACH YOURSELF in half usual time, at trifling cost, with the wonderful Automatic Transmitter, **THE OMNIGRAPH**. Sends unlimited Morse or Continental messages, at any speed, just as an expert operator would. Adopted by U. S. Government, and leading Universities, Colleges and Telegraph Schools. 3 Styles. Catalog free. **OMNIGRAPH MFG. CO., 13-19 Hudson St., NEW YORK**

If you own a Radio Phone Set—and don't know the code—you are missing most of the fun.

New Health Beauty Vigor with Violet Ray

Scientific, Painless Treatment Used by Doctors, Hospitals, Sanitariums—Now Offered to Every Home



Let us tell you how thousands of men and women suffering from rheumatism, paralysis, neuritis, nervousness, skin diseases, headaches, constipation, sprains, prostate trouble, goitre and many other ailments, even hay fever and asthma, have found quick relief, new health and vitality with this marvelous, scientific invention. Pains vanish almost instantly

Violetta 10 Days FREE TRIAL
For Health—Beauty—Vigor

Endorsed and used by hospitals, sanitariums and physicians. Every home should have one. Saves hours, days, months of suffering. No medicine. Painless, pleasant treatment. Only the violet ray can penetrate to every nerve affected. Simple, safe, painless—anyone can use VIOLETTA. Don't suffer pain and poor health when you can try VIOLETTA 10 days FREE.

This Book Free

Tells all about violet rays—how this marvelous discovery by Nikola Tesla, the electrical wizard, now brings this mysterious curative power to all. Contains many astounding testimonials from our hundreds of satisfied users. Send for all the facts and our liberal trial offer. Mail the coupon now.



VI-REX CO., Dept. 1231
2304 Warren Ave., Chicago

VI-REX COMPANY,
2304 Warren Ave., Dept. 1231 Chicago
Please send me your free book on Violet Rays and details of your 10-day free trial offer.

Name

Address

City State

Allment

LEARN MECHANICAL DENTISTRY IN THREE MONTHS

and qualify to earn \$2,000 to \$5,000 a year.

FREE employment service enables you to **EARN WHILE LEARNING** this NEW money-making Profession. Age no barrier and no previous training required. The only school in New York where students learn by doing actual work in gold before graduation. **Individual instruction.** Day or night sessions. Write NOW for free catalog P and **SPECIAL TOOL OFFER**

N. Y. SCHOOL OF MECHANICAL DENTISTRY
Penn Arcade, 147 W. 33rd Street New York
FREE RAILROAD FARE

BE AN OFFICER
in the U. S. Coast Guard
\$1700 Up to \$7,500 Yearly

\$780 yearly at the U. S. Academy while training. You rank Ensign to Captain in service. Age requirements 18 to 24. Write Dept. N, for information.

COAST GUARD PREPARATORY SCHOOL
4000 Ga. Ave. N. W. Washington, D. C.

NO JOKE TO BE DEAF
—EVERY DEAF PERSON KNOWS THAT

I make myself hear, after being deaf for 25 years, with these Artificial Ear Drums. I wear them day and night. They stop head noises and ringing ears. They are perfectly comfortable. No one sees them. Write me and I will tell you a true story how I got deaf and how I make you hear. Address

GEO. P. WAY, Artificial Ear Drum Co. (Inc.)
80 Hoffman Bldg., 2539 Woodward, Detroit, Mich.

New Hair Quickly

—or you pay nothing!



A new and scientific home method. First one endorsed by Science. **Marvelous Infra-Red Rays** simply applied

A noted surgeon has discovered an amazing way to give hair-growing tissues new life. Called Dermo-Ray. In 30 days no more dandruff. No more falling hair. And new where hair-roots are actually dead. *These results within 30 days—or you don't pay a cent.*

To use Dermo-Ray you must have electricity at home. For Dermo-Ray operates from light socket. You put on light weight silk cap, then attach plug, sit down and read or rest a short time each day. Coils in cap produce marvelous Infra-Red Rays science has found. A delightful mild warmth is all you feel.

Send no money. Order nothing

Coupon brings opinions of authorities, facts, prices, terms. Learn by mailing coupon today, how you may have beautiful healthy hair.

FREE TRIAL OFFER

The Larson Institute
26 East Huron St., Chicago, Ill. Dept. 4

Gentlemen: Send me at once without obligation full particulars—in plain envelope, about 30-day free trial of Dermo-Ray.

Name

Address

City State

Can you fix it

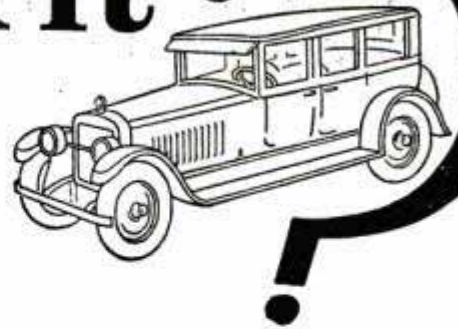

New books have "jiffy index," making all facts instantly available. You find anything you want to know in a moment, in this brand new 1926 edition.

These books tell how

HERE are the most interesting, the most practical books we have ever published on automobile construction, operation and repairs. Brimful of facts, photographs and explanations so easy to understand that anyone can learn how in almost no time.

Over 2000 pages, with diagrams, blueprints and everything else needed to make anyone an authority on automobiles.

Whether you want to qualify as garage owner, auto repair expert or merely wish to know how to keep your own car 100% efficient, you will welcome these books, especially on our

No Money Offer

This plan brings this valuable information within the reach of everyone. You don't send us a single penny. You don't have to pay us anything—just send your name and address and we'll send you the complete set of 5 volumes, specially bound in Flexo covers.

Read them carefully; keep them 10 days; find out anything you want to know, and then if you want to keep them, send only \$2.00 then and \$3.00 per month until the special low price of \$24.80 is paid. There is no further obligation.

American Technical Society Membership Free

This is a great organization for the publishing and spreading of specialized knowledge—we have over a million dollars of resources, enabling us to get the cooperation of the largest automobile manufacturers and dealers, who have furnished us plans and photographs. If you send NOW for this new edition of Automobile Engineering, we will include a Consultation Membership in this great organization.

Eighteen automobile experts will be ready to help you at all times. You can write or wire any time for special information. Answers will be sent to you promptly—without cost.

EMPLOYMENT SERVICE FREE

In addition to all this, those who send now will be entitled to the services of our EMPLOYMENT DEPARTMENT without charge. We are in daily contact with firms all over the country who need good men and are willing to pay big. This service costs you nothing. Don't miss this special offer. Send now.

Don't Hesitate

There are no strings to this offer—it means just what it says. Send name and address on the coupon and ALL of the five books—the complete set—will be sent to you for examination.

Remember one fact only which you can find in these books may save you an expensive repair or help you to a better job.

Learn All About Autos

Get these five big books on this liberal offer and learn all the things you want to know about autos.

Carburetors, engines, springs and spring suspension, brakes, 4-wheel drives, lubrication systems—all are fully covered.

These complete and comprehensive auto books are yours if you want them on this easy plan. Send for a set NOW; there's nothing to pay.

Jiffy Index
*Jiffy Index
Puts Facts
At Your Fingertips*

You don't have to read the books through; the index enables you to put your finger on the information wanted in a jiffy.

For Free Offer, Use Coupon

American Technical Society,
Spec. Dept. A-919, Chicago, Ill.
I would like to look at the 5 Auto Books described above. Send them on your FREE offer. I will examine them carefully and return them in 10 days unless I like them; in which case I will send you \$2.00 then and \$3.00 per month until the total price of only \$24.80 is paid. I am entitled to the services of your employment department without charge. You are to also send me Free Consulting Membership Certificate in the American Technical Society.

Name.....
Street.....
City.....State.....
Reference.....



Get on "Uncle Sam's" Payroll

MEN 18 TO 45

City and Rural Mail Carriers

\$141.67 to \$275.00 Month

AFTER REGULAR APPOINTMENT
Many Other U. S. Gov't Jobs Now Obtainable

STEADY WORK. PAID VACATION. COMMON EDUCATION SUFFICIENT. PULL UNNECESSARY.

MAIL COUPON—TODAY SURE

Coupon
 Franklin
 Institute
 Dept. D312
 Rochester, N. Y.

Rush to me, WITH-
 OUT CHARGE, (1)
 Your Copyrighted 32-
 page Civil Service Book. (2)
 Tell me how to get a position
 as City or Rural Mail Carrier at
 \$141.67 to \$275.00 a month. (3) Send
 Sample Coaching.

Name.....

Address.....

LEARN CARTOONING



The Landon PICTURE CHART method of teaching makes ORIGINAL drawing easy to learn. Hundreds of sketches like the above explain every step in creating ORIGINAL heads, figures, animals, etc.

Successful Cartoonists Earn Big Salaries

The cartoonists who draw "Freckles and His Friends," "Winnie Winkle," "Regular Fellers," "Cicero Sapp," "Guss and Gussie," "Mom 'n Pop" and hundreds of other artists, including Dorman Smith, Ethel Hays and Edwina, credit their start to the Landon Course of Cartooning. They learned to draw through the Picture Chart Method in their spare time, at home, and are now earning from \$75.00 to \$300.00 and more per week. Send 6c in stamps today for sample Picture Chart and full explanation of this wonderful course and information showing possibilities for you. Please state your age.

The Landon School

138 National Bldg., CLEVELAND, OHIO

TELEGRAPHY

(Morse and Wireless) and RAILWAY ACCOUNTING taught thoroughly. Big salaries; great opportunities. Oldest, largest school. Endorsed by Telegraph, Railway, Radio, and Government officials. Expenses low—opportunities to earn large portion. Catalog free. DODGE'S INSTITUTE, Jones St., Valparaiso, Ind.

Learn Watchwork, Jewelrywork and Engraving

A fine trade commanding a good salary, and your services always in demand. Address **Horological**, Dept. P, Bradley Institute, PEORIA, ILLINOIS, for our latest catalog.

NOW Boys ^{earn} Men's Wages

\$75⁰⁰ to \$125⁰⁰ Weekly, Paid to

AUTO MECHANICS

Why go on begging for a raise? Why growl and complain because you don't get it? Why, when every city, town and farming community is pleading for more auto and tractor mechanics—trained as McSweeney students are trained, to know cars of every make and to know them "inside out"?

Every month my men are taking fine jobs formerly filled by half-trained students or half-baked, self-trained mechanical tinkers.

I Train You in 8 Weeks

Think of it! Working with real tools on real equipment you become in only EIGHT WEEKS a better auto mechanic than men who have "fiddled" around an ordinary garage for years trying to learn. Let me send you the proof, letters from former McSweeney students now earning up to \$10,000 a year. "Mac's SHOP WAY Means Bigger Pay."

Your Money Back Guaranteed

If, when you have finished your training, you are not perfectly satisfied; if you are not qualified to fill a big pay job, I will re-

fund every cent of your tuition. There is a reason for my making such a convincing offer. Ask yourself why. Then write quick for my remarkable SPECIAL TUITION OFFER. Save one-third now. See what you get:

FREE Your Board for 8 Weeks and Your Railroad Fare

For a limited time only I will pay your railroad fare to Cincinnati or Cleveland and give you your board free for 8 weeks. Send the coupon NOW—before it is too late—for my big illustrated book and full particulars of this amazing offer. Don't delay.

McSWEENEY Auto, Tractor and
 Dept. LO-14 Electrical SCHOOLS
 Cleveland, Ohio
 Cincinnati, Ohio

Please send your Special Offer and Big Illustrated Book.

Name.....

Address.....

City.....State.....

We Guarantee to Improve Your Voice 100%



Read how to do it in "PHYSICAL VOICE CULTURE", the greatest book ever written on voice building. It will show you the one scientific, tested way to build a powerful singing or speaking voice. Send coupon below for—

Free Book!

Glad to Tell Everybody What Your Course Did

I shall certainly be delighted to tell anyone what your course did for me. In fact, I have been telling people for the last three years and started several people in the work in Japan.

When one lives in New York, as I do now, and sees the number of wholly unqualified people who are teaching singing, it seems as if there ought to be some test for teachers. I think that learning ten operatic roles, one after another, is a pretty good test of the condition of a person's throat, don't you? My voice doesn't seem to have suffered in the least from it. Florence Mendelson, New York City.

Wouldn't Part With Course for \$1,000.00

I have a great deal to say about this wonderful course, and want you to know that I am a happy man since taking it up. I needed your course badly, very badly. Being a teacher, I have to speak, at times, quite loud, and the strain on my throat was actually felt, and hoarseness followed. My voice is absolutely clear and resonant now. In fact, I have no words to thank you enough. I wouldn't part with my course for a thousand dollars.

Julio C. De Vosconcellos, New Bedford, Mass.

Lost Voice Restored—Sings Better Than Ever

I am very glad to be able to inform you that the study and practice of your exercises is making a great change in my voice.

You may appreciate what this means to me when I tell you that an illness while in France, weakened my throat to such an extent that I feared I would never sing again. However, after studying your lessons, I find that I can sing better than ever. In fact, I was told by a friend who had heard me sing at a reception that I had never been in better voice than I am now. J. Ralph Bartlett, Newton, N. H.

THE three letters on this page are from men and women who have learned that *Physical Voice-Culture* is the one, infallible, tested, scientific method of voice building. They are just a few of the thousands telling the same stories of success, in many cases, after all other methods of voice building had failed.

The new book, *Physical Voice-Culture* will show you how to build up a superb voice by the development of muscles whose existence you never suspected. No matter what condition your voice is in now, it will be improved at least 100% or every cent of tuition will be cheerfully refunded when you have finished the course.

Just a few years ago, Bert Langtre's voice was almost destroyed by catarrh and asthma. An impediment in his speech caused him untold embarrassment and suffering. Now he is singing in Grand Opera in California. "An unusual case," you say. Not at all. He merely took advantage of the opportunity you are given here.

Build up your voice the simple, easy, natural way by silent physical exercises in the privacy of your own home. The *Physical Voice-Culture* method is ideally adapted to home study. It is being taught as successfully by correspondence as by personal instruction. No one need know that you are studying until you have developed a strong, beautiful voice. When you are constantly urged to sing or speak at your church, at private receptions or public functions—when you are the most popular person in your circle of acquaintances, then you will know the rich rewards of *Physical Voice-Culture*.

Mail This Coupon!

Find out at once about the wonderful possibilities of your voice—possibilities that you have never realized! Simply send coupon for this book. Read the astounding true stories of what others have done. This may be the turning point in your life. Mail the coupon today.

Perfect Voice Institute
1922 Sunnyside Ave.
Studio 13-59 Chicago, Ill.

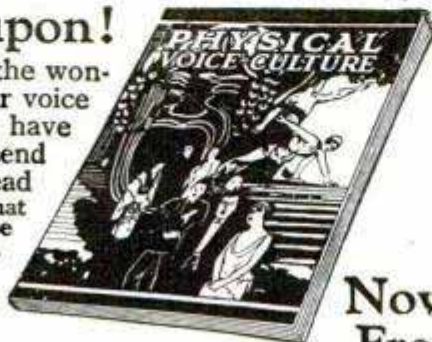

Now Free

PERFECT VOICE INSTITUTE, Studio 13-59
1922 Sunnyside Ave., Chicago, Ill.

Gentlemen: Send at once, free and without obligation, your beautifully illustrated book "Physical Voice Culture" and full information regarding your home study method of voice building. It is understood that I do not have to pay a cent for this book, either now or later, and that I do not have to return it.

Name.....

Address.....

Make That Dream Come True!

Haven't you often pictured yourself playing the Hawaiian Guitar, a happy crowd around you, everybody enjoying and admiring your playing? Now you can reach your goal—and play all the latest hits just as the Hawaiians do!

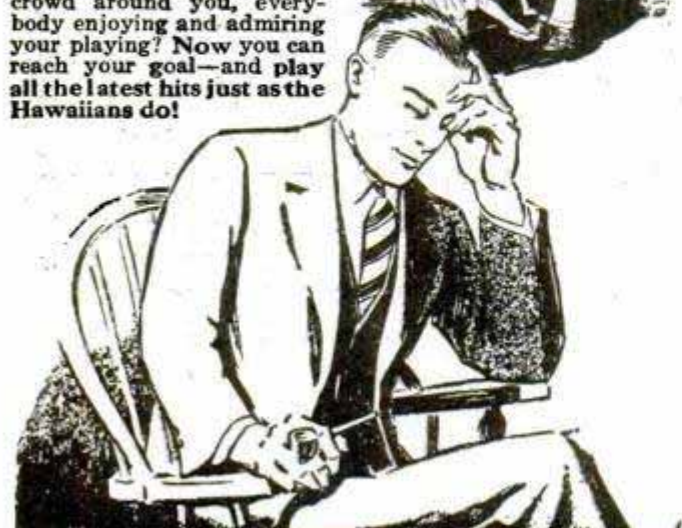

You can play the HAWAIIAN GUITAR just like the Hawaiians!

\$15
HAWAIIAN GUITAR
with Genuine Seal Grain
Fabrikoid Cover
FREE
when you enroll

Complete Conservatory Course

52 complete lessons. Pictures explain every move. Our method is simple, practical and interesting—only 4 motions to learn. No tiresome scales and exercises—you play a real piece your very first lesson.

Expert Instruction by Native Hawaiians

Get the advantage of expert instruction by Kolomoku, Kalaluki, Ferera and Seville—every one famous as both player and teacher. Even if you never touched a musical instrument in your life, under their direction you make rapid headway—you will be astonished when you see how easy it is!

This Sweet Toned Hawaiian Guitar

In genuine Fabrikoid Case—and complete playing outfit including picks, steel playing bar, etc. sent you free when you enroll. Retailers ask \$15 or more for a similar outfit without the case. Remember, there are no extras—we furnish everything with the course.

Learn In Spare Time

Pick up your guitar at any time and play. Your lessons are always handy—you can always refer to them. You are never hurried or forced. And no waiting for a class to form—start now—go ahead as fast as you like.

Pay as You Play

Small first payment starts you. And the entire 52-lesson course comes to just a few cents a lesson! Begin now.

We Guarantee

in writing to teach you. And after graduation we coach and advise you without charge. Over 45,000 successful graduates.

Tenor Banjo and other courses—Violin, Tiple, Tenor Guitar, Banjo Ukulele, Ukulele—under well-known instructors. Write for information.

FIRST HAWAIIAN CONSERVATORY OF MUSIC, INC.

9th Fl., Woolworth Bldg., Dept. 348, New York, N. Y.

Approved as a Correspondence School Under the Laws of the State of New York

SEND THIS COUPON FOR LIBERAL OFFER!

First Hawaiian Conservatory of Music, Inc.
9th Fl., Woolworth Bldg., Dept. 348, New York, N. Y.

Please mail full information about your 52-lesson Hawaiian Guitar Course. I am not obliged to enroll unless I want to.

Name _____
Address _____
City _____ State _____



STOP Worrying About Your Job and your Future

Don't be satisfied with ordinary low-paid jobs that get you nowhere—that you can lose by strikes, lockouts and layoffs. If you are an American citizen, 18 years or older you can get a Government Civil Service position. Pay is from \$1900 to \$2700 to start; work is steady, hours easy, vacations with pay, and plenty of chances for quick raises to better paid positions.

Let me train you to pass the U. S. Civil Service Examination with high rating so you will be eligible for one of the first appointments in Railway Mail, Customs, Internal Revenue, Departmental Immigration, Postmaster, Post Office and Rural and other Branches. Ex-service men get the preference. Hundreds of successful students. I was a Secretary and Secretary Examiner for eight years. Write for 48 page free book. Tells all. Send postal now to Arthur R. Patterson, Prin.

PATTERSON CIVIL SERVICE SCHOOL

Dept. 312, Wisner Bldg., Rochester, N. Y.



Wanta Play Banjo?

C. McNeil—Earn money thru famous McNeil Banjo Course. Easy as A B G with CHORD-CHART SYSTEM and phonograph record by Chas. McNeil, 5 years with Brunswick. Easy payments. Write for Free Book and Banjo offer! CHICAGO TENOR BANJO INSTITUTE 1621 N. Lincoln St., Chicago

BOW LEGS?

OUR GARTER (Pat'd)

Makes Trousers Hang Straight

If Legs Bend In or Out. Self Adjustable. Free Booklet—Plain Sealed Envelope

THE T. GARTER CO. Dept. 2, New London, New Hampshire

Learn the Truth! Your Character Revealed by Your Handwriting 10¢



It has been proved by authorities that your handwriting reveals your character. Let our character reading expert tell you about yourself, your sweetheart, your friends. All character traits revealed. Are you kind or cruel; industrious and energetic? Are you lovable? Have you the making of success? We tell you all. Know the truth.

Mail us handwriting of person whose character you want revealed. Enclose only 10c in stamps or coin. Your answer will be immediately mailed to you in plain wrapper.

Ritocraft Institute, 225 W. 34th Street Studio 90, New York



Join The Gasoline War!

Cut Your Gasoline Cost to 9¢ Per Gallon

\$51 in an Hour

The Stransky Vaporizer is one of the biggest sales propositions of the century—you can make big money quick. But don't take our word for it. Read what these men say. J.W. Cronk made \$51 in one hour. He says: "The results of one hour's work—17 men gave me orders for the vaporizers."

\$120 in One Day!

I have found out that the Stransky will do what you said it would. I took forty orders in one day and wasn't out long. My Ford runs better than it ever did. I can save half the gas and it pulls better.—J. M. James.

\$48 in 3 Hours

My gas bill has been cut nearly in half. I have removed every particle of carbon from my engine. Since I installed it my engine runs as good as new, starts easier and quicker. I went out Saturday about three hours and secured 16 orders.—J. A. Williams.

ONE MILLION Satisfied Users

Ford Runs 60 Miles on a Gallon

I made approximately 60 miles on a gallon of gas in a Ford sedan, as I made 15 miles on one quart of gas.—O. C. Zeigler, Pa.

32 Miles with Buick

Vaporizers installed on both Buick and Ford are doing wonderful work; getting 32 miles on Buick and 51 miles with Ford.—Harvey C. Hipple.

Say good-bye to the high cost of gasoline! For now an amazing new invention—a ridiculously simple little device—makes practically any car give twice its regular mileage to the gallon! Already it is being used by over a million satisfied car owners—on all makes and models of cars. And now the inventor will send you a sample at his own risk! Read his offer below.

\$250 to \$500 a Month

WITH this wonderful new invention, auto owners in all parts of the country have chalked up records of from 37 to 57 miles and even up to 60 miles on a gallon of gasoline.

And now this amazing new invention is making big money for agents and distributors. Now you, too, can make good money—just telling your friends about it. You should easily earn astonishingly big profits in full or spare time.

Fits Any Make or Model Car

Here's how this wonderful little device works—how it adds more power and mileage to any make or model car. Every carburetor is adjusted to make starting easy—it gives a rich mixture to start a cold engine. But once the engine gets heated up the mixture is far too rich, resulting in faulty explosion.

Half the gasoline is drawn into the cylinders in a raw state and instead of exploding, it burns. This causes a heavy deposit of carbon.

But with this startling little device in a car all this is changed. As soon as the engine warms up, this device automatically begins to admit a much larger volume of air, thoroughly vaporizing all the gasoline, giving it fully 50% more power—breaking it up so that it explodes instead of burning.

Introductory Sample Offer

To introduce this new invention Mr. Stransky, the inventor, will send a sample at his own risk. Not only that, but he will actually pay you for testing his Vaporizer if you are not delighted with it. Write at once for his proposition.

The demand for the Stransky Vaporizer is enormous. Agents handling this device are simply coining money. Splendid for spare time work.

Be the man to cash in big in your community.

MAIL THIS COUPON TODAY

J. A. STRANSKY MFG. CO.,
W-10 Stransky Bldg.,
Pukwana, South Dakota.

Tell me how I can get sample of the Stransky Vaporizer at your risk. Also tell me how I can make from \$34 to \$69 a day as your distributor. This does not obligate me in any way.

Name.....

Street or R. F. D.....

City.....State.....

J. A. Stransky Manufacturing Company

W-10 Stransky Building
PUKWANA, S. DAK.



“I’m making real money now”

“SEE that coupon? Remember the day you urged me to send it to Scranton? It was the best thing I ever did.

“Mr. Carter called me in today. Said he’d been watching my work for some time—ever since he learned I was studying with the International Correspondence Schools.

“Then he asked me if I thought I could take over Bill Stevens’ job. I told him I was sure I could—I’d had that goal in view ever since I started my I. C. S. course.

“I start tomorrow, Mary, at an increase of \$60 a month. It’s wonderful how spare-time study helps a man to get ahead.”

For thirty-five years, the I. C. S. has been helping men to win promotion, to earn more money, to get ahead in business and in life.

You, too, can have the position you want in the work you like best. Yes, you can.

All we ask is the chance to prove it. Without cost or obligation, just mark and mail this coupon.

Write for Free Booklet

INTERNATIONAL CORRESPONDENCE SCHOOLS
Box 5617-E Scranton, Penna.

Without cost or obligation, please tell me how I can qualify for the position or in the subject before which I have marked an X:

BUSINESS TRAINING COURSES

- | | |
|--|---|
| <input type="checkbox"/> Business Management | <input type="checkbox"/> Salesmanship |
| <input type="checkbox"/> Industrial Management | <input type="checkbox"/> Advertising |
| <input type="checkbox"/> Personnel Organization | <input type="checkbox"/> Better Letters |
| <input type="checkbox"/> Traffic Management | <input type="checkbox"/> Show Card Lettering |
| <input type="checkbox"/> Business Law | <input type="checkbox"/> Stenography and Typing |
| <input type="checkbox"/> Banking and Banking Law | <input type="checkbox"/> Business English |
| <input type="checkbox"/> Accountancy (including C.P.A.) | <input type="checkbox"/> Civil Service |
| <input type="checkbox"/> Nicholson Cost Accounting | <input type="checkbox"/> Railway Mail Clerk |
| <input type="checkbox"/> Bookkeeping | <input type="checkbox"/> Common School Subjects |
| <input type="checkbox"/> Private Secretary | <input type="checkbox"/> High School Subjects |
| <input type="checkbox"/> Spanish <input type="checkbox"/> French | <input type="checkbox"/> Illustrating <input type="checkbox"/> Cartooning |

TECHNICAL AND INDUSTRIAL COURSES

- | | |
|---|--|
| <input type="checkbox"/> Electrical Engineering | <input type="checkbox"/> Architect |
| <input type="checkbox"/> Electric Lighting | <input type="checkbox"/> Architects' Blue Prints |
| <input type="checkbox"/> Mechanical Engineer | <input type="checkbox"/> Contractor and Builder |
| <input type="checkbox"/> Mechanical Draftsman | <input type="checkbox"/> Architectural Draftsman |
| <input type="checkbox"/> Machine Shop Practice | <input type="checkbox"/> Concrete Builder |
| <input type="checkbox"/> Railroad Positions | <input type="checkbox"/> Structural Engineer |
| <input type="checkbox"/> Gas Engine Operating | <input type="checkbox"/> Chemistry <input type="checkbox"/> Pharmacy |
| <input type="checkbox"/> Civil Engineer | <input type="checkbox"/> Automobile Work |
| <input type="checkbox"/> Surveying and Mapping | <input type="checkbox"/> Airplane Engines |
| <input type="checkbox"/> Metallurgy | <input type="checkbox"/> Navigation |
| <input type="checkbox"/> Steam Engineering | <input type="checkbox"/> Agriculture and Poultry |
| <input type="checkbox"/> Radio | <input type="checkbox"/> Mathematics |

Name.....
Street Address.....
City..... State.....

Occupation.....
Persons residing in Canada should send this coupon to the International Correspondence Schools Canadian, Limited, Montreal, Canada.



Play Piano Jazz BY EAR
~in 90 days!

YOU can play real tunes from the start. No notes to puzzle you—no tiresome scales to practice.

You need not know a thing about music. Even if you have never touched a piano, if you can hum or whistle a tune, we can teach you to play all popular song hits by ear at a very small cost. No need now to spend years practicing under old-time method. My new and original system teaches you easily and quickly. Be a jazz master and make yourself popular everywhere you go. And the best part of it is there is nothing hard about it. Write at once for

FREE BOOKLET To show you how easily it can be done.

This wonderful home course is offered at a ridiculously low cost. A little practice gives amazing results. You can sit down and play any popular jazz piece that you hum.

David M. Suttle, Director
ILLINOIS SCHOOL OF MUSIC
663 Hearst Square, Chicago

Send NOW for FREE Book

Know the School



By the Emblem

Schools of Opportunity

The private business schools of America open the doors of opportunity every Monday morning to young people who are ambitious to achieve success in the commercial field.

Prominent among these schools are nearly three hundred accredited by this Association for their outstanding worth.

Prospective students of the business subjects should first of all write for our free book “The Sure Way to Success” and a list of Accredited Schools.

National Association
Accredited Commercial Schools
1618 Mallers Building, Chicago.

National Association of Accredited Commercial Schools,
1618 Mallers Bldg., Chicago.
Send Booklet E and list of schools.

Name.....
Address.....

Tools FREE

of ANY Extra Charge

Also a Drafting Table

Act NOW!



This is NOT a "Student's" Outfit but an Imported Set of Professional Drafting Instruments, a Chief's Drafting Table, and Standard Supplies.

***Yours* for the Asking!**
 No Extra Cost Whatever. No Conditions except to Reply Promptly. This offer Open
to All who Speak Up NOW!

I need YOU with 100 firms BEGGING ME to send them more DRAFTSMEN. Many offer to take BEGINNERS, at \$50 a WEEK. Graduates can start at \$90 and \$100! GET BUSY!

Every industry in this country is using draftsmen in droves! In twenty-five years, I've never been so hard-pushed to turn out enough new men. In fact, it's the shortage that brings you this wide-open offer of all instruments—a real drafting table—full working outfit—complete, standard supplies—even paper and pencils and ink! No extra charge for any of them. That's how I hope to get the required men in record time.

Drafting is the field for any man who wants to get somewhere. For men who want to be heard from. Want work that counts, and pay that makes working worth while and life worth living.

This Opportunity Doesn't Call for Cash, so Don't Pass It Up for Lack of Ready Money

Please don't beat yourself by thinking of your finances at this time! It isn't money I want now—it's men. You, if you mean business. What I am after is your application. Once I get that, you'll get action. I'll have you ready to draft for important pay—in any engineering or industrial line you like—before you know it. So get my proposition in front of you this week! Then, if you do enroll, you're in line for my free outfit offer.

WELL PAID JOBS are soon sighted by men under Dobe training! They get offers before they're through. Are often spoken for months ahead of graduation. And I have students from 17 years of age to 51 at present time! So: first of all, and right now, send this coupon for my new free book Successful Draftsmanship; fully illustrated; explains everything.

I'll teach you draftsmanship by practical methods that make a man easily and quickly finish the whole course. I use modern methods; I employ every short-cut; but I leave nothing out that you have to know to earn \$3500 to \$10,000 a year as a practical draftsman.

LEARN AT HOME but on the same kind of actual drafting room jobs we assign you from our own drafting rooms. It isn't hard to do. Drafting isn't "drawing." You don't need "talent." If you are interested and can read and write, I guarantee to make you a good draftsman. (Dobe-trained men are draftsmen and chiefs in big concerns all over the country—and many have made good abroad.)



YES!

That's Chief Draftsman Dobe's answer to "Can I Succeed in Drafting?"

YES!

Does Dobe really turn out practical draftsmen in a few months?

YES!

Is there always such a big call for men who can draft as Want Ads in the newspapers show at the present time?

YES!

Do I actually get all instruments and supplies without one dollar's extra cost?

YES!

FREE TOOLS COUPON

CHIEF DRAFTSMAN DOBE

1951 Lawrence Ave., Div. 13-59, Chicago

Send me free and postpaid Successful Draftsmanship Book and material telling all about your home course, terms, etc.

Name..... Age.....

Address.....

Magic

Learned Easily At Home



Dr. Harlan Tarbell
Master of Magic who has mystified magicians as well as laymen with his marvelous tricks.

Astonish Your Friends

Gain that magnetic popularity that makes you the center of any crowd. Business and social success is assured the man who can perform mystifying tricks. You can earn big money either on the side or as a professional, as well as being the most popular person in your crowd. Why envy others' skill? You can learn Magic yourself, quick and easy.

Earn \$250 to \$1000 a Month

Even sleight-of-hand, generally supposed to require long practice, is NOW made simple to learn. For Dr. Harlan Tarbell, one of the really Great Magicians, has finally opened up the secrets of his profession in a completely illustrated course offered at a merely nominal cost. Through the wonderful Tarbell System you will be able to mystify and entertain your friends with simple tricks taught in your very first lesson. After that Dr. Harlan Tarbell takes you through the entire maze of sleight-of-hand, card tricks and elaborate stage diversions. The apparently superhuman doings of the accomplished magician become as simple as ABC when you just know how.

Mail Coupon for Special Offer

There is a tremendous demand for magic entertainment. Clubs, Lodges, Charity and Social affairs—all will pay high fees to the man who knows Magic. Dr. Harlan Tarbell really gets as high as \$250 for an half hours work right now. Opportunity everywhere to make money aside from your regular occupation. Salesmen find it a tremendous asset. Find out all about this unprecedented opportunity to learn Magic. The coupon brings full details without any obligation. Mail it TODAY.

Tarbell System, Inc.

1926 Sunnyside Ave., Studio 93-59 Chicago

Tarbell System, Inc.

1926 Sunnyside Ave., Studio 93-59 Chicago

Tell me all about Dr. Tarbell's new and simple system by which I can learn the secrets of MAGIC. No obligation on my part.

Name.....

Address.....



Your Choice

\$20⁰⁰

Musical Instruments

FREE TO OUR STUDENTS

Your choice of a Violin, Tenor Banjo, Hawaiian Guitar, Banjo, Cornet, Ukulele, Banjo Ukulele, Guitar, Mandolin or Banjo Mandolin. You will be proud to own any one of these instruments and you can have one absolutely free. A few cents a day for lessons is your only expense. Our system of teaching is so easy that you can play several pieces by note with the first four lessons. We guarantee success or no charge. Instrument and lessons sent on one week's free trial. Write for booklet today, no obligation.

CHICAGO CORRESPONDENCE SCHOOL OF MUSIC
1632 N. Halsted St. - Dept. 91 - Chicago, Illinois

BE A JAZZ MUSIC MASTER



Play Piano By Ear

Play popular song hits perfectly. Hear the tune, play it by ear. No teacher—self-instruction. No tedious ding-dong daily practice—just 20 brief, entertaining lessons, easily mastered.

At Home in Your Spare Time Send for FREE BOOK. Learn many styles of bass and syncopation—trick endings. If 10c. (coin or stamps) is enclosed, you also receive wonderful booklet "How to Entertain at Piano"—and many new tricks, stunts, etc.

Niagara School of Music
Dept. 1015, Niagara Falls, N. Y.

Send for this Free Book

BE A RAILWAY TRAFFIC INSPECTOR

PAYS UP TO \$250⁰⁰ Per Month
EXPENSES INCLUDED

Joseph Sues writes: "Immediately after finishing my course in Traffic Inspection, which took only a few months, I was given employment and helped in every way, never losing a single day's work. The Institute gives a thorough and efficient training and then helps the graduate to a pleasing, permanent position."

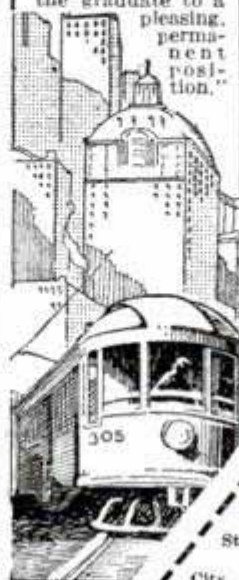

YOU GET A POSITION, without waiting, without extra expense, as soon as you complete the training. This position must pay not less than \$120.00 per month to start, sometimes more, or we refund every cent you have paid us. Moreover, we place our graduates in positions all over the country.

We arrange all the details and can make this generous offer because of our eight years' experience in supplying the growing demand for Railway Traffic Inspectors. We must supply many more trained men in the next few months.

Easy, pleasant work with unusual opportunities for advancement. Travel; see the country or remain near home. Something new every day. Report to important railway officials.

Send coupon for details; how you can prepare in three months spare time training at home; how any average man can qualify. Learn why you take no risk in securing a position.

Standard Business Training Institute
Buffalo, N. Y.

Standard Business Training Institute,
Buffalo, N. Y.

Send me, entirely free, Booklet No. D-304, giving full particulars about course in Railway Traffic Inspection.

Name.....

Street.....

City..... State.....

What I would do if I wanted more money—By J. Matheson Bell

FIRST of all I'd make up my mind definitely that I was going to get it.

I don't believe any man living can get things worth while without firmly believing that he can. Determination will conquer failure anytime, anywhere.



"Busted" and Blue

I'll work harder on my present job to make the boss feel that he owes me more. But I won't stop there.

I'll put my spare time to work. I'll quit losing money by making my evenings pay.

I wouldn't give up my present job but I'd make more money by working longer hours.

I'd find something that could be sold evenings, either in my home or some one else's home.

That something would have to be a little out of the ordinary because it would have to be of special interest in the evening.

That would be the time of day when both the man and his wife are at home so I'd find something that would be of interest to both of them.



Decides to Work Harder

I feel sure that such an article would have to be something for the home, something they would both use and enjoy.

So far so good, but what will that something be.

Piano?

Fine, but come to think of it I can't even play one myself so that's out.

Automobile—

Sounds better, guess I could learn how, but seems to me that everybody I know has one. At any rate the auto sounds good—let's see if there is anything better.

Phonograph—

Doesn't sound near so good as the auto.

Vacuum Sweeper—



How Can I Make More?

Not so much interest to the man and I don't see just how I'd show up dust at night.

Radio—

Why, the Sam Hill didn't I think of that before, but let's see if it will do—let's see what its good points are as well as its bad ones.

True—I don't know anything about radio, but I have lots of friends who have learned something about it, so I think I could. What sounds good to me is, that I can demonstrate in the home in the evening, the very time of the day for me, and that's just when all the music is being broadcasted.

I'll have competition. I expect it. I'll have to know just what my demonstration will do that the other fellow's won't, so let's see what would make the biggest appeal.



Thinks Hard!

Of course, they would be impressed with music from our nearby stations but I feel sure that if I bring in great distances they will be more impressed. It will have to bring in music loud enough so they can sit away back in the room and enjoy it. It must have volume.

They may be satisfied with music from nearby stations, but they'll ask me for distance, so I must be able to get "by" our powerful nearby station. The radio I want must be selective so I can tune out our nearby station if I desire.

I can picture myself in some prospect's home with a radio that will do that, but I wonder if that is enough—maybe my competitor will be there also—maybe he can do all those things as well as I can.

Then where am I?

I've got it—I'll tell you what my radio must do—I want one that my prospect can do all the tuning, so that he will get the thrill of bringing in the music from a distance clear and loud and with a tone that will please.

After all he is the one who is going to operate it, so why wouldn't it be better and best if all he had to do was sell himself. I'll admit I'm not much of a salesman. I'll admit I'm not much of a salesman, so if I find a radio that



Gets An Idea—

will sell itself then I'll not only whip competition but I'll do it easily.

Best of all, I'll make that extra money I want.

Who knows, I may be so successful at it that I can give up my present job and give it all my time—Geethat sounds

too good to be true, but other men have done it so why can't I—I can and I will.

But what radio can I sell that will do what I want and yet sell at a reasonable price—I don't want one so high that my people can't buy—but it must be a good one.

Then when I do sell it, they will want me to fix anything that goes wrong so somebody must teach me how to service radio—that's something I can't afford to overlook.

Where is such a radio?

Where is a manufacturer who will teach me how to sell and how to demonstrate—where I can learn this business, both selling and servicing radio—there must be someone.



Writes to Mr. Bell

a 64-page book "The Ozarka Plan" which they will send me if I tell them about myself and mention the name of my county. Where is my pen and some paper? I'm going to make more money and I'm going to start right now by writing for this book.

There is—Ozarka Incorporated of Chicago—the sign of the long distance goose—they have

J. Matheson Bell, Pres., OZARKA, Inc., 122 W. Austin Ave. C Chicago, Illinois

Use This Coupon!

I am greatly interested in the FREE Book, Ozarka Plan No. 100, telling how I can establish myself in the radio business and increase my present income.

OZARKA



INCORPORATED

122 W. Austin Avenue C Chicago, Illinois

122 W. Austin Avenue C Chicago, Illinois

Name.....

Address.....City.....

County.....State.....

"\$50⁰⁰ for One Hour's Work!"

C. W. LaRoe.



Learn to Draw This Quick Easy Way

HERE'S positive evidence that the Washington School actually prepares its students for real money-making positions in Commercial Art! Read what C. W. LaRoe says:

"Within a year after I mailed my first lesson I was selling humorous sketches to national publications, particularly magazines. Even more important, the instruction in composition and decoration has enabled me to produce drawings requiring less than an hour's work each, which I have sold for as high as \$50. Any chap with a desire to draw and determination to learn art's essentials, can get them from the Washington School of Art."

YOU, too, can quickly enter this highly paid field of Commercial Art—through this easy method of learning to draw right at home. Never was there such a need for artists as today! Many commercial artists earn up to \$200 a week and more. And now you, too—without talent or previous experience—can soon prepare yourself to fill one of these high-paying artist's jobs.

Coupon Brings Free Book

A new handsomely illustrated book has just been printed, which gives all the best up-to-date information on the thousands of wonderful opportunities in Commercial Art and shows how this startling method easily enables you to enter this field. It tells about our students—their success—what they say—actual reproductions of their work—how they made big money while studying. This attractive book will be sent without cost or obligation. Send for it. Mail coupon now! Washington School of Art, Room 3012-D, 1115-15th St., N. W., Washington, D. C.

Washington School of Art, Inc.,
Room 3012-D, 1115-15th St., N. W.,
Washington, D. C.

Please send me, without obligation, free book, "Quick Easy Way to Become an Artist," together with full particulars of Attractive Offer to every new student.

Name.....
(State whether Mr., Mrs. or Miss)

Address.....

City.....State.....



Send 2c now for postage on FREE BOOK-LET giving full details



We have openings for a few new members in Fireside Industries, a national organization of artistic home-workers. No experience needed. We teach you just what to do and furnish outfit to members without extra cost. Satisfaction guaranteed.

FREE BOOK Tells How

You can easily make extra money, in spare hours or full time without leaving home. Fascinating work, decorating beautiful art novelties to supply big demand. Read experiences of successful members.

FIRESIDE INDUSTRIES
Dept. 66-W, ADRIAN, MICH.

WANTED MEN AND WOMEN TO TEACH DANCING

Earn \$5,000 to \$10,000 a year. Get ready in spare time—right in your own home. Previous teaching experience or knowledge of dancing unnecessary. Arthur Murray, America's foremost dancing instructor, will show you how to cash in BIG on the wonderful opportunities now open to teachers in this fascinating, highly profitable profession. He will show you how to open a studio of your own—how to make yourself quickly and favorably known—how to bring pupils flocking to you—how to organize classes—how to train assistant teachers as you require them—how to advertise—in short, everything you need to know in order to establish a permanent, big-paying business in an amazingly short time. Write for details quickly. No obligation. National Institute of Social Dancing, Dept. T112, 7 East 43rd St., New York City.



If interested merely in learning HOW TO DANCE—not to teach—send 10c for five sample lessons.

Big Money for You as an Automobile Mechanic

These four practical books, written by five well known teachers of automobile practice, will teach you right in your own home during your leisure time just what you need to know about automobile troubles and repair. They will teach you automobile construction, maintenance and repair as experts know them and will help you to earn an expert's pay.

Practical Automobile Library: Four Books—\$1.50 in 10 days and \$2 monthly for 6 months—only \$13.50 in all!

Hundreds of question-answering diagrams—hundreds of clearly-marked illustrations—make the books plain and readily understandable. All the explanations and descriptions are clear, simple, direct. Every chapter is packed with definite, step-by-step, how-to-do-it information. Here is your opportunity to enter a big-pay field.

Sent FREE

Send No Money Mail the Coupon

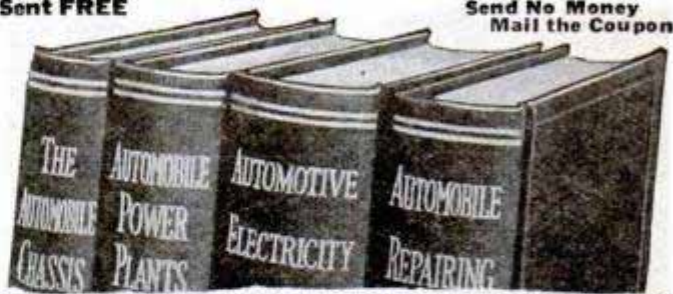

FREE EXAMINATION COUPON

McGraw-Hill Book Co., Inc., 370 Seventh Ave., New York

Send me for 10 days' free examination the New Practical Automobile Library. If satisfactory I will send you \$1.50 in 10 days and \$2.00 monthly until the special price of \$13.50 is paid. If not wanted, I will return the books at your expense.

Signed.....

Address.....

City and State.....

Position.....

Employer..... P. M. 12-1-26



Tire Punctured 857 Times LEAKS NO AIR!

Magic Tire Fluid Heals Punctures In Amazingly Simple Way! Makes All Old, As Well As New Tires Puncture Proof. Increases Mileage of Tires Tremendously. Seals Slow Leaks, Valve Leaks and Porous Tubes. Prevents Rim Cuts and Broken Side Walls. Absolutely Sensational. Read Inventor's Free Trial Offer Below!

EARN \$150 A WEEK!

SO startling is this invention, so marvelously successful, that our representatives are piling up big profits for just a few hours' work. Every auto owner, whether he drives a Ford or a Cadillac, is eager to buy—he detests the fuss and bother of changing tires on the road and mending tubes.

This wonderful, new scientific discovery is called Aer-Pruf. Steve H. Temple drove a tire that had been punctured 50 times over 3,000 miles and it did not leak a pound of air! An old tire, after being treated with Aer-Pruf, was punctured with 857 nails without a single leak. Another tire was punctured 1,100 times!

Seals Punctures While You Drive

Aer-Pruf seals punctures instantly while you are driving so that you never know you

Aer-Pruf Tires Are Air Filled Tires

AER-PRUF MFG. CO. Dept. T-3187 Logan Bldg. Mitchell, South Dakota

have a puncture. It doubles tire mileage because it prevents driving with partly flat tires—the biggest cause of tire trouble. No injurious effects on casing or tubes. Will last the lifetime of the tube. Applied in a minute. Aer-Pruf does away entirely with changing tires and patching tubes on hot, dusty roads—in blazing sun or in freezing snowstorms.

Absolutely no sales talk is necessary—a deaf and dumb man can sell Aer-Pruf. If you have a car you can equip one of the wheels with an old tube to use for demonstration. But you don't need a car—an old discarded casing and rim will be sufficient to bring in \$15 to \$25 every day.

Free Sample Offer

Right now we are making a big special offer to send you FREE Sample Sets of Aer-Pruf and to pay you for the time required to test these samples if you are not amazed and delighted with them. Just send the coupon for full details.



AGENTS! \$14 AN HOUR

So startling and marvelously successful is this new invention that salesmen are piling up big liberal commissions for just a few hours' work. J. O. Bright made \$29.00 in 2 hours. H. J. Dubois netted \$9.00 in five minutes. And Frank Ryman made \$57 in a single evening. Every auto owner wants to buy on sight. Ideal for full or spare time—\$200 to \$400 a month!

AER-PRUF MFG. CO.

Dept. T-3187, Logan Bldg.,
Mitchell, South Dakota

Please send me full details of your FREE Sample Offer and your offer to pay me for my time in testing these samples if I am not amazed and delighted with them.

Name.....

Address.....

City.....State.....

See the World FREE!



Taste Romance and Adventure— In the Far Lands of the Earth

How often you've longed to see for yourself the awe of Egypt's pyramids—the beauties of the gorgeous Mediterranean sunset—the squalor of China's ancient cities!

Spend a few years, or the rest of your life, tasting high adventure on the seven seas and in all the world's great ports—roving the earth's highways and byways! You can do it FREE—all your expenses paid—and earn a good salary besides!

Only one profession will carry you around the world at will, traveling like a gentleman, but that's the most interesting and pleasant work there is—Radio Operating! Easily and quickly learned, there's no other profession like it for the man who wants the experiences and pleasures of world-travel. Radio operators are needed—all sea-going ships like the one shown here must carry from one to half a dozen or more.



Take a Look Beyond the Skyline— Without a Penny's Expense

Radio operators aboard ocean liners live luxuriously—they rank as officers of the ship. Meals, a private cabin, all other living needs are furnished free, and besides the operator draws a good salary. You can learn quickly and easily at home in your spare time to be a Radio operator through our practical training methods. Take a look at the FREE BOOK which tells how—mail coupon below.

This U. S. Government-recognized school has been training successful operators since 1914. Our graduates are all over the world. We maintain an Employment Department to put you on your own ship. The world-famous NATROMETER, our own patented invention, obtainable only by students of this Institute, is recognized as the best and easiest way to learn the Radio code. A few short months, with the aid of the famous Natrometer and our quick home training, and you too can be a fully qualified Radio operator, sitting in your cabin like the one shown above, bound out for Liverpool or Nagasaki!

Read the Free Book that tells all about this fascinating profession and our practical Government-recognized methods of training you for it. Send coupon TODAY—no obligation. Special tuition offer now on for limited time includes world-famous Natrometer free of extra cost with your course! Act at once.

**NATIONAL RADIO INSTITUTE
WASHINGTON, D. C.**

SPECIAL OFFER COUPON

National Radio Institute,
Dept. PT-77, Washington, D.C.

Gentlemen: Without obligating me in any way send me your free book and information about your special limited Natrometer offer.



World-Famous
Natrometer

Name.....

Address.....

LAW in Spare Time

Learn law and earn more money. Qualify for a high salaried executive position or prepare to enter the practice of law. Study at home through the Blackstone Course prepared by 80 prominent legal authorities including Chief Justice William H. Taft. Blackstone graduates practicing law everywhere. LL. B. degree conferred. Magnificent 25 volume law library furnished immediately upon enrollment. Moderate tuition fee. Low monthly terms. Money Back Guarantee. Write today for Free copy of our 128-page book. "The Law Trained Man."

BLACKSTONE INSTITUTE, Inc.

Dept. 59 4753 Grand Boulevard Chicago
America's Foremost Non-Resident Law School

Drum Lessons With the Outfit



With each genuine Ludwig Trap Drum Outfit we furnish an instruction method. Ludwig drum sets from \$32.50 up. Call on your music dealer or write us for full particulars. Send for free catalog.

World's Largest Makers of Drums and Banjos

LUDWIG & LUDWIG

1611 N. Lincoln St.

Chicago, Ill.

Learn to PAINT SIGNS and SHOW CARDS

We quickly teach you by mail, or at school, in spare time. Enormous demand. Big future. Interesting work. Oldest, foremost school.

EARN \$50 TO \$200 WEEKLY

John Vassos, N. Y., gets \$25 for single show card. Crawford, B. C., says: "Earned \$200 while taking course". Send today for free information, samples and guarantee.

DETROIT SCHOOL OF LETTERING
154 Stimson Ave. Est. 1899 Detroit, Mich.



Hotels Start You With Salaries up to \$3500 a Year — with your living

HOTELS, restaurants, clubs, apartments, everywhere need trained men and women—salaries to start up to \$3500 a year with your living. Over 70,000 high-class positions paying \$2,500 to \$10,000 a year are open every year in the hotels of the United States. Today, this is the 4th INDUSTRY IN AMERICA—with over \$1,000,000,000 in new hotels and clubs being built in 1926. These new hotels, clubs, restaurants, etc., will need nearly 200,000 trained men and women. You can have one of these high-class big-pay positions, fascinating work and meals and luxurious apartment usually furnished FREE! No previous experience necessary. The Lewis Schools guarantee to give you the valuable knowledge that it has taken some of the most successful hotel men years to obtain—men who are now making \$5,000 to \$50,000 a year. We train you by mail in your spare time at home with the Lewis Simplified Study Plan, and we put you in touch with big opportunities. Our students employed, our methods endorsed by leading hotel men everywhere. Send today for Free Book, "YOUR BIG OPPORTUNITY," showing how we can train you for one of these splendid positions, and explaining our Money-Back Guarantee.

**LEWIS HOTEL TRAINING SCHOOLS
Room A-388 Washington, D. C.**

FREE BOOK COUPON
LEWIS HOTEL TRAINING SCHOOLS, Room A-388, WASHINGTON, D. C.
Send me without obligation the Free Book, "YOUR BIG OPPORTUNITY."

Name.....

Address.....

City.....State.....

SHAME ON YOUR WEAKNESS!

Why Be Despised When You Can Be Admired?



LIONEL STRONGFORT

Dr. Sargent, of Harvard, declared that Strongfort is unquestionably the finest specimen of physical development ever seen.

health building into my startlingly interesting book, "Promotion and Conservation of Health, Strength, and Mental Energy." It is priceless! In it are plain facts that will astonish you and help you out of your sorry plight. It will tell you frankly how you can make yourself over into a vigorous specimen of vital manhood with 100% pep, power and personality. It doesn't mince words. It will show you how to be true to the best that is within you—teach you how to be a real fellow. It is a man-builder—a success-maker and a life-saver. Just check the subjects on the free consultation coupon on which you want special confidential information. Send for your copy of this book right now—TODAY!

LIONEL STRONGFORT

Physical and Health Specialist for over 25 Years

Dept. 273

NEWARK, N. J., U. S. A.

Here's something that ought to make you sit up and take notice if you are lacking in energy, pep and staying powers. "Physical weakness is a crime"—many states say so when they require certain physical qualities in applicants for marriage licenses. "Physical weakness is a crime"—the United States Army and Navy say so when they put you through a rigid physical examination before enlistment. Big corporations say so, too, by insisting on higher physical standards in their employees. **There is no place for you if you are a weakling!**

If you are a nervous, timid, fidgeting, shambling fellow, you are not wanted anywhere—you don't attract men or women—you repel them. You can't indulge in the ordinary pleasures of life. You can't enter sporting contests—you lack the energy and stamina of the athlete. You don't get on in school or college—the fellows won't stand for your ailing and complaining, and your mental gloom. You can't hold down a good job—you are too languid and pepleless. Your outlook on life is marred by fits of the blues.

Nature exacts a terrible penalty when you've gone too far with her. She whips you into such a state of debility and despair that you become a miserable specimen of a man—an object to be pitied or shunned.

DON'T FOOL WITH DOPE AND DRUGS

Man, you won't get anywhere experimenting with drugs, dope and booze to stimulate the system. Gymnastic apparatus, stretching, pulling and lifting machines often aggravate your condition. Starvation diets may merely weaken you more. Electrical and many other trumped-up treatments, muscle manipulation, baths, ordinary physical culture, forced deep breathing, mystics—all fail to get to the cause of your weaknesses and diseases. Nature only can help you. Nature is supreme in the regulation, restoration and revitalizing of the human body. But you must give Nature a chance—you must help her—and this you can do most certainly, most effectively through

STRONGFORTISM

—Science of Health and Strength. It Will Do Wonders for You

Strongfortism isn't an experiment. There's no guesswork about it. It was through the methods I used in developing my own body until I won the world's record as the finest specimen of muscular development and championships in feats of great strength, in Europe and in the United States, that I constructed the science of STRONGFORTISM. It is through it that I reclaim wrecked and weak men, make them into new beings and give them a body and arms of which they can boast. I require you to use no apparatus. No drugs or medicines are prescribed. No inconvenient hours are required. Only a little of your time in the privacy of your own home is necessary to follow my easily understood instructions—and, oh man, how glad you'll be that you listened to me, once you started on my course. It means a new day for you, that's sure as you're alive.

You can banish your weakness. You can be a man to be feared in physical combat. There is no doubt about it. I can prove it if you'll just sit down and tell me frankly that you are willing to guide by what I tell you.

**Send for My Free Book
It Will Prove a Revelation**

No man seeking to be healthy, vigorous and strong can afford to be without this book. I've packed the experience and research of a lifetime of physical and

— CLIP AND SEND THIS COUPON —

FREE CONSULTATION

ABSOLUTELY CONFIDENTIAL

Mr. Lionel Strongfort, Strongfort Institute, Dept. 273, Newark, N. J.—Please send me absolutely free my copy of your book, "PROMOTION AND CONSERVATION OF HEALTH, STRENGTH AND MENTAL ENERGY." I have marked (x) before the subjects in which I am most interested.

- | | | |
|---------------|-----------------|-------------------------|
| .. Colds | .. Weak Back | .. Weak Heart |
| .. Catarrh | .. Weak Eyes | .. Great Strength |
| .. Asthma | .. Flat Chest | .. Lung Troubles |
| .. Headache | .. Despondency | .. Poor Circulation |
| .. Rupture | .. Emaciation | .. Round Shoulders |
| .. Thinness | .. Rheumatism | .. Skin Troubles |
| .. Pimples | .. Nervousness | .. Stomach Disorders |
| .. Insomnia | .. Constipation | .. Increased Height |
| .. Overweight | .. Short Breath | .. Muscular Development |

Name.....

Age..... Occupation.....

Street.....

City..... State.....

RUSSELL PATTERSON



**Makes a
\$150
Drawing
in a
Few Hours!**

—and now teaches you his original methods in a series of 20 snappy lessons—brimful with sparkling interest from the very start—a departure from the

purely conventional. This training constitutes the last word in Humorous Illustration, teaching a New Art for a New Age—a pleasant relief from the old style, standardized instruction. Learn to draw the dashing, peppy types that are all the rage as exemplified by Mr. Patterson's numerous contributions to magazines. Let him teach you his clever technique. What profession could compare with this in its irresistible appeal or sheer earning power? Write now for full information.

**Russell Patterson School of
Humorous Illustration**
Michigan Ave. at 20th St., Dept. 12
CHICAGO - - - ILLINOIS



Learn to Write

I Teach by Mail

I CAN make a good penman of you at your home during spare time, no matter where you live or how poorly you now write. My simplified system has shown thousands of others the way to good penmanship during the past twenty years — it can and will do the same for YOU!

Beautifully Illustrated Book
**“How to Become
a Good Penman”**
FREE!

It contains general information, with testimonials and beautiful specimens of penmanship showing what others have accomplished by the Tamblin System. (Your name elegantly written on a card if you enclose stamp for postage.) **WRITE TODAY.** Address

F. W. TAMBLIN
 418 Ridge Bldg., Kansas City, Mo., U. S. A.





SAXOPHONE MUSIC Catalog

Just out—complete catalog of latest jazz hits, also standard saxophone solos, duets, trios, quartettes—2,000 selections. Largest general dealers of saxophone music and supplies in the world. *Expert repairing.* Send for free catalog today.

FINDER & URBANEK Inc., Dept. 2057, 1322 West Congress St., Chicago

FREE 352-Page Catalog Books of all Publishers

Save time and money when buying books. Here is one central source carrying books of all publishers. Quantity buying permits lowest prices to you. Send for our 32nd Annual Illustrated Catalog describing over 25,000 books; used by public, private and school libraries and individuals everywhere. It is FREE. Write today.

THE BOOK SUPPLY COMPANY, Dept. 13
 231-233 West Monroe Street, CHICAGO, ILLINOIS

MINSTRELS

Musical Comedies and Reviews, with full instructions for staging. You can stage your own show with our books. Full line of plays, stage songs, crossfire, monologues, afterpieces, vaudeville acts and make-up.

CATALOGUE FREE
T. S. DENISON & CO., 623 So. Wabash, Dept. 19, CHICAGO

FOREST RANGERS

Men wanting forest ranger, mail clerk, or other government positions, write for particulars.
MOKANE, 236, DENVER, COLO.

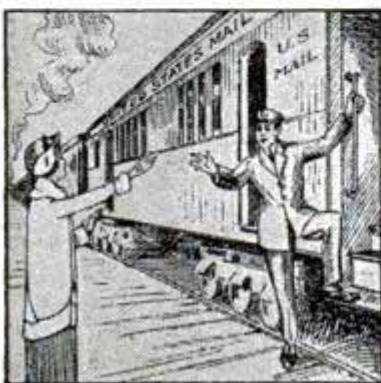

Travel—for “Uncle Sam”

RAILWAY POSTAL CLERKS—MEN—BOYS 18 UP

CARRIERS—POSTOFFICE CLERKS

\$1700 TO \$2700 YEAR

Steady Work. No Layoffs.
Paid Vacations.

Common Education Sufficient

MAIL COUPON IMMEDIATELY

FRANKLIN INSTITUTE,
 Dept. D-177, Rochester, N. Y.

Sirs: Rush to me without charge, 32-page book with (1) Sample Railway Postal Clerk coaching; (2) List of government jobs now open to men and women, 18 up.

COUPON

Name

Address

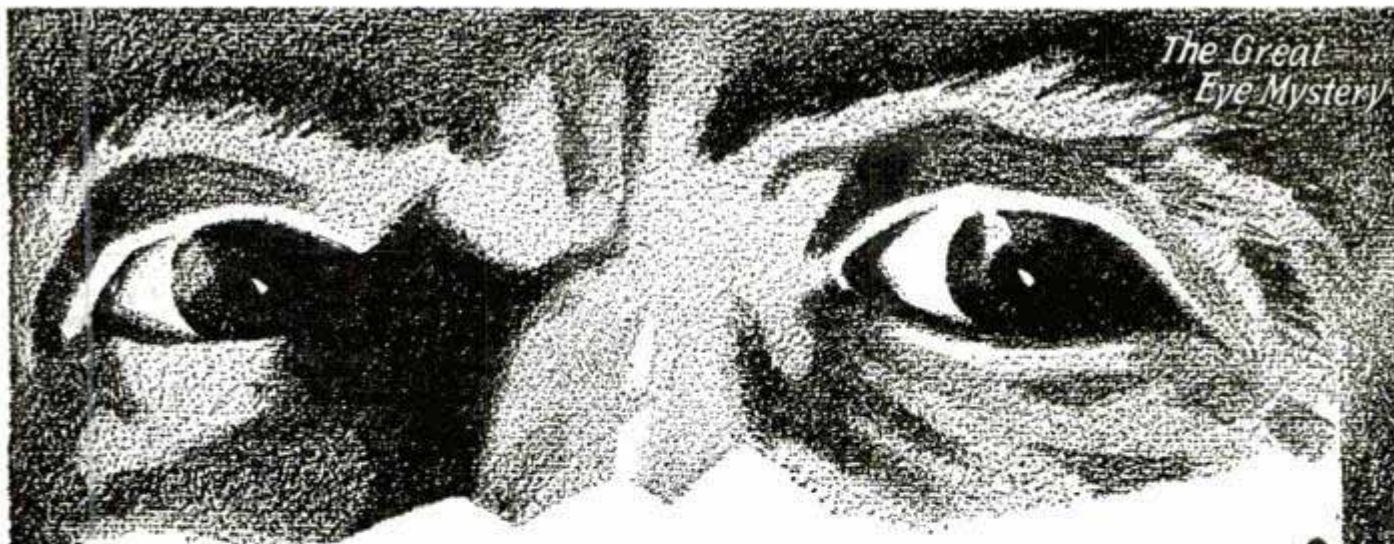

Follow These Eyes!

YES, follow these eyes with Secret Service Operator No. 99 and get the thrill of your life! Follow him — see how deftly he works, as he shadows and unravels "The Great Eye Mystery"—one of the greatest crime mysteries ever known.

This amazing, gripping, thrilling mystery is *revealed* for the very

first time in the confidential reports Operator No. 99 made to his chief. Here, he depicts terrible weird murders, clever robberies. He fascinates you with the thrills of his shadow work. Time and again this great criminal escaped capture like a gust of wind, leaving only the memory of those horrifying, terrifying eyes.

And then — one day Operator No. 99 found finger prints! They told the story. They landed this great criminal. They unravelled "The Great Eye Mystery" . . . write for this gripping, thrilling, confidential report of Operator No. 99. Never have you read anything like it. You will never forget it. Send for it and get the thrill of your life!

FREE The Confidential Reports No. 99 Made to His Chief

And the best part of it all is this. It may open your eyes to the great future for YOU as a highly paid Finger Print Expert. More men are needed right now. This school has taken men just like you and trained them for high official positions. This is the kind of work you would like. Days full of excitement. Big salaries. Rewards.

Earn \$2500 to \$10,000 a Year *You Study at Home in Spare Time*

No advance education is needed. Any man who can read and write, and think can make good. A wonderful book tells all about what others have done. Shows pictures of real crimes and the men who solved them. We'll send you a FREE copy with the free reports. Get the special offer now being made. Mail the coupon.

University of Applied Science
1920 Sunnyside Ave. Dept. 93-59 Chicago, Ill.

University of Applied Science,
1920 Sunnyside Ave., Dept. 93-59 Chicago, Ill.

Gentlemen:— Without any obligation whatever, send me the Free Reports of Operator No. 99 and your new, fully illustrated Free Book on Finger Prints.

Name _____

Address _____

Age _____



For the first time
in America!

EUROPE'S MOST FAMOUS METHOD OF LEARNING FRENCH

How we envy the ease and charm with which so many foreigners speak several languages besides their own! How do they acquire this wonderful facility? Surely not by the American school method of memorizing uninteresting rules and long, tedious lists of irregular verbs!

No—a very different method has been used in Europe for many years. This method, created by the great publishing house of Hugo, which has published millions of language books and conducted language institutes in many cities, is now introduced for the first time in America.

HUGO'S "FRENCH AT SIGHT"

No rules! No tiresome verb lists! Easy French sentences, starting in your very first lesson, about subjects that you discuss every day. In a very short time you will be speaking French fluently and charmingly, as the French themselves speak it, for an ingenious device gives you correct pronunciation and accent.

Complete Course Only \$12.00

—If you act quickly. To introduce a method that has been used successfully by so many thousands of Europeans, Hugo's Language Institute of London now authorizes us to offer a special American edition of their complete "French-At-Sight" course, in 24 lessons, at the astonishingly low price of \$12.00; payable on convenient terms of only \$2.00 a month. The coupon brings you the complete course to examine FREE. To all who enroll now, we will also give

FREE This Beautiful Imported French Dictionary

623 pages—50,000 words

Our representative found these charming pocket size volumes in Paris—the 1926 edition of the famous Cestre-Guibillon, Français-Anglais and Anglais-Français dictionary, the best of its kind. The binding is a rich, dark green seal grain; the page edges red. Quaint hand lettered gold titles and a unique coq d'or lend an old world charm. Yours, free, if you mail the coupon NOW!



Doubleday, Page & Co., Dept. F-3712
American Representatives of Hugo's Language Institute of London, Garden City, New York

Gentlemen: Please send me, for free examination, the complete Hugo "French-At-Sight" course, in 24 lessons. Within 5 days I will return the course or send only \$2.00 first payment and \$2.00 a month until \$12.00 in all is paid. I am also to receive an imported French Dictionary, of 50,000 words, at no extra cost.

Name.....
Address.....
City..... State.....
Occupation.....
5 per cent. discount for cash with order.

HOW TO GET WHAT YOU WANT

Better Job—Money—Health—Automobile—A Home—whatever you want YOU CAN HAVE IT if you follow this simple plan of mysterious power. Endorsed by men of world wide fame. Boiled down to vital essentials in wonderful new book, "IT WORKS," just published. Only book known that you have to give away to get one. Send \$1.00 with name and address of yourself and two others that you want to help, and copies of this book will be sent to all three. Money back if not more than satisfied.

WRITE TODAY

LARGER LIFE LIBRARY

19 South LaSalle St. Dept. P. M. Chicago, Ill.

SALESMEN:

Write your name and address on a postal and mail to us. We'll show you sure earnings of \$20.00 a day. Will you risk one minute and a one cent stamp against \$20.00? Mind you, we say we'll SHOW you. Address Dept. 1053.

WILLIAM C. BARTLETT, Inc., 850 W. Adams St., Chicago



9 Big Books covering all subjects fully:

- Surveying
- Map Making
- Roads
- Bridges
- Culverts
- Railroad Engineering
- Estimating for Steel Buildings
- Masonry
- Water Supply
- Water Power
- Cost Systems

Want to make more money?

Be a Civil Engineer

Here is an easy way to learn. You hold your future in your own hands. If you have a grammar school education, and want the advantages of knowledge usually gained in college, you will welcome this new system of reading at home. No long hours of grinding study; just the meat of every subject told in such a simple way that anybody can understand.

These books were prepared by men who were experts, they are full of boiled down facts and easily learned methods which save time and study. Civil Engineers are more important than ever; steel buildings, bridges, highways, railroads and harbor projects make Engineering more important than almost any other profession.

If you want to get ahead—try this easy way
We Ship Nine Books FREE

This is a "straight-from-the-shoulder" offer to men who want a big future. If you could hear half the stories of success we receive, you would not hesitate a minute. Send for the books now; just your name and address; and we'll ship the entire set of nine volumes. Keep them ten days, then if you realize how valuable they are to you, send only \$2.00, and after that only \$3.00 per month until the small total of only \$29.80 is paid. A free membership in the American Technical Society will be included if you send NOW. This entitles you to full consultation privileges with 18 engineering experts.

The special jiffy index puts facts at your finger tips

AMERICAN TECHNICAL SOCIETY, Dept. C-319, Chicago
You may send me, for Free examination, your nine new books on Civil Engineering. Unless I return them in ten days I will send you \$2.00 as first payment, then \$3.00 per month until the special price of only \$29.80 is paid. Include membership in the American Technical Society.

Name.....
Address.....
City..... State.....
Reference.....

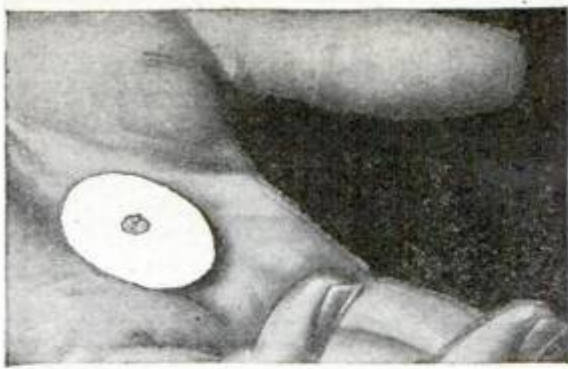

My Rupture Fear Vanished in 2 Seconds



In a flash I knew that at last science had given to rupture victims real, quick, positive relief. I knew that through the discovery of a well-known American Scientist my rupture suffering was over.

Tiny Magic Dot a Rupture Wonder

An extraordinary little device, weighing less than 1-25 of an ounce, now makes heavy, cumbersome, old fashioned devices, cruel springs, heavy straps and pads unnecessary. This new invention is called "Magic Dot," and by its use it is now possible to walk, run, jump, exercise, bend, etc., with perfect security—without cruel pressure or barbarously tight strapping. At last, here is a way to prevent coming down of rupture, and tiny Magic Dot is only a part of the wonderful New Science System.

Breathes Air

A wonderful new pad, light in weight, soft and pliable, actually breathes air. Smaller, much smaller, than you ever thought possible. Washable and sanitary!

FREE Sample

The pad is made of an amazing new material called Airtex. A sample will be mailed absolutely free, without obligation. These two items are only a part of this new system that is said by doctors and rupture victims alike to be a thousand years ahead of all other methods.



FREE Inspection

We could never tell you all of the remarkable features of this modern, scientific rupture relief, but without risk you can have it for free inspection. Send no money. You can easily get full particulars and free illustrated material. Find out now how you can get New Science Rupture System for free inspection. Merely clip coupon, and mail it to

NEW SCIENCE INSTITUTE

2131 Clay Street Steubenville, Ohio, U. S. A.

NEW SCIENCE INSTITUTE

2131 Clay St., Steubenville, Ohio.

Please send me at once full details of your free inspection offer. I am not obligated.

Name.....

Address.....

City..... State.....

I'll End Your FEARS in 48 Hours



David V. Bush

Give me 5 days and I'll prove to you that I can give you real courage—courage that wins—courage that crushes all obstacles. I can give you Grit and Gumption enough to fight your weight in wildcats.

By DAVID V. BUSH

The Man Who Destroyed Fear

Are you afraid of people? Are you afraid of your superiors? Are you afraid of Public Opinion? Give me 48 hours and I'll prove I can banish all your fears—now and forever.

Don't be a cringing, crawling imitation of a man. Brace up.....Throw your shoulders back.....Stick your chest out! Show folks who you are. Show folks you've got a good opinion of yourself and they'll respect you and look up to you.

Grit and Gumption Win

You must see this new book in which Dr. Bush give his secrets of real, he-man courage. It is called "Spunk." You can't read it without a quickening of your pulse—without a new surge of red-blooded courage.

This book is declared to be the masterpiece of Dr. Bush, who has astounded throngs in America's greatest cities and shown thousands the one way to health, prosperity and happiness. Write for this amazing book today. Send only 50 cents in full payment. If you are not delighted, return the book within 5 days and your money will be instantly refunded.

DAVID V. BUSH, Publisher

225 N. Michigan Blvd., Dept. K-10512, Chicago, Ill.

DRAW CARTONS

Turn Your Talent Into Money

Cartoonists earn from \$50 to \$300 per week—some even more. Remarkable new Circle System of Drawing teaches you in half the usual time. Send for **booklet** and sample **lesson plate** explaining full details of the Course.

THE NATIONAL SCHOOL OF CARTOONING
623 Penton Building Cleveland, Ohio



AGENTS

NEW! GRAB THIS FREE OUTFIT QUICK!

STAY-PREST Trousers Presser—wonderful new invention—looks efficient, and it is. That's why 250,000 have been sold already.

My First Week I Made \$93

"Since then I have earned over \$100 every week," says S. L. Patterson, of Iowa. Many others making big money. No wonder! Millions of interested prospects. A quality product. Puts lasting crease in trousers. Takes out bagginess—smoothes entire surface—demonstrates in 40 seconds. Sells quick to every man.

FREE Selling Outfit

Your profits paid in advance. Simply write orders. We deliver and collect. Test it without cost, full time or side line. Send postcard for offer of free demonstrator. Join the big money-makers. Write today.



Folds to 15 inches)

THE GETGEY-JUNG COMPANY
W-121 'G & J Bldg. Cincinnati, Ohio

LEARN TO FLY

MAKE \$75.00 TO \$200.00 WEEKLY

We teach you theoretical and practical aviation by mail. Write for **FREE** illustrated folder.

UNITED STATES SCHOOL OF AERONAUTICS
(DEPT. E) MAYWOOD, ILLINOIS

Want REAL Muscle? Get a Real Exerciser

My Guarantee is Backed by a \$10,000 Challenge!

The apparatus that wraps your entire body in muscles of spun-steel, IS ALSO THE BIGGEST BARGAIN. These pictures tell a story that you should know. I knew that the McFADDEN PROGRESSIVE was the best exerciser that science and money could build because for years it has been producing the best bodies. But I wanted to show you. I took one of my cables and one from an average exerciser—and I cut them in two! Study the diagram. Have these padded affairs fooled you? FORGET IT! Here's the exerciser you want. The one that will put crushing power in every muscle of your body.

"Have just completed your course. Results exceeded expectations. This picture tells the big story in itself."
—Thomas Balch

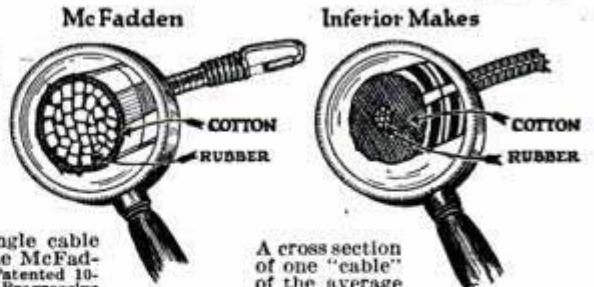

A single cable of the McFadden Patented 10-Cable Progressive Exerciser, no thicker than others in outward appearance—yet stronger by 75 per cent, inside the thin worsted covering. Here is quality! Every McFadden cable is made of 40 strands of the best grade rubber procurable. There is no padding with extra wrappings of worsted—no attempt to produce the exerciser cheaply.

A cross section of one "cable" of the average exercisers. The cheapness and weakness of construction are easily seen in the diagram. Six or seven rubber bands, wrapped and padded with a cotton covering to give them the appearance of size and strength and to make them look like the McFadden.

You Get the BEST Apparatus and SAVE \$22 This Is What I Give You:

- 10 Cable Progressive Exerciser, worth.....\$8.00
- Patented Progressive Handles with 1,000 pounds resistance, worth..... 2.00
- Patented Progressive Stirrup with 1,000 pounds resistance, worth..... 1.00
- Patented Progressive Head-Gear, the only one of its kind, progressive resistance and adjustable to any size head and neck, worth..... 3.00
- 12 Weeks' Home Instruction Course, the most wonderful ever written—the kind you cannot get elsewhere, worth..... 15.00
- The Michael McFadden Encyclopedia, worth..... 1.00
- \$30.00**

Any of the Above Can Be Purchased Separately at the Prices Shown
TOTAL WORTH \$30.00!

ALL for \$8.00 and Jim Corbett's Boxing Book FREE Full of pictures and inside dope on the ring, this big book goes FREE with every set of apparatus I ship for the next twenty days and if you are not entirely satisfied with the outfit, return it immediately and your money will be refunded without delay.

MICHAEL McFADDEN, Dept. R-109, 103 East 13th St., NEW YORK CITY

MICHAEL McFADDEN, Dept. R-109, 103 E. 13th St., New York City

Dear Sir: Enclosed please find \$8.00 in full payment for your 10-Cable Progressive Exerciser with Patented Handles, Patented Adjustable Stirrup, Head Gear, 12 Weeks' Home Instruction Course and Encyclopedia.

(Print Plainly)

Name.....

Street No.....

City..... State.....

ELECTRICAL OUTFIT Complete FREE

when you enroll



\$50 value—Real tools. No toy!

TO MAKE REAL MONEY get into electricity. No matter what your age or education, we can train you in a little while for a real job. A job where you do the bossing at \$65 a week and up. Even electrical tradesmen make big money now. The boom has just started. **WITH OUR TRAINING** you can get the kind of job you've always wanted. Or go into business for yourself. You don't have to know one thing about electricity now. Just put yourself in our hands. A

few fascinating hours a week in work with a real kick.

WE GIVE YOU real equipment to work with at home. The same things you use later on the real job. And a money back Guaranty that our training must satisfy you or your money back—every penny.

22 YEARS' EXPERIENCE in training men is our record. Commonwealth Edison, Harnischfeger Corp., Allis-Chalmers are only a few who recommend S. of E. **72 PAGE BOOK FREE** if you mail coupon. Act today. Give yourself a chance.



Charles P. Steinmetz, A.M., Ph.D., "electrical wizard" of General Electric was for the last 8 years of his life on advisory board of S. of E.

\$65 a Week and Up!

A chance for a real career in electricity. In your own business or rapid advancement with electrical concerns.

CLIP NOW!

SCHOOL of ENGINEERING Dept. H-PM, 127, Box 572: Milwaukee, Wisconsin

Send me FREE and post-paid your big 72 page book giving details of your home study course in Electricity and money back guaranty.

Name.....
Age..... Education.....
Address.....
City..... State.....

A Great Book Free with this pay-raising library

For a short time only we will give every subscriber to the New Library of Machine Shop Practice a copy of French's Engineering Drawing—the greatest book on mechanical drawing ever written. This book makes drawing as plain as day—tells you all about instruments, plans and methods—and prepares you to handle any drawing job you will ever have to do. It comes to you absolutely free with

Machine Shop Practice

9 volumes — 3065 pages — 3608 illustrations (A combined home study course and reference library)

The New Machine Shop Library is written for practical men. It gives you the best methods for every kind of machine shop work. It explains machine tools and their operation, drawing and design, tool work, gears and grinding, jigs and fixtures, automatic screw machines and their tools and all of the mathematics you will ever have to use. It is plainly written, completely illustrated—the very best kind of help to the machine shop man who wants to advance himself.

Sent FREE

No money down—only 7c a day



FREE EXAMINATION COUPON

McGraw-Hill Book Co., Inc., 370 Seventh Ave., New York

Send me for 10 days' free examination the New Library of Machine Shop Practice. If satisfactory, I will send you \$1.50 in 10 days and \$2.00 monthly until the special price of \$19.50 is paid. If not wanted, I will return the books at your expense.

On receipt of my first payment of \$1.50 it is understood that I am to receive, free of charge, a copy of French's Engineering Drawing.

Signed.....
Address.....
City and State.....
Position.....
Employer..... P.M. 12-1-26

If I can't grow hair for you in 30 days you get this check refunding every penny of your money

By Alois Merke,
 Founder of Famous Merke Institute, Fifth Avenue, New York

IS that clear? If my treatment fails to grow new hair in 30 days—if it doesn't end dandruff—if it doesn't stop falling hair—simply tell me so and I will immediately mail you a check for every penny you paid me.

No matter how fast your hair is falling out—no matter how much of it is gone—this offer stands.

I don't ask you any questions in case you are not satisfied with my treatment. I don't even ask you in what way my treatment failed.

If you are not absolutely delighted with the results you get—if my treatment fails to do any one of the things I say it will do—simply let me know and I will send you by return mail a check refunding every penny of your money. And, remember, you alone are the judge of whether my treatment works or not.

Why This Offer?

How am I able to make this amaz-

ing offer? The answer is simple. My system of hair growth is founded upon a recent scientific discovery. I have found during many years of research and experience in the Merke Institute, Fifth Avenue, New York, that in most cases of baldness the hair roots are NOT dead. They are merely dormant—asleep!

It is an absolute waste of time—a shameful waste of money—to try to penetrate to these dormant roots with ordinary oils, massages and tonics which merely treat the surface skin.



HERE'S PROOF!
Hair Coming Back

"Having used your Thermocep Treatment for 30 days, find a new growth of hair coming back on bald spot. It is growing in very fine. The Thermocep is a treatment that everyone who is losing his hair should buy."—G. H. C., Portland, Me.

Dandruff Leaves Entirely

"I want to tell you how wonderful your treatment is. The first week my dandruff left entirely, and by the third week a new growth of hair could be seen all over my head."—Mrs. H. S., Port Angeles, Wash.

Y o u wouldn't expect to make a tree grow by rubbing growing fluid on the bark—get at the roots. And that is just what my scientific system does. It penetrates below the surface of the scalp. It stimulates the dormant roots. It awakens them. The tiny capillaries begin to pump Nature's own nourishment into them. Hair begins to grow again. It takes on body and color. No artificial hair foods—no rubbing. And here's the wonderful thing about this system. It is simple. You can use it at home—in any home that has electricity—easily—without the slightest discomfort.

Free Booklet Tells All

Thousands of men and women have been treated successfully at the Merke Institute. Hundreds daily are getting



amazing results with this easier, less expensive "at home" system of hair growth. Now, I do not say that all cases of loss of hair are curable. There are some that nothing in the world can help. Yet so many men and women write in daily about the wonderful results that I gladly make this offer. Try this remarkable treatment for 30 days. Then, if you're not delighted, simply return the treatment and you will get your money back instantly and without question.

There's no room here to tell you all about your hair and about the amazing contract I offer you. But I will be glad to tell you all about it if you are interested. Just mail the coupon and I will send you, in plain wrapper, without cost, a wonderfully interesting booklet that describes in detail the system that is proving a boon to thousands in this and other countries. Mail this coupon and the free Booklet will reach you by return mail. Allied Merke Institute, Inc., Dept. 1612, 512 Fifth Avenue, New York City.

Allied Merke Institute, Inc.,
 Dept. 1612, 512 Fifth Ave.,
 New York City.

Please send me, in plain wrapper—without cost or obligation—a copy of your free book, "The New Way to Grow Hair," describing the Merke System.

Name.....
 Address.....
 City.....State.....

MOTOR BOOM

**Over One and One-Half Million Autos in California Now
—with Over Two Hundred Thousand Tourist
Cars Entering State Each Year!**

**Shortage of Repair Shops Opens Hundreds of Opportunities
for Men to Get Into Money-Making Automotive Business**

From every state in the Union, thousands of autos are heading toward California! Determined to escape the rigors of Eastern winters, thousands of families are touring Westward to the land of sunshine. Already there are over one and one-half million automobiles registered in California—four out of every five families have a car!

Right now the streets and highways of California are crowded with autos—and new cars are driving into the state by the hundreds every day. The ideal motoring conditions—thousands of miles of paved roads—sunshine almost every day—hundreds of beach and mountain resorts—mean that automobiles in California are used *more* than in other states. 365 days of motoring each year—and every car is spending a dollar or more each day for upkeep!

Downtown Los Angeles streets are jammed with autos. Scene shows traffic at Auto Club of S. C. corner. Their records show that an average of 16,425 cars enter California each month from other states!

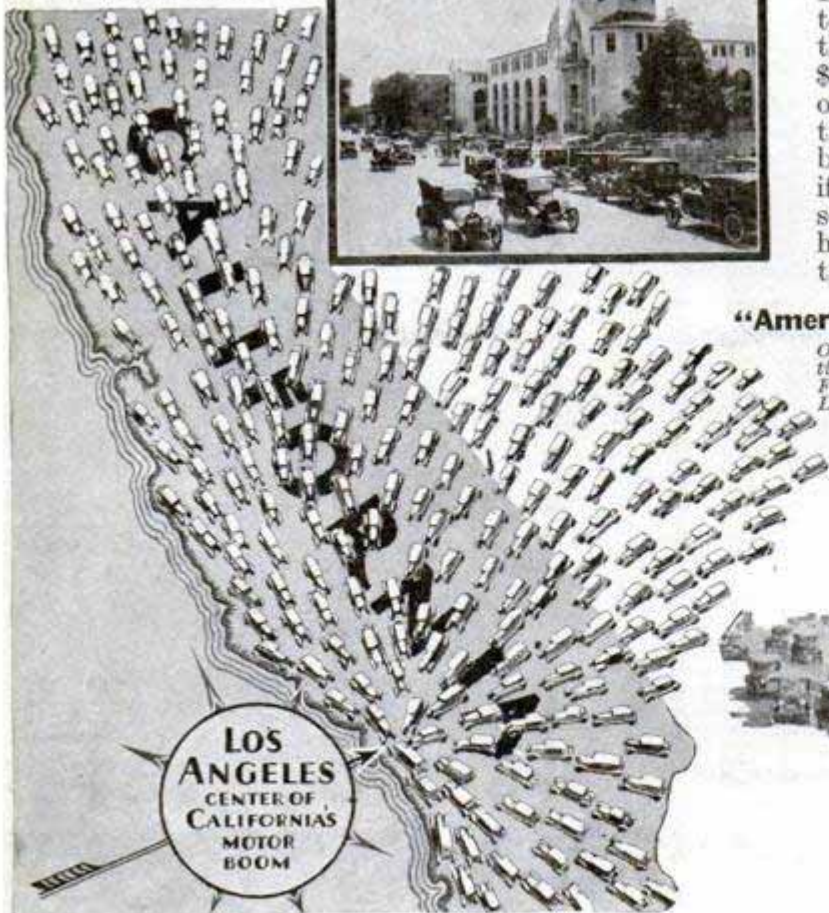

Big Demand for Auto Men

This unusual condition has created a unique labor shortage in California. Thousands of skilled auto repair men are urgently needed to keep this vast army of motor cars in daily operation. But garage owners everywhere admit that they cannot get the right kind of men. They are forced to hire amateur, inefficient mechanics. Every garage in California is swamped with auto repair work—and employers are issuing a hurry call for "trained men."

Any man who really knows how to repair automobiles will find steady work in California at a salary ranging from \$45 to \$125 a week. It is easy for skilled men to go into business for themselves and make \$10,000 a year or more operating garages, ignition shops, tire shops, battery shops, etc. California cities are growing so fast that there are hundreds of good locations always available.



Over 16,000 men have learned the auto trade in Los Angeles in the shops of the National Automotive School

"America's Busiest Corner"

Over 60,000 cars pass the National Automotive School corner, Figueroa and Santa Barbara Sts., Los Angeles, during daylight hours every day. According to a recent traffic check this is considered by traffic authorities the busiest corner in America



IN CALIFORNIA!

Men Now Training for Jobs That Pay \$200 to \$600 a Month

This year's motor boom has made the labor shortage so acute that California's world-famous automotive training institution—the National Automotive and Electrical School at Los Angeles—is taking an emergency step to provide the hundreds of California employers with trained automotive mechanics quickly.

Special day and night classes are being organized every week and inexperienced young and old men from all walks of life—farmhands, high school boys, miners, clerks, etc.—are given personal instruction on all kinds of automotive repairs. Expert instructors teach each student individually how to make all repairs on Packards, Fords, Cadillacs, Buicks and all standard cars. Students get real shop practice performing actual jobs under the watchful eye of an instructor who sees that they learn every job thoroughly.

Become Auto Experts Quickly Earn \$6 to \$16 a Day

After a few months of this training, the student graduates as a genuine automotive mechanic—experienced in every branch of automotive service. Then the free employment service of the National school introduces him to several employers. The student starts usually at \$45 a week—but his superior training and ability soon win promotion and pay increases. Employers recognize that National-trained men know their business—and because of the keen demand for really skilled men, employers are anxious to find such men and pay good salaries to hold them.

Nationally Famous for Quality Training

Over 16,000 men have been trained for success at the National Automotive School in the past quarter-century! This school has won a nation-wide reputation for quality training. Students travel thousands of miles and from foreign countries especially to get the advantage of National training. This million dollar school—with its four acres of shops—is equipped to give complete training. No student is "rushed through" National. The Welfare Department sees that each man gets as much training as he needs to qualify him to meet the requirements.

Employers and educational authorities all over the country have endorsed the National system of practical training. Employers recognize that a man learns more in a month at National than he would in a year as a garage apprentice.

Never Before Such Opportunities

Right now there is such a demand—not only in

California, but in almost every state—for trained auto experts, that National cannot begin to supply the requests from employers. Never before in the history of the automotive industry have there been so many opportunities for young men to step right into big pay jobs with an assured successful future.

Big California Auto Book Free

Before you decide on your future—send for the 74-page illustrated National Auto Book. It tells you how to cash in on California's motor boom. It describes National's successful training methods—free employment service, etc. This book shows you the way to big pay! Send for it right away. It's free! Address

National Automotive School,
Dept. 665,
4006 Figueroa Street,
Los Angeles, California



LEARN AUTOS IN LOS ANGELES

There is a bigger demand for trained auto men—to service the millions of automobiles in California—than National can supply. Employers are asking us to train men for them. After a short training in National shops you are qualified for a steady job paying \$45 to \$125 each week. No previous experience necessary.

CALIFORNIA HAS A JOB FOR YOU

You learn more about autos in a month at National than you would learn in a year as a garage apprentice. Why work for small wages for years when a few months at National enables you to step right into the big-pay class. You will probably start at \$45 a week and work up to a business of your own in this land of opportunity. National training places you head and shoulders above other men because when you leave National you know

Expert Instructors Personally Show You How to Make Repairs



FREE EMPLOYMENT SERVICE

ALL about autos! You can earn room and board by part time jobs while training. After you complete training National will introduce you to big employers and you can pick the job you want.

In this fast-growing state the trained man will always find plenty of work at good pay.

Read about the Opportunities in California in the big 74-page National Auto Catalog. It tells you how you can become a big pay auto expert in California. Sent free—mail coupon.



NATIONAL AUTOMOTIVE AND ELECTRICAL SCHOOL

Established a Quarter Century Ago

National Automotive School, Dept. 665,
4006 Figueroa St., Los Angeles,
California

Send me your free book showing how I can benefit from California's motor boom.

Name.....
Address.....
City.....
State.....

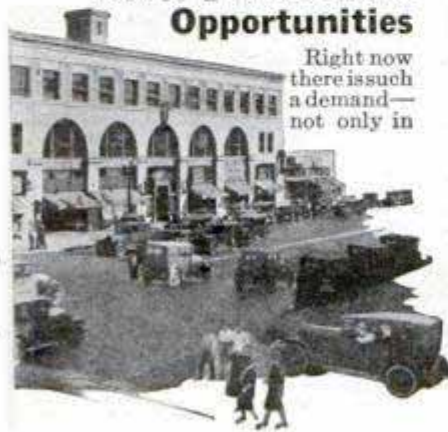

Over 16,000 men have learned the auto trade in Los Angeles in the shops of the National Automotive School



Choose as Your Profession Electrical Engineering

Electricity offers a brilliant future to the young man who is about to choose his career. Never before has there been such wonderful opportunity in this great field. Big paying positions in electrical work the world over are open to trained men—men who possess specialized, practical knowledge. Come to the School of Engineering of Milwaukee—the largest and best equipped electrical school in America. Here you are trained in both theory and practice by a faculty of experts. You learn in large, completely equipped laboratories. If you have 14 high school credits or equivalent, you can become an Electrical Engineer with a Bachelor of Science degree. Any credits you may lack can be made up in the short intensive Junior Electrical Engineering Course.

B.S. Degree In 3 Years

A Complete, Practical, Electrical Education

Learn by the thorough, approved scientific methods which our twenty years of specializing enable us to give you. In addition to Electrical Engineering, the following complete courses are given: **A. C. and D. C. Armature Winding—Wiring and Testing—Junior Electrical Engineering—Electrotechnics—Commercial Electrical Engineering—Automotive Electricity—Radio Sales and Service.**

Earn While You Learn

By our special system you may earn part of your way while learning. Our Employment Department will secure you a position to which you may devote a part of each day, spending the remainder at the school. This plan both solves the students' financial problems and provides splendid experience at the same time. Low tuition fee. Board and room reasonable. Daily Broadcasting WSOE. School Orchestra. Fraternities.

New Term Begins Jan. 3

Write for FREE Catalog

Write today for our free, illustrated catalog. Read about this wonderful institution and the great opportunities that lie before you. Find out about our specialized method of training and the details of our "Earn While You Learn" plan.

SCHOOL of ENGINEERING of Milwaukee
FOUNDED 1905
Dept. P.M. 927, Jackson and Oneida Sts., Milwaukee, Wis.

SCHOOL OF ENGINEERING OF MILWAUKEE
Dept. P.M. 927 Jackson and Oneida Sts. Milwaukee, Wis.
Without obligating me in any way, please mail free 64-page illustrated book, "Electricity and the One Best Way to Learn It," and particulars regarding the course I have marked with an X.

- Electrical Engineering.
- Commercial Electrical Engineering.
- Junior Electrical Engineering.
- Electrotechnics.
- Armature Winding.
- Light, Motor Wiring and Testing.
- Automotive Electricity.
- Radio Sales and Service.
- Home Laboratory Service.

Name.....Age.....
Address.....
City.....State.....
Education.....

How to Work Wonders With Your SUBCONSCIOUS MIND



David V. Bush

Give me just 60 minutes and I'll unlock the floodgates of that vast reservoir of mental power—your Subconscious Mind. Note the immediate effect on your business, social and everyday life.

By DAVID V. BUSH

A vast reservoir of mental energy! A huge storehouse of brain power! That's the Subconscious Mind. You've got it. Your friends have it. Everyone has it. But not one in a thousand knows how to use it.

In 60 minutes I can show you exactly how to awaken your Subconscious Mind—how to harness it—how to make it work for you—how to make it solve problems—how to make it remember things—how to use its vast creative powers to boost your success and double your money-making ability.

In my new 140-page book, "The Subconscious Mind," I tell just what the Subconscious Mind is—just how to reach it—just how to control it—just how to get the most out of it. It's simple as A. B. C.

ONLY 50 CENTS

Write today for this amazing book, "The Subconscious Mind." Send only 50 cents in full payment. If you are not delighted, return the book within 5 days and your money will be instantly refunded.

David V. Bush, Publisher, 225 N. Michigan Blvd. Dept. T-10512, Chicago, Ill.

TELEGRAPH-RADIO

\$18 to \$35 a week while training for Radio and Telegraph Operator jobs at \$150 to \$300 per month. Write for particulars.

CHICAGO TELEGRAPH INSTITUTE
Dept. 1-12-26 1338 S. Michigan Avenue, CHICAGO

Free Trial

In Your Own Home

FREE Instruction with Every Instrument



Deagan Xylorimba

Become a crack Xylorimba player right in your own home. Easiest instrument to play. Learn in a few hours with our 14 free complete lessons. Earn \$80.00 to \$200.00 a week. Deagan instruments are world-renowned—used extensively in leading dance, theatre and concert orchestras.

FREE LESSONS—A YEAR TO PAY!
Our free trial, easy payment plan makes it easy to learn at home. Send coupon below for illustrated literature and details of our special free trial offer.

.....**Send Coupon Today!**.....

J. C. DEAGAN, Inc., Dept. 1459, 1770 Berteau Ave., Chicago, Ill.
Dear Sirs: Without obligation, please send me literature and information regarding your free trial Deagan Xylorimba.

Name.....
Address.....
City.....State.....



Eveready's exclusive
 Layerbilt construction *makes*
this the most economical
of "B" batteries

IMPROVEMENT on top of improvement has been the history of Eveready Radio Batteries. Here, in the radically different Eveready Layerbilt, is the "B" battery which tops them all. The ability of this battery to give you unrivaled service and economy is due to its unique internal design. Instead of the usual assembly of round cells, it is built of *flat* layers of current-producing materials pressed firmly together. This construction makes use of the spaces now wasted between the round-type cells and avoids the usual soldered wire connections. Eveready Layerbilt is every inch a

battery. This exclusive Eveready Battery development packs more active chemicals in a given space and enables them to produce more current and give longer life.

Tuesday night means Eveready Hour—
 9 P. M., Eastern Standard Time, through
 the following stations:

WEAF—New York	WTAM—Cleveland
WJAR—Providence	WWJ—Detroit
WEET—Boston	WGN—Chicago
WTAG—Worcester	WOC—Davenport
WFI—Philadelphia	WCCO { Minneapolis
WGR—Buffalo	{ St. Paul
WCAE—Pittsburgh	KSD—St. Louis
WSAI—Cincinnati	WRC—Washington

EVEREADY
Radio Batteries
—they last longer

This HEAVY-DUTY EVEREADY LAYERBILT BATTERY gives twice the service of the smaller Light-Duty batteries and greatly reduces your "B" battery operating cost.

Use Eveready Layerbilts on any set, and get not only this extra service, but also — the greatest "B" power operating economy—the utmost in "B" power dependability — D. C. (direct current) in its purest form, which is so necessary for pure tone quality.

Manufactured and guaranteed by
 NATIONAL CARBON CO., INC.
 New York San Francisco
 Canadian National Carbon Co., Limited
 Toronto, Ontario

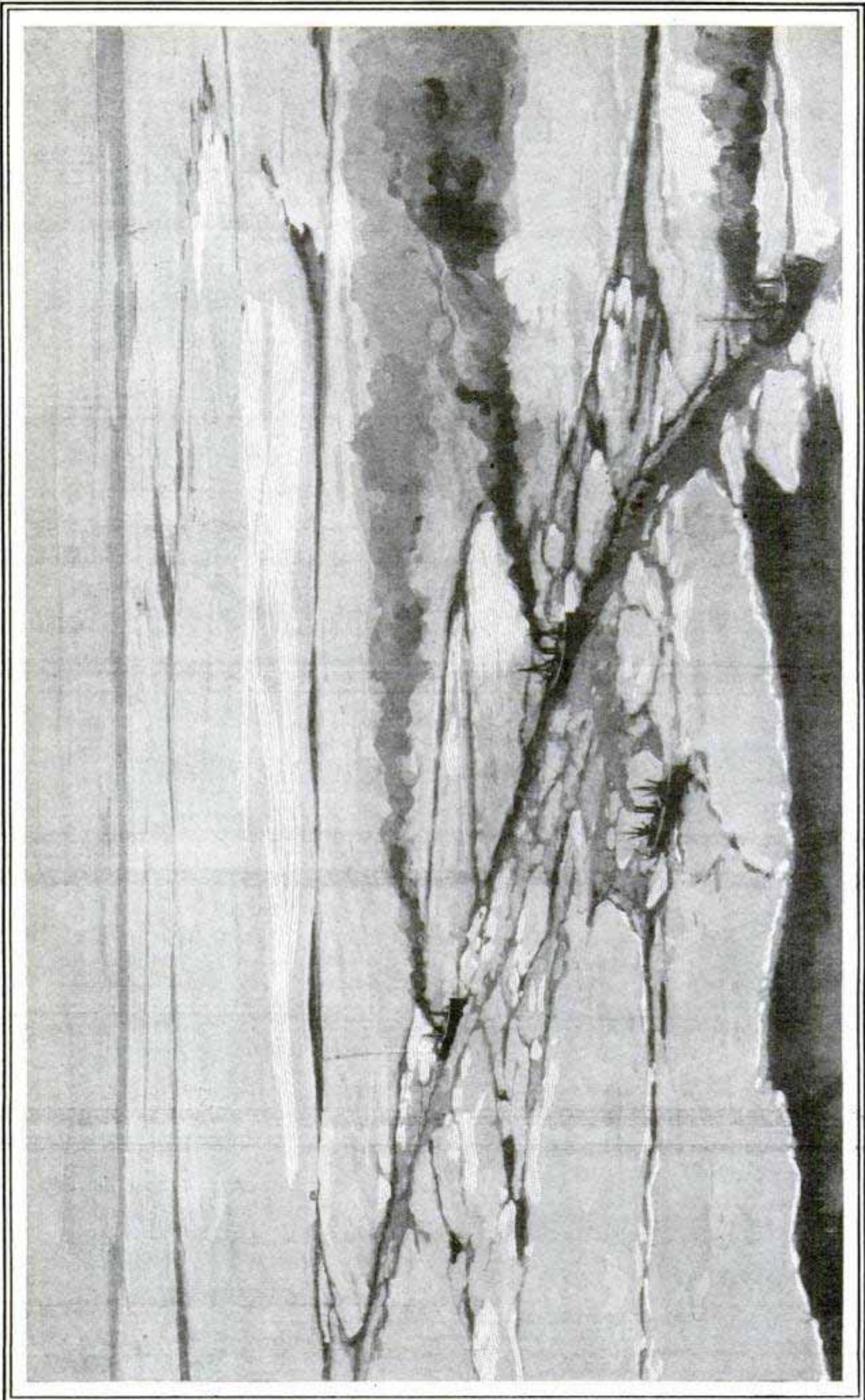

Fifteen Steamers Caught by Unseasonal Ice Floes in the Baltic Sea Were Saved When the Russian Ice Breaker, Shown in the Right Foreground, Cleared Lanes through Which They Reached Leningrad; Several German Ice Breakers Aided in the Rescue Work—See Page 984

Popular Mechanics Magazine

REGISTERED IN U. S. PATENT OFFICE

WRITTEN SO YOU CAN UNDERSTAND IT

Vol. 46

DECEMBER, 1926

No. 6

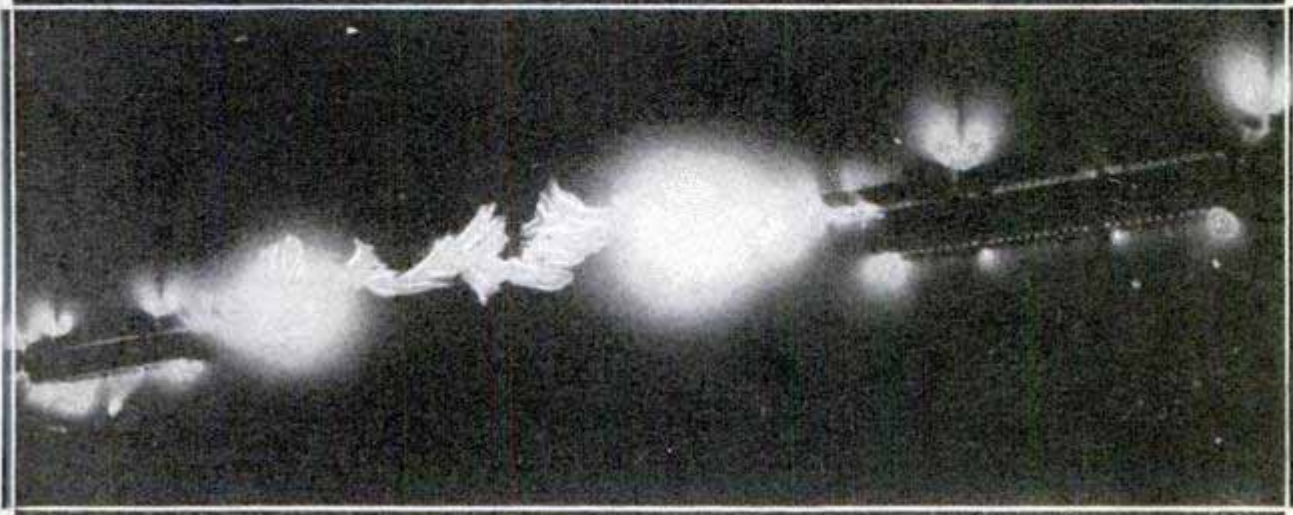

Writhing Ribbon of Living Flame, Twenty Feet in Length, Created When More Than Two Million Volts of Electricity Were Released in the Greatest Man-Made Lightning Flash

Man-Made Lightning Leaps Twenty-Foot Gap

Crash of Artificial Thunder Inaugurates Laboratory That Uses over Two Million Volts to Solve Power-Line Troubles

A DAZZLING flash of flame, twenty feet long, marked the opening of a high-voltage laboratory at Stanford University. Two million and a hundred thousand volts were condensed in the initial man-made lightning. The exhibition was the first test of apparatus with which Dr. Harris J. Ryan, in whose honor the laboratory has been named, expects to solve the pressing problems of long-distance, yet economical, transportation of electric power.

The development of the water-power resources of the Pacific coast, which embrace sixty per cent of all the available water power in the United States, has been handicapped by the fact that the falls where power is generated are mainly far back in the mountains, 200 miles or more from the cities where the power is needed. Electricity at moderate voltages cannot be sent over long distances without tremendous losses, due to the resistance of the power lines, while development of high-

tension lines has been hindered by the inability of engineers to control the current and prevent its breaking down the insulators used. The highest power handled so far has been 220,000 volts, over a line designed by Dr. Ryan.

In the new laboratory, he plans to study the action of high voltages and design insulators and equipment strong enough to carry the enormous pressures. The initial experiment showed that 2,100,000 volts would leap through twenty feet and one inch of air space, but if no grounded substance is within that distance of the high-tension line then the current cannot escape.

Six giant transformers, each of 350,000 volts' capacity, compose the main equipment of the Ryan laboratory, which is housed in a large building resembling the hangar of a dirigible. Painted a dead black in the interior, and with every crack sealed against light, it can be turned into a cavern of gloom, so that the investiga-

*Cont. L. S. Nichol, of Pacific Press⁸⁸¹
Mountain View, Calif.*

tors may observe the first faint hint of corona light around the insulators and watch it grow until the danger point is reached and the bolt leaps through space.

Outside, the university has set aside right of way for an experimental high-tension line that will be seven miles long when all sections are completed. Here the theories worked out in the laboratory will be put to actual test by sending the output of the six big transformers through special lines supported by insulators designed to meet the requirements shown in the laboratory tests. With twenty feet of clear space needed to keep the electricity from escaping, three doors, forty-seven feet high and forty feet wide, are provided in one side of the building, and when they are rolled back, the connecting wires to the high-tension line will run through the center of the openings.

In his opening-day demonstration Dr. Ryan performed two experiments to show the capacity of the laboratory to generate the greatest man-made lightning bolts ever attempted. In the first, two huge electrodes, six by eight feet in size, were suspended more than eighteen feet apart,

the massive doors closed, and the switch thrown that awakened the transformers to life. In a moment, a purplish haze began to glow about the corners of the electrodes as Dr. Ryan moved the control switch up to 500,000 volts. As he advanced it farther, darting tongues of flames began to appear. They twisted and writhed like fiery snakes, shooting here and there, feeling their way through the air in search of some path to the ground. The flames grew longer and longer as Dr. Ryan called out "a million volts." Above the huge electrodes, suspending them from the ceiling, mounted tier on tier of enormous insulators.

Up these the flames climbed, until it seemed they would reach the ceiling and escape. At two million volts the boldest tongues were almost to the rafters, and the hissing uproar was almost deafening. Then with a tremendous thunder clap the current jumped the gap in a blinding sheet.

The second experiment was made with brass rods as electrodes, each sharpened to a needle point. The points were placed just over twenty feet apart, and again the bolt leaped the gap.

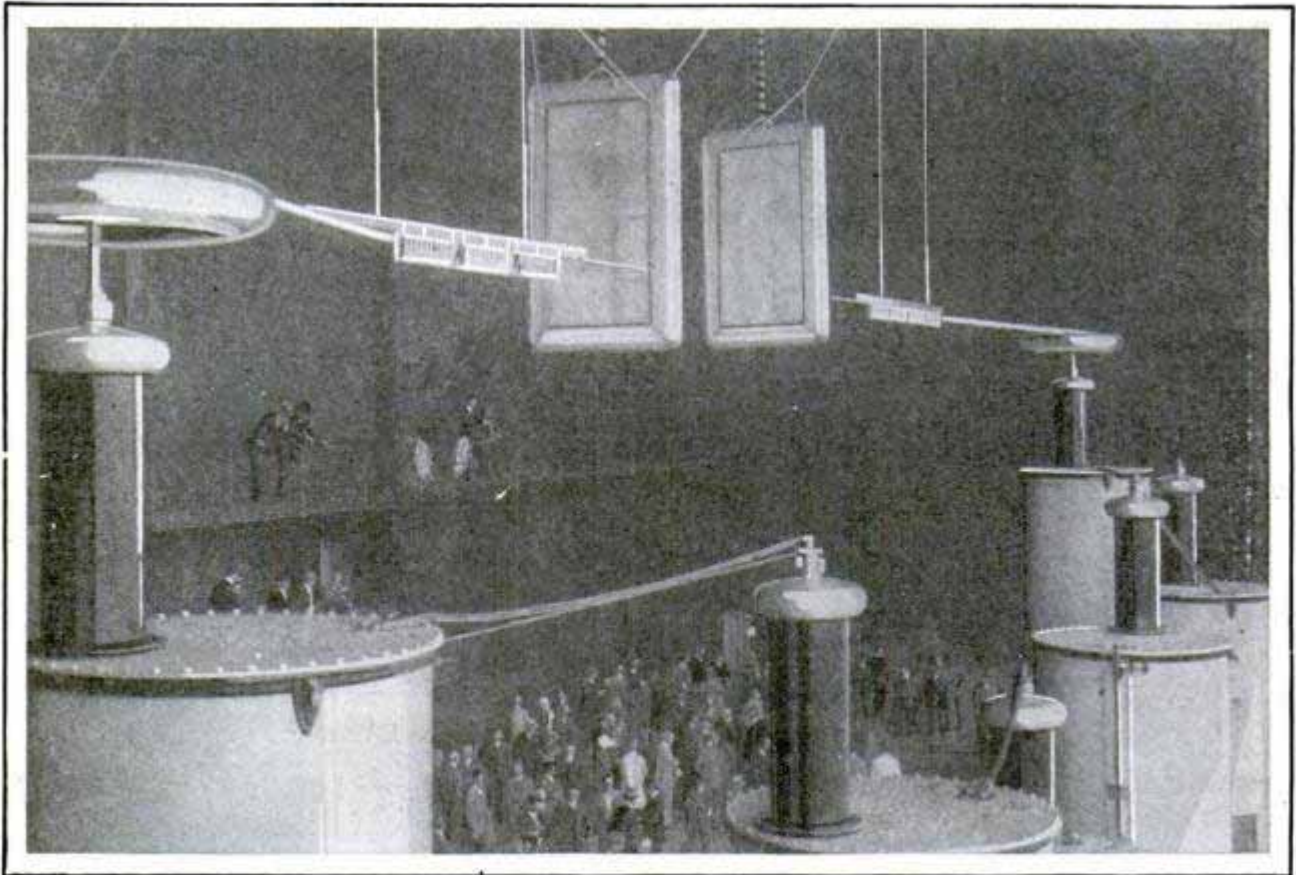

Tops of the Giant Transformers, and the Huge Plate Electrodes, Suspended Eighteen Feet Apart; Note the Comparative Size of the Spectators on the Balcony and Main Floor

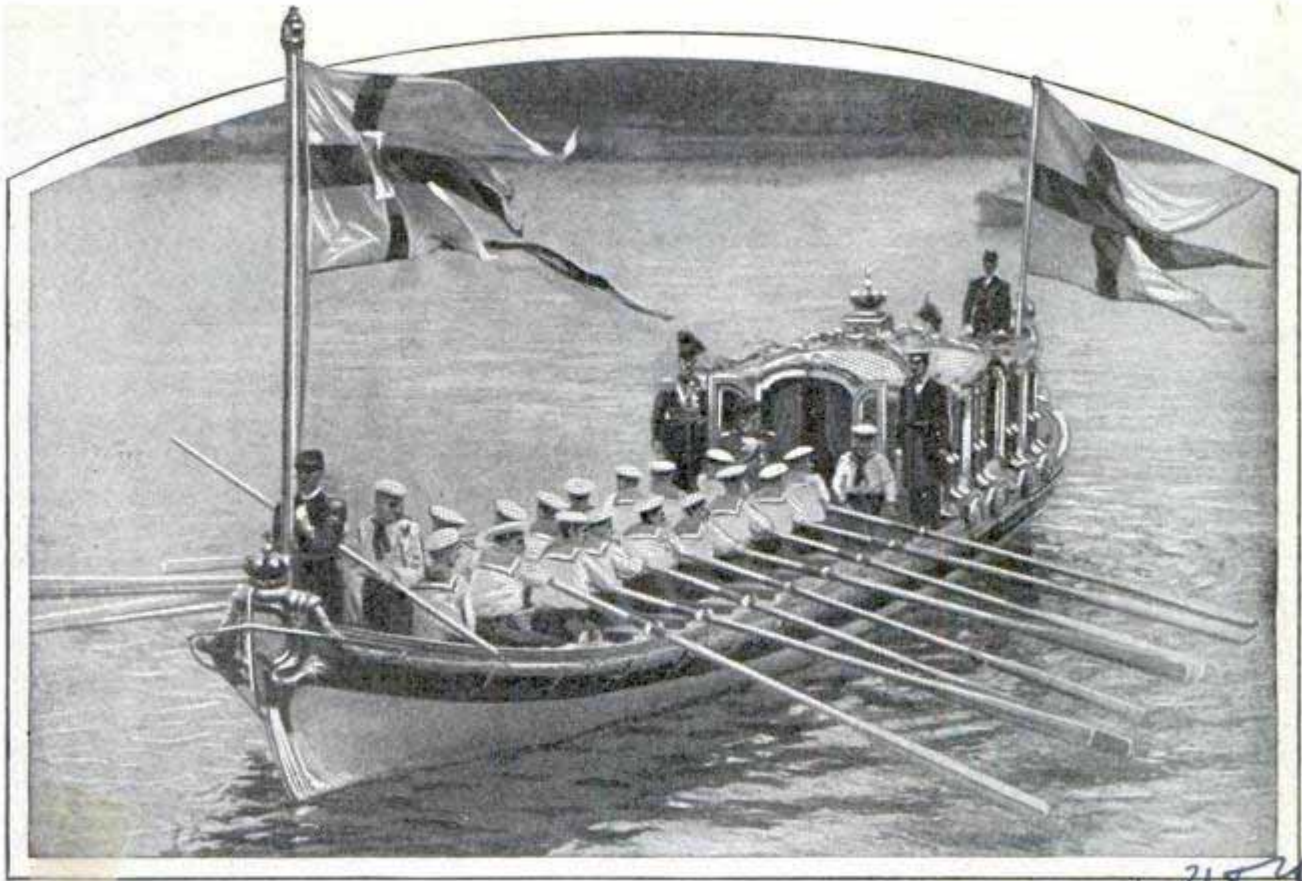

When the King of Sweden Goes Forth to Meet Royal Visitors Arriving by Steamer; Oar-Propelled Cutter and Its Picked Crew, Suggesting Galleys of Ancient Days

OARS PREFERRED TO MOTOR ON ROYAL CRAFT

This is truly the age of motors, but on several occasions when extreme dignity is to be observed, customs of the past are still followed. Horses draw the royal coach of England and, in Sweden, when the king goes forth to meet the visiting heads of foreign nations, he uses an oar-propelled cutter to reach the steamer. The boat has been elaborately redecorated and is fitted with a sheltered cabin impressively guarded by attendants. A picked crew of oarsmen is detailed to row.

PEAT FIBER USED FOR CARPETS AND WOOD SUBSTITUTE

555

Peat as fuel is widely used in many countries and often proves a reliable source of warmth during coal shortages, but recent experiments with the substance show that its serviceability is not limited to stoves. German investigators have found that its fibers can be dyed, bleached and woven into carpets, drapes and even clothing, while experiments at Hamburg and Dresden indicate that it may prove

an excellent substitute for wood. The peat is subjected to great pressure and, at the same time, combined with wax. The resulting material is said to resist water, fire and variations of temperature and costs about three-fourths as much as oak of commercial grades. It is so hard that it can be employed for paving material and for railroad ties. Peat filling for mattresses and cushions is also in demand.

METAL RULE FOR FITTING CORKS SAVES DRUGGIST TIME



To measure the mouths of bottles, a graduated metal rule quickly tells the size of the cork that will fit. Readings are plainly legible on the side of the gauge. The measure is tapered to fit bottles of many different capacities and is specially serviceable in drugstores and laboratories where corks are constantly used.

Chicago Evening Post
9/28/26

Scientific Equipment Co. 70 2nd St. New York.

527



© Herbert Photos

Demonstrating the "Seaplane" Dive; Cardboard Wings and Foot Supports Permit Graceful Soaring

SWIMMER DOES SEAPLANE DIVE WITH CARDBOARD WINGS

Contestants in a water carnival on the Isle of Jersey introduced a novelty in fancy diving last season by wearing cardboard wings on their arms, and "tail" and "landing-gear" equipment. The swimmers resembled seaplanes as they shot through the air and were able to make longer and more graceful flights with these appendages.

CLOTH FROM PINEAPPLE

A durable fabric that takes dyes well and is said to resist wear almost as staunchly as leather, is being manufactured from the fibers of pineapple leaves in the Philippines, through-

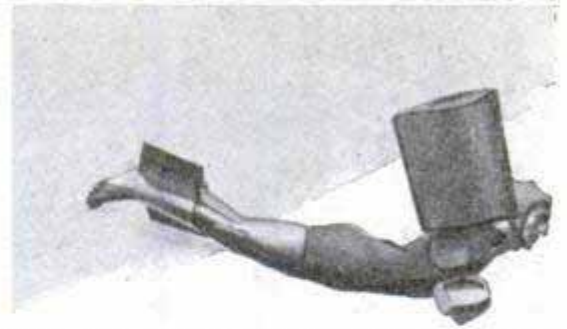

out the Indian archipelago and in parts of China. The "pina" cloth, as it is called, is attracting attention in the textile world as it is not difficult to prepare and its qualities commend it to wider usage. The fleshlike tissues are stripped from the leaves and when the fibers have been removed, they are soaked, washed and bleached several times, before going to the weaver.

RED OR WHITE COOLEST COLOR FOR HOT CLIMATES

Red is a satisfactory color for clothing in hot weather as it absorbs less of the sun's rays than other shades. Black is the worst and white ranks close to red. Fabrics that reflect light are preferable to those that absorb it. Artificial silk is an excellent material, although it is said not to exclude the rays that tan the skin. Dark clothing is warmer, hence to be preferred in winter, and undergarments that fit snugly but not too tight help keep the body warm if made of the right materials.

answers 9/18/26

REFLECTED LIGHT FOR SHAVING SHIELDED FROM EYES



Light from Mirror Shines Upward on Face, Keeping the Glare from Eyes

Fashioned as part of a shaving mirror for the wall or chiffonier, an electric light is so adjusted that the illumination is thrown upwardly on the face but cannot strike the eyes directly. This not only protects the vision but lights the face so plainly that thorough work with the razor is easier.

*Metrophoton Electric
Mfg. Co. 10 outward
- 17th St. Lins & Lane*

Emb. N. Sournesey, Thunderley Green, England.

54

SUN-MADE TARGETS TEST SKILL OF PLANE GUNNERS



A DOG-FIGHT WITH "SHADOW PLANES"

Shooting at Shadows, Thrilling Target Practice for an English Aviator on a Sunny Day; Fire from the Lower Plane Is Directed on the Shadow Cast on Water from Ship Above; Hits Registered by spurts of Foam Are Seen by Observer

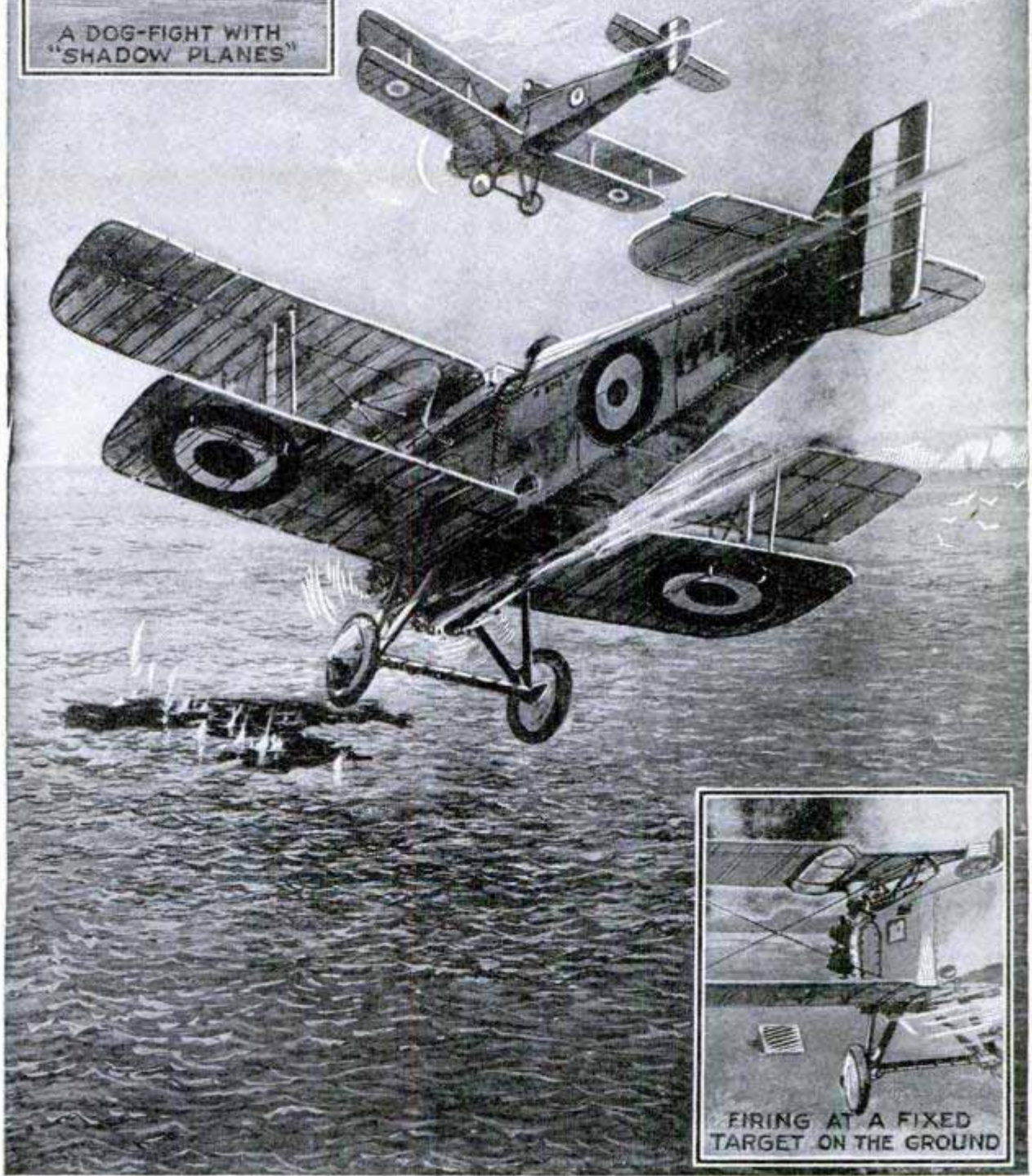

FIRING AT A FIXED TARGET ON THE GROUND

5/18

30 E 42nd St.

New York

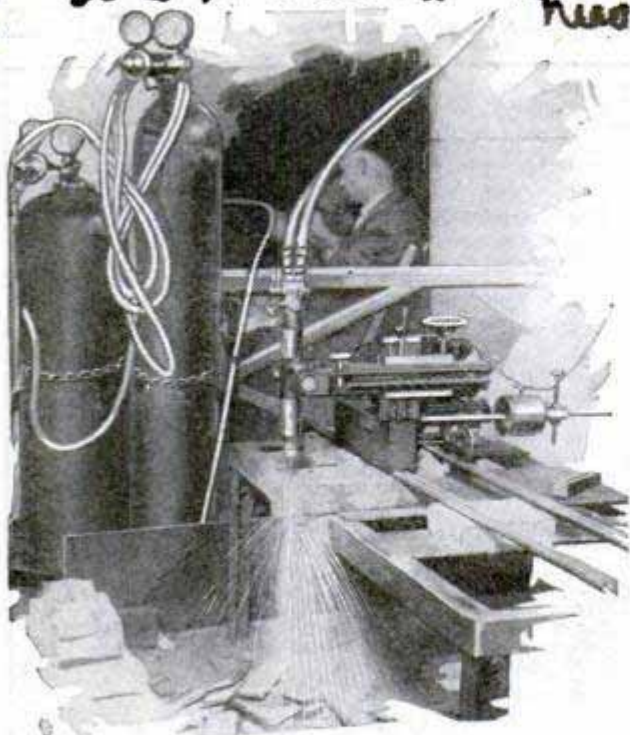

Hot Flame Cutting Thick Steel; Motor-Driven Carriage Propels the Block of Metal

STEEL-CUTTING FLAME IS RUN BY ELECTRIC MOTOR

Propelled by a small electric motor, a steel cutter using an oxyacetylene-torch flame makes successive slices without the need of a workman to guide the instrument. It is said to penetrate steels of great thickness and to reduce hazards.

EYE TROUBLES DUE TO POOR LIGHTING

Poor lighting is largely responsible for the fact that seventy per cent of the eyes of adults have one or more defects, according to Matthew Luckiesh, an authority on illumination. Near-sightedness, eye strain and nervous disorders are among the ill effects of inadequately lighted homes, offices and factories, he points out, and declares that, in addition to insufficient artificial light and restricted sunshine, too heavy demands placed upon the vision by excessive reading, writing and other tasks, are the cause of eye

Cleveland, Ohio. President. Illuminating Eng Society 5-26

afflictions in many persons. He asserts that twenty-three per cent of the electric filament lamps in use have no shades, fifty per cent of shades employed do not properly shield the eyes or diffuse the light, and that many of the ceiling fixtures are obsolete, while many sockets should contain lamps of higher wattage. He recommends that the number of service outlets from the lighting circuits should be trebled and the total wattage in the average American home at least doubled.

496

FLINTLOCK FIRED AT GUN MEET IN HONOR OF DANIEL BOONE

One of the features of the interstate rifle and pistol matches at Sea Girt, N. J., is target practice with weapons of former days at a range of fifty yards. This event is known as the Daniel Boone match and gives modern marksmen a chance to demonstrate their skill, and hardihood as well, for some of the pieces have a terrific kick. An old flintlock gun such as was used by the pioneers was fired by David McDougal, fifteen-year-old son of Lieut. Col. Douglas C. McDougal of the Marine corps. He was the youngest entrant in this match.



Maj. Gen. John A. Lejeune, at Left, and Lieut. Col. McDougal Watch Young McDougal Fire Old Flintlock

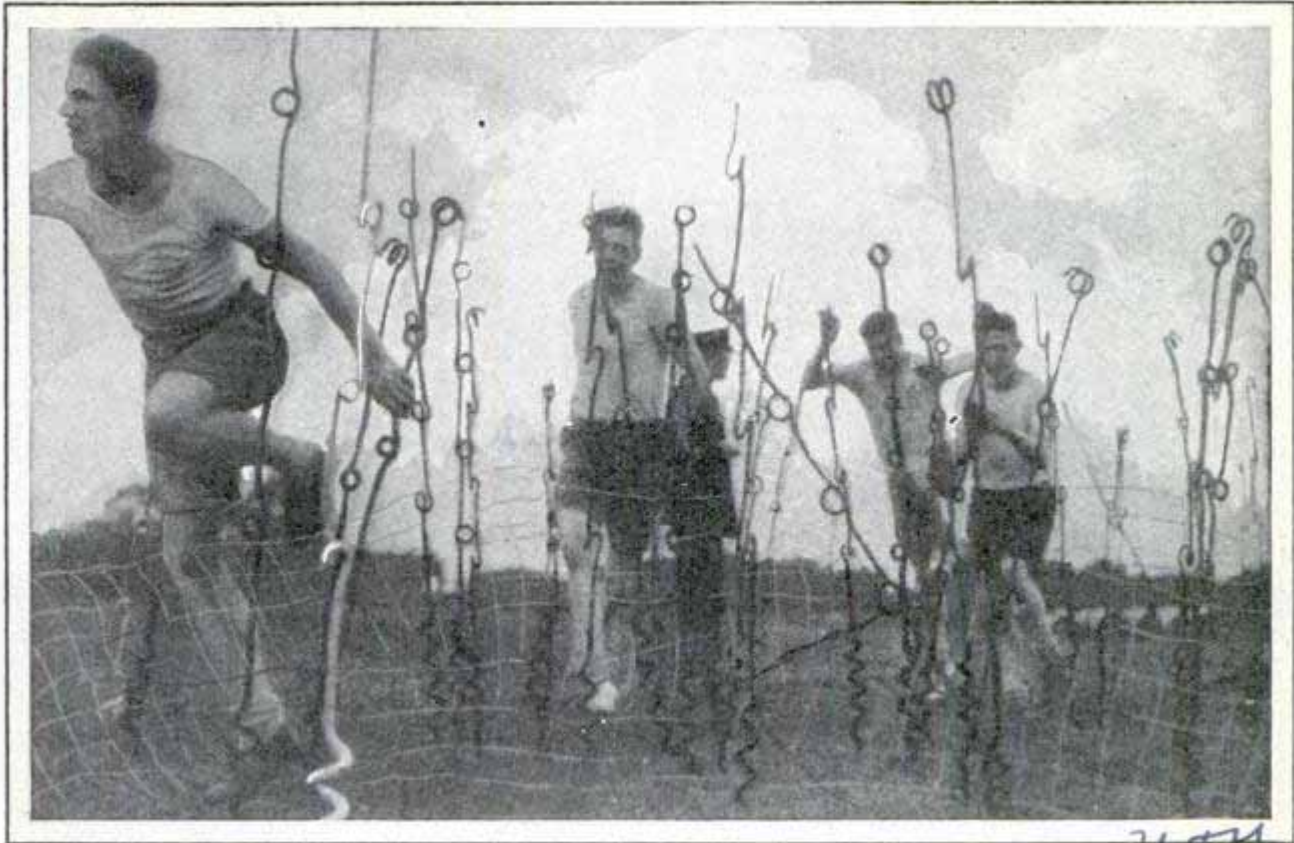

Suggesting the Perils of Going through "No Man's Land" in Wartime; Runners Breaking Past a Network of Wire Barriers in Quebec Obstacle Race

RACE THROUGH WIRE BARRIERS TAXES RUNNERS' SKILL

Tangles of wire netting and upright barriers of metal were placed on a race course in Quebec to test the runners' ability to pass through obstacles. The obstructions were woven in such a way that they did not injure the participants. Watchers were on hand to see that the runners did not attempt to evade them by departing from the course.

RADIO TEST OF AUTO FINISH REVEALS FLAWS

Elementary principles of radio amplification are being used in an automobile factory to inspect surface finishes. Light is directed on the area to be examined and the intensity of that which is reflected is determined as it strikes a photoelectric cell. An amplifier and measuring instruments enable the examiners to tell accurately the degree of polish on the surface. An advantage of this process is that it removes much guesswork and eliminates errors that often are made when reliance is placed wholly on a workman's judgment. In order to find cracks

in ground surfaces, too small to be seen even with a microscope, the parts are magnetized and immersed in a solution of kerosene oil having suspended in it very fine iron dust. A magnetic field surrounds the crack and the particles adhere in a peculiar way on a hardened surface which has such a defect.

POLISHED COVER ON STEEL NUT KEEPS OUT RUST

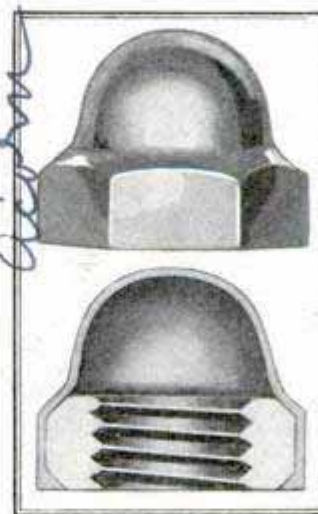

Steel hexagonal nuts, with a covering of brass, copper, nickel, silver or other metals, are shielded from rust and present an attractive appearance on outside work. The nut is tapped all the way through and inspected before the covering is put on.

Colombia supplies about one-half of the world's platinum.

Described by C. S. D. work at meeting of Society Automotive Engineers

Cleveland Ohio.

The Henry Corp. 2151 Stanton Road.

Packard Motor Car Detroit Mich.

15 N. Jefferson Chicago

512

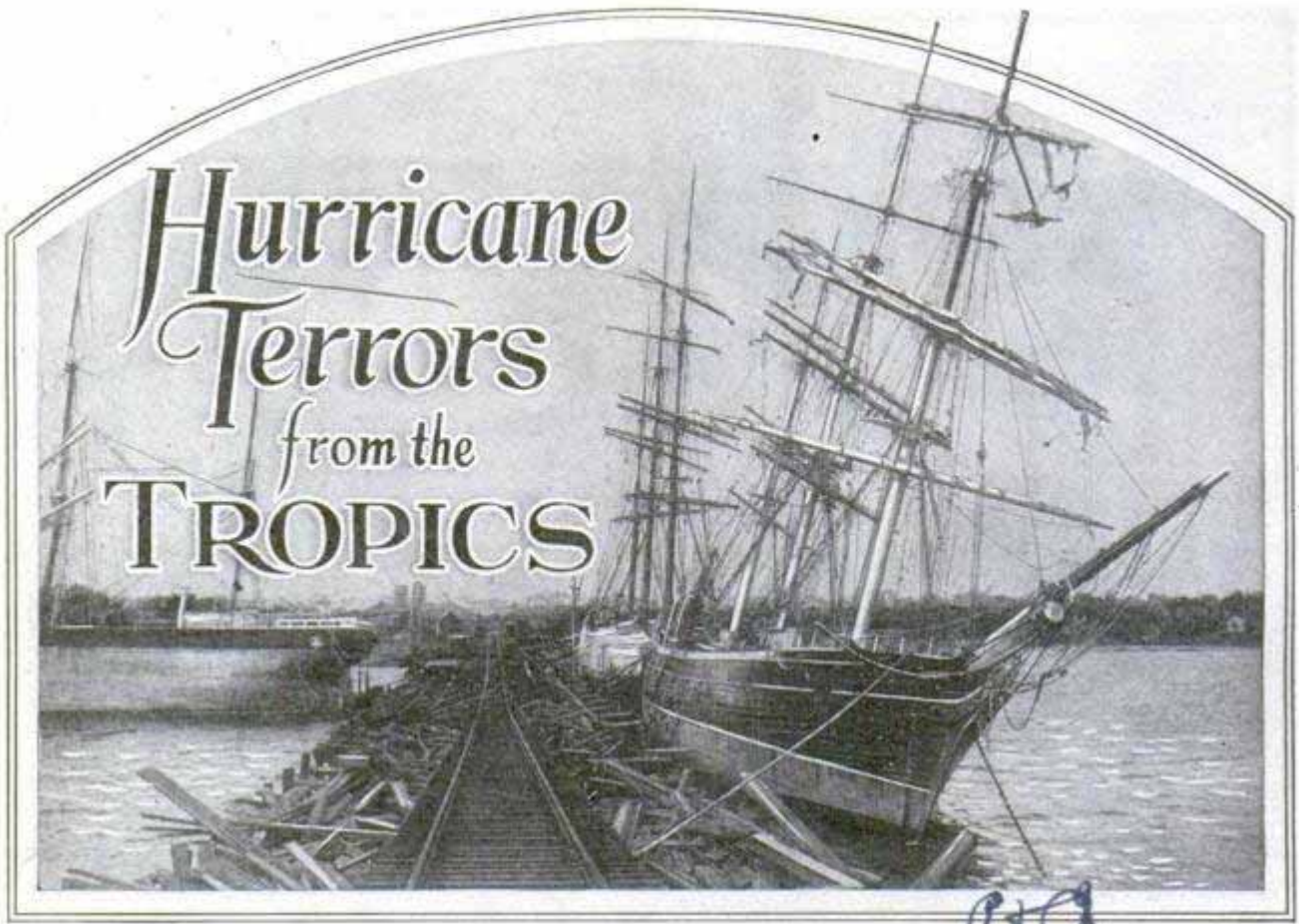

Handwritten initials: P.H.A.

Cyclones of the Sea That Occasionally Sweep Inland and Take a Terrific Toll in Southern States Are All Born near Equator

A TERRIFIC gale blew out of the sea all night long, rain fell in solid walls and giant waves washed ships high and dry on the land, eyewitnesses said in describing the recent Florida hurricane. Then, at dawn, the gale suddenly ceased and householders, in bathing suits, waded out to inspect the damage, thinking all danger was over. But within an hour the gale sprang up again, this time blowing in the opposite direction!

The terror-stricken survivors did not realize it, but they had just lived through the passage of the central vortex of the worst terror of the seas, a tropical hurricane. During that hour of deceptive calm they were in the exact center of a vast bowl of raging winds, a bowl that probably measured between 200 and 300 miles across, with winds whirling round its rim in a counterclockwise direction at a speed ranging from sixty miles or so an hour near the edge to 100 to 120 miles an hour near the center.

This bowl, moving slowly toward the northwest, was advancing at a speed of

between fifteen and twenty miles an hour, and since the calm of the vortex lasted just about an hour at Miami, it follows that the vortex was some fifteen to twenty miles across. Because the storm approached from the southeast, Miami and southern Florida first felt its northern side, and, since hurricanes in the northern hemisphere always revolve in a counterclockwise direction, the gale blew in from the sea. Then came the center of the storm, with its hour of calm, and again the stricken district was plunged into the gale, but this time the southern side was passing over, so the wind came out of the west.

Some five or six days before the storm, a true cyclone had been born far out at sea, southeast of Porto Rico, probably halfway to the African coast, and in that region that mariners call the doldrums, a belt of calms which stretches for ten to twelve degrees north from the equator. It probably was born somewhere between nine and thirteen degrees north latitude, for, in forty years of observation, a hur-

Below, Street in Miami after the Recent Hurricane; at Right Is a Jumble of Wrecked Houses Ruined in a Galveston Storm



Below, Map Compiled from Weather-Bureau Charts for the Miami Hurricane Period, Showing Location of Storm Center at 8:00 A.M., from the Day Before It Struck Miami Until It Finally Blew Itself Out North of New Orleans; Note How It Slowed Down Until Three Days' Storm Zones Finally Overlapped at Mobile and Pensacola

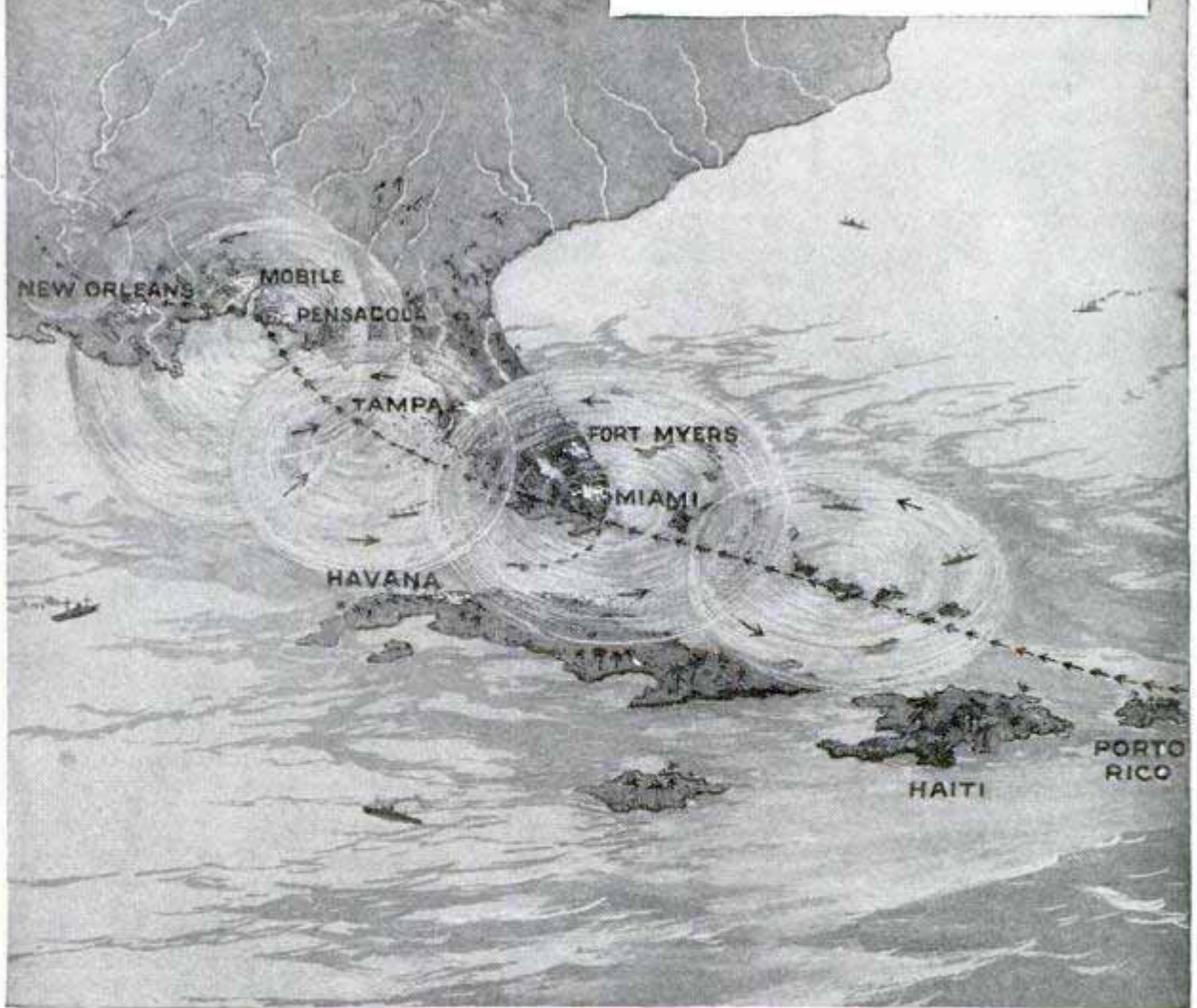



© International Newsreel Corp.
 Wreckage Left by the Storm at Dania, Florida, One of the Many Small Towns That Suffered Severe Loss

swept up the sea lanes, taking a heavy toll of shipping, as November hurricanes always do, but missing the land. It might have followed the coast, as often happens, as far north as the vicinity of Boston, and then swept across the Atlantic.

Few people realize the exactitude with which such storms can be plotted, their course foretold, and warnings issued. The weather bureau had this one marked down two or three days before it struck Florida, figured where it would strike, and issued storm warnings. While a hurricane is rivaled only by a tornado in its force and the

ricane has never formed closer to the equator, because the deflective force of the earth's rotation cannot originate a wind vortex at or near the equator.

North of the new-born storm lay a vast island of heavy air, stretching from the region of the Azores west and south over the sea and over the eastern states, reaching as far south as northern Florida. This high-pressure area is found over the north Atlantic each summer, sometimes falling short of the American coast and sometimes reaching far inland. The cyclones of the tropics cannot break through it, and, since the area moves too slowly to pass in front of them, the hurricanes always sweep northwestward until they can round the heavy air, when they turn northeastward again and continue on their way, often as far as Iceland.

This time—and it proved fatal to hundreds of people and millions of dollars' worth of property—the high-pressure island reached so far inland that the cyclone was driven westward across Florida, over the eastern arm of the Gulf of Mexico, and across southern Alabama, until it finally blew itself out somewhere north of New Orleans. Had the area been smaller, as it will be in late October and November, the storm would have swung northeast before reaching the coast and

damage it can do, its actual forward movement is quite slow, only fifteen or twenty miles an hour, as a rule, so that frequently several days will elapse between the first warning and its arrival at a point where it can do great harm.

Two things are necessary to start a tropical cyclone on its way. One is high temperature and the other high humidity, both common in the doldrums. Into the area of expanded, low-pressure air, the winds begin to rush, and then the earth's rotation starts them swirling about a rapidly forming vortex. They swirl faster and faster, and drag more and more air into the motion. Stick your finger into a basin of water and twirl it round and round to form a miniature whirlpool. As the speed increases the whirling water overcomes more and more of the inertia of the water outside itself, until soon you will have the whole basinful swirling around. That is just what happens when a cyclone is born.

The first half of September is the worst period of the year for tropical hurricanes, and the first half of October second. For some strange reason there is a lull during the latter fifteen days of September. Charles L. Mitchell, a weather bureau scientist, who has tabulated and plotted the paths of every hurricane reported

Center and Lower Pictures
© P & A; Insert © Pathe



Tall Steel Buildings Resisted the Wind, But Small Boats Were Landed High and Dry in a Miami Park

Top, U. S. Sub-Chaser Driven Ashore by Wind and High Waves, Left on Beach When Sea Receded



Part of Miami's Water-Front Wreckage, with Two Fine Yachts Piled Up against the Bow of a Big Freighter

from 1887, when daily weather maps of the North Atlantic first appeared, down to the end of 1924, discovered there were 239 such tropical storms in those thirty-seven years, and that 149, or sixty-two per cent of them, occurred during the two months of September and October, while seventy-eight per cent were catalogued in the three-month period including August. Not all of these, by any means, reached hurricane strength of sixty miles an hour or more. In fact, the chances are only six to nine that a September tropical cyclone will attain hurricane strength, while in November, when the last of them occur each year, the chances are only one in nine.

They are always accompanied, however, by storm tides, which far outrun the slow-moving storm and tell, sometimes many hours in advance, just where the storm will strike, and by their size give a clew as to its intensity. I. M. Cline, who made an exhaustive survey of tropical storm tides for the weather bureau several years ago, reported that the waves and swells of the greatest strength originated in the rear right-hand sector of the storm and advanced through the smaller waves in front of it, racing ahead in the same di-

rection in which the storm was traveling at the time they started. Because of the tremendous wind velocity where they originated, the waves frequently attain a speed of forty-five miles an hour.

He found also that waves from a hurricane that struck Texas in September, 1919, traveled 800 miles in between fifteen and twenty hours, and arrived well in advance of the storm. The highest water is always a few miles to the right of the point where the center of the hurricane will pass, and high water often extends for 100 to 200 miles to the right of the vortex, while it will be felt for only a few miles to the left.

The paths of the storms are always controlled by the high-pressure area which they are trying to pass, and as this sometimes shifts they often follow strange and erratic courses, occasionally even performing a loop and going back over ground they have already covered. When that happens, though, the loop is always to the left. Most of those charted since 1887 have followed roughly a great horse-shoe-shaped course, starting east of South America, coming up toward southern United States, then swinging back north-eastward to Iceland and Scotland.

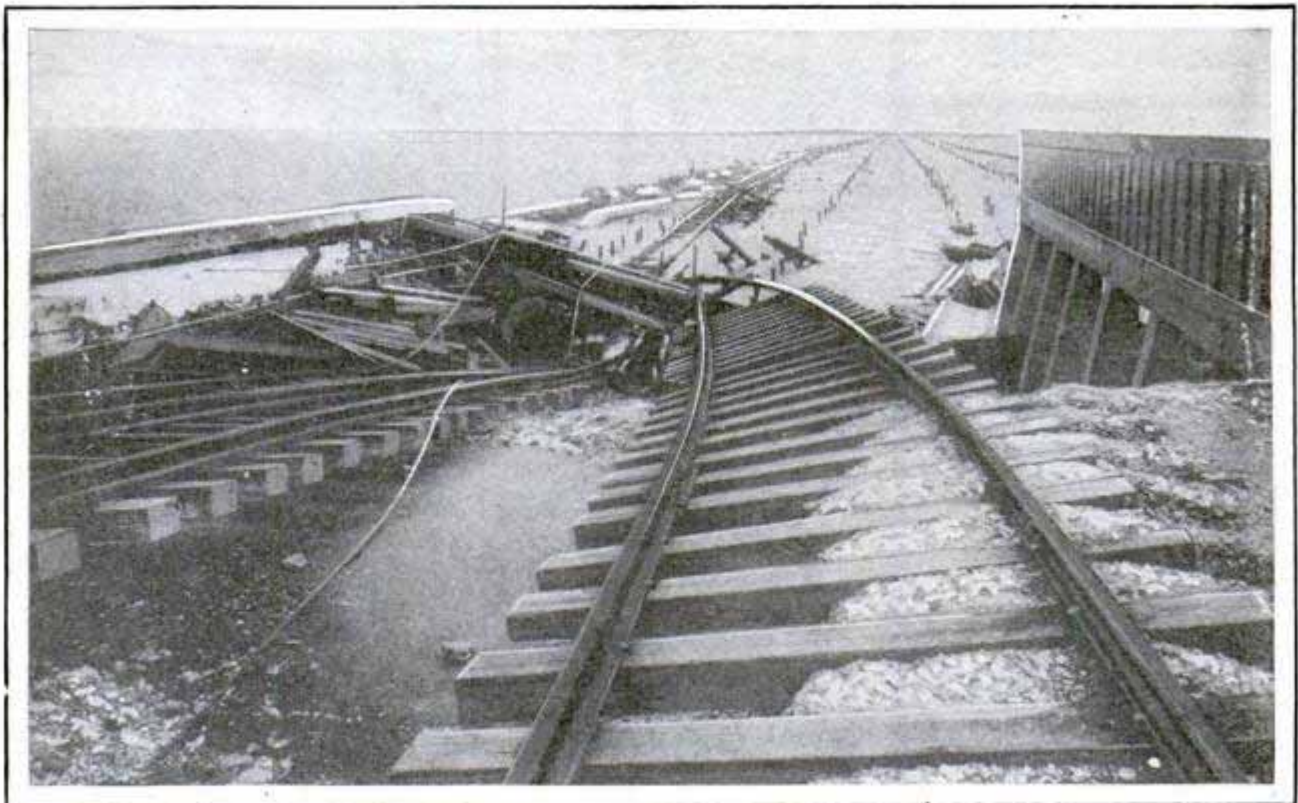

Wreckage of the Causeway Connecting Galveston, Texas, with the Mainland Following the Hurricane of 1915, the Second Disastrous Gulf Storm to Strike This Point

CHIN AS INDEX TO CHARACTER

Mullbourne

Receding chins are commonly believed to indicate lack of will power; square, protruding ones, strength and determination, and those with dimples, an attractive personality. But in the opinion of Dr. W. Stanley Wilkinson, an Australian dentist, and other investigators, character is not revealed by the shape of the chin. Its contour rather expresses a much simpler matter, it is believed—whether or not the owner sucked his thumb to excess during the first six months of life. Dr. Wilkinson holds that the round chin is the result of the stunting effect produced on the growth of the lower jaw by thumb sucking. When the habit is not practiced, the jaw normally tends to assume a well developed forward tendency.

SMALL RACING AUTOS TO RUN ON NORWEGIAN RAILROADS

473

Gasoline-burning units are being used on several railways to supplement steam trains and now a Norwegian line has ordered a large number of racing cars of English make for service on its rails. The wheels are flanged, a broad windshield protects the occupants and a single headlamp, in front, promotes safety at night. In the event that steam power becomes impractical, railroad tracks will be utilized for motors, it is predicted. A road already has been constructed upon the right of way of an abandoned railway in Colorado.

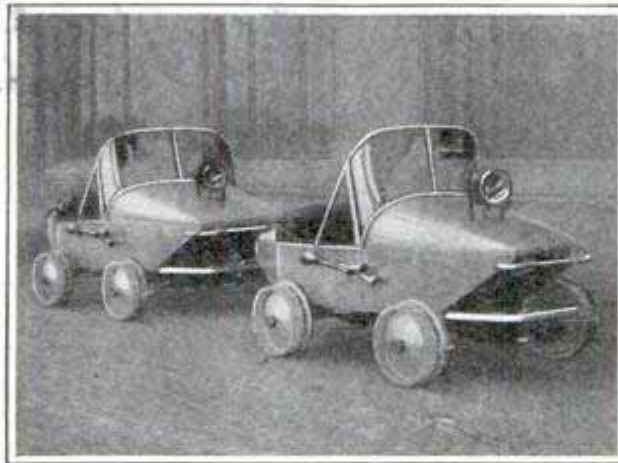

Racing Autos Built for Norwegian Railroad, to Supplement Steam Traffic

Douglas motors

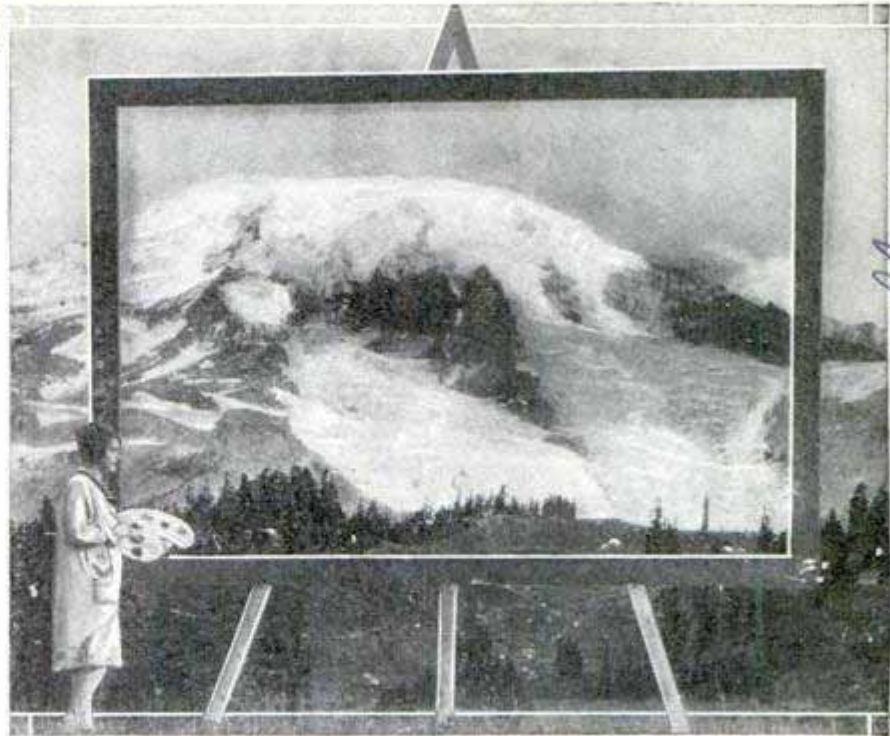

Mt. Rainier as It Appears behind Open Frame, as if Transferred to Canvas by a Skilled Artist

Edith's Beachburg & Co. 25 Broadway New York

RAINIER SEEN THROUGH FRAME RESEMBLES PAINTING

Beauties of majestic Mt. Rainier were emphasized by the simple device of placing a large frame by a roadside several miles from the peak, producing the effect of a painting. The illusion was further carried out by the presence of a young woman with palette and brushes.

mis Broadway New York

BULLET CLEANS RIFLE BARREL AND PREVENTS RUST

Cleaning rifle barrels after firing is said to be unnecessary if cartridges containing a special, lately introduced priming mixture are used. The substance is said to make the inside of the barrel proof against rust, stain and corrosion. Millions of .22-caliber cartridges were fired to test the mixture and none of the rifle barrels showed any signs of rusting or pitting, it is said.

Keenore

Remington Arms Co. 25 Broadway New York

209 S State St Chicago

*Horological Institute
Washington, D.C.*

285

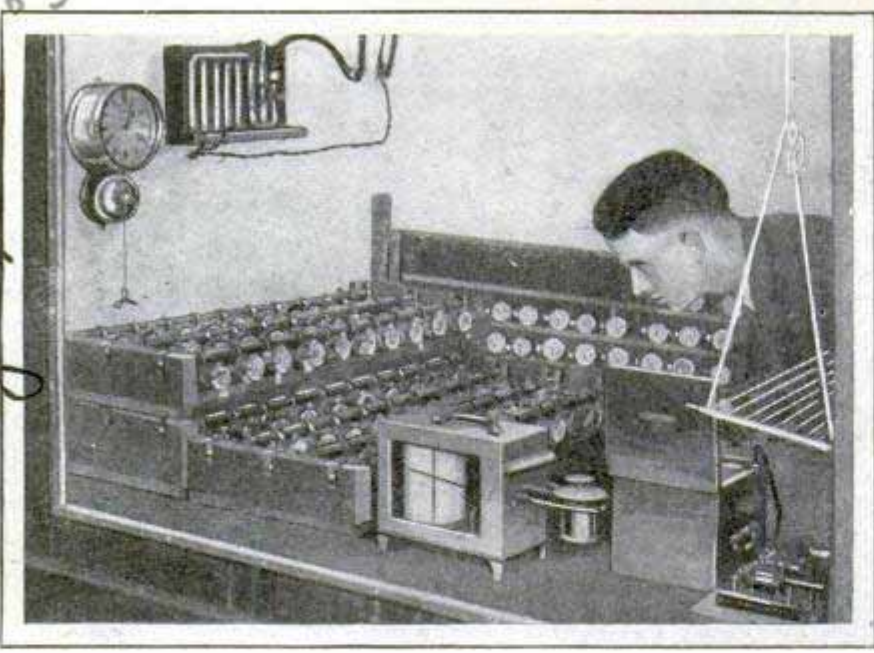

Watches under Test at Bureau of Standards after Being Repaired by Candidates for Certificates as Experts with Timepieces

TEST WATCHES NINETEEN DAYS TO PROVE REPAIRERS' SKILL

Watches which have been repaired and adjusted by candidates for certificates as experts with timepieces are subjected to rigorous tests at the bureau of standards. For nineteen days they are put through a variety of examinations while any discrepancies in time recorded are noted. The ordeal involves numerous changes of position, subjection to heat and cold and other severe trials.

LOCOMOTIVE RUN BY TURBINE DEVELOPS HIGH SPEED

Calculated to haul heavy trains for long distances at more than seventy-four miles an hour, an express turbine locomotive

has been built for the German state railways. Economy of fuel at high speeds, keeping oil from exhaust steam, so that the life of the engine will not be so greatly impaired in reusing water by condensation, and simplicity of operation are claimed for it. A feature of the locomotive is that the tender, besides carrying coal and a store of water to make up for losses by evaporation, is also a cooler to reduce the heat of the water, which is used again in the condensers. The liquid flows through a flexible tube below the engineer's cab into a system of distributing pipes on the roof where it goes to a large number of vertical copper sheets. As it trickles down these, it comes in contact with cool air currents.

AUTO OILER WITH SIGNAL LIGHT LENGTHENS MOTOR'S LIFE

When the oil supply gets too low, a red light flashes on the instrument board in an automatic lubricating system devised for a popular make of small cars. It is so arranged that the oil is kept midway between the upper and lower petcocks, the level found to give the best results. The system is said to insure proper circulation of oil in the crankcase, thus prolonging the life of the motor, and to eliminate smoke from the exhaust.

2034

*Lawrenceville, Ky.
Main St.
W. main
1034 W. main
Co. d me, 1034 W. main
812.00*

*See Ready Automate
no Chicago dealer*

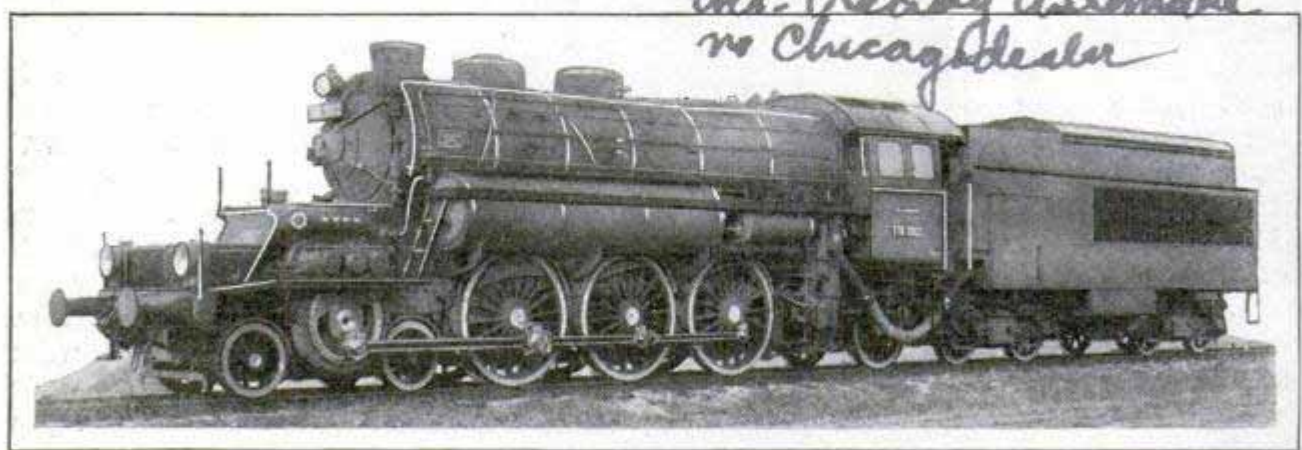

Turbine Locomotive for German Railway to Haul Long Trains at High Speed; the Tender Has Cooling Apparatus Indicated at Side to Reduce Temperature of Condensing Water

*Designed by... in Munich
Germany*

LESSONS BY RADIO TO PUPILS IN FIVE STATES

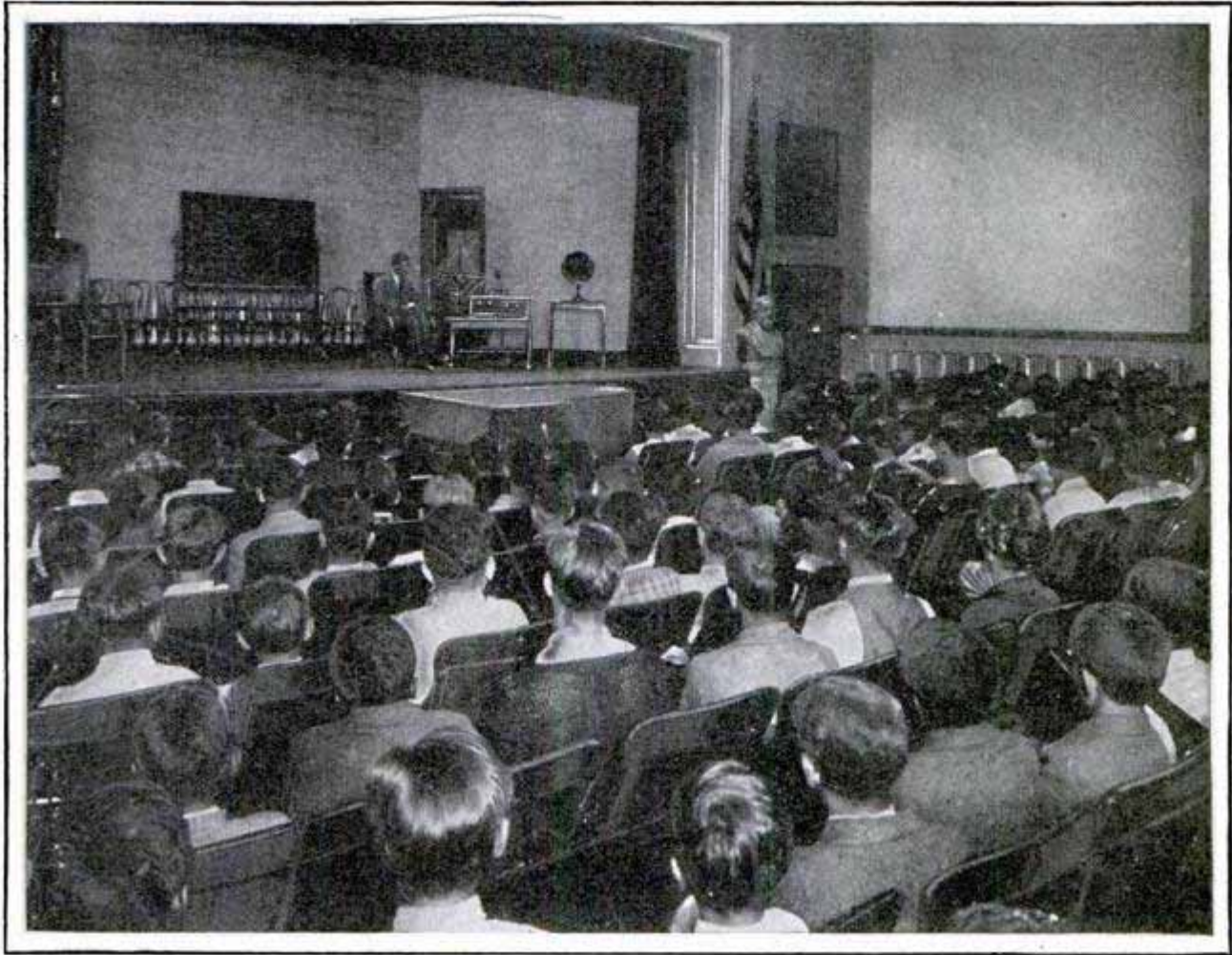

Some of the Thousands of Pupils Who Listened to Distant Teacher by Radio; Scene as One of Twenty Lessons Was Being Broadcast from Station WTIC

Travelers station

More than a quarter of a million pupils in schools of Vermont, New Hampshire, Connecticut, Massachusetts and Maine listened to the same teacher during a series of lessons broadcast by radio from station WTIC at Hartford, Conn. The "course" included twenty lectures and, to save time in announcing, the program for each was written on a blackboard.

"FISH ENOUGH FOR ALL WORLD" IN CANADIAN LAKES 493

Lakes in the barren lands of Canada's northwest territory hold "enough fish to supply the needs of the world for the next fifteen years," according to Pilot C. S. Caldwell, who spent four months in the region with a party of government engineers prospecting for minerals. The expedition flew to the lands between Great Slave lake and Bathurst inlet in a flying boat, said to be the first that ever

has visited that part of the country. The ship traveled between 6,000 and 7,000 miles. The prospectors were left to return by river and rail.

EXPOSURE METER FOR PHOTOS OPERATES IN ANY LIGHT

Correct time for exposures with any type of camera is said to be accurately registered on a novel meter. It is held to the eye and, when the right exposure is indicated, a small collar arrangement is turned, registering the adjustments to make in the camera gauges.

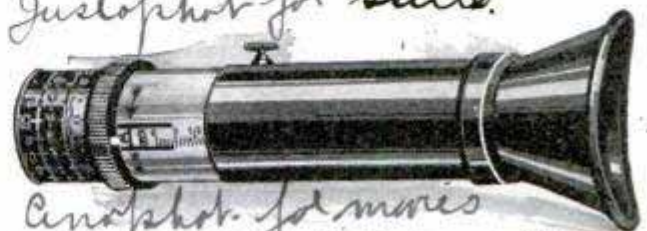

Photo-Exposure Meter with Eyepiece at Right and Turning Gauge at the Other End

Baso Camera Co, 109 N. Dearborn Chicago

arsenal school at Hartford
Mr. Irem Product Corp. 152 W. 42nd St. New York

average year

487

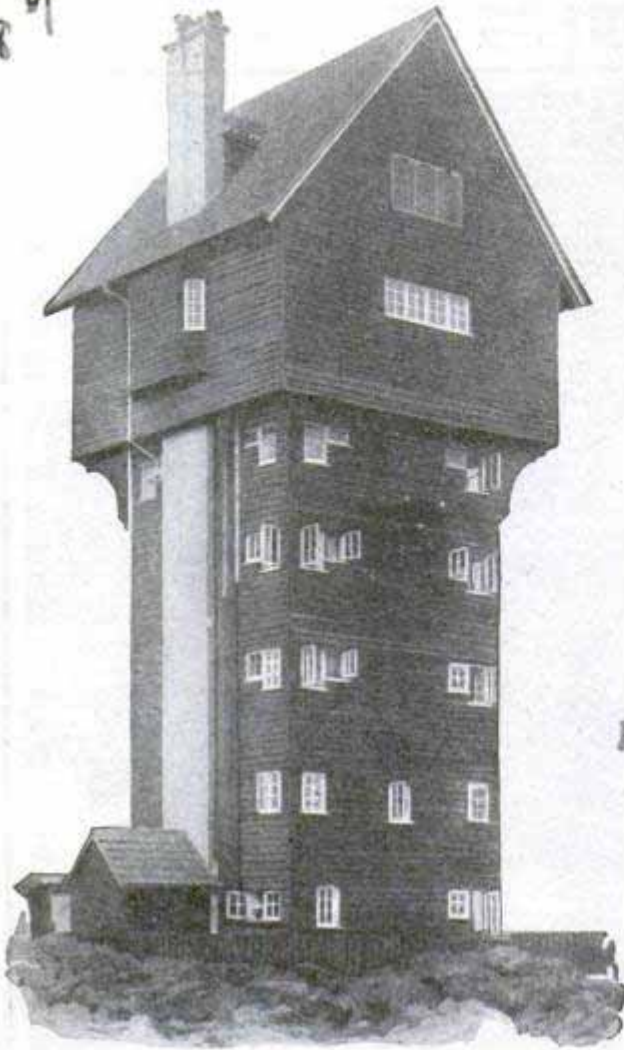

Bungalow Apartments on English Coast in Transformed Windmill Tower and Water Tank

OLD WINDMILL TOWER REMADE INTO SKYSCRAPER BUNGALOW

No longer serviceable as a windmill support, an old tower and water tank on the Suffolk coast, Eng., were remodeled into a series of bungalow apartments. The upper rooms were considered especially desirable, as they afforded a wide view.

EIGHTY-THREE DIE IN AIR ACCIDENTS THE PAST YEAR

Poor planes, lack of training on the part of the pilots and stunt flying were responsible for about seventy per cent of the aviation accidents that occurred in the

United States in 1925, according to a survey by the Aeronautical Chamber of Commerce of America. There were 112 mishaps. Eighty-three persons were killed and 112 injured. Errors in piloting caused thirty-four of the accidents; lack of landing field facilities, eight; faulty craft, eighteen; stunting, twenty-five; carelessness, six, and unknown causes, twenty-one. Significance is attached to the fact that not a single accident was attributable to lack of weather data. The report states that a majority of the small operators of planes at this time own war-time material, and it is suggested that a strict inspection would result in the discarding of much of the apparatus.

SHOES MEAN LIFE OR DEATH TO MOUNTAIN CLIMBERS

482

Being well shod is one of the most important factors in climbing mountains, and frequently the wearer's life depends upon the sharpness of the cleats in the soles and the strength of the entire foot support. Fully as important to the careful mountaineer is the fit of the shoes. Foot examinations, following the draft for the World war, showed that proportionately more men in the mountain regions of the west were disqualified on account of pedal ailments than in other sections of the country. This was partly explained on the ground that a combination of rough territory and ill-fitting shoes is doubly injurious to the feet.

at Thorpe



Heavy Hobnailed Shoes of Different Types, but All Intended for the Same Purpose, Safety in Climbing Mountains

509

International



Ready for a Ski Slide in Motorcycle's Wake, a Popular Winter Sport in Canada

**SKI RACES BEHIND MOTORCYCLE
 EXCITING WINTER SPORT**

at Montreal 2252
 Speeds of ninety miles an hour are attained in one of the latest winter sports, ski racing over hard snow and ice behind motorcycles. While the skier clings to two ropes and endeavors to keep his balance, the cycle rider pulling him must be adept at making quick turns and on the lookout to prevent skidding. Patrons of Canadian winter resorts have found the pastime thrilling and full of opportunities to demonstrate their skill. Relay races add to the enjoyment of the sport.

**RADIATORS HIDDEN IN WALLS
 SAVE ROOM SPACE**

520

Attachable to either a steam or hot-water system, radiator units that may be safely built into the wall and, when installed, are completely hidden from view, have been introduced to save space and to promote better heating. They consist of an outlet grill above and have an inlet opening below. The grill is fitted with a control damper to shut off the heat when desired. The entire unit may be set in a wall or partition only four inches thick. The core of the radiator itself is

made of a special metal to which are attached a large number of copper fins. There are no brazed, soldered or welded joints, so that expansion and strain cannot cause leakage. Tests have shown that it safely holds as much as 220 pounds of steam pressure when thawed out with boiling water after it had been frozen for several hours at a temperature of five degrees below zero.

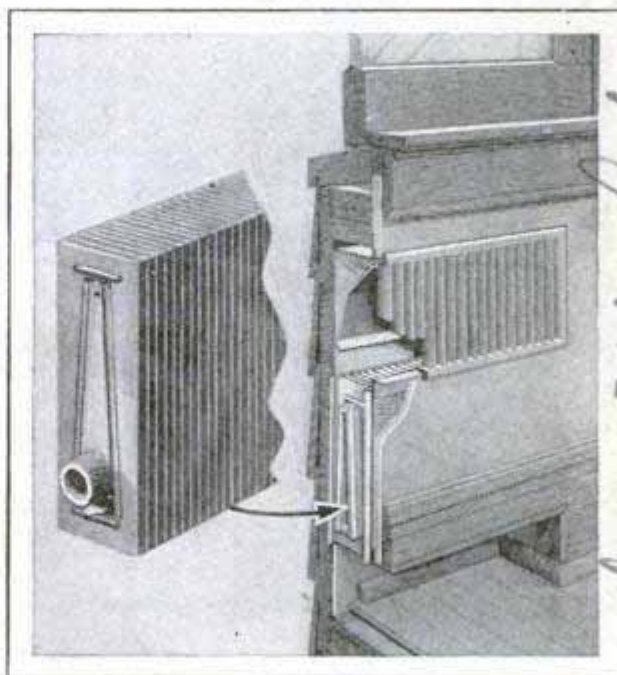

End of Radiator Core Showing the Fins, and Diagram of Typical Installation

*Herman Nelson Corp.
 Montreal*

invisible leakproof

2003

When the White Tops

Winter Quarters Mean Months of Hard Work Training Animals, Practicing New Stunts and Repairing Circus Equipment

By EARL CHAPIN MAY *Sharon Conn*

THE world's greatest show, like others advertising themselves as such, has reached the end of its tented journey. The official route book, issued annually, relates, among other facts, that it has traveled 14,000 miles between May 1 and November 1. The route has taken the tented city from the Atlantic to the Pacific. The magic canvas city has risen, throbbed, been torn down and moved nearly 200 times.

The boss canvasman and his rough-necks are tearing her down and rolling her up for the last time. The circus band is not playing "Home, Sweet Home," for all showmen know, from experience, it

Hagenbeck Wallace

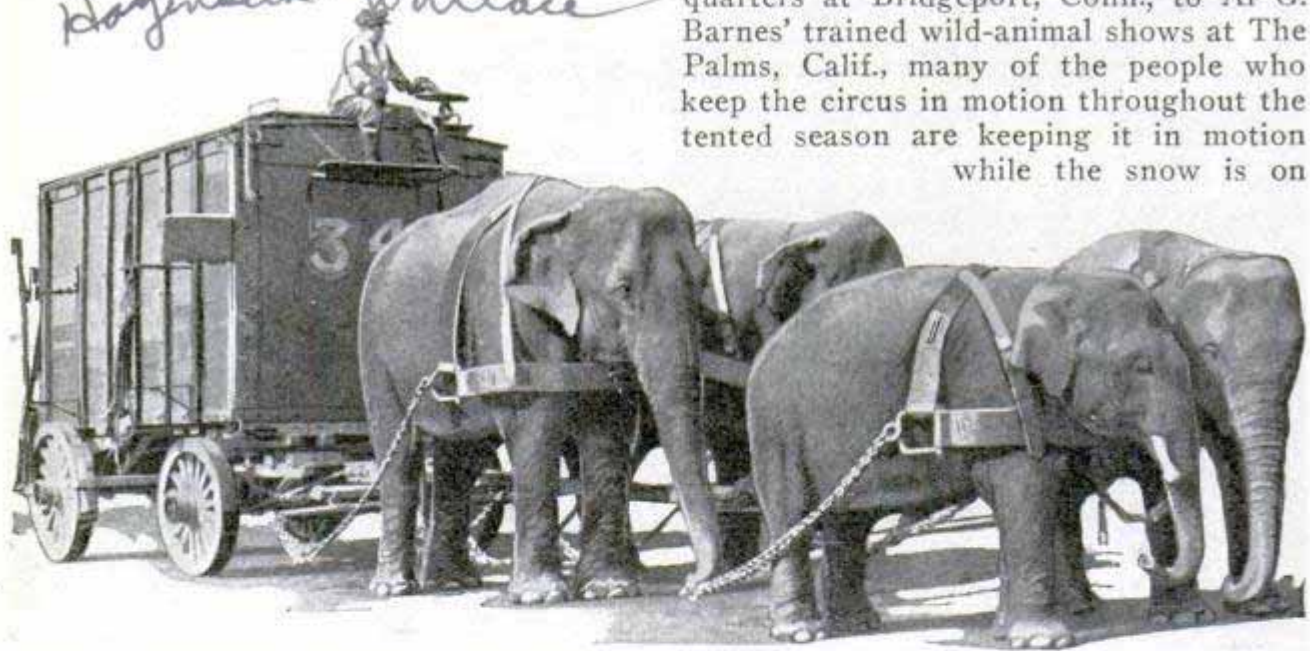

Elephants Are Kept in Condition by Helping Out with the Heavy Work of Moving Canvas, Stake and Animal Wagons around the Lot, When Not Busy Rehearsing New Acts for the Tented Show

ed circus train is about to pull out for winter headquarters.

"Season's closed!" all cry. And the wistful small boy, saying his own farewell to life's greatest joy, wonders audibly, "Where do the circuses go in winter?" For the small boy's information, the fact is here set down that circuses go on forever. The train that takes the circus to winter quarters also takes most of the circus, whether it be man, woman, animal or inanimate material, into intensive winter training.

This training is of diverse kinds. From the Ringling Brothers and Barnum and Bailey's combined shows in their winter quarters at Bridgeport, Conn., to Al G. Barnes' trained wild-animal shows at The Palms, Calif., many of the people who keep the circus in motion throughout the tented season are keeping it in motion while the snow is on

brings bad luck to play "Home, Sweet Home" on the circus lot. But the thousand or more managers, performers, hostlers, cooks, waiters, ticket sellers, musicians, freaks, property men, and what not of the modern gypsy city, are saying farewell to each other and the road. The load-

the ground. From Peru, Ind., where the Sells Floto and Hagenbeck-Wallace circuses are installed in their acres of steel, brick and wooden buildings, to Beaumont, Tex., where the Christie and Lee Brothers make their winter stand, skilled hands are repairing the ravages of a long season.

are Said Away

Wagons are being retired, and repainted. Tents are being built or rebuilt. Baggage horses are being turned out to pasture. Ring stock are being groomed and tested out for new acts. Wild animals are taking new lessons in the art of entertaining the great American public. New wardrobe is being designed, made up and be-spangled. New center, quarter and side poles are being trimmed for the coming battle with the elements; new blue seats, jacks and stringers are being sawed and hammered into shape. Each winter quarters is a humming factory.

The cash replacement value of the twenty circuses that annually tour this country is close to \$15,000,000. It costs more than \$5,000,000 to winter, repair and generally renew these circuses. So much for the physical side of the circus business. The horse and animal trainers and the men and women artists who thrill the millions that pay their way into the white tents, have their own methods of training during the winter.

In and around Bridgeport, Mable Stark, if she is scheduled to wrestle her tigers during the season to come, keeps two of her baby pets in her comfortable apartment, where, in off-hours, they snooze in her lap. Mr. and Mrs. Emil Pallenberg, premier bear trainers of the world, are at home in a Connecticut village—at home with their bears, which have apartments of their own. When not mastering the roller skates or two-storied bicycles, the Pallenberg bears are as comfortably ensconced as any fancy thoroughbreds. George Denman, dean of elephant trainers, is also at home, in his great elephant barn where, with block and tackle and

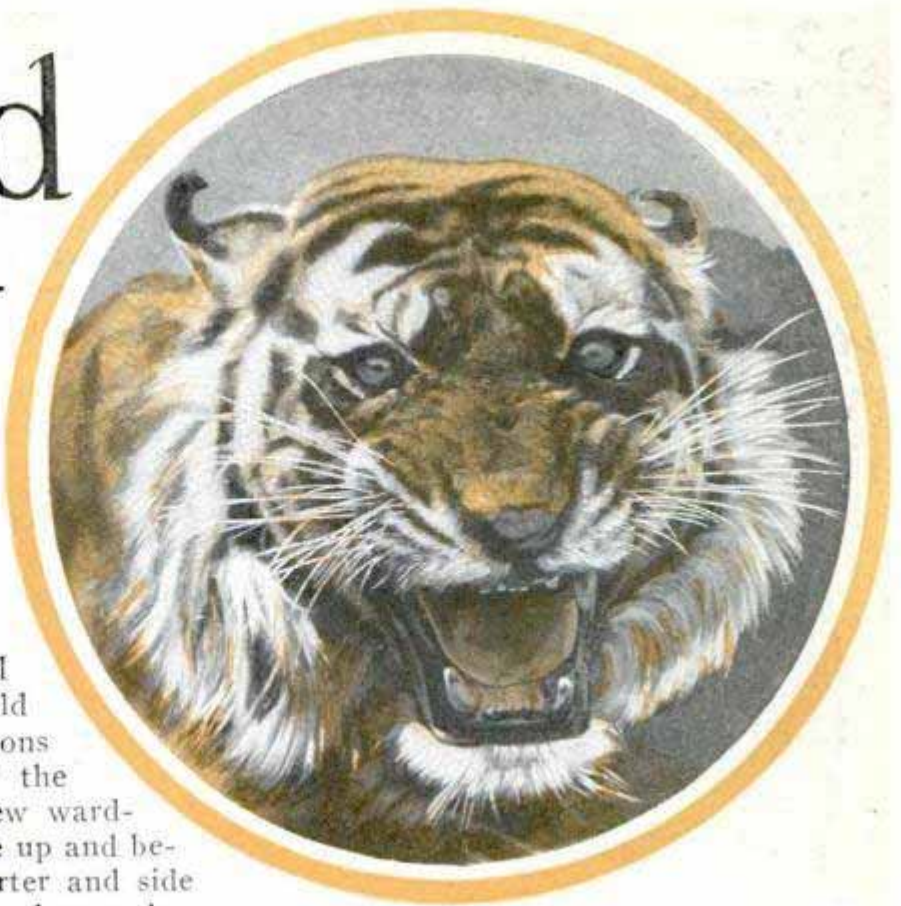

wise words of command, he teaches forty pachyderms to stand on their heads or hind feet in ponderous unison.

Down in Central City park, Macon, Ga., Steve Batty is practicing, in the steel training arena, a thrilling fight with "Wallace, the Untamable Lion" of the Sparks' circus, while Franz Woska rehearses his tigers or leads one into the open where Mrs. Clifton Sparks and Clifton Sparks, Jr., pal with the royal Bengal pet and M. Burns is training Bibb county pigs.

In the ring barn at West Baden, Ind., Robert Thornton or Carlos Carreon, assisted by Mrs. Thornton and Mrs. Carreon, are breaking in new liberty and menage horses for the John Robinson show, soon to go on tour for the one hundred and second consecutive year.

There is no rest for circus people winter or summer. But all the winter work is done without the stimulus of crashing circus bands, without the color of silken tights, without the excitement engendered by thousands of towners, craning their necks from tiers of blue seats. Circus training, in the winter time, is an unemotional affair.

If you happen into the famous Davenport ring barn in Cicero, a western suburb of Chicago, you may find a man in

2003

Miss Ione Carl Spends Her Winters Wrestling with a Man-Eating Royal Bengal Tiger, with Leather Suit, Cap and Gloves to Protect Her against Casual Scratches

John Robinson



overalls methodically cracking his long whip, while a broad, sleek "rosin back" lopes gently around the forty-two-foot ring. On the back of that fat horse may stand a young woman in sweater and bloomers, tripping the light fantastic or even attempting back somersaults. Her hair is done up tight. Her expression is tense. Her horse discloses a most annoying tendency to hump just before the lady wants to take off for another backward mid-air turn. "Drat the beast!" she exclaims, or phrases her remarks more vigorously. For when a horse humps it elevates its hind parts to most prodigious heights. A hump may spell disaster to the most experienced equestrian. Humping is a bad habit, difficult to cure. So our young lady does not kiss her hands or flaunt her tarlatan skirts at admiring throngs. She says, "drat the horse!" or some other unconventional thing.

A rather dispiriting inclosure is a ring barn. Of wood or brick, with windows

not too well cleaned, and, perhaps, no heat but from an ancient stove in one far corner—near which the shivering artist must change her clothes—the ring barn is undeniably a place to work. There's nothing to inspire the equestrian but a grim determination to be the greatest of her kind.

Or, perhaps, one wanders to Bloomington, in central Illinois, and on its outskirts finds a great, wooden structure known as Eddie Ward's training barn. There, amid a maze of rigging, ropes, trapeze bars and nets, boys and girls in rompers or faded, threadbare tights learn to fall into the net or execute the "hock, and one-and-a-half, with pirouette and half return" far above good Mother Earth. Eddie is training his flyers for another season under canvas. But in that high-arched, gloomy barn the crowded tents, smell of tanbark, and lilting music of the circus waltz all seem years and millions of miles away.

The towners who view the big show with varying degrees of interest know nothing of the "mechanic" without which no circus would be such. For riding acts the mechanic is a belt around the rider's waist. This belt is swiveled to a small iron ring, which, in turn, is fastened to a rope. This rope runs upward through a pulley at the end of a crane. This crane revolves around a pole, standing in the center of the training ring. The other end of the rope is held in the riding master's hand. When the beginner leaps into the air to turn a somersault the trainer pulls upon the rope. And when the rider, coming down, misses her uncertain footing upon the rosin back, the trainer gently lowers her to safety on the ground, or on her charger when it comes around the ring once more. Fine training for the stomach muscles is the mechanic, used ever since circuses began.

In Eddie Ward's training barn the mechanic serves a loftier purpose, although it also serves a similar end. The begin-

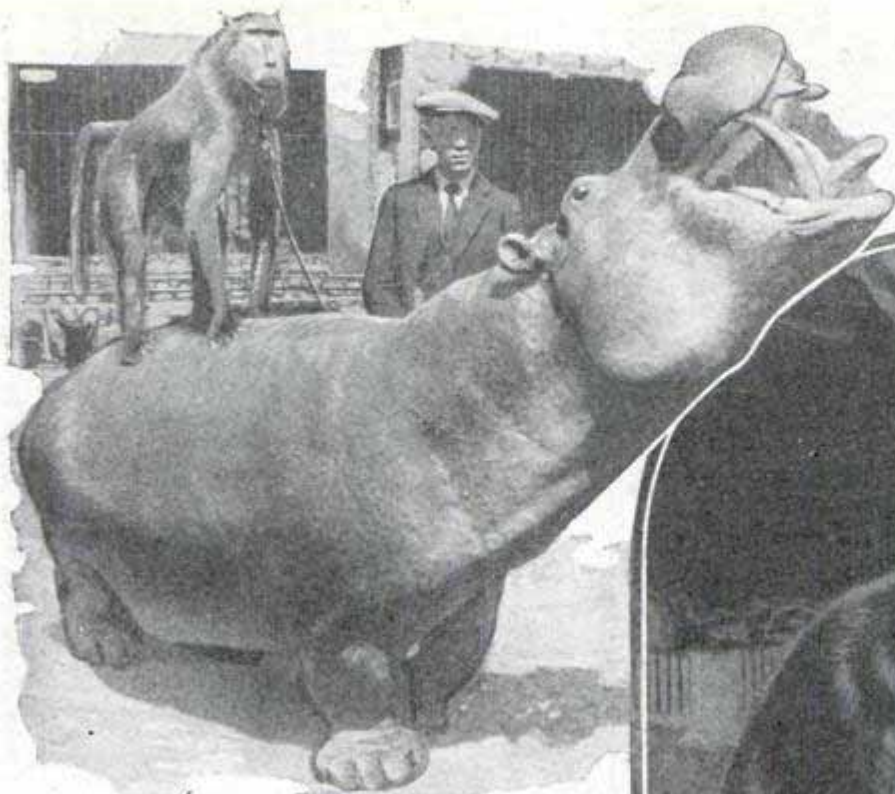

Even the Hippo Comes Out of His Water Tank to Take a Lesson in Carrying a Baboon around the Arena.



Maginbeck. Walter.

The Bear Wears a Muzzle While Being Taught the Rudiments of Wrestling behind the Scenes at Winter Quarters; Left, Naida Miller on Her Wire



It Takes Months of Patient Training to School the Horses to Remain Motionless in the Tableaux of the Statuary Acts

Courtesy Burke & Atwell

2003

Runglung

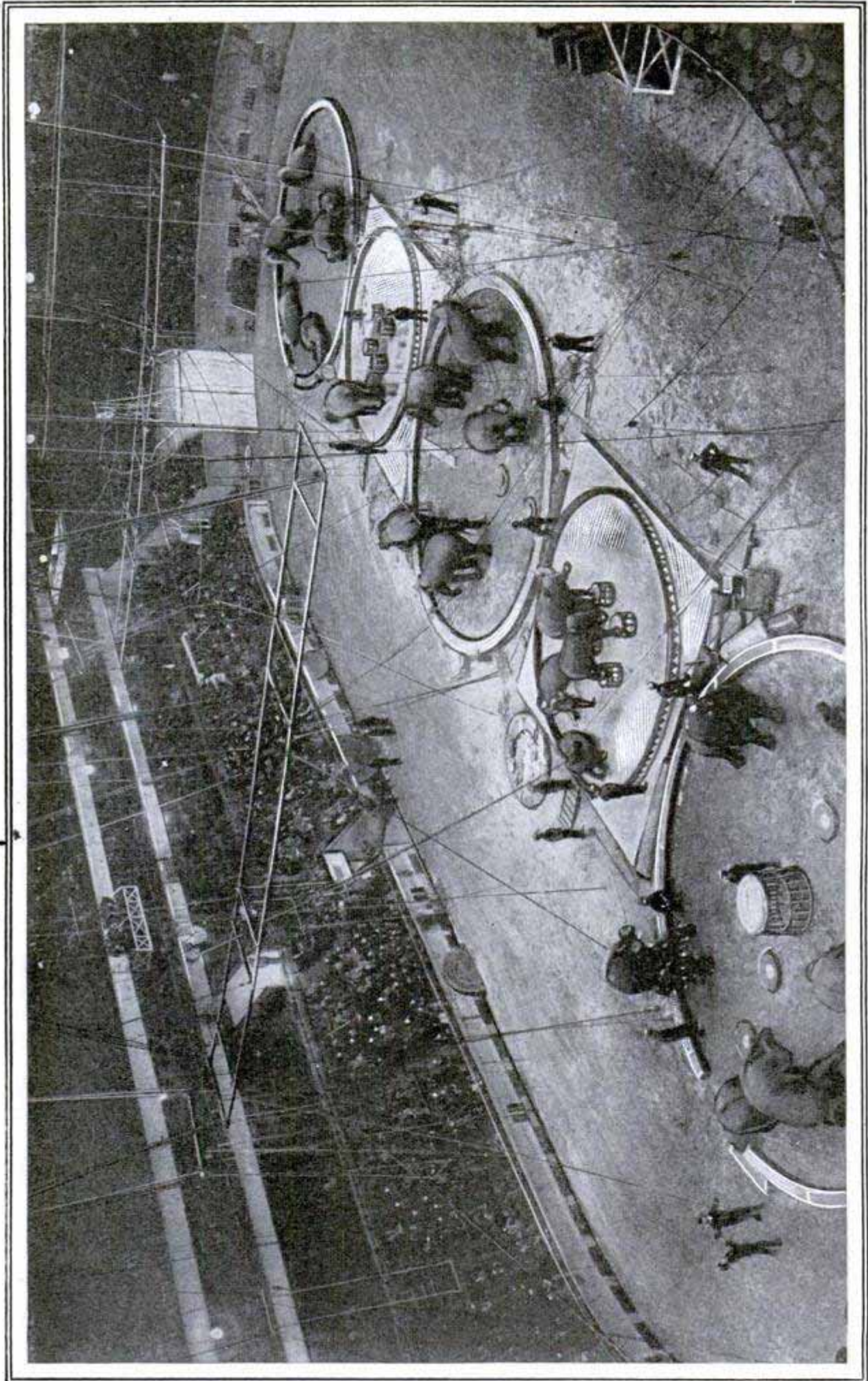

First Show of the Season, When the "World's Biggest" Opens in Madison Square Garden; Several Months' Work Has Been Spent in Perfecting the Elephant Herds in Juggling, Dancing, Acrobatics and Music, All to Furnish a Few Moments' Enjoyment in the Arena

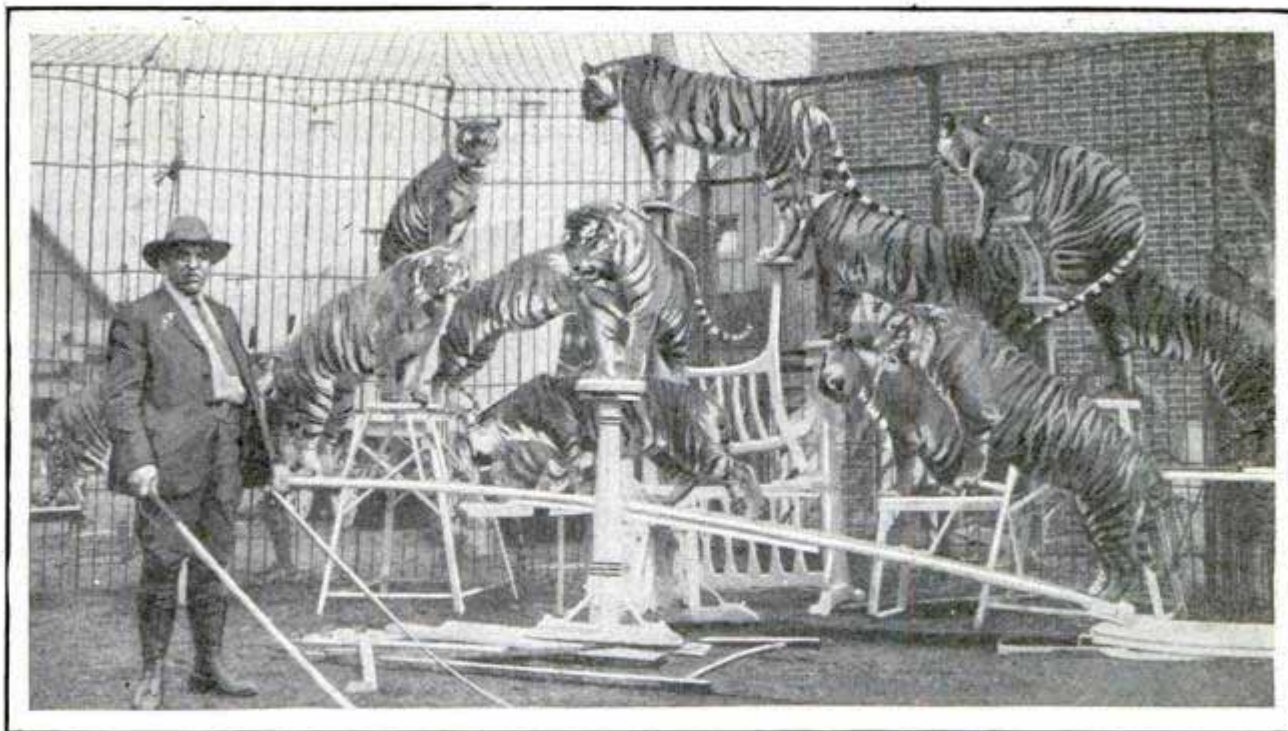

Robert MacPherson Spends His Winters at the Hagenbeck-Wallace Quarters Taming a Herd of Bengal Tigers in the Big Steel Cage; They Are Even More Dangerous than the Lions

ner who essays to do a double somersault from a trapeze to the catcher's hands flies through space, but as the beginner flies, Eddie and some trusty lieutenant, each holding a rope running over a pulley in the great barn's roof, pull on a belt around the budding flyer's waist. And if that flyer misses his catch, he comes down gently, as Eddie and his lieutenant slowly release the rope. Thus are the necks of young flyers saved for the future show.

All the world's a ring to circus people and all people, of worth, merely performers. The greatest danger that faced the circus performer of the olden days—the danger of going stale from lack of public appearance—passed with the last decade. The growth of vaudeville and the increase in winter circuses, especially those played "under auspices," have opened a new field of endeavor for the men and women of tights and spangles.

Training barns must always exist for beginners. But once the performer has attained unusual excellence he or she works both winter and summer. Stars are always in demand. Lillian Leitzel—as a feature with the Ringling Brothers and Barnum and Bailey combined shows, she throws her body over her shoulder a hundred times with one wrist in a rope loop—plays metropolitan vaudeville theaters from December to March, then goes

Peru. Ind.
directly to the spring opening of the big show in Madison Square garden.

So great has been the development of the indoor or winter-circus idea during the past few years that riding acts and even big flying acts are in demand through the winter months. The erection of such buildings as the Cleveland auditorium, and the eleventh-hour discovery that most of our national-guard armories are big enough to house a three-ringed snow-time show, have materially increased Christmas cheer for thousands of circus performers. The lot of the kinker, as the circus performer is sometimes called, is far from a hard one.

There is still required during the period between fall and spring a vast amount of patience and persistence upon the part of Roy Rush, for example. Roy teaches horses and dogs to remain motionless during the "statuary acts" in the Big Show. He does this by tenderly manhandling his animals, then rewarding them with apples or sugar or petting.

The trained-seal act is the stand-by of many a traveling circus, because the seal is a natural-born actor. It loves the lime-light and dotes on applause. By precept and example and judicious distribution of fresh fish, a trainer can make a troupe of amateur seals qualify as professionals in about three months.

2003
 A good elephant trainer can break in a herd of young bulls fresh from Asia in about three months, depending upon the individual elephant's temperament, for elephants are highly individualized. But most are keen about showing off and once a bull has learned its routine it is apt to go through a performance without the trainer's cue. All trainers as well as all performers are constantly on the alert for new business. The Charleston had hardly got under way before Bob Stickey IV, scion of one of the oldest circus-riding families, perfected a Charleston on twelve-foot stilts. Bob has been working steadily in theaters ever since. He could get a handsome salary with a circus if he cared to troupe under canvas again.

This matter of originating new business is of paramount importance to all circus performers, save and excepting only those who are so pre-eminent in their particular feats that the public demands their annual repetition. Clowns are everlastingly driven to think up new and funny stunts. That is how Buck Baker came to originate the trick automobile that goes backward and forward at word of command without the touch of human hands; why Pete Mardo comes out every year with new "walk-arounds," and other funny business—and why there are lines in his face. Clowns put more gray matter into their work than any other class of circus per-

former. But all of them do a lot of studying winter and summer. A new style of somersault; a new head balance on trapeze; a new method of sliding down a wire upside down—all these are literally meat and drink for the "kinkers."

And first, last and all the time, circus people must keep in condition and keep down their weight. This is a more serious matter than the layman suspects. The average star circus performer actually appears in the ring less than twenty minutes a day. He does a deal of limbering up, before he goes on, summer or winter. But outside of that he takes little exercise.

Contrary to most non-professional opinion, circus performers have vision and imagination. Otherwise, they would not be up in their profession. If you happen to see in some circus a pretty and graceful young lady billed as Naida Miller, and note her in silks and satins waltzing on the light wire to the tune of "Over the Waves," just remember that it took the better part of six years in some cold training barn or an equally uninspiring gymnasium to perfect an artistic act which lasts less than six minutes. That's the difference between practice and performance in the circus business.



The King of the Jungle, Whose Massive Head and Big Mane Make Him the Premier of Animal Actors

**ORCHARD PIPE LINES SUPPLY
OIL FOR HEATING SYSTEM**

Oil-burning heaters have been used for some time in large fruit orchards to reduce damage from frosts on chilly nights, but in large groves so much time is consumed in filling the firepots that extensive harm is often done before the heaters can be replenished. This difficulty has been surmounted in a large California orange district by installing a 600,000-gallon reservoir for each 1,000 acres and piping the oil to various filling stations established in the orchards. Because of the high pressure, a wagon can be filled to its capacity, 600 gallons, in three minutes, it is said, and not much time is required to drive to the heaters and fill them. The main tank holds sufficient oil to last three nights. During the frost season, night riders patrol the groves and sound an alarm when the temperature descends to the danger point. The big reservoir is refilled from a railroad siding, two miles distant.

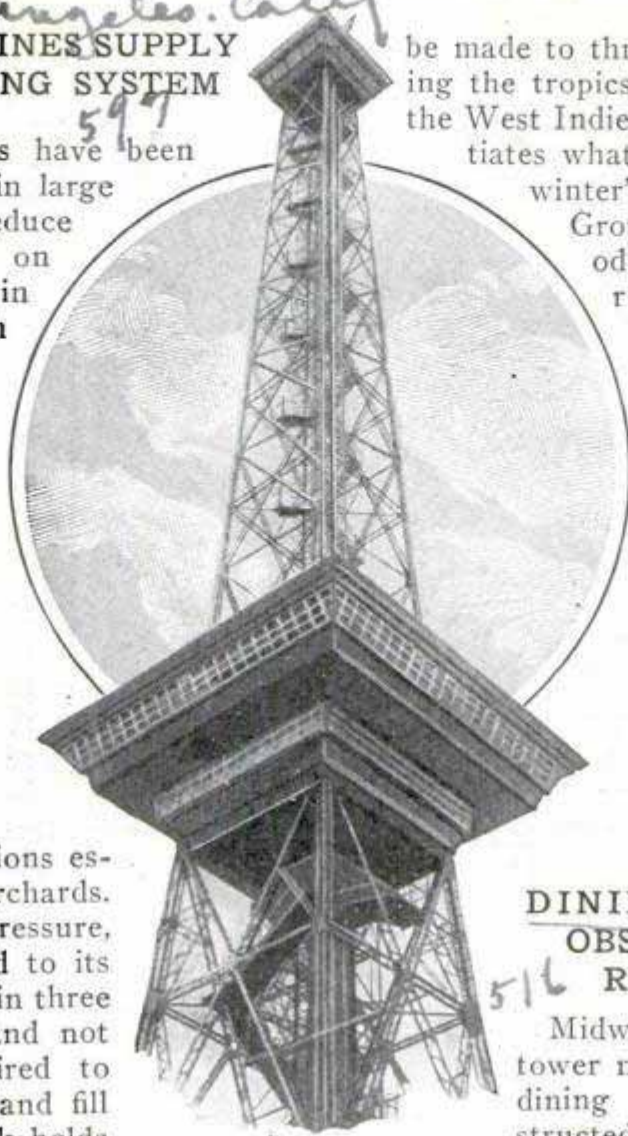

Where Diners May Enjoy Cool Breezes and a Wide View; Exterior of the Radio-Tower Cafe, near Berlin; an Observatory Is at the Top

be made to thrive in regions bordering the tropics, such as Mexico and the West Indies, and further substantiates what was shown after last winter's frost at Cocoanut Grove. In that cold period, Hevea, the Brazilian rubber tree, suffered less than the Mexican variety, although the former was considered much more sensitive to low temperatures. A search was made by department-of-agriculture men through other towns in Florida for more Brazilian trees that may have been set out as ornaments and lived.

**DINING SALON AND
OBSERVATORY ON
RADIO TOWER**

516 Chartollenberg

Midway on a high radio tower near Berlin, a spacious dining room has been constructed. A clear view is afforded from every side, and windows are arranged to allow full benefit of the breezes when desired or may be tightly closed for protection. The cafe is reached by an elevator and by stairs which continue to the top of the mast where an observatory is provided.

**RUBBER TREE IN FLORIDA YARD
TWENTY-FIVE YEARS OLD**

Discovery of a Brazilian rubber tree, twenty feet high and three or four inches thick, in a Florida garden near Palm Beach interested plant experts recently, as this tree usually flourishes only in warmer climates near the equator and experiments in raising rubber plantations in Florida have not proved successful. The tree was evidently about twenty-five years old and had lived through cold snaps that had killed other trees. The find indicates, some authorities hold, that the hardiest rubber trees might possibly

**LIGHTWEIGHT TAPPING WRENCH
ALSO WORKS IN LATHE**

Taps are firmly held independently of the handle in an easily manipulated wrench

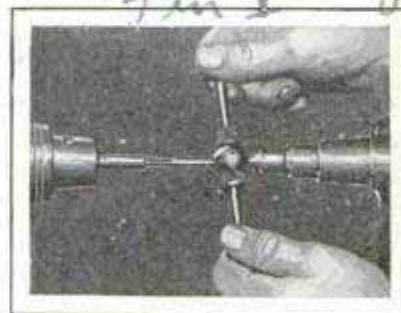

that is said to keep a perfect center and take a wide range of taps and reamers. It may also be adapted for use in the lathe.

*Found by G. L. Cook
U.S. Forest Service*

*Stark Products, Corp.
380 7th, Clark*

455

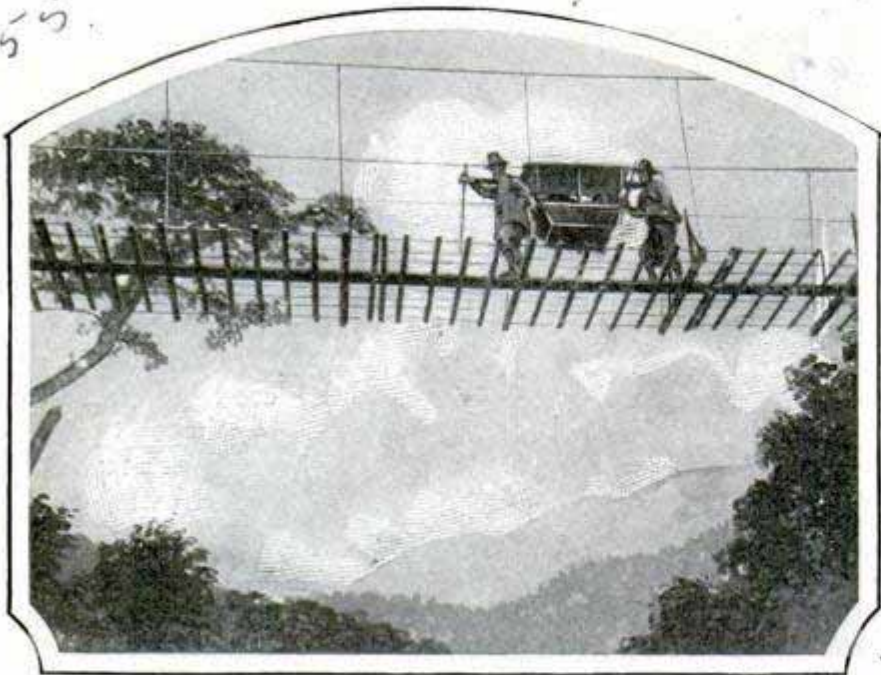

© Herbert Photos
Carrying Baron Okura across Rope and Bamboo Suspension Bridge over Deep Ravine in Japanese "Alps"

OLD ROPE AND BAMBOO BRIDGE AIDS TRAVEL IN JAPAN

Spanning a deep ravine in the Japanese "Alps," is a primitive suspension bridge fashioned of rope and bamboo. It is securely rigged but narrow, and crossing is not without its perils to the inexperienced, although the natives walk over it with ease. Some of the Japanese ride in the old-fashioned conveyance, the "kago."

WONDERFUL TRAITS OF BIRDS TOLD BY SCIENTIST

A species of bush turkey knows how to ventilate its nest; the male of the satin bower bird seems to have an artistic sense, for it throws out flowers that do not appear to harmonize with the color scheme of its home, and others play, apparently make plans for the future and indulge in war dances. These are some of the marvelous traits of birds as described by Dr. Lucius C. Pardee, a Field Museum of natural history lecturer. He asserts that many of the feathered

tribes are big-brained and learn quickly. One of the smartest is the honey guide, a species from Africa. It is fond of the sweet but unable to get it from the bees' nests. It therefore leads a man, usually a porter from some traveler's caravan, to the bees by making a great disturbance to attract attention, or it enlists the help of the ratel, a little animal with a skin so thick that bee stings do not penetrate it. In the confusion that follows the robbing, the bird usually gets its share of the honey. A kind of plover

hops into alligators' mouths and robs food from the reptiles without apparent fear of being bitten. One group of birds punishes theft, crows hold "trials" and sentence culprits to death, and others have elaborate courting ceremonies.

WOMAN CARVES SHIP MODEL WITH FEW TOOLS

432

Working with only a few tools available in her home, a Los Angeles woman has completed a model of an ancient Spanish galleon, complete from keel to

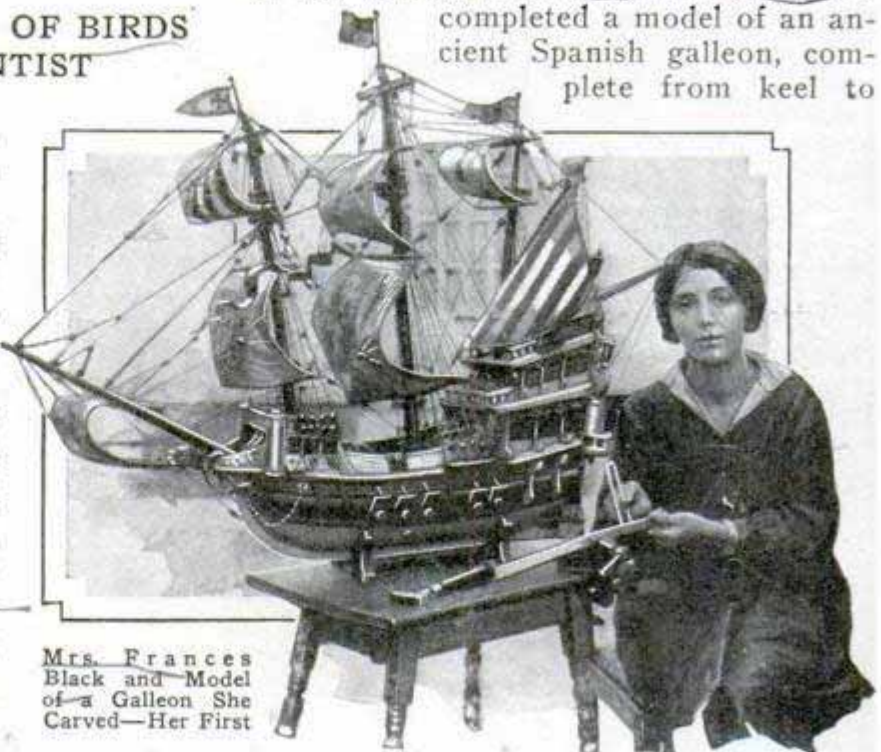

Mrs. Frances Black and Model of a Galleon She Carved—Her First

Chicago
Michigan

masthead. The builder had never been interested in ships until she saw models pictured in a book her young son was reading. Her model is forty-eight inches long from bowsprit tip to stern and stands thirty-six inches high. All the material that went into it cost less than five dollars.

NEW USES FOR SULPHUR

From his research and study of sulphur, started as a hobby, an eastern chemical engineer has found many new uses for the mineral. By mixing in an alloy, he molds it into vases and urns that closely resemble bronze but are much lighter. Soft wood is made hard and durable after immersion in a bath of molten sulphur and the substance is used to coat a base of flannel cloth in molding horns for radio sets and phonographs. Cheap toys of paper and wood pulp become stronger after treatment in a bath of sulphur, and the mineral has been found to add great strength to concrete products. One of its most important uses is for covering underground pipe. Tests have shown that a jacket of cloth and sulphur, about one-eighth of an inch thick, wrapped around a pipe, shields it from rust, while other sections, not so protected, become pitted and worn. This has been determined by examination, once a year, of some twenty pipes laid in different parts of the country from Maine to California. Sulphur resists acid and water and, although it burns, is not easily ignited.

TOY BALLOONS AID DIVER IN PROLONGING THRILL

Holding a huge bunch of toy balloons, which slightly decreased the rate of his descent, a diver in an eastern water carnival introduced a novelty in leaping from a 100-foot tower. The slow fall prolonged the thrill of the spectators.



Easing the Landing from a 100-Foot Dive; Using Toy Balloons for Part Support to Prolong the Thrill

© Herbert Photos

EQUINOX NOT CAUSE OF STORMS

Stormy weather and the equinox, the time when the sun crosses the equator on its journey northward or southward, are closely associated in many minds, but examination of records show that there is no connection, and weather authorities declare that the sun's movement at that period has nothing to do with storms. An unusual amount of rain and some wind in the region around Chicago during the five days from September 20-24 were cited as evidence of the effects of the equinox last fall, but Prof. Henry J. Cox, senior observer of the weather bureau, explained that there

was no relationship between the storms and the sun's position. The records since 1872 showed that there was no rain at all during most of the five-day period each year, and on only four days during the interval was there more than an inch of rainfall in any one twenty-four hours. The highest wind velocity recorded during the period, over ten years, did not exceed twenty-three miles an hour. "There is no more likelihood of a storm just at the equinox than a few days earlier or later," Prof. Cox declares.

12 E. 41st St New York

Wm. H. Kobbé
Research Engineer
Sulphur Co

Chicago, Ill. 9/26/26

429

541

525

*Just - O'Neil
London, Eng*



Young Shaw Flying Kite, and Close View of Its Head with Butterfly "Messenger" at Bottom

INDIANS PRODUCE MUSIC FROM ACORNS

552
An unusual musical instrument is the string of acorns fashioned by members of an Indian tribe. The nuts are tuned according to size and strung together in the order of the musical scale. The player takes one end of the string in his hand and holds each acorn in turn between his teeth. Using the other hand, he swings the string and pulls it taut. This causes the acorn to vibrate and produce a clear note.

EMERGENCY-BRAKE HORN SWITCH AID TO SAFETY

434
When an emergency requiring the use of the hand brake arises, it is usually sufficiently urgent to necessitate a firm grip on the steering wheel rim with the other

EIGHTY-FIVE-FOOT KITE HAS BLINKING EYES

469
Lee Shaw, sixteen-year-old Japanese school boy of Los Angeles, has won considerable notice for the marvelous kites he constructs. The one he considers his masterpiece is in the form of a huge dragon, eighty-five feet long and brilliantly colored. It flies with the head toward the ground, the flapping tail extending upward, the reversal of procedure in ordinary kites. A feature of the design is the arrangement of the eyes, which have movable centers that give the effect of winking. Another innovation is a butterfly figure, four feet across, that can be made to soar up on the string as though attacking the dragon.

hand. In such circumstances it is impossible to reach the horn button, even though the emergency may demand a warning signal. To meet the difficulty, an English manufacturer has introduced an extra horn button which attaches to the top of the emergency-brake lever, where it can be pressed by the thumb of the hand using the brake. The button is

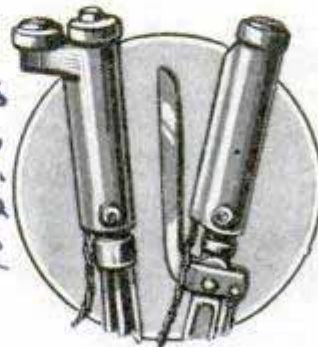

connected in parallel to the regular horn-button circuit so that either one operates independently of the other. Two types of mountings are supplied, one for brake levers with

At one time, physicians prescribed gold-rod pollen to stop bleeding.

a button release for the locking pawl, and another for the side-lever type.

*A. E. J. Conventions
411 Holloway Road
London N. 19 Eng.*

4 11

Also of Austria

FAMOUS CLOCKS SEEN IN ALL PARTS OF THE WORLD

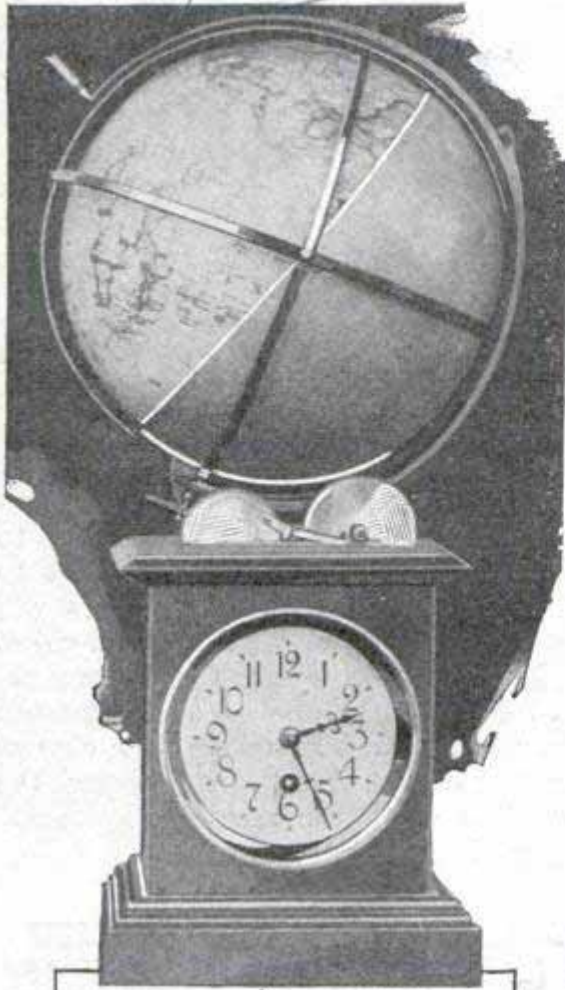

Austrian Clock That Tells Year, Month, Day and Time Everywhere on the Globe

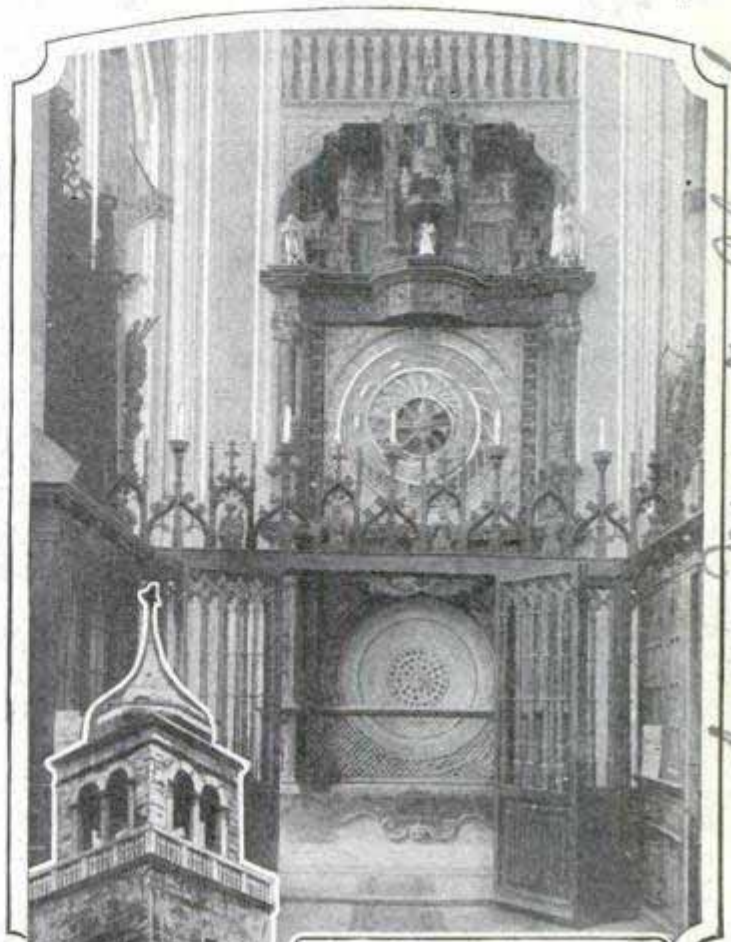

Astronomical Clock in Lubeck, Germany, That Shows Time, Tides and Constellations

dominican Church

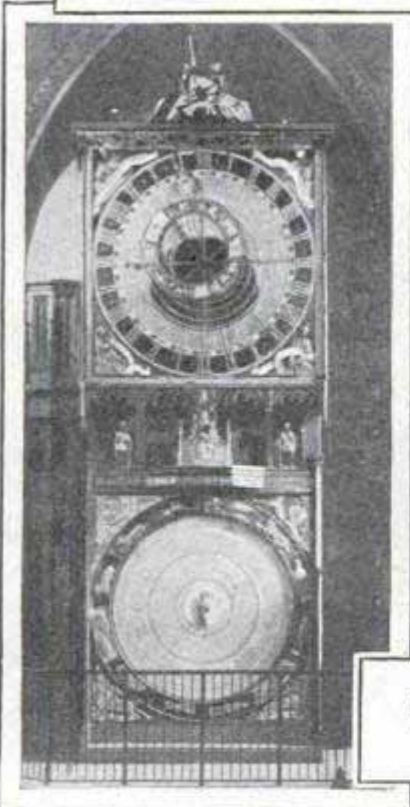

Left, Time, Tide, Star and Zodiac Clock at Lund, Germany, and, Above, Twenty-Four-Hour Clock at Riva, Italy

Lake of Garda.



Miss Irene Origg
Angel Shark Caught off Catalina Island; Name Suggested by Winglike Fins

RARE ANGEL SHARK CAUGHT OFF CALIFORNIA

One of the prize catches of the season off Catalina island was an angel shark, a comparatively rare variety distinguished by its winglike fins. It is regarded as among the least harmful of all the 150 and more species of sharks and is thought by some scholars to be a connecting link with the rays, an ocean tribe resembling the sharks. It feeds partly on smaller fish, but is too scarce to work heavy inroads on the desirable supplies.

HOW TO CLEAN PRECIOUS GEMS TO PRESERVE LUSTER

When diamonds lose their sparkle, they should be first washed in warm, soapy water for a minute or so, dried on clean soft flannel, then rubbed with toilet water and set aside for forty-eight hours. Water should never be used on turquoises. All they need is application of a methylated spirit, with a soft cloth, and a brisk rubbing. This treatment is also good for pearls, which rarely should be cleaned with water. A little whitening on a long camel's-hair brush, followed by a polish with chamois leather, is

also effective. Great care should be used in cleaning opals, as they are easily cracked if in too close contact with heat. Several preparations are on the market for renovating them, and directions in applying these materials should be followed strictly. Jet is cleaned with a little good olive oil applied with a soft cloth. Plain jewelry can be brightened in warm, soapy water and polished with chamois after being wiped dry. A bright day should be chosen for cleaning gems, because dampness and lack of light make them appear at their worst, so that their defects are not so easily determined. When rubies, pearls and other precious stones seem to have lost their beauty to such an extent that cleaning appears to do no good, renovation by experts will often restore their original life and color. Sapphires, for instance, are sometimes restored by chemical baths and exposure to sunshine. When turquoises change from a beautiful blue to a sea-green, the original hue is often regained by "skinning" and repolishing them.

CAMERA AS LARGE AS AUTO USED AS AN AD

Built as an exact reproduction of a "kodak," an automobile body designed by a Maine photographer for his car advertises his business wherever he goes. The bellows contains racks for camera and supplies, and the autographic slide opening accommodates the windshield.

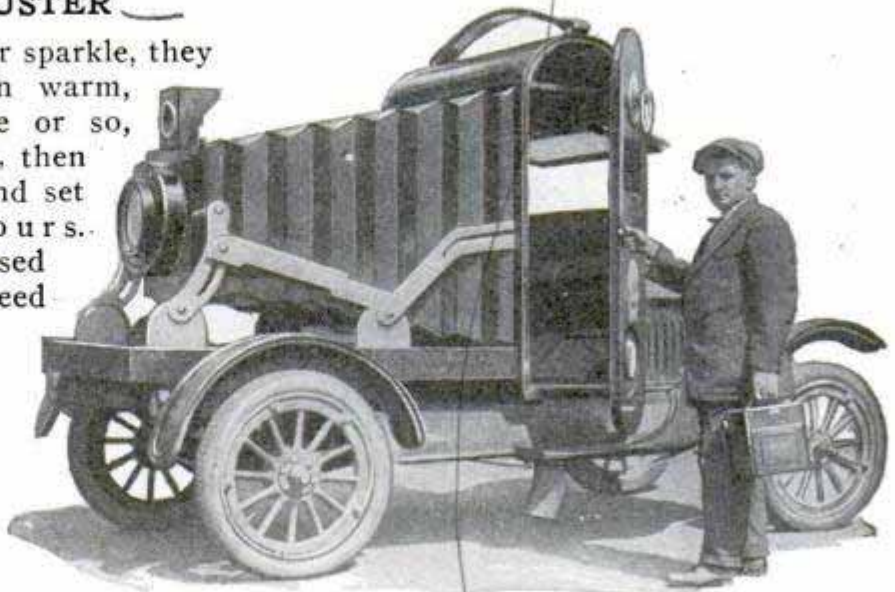

Heralding the Approach of Photographer, This Camera-Bodied Auto Attracts Wide Attention and Carries Quantities of Supplies

*Louis A. Signaret,
Biddeford, Maine*

*Mr. George W. Holden, Vine Road,
Highfield, New York
Chloroform*

572

Prof Henry and Dr Kunitake Kawano, Helmholtz Institute

Berlin Germany (York mfg. Co. York. Pa)

SILK FROM FISH SHELLS

50

Durable fibrous material, said to be stronger than real silk and fully as lustrous, has been prepared from insects and shellfish, according to reports from Germany. The basic substance used is "chitin," a white horny material found in the outer covering of various insects, crustacea and other invertebrates. In the bodies of these creatures it gives a certain resisting power in the absence of skeletons, and its durability is evidenced by the fact that specimens are preserved for a long time without artificial means after they have been pinned to cases and display cards. Two scientists of a German institution made a preparation from chitin and finally succeeded in spinning it into fine, shining threads which can be woven into many fabrics.

—2277

SNOWPLOW ON MOTOR TRUCK THROWS TO BOTH SIDES

Snow is hurled to one or both sides of the roadway by a rotating plow on a motor truck. This is effected by a pair of three-arm fan blades which may be turned in the same or opposite directions. To afford the driver a clear view ahead, a large sighting pipe extends from the seat. Practically all of the truck is tightly inclosed so that the cold and flying snow are kept out of it effectively.



Snowplow Truck, Showing Fans and Sighting Tube

and Joseph C. Chladek, Mount Horeb, Wis

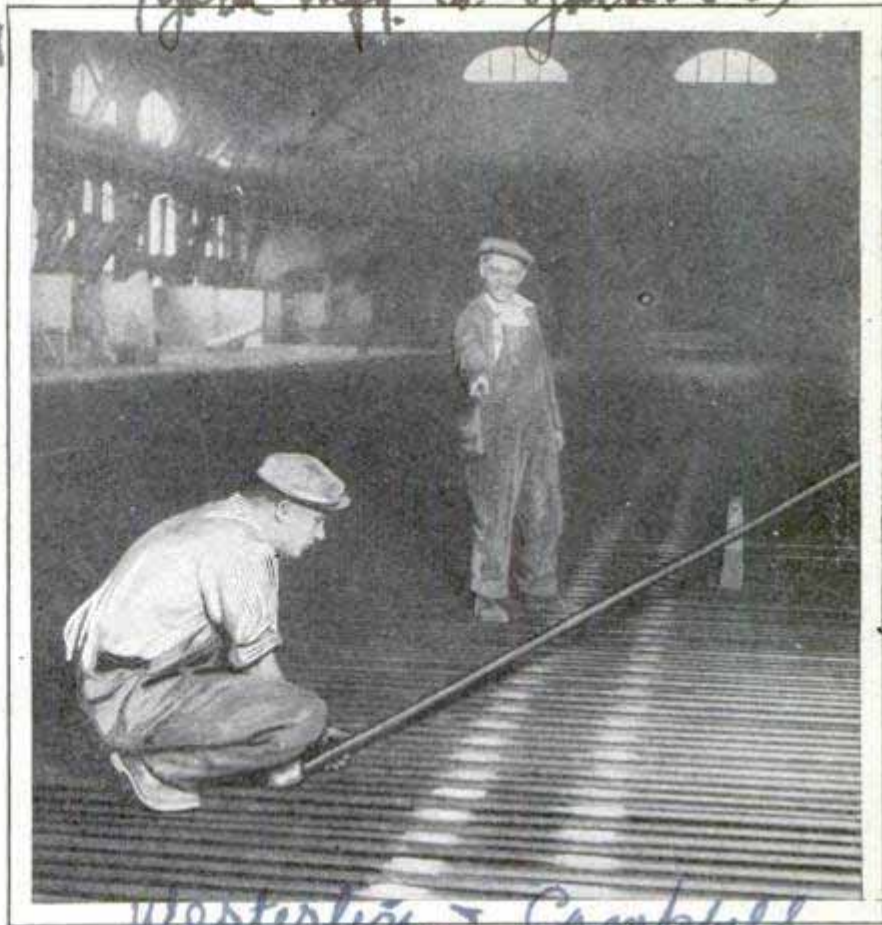

Installing Pipes for Skating Rink in Coliseum; They Can Be Emptied Quickly and Ice Thawed with Steam

ICE RINK AND BALLROOM ARE COMBINED IN ONE

431

A combined dance floor and ice rink, 180 feet long and eighty feet wide, recently was completed in Chicago's famous Coliseum, scene of many political conventions. The combination was made possible by an arrangement whereby the ammonia cooling system can be cut out, the pipes emptied and live steam forced through them to melt the ice. In two hours the floor is ready for dancing.

Write our Bureau of Information if you wish to know who makes or sells any article described in this magazine; the service is free.

Installed by Westerton and Campbell 1113 Cornhill



Wide Double Highway in Michigan, with Car Tracks between One-Way Pavements. Provides Lanes for Slow, Medium and Fast Traffic; the Road Connects Two Auto-Building Cities

WIDE ROAD FOR AUTO TRAFFIC HAS LANE FOR HORSES

Two hundred feet wide and with an electric line between the two concrete roadways for automobiles, a "super" thoroughfare has been completed between Detroit and Pontiac, Mich. It extends a distance of eighteen miles and the outer right-hand tracks on each roadway are open to horse-drawn vehicles, which must not enter the other lanes. The maximum speed for traffic on the automobile divisions is twenty-five miles an hour.

ENGINE TO AID SWIMMERS IS RUN BY AIR

A propeller driven by compressed air from tanks and to be strapped about the body was recently patented by a Denver man as an aid in teaching swimming. His device consists of a canvas breastplate, reinforced with light flexible ribs,

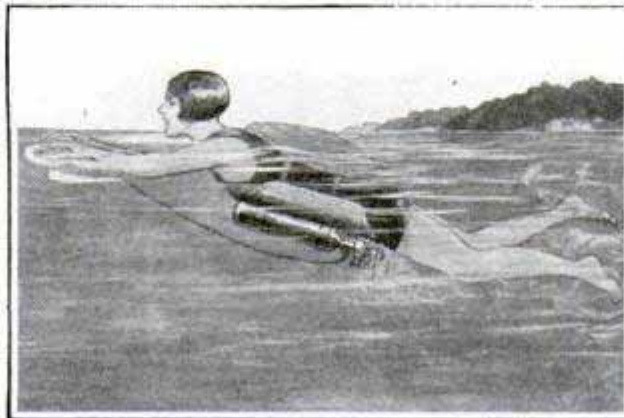

Air-Driven Motor for Swimmers

and with clips to hold the air tank and motor, the propeller being protected by guards to save the wearer's legs. A rubber bag fits over the swimmer's back and is inflated through a valve to help sustain the extra weight of tank and motor.

THREE-FIFTHS OF ALL RADIO STATIONS ARE IN U. S.

The United States has three-fifths of the world's broadcasting stations and five times more receiving sets than are in use in any other country, according to a survey by the department of commerce. That foreign nations are rapidly increasing their radio equipment is shown by the fact that,

last year, radio apparatus exported from this country were valued at \$10,000,000, eighty per cent more than the value of the total exports in wireless in 1924 and ten times the total for 1921. The United States is the only important country where the radio fan

448
Mr. G. G. Orison, Birmingham, Ala.
412. Harrington, Denver, Colo. Letter re: A
Worth Co.

can listen in free. A license fee of one franc per year is charged in France, \$18 in Salvador and \$13 in Lithuania. In the British Isles, the fee is ten shillings, and in Sweden about \$2.70.

ENERGY EXPENDED BY MUSICIANS MEASURED

Tests in Vienna are said to show that the amount of energy expended in whistling, speaking, singing and in the playing of brass instruments is comparatively slight. Pianists and players of stringed instruments consume much more energy, it was found. The director exerts relatively little. The measurements were made by placing tight masks and rubber hoods over the heads of members of an orchestra and of a number of men and women singers. Meters were so adjusted that the amount of energy expended while the persons were performing could be judged.

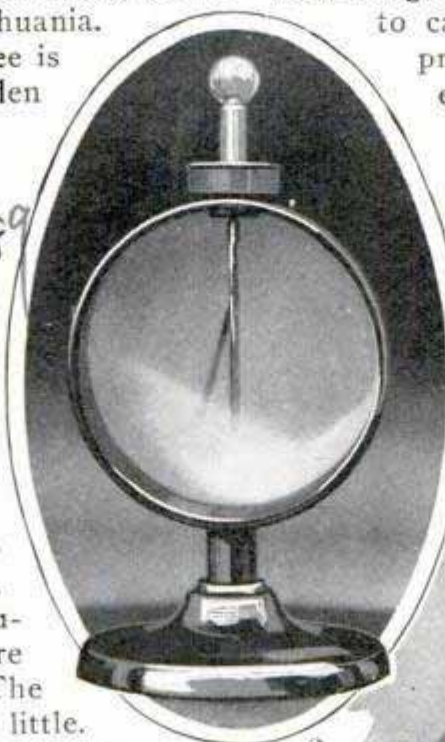

Electroscope in Use While Hunting for Lost Radium, and Closer View of Another Type

for these missing needles. With the aid of it, a southern professor has won fame as a "radium detective" and has recovered more than \$20,000 worth of the substance. The detector is essentially a small glass box containing an amber rod to which gold leaf is attached. When a hunt is on, the knob at the top of the rod is electrically charged simply by rubbing it. This causes the leaf to stand out. But if the instrument is brought close to radium, the gold quickly moves back to its original position, due to the action of the radium emanations, in breaking down the electrical charge. After the searcher has picked up a clue to the lost needle, he rubs the rod and watches the leaf closely while moving the finder about. In one instance, a radium needle was discovered in a pile of ashes.

DOOR KNOCKER RINGS BELL AND LIGHTS LAMP

A door knocker that not only knocks but rings an electric bell and lights a small lamp, which remains burning until it is switched off by the opening of the door, solves the problem of utilizing an attractive old-style knocker, and yet being able to hear it all over the house. From outside the knocker has nothing to show that it is, in reality, only the switch of an electric doorbell.

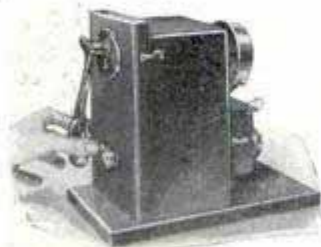

LOST FORTUNES IN RADIUM FOUND WITH AMBER ROD

One of the difficulties in using tiny needles of radium in treating diseases is that the costly little "splinters" are frequently lost and, until found, represent



Institute of Patentes, Victoria St. London, England

Prof. J. B. Edwards, Dept. of Physics, Georgia School of Technology, Atlanta, Ga.

N.Y. Times 9/11/26

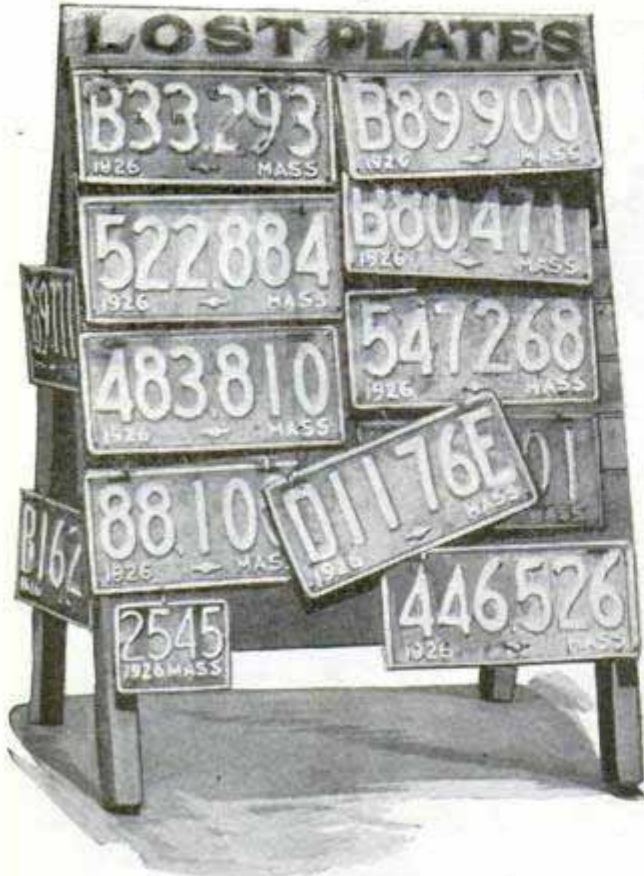

Lost Auto-License Plates Are Placed on This Rack When Found, to Aid Owners

LOST AUTO-LICENSE RACK AIDS MOTORISTS

2193

Chelsea Mass

The police department in an eastern city has provided a rack for lost license plates so that motorists may be spared trouble if they happen to lose the tags. The rack is placed in front of headquarters, where persons may call for their plates, identify them and take them away. The plan is also an aid in tracing stolen cars, as persons finding license plates are urged to bring them to the police who are sometimes able to get clues to the thieves from the place where the tag was found and fingerprints on it.

Ⓞ Buggy whips valued at \$296,270 were sold in this country last year.

HALF OF DEATHS FROM FIRE OCCUR IN HOMES

498

There is a cry of "fire" in somebody's home every three minutes, investigators report. Sometimes the damage is slight, but often the results are serious and, each year, millions of dollars' worth of property are destroyed and more than half of the 15,000 annual human toll of fire in this country is taken in the homes. Defective chimneys and flues are the chief cause, reports of the national board of fire underwriters show, being responsible for eleven per cent of the total. Sparks on wood-shingle roofs cause nine per cent. Next come stoves, furnaces, boilers and their pipes. More than 700,000,000 matches are struck every day in the United States or about 500,000 a minute. Carelessly tossed aside, these and tobacco stubs prove costly hazards. About five per cent of the household fires are caused by petroleum and its products. Oil stoves are improperly operated or are knocked over, but the garage is held the chief offender. If the total annual fire loss were averaged among all the dwelling-house fires, it would be sufficient to provide enough \$10,000 homes to take care of the population of Bridgeport, Dayton, or Dallas, statisticians assert.

ELECTRIC LAMP HELD IN MOUTH LEAVES HANDS FREE

452



Especially Useful in Developing Pictures; the Lamp, Held in Teeth, Permits Free Hand Movement

For the photographer, meter readers, mechanics and others, a small electric light is held in the mouth and the switch pressed with the teeth. Both hands are left free for work, and the illumination is directed just where it is needed. The light is safely insulated, weighs but little and does not injure the eyes. The battery is carried in a pocket.

Especially Useful in Developing Pictures. 47. Germany.

407

SANDS OF AMERICA'S SAHARA BRIDGED BY CONCRETE

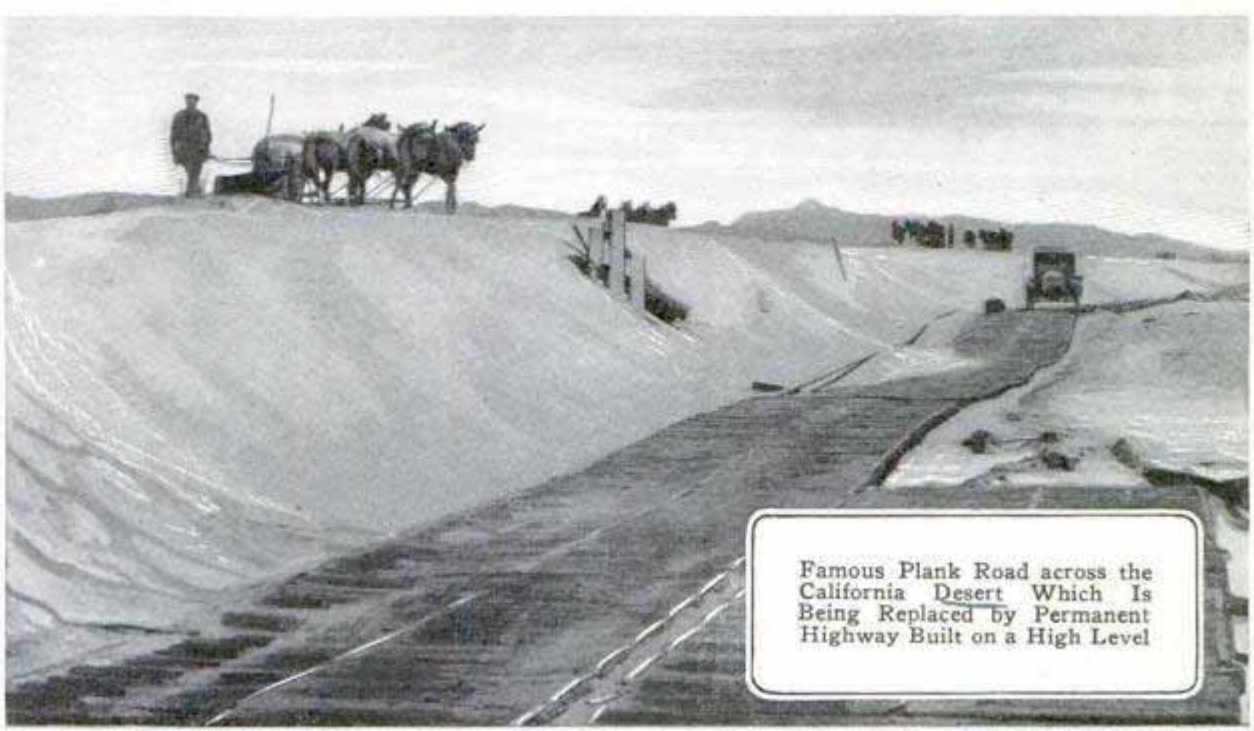

Famous Plank Road across the California Desert Which Is Being Replaced by Permanent Highway Built on a High Level

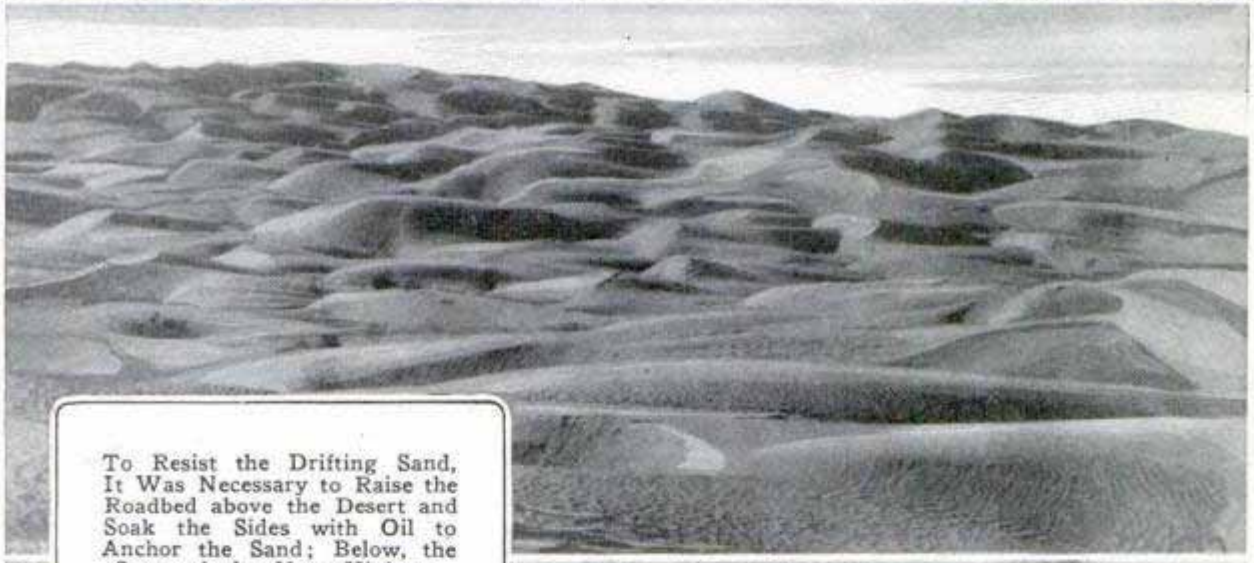

To Resist the Drifting Sand, It Was Necessary to Raise the Roadbed above the Desert and Soak the Sides with Oil to Anchor the Sand; Below, the Start of the New Highway

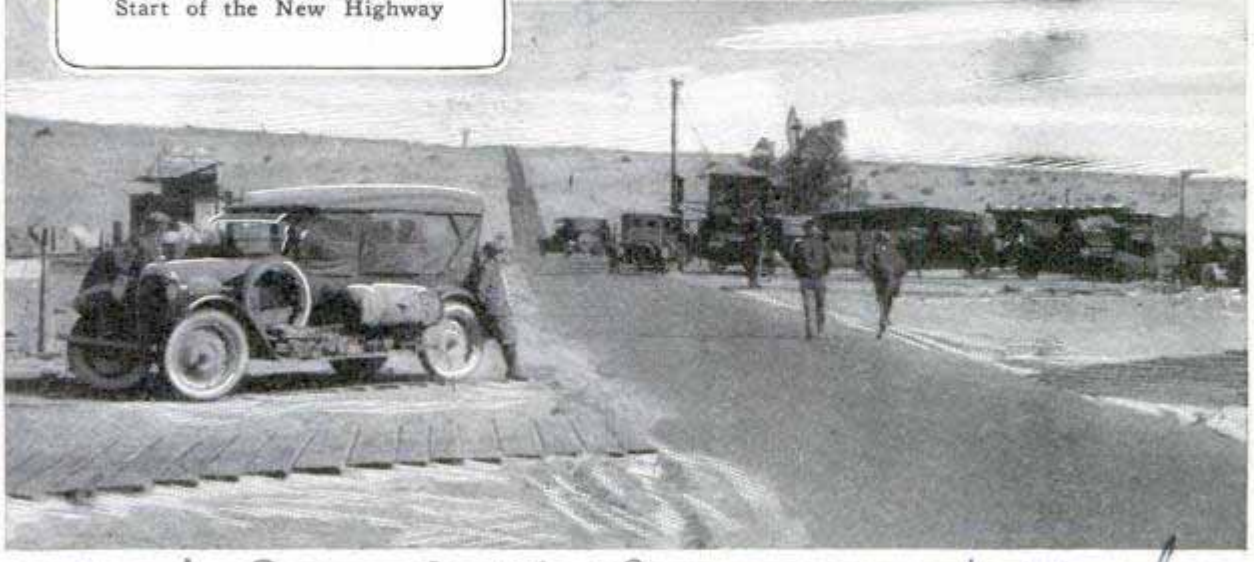

Cont. Miss Belle Margaret Harkins 915
 208 Baltimore Ave.
 800. So. Burlington Ill.

Speaker Corp. of Phila.

445

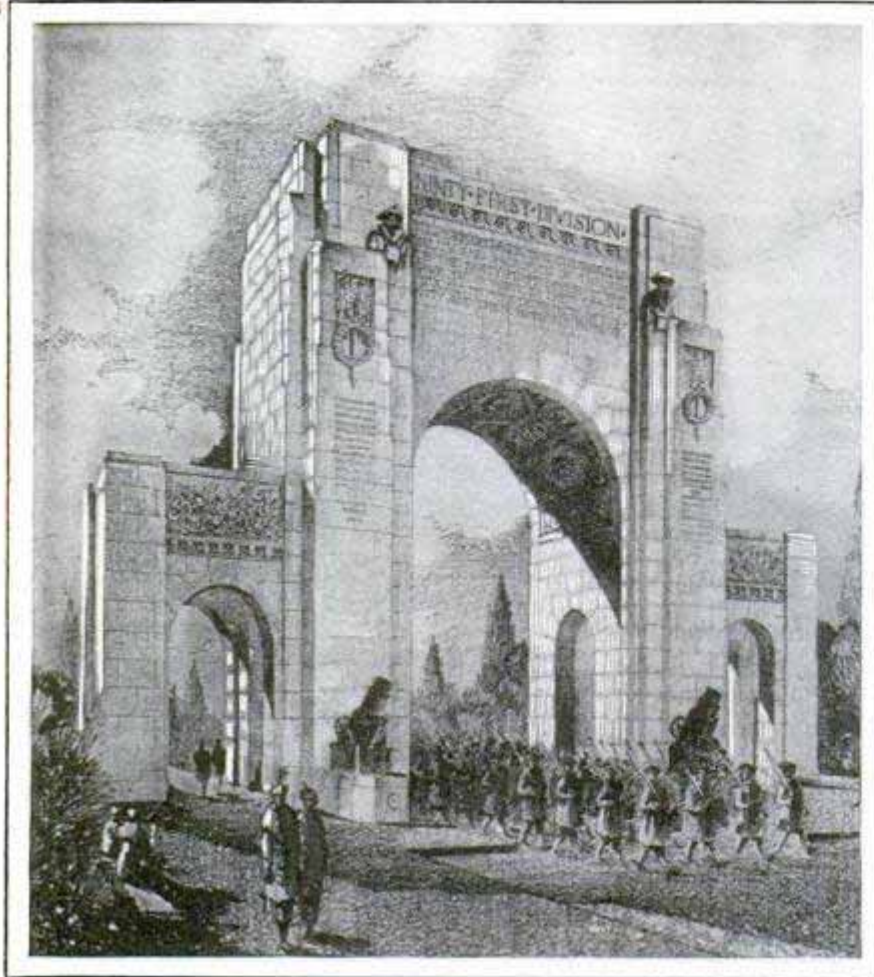

In Honor of the Heroes of the "Wild West" Division, Stone Arch over Camp Lewis Highway near Seattle, Washington

STONE ARCH SIXTY FEET HIGH HONORS WAR HEROES

The heroic figures of two doughboys flank the inscription on a massive stone arch erected over the Camp Lewis highway, near Seattle, Wash., in honor of the men of the ninety-first or "Wild West" division. The monument is sixty feet high and cost approximately \$100,000. Two smaller spans at the sides emphasize the proportions of the central arch which bears a dedicatory inscription.

MUSIC FROM PLANE IS HEARD WITHOUT RECEIVERS

Enter the "singing and talking airplane." Successful sending of music and speech from an airplane at altitudes ranging from 1,000 feet to a mile with such volume that the sounds could be plainly heard by persons on the ground without the help of radio receivers or other apparatus was a feature of a recent air meet in Philadelphia. The plane was equipped with

powerful amplifying instruments so adjusted that they would not be damaged when the ship took off or landed. Engineers believe this demonstration opens up a new field of usefulness for the airplane. With such equipment, observations and other important data could be relayed directly to listeners on the ground. It is pointed out that the day of an "aerial town crier" may be at hand. He will be able to announce news bulletins and other information while moving swiftly overhead.

COMBINED SANDER JOINTER AND EDGER

A novel type of sander, recently placed on the market, combines three tools in one machine, yet has but one moving part, the armature of the motor. The novelty lies in the fact that the armature is also the sand drum, the sand paper being wrapped around it. The machine can be operated as a hand sander, working like an ordinary plane,

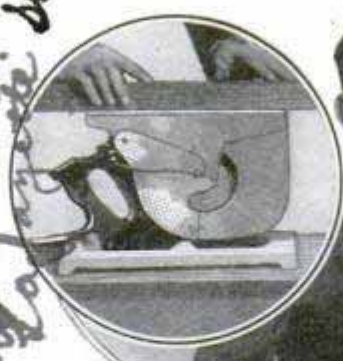

Novel Sander Operated Either by Hand, or Reversed, in Special Mount, to Become Table Type

Electric Co.

Designed and installed by Blee Laboratories and Graybar

Sikorsky
new York - Chas. A. Sikorsky
178

And Way Co. Profuds.
Ceday own.

Western Electric Co. No 1
Public Speaking

Chicago - H. L. Rogers
440
1st Dearborn

Brooklyn, N.Y. 917

and turned upside down in a special rest, it becomes a table sander. It is equally useful for edging casings and similar work.

SALTNESS OF SEA IS TESTED TO TRACE ICEBERGS

484

How salty is the ocean? To members of the ice patrol, the question is not an idle one, for its answer may give them a clue as to the movements of ocean currents and hence the presence of bergs that may drift down into the shipping paths, menacing life and property. Just recently, an instrument has been devised for making rapid and accurate measurements of the salt content of samples of sea water on ship board. It operates on the principle that the resistance in an electrical circuit varies with the salt content of the water. By means of current supplied by a microphone hummer, and a set of head telephones with the instrument, the investigator is able to detect the difference in resistance offered by samples of water placed in the tester. Two ice-patrol cutters, the "Modoc" and the "Tampa," have been equipped with these instruments and 622 tests were made on board the latter vessel during the season just past. The method has proved much more rapid and accurate than the chemical process of treating the water with silver nitrate.

AUTO AWNING KEEPS OUT SUN AND DIVERTS RAIN

365

An automobile awning that fits in the top of the door and opens with it has proved a valuable accessory, particularly in the southern states. The awning projects a few inches from the side of the car, and hangs low enough to afford shade without obstructing the view. The metal frame is strongly made, to prevent rattles or flapping, even if the car is running at high speed.



Automobile Awning in Place, Showing How It Provides Shade from the Sun for the Passengers

L. H. Williams,
Box 1177
St. Joseph, Mo.

SUITCASE MOUNTED ON WHEELS TO SIMPLIFY CARRYING

318

A folding wheeled carrier, opened or closed at a touch, has been devised for handling luggage more easily.

Suitcase Rolls along Easily on Wheeled Carrier Which Folds Up When Not in Use



And, Miss Maude Dealy

When shut, only the small wheels project and the standard may be adjusted to various heights to suit tall or short users.

Can be ordered through department or sporting goods stores

CHINESE COIN MONEY FOR DEAD TO BURN AS OFFERINGS

478

How a religious belief affects the economic life of a people is illustrated in China, where it is thought that dead persons need money as much as the living do. Hence, the manufacture of a special kind

of coin, which is burned as an offering to the spirits, has become a large business. In one province, it amounted to \$15,000,000 last year. The money is of tin-coated paper, fashioned in the form of a small shoe, and is hollow so that it will burn easily. Sometimes thousands of them are burned at once.

The Chinese Economic Bulletin, 1/14/26, Nan H. Yang, Peking, China.

made at Sheching Province

151

Information from...
Detective Pub Co.
1029 S. Wabash Chicago

The New WAR

See also Services - Federal Laboratory Sales Co.,
1018 Westinghouse Bldg.,
Pittsburgh, Pa.

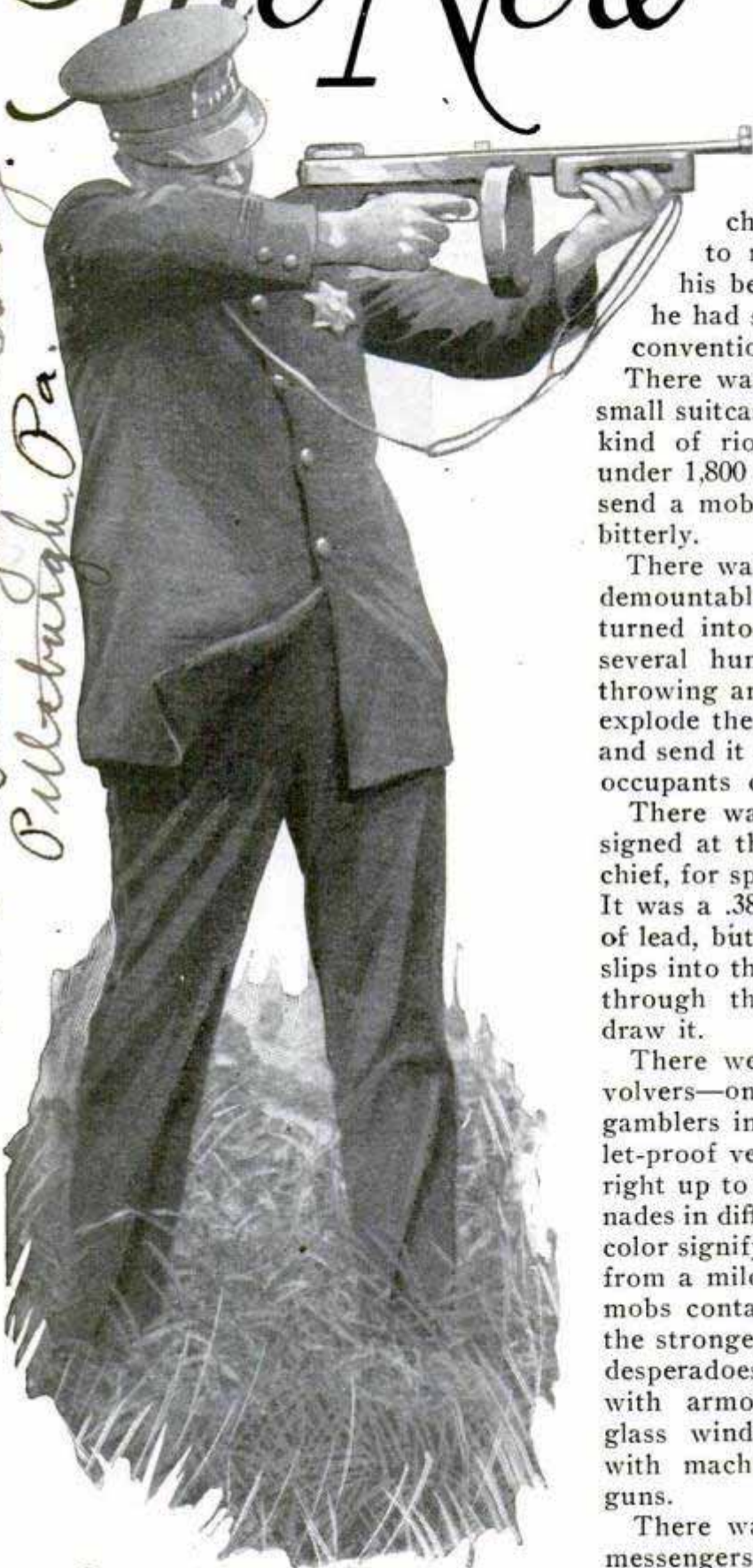

THE old-fashioned policeman, who relied chiefly on a locust night stick to maintain peace and order on his beat, would have been dazed if he had seen the exhibits at the recent convention of American police chiefs. There was an affair that looked like a small suitcase, but turned out to be a new kind of riot gun, loaded with tear gas under 1,800 pounds' pressure, sufficient to send a mob of 2,000 men home, weeping bitterly.

There was a light machine gun with a demountable stock, so that it could be turned into a revolver, capable of firing several hundred shots in a minute, or throwing an incendiary bullet that would explode the gasoline tank of a bandit car and send it up in flames almost before the occupants could tumble out.

There was a new model revolver, designed at the request of Chicago's police chief, for special use of plain-clothes men. It was a .38-caliber gun, firing 200 grains of lead, but with a barrel so short that it slips into the coat pocket and can be fired through the coat without stopping to draw it.

There were tear-gas cartridges for revolvers—one of them stopped 150 angry gamblers in a single raid one night—bullet-proof vests that enable a man to walk right up to a spitting revolver; hand grenades in different colors, four of them, each color signifying the contents, which ranges from a mild little sneezing gas for mixed mobs containing women and children, to the strongest of tear gases for barricaded desperadoes. There were motorcycles with armored shields and bullet-proof glass windows, their sidecars equipped with machine guns and sawed-off riot guns.

There was a suitcase handle for bank messengers' bags, harmless so long as the

918 Patent controlled by Auto-Armance Corp. Mfg. Cold Arms
Mfg. Co. Conn

Protective Examiners Corp.
Louis Wiesbrod, Agent, 358 W. Madison
Chicago. 157

on CRIME



Police Chief Testing a Bullet-Proof Vest by Firing Point Blank at the Inventor, Who Wears the Vest and a Smile; on Left Page, the Latest Light Machine Gun

owner holds it, but throwing out clouds of tear gas if any unlucky bandit should force the messenger to drop the bag, and a briefcase for bond messengers that worked the same way.

A pretty little desk ornament, sometimes in the form of a lizard or modeled after a racing greyhound, turned out to be a gas bomb. Connected to a radio C-battery, with wires and switches at each door and window, it is designed to protect your house from burglars, or, placed on the cashier's counter, with a foot button on the floor, it will guard against holdup men.

Two neat little nickelplated devices, which might be mistaken for some new kind of automobile ventilator, were screwed on a car in place of the cowl lights. A button on the floor connects them to a tank of gas and, when pressed, distributes blinding tears among all within a twenty-foot range on either side of the automobile.

There were innocent-looking devices that can be distributed around the factory paymaster's office to cover it with a screen of smoke and gas; gas bombs to be installed in the safe, and even one of those oversized bright-red fountain pens that turned out to be the latest thing in personal weapons, shooting a .38-caliber tear-gas cartridge through a false plug in the end.

In the armament line, there were guns that ranged all the way from the short-barreled revolver for detectives to the old-fashioned frontier model Colt of 1878, the single-action gun that won the west, and is still sold in quantities out there. An expert pistol shot demonstrated the latest things in quick draws and rapid firing. The feature was an upside-down shot. He advised the policemen to carry an extra gun, worn butt forward on the left hip, and to be drawn with the left hand, flipped forward and fired upside down by

151
 Superior Motorcycle Co.
 Springfield
 Mass.



Short-Barreled Gun, Top, Can Be Fired through the Pocket; Center, Armored Sidecar with Bullet-Proof Glass, and, Below, Firing a Gun Upside Down with Left Hand

the little finger, or any other finger that happened to fall in the trigger guard. The idea is that, if the officer is holding one prisoner with his right hand, or his right arm is injured by a shot, he still has the left-hand gun to fall back on.

Most policemen carry .38-caliber double-action revolvers. Few put their trust in automatic pistols, and few carry anything smaller than a .38, as the lighter arms lack stopping power. To increase the latter, one of the arms companies exhibited a new type of police ammunition, with a 200-grain lead bullet without any jacket. Steel and copper-jacketed bullets make neat holes for the surgeon to patch up, but don't always put the bandit down for the count. The new ammunition is almost a dum-dum, making an enormous hole. Fired through a telephone book

two inches thick, the lead pellet cut out perfect cones, small at the front and two inches or more across where it came out at the back.

The exhibits of devices for fighting crime were many and varied, but even more space was devoted to traffic-control equipment—something the old-fashioned policeman with his locust stick never heard of. There were automatic lights of a dozen varied kinds; metal markers that can be driven into the pavement and will last for years; new kinds of paints for traffic signs, guaranteed to stand up for weeks under constant heavy traffic, and signs that come stuck together like fly paper and are unrolled, slapped down, and left for the passing auto tires to iron into place.

And for the old-fashioned policeman, one exhibitor—and only one—showed the new styles in locust night clubs, but another whose

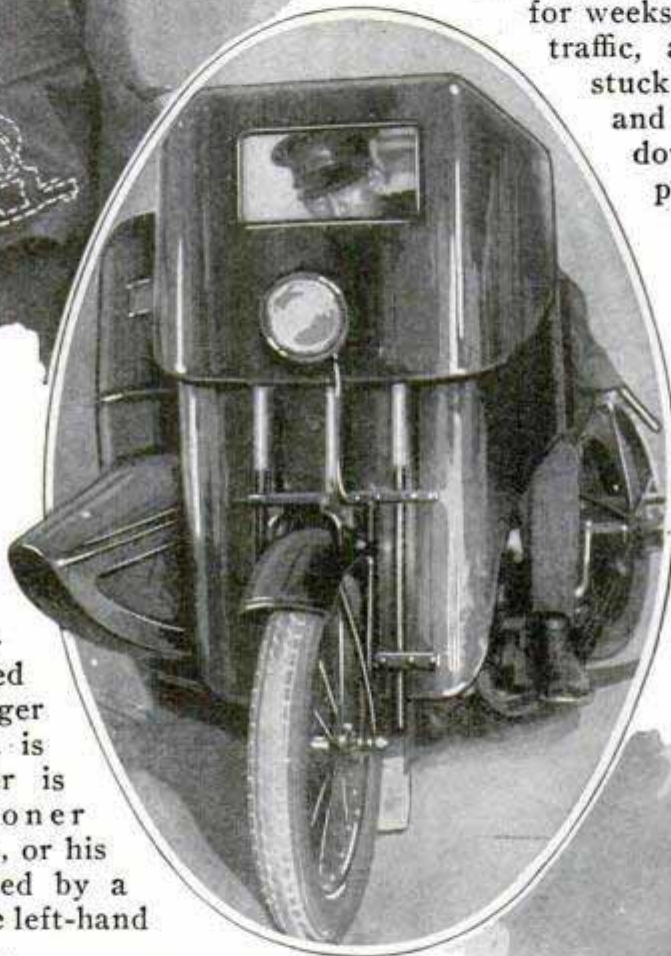



Full-Sized Human Target, with a System of Scoring for Disabling or Fatal Wounds, Is Used by Policemen on Their Revolver-Practice Ranges



Above Is a Tear-Gas Cylinder That Fits inside the Bond Messenger's Briefcase, While a Chain and Finger Ring Work the Trigger; the Unlucky Thief Who Grabs the Bag Soon Finds He Can't Hold It Because of the Cloud of Gas

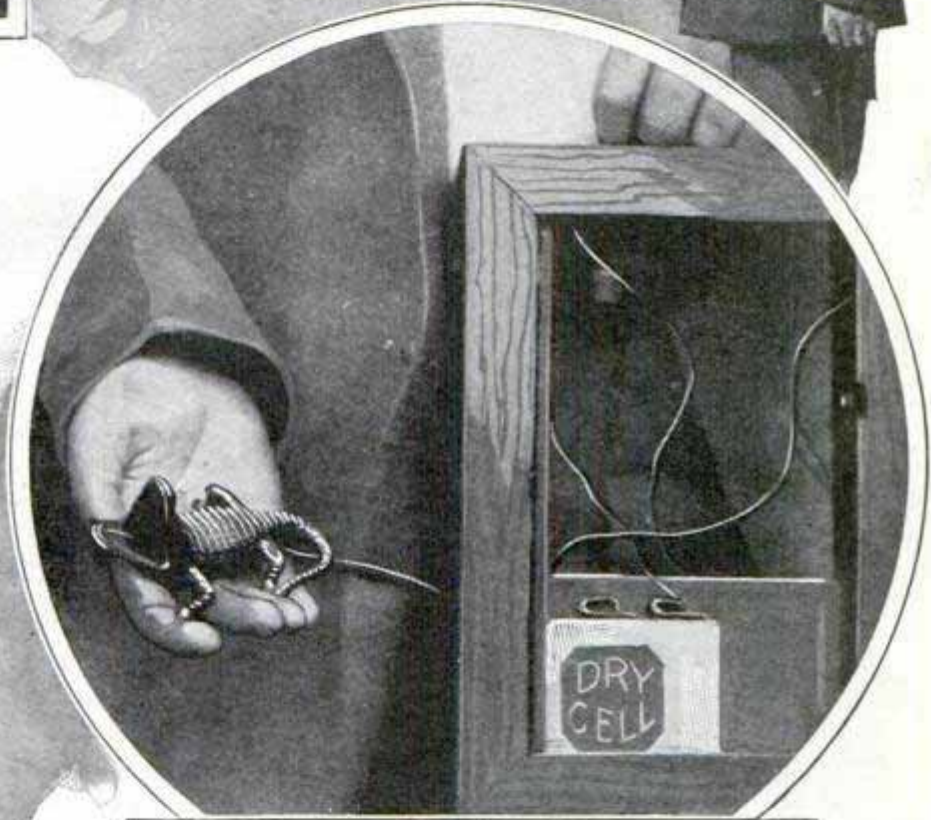

An Innocent Little Ornament Conceals a Tear-Gas Cartridge Which Is Fired if Anyone Opens a Door or Window Connected in the Electrical Control System



Suitcase Tear-Gas Riot Gun and a Suitcase Handle Concealing a Gas Bomb Which Is Discharged if Pressure on the Trigger Relaxes

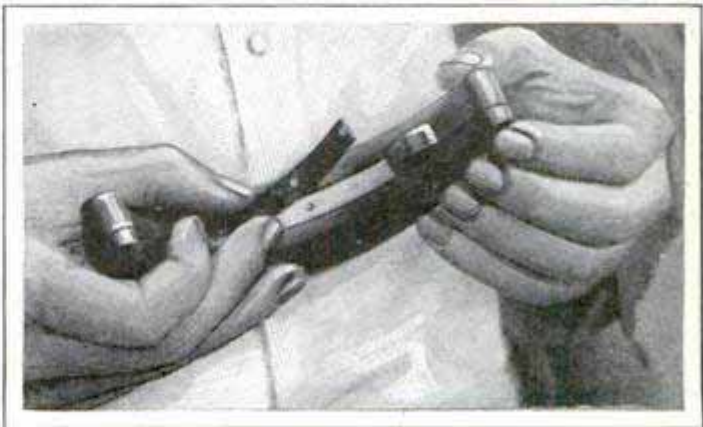

151

Concealed in the Police Billy Is a Gas Cartridge Which Will Make the Most Hardened Bandit Drop His Revolver

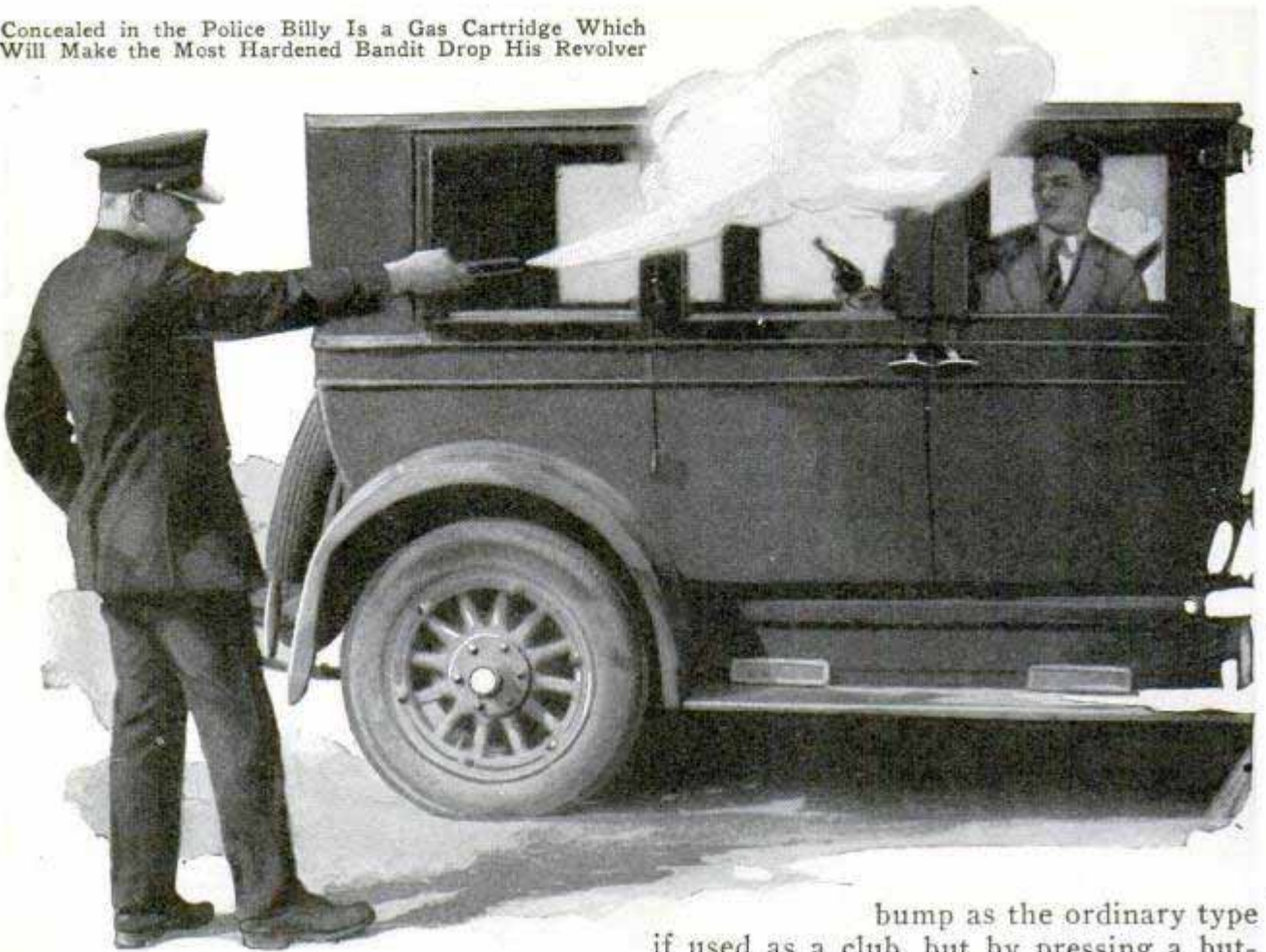

display of billies turned out to be tear-gas bombs attracted more attention. They look exactly like the old-time article, and

are fully as capable of raising a large

bump as the ordinary type if used as a club, but by pressing a button at the end they will shoot a cloud of gas into a man's eyes.

MACMILLAN FINDS NORSE RUINS NEAR AMERICAN SHORES

Norse legends reciting that vikings settled in America more than 400 years before Columbus discovered the land were further substantiated recently when Donald MacMillan, arctic explorer, returned from Labrador and Greenland with word that ancient ruins on Sculpin island, twenty miles off the coast of Labrador, bore close resemblance to Norse ruins he explored in 1925 in Greenland. No inscriptions were uncovered in the first examination, but the ruins were so like the viking relics in Greenland as to furnish almost positive proof of their similarity of origin. The explorer plans to go back next year to establish a permanent scientific station near the island, and at that time will dig further in search of inscriptions.



The Latest Thing for Personal Protection Is an Oversize Fountain Pen That Is Really a Gas Gun in Disguise

N.Y. Herald Trib.
9/5/26

Amerson Chemical

SHRUB MAY SOLVE RUBBER PROBLEM ⁴²⁸

America may become independent of foreign-grown rubber by cultivating the guayule shrub, which is found in northern Mexico and parts of Texas, and is now being grown in California, according to announcement at a recent scientific congress. Improvement of the plant under cultivation and better methods of extracting the rubber have solved the major difficulties, it was said. A rubber-company president, who made the announcement, explained that the billion pounds of rubber consumed each year in the United States required the labor of 600,000 plantation workers, whereas the same amount of guayule rubber could be grown on American farms with about 40,000 workers.

Mr. David Spense
Continental Rubber Co.
TRUCK SHOVELED UNDER LOAD
REDUCES LABOR COST

⁵⁰⁸
 Economy and ease of operation are claimed for a two-wheeled truck that has a shovel-like extension which slips under boxes, barrels or other objects. One man with this outfit can lift 500 pounds, it is asserted, often saving the time and expense of a helper. The strong handles afford ample leverage when the load is once adjusted. The truck is designed for operations in close quarters and, after use, it is easily slipped out from under a heavy package.



Shovel Extension on Truck Is Readily Slipped under Load

Alumite Die Casting & Mfg. Co.
 2640 Belmont Ave.
 Chicago

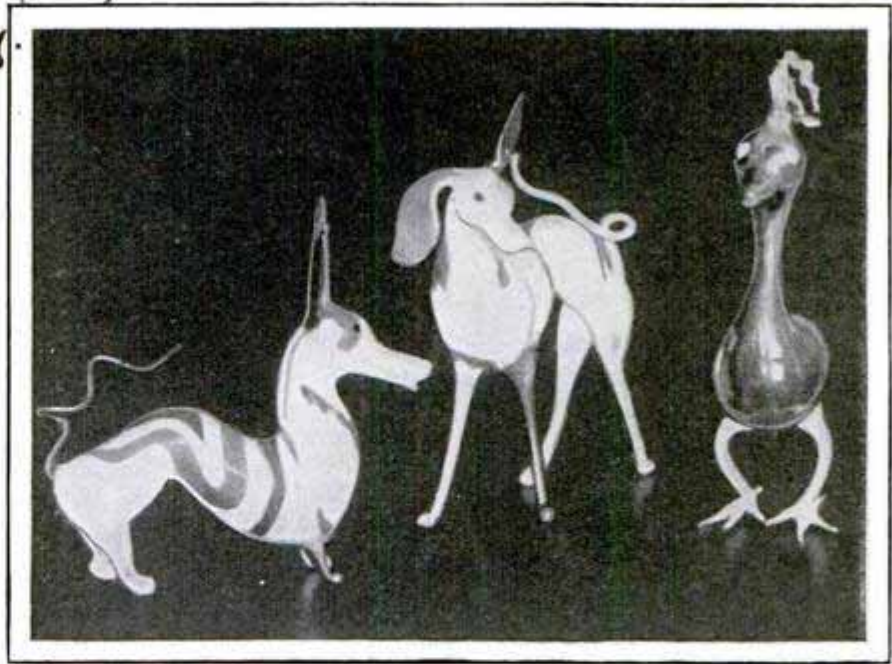

One of the Latest Fads from Berlin, Wooden Dogs and a Duck, Carried by Women instead of Live Pets

WOODEN DOGS ARE CARRIED BY WOMEN OF FASHION ⁴²³

Women of fashion in Germany are carrying wooden dogs and other animals, fantastically carved, instead of live ones. The wood substitutes require no attention and no food, which makes them much easier to keep. An Austrian artist is responsible for the fad, having created most of the designs so far in use.

PHONE SMALLER THAN WATCH FOR MINE-RESCUE WORK ⁵⁸¹

To communicate with the forty-three miners who were trapped in the cave-in of a shaft near Ironwood, Mich., last September, a tiny phone, smaller than a watch, with receiver and transmitter combined was constructed. It was one and three-quarters inches long, three-eighths of an inch wide and one-quarter of an inch thick, and was to have been lowered to the imprisoned men through the drill pipe. A howler was attached instead of a bell.

Thomas H. Hampton, Co.
Alver Building

1917

POPULAR MECHANICS
American Philatelist, 807-2nd
226 Federal St. Portland, Maine
Francis Weekly Stamp News



Worker Making a Test Run on Cable That Hauls Persons to the Top of an 11,000-Foot Peak in Germany

CABLE ROAD UP ALPINE PEAK BUILT FOR TOURISTS

Travelers are hauled to the top of the Zugspitze, an 11,000-foot peak in the German Alps, in cars suspended from a strong steel cable. Twenty persons can ride at once in the passenger cars.

SEARCH FOR FREAK STAMPS YIELDS FORTUNES

When an absent-minded engraver put "post office" instead of "post paid" on a plate to print some stamps for the wife of the governor of Mauritius back in the middle of the last century, he unwittingly

laid the basis for several small fortunes. Two of the stamps, still pasted on an envelope, were sold not long ago, for \$86,000. The plate was destroyed and only a few stamps made.

They had been ordered for invitations to a ball given by the governor's wife. Stamps were then an innovation. Hardly a year passes without some country blundering in one of its issues. The resulting "freaks" are eagerly sought and prized by collectors throughout the world. Shortly after the air mail was started in the United States, a young man purchased 100 twenty-four cent stamps and received a thrill when he looked at the sheet, for the aeroplane on the design was printed upside down. He went back to the window for another 100. The clerk explained the mistake and asked to have the first sheet back in return for others, but the young man refused. He took it to a stamp expert and received \$10,000. It is now in the collection of Col. E. H. R. Green, son of the late Hetty Green, and is valued at \$20,000. The

Columbian exposition in Chicago yielded another odd mistake. On one issue of special stamps made for the occasion, Columbus, smooth-shaven, was seen sighting land and on the other, actually landing but wearing a full beard. Another highly prized freak stamp was issued from the island of St. Kitts in the British West Indies. It shows Columbus using a telescope, an instrument that did not appear until many years after the great explorer. Early "provisional" stamps issued by individual post offices before the federal government had authorized stamps are also highly valued. One from Boscawen, N. H., brought \$12,000 recently. The same price was paid for a provisional stamp

national Bank Bldg. New Hampshire Bldg. 111
This also stamp also

N.Y. Herald 9/19/16

issued by Alexandria, Va., and one, dated 1846, from Lockport, N. Y., brought \$10,000. Fortunes in stamps are sometimes found on letters that have accumulated in rubbish piles. A stamp company found \$15,000 worth in two carloads of waste paper and \$75,000 worth was found when an old bank moved into new quarters.

SILENT RADIO REPLACES FOG GUN 460

Booming of the fog guns is less frequently heard around the harbor of Calais, France, for many ships are now piloted through mists with the aid of radio signals broadcast on such high frequency that they are inaudible to the human ear. A special sending apparatus transmits the impulses which are picked up on receiving sets on the vessels. By means of the direction and volume of the sound, as registered, the navigators can follow a safe course.

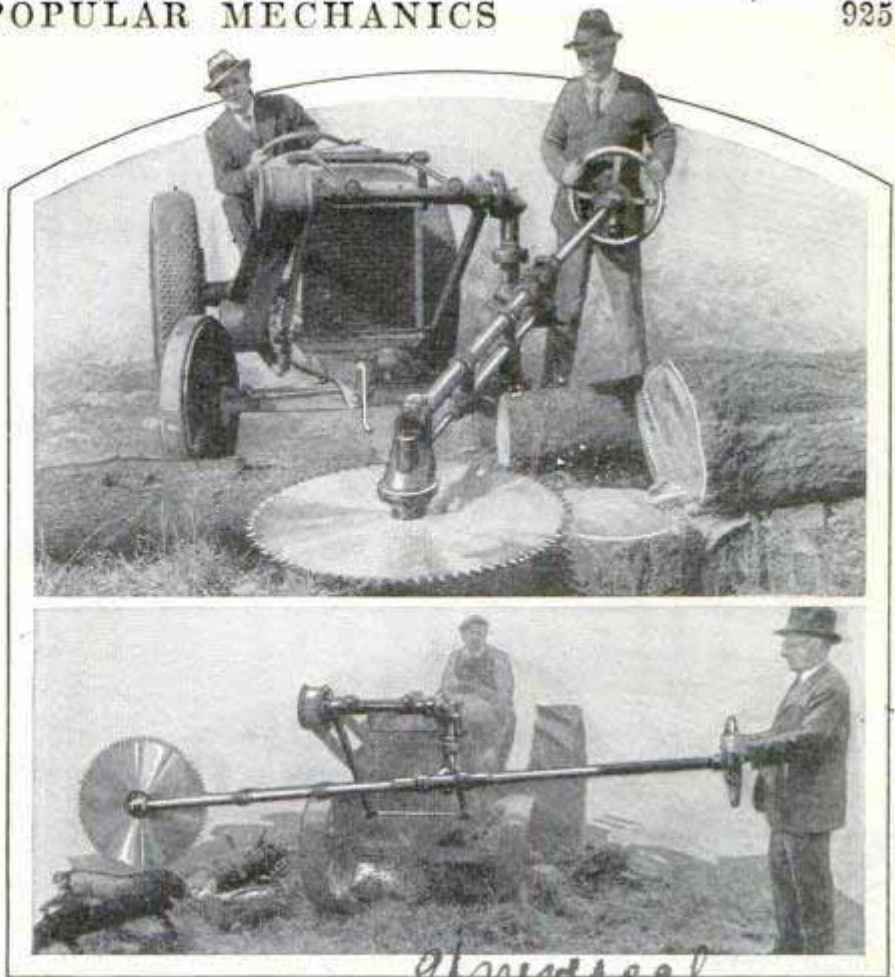

Tractor Sawmill in Operation, to Show How Easily It Can Be Adjusted to Different Cutting Tasks

SAW ATTACHMENT FOR TRACTOR CUTS AT ANY ANGLE

Reversing the usual method, the sawmill can now be taken to the tree in a rigging for the farm tractor. It can be attached in a few minutes, the makers assert, folds close to the machine, when passing through brush, and can be swung about to cut at various angles, as may be required to suit different jobs. The outfit is especially adapted to clearing land, sawing cordwood, logs or stumps, and auxiliary attachments are being developed for drilling wood or post holes and for cutting threads on gas or water pipe. According to reports, the rig has actually felled and sawed up to twenty cords of oak in one day.

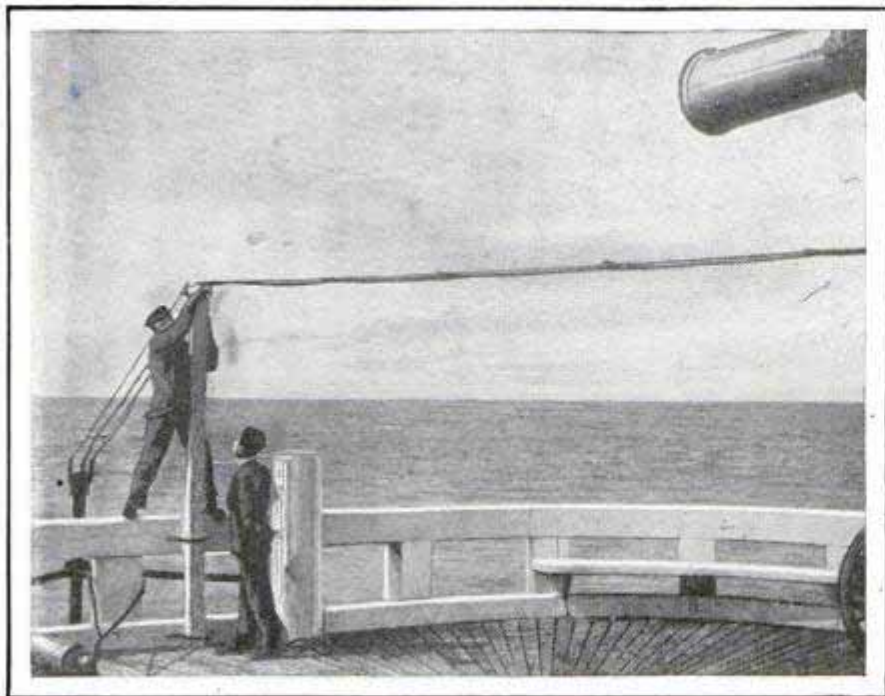

© Herbert Photos
Rigging Aerial under Fog-Signal Transmitter at Upper Right

Share Ultra & more

*D. J. Wood & Co.
200 E. 9th St. Portland, Ore.)
Export - Q. S. Cleary & Co.
330 S. Franklin St. Chicago*

BEAUTIFYING NATION'S CAPITAL TO COST MILLIONS

408

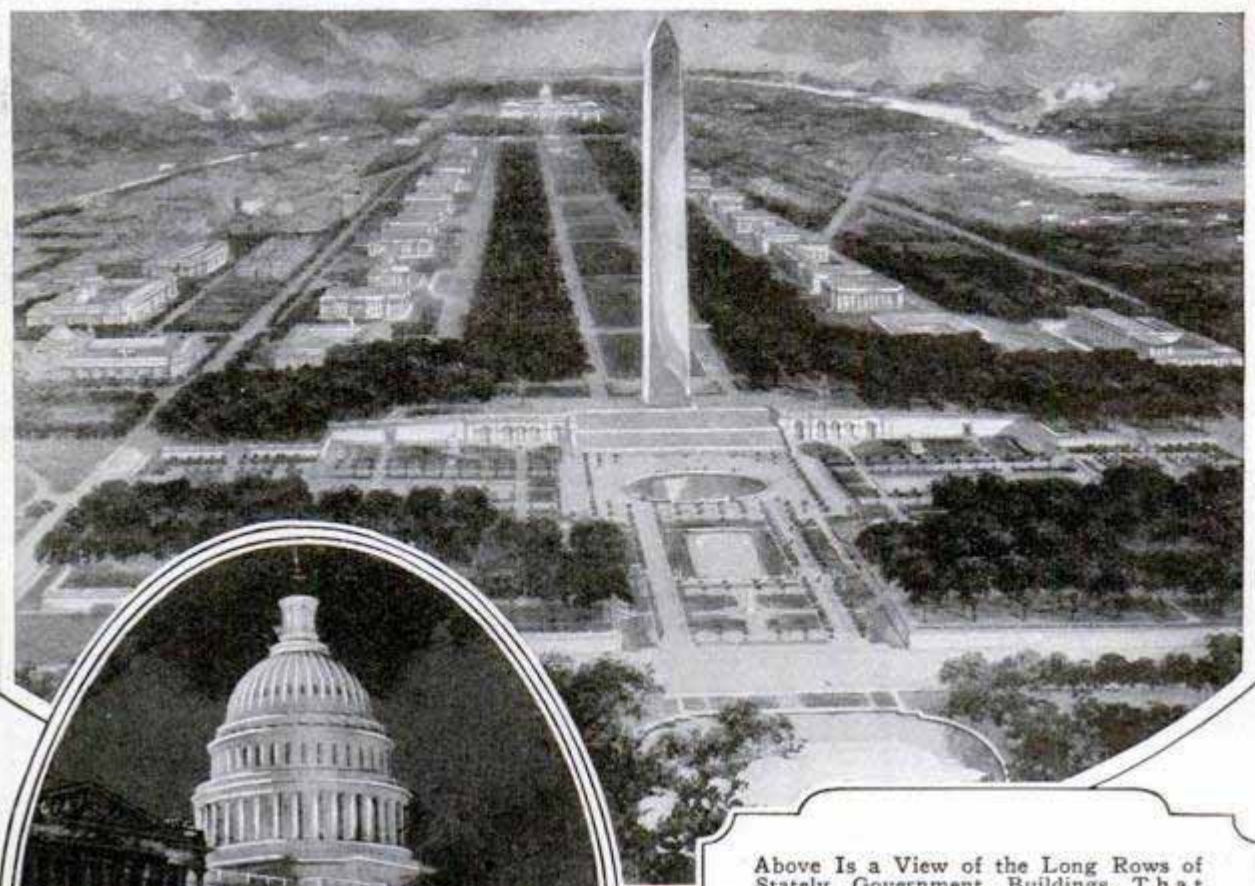

Above Is a View of the Long Rows of Stately Government Buildings That Eventually Will Line the Route from the Washington Monument to the Distant Capitol When the Plan-Commission Program for the Beautifying of Washington Is Completed; at the Left Is the Present Capitol Building and, Below, as It Will Appear When Completed by the Building of the Central Wing

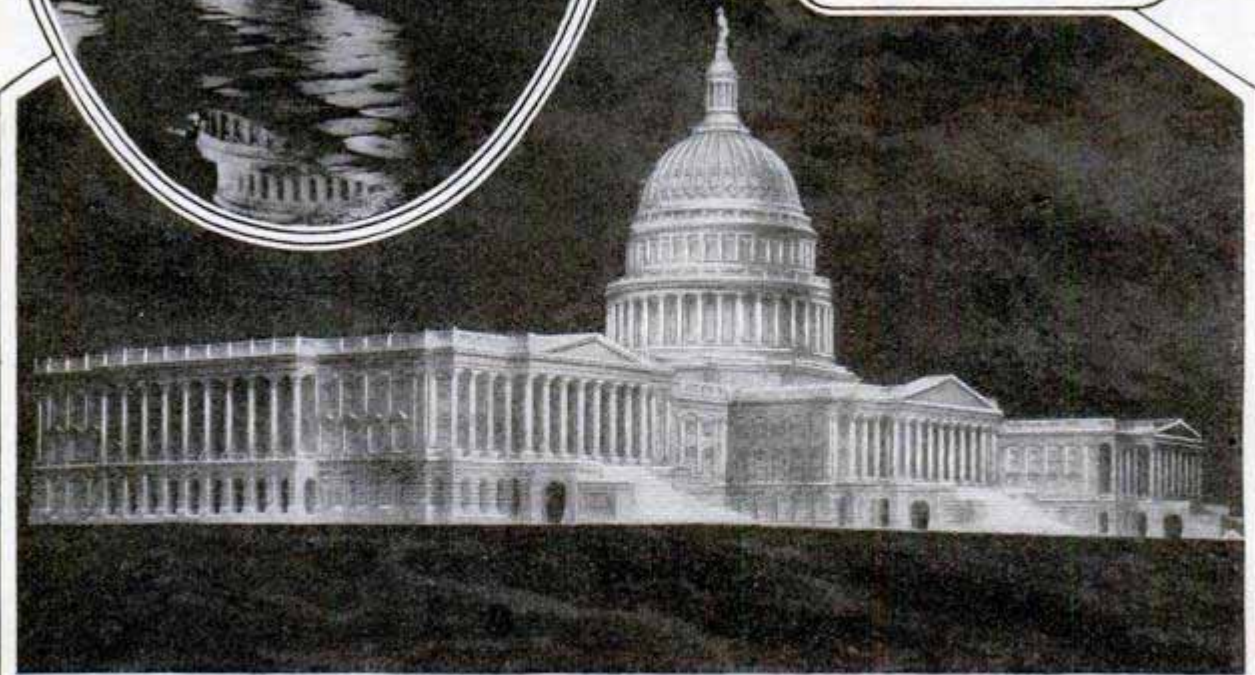

Plans for the completion of the capitol building at Washington, in accordance with the design of Thomas U. Walter, prior to the Civil war, will be presented to congress this winter as the result of the appropriation of \$165,000,000 last session for public buildings in the capital, and for post offices and other structures in other cities. The plans call for removal of the old east portico and the substitution of a central wing to extend out in line with the senate and house wings, and for the renovation of the rotunda to the original design. The central portion was fostered by Washington, but was not completed until 1830. The two wings, housing the house and senate, were begun in 1851 and completed in 1859, and since that time successive congresses have turned a deaf ear to appeals for funds to complete the building. The program authorized by the last congress includes permanent buildings for the departments of commerce, justice, labor, state and agriculture, a monumental home for the supreme court, and buildings for the internal-revenue department, liberty-loan annex, additions to the government printing office, etc. Practically all the new buildings will be in the Mall area, lining the long vista from the Washington monument to Capitol hill.



© Herbert Photos
 How a Painter Solved the Hot-Weather Problem;
 Small Fan Attached to Support Kept Face Cool

PAINTER WEARS ELECTRIC FAN FOR COMFORT AT WORK

By plugging an electric fan to the house-lighting circuit and rigging it to a support on his back, a painter avoided discomfort on a severely hot day. Wiring and attachment were arranged so as not to interfere with the worker's movements.

STEEL PURIFIED BY SHAKING WHILE IN MOLTEN STATE

By subjecting molten steel to about 100 jolts a minute, a German metallurgist is reported to have found a way to liberate most of the gases and sulphur from the melt which often cause bubbles and other imperfections in the finished product. The furnace itself is shaken and the effect is said to be similar to that which occurs when a bottle of ginger ale is bounced or jolted to help remove the gas. The steel made by the process is reported to be so pure that it is well adapted to the manufacture of thin castings.

MUFF AND HANDBAG COMBINED LATEST PARIS FASHION

Muffs have come into fashion again in Paris in a serviceable form of combination hand warmer and bag, doing away with an extra article of luggage. It is made of black velvet with a silk lining, and space sufficient to hold toilet accessories and other things for an overnight trip is provided on the inside. The contents are securely held against falling out by accident.



© Herbert Photos
 Bag Open, Showing Pocket, and Carried as Muff

Harry Sloneer Newark N.J.

making umbrella.

Iron age

458.

928

*Hotel Baltimore Crumrine, Cr. ed
designed by J.A. Spengler, Jr. mgr. lighting
Dept. of Public Works
53
Lighting Dept.*

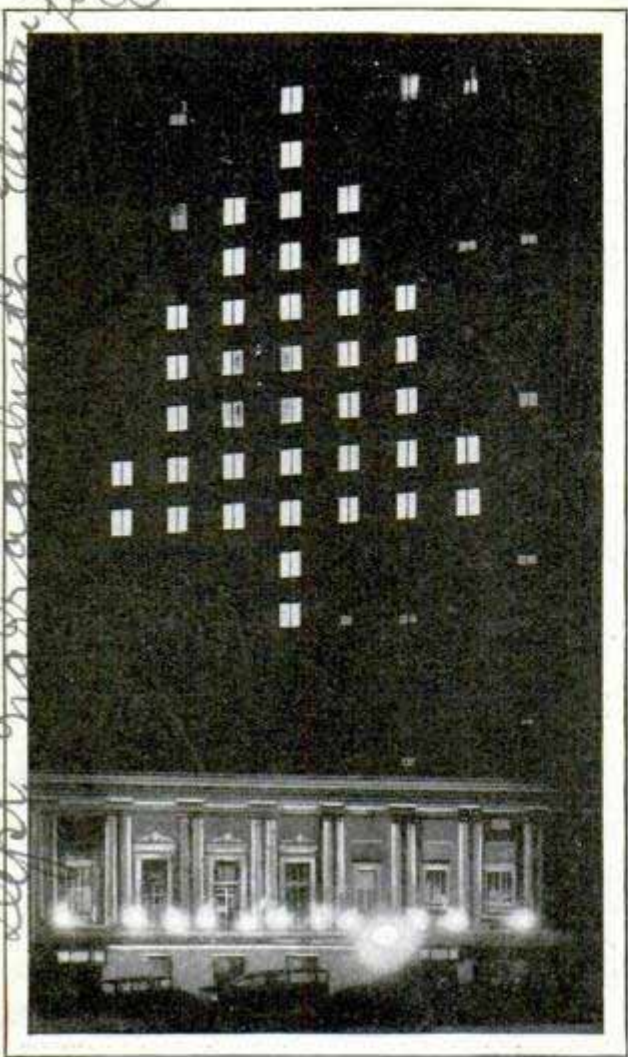

Christmas-Tree Design of Lighted Windows in Big Office Building; Green Shades Heightened Effect

PATTERN OF LIGHTED WINDOWS FOR HOLIDAY DISPLAY

Outlined in glowing green on the side of a large hotel in the east, the figure of a Christmas tree presented a striking holiday appearance at night time. The effect was obtained by shading the windows with green crepe paper and lighting only those rooms arranged to form the shape of the tree. Lamps of increased brilliance were employed to augment the glow.

HEAD, NOT BAD EYES, TO BLAME FOR MOST AUTO ACCIDENTS

574

Defective eyesight is less to blame for auto accidents than deficient mentality, in the opinion of Dr. Harold D. Judd, of Detroit, Mich., who recently made an analysis of 100 motor mishaps. He concluded that a man with but fifty-per-cent visual efficiency and a nearly 100-per-cent mentality would make a more careful

driver than one with perfect eyes and poor judgment. Observation also showed that a combination of good eyes and full intelligence often makes a man more careless than the one who knows his eyesight is not good, but who is normal mentally. To make his study, Dr. Judd devised a way of testing the vision and alertness of the drivers at the same time. The subjects were seated before a screen and instructed to tell what they saw and what action they would take as soon as they were certain of the sign being projected on the curtain. A slide with the word "Stop" was first shown. The letters were too small to be distinguished at the beginning, but were gradually increased in size until the subject could identify them. The quickness of the response was considered a measure of eyesight efficiency and alertness as well. The use of the slide was based on the theory that objects are really recognized by their form long before they reach the size at which they are actually distinguished.

ROPE TIED IN SAILORS' KNOTS WOVEN INTO BASKET

The decorative possibilities of useful knots seamen employ were suggested in a rope basket fashioned by a sailor. The cords were twisted and tied into a sturdy framework of fancy pattern and the basket



Basket for Holding Flowerpot Fashioned of Rope Tied in Sailors' Knots of Various Kinds

shaped for holding flowerpots or for other decorative purposes.

*Stone 2957 Washington St.
San Francisco, Calif.*

Cover, C.C.

psa

*University of California
Berkeley, Calif.*



Charles Kellogg

Sensitive Flame at Left and, Right, Microphone That Transmitted Voice to Extinguish the Blaze, Which Was Twelve Miles from the Broadcasting Station

**RADIO VOICE PUTS OUT FLAME
TWELVE MILES AWAY**

Radio reproduction of a high-pitched male voice extinguished a sensitive flame about twelve miles from the broadcasting station during a test from KGO recently. The experiment was witnessed by a number of scientists and students. A shrill note was sounded by a man whose voice resembles that of a bird. As the vibrations were reproduced at the receiving end, they caused the flame to flicker and go out. This effect of a strong, high-pitched voice on fire has been known for a number of years, but is said never before to have been demonstrated by radio.

LIGHTNING STRIKES ROAD

Instances of lightning striking concrete roads and traveling along the reinforcing have aroused the interest of engineers and inspired the question as to whether highways of this sort should not be "reinforced" against bolts as well as against cracking and load. Not long ago, a road in Florida was struck, the lightning splitting and going about 720 feet in each direction through the reinforcing before it

entered the ground. In searching for the path of least resistance, the current jumped across the pavement often, generally at the joints. In arcking across the interrupted mesh, it caused enough heat to break out pieces of concrete about a square foot in area. Other instances of lightning's effect on concrete roads are on record. A bridge pavement and railing were destroyed during one storm and a road slab in another.

**HOOK HOLDER ON FISHING ROD
KEEPS LINE FROM BRUSH**

Fastened by means of a snap similar to that on gloves, a clasp attached to the fishing-rod handle keeps the hook and line from becoming entangled in the brush and also prevents injury to the hands. It can be adjusted to any convenient position and protects the hook from damage.



496

86

*General Electric
American Society
of Civil Engineers
Berkeley, Calif.*

*described by W. S. Wheat,
Engineer of Escambia County*

*Rainer Novelty
Co., Renton
Wash.*

Physique du globe, Paris France

**SHOES FOR WALKING ON WATER
FITTED WITH PADDLES**

219

*German Steyerlein
Munich Germany*



Operating the Paddle Foot Boats; Blades Are Moved Back and Forth by Levers

By means of a rowing apparatus attached to water shoes, a German inventor has devised a fair rate of speed can be attained on smooth lakes and streams, it is reported, and the wearer enjoys the combined thrills of boating and water skiing. The paddles are actuated by hand levers rigged to the floats, which are large enough to support considerable weight.

**AIR THIRTY MILES UP HOTTER
THAN BOILING WATER?**

463

Like the deep sea, the upper air is a region of mystery. Investigators are even divided on the question as to whether it is hot or cold. Some believe that it exceeds 220 degrees Fahrenheit, others hold that it reaches a temperature as low as seventy-five degrees below zero. The problem was studied with new interest recently following a series of sound tests in France. Several tons of explosives

were set off at a place about midway between Paris and the Pyrenees. Observers, stationed at various points, were notified as to the exact time the explosions were to take place, and then made notes as to the instant the sound arrived. Wind conditions, temperature and other factors were taken into account, and the records, several hundred of them, were compared. From these data, various deductions were made as to the state of the upper air. Prof. Charles Maurain, a Paris scholar, concluded that the air has a uniform temperature up to over thirty miles. J. F. Whipple, a British weather expert, decided that the results indicated that the temperature begins to rise at about twenty miles and, at thirty, may reach 220 degrees Fahrenheit. While the cold theory seems to be supported by the findings of aviators, scientific opinion elsewhere, so far as expressed, is divided on the subject.

**PLAYHOUSE IN FORM OF CASTLE
BUILT OF COBBLESTONES**

37

Constructed of stone, a playhouse built by Robinson Jeffers, the California writer, for his two sons, has a tower like that of a castle. It is roomy and cool, and harmonizes with the rugged lines of the seashore near which it is located.

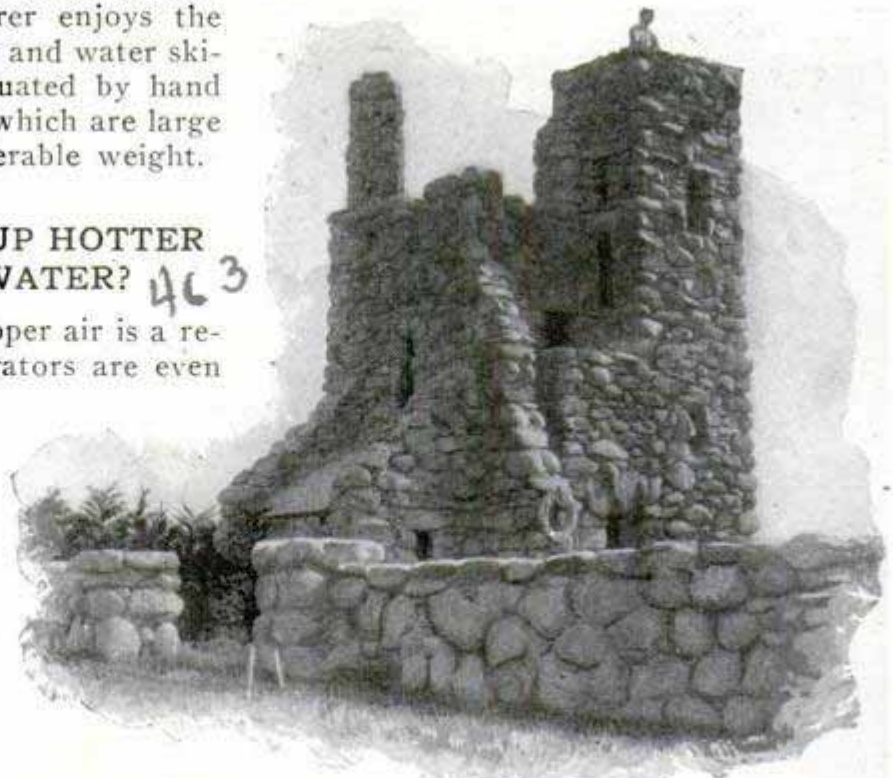

Tiny Stone Playhouse Castle Built by California Writer for His Sons; the Tower Serves as Observatory and Contains Several Rooms

*at Carmel-by-the-Sea,
Monterey County Coast.*

433

GOLDEN SPIKE DRIVEN TO MARK RAIL ANNIVERSARY

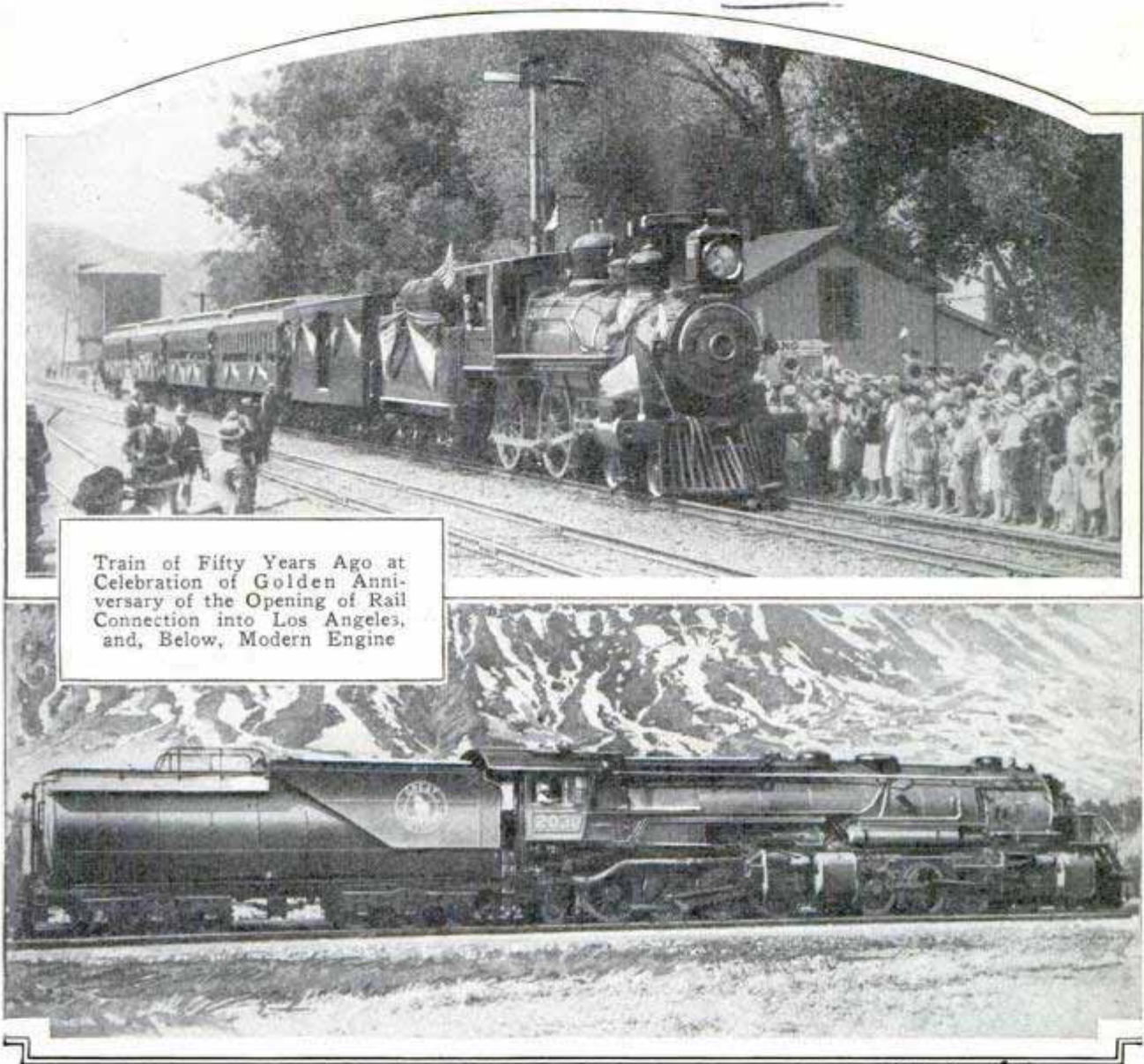

Train of Fifty Years Ago at Celebration of Golden Anniversary of the Opening of Rail Connection into Los Angeles, and, Below, Modern Engine

u + u.

The golden anniversary of the arrival of railroad transportation in Los Angeles, recently was celebrated at the wayside station of Lang, forty-five miles north of the film capital, when the original train that made the first run fifty years ago, carried pioneers and city officials to the scene. A golden spike was driven on the spot where the rails were joined half a century ago. A de-luxe special of latest-model Pullmans, drawn by one of the biggest engines in the west, brought Mayor Rolph and a party from San Francisco to meet the old-time train from the south at Lang. The difference in railroading at that time and now was strikingly demonstrated by the contrast between the first locomotive that entered Los Angeles and the new-type freight giant, which otherwise is

used by the Great Northern only to pull mile-long ore trains over the mountains.

1887

TWO-PIECE RIM ON AUTO WHEEL SIMPLIFIES CHANGING TIRES



Held together by studs in the face of the flange, a two-piece auto-wheel rim makes it easier to change tires, as neither lugs nor the usual tools are needed. When mounted,

the flange lies flat against the felloe, with the result that exact alinement of the tire and rim is obtained.

W. A. Jones, c/o National Vehicle Rim Corp

National Vehicle Rim Corp, 308, wheat Bldg.

How To Climb Mountains

By JOHN EDWIN HOAG

205 *Union League Bldg*

216
DRIVING an automobile over ordinary highways and city streets is one thing, but driving in mountainous country is quite another. A person may be the most

roads. The motorist who goes into such country for the first time has a multitude of things to consider which do not play such an important part in ordinary highway driving. The first thing to be looked after is the car itself. Some automobiles are good mountain cars and others are not. A powerful motor, of course, is always desirable. The power of the motor, however, is not so important as the size and wheelbase of the vehicle, and the weight of the load that the motor is called upon to pull over steep grades.

Any monstrously big automobile with a long wheelbase is a menace to life on steep and tortuous mountain roads. No matter how powerful it is, it cannot be handled on the turns satisfactorily and safely. It is clumsy and awkward to drive on roads that may be only a foot wider than the car itself—and particularly, when that foot of spare road is at the edge of a 2,000-foot cliff. And, just as the medium-sized car is better than the large one, the smallest of automobiles, if slightly altered for mountain use, is still better.

The Ford that is to be subjected to such use should have a variable gear transmission, adding two more speeds to those supplied by the manufacturers. It should be

The Kind of Road in the Mountains That Makes the Passengers Want to Walk



proficient of drivers under average road conditions, but literally a babe in the woods when he finds himself on a steep and narrow trail that goes wiggling up and over some titanic range of precipitous mountains.

The motor tourist from the level country meeting the hills for the first time is usually terrified. Some lose their heads completely. Others become violently ill from nerve strain. Mountain sickness, a near relative of seasickness, afflicts persons who are sensitive to changes of altitude. Automobiles become weak and languid trying to digest the rarefied atmosphere of high elevations. Radiators boil like teakettles where water boils at such low temperatures that food cannot be cooked in it.

People lacking previous experience in mountain driving make many mistakes that knowledge would enable them to avoid. Disastrous accidents are often the result. The purpose of this article, therefore, is an attempt to convey information that should be of value to the motor tourist inexperienced in mountain driving. No driver who has not had sufficient experience to handle his car by purely mechanical movements of the hands and feet has any business venturing onto mountain

Save Your Brake Bands and Put the Engine in Low, Then This Will Not Happen

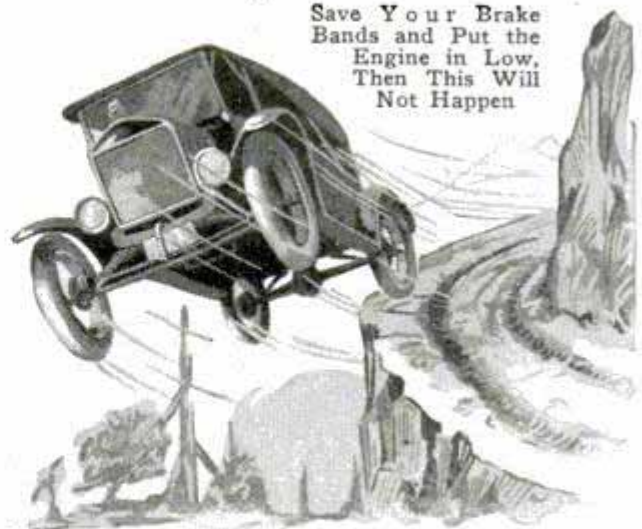

fitted with a circulating pump to increase its engine-cooling efficiency, and should have rear-wheel brakes that will stand the most abnormal demands of service with-

Safely In Your Car

Los Angeles, Calif.

out overheating or burning out. These accessories can be obtained at a cost of about \$100, and they are worth many times the price.

It goes without saying that the conditions of mountain service make it imperative that a motor car should be put in good mechanical condition before it is taken into the hills. No single part of the car should have more careful attention than the brakes. Brakes may mean life or death. If the brake bands show any appreciable wear, they should be replaced. The valves in the motor should be ground in, and the motor itself should receive every attention that will give it the last possible ounce of power.

Brakes are important for ordinary traffic driving, but a thousand times more important in the mountains. Yet the driver who attempts to come down off a mountain by pushing out the clutch and checking speed with the brakes, is literally playing hookey from the graveyard. No automobile brake that was ever built will stand such use for a single hour without going out of business entirely. The engine that drives the car up the hill is the brake to use for getting down. You can't hurt the engine by properly using it to check the speed of descending a slope. Come down in second gear or, if the hill appears to be particularly steep and dangerous, get into low before you start down. If you try to shift into low after the car has developed excessive speed in second, you may find yourself coasting down the hill in neutral.

No car can gain dangerous speed on any road grade when coming down in low gear with a closed throttle. If, however, the grade is so steep that too much speed is gained in either second or low gear, the foot brake should be used occasionally without releasing the clutch. In many mountain states road signs now tell the driver when the low gear should be used. But, if no such sign is seen, he must rely upon his own judgment. In these states, the motor laws usually stipulate that gears must be kept constantly in mesh while



The Pechecio-Pass Road in Lower California

traveling mountain roads, except when it is necessary to shift from one gear to

216

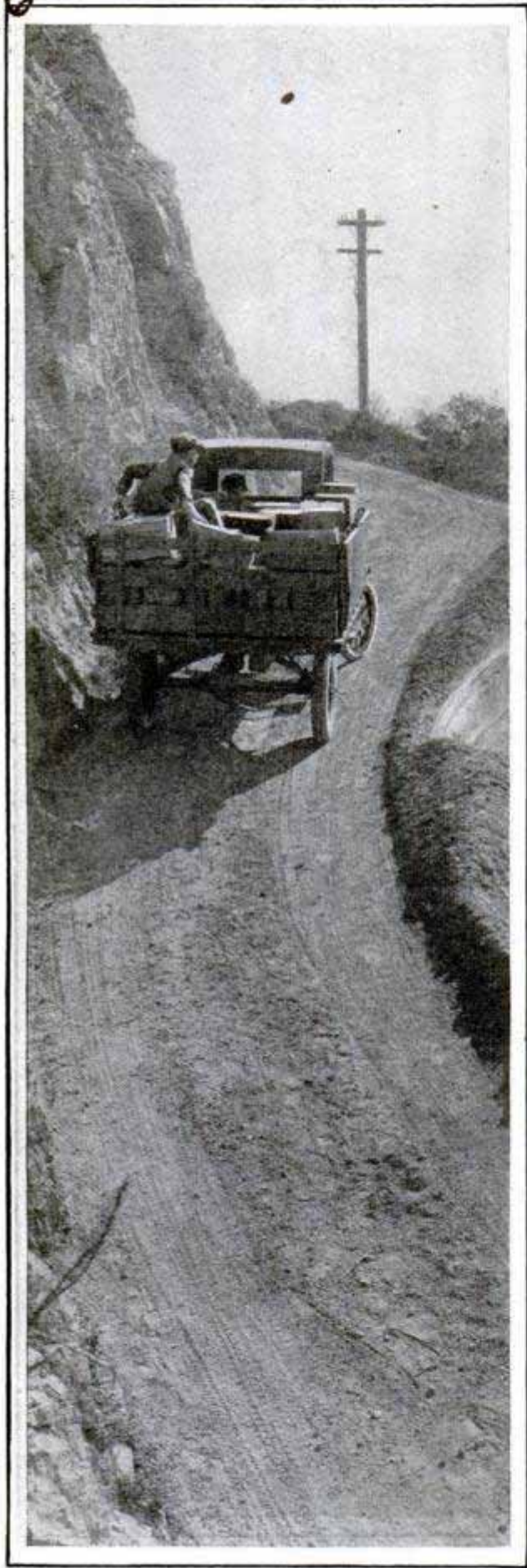

This Grade on Mt. Wilson, Rising One Mile in Nine, Is a One-Way Road; on Mountain Roads That Are Wide Enough, the Up-Bound Car Always Has the Right of Way and Takes the Inside

another. Inexperienced drivers frequently make the mistake of switching off the ignition when coming down a long steep grade in second or low gear. This is bad for the motor, because fuel that is not exploded is being constantly pumped into the cylinders. It cuts the oil off the cylinder walls and may do serious damage. A much better method is to leave the ignition on, closing the throttle as far as it will go.

In going up a grade and around innumerable blind hairpin turns, the driver must use his judgment to decide what gear he is going to need to make the grade. It is better to start up the hill in low gear than to have to shift from second to low in the middle of the grade with the attending danger of stalling the engine, and possibly backing down out of control. When a car is unintentionally stalled in the middle of a steep grade, someone should be assigned to the task of blocking the wheels before the driver attempts to start the car or leave his seat. Stones are usually available for this purpose. If stones are used for wheel blocks, it is only courtesy to other travelers of the road that they be removed before you go on.

The courts of all the mountainous states have ruled that responsibility for a collision between two vehicles on a mountain road always rests upon the driver who is coming down the grade. This is logical and as it should be, for it is almost impossible for the driver coming up to cause an accident to any vehicle other than his own. The fellow who is roaring up the grade in low gear with his foot hard and heavy on the gas can bring his car to an almost instant stop. He has but to take his foot off the accelerator—and the law of gravity stops him. On mountain grades that are wide enough to permit vehicles going in opposite directions to pass each other, it is customary, in tight places, for the descending machine to take the outside of the road. This is precisely the reverse of the American rule by which all traffic keeps to the right-hand side of the road. In the mountains one goes to the right or left according to the circumstances. If there is any question of doubt or misunderstanding of signals between drivers of machines approaching each other from opposite directions, it is the

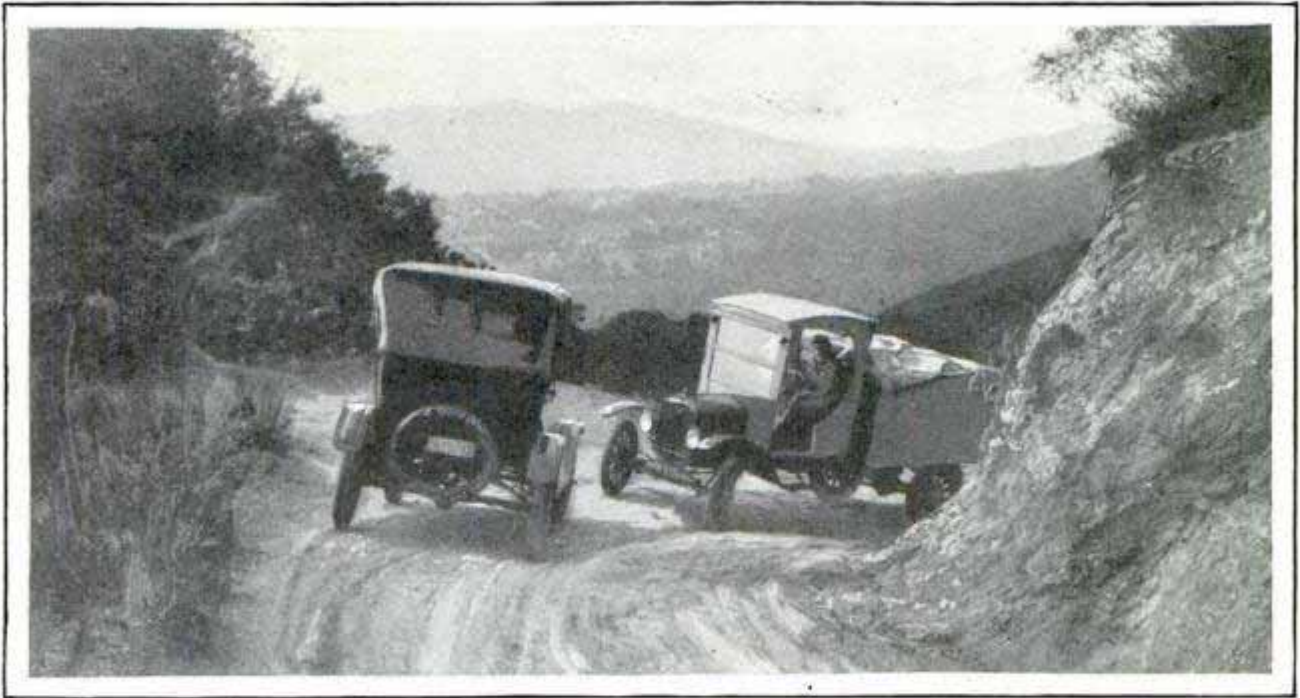

Ordinary Traffic Rules Do Not Always Apply in the Mountains; the Descending Car on a Steep Grade Is Supposed to Take the Outside, Whether It Is Right or Left

duty of the driver of the descending machine to come to a stop. The up-bound car always has the right of way.

Next to good brakes, an electric horn, or some sort of device that will make the greatest possible noise, is the best kind of insurance against accidents. Horns for mountain use are valued according to the volume of racket they can make. A horn that would be loud enough in the city could not be heard around a hairpin curve in the mountains where motor cars roar



A Hinged Sprag Drags on the Road, But Digs In When the Car Stops and Holds It

up the grades with wide-open throttles, and usually with mufflers, and even exhaust pipes, removed. Safety in the mountains is thus reckoned largely in terms of noise. The more noise you can make the safer you are.

The volume of noise is also important

because many autoists go temporarily deaf from sudden changes of altitude. Deafness is caused by the fluctuation of atmospheric pressure at varying altitudes. When such deafness occurs, it can be relieved instantly by the mountain driver who knows the trick. Hold the nostrils shut with the fingers, and then blow hard. You'll hear a noise inside your head like an exploding firecracker, and—presto!—you've got your normal hearing back.

Very few persons besides those suffering from heart disease, high blood pressure, or other similar infirmity, suffer any inconvenience other than temporary deafness from altitudes below 5,000 feet. Above 5,000 feet, however, and on some western roads where altitudes of from 10,000 to 14,000 feet are encountered, the conditions met in mountain motoring are almost identical with those experienced by aviators. In other words, the motorist, to withstand these very high elevations, must be of sound physique. If one is contemplating a trip into high altitudes, especially if he expects to drive, it is advisable to call on the family physician for an examination before starting. If the doctor says your heart action or blood pressure is abnormal in some way, there is only one recourse. That is not to go.

Altitude also affects the automobile motor somewhat as it does the human body. Few cars begin "to feel it" below

216
 Even in Mexico the Dangerous Curves Are Marked; This Sign in Pechecio Pass Says, in Spanish, "Dangerous Curve; Moderate Your Speed"



5,000 feet, but from there on, engines rapidly lose power for each 1,000 feet of altitude gained. A car that would romp up a grade in second gear at 5,000 feet would have to get into low gear to make the same grade at 10,000 feet. Above 10,000 feet many perfectly good automobiles cannot even pull themselves along in high gear on level ground.

In high altitudes motorists will also find the radiators boiling violently for no apparent reason. That is nothing to get excited about. Water boils at 212 degrees at sea level. At an elevation of 10,000 feet it boils at a so much lower temperature that potatoes can be kept in it for a week without ever cooking them to a point where they would be fit to eat. So, if the radiator of your car sizzles and roars like an overheated teakettle, let it boil. It won't hurt anything unless it actually boils dry. To offset this condition of violent boiling at low temperatures it is advisable to refill the radiator frequently.

When you go into the mountains, leave all your speed schedules at home. Too much speed is the cause of almost all mountain-road accidents. Any attempt to make fast time over mountain roads is not only dangerous but utterly futile. The wildest kind of driver cannot hope to gain

more than a few minutes over a sane and conservative driver in traveling over a distance of fifty miles. No possible saving of time that might be effected by wild driving in the mountains can offset the risk it involves.

One highly important thing that every motorist in the mountains should know is how to bring his car back under control after he has lost it on a grade. On such roads there are usually just two places for a derelict car to go. One is off the cliff, and the other is into the sidewalls of the grade. Obviously, the wall is the choice, but there's a knack in bringing the car to a stop without upsetting. The inexperienced driver who finds himself heading down a grade through "losing his gears" or brake failure, usually takes a death grip on the steering wheel and hangs on for the inevitable. When this happens to the trained driver, he gently pulls the steering wheel over toward the wall. Fenders and running board gradually begin to scrape and dig in. The car seldom goes more than a few feet before friction overcomes gravity, and the vehicle is brought to a stop with no damage greater than the loss of a little paint.

Of course, when a car goes out of control while ascending a grade, and starts to

back down, the steering wheel is manipulated very gently in the opposite direction from the way it would be moved if the car were going forward. Quick use of the brakes, however, is the best method of checking a car which has begun to back down. Edging into the wall is merely an alternative in case of brake failure.

I have known many mountain drivers who have fitted their automobiles with a heavy metal sprag, as shown in one of the accompanying illustrations. This device, which works like the stiff quills of a woodpecker's tail in keeping him from sliding down the trunk of a tree, is an absolute safeguard against a motor car going out of control and backing down a grade.

When coming down steep grades that are often many miles in length, motorists can save their brakes, and the strain of holding the car in check, by dragging a small tree tied to the rear of the vehicle.

ANNUAL LOSS FROM ACCIDENTS FIVE BILLION DOLLARS

Upward of 12,000,000 accidents occur in the United States every year, according to a survey made by officials of a New York hospital. Of these, between 2,500,000 and 3,000,000 are industrial. The economic loss computed on the basis of a day's wage of \$4, if applied at the same ratio to all accidents in the country, would show a loss of nearly \$5,000,000,000, not considering destruction of property. One person in every nine meets with a mishap every year, the survey showed, and one out of every ten deaths is due to accidental causes. An average of more than 100,000 persons lose arms, feet or hands as a result of accidents in the space of a year.



Seat Pulled Forward to Aid Passenger in Alighting, and Close View of the Sliding Rack

SLIDING FRONT SEAT FOR AUTO GIVES MORE ROOM

By merely pulling a knob, an adjustable automobile seat can be slid backward or forward allowing ample room for passengers to get in or out and enabling the driver to change position for greater comfort on long trips. It is simple to install and may be tilted up and forward like the usual kind.

TWELVE-FOOT MAIL BOX ADVERTISES TOWN



Huge Mail Box Built Especially to Receive "Boosting" Letters Written by Residents of Florida Town

To hold letters which residents of a Florida city were asked to write to their friends, explaining the advantages of the place, a mail box, twelve feet high, was provided. Even this huge receptacle was not large enough to contain all the messages.

475 Pontiac, Mich

123 E. Parkling Road
Chicago

Reconstruction Hospital
Central Park West at
104th St. New York

Delray, Florida

Baltimore, Md.

So Small It Can Be Carried in a Handbag. This Pony Saves Shipping Costs



Sweetheart

TINY PONY IS TOO SMALL TO WEAR SHOES

So small that it is impossible to shoe it for fear of splitting its hoofs with the nails, a tiny pony owned by a Baltimore man stands only twenty-six inches high, though it is eighteen months old. The animal weighs but fifty-six pounds, which is claimed to make it the world's smallest horse and a rival in size of the extinct five-toed horses whose bones are found in the west. While the pony is not big enough to ride and work, its small size has an advantage when traveling, because it can be carried in an enlarged suitcase.

Forty-eight U. S. radio-compass stations gave bearings to 83,900 ships in 1925.

AIR FROM WELL IS HARNESSSED TO AID DIGGERS

465 Scurry County

Oil-well diggers in a Texas field received a surprise not long ago when they struck a cold current of what at first was believed to be a mysterious gas. Investigation showed that it was air. Adopting the suggestion of one of the workers, the flow was harnessed to the drilling machinery, which had been put out of commission by the failure of the steam supply, and, in a short time, the rigging was working smoothly. Gauges showed a pressure of 120 pounds to the square inch. Ice-machine oil was substituted for the regular steam-engine variety, which would have been unfit for use under the circumstances, and the power plant was found to perform as well under the frigid air as it had done under steam. The current had an initial pressure of about 400 pounds and about ninety-three per cent of it was nitrogen. Pipes through which it was conducted soon became coated with a heavy layer of frost. The flow is still being used to continue the drilling down to the oil level below the depth of 1,100 feet where the air was encountered.

Cont. J. W. Ray 96 W. Northing St. Dallas, Tex. 2414 1/2 S. W. Ave.

FLEXIBLE PULLER FOR PACKING SAVES TIME AND INJURIES

446
Removing tightly jammed packing from hot stuffing boxes often takes considerable time and trouble and is likely to result in burned and bruised hands. To simplify this task, a set of flexible pullers has been devised. Each has a corkscrew hook at one end and a convenient handle at the other. The shaft is easily poked into difficult corners of the box and a turn of the grip engages the packing, which can then be dislodged easily and quickly. With this tool there is little likelihood that the worker will hurt his hands.



Chicago Phoenix Products Co., 925 W. Northwood Ave. Phoenix



Japanese Men and Women in Race with Odd Paddle Cars; Steering Wheel Swings Rudder in Front for Guiding, and Power Is Applied to Rear Wheel through Pedals

**RACE BETWEEN WATER CYCLES
LATEST JAPANESE SPORT**

A novelty in aquatic sports has appeared in Japan with the introduction of a foot-propelled paddle boat guided by a wheel resembling the steering apparatus of an automobile. The rider works the gears with pedals. Races between these craft test the skill and strength of the operators.

**CHINESE USE ROSES TO FLAVOR
TEA, CANDY AND WINE**

Great quantities of roses are grown and sold annually in China, not for ornamental purposes but for flavoring. They are used extensively to scent tea leaves; pounded into a pulpy mass, they are added to other ingredients in making candy and are also employed to impart a pleasing taste to homemade wine. Some confectioners use them to scent melon seeds. The rose trade forms a large part of the business of one of the guilds of China. The blossoms are often dried and stored in large receptacles, covered with oil

paper, for later use. The drying reduces their weight by about half and is done by applying gentle heat or in sunlight. In some parts of China, roses retail at about \$1 for 450 flowers. The dried blossoms command a slightly higher price.

**SIDEWALK PERISCOPE ON AUTO
SEES AROUND OBSTACLES**

Autoists are afforded a view of the road ahead of a car or other obstructions running in front of them by means of a periscope that operates sidewise instead of vertically. It consists of three mirrors so arranged that the driver may actually see around the car ahead to make sure if the highway is clear for an attempt at passing. During a test of the attachment in Paris, a blanket was placed over the windshield and the car was guided through the city safely and without trouble simply by looking at the forward reflecting mirror.

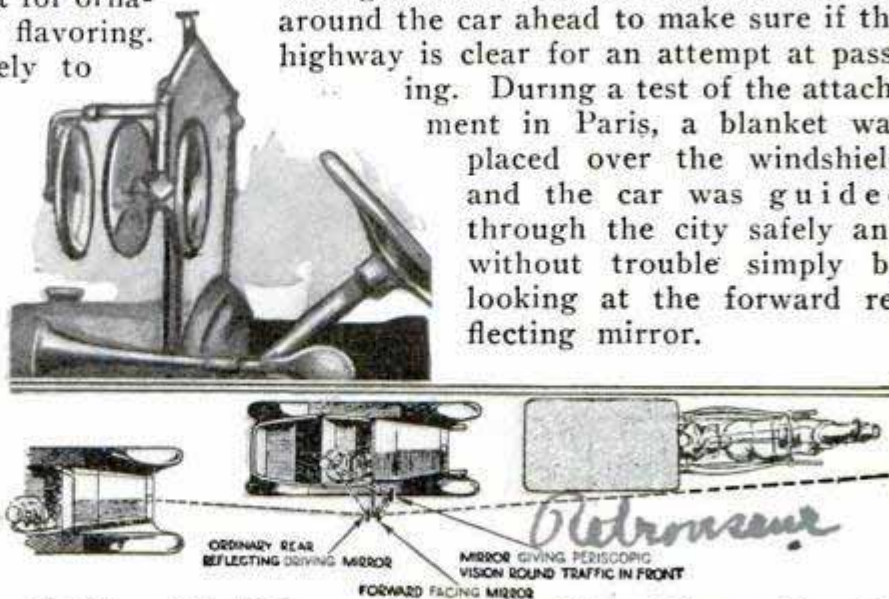

Close View of the Periscope at Side of Automobile, and Diagram Illustrating Vision It Affords

The Chinese Economic Bulletin 8/14/26

Paris 160 francs
He Nan He Yee Pekin

was developed in the United States 44 and 45 Paris 190, France

288

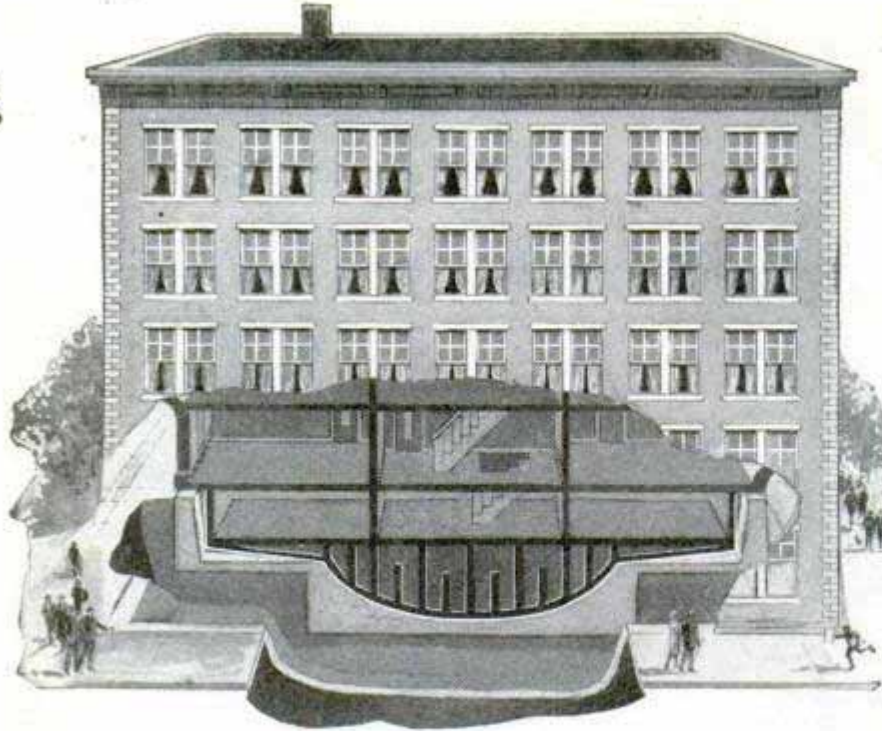

Drawing to Illustrate How House Rests on Tumbler Base and Can Be Tipped by Quake but Righted Again

QUAKE-PROOF BUILDING SWINGS ON FLOATING FOUNDATION

An interesting type of earthquake-proof building has been designed by a German architect for erection in Japan, and other countries that suffer from occasional shocks, and in mining districts where blasting and falling areas of rock and soil often damage houses of ordinary construction. The secret of the German's plan, which has been subjected to a number of tests, is that the building rests upon a curved base that fits into a corresponding depression in the foundation. This bottom is filled with a cheap grade of concrete to give it weight and reduce expense and the entire section functions both as an anchor and a pivot, allowing the building to sway in any direction and protecting the walls from the shock of the quake. To

if an experiment on a southern line proves successful. The porter plays the chimes as he passes down the aisle, and the melodious notes, like those of mission bells are calculated to be as effective as other calls and much more pleasing.

CHIMES TO ROUSE PASSENGERS ON PULLMANS

477 Four-toned chimes will be used to awaken sleeping-car passengers instead of shouts and tugging at the bed clothing.

CYLINDER-HEAD LIFTER FITS SPARK-PLUG HOLES

416 Although it fits any of the three standard sizes of spark-plug holes, a cylinder-head lifter, recently perfected, is sold in only one model. The threads which enable it to be screwed into any of the three-size holes are all on one shaft. The tool has a ratchet device enabling it to be screwed in place in cramped quarters, and when used, it is claimed, protects the gaskets from damage incurred in trying to pry the head up by the use of wedges.



Lifting a Cylinder Head with Two Handles Which Screw into Any-Size Spark-Plug Opening

Chicago Daily News 9/17/26

304 S Dearborn Chicago

Walden Worcester & Co.
Worcester, Mass.

2020 Assembled by Mr. H. Arran Jervis
New York City.

QUEER THINGS USED AS MONEY CENTURIES AGO



Big Money from Sweden; an Eight-Daler Copper Coin, Twelve by Twenty-Four Inches and Weighing Thirty-Two Pounds.

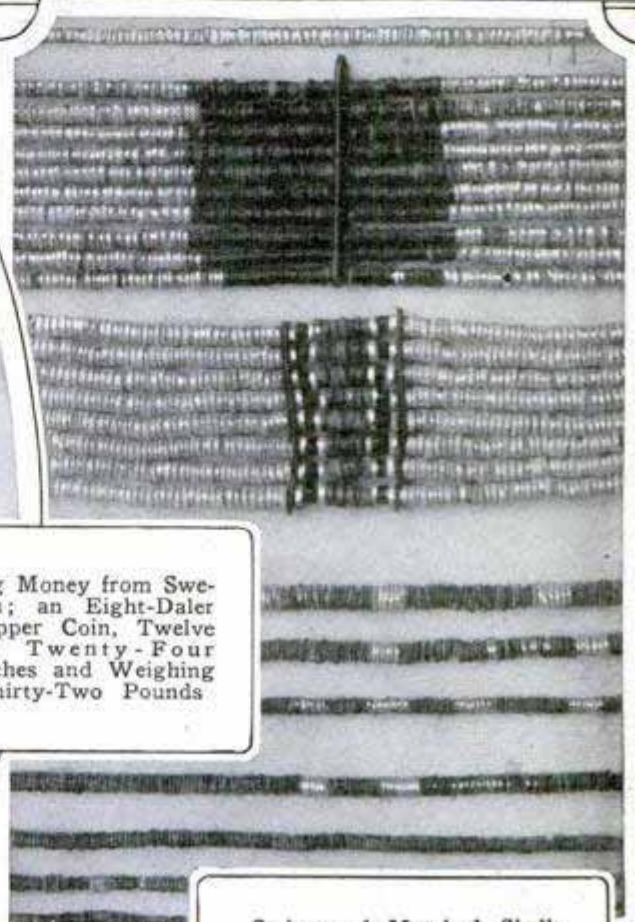

Strings of Matched Shells Serve as Coins among Certain Savage Tribes; Sample from Field Museum of Natural History

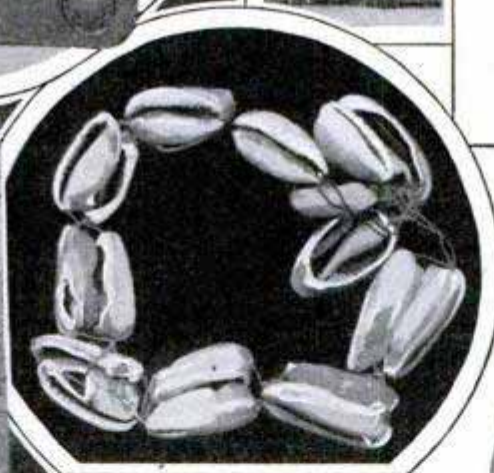

Another Example of Shell Money; Counterfeiting Was Difficult in Those Days Also



Oldest Known Paper Money. Produced in China More Than 500 Years Ago



Rare Copper Coin from the Congo, a "Lunkana." Used in the Purchase of a Wife

PLANE BUILT LIKE SEAGULL HAS TURNING WINGS

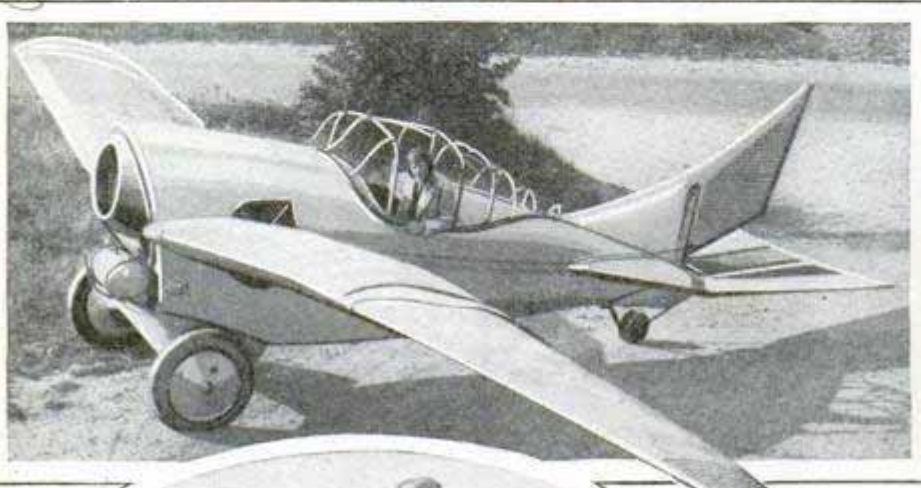
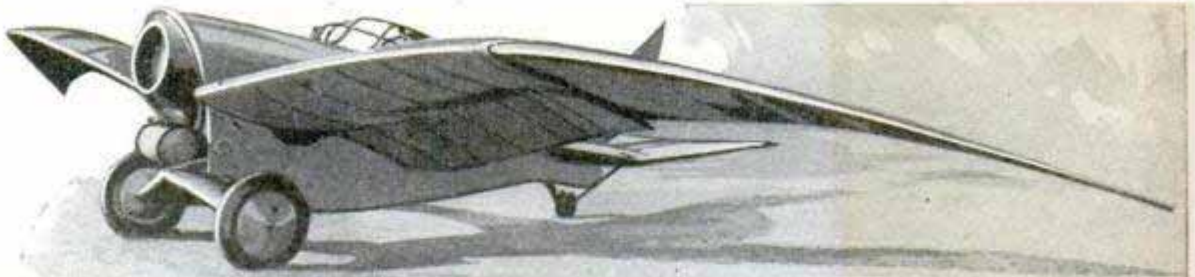

Novel Airplane and Seagull from Which It Was Modeled; the Wings Are Jointed a Short Distance from the Body So That They Can Be Turned at Right Angles, to Check the Speed When Landing as a Bird Does to End a Long Swoop

© Herbert Photos



this the inventor believes he can stop the plane within a few feet after it touches ground, using the wind resistance to check forward movement, just as a bird turns its wings to end a swoop.

Modeled from a plaster cast which the builder made of a captive seagull, a new type of airplane recently completed by a New York inventor offers several novel departures from the usual type. The fuselage, with very slight variations, is an exact duplicate, on large scale, of the gull's body. Wind-tunnel tests, however, disclosed that the gull's wings, while admirably designed for flying at comparatively low speeds, were not exactly suited to high-speed airplane flight, so the ship's wings are considerably modified. The most novel feature, however, is an arrangement by which a hydraulic pump and gear, controlled by a lever in the cockpit, can turn the wings from their normal position to one of almost a right angle to the direction of movement. With

SEVEN TOOLS IN ONE SAVES TIME AND WORRY

1528.

Shaped like a pair of pliers, a handy tool that can be slipped into the pocket, is intended for crimping pipe, cutting wire, and for use as a screwdriver, punch, wrench and hammer. It is made of hard steel and is fashioned to last a lifetime.

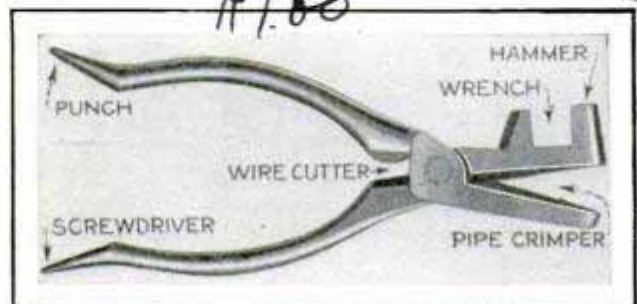

Various Uses of Combination Tool Illustrated; Its Shape and Size Permit Carrying in Pocket

Built by Kertham Products Co. Stewart Ave. Garden City, N.Y.

\$1.00

413 N. State Chicago

L. G. Mueller & Son Co. 197 Reed St.

**USE OF VOLCANIC ENERGY
URGED BY CHEMIST** 468

Harnessing Vesuvius itself is beyond actual possibility, according to Prince Giñori-Conti, president of the Italian society of general and industrial chemistry, but he believes that the natural reservoirs of heat lying near by may be utilized, and cites development of this sort that already has been accomplished in other parts of Italy. In the Soffioni district, for instance, where generation of power from the steam springs was a secondary objective, a number of valuable industrial products have been obtained, such as boron and its derivatives, borax, perborate of soda and other boron salts. Carbon dioxide, helium, argon and other gases have been found, he reports, and from the steam spouts of Tuscany, ammonia is separated for the production of carbonate of ammonia. Borax is also obtained, and special plants which depend upon heat and gases from the springs have been erected at Lardello in Tuscany. The steam flow under the earth is being tapped by means of wells drilled to depths ranging from 180 to 750 feet and sixteen inches in diameter. Steam appears in many instances at forty-five or fifty feet. Rotary drills of the latest type are used for the work, and the bore is sunk until skilled engineers decide that no further advantage will be gained. From two to six months were required to drill a well, but the operation is now conducted more rapidly. The prince declared that the geysers in this country may afford a valuable source of industrial power by proper development.

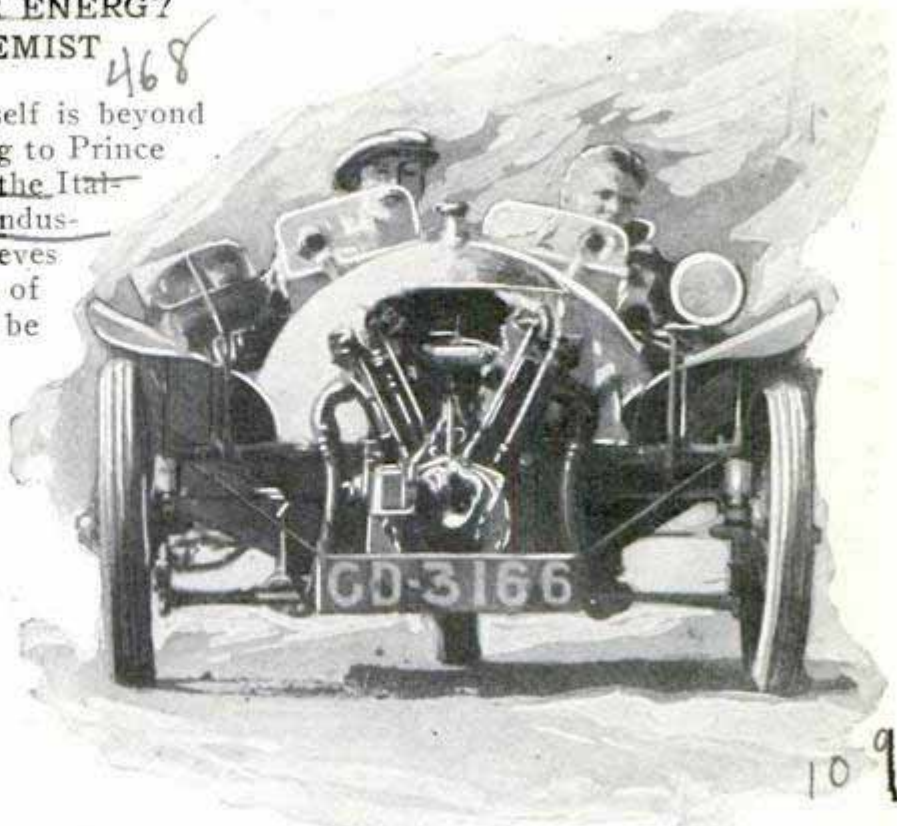

Tricycle Auto Appears in Racing Circles; This Car with Rear Third Wheel Won a Six-Day Event in Scotland

**THREE-WHEEL AUTO IS FIRST
IN SIX-DAY RACE**

Automobiles, built tricycle-fashion with but three wheels, have been used in Germany for taxicab and private service and they now appear in racing circles. A car of this type, with the single wheel at the rear, won a six-day motor trial event in Scotland. Other autos of curious design also took part in the race.

Edinburgh
**WATER BOTTLES HEAT CARS
ON ITALIAN RAILROAD** 1609

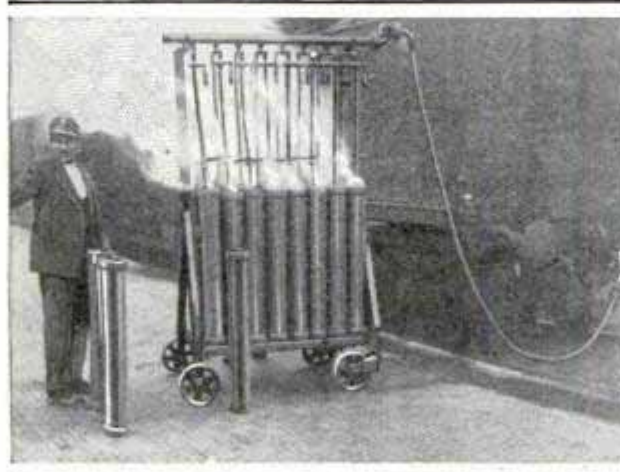

Hot-Water Bottles for Railroad Cars Being Filled

Cars on an Italian railroad are kept warm by hot-water bottles of steel, filled from the engine and placed under the seats. They are said to be sufficient for the journey, save the expense of plumbing and require but little repairing. When needed, more tanks are added or the hot water renewed.

NEW THRILLS ARE FOUND IN GIANT WATER BALL

A giant water ball, fourteen feet in diameter, built by the chief of police at Avalon, a Catalina island resort off the California coast, provides a thrilling water game for swimmers. Half of the ball is painted red and the other half green, and the object of the two contesting



two crews appeared, one climbing the pole and dropping the grain to the others to be carried away. Bands of glue were painted around the stick but after a few ants had been caught, others built a dike over the adhesive, using grains of sand and earth for the purpose. In a final attempt to foil the insects, the grain box was set on a tripod which was placed in a pan of water. For a long time, this baffled the ants, but finally came a file carrying

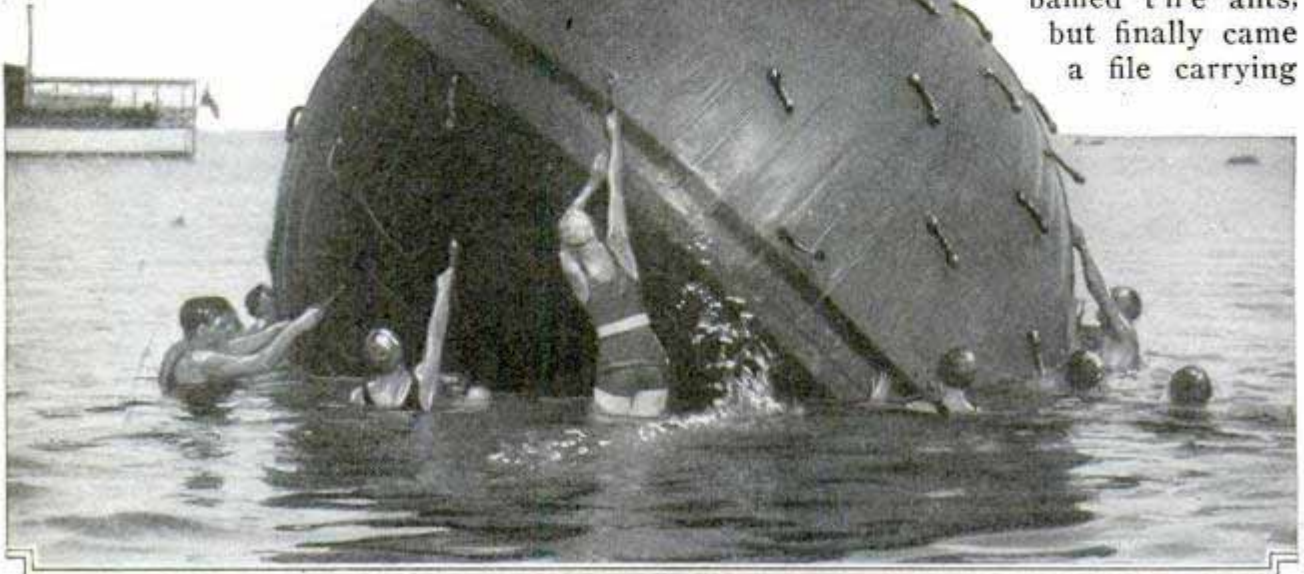

Water Ball Game in Which Duckings Are Frequent; Sides Are of Different Colors and Teams Try to Get Their Shade Out of the Water

teams is to keep the color they have selected for their own above water. The ball is studded with short ropes by which it can be maneuvered.

ANTS DISPLAY BRAIN POWER BUILDING PONTOONS

Do ants think and reason? A French scientist reports experiments from Africa that would tend to support the theory that these insects do have a form of intelligence. Grain was placed in a box in a garden to attract birds, but the ants, a black species, discovered it first and made away with it. The box was then placed on a pole, but the ants quickly climbed the support and continued the robbing. At first, they laboriously carried the grain kernel by kernel down the pole, but on the second day

leaves and tiny twigs. They formed a pontoon bridge to one leg of the tripod and so reached the grain. What interested the investigator especially was the fact that the ants evidently had formed a conception of the different natures of glue and water, and chose materials that would float to build the bridge, but used heavier substances to pass the glue.

AUTO MOTOR RUNS ICE CUTTER FAST AS MAN CAN WALK

Running on rollers somewhat like those of a caterpillar tractor, an ice cutter for rapid work is propelled by a small automobile engine. It is said to be especially adapted to use on small lakes, and will cut even thick ice about as fast as a man cares to walk.

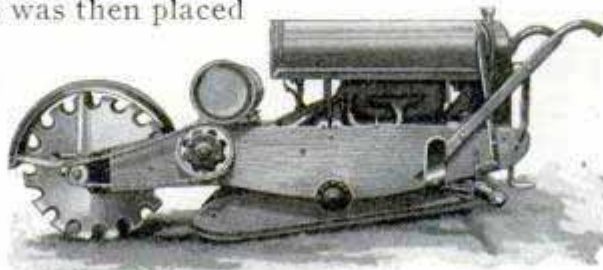

For Rapid Ice Harvests, Saw Propelled by Auto Motor Runs on Rollers like Those of Tractor

Made by M. Charles Jourdan
Algiers

Dr. W. Williams

Prof. Alphonse Labatte
French Museum of Tech. & Nat. History
Algiers

401
Lm Alger

2258

Way Ice Saw Co. New York
Hawkes Co. N.Y.

325

described at American Chemical Society
L. S. 336 Lake Shore Drive, Chicago
Esriper My Co. 536 Lake Shore Drive, Chicago

General Electric Co
Schenectady, N.Y.

HOTTER FLAME FOR WELDING IS FOUND

435

Industrial benefits are predicted from a process for producing a flame said to be much hotter than any hitherto known. Its temperature is estimated at 7,000 degrees Fahrenheit. Tungsten wire melted in it like an icicle in a gas jet; a tube of sheet steel was welded at the seam without solder, and when the flame was played on a plate of chrome steel, it left a string of puddles in its wake. It is produced in a blowpipe outfit similar to that used in welding or cutting steel on street-car tracks. An essential feature of the process is that the hydrogen used is handled in such a way that metals do not oxidize under the flame since they are surrounded by hydrogen gas at the heating spot. This is said to make possible the welding of such metals as aluminum and magnesium. They ordinarily fall into white powder when they are heated in air.

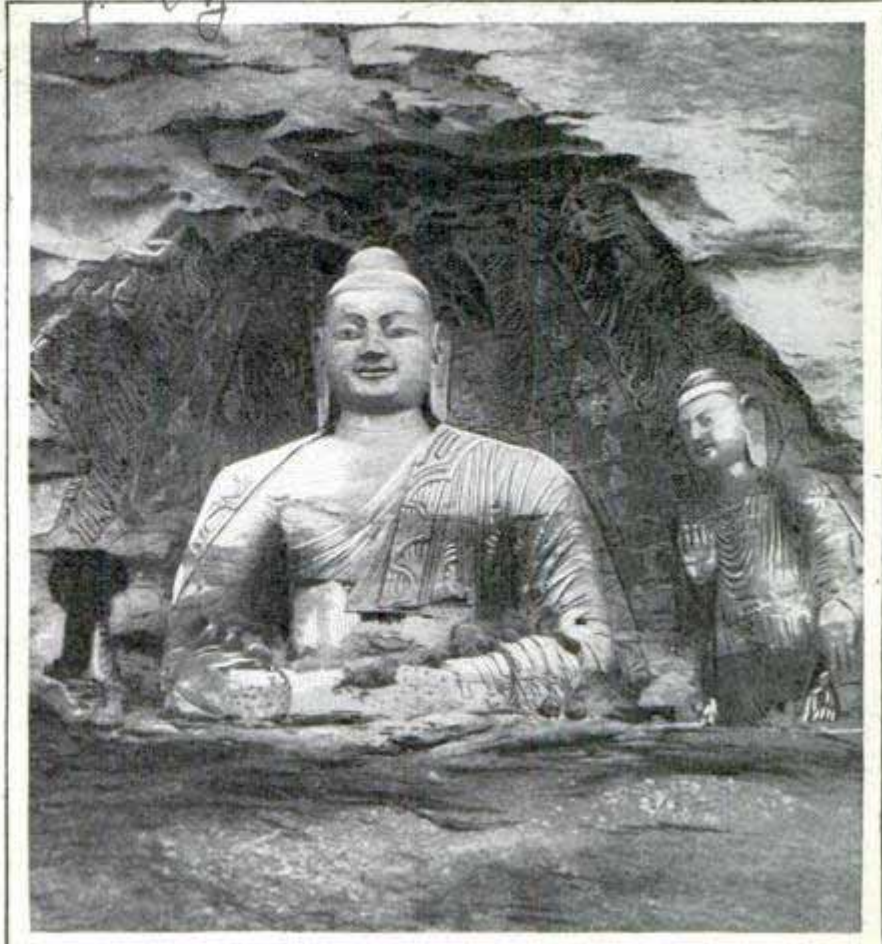

Gigantic Figure of Buddha, Carved from Living Rock, Which Was Accidentally Revealed When a Mountain Cave-In Opened the Shrine to Light

GIGANTIC FIGURE OF BUDDHA DISCLOSED BY CAVE-IN

Partial collapse of a grotto among the mountains of western Tibet brought to light the gigantic figure of a Buddha that had been carved from the rock. The idol had been placed as though guarding the sanctuary. Its form and the finish of the carvings behind it showed that the makers were craftsmen of no mean skill.

MUD GRIPS FIT ON AUTO TIRES WITHOUT MARRING WHEEL

282

Grips to aid in getting the car out of bad ruts, mud or snow, are clamped around the tire to the edge of the rim and can be put on or removed without scratching the wheel. They are made for balloon or cord tires and are easily adjusted with a setscrew.



Camels are believed to be the first animals used by man.

HOLDER RACK ON TYPEWRITER FOR ERASER, PENCIL, PINS

1915

Attached to the base of the typewriter, a holder rack for pencil, eraser, pens and pins, keeps these articles in handy position for use and saves table space. A coil spring grips the pencils securely, and the pins are easily removed from a cushion.



Price \$1.00

Archie McInnes,
Box 81, Mangum,
Okla.

2138

*Aero mail specialty by
Portland Ore*

*Aero Mail
Lewis & Myers Co
Valparaiso Ind*

How Toys Are

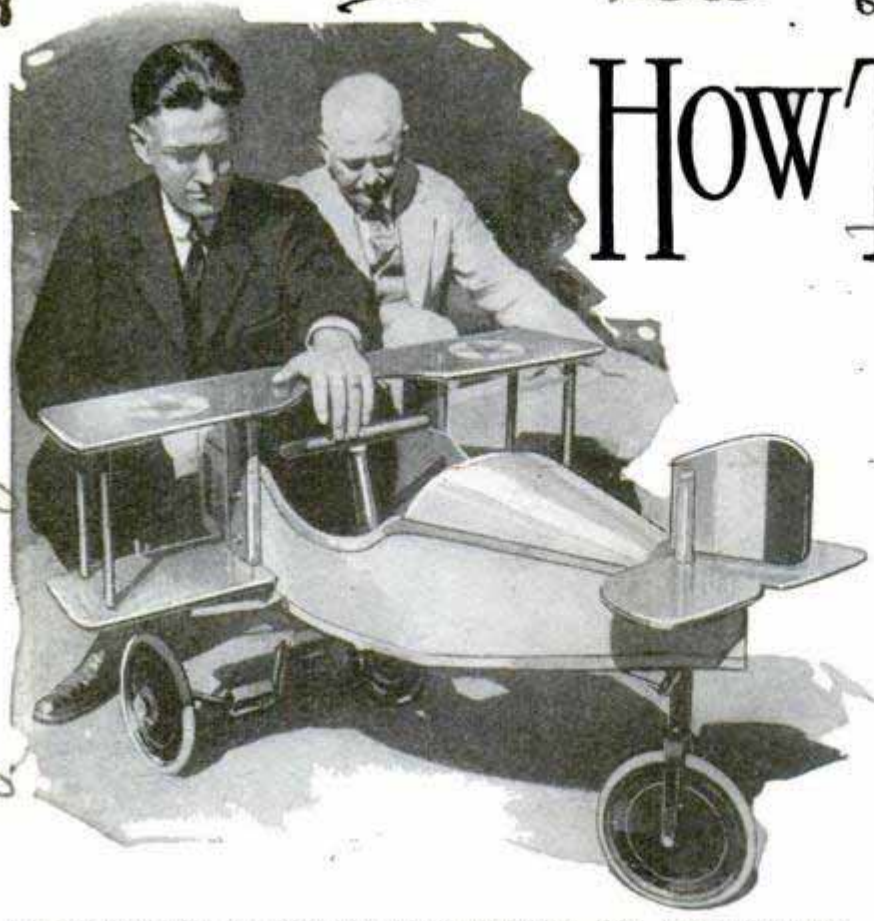

Toy Automobiles Are Giving Way to Airplanes, Still Foot-Driven but with Wings and a Propeller That Revolves in the Breeze

in a boy's magazine of a contraption of tissue paper, feathers and rubber bands that would actually fly. He built one, and it worked. Trying to get a ship that would fly higher and farther, he built a second twice as big—and it wouldn't fly. His search for the reason led him into a study of aeronautics. Today he is the designer of a big all-metal airplane and head of one of the largest aviation factories in the country, the William Stout division of the Ford Motor company, named after him.

*d.
d. Or
illi
are
.N.Y*

TWO boys, one eleven and the other seven, were playing together years ago with a new toy their father had just brought home. It was a whirligig, propelled by a rubber band, and when the latter was twisted and the toy released it flew up to the ceiling and dropped back to the floor. The boys thought how fine it would be to have a big whirligig large enough to carry them up into the air, and out of that thought, years later, came the airplane—for the pair were Wilbur and Orville Wright.

A boy in Sweden, in the early days of the last century, was fond of building toys that worked. He heard a description of a windmill, something he had never seen, and with some borrowed tools he built one. Out of that interest in mechanics came a long series of inventions that included hot-air engines, the screw propeller for ships and, finally, the first iron-clad battleship, the "Monitor" of the Civil war. The boy was John Ericsson.

Another youngster, working in a tiny shop in the basement of his minister father's parsonage in a Minnesota town not so many years ago, saw a description

The part that toys have played in changing the world is beyond estimate. Great inventions and marvelous discoveries without number are traced back to the formative influence of a childhood toy. And the use of models, toy-sized replicas, is growing wherever great building and engineering feats are undertaken. The architect's wash drawing of a proposed new building is supplemented by an exact plaster model, often surrounded by other buildings or landscaping, so that the prospective owner can see, in the toy, just what he is to get in the finished building.

Revolutionized by the war, which cut off, in 1914, the importation of toys from Germany and Switzerland, the business of supplying educational and amusement devices for children has become distinctly Americanized, with strong emphasis on the educational angle. The old-fashioned tin soldiers, clock-spring locomotives, jumping jacks and similar things are being displaced by complete electric railroads, provided with lights, automatic couplers and the latest things in block signals; by construction outfits that build anything from a steel skyscraper skeleton

*Emb
B. B. Shackwell
3/19 Monroe City Chicago*

Sand Toy - Dan, Jay Phillips Ave. and New York Central at Toledo, Ohio.

Changing the World

2138

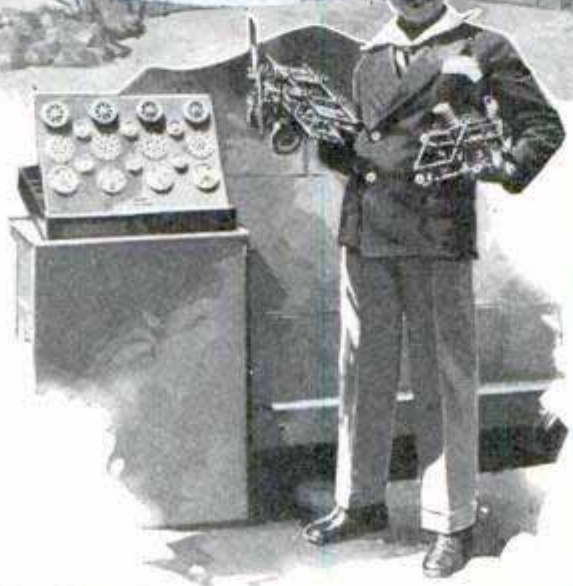
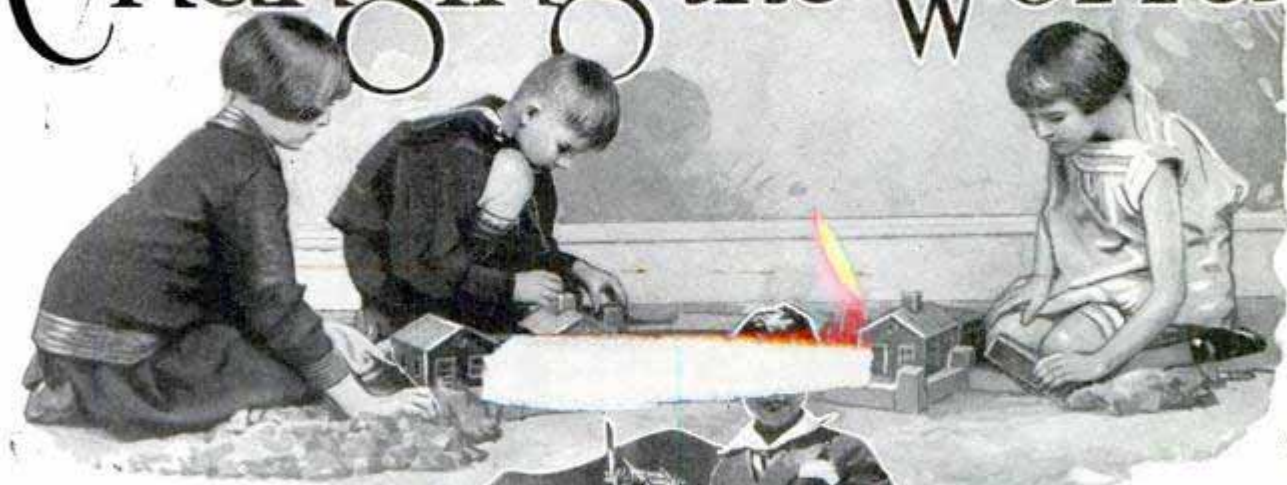

Sand Modeling Teaches Building, and Mechanical Sets Satisfy the Longing to Make Something

to a marvelously intricate piece of machinery; by laboratory outfits that enable the young chemist to perform surprising experiments at home, and by dozens of others, all calculated to help shape the child's mind for success in after life.

Instead of the little red wagon of twenty years ago, there are automobiles that are accurate scale models of real cars, with all the accessories from balloon tires to the windshield wiper. The supremacy of the toy automobile, however, is now being challenged by a similar foot-driven vehicle which has airplane wings and a revolving propeller. In the search for realistic toys, even the expressionless doll of the past is being displaced by models designed from famous cartoons and comic strip characters.

The demand of the American boy for toys "that will work" has been the biggest factor in building up the new toy industry. A generation ago a cast-iron fire engine, hitched to cast-iron horses and pulled along by a string, provided plenty of thrills, but the modern fire engine is an exact model of the latest motor-driven apparatus, is run by its own motor and has

a pump that draws water and throws a stream six feet or so from a length of real rubber hose.

For the boy who has outgrown the foot-propelled automobile, there is now a car on the market driven by an electric motor, taking power from a storage battery. It has a speed of five miles an hour and will run ten miles on each charge.

The old-fashioned sand pile has even come in for modernization, with a set of metal forms which can be clipped together, packed full of sand, then taken down, leaving a complete sand village of houses and stores.

The modern boy of six or eight learns more about electricity than grown men knew a generation ago, for many of his toys utilize it. Even the toy steam engine is abandoning the alcohol lamp as a heating element, and is now operated by an electrically fired boiler that plugs in on the house-wiring circuit like a toaster or a curling iron.

The biggest advance in teaching mechanics, however, has been in the steel-construction sets. Starting with simple building girders, they rapidly adapted intricate gears, plain and beveled, pinions,

Metal Ware Corp 111 W. Washington Chicago

Louis J. Gork 715 Pershing Square Toledo, Ohio

2132

A Famous Film Actor Spends His Spare Time with a Building Outfit That Teaches Him How to Make Models That Are Mechanically Correct and Actually Will Operate

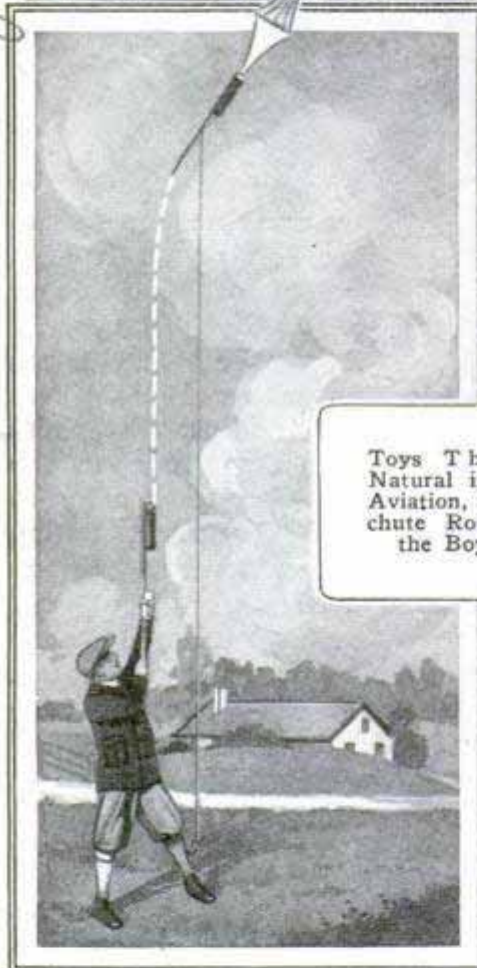
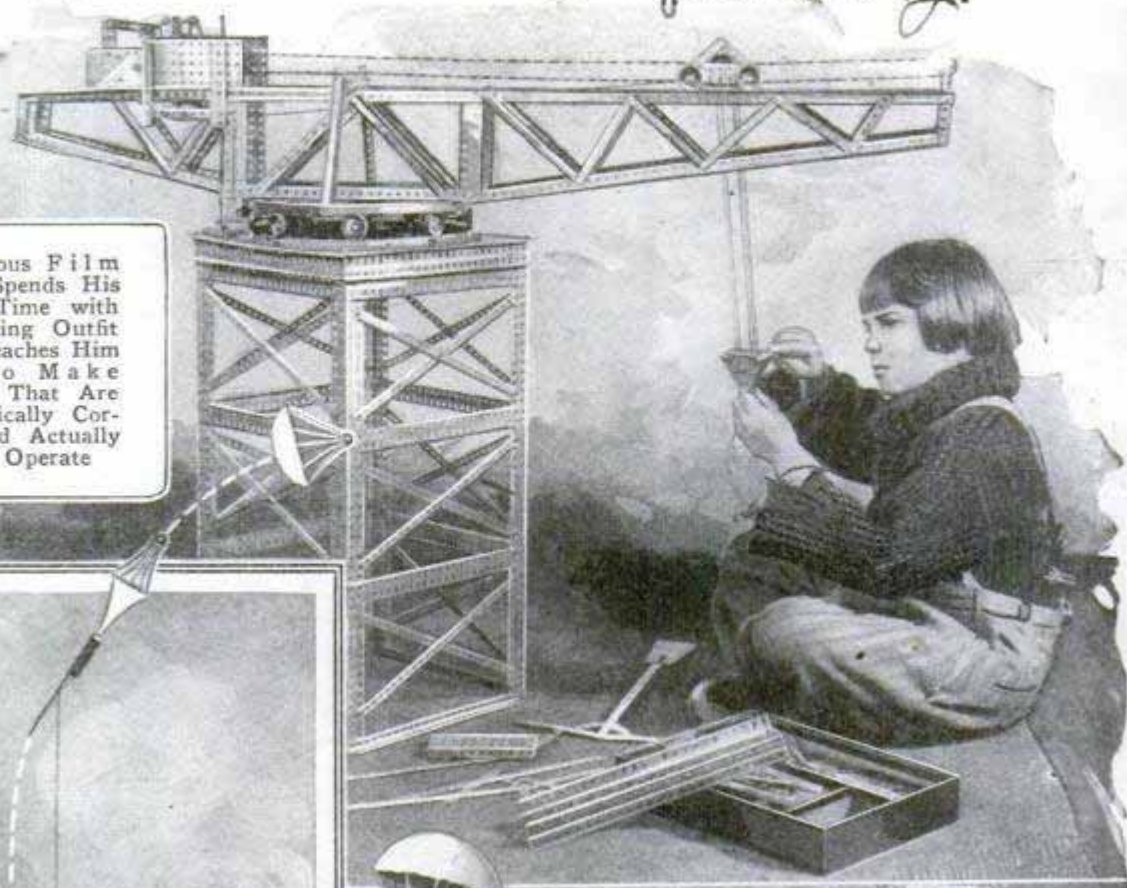

Toys That Fly Are Natural in the Age of Aviation, and a Parachute Rocket Interests the Boy in Flying

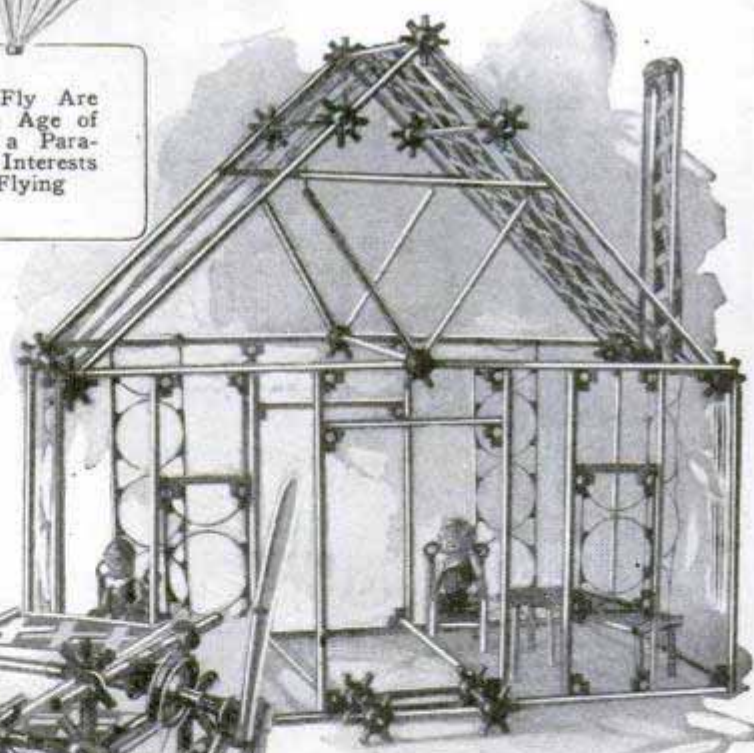

Invention of Steel Structural Toys from Which a Variety of Models Can Be Built Was America's First Big Contribution to the Revolutionizing of the Toy Industry to Meet the Needs of the Modern Boy

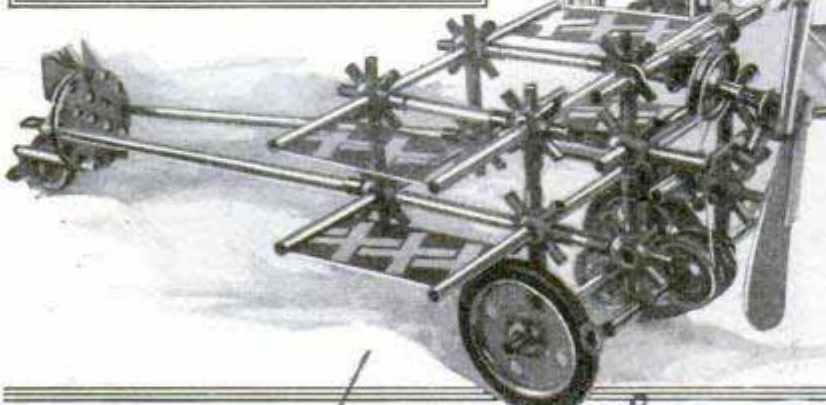

A. E. Glenville, Pleasantville, N.J.

Probably - Structo Mfg Co
212 West 11th St. N.Y.C.

2138



racks and other machine parts, until they enabled the erection of exact models of intricate machinery. With them a small boy quickly learns more about derricks, hoists, steam shovels and other big machines than his father ever knew. The desire to build things which they inculcate, is reflected in the improvement in toy tools. The old-fashioned lead saw, white-metal plane and chisel and cast-iron toy hammer have been replaced by good tools, as well made as any in father's kit. The class of things boys want to build has improved steadily, until now they undertake radio sets and cabinets, model ships and similar complicated work that no boy a generation ago would have thought of trying.

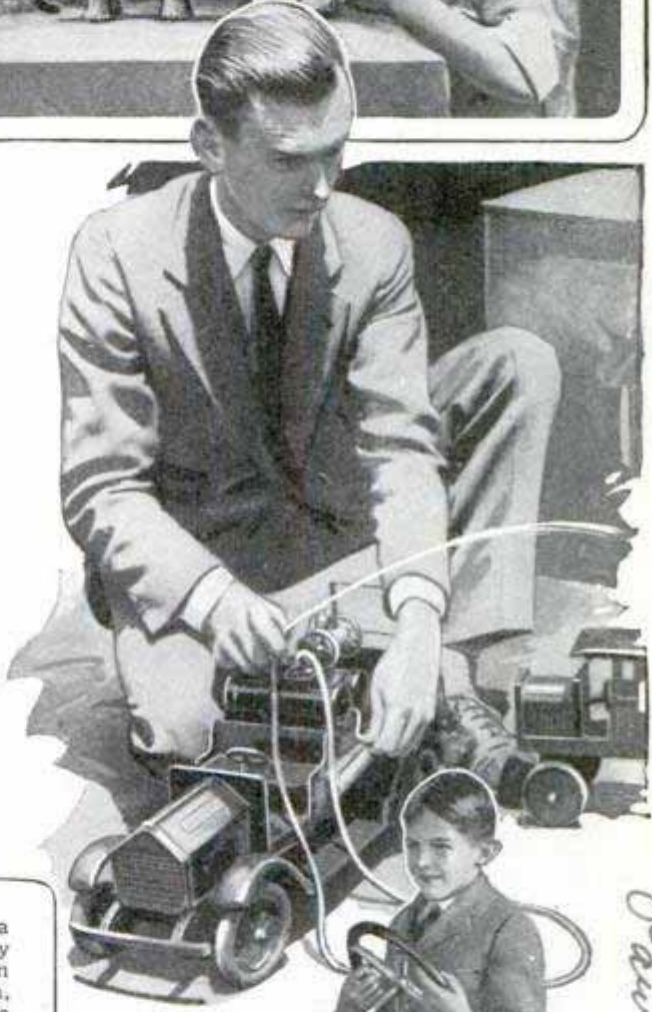

Give the Right to the Revolution in Construction Co.
of - Products in Metal and
Plastic

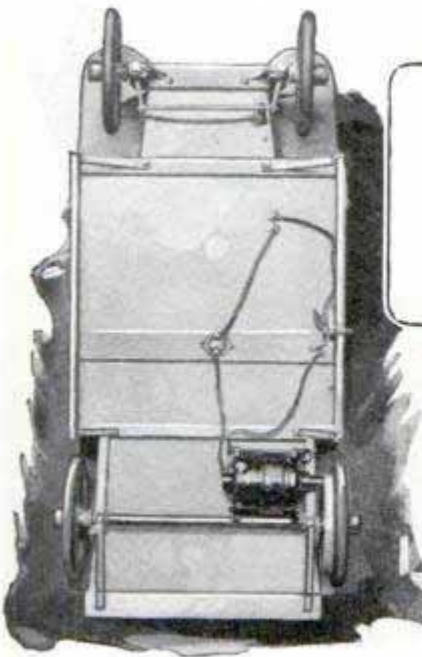

Modeling with a Special Plastic Clay Makes Sculptors in the Kindergarten. While a New Fire Engine Is Not Only Motorized but Actually Pumps Water

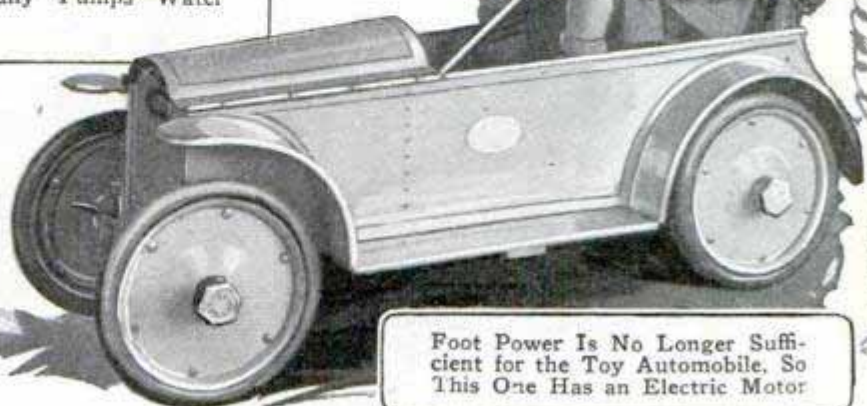

Foot Power Is No Longer Sufficient for the Toy Automobile, So This One Has an Electric Motor

2138

Their elders, too, are building more models, for home decoration or industry, than ever before. Several of the large automobile factories produce all new-car designs in model form before undertaking production. The models are studied from every angle to make sure that the lines are harmonious, that tops are in the right proportion, fenders correctly designed, and that the car looks its worth. Some of the model automobiles are put to strange uses. Courts have turned to them to reconstruct the scene at traffic accidents and fix the blame. Window decorators employ many of them.

Out in California two boys who built model ships as youngsters kept on as they grew up and now, though barely in their twenties, have one of the largest model factories in the country. They produce complicated and exact ship models for steamship lines, plant models for many industries, and out of their profits have organized a company which owns a large seagoing yacht, to be employed in taking select parties on round-the-world cruises.

Building of toy models as a pastime for grown folks has never reached the propor-

tions in this country that it has attained in England, but there is a constantly increasing demand for model parts and plans. Toy trains that actually work are the favorites abroad. Hundreds of amateurs in England build them as a hobby, complete in every detail and reproducing such famous engines as the one that pulls the crack "Flying Scotsman" from London to Edinburgh. Many of the model builders have home workshops and make every tiny piece that goes into their locomotives, while others buy rough castings, machining them on their home lathes, and still more get the finished castings from model makers and assemble them.

DIG UP CITY WHERE ABRAHAM OFFERED SACRIFICE

499

Walls, gates and towers of the city, where Abraham built the altar to sacrifice Isaac, where Jacob buried his idols and, according to tradition, Joseph was buried, have been found near Nablus in Palestine, it is told in reports from the international archaeological expedition headed by Prof. Ernest Sellin of Berlin university. The excavations also revealed remains of a Canaanitish temple and of Baal images.

Chicago Journal 9/21/26

Porter Chemical Co
Hagerstown, Md

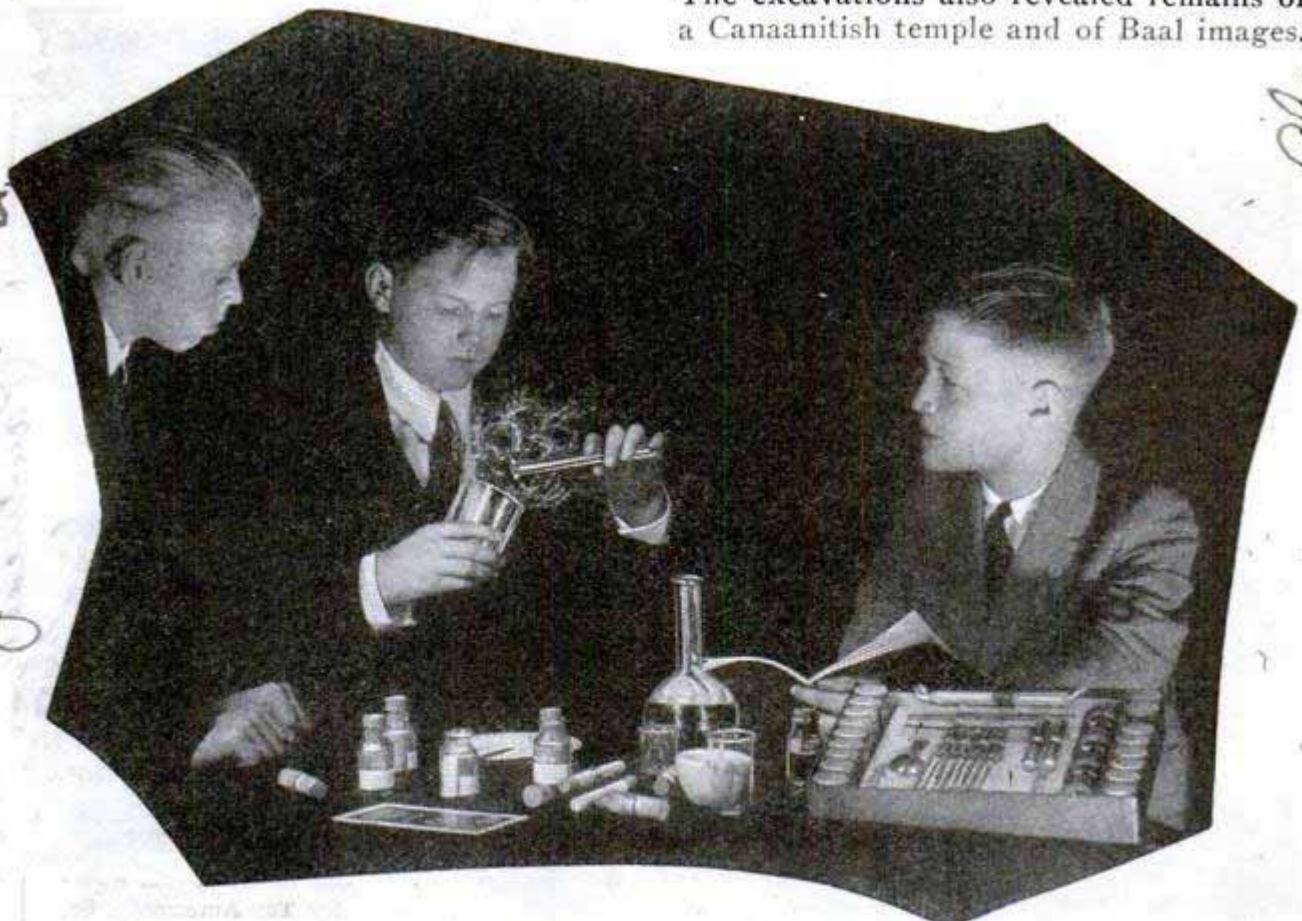

Chemistry Is Being Taught Future Research Experts by Toy Outfits That Enable Them to Perform a Host of Interesting and Startling, Though Harmless, Experiments Right at Home

BIG COAL STRIKE IN ENGLAND HELPED CLEAR AIR 530

Decrease in smoke and the consequent brightening of the skies incident to the coal strike in England have shown persons there the advantages of clean air and will aid in the adoption of fuels that do not defile the atmosphere, it is believed. The effect was in direct contrast to that which was produced by the hard-coal strike in the United States, when much more soft coal was burned in eastern cities, increasing the amount of smoke. Measurements have been made in this country of the quantities of dust and soot that fall in one year. In the dirtiest of the ten centers examined, it was found that 794 tons accumulated to the square mile in 1924 and, in the cleanest, the deposit was 101 tons. Much of the refuse from industrial chimneys is gritty ash, while smoke from domestic flues contains a high percentage of tarry matter which is injurious to plant life as it clogs the pores of the leaves and often kills the growth.

REAR WHEEL RUNS AUTO PUMP SAVING HAND LABOR 499

Rapid operation and ease of adjustment are claimed for a patented automobile tire pump that may be run either by power from the rear wheel or by the crankshaft of some autos through the starting-crank hole. For the wheel drive, permanent attachments are fixed on each of the rear pair and the pump is slipped into a clutch. Its driving gear is engaged as the wheel rotates after being jacked up. The rear tire of a small automobile was inflated to a pressure of sixty pounds in one and one-half minutes with this pump, the inventor declares. It folds into small space when not in use.



☐ Limestone is used to a much greater extent in building than any other form of natural stone.

Inserting Can of Ice Cream in Thermos Bag, Which Serves as Substitute for Ordinary Tub with Its Melting Ice



THERMOS BAG FOR ICE-CREAM CANS ELIMINATES TUB

A thermos bag for ice-cream cans, claimed to keep the contents hard for fourteen hours, has recently been placed on the market. It avoids the icing of a shipping tub, and the sloppy mess the latter makes when the ice begins to melt. Heavy express charges on the return of water-soaked wooden containers to the manufacturer are also saved.

MUSICAL WHISTLE ON ENGINE WON'T DISTURB SLEEPERS 480

Locomotives of a western railroad are being equipped with an improved "chime" whistle, sounds from which are described as "soft as the wood winds of a symphony orchestra." While the mellow tones can be heard as far as the screech of the usual type, experts declare, they are not likely to rouse residents along the right of way from their slumbers.

372

Montgomery Washburn & Co. Dangerous

el celeso racket

John C. Dyer 10 main St. New Amsterdam, Bernice

dmw.

Chicago Milwaukee and St. Paul
J.W. & R. Sullivan

Electric Furnace man



Examining the Electric Stoker; Fuel Bin Is Seen at Right, with the Ash Chute in the Foreground, and Motor under Hopper.

"ELECTRIC MAN" FIRES FURNACE AND REMOVES ASHES

Electrically operated, an automatic furnace tender now on the market, puts on fuel when it is needed, shakes the fire, removes the ashes and adjusts the dampers without the aid of a human attendant. It can be used in connection with various styles of furnaces in which coal of the smaller sizes is burned.

WHERE OUR CHRISTMAS TREES GET THEIR NAMES

The Douglas fir, a native of the northwest but now being planted extensively in the east, is becoming a popular Christmas tree, according to the American Forestry association. The Douglas fir was named for a Scotch botanist who discovered it on an exploration trip in 1825, but its scientific name is *pseudotsuga*, meaning "false hemlock." As a matter of fact, it is neither a hem-

lock nor a fir, and, though it is sometimes called a spruce, it isn't that either. The tree belongs to an entirely distinct species. The tree most commonly used for Christmas trees is a real fir—the balsam, so called because its blisterlike pockets yield the resinous liquid known as Canada balsam, which is used, among other things, for attaching cover plates to microscopic slides.

4/11. Dragons such as adorn the Chinese flag have been brought nearer to reality in the capture of two huge lizards on the island of Komodo in the Malay archipelago. Each is eight feet long, weighs

200 pounds and has a body as thick as a man's, covered with a protective armor. Like the legendary dragon, they have red, forked tongues and sometimes make a loud hissing noise resembling escaping steam. Their legs are short and stubby and each foot has four claws. The tails are spiked. Scholars believe that the lizards, which were brought to the United States, may be descendants of an ancient species that inspired early belief in fiery dragons. They were captured by Douglas Burden, a trustee of the American Museum of Natural History, after a British aviator had sighted them from an airplane.

SHOE POLISH IN STICK FORM EASILY CARRIED AND USED



Stick of Shoe Polish Compared with Brush; Fingers Are Protected from Stains

Held in a container like that used for shaving soap, a stick of shoe polish fits the coat pocket, is easily applied and reduces waste. A large stick is said to last for a year.

Swank
Chicago
Malcolm + Wilson
256 Church St.

Illustration by Lagrange & Co., New York
29 E. 24 St., New York

1654
Somerset Stoker Co
411
418
Washington, D.C.
New York

FREAK LIGHTNING FOUND TO BE MOST DANGEROUS

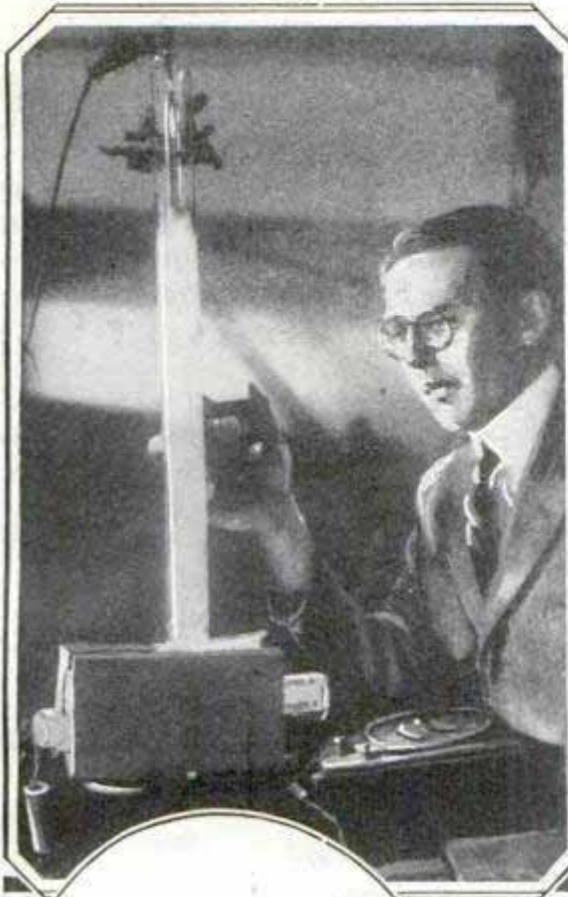

Experiment with Artificial Lightning: Apparently, There Are Two Kinds of Lightning, the Sort That Follows Known Laws of Electricity and a "Freak" Flash Still a Mystery

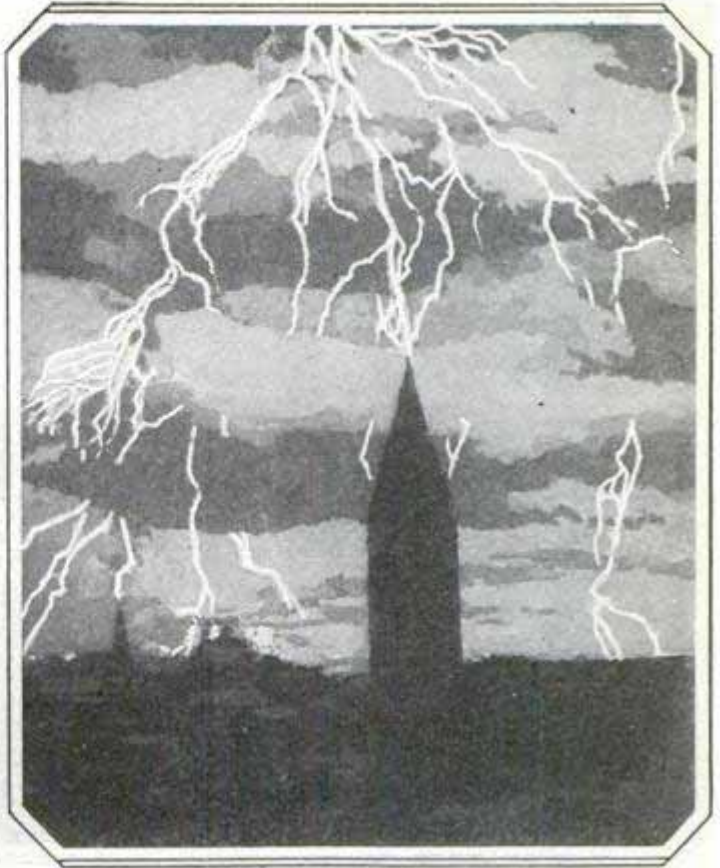

Lightning Rods Have Proved Effective as Protectors against the Ordinary Variety, but the Freaks Often Cause Damage in Spite of Conductors; Each of the Streaks at Left Has Voltage a Million Times That of House Current



ing an investigation conducted by F. W. Peck, Jr., lightning expert, of the General Electric company, to determine the manner in which lightning causes surges in transmission

What is lightning? Dr. D. E. Dorsey, of the National Research Council, has attempted to answer this question, declaring that lightning is of two kinds. One variety follows the normal laws governing electricity. The other variety, by far the most dangerous in the havoc it may work, originates not in electric sparks and flashes but is a self-contained body of material and electrical particles which catapults toward the earth obeying no natural laws at present known to men of science. Dur-

wires and power-plant equipment, it was discovered that the voltage, the force behind an ordinary lightning bolt, is nearly a million times as strong as the force behind the current in the socket at home. No less wonderful is Mr. Peck's estimate that a single flash of lightning may carry power at the rate of 50,000,000 kilowatts, twice that which would be generated throughout the United States if all dynamos and power plants in the country were working simultaneously.

Ammanah Chicago

954
2282

Introducing an Oriental Note into American Architecture; Intricately Designed Tile Tower Roof of the New Los Angeles Public Library; Brilliant Colors Enhance Its Beauty

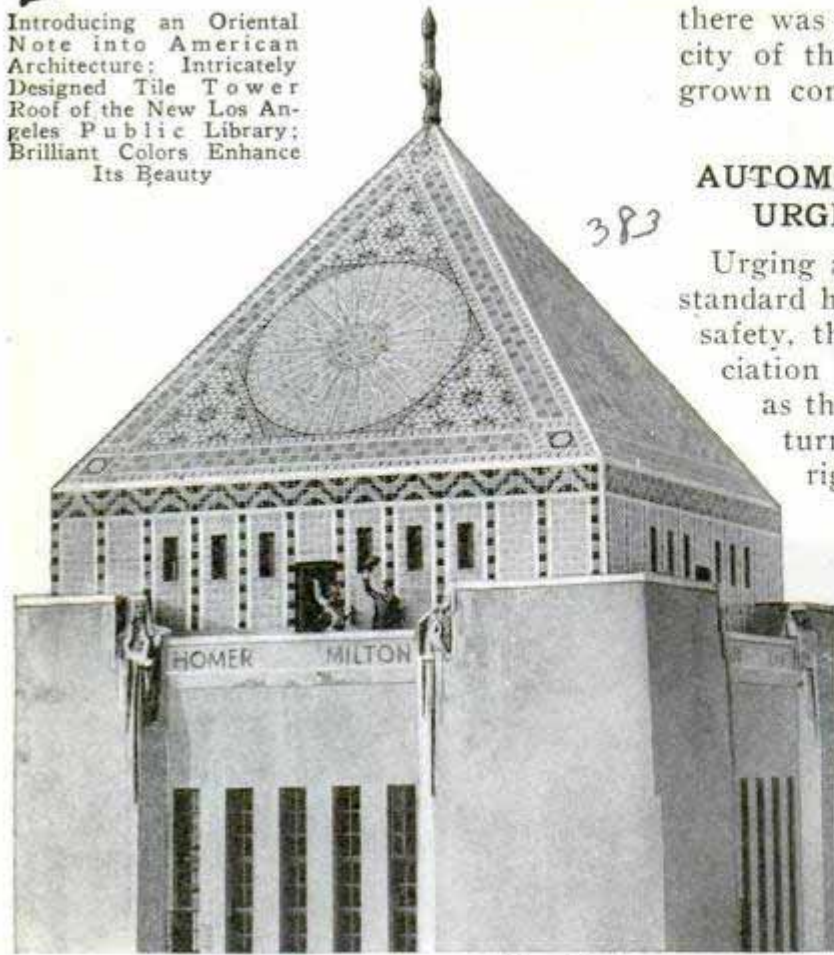

383

LIBRARY ROOF IN TILE MOSAIC BEARS ELABORATE DESIGN

Constructing the roof of the Los Angeles public library is said to have taken more time than was required for all the rest of the building, as it was finished in thousands of pieces of tiles, set in colorful and intricate designs. The bright patterns are visible far away, especially those on the roof of the tower, which is one of the chief features of the structure.

PHILADELPHIA BUILT ON GOLD BUT DOESN'T MINE IT

The city of Philadelphia rests on a fortune in gold, according to old records of assays made in 1861, but the metal does not appear in sufficient quantities to make recovery worth while. In fact, the assays showed values of three cents to each 120 pounds of clay. With only one part of gold in 1,000,000, even modern mining methods would not make the recovery pay. The investigators who made the old survey, however, and whose report has recently been uncovered, estimated that

there was \$126,000,000 in gold under the city of their day—and Philadelphia has grown considerably since then.

AUTOMOBILE SAFETY SIGNALS URGED FOR ALL DRIVERS

Urging all automobile drivers to adopt standard hand signals as one step toward safety, the American Automobile association has compiled the following list as the best and simplest: For a left turn, extend the arm horizontally; right turn, extend the arm upward above horizontal; to indicate a stop, extend the arm below the horizontal line. The suggestions concentrate on just the three positions of the arm which are easily remembered and clear at a distance.

PHONOGRAPH WITH ELECTRIC ARM HAS RICH TONE

203

Ordinary phonographs are operated electrically without extensive alterations by a simple attachment that replaces the regular arm and horn. It can be used through the medium of a radio power speaker with a one and one-half volt battery or with a speaker alone on a six-volt battery. In volume and quality of dance records, for instance, the reproduction is said to approximate that of a small orchestra, and adjustments are provided for moderating the sound to suit the needs of a living room.



Electric Arm Adjusted to Ordinary Phonograph; Tones May Be Modulated and Installation Is Simple

The Bristol Co. Waterbury

Public Ledger 7/25/26

W. Jackson, Chicago

SUPER-SPEED BOAT KEEPS TROPHY FOR AMERICA

Capable of making eighty-one miles an hour, and said to be the fastest boat afloat, the "Miss America V," Gar Wood's latest speed creation, succeeded recently in keeping the famous Harmsworth trophy in the United States, to which Wood brought it half a dozen years ago. The trophy was donated by the late Lord Northcliffe, who was a Harmsworth prior to his elevation to the

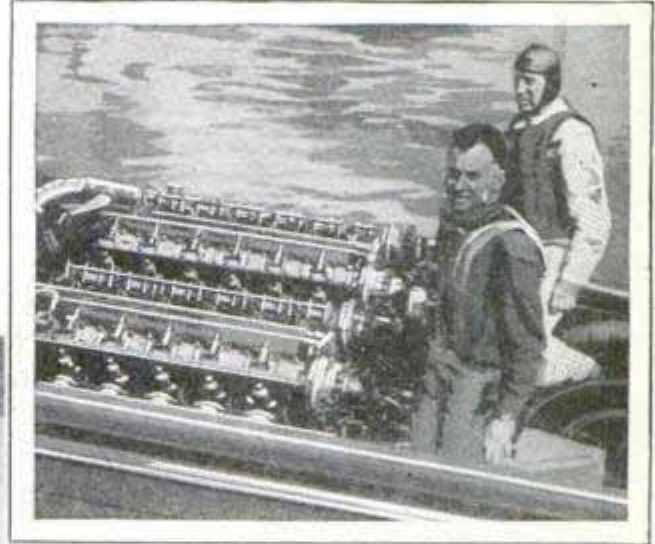

Gar Wood's New Craft Which Kept the Harmsworth Trophy in America, and, in the Inset, the Owner (in Helmet) and His Mechanician



peerage. "Miss America V" led her sister ships, the "Miss America IV" and "Miss America III" across the finish line, after the only foreign entry, a French contender, had been distanced by more than three miles. The winning boat is propelled by two twelve-cylinder engines capable of developing 1,100 horsepower.

LONG LINE OF CONCRETE EARS 427 IS AIRPLANE DEFENSE

England's southeast coast is being equipped with a new form of airplane detector, built of concrete. The detector consists of a series of disks, like huge plates, eighteen to twenty feet in diameter and supported on short legs a foot or so above the ground. A length of

pipe, to contain a delicate microphone, sticks up from the center, while each disk is surrounded by a concrete protecting wall, a foot outside its outer rim. The disk catches the sound waves striking its entire surface and transmits them to the microphone, which is connected electrically to a distant observatory, where the plane's direction and speed are estimated.

TELESCOPE PENCIL AS RULER AID TO DRAFTSMEN 1617

Fashioned in three telescoping sections, a metal pencil is a one-foot rule when extended, and when collapsed, is of ordinary size, so that it saves space in the draftsman's or artist's kit. It is also useful to carpenters and mechanics.



Pencil Extended for Ruling; Sections Collapse into Single One at Base

H.C. James 9/7/20

*Holland, R. Markley,
E. N. Smock & Co
19 S. Wells St Chicago*

402

WOMAN



Helen Filkey, Left, Set Three World's Records in One Day; Gertrude Ederle, Above, Made Another

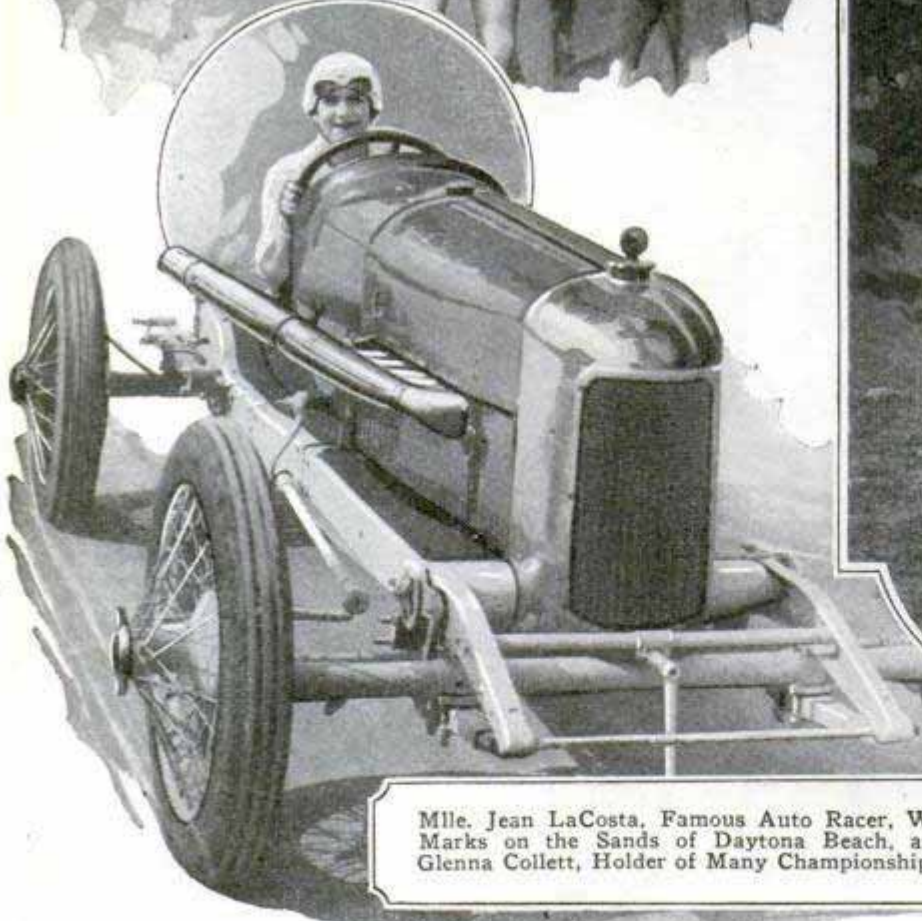
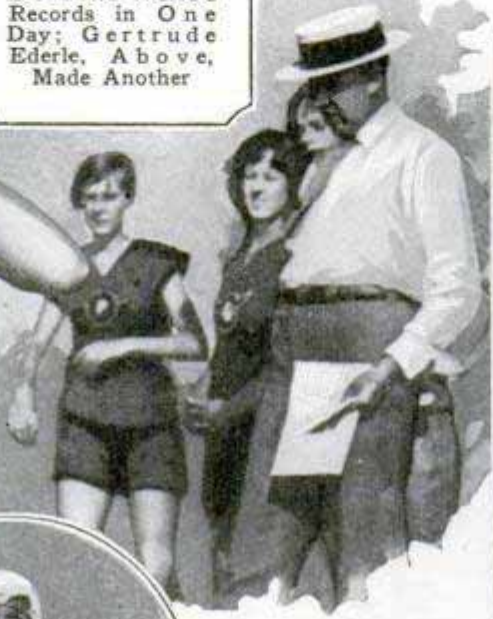

Mlle. Jean LaCosta, Famous Auto Racer, Who Set New Speed Marks on the Sands of Daytona Beach, and, at Right, Miss Glenna Collett, Holder of Many Championships in the Golf World

24

CHAMPIONS

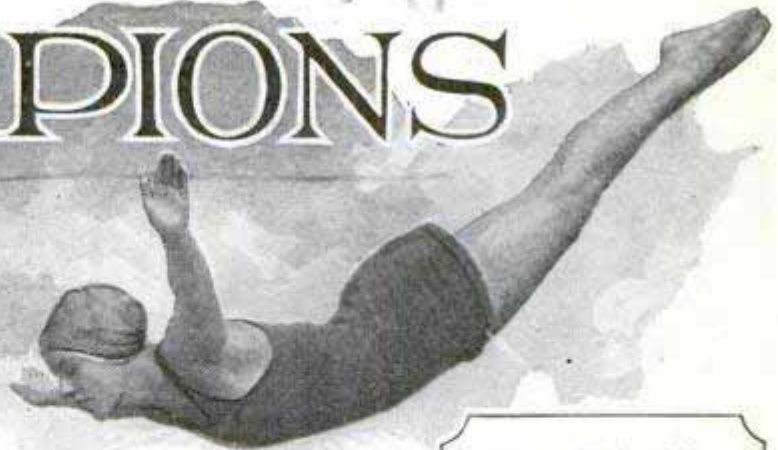

Helen Wainwright, National and Olympic Diving Champion, Above, and at Left, Helen Wills

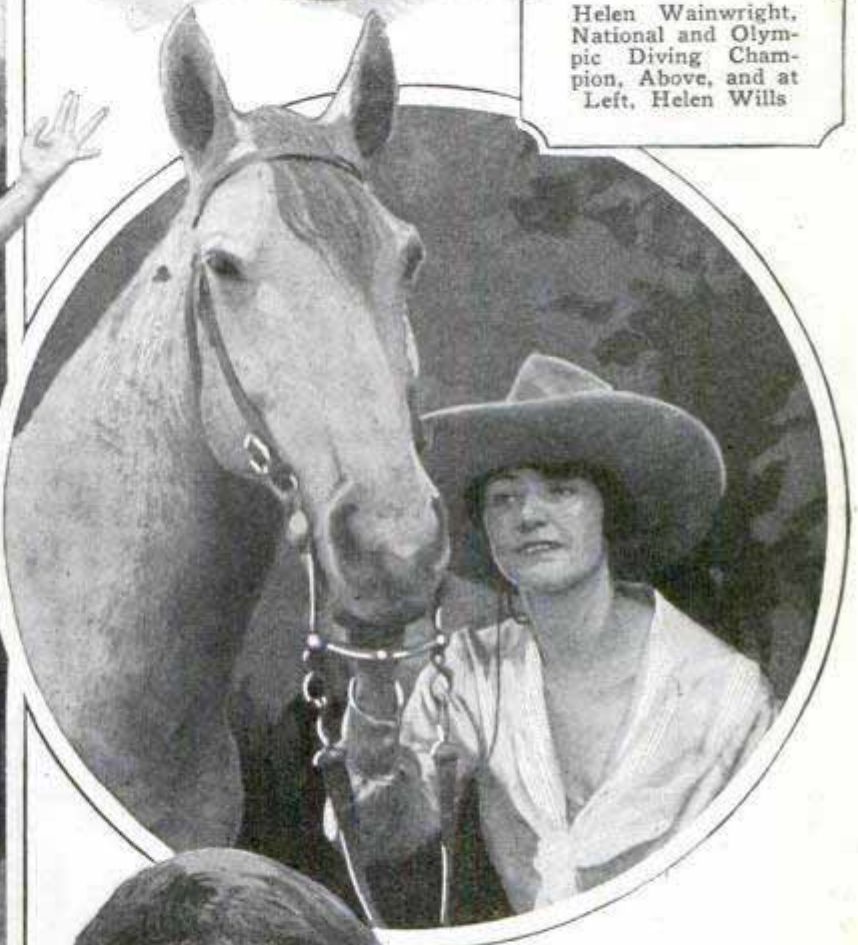

Lydia Hutchinson, Heroine of the American Dog Derby at Ashton, Idaho, with "Old Maje," Her Lead Dog, and, Above, Mabel Strickland, World's Champion Cow Girl, Who Won Back the Title She Had Held for Years in Recent Chicago Rodeo

Rush. See ad.

BOOK HOLDER ON TYPEWRITER SIMPLIFIES COPYING



Adjusted on Holder near Typewriter, Big Book Is Easily Copied and Protected from Damage

To save trouble in typing from large volumes, an attachment invented by a Texas man supports them in a convenient position for the operator, protects the books and saves desk space. It is intended especially for handling large court records.

HALF OF WORLD'S GOLD OUTPUT GOES TO ORIENT

438

India and China absorbed seventy per cent of all the silver produced in the world last year, while India alone took more than half of the total gold production, according to official reports. These facts have been overlooked in the westward rush of gold across the Atlantic since the war. Thirty-four per cent of the amount of gold imported by India last year came from the United States. That country also is the greatest market for American silver, buying all but about 2,700,000 ounces of the total amount produced here in 1925. The value of India's gold imports last year was three

times that of the silver. Almost all the metal is hoarded or used for ornaments, and the wide demand for it has caused economists to speculate as to the possible effect that may be produced on world supplies. In 1925, while silver production declined over the previous year, gold barely held its own. Further troubles are expected in the silver industry if India's trend toward gold continues. The chief difficulty in the silver question is said to be to find markets, not the curtailed supply. Eighty per cent of it comes as a by-product in the smelting of lead, zinc and copper, large amounts of which have been produced in the last few years.

GENERATOR THAT COULD LIGHT HOMES OF A MILLION

299

Capable of supplying 80,000 horsepower of electrical energy, a huge generator at an eastern plant, could light 300,000 six-room homes, sufficient to house 1,000,000 persons. A generation ago, it would have met all the electrical needs of the city of New York. It is sixty feet long and consumes thirty tons of coal an hour. For steam-condensing purposes, 96,000 gallons of water are required every minute.

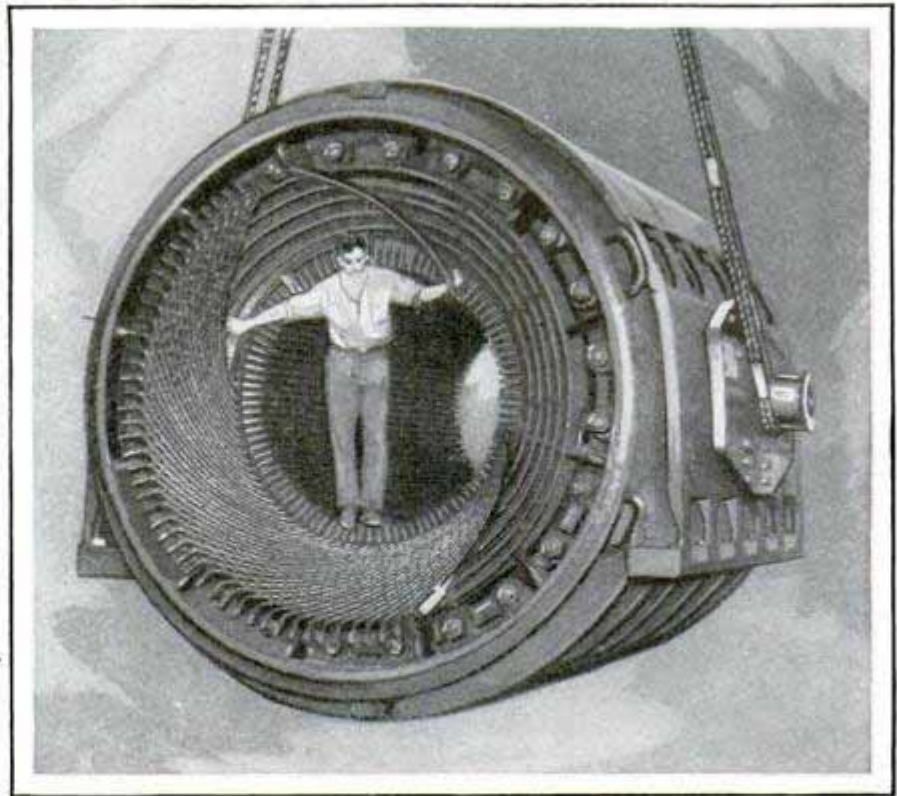

Big Generator Dwarfs a Full-Sized Man; It Can Supply Current Enough for 300,000 Six-Room Houses

Camera Reports 9/420 0.591

New York Edison Co. East River Station

393

WIZARD OF THE FORGE FASHIONS FLOWERS OF IRON



Mr. Cran and Samples of Artistic Pieces He Forged in Iron

*Box 40
1364 Randolph Road*

Mar 18th 1896

Working in an ordinary blacksmith shop, with crude tools, James Cran of Plainfield, N. J., has attracted wide attention by reproducing the beauty of flowers in metal. The only tools used were a cross-peen hammer, tongs of various sizes, pliers, and one or two other simple implements, all of which were made by the smith himself. Mr. Cran works entirely from memory, using no model. He studies his object closely, fixes it firmly in his mind and then starts to work at the forge.

PLAN TO CHART MYSTERY PEAK WITH A FLYING BOAT 517

Mt. Everest is not the only peak that has defied the adventurer. In British Columbia, the highest mountain of the province, at the head of the wild Homalko canyon, has successfully repulsed expeditions, and only last summer it defeated

the efforts of two parties to reach the summit. But it will not go uncharted, say the explorers, and plans are now under way for an air conquest of the rocky spire, using a flying boat from which to take photographs and records for surveyors. The peak is believed to have first been sighted in the '80's, when a route was being sought for a transcontinental railroad. Calculations showed that its height was in excess of 13,000 feet and it may even challenge Mt. Rainier's 14,400 feet, engineers believe. The difficult barriers that lie about it have taxed the hardihood of experienced mountaineers. One of the few ways of entrance is by the Homalko river, the "Terror of the North." Its muddy eddies have trapped many boatloads of equipment sent in to establish a base for expeditions that hoped to reach the top of the peak. It is proposed to name the mountain after George Dawson, a pioneer geologist.

Chicago Daily News 9/23/26

63 Melcher St
64 Boston Mass

Number: 9/4/22

Chicago } 106 S Michigan
Cleveland } 11 S Dearborn
Brooklyn }
St. Paul }
New York }
Cleveland }
St. Paul }
New York }
Chicago }
St. Paul }
New York }
Cleveland }
St. Paul }
New York }

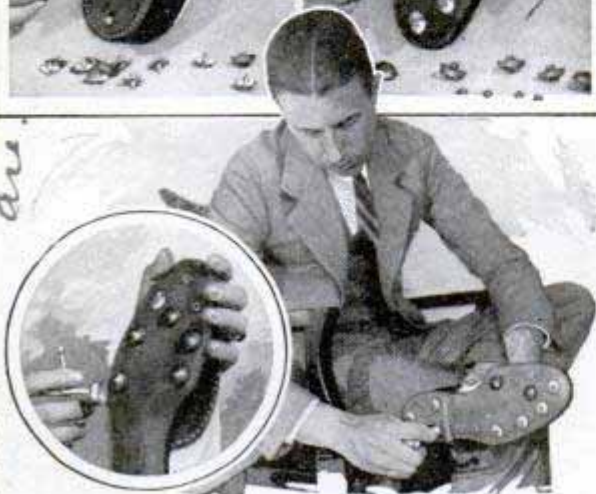
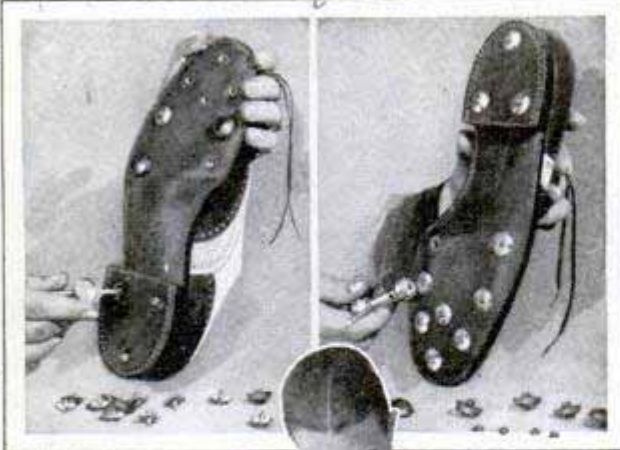

Inserting the Spikes, Rubber-Tipped Pegs and Screws; Same Tool Can Be Used for All

THREE PAIRS OF SHOES IN ONE WITH DETACHABLE SPIKES

Sharp metal spikes, round rubber pegs or flat brass slugs for street wear, are quickly screwed into sockets on the soles of a special golf shoe, affording the service of three pairs from the one. A wrench with screwdriver attachment, prongs for the spikes and a knurled socket for the pegs simplify inserting or removing the units. A complete change can be made in less than five minutes.

110 N. 45-200 N. \$ 48

WAFFLE BROWNED, IRON OPENS SAVING WORK AND BURNS

When the waffle is properly cooked, the top of an electric iron automatically flies open and the attendant is spared the task of repeated inspections and the risk of burning the food. A simple timing device operates the lid and it can be set at any one of three different adjustments for various degrees of brown-

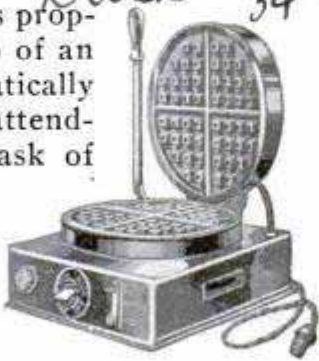

ing. The iron has been treated in such a way that grease is not needed, the manufacturers report.

MILLIONS OF MILES OF SILK GIVEN RIGHT OF WAY

413

A fortune in silk, 780,000,000 miles of thread from the cocoons of Japan, and valued at \$6,000,000, recently broke all records when it was rushed across the continent in a special train that had the right of way over even the fastest limited. The silk special made the run from Seattle to Chicago in fifty-nine hours thirty-six minutes, slightly more than half a day under the limited schedule of seventy-two hours. The silk specials are used to get the raw material from the Pacific coast docks to eastern factories to cut down the high interest charges, which in this case amounted to \$900 daily on the 5,200 bales.

WINKER FOR AUTO STOP LIGHTS HELPS PREVENT ACCIDENTS

531

Attached to the underside of the auto floorboard and connected in the stop-light circuit, a flasher unit causes the signal to wink about sixty times a minute when the brakes are applied, to help attract the attention of motorists in the rear. This leaves no doubt as to the intention of the driver, and the flashing can be seen for a considerable distance, affording ample warning in time to slow down and prevent collisions.



ICE CREAM FROM CRUDE OIL FREAK OF SCIENTISTS

421

Ice cream made from crude oil was recently described at a chemical convention by Prof. James F. Norris. He explained that ordinary crude oil, by extension of the cracking process used to increase its gasoline yield, could be re-formed in new atomic combinations which yielded edible fats, identical with those occurring in ani-

Remedy + 22 ans
Sebastian, n-H
Pre American
Chemical
Society

International Electric Elev. Corp
234. 9th St. San Francisco Calif

mal and vegetable matter used for food. Not only can the product be used for ice cream, but different combinations will yield alcohol, acids, flower perfumes, fruit flavors, drugs and all sorts of dyes. He also announced that glycerin could be obtained from petroleum.

SYNTHETIC RUBBER FROM POTATOES

503

Chemists are experimenting with corn and potatoes as a source of materials for the manufacture of synthetic rubber, it is reported. The vegetables are first converted into alcoholic products which can be used in rubber making.

While the process is not yet commercially profitable, investigators declare that the measure of success already attained, promises well for the future.

see Dec 1928 94 C

GRAIN DUST IS USED AS FUEL TO RUN AUTO MOTOR

437

Successful experiments with various kinds of dust as fuel for motors indicate that a substitute may be found for gasoline in materials that are relatively cheap and plentiful, engineers declare. For instance, workers in the department of agriculture have rigged an automobile engine so that it can be run by grain dust, and it is said that the method opens a way for large savings to farmers. Motors have been run on similar principles in Germany.

Dr. W. A. Noel.



Dr. Dixon Holding a Surf Bird, and a Closer View of the Nest with Its Four Peculiarly Marked Eggs

NEST SOUGHT FOR CENTURIES FOUND IN ALASKA

358

What is believed to be one of the longest hunts ever made for a bird's nest has recently ended with the finding in central Alaska of the home of the surf bird, a "mystery" flyer that has been observed in migrations all along the Pacific coast of both Americas, but whose nest has escaped the search of scientists for 200 years. The discovery is credited to Dr. Joseph Dixon of the University of California. Four eggs were found.

Economic mammalogist

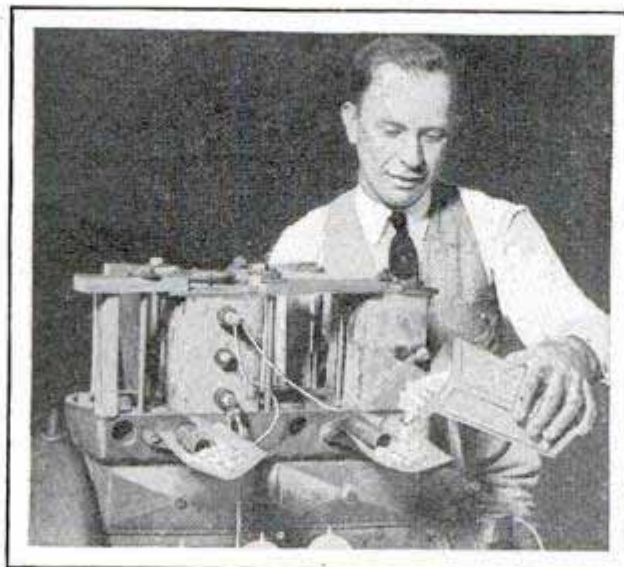

Copyright, Henry Miller
Using Corn Starch as a Substitute for Gasoline as Fuel to Run Automobile Engine

Popular Mechanics Magazine does not publish the name of the maker or seller of any device described in its pages, but this information is kept on file and will be furnished, free, by our Bureau of Information.

ROD SUPPORTS MOVIE CAMERA AS TRIPOD SUBSTITUTE

351

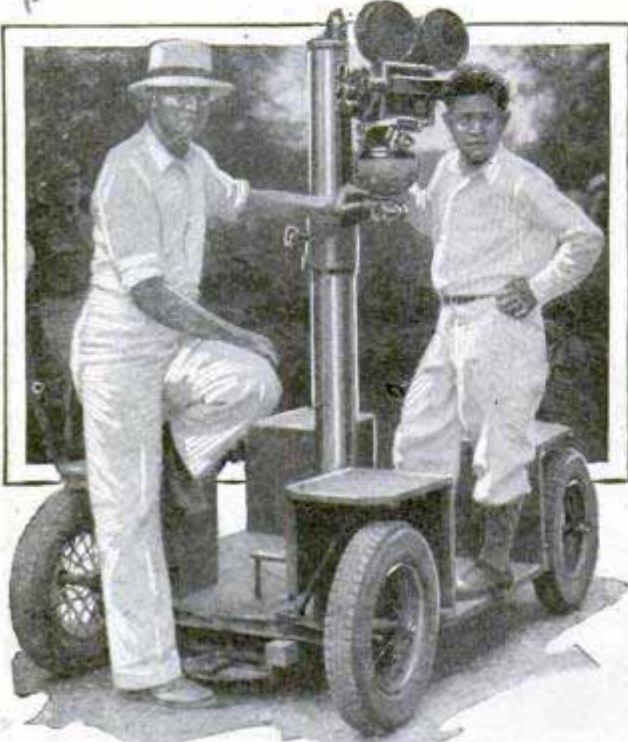

Motion-Picture Camera on Its Adjustable Rod Support and Rubber-Tired Truck

In place of a bothersome tripod, a tubular-rod mounting was used for the motion-picture camera in filming a Texas scene, and with great success, it is reported. The support was mounted on a light, rubber-tired truck and the instrument was counterbalanced on swings, pivoting in such a way that a touch was all that was necessary to adjust it up or down or in any direction. This great mobility is considered an important advantage over the usual tripod.

SPARE TIRE OF WOOD BLOCKS COSTS LESS THAN RUBBER

348



Said to cost less than half the price of a rubber casing and inner tube, an emergency spare tire for the automobile consists of interlocking spruce blocks incased in steel bands and with a steel tire shrunk

on. It affords ample protection for the rim and does not make riding uncomfort-

able, according to reports. A feature is that no rivets or bolts are used, metal connections being held by spot welding.

BARRIERS AND HAIRPIN BENDS ADD THRILLS TO AUTO RACE

344 Novel features were introduced this year at the first Grand Prix international auto race run in England on the Brooklands track. The distance was 287 miles and, in order to provide the spectators with plenty of interest and to test the skill of the drivers, twists and turns were incorporated in the course. In the straight-away at the finish, two obstacles in the form of short banks of sand were placed so that competitors had to drive around them. A steel bridge was built across the track to allow visitors easy passage to the reserved inclosure. The race was won by France at an average speed of seventy one miles an hour in a running time of four hours fifty-six seconds.

WATCH SERVING AS CUFF LINK IS PROTECTED BY SLEEVE

272 An interesting form of the wrist watch has appeared in a small timepiece that

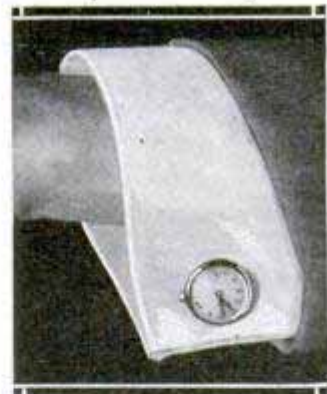

can be worn as a cuff link. It is always in a convenient position for use and has the additional advantage of being protected against breakage of the crystal or other injury by the coat sleeve.

DAY LENGTHENING AS MOON PRECEDES FROM EARTH

411 Days on earth are growing longer and the moon is gradually getting farther away from us, according to Prof. Harlow Shapley, director of the Harvard observatory. However, there is no cause for immediate alarm, as the slowing of the earth due to the tidal pull of the moon amounts to only one-thousandth of a second in a century, while the moon is receding only seven feet in 100 years.

Economy Electrical Mfg. Co.
Kansas City, Mo.

Rubber Jewelry Co. Berlin Germany

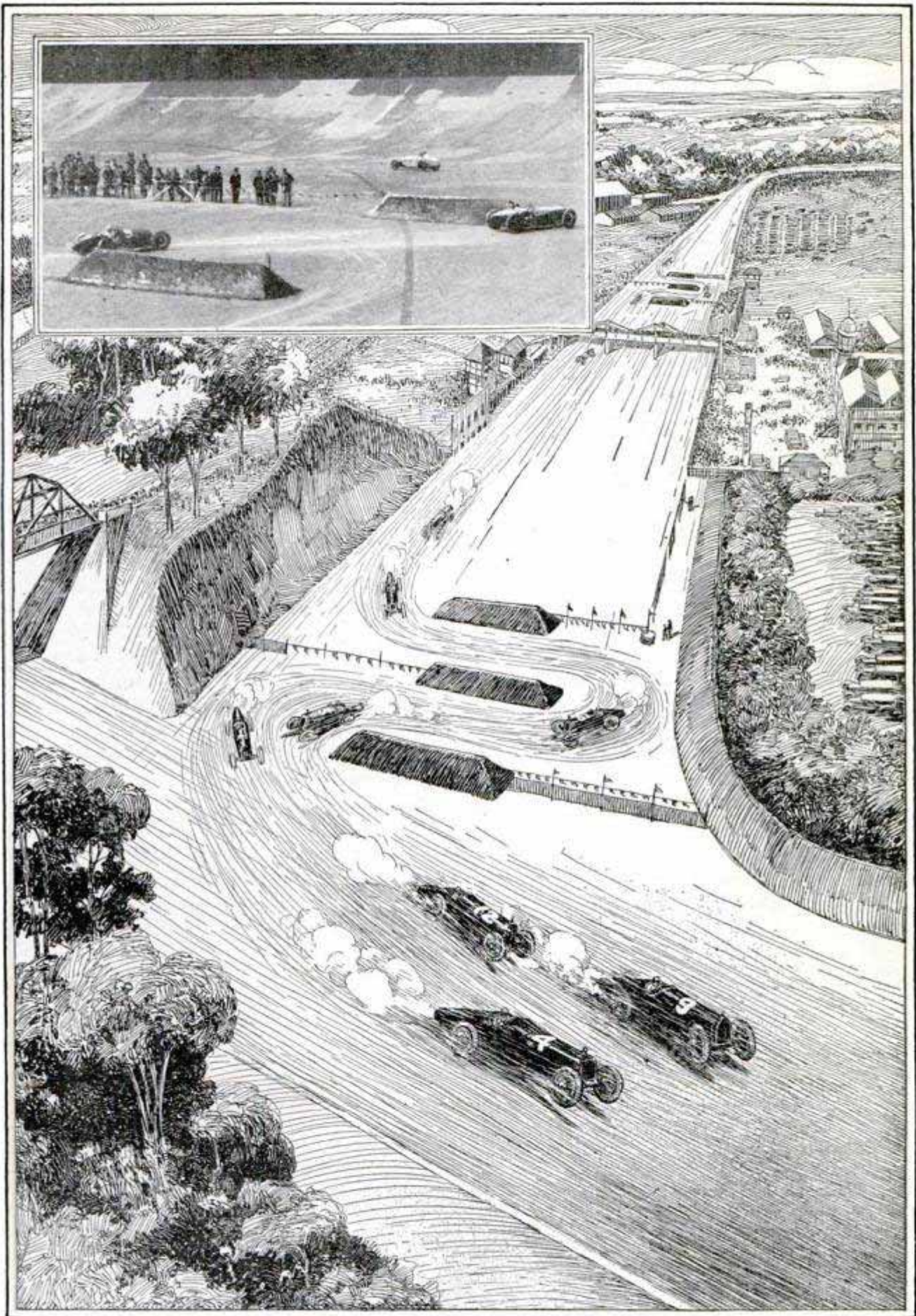

Sand Banks Resembling Golf Bunkers Turned an English Automobile Classic into an Obstacle Race, with the Drivers Demonstrating Their Skill in Turning Corners at High Speed

Calif. #1, 285,661. No. 1926198

Wm. John Fletcher
San Francisco, Calif.

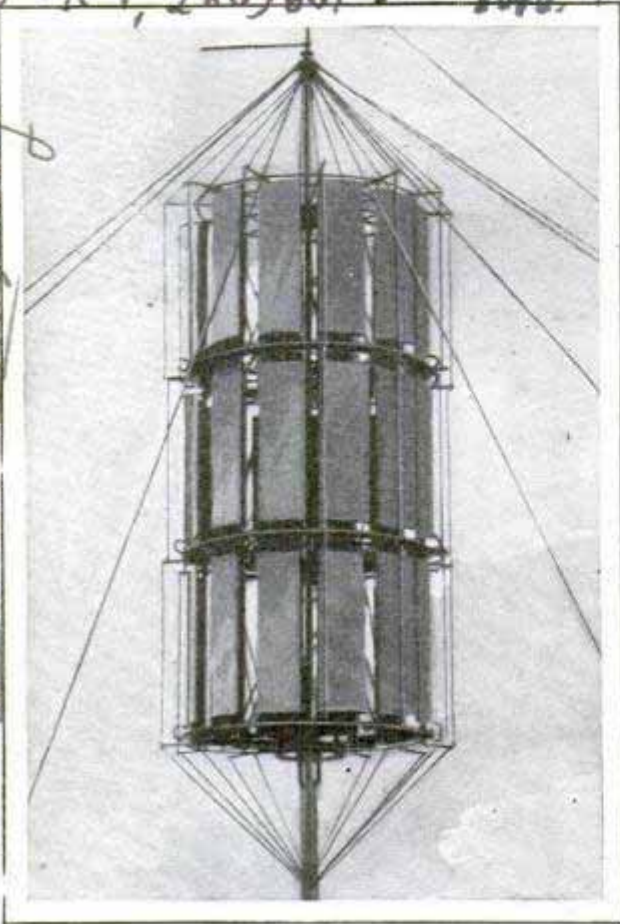

Ready to Catch Breezes from any Direction; Windmill with Perpendicular Blades for Generating Power

VERTICAL BLADES ON WINDMILL TO GENERATE POWER

Individual fans are set in perpendicular fashion instead of radiating from a center in a windmill a western inventor has constructed. He intends to use it for generating electric current and for irrigation purposes. An extensive surface is exposed to the wind in all directions.

CORNSTALK AS PAPER SOURCE TO HELP SAVE TIMBER

Experiments in preparing several satisfactory grades of paper from cornstalks, at Iowa state college, are held to indicate that a way may have been found to reduce the inroads on timber and to afford the farmer an income from what is now chiefly a troublesome waste and the winter abode of a destructive pest, the corn borer. The cornstalk product has been made in different

qualities from a coarse box kind up to the finer grades for writing purposes. Cooked liquors from the stalks furnish a strong adhesive material which can be used in the making of box board, in billposting and for other purposes, it is reported. It is also pointed out that the stalks require only eleven days for seasoning, whereas wood needs nine months to two years, and only one hour of cooking is necessary for corn pulp against forty-eight for wood. The stalk paper also takes ink satisfactorily without calendering and sizing.

TRACTOR OUTFIT UNLOADS CARS SAVING HAND SHOVELING

From six to eighteen cars of sand, gravel or other loose material may be unloaded in one day with a combination tractor and scraper outfit, it is claimed. The capacity depends upon the number of men in the crew and the size of the apparatus. The rigging consists principally of a frame support clamped to the side of the car and a tractor to pull the scrapers which are dragged through the car and dumped in a chute that empties into a truck at the side. When a car is unloaded, the outfit is quickly moved to another with the tractor and made ready for work in a few minutes. Only one man is required to do this. A farm tractor of common type, with simple attachments, may be used. The scrapers are so designed that they are said to pick up all the material, making it unnecessary to do any hand shoveling.



Tractor-Scraper Rigging for Unloading Cars of Loose Material; Entire Outfit Is Easily Moved to Another Car and Attached

Ames, Iowa.

Amaha
Baker Steel & Machinery

Dr. O. P. Sweeney

Chicago Dealers
Equipment Co.

v. 5th, I have tried a number of times to
at the whereabouts of Mr. John Fletcher, the
inventor of the Windmill with vertical blades.
The windmill is located on a
vacant lot with the following signs on the house;
John Fletcher, Windmotor patent #1285661 and
the other side of the building is Western Wind
Power Company. No one in the locality seems to know
anything about this man.
You might try the patent office
Washington and see if they know anything.

Very truly yours,

INTERNATIONAL NEWSREEL CORP.



9/18/26

SEEK FABLED "CITY OF BRASS" IN SAHARA DESERT

Somewhere in the Sahara desert, so runs the Arab legend, is a marvelous city with two tall towers of brass that gleam like twin beacon fires in the sunshine, with walls so long that it takes a camel two days to walk around them and with twenty-five hidden entrances. The bodies of soldiers and merchantmen lie shriveled in the silent streets, for the city's residents were starved by a seven-year drought, and the drifting sands have all but covered the dwelling places. Bent on finding it, if there is such a city, a French expedition has been sent to traverse some 2,000 miles of desert paths from Tugurt to Timbuktu. Explorers believe that if this "City of Brass" is not found, others will be discovered, for the sand drifts are known to hide many a settlement whose inhabitants probably starved to death during long rainless periods, were killed by invaders or abandoned their towns for others where there was water. Many of the old tales of this kind, when sifted down, have been supported, to a degree at least, by fact. The city of Troy is no longer regarded as a myth and the cave that doubtless inspired the legend of the Minotaur has been explored. Recently, an expedition from the University of Chicago visited the "Nameless City" of the Syrian desert and photographed paintings on the walls just in time to preserve the record, for the ancient murals were obliterated by the Arabs as soon as the British troops had been withdrawn.

604

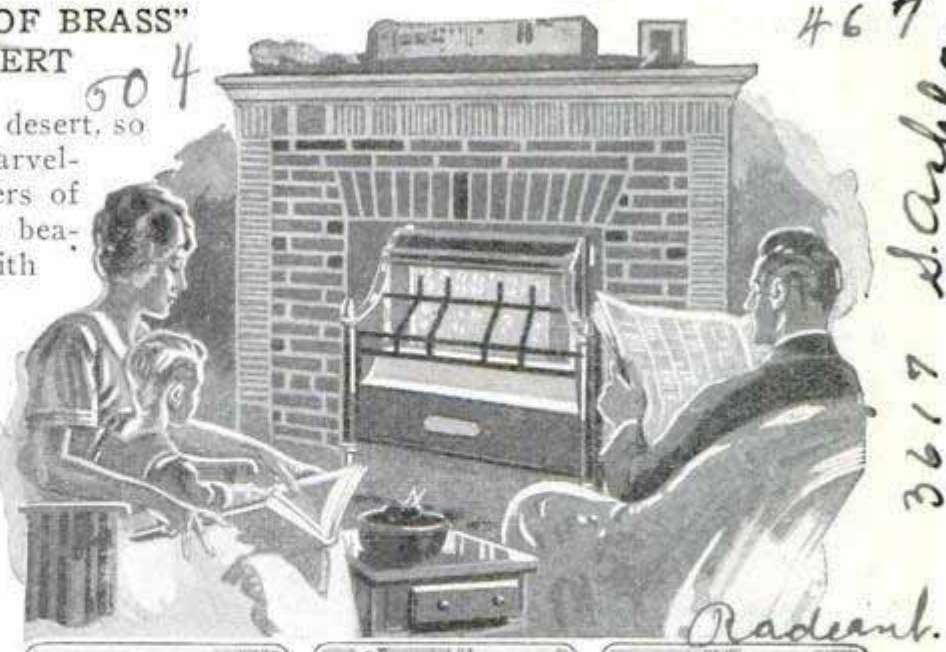

Radiant.

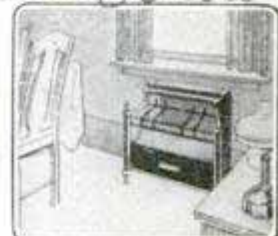
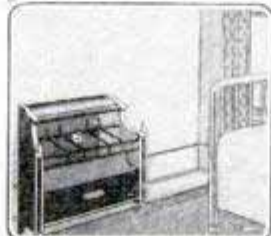

Heater in Typical Uses; It Can Be Carried to Any Part of the House and Is Quickly Put into Operation

HEATER THAT BURNS GASOLINE SERVES AS FIREPLACE

Said to radiate a clean, warm, odorless heat, a portable grate burns gasoline and requires no pipe or hose connections of any kind. The fuel is carried in a tank below the upper part, and is made to generate gas for operation in four minutes. Guards are bolted to the side of the radiator to keep out papers, curtains, etc.

WARMLY LINED SLEEPING BAG CARRIED IN SHAWL STRAP



Weighing but ten and one-half pounds, a waterproof sleeping bag is lined with down or wool and fits snugly about the head and shoulders to keep out drafts. An additional feature is a flap that may be supported by sticks to afford a shelter from the wind. The bag can be rolled into a small parcel that may be carried in a shawl strap.

Write our Bureau of Information if you wish to know who makes or sells any articles described in this magazine. Send no postage; the service is free. Shield for the Head Is Feature of This Sleeping Bag; It Is Seen Folded Up at Left

467

3617 S. Ashland Chicago

Wght. 10 1/2 lbs. Down - \$36.00 Wool - \$26.00

C.C. Folsom Co. 1005 First Ave Seattle Wash

417. Ge. Davis Inst. Sept. 1926 370

WORLD'S LARGEST LENS TO BRING STARS NEARER US

Huge Telescope at Meudon, France, is a Twin Instrument, for, besides eyepieces, it contains apparatus for taking photographs while observer works; vault-like doors in rectangular tube can be tightly closed to keep dust from lenses

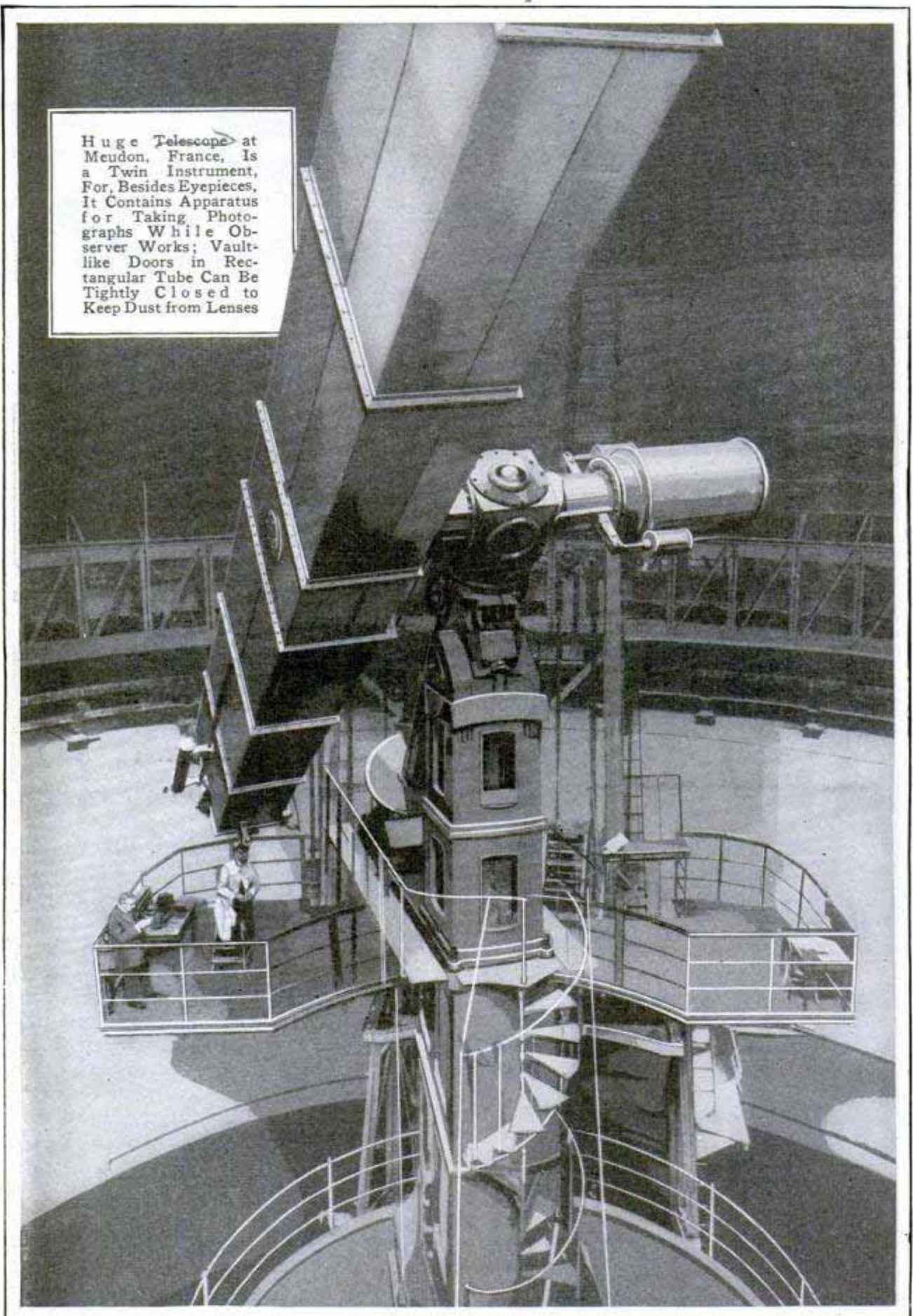

*California Sea Products Co.,
Russ Bldg.
San Francisco, Calif.*

GUN HARPOONS DRIVE WHALES TO NEW HAUNTS 497

Only seventy whales were killed by a fishing company off the coasts of Mexico and Alaska this year, whereas the usual number has been around 350. The reason, experts declare, is that harpoon guns, which have reduced whaling from a romance to a business, have driven the monsters from their old haunts. Plans are being made for invasion of the new resorts next year and a floating factory has been constructed from an old ship to save time. Instead of towing the mammals to shore after capture, they will be brought back as barrels of oil, and bags of bone dust and fertilizer prepared on the traveling reduction plant.

AUTOMOBILE COTTON PICKER PROTECTS THE PLANTS 382

An automatic cotton picker which, it is claimed, will pick matured cotton without damaging the plant or the unopened bolls, has recently been placed in production. The machine is said to be the first practical cotton picker of its type. It consists of an automobile with pneumatic tires and an arched frame, from which is suspended two revolving cylinders studded with needlelike steel fingers. The cylinders are turned by the same motor that drives the machine, and timed to revolve at the same rate as that at which the outfit moves forward. In operation, the machine straddles the cotton row, with the plants passing between the two cylinders. The fingers catch and extract the fully matured cotton, revolving as they do so at a high speed on their own axles, and then, as they are withdrawn from the blooms, stripper bars remove the cotton and a suction pipe carries it to a storage compartment. The difficulty in building a picker is that it must not damage unripe bolls, since cotton matures over a period of weeks.



Lighthouse Tower Cottage at Seaside Resort; It Contains Ten Rooms and Three Baths

COTTAGE BUILT AS LIGHTHOUSE AFFORDS WIDE VIEW 197

Containing ten rooms and three baths, a summer cottage on the Massachusetts coast resembles a lighthouse. Its shape affords a view of the ocean and a breeze through almost every window.



Picking Cotton by Auto; the Machine Straddles the Row and Is Said Not to Injure Plants or Unopened Bolls

*Located at Powder Point
Mr. and Mrs. Harry Mann. Accompanied by
Mrs. Mrs. H. H. Clark, West*

*H. N. Berry & Son,
Esseenville Miss*

405

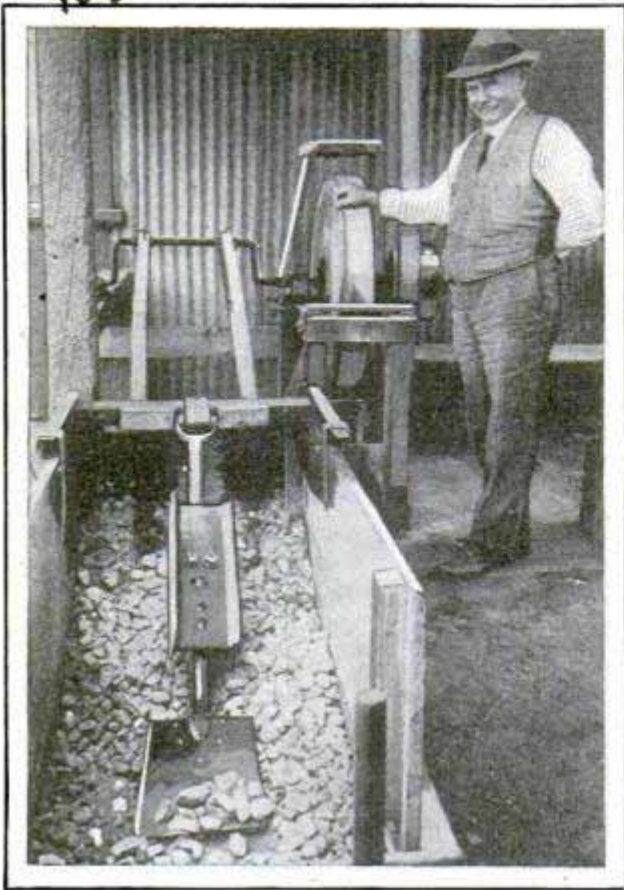

Grindstone Shaft Forces Shovel Repeatedly through Rock, to Determine the Tool's Lasting Qualities

"MECHANICAL MAN" TESTS LIFE OF RAILWAY SHOVELS

To determine how long shovels used by laborers in handling rock ballast will stand up under the constant wear, the Los Angeles street railways have constructed a "mechanical man" which automatically shovels rock until the shovel is worn out. Samples, heavily weighted with railroad iron to make them dig in, are connected to a support operated by an extension of the shop grindstone shaft.

HAMMER PULLS NAILS WITHOUT BENDING

Shaped so that nails can be pulled straight up and thus kept from bending, a one-piece hammer is especially useful in opening boxes and in performing other odd jobs. To aid in this, the opposite end is shaped like a pry bar. The handle and head are made of solid steel.



COLOR OF GOLD DEEP ORANGE INSTEAD OF YELLOW

453

Gold is not yellow in reality, but a deep orange color, according to metallurgists. White light reflected from it gives it the familiar yellowish hue as the true color is diluted. The precious metal assumes other shades besides yellow and orange. Ground into a fine powder, pure gold becomes ruby-red. This rich color is commonly seen in the special glass used for photographic dark-room lamps.

LOCK WITHOUT KEY OPENS AT TOUCH ON BUTTONS

1534

Instead of key and key-hole, a master lock for doors is opened by a system of buttons arranged in parallel rows below the knob. They are said to be proof against tampering, and the door can be opened only when the buttons are pressed in a certain order. The combinations can be varied and different ones used on different doors.

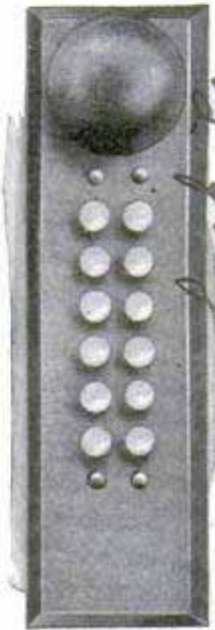

Master lock for door 753, Elkhart, Ind.

NEW MOTORIST MORE CAREFUL THAN EXPERIENCED ONE

451

No matter how long a man has operated a car, he always has something to learn about careful driving, according to Thomas P. Henry, president of the American automobile association. He cites accident reports to show that the experienced driver is often a greater offender than the beginner, and that a motor pilot with ten or twelve years' training frequently develops a careless attitude, takes too great risks and, consequently, is a greater menace to public safety than the driver who is just beginning. As an example, one large city reported only twenty-three accidents that involved persons who had been driving three months or less, during the first quarter of this year, while sixty-four were registered against motorists whose experience varied from three months to a year. Those who had

Bridgport Hardware Mfg Co. Conn.

539 Dearborn Chicago 969

436

driven from two to five years, and who had accidents during that first quarter period, numbered 405, while 688 were practiced operators with records of five and more years' standing. Mr. Henry made allowance for the fact that the experienced drivers are in the majority and therefore more of them would be involved in accidents, but concludes that "the preponderance of mishaps caused by the more practiced persons has but one explanation and that is simply carelessness and a tendency to take chances. The lesson for motorists is plain—'never too old to learn'."

WHEELBARROW SANDER DUSTS SLIPPERY WALKS *1689*

Icy sidewalks are quickly and thoroughly coated with sand from a hopper spreader invented by an Iowa man. The attachment is fixed to an ordinary wheelbarrow which is filled with sand for replenishing the hopper and the flow of the material is regulated by a lever within easy reach. A pan with several strips on it effects even distribution.



Wheelbarrow Sander Attachment in Operation, and Side View Showing Connections



To Protect the Blind at Night; Flash of Light on Armband Identifies the Man in Darkness

LIGHTED ARMBAND FOR BLIND GIVES NIGHT PROTECTION

Worn on the outside of the coat, an illuminated armband for blind persons serves as a signal when they desire assistance and also informs others of the wearer's condition, to prevent accidents. The band is lighted from a small electric battery and the current may be turned off or on whenever desired.

PHOTO TAKEN THROUGH EYE OF GLOWWORM *426*

That insects can often see as well as human beings was demonstrated recently before the British Association for the Advancement of Science by Prof. H. Eltingham, who showed pictures taken with the eye of an insect used as the camera lens. One portrait of a man, which was good enough to stand enlarging and throwing on a magic-lantern screen, was taken through the eye of a glowworm, though its eyes are only one fifty-thousandth of a square millimeter in size. Dragonflies also can see as clearly as men, he said, while butterflies have eyes good enough to recognize each other at distances of more than a yard.

*Chas. Alfred Knight
McCregor, Iowa*

1810

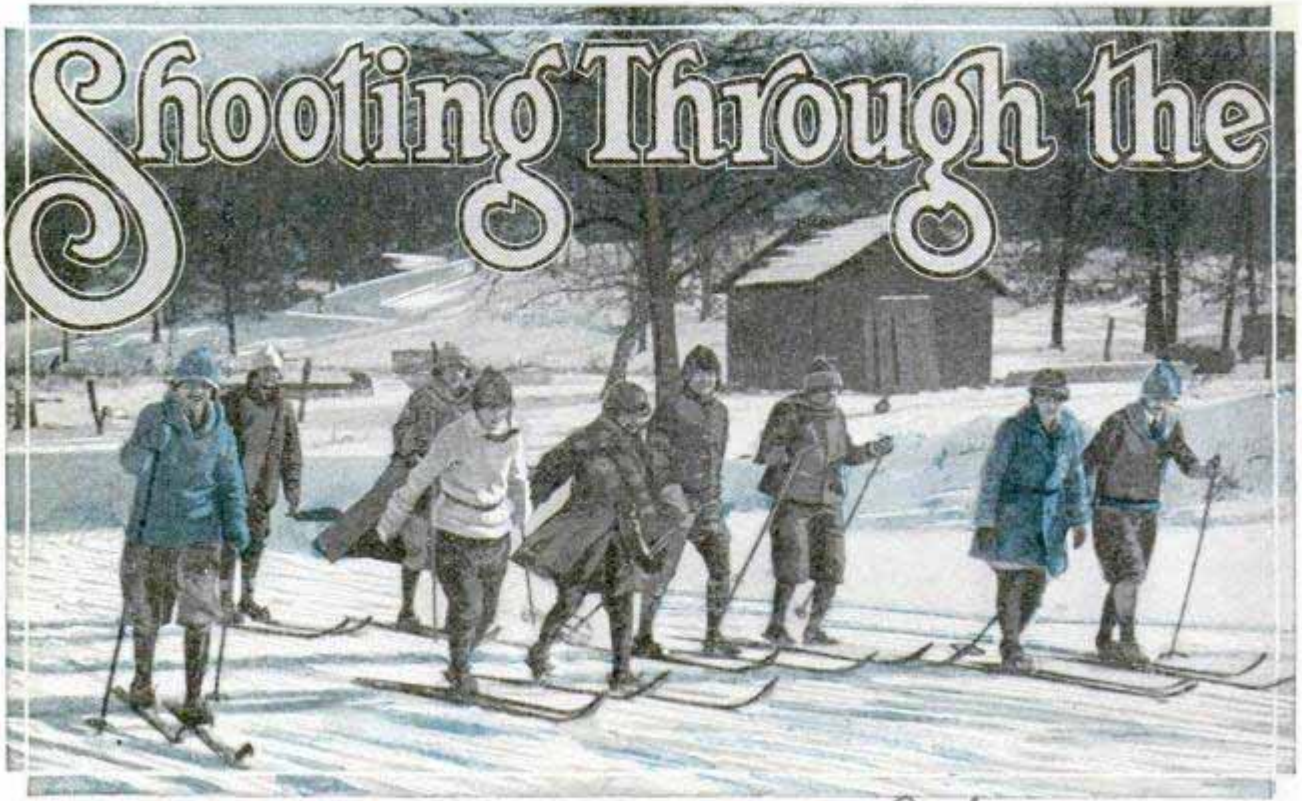

By EARLE W. GAGE, *Ashville, N.C.*

SKIING—flying through the air on a pair of wooden wings—that's the zenith of winter sports. "It's great sport—for the fellow who looks on," is the testimony of the conservative, but to the man who doesn't mind burying his nose in a ten-foot drift today, provided that he can take a ninety-foot leap into the blue air tomorrow, skiing is the king of all snow pastimes.

And if the thrills of plain skiing fail to register, why, there's ski jumping and ski kjouring. And it is most simple, safe and healthful sport, this sailing around the snow lands on a pair of wooden runners that seem to compete with the airplane for speed and thrills. It's easy to learn, and, anyway, the snow is soft!

For a moment you are poised at a giddy height, with two slender wooden runners attached to your feet. Then you let go and start gliding down the steep hillside pitched by nature at an angle of thirty or forty degrees. Faster, faster—yet faster you go until you are skimming along at airplane speed. This is rare exhilaration, flashing down the blue-white slope.

Then you come to the gentle acclivity, or take-off, which ends abruptly. Beyond that—nothing but just air. For the fraction of a second you experience a terrific upward rush as you clear the take-off that lifts you whistling through the air, hurling you for a hundred feet or more to the featherdown landing.

For the fraction of a minute you seem to hang suspended with a great white panorama of snow, blackly dotted with human beings, seemingly miles below.



1910

Air on Wooden Wings

Then down, down you swoop like a frightened barn swallow. A single second more, and you have landed with an impact that fairly shakes your teeth loose, drives the breath from your lungs, and you are enveloped in a great cloud of swirling powdery snow. If you are not a professional, over and over you roll, since only the skillful are able to make the landing without a fall.

No pastime has so taken the New World as skiing. Its devotees have increased by leaps and bounds in the past few years, since Nels Nelson sailed from his white Norwegian hillside clear into the hearts of Americans on his trusty skis. Everything, from the wee hill for the greenhorn to the towering featherlike snowslide for the skilled, holds forth a challenge and an invitation to come and conquer.

This is the oldest known form of all winter sports. The "gliding Finns" let their neighbors, the Norwegians and the Swedes, copy their early models, but the idea went no farther for many years, and skiing seems to have been confined to the northern lands for centuries. The opening of the Middle Ages brought warfare and fierce battles, and armies were fitted with slender wooden runners and made able to travel in all kinds of weather.

Less than a generation ago skiing was confined to the Scandinavian countries and Russia. Early in the 90's, the French consul at Kolmar appeared in front of the Feldbergerhof, at Feldberg, Germany, with a pair of skis over his shoulder and orthodox Norwegian skiing took root in the Black forest. A little later Herr Zdarsky of Lilienfeld, Austria, invented a ski and a theory of skiing all his own, and thus attracted so much attention that special trains from Vienna started, carrying devotees of the sport into the country for winter holidays. Then Paulcke introduced skiing in Switzerland and created a sensation that still persists.

Although ski contests are held in America, all the way from Revelstoke, B. C., to old Vermont, it is in Switzerland that



all kinds of the sweeping wooden slippers meet to pull off the great International Championship ski jump, in the heart of the high Alps. Henry Hall, of Detroit, made the world's record jump at Revelstoke, 229 feet, which hasn't been beaten, but he has two brothers, Carl and Clarence, who are making it hot for him to keep that title. "Bing" Anderson, of Berlin, N. H., holds the eastern-states record of 172 feet, and is rated as one of the best jumpers in that part of the country.

The skis appear to be about the most awkward of footgear, but those who have mastered the strips tell us that they are about as playful as a pair of kittens. It is the custom, when donning them for the first time, to intrust yourself to the professional teacher who takes you out to some lonely slope, far away from maddening civilization, and advises you in falling to relax every muscle in your body and let yourself go; that only by making no attempt to save yourself will you be quite safe from straining a muscle. Not quite so easy as it sounds! After you have reached the stage where you can

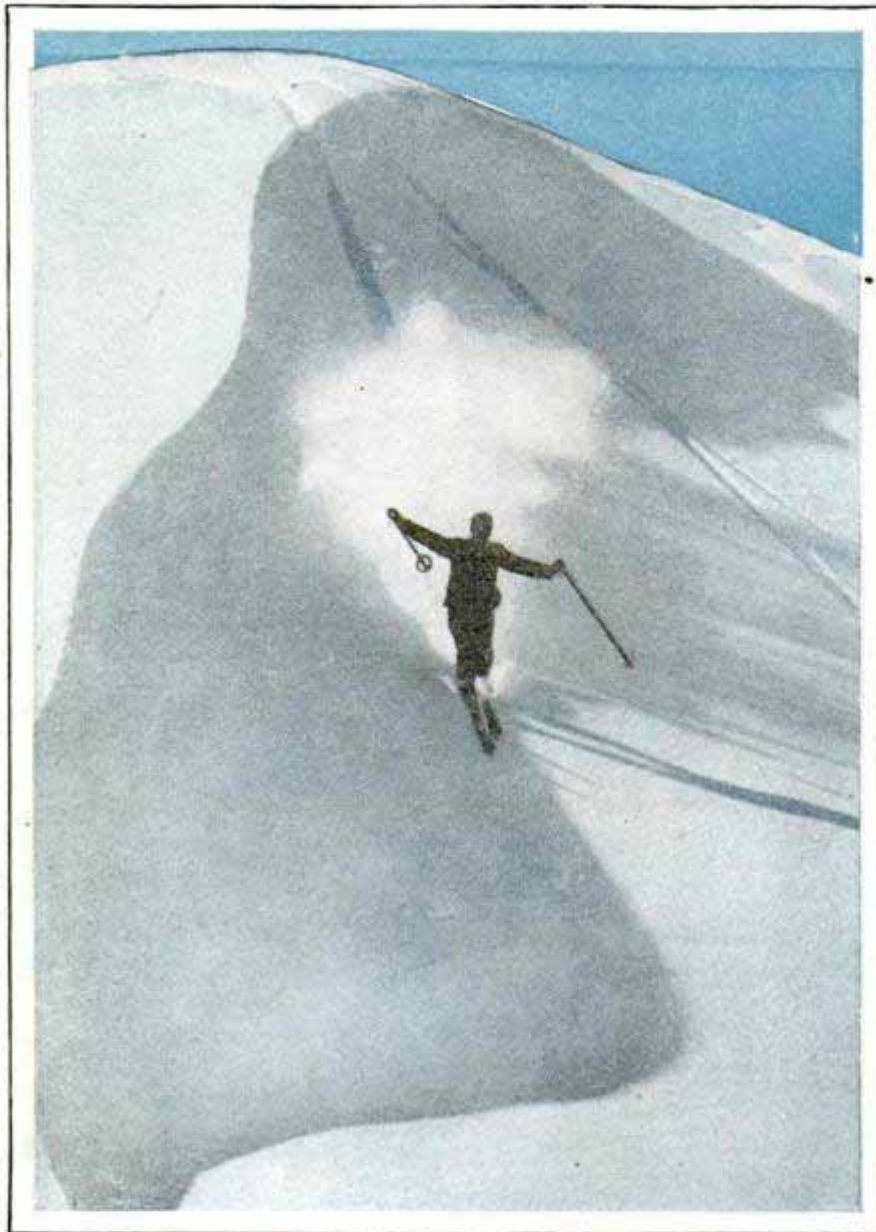

Enjoying Thrills after a Hard Climb; a Skillful Ski Jumper Balancing Himself as He Swoops down a Snowy Alpine Slope

negotiate such little things as stone fences and tree stumps, it is time to learn the "Christiania swing," "stem turn," "Telemark turn," "herringboning," "swings," "stops," and a few other little tricks, all of which combined make a finished artist.

The knack of getting over the snow on these long runners is so easy to acquire, if the right principles are caught at first, that, at the end of a sunny afternoon's running, the ordinary person will be able to manage his skis fairly well.

The novice should start running wee slopes. The Telemark position is most popular with professionals, and is a good one to learn. One ski is held slightly in advance of the other, rear knee bent. Hold the skis closely together, and make

but one track. Carry poles with points to the rear to avoid accident.

In climbing the hill, use the herringbone method, and you will be able to travel much faster than you could walk. Turn the points of the skis outward and tips of inside edges downward. One ski should be slightly above the other. The wider the angle formed by the two diverging skis, the firmer the grip. By lifting each ski in turn over the other, the runner can move straight up the slope as fast as his energy permits. Lean toward the hill and plant the skis firmly.

In climbing steep slopes, use the "traversing" method. Heading diagonally up the hill, lift the upper ski forward and upward, then bring the other up beside it.

Complete control of skis means mastery of two methods of turning or swinging at full speed, either the Telemark or the Christiania. The first is usually found easiest in right-hand swings.

The outer ski leads in making the right turn; to turn to left, the right ski is pushed forward until the foot is opposite the point of the left ski. Place weight on the forward ski, with body inclined forward and left knee bent deeply. Turn the right or leading ski inward, or "edge" it, and press sharply outward on right heel. The leading ski will swerve to the left, followed by the unweighted left ski. Continued pressure brings the skier to a full stop, facing uphill.

In the Christiania swing, the inner ski leads. Headed down the slope, advance the right ski slightly. When you wish to turn, shift the weight quickly to the right ski, edge it and twist sharply to the right, leaning toward the hill, somewhat in the

manner of making a sudden stop in skating. Put the pressure on the heel of the ski. This turn is valuable for a quick swing on snow too smooth or hard-packed for the Telemark.

The principal braking movements used to reduce speed on steep and uncertain descents are the "snowplow" and the Telemark. The first is done by placing the skis with points together and heels separated as far as possible. Both skis are edged inward, and the degree to which they are edged determines the braking effect. This leads to a turn, for, by shifting the weight to either ski, the skier is bound to follow that ski into a turn in the opposite direction. The right ski, being pointed inward, will run to the left if weighted; the other is sure to follow.

The Telemark brake is used for very steep slopes, and consists in placing one ski, edged inward, across in front of the other at right angles. The skier runs on the second ski with knee deeply bent and brakes himself with the first ski.

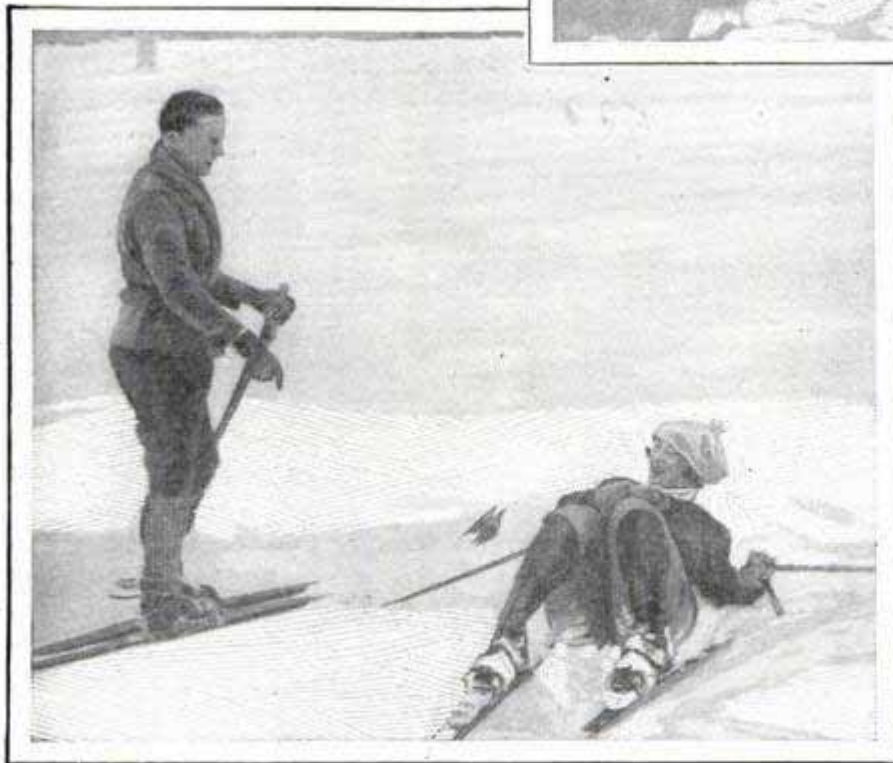
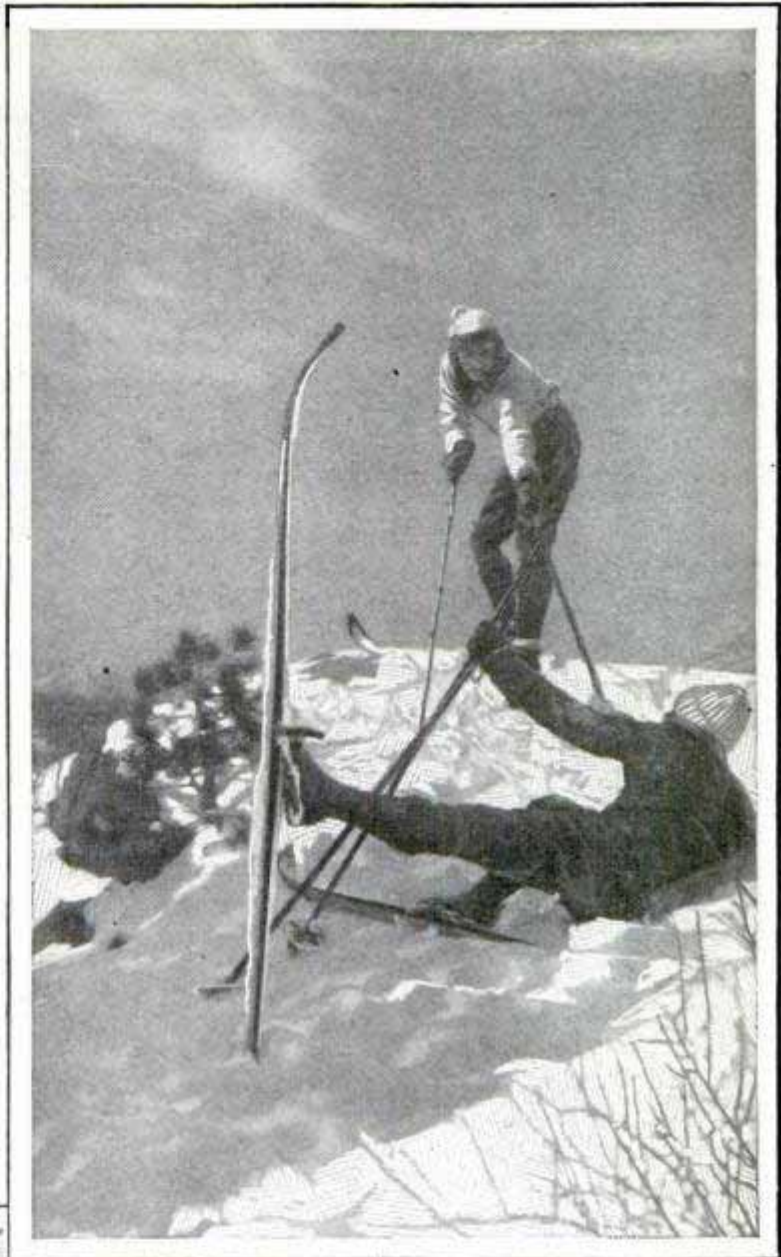

Summer Tourists in Estes Park, Enjoying the Ups and Downs of Skiing, and Below, Anthony Maurer, a Ski Champion, Coaching a Pupil

Jumping consists of two very important elements—spring and balance—each of which governs the form so prized by professionals. Judges rate form equally with distance in jumping contests.

Running in the Telemark position, the jumper bends quickly when a few yards from the take-off, pressing the knees firmly to-

1810

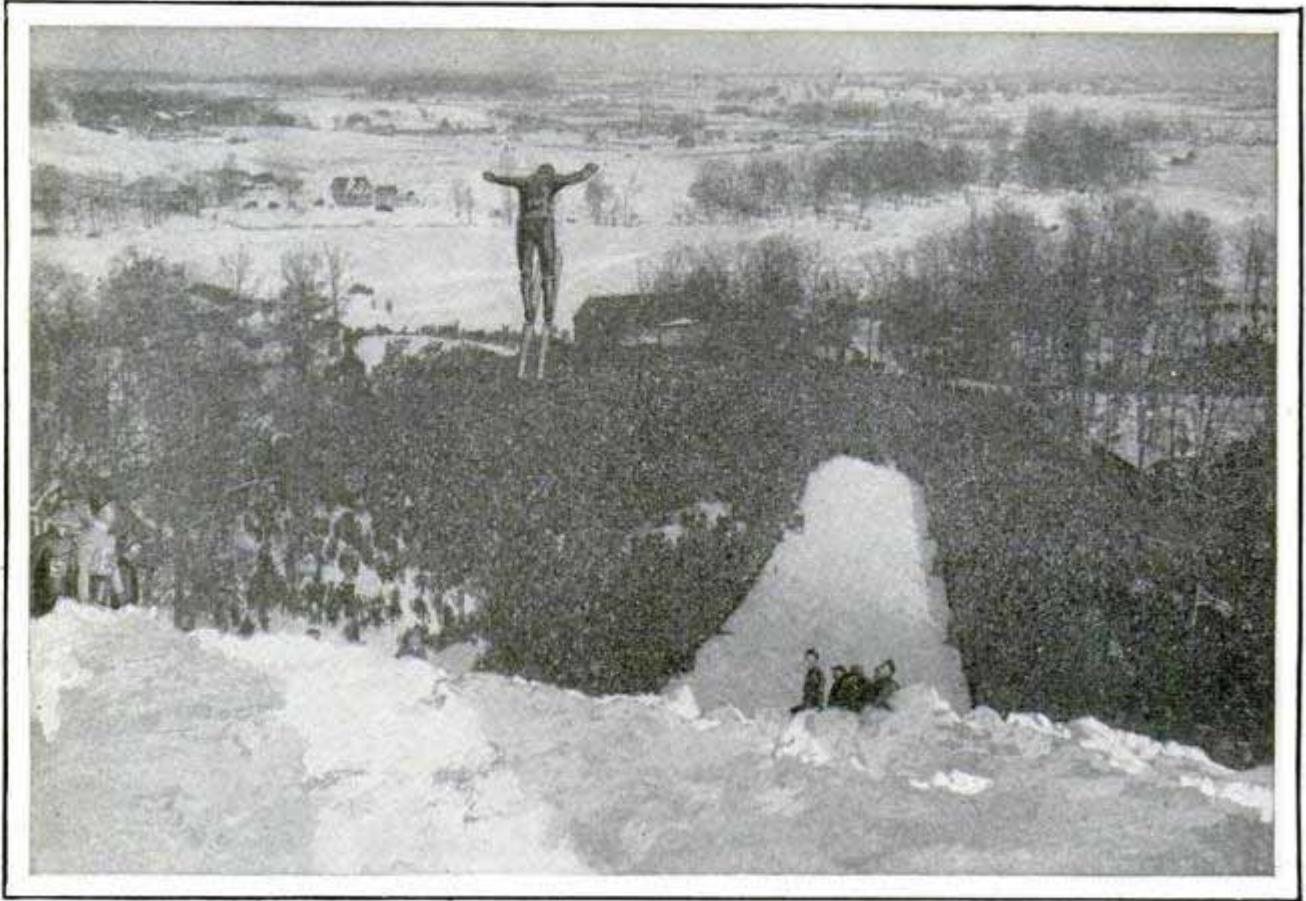

Shooting from the Take-Off for a Long Jump toward Eager Spectators Below; a Scene at Cary, Ill., during a Meet Sponsored by the Norge Ski Club

gether with his hands extended at the level of his ankles. Just before reaching the lip of the take-off, he makes his "satz" or leap by snapping stiffly erect and a little forward, at the same time swinging his arms up sharply. Heels should not leave the skis, toes are pressed downward, skis held parallel and body inclined forward as the jumper takes to the air.

During flight, the skier should move his body constantly forward to conform to the angle of the slope below. In landing, the skis should be held together and the knees bent slightly. Upon feeling the snow, the jumper should push one ski ahead slightly, and run in the Telemark position, rising to an erect position as soon as his balance is assured.

Successful ski jumping calls for a fair degree of muscular co-ordination, joined with abundant spirit and nerve, and the many points which every skier will pick up only after exercise.

A spectacular pastime is ski kjoing. This is performed on a frozen lake covered with a few inches of snow. A trained horse fitted with a specially constructed light harness is driven by an expert skier,

who stands a few feet behind. He holds the whiffletree with one hand and with the other guides the horse by the reins. Very exciting races are run, usually against time, which are as thrilling to the skier as to the spectators.

**NERVE-RACKING NOISE ENDED
522 WITH GUN SILENCER**

Originally devised to muffle the explosions of firearms, the Maxim silencer has been adapted to oil-electric locomotives to help eliminate some of the nerve-racking din of peace-time industry. It is now in use on eight American railroads and is said to have been developed to such a high degree of efficiency that the noise of the exhaust may be heard only faintly within a dozen feet of the engine. The silencer was greatly modified for this service, and several months were required to adapt it. The attachment is on top of the locomotive and traps the exhaust in such a way that the energy of the sound waves is absorbed before they reach the outlet, but there is said to be no interference with the release of gases to the atmosphere.

*Ingersoll Rand Co
11 Broadway
New York*

*360 N. Michigan
Chicago*

CHEMICALS RAISE AUTO MILEAGE *336*

Chemicals that hasten the curing process and improve the quality of rubber are among the laboratory's valuable contributions to motoring. One authority estimates that they are saving the American public \$50,000,000 a year by reducing the time required to prepare the rubber, and have saved the manufacturers \$80,000,000 additional capital investment. The increased mileage effected through this means is placed at 240,000,000,000 tire miles in the last ten years.

430
TRUCK CARRIES OIL DRUM UPRIGHT

An oil-drum truck that picks up and carries the containers without spilling the contents of open ones has recently been devised. Two movable flanges, curved to fit around the drum, move down and grip the container when the truck handle is raised, and lift

it off the floor when the handle is depressed.



Truck for Hauling Drums of Oil or Other Liquids without Spilling; Movable Flanges Grip the Sides

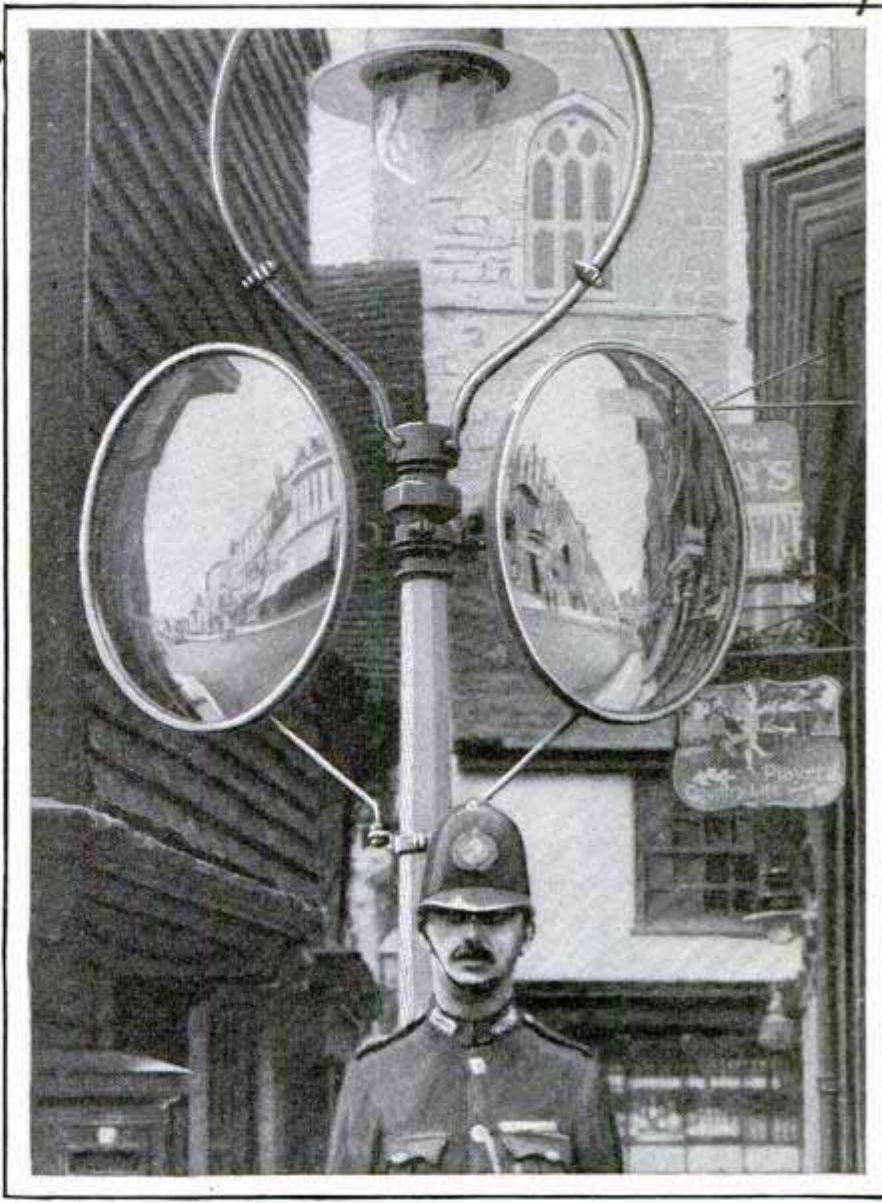

© Herbert Photos
 Mirrors Reflecting Vistas in Two Side Streets of the Three That Meet, to Aid Motorists and Traffic Policeman

MIRROR GUIDES AT CROSSING HELP PREVENT ACCIDENTS

Motorists approaching the intersection of three streets in Ashford, Eng., are able to observe traffic in the other two in large mirrors so adjusted that vehicles in either road are plainly reflected. This also lightens the task of the traffic police.

LAMPS WOUND UP LIKE CLOCKS TESTED FOR ARMY USE *57.3*

Individual electric lights, supplied with a small spring-driven generator, have been tested by army officials as a substitute for the usual dry-battery flashlamps. Ten seconds of cranking is said to produce a bright light for three minutes.

Mr. C. W. West, Jigard, Ore.

Mr. C. W. West, Jigard, Ore.

332. 233 W. 42nd St. New York

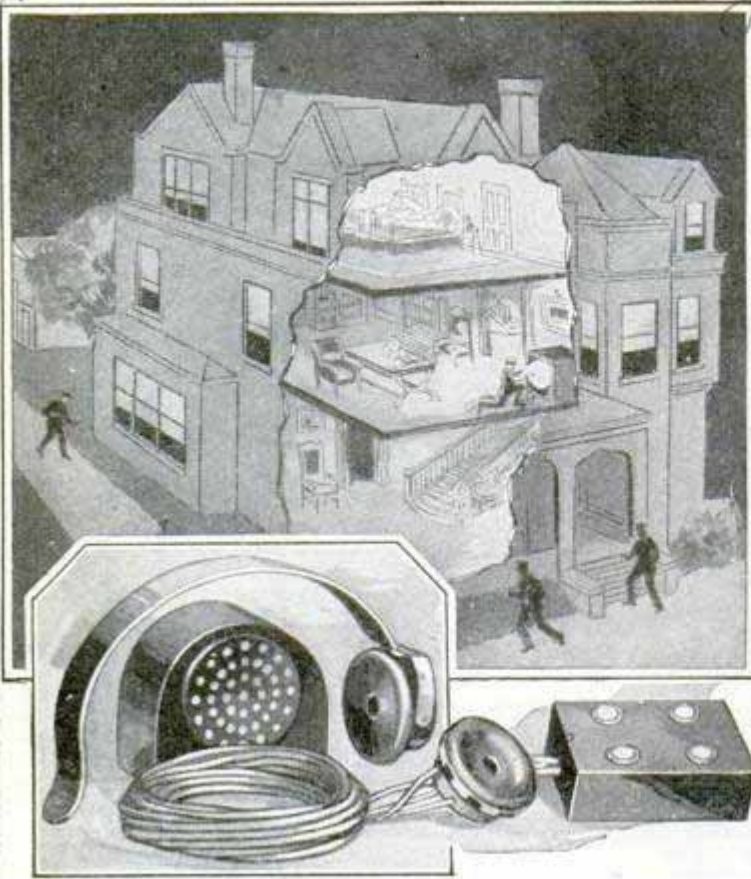

Microphone, Headset and Switch of Listening Device That Locates Sound in Any Part of the House

MICROPHONE GUARD FOR HOME DETECTS THIEVES

For houses, factory grounds, farms or large buildings, a set of sensitive sound detectors, connected to a central listening unit, enables the proprietor or watchman to locate almost instantly any intrusion. Each microphone is incased in a pressed-steel receptacle and may be concealed about the rooms. Wires connect with a central key box. By pressing one button after another, the entire premises may be patrolled. In case of a burglar's visit, for instance, he could be located and every movement plainly detected even to footsteps on a carpeted floor, it is said.

WHITE ANTS MENACE WOOD IN BUILDINGS

White ants, or termites, annually cause enormous damage to buildings throughout the United States as the result of placing untreated wood in contact with the ground. A large Catholic church in Illinois was closed last year when it was discovered that four carved wooden pillars, supporting the roof, had been eaten

out from the inside until a mere shell was left. Only the absence of heavy snows during the previous winter had prevented collapse of the roof. The ants can only enter and live in a building where wood which has not been treated is in contact with moist soil. If the sills are impregnated with creosote the ants will not gnaw their way in, while cement, brick or stone foundations under the sills offer even better protection. If present, the termites soon dry up and die.

AIR-VALVE GEAR SHIFT FOR MOTOR CARS

Auto gears are shifted by pressing a little attachment on the steering column instead of by the usual lever in an arrangement developed by eastern inventors. It utilizes suction from the motor intake manifold, creating a vacuum in two small cylinders attached to the top of the gear box. Air valves are so adjusted that the desired speed shift is made the instant the driver presses down the clutch pedal. Successful tests have been made with the installation on 600 cars of twenty-six makes, according to reports. It is said that the gears cannot be stripped when using this attachment.



Gears Are Shifted by a Valve on the Steering Column of This Automobile

vacuum gear shift to searchman's 114

*Mr. John Craig
New Haven Conn.*

Chicago

*Phila. Public Ledger
8/29/26*

SMALL MODELS GROW INTO GRAND OPERA SCENES

Weeks before an audience witnesses a new performance of the Chicago Civic Opera company, the scenes have been critically inspected in miniature settings fashioned by Julian Dove, art director, in the

cars from all over the country. No one railroad has enough of the long cars to carry all the property. Besides the collection of model stages, the studio building houses most of the company's \$7,000,000



Julian Dove and Some of the Hundreds of Models of Opera Scenes Which Are Prepared to Study Lighting and Scenic Effects Before the Props Are Painted

company's huge studio and property building. Each model is constructed on a scale of a quarter of an inch to the foot and is complete in details even to coloring and the arrangement and costuming of the actors, who are represented by realistic little dolls. These tiny originals are the real beginnings of the elaborate productions on the big stage, for they serve as guides for the carpenters and other craftsmen who simply enlarge upon these first patterns. A miniature stage and its setting costs \$200 or more, depending upon its character, so that \$1,000 is not an unusual sum to pay for first casting an opera in these diminutive molds. The expense is considered justified because it saves later errors that would be far more costly to correct. Each model can be lighted so that the actual effect of the finished scene can be studied. In fashioning the sets, the artists must also keep in mind that the drops and other pieces will have to be moved quickly by scene shifters and that they must be collapsible so that they can be packed away when the company goes on tour. To hold the huge drop curtains and other equipment, the longest baggage cars in the country are pressed into service and the making up of a train for the opera requires a special call for

worth of equipment, the electrical, carpenter, wig-making and metal-plating shops where the armor and other trappings are made, besides a vast studio where the scenes are painted. A big rehearsal room that can quickly be converted into a working stage also occupies the structure. Not many persons realize that a small menagerie is a necessary part of the opera company's equipment. A meek and lowly donkey is a feature of "Pagliacci," geese are needed in "Koenigs-kinder" and a goat performs in "Dinorah."

FIELD GLASSES AS SPECTACLES RELIEVE FATIGUE

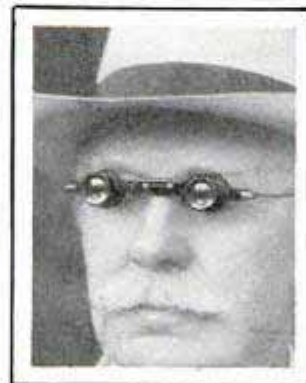

user both as to focus and distance between the lenses.

304
Holding field glasses in position soon becomes tiresome and, to eliminate this, a pair has been made to be worn as spectacles with supports over the ears. They are adjustable to suit any

*Palo Co. w. 23 rd
15 3 New York*

superior

Canal Lock of Hohenzollern Canal

International for Shipping and Water Power

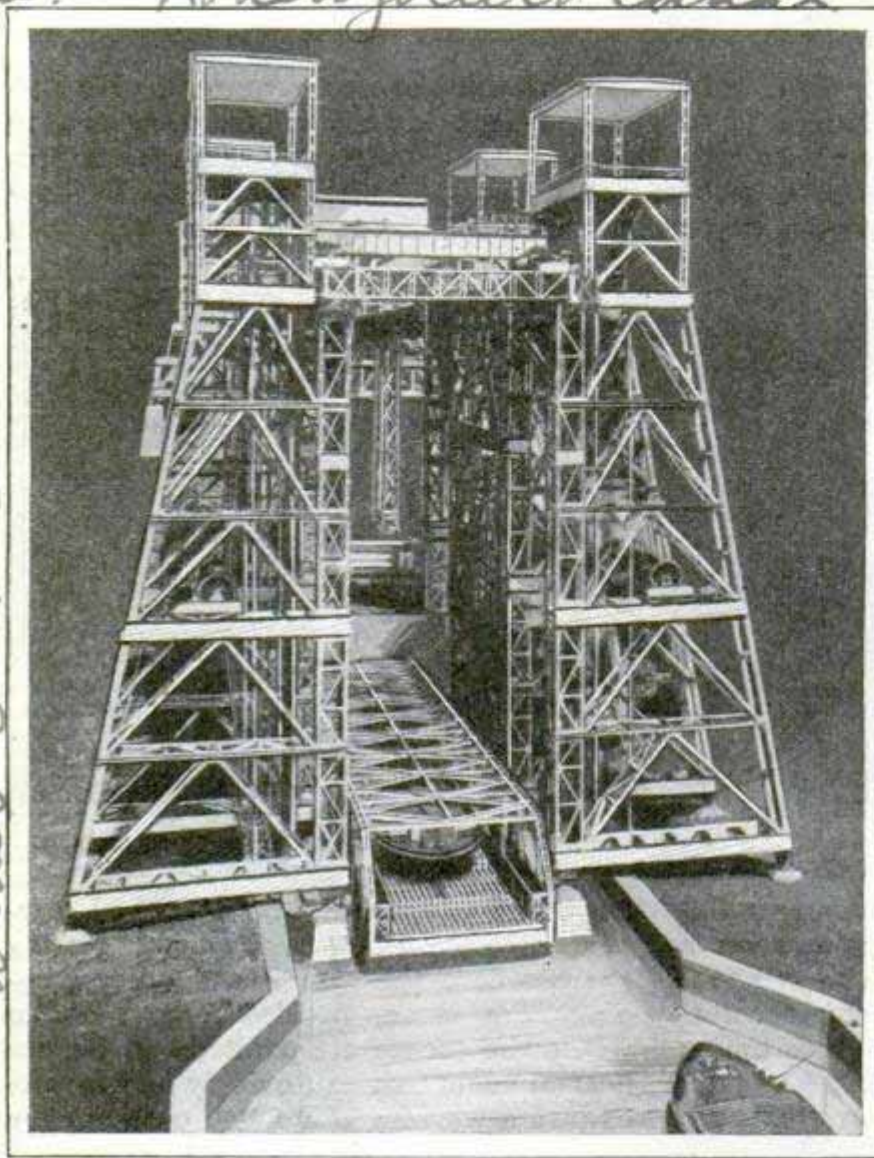

Working Model of Boat Lift; Craft Is Floated upon Platform in Center and Raised or Lowered

STEEL CAGE FOR LIFTING BOATS SUBSTITUTE FOR LOCKS

One of the interesting exhibits shown at the recent exposition for shipping and water power in Germany was a design for an apparatus to be used on canals for lifting or lowering boats. It consisted chiefly of a cage supported by steel framework on either side of the channel. The boat is run upon the cage and transported through the air to the higher or lower portion of the canal.

■ A species of Malayan bat has a wing spread of five feet.

ELEPHANT MARKET FEELS HIGH COST OF LIVING

³⁹³ A ton of elephant, f.o.b. Europe, is worth \$3,000, according to recent figures made public by John Hagenbeck in an announcement detailing the rising cost of jungle giants. The price has advanced considerably in recent years, partly because of higher shipping charges and labor costs and partly because the elephants are wise to the lures of big-game hunters and avoid their pitfalls with more success than in the past. A one-ton elephant is not a large beast, and circuses, zoos and others who want larger animals pay proportionately higher prices.

Public Ledger 7/25/26

CYLINDER GAUGE LESSENS COST OF REPAIRS

³⁸³ Guesswork is eliminated in determining the condition of motor cylinders with the aid of a recently marketed combination micrometer and gauge which reveals defects to an accuracy of one one-thousandth of an inch. It quickly shows if the cylinder is tapered or otherwise out of round and, after such variations have been determined, the diameter of the cylinder is found with the aid of the micrometer. Four adjustable rods supplied with each gauge, which is self-centering and non-collapsible, permit its use on diameters varying from two and five-eighths inches to six inches. Readings are registered on a dial.

Price - \$17.50

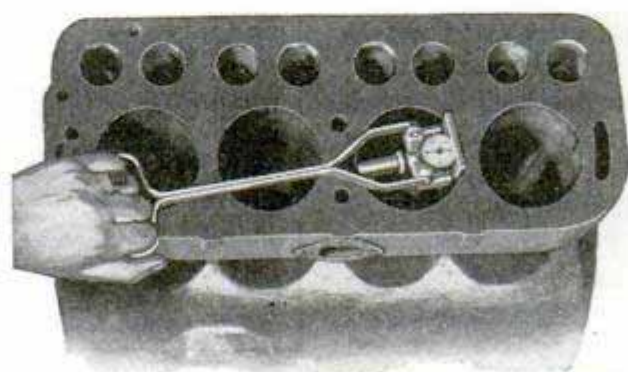

Combination Cylinder Gauge and Micrometer in Working Position; the Handle Permits Easy Use

Wrenchleg. Myers Co., Jackson Mich.

The Magic Lure of Numbers

By J. EARLE MILLER

THERE is a story told about the "Wise Men of Gotham," who had a school with twenty-four pupils. They built a schoolhouse in the form of a hollow square, with eight classrooms surrounding a playground. In each of the eight rooms they placed three of the twenty-four pupils, and it was a simple matter then to check up and see that all the boys were studying, for the wise men had only to count and make sure there were nine boys in the three rooms on each side of the school.

But four of the pupils slipped out just after a check, and on the next round the wise men still found nine boys on each side! And then the four came back and brought four friends, and still there were nine on each side. Soon four more friends dropped in—and yet there were only nine on each side, though now there were actually thirty-two instead of twenty-four boys in the school.

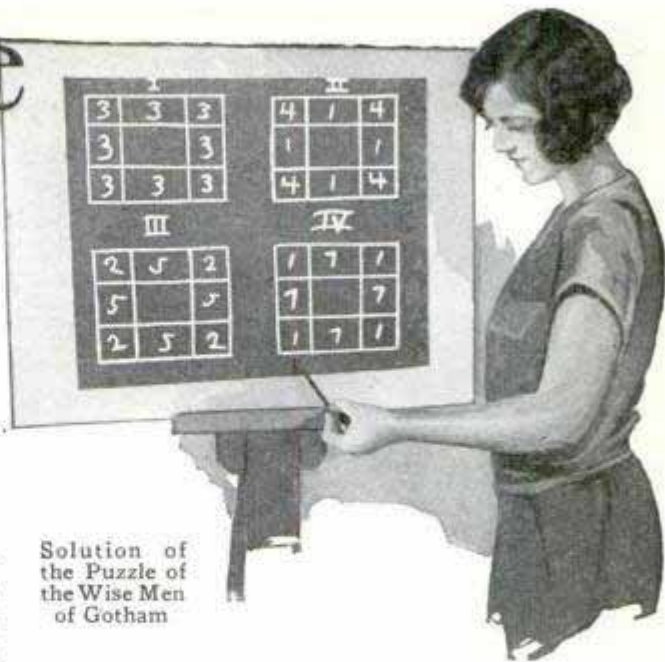

Solution of
the Puzzle of
the Wise Men
of Gotham

Figures, some one once said, do not lie, but they apparently tell some pretty large untruths, as you can see when you examine the photographic solution of this puzzler.

There is no end to the marvels that can be performed with numbers, to the amusement and mystification of your friends. From the simple proof, by algebra, that two is equal to one, to an equally simple method of becoming a multimillionaire in one month by saving your money, you can furnish an entire evening of amusement.

The problem of getting rich in thirty days requires only that you save one cent the first day, two the second, four the third, and so on, doubling the amount each day during the month. The saving gets a bit hard toward the end of the thirty days—particularly on the thirtieth, when the amount to be saved will be more than \$5,000,000—but your total wealth at the end of the month will be more than ten and three-quarter million dollars.

Another equally famous demonstration of the enormous totals reached by geometrical progressions is to ask for a position for one year, offering to work the first week for one cent, the second for two, the third for four, and so on for fifty-two weeks. Most any employer, who hasn't previously fallen for the same offer, would



With Fifteen Checkers, Can You Force an Opponent to Take the Last One by Drawing One, Two or Three?



Here Is a Rectangle of Paper Whose Apparent Surface Increases Several Square Inches as the Parts Are Moved

be willing to accept such a seemingly reasonable proposition. If he does, however, be sure and insist on a bond for the final week's salary, for your pay for that one week alone would be some 1,500 times the total of all the money in the world, while the grand total for the year would be more than 40,000 billion dollars. There is a simple method, by the way, of obtaining the total of a column of such progressions, without the bother of adding the long list of figures. Simply multiply the last number by two and subtract the first. For example, the

progression, starting from 1, would be 2, 4, 8, 16, 32, 64, 128, etc. Adding the figures given makes a total of 255, whereas if you multiply the final number by 2, you get 256, and subtracting the first number gives 255, the actual total of the series.

There are a number of interesting arithmetic puzzles. One can be performed with fifteen counters—checkers, poker chips, matches or any small articles that are available. Announce to a friend that you will each withdraw one, two or three at a time, and that you will force him to take the last counter. You start the game by withdrawing one or more—the number is not important; then your opponent does the same, and so on, alternating draws. The only thing necessary is to see that on your next to the last draw you leave five counters, then, no matter what he draws, you can take away enough the next time to leave only one.

Another puzzle, which has several variations, is performed with thirty counters. The story connected with the puzzle is that there were fifteen Christians and

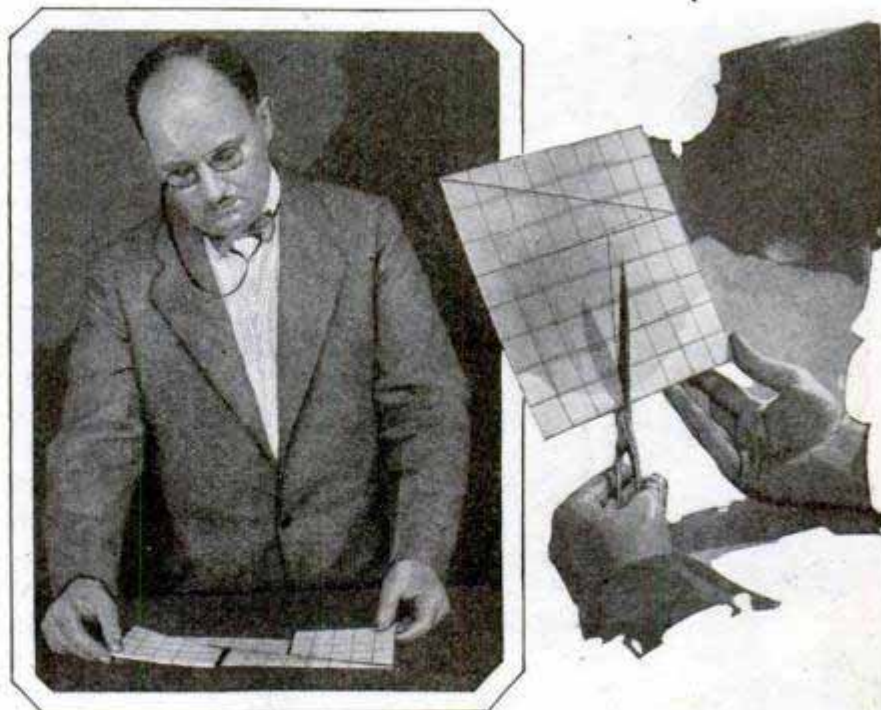

This Shows How to Cut a Square of Paper So That Sixty-Four Square Inches Can Be Rearranged to Cover a Space One Inch Larger

fifteen Turks on a ship at sea when a storm arose and the captain announced that half the passengers would have to be thrown overboard. It was agreed that all should form a ring and, starting from a designated spot, every ninth man should be cast into the sea. When the work was over it was found that the fifteen Christians were left and all the Turks had been counted out. The puzzle, and this is where the checkers come in, is to find in what order the thirty were placed. It can be determined by laying the thirty pieces in a ring, picking a starting point, and then counting to the ninth piece, marking it with a "T" for Turk, and so on until fifteen have been marked. The other fifteen will be the Christians. The solution will be found to be four Christians, five Turks, then two Christians, and so on. In another variation every tenth man was cast overboard, and the solution can be reached in the same way.

The puzzle of the Arab, his three sons and his seventeen camels dates back in history as far as that of the thirty passengers at sea. According to the story, the Arab died and left a

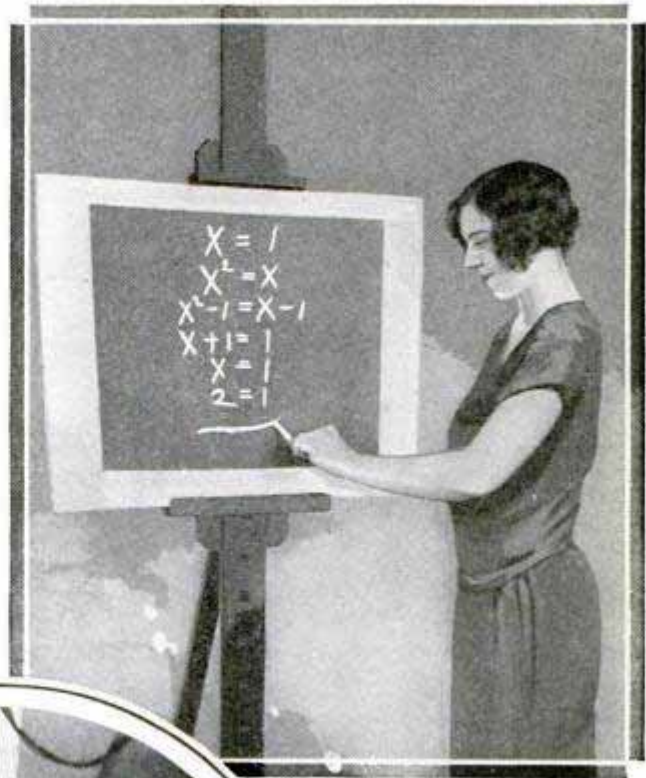

Above Is the Apparent Proof, by Algebra, That Two Equals One, While at the Left and Below Is an Interesting Trick Performed with Paper

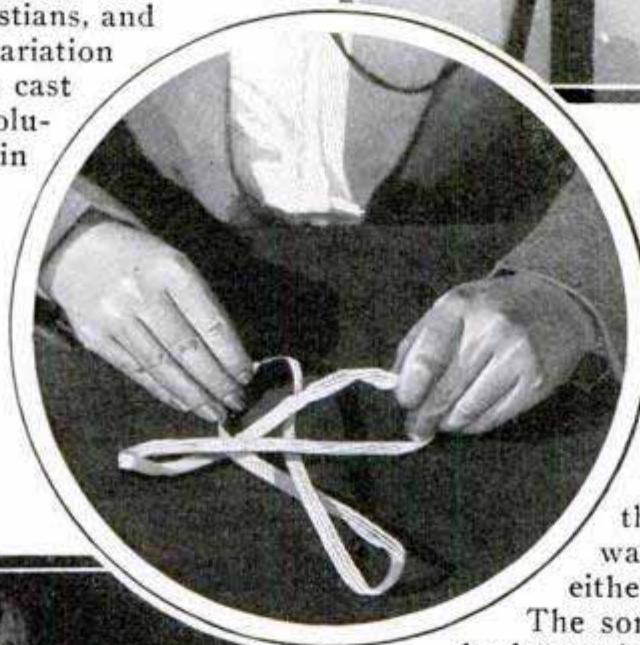

will stating the eldest son should have half his camels, the second son one-third and the third one-ninth—but the number seventeen was not divisible by either two, three or nine.

The sons solved the problem by borrowing another camel from a neighbor. That made eighteen, and the eldest son took nine as his half, the next took six as his third, and the youngest took two as his ninth—a total of seventeen—and the borrowed camel was returned to the neighbor. The secret of the puzzle lies in the fact that one-half, one-third and one-ninth, when added make seventeen-eighteenths, instead of the whole of the father's wealth.

Mathematicians have been able to prove most of the problems submitted to them, but there is one for which no mathematical proof has ever been devised, and that is why a map maker need use but four colors to print his maps. The fact has been known for centuries, but no one has ever determined a method by which it could

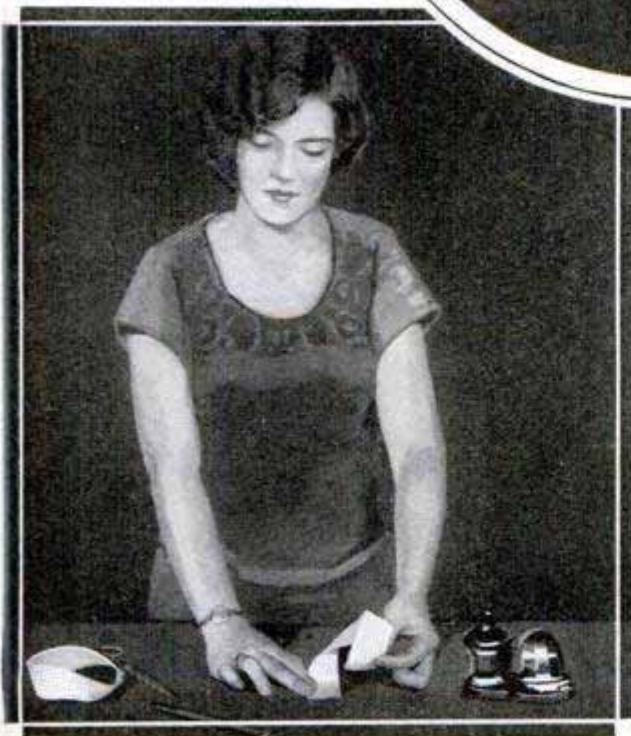

1980
 be proved. If you try drawing you will soon find that it is impossible to draw any figure of five districts each of which touches the other four, the only circumstance under which more than four colors would be necessary to mark the divisions.

While you are practicing drawing, there is an equally old catch problem that can be tried. The story with it is that a ship had a five-by-thirteen-inch hole in its bottom, and the only board the ship's carpenter could find with which to make repairs measured eight by eight inches. The hole was sixty-five square inches in area and the board only sixty-four, but the carpenter knew how to saw it up to add a square inch to its surface.

It seems impossible, but if you will lay out a square of eight units to a side—quarter or half inches will do as well as inches—and then cut it in four pieces you will find you can reassemble the parts in a five-by-thirteen-inch rectangle. Measure down three units from the top, and cut across on that line. Next draw a diagonal from corner to corner of this three-by-eight piece and cut it into two triangles. Now measure three units from the corner along the top of the larger piece, and three units from the opposite corner along the bottom edge, connect the two points with a line and cut. Finally reassemble the four pieces, as shown in one of the

illustrations, and you have your sixty-five-unit rectangle made out of sixty-four square units of paper.

What actually happens, of course, is that the parts do not fit together, but the variation is so slight that it is almost unnoticeable.

Another equally interesting mathematical untruth can be told with a paper eleven by thirteen inches—or smaller units, if desired—in size. Draw a diagonal from one corner to the other, cut the paper into two triangles and lay them down, in their original position. Now shift the top one one unit up. The original paper contained 143 square inches, but you now have—apparently—a square twelve by twelve inches, plus two triangles, each of one half unit, or a total of 145 square inches. Shift the top triangle another unit, and you have a square of 143 inches, plus two whole and four half squares, or 147 square inches in all. Shift it another unit and you have a square—apparently—of ten by fourteen inches, plus six whole and six half squares—or a total of 149 square inches. By this time you will have discovered what is wrong—the original paper not being a square, the diagonal on which it was cut did not form a forty-five-degree angle, and so, after you have progressed a couple of squares you discover the lines don't match, and that your seem-

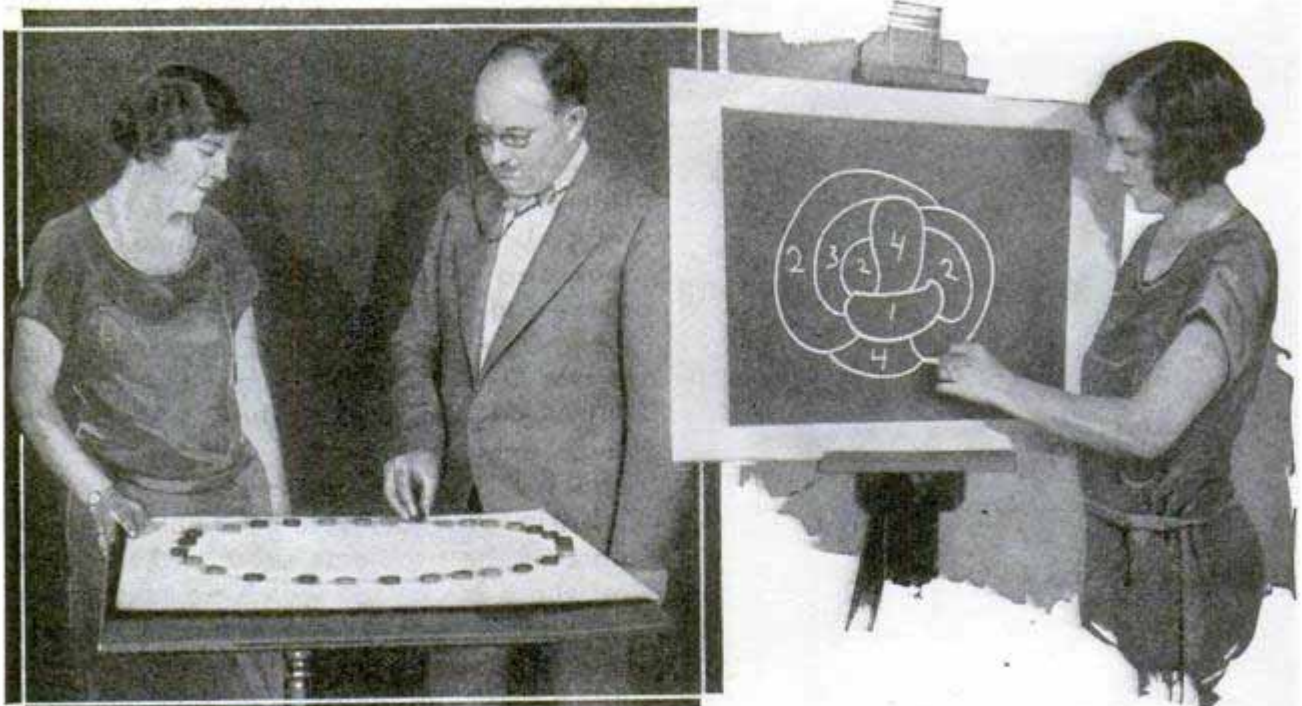

The Puzzle of the Turks and the Christians, at the Left, Is an Interesting Game, While at the Right Is a Sketch Showing Why the Map Makers Use Only Four Colors to Show All Countries

ing square is not a perfect one.

The old trick of finding a secret number, is one of the many puzzles of arithmetic that appear hard, but are really easy. Ask someone to fix on a number, tell him to double it, add four to that sum, multiply the whole by five, add twelve to that product, and multiply the whole by ten. Then have him deduct 320 from the final figure, and tell you the remainder, and immediately you tell him his original number. To get it you simply cut off the last two figures of the total he told you, and the number remaining is the one he started with.

Another puzzle with a mathematical twist can be performed with a strip of paper and a pair of shears. Cut a strip, say two inches wide, from the side of a sheet of paper and paste the ends together, first twisting the paper once, as shown in one of the illustrations. Then start cutting down the center of the strip, and ask someone, as you proceed, how many pieces of paper you will have at the finish. The natural answer would be two, but as a matter of fact, because of the twist, you will have but one. Then start cutting again and repeat the question. When you finish the cut you may be surprised yourself at the result, for there will be two rings, but linked together.

510

VALUE OF JUNK PILES IN U. S.

Since 1924, some 800,000 tons of waste has accumulated in the nation's junk heaps, according to an electrical expert, and this is worth about \$200,000,000,000, not counting iron and steel. It is estimated that rust damages these metals to the amount of at least \$300,000,000 a year.

Chicago Evening Post
9/22/26

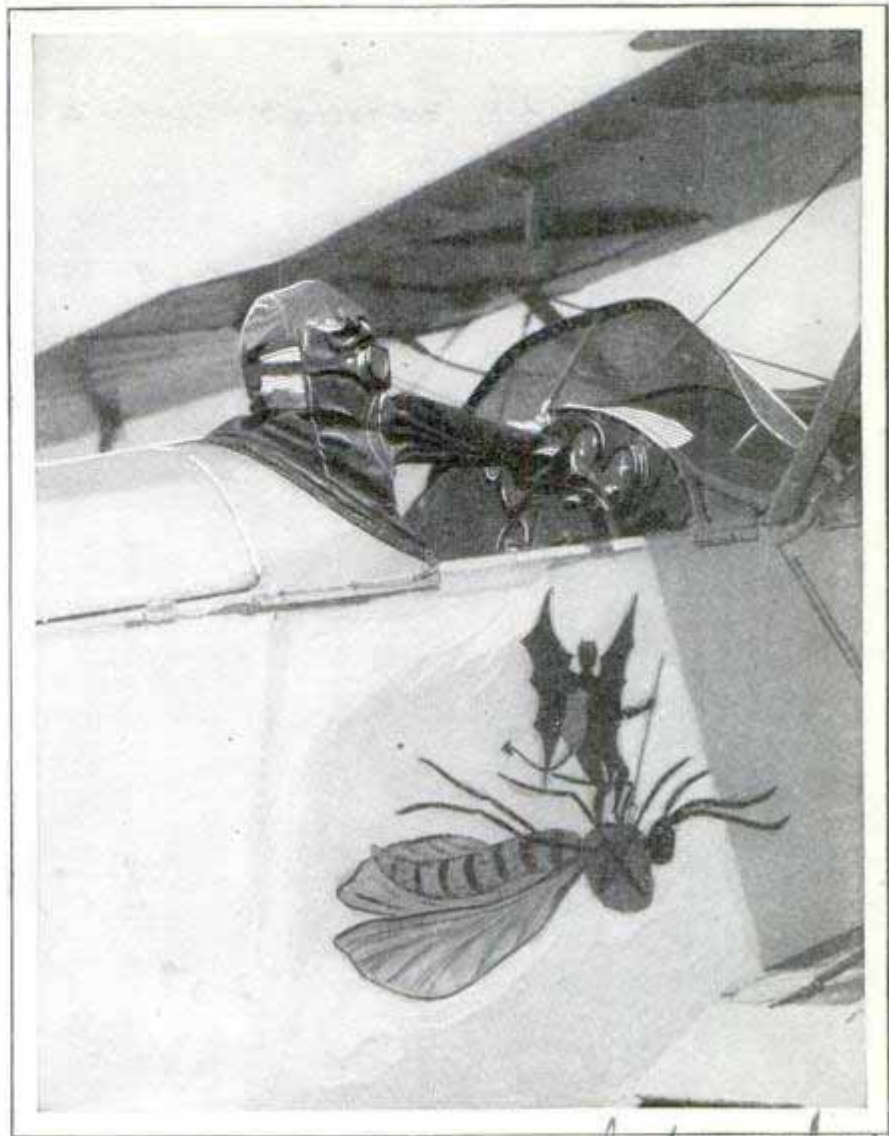

Marine Flyer About to Take Off for Campaign against Mosquitoes; Poison Dusted over Swamps Proved Effective

AIRPLANE WAR ON MOSQUITOES WAGED BY MARINES

Noted for their skill in fighting, U. S. marines directed their energies at a lowly but formidable foe last summer, the mosquito. From specially equipped airplanes, mixtures of hydrated lime and Paris green were dusted over swamps around Quantico, Va., a marine base, to kill the insects at their breeding places. The work was done at a total cost of less than ten cents an acre, it was reported. The planes were marked with a devil design depicting a mosquito being put to death. Pilots wore gas masks to protect themselves against the poison dust.

Chemicals to the value of about ninety-eight cents are contained in a man's body, it has been estimated.

**BUILDINGS ARE SAWED IN TWO
 TO DRY MOISTURE**

313

no 31, 1926

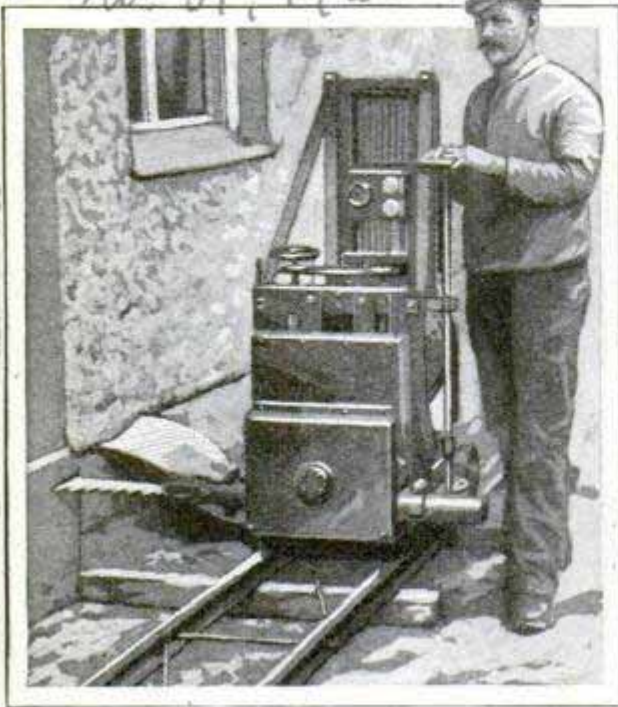

Motor-Driven Saw That Cuts Stone Buildings to Make Room for an Insulating Line against Dampness

In order to save old stone or brick buildings threatened with ruin by dampness, a new method of drying them permanently has been developed in Germany. Use is made of a special electrically driven saw which can be set to cut the walls a suitable distance from the ground but below the flooring. The cuts are made at intervals of one and one-half to two feet. The slits, about one-half inch wide, are cleaned thoroughly and an "insulation plate" put in, the free-hanging part of the walls being supported by steel wedges while this is done. The still remaining interstices are filled with neat-cement grout. The rest of the wall is then treated in the same manner until there is a continuous layer all around the building which no dampness from the ground can penetrate. As in ordinary construction, the upper part is dried out by the usual means. Even mold is removed entirely by this method, it is reported. The success of the plan indicates that it will no longer be necessary to

condemn old buildings that are beginning to fall apart largely because of moisture. The Holy Ghost church in Munich was saved by this means, as was an ancient hunting lodge not far from the city.

**ICE-BOUND BALTIC SEA GRIPS
 FIFTEEN STEAMERS**

1769

Like many other sections, the northern part of Europe passed through an unusually severe winter last season. From October until late in the spring, extremely low temperatures prevailed over the Baltic and the gulfs of Bothnia and Finland were frozen over, taking on the appearance of polar regions. Varying winds broke the solid ice and formed the floes into hummocks of enormous size. At one time, some fifteen steamers bound for Leningrad, were firmly locked in the Gulf of Finland, and others were bound along the eastern shore of the Baltic, off Esthonia. An ice breaker had to open several channels to release the vessels.

L'illustration 3/20/26

**FIRE ENGINE WITH WATER TANK
 SERVES RURAL DISTRICT**

2157

The usefulness of a fire truck in a California city extends far beyond the area provided with hydrants and city mains, for it carries a large tank full of water in addition to pumping equipment. The idea was conceived by the fire chief as a means of protecting the country districts from grass and grain fires. On one occasion, the engine extinguished a blaze along a six-mile front with 250 gallons of water.

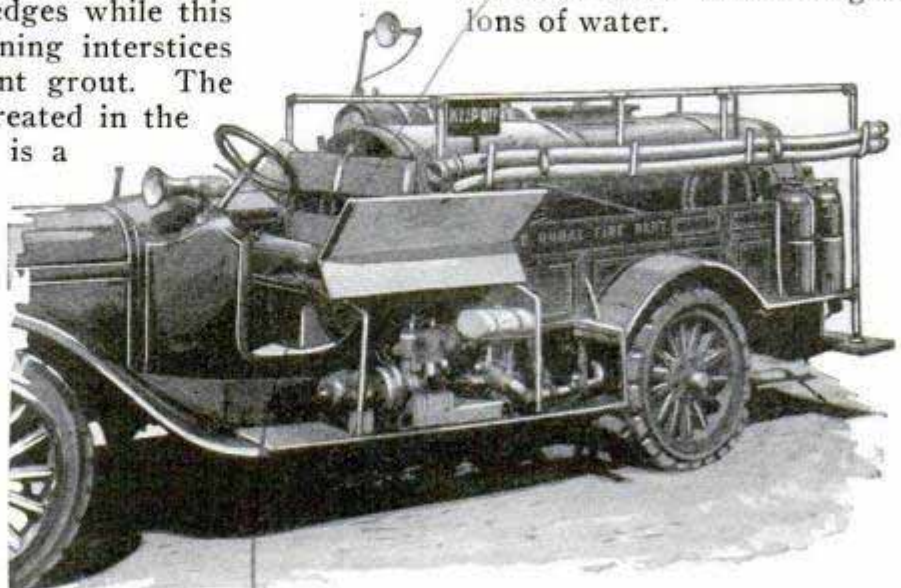

Fire Truck Used to Extinguish Fires in Rural Districts

*Chief A. G. Bailey
 Redondo Calif.*

SHADOW EFFECTS SHOW WAY TO PLACE LIGHTS

Chas. Albert Nelson
House Winter 1914 No. 24
Berlin, W 30, Germany

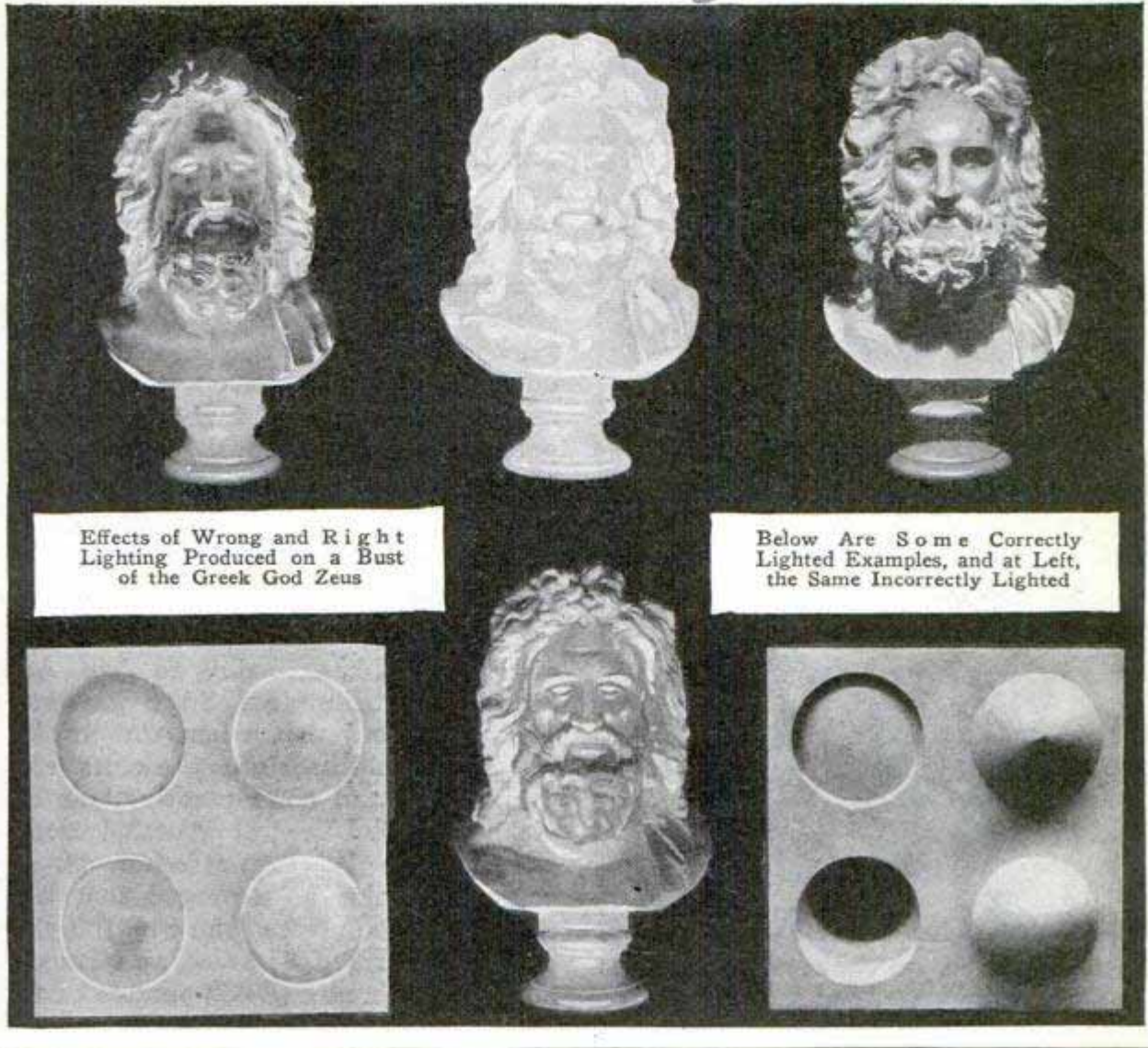

Effects of Wrong and Right Lighting Produced on a Bust of the Greek God Zeus

Below Are Some Correctly Lighted Examples, and at Left, the Same Incorrectly Lighted

Correct placing of lights to bring out the best effects of your furniture and ornaments is being given considerable study by lighting engineers. The wide range of results that can be obtained by incorrectly and correctly placed lights is demonstrated by photographs of such deeply carved figures as the famous Zeus of Otricoli. With every moving of the light the camera records a different impression of the face. Strong glare lights cause it to lose detail; lighting from below puts shadows where they shouldn't be, with consequent alteration of the features, and cross lighting robs the bust of its best lines. Only when lighted at a certain angle from above do the shadows of the eyes, nose and beard fall naturally to bring out the beauty of the carving. A similar test can be made by photographing panels of recesses and

projecting ornaments. Correct shadowing is necessary to bring out their shape, and when the lights and shadows are wrong, the camera, and the eye too, get an entirely erroneous impression. Generally paintings, busts and other ornaments on the walls and mantelpiece appear to best advantage when lighted from in front and above. This is particularly true in paintings and sculpture where the artist worked by sunlight, since his shadow effects naturally follow those laid by the sun. If the artificial light is placed to duplicate the location of the sun you bring out the high lights and shadows the artist saw in the original. Busts and other objects placed on top of bookcases or mantelpieces and lighted from in front or below by floor lamps seldom appear to good advantage.

323

Everhood. Price \$200 up
 and \$200

Miami
 Fla.



Adjusting the Helmet, and Illustrating How It Could Be Used in Repairing a Propeller

HELMET FOR SHALLOW DIVING AIDS IN SHIP REPAIRS

Explorations on the sea bottom to a depth of 100 feet are within the reach of amateur divers by means of a helmet and simple air-pump apparatus specially devised for emergency repairs on small ships. The headpiece is weighted, fits snugly but

comfortably on the shoulders and can be removed while the person is under water, in case of accident. No suit is needed. As the air rushes in, it forces the water out of the helmet, keeping the head and neck dry. Vents permit the surplus to escape so that there is never too much air in the breathing compartment. There are two removable windows, permitting an almost unobstructed view. The helmet remains adjusted regardless of the position assumed by the wearer who can work in any posture except standing on his head. Besides proving of great aid to mariners, the outfit is reported to have become popular among pleasure seekers who desire to experience the sensations of diving and see the wonders of the submarine world.

ELECTRICITY COMPELS COWS TO GIVE MORE MILK

4 20

Electricity is being used to make cows give more milk, according to Prof. A. E. Stewart of Minnesota State university. Farmers found that when the drinking water was cold in winter the cows would drink little, and consequently their milk yield fell off. Several installed electric pumps with heating attachments, and water fountains so arranged that when the cow's nose pressed the cup, the pump delivered warmed water. One farmer reported an increase of 430 pounds of milk a week, giving him an extra \$35 a month revenue. The installation cost \$140 and in five months he made \$175 from it.

TWO-PIVOT TURNS FOR AUTOS RELIEVE CONGESTION

2150

Two pairs of turning points at street intersections instead of the customary single one in the center have been adopted in Los Angeles to reduce delays and confusion. They are said to have proved especially satisfactory when cars approaching each other are turned to the left. Neither driver has to wait for the other, consequently cars do not encumber the street center.

Crossing

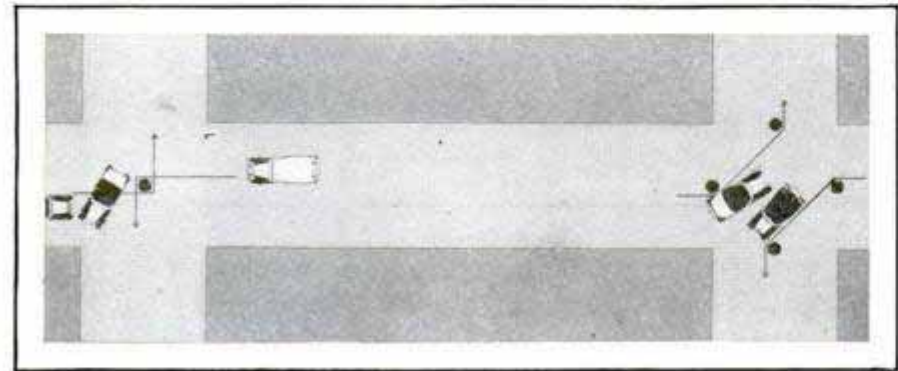

Advantages of the Double Turning Point Seen at Right

Saving Things



Wringing the Mop by Twirling It; End Fits into Corrugated Double Cone in Pail



Electric Ironer on Casters Also Has Table with Concealed Drying Rods in End

Easily Attached to Sink Stand or Table, Pivot Stool Lightens the Housewife's Task and Saves Space



Simple to Wash on Both Sides and Suited to Good Ventilation, Windows in Swinging Casements Ease Task of Cleaning

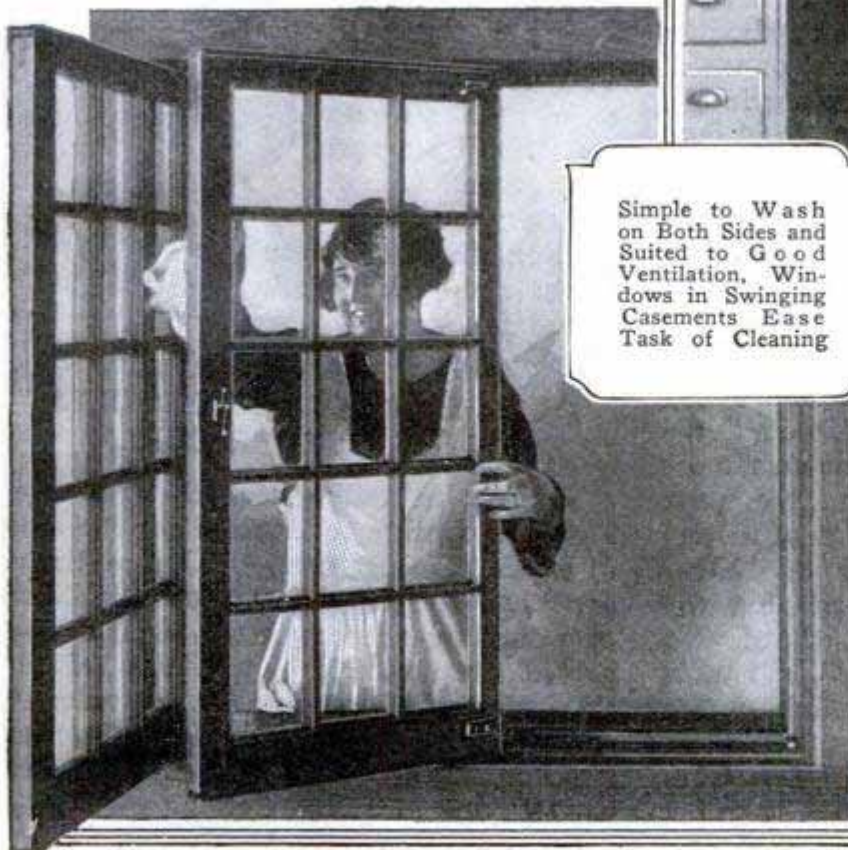

Can Opener with Spout for Pouring Liquids

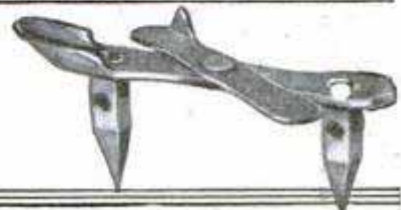

PORTABLE SANDER FOR BOATS SAVES BUILDERS' TIME

70

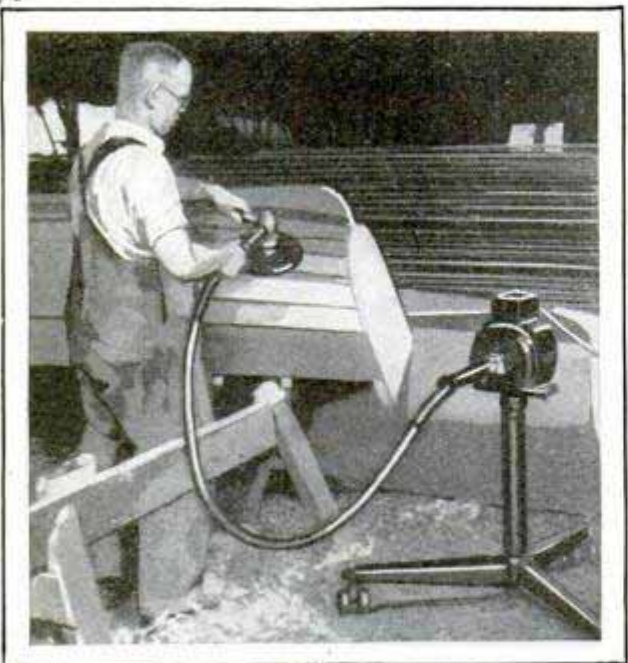

This Portable Electric Sander, Designed Primarily for Finishing Boats, May Be Put to Other Uses

Driven by an electric motor supplied with current from a lamp socket, a portable sander for finishing boats, eliminates most of the slow and laborious hand work that this operation requires. It functions on flat or irregular surfaces, a sanding drum, which is inflated with air and covered with a band of abrasive material, reaching almost all parts of the hull. Drill chucks may be attached to the flexible shafting for boring holes in steel or wood or an emery wheel fitted to form a grinder, and the outfit also may be converted into a buffer for polishing.

HAMMER HAS STEEL "BACKBONE" TO KEEP HEAD ON



Hammer head and handle are said to be bound together as an almost indestructible unit by means of a steel tie-rod or "backbone" running the full length of the grip. The handle is formed from two pieces of white hickory, double-dovetailed together

with the grain opposed and set with waterproof glue, which resists great strain. The rod will also balance the handle better.

WHEN PEOPLE MARRY IS SHOWN 387 BY JEWELRY SURVEY

June weddings have been cut in half in the last quarter of a century, according to a marriage survey made in many cities by a wholesale jeweler trying to plot a wedding curve as a guide in stocking up with wedding presents. Formerly about one-fourth of all weddings occurred during the month of roses, but now the total has dropped to twelve per cent. September is second with 9.6 per cent, while November, because of Thanksgiving, and December, with the Christmas holidays, are tied for third place, with 9.3 per cent. April is at the bottom of the list, with only 7.5 per cent of the marriages.

GARMENT HANGER FOLDS UP INTO CASE FOR POCKET

1969

Hangers for coats and trousers are being manufactured of collapsible rods that fold into a small leather case for the traveling bag or pocket. They are constructed of rustproof metal, will support considerable weight and, because of the telescoping feature, are easily and quickly adjusted for service.

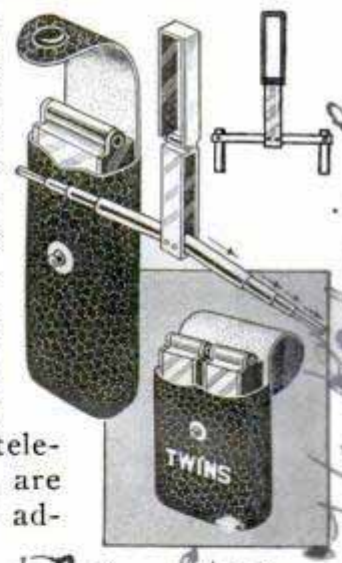

budget 50¢ - \$1.00

ACCIDENT SOLVES PROBLEM OF HIGH-SPEED CABLE

403

Behind the landing recently of the new high-speed cable to Europe lies the story of a scientific accident—a chance discovery that made possible the commercial use of permalloy, the new metal sheath which solved the electrical problems of fast transmission of dots and dashes under the sea. The electrical engineers who were experimenting with the new material were unable to weld it, and welding was one of

Western Electric News 195 Broadway New York

The American Hammer Corp 715 E 13 St New York

The Palmetto Co. 1308 Ave. M Sept. 1926

*Realty Bldg. 989
361 Charlotte, N.C.*

scene, the composition being as carefully executed as a painting. A tiny tree, with a sprig of bamboo, a moss-covered rock and some blades of grass are brought together to recreate a scene that some artist of hundreds of years ago saw and admired. The outstanding piece of the exhibit was not even a tree, but simply a small piece of natural rock that happened to be formed in the image of Fujiyama, the sacred mountain of Japan. Though of no value in itself the little piece of stone was valued at 11,000 yen.

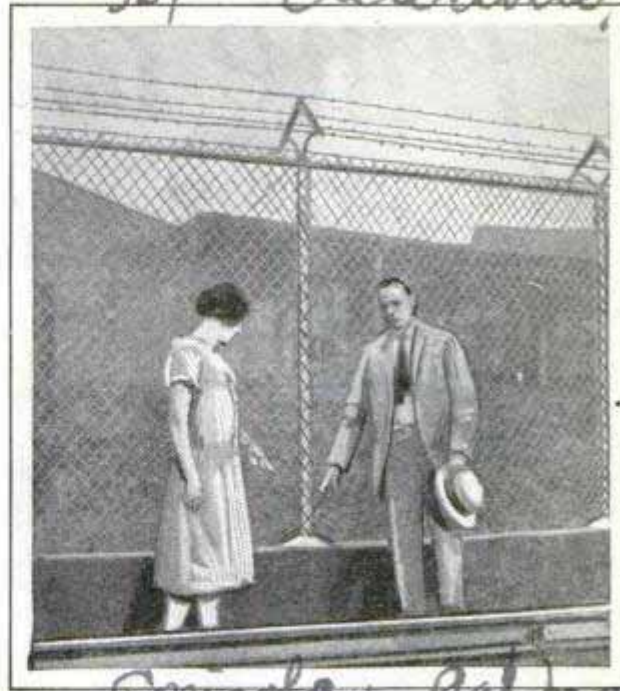

Concrete Base for Fence Posts, Which Comes Ready-Made and Is Designed to Fit Any-Size Post

TANK CAR AS FILLING STATION SERVES RAILROAD *142*

Gasoline is being distributed to storehouses and tanks along the lines of a western railroad from a traveling filling station, a specially equipped tank car. It has a capacity of 12,500 gallons, self-measuring pumps that deliver fifty-five gallons in three minutes, and hose lines and connections. It saves repeated handling of full and empty drums.

Railroad Tank Car Equipped with Pump and Equipment to Serve Supplies

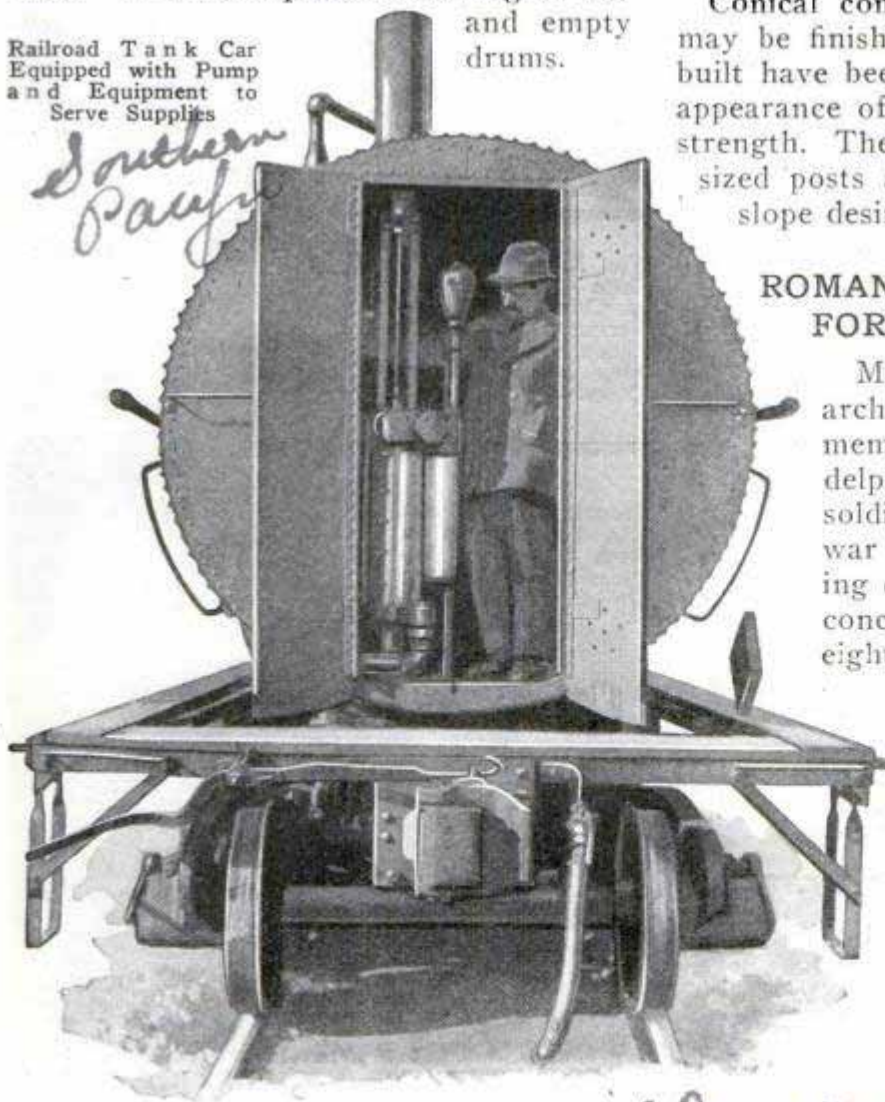

Southern Railway

CONE-SHAPED BASES FOR POSTS IMPROVE LOOKS OF FENCE

Conical concrete bases for posts that may be finished even after the fence is built have been designed to improve the appearance of the barrier and add to its strength. They can be had to fit different-sized posts and to give any degree of slope desired.

ROMAN ART COPIED IN ARCH FOR AMERICAN TROOPS *395*

Modeled after the triumphal arches of ancient Rome, a war memorial to be erected in Philadelphia in honor of the city's soldiers who died in the world war will be one of the outstanding ornaments of the city's new concourse. The arch will be eighty-two feet high and twenty feet deep, faced with limestone. The inscription surmounting it will read: "That the principle of liberty and justice might prevail, these dead have died. We, their survivors, feeling a deep sense of gratitude and loving sympathy, have by public subscription erected this arch to their eternal memory."

Designed by Henri Gabriel Marceau

Phila. Penn.

887

Time and Money for Your Home



Home Laundry in Compact Unit, Combining Washer and Drier; No Wringer Is Used, Moisture Being Removed by Centrifugal Force

One-Burner Steam Cooker Has Only Three Parts, with Glass Coating over Seamless Steel, and Preserves Flavors



Tea Enough for Six Cups Can Be Placed in This Hinged-Cap Perforated Spoon for Quick Brewing, or It May Be Used for Dissolving Chocolate

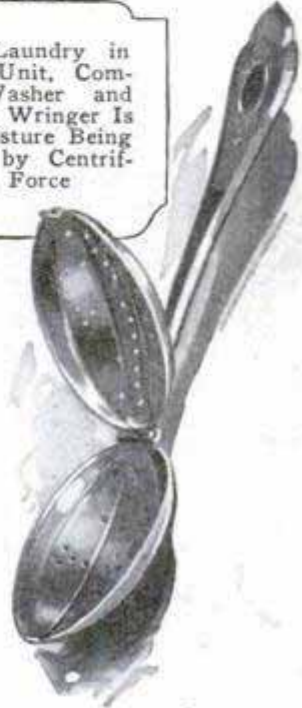

Electric Toaster with Lift Top Browns on Both Sides and Reduces Waste of Heat; Operates from Light-ning Socket



Revolving Whipper for Cream, Butter or Eggs Fits inside Glass Fruit Jar

246 Wayne Kenemore Secretary
Horse Association of America

SIX HORSES DEFEAT ELEPHANT IN PULLING CONTEST-

Union Stock Yards Chicago



Eight Horses Pulling Almost as One during the Test, and "Old John," Powerful Circus Elephant, Demonstrating His Strength; He Was Defeated by a Six-Horse Team

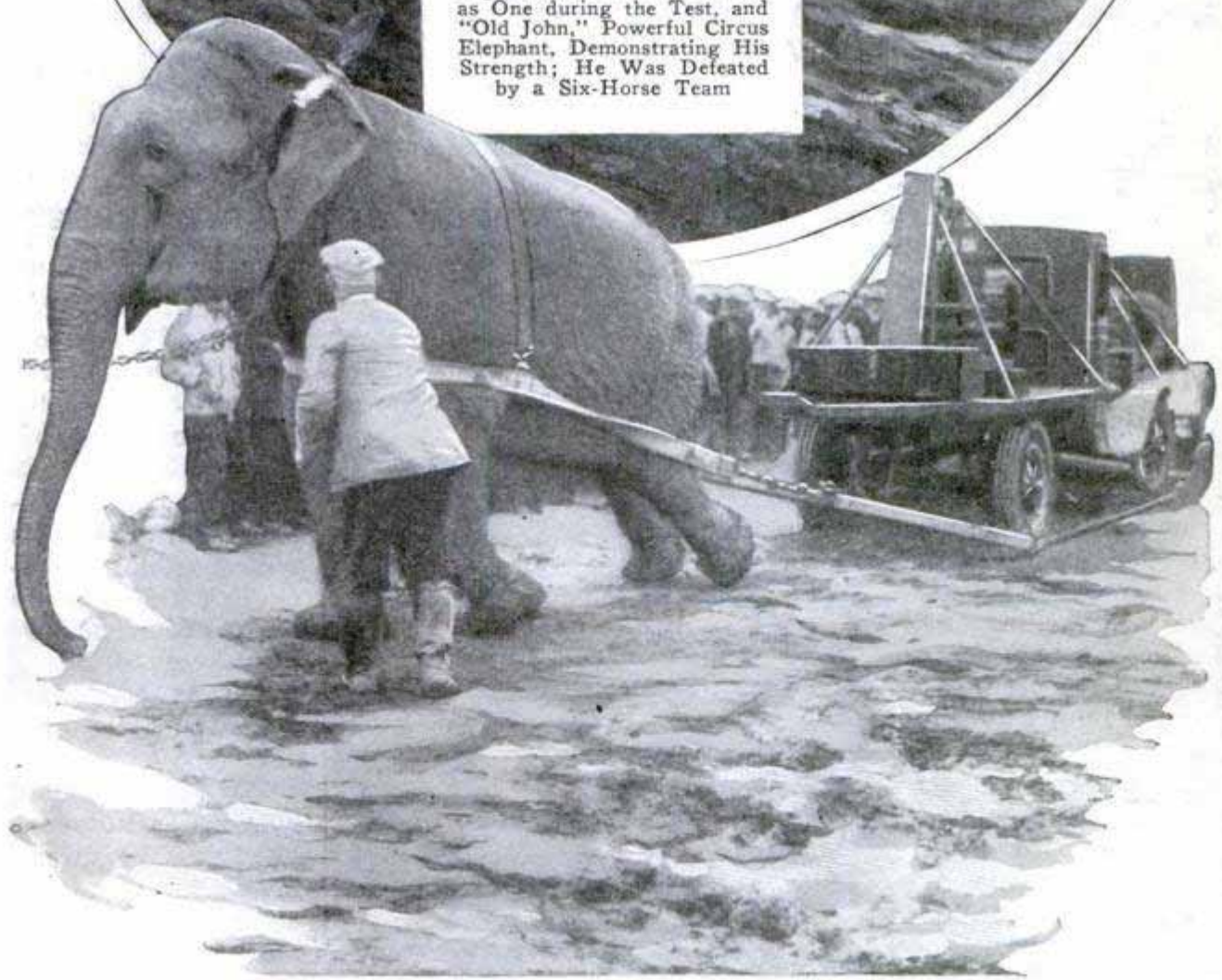

*John M. Donbrigar
462 Macomb St.
Detroit Mich*



Offending Motorists in Detroit Are Reprimanded from This Loud-Speaker Police Car So That Others Can Hear and Take Warning

LOUD SPEAKER ON POLICE AUTO AIDS SAFETY CAMPAIGN

"Lectures" given traffic violators in Detroit can be heard for a considerable distance through a loud speaker on a police automobile. The public reprimand broadcast in this manner is said to be effective both on autoists and pedestrians who are upbraided for jay walking.

STOPPER MAKES SIPHON BOTTLE AND PROTECTS CONTENTS

A stopper that keeps ginger ale and other charged drinks from becoming flat while awaiting use, and at the same time converts the containers into siphons, expelling the liquid under pressure, has been invented by a Chicago man. The siphonette, as it is called, consists of a rubber tube, inclosed in a metal case, equipped with a lever under spring tension to pinch the tube shut.



Besides Corking Charged Drinks This Stopper Also Makes a Siphon of the Bottle

The end of the handle is fitted with a bottle opener. With the stopper in place, only a slight shake of the bottle is necessary to generate sufficient carbonic acid gas to expel the contents with considerable force.

OIL WELL DRILLED MILE AND A HALF

389 Surpassing all previous deep-well records, a shaft being sunk in California has passed the 8,000-foot level. The engineers plan to continue drilling so long as the drills, which are electrically driven, can be kept operating. Extremely high temperatures have been met below 7,000 feet. The well tapped an oil-bearing sand at 3,600 feet, and good oil and gas flow at 5,375 feet, while extremely heavy gas pressure was encountered at 5,480 feet. Oil was also found between 5,620 and 5,900 feet.

GROWING OF DWARFED TREES ENCOURAGED IN JAPAN

396 To keep alive the art of growing dwarfed trees, Japanese connoisseurs of flowerpot-size forests have formed a Dwarf Tree Encouragement society and begun holding annual exhibitions. Recently 300 of the finest examples in the islands were exhibited, including tiny pines with a pedigree showing them to be as much as 500 years old. One, of that age, is valued at 10,000 yen, or \$5,000. The art is not confined just to dwarfing a tree, but includes the complete reproduction, in miniature, of a natural

*Siphonette by C. H. Huron
10 E. Huron
Chicago*

Emb. N.C. Me. Lond. 17, 17 All Paul & Public Ledger. 7/10/26

the processes necessary if it was to be used. All kinds of flux and all sorts of heating periods were tried without success. Finally, after a sample had been heated and sprinkled with borax, a workman casually picked up a salt cellar left standing near by after lunch and idly started to sprinkle salt over the borax. The top flew off the cellar, covering the sample with salt, and the engineers were amazed to see it combine with the borax and form a jellylike covering which prevented air from reaching the weld, to form the cracks that had ruined all the previous experiments.

HOT-WATER AUTO HEATER 1567

Clean, safe and odorless heat is provided for the automobile without the hazard of carbon-monoxide gas from an easily installed attachment operating somewhat like a hot-water plant for homes. It uses water from the motor's radiator and is put on with a special connection that requires only two holes to be bored through the floorboards and no cutting of other fittings. Water is kept circulating continuously through the heater by the action of the pump. The outfit is manufactured in two sizes, for the floor or footboard.

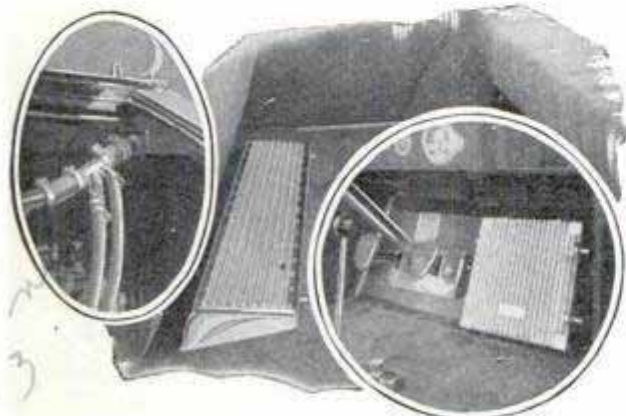

Heater Installed, and Close View Showing Connections to the Radiator Water Supply

*Mot. Acc. Co.
42 Broadway
New York*

TWENTY-FOUR-FOOT ROOSTER ADVERTISES FARM 109

Attention is called to a poultry farm near Los Angeles by a huge sign in the form of a rooster twenty-four feet high. Bright colors and a realistic profile add to the ef-



This Giant Red Rooster Forms an Effective Sign for a Western Poultry Farm, as It Stands Twenty-Four Feet High

fectiveness of the marker, which has proved a good investment for the farmer.

PARACHUTES TO LAND MAIL ON NON-STOP FLIGHTS 397

Wayside stations where air-mail ships can drop bags without the necessity of landing are to be introduced on airways in Europe. Experiments with small parachutes have shown that the mail bags can be dropped 5,000 feet without damage to the contents. The details of the device have been kept secret, but it is understood to embrace a clockwork arrangement by which the bags can be dropped like a plummet until within a short distance from the ground, when the parachute opens and checks the descent. The long drop before the chute opens enables the pilot to aim the bag at the landing field, and keeps it from drifting several miles away before the wind.

Continental

Adopted by Annapolis Railway and Electric Co. 186 Baltimore, Md.



Safety Straps of White against Dark Uniforms Used to Protect Street-Railway Employees from Motorists

BELT GUARDS STREET WORKER AGAINST MOTOR ACCIDENTS

Street-car company employes of an eastern city, who must spend much of their time on the tracks, are distinguished by broad white cross belts so that they can easily be seen by motorists. The straps are visible on dark days or at night as they stand out in sharp contrast to the workers' dull-colored clothing.

PHILIPPINE MAHOGANY UNDER BAN 388.

Orders barring the use of the term "Philippine mahogany" were issued recently by the Federal Trade commission against three lumber companies which had been importing the wood from the islands for use in furniture making, and other industries where a substitute for real mahogany could be employed. The board ruled that the wood

did not belong to the same family as true mahogany, that it was much more porous than the genuine lumber, and that the practice of passing it off as mahogany by filling the pores was unfair. The filling later shrinks into the pores and the appearance of the wood deteriorates with age instead of improving, which is one of the characteristics of true mahogany that makes it particularly valuable.

TRUCK WITH "UPSTAIRS" DRIVE 330 AIDS LIGHTING REPAIRS

Included in the automobile fleet of an eastern power company is a tower wagon with a dual-control arrangement to simplify work on street lights and poles. It has an extension steering post reaching to a seat on the upper platform from which a second wheel and controls to operate the electric truck are manipulated. With this outfit, when the workman has finished at one pole, he has only to step down a short distance to the upper driving seat. He can thus do the driving and the repair work also, saving an extra man. When the truck is to go long distances, the usual driving position is maintained. The tower is telescoping and can be raised to a maximum height of seven feet eight inches.



The Upstairs Drive on This Public-Service Truck Enables the Lineman to Make Repairs and Drive On without Climbing Up and Down Every Time He Finds It Necessary to Shift Position

Electric & Gas Co., Jersey City, N.J.

Furniture Age Sept. 1926

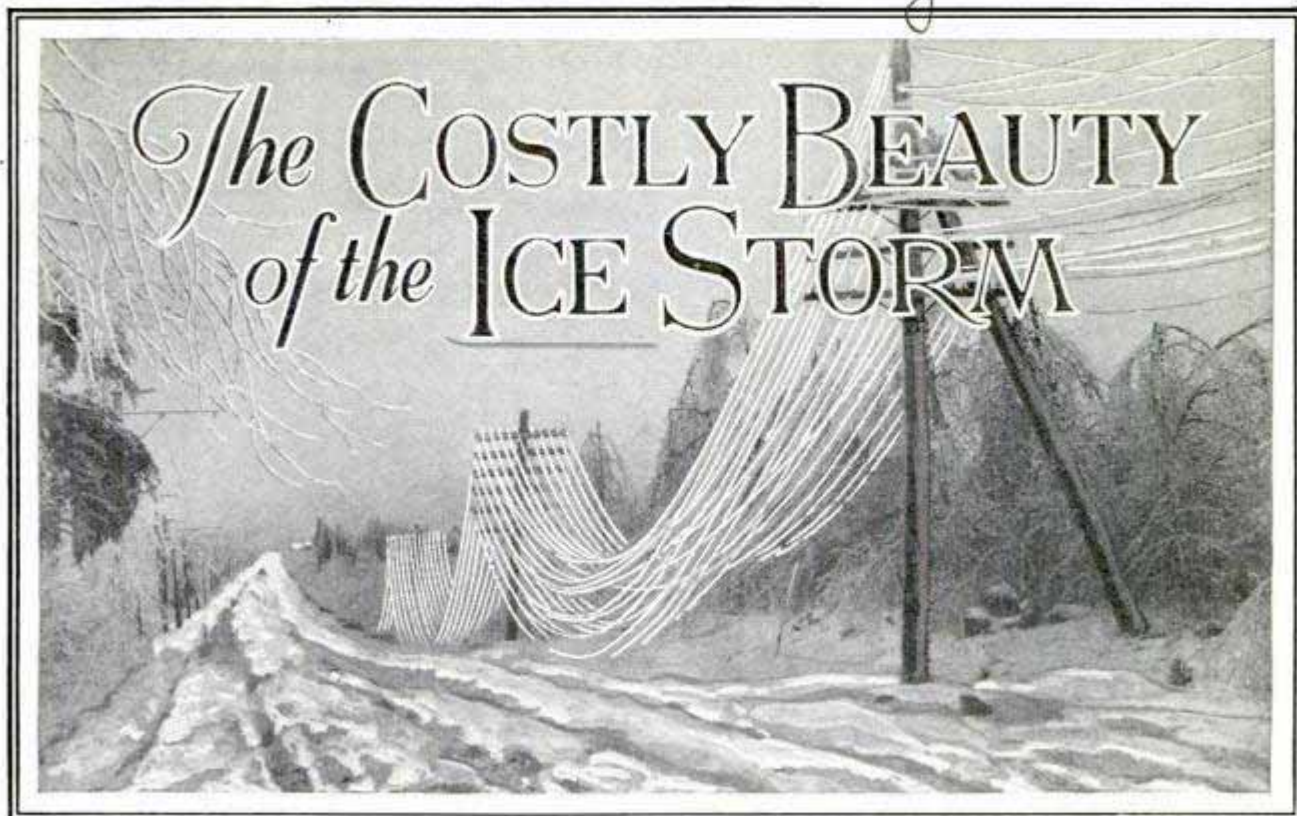

Dazzling Spectacles of Nature for Which We Pay Millions Every Winter in Damage to Wires and Stoppage of Communication

By CALVIN FRAZER

A SPECTACULAR product of Hollywood may extract millions of dollars from American pocketbooks, but the mulcting process is generally spread over two or three years and the audience is nation-wide. Nature now and then taxes us just as much for a show that lasts but one or a few days and is seen only in a limited section of the country.

Ice storms occur when, with the temperature of the air at the earth's surface below the freezing point, rain falls from warmer air aloft. The drops turn to ice on striking the chilled surface of terrestrial objects, and continued rainfall steadily increases the accumulation. The typical deposit is clear ice, though it is sometimes mixed with previous deposits of ordinary snow.

Many ice storms do no damage. It is only when the ice coating becomes heavy enough to break the branches of trees and the wires and poles of telephone, telegraph and power systems that Nature begins to pile up a bill for her services as a scenic artist. Transmission lines are usually designed to carry a deposit of half an inch of ice on the wires in calm weather,

though with high winds a considerably lighter load is destructive. Roughly speaking, only about one-third of the ice storms occurring in the northeastern United States reach the danger point of ice and wind.

Of the wire services the telephone companies are the greatest sufferers, as their overhead wires greatly exceed in mileage those of the telegraph and light-and-power companies combined. Heavy losses from ice storms are expected every winter, and in order to ease the strain on a company's resources they are met from a special reserve fund accumulated through the year and charged monthly to operating expenses. A single storm a few years ago entailed an outlay of \$7,500,000 for repairs and reconstruction.

In the course of a few hours a single telephone wire may acquire a solid ice coating three inches in diameter and accompanied by even longer icicles. Whereas the weight of wires in the normal span between two poles in a forty-wire lead is less than 200 pounds, such an ice coating may add a weight of about 15,000 pounds to the load supported by each pole. If a

47 heavy gale is blowing, the pole is further subjected to a bending force due to the wind pressure on the ice-covered wires. Exposed to such stresses, the lines frequently fail, and even if they do not from this cause, they are often brought down by trees falling across the span.

Damage to trees sometimes constitutes a heavy item of loss in an ice storm. In February, 1922, the worst of these storms that has ever visited Michigan destroyed hundreds of thousands of trees in that state. Many fine orchards lost from fifty to seventy-five per cent of their trees. The deposit of ice was enormous. At one place a twig weighing only an ounce was found to be coated with two pounds of ice. Another, the size of a lead pencil, supported an ice column nine inches in circumference. In the great New England ice storm of Nov. 25-29, 1921, the city of Worcester, Mass., alone lost 8,000 shade trees. In this storm it was estimated that a tree fifty feet high, with an average width of twenty feet, carried a load of five tons of ice. In the New Eng-

land woods, after the storm, the trees lay prostrate in windrows.

In December, 1924, one of the most disastrous ice storms in American history tore down 34,000 poles of the utility companies in Missouri, Oklahoma and Texas, putting out of service more than 25,000 miles of open wire. The focus of destruction was St. Louis, which, on the morning of the nineteenth, found itself almost totally cut off from the rest of the world. With wires and cables prostrate, or grounded by tons of ice, long-distance communication whether by telephone or telegraph was practically impossible. Every line leading west was partially or totally crippled. Ten thousand city telephones were out of order, while almost every station in St. Louis county was dead.

In an emergency of this kind, a veritable army of repairmen must be mobilized. The telephone company drafted linemen and foremen from surrounding states, and for weeks following the storm 3,000 men were at work in eastern Missouri alone.

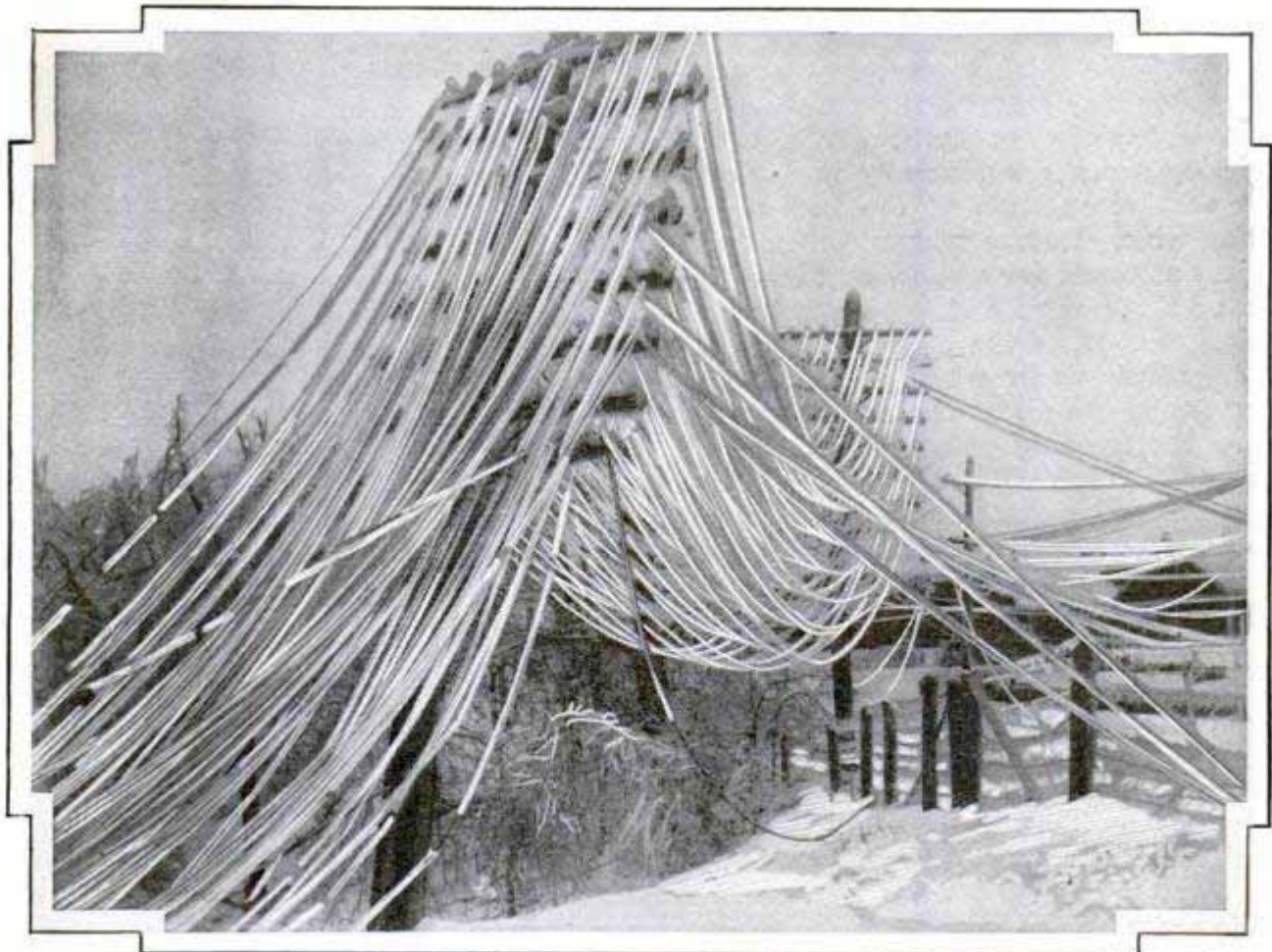

The Greatest Enemy of the Telephone Lineman; the Ice Coat on Each Wire Is Three Inches in Diameter and Weighs Eighty Pounds per Wire between the Poles

47

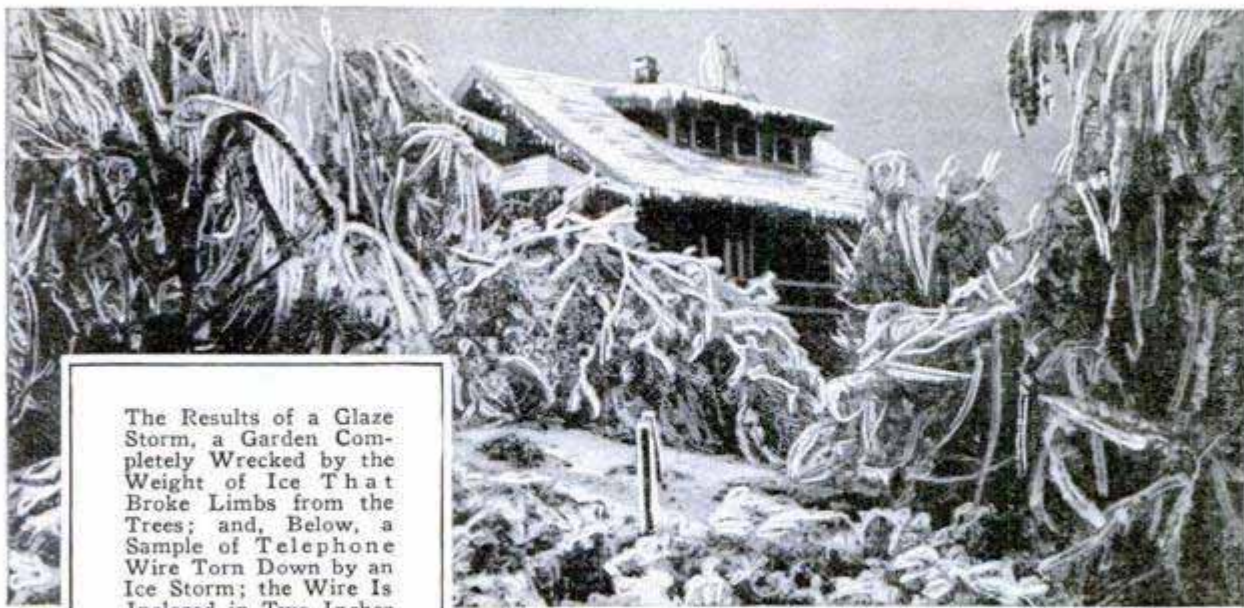

The Results of a Glaze Storm, a Garden Completely Wrecked by the Weight of Ice That Broke Limbs from the Trees; and, Below, a Sample of Telephone Wire Torn Down by an Ice Storm; the Wire Is Inclosed in Two Inches of Ice, with Icicles Five to Nine Inches Long

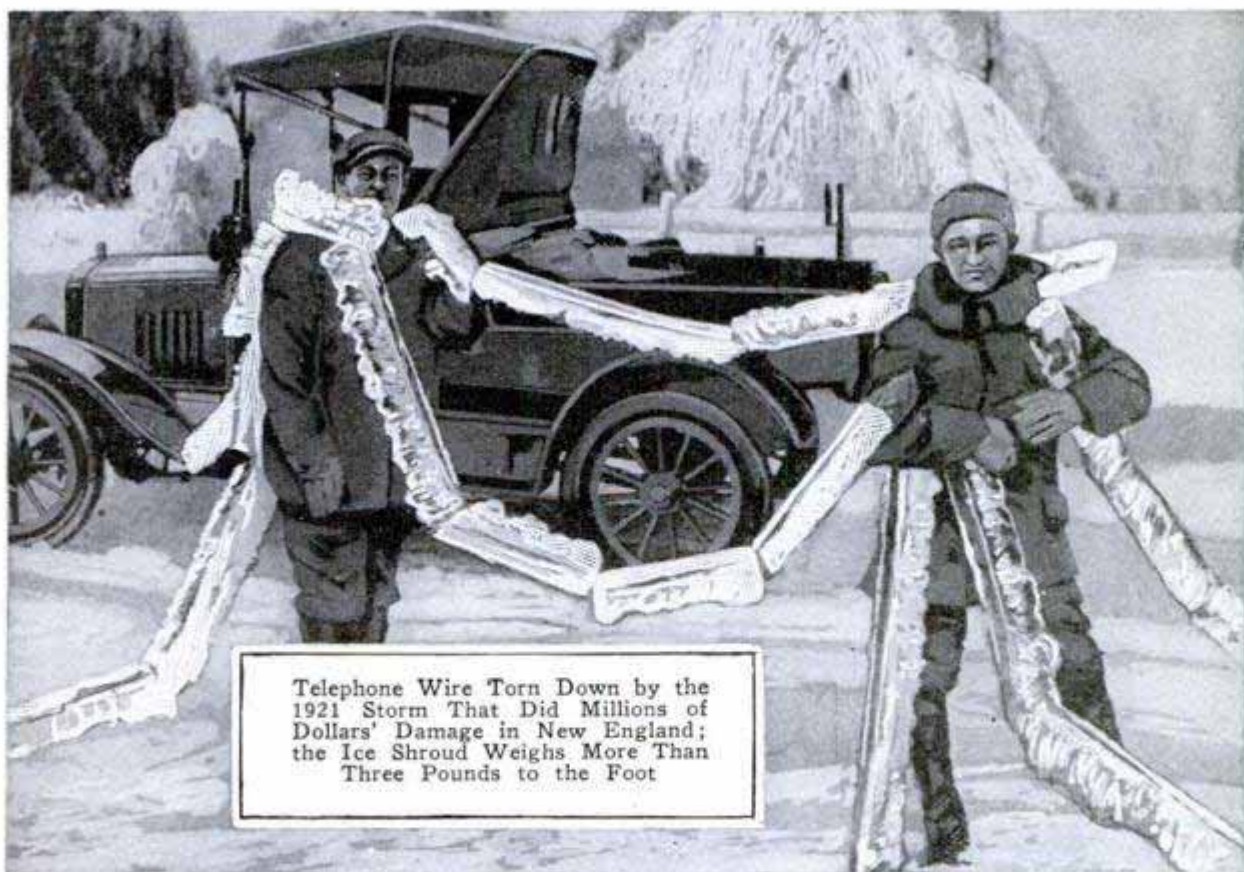
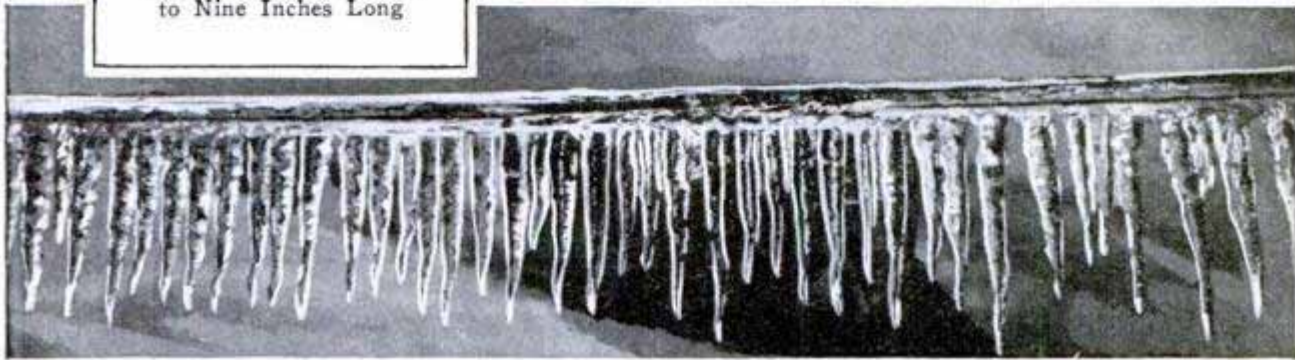

Telephone Wire Torn Down by the 1921 Storm That Did Millions of Dollars' Damage in New England; the Ice Shroud Weighs More Than Three Pounds to the Foot

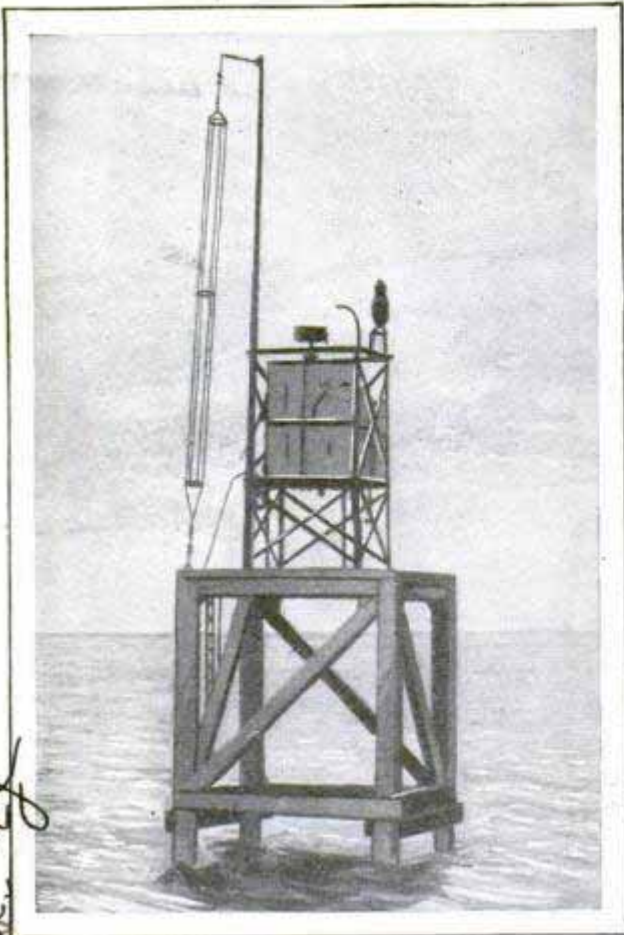

Radio-Operated Fog Signal Requires No Attendant; Impulses from Distant Station Start and Stop It

RADIO OPERATES FOG SIGNAL TO GUARD SHIPPING

Radio impulses sent from a transmitter more than eleven miles away operate a fog signal at the entrance to the Firth of Clyde, Scotland, saving a special attendant. The alarm is stopped by the same means, impulses of a different frequency actuating the mechanism that shuts off the signal.

WRENCH WITH SPRING ON JAW IS SELF-ADJUSTING

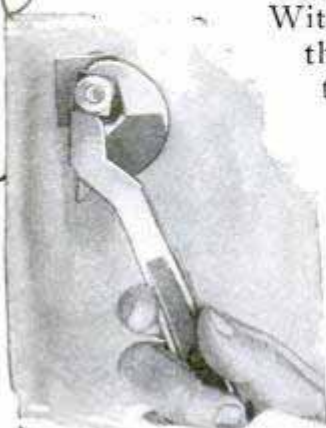

With a stiff spring on the back, which throws the upper jaw in place automatically, a self-adjusting wrench affords powerful leverage and locks more tightly as pressure on the handle is increased. It is made of steel.

500 PLAINS ONCE FOREST-COVERED FOSSIL NUTS INDICATE

Dense forests of a species of walnut tree grew on what are now the open plains and sand drifts of western Nebraska, in the opinion of scholars who have studied collections of fossil nuts found in that region. They were discovered along with remains of prehistoric animals and were first believed to be hickory nuts, but comparison with all existing species of the hickory and walnut led to the conclusion that they were more closely related to the latter. From these fossils, it is held probable that the climate of the region was very different from present conditions, for the trees demand much rainfall and a deep, rich soil. The abundance and character of the associated animal life, as shown by other fossils, indicate that the forests were not confined to narrow areas along the banks of watercourses but that they covered considerable space, the investigators believe.

STREET-CAR STRAPS CARRY ADS TO INCREASE REVENUE

1429. Straps in street cars and other public vehicles in London are being put to a double use by the addition of small display cards to the portion just above the grip. Advertisements so placed are in a conspicuous position both to seated and standing passengers, and the plan affords room for several more placards than can be accommodated on the regular side panels above, thus affording more revenue.



The Popular Mechanics Bureau of Information offers its free service to all readers of this magazine. Names and addresses of manufacturers and dealers in articles described, and any other details in our possession, will be promptly furnished by addressing the Bureau.

Mastermarch Corp. Turlock, Calif. /
 Taken over by - Seller Bros., Newark, N.J.

Chicago-Whitehead Sales Co., 21 S. Clinton, Chicago

Prof. E. W. Berry, Paleontologist, Johns Hopkins Univ. Eng. /
 Hangerstraps + General Advertising Co. Ltd. 128, Long Acre, London W.C.2.

MACHINE IS MADE TO DRAW BILLIONS OF CURVES

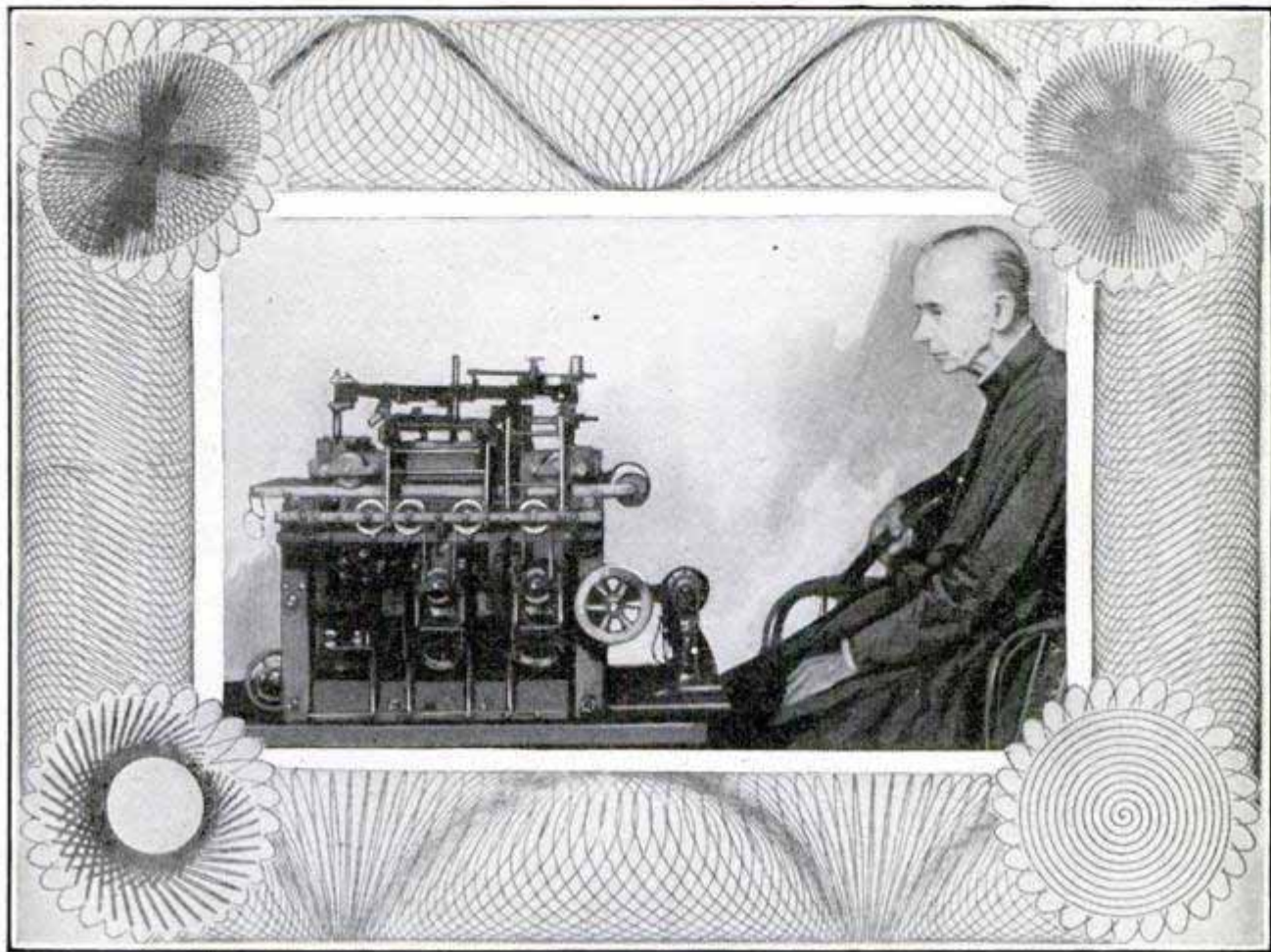

Father Rigge with His Curve-Drawing Apparatus; the Border Shows Samples of Some of the Billions of Curves That Can Be Traced with the Outfit

From simple parts which he purchased at small cost, the Rev. William F. Rigge, of Creighton university, internationally known astronomer, has fashioned a remarkable drawing instrument in connection with his study of the stars and of mathematics. Only a few adjustments are necessary to have the apparatus trace 7,618,782,498 curves. All are made with exceeding accuracy and the variety of design not only illustrates the scientific features of curved lines, but their beauty as well. The work is done chiefly by the action of a series of geared wheels. The paper is made to move under the pen, and, by set-

ting the instrument properly, pairs of curves are traced in stereoscopic effect so that the finished pattern seems to have three dimensions, like a wire basket for instance, standing out distinctly in space.

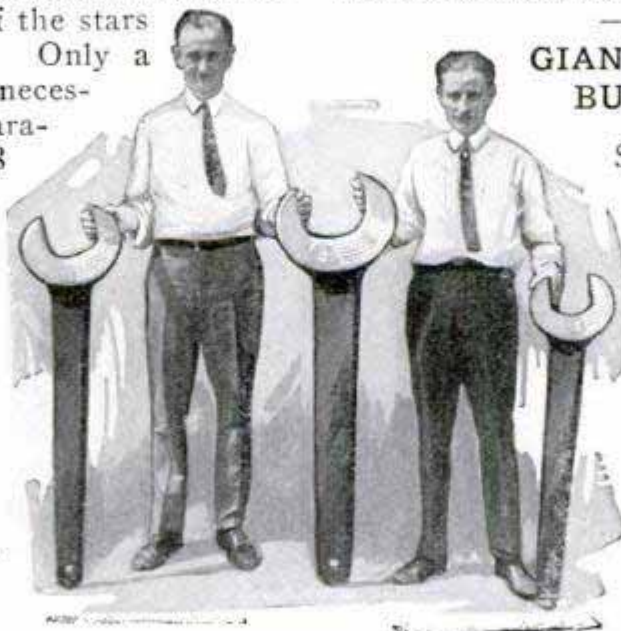

Big Wrenches Built for Electric Crane

GIANT WRENCHES ARE BUILT FOR CRANE 391

Special wrenches were necessary in assembling a huge electric crane used in constructing the buildings at the new Wilbur Wright flying field, being established near Dayton as the home of the air-service engineering division. One of the big wrenches weighed over 150 pounds.

no data
 Cml. Truman B. Mills
 11 S. Wilkinson St. Dayton, O.

1000
1896

The Trepower Observatory

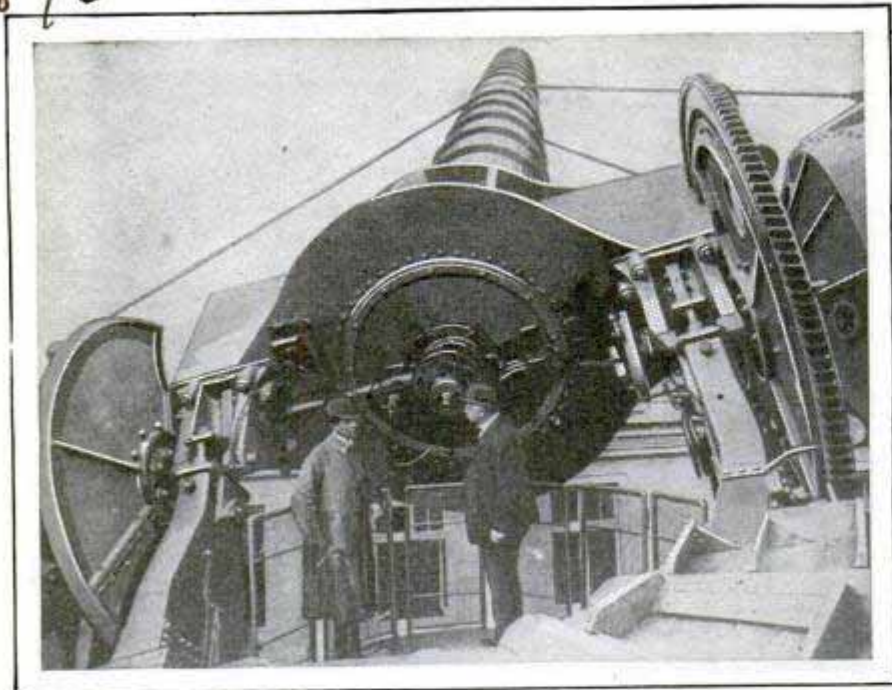

This Is the Observer's End of a German Telescope More Than Sixty Feet Long and Shows the Tremendous Gearing Used

SIXTY-EIGHT-FOOT TELESCOPE ASTRONOMERS' "BIG BERTHA"

Pointing at the stars from a German observatory in Berlin, a telescope tube more than sixty-eight feet long is helping astronomers solve the riddles of the skies. It is mounted on a special gearing for quick and accurate adjustments.

SHIFTING OF NORTHERN LIGHTS BLOCKS RADIO RECEPTION

The mere presence of northern lights does not interfere with radio reception, according to Paul Magee, chief operator on the arctic exploration schooner "Bowdoin," but when they jump about, changing their altitude and position, the effect is to completely shut off the signals. This result was noticed during the 4,000-mile journey through northern waters on the MacMillan expedition. At one place, an aerial was stretched between two rocky cliffs more than 100 feet high, affording a much better position than

442

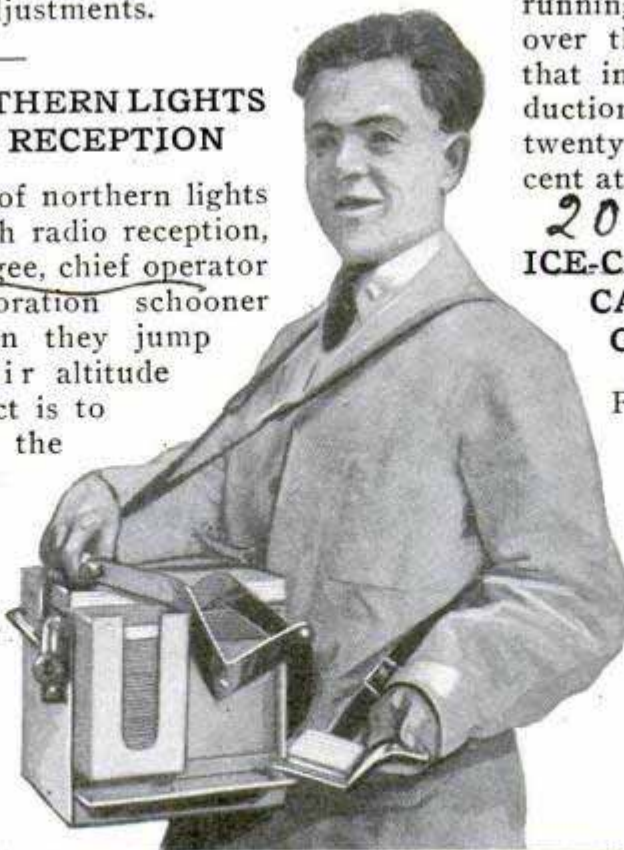

Distributing Ice-Cream Sandwiches from Portable Cabinet; the Confection Is Protected from Dust

was available on the schooner. At that location, the lights were in a band of maximum frequency and brilliancy. After working for several hours, the explorers proved to their own satisfaction that the lights did not affect the reception of signals from the United States. But as the light cone ascended or declined in the sky, the signals were cut off.

SCIENTISTS STUDY STREET-CAR NOISE

582

Certain types of gears and speed and open windows contribute to unpleasant noises in street cars, while insulated wheels, flooring in one piece and rubber cushions under the center plates help reduce them. Investigators at the university of Wisconsin have found. It was determined that leaving the windows open increases the noise about thirty-three per cent in cars running at the same speed over the same track, and that insulation caused a reduction in noise of about twenty to twenty-five per cent at twenty miles an hour.

208

ICE-CREAM SANDWICH CARRIER KEEPS GOODS CLEAN

For dispensing ice-cream sandwiches, a carrier that holds a quart of cream, sufficient ice to keep it hard and a number of wafers, protects the contents from dirt and saves time in distributing. The holder, filled, weighs but eighteen pounds, is simple to operate and is not likely to get out of order.

Wherryman Utilities Assn
Electrical Engineer
Prof. J. V. Rood, Dept. Road

The Samsco Co.
Milwaukee Wis
Price \$5.00

How to Build a Portable Tube Booster

By L. B. ROBBINS

AFTER the apparent death of seven UV-199 tubes, I began to look around for some means of reviving them for further use. Rejuvenators of various types are on the market, but all require a 110-volt lighting circuit and this was not available.

The problem was solved at small expense by the simple apparatus described in this article. It operates from ten flashlight cells, may be easily carried in the hand or slipped into an overcoat pocket and will restore to efficiency a tube of either the 199 or the 201-A type. Tubes with shorted grids and filaments, of course, are beyond recall, but where they have lost their original "pep" they may be restored to usefulness in a short time. The instrument is provided with a standard socket and adapter so that either the large or small tubes may be handled; if the tubes are of the new X-type, the X socket should be used. Make sure that your tubes are of the type that may be rejuvenated, because some cannot be so treated.

The construction of the booster is very simple. A shallow tray or box of clear-grained $\frac{1}{2}$ -in. soft wood, measuring $6\frac{3}{4}$ in. long by 5 in. wide and $1\frac{5}{8}$ in. high, inside measurements, provides the container for the ten flashlight cells. The corners must be square and there should be no metal projections of any kind inside. The over-all dimensions of the cover are $7\frac{3}{4}$ by 6 in.; four pieces of stiff spring brass, $1\frac{1}{2}$ in. long by $\frac{1}{2}$ in. wide, are cut and bent in the shape shown in the detail. A hole is drilled in the center of each and they are then screwed into the sides of the tray in the positions indicated in the layout, the first clip $1\frac{1}{4}$ in. from the end and the second one $2\frac{3}{4}$ in. from the first. The clips on the opposite side of the tray are mounted the same distance apart, but the start is made from the opposite end of the tray. Use short brass wood screws that will not pierce the wood, and arrange the clips horizontally so that they will make the necessary connections for the dry-cell units. Two brass end-cell connectors are

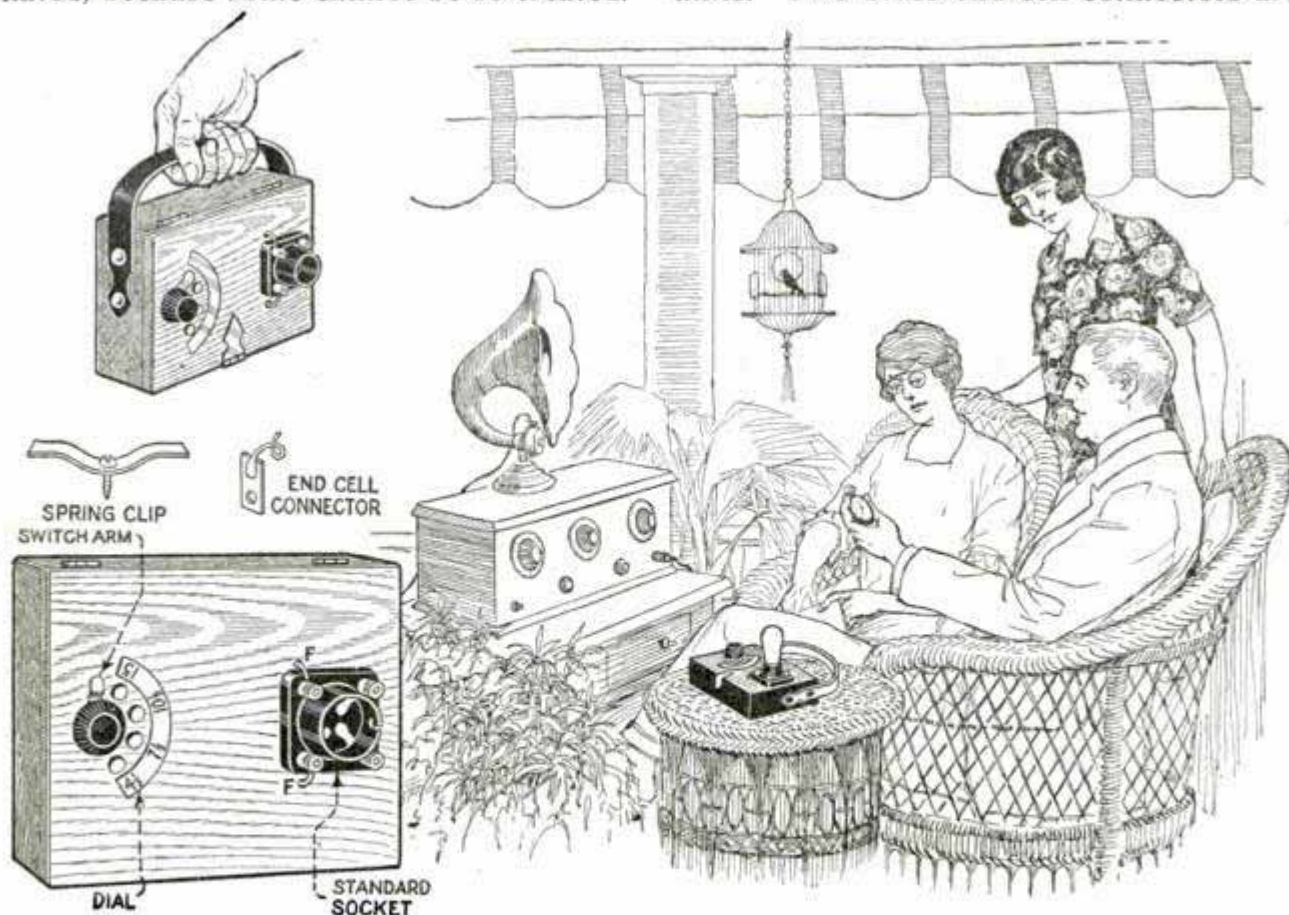

Upper Left, Completed Instrument Showing Carrying Strap in Position; Below, Details of Spring Clips, End Connectors and Close View of Top; Right, Timing Tube under Treatment

then cut from the same stock, $\frac{1}{2}$ in. wide and 1 in. long, and a short length of flexible wire is soldered to each connector, as

to the terminals. This line-up will bring one end connector against the negative pole of the first cell, and the other against the positive terminal of the end, or tenth, cell. Three thin brass connectors, 1 in. long and $\frac{1}{2}$ in. wide, with a short piece of flexible wire soldered to each, are slipped between the cells for the voltage taps to the switch points, at $4\frac{1}{2}$, $7\frac{1}{2}$ and $10\frac{1}{2}$ volts, the 15-volt tap being the lead from the positive end terminal. The three voltage connectors are placed between the third and fourth, fifth and sixth and seventh and eighth cells, respectively. The switch arm is mounted 1 in. from the end of the cover, and the four switch contacts as shown in the view of the top of the finished instrument. Care should be taken to let them project as little as possible on the underside of the lid. Glue a small arc of white bristol board or celluloid close to the taps, and mark the various voltages as shown.

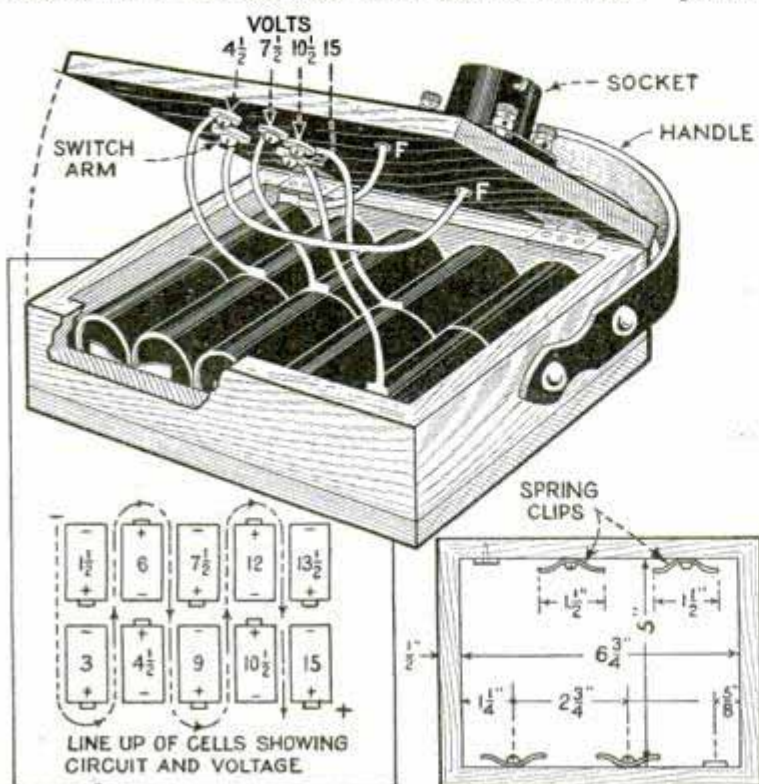

Above, Lid Partly Raised, Showing Battery Connections; Cut-Out Section at Front Shows Spring Clip in Position; Below, Line-Up of Cells and Layout of Tray

shown. These terminal connectors are then screwed to the inside of the tray about $\frac{5}{8}$ in. from each end in the positions shown in the layout.

Ten flashlight cells, of the round $1\frac{1}{2}$ -volt type, are then inserted in the tray in the manner shown in the line-up diagram. The base of the zinc shell being the negative terminal of each, and the small brass terminal at the opposite end the carbon or positive, two cells are laid end to end, positive to negative, and will just squeeze into the width of the tray; the direction of every other pair is reversed as shown in the diagram, the voltage being progressively indicated on each cell. Spring the brass clips out so that the cells are held firmly in place, making tight connections

the other end of the lid and two small holes are drilled near the filament posts for the flexible leads, one to the negative end connector at the first cell and the other to the switch arm. The voltage leads are then soldered to their contact points on the underside of the lid, the 15-volt tap going to the positive end connector at the tenth cell. If flexible rubber-covered wire is not available, use No. 18 magnet wire and cover each lead with thin spaghetti tubing. Bend the ends of the brass strips over flat and fill any spaces between the cells with cardboard to keep them rigidly in place. Hinge the cover on one side and provide two small hooks, one at each end of the tray; arrange the hooks to engage with two pins driven in

MATERIAL LIST

- 1 box of $\frac{1}{2}$ -in. wood (inside measurements $1\frac{1}{8}$ in. deep, 5 in. wide and $6\frac{3}{4}$ in. long).
- 1 lid of $\frac{1}{2}$ -in. wood (over-all dimensions 6 by $7\frac{3}{4}$ in.).
- 1 strip spring brass, $\frac{1}{2}$ in. wide by 8 in. long.
- 1 piece of thin brass sheet, $\frac{1}{2}$ by 3 in.
- 1 switch lever.
- 4 contact points.

- 1 standard tube socket.
- 1 adapter for 199-type tubes. If X-type sockets and tubes are used no adapter is necessary.
- 2 small brass hinges, with wood screws.
- 20 short brass wood screws.
- 10 $1\frac{1}{2}$ -volt flashlight cells, round uni-cell type.
- 1 leather strap, 1 in. wide by 16 in. long.
- 2 small catch hooks, or a small hinged hasp.

2 ft. flexible rubber-covered fixture wire.

the ends of the cover so as to hold the lid tight down on the tray when closed. A small, hinged hasp may be substituted if desired. If there is any play between the lid and the cells use felt or cardboard to pack the cells firmly. The leather carrying strap may be made from an old belt and is fastened with short wood screws in the manner shown in the illustration, thus completing the instrument.

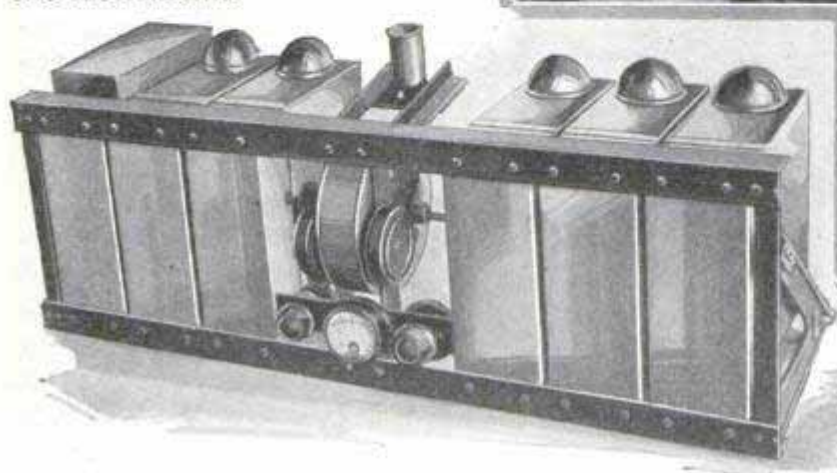

Left, Eight-Tube Neutrodyne, Showing Method of Shielding; Above, Comparison in Size and Type of Early Crystal Set with the Single-Control Receiver

To rejuvenate a tube, place it in the socket with the switch arm off; then with your watch in hand, flash the tube by placing the switch arm on the voltage indicated for that particular tube. For the UV-199 or C-299 tube, the flash should be on $10\frac{1}{2}$ volts for 45 seconds. At the end of this period bring the switch arm back to the $4\frac{1}{2}$ -volt tap and leave it there for 10 minutes. Replace the tube in the set and, if the tube does not show the required improvement, repeat the process. The UV-201A and C-301A tubes should be flashed at 15 volts for 45 seconds and then burned at $7\frac{1}{2}$ volts for 10 minutes. While the life of the small dry cells composing this unit is not long enough for use in a commercial way for tube boosting, the amateur who has only a few tubes to rejuvenate occasionally will be well served by the instrument. When the cells go dead, they should be removed quickly and fresh ones inserted.

☐ The homemade battery charger described in our October issue is for 110-volt, 60-cycle alternating current only, not for 100-volt, as erroneously stated on page 657.

One-Control Neutrodyne Works on Loop 997a

This eight-tube receiver of the neutrodyne type may be operated with one hand, through a precision single-control mechanism in the form of a bakelite disk which, by means of a vernier gear, turns a rotary drum bearing a wavelength scale. This one tuning control takes the place of ten ordinary adjustments and eliminates the necessity of expert knowledge in the operation of an elaborate receiver of this design. The set will work with either a loop, indoor or outdoor antenna. Copper shielding is used for the r.f. stages and the detector tube, and a steel compartment is provided for the a.f. stages. Metal caps above the assembly are removable for the purpose of inserting various tubes in their proper sockets. A double-range voltmeter is located below the control unit, and an eight-position switch permits the operator to note instantly the A, B, and C-voltages applied to the various parts of the circuit. New engineering features are claimed to eliminate distortion, insuring great volume combined with excellent tone and selectivity and ease of operation.

*Fred. Eismann
Radio Corp. Juniors
St. + Liberty Ave*

W. J. Brown

New Device Combines Phonograph and Radio

A new device combining the phonograph with the radio set is now available.

the curved membrane. This method differs from the usual pistonlike action directed at right angles to the surface. The speaker has a width of 17 1/2 in. and is 13 1/2 in. in height.



Radio Set Connected to Phonograph Reproducing Records with Increased Volume and Better Tone

The instrument is connected to the tone arm of the phonograph and a flexible cable, terminating in a specially designed plug, is inserted in the radio set. The record is played in the usual manner and amplified by the radio set, and the combination is claimed to give exceptionally good results. It has the advantage that favorite tunes can be played at any time with the full tonal value of the radio, and can be regulated fast or slow to suit the listener. Actually, the phonograph becomes the broadcasting station, so that all the advantages of radio tone are obtained without interference from static or other atmospheric disturbances.

Length of Aerial Important

In a large measure the performance of the set depends on the length of the aerial. The time has passed when the 100-ft. aerial was advised for all sets. As a general rule, the longer the aerial, the greater the signal strength, although the interference is amplified in the same ratio, and the set becomes sluggish. Also, the long aerial tends to absorb energy from the set, and has the effect of loading the circuit, preventing oscillation. The good results that are obtained by the long aerial are discounted by preventing the tuning of the modern set to the very low wavelengths, now in general use. For these waves a short aerial is required, and has the effect of adding energy to the set, also increasing selectivity. The aerial must not be too short, however, or the set will not operate. The proper length will be found by experiment. The height of the aerial depends on the location, and should be at least 20 or 30 ft. above the ground, the higher the better. For receiving purposes a single-strand aerial is just as efficient as the multiple-strand type. A good suggestion for the average set is to use three different aerials; a short one of about 40 ft.

Loud Speaker Shaped like Book

A new loud speaker of unusual design is made in the form of an open book. It has tinted pages done in sepia, is finished in gold and brown-morocco leatherette and has an artistic appearance. It rests on a small easel but may be hung on the wall if desired. It employs an electromagnetic unit applied tangentially to the edge of

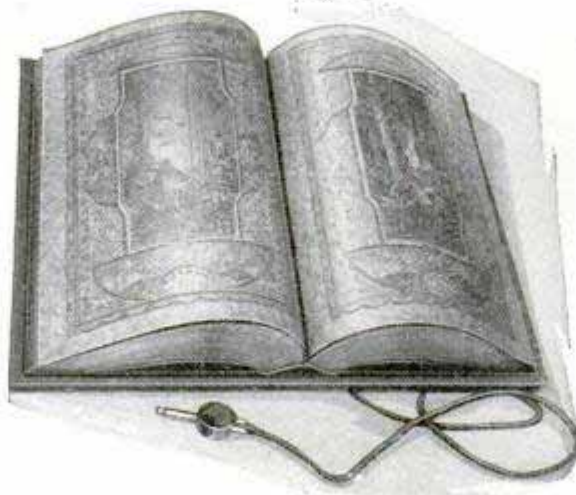

Loud Speaker, in the Form of Book with Illuminated Pages, Resting on Easel

of the horizontal type, for stations below 300 meters; another about 70 ft. for the higher wavelengths, and one of the inside type for local stations. The latter may consist of two or more turns of bell wire around the room, behind the picture molding; a switch can be arranged for cutting in any one of the three aerials as the occasion may demand.

David Krines, Inc. 1579 Broadway New York 1067
Utah Products Co. 1421 S. Michigan, Chicago 1059-D

116 S. Wells
Chicago
\$17.50

Three-Tube Set Works on Loop

Ideal City Set Is Selective, Operates Loud Speaker and Gets Rid of Aerial Nuisance

By FRANK L. BRITTIN

THIS little receiver is designed to fill a particular need and, for good performance at low cost, is in a class by itself. One often overhears a remark that runs something like this, "I would like to build a small set that would be selective enough to separate the powerful local stations, work on a loop, and have good loud-speaker volume; I am not interested in distance, as the local stations have excellent programs."

At first thought this seems like a rather large order, but Popular Mechanics radio laboratory now offers just such a set, thoroughly tested, that has excellent tone and good loud-speaker volume. The standard parts, shown in the layout, cost but \$28.80; this cost, however, does not include the ac-

usual outside aerial; no ground wire is required, and it is extremely simple to tune.

Although it is always best to follow material specifications closely for maximum results, this is one set where some latitude is permitted; with the one exception that the variable condenser must be of the type specified or similar type that has not a "live" shaft. The a.f. transformers may both be 3 to 1 or $3\frac{1}{2}$ to 1 ratio, or as specified; the other parts will usually be found around the average experimenter's worktable or can easily be obtained from the nearest dealer in radio supplies.

The simple layout is clearly shown on the blueprint page and the battery hook-up is shown in the circle at right. The front panel is $\frac{3}{16}$ by 7 by 14 in., and the drilling-template for this panel is shown on another page above the schematic diagram. The instru-

ments on both the front panel and baseboard are arranged so that the leads

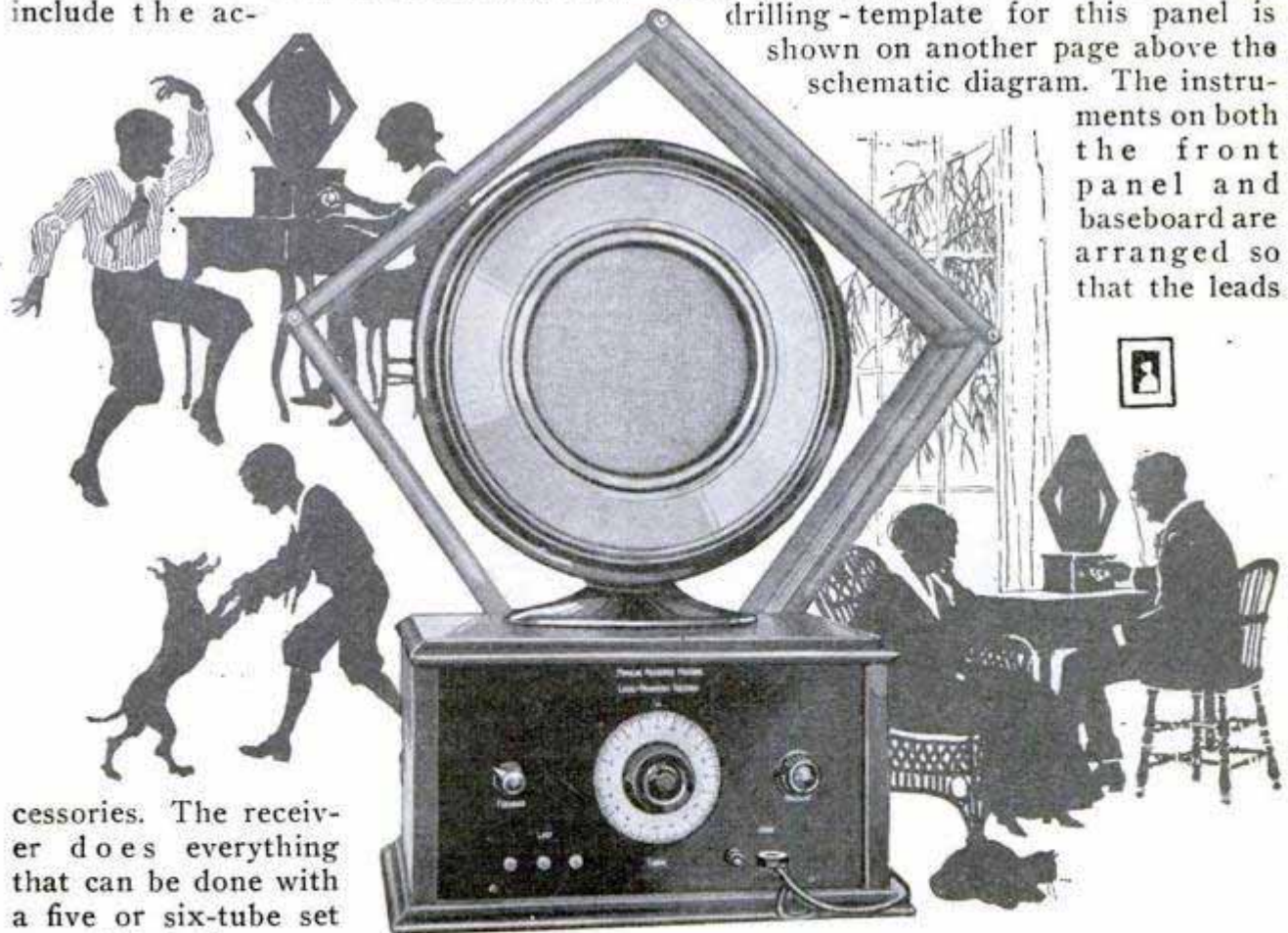

cessories. The receiver does everything that can be done with a five or six-tube set except that the range is limited to about seventy-five miles. In addition, it works on a loop instead of the

may be kept short. The detector-tube socket must be of the cushioned type, but

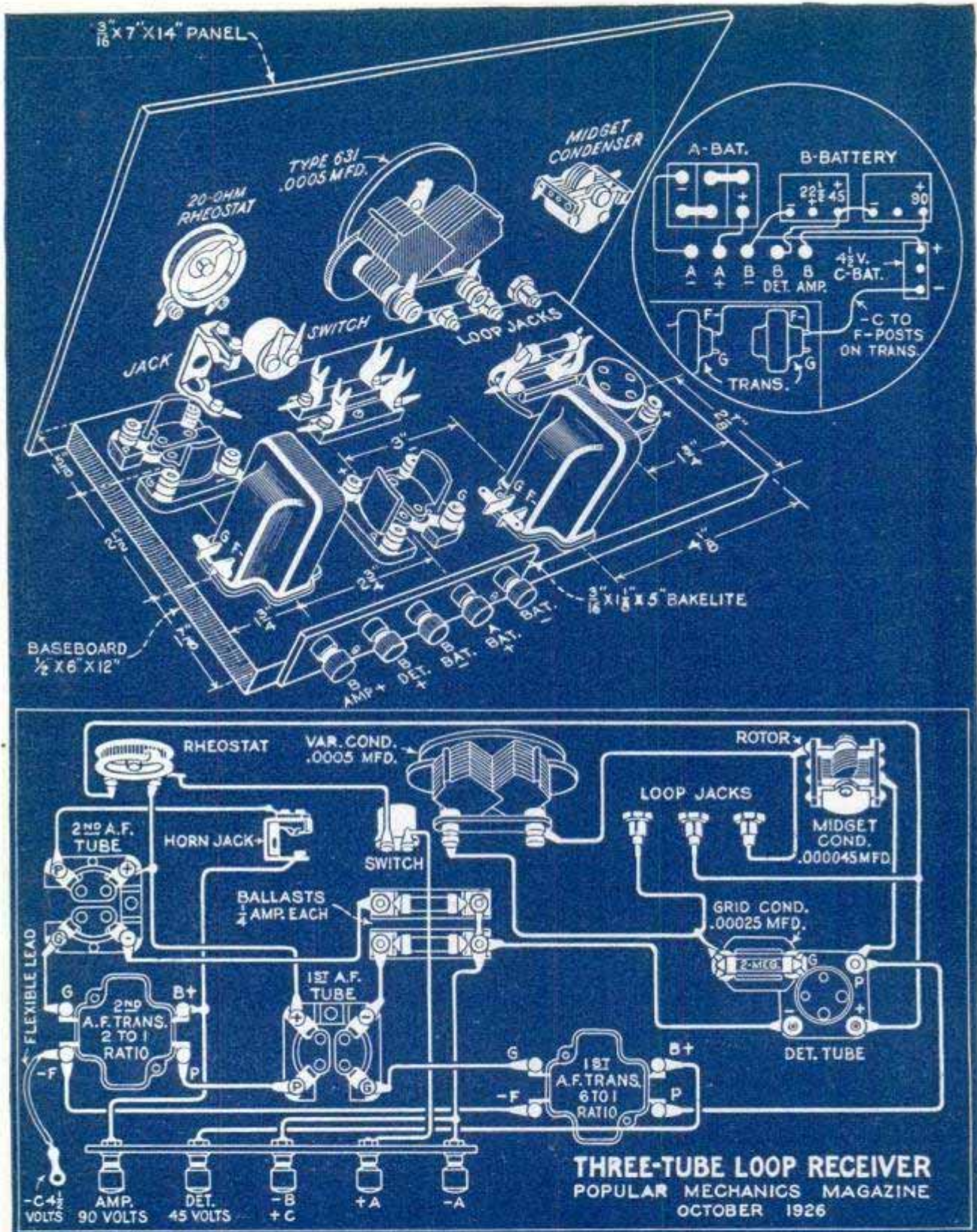

Above, Panel and Baseboard Layout Showing All Instruments in Position Ready for Wiring; Right, A, B and C-Battery Connections; Below, Simplified Wiring Diagram

the other two may be of any good standard type suitable for the tubes used. It is possible to use the 199 dry-cell tubes in this set, but the best results will be obtained with the standard 201-A type. One of the new 200-A or 300-A detector tubes may be used if desired, without changing

the circuit. If a.f. transformers of different ratios are used, always place the one having the highest ratio in the first stage. The battery binding posts are arranged on a strip of bakelite, $\frac{3}{16}$ by $1\frac{1}{8}$ by 5 in., this strip being screwed to the rear edge of the baseboard as shown in the layout

diagram. Place soldering lugs of the long round-hole type under all terminals before starting the wiring.

The wiring diagram is given below the instrument layout and is so simple that little instruction is necessary. Follow the point-to-point connections carefully, and be sure that the rotor plates of the midget condenser are connected just as shown. It will be noted that the two $\frac{1}{4}$ -amp. ballasts are connected together at one end and the lead taken to the negative-A post and to the negative post on the detector-tube socket. One ballast controls the filament of the first a.f. tube and the other the second a.f. tube, the detector tube being controlled by the 20-ohm rheostat. Use round tinned-copper busbar wire for the circuit and spaghetti tubing only where necessary to prevent shorts. The F-posts on the a.f. transformers are connected together, and the flexible lead, shown in the wiring diagram, is taken to the negative terminal of a $4\frac{1}{2}$ -volt C-battery, the positive lead from this C-battery running to the negative-B post that is common with the A-negative in the wiring diagram. This small C-battery takes up little room and may be placed in the cabinet with the set. The grid condenser and gridleak are mounted directly on the G-post of the detector-tube socket.

Check the wiring carefully and when completed, connect the A-battery and turn on the filament switch. Place one tube successively in each socket to test

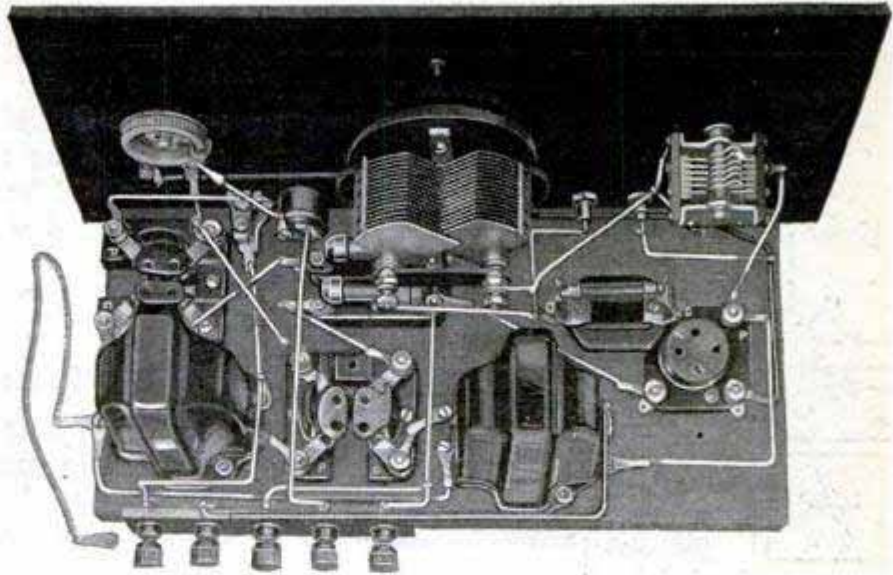

Rear View of the Completed Set

this circuit; if OK, turn off the switch and remove the tube. Now connect the B and C-batteries and place all three tubes in their respective sockets. The loop plugs are then inserted in the small jacks, taking care that the center loop lead goes into the central jack. Finally, plug in the loud speaker and the set is ready. Turn on the filament switch and slowly rotate the large condenser dial; if a station squeal is heard, adjust the midget condenser until this squeal is eliminated, bringing in the station clear with the large condenser. The detector-tube rheostat is then adjusted for best results, and one station after another can be brought in by slowly rotating the large condenser. After the correct setting of the midget condenser has been found, it will not be necessary to readjust it for every station. The loop will be found directional and usually gives best results when turned toward the transmitting station. This is not always the case, due to deflection from near-by metallic bodies.

This is a set that any child can tune and

MATERIAL LIST

- | | |
|--|---|
| 1 panel, 3-16 by 7 by 14 in. | 1 grid condenser, .00025 mfd., with gridleak clips. |
| 1 baseboard, $\frac{1}{2}$ by 6 by 12 in. | 1 2-meg. gridleak. |
| 1 20-ohm rheostat. | 1 a.f. transformer, 6 to 1 ratio. |
| 1 open-circuit jack, short type. | 1 a.f. transformer, 2 to 1 ratio. |
| 1 push-pull filament switch. | 5 binding posts with engraved tops. |
| 1 Remler capacity unit, .0005 mfd., type 631. | 1 bakelite strip, 3-16 by $1\frac{1}{4}$ by 5 in. |
| 1 midget condenser, .000045 mfd. | 1 $4\frac{1}{2}$ -volt C-battery, large type. |
| 3 midget loop jacks and plugs. | 2 45-volt B-battery units. |
| 1 X-type tube socket, spring-suspended or cushioned type. | 3 UX-201A or C-301A tubes. |
| 2 X-type sockets, any good make. | 36 soldering lugs, long round-hole type. |
| 2 Daven ballasts, $\frac{1}{4}$ -amp. each, complete with mountings. | 3 2-ft. lengths round tinned-copper busbar wire. |
| | 1 length good black spaghetti tubing. |
| | 1 three-tap loop, box-type preferred. |

FRONT-PANEL TEMPLATE
3/16" X 7" X 14"

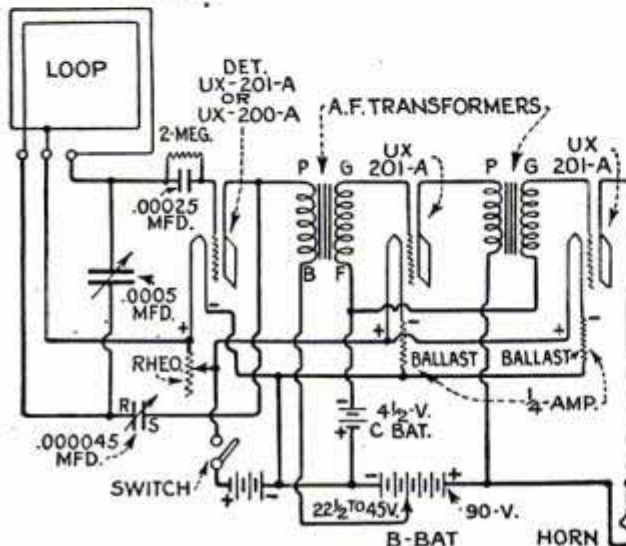
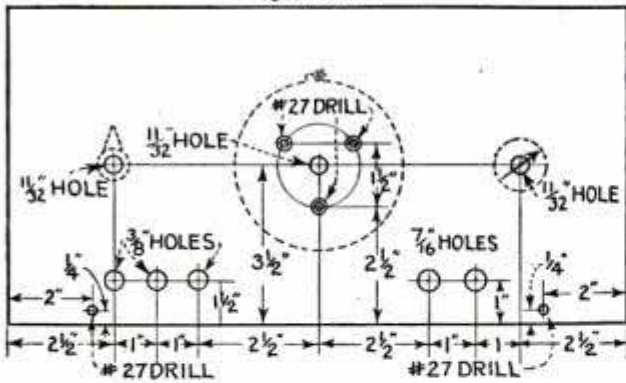

Front-Panel Drilling Templates, and Below, Schematic Diagram of the Set

the results are really remarkable for a loop set employing but three tubes. The razor-edge sharpness of tuning makes it an excellent auxiliary set for the big-city listener who may have a much larger set for the DX-programs. A large set, unless it be a superheterodyne, is not necessarily one that tunes sharply; in fact, very few large sets even of the tuned r.f. type are selective enough to separate the high-powered locals under all conditions.

A large blueprint of the layout and simplified wiring diagram, may be obtained from Popular Mechanics Radio department, 200 E. Ontario st., Chicago, for 15 cents to cover postage and packing. Specify blueprint No. 116.

Alcohol for Cleaning Panels

Avoid water when cleaning radio panels or any part of a radio receiver. If the panel gets dirty or greasy, dampen a soft cloth with alcohol and rub it lightly over the surface to be cleaned. This will remove the dirt and grease, then dry the

panel with another cloth. The alcohol will evaporate quickly without damaging the set in any way, and will leave a high polish. Ordinary household rubbing alcohol can be used for this purpose, but care should be taken not to spill any on the polished woodwork of the cabinet or console, as it will ruin the varnish unless immediately removed.

Some Radio Troubles

Clicking noises, heard when one presses against the panel or subpanel of a radio set, usually indicate a loose connection somewhere, or a faulty contact of tube prongs in the sockets. A loose or faulty grid connection usually betrays itself by a peculiar peanut-wagon whistle, which may also be due to leaky by-pass condensers, faulty transformers or loud-speaker cords. Grating noises, heard when turning the condensers, are often caused by touching condenser plates, which should be adjusted. In manufactured sets having sockets riveted firmly to the sub-panel, the shells are sometimes a little too large for the tube base and the tube prongs do not make a good contact with the spring prongs in the sockets. Bend the latter up with a piece of wood and insert the tube carefully.

1013-a

Wall Socket for Radio Batteries

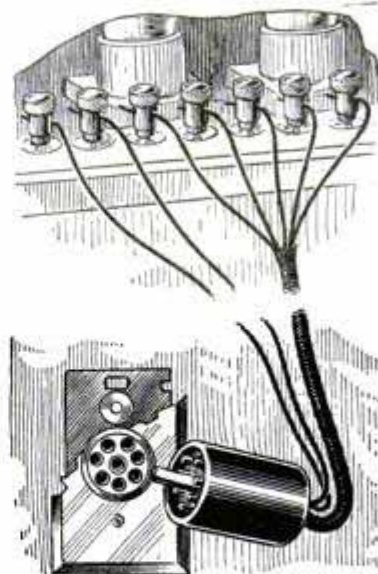

A handy wall socket for the standard multi-plug battery-cable is now available. The socket is mounted in the wall at a point convenient to the set, and the leads are run to the batteries, preferably kept in the basement or an adjoining room. The corresponding leads from the plug are taken direct to the binding posts on the set, as shown in the illustration.

2226 Wabornia Ave

Howard Jones Co.
618 S. Canal St.
Chicago

*Imperial Airways
Airdrome, Croydon Eng.*

RADIO NEWS FROM FAR AND NEAR

1030- *to*

*Bourget
France*

1072- *R*



Mr. J. P. Buckley of the Bureau of Standards Laboratory with a Model Illustrating the Directive Radio Beacon for Guiding Planes in Night Flights

1071- *R*



a

Passenger
Pilot of Passenger Airplane Operating between Croydon, Eng., and Bourget, France, Equipped with Wireless Telephone for Safety Communications. Right, Two Japanese Misses with Parabol Receivers



Left, Japanese Performer before the Microphone in Station JOCK at Nagoya, Japan; This Station Serves Japanese and Chinese Listeners and Is Often Heard as Far as California

Using Resistance-Coupled A.F. Amplifier in 1927-Model Superhet

If desired, resistance-coupled a.f. amplification may be employed in the 1927-model of Popular Mechanics superheterodyne, described in the

panel, being dotted in to show their location and facilitate the work.

The two 4½-volt C-batteries are connected in series for the necessary 9-volt C-battery required for the MU-6 power tube in the last stage. These C-batteries are located directly in front of the unit and are held in position with two short brass brackets, and a small strip of wood or bakelite is employed to wedge them in position. It will be noted that the A-battery connections to the a.f. unit are taken direct, as the MU-tubes have 6-volt filaments and are lighted directly from the 6-volt A-battery; the A-battery circuit being completed through the switch to the B-negative post that is common with the negative-A. A 1-meg. resistor is substituted for the usual .1-meg. in the first input clip of the a.f. unit. In some cases it will be advisable to use 2 meg. but greater volume is obtained with the smaller value. Before connecting the 9-volt C-battery to the unit, be sure to remove the connector strip between the small binding posts on the front edge of the unit. The various B-battery volt-

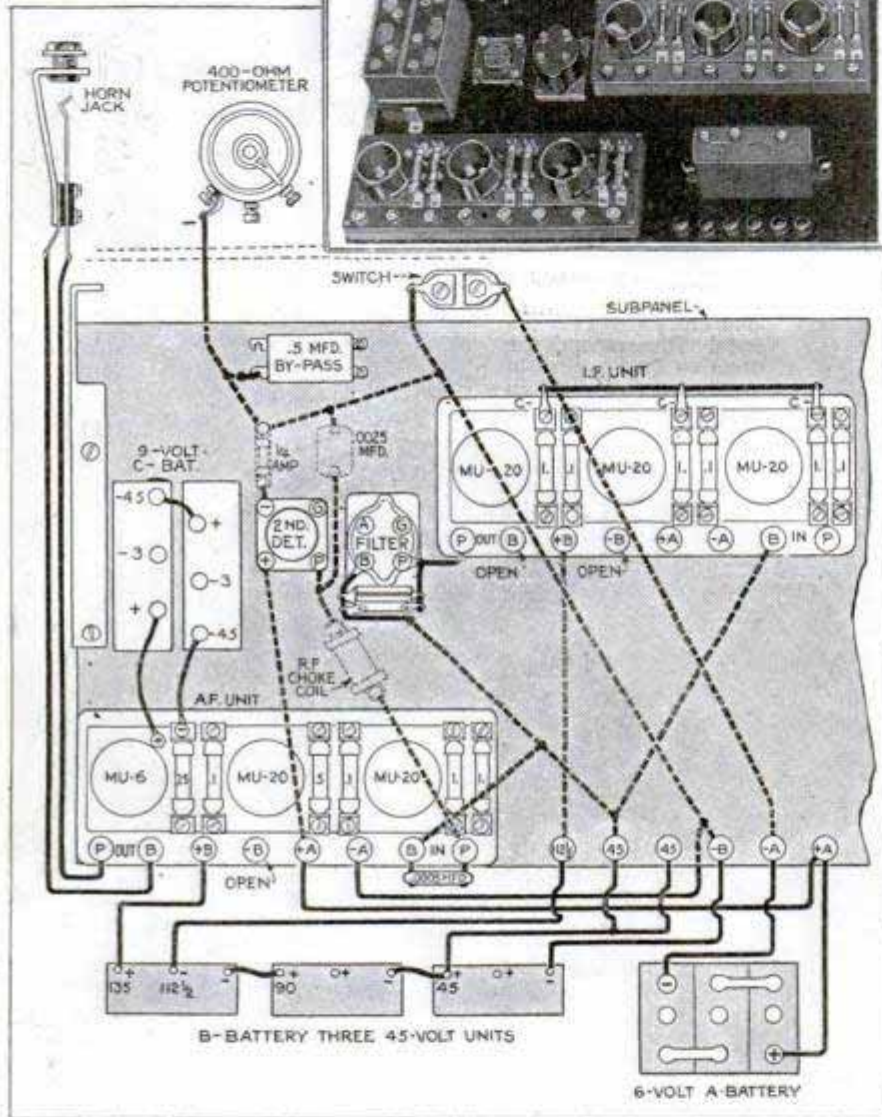

October, 1926, issue, and as many of our readers who have such amplifier units may wish to use them in the new set, we have prepared the accompanying wiring diagram, to show necessary alterations in the circuit. The photo at the upper right shows the changes in the layout, with the a.f. unit in position at lower left, but neither the wiring diagram nor the photo shows any other parts or wiring than those involved in the changes. The dotted lines indicate the wiring under the subpanel; the fixed condenser, choke coil and ballast, also mounted under the sub-

panel, being dotted in to show their location and facilitate the work. The volume of the set may be controlled by the oscillator rheostat, or by a modulator horn plug.

The October, 1926, issue, containing the complete article, may be obtained from Popular Mechanics Magazine, circulation department, 200 E. Ontario st., Chicago, at the usual price, 25 cents. The complete set of original blueprints, full-size drilling templates and additional photos are available from our radio department for 75 cents. Specify blueprint No. 114.

Tips on Jacks

by
Jack Sinclair

JACKS are a small but important part of all radio receivers, every set having one or more of these switching devices. They are made in many types, and differ very little from those of the standard telephone switchboard. The types in common use are shown in Figs. 1 and 2. Those in Fig. 2 are of the new short type, desirable where compact wiring is necessary, as in portable sets, or wherever space is at a premium.

A little knowledge of jacks and their uses is of value to all radio owners and builders as they furnish an easy method of adjusting the set to suit individual

needs. For example, one often wishes to use headphones instead of the loud speaker, especially late at night after the other members of the family have retired. If the set employs a horn jack only, it is not practical to detune or choke the set down for the phones. Also, phones are often necessary when locating distant stations which, when once located, may be tuned in at loud-speaker volume.

The insertion of an interstage jack in the first a.f. stage is a simple matter, the wiring diagram and illustration of the type of jack used being given in Fig. 1. If desired, the phone jack may be placed at the out-

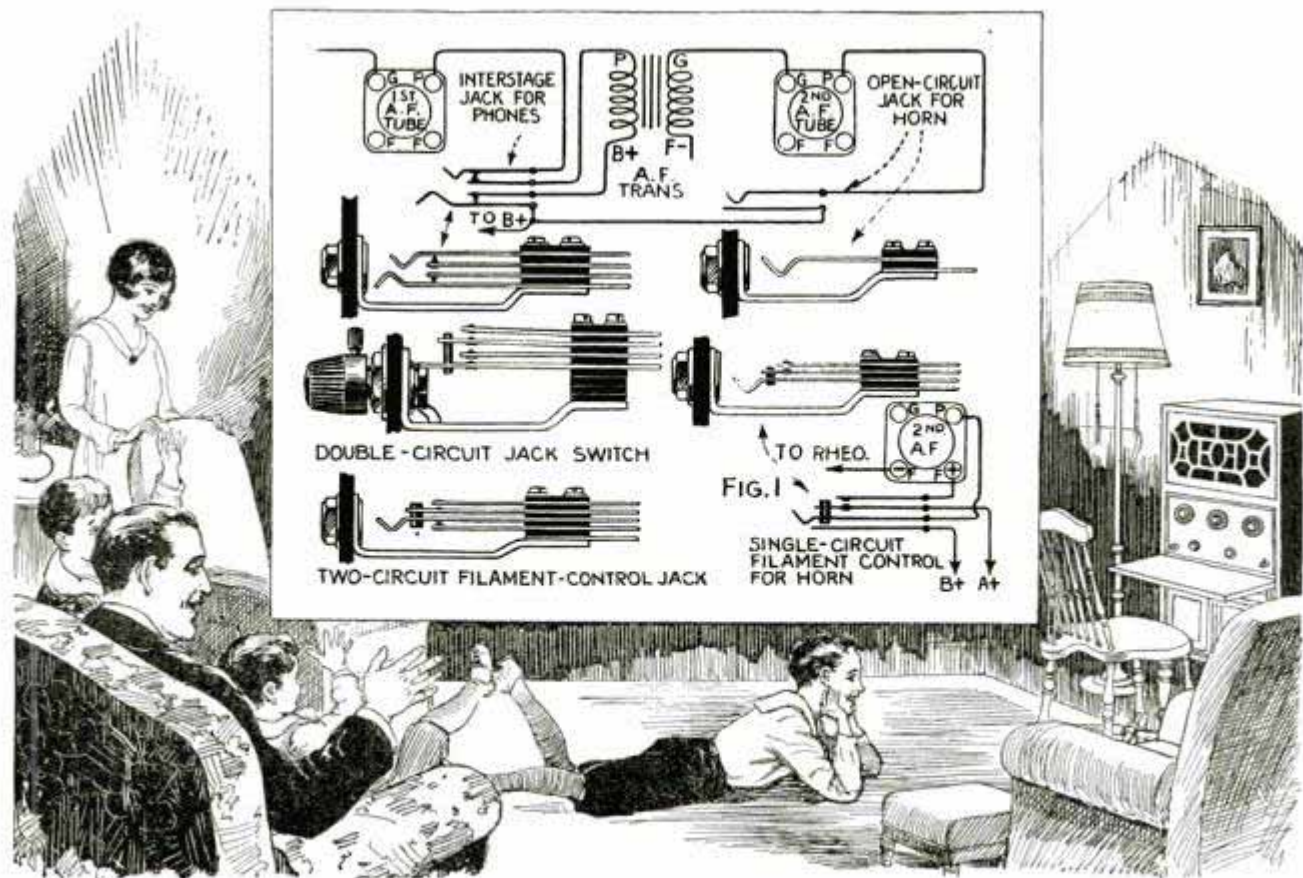

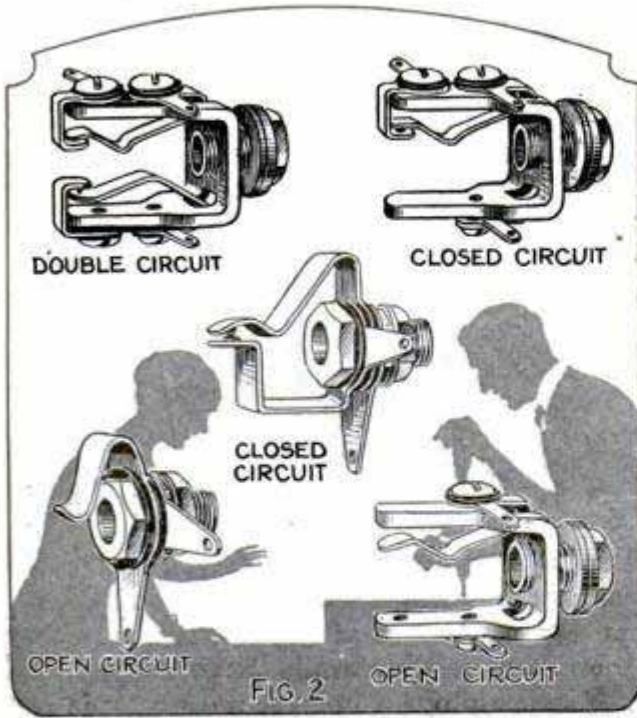

put of the detector tube, but better DX results are obtained if one stage of a.f. amplification is used.

The diagram at the lower right, Fig. 1, shows a jack of the filament-control type applied to the last or horn stage. When the horn or loud speaker is plugged into this stage, the filament of the tube is automatically lighted. If an interstage jack is used for the phones, the horn plug is removed and the last tube is cut out, resulting in more economical operation. A two-circuit filament-control type is shown at the lower left in the same illustration, making possible the same kind of filament-control at any interstage point. The double-circuit jack switch shown above is an improvement of the standard jack in that no plug is required since it is operated by the small knurled knob at front. This type, which is available in several forms, is handy for cutting in various external devices, switching from phones to loud speaker, or from one speaker to another. Eliminating the plugs, the speaker and phone connections are made permanently in the set, and these jacks are commonly used in receivers of the console type

where external leads are to be avoided. A plug combined with an adjustable resistance unit offers a convenient method of controlling the output volume without resorting to detuning or changing the set from its most efficient operating point. This is a simple matter for those using the standard jack and external plug for the loud speaker, but presents a problem where the switch jack is connected in the set itself. Fig. 3 shows the solution of this problem by rewiring the loud-speaker circuit and placing an open-circuit jack near the jack switch, so that the modulator plug can be used to control the volume. The modulator plug is shorted with a small loop of wire, with phone-cord tips at

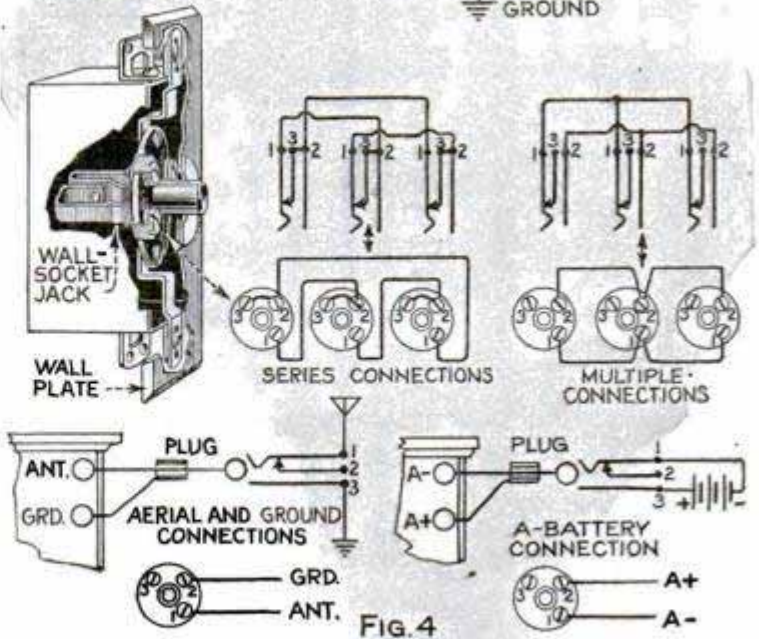
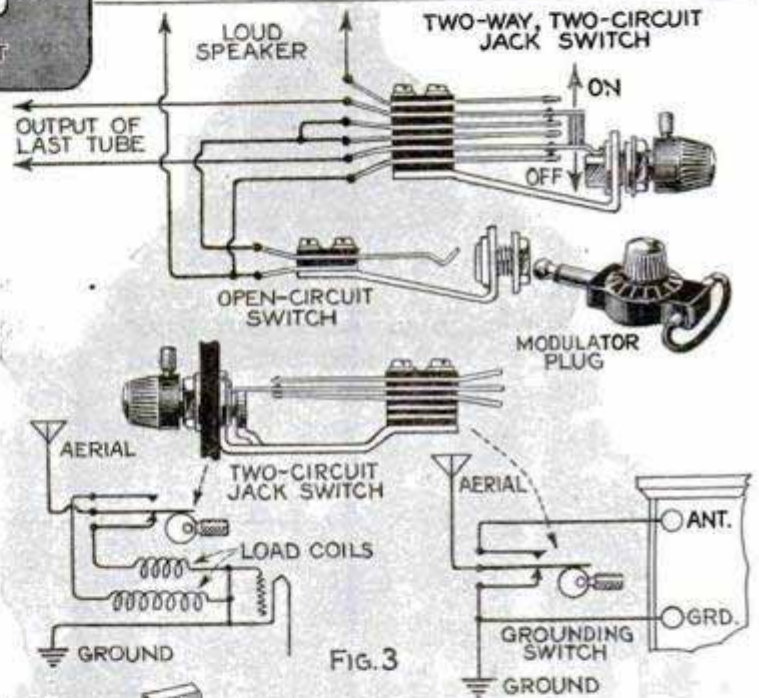

either end, to complete the circuit through the plug. When the jack switch is in the on-position and the plug shorted with the wire, the loud-speaker volume is controlled by varying the small knurled knob on the plug. The wire across the plug may be removed and replaced with headphones, connecting the phones and speaker in series if desired. A second loud speaker located in an adjoining room can be plugged in instead of the phones for two-speaker operation if required. When the jack switch is thrown to the off-position the external speaker or phones can be operated independently of the loud speaker in the set. The two-circuit jack switch, Fig. 3, is useful for cutting in load coils

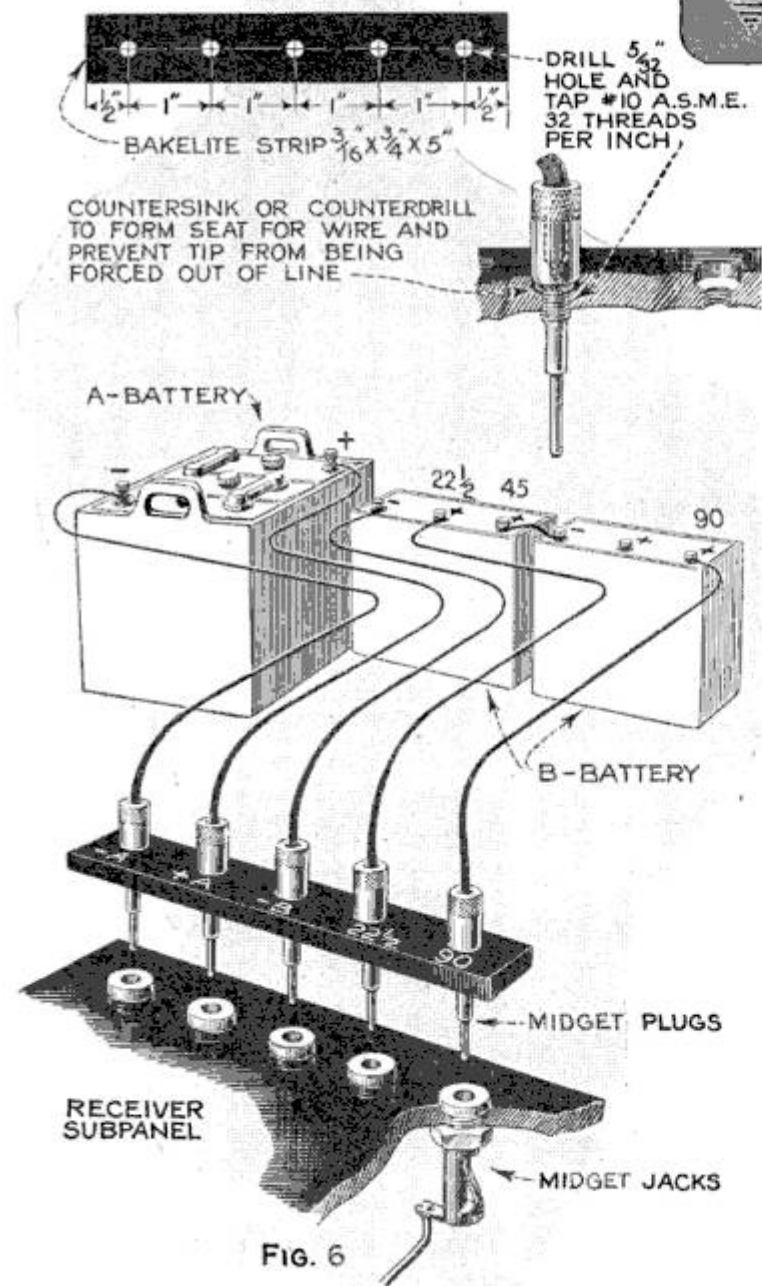
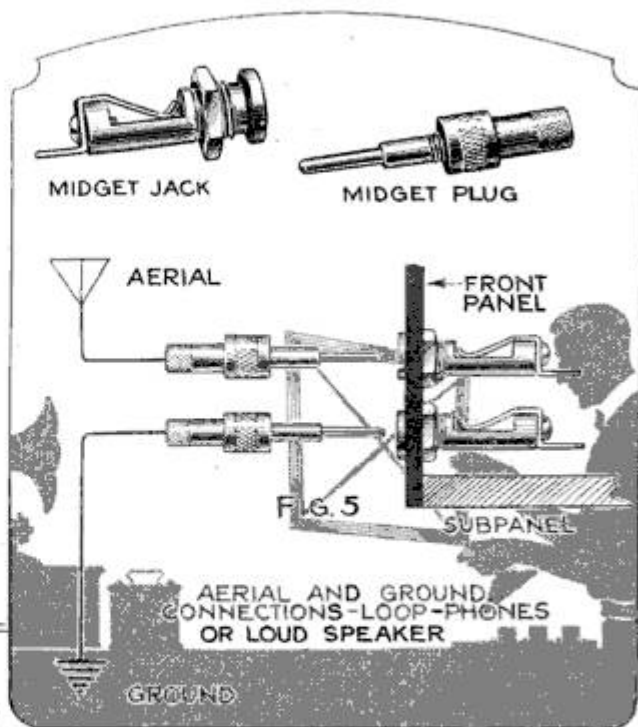

FIG. 6

as shown in the diagram below, or for an aerial-grounding switch, that may be thrown when the set is not in use, as shown at right.

Wall-socket jacks are now coming into general use and it is practical to install an outlet in every room. A jack of this type is shown in Fig. 4 and is easily wired as shown in the diagram. It fits in the smallest-size outlet box, and a neat brass wall plate is supplied with it. The wires are connected to the screw terminals, and the jack is fastened to the outlet box with two screws; the plate is then attached. In addition to serving as a convenient outlet for connecting phones or loud speakers, this type of jack may also be used for connecting ground and aerial wires to the set, and for battery connections. Batteries may be placed in the basement, or elsewhere, and the wires brought to the wall-socket jack located at a point near the set.

Handy plugs and jacks, known as the midget type and shown in Fig. 5, are in great favor with the experimenter. The aerial and ground diagram shows one of many applications. They are also used extensively for loop connections and to take the place of

battery binding posts, as shown in Fig. 6, which illustrates an arrangement made in the form of a block for all the battery connections. The jacks are mounted at the rear of the subpanel and centered exactly 1 in. apart. The plugs are set in the strip of bakelite shown in the diagram, so that all connections are made or broken at the same time. The mounting strip is, of course, subject to variation for the number of connections necessary. Spot the location of the plugs along the strip, carefully spacing the plugs as indicated. When the connector strip has been laid out, clamp it to the subpanel in the position it is to occupy in the finished set, and using a $\frac{5}{32}$ -in. drill, perforate the strip and subpanel. The holes in the latter will serve as centers through which the somewhat larger drill required to make the holes for fitting the jacks are drilled. This will insure an accurate line-up of the plugs. The holes are now tapped for the plugs in the connecting strip. For this purpose use a No. 10 A.S.M.E tap having 32 threads per inch. After the holes are tapped, they are countersunk or counter-drilled slightly, to form a seat for the wire and prevent the tips from being forced out of line. The threaded sleeve that is a part of the plug, and which is required when the plugs are used individually, is removed and discarded. Insert the wire in the hollow end of the tip, bringing the bare end out through the hole provided for this purpose, and bend it around under the shoulder above the threads; the plug is then screwed into the bakelite strip.

Flexible, rubber-covered wire is rec-

ommended for the battery connections. The jacks are mounted on the subpanel and the set leads soldered to the lugs. The contact springs are held in place by small screws with lock washers under them, to secure a good permanent contact.

1061-02

Fused Battery Cable Protects Tubes

A new battery cable is provided with fuses designed to protect the tubes, wiring and rheostats in a radio set from short circuits. A small capacity fuse is inserted in the B-negative battery lead, indicated by the black-red wire, and a 2-amp. cartridge fuse is placed in the positive A-battery lead, indicated by the yellow wire. The fuses are removable and are protected from breakage by a bakelite cover held together by two friction pins. These cables are available in five and seven-conductor types, but the position of the fuses is the same in both

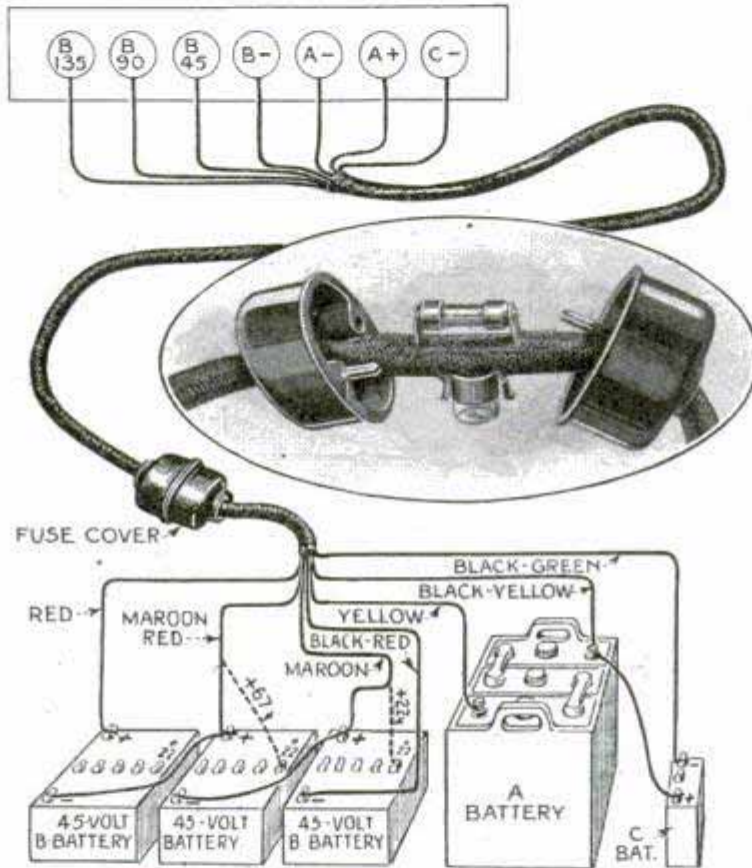

Fused Battery Cable with Connections from Battery to Set; Insert, Bakelite Cover Separated, Showing Position of Fuses

types. The B-battery fuse is designed to protect the tube filament from high B-voltage should it be applied through error or accident. It will protect a single tube of the 201-A or WD-12 type, which have a current consumption of .25 amp. or three tubes of the UV-199 type, which consume .06 amp. each.

Side-cutting pliers look very much like other pliers, although in reality they are not pliers at all, and in radio work are far superior to the regular kind with the cutter below the nose; they are especially handy in cutting off wires in difficult places when wiring complicated circuits.

Palden mfg Co 2300 W. Western Ave Chicago.



Build a Winter Toboggan Slide

By EARLE W. GAGE

ALTHOUGH making a toboggan chute is a very simple matter, it must not be slighted in the least. As much atten-

tion should be paid to its building as the engineer pays to providing a track for an express train. In fact, few trains travel



"Zipping" Down an Icy Path at Ninety Miles an Hour, with Body Close to the Whizzing Face of the Ice—a Real Delight of Winter!

at the speed of the average toboggan. A slight miscalculation in a curve will make the swiftly moving toboggan turn turtle; a small deficiency in the edging of the track may turn the swooping thing loose in the unpacked snow and send its passengers to the hospital.

Tobogganing carried on in soft snows on hillsides is great fun, but the iced slides, where high speed can be attained, are the real sport. Such a slide usually crowns the summit of some slight elevation, and the depth of

the drop is made gradual by supporting trestlework, the width of which varies according to the number of chutes desired. These chutes are virtually troughs, flooded and frozen, one separated from the other by means of a ridge of boards and ice at the starting plat-

form, and by frozen-snow sides from that point on. Each groove is the width of a toboggan, so that steering is unnecessary, and the risk of upset and accident is reduced to a minimum.

A very satisfactory slide may be built of planed spruce boards in sections 12 ft. long, each being in the shape of a trough. The inside width of the trough should be 22 in. at the lower and 24 in. at the upper end, the sides being 12 in. high with a flare of 4 in. Four 4 by 4-in. crossbars are used to tie the boards together, each bar extending 4 in. beyond the bottom boards, and carrying a bracket cut from the same size of wood to hold the sides in place.

The crossbar on the upper end of the trough is exactly at the end of the boards; at the lower end it is 4 in. from the end. This allows one trough to lap 4 in. into the other. The bars should be so placed as to butt tightly against each other. The distance between them is divided to equalize the strength of the trough. All edges

and corners are planed off to prevent splinters, and a sharp lookout must be kept on the edges.

The individual troughs are thoroughly nailed, but no nailing is done in putting the slide together. The troughs are simply placed in position on the ground, beginning at the lower end and fitting in each toward the top, leveling under the bars as the ground may require. This chute will be found a very convenient size. The sections are easily handled and packed

away, and they will last for many years if they are given proper care.

In order to have the chute in good running order, the ice in it must be smooth and keen. It is best prepared by fill-

ing the chute with snow and beating it down firmly until a layer about 2 in. thick is formed in the bottom. If the temperature is favorable, this should be sprinkled until it forms a keen icy surface. After a few days' care and cold weather, the condition of the chute will improve. Should holes form in the ice, they may be patched with snow, sprinkled until it forms a slush and beaten smoothly into the holes.

A line should be drawn from the point in the field where the run is to end, straight to the bottom end of the toboggan slide, and the runs built from the bottom upward, so that the lower sections can be used while the construction of the upper part is still in progress. Sprinkle the snow that has been packed into a groove to provide an icy coat. Never use the run when there is the slightest chance of the runners cutting through, for this will ruin the slide.

The larger runs, where winter sports are the fashion, average anywhere from a quarter to a mile in length, and they have a drop of from a few feet up to several hundred feet. They may have every variety of turn, from the sharp corner to the most gentle curve. There is a 2,100-foot chute on the Hudson river, New York,

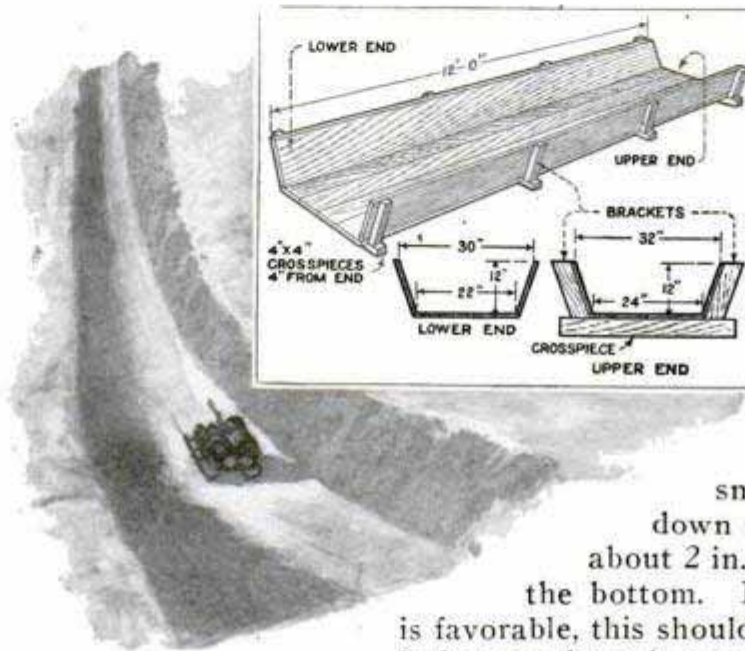

where the start is down a slope of not more than 30° , yet the speed attained at once is breathless. The all-wooden toboggans do the chute in from 20 to 26 seconds, and the steel-shod type in from 12 to 17 seconds.

The modern toboggan, described as a skeleton, consists of a light, but exceptionally strong, steel framework with a yard-long padded seat, on which the rider lies flat, steering the craft with hands and feet. In order to secure both strength and lightness, it is built narrow, of well-seasoned, straight-grained wood, fastened together by light crosspieces, usually of steel; the front end is bent up and over to form the hood, and fastened securely by means of wire or leather thongs. Toboggans are 4 to 9 ft. long, about 18 in. wide and hold from one to five passengers.

Indirect Illumination on Dash



Marking Films in the Dark Room

I have developed many thousands of films and for some time had difficulty in reading the numbers or names written on the red paper when working in the dark room. Finally I hit on the following simple remedy. All films were inscribed with a blue pencil. When looked at in the red light the blue inscription appeared black and made reading easy. Ordinary penciled or inked letters fade into the red paper when viewed under a red light.—L. B. Robbins, Harwich, Mass.

Emergency Gluepot

When a large quantity of glue has to be heated and no pot is available, a good one can be made in a few moments. Just get a 25-cent galvanized-iron pail at the hardware store, and pick up an empty 5-gal. oilcan at a neighboring garage. With tin snips, cut the latter off halfway from the top, as shown, bend the sharp edges over toward the inside and hammer them



flat, so that there will be no danger of cutting one's hands. Fill this part about half full of water, put the glue in the pail and set the pail in the can. This makes as good a gluepot as you can wish for.—E. R. Haan, Chicago, Ill.

Paper Fastener Makes Neat Pencil Clip

In offices and schools, where pencils are frequently lost or mislaid and one finds it rather expensive to buy new clips all the time, it is much better to use the cheap and easily made clip shown in the illustration. It is formed from an ordinary paper clip; one end of the clip being bent down and around to form an eye that fits over the pencil snugly, as indicated by the dotted lines. A pair of long-nosed pliers is the best tool to use in doing the bending.

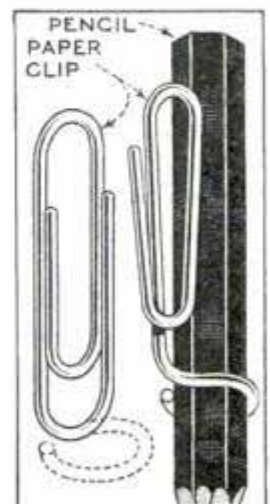

☛ The burner of an acetylene bicycle lamp fitted to an ordinary gas jet will produce a very hot flame.

Continuous Supply of Paper for Drawing Table

Here is a drawing table that has a continuous supply of paper on hand. No



Drawing Paper Is Always Handy When a Roll Is Attached to the Table

dimensions are given for the table, but the front edge of the top should be at least 32 in. from the floor, with the top at the rear about 4 in. higher. The table proper should be about 3 ft. wide and 3 or 4 ft. long. Ordinary $\frac{3}{4}$ -in. lumber can be used throughout, except for the legs. These are cut from 2 by 4-in. stock so that each is approximately 2 in. square. Set the legs through the bottom of the table so that they come to the top in each of the four corners, thus providing greater strength. Each leg can be braced at the end by mortising in 1 by 3-in. pieces, and a footrest can be provided if desired. Cut boards for the top with the edges well jointed and with cleats on the underside for additional strength. The top should project over the front about an inch to facilitate lifting and also to give greater arm room. Ordinary hinges can be attached for holding it in place. For the drawing-paper feature, erect two boards at the top and back of the table in an upright position, attaching them with screws through the underside or bracing them with additional pieces on the outside. Provide each upright with a notch to take the rod which holds the paper roll. Place the roll between the uprights and attach a

strip of iron or brass to the table top, as shown, by means of bolts. The front edge of the iron strip should be beveled slightly so that the paper will tear smoothly. This strip should be held down snugly. To facilitate pulling out the paper after one piece has been torn off, cut a depression just under the middle of the iron strip in the table top or drill a hole clear through. This will give your thumb and finger room to grasp the paper and pull it.—Dale R. Van Horn, Walton, Nebr.

Priming Wood

Many painters have used yellow ocher for priming because it is cheap, but actually it is most expensive, because it is too coarse to penetrate the pores of the wood and get any kind of an anchorage. It also absorbs moisture, which naturally affects the succeeding coat of paint. Sometimes it comes to the surface after the job has been finished, causing blistering and peeling, and in some cases it has never dried. From these facts it is easy to see that there are some materials which may be inexpensive but lead to a great deal of extra work to correct the error of using them.—L. H. Georger, Buffalo, N. Y.

Photographic Prints Are Flattened in Roller Shade

Photo prints generally curl when drying, but can be readily flattened again by

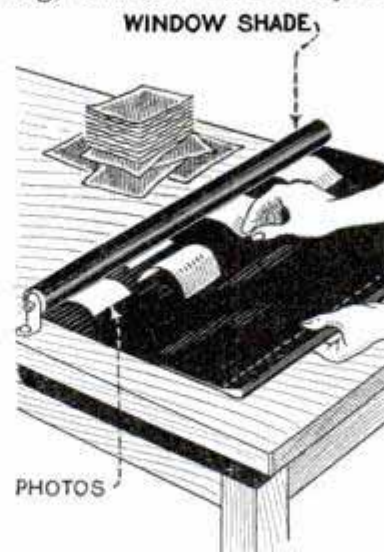

rolling them in a curtain as shown in the drawing. Of course, the prints are placed on the shade with the concave side down so that, when the shade is rolled, the prints will be turned in the direction op-

posite to the curl and this will flatten them. Sometimes it is necessary to repeat the operation a few times.—Walter X. Brennan, Mt. Clemens, Mich.

Effect of Temperature on Varnish

According to the best experience with varnish there are several points in its application which are of value to assure good work. The quantity of turpentine should be twice that of the oil. Turpentine must be used in all varnish or it will not dry, but less turpentine is needed in summer, because the heat causes the varnish to get thicker. In winter less oil should be used so that the varnish may dry rapidly, and more turpentine to increase the evaporation.

Christmas-Tree Decorations

In decorating Christmas trees a saving can be made by using burned-out electric lamps. They usually can be obtained for the asking, and should be prepared as follows. Using a drill press, small holes are bored through the cement in the base of



the lamps. Wire loops, bent as shown, are slipped into these holes, the bend preventing their easy withdrawal, and the projecting wire is wrapped about the tree branch with ease. The bulbs are dipped into a dilute solution of shellac and dusted with ground glass,

of which different colors are obtainable. While such decorations are, of course, suitable for the home tree, the idea was found especially valuable when it was necessary to decorate a large tree for a public square.—H. E. Benson, Boulder, Colo.

Corrosion in Hot-Water Pipes Prevented by Water Glass

Corrosion in hot-water or steam pipes can easily be prevented by adding $\frac{1}{2}$ gal. of water glass to the water supply and letting it circulate for a day or so before the furnace firing is discontinued. The water glass forms a coating on the inside of the pipes, which effectively prevents rust after the water has been drained out.



Increasing Capacity of an Ordinary Swing So That Three Can Ride Comfortably

Increasing Capacity of Swing

Even young children have inventive ability, as is illustrated in the photo. Where it was possible for only one to use the swing previously, three children can now ride at once and with more comfort. An extra rope is used to hold a board horizontally. Large screweyes are driven into the underside of the board and the rope is passed through these so that it cannot slip from under the board while the swing is used.—James E. Noble, Toronto, Can.

Shock-Absorbing Seat Cushion

The driver of a Ford truck, hauling lumber from a portable mill over a rough road, devised a shock-absorbing seat cushion from an old inner tube. He claims that this device not only lessens road jar, but is also

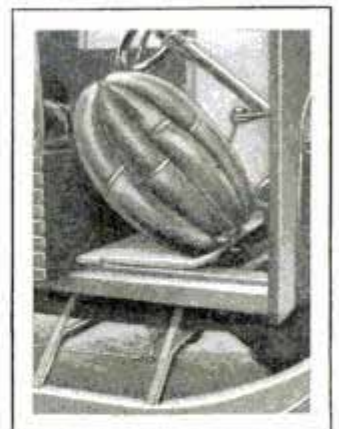

much cooler in summer than the usual upholstery. Such a cushion is made by folding an old inner tube as shown in the photo. It is kept in place by a length of rope.—F. Amos, Kalama, Wash.

☞ A clay pipe can be used as a crucible by breaking off and plugging the stem.

COLONIAL BRIC-A-BRAC for the AMATEUR

By R.O. Buck, 6917 Alcott
Av. Chicago



HANGING SHELF

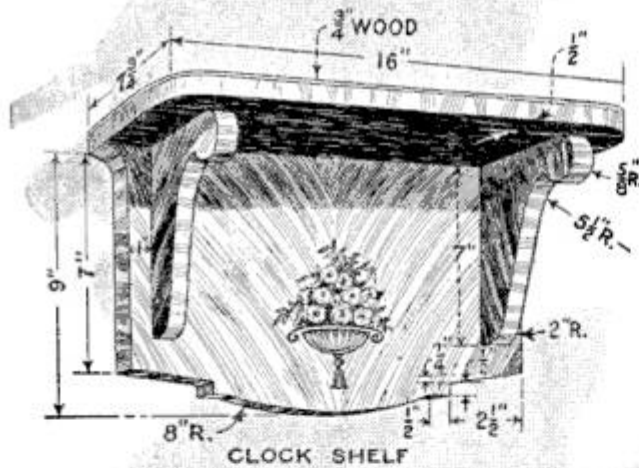

CLOCK SHELF

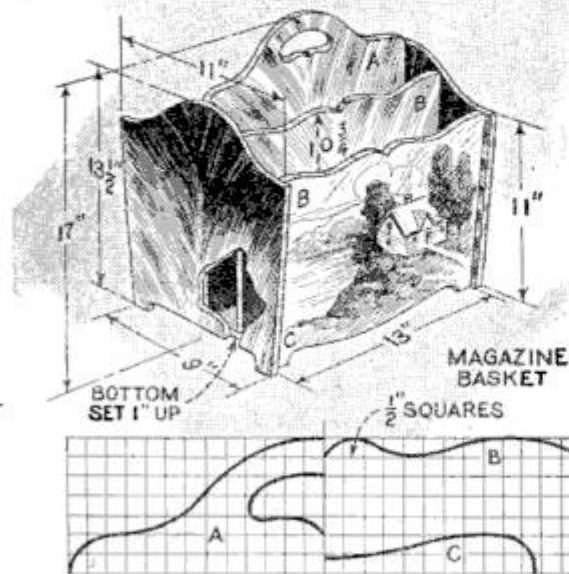

MAGAZINE BASKET



THE cycle is complete and the things our grandmothers considered smart are back with us again. The whatnot, corner shelves, wall brackets, and the like, have come into their own. Those of us who are fortunate enough to have some of these treasures of a former day in our attics can get them out, give them a bit of finishing and make them the envy of our less fortunate friends.

In case you happen to be one of the aforesaid friends, and possess neither attic nor heirlooms, you can, if you are handy with tools, make any of the articles illustrated with just the ordinary tool equipment found around a home. You will be agreeably surprised and pleased to note the change a few articles of this sort will make in a room. The home touch which you may have missed in your modernly furnished rooms can be added in just this way and with a very small expenditure of time and money.

Most of the articles illustrated are small and can be constructed of any close-grained soft wood of the thickness shown. Poplar, gum or white pine are all suitable for the purpose. For two or three of the larger articles, plywood is specified, so that greater width or strength may be obtained without the necessity of increasing the thickness of the pieces and producing a clumsy-looking piece of work.

A cross-section diagram is given of all the curved edges so that you can lay out a full-size pattern easily, or perhaps you may wish to design these curves yourself. If you do so, avoid sharp changes and rather make the lines of the curves long and sweeping.

Brads and finishing nails driven home with a fine nail set are best for fastening objects of this nature. Glue is not advis-

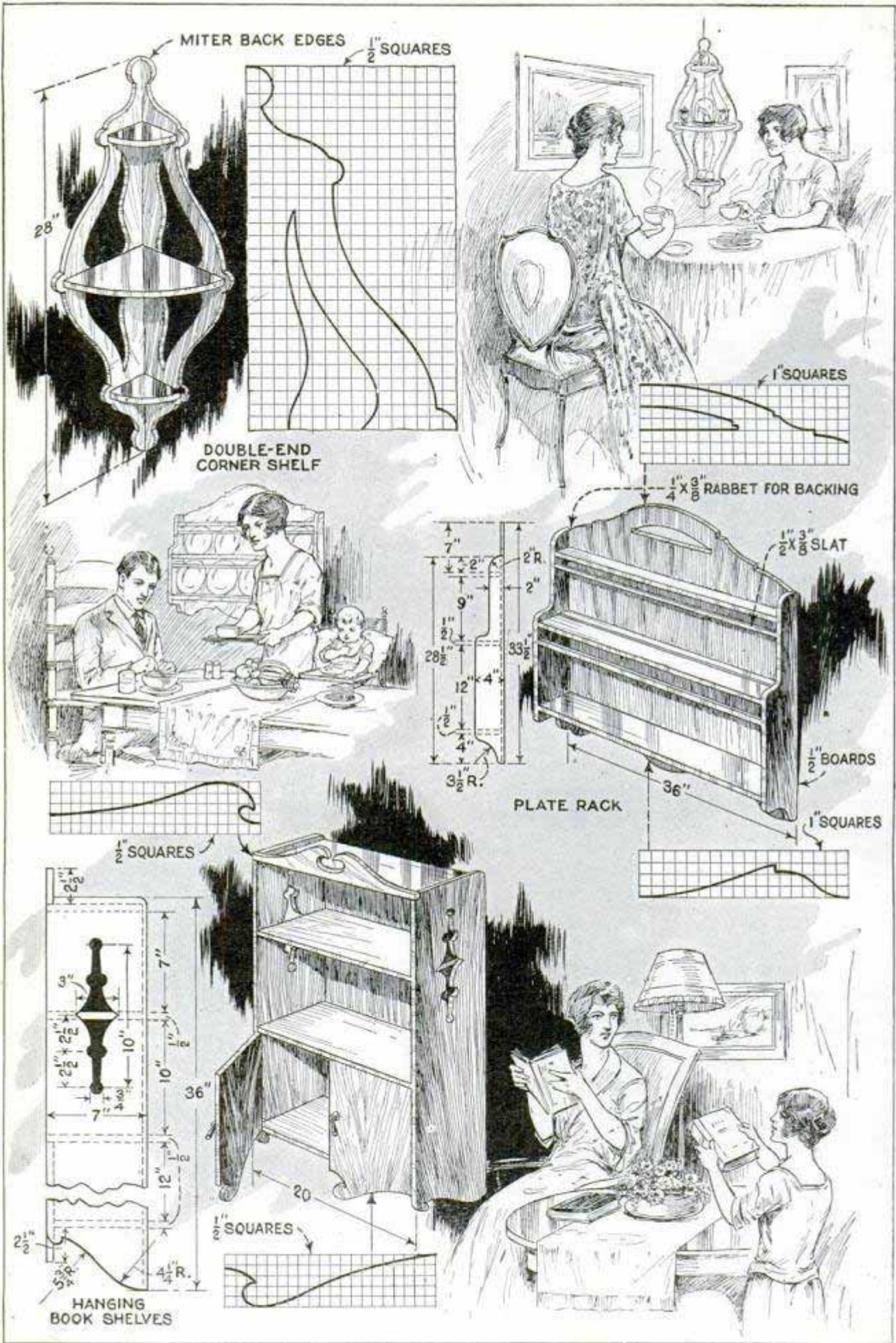

it is almost impossible to get the lacquer out of the brush. Lacquer is not only desirable because of its durability and quick-drying qualities, but also because of the beautiful colors which can be produced so easily. The popular colors for articles of this type are Chinese red, tobacco brown, jade green, Chinese yellow, Holland blue, nickel gray and black. Black may be used effectively for an all-over coat with red or gold stippling, or just for edges or blending. Roman gold is used in

much the same way or as your ingenuity may suggest.

Designs similar to those sketched can be obtained in the form of transfers from most art-material dealers and add greatly to the beauty of these articles, especially if they have rather large parts of the surfaces exposed.

No home workshop member need hesitate about attempting any of the articles illustrated, as he can rely on the finish to cover up minor imperfections.

Box on Pole Stores Clothesline

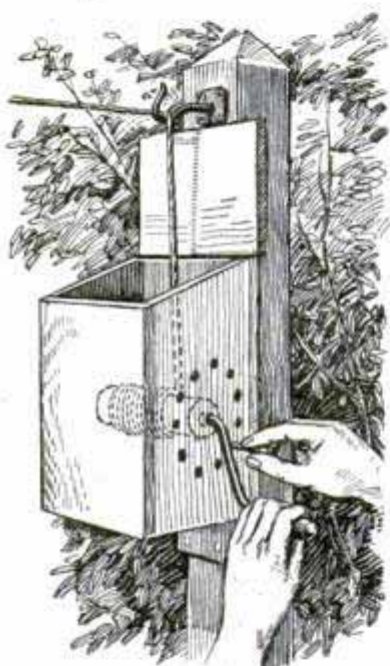

Winding up the clothesline and taking it into the house is not necessary if the reel and holder shown in the illustration are used. The clothesline can be drawn tight with the crank and can also be held in place by pushing a $\frac{1}{4}$ -in. carriage bolt

through one of the holes in the side, as indicated. When not in use, the line is wound on the roller and the lid closed until wanted again.—Francis W. Henry, Pottsville, Pa.

Concrete Troughs Cast Upside Down

When wooden forms are made for casting concrete troughs, the builder is often confronted with the difficulty of removing the trough intact because the form swells after the concrete is poured. The work can be simplified and the expense of lumber reduced by casting the troughs upside down over earth forms. Lay several planks on the ground, close together and level. Build up a mound of earth, preferably clay or some close-binding soil, to the shape and size of the interior of the trough. Wet it, pat it down and then

cover it with tar paper, pinning the latter in position with a few nails stuck through the paper into the form. Build a board form for the sides and ends of the trough, making it several inches wider and longer than the dirt form, and place it over the latter. The form should be about 4 in. higher than the mound. Pour in the concrete and allow it to set for three or four days. Then, by knocking off one side of the wooden form, the rest may be removed. The resulting trough can be picked up and turned over, and the rough corners and edges can then be smoothed off. This method saves much time in form building and gives just as good a job.—L. B. Robbins, Harwich, Mass.

Driving Screwhooks into Ceiling

When fastening screwhooks in ceilings or other places for ceiling fans, fixtures, gymnasium equipment, etc., I have found the following method entirely satisfactory.

First drill a hole a little smaller than the screwhook and then insert another hook in the brace instead of the bit. Start the screwhook into the hole and drive it home as shown in the drawing.—Thos. F. Johnson, Schulenburg, Texas



Box 223

Cuero, Texas

Meyers, 133 W. Washington
Chicago
Thayer & Chandler
915 W. Van Buren Chicago



Build Your Own Ship Model

By J. EARLE MILLER



Parts 1 and 2 appeared in the October and November issues

YOU are now ready for the stakes, or bands of molding, along the hull, which serve both for ornament and as bumpers to protect the ship when rubbing against the dock. The stakes are $\frac{3}{16}$ in. thick and $\frac{1}{2}$ in. wide. Start with the top band along the poop. It begins on the line of the main-deck rail, where the latter curves sharply upward to meet the poop rail, and runs back, parallel to the latter and $\frac{3}{8}$ in. beneath it. Glue and pin it in place. The next stake runs along the top edge of the solid main-deck bulwark, just beneath the stanchions, and continues the full length from stern to fo'c'sle. The curve of the bulwark gives the correct line, and when carried out to the stern, the stake will be parallel to the first one. The same curve is carried forward and upward along the fo'c'sle so that the stake is parallel to the fo'c'sle bulwark line. A short stake is glued along the bulwark, just beneath the open rail, and uprights connect it at front and back of the forecastle with the long stake below. Between the uprights, a narrower stake divides the fo'c'sle side into two panels. It is so placed as to continue the main-deck rail line. The next long stake starts at the beak rail, and continues aft the length of the ship, parallel to the stake above.

Another full-length stake starts at the top of the beak bulwarks and continues aft, parallel to the one above. The final

stake, marking the water line, carries the line of the lower edge of the stem back in a gentle sweep to the point of greatest width at the stern, just above where the hull turns in sharply to form the stern lines. Instead of following the stem and hull lines it starts with a knee, roughly triangular in shape, forming additional bracing for the stem. Cut the knee to the shape shown, and carve or file down the edges to fit the lines of the stem and hull. Glue and pin it in place, and then fit the long stake. The final task on each side is to break up the top panel beneath the poop rail with five ornamental uprights. Cut a strip of basswood, $\frac{3}{8}$ in. wide and $\frac{1}{16}$ in. thick. At intervals of $\frac{3}{8}$ in. along its center line drill $\frac{5}{16}$ -in. holes, and then, with a knife, cut off sections, slicing through the center line of each hole. The result is small pieces, somewhat like an hourglass in shape. Five are required for each side, placing them equally. Only two stakes are required across the stern, placed as shown. From the same stock, cut three pieces and glue and pin them across the break of the poop, quarter and fo'c'sle decks, flush with the deck line.

The cradle may be made at any time, but is handy to have before the rigging starts, as it keeps the boat upright. It is cut from $\frac{1}{2}$ -in. white pine, using two pieces $2\frac{1}{2}$ by $6\frac{1}{2}$ in. They are joined by two braces, $6\frac{1}{2}$ in. long, which may be made of round dowel stock, square, or, if

a lathe is available, turned to an attractive shape, as was done in the case of this model. The end members are cut as shown in the sketch. Find the center point on the keel, measure $3\frac{1}{4}$ in. each way and bend two pieces of radio bus wire or wire solder to shape around the keel and sides of the hull. Lay the wire down on the end members of the cradle, adjusting it so that it comes just within the ends, keeping the center on the center line of the wood. Mark along the inner edge of the wire with a pencil, and, with a coping saw, cut out the cradle. After it is assembled, final fitting can be done with a file. The cradle is completed by gluing strips of green or brown felt along the top and bottom surfaces.

The deck furniture comes next. The inside of the bulwarks and the ends of the poop, quarterdeck and forecastle should be painted at this stage, and windows and doors added. The color scheme decided on for this boat was light gray or white underbody, black upperworks, with a French gray or white panel below the rails, so a deeper, pure gray was used for deck furniture and the inside surfaces. The best results are obtained by using automobile paints ground in japan, and sold in 4-oz. tubes. The japan colors dry much quicker than paints mixed in oil, and this is emphasized by cutting the paints as they come from the tube with enough turpentine to make a thick cream.

The doors to deck house and forecastle are cut from the grained paper pasted on cigar boxes to imitate wood, and a narrow black border is painted around them to represent the frame. The windows are painted with black borders and crossbars, and aluminum paint, the kind that comes in powder form with a separate can of solvent, is used for glass, while the shadows are touched up with a dash of light blue in the corner of the glass.

The deck furniture needed for this model includes four hatch covers, one windlass, a lifeboat, pump, a carved block and a bitt or bollard. The details of all are given in the sketches. The hatch covers are cut from $\frac{1}{8}$ -in. wood; their edges and a band around the top are painted black to represent the hatch coaming, and the center is painted a light brown, to represent time-worn and sea-stained can-

vas covers. The windlass and pump are made from pieces of $\frac{1}{8}$ and $\frac{7}{16}$ -in. dowel stock. The base of the capstan is notched to take the pawls, which are cut from wood and glued to the deck (see deck plan). The pump handle is glued in the notched support which in turn is glued to the side of the upright barrel; a spout, cut from $\frac{1}{8}$ -in. dowel rod and hollowed out, is glued in a hole drilled in the side, and the inner end of the pump handle is fastened to a wire which passes down through a hole drilled through the center of the barrel.

The lifeboat can be whittled from a piece of 1-in. pine. The top is beveled down $\frac{1}{8}$ in. on each side, and this surface painted the same brown as is used on the hatch covers, to represent the canvas cover. Lashing ropes are painted around the sides, and the underbody is white, with a black band around the gunwale. When assembled, the boat is lashed with black linen thread to short pins driven into the sides of the largest hatch cover, and the latter is then glued in place on the deck.

The carved figure or fairlead block that carries in its middle the block by which the main-yard lifts are led aft to the capstan, and from there to the belaying bitt, presented the greatest difficulty. Such carved figures were common on these old ships. The difficulty was finally solved when a set of tiny $1\frac{1}{2}$ in. high Noah's-ark figures, carved from wood and painted, were found in a toy store. Two small holes were drilled through Noah's stomach, spacing them $\frac{1}{8}$ in. apart, and the space between carved slightly, so that it resembled the pulley wheel of a block.

Three sets of ladders, to forecastle, quarter and poopdecks, complete the deck equipment. They are cut from $\frac{1}{16}$ by $\frac{3}{16}$ -in. white pine. The ends are beveled off to fit deck and wall, and steps, $\frac{3}{8}$ in. long, glued in place, each assembly being held together with the small clamps until the glue has set thoroughly.

All the deck furniture is painted before being glued in place. Pure gray, the same as on the bulwarks, was used, with black for the ends of the pump handle and capstan bars, and the part of the bitt where the rope would chafe. The ladder treads were done in gray and the sides in black.

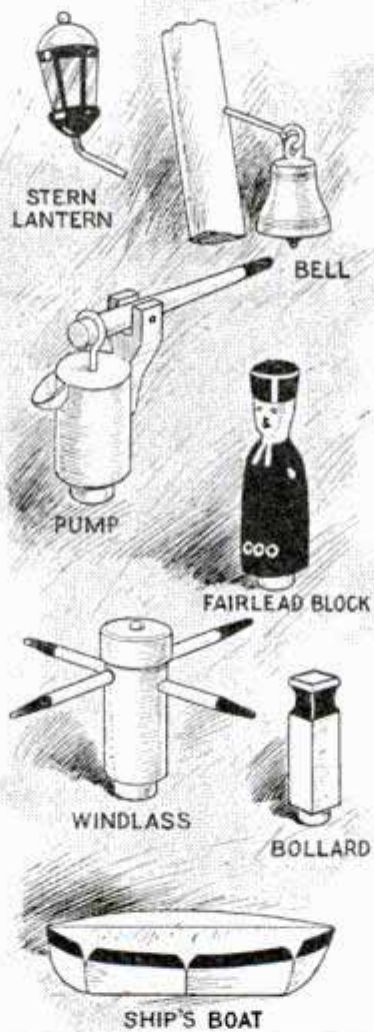
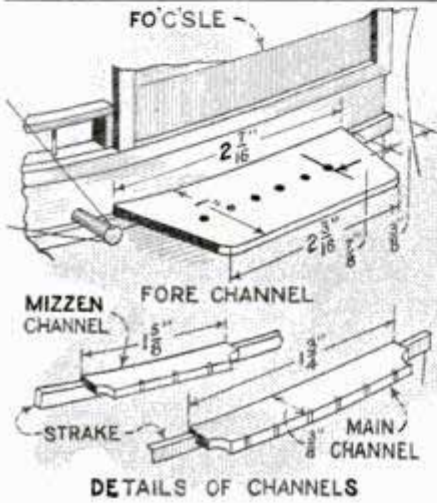
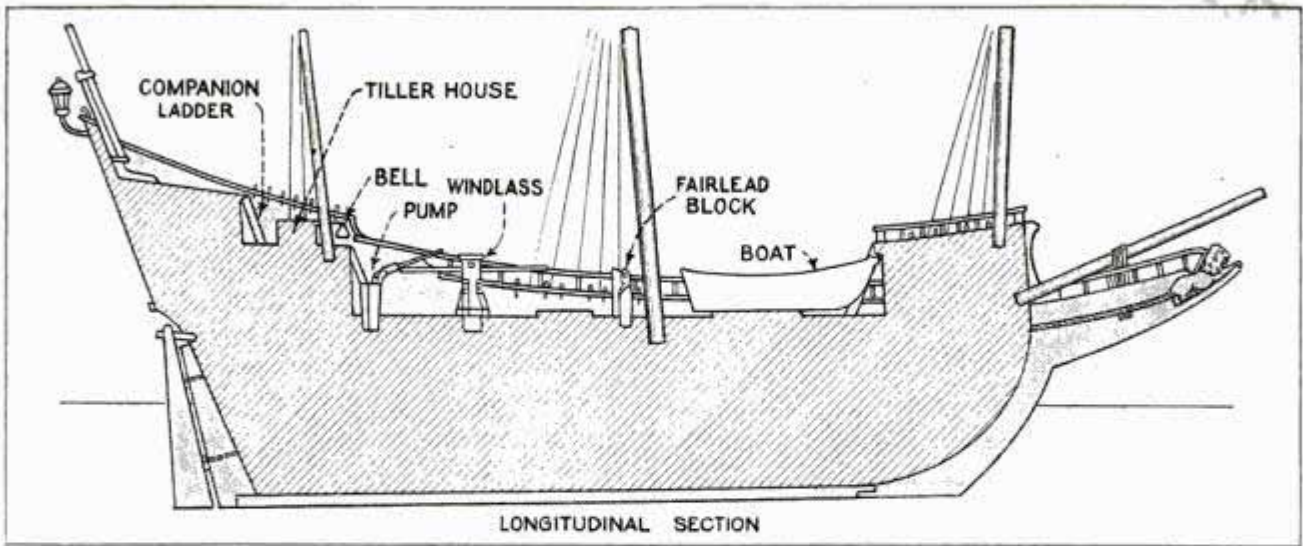

notches cut to half the width of the first strake below the main-deck line. Their position is shown in the plan view, and dimensions for cutting them are also given.

For the gun ports, draw a line straight down from the after end of the fore-castle, then measure back $\frac{3}{4}$ in. between the second and third strakes. That gives the front line of the open gun port. Lay out a $\frac{1}{2}$ -in. square, drill holes in each corner, $\frac{1}{4}$ in. deep, and, with a chisel, cut out the port. The gun is made from $\frac{7}{16}$ -in. dowel stock, $\frac{3}{4}$ in. long, $\frac{1}{2}$ in. showing and

The deck plan shown will be sufficient guide for placing the furniture.

Pin rails, to carry the belaying pins, channels, through which the shrouds are fastened, guns, gun ports and port covers, and the ornaments of the stern, complete the work on the hull. There are three channels on each side, cut from $\frac{3}{32}$ -in. basswood, and glued and pinned in place in

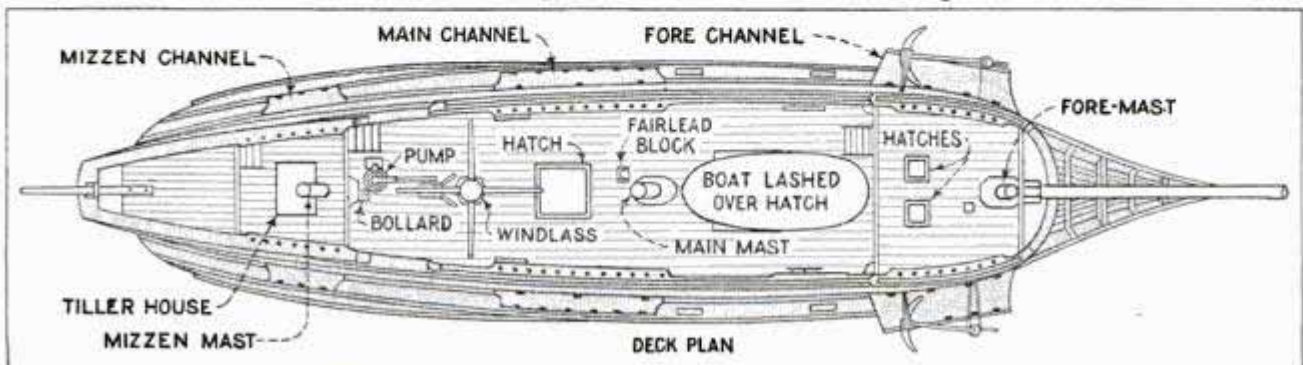
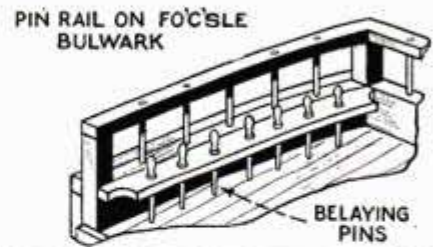

the other $\frac{1}{4}$ in. glued into a hole drilled in the back of the port. Paint the inside of the open port dark gray, gild the gun itself with gold enamel, and paint the tip of the muzzle either with black or silver paint. The port cover is $\frac{1}{2}$ in. square, cut from $\frac{1}{8}$ -in. basswood. Drill a small hole near the edge in the center of one side and fasten a short piece of wire. Drill a No. 60 hole through the bulwark, just above the deck line, pass the wire through, twist the end to prevent its pulling out, and glue the other edge of the port cover to the top of

the port opening, letting it stand out at an angle of 45 degrees.

The front edge of the second port cover is 2 in. aft of the rear edge of the open gun port. The cover is cut to the same size as that for the open port, a similar wire lanyard attached and fastened through the bulwark, and the cover itself glued flat to the hull.

The pin rails are cut from $\frac{1}{8}$ by $\frac{1}{4}$ -in. basswood. The foremast rails run the length of the fo'c'sle deck on each side, and are glued and pinned to the bulwarks, flush with their top. The mainmast pin rails are $3\frac{1}{2}$ in. long, and are fastened in the same way to the bulwarks of the main deck, their front end being $3\frac{3}{4}$ in. aft of the forecastle. The mizzenmast pin rails are $1\frac{3}{4}$ in. long and are fastened to the solid bulwarks of the poop, about $\frac{3}{8}$ in. above the deck and approximately on the same line as the main-deck rail. Before attaching the pin rails drill No. 60 holes in them at $\frac{1}{4}$ -in. intervals, to take the belaying pins, to which all the loose tackle ends later will be fastened.

The stern ornaments include a lamp, the half moon, two small shields and two windows, painted on port covers. The lamp, $\frac{5}{8}$ in. thick at its greatest width and $1\frac{3}{16}$ in. high, can be cut from an ordinary

cork, or carved from wood. A bead, glued to the top will serve as the ball. The five faces are cut down flat and painted with aluminum paint, to represent the glass, while narrow black lines between them take the place of the iron bars of the frame. The top is gilded, and the ball painted black, as is the base. Drill a No. 58 hole in the center of the base,

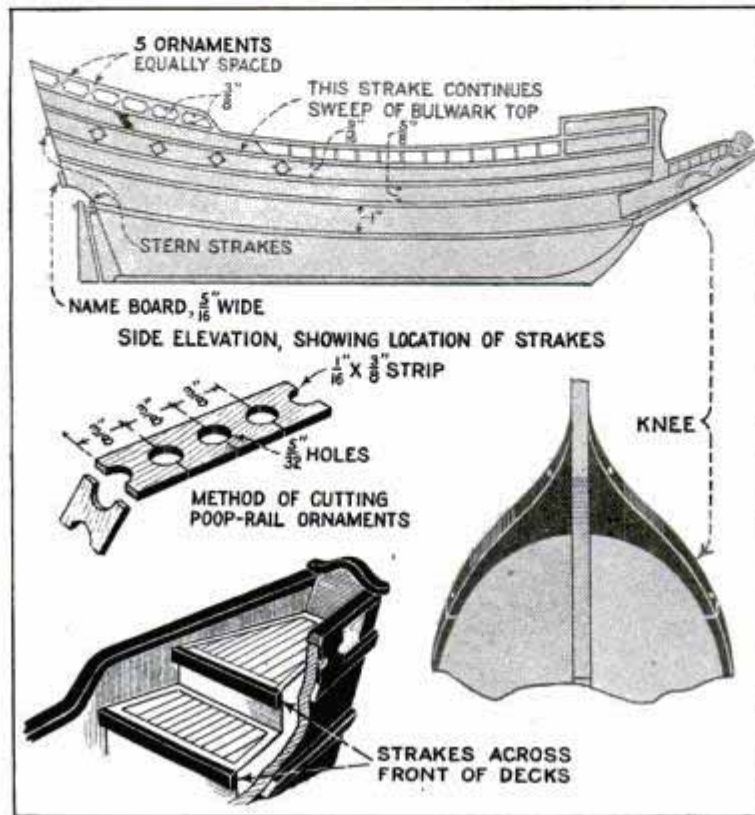

and a corresponding hole in the stern bulwark, $\frac{3}{8}$ in. below the rail top. Cut a short piece of wire, insert one end in the bulwark hole and the other in the lamp, and then bend it upward until the lamp is parallel to the stern.

The half moon is sawed from a piece of $\frac{1}{16}$ -in. basswood. Gild it with gold paint and then add the eye, nose and mouth lines with black paint. The shields for the two coats of arms are cut from the same thickness of wood and painted red for the background, the lion on the one in gold, and the bend on the other in gold, with three small crosses of black. The windows are painted on $\frac{1}{2}$ -in. port covers with aluminum paint, set off with black borders and cross lines. (See the stern view in Part I.)

Beneath the windows, and just above the sharp break where the stern is cut inward, a name board, $\frac{1}{4}$ in. wide by $\frac{1}{8}$ in. thick, is glued in place.

Add the keel, rudder and rudder post, made and fitted as shown, and you are ready to start painting the hull. The keel,

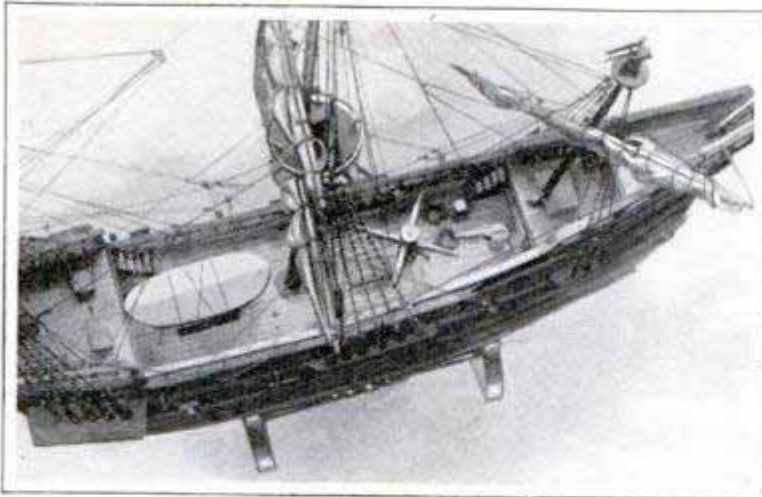

$\frac{3}{16}$ by $\frac{3}{16}$ in., runs from the lower end of the stem to a point $\frac{5}{16}$ in. beyond the stern. The rudder post is notched to fit over this projection. After you have sawed out the rudder post, cut the heads off two long bank pins, bend them into staples, glue the post in place

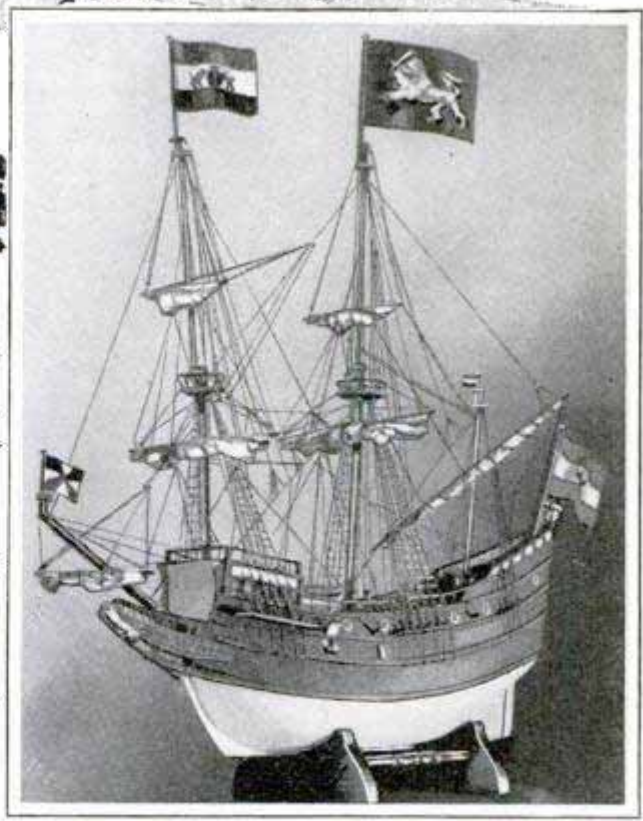
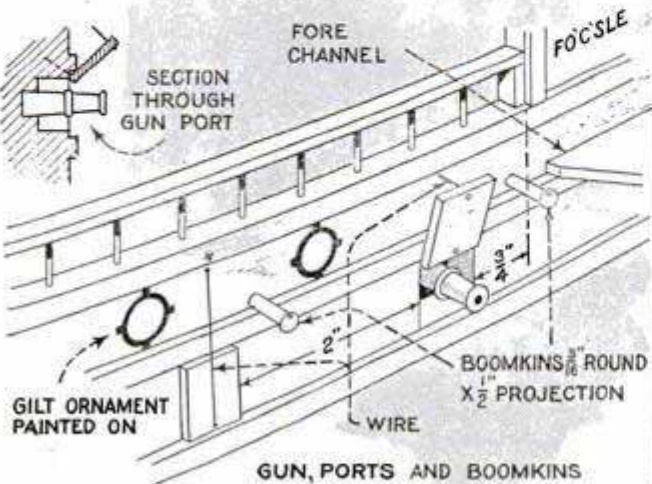
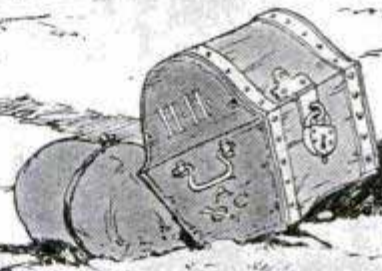
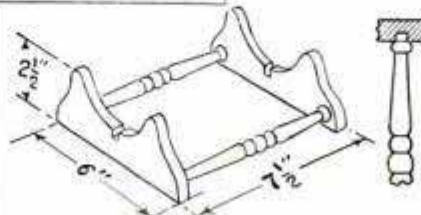
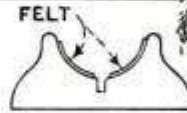

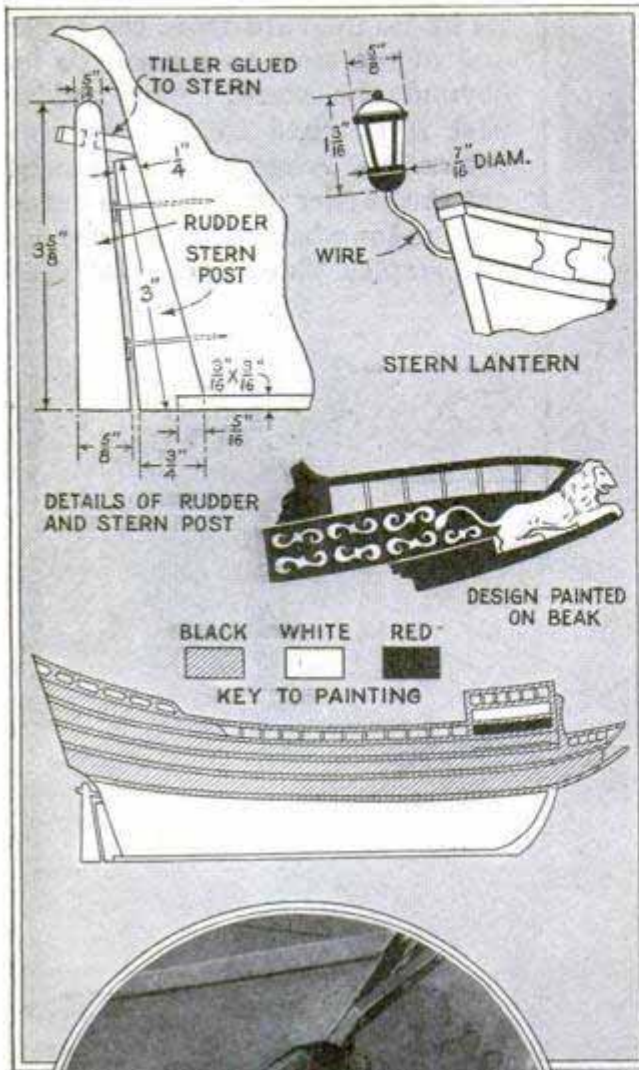

and then slip the staples around it and drive them into the hull. Leave the staples projecting slightly from the post until the rudder is attached. Cut the rudder, like the rudder post, from $\frac{3}{16}$ -in. basswood, drill a $\frac{3}{32}$ -in. hole through it to take the tiller bar, which is made in two sections, $\frac{3}{16}$ in. wide and $\frac{1}{8}$ in. thick. Round the ends to fit into the $\frac{3}{32}$ -in. hole, and glue them in. Next cut the heads from two common pins, bend them to form right angles, and drive the pointed ends into the rudder at the proper points so that, when the ends projecting downward are slipped into the staples around the rudder post, the lower end of the rudder will be on a line with the keel. Two more port covers, each $\frac{1}{2}$ -in. square, are glued on either side of the rudder, just below the water-line strake.

The boat is now ready for painting. The color scheme for this boat called for a light gray underbody, which was obtained by mixing French gray and a small amount of pure gray, to get a color which avoided

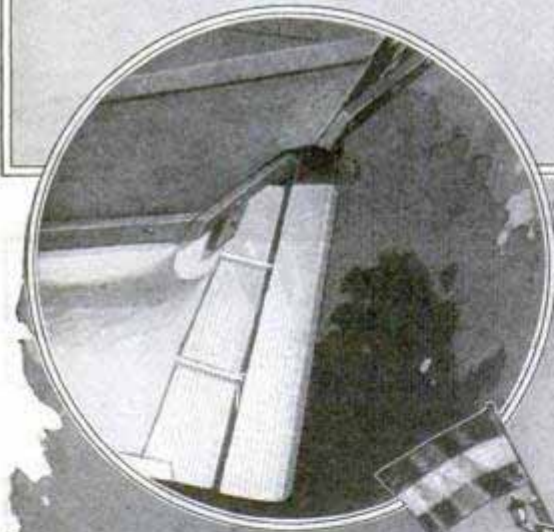

Details of the Fitting of the Rudder, Stern Lantern and Key to Hull Painting; for Details of the Stern Ornaments, See Part I, in the October Issue; the Lower Photo Gives a Good Idea of How the Model Is Painted

the chalky appearance of straight French gray. White can be used if desired. Underbody, stem up to the knees, and the rudder and rudder post below the waterline, were painted with this. The two port covers on the stern, below the painted water line, were done in black.

The upper part of the hull was painted a dead black, with the exception of the top panel on the poop and the two panels on the forecastle sides. The upper one of these, and the space between the ornaments on the poop panel, were painted with French gray, and the lower of the forecastle panels with the oriental red used on the coats of arms on the stern. The beak bulwarks and that part of the stem including the knees, which comes above the water line, were painted black, the figurehead was gilded, and two bands of gilded designs run, one along the beak bulwarks and the other along the stem, from the lion's tail back to the hull, filling in the space between the knees and the floor of the beak. Six gold ornaments were painted along the sides, as indicated in the sketches. These are simply $\frac{1}{2}$ -in. circles, with four projecting arms, forming the tips of a cross. The closed gun ports were given a narrow gold border to make them stand out from the hull.

The upper part of the stern requires more work. The bulwark rail, the edges down to the name plate, including the ends of the strakes, were given the effect of molding by painting a simple running design. The space around the half moon was broken up with four small gold stars, the name plate "Halve Maen" painted in gold, and the monogram of the company owning the boat, the Ostindische Cie van Amsterdam, painted between the two coats of arms, which represent the heraldic figures of the municipal arms of Amsterdam at the time of Hudson's adventures in America.

Next month's article will tell how to make the masts and spars and rig the ship.

☛ If body vibration in your auto comes from the door panel or cowl, remove the upholstery, obtain some thick felt and cement it to the inside surface of the metal with thick shellac; this will nearly always remedy the trouble so that it ceases to be annoying.

Clip Keeps Notebook in Vest Pocket

Machinists, foremen, and others who carry a notebook or price list in their vest pocket, frequently lose them when stooping over. By obtaining an ordinary pencil clip and attaching it to the book, as shown in the drawing, this can be avoided, and it also prevents the book from falling to the bottom of a deep pocket.—A. Bereskin, Winnipeg, Can.



Safety Catch for Door Hook

Often it is desired to lock covers of boxes, doors and cupboards by means of ordinary hooks, and in cases where these might open by vibration or sudden jars, it is a good idea to provide a safety catch to prevent this. Get a brass plate, about the size, in proportion to the hook, shown in the illustration, bend it at right angles at one end and drill a hole in it as indicated. The screw on which the hook catches is

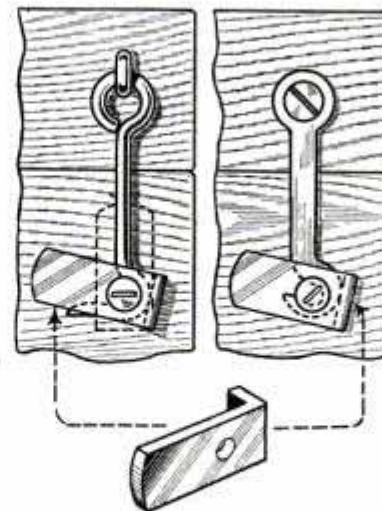

removed and is then replaced with the brass plate in position. It must, of course, be free to turn easily. When the plate is held in the position indicated by the dotted lines of the left-hand detail,

the hook can be slipped off the screw, but when in the horizontal position, to which it naturally falls by gravity, the hook is securely locked.

Ladder Repaired with Wire



If your ladder is at the stage where it threatens to give way when you are half-way up, it is well worth while to spend an hour repairing it. To do this, get a plow plane and groove a path along the sides of the two standards, making the groove about $\frac{1}{16}$ in. deep. Next get some

heavy galvanized-iron wire, insert it in the groove, and stretch it tight, using small staples to hold it in place. You can get the wire very tight if you take your time, and after the job is completed, you will find that your ladder is much stronger.

Floors Painted in Two Colors to Improve Appearance

In trying to improve the appearance of a worn softwood floor one usually tries to figure out what paint to use and what color would be most attractive. On this basis the paint is bought and the job done, the result being a more or less indifferent effect in a single color, which grows tiresome in time. The drawing shows methods of floor decoration, which have been followed out with pleasing effect. If nothing elaborate is desired, borders can be painted around



the room that should be in lighter and darker colors contrasting to the rest of the floor. For example, a foot from the wall a strip, about 2 in. wide, is laid off and marked with a chalkline; the main floor space is painted gray, the border darker and the space between it and the baseboard, either a lighter or darker color as desired. Then there is the alternative of painting the space between the narrow border and the baseboard checker-fashion, in order to obtain something of the effect of marquetry flooring.

Disinfecting Poultry

A Wisconsin poultryman uses a novel and simple method for disinfecting the birds of his flock, as shown in the illustration. A cloth bag of coarse weave, somewhat similar to window-curtain material, is partly filled with disinfecting powder and this is tacked above the small door of the poultry house so that fowls entering or leaving the house must brush it with their backs.



Each movement of the sack sifts a small quantity of the powder into their feathers, and, as the process is repeated many times each day, the thorough disinfection of each fowl is insured.

Don't Grease the Springs

One of the things the automobile driver is prone to do in the attempt to make his car ride as easily as possible is to jack up the car, pry the spring leaves apart, and apply a liberal coating of grease or lubricating oil between the leaves. Some cars may be designed to use lubricant between the leaves; however, in the majority, this practice is not only unnecessary, but, in addition, is apt to ruin the riding qualities of the car for a considerable time. Most cars are designed and sprung so there must be friction between the leaves; not enough friction so that the car will ride hard or

squeak, but enough to give a cushioning effect and an easy spring action, instead of the oscillating action that a coil spring will give, for example. When the springs are lubricated the friction is destroyed, and the car bounces, and keeps on bouncing, when it passes over the slightest bump.

The only thing that is necessary to do with most springs is to keep them free from rust, and this may be accomplished by brushing a little penetrating oil, not lubricating oil, along the sides of the leaves occasionally. Spring covers are an excellent precaution against the entrance of moisture between the leaves, and they should be used wherever possible. Where the owner does not want to apply spring covers, on the score of expense, an excellent substitute can be made by wrapping the springs with a layer of black friction tape. This makes a close-fitting cover, and one that will wear for a long time. The last turns can be bound with a turn or two of wire, and the tape given a coat of enamel, to improve both the appearance and the moisture resistance. If in doubt whether the springs should be lubricated or not, write the manufacturer, but don't apply lubricant, until you know for sure that it will be of benefit.

Cardboard Carton Files Magazines

Magazines can be kept together in neat cardboard cartons made to fit over them snugly. Get some heavy paper of the tough, brown fiber kind and cut it out as shown in the lower detail, reinforcing it by gluing on pieces of cardboard. The overlapping edges of the paper are then glued down over the sides, to form a carton. To keep a number of issues in the carton, remove the advertising and file the magazines in loose-leaf form.

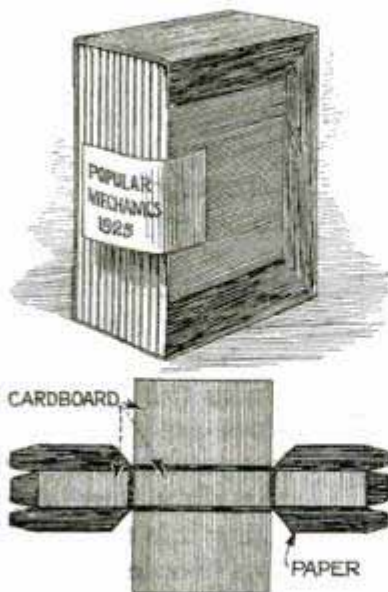

Simple Repair for Torn Tent

During a heavy rainstorm a party of campers had the misfortune to have the wall

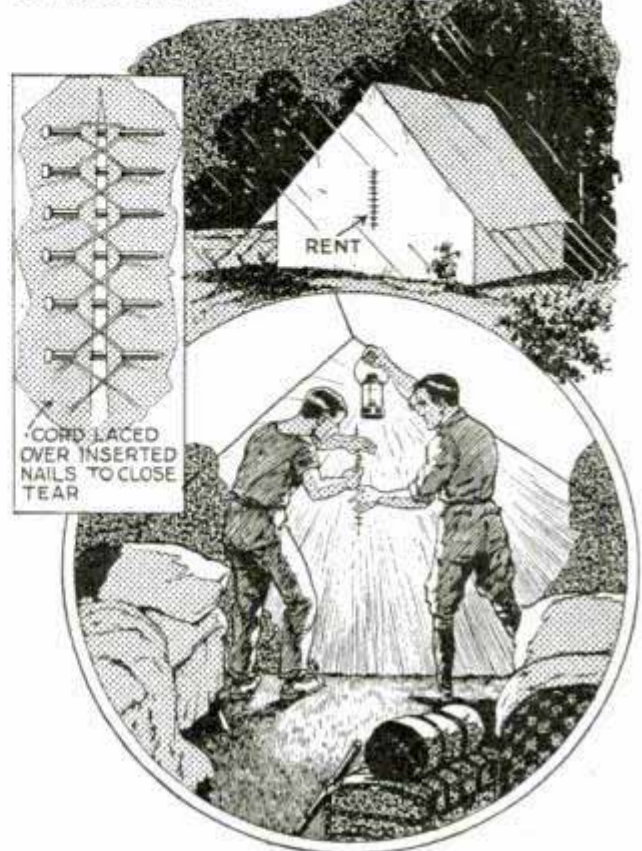

Repairing a Torn Tent with Nails and Lacing from the Inside during a Rainstorm

of their tent torn and were at a loss to repair it as no needle was available. However, the rent was satisfactorily closed by means of nails, as shown in the drawing. The nails were stuck through the canvas from the inside across the rent, leaving the heads and points projecting so that a length of twine could be laced over them. In this way the edges of the canvas were drawn together. Had the nails been lacking, green twigs with sharpened ends might have been used quite as effectively.

Test for Detecting Sewer Gas

If you suspect sewer gas but cannot readily determine whether it is that or some other odor, here is a good test: Soak a piece of white unglazed paper in a mixture of 1 oz. of lead acetate and a $\frac{1}{2}$ pt. of rain or distilled water. When the paper is thoroughly dry place it in the suspicious locality and if sewer gas is present the paper will shortly turn dark.—L. B. Robbins, Harwich, Mass.

**The Busy-Blacksmiths Toy
Amuses Everyone**

As the moving parts of the busy-blacksmiths toy are ordinary clothespins pivoted on short wooden slats, it is extremely easy to make it, and it will prove very popular. The clothespins

constructional details. The slats are spaced about $\frac{1}{4}$ in. apart when their ends are in line. Holes are drilled in the clothespins at an angle to receive the hammers,



Busy-Blacksmiths Toy. Made from Thin Wooden Slats and Ordinary Clothespins, Is Easy to Construct, and Will Prove a Popular Number with Children

are sandpapered smooth and are then carved and painted, or merely painted, to resemble men. Two $\frac{1}{8}$ -in. slats, $\frac{1}{2}$ in. wide and 11 in. long, are also sandpapered smooth so that they will fit loosely between the slot in the clothespins, where they are attached with headless wire nails at points $5\frac{1}{2}$ in. apart, as indicated in the drawing that shows the dimensions and

which consist of small blocks whittled to shape with a jackknife, and short lengths of $\frac{1}{8}$ -in. dowel stock, or similar round pieces, carved from any piece of wood. Glue is used to hold the handles of the hammers in the clothespins and in the hammer heads. The anvil is attached to the upper slat, as indicated, it being cut to straddle the slat and then nailed on. Its size should be such that the two hammers will strike it alternately at the time the slats come together as they are pulled or pushed lengthwise in opposite directions by two playmates. The hammer shanks must also be of such a length that the heads will strike the anvil squarely when the slats are pulled. Usually this toy is operated by grasping the end of the slats, but another method of using it is to set it on the table with two people to operate it. It is also possible to run this toy with a small engine. In that case, the bottom slat should be fastened rigidly to

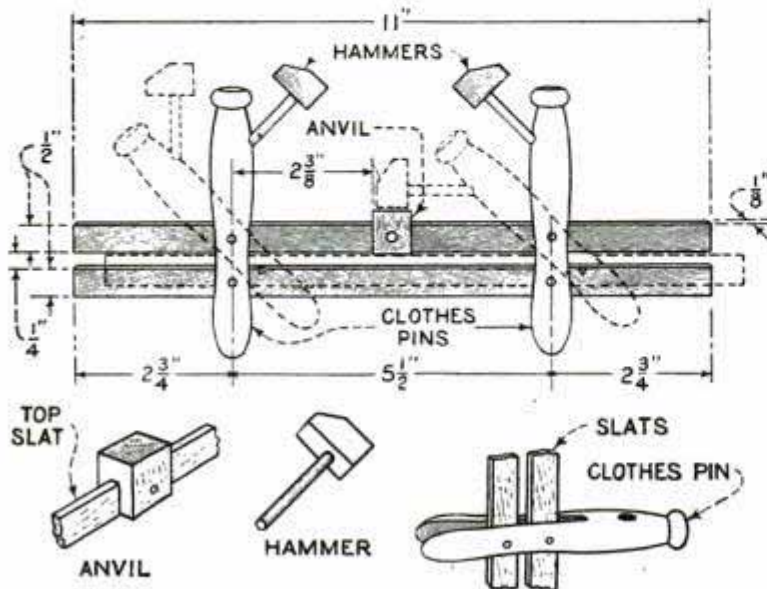

a wooden base and the upper slat joined with a connecting rod to the flywheel of the motor. A toy of this type is strong and will afford endless amusement for the children.

How to Detect Rosin Varnish

It does not take long to learn that varnish containing rosin is a very inferior grade. The best test to detect a rosin varnish is to rub the ball of the finger over it. If the varnish used is of good quality, the shine of the polish will be increased, but if it is rosin varnish, the rubbed spot will appear dull. This proves that rosin varnish is not hard enough to withstand wear of any kind. One should always be sure, when buying varnish, to get the best. Naturally the cheapness of rosin varnish has brought it into use in many homes, which have been built for price and not for service. It will pay anyone to avoid anything in varnishes which has a rosin base, for it will be ruined by water.—L. H. Georger, Buffalo, N. Y.

Shock-Absorbing Iceboat Runners

The usual method of fastening iceboat runners is to use a single bolt through the runner and the chock, which gives no resiliency whatever, and results in making the iceboat travel uncomfortably. The method shown in the illustration involves the use of two iron chocks for each runner.

Long bolts are welded to the chocks to stand vertically. The bolts are slipped through holes drilled in the ends of the runner plank, and steel coil springs are provided above and below the plank to serve as shock absorbers. A washer and cotter pin at the upper end of each bolt, above the top spring, keep the runners in position securely.

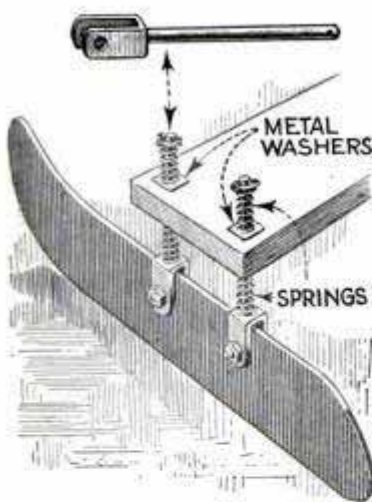

Fountain Provides Water for Dogs

A plumber of Huron, S. Dak., arranged a water fountain in the street to provide water for dogs. A square depression,



Overflow of Water Fountain Provides for Thirsty Dogs in Sidewalk Depression

about 4 in. deep, was made in the concrete next to the curb. During the summer months the overflow from the fountain was directed into it, the recess itself having an overflow into the gutter. People continually using the fountain kept the depression full of fresh water.—Frank W. Bentley, Jr., Missouri Valley, Iowa.

Spring Construction for Seat of Racing Auto

Additional riding comfort on bucket seats for racing-type autos can be gained by providing the spring arrangement shown in the illustration. It consists of two U-shaped supports, made from old carriage springs, which are drilled at the ends for bolts, and bent at the centers. To obtain the required stiffness, two or more helical springs are attached to the flat springs as indicated.—G. A. Luers, Washington, D. C.

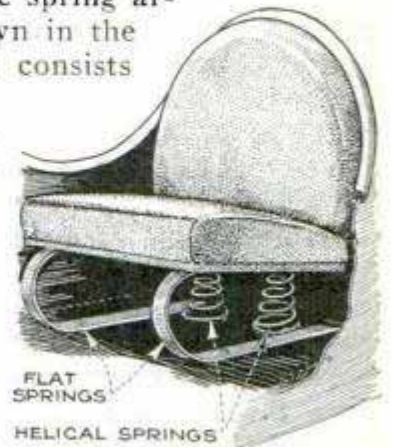



Swing for Indoor or Outdoor Use Is Adjustable and Can Be Used Also as a Trapeze

Combined Swing and Trapeze Adjustable for Children of Various Ages

All youngsters love to swing. The problem of making one swing serve for children of various ages and sizes was solved in the following manner: A sufficient length of $\frac{7}{8}$ -in. manila rope, two 25-cent swivel rope hitches, a pair of iron rings and a plain-board seat were obtained. If available, a pair of swinging rings, such as are shown in the photo, come in handy but are not essential. The height of the seat can be regulated by lengthening or shortening the free ends of the suspension ropes through the hitches. The advantages of the latter are that they do away with the tying of knots, are easily adjusted and do not slip as a carelessly tied knot may do. By removing the seat and rais-

ing the rings a swinging trapeze is formed which is much enjoyed by children, as well as adults. The swing can be arranged either indoors or outdoors.—Elizabeth S. Friedman, Washington, D. C.

Refinishing Old Canvas Canoes

Canvas canoes, which have been painted from year to year with all the colors of the rainbow, sometimes need a good treatment of paint remover. To get rid of the coats of old paint without damage to the canvas offers a problem to many, but can be done in the following way: Apply any good paint or varnish remover and allow it to stand 10 minutes; then use a scrubbing brush dipped in gasoline. This should be done outdoors where there is plenty circulation of air. Never use a putty knife, as this has put more holes in canvas canoes than any other method of removing paint. A stiff scrubbing brush or large-size nail brush will do the work nicely. A little hard work with the brush and gasoline and paint remover will prove far more efficient than any other method, as the chance of slipping and cutting holes is eliminated.—L. Georger, Buffalo, N. Y.

Safety Blocks Hold Auto Wheels

It is rather a serious matter if any of the cars fitted with disk or wire wheels run off the jack when changing wheels. To prevent this, it is a good plan to carry

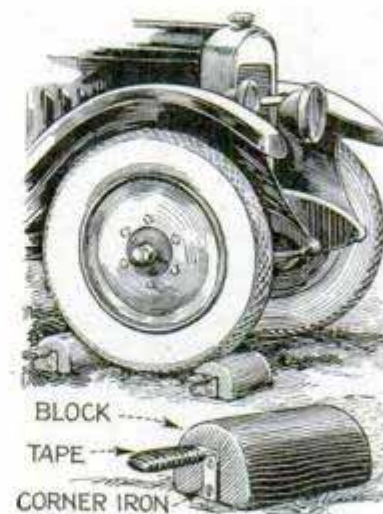

a pair of half-round wooden blocks, about 5 by 8 in., as shown in the drawing. The blocks can be quickly placed in front and behind one of the wheels. A handle can be made of a large corner iron, nailed or

screwed to the end of each block and wrapped with tape. The handles allow the blocks to be placed without danger of pinching the fingers.

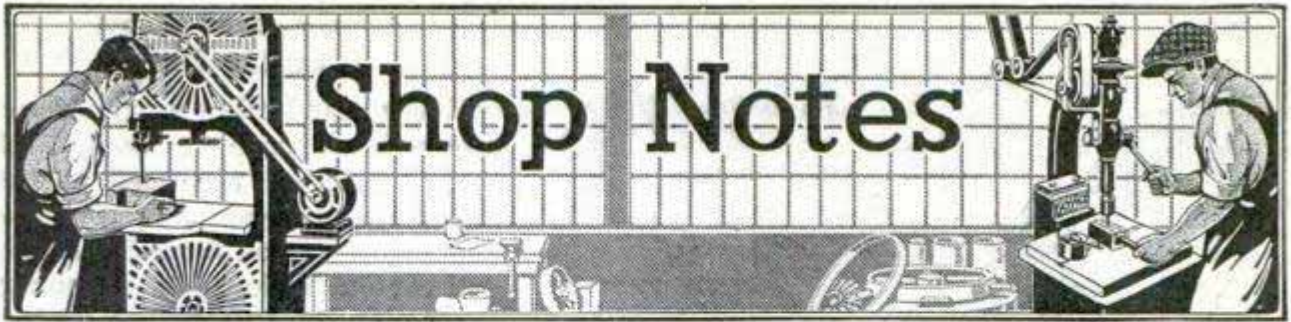

All Shop Notes published in 1925, in book form—Fifty Cents—from our Book Department

Wrecking Crane for Small Garage

By GEO. H. CAPPEL

NOWADAYS it is almost a necessity for every garage to have a wrecking crane and a good serviceable crane can readily be built by any enterprising mechanic. The drawing shows one which is made chiefly from two discarded auto frames. The dimensions given may be followed or the crane built to any suitable size. The front side bars of the frame are cut 6 ft. long and are bent at the top and bottom, as shown. The horizontal side bars, I, are from another frame. They are cut 3 ft. long, are spaced 24 in. apart and are mounted on two cross bars, H, which are 30 in. long. The method of bolting them together is shown at C. A $\frac{3}{4}$ -in. hole is

$\frac{3}{4}$ -in. bolts and a piece of $\frac{3}{4}$ or 1-in. gas pipe, cut to fit between the inside of the channels, keep the frame from drawing together and make a tight connection when the bolts are drawn up tight. A front cross brace, N, made of $\frac{1}{4}$ -in. flat stock, 2 in. wide, is used to strengthen the

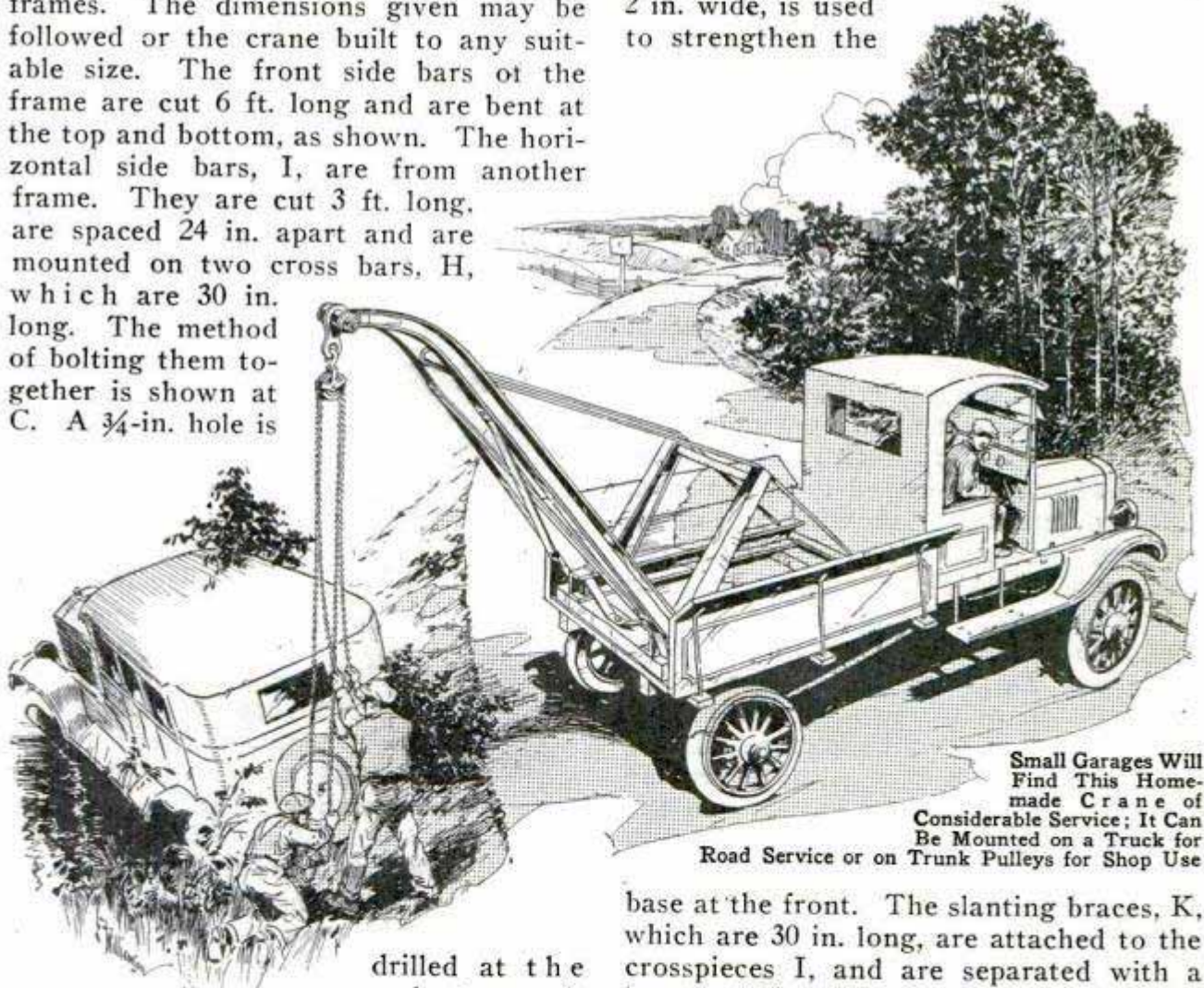

Small Garages Will Find This Home-made Crane of Considerable Service; It Can Be Mounted on a Truck for Road Service or on Trunk Pulleys for Shop Use

drilled at the ends, to permit bolting to a truck. These holes should be drilled $28\frac{1}{2}$ in. center to center if the crane is to be used on a Ford truck. Long

base at the front. The slanting braces, K, which are 30 in. long, are attached to the crosspieces I, and are separated with a length of $\frac{3}{4}$ or 1-in. pipe, F, through which a long $\frac{3}{4}$ in. bolt is slipped. The braces, K, serve as a rest for the round-iron braces, E, which are attached last. The

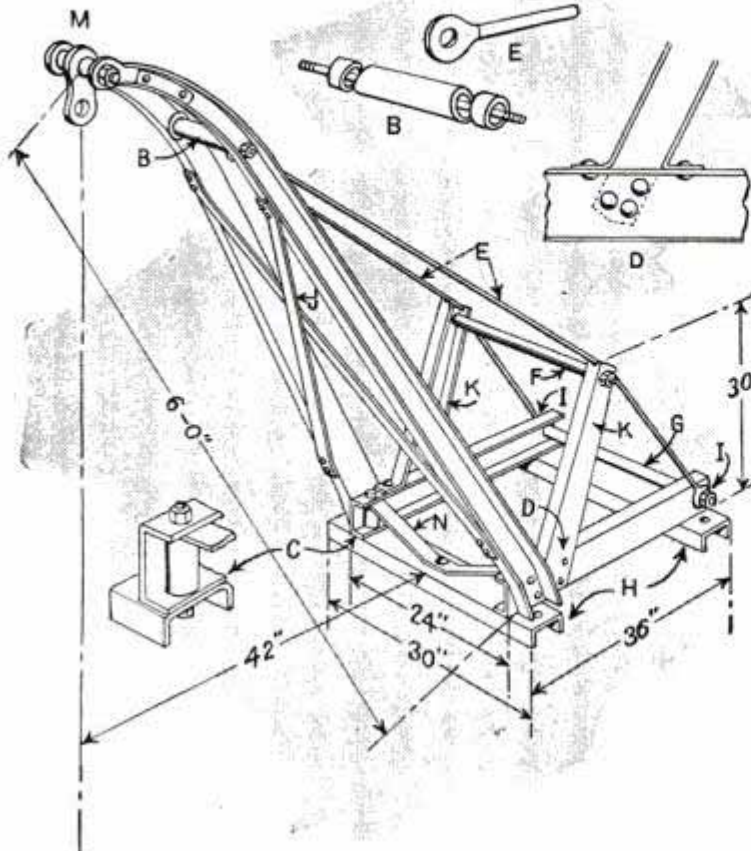

Constructional Details and Dimensions Which Show How the Crane Is Made and Assembled

main members of the crane are braced as shown with flat crosspieces, J. The crosspiece, B, like F and G, consists of a $\frac{3}{4}$ -in. bolt and a $\frac{3}{4}$ or 1-in. pipe. This completes the framework of the crane except the head, M. This should extend about $3\frac{1}{2}$ ft. beyond the rear crosspiece, H. An eye or hook plate is forged out of an iron bar, 6 in. long, $\frac{3}{4}$ in. thick and 3 in. wide. The lower hole is drilled to fit the hook on the differential block, while a $\frac{3}{4}$ or $\frac{7}{8}$ -in. steel bolt is slipped through the top hole and the ends of the frame. The brace rods, E, are attached after the frame is assembled so that they will have a tight fit. The detail, D, shows how the braces, K, are bent and bolted to the cross bars I.

If it is desired to use the crane also for general service in the garage, this can be done by bolting $6\frac{1}{2}$ -in. bars to the bottom of the crane. Large trunk pulleys are used for the front end and a castor at the rear end. In this way the crane can be used in the shop and only four bolts are needed to attach it to the pulleys. When used as a floor crane, it may be found desirable to weight the castor end. For light lifts, of course, this is unnecessary.

Sweet-Clover Stems Used for Feed

Every year I allow a part of my sweet-clover crop to seed, and then I harvest the seed. The stems of the clover then have become so large and hard that stock will eat but little of it. Running it through the threshing machine breaks up the stems so that they can be fed into a grinder made for handling ear corn, and last winter we ground about 40 bu. of clover straw. When mixed with oats or other ground feed, it is relished by stock and appears to have considerable food value.—Geo. G. McVicker, North Bend, Nebraska.

Valve-Cage Tool Adjustable for Height

To release the pressure while removing spring-washer locks from valve stems, the illustrated tool will be found useful. It consists of one piece of $\frac{1}{4}$ by 3-in. steel, $5\frac{1}{2}$ in. long, and two $\frac{3}{8}$ by 9-in. steel rods, which have been threaded 1 in. of their length at the lower ends and $3\frac{1}{2}$ in. at the upper ends. Six $\frac{3}{8}$ -in. nuts are used on the rods, as shown, to properly locate the upper and lower plates. The upper plate is of $\frac{1}{4}$ by 2-in. steel and is $4\frac{3}{4}$ in. long, two holes being drilled in it, $3\frac{1}{4}$ in. center to center, and two holes drilled and tapped in the base the same distance apart. In the center of the upper plate, a $\frac{1}{2}$ -in. standard thread is tapped in which is fitted a 3-in. capscrew, with a piece of $\frac{1}{8}$ by $\frac{3}{4}$ -in. steel, $2\frac{3}{4}$ in. long, to form a thumbscrew handle. To the lower end of the capscrew is fitted a spring-washer release, made from $1\frac{1}{16}$ -in. stock, $1\frac{1}{4}$ in. long, with a $1\frac{1}{16}$ -in. hole drilled in the center. A cross slot, $\frac{5}{8}$ in. wide, is cut as shown in the photo, and the piece is then joined to the capscrew by reducing



the end of the screw to $\frac{5}{16}$ in. in diameter for a distance of $\frac{3}{8}$ in. A $\frac{5}{16}$ -in. hole is drilled in the solid end of the spring-washer release and the end of the capscrew is riveted over, to prevent the washer release from coming off the screw. This makes a satisfactory cage tool as it holds the valve spring in whatever position desired and is adjustable to cages of all heights within its capacity.

Homemade Tool for Straightening Steel Flanges

Straightening steel flanges is usually done with a sledge hammer, the metal being well heated to make the work easier. In a Denver steel shop, where a great deal of repair work is done, a special tool was made for this purpose. It was made from a No. 4 alligator wrench and has been found indispensable for straightening steel flanges $\frac{1}{2}$ in. or less in thickness. The wrenches are heated in a forge and closed to a $\frac{3}{4}$ -in. gap. A 2 or 3-ft. section of $1\frac{1}{2}$ -in. gas pipe is slipped well up on the handle of the wrench, hammered down and welded. With this tool a workman may straighten flanges up to $\frac{1}{2}$ in. cold, without the muscle shock occasioned by the use of a sledge.—Jos. C. Coyle, Denver, Colo.

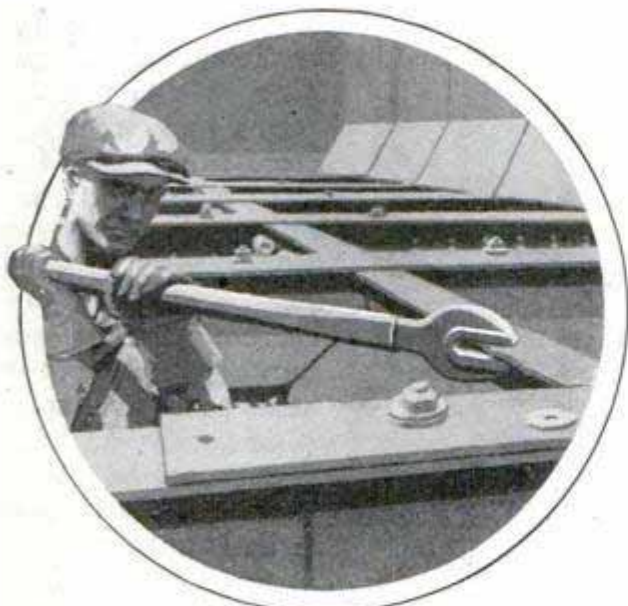

Straightening Steel Flanges Up to Half-Inch Thick without Heat with Specially Made Tool

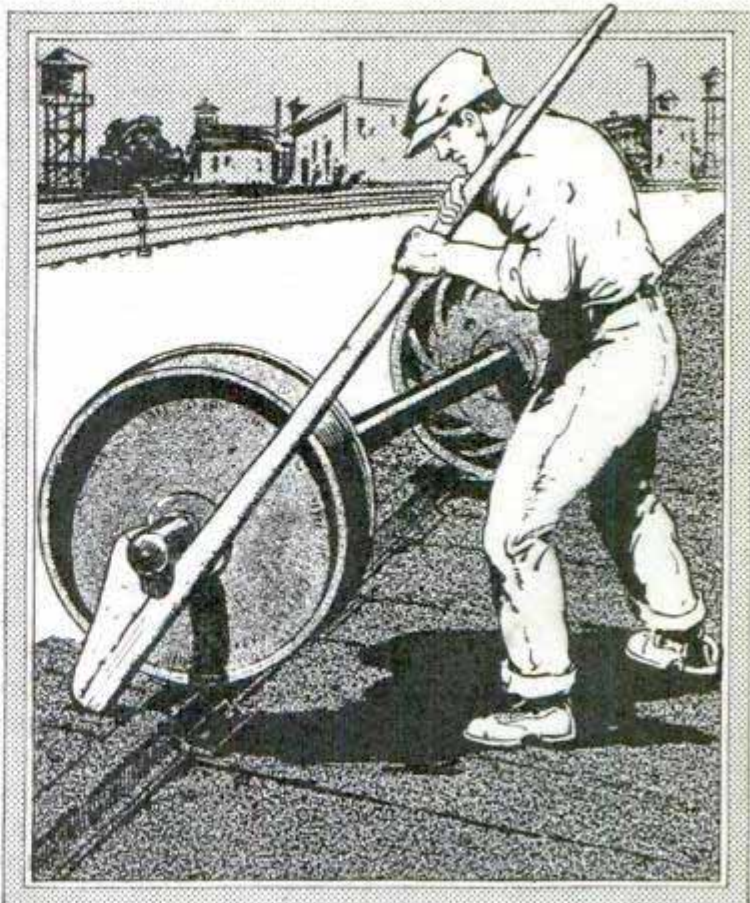

Handy Wooden Jack Facilitates Handling Railway Trucks over Tracks and in Shops

Handling Railway Trucks Easily

In rolling a pair of railway trucks it is difficult to change the course in which the wheels are rolling and to get them across tracks with the unaided hands. The jack shown in the drawing has been found very helpful in this task. A hardwood handle, resembling that of a peavey, but heavier at the lower end, has a triangular block of hardwood, 3 in. thick, spiked to the lower end. The upper end of the block, which is 4 in. wide, is curved to fit the axle of the truck. With the handle set vertically on the ground, the top of the block should be about 3 in. higher than the underside of the axle. In use, the jack is passed under the axle, and when the handle is pushed forward, the axle will be lifted and carried ahead. One man can turn or run a pair of trucks over the track with this jack.

☞ When babbitt metal has been heated repeatedly, the tin and antimony are partly burned out making it unsuitable for use for bearings, etc.; oxidation is indicated by the formation of scum on the surface.

Good Hydrant Installation

For the average farm where running water is piped to two or three outside points, the installation shown in the photo will prove satisfactory. The shut-off is set far enough underground to prevent its freezing in winter. Then this is covered with a column of 4-in. bell tile, and the stack is brought just above the ground with the bell of the last section of tile on top. A ½-gal. pail cover just fits into the bell, and a hole punched through the center of the cover will then make the installation complete.—Dale R. Van Horn, Walton, Nebr.



Emery-Wheel Stand

The emery-wheel stand shown in the drawing is made from an old piston which had been discarded from an automobile engine. It is mounted on the bench top by two long bolts, as shown. A wood block is placed between the bench and the piston to make it stand at the proper height. The wristpin bushings are left in the piston and serve as bearings for the shaft. The latter should be the right size to fit nicely in the bushings, and long enough to mount an emery wheel on one end and a pulley on the other. The end that carries the wheel can be threaded and the wheel clamped between two nuts, while the pulley is fastened with a key or a setscrew. A stand of this kind will carry a good-sized wheel, as considerable bearing



Serviceable Bench Stand for Emery Wheel Is Made from Old Piston

surface is provided by the wristpin bushings. In drilling the holes for the bolts, it is of importance to place them far enough apart so that the bolts will not interfere with the shaft.—Harold Jackson, Kankakee, Ill.

Altered Machine Tap Works Better

The machine tap will run into the work much more readily and will not break so easily if it is altered as indicated. Take any tap with four flutes and grind the threads down one-half of their depth on two opposite flutes. Whereas the ordinary tap would usually break after I had tapped about 90 holes, the altered tool tapped 450 without breakage. It is evident that this meant quite a saving where thousands of holes had to be tapped.—Arthur Whittier, Norwood, Mass.



New Use for Dictaphone

The dictaphone can be used to record orders for merchandise arriving by long-distance telephone. To do this, hold the mouthpiece of the dictaphone directly under the telephone transmitter so that you can speak into both at the same time. When the order starts coming in, each item is repeated to the customer and is thus recorded by the dictaphone. Shipping directions, terms and other information needed for the prompt and correct billing of the shipment may also be included. This method insures accuracy and at the same time saves telephone tolls as the order can be taken more quickly than if it had to be written down by hand.—M. W. Lowry, Athens, Georgia.

Improved Drill and Wire Gauge

A single drilled plate is the common form of drill and wire gauge, but a better instrument is obtained by using two plates as shown in the drawing. The difference in diameter of the drills is so slight that it requires close gauging to determine the exact number, and users of the single-plate gauge ordinarily try the next smaller hole as a check after the drill has been fitted, for, if this is not done, the drill or wire may be passed as a size larger than it is. The double-plate gauge, however, prevents mistakes of this kind and saves the time required to pull out the work and try it in the next hole. To make it, two plates were drilled together from the smallest to the largest size. After drilling, a spacing piece was pinned between the two plates and the pin riveted over on both sides. The riveting is not done until the plates are tight and is stopped when the plates are held snugly but movably on the pin. Next the back plate is moved around one hole, which brings the next smaller holes in line with the holes in the upper plate.

In this position a hole is drilled through both plates and the spacer, and a loose pin inserted. In use, the gauge is suspended by a wire holder from a nail or hook in the wall so that it can be spun around to bring the required hole to the most convenient position.

The work is tried in the holes until it enters the one it seems to fit best. It is then pushed farther through to try it in the next smaller hole, which is in line with it in the back plate. If it fails to enter this, its size corresponds with the number of the hole it entered.

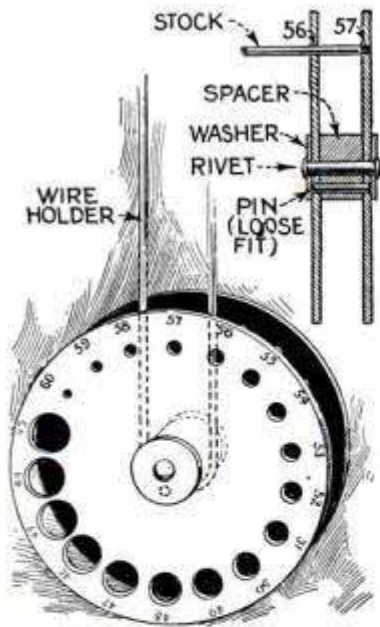

Special Frame for Holding Dump Doors Aids Riveters

Support for Dump Doors Makes Riveting Easier

The device shown here was originated at the shops of a western railroad for holding dump doors of ore cars, as well as other broad, flat steel equipment, while riveting them. It is made of 4 by 6-in. timbers, securely bolted together in an A-shape and reinforced at the bottom with steel straps, which are turned up near the end of the two timbers that form the base of the device, to keep the doors from slipping. It is 3½ ft. in height, and the base timbers are the same length, which makes it convenient for the crew to stand in an easy position while performing their task with the rivet gun and the bucking bar. —Jos. C. Coyle, Denver, Colo.

Keeping Soldering Kit Handy

The electrician, tinsmith or other mechanic, who is often compelled to work in low attics or other small spaces, will find the illustrated stunt of providing pockets on the side of the blowtorch of considerable convenience, as it serves to keep the solder, flux, tape, etc., at hand and less likely to be mislaid.



BRASS POCKETS



Simple Automatic Counter Attached to Frame of Roller Conveyor Is Found Dependable

Simple Counter for Roller Conveyor

The drawing shows a simple method of attaching a counter to a roller conveyor. The counter is placed on a bracket attached to the frame of the conveyor at a turn, and should be located on the outside of the curve, for the reason that there will be greater separation between the units at this point than elsewhere. The operating lever is made from light bar stock and is actuated by a spring attached to the counter arm, which can be swung out of the way instantly whenever desired. —J. S. Hagans, Chicago, Ill.

Handling Bearing Shims

While working under the car on the main bearings, it is sometimes discouraging to have the thin shims slip off the bolts and scatter on the floor. A good method of preventing this is to bend the shims in the center slightly. Shims having a single hole are bent across the hole as shown in the upper detail. Those having two holes are bent between the holes as

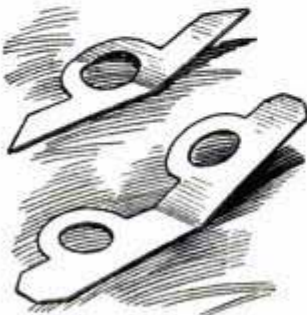

shown below. Take care that the ends point up so that, when the bearing cap is replaced, the shim is smoothed out and the bending has no effect upon the fitting of the bearing. By replacing the heavier shims first, the thin ones will serve to hold all of them in place until the bearing cap is started over the bolts.—S. J. Gee, Montpelier, Idaho.

A Homemade Plumb Bob

Get a piece of cold-drawn steel, hexagon in shape, $4\frac{1}{4}$ in. long and $\frac{3}{4}$ in. wide. Lay out and center-punch for a $\frac{3}{16}$ -in. hole near the top end, according to dimensions given in the drawing. In locating this hole allow for $\frac{1}{32}$ in. to be faced off at the end. After the hole has been drilled, set up the work in the lathe. Place it in a three-jaw universal chuck, with the drilled end of the work extending $1\frac{1}{2}$ in. Adjust it so that it runs true. Now arrange the belt for the proper spindle speed, set the lathe tool for facing and face the end. Center the end of the work with the centering tool held in the toolpost. Center-drill this end as indicated, using a center drill with a $\frac{3}{32}$ -in. pilot drill, and drill a $\frac{3}{16}$ -in. hole in the end to intersect the $\frac{3}{16}$ -in. hole. Remove the drill chuck from the tailstock spindle, insert the hardened center and adjust the tailstock so that it will support the end of the work. Get a round-nose tool, ground to form the fillet at

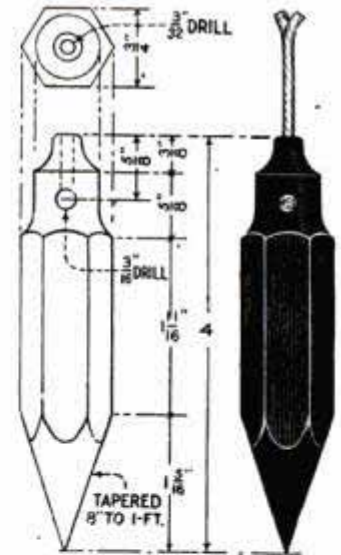

the end, and turn down to two diameters as indicated. Round the corner at the end with a file and polish the machined surfaces with a piece of emery cloth. Now turn the work around in the chuck so that it extends $1\frac{3}{4}$ in. True it as before and set the compound rest at a 108° angle, reading from the headstock side, with the handle toward the tailstock. Then turn down the work to a point and finish with emery cloth.

Keeping the Closed Car Warm

As cold weather approaches, the motorist is faced with the problem of keeping the car warm. The quantity of cold air that comes in through the floorboards and around the windows is surprising. This is especially true when the car is in motion. As the heat from the engine naturally escapes through the vents on the sides of the hood, one auto owner conserved a great deal of this heat by closing up these vents on the inside of the hood with two strips of cardboard, so that the fan blew the heated air from around the motor back against the floorboards, thus aiding in heating the inside of the car. The strips were held in place with no fastenings by simply bending the ends out through the first and last slot in the hood.

Gate Keeps Stock Safe and Ventilates Barn

To prevent the escape of stock from the barn and yet provide proper ventilation during the hot months, one farmer built a slat gate, hinged at the top as shown in the illustration. This gate is made of several 1 by 6-in. boards nailed to three vertical pieces, which are long enough to reach from the door sill to the top of the opening, where they are nailed to another horizontal piece, hinged to the top of the opening. A rope runs from the bottom of the gate over a pulley fastened to a ceiling joist at the proper distance inside, and a pull on this rope opens the gate. There is also an automatic lock, made of a 2 by 4-in. piece, 3 ft. long. This is hinged to the ceiling and has a notch, which engages with the lower edge of the gate when it is raised. The lower end of this lock is within reach.

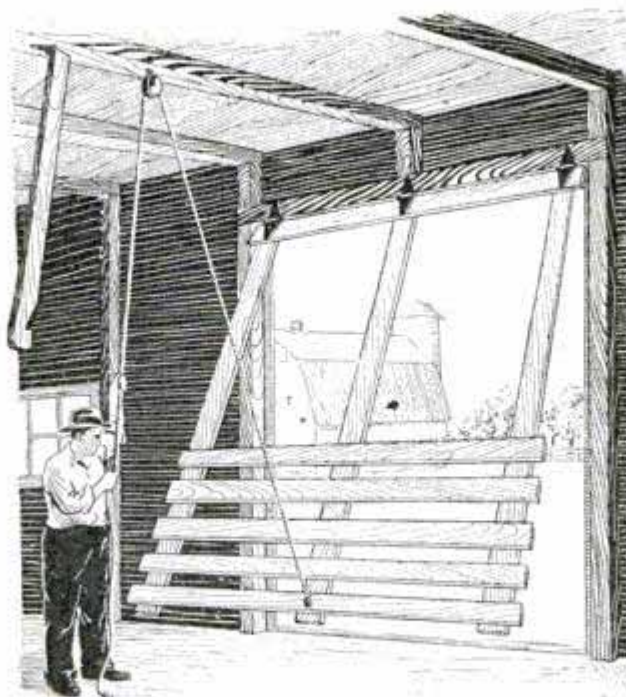

Gate with Hinges at the Top Keeps the Stock in the Barn and Provides Plenty of Ventilation

Triangle Fitted to Be Used as T-Square

There are a great many instances where it is necessary to make rough sketches and where a little accuracy is of considerable value in future work. The drawing shows how a medium-sized triangle was made to do double duty. A short strip of heavy celluloid was slotted to give a snug fit on the edge of the triangle so that it could be removed when not needed. The method of using the device is clearly shown in the illustration.—L. H. Georger, Buffalo, N. Y.



Protection for Stucco-Finished Houses against Water Stains

Stucco should never start closer than 8 or 10 in. to the ground line. Splashing from rains will otherwise be sure to discolor it and cover it with dirt or soot, which lies on the surface of snowbanks next to the house walls. Another blemish often seen on stucco finish is discoloration just below the windows, such as rust from screens and windows. Extra-wide sills or sills with a groove or other trough-shaped depression near each end to force the water to run off through them are the best means to prevent this trouble.—Geo. G. McVicker, North Bend, Nebr.

☞ Chicks hatched in the middle of March will be early layers.



Old Hammers Drawn Out Make Good Tools for Removing Rivets

Tool for Backing Out Rivets Made from Old Hammer

In a large Denver shop old hammers which have become chipped and unsafe for use are drawn out to a $\frac{3}{4}$ -in. point, as shown in the photo, and are used for backing out old rivets, after the head has been removed with an air chisel. The "backout," as it is called, may be held safely upon a rivet by one workman while it is being struck with a sledge by a second man.—Jos. C. Coyle, Denver, Colo.

Handy Mallet for Glaziers

Glaziers and others who have occasion to reglaze windows and doors will find the mallet shown in the drawing of considerable assistance in their work. It consists of a piece of flat steel, squared and polished, through which a hole is drilled from end to end to receive a length of heavy steel wire. The hole is counter-sunk at one end to permit the end of the wire to be clinched without projecting beyond the side of the head. The wire is bent as indicated, to form a handle, and should fit

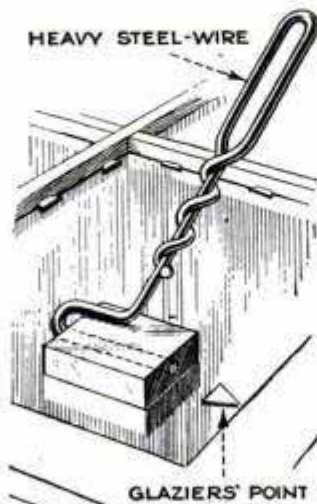

rather loosely in the hole. Thus, the head of the mallet will always lie flat against the glass no matter at what angle the handle is held in driving the points. In many shops beveled chisels or other similar tools are used for this purpose, but this tool will be found much more valuable and well worth the time required to make it.—G. E. Hendrickson, Argyle, Wis.

Holder Helps in Grinding Bearing Caps

Grinding bearing caps on an emery wheel is a job that requires care in order to get the flat surface of the cap ground evenly. A simple holder, which can be made in a short time and makes the work much easier, is shown in the illustration. It consists of a length of flat steel, bent to a U-shape and having the ends ground to fit in the bolt holes of the caps. Two holes are drilled through the sides of the holder to receive a bolt, which is provided with a wingnut to tighten it so that the holder will grip the bearing securely. In

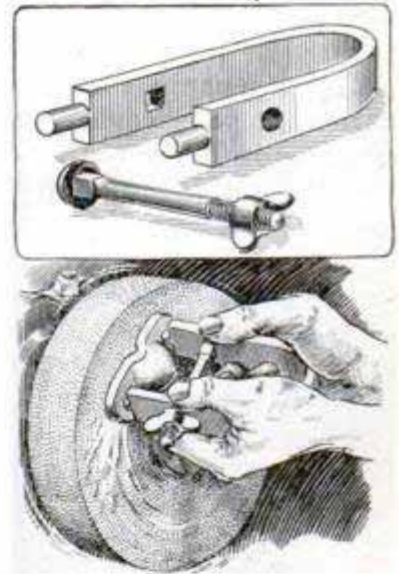

this way, a comfortable grip is obtained, and at the same time the fingers are protected from the surface of the emery wheel.—G. A. Luers, Washington, D. C.

Waterproof Varnish for Wooden Trays

Wooden trays are often built for dark-room or laboratory use. To make them waterproof, yet chemically clean, is a simple matter if the following coating is applied: Melt $\frac{1}{2}$ lb. of common brown rosin and add 2 oz. of yellow-wax chips, stirring the mixture until it is smooth. This will fill all cracks and pores and will render the wood absolutely non-porous.—L. B. Robbins, Harwich, Mass.

Improving Your Hot-Air Furnace

By J. TATE

ACCORDING to a well-known heating engineer, it is possible, by a few simple and inexpensive changes, to effect a saving of 20 to 30 per cent in the coal required to heat a house in severe weather, where a hot-air furnace is used for heating. "In fact," he says, "it is easy to change hot-air house heating from a system markedly inferior to steam or hot-water apparatus to a system that compares very favorably with them in nearly all respects."

It may not be possible for all readers to realize the saving mentioned above, for some of the improvements indicated later may already be incorporated in their own furnaces, but there are many installations where the full amount may really be saved.

The first simple improvement possible to make in the majority of hot-air furnaces is that of a simple apparatus for humidifying the warm air supplied to the rooms. The desirability of maintaining a reasonable amount of moisture in the air of the average home is recognized by all heating and ventilating authorities: it is, in fact, essential to health, protection of woodwork in the house and economy of fuel. Where sufficient moisture is present in the air, the temperature of

the rooms can be kept at a lower point than when the air is dry, with equal comfort to the occupants, and a lower temperature means a saving in coal to begin with. In addition to this, if the air is dry, moisture is evaporated from the woodwork of the house and the furniture, with more or less disastrous effects, and the effect on the occupants is no less bad from the standpoint of health. Fortunately, it is comparatively easy to humidify the air in a hot-air furnace, much easier than it is to do the same thing in a house heated with steam or hot water. Do not, however, rely on the cast-iron water pan fitted to many furnaces to do the work, for it will not. There is only one place to fit a humidifying pan in the average hot-air furnace, and that is on top of the radiator or heating

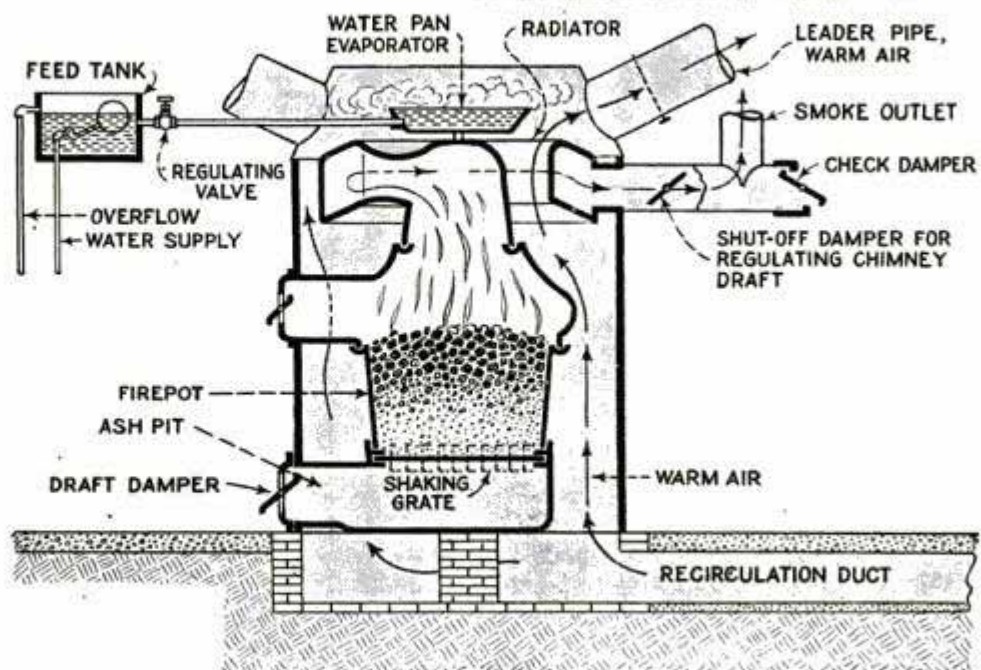

FIG. 1

The Addition of a Simple Humidifying System to the Hot-Air Furnace Not Only Adds to the Comfort of the Home Owner, but Helps Save Coal

drum, just beneath the bonnet of the furnace. The installation of such a pan, which should be of cast iron, is shown in Fig. 1. To make the tank function without attention, an automatic ball cock is arranged in an external tank to keep the pan in the furnace constantly supplied with water. A regulating valve is fitted in the supply line leading to the furnace pan, and an overflow pipe to the external tank. In extreme weather, when the furnace is running at full capacity, the regulating valve must be closed somewhat, in order that the air in the house may not become too saturated and the windows covered with frost. The only thing to watch in fitting such a humidifier is to keep the water level in the float tank at the same level as is required for the furnace pan.

The next thing to consider is whether the cold-air supply to the furnace is taken entirely from outdoors. If it is, that means that all the air handled by the furnace must be raised from the temperature

prevailing outdoors to the temperature required for the house. In very cold or windy weather, the temperature difference is very considerable, and a lot of coal is needed to raise the temperature of the air to the higher level. This can be avoided almost entirely by the addition of a recirculation duct, through which all or a part of the air to be heated is taken from the interior of the house. Many furnaces are now fitted in this way, but many old ones are not, and it makes a considerable difference in the amount of coal burned in cold weather, and often a very appreciable difference in the comfort of the house, whether the air must be raised from zero or below to 68 or 70°, or from 50 to the same degree.

One heating engineer solved the problem in his own house by using a recirculation duct, cast right in the floor of the cellar, as indicated in Fig. 1. The main reason for using this construction was that, while it is well known that such a duct should have a cross-sectional area equal to the combined areas of all the hot-air pipes leading to the rooms, the lack of room in the ordinary cellar often makes the installation of a duct of such size impossible. The duct cast in the floor overcame this objection. The floor and walls of the duct were cast in concrete. For the top of the duct slabs of reinforced concrete were cast in open forms, about 3 in. thick, 3 ft. long and 2 ft. wide, with beveled edges. After the slabs were seasoned

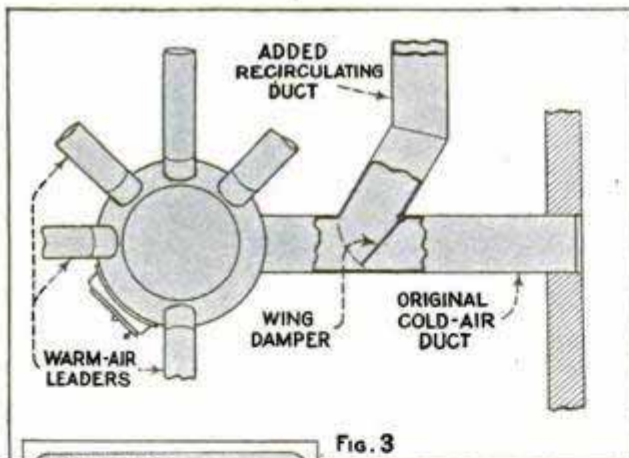

Fig. 3

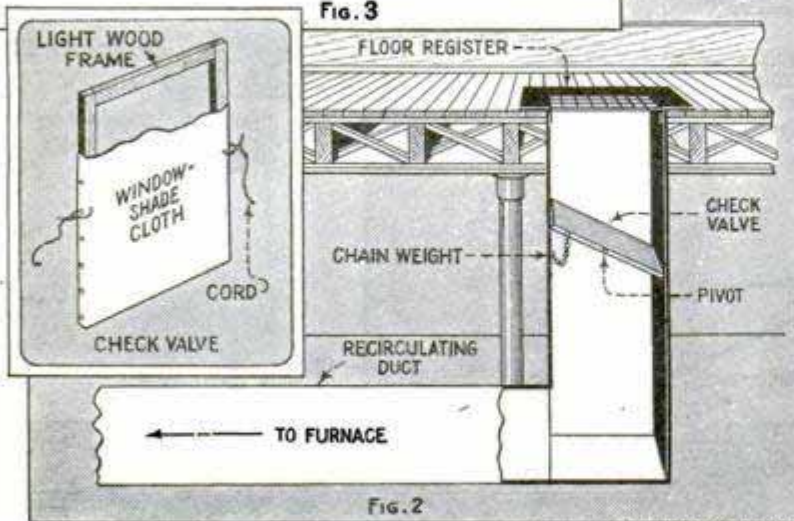
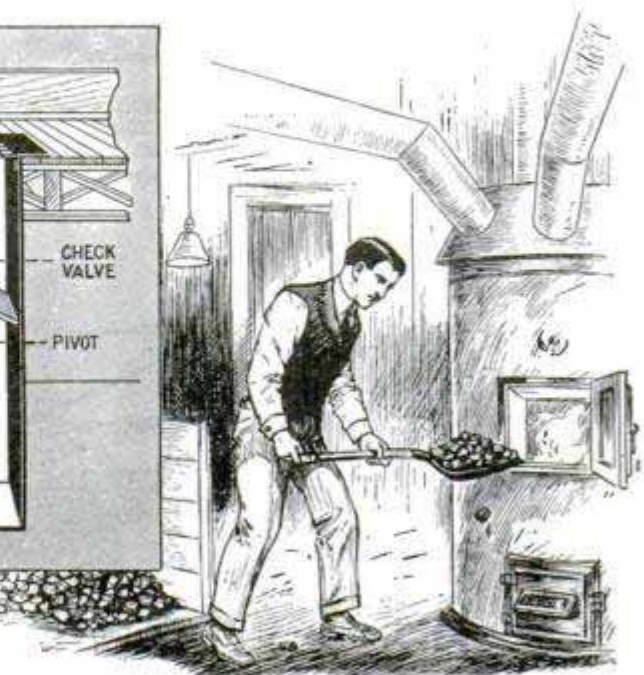

Fig. 2

Details of the Fitting of the Recirculation Duct, Floor Register and How the Check Valve or Damper Is Made and Installed



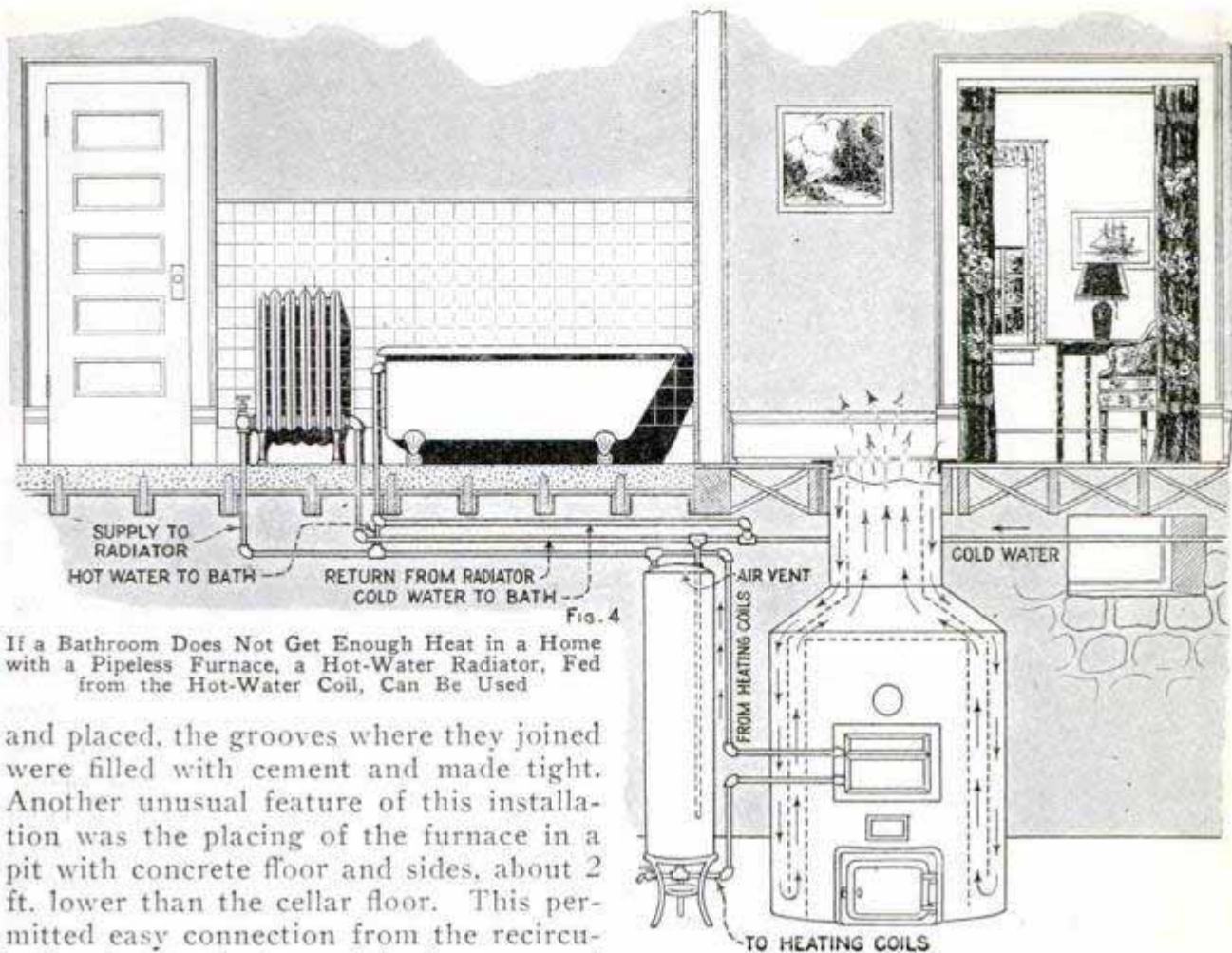

Fig. 4
If a Bathroom Does Not Get Enough Heat in a Home with a Pipeless Furnace, a Hot-Water Radiator, Fed from the Hot-Water Coil, Can Be Used

and placed, the grooves where they joined were filled with cement and made tight. Another unusual feature of this installation was the placing of the furnace in a pit with concrete floor and sides, about 2 ft. lower than the cellar floor. This permitted easy connection from the recirculation duct to the base of the furnace, and saved labor in feeding coal to the furnace, while the extra height helped the draft in the hot-air flues, especially those leading to the first floor.

Where the floor duct cannot be installed, it is necessary to use a sheet-metal duct, proportioning this as mentioned above, or, if this is impossible, then as large as possible, at least as large as the original cold-air duct. The recirculation duct should be joined to the cold-air duct as illustrated in Fig. 3, so that a wing damper can be fitted to enable the air supply to the furnace to be taken either from outside or inside the house, or mixed in whatever proportions may be desirable, depending on the weather.

Occasionally, with a strong wind blowing into the outside cold-air duct of the installation described, more air would enter the duct than the furnace could handle. With the wing damper set, as it usually was, to take part of the supply from the inside and part from the outside, a strong current of cold air would flow around the damper and into the house through the recirculation duct and the register in

the hall. This could be stopped, of course, by closing one of the ducts by means of the wing damper, but this was often undesirable. What was needed, therefore, was a very light, almost frictionless check valve in the recirculation duct; one that would offer no resistance to the downward flow of the air from the house, but that would close against any air coming back through the duct from the outside. The valve that was finally fitted is shown in Fig. 2. This was hung in the vertical duct from the first floor in an inclined position, and was supported on cord trunnions near its center of gravity, so that it would swing closed by its own weight, but would open under the slightest suction from the furnace. In order to balance the damper accurately a very light chain was hung in a loop with one end attached to the side of the flue, and the other to the side of the damper. By altering the length of the loop, it was easy to adjust the damper, which worked perfectly.

Where a one-register or pipeless furnace is used to heat the house it is often the case that the bathroom is always more

Manual Regulator Co.
 2709 1/4th Ave
 Minneapolis, Minn.

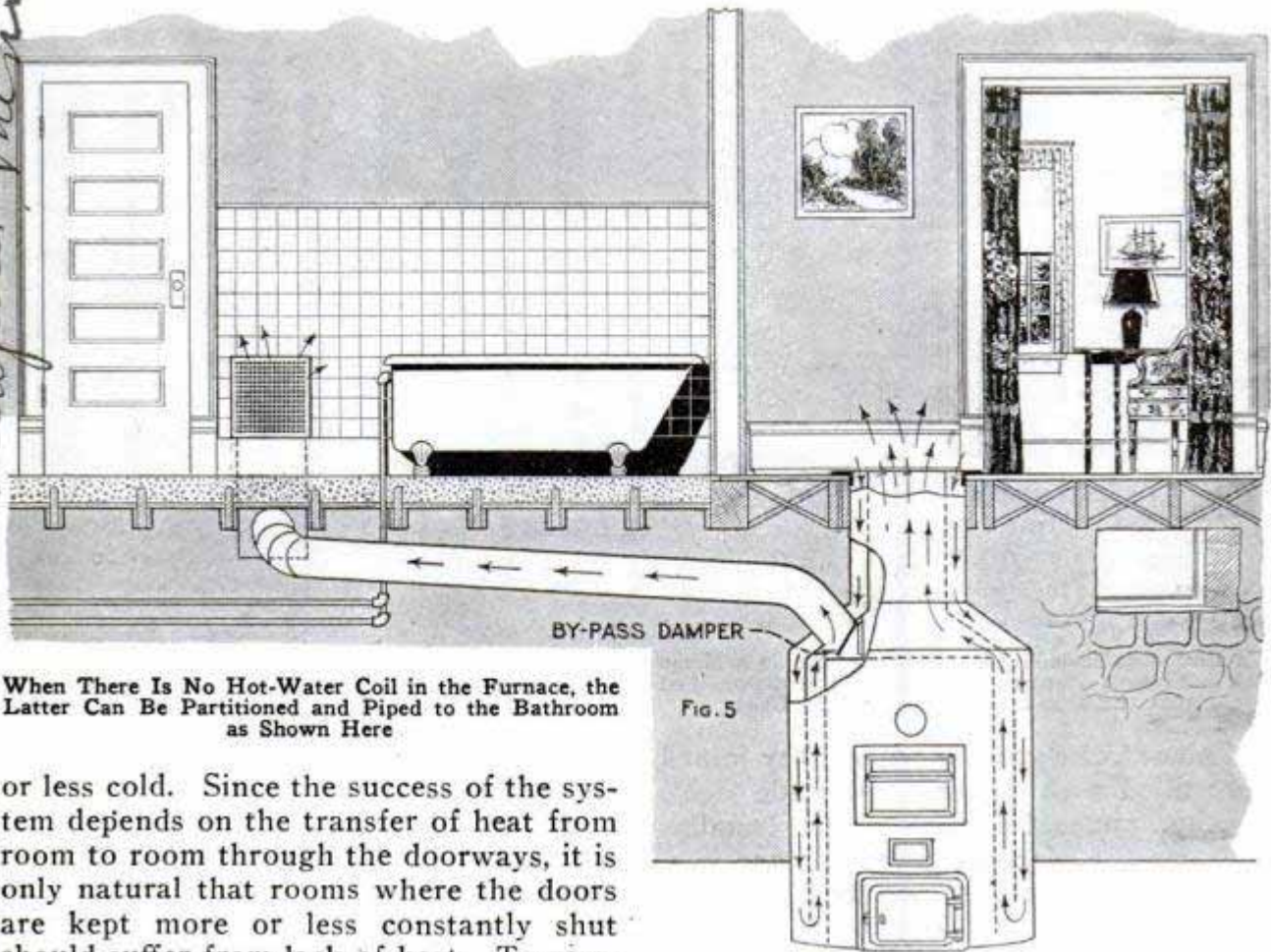

When There Is No Hot-Water Coil in the Furnace, the Latter Can Be Partitioned and Piped to the Bathroom as Shown Here

Fig. 5

or less cold. Since the success of the system depends on the transfer of heat from room to room through the doorways, it is only natural that rooms where the doors are kept more or less constantly shut should suffer from lack of heat. To remedy this partly, transoms can be provided over the doors, and these should be kept open. An opening should also be made at the bottom of the door. Another plan is to install a hot-water radiator connected to the range boiler,

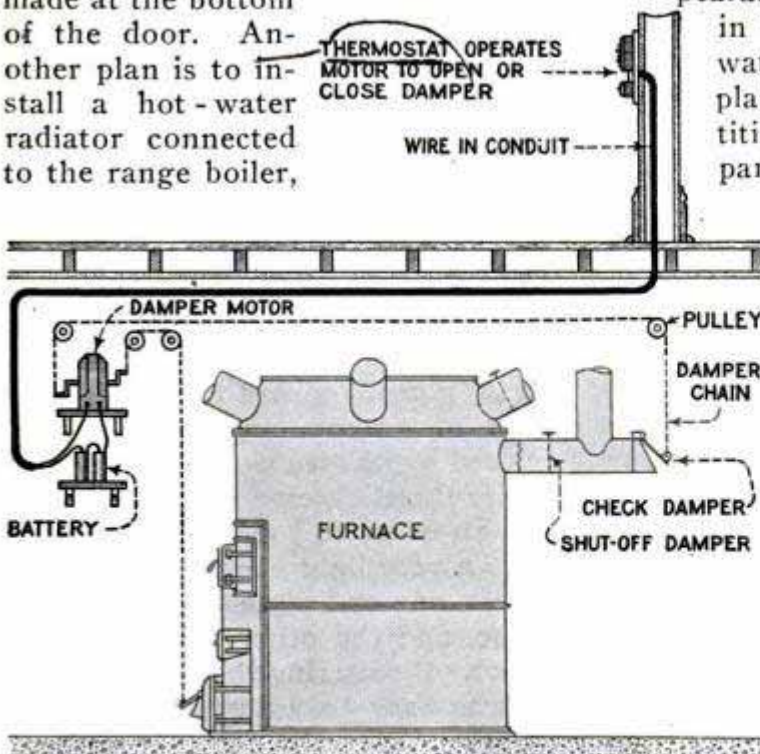

Fig. 6

Reducing the Number of Trips to the Cellar in a Day, and Keeping the Temperature at a Constant Figure, a Thermostat Installation Is Well Worth While

as shown in Fig. 4; if there is sufficient space, and there is no objection to the appearance, the range boiler may be located in the bathroom and connected to a water coil in the furnace. Still another plan is shown in Fig. 5, in which a partition is fitted to the furnace, and a part of the hot air led to a register in the bathroom by a regular leader pipe. There should be a damper in the leader pipe, so that all the heat can be sent to the rest of the house when heat is not needed for the bathroom.

An automatic thermostat (Fig. 6). for controlling the furnace drafts, will not only prove of great convenience, but will be found a fuel saver. These devices consist of a thermostat in one of the living rooms, which controls a clockwork motor mounted near the furnace, and this motor, in turn, controls the ash-pit and check drafts. When adjusted and set, the thermostat will open and close the drafts all day to main-

tain a certain temperature, and many models can be set so as to keep the house at a lower temperature during the night, and to open the drafts to raise the temperature in the morning. These devices save fuel and frequent trips to the furnace and they also serve to keep the temperature in the house much more uniform than can be done with the infrequent manual attention usually given the fire.

However, in cases where certain kinds of soft coal are burned in the furnace, the use of a thermostat of this type is impractical, since the fire must be broken up at regular intervals, due to the caking and swelling of the coal, and, if the fire must be attended to in this manner, the dampers can be adjusted at the same time, but with the majority of coals and coke, the use of the thermostat will be attended with greater fuel efficiency and increased comfort in the house.

A Portable Hog Corral

The problem of transporting hogs from field to field by means of a portable corral was solved by two farmers as shown in the illustration. The inclosure is made of 1 by 6-in. boards and is triangular in shape, with one side hinged so that it can be used as a gate. Three wheels, two on one side and one at the apex, allow just sufficient clearance for the corral to be readily pushed over the ground. Since using this method, hogs have been easily

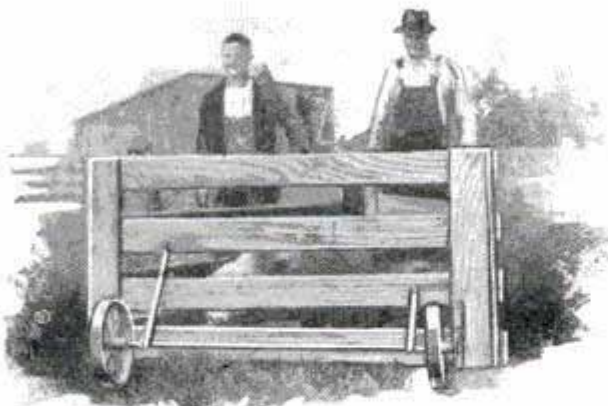

Portable Pen in Which Hogs Are Transported from Place to Place

moved over a plank bridge from which, with ordinary driving methods, the animals were frequently frightened into the creek and drowned.—Mel Wharton, Portland, Oreg.

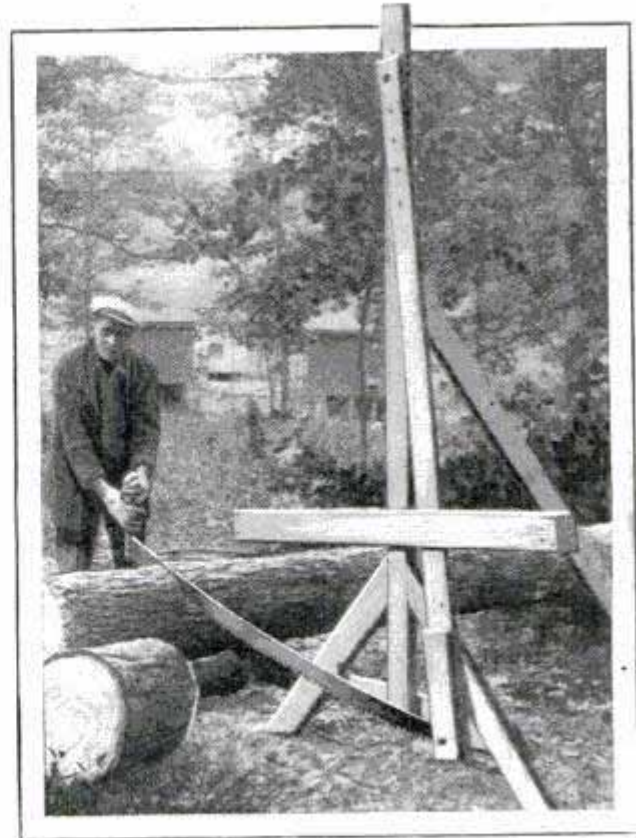

By Actual Test This Sawing Outfit Has Been Found to Do the Work of Two Men

One-Man Saw Outfit

This one-man saw outfit was made in two hours at a cost of 50 cents for material. The entire frame, including the pendulum, is made of 2 by 4-in. material. The pendulum works in a slide to prevent vibration and is adjustable in length for various sizes of timber by means of the holes bored in the upper end. This saw rig, by actual test, did the work of two men with a crosscut saw. It folds up like a pocketknife and is easily moved from log to log by one man. Also, it is adjustable to uneven ground.—E. Ellsworth Claspby, Lewiston, Pa.

Fill Tractor Tank with Kerosene to Prevent Rusting

When our tractor is placed in the shed for the winter, or at other times when it is not in use for several weeks, we fill the fuel tank with kerosene. Formerly this was not done and we often had trouble with rust getting into the pipe line to the carburetor. The rust forms on the inside of the tank, drops to the bottom and, as soon as the tank is filled, it washes along into the carburetor line.—Wendell N. Mitchell, Rogers, Nebr.

Ferrotyping Prints

When ferrotyping prints it will be found that a large percentage of the surplus water can be absorbed by a large piece of



Large Piece of Oilcloth Absorbs Surplus Moisture from Ferrotyped Prints

oilcloth and the prints will then dry much more quickly. Such a piece of oilcloth is much handier to use than blotters and costs less.—Auguste Mathieu, Chicago, Ill.

Motorcycle Engine Makes Good Air Compressor

A discarded single-cylinder motorcycle engine can be readily converted into an efficient air compressor by making only a few changes in the operating mechanism. In most cases it will be found that the compression, though rather high, is not sufficient to inflate a large storage tank to 150 lb. or more, but this difficulty is easily overcome. Take the motor apart and get a plate of brass, or other similar metal, about $\frac{1}{4}$ in. thick. Cut a disk out of this a

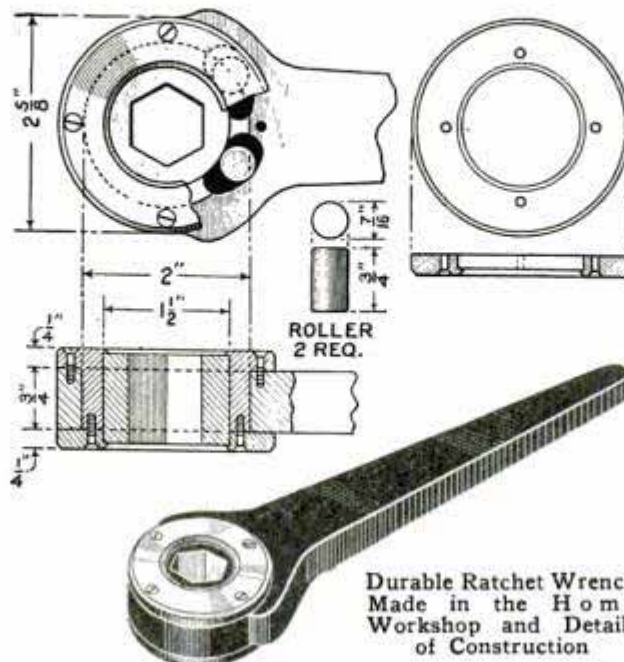

few thousandths of an inch smaller in diameter than the diameter of the cylinder, and fasten it to the piston head with machine screws that have their flat heads counter-sunk below the surface. This should raise the compression to the proper point, but if it does not, thicker metal must be used depending on the amount of space left between the top of the piston and the cylinder head. Remove the pushrod that operates the exhaust valve and discard it. Also remove the spring and the operating mechanism of the intake valve. Grind both valves carefully and replace the intake spring with a lighter and weaker one, which will open automatically on the suction stroke of the piston. New piston rings should be installed if necessary. Then reassemble the motor, connect the air line to the spark-plug hole and insert a check valve somewhere in the line near the compressor. Mount the engine conveniently to the power supply and, if the compressor originally was one of the belt-driven machines, the original pulley will still serve its purpose. If the engine was equipped with a sprocket, this should be removed and a flat pulley substituted. Plenty of good oil should be provided in the crankcase at all times to give lubrication, and a glass oil cup may be installed on the side to show the height of the oil.

Homemade Ratchet Wrench

A handy set of ratchet wrenches can be made up by the home mechanic. Good steel, which is capable of being oil-tempered, should be used for this purpose. The sockets are hardened, but the handle is left normal. The rollers, which take the place of the usual ratchet and pawl, are also hardened. In use, a very slight back movement will release the rollers, yet they grip firmly.

—Arthman N. Capron, Athelstan, P. Q. Canada.

Durable Ratchet Wrench
Made in the Home
Workshop and Details
of Construction

HINTS FOR BUILDER AND HOME OWNER



Utensil Racks above Sink, Fitted with Cup Hooks, Add to Kitchen Convenience and Please the Housewife

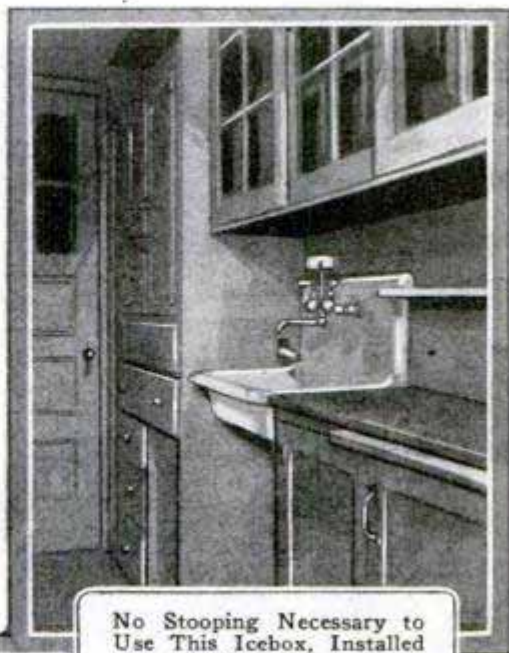

No Stooping Necessary to Use This Icebox, Installed above a Kitchen Casing, and Draining into the Sink

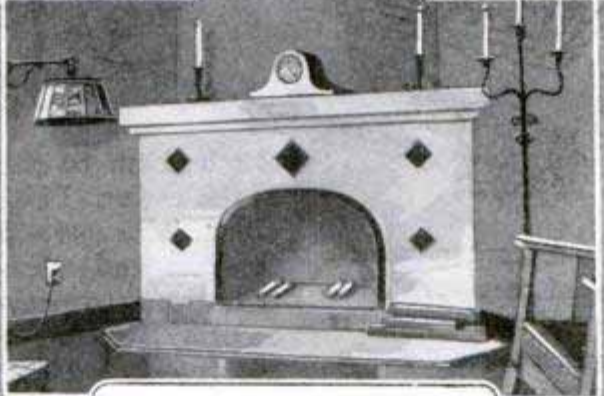

Four Ordinary Window Weights, Shown on Hearth, Serve Just as Well for Wood Burning as Costly Andirons

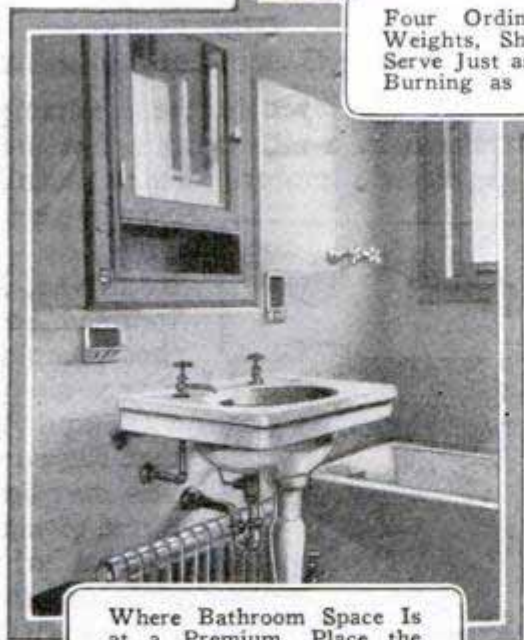

Where Bathroom Space is at a Premium, Place the Radiator Back of the Wash-bowl as Shown



The Lower Ends of the Shelves Are Notched over a Rail Which Is Fastened to the Wall like Trim

Sliding Drain Pan for Service Station

In a new drain pit just constructed at Wahoo, Nebr., a special sliding drain pan was installed to facilitate the handling of the used oil taken from

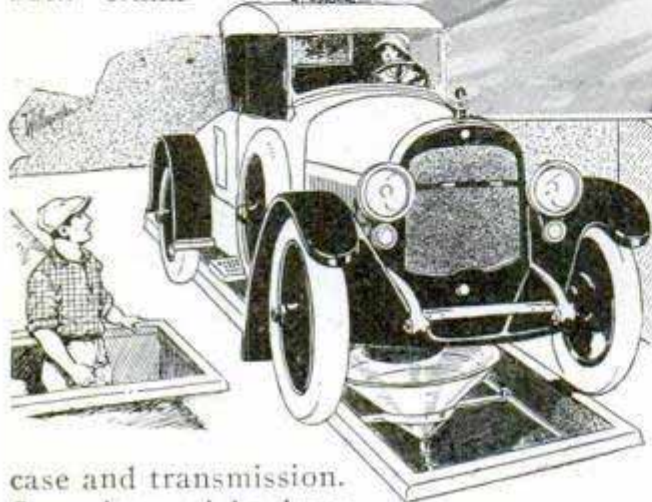

both crankcase and transmission. Strap-iron side bars are fastened to both sides of the pit, as shown, and sliding brackets are welded to an iron ring 26 in. in diameter, which holds a large funnel-shaped receiver. This can readily be moved directly under either the crankcase or the transmission drain. The funnel fits into the elbow of a 2-in. pipe leading back into the end of the pit through another pipe, which in turn extends 8 ft. underground to a receiving tank at the bottom of the pit. The service man enters the pit through a trap at the side rather than at the end. Both trap and pit are provided with covers.—Ralph W. McPherson, Wahoo, Nebr.

Imitation Marble Tiles

To prepare imitation marble finishes for decorative purposes, cut pieces of fiber wallboard into squares of the desired size and round off the edges with a sandpaper block, then coat the squares with white or colored paint and allow them to dry. A pan large enough to hold the squares is partly filled with water. On the surface of the water drop some ordinary but rather thin-mixed oil paint the color of

the veining. It will be found that the paint will distribute itself over the surface of the water in all sorts of irregular shapes. Now take the squares, one at a time, and, holding them by diagonally opposite corners, just

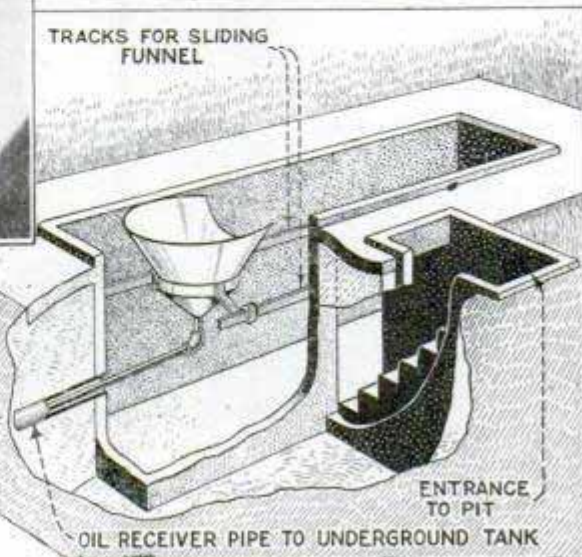

Novel Sliding Drain Pan in Oil Pit at Auto-Service Station Facilitates the Removal of Crankcase and Transmission Oil

touch them to the paint-covered surface of the water. This will produce the veined effect. Remove the squares, turn them face up and allow them to dry. There is nothing to prevent a second treatment to produce veins of two or more different colors.—J. S. Hagans, Chicago, Ill.

Making Gauze Motor Brushes

Being employed in the mechanical department of a mill using a few low-voltage electric motors, which usually are equipped with copper-gauze brushes, I constructed some of these, employing a very simple device, and believe that the construction may be of interest to many. A piece of cold-rolled steel shafting of suitable diameter was obtained for the forming die. This was cut

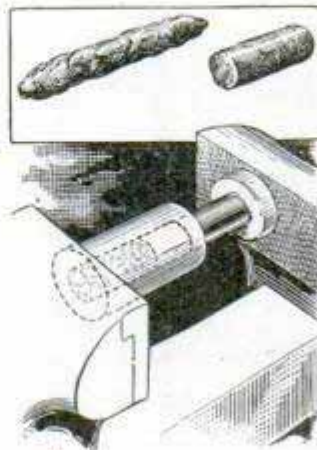

about three times the length of the brush

and its ends squared. A hole of the same cross section and size as the brush was drilled entirely through this shafting. A punch was turned to make a sliding fit in this hole, its length from the shoulder to the end being made equal to that of the die minus the length of the brush. The material for the brush was flexible lamp-cord of suitable size, from which the insulation was removed. The wire was wadded up so that it could readily be forced into the die. The wad was placed in the die, the punch started, and the whole placed between the jaws of a vise and screwed up until the shoulder of the punch rested against the end of the die. The finished brush is pushed out of the die by means of a suitable drift. It is well to keep both the die and the punch well lubricated.—W. J. Edmonds, Whitehall, New York.

Wrench Attachment for Catching Nuts

A simple device for preventing the loss of nuts when dismantling or assembling machinery is shown in the illustration. It is, of course, always undesirable to drop small pieces like these into other parts of the machine where they can hardly be

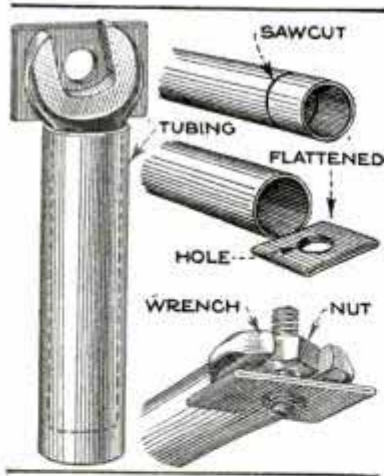

extricated and may cause trouble if left. Such trouble can be prevented by the use of the wrench attachment shown in the illustration. It is made from a short length

of brass tubing, first sawed nearly through at one end and flattened out; then a hole is drilled through the flat part. This hole clears the end of the bolt if it happens to project through the nut. No particular care is required when using this attachment, as the nut drops on the flattened end when released from the bolt.

☛ Graphite and oil will arrest cutting in bronze bearings when oil alone will not.



Wooden Pump Handle and Bracket Found Satisfactory in Emergency

Emergency Repair for Pump Handle

When the bracket on which the pump handle was pivoted broke off, the emergency repair shown in the illustration was adopted and found entirely satisfactory. Two pieces of 1 by 4-in. boards served as a standard, on the end of which a wooden handle was pivoted. This support was braced at the bottom and fastened securely to the wooden platform of the pump. The emergency handle thus made was found just as useful and convenient as the original.—L. M. Jordan, Vredenburgh, Alabama.

Handy Basting-Thread Pick

Tailors and seamstresses will find the alteration on a thimble shown in the illustration very handy for removing basting threads. An angular cut is made through the end of a common thimble and the piece is bent outward. With the thimble worn on the middle finger, the projecting point can readily be inserted under the stitches to be removed.—G. E. Hendrickson, Argyle, Wis.



Spring-Winding Arbor

To wind an odd-shaped spring, such as shown in the illustration, is not difficult, but how to get it off the arbor is perplexing.

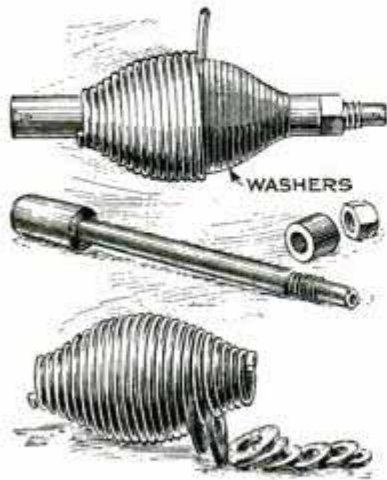

We had a large number of these springs to wind and the work was done in the following way: The arbor was turned down a little, as shown, in the center and $\frac{1}{16}$ -in. washers

were slipped on and held by a nut. The assembly was then put in a lathe and the washers turned down to the shape desired for the coil. After a spring had been wound, the arbor was removed from the lathe and the nut unscrewed. It was then an easy matter to slip the washers out of the spring as indicated in the lower detail. For convenience in reassembling, the washers should be numbered. — Charles Kugler, Philadelphia, Pa.

Lift for Handling Auto Hood

Handling the hood of an auto while working on the engine is something of a problem to many auto mechanics since it is easily marred and, if large, difficult to handle for one man, without damaging either the hood or the fenders. Four pieces of heavy wire or light round stock, shaped as shown in the detail and each measuring about 36 in. from eye to hook, form a sling and are strung together with a strong rope, which runs over a pulley as indicated. In use, the hooks

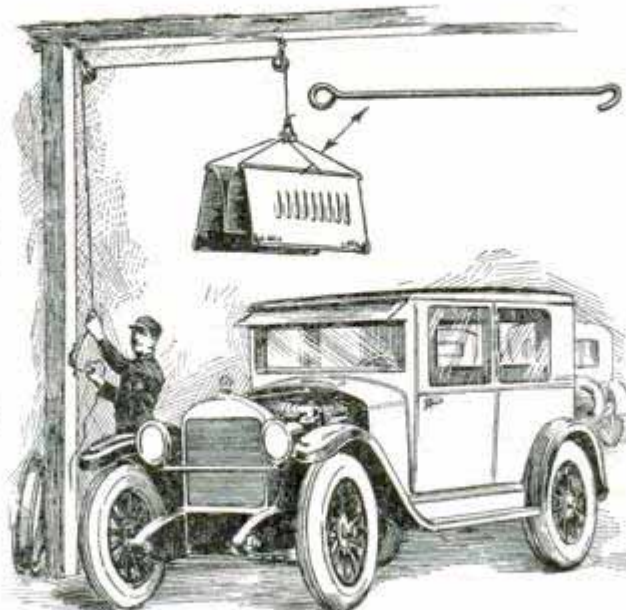

Lifting Auto Hood Entirely Out of the Way to Prevent Marring It

are slipped under the edges of the cover and it is then pulled up and out of the way, the rope being fastened securely. — G. C. Douglas, Raleigh, N. C.

Sensitive Depth Gauge

All regular-type depth gauges have one fault; it is impossible to tell if the depth being measured is more than the setting of the gauge. This does not apply, of course, in the case of parts where the

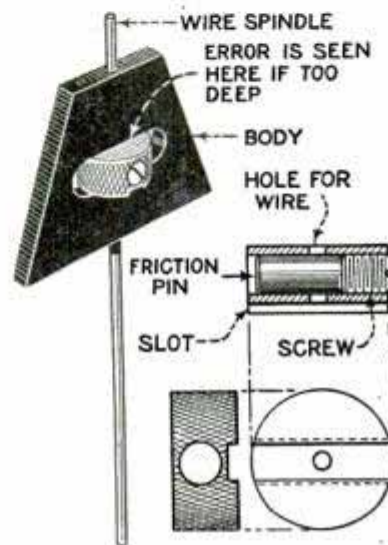

depth can be seen, nor is it a disadvantage where only one part is being measured, but when a depth gauge is used for inspecting a number of pieces, it is set to the correct depth and, if the work is too shallow, the

body of the gauge will stand clear of the work. If the body of the gauge touches the work, however, there is no means of telling how deep the part is without altering the setting of the spindle. The sensitive gauge shown is particularly adapted for inspection work, because it not only

measures the depth to which it is set, but also shows if the part is deeper, and how much. The body is made of $\frac{3}{16}$ -in. flat stock and the wire spindle is $\frac{3}{32}$ in. thick. A slot is cut in the center of the body to receive a special tightening collar, which is a knurled round piece, drilled in the center for the wire spindle, through the side for a friction pin, and is also drilled and tapped for a set-

screw. The friction pin is drilled to receive the wire spindle also. The bottom of the tightening collar is slotted, to clear the width of the body about $\frac{3}{16}$ in. When setting the gauge to depth, the collar is turned with the slot at right angles to the body, but, in use, the slot is turned back in line. The body of the gauge will stand clear of the top surface of the work in the ordinary way if the depth is too shallow, but if the hole is too deep, the spindle will drop down and show the extent of the error between the top of the tightening collar and the slot. If the hole is correct, there is no play in the spindle and the body of the gauge rests on the work.—Harry Moore, Montreal, Can.

Tightening Storage-Battery Terminals

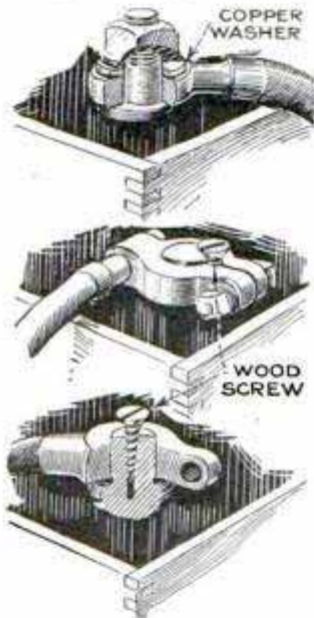

Storage - battery terminals must be kept tight to prevent them from loosening due to constant vibration. When the nut cannot be screwed down any more because of the shoulder on the terminal one or more copper washers under the nut will often remedy the trouble. Another method of tightening the lug on the terminal is

to drive down a small wood screw into the terminal or between the lug and the terminal, as shown in the two lower figures of the illustration. This acts as a wedge and spreads the terminal, taking up all the play between the lug and terminal. Even a nail will serve if a screw should happen not to be at hand.—G. A. Luers, Washington, D. C.

April is the best month of the year in which to hatch Leghorns and other light breeds of poultry.

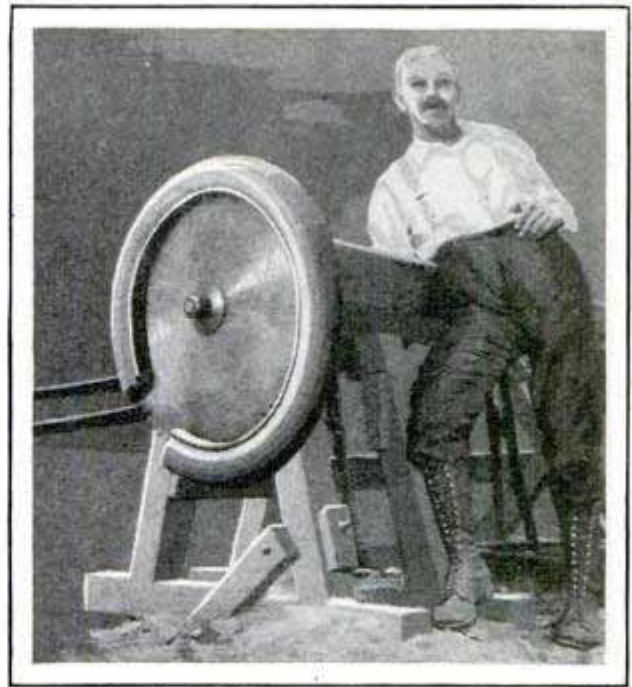

Old Auto Casings Slipped over Large Circular Saws Offer Protection

Casing Protects Circular Saw

Old automobile casings will be found useful around woodworking plants, mills and in farm shops having large circular saws. Cut the casing as shown in the photo so that it can be slipped over the saw easily. This not only protects the saw but also prevents anyone from getting hurt while the saw is not in use.—J. B. Tate, Mokelumne Hill, Calif.

Handy Graduation for Calipers

Calipers will be found much handier if graduated as illustrated. The points are first set to the desired dimensions and lines are scratched on one side with the scribes. The other arm should be beveled. The dimensions should be stamped or deeply etched so as not to become unreadable.—C. D. Zellar, Chicago, Ill.



IN accordance with the editorial policy of this magazine never to accept compensation in any form for what appears in our reading pages, and also to avoid the appearance of doing so, we are obliged to omit the name of the maker or the seller of any article described. This information, however, is kept on file and will be furnished free, by addressing Bureau of Information, Popular Mechanics Magazine, Chicago.

236

Is This Your Home?



Copyright, Architects' Small House Service Bureau



Plan No. 4B14

QUESTIONS regarding home building addressed to this magazine will be answered by The Architects' Small House Service Bureau of the United States, Inc., controlled by the American Institute of Architects and endorsed by the United States department of commerce. Inclose 10c and self-addressed envelope. Blueprints, specifications and material list for the house shown here may be obtained at nominal cost. Inclose self-addressed stamped envelope for reply. If further information is desired, send 5c and stamped envelope for a 24-page booklet explaining how the Small House Service Bureau functions and showing 12 sample plans. A new booklet, entitled "Fifty Ways to Lower Home Building Costs," illustrated by ten bureau houses actually lived in, and showing how as much as \$1,000 can be saved on a home, may be obtained for 20 cents.

THIS four-room bungalow is an unusually fine example of the home that is all on one floor. Although of a conservative style, it has many individual features.

The porch may be inclosed as an extra room, or left open with trellises for trimming. In either case, it is within the main body of the house, and gives protection to the entrance door.

The working drawings for this design provide two methods of locating the partitions. One allows for a dining alcove and the other for a dining room approximately nine by twelve feet. There are many people who consider a formal dining room essential, and this alternate arrangement was worked out so that anyone who wanted a larger dining space than the dining alcove provided in the original plan, could build from this design. The one set of plans provides for both these arrangements, however.

The rooms open into each other in a convenient manner. The living room, approximately seventeen by thirteen feet, has windows on two sides and a handsome

fireplace at one end. A closet opens from the living room. In the alternate plan the living room and dining room are almost one large room, because of the wide opening between them.

The kitchen is arranged for the greatest efficiency, with plenty of cupboard room and everything within easy reach.

The two bedrooms and bath open from a small hall. Each bedroom has a large clothes closet, and there is a linen closet in the bathroom.

Home Builders' Questions

Q. How much extra will it cost to add a fireplace to our house while building? Can much be saved by building an inside fireplace instead of an outside one? **A.** The extra cost for a fireplace ranges between \$250 and \$400, depending on how many flues it contains, its size, height, the design of the mantel, and so on. An inside fireplace saves the difference in cost between face brick and common brick for that part of the stack which is within the house above grade.

Q. What is the ideal exposure for the different rooms of an ordinary house? **A.** The living room and living porch should be to the south or southwest, the dining room should have an eastern exposure for morning light, the principal bedrooms should have advantage of the best summer breeze. The best outlook from the living rooms should be given much consideration in arranging the rooms and facing the house.

Stands abuse and follows through



Use "Yankee" Bit Extension in a "Yankee" No. 2100 Brace—a combination of the two finest tools of their kinds.

"YANKEE" Bit Extension is *new!* Bit held by socket. No jaws to break. No loosening and pulling out of bit in work. No trouble to "follow through." And bit in "Yankee" Socket can't jam.

"YANKEE" No. 2150

Bit Extension

Lengths: 15, 18, 21, and 24 inches.

Full nickel-plate finish. Holds large range of bit shanks.

Ask your hardware dealer to show you this new "Yankee" Tool for saving time and labor.

"YANKEE"

Christmas Suggestions

No. 1530	Ratchet Hand Drill
No. 30-A	Spiral Ratchet Screw-driver
No. 41	Automatic Push Drill
No. 1555	Ratchet Breast Drill
No. 90 or 95	Plain Screw-drivers
No. 1992	Vise with Swivel Base
No. 2100	Ratchet Bit Brace
No. 10 and 15	Ratchet Screw-drivers

Dealers everywhere sell "YANKEE" Tools

"Yankee" on the tool you buy means the utmost in quality, efficiency and durability.

Write for Free "Yankee" Tool Book

This interesting little book is for all lovers of fine tools. It tells just what you want to know about all the famous "Yankee" Tools. Write for your copy today.

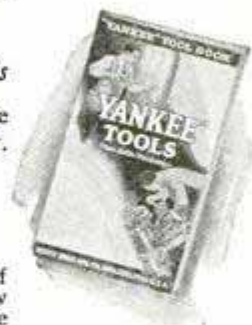

NORTH BROS. MFG. Co., Philadelphia, U. S. A.

"YANKEE" TOOLS

Make Better mechanics



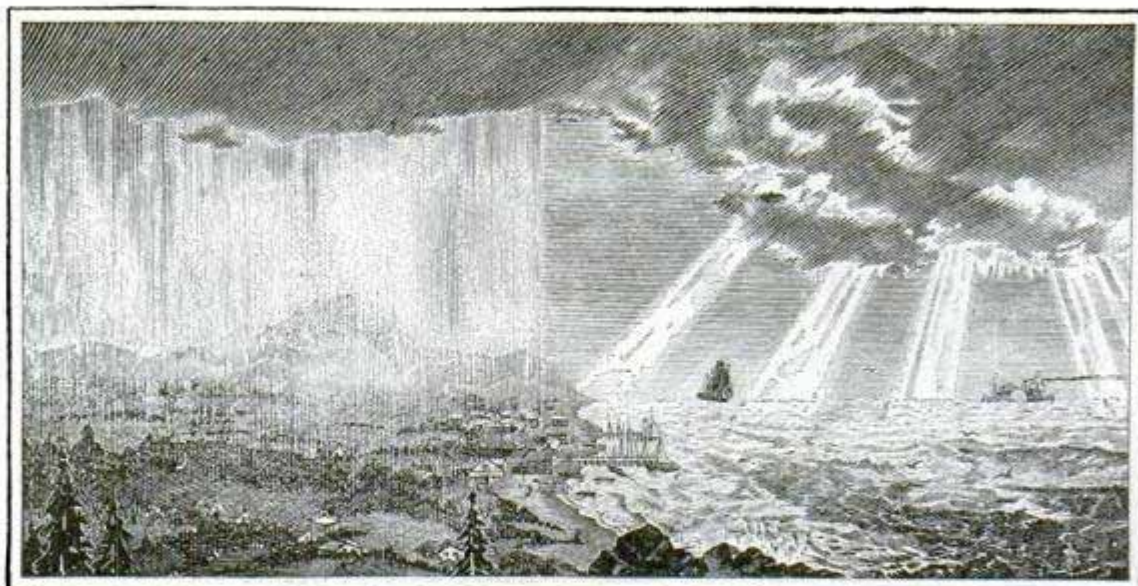

Rain and Telephone Calls

THE annual rain fall in the United States would weigh over three and one-half trillions of tons.

This vast weight is drawn up to the clouds by the unseen but effective power of the sun; representing energy equivalent to 300 billion horse-power.

The annual telephone conversations total over twenty-five billion a year. As silently as sunlight, electricity, mastered by the human mind, carries the voices of the nation.

There must be the man-power of 300,000 individuals to build, maintain and operate the telephone system.

There must be the money-power of over seven hundred million dollars a year to pay for operating the plant, in addition to three billion dollars invested in the plant.

The rain sustains life; the telephone furnishes swift communication for the nation, and they are alike in requiring a vast amount of unseen energy.

AMERICAN TELEPHONE AND TELEGRAPH COMPANY
AND ASSOCIATED COMPANIES

BELL



SYSTEM

IN ITS SEMI-CENTENNIAL YEAR THE BELL SYSTEM LOOKS FORWARD
TO CONTINUED PROGRESS IN TELEPHONE COMMUNICATION

Hammer Heads *do* Loosen

But!
You can
tighten →
 a **PLUMB**

*Just a turn of
 the screw makes
 it tight again*

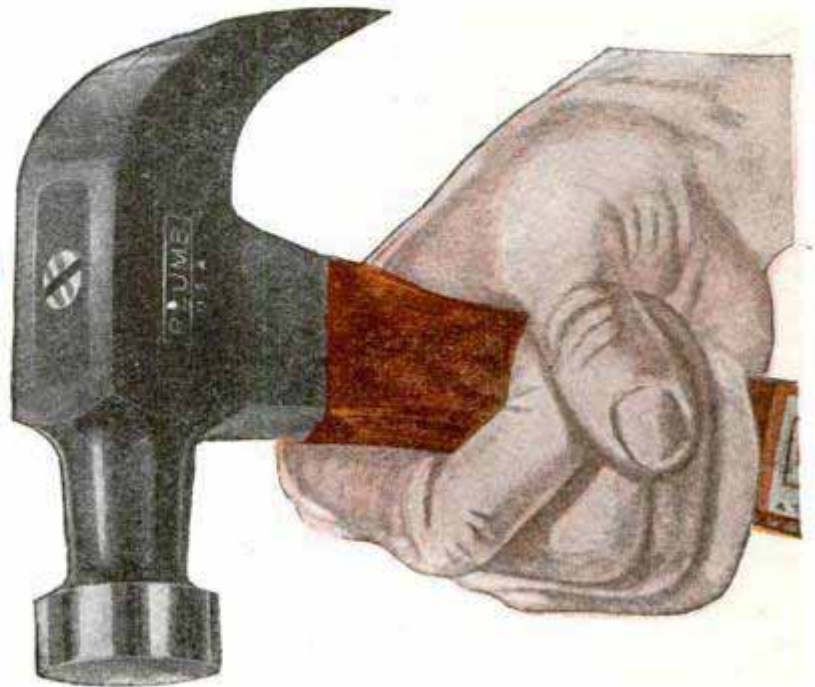

WOOD will shrink. You know what happens to your chairs and tables.

It is the same with tool handles. No matter how tightly a new hammer is wedged—when the wood shrinks the handle will loosen and the head will wobble.

Plumb studied this problem for years. And finally solved it.... with a wedge that does this: When a Plumb handle loosens you take a screw driver, turn the screw wedge,

— and your hammer is tight again.

That is all you do.... just turn the screw and the handle is tight as new.

This remarkable invention does away with loose handles. It gives you a tool that is always balanced, always safe to swing.

All Plumb Tools (and no others) have this patented screw wedge. Good hardware stores everywhere sell Plumb Hammers, Hatchets, Axes and Sledges.

FAYETTE R. PLUMB, Inc., Philadelphia, U. S. A.

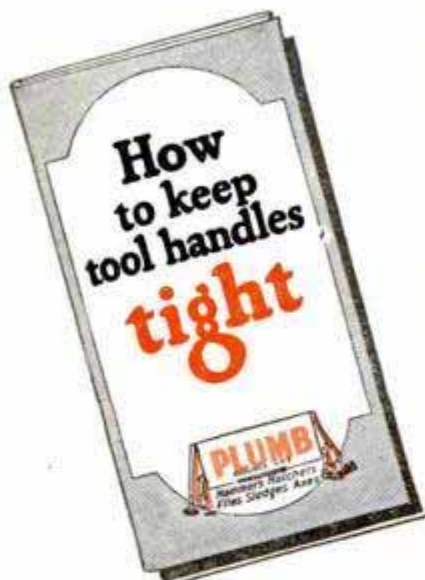

It's Free

Write for this free booklet telling the story of a remarkable invention that does away with loose handles on tools.

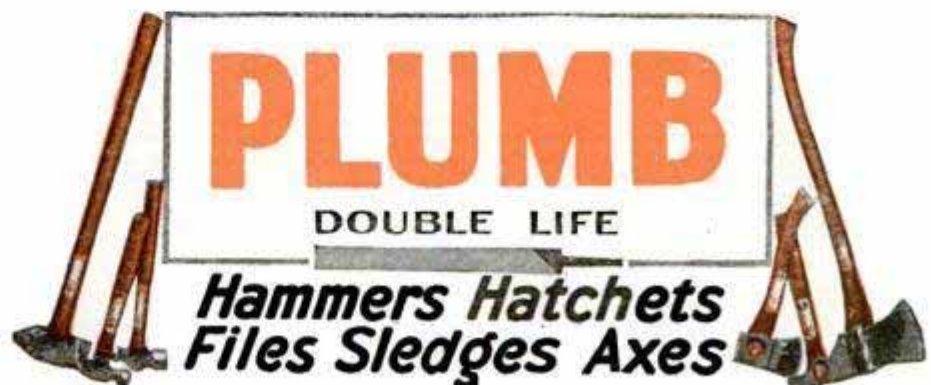



A Christmas tip from the carpenter

LOOK at any fine piece of carpentry work. The finish comes largely from the skill of the carpenter, of course. But there's something else. Look into his kit. You'll see not only an adequate number of tools, but you'll find them all *fine* tools, many carrying the Stanley name.

Right there is a Christmas tip from the carpenter—a chest of Stanley Tools this year for some man or boy! A fine assortment of tools and all good tools—the right set for repair work or the making of such things as book cases, dog houses, and other useful articles. The sturdy oak chest keeps the tools safe and handy. A Stanley Tool Chest is a complete gift.

STANLEY

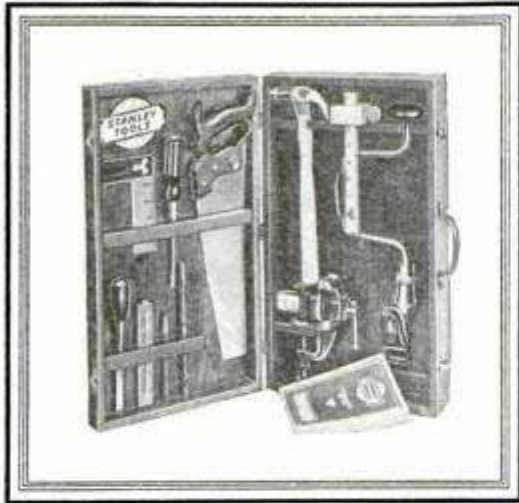

No. 904 Tool Set



No. 860 Work Bench and Tool Cabinet

Buy separately or in assortments

You will find Stanley Tool sets at a wide range of prices and in a wide variety of assortments—from No. 904 with 12 tools in a fine oak chest at \$15, to No. 850 with 49 tools in a beautiful cabinet at \$95.

There are also assortments of the same Stanley Tools in cardboard display boxes *with simple directions from which the recipient can make his own chest*. There are several of these “Make Your Own Chest” assortments, at prices from \$5 to \$20.

There's a Stanley Tool Set to fit every pocket-book!

Ask your hardware dealer to show you the line of Stanley Tools. And send for our Catalogue No. 34-D which describes Stanley Tools both separately and in assortments. Address: The Stanley Works, New Britain, Conn.



No. 907 Tool Set



No. 902 Tool Set

The best tools are the cheapest to use

Ask your hardware dealer

TOOLS

As if by Magic!

—you can run your "Lionel Standard" Train at various speeds, stop it and reverse it by manipulating a small lever placed at any distance from the track. *As if by magic*—your Lionel Automatic Train Control will start and reverse your Lionel Train without being touched by hand, and *as if by magic*—you can switch your "Lionel Standard" Train from track to track with the new Lionel Electric Switches by manipulating another small lever placed at any distance from the track.

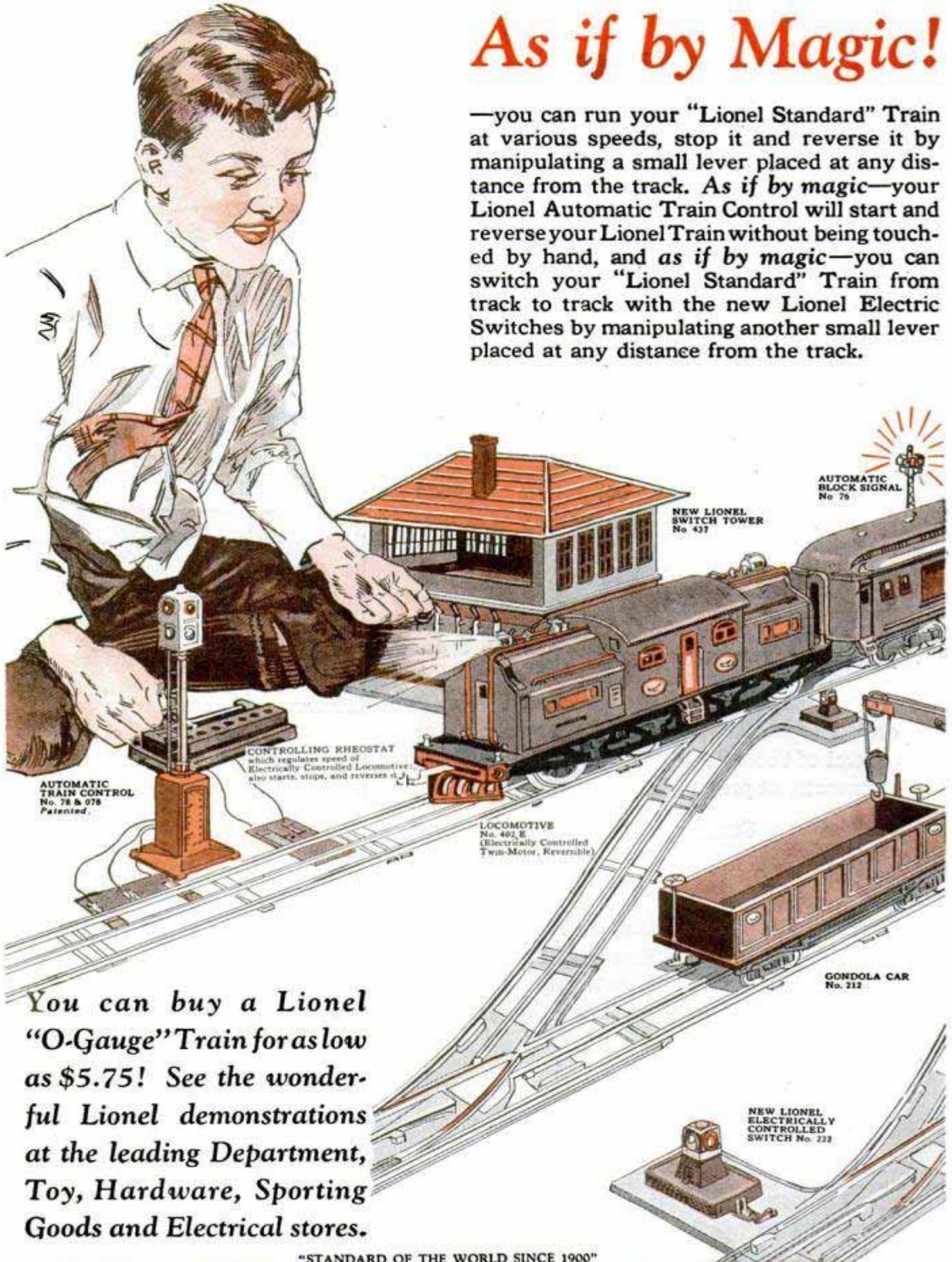

AUTOMATIC TRAIN CONTROL No. 78 & 078 Patented

CONTROLLING RHEOSTAT which regulates speed of Electrically Controlled Locomotive; also starts, stops, and reverses it.

NEW LIONEL SWITCH TOWER No. 437

AUTOMATIC BLOCK SIGNAL No. 79

LOCOMOTIVE No. 462, E (Electrically Controlled Twin-Motor, Reversible)

GONDOLA CAR No. 212

NEW LIONEL ELECTRICALLY CONTROLLED SWITCH No. 222

You can buy a Lionel "O-Gauge" Train for as low as \$5.75! See the wonderful Lionel demonstrations at the leading Department, Toy, Hardware, Sporting Goods and Electrical stores.

"STANDARD OF THE WORLD SINCE 1900"

LIONEL ELECTRIC TRAINS

MODEL RAILROAD ACCESSORIES

"MULTIVOLT" TRANSFORMERS

The New Lionel 100% Electrically Controlled Railroad
(for "Lionel Standard" Track)
is the Supreme Achievement in Model Railroading!

Lionel Trains and equipment have been "Standard of the World" since 1900. And now, after years of experiment, Lionel engineers have accomplished the greatest achievement in the history of model railroading by creating The New Lionel 100% Electrically Controlled Railroad for "Lionel Standard" track.

Lionel makes the most complete and perfect line of model Passenger and Freight

trains in the world,—both electrically controlled and hand-controlled for "Lionel Standard" track; and hand-controlled for "O-Gauge" Track. Lionel Trains are *real* in everything except size; every piece beautiful in design, perfect in construction, and fully guaranteed. They contain hundreds of improvements and refinements not found in other lines. Yet Lionel Trains are the lowest in price consistent with supreme quality.

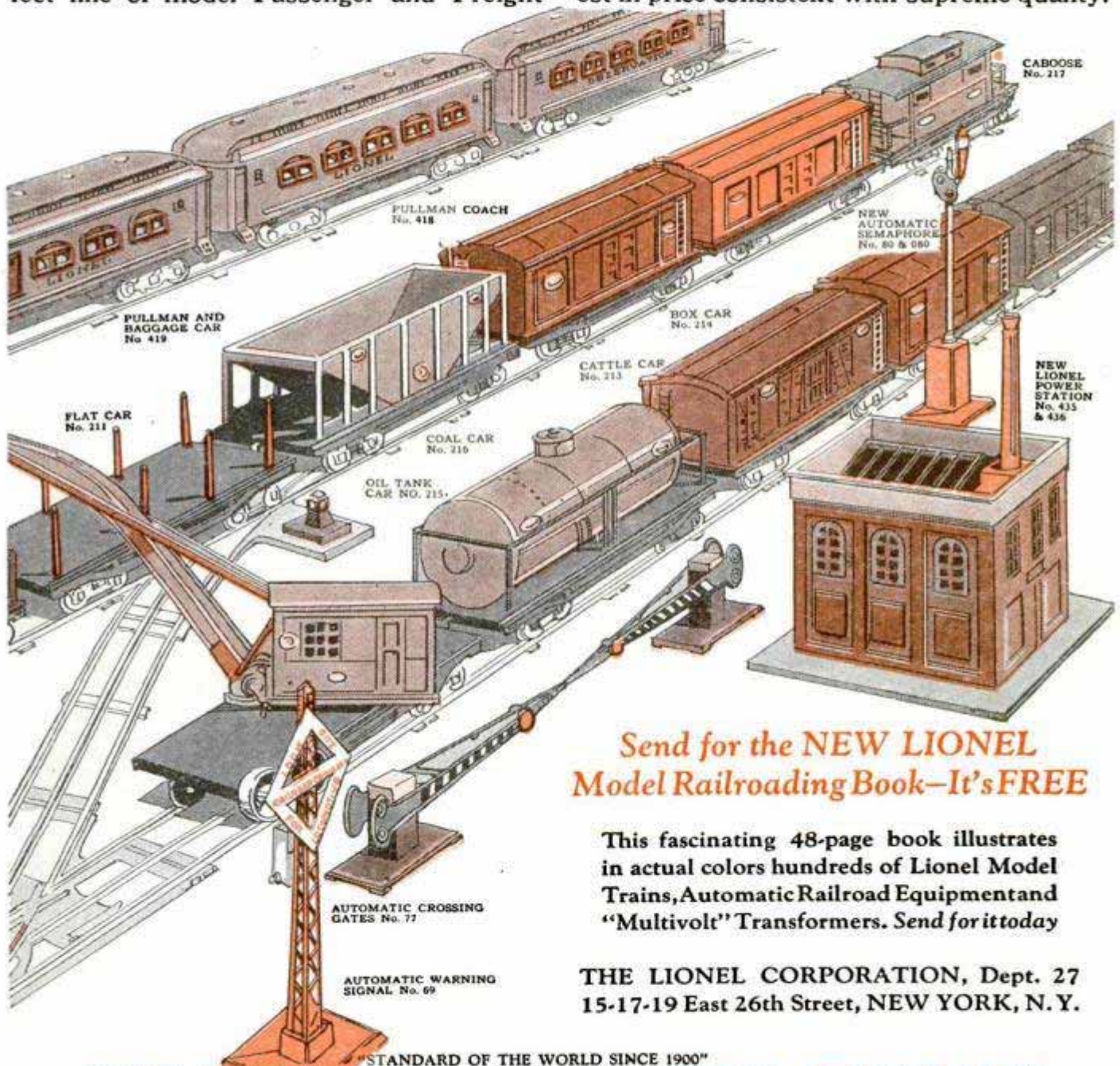

Send for the **NEW LIONEL**
Model Railroading Book—It's FREE

This fascinating 48-page book illustrates in actual colors hundreds of Lionel Model Trains, Automatic Railroad Equipment and "Multivolt" Transformers. *Send for it today*

THE LIONEL CORPORATION, Dept. 27
15-17-19 East 26th Street, NEW YORK, N. Y.

"STANDARD OF THE WORLD SINCE 1900"
LIONEL ELECTRIC TRAINS
MODEL RAILROAD ACCESSORIES
"MULTIVOLT" TRANSFORMERS

HERE'S THE SOLUTION



\$2
Brings Your Choice



N50—Gent's 18k. white gold ring, extra heavy; blue sapphire in center; 2 blue-white diamonds. Price—\$57.50—\$5.55 a month.



N51—Ladies' 18k. white gold ring, beautifully designed; furnished with AAA quality blue-white diamond—Price \$50.00—\$4.80 a month.



N52—Ladies' 18k. white gold ring; 2 blue-white diamonds in shank, large AAA blue-white diamond in center—\$39.50—\$3.75 a month.



N53—Ladies' 18k. white gold ring, lace-work design, with 3 blue-white diamonds—\$29.50—\$2.75 a month.



N54—Artistic floral design in ladies' 18k. white gold ring, with AAA quality blue-white diamond—\$42.50—\$4.05 a month.



N56—12size, 7-jewel Elgin Watch: 14k. gold-filled case with chain and 14k. gold-filled self-filler fountain pen. Complete—\$23.50—\$2.15 a month.



N55—A bargain in ladies' 18k. white gold ring, open lace-work design; AAA blue-white diamond—\$35.00—\$3.30 a month.



N57—Gent's Initial Ring, engraved design, 14k. solid white gold with genuine onyx and Old English initial in white gold. Any initial furnished—Price \$22.50—\$2.05 a month.



N58—Famous Bulova Gent's Strap Watch: 14k. gold-filled case, guaranteed 15-jewel movement—\$28.50—\$2.65 a month.



N59—18k. white gold birthstone Dinner Ring; lace-work design; your birthstone in center; 2 blue-white diamonds in heart form on each side. Mention birth month—\$45.00—\$4.30 a month.

L.W. SWEET Inc.
DEPT. 66-T 1660 BROADWAY NEW YORK

DIAMOND IMPORTERS AND MFG. JEWELERS

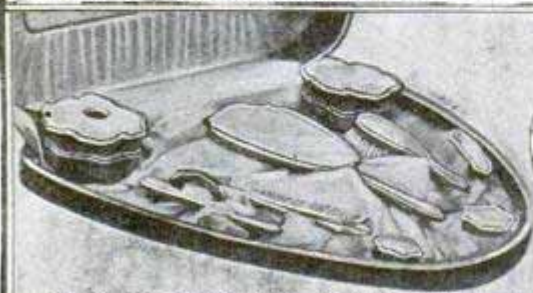

N60—A rare bargain in a 12-piece Pearloid-on-Ambertone Boudoir and Manicure Set. Complete in handsome silk-lined presentation box—\$29.50—\$2.75 a month.

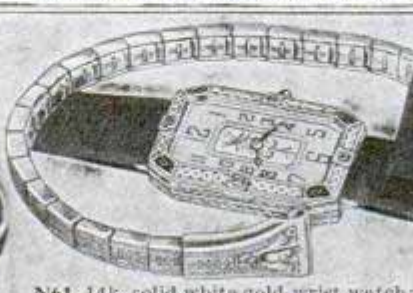

N61—14k. solid white gold wrist watch; 4 blue-white diamonds; 4 blue sapphires. 15-jewel movement, with expansion bracelet; complete in gift case—Price \$45.00—\$4.30 a month.



FREE!

Our Golden Jubilee Booklet, with over three thousand Bargains in Diamonds, Watches and Jewelry, will be sent FREE.

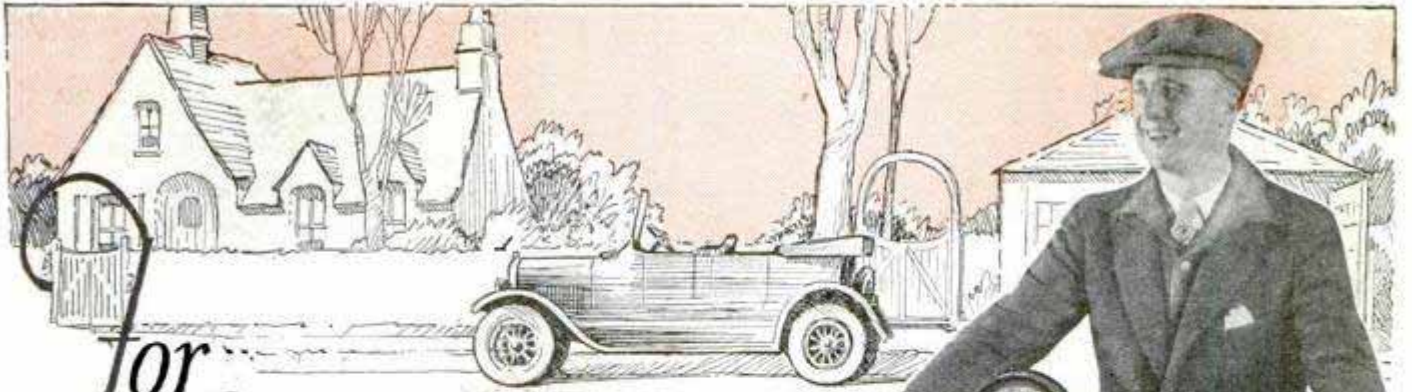

For Personal Errands

-Ride at 1¢ per Mile

WHY spend 7 to 10 cents per mile when the Harley-Davidson Single can be operated for one cent per mile?

This new-type motorcycle offers you the lowest cost power travel. It is even less expensive than riding on street cars!

Convenient, too. Always ready. Needs only 2 x 8 foot space — even the smallest garage has spare room for it. Travels 80 miles per gallon of gasoline. No radiator troubles. Dependable, safe, comfortable, economical the year 'round for business or pleasure.

Your dealer offers a convenience Pay-As-You-Ride Plan and the price of the Single, complete with three-speed transmission and full electric equipment, f. o. b. \$ **235** Milwaukee, is only

See your dealer — and mail us the coupon.

HARLEY-DAVIDSON MOTOR CO.
Department P. Milwaukee, Wis.

The HARLEY-DAVIDSON
[New-Type Motorcycle] **Single**

Easy to Ride
Safe

Mail Now!

HARLEY-DAVIDSON MOTOR CO.
Department P. Milwaukee, Wis.

Interested in your Single; send catalog and my dealer's name.

Interested in your dealer proposition. Is my territory open?

Name.....

Address.....

The Harley-Davidson Single is easier to ride and control than a bicycle — safe and dependable.



“Where’s your combination square?”

Any man that’s ever worked with a Starrett Combination Square can’t see how it’s possible for anybody else to try to get along without one.

And they are—those No. 94’s—just about the most useful tool in the chest. They replace seven separate tools—square, miter, height, depth and marking gages, rule, level and plumb—and they’ll do the work of each just a hair better than the original tool would do it.

If you haven’t a Starrett Combination Square in your chest now, your nearest good hardware dealer has one that he’ll part with—for a consideration. And it’s worth it. It’s also worth while writing us for a free copy of Catalog No. 23 “AP.”

THE L. S. STARRETT CO.

*World’s Greatest Toolmakers
Manufacturers of Hacksaws Unexcelled
Steel Tapes—Standard for Accuracy
ATHOL, MASS.*

Starrett
No. 94 Combination
Square



Use Starrett Tools

New! the
**MULTICOLOR
 MECCANO**



Special No. 3x Outfit—~~\$11.50~~
 Reduced to \$10.00

Has a powerful reversing electric motor and big book showing how to make over 200 models. Sent prepaid upon receipt of price if not at your dealer's.

Now you can build models in colors!

You've never seen anything like it, fellows! Look at the beautiful models on this page with their lustrous coloring—all made with the new Multicolor Meccano. Part after part gleams with brilliant colors, that's why the models are so realistic. And all the fine engineering quality for which Meccano has always been famous, is still there.

We wanted the best colors we could find so we selected Duco, the same genuine Duco that is used on the finest automobile bodies—you'll probably find it on Dad's new car. This gives a hard tile-like finish. And Duco-finished parts cannot rust.

Get the newest thing in construction toys. Building with Meccano is dead easy. No study required. Build your models in bright colors—flaming red for the Fire Engine, olive green for the Tank Car—only Multicolor Meccano gives you this, yet it costs no more.

You'll certainly give the gang a surprise when you display your up-to-the-minute Multicolor outfit. No more colorless, dull models for you—be a leader! This is the day of the new Multicolor Meccano.

There are sets from \$1.00 to \$45.00. Two dandy specials at \$5 and \$10 include motors. See them at your dealer's.

Send for This FREE BOOK

It's an interesting story entitled, "How Jack Discovered the Perfect Toy." It will tell you all about the new Multicolor Meccano. Sent free for your name and address and those of three of your chums. Put No. H-3 after your own name for reference.

MECCANO COMPANY, Inc., Div. H-3, Elizabeth, N. J.
 In Canada: Meccano, Ltd., 45 Colborne St., Toronto



TRADE MARK

REG.

WURLITZER

SUPREMACY IN MUSICAL INSTRUMENTS

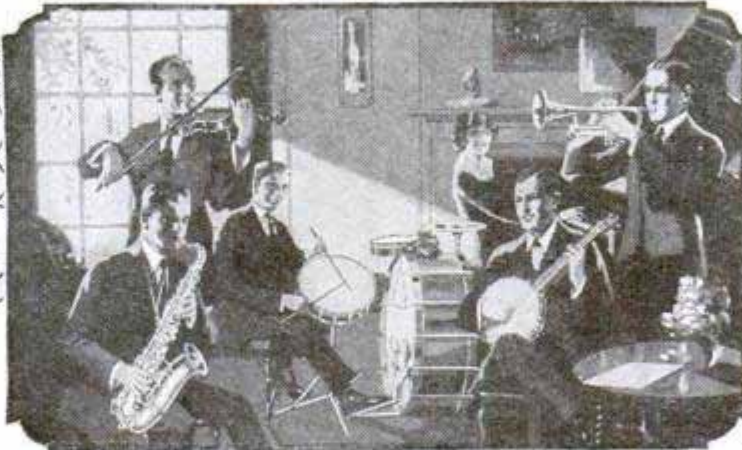

Learn to Play

You are always popular and sure of a good time if you can play some musical instrument. By yourself, with your friends around the piano, in orchestras or bands,—there is no end to the pleasure music will give you. And there is no easier way to earn money in your spare time. Choose your instrument now and let Wurlitzer help you buy it and learn to play it.

Try Any Instrument in Your Own Home At Our Expense

You may now have any known musical instrument for an ample free trial in your own home. There is no obligation to buy — no expense for the trial. You may return the instrument to us if you decide not to keep it.

Monthly Payments

The Wurlitzer plan makes it easy for you to own the instrument you want. Payments are conveniently arranged in small monthly sums — a few cents a day will pay.

Wurlitzer instruments are known everywhere for their unusual tone quality and excellence of workmanship. They are used by the greatest

professional musicians, bands and orchestras. Harry L. Jacobs of Sousa's Band, Brooke's Marine Band, and Chicago Grand Opera says: "I am proud to be the owner of one of your new cornets. It is positively superior to anything I have had in all my years of cornet playing."

Easy to Buy

Thousands of amateur musicians are playing on Wurlitzer instruments. Many of them could not have bought except through the Wurlitzer selling plan. Wurlitzer is the world's greatest music house, with stores and dealers in all parts of the country. But no matter where you live you will receive the same service by mail as though you lived next door to the factory. Send the coupon today.

Send for Free Catalog

The greatest musical catalog ever published. Over 3,000 articles—every known instrument described and illustrated—many of them shown in full color. Gives you all details of the Wurlitzer plan. Send coupon now.

The Rudolph Wurlitzer Co., Dept. 1779
117 E. 4th St., Cincinnati 329 S. Wabash Ave., Chicago
120 W. 42nd St., N. Y. 250 Stockton St., San Francisco

Send me absolutely free, your new illustrated catalog of musical instruments. Also tell me how I may try any instrument in my own home at your expense and how the Wurlitzer plan makes it easy for me to buy. No obligation.

Name _____
Address _____
City _____ State _____
Instrument _____
(State instrument in which you are interested.)



GREATEST VALUE EVER OFFERED

THE NEW IMPROVED INKOGRAPH

The Perfect Writing Instrument

\$2.98 FREE
10 DAYS TRIAL

Answers the purpose of both pen and pencil combined. Its point is shaped like a fine lead pencil point and writes with ink free and easy without a miss, skip or blur. The steady uniform flow of ink actually improves your handwriting. Won't blot, scratch, leak or soil hands.

Combines The Best Features

of pen and pencil, minus the weak points of both, plus improvements not found in either. The lead pencil smudges, the point breaks and its writing soon is obliterated. Most fountain pens skip, scratch, flood, clog, leak, blot, soil hands and clothing. The old stylographic ink pencil dries up, balks, blots, writes heavy, flows unevenly and is never reliable. The Inkograph feeds as fast and uniform on the 20th page as it did on the first.

Cannot Leak

Not the tiniest drop of ink will spill although one filling is sufficient to write thousands of words.

Makes 3 to 4 Carbon Copies

at one time with original copy in ink. Bear down as hard as you like, without fear of bending, spreading, injuring or distorting its 14Kt solid gold point.

Draws Lines to a Ruler

without smearing, smudging or blurring the paper. Writes with any color of ink.

Requires No Blotter

The ink dries as fast as you write, because the flow is fine, even and uniform.

Patent Automatic Feed

Prevents clogging. No complicated mechanism to clean or get out of order. A year's guarantee certificate with full directions accompanies each Inkograph and is your absolute protection.

An Instrument of Refinement

In appearance it is extremely attractive. It's beautifully highly polished finest quality of hard rubber, its **14Kt Solid gold point and feed, gold band on safety screw cap, gold self filling lever and gold clip** makes it an instrument of distinctive elegance and refinement. The equal in size, workmanship and material of any \$7, \$8 or \$9 fountain pen. Also made in ladies' size.

INKOGRAPH CO., Inc.
185-35 Centre St., New York City

AGENTS Sell Inkographs, make bigger profits, more sales, without investment. Quicker commissions, popular prices, no competition. Send for an Inkograph or write for special sales plan booklet.

DEALERS

Send for catalog and trade prices.

SEND NO MONEY

Your name, address and style number of the Inkograph of your choice are sufficient. Pay postman \$2.98 plus postage on delivery. Specify if you want ladies' size. When cash accompanies order Inkograph will be sent postage prepaid. If within ten days the Inkograph does not prove satisfactory return it and we'll refund your money.

INKOGRAPH CO., Inc.,
185-35 Center St. N.Y.C.

Gentlemen: Send me Inkograph Style No. _____ I will pay postman \$2.98 plus postage on delivery.

Name.....

Address.....

City.....State.....



STYLE No. 17 D.F.
The Executive, an ebony black rubber, highly polished Inkograph of superb refinement, the choice of men of affairs.

Illustrations Actual Size

STYLE No. 6 D.F.
The X Ray Inkograph, barrel made of transparent amber material which makes it possible to see how much ink it contains. Has large ink capacity. Filled with ink dropper, not a self filler.



STYLE No. 20 D.F.
The Big Chief, made of highest quality red rubber, a large sturdy attractive Inkograph.

Illustrations Actual Size

STYLE No. 19 D.F.
The Big Chief, made of mottled rubber which is black and red rubber artistically blended producing an effect of extreme beauty and refinement.

The Writing HEMISPHERE

The INKOGRAPH ACCOMPLISHMENT

That 14kt solid gold ball like point which is hard, round and smooth, glides with ease over the coarsest paper and makes it possible to write in ink as rapidly as with the softest lead pencil.

Lifts 75 Tons—because the smaller parts are accurately made

The combined efforts of many small parts, accurately made, result in this derrick's lifting 75 tons. Although your work may be an everyday job, a repair job at home or work on a hobby, and the parts may not be required to withstand such a strain, they should nevertheless fit with the necessary accuracy. Tools of Brown & Sharpe Quality help you do difficult jobs more easily.

Ask your dealer for a free copy of Brown & Sharpe Small Tool Catalog No. 30. Keep it in your kit to use as a reference when buying tools. If your dealer cannot furnish a copy, write us direct.

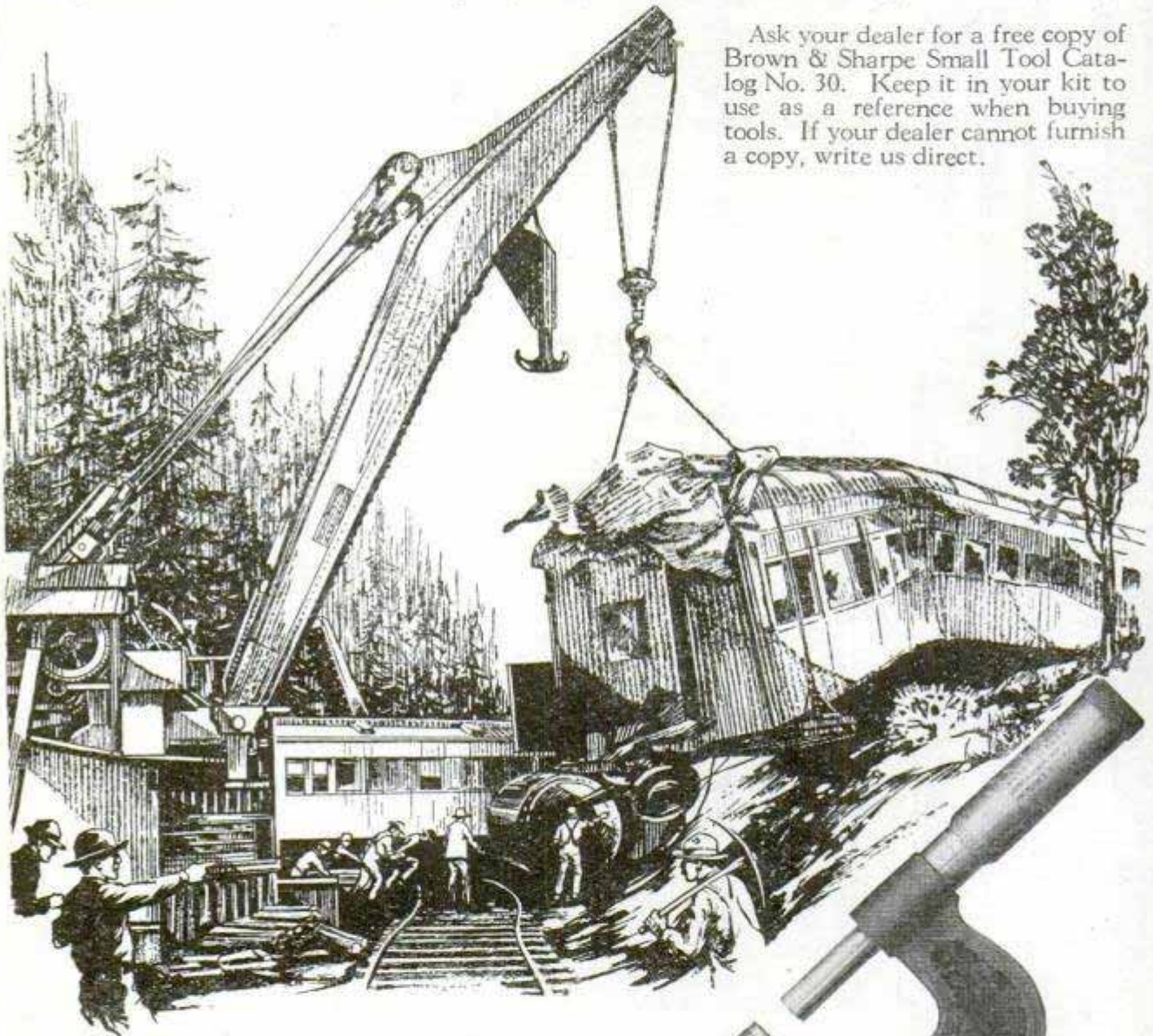

BROWN & SHARPE TOOLS

Micrometer Caliper No. 11 is but one of over 2300 different tools in the complete Brown & Sharpe Line. It measures from 0 to 1" by thousandths of an inch and assures accuracy in small parts.

BROWN & SHARPE MFG. CO., Providence R. I., U. S. A.



Speedway Shop

Make things AT HOME

10 Days Free Trial

In your own home—

Here is just what you have been waiting for! The big opportunity! The Speedway Shop is a compact and efficient electric workshop for you men who are "handy" with tools, mechanics, or experimenters!

The Speedway Shop is driven by the powerful back geared Speedway electric motor—famous the world over.

We are offering you the Shop on a 10 day free trial in your own home. Test it! Experiment with it! Use it as you would your own! You will find it the handiest, fastest metal and wood working outfit you have ever laid your eyes on. It is complete in every sense, and ready for operation.

Fascinating! Intriguing! Interesting! That's what users say about the work you perform in your own home with the Speedway Shop and Tools. You can make almost anything — attractive, odd furniture, toys, home and garden improvements, radio manufacturing, consoles, bric-a-brac, book shelves — countless useful articles. You can do buffing, polishing, grinding and drilling either at the bench or wherever you find a lamp socket and—all of this for only \$10.00 down—the balance on easy terms.

8 motor driven tools
Try them in your own home

A complete wood-turning lathe, bench saw, scroll or jig saw, a portable electric hand saw and all accessories for both portable and stationary power drilling, buffing, grinding and cleaning. Attaches to any light socket and converts a work bench into a complete private tool and machine shop. You can buy 2 or 3 units at first and add others as you need them.



Portable Saw Unit

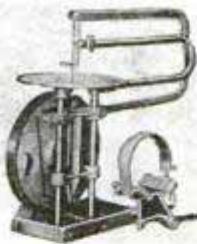

Jig-Saw Unit

\$10.00 Down

Want a shop? It's easy to own one. We make it easy to pay while you enjoy a Speedway Shop right in your own home.

Don't hesitate. We want you to know more about the Speedway Shop and Tools. Every tool in the "Shop" is high-grade, built for regular work. A money maker for the small job man. A pleasure for the householder.

Get the full particulars. Send in the coupon today.

ELECTRO-MAGNETIC TOOL CO.

Dept. 212—1830 S. 52nd Ave.,
CICERO [adjoining Chicago], ILLINOIS

A Blueprint a month FREE

Each month for a year we will furnish you a blueprint of your own selection free to help you to get maximum service from the Speedway Shop and Tools. Write for a list of the interesting blueprints we have for you.

Write for full information

SEND COUPON NOW

Electro Magnetic Tool Co., Dept. 212
1830 S. 52nd Ave., Cicero, Ill.

Dear Sirs: Please send me full particulars about your 10 Day Free Trial, Free Blueprints and Your Easy \$10.00 Down Payment plan on the Speedway Shop.

Name.....

Address.....

City.....State.....

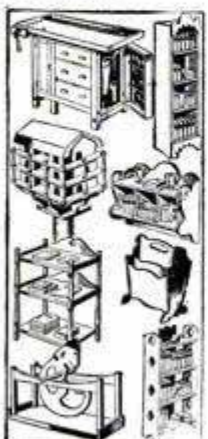

THE annual question is in everybody's mind. The annual gift list is in everybody's pocket. Here is just the right present for son or daughter, for best friend, for close business associate—in fact

A Gift for Everybody

The Remington Portable Typewriter

It may be selected with the assurance that it is the recognized leader—in sales and popularity. It meets every requirement of personal writing. It is the world's lightest writing machine with standard keyboard—tips the scales at only 8½ pounds net. And it is the most compact of all typewriters—fits in a carrying case only four inches high.

It is faster than the speed demands of even the most expert user; and its dependability is *Remington dependability*.

From every standpoint it is *the* gift for everybody.

Terms as low as \$5 monthly. Sold by Remington branches and dealers everywhere. Send for our booklet "For You—For Everybody." Address Dept. 12.

REMINGTON TYPEWRITER COMPANY
374 Broadway New York

Branches Everywhere

Remington Typewriter Company of Canada, Ltd.
68 King Street, West, Toronto

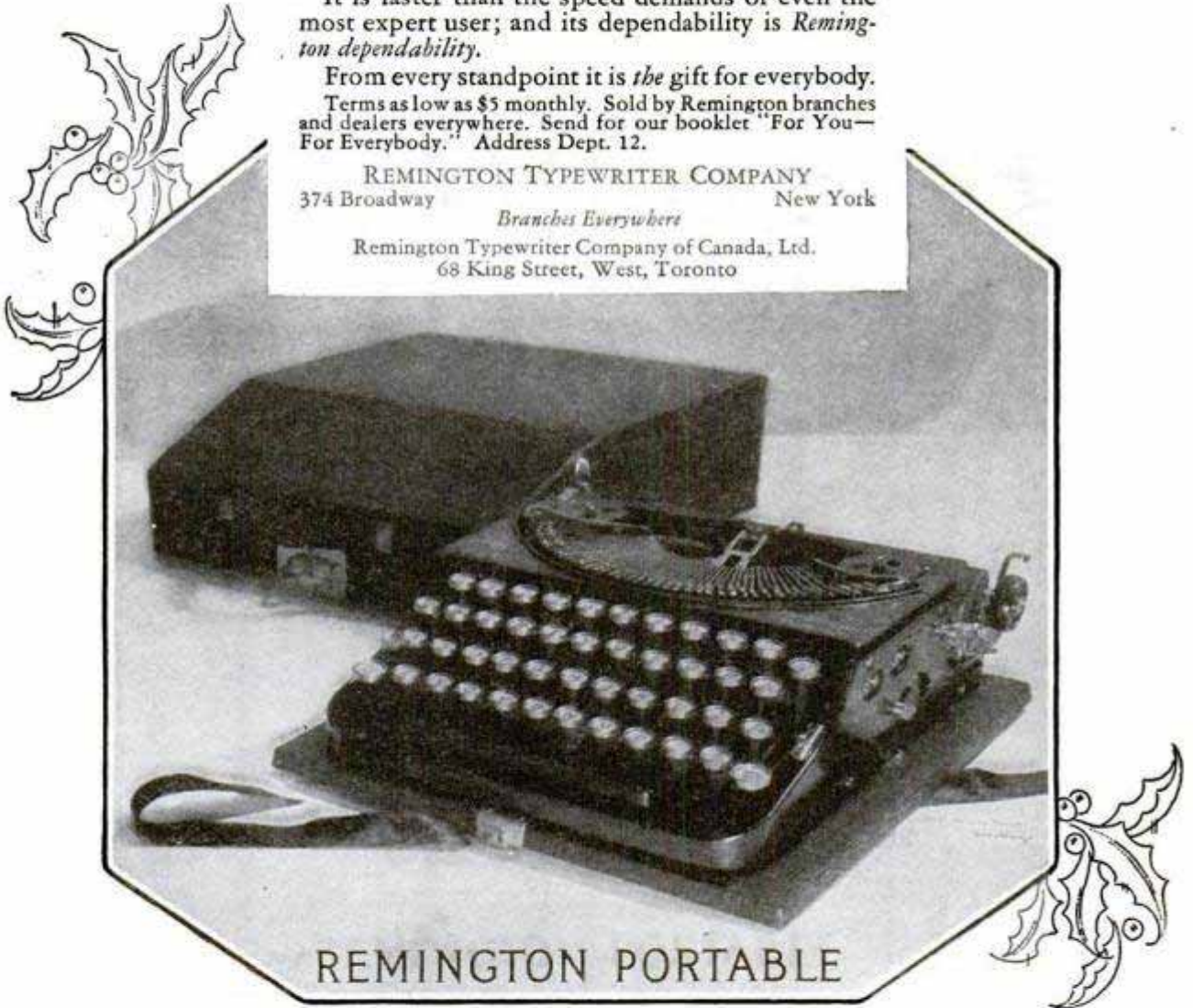

REMINGTON PORTABLE

Remington Typewriters

A MACHINE FOR EVERY PURPOSE

Remington-made Paragon Ribbons and Red Seal Carbon Papers always make good impressions



Hello boys!

Get my free book.

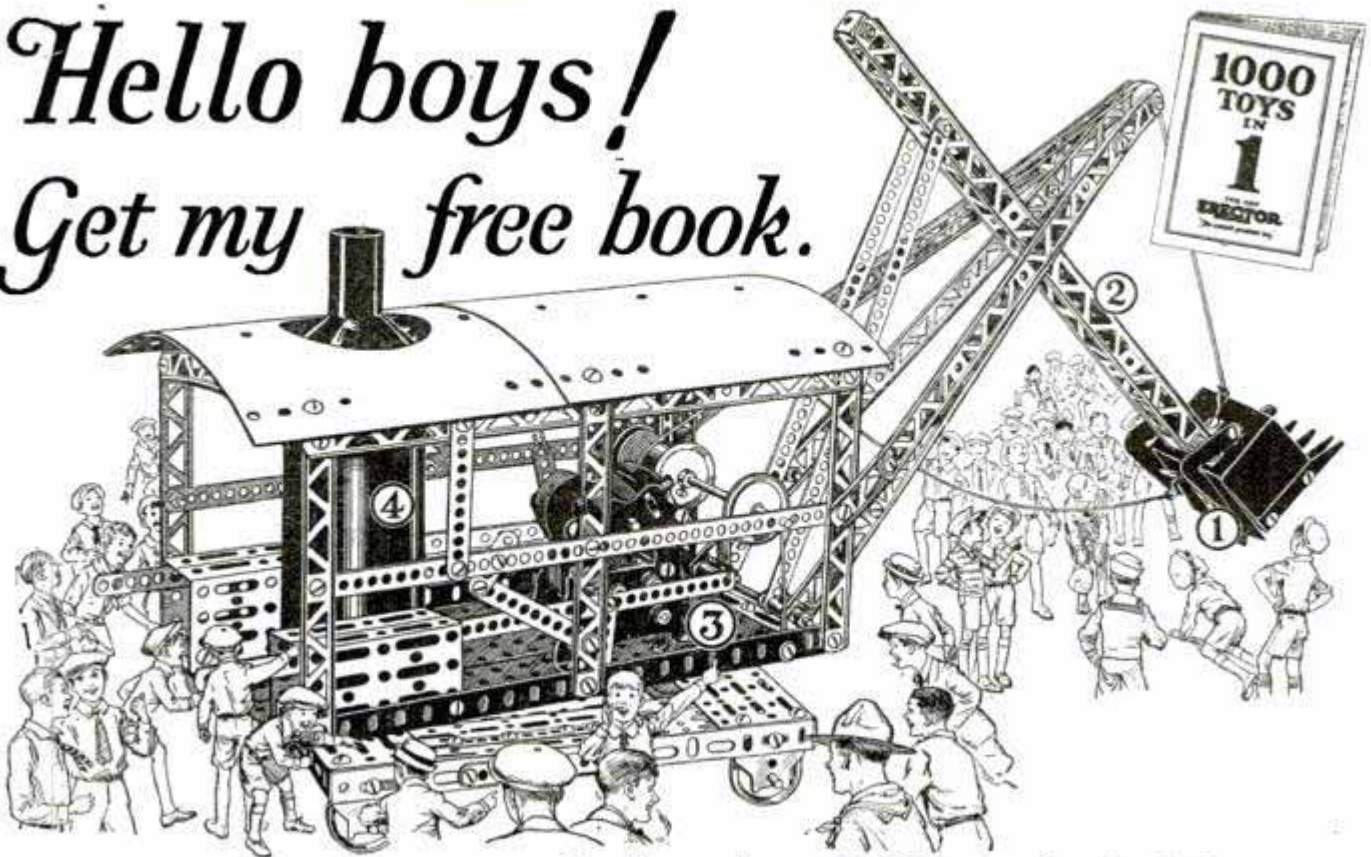

It tells you how to build steam shovels, dredges, automobiles, aeroplanes, engines—1000 working models, many in colors, all from one marvelous construction set.

WHY ERECTOR IS "The World's Greatest Toy"

- 1—*Erector Enamelled Scoop, Erector Enamelled Dredge Bucket, Curved Erector Girders, Giant Fly Wheel Enamelled Red*—All Exclusive Erector Features.
- 2—*Erector Square Girder*. They are real girders just like engineers use in making skyscrapers and bridges.
- 3—*New Powerful Erector Electric Motor*. (In No. 4 Set and up).—You can make 27 interesting experiments with the Erector Motor alone. You can attach pinions and gears direct to both sides.
- 4—*Erector Enamelled Steam Boiler*. (In No. 7 Set and up).—There is no end to the models that this Erector feature makes possible—Steamboats, Fire Engines, Hoisting Engines, Locomotives, etc.
- 5—*Erector Parts In Colors*. (In all sets).—Erector is made from structural steel, nickel-plated and lacquered. It is the pioneer construction toy with parts finished in colors, enamelled and electrically baked (not just painted). An exclusive Erector feature.
- 6—*Perforated Strips—Four Holes To The Inch*.
- 7—New Erector contains more parts and builds more models than any other toy.
- 8—New Erector contains the greatest assortment of gears—ten in all—from die-cast, beveled gears, solid brass gears, to the big 50-tooth steel gear.
- 9—*New Erector is Electrified*—Starting with the No. 8 Set you can illuminate your models.

New 1926 Exclusive Erector Features

- 10—*New No. 10 DeLuxe Book*. Over 200 pages showing how to build 1,000 models.
- 11—*Big, Solid Steel Disc Wheels*—Electrically enamelled in red with oversize balloon tires.
- 12—Many other new feature parts such as radiators, fenders, auto hood, springs, steering wheel, heavy truck axles—all finished in colors.
- 13—*New Giant Erector Curved Girder*—Makes very large wheel over 14 feet in circumference.

JUST think of the fun that is waiting for you when you read about these marvelous working models of the greatest engineering feats—trains, draw-bridges, steam shovels, concrete mixers, lighthouses, engines, motors, dynamos, railroad signals. And when you actually own a new Erector Set you'll get the thrill of your life when the motor starts to purr and the model which you have built with your own hands starts working—Oh, boy! how you will shout.

Christmas or any other time will be the best day of your life when you get your Erector. The box is jammed full of fun. When you lift the lid and see all the wonderful parts, some in colors, your hands will itch to start building models right away. You'll play with Erector first. You'll be playing with Erector a year from now, too.

But send for my book this very day. Then you can show Dad the pictures of these dandy Erector models. He will understand why boys call the New Erector the world's greatest toy.

The Super Erector No. 7—\$10.00

The Set that builds the Steam Shovel

THE most popular Erector Set. This is the first set to contain the famous new Erector digger part, so that you can build the Steam Shovel illustrated above. Contains powerful Erector electric motor which makes your model run; new Erector boiler for building engines; also base plates, curved girders, perforated strips, die cast gears, bevelled gears, solid brass gears—473 parts, some in colors, enamelled and electrically baked; builds 533 models shown in 76-page manual. Packed in a varnished, hard-wood box. Tell Dad now that this Erector Set will make you happier than any other present.

MY FREE OFFER When you send this coupon for my free book, you will also get an amazing present; the mysterious Erectorscope. It will mystify your friends. You've never seen anything like it. Just look through the Erectorscope! You won't believe your eyes. Everybody will want to look through it, too. Send the coupon now and get the book and the Erectorscope absolutely free.

625
Coal Elevator.
End View

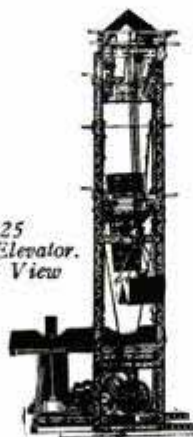

Buy an Erector Today.

At all stores where toys are shown.

THE A. C. GILBERT CO.,
153 Blatchley Ave., New Haven, Conn.

Please send me FREE my copy of the book, "1,000 Toys in 1," and the mysterious Erectorscope.

Name.....

Street.....

City.....State.....

CROSLY RADIO

All prices slightly higher west of Rocky Mts.

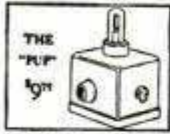

This little double-circuit 1-tube set has made long distance records.



4 tubes. Amazing efficiency, Crescendon equipped!



The 4-29 in portable form.



5 tubes, 1-dial control acuminators, Crescendon, power tube adaptability.



5 tubes. True-cascade amplification; non-oscillating and non-radiating.



In a mahogany console. 5-tube 5-50 receiver Crosley Musicone speaker, ample compartment for batteries.



12-inch size, \$12.50. Super Musicone, \$14.75. Musicone Deluxe, \$23.50. Also beautiful Musicone console with room for batteries and accessories, as below.



5-tube 5-38

with the
CRESCENDON
which builds great volume
on distant stations

\$38

Sit down before any ordinary 5-tube tuned radio frequency set and turn the dials. Some Stations will come in clear and loud. Others you will hear but faintly and the manner in which they slip away is exasperating.

Then try a Crosley 5-38. From a far-away station come the faint strains of an almost forgotten melody. How keenly you want to hear it! You turn the Crescendon and, with a rush of swelling tone, the music suddenly reaches a volume and clarity as though it were broadcast from a station but a few miles away!

Such is the function of the Crescendon—an exclusive Crosley device—a feature of this 5-tube tuned radio frequency set, known as the Crosley 5-38.

In external appearance, too, the set will delight you. The beauty of its two-tone mahogany cabinet is enhanced by art metal trimmings which harmonize in color and design. The dials are recessed behind windows and vernier-controlled condensers make tuning easy and accurate.

Like all Crosley radio sets, the famous 5-38 is available at extremely low cost—the result of Crosley mass production which has established the world's greatest radio values.

THE CROSLY RADIO CORPORATION, CINCINNATI—POWEL CROSLY, Jr.,

President

Crosley manufactures radio receiving sets, which are licensed under Armstrong U. S. Patent No. 1,113,149 or under patent applications of Radio Frequency Laboratories, Inc., and other patents issued and pending. Owning and operating station WLW, first remote control super-power station in America. All prices without accessories.

For Catalog write Dept. 15.

Crosley Features

"CRESCENDON"

When, on ordinary radios, ears must strain to catch a station miles away, a turn of the Crescendon on Crosley radios instantly swells reception to room-fill-

ing volume. An exclusive Crosley feature. ALL-METAL SHIELDED CHASSIS

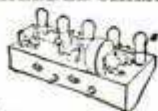

This truly great radio achievement, found in several Crosley sets,

furnishes a substantial frame for mounting elements, produces excellent alignment of condensers, shields the units from each other, prevents interstage, improves the stability of the circuit, increases selectivity and saves costs by standardizing this phase of manufacture.

THE SINGLE-DIAL STATION SELECTOR

Nothing in radio equals the joy or the convenience of single dial control. Crosley single drum control enables you to find the stations sought without log book or "tuning"

"THE ACUMINATORS"

Crosley Acuminators permit tuning in—loud and clear—weak stations passed over and entirely missed by ordinary single dial radios. In tuning high powered and local stations they are not used.

HEAD PHONES \$3.00

QUALITY AND BEAUTY IN CABINETS AND CONSOLES



Kingsbury Motor Truck, No. 318. 25 inches long. Handsomely finished in enamel. Rubber tires. Cushioned bumper. Spring motor, wound crank-fashion from the front. Price \$15. West of the Mississippi, \$16.50

Load it up and start away!

HAVE a trucking business all your own! Load up to capacity at your "warehouse." Crank your motor—which winds the strong powerful spring. All set! Put the motor into gear with the lever beside the driver's seat. And away you go. Around the corner a package to be delivered. Pull back the lever at the driver's seat—brakes on—the truck has stopped. Deliver your package, and you're off to the next stop. Don't stop to crank yet—your truck will run 200 feet before this is again necessary.

A toy that will make you the envy of every boy on the street. The finest toy we have ever built—and Kingsbury has built fine toys for over 35 years.

Better put this truck on your "Christmas Stocking List" right NOW.

KINGSBURY

MOTOR DRIVEN TOYS

This wonderfully lifelike motor truck is just one of an almost endless series of mechanical and pull toys made in Keene, N. H., by Kingsbury. If your dealer is not now showing Kingsbury Toys for Christmas, send for Catalog that shows and describes Fire Engines, Ladder Trucks, Hose Wagons, Busses, Delivery Wagons, Trac-

tors, Trolley Cars—every kind of wheeled toy, priced within everybody's means—toys from \$1 up.

THIS NON-SKID ERASER, 10c

Send 10c coin for this miniature disc wheel whose non-skid balloon tire is a rubber eraser.



KINGSBURY MANUFACTURING CO.

83 MYRTLE ST.

KEENE, NEW HAMPSHIRE

Dealers: Our complete line is sold and displayed by Riemann-Seabury Co., 215 Fourth Ave., New York City

Isn't it natural?

A EUROPEAN WIT says "Americans not only *want* the best of everything—but spare nothing to *get* the best of everything." A characteristic that explains, perhaps, why American cigarette smokers so willingly pay a few cents more to get Fatimas

F A T I M A



*"What a whale of a difference
just a few cents make"*



Try this NEW way to improve your craftsmanship

LePage's New Books will show you how

Handiest tool in your Work Shop

Perhaps you have never thought of the special advantages of using LePage's Liquid Glue. It is always ready for immediate use. No weighing, soaking or heating is required. Its quality is always the same. It "sets" slowly enough so that you have plenty of time to place the joints together exactly as they should go. Slow setting also allows LePage's to penetrate the wood, increasing the strength of the joint. LePage's Liquid Glue is equal in strength to any animal glue. Buy a can for your workshop. It is the easiest, quickest, handiest form of Glue. Insist on LePage's.

Recipe for Making LePage's Gesso

To make one cup of LePage's Gesso, you need 1 gill can of LePage's Glue, 1 1/4 cups whiting, 3 teaspoons linseed oil and 3 teaspoons varnish. Place whiting in mixing bowl and pour in slowly in this order: LePage's Glue, linseed oil, and varnish. Mix until smooth. All ingredients obtainable at nearest hardware store.

WITH the coming of the long winter evenings, the best time of the year is here for the man with the Home Work Shop Hobby. What articles of furniture are you planning to make this winter? Whether it is a radio cabinet, end table, book case, cedar chest, or any other piece of household furniture, LePage's New Books can be of practical help to you.

"LePage's Practical Suggestions for the Home Work Shop," and "LePage's Gesso-Craft Book," will help you come closer to equalling the skill of the trained cabinet maker, turning your evenings spent on this hobby to better account. They tell you how to make strong joints with glue, and not only with glue, but with glue in its most convenient form—LePage's Liquid Glue.

These books also show you how to cover up small defects in your craftsmanship. Now and then a tool will slip and an error is made. Or there are holes to be filled where nails or screws have been countersunk. Or the edges of a joint are not exactly even. A simple new way to repair these defects is with the use of LePage's Gesso instead of putty. LePage's Gesso will stick to any surface—wood, metal, glass, etc. It can be sandpapered, planed and painted or stained just like wood. We give you in the small panel below a simple formula for making LePage's Gesso, but of course we tell you more about it in the books themselves, together with practical information on decorating your finished articles with Gesso.

Send 10 Cents for These NEW LePage's Books



THE practical and useful help of these two books is yours for only 10 cents. Just write your name and address on the coupon below, tear the coupon out and mail it to us today with 10 cents in coin or stamps, and we will at once send you a copy of these two LePage's Books, postage paid. Address LePage's Craft League, Dept. RR-3, Gloucester, Mass. Tear out the coupon now so you will not forget it.

LE PAGE'S GLUE

Bottles, Tubes, Cans

LePage's Craft League, Dept. RR-3, Gloucester, Mass.

Gentlemen: Enclosed you will find 10 cents (coin or stamps) in payment for "LePage's Practical Suggestions for the Home Work Shop," and "LePage's Gesso-Craft Book." Please send a copy of each to:

Name.....

Street.....

City..... State.....

He has good tools—his work shows it

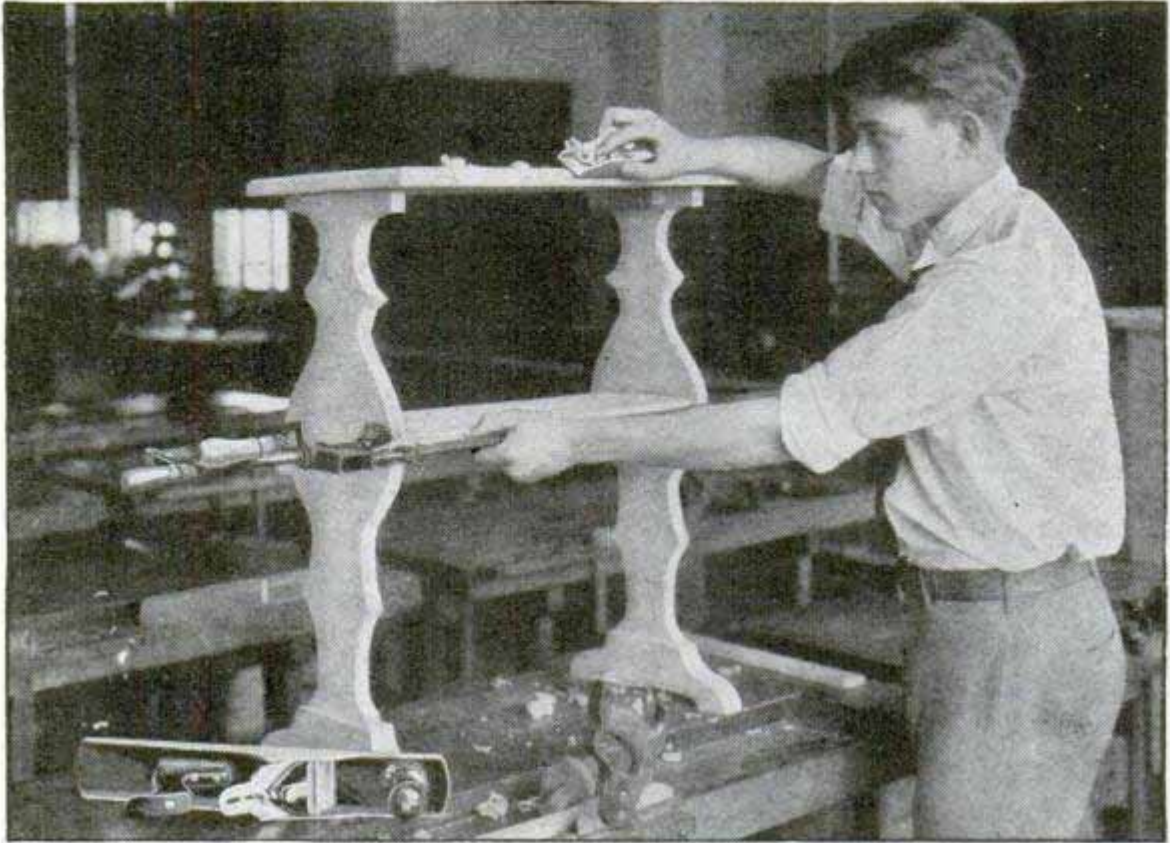

NO REASON now for anyone to work with unsatisfactory tools. In every class of tools there are leaders. Devised by workers who simply had to have something better than what they were using. Produced by manufacturers who have overlooked nothing that might better design and quality. Sold at prices which every worker can afford to pay.

Sargent Planes will help you to get better results. Quicker results, because of their simplicity of adjustment and ease of handling. The Auto-Set has a feature found in no other plane. The cutter may be removed, sharpened and replaced

without changing original adjustment. With this and the small Steel Block Plane you can do practically every finishing job that comes to a school or home work-bench.

See them at your hardware dealer's. Note the perfect balance and finish! The cutters of special chromium steel! How keen these are—and they keep that way even after a lot of planing. You will be surprised at the prices—too. Low, for the tools that so many professional carpenters use. Write us for booklet. **SARGENT & COMPANY, Manufacturers**
49 Water Street New Haven, Conn.

SARGENT PLANES

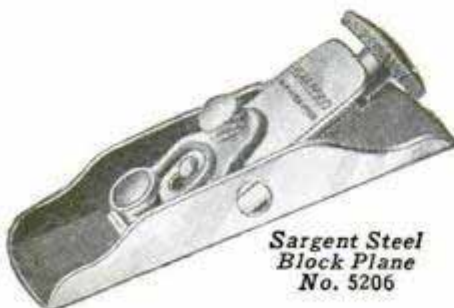

*Sargent Steel
Block Plane
No. 5206*

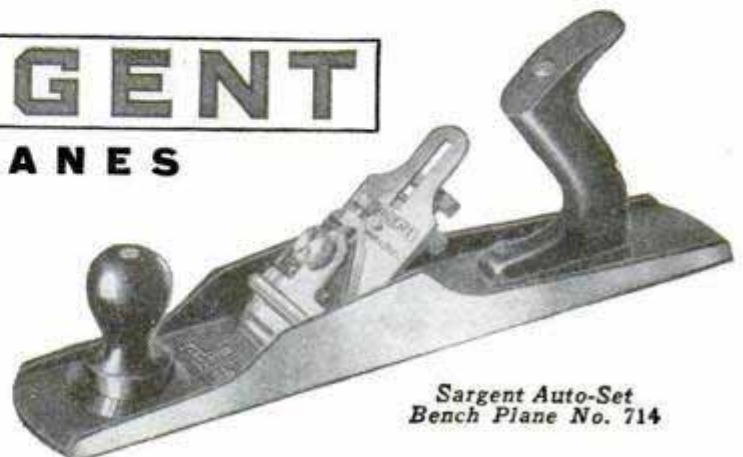

*Sargent Auto-Set
Bench Plane No. 714*



Play Billiards

The "PLAYMATE"



\$26⁵⁰ Cash

Balance on easy terms

A modified standard billiard table, size 3½ x 7 ft., with folding legs. Has genuine slate bed and all the playing qualities of the professional size table, cushions, angles and balls being scaled down with scientific precision. Comes complete with full playing equipment.

At a slight additional cost interchangeable cushions may be had, making it available for either carom or pocket billiards. Smaller tables for pocket billiards only, sizes 2½ x 5 ft. and 3 x 6 ft., may be had at still lower prices.

Make This Christmas The Best Ever

Have Dad Give You a Brunswick Home Billiard Table

NO game will provide more genuine pleasure, more fascinating entertainment, more lasting enjoyment than a Home Billiard table. It is the greatest gift of all—and lasts for years and years.

Right now is the time—of all times

Brunswick Home Billiard Tables are Inexpensive

A small initial deposit brings one to your home in time for Christmas. The balance may be paid as you play. No extra space or

—to obtain one. For billiards is a sport you and everyone you know can play and enjoy. And the more you play it the more interesting it becomes. It is splendid exercise, does you good both physically and mentally. Develops judgment, clear thinking and coolness.

special room is needed for the newest Brunswick Home Table—the Playmate. And there are a number of other attractive models.

THE BRUNSWICK-BALKE-COLLENDER COMPANY

Established 1845

Branches in All Principal Cities of the U. S. and Canada

Write today for full descriptions, prices and easy terms. Fill out and mail the coupon NOW!

THE BRUNSWICK-BALKE-COLLENDER COMPANY

Dept. H-1243, 623 S. Wabash Avenue, Chicago, Ill.

Gentlemen: Please send me complete descriptions of your home billiard tables, together with prices and terms, and oblige.

Name.....

Address.....

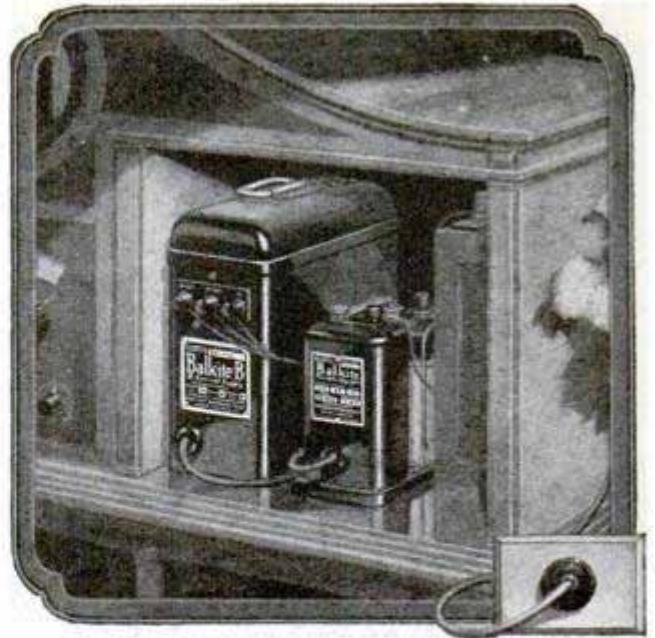

The new Balkite "B" at \$27⁵⁰ and the Balkite Trickle Charger furnish all radio power from the light socket



The New Balkite Charger

MODEL J. Has low trickle charge rate and a high rate for rapid charging. Can thus be used either as a trickle or as a high rate charger. Special model for 25-40 cycles. Price \$19.50. West of Rockies \$20. (In Canada \$27.50.)

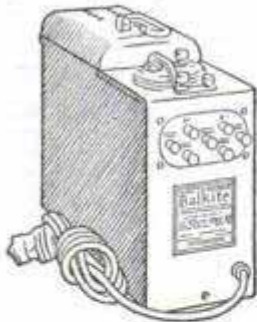

Balkite Combination

When connected to the "A" battery supplies automatic power to both "A" and "B" circuits. Automatically controlled by the filament switch on your set. Will serve any set now using either 4 or 6-volt "A" batteries and requiring not more than 30 milliamperes at 135 volts of "B" current—sets of 8 tubes or less. Price \$59.50. (In Canada \$83.)

Operate your present set from the light socket by adding the new Balkite "B" and the Balkite Trickle Charger.

Balkite "B" eliminates "B" batteries entirely and supplies "B" current from the light socket. Balkite "B"-W at \$27.50 for sets of 5 tubes or less requiring 67 to 90 volts. Balkite "B"-X at \$42 for sets of up to 8 tubes. Balkite "B"-Y at \$69 for any standard set.

* The Balkite Trickle Charger at \$10 is probably the most popular of all chargers. Over 200,000 are now in service. Instead of operating intermittently at a high rate, it operates continuously at a low rate, thus automatically keeping the battery at full charge. In effect it converts your "A" battery into a light socket "A" power supply.

Both Balkite "B" and the Balkite Trickle Charger are noiseless in operation, permanent pieces of equipment, with nothing to renew or replace. Other than a little household current, their first cost is the last. Add these Balkite Units now and own a radio set always ready to operate at its best.

Balkite Trickle Charger \$10.50 west of Rockies. In Canada, Trickle Charger \$15; "B"-W \$39; "B"-X \$59.50; "B"-Y \$96.

FANSTEEL PRODUCTS COMPANY, Inc., North Chicago, Ill.

(Listen to the Balkite Radio Symphony Concerts with Walter Damrosch and the New York Symphony, Saturday nights, 9 P. M., Eastern Standard Time. Stations WEA, WEEL, WGR, WFI, WCAE, WSAI, WTAM, WWJ, WGN, WCCO, KSD, WDAF.)

FANSTEEL
Balkite
Radio Power Units

Ives Electric Reversing Locomotive. The third successful year. Operated by Ives Push Button Control. Press the button to stop—again to reverse.

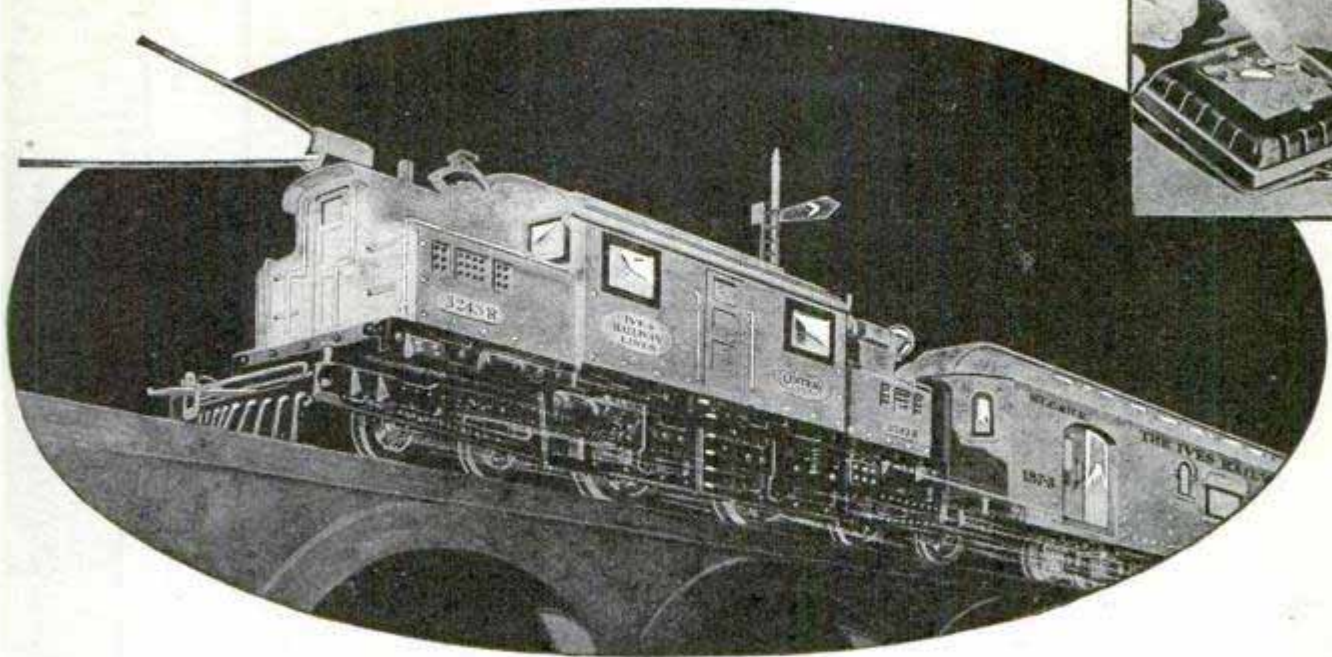

You couldn't have more fun if you ran the famous *Olympian Flyer!*

OVER the Rockies on its electrified track daily speeds the famous train, Olympian, on its way to the sunny Pacific. It has every modern improvement ever invented for electric trains—and you will find these same improvements in Ives Electric Trains.

As your Ives Express speeds around the track, Banjo Signal 333 flashes out the warning at the highway crossings, keeping the track clear (*Safety First!*). Signal 331 flashes to the engineer danger or clear track, as the case may be.

When Signal 331 flashes the red, press the button and the train stops. Press it again, and it backs up to the point of safety. Now the light flashes green. Press the button twice, and proceed on your journey. How can you beat it for real good fun and realism!

Trains of superb power

IVES locomotives have all kinds of power for pulling long trains at express speed. All motors, even the smallest, are built with extreme care. There is an almost endless variety of passenger and freight cars, stations, etc. Prices range from the \$1.50 mechanical train to the big, complete \$50 electric outfit.

Toy, department, electrical, hardware and sporting goods stores sell Ives Trains.

FREE—Biggest, most interesting Train Book for boys ever issued

THE 1926 Book of Ives Trains is the largest, most colorful and fascinating book of miniature railways ever published. It has 44 pages, illustrated in full colors throughout and tells you everything you want to know about electric and mechanical trains. Mail the coupon today.

[Safety First!]



Ives Automatic Two-Light Target Signal 331
(For any size track)

It flashes red—it flashes green
The prettiest signal ever seen



Ives Automatic Bell-Light Banjo Signal 333

(For any size track)
Three automatic features in one. Ives is the only miniature railway that has this wonderful automatic banjo signal.

The Ives Manufacturing Corporation

Established 1868

Holland Avenue, Dept. D-7, Bridgeport, Conn.



THE IVES MANUFACTURING CORPORATION
Dept. D-7, Holland Avenue, Bridgeport, Conn.

Please mail me your FREE 1926 Book of Ives Trains, containing 44 pages in full colors.

Name.....

Street.....

City..... State.....

Here are the eight different size drill points included with Mr. Punch.

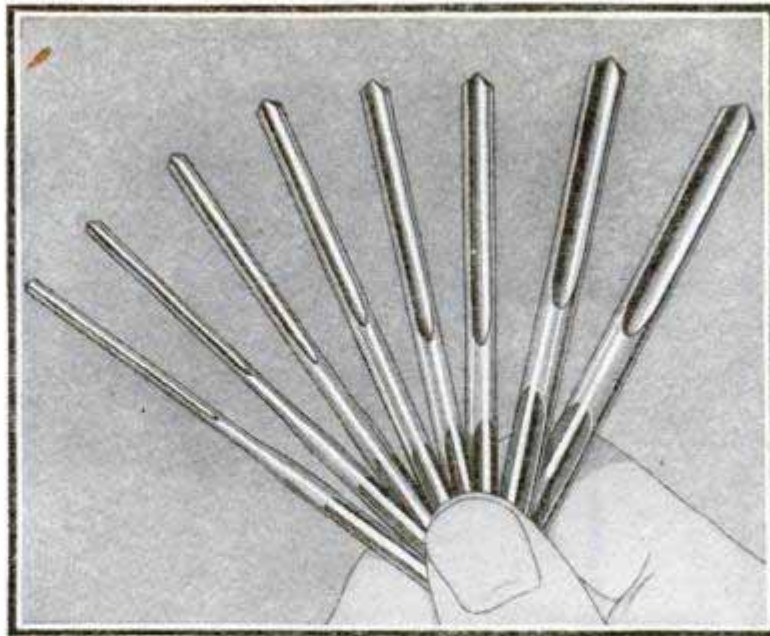

To bore clean holes quickly—easily without splitting or cracking

Use Mr. Punch

—the Goodell-Pratt Automatic Drill

THIS automatic drill makes holes of any diameter from $\frac{1}{16}$ to $\frac{11}{64}$ of an inch—and does it quickly—and clean as a whistle.

You push—Mr. Punch twists. No skill is needed to do the job right. No cracking, or splitting, or splintering. Hard wood, soft wood, plaster—are all alike to Mr. Punch.

A hollow space in the handle is divided into 8 compartments, each to hold a drill point of the size marked on it.

To get the drill you want just turn the cap so that the top hole

is opposite the compartment the desired drill is in. The point is released through the top hole.

Mr. Punch is beautifully nickled and polished. He is 10 in. long and weighs 8 ounces. Good hardware dealers everywhere sell Mr. Punch. If yours doesn't, write us.

Send for the book of 1500 Tools Catalog No. 16 pictures and describes each of the famous Good Tools made by Goodell-Pratt. This book is interesting and valuable to everyone who works with tools. It's FREE. Write for a copy NOW.

GOODELL-PRATT COMPANY, GREENFIELD, MASS., U. S. A.

MAKERS OF *Toolsmiths* MR. PUNCH

GOODELL-PRATT
1500 GOOD TOOLS

Newest Invention! SPORS Pen

No wonder it's so easy to make \$20 a day when you can distribute this new unbreakable self-filling Fountain Pen with these latest improved inventions.

IMPORTED GUARANTEED FOR TWO YEARS
—WRITES LIKE A \$7 PEN.

Your Sample Pen Costs You ONLY **65¢** Sells for **\$1.25**

FREE
SILK NECK RIBBON TO MATCH WITH EACH LADIES' STYLE PEN

FREE

Big Specialty Catalog showing Best Sellers from all parts of the world.

There Are Dollars to Be Made

almost every time you turn around. Fountain Pens are always in demand. Nearly everyone uses them, especially when they can get a Fountain Pen like ours for only \$1.25 that writes as good as a pen selling for three and four times this price.

Money Back Guarantee

If you cannot make at least \$10.00 a day, all you have to do is to return unsold goods to us any time within 60 days and we will refund your money at once.

Could we give you a guarantee like this if we had any doubt that the average person cannot make at least \$10 a day?

7
BEAUTIFUL COLORS:
Red, Green, Yellow, Purple, Mahogany and Green Molot

WRITES AS SMOOTH AS A PENCIL ON ANY KIND OF PAPER. 8 GROOVES FOR INK TO FEED. EASILY TAKEN OUT AND CLEANED. EXTRA POINTS COST ONLY 15¢.

WHAT TO GET FOR CHRISTMAS?

Do you realize that people all over the United States are asking that very question? Wondering what they should get for Susie or Bill or Mother or Dad or Brother? Show them these new style unbreakable SPORS pens, which come in different colors in either the ladies' or men's style and a sale is made every time. These pens are put up in beautiful holly boxes all ready for the customer to send out before Christmas.

BARREL AND CAP MADE OF THE BEST AND STRONGEST MATERIAL WHICH WILL LAST PRACTICALLY A LIFETIME

STRONG ATTACHED CLIP

Biggest improvement ever thought of in pen history. Small air tight place for point keeps ink from drying and will write the instant it touches the paper without first shaking the pen.

60-DAY TRIAL

Money back if not pleased. A perfect pen for every need under all conditions—for any kind of paper.

F. SPORS & CO.,

300 Main St., Lesueur Center, Minn.

- Send me one Spors pen, 65c c. o. d., plus postage.
 - Send me 12 Spors pens, \$6.42 c. o. d., plus postage.
 - Send me 36 Spors pens, \$18 c. o. d., plus postage.
 - Send me catalog, no obligation on my part.
- Mark X opposite proposition interested in.

Name.....

Address.....

City..... State.....

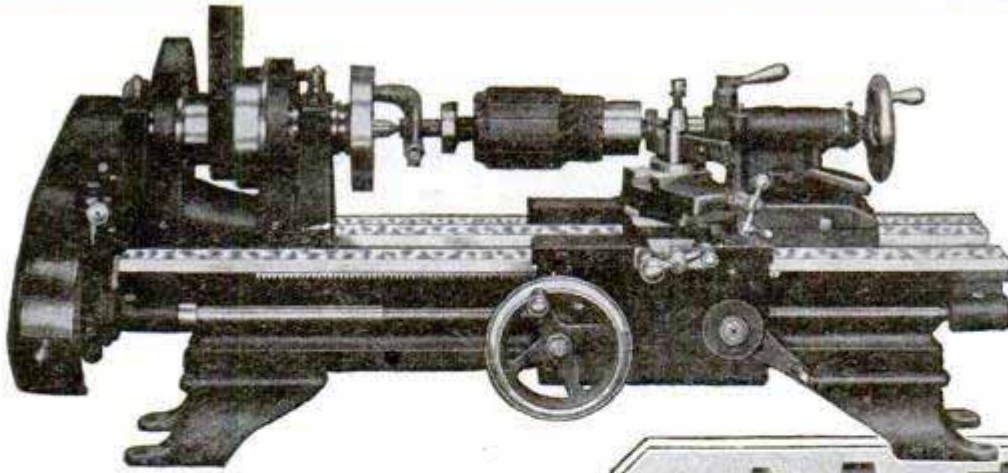

South Bend No. 22
Back Geared Screw
Cutting Lathe

9 $\frac{1}{4}$ " x 3'; Swing
over bed, 9 $\frac{1}{4}$ "'; distance
between centers, 16 $\frac{1}{2}$ "'; width of
belt cone drive, 1"
length of bed, 3 ft.
Countershaft and
equipment as shown
below included with-
out extra charge.
Shipping weight,
350 lbs.

9 INCH Back Geared Screw Cutting LATHE

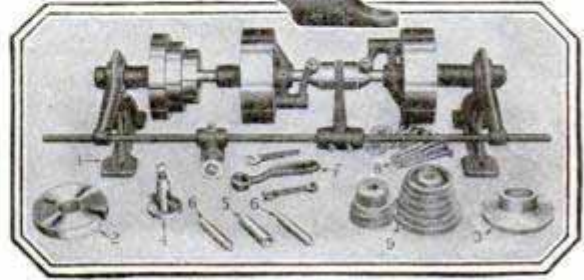

with Automatic Feed, 3/4 in.
Hollow Spindle, and Graduated
Compound Rest. Double Friction
Countershaft Drive included

Only **\$150** Easy
Payments
if desired

This is the same 9" x 3' South Bend Lathe used in thousands of shops—a high-grade tool of accuracy and precision. To make this low price possible, we have stripped the Lathe of all parts not needed in the average shop. You waste no money on equipment seldom used. You buy the utmost for your Lathe dollar.

Some of the Work This Lathe Will Do



Piston Work



Armature Work

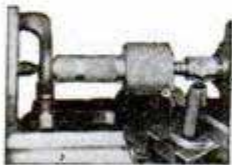

Cutting Threads

This 9" x 3' Lathe will cut standard screw threads. It will turn, bore, drill, chuck, face file, polish, ream, grind, etc. In fact, it will, within its capacity, take care of practically all kinds of machine work on all kinds of metal, fibre, hard rubber and wood.

Takes Only 1/4 H. P. to Run

Operated by Countershaft or Motor Drive. Requires only 1/4 H. P. Motor, and can be driven from lamp socket.

Easy Payments

Lathe shipped for small down payment. Balance can be met from the extra income Lathe will save and make for you. Free Book "How to Run a Lathe" sent to each purchaser.

Write for Bulletin 22-J

South Bend Lathe Works

816 E. Madison St.

South Bend, Ind.

Attachments, Chucks and Tools for this Lathe

- 1—Hand Wheel Draw-in Collet Chuck
- 2—Hand Lever Draw-in Collet Chuck
- 3—Graduated Taper Attachments
- 4—Milling and Key Way Cutting Attachment
- 5—Electric Grinding Attachment
- 6—Electric Mica Under-cutter
- 7—Semi-Automatic Bed Turret
- 8—Thread Indicator
- 9—Adjustable Thread Cutting Stop
- 10—Step Chuck and Closer
- 11—Independent 4-Jaw 6-inch Chuck
- 12—Universal 3-Jaw 4-inch Chuck
- 13—Center Rest
- 14—Follower Rest

SOUTH BEND LATHES

52 WEEKS

ONE FULL YEAR to PAY

12 MONTHS

PAY NEXT YEAR For Your Xmas Gifts

DIAMONDS WATCHES & JEWELRY

Biggest Values-Easiest Terms

NO RED TAPE

CASH PRICES but CREDIT TERMS

NO DELAY

SPECIAL \$5.00 a MONTH

Easy to Pay

\$60



This exquisite diamond ring is considered extremely handsome. The best quality genuine blue white diamond is full of fiery brilliance and sparkling colors. It makes a wonderful engagement ring or friendship ring. Your friends will think you paid \$100.00 for it. Everyone will admire it. The gift case is free.

No. 39

Special Sale of Xmas Gifts

Every article in this sale was selected first for quality, because we sell only the finest grades of diamonds, watches and jewelry. Prices were reduced, thus giving our customers the greatest possible value for their money. You can take a year to pay—weekly or monthly as you prefer.

All Credit Dealings Confidential

No one will know that you are buying from us on credit unless you tell them. You will like our confidential system.

Money Back Free Trial Guarantee

The quality and value of everything we sell is fully guaranteed. We allow 10 days free trial. If you return the purchase, we return your deposit. When you return a diamond in exchange for a larger diamond, we allow you 5% more than you paid for it.

No. 74

\$89



\$5 Down and \$7 a Month
This great big cluster of seven best grade sparkling blue white diamonds is set in **SOLID PLATINUM** in this 18 karat solid white gold ring. The cluster of 7 diamonds sparkles and flashes like 2 carat solitaire and looks like one big diamond. Notice the 2 extra fine diamonds set in the sides of this ring.



No. 3



No. 76

Extra fine quality diamond of rare brilliancy set in exquisite ring.

\$99 \$9 Deposit \$7.50 a Month



No. 38

\$42

\$2 Deposit \$3.33 a Month

Ladies small, fashionable wrist watch, 14 karat solid gold case, with 15 jeweled movement, set with 4 diamonds and 4 sapphires. It makes a splendid Christmas present.

4 Diamonds and 4 Sapphires



No. 78



No. 79

Large cluster of seven best blue white diamonds set in **SOLID PLATINUM**. The 18 kt. ring has two blue sapphires.

\$69 \$5 Down \$5.35 a Month

Extra brilliant cluster of seven best diamonds set in platinum in 18 kt. gold ring.

\$79 \$7 Deposit \$6 a Month



No. 4



No. 77

\$49. Pay \$4 Deposit and \$3.75 a Month. Brilliant blue white diamond and 2 sapphires set in 18 kt. gold.

\$99. Pay \$9 Deposit and \$7.50 a Month. For man's heavy 18 kt ring, with fine blue white diamond.

14 Karat Solid Gold \$1.00 Deposit \$1.50 a Month

Stylish 14 Kt. solid gold wrist watch with 15 jeweled movement. Worth \$30. Extra sterling silver bracelet free.



No. 80



No. 81

Pay \$4.60 a month for cluster of seven fine diamonds set in platinum. The 18 kt. ring is set with blue sapphires.

\$59 \$4 Deposit

Men's cluster of seven diamonds.

\$69 \$5 Deposit \$5.35 a Month

SOLID PLATINUM RING

Perfect Diamond No. 75 \$98



\$8 Deposit - \$7.50 A Month
The sparkling, blue white diamond set in this ring is guaranteed the finest quality—perfect and flawless. It has no imperfections of any kind. All the colors of the rainbow flash from this diamond. The ring is genuine solid platinum. It makes a wonderful engagement ring.



Choice of Elgin or Waltham Watch

\$21 \$1.00 Deposit \$1.75 a Month

Latest style, handsomely engraved, 12 size watch, octagon shaped, white gold filled case, fitted with your choice of high grade movements. It comes in an expensive gift case, has a valuable chain and knife attached.

No. 82-\$25 \$1 Deposit \$2 a Month

Men's wristwatch, 15 jeweled, high grade movement, in choice of white or green gold filled case. Fitted with strong leather strap.



No. 71

\$27.50 \$2.50 Down \$2 a Month

Ladies' Diamond Onyx Ring of very latest style, set with sparkling blue white genuine diamond. The handsome engraved ring is 18 karat solid white gold. The long oval onyx is the most popular style.

No. 72-\$20 \$2 Deposit \$1.50 a Month

Rectangular shaped onyx ring set with sparkling blue white diamond. The 18 karat ring is richly engraved.



3 Large Diamonds 4 Smaller Diamonds 8 Sapphires
No. 73-\$109 \$9.00 Deposit \$8.35 a Month

Dinner rings like this are the style today. The exquisite design of this popular ring pleases every one who sees it. The mounting is 18 kt. solid white gold, hand pierced and engraved. The sparkling blue white diamonds are full of brilliancy, and are beautifully set off by the dark blue sapphires.

WRITE FOR CATALOG

If you want something not shown in this advertisement, it is in our catalog. Thousands of bargains in diamonds, watches, wrist watches, jewelry of all kinds, silverware, toilet sets, etc.



Bargains for Cash Buyers
We are the only credit jewelers who also operate a strictly cash jewelry store, famous for its values. Nationally advertised jewelry is sold on credit at the cash store prices. Just mail the coupon.

THIS COUPON MAKES IT EASY

TEAR OUT AND MAIL!

STERLING DIAMOND & WATCH CO., Inc.
1540 Broadway, Dept. 2233, New York, N. Y.
GENTLEMEN: I HAVE SELECTED NUMBER.....
 Please mail it to me by parcel post, C. O. D. the small deposit and I will pay the postman when he hands the package to me. Send size.....
 I enclose \$..... as a deposit to show my good faith. Please send the article size..... direct to my home for me to wear on free trial.
 Do not send any jewelry now but send your big bargain catalog to me showing thousands of diamond, watch, jewelry, silverware and toiletware bargains for me to choose.

NAME.....
LOCAL ADDRESS.....
CITY & STATE.....

STERLING DIAMOND & WATCH CO.
Square Deal Credit Jewelers—Diamond Importers—Established 1879
1540 BROADWAY Dept. 2233 NEW YORK
MAIL FREE CATALOG COUPON



HARRY HARTZ says

"It has been invaluable to me in getting my car ready for many races."

HARRY HARTZ, acclaimed 1926 racing champion, is an enthusiastic user of the Prest-O-Lite 5-in-1 Outfit. Here is his letter:

"I want you to know how well pleased I am with your Prest-O-Lite 5-in-1 Outfit. It has been invaluable to me in getting my car ready for many races.

"It is the most convenient outfit I have ever used, and the different torches and soldering iron make it possible for us to perform delicate heating, melting and soldering jobs that would be impossible with any other kind of heat unit."

Harry Hartz

The Prest-O-Lite 5-in-1 Outfit will save time and money in any service station or garage. Four different size torch heads give just the right flame for every job. Easily carried anywhere. No delay, no pumping, no generating. Operates on Prest-O-Lite Gas.

Complete in canvas roll case; four torch heads, soldering iron, hose and wrench, \$7.50. Ask about this equipment at any Prest-O-Lite Service Station or write us for full details.

THE PREST-O-LITE CO., INC.
INDIANAPOLIS, IND.

New York San Francisco
In Canada: Prest-O-Lite Company of Canada, Ltd.
Toronto, Ontario

Prest-O-Lite Gas

"The gas of a thousand uses"

\$7.50



Convenient Canvas Roll Case

New - Wonderful Soldering Iron and Blow Torch In One!

Saves time, trouble and money for EVERY householder, farmer, auto owner, mechanic, tinsmith, radio fan, plumber, electrician, dentist, jeweler, painter, printer, garage, repair shop.

For every handy man! Pays for itself in one job! Enables you to do easily a lot of work that would otherwise require a plumber or tinsmith. Needs no pump or pressure system—no stove—no charcoal pot—no separate blow torch. No fussing! No trouble.

Burns an hour at less than 1/4 cent for gasoline. Ready in a jiffy! Remove copper point and you have an ideal BLOW TORCH for burning off old paint, tempering tools, thawing frozen pipes, etc., etc.



**Send No Money
10 Days FREE Trial**

The Justrite will be sent you prepaid complete, with sal ammoniac and solder, for ten days' trial. When it arrives simply pay postman \$3.00. If not satisfied after 10 days, just mail it back and your \$3.00 will be returned at once. Write us TODAY!

Agents! Get our extremely liberal offer NOW! Sales come so fast you'll be amazed! Our agents tell us that just as soon as people see how the Justrite works and how much time and trouble it saves, they want it! Nine times out of ten a demonstration means a sale. Drop us a postcard for our extremely liberal offer. Do it TODAY!

**Justrite Mfg. Co., Dept. 13-59
2071 Southport Ave. Chicago, Ill.**



DARCHE "CALL-ME" ELECTRIC ALARM AND LIGHT CLOCK

Will ring until you get up and STOP it. No home complete without one. Can be used as an "alarm clock" or "mantel clock." With a little effort on your part you can get one

FREE OUR OFFER TELLS YOU HOW

Agents, here is a big money-maker, no competition, sells on sight. A good punch board proposition. Write today for our descriptive literature. An ideal GIFT for any occasion. Mahogany finish. Size 10 1/2 x 8 1/2 x 4. This applies to U. S. only.

Darche Mfg. Co., 643 Washington Blvd., Chicago

BE PRESIDENT OF YOUR OWN COMPANY

CONCEIVE that of all methods present or past, the Nestler Rubber Fusing Process (U. S. Pat. No. 1,354,992) alone, produces a positive fusion or welding of new and old rubber! —The first and only practical and successful method of re-rubbing a tread worn tire, is here—a simple, quick, inexpensive process that makes tires new again and cuts tire costs in half!

Each year since 1917 thousands of tires have been successfully Nestlerized annually by ourselves and licensees. Due to increased demand caused by high tire prices we have decided to issue a limited number of additional licenses. License rights will include protected territories, free instruction, and full cooperation. 17 million cars and 34 million tires replaced annually constitute a limitless opportunity for business and profit.

The demand for territories is great and prompt action is vital. A printed proposition with full facts and detailed information is now ready. Write for it TODAY.

**NESTLER
RUBBER FUSING
STATION
TIRES**

NESTLER RUBBER FUSING CO., Inc.
DEPT. P12
245 W. 55th Street, New York City



**30
DAYS
FREE
TRIAL**

7 Tube Set Single Dial Radio

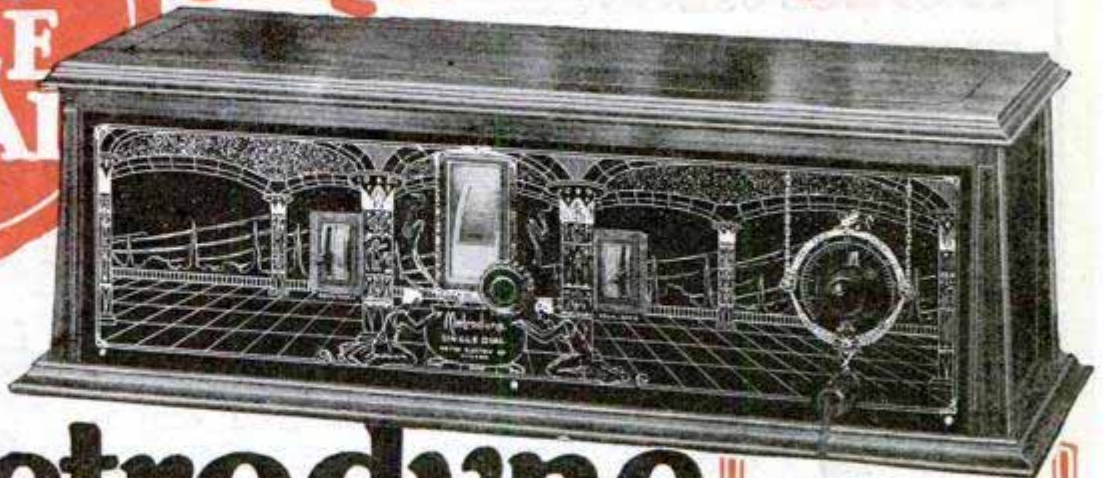

The Metrodyne

ONLY ONE DIAL TO TUNE

Retail Price
\$75
Completely Assembled
**BIG DISCOUNTS
TO AGENTS
AND DEALERS**

Wonderful offer direct from the factory! The world's greatest radio. A perfect working, single dial control, 7 tube receiver. And just to prove our claims, we will ship it to your home for 30 days' free trial. Test it under all conditions. Test it for distance, volume and tonal quality—and if you are not convinced that it is the best single dial set you ever heard, return it to the factory. We don't want your money unless you are completely satisfied.

BIG PROFITS TO AGENTS AND DEALERS

Our Agents and Dealers make big money selling Metrodyne Sets. You can work all or part time. Demonstrate the superiority of Metrodynes right in your home. Metrodyne Radios have no competition. Lowest wholesale prices. Demonstrating set on 30 days' free trial. Greatest money-making opportunity. Send coupon below—or a letter—for our agent's proposition.

Metrodyne Super-Seven Radio

A single dial control, 7 tube, tuned radio frequency set. Approved by America's leading radio engineers. Designed and built by radio experts. Only the highest quality low loss parts are used. Magnificent, two-tone walnut cabinet. Artistically gilded genuine Bakelite panel, nicked piano hinge and cover support. All exposed metal parts are beautifully finished in

24-k gold. Easiest set to operate. Only one small knob tunes in all stations. Dial is electrically lighted so that you can log stations in the dark. Volume control regulates reception from a faint whisper to thunderous volume, 1,000 to 3,000 miles on loud speaker! The Metrodyne Super-Seven is a beautiful and efficient receiver, and we are so sure that you will be delighted with it, that we make this liberal 30 days' free trial offer. You to be the judge.



**6
Tube Set
\$48.50**
RETAIL PRICE
Completely Assembled

METRODYNE SUPER SIX RADIO ON 30 DAYS' FREE TRIAL

Wonderful 6 tube, long distance radio set. Approved by America's leading Radio Engineers. Easy to operate. Dials log easily. Tune in your favorite stations instantly on the same dial numbers every time. No guessing. 30 days' free trial.

Mr. Howard of Chicago said, "With 5 Chicago Stations on the air I tuned in 17 out-of-town stations, including New York and San Francisco on loud speaker very loud and clear."

We are one of the pioneers of radio. The success of Metrodyne sets is due to our liberal **30 Days' Free Trial Offer**, which gives you the opportunity of trying before buying.

MAIL THIS COUPON 
or send a postal or letter. Get our proposition before buying a radio. Deal direct with manufacturer—
Save Money.

METRO ELECTRIC COMPANY
2161-71 N. California Ave., Dept. 149, Chicago, Illinois

Mail COUPON Below! Let us send you proof of Metrodyne quality

C. J. Walker, Mariposa, Calif., writes: "Received my Metrodyne Single Dial set O. K. I believe that these one-dial sets are going to be excellent sellers. I had no trouble in tuning in stations enough to satisfy anyone, so you will please send me another set."

Roy Bloch, San Francisco, Calif., writes: "Very often we travel from New York to the Hawaiian Islands quickly—from station to station—by means of the little tuning-knob which operates the electrically-lighted dial. The Metrodyne Single Dial Set is much easier to operate than any radio set I've ever seen."

We will send you hundreds of similar letters from owners who acclaim the Metrodyne as the **greatest radio set in the world.** A postal, letter or the coupon brings complete information, testimonials, wholesale prices, and our liberal 30 days' free trial offer.

METRO ELECTRIC COMPANY
2161-71 N. California Ave., Dept. 149
Chicago, Illinois

Gentlemen:

Send me full particulars about Metrodyne 6 tube and 7 tube sets and your 30 days' free trial offer.

Name.....

Address.....

If you are interested in AGENT'S proposition, place an "X" in the square →

HOT - HOT - HOT - HOT - HOT - HOT - HOT - HOT - HOT - HOT - HOT - HOT - HOT - HOT - HOT - HOT

For Every Purse and Purpose

TURNER Master No. 45 BLOTORCH

TURNER Master No. 45 BLOTORCH has these improvements (Turner patents) which give it leadership over all others:

Baffle in the burner; *Heater Plug* in feed pipe to generate today's fuel, without clogging; *Adjusting Needle* separate from cutoff to prevent enlarging of orifices; *One Opening* in tank above fuel line;

No Soldered Connections—

"noleakers"; *Safety Valve* prevents excess pressure causing leaks and explosions; *Convenient Handle* fits any size hand.

Nothing Better—if it could be made we would make it.

\$7⁷⁵
Post-paid

Money back if not satisfied



THE TURNER BRASS WORKS
Charles St., SYCAMORE, ILL.

SAFE - SAFE - SAFE - SAFE - SAFE - SAFE - SAFE - SAFE - SAFE - SAFE - SAFE - SAFE - SAFE - SAFE - SAFE

Skilled Labor is dependent on Good Tools

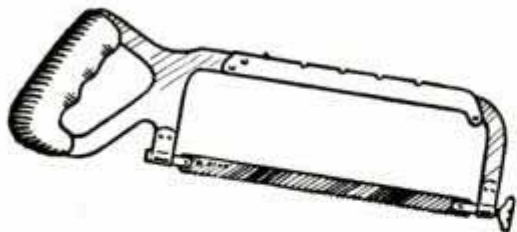

AND THEY RELY ON STAR BLADES

After 43 years of hack saw research and development work, we offer the Star Special Flexible Blade as the most efficient flexible cutting hack saw blade ever produced.

STAR HACK SAWS

Let us send you samples of this blade free

CLEMSON BROS., Inc., Middletown, N. Y.

Ask for Keds by name

They are not Keds unless the name Keds is on the shoe

REDUCED PRICES ON ENGINES

Now—big sale on most practical farm engine ever built—the famous OTTAWA. Low cash prices—easy terms—on all sizes 1 1/4 to 7 H-P. Each engine pulls big surplus of power. Easy starting. You must be satisfied or money refunded. 30 day trial. 10-year guarantee.

FREE BOOK

—"How to Know Better Engines." Write today for your copy. A post card brings it.

OTTAWA MFG. CO.

531 D King St., Ottawa, Kan.
Desk 531 D Magee Bldg., Pittsburgh, Pa.

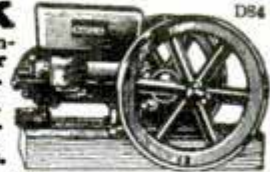

\$25 to \$45

GET THE NEW IDEA

BATES MOTOR SAW
— 6 SAWS IN 1 —

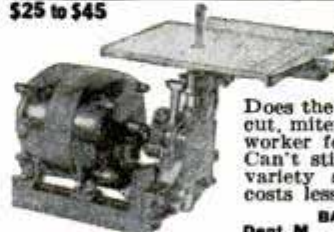

Does the work of band-saw, rip-saw, cross-cut, miter, bevel and scroll-saw. A wonder worker for the home shop. Direct drive! Can't stick! Cuts 2" wood. Most amazing variety saw ever invented. Does more, costs less! Not a toy. Write for circular.

Dept. M **BATES MOTORCRAFT COMPANY**
28 N. Clinton CHICAGO, ILL.

\$6

CASH WITH ORDER



17" Over all, 4" Swing, 11" Centers. Shipping weight 13 lbs. Bed is machined and lathe well built. Also made in larger sizes.

SYPHER MFG. CO., Dept. L, Toledo, O.



SIMONDS

NEW PLANER SAW

Leaves a Surface of Smoothness

Hundreds of plants are replacing their novelty saws with the new Simonds Planer Saws because the Planer Saw leaves a smooth cut at a faster hand feed than is obtainable with novelty saws.

The new Planer Saw can be used for soft or hard wood; for ripping, cutting off, or mitering. And it is made with the same precision and tempered steel that have distinguished Simonds cutting edges for nearly a century. Ask your dealer about the new Simonds Planer Saw. Or write direct for literature and full information.

SIMONDS SAW AND STEEL COMPANY
 "The Saw Makers" FITCHBURG, MASS. Established 1832
 Branches and Service Stations in Principal Cities

CALCULATIONS

In Office, School, Store and Shop can be instantly made with the Midget Slide Rule. It gives the answer to any problem involving fractions, mixed-numbers, decimals, whole-numbers, roots, powers, Logs, and Trig. Functions. Thousands of these rules are used by Accountants, Engineers, Clerks, Students, etc. It is the most versatile calculator ever invented. If you have any figuring to do, order a Midget Slide Rule on trial. Made of aluminum with figures on white celluloid. Size 4". Price with Instruction Book, \$1.50. Leather Case, 50c extra. Catalogue Free. Sent C. O. D. if desired. Your money back if you are not satisfied.

GILSON SLIDE RULE CO., Niles, Mich.



For quick action get your hands on one of these CRESCENT-Smith & Hemenway Drop-forged Tools

For turning nuts, bolts, and screws, cutting wire and metal, or doing similar jobs without fumbling or lost motion there is nothing like the tools in this complete line made by the "Originators of the Crescent Wrench."

CRESCENT TOOL CO.

210 Harrison Street
 Jamestown, N. Y.

Originators of the
 Crescent Wrench

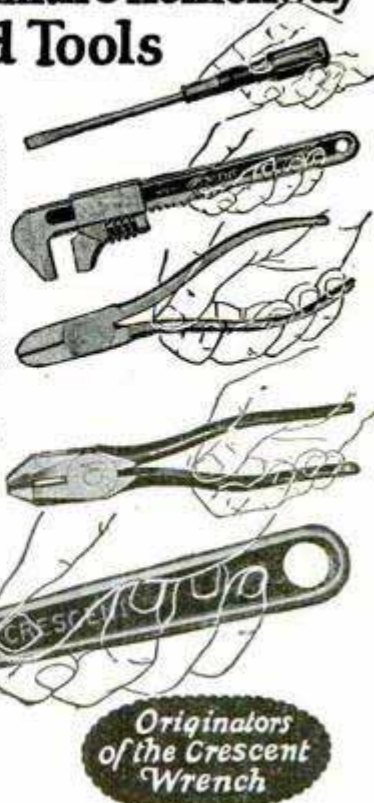

Originators
 of the Crescent
 Wrench

BURN YOUR NAME ON TOOLS

WITH THE ARKOGRAF

PROTECT YOUR TOOLS FROM THEFT

Write with electricity any name or design on the hardest and finest tools and instruments, or any metal, like writing on paper with pen or pencil. Complete Outfit \$3.50—Prepaid Anywhere. Interesting illustrated circular free. Write today. Agents wanted. ARKOGRAF PEN CO., 1171 E. Stark St., Portland, Oregon



Interlox

MASTER SLIDE RULE

Takes accurate inside or outside measurements

MASTER RULE MFG. CO., 613 E. 136th St., NEW YORK

Works fast. Slides in and out quickly. Durable made of brass trimmed boxwood. Any length 2 to 8 feet.

Ask your dealer.

Dealers and Agents: request attractive proposition



You can get yourself no Better Christmas Gift than

A Gerstner Tool Chest

Ideal for Toolmakers and Machinists

Write for free catalog



436 Columbia St., DAYTON, OHIO



\$5 DOWN Buys A WITTE STATIONARY ENGINE

The One Profit Engine

NO INTEREST CHARGES

NOW, more than ever, the need for economical, dependable power is felt by the producer who is faced with ever-increasing labor costs. WITTE Throttling Governor ENGINES answer this important question perfectly—now an economical, dependable power plant is within the reach of everyone.

To-day the WITTE ENGINE sells at the lowest price in history. Into this WITTE has gone the ripe experience of more than 42 years of engine building—over 150,000 users all over the world have placed upon it their stamp of approval. You, too, can put a WITTE on your place, secure in the knowledge that it represents the Standard of Power.

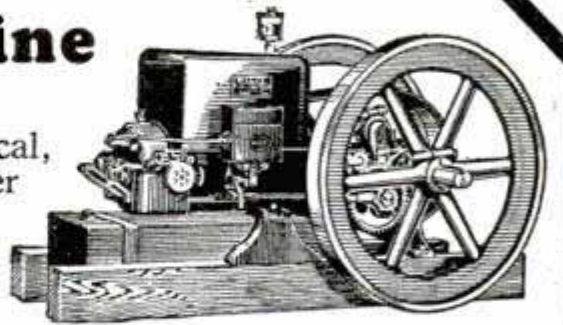

The Most Modern Engine

The Witte Throttling Governor

the original and leader of the throttling-governor type. An even, steady speed with a big surplus of power for the heavy loads.



The minimum in fuel consumption—the WITTE ENGINE burns kerosene, gasoline, gas-oil, distillate or gas at a

fuel cost of less than 2c an hour per H. P. Simple, trouble-proof and guaranteed for a life-time of hard work. Completely equipped with WICO Magneto, speed and power regulator and throttling governor, square, protected tank and die-cast removable bearings.

WITTE ENGINE WORKS

(FOUNDED IN 1870)

1747 Witte Bldg., Kansas City, Mo.

1747 Empire Bldg., Pittsburgh, Pa.

1747 Witte Bldg., San Francisco, Cal.

Quick shipments also made from nearest of these warehouses: Minneapolis, Minn.; Atlanta, Ga.; Trenton, N. J.; Richmond, Va.; Tampa, Fla.; New Orleans, La.; Dallas, Tex.; Laredo, Tex.; Denver, Colo.; Billings, Mont.; New York, N. Y.; Albany, N. Y.; Bangor, Me.; Portland, Ore., and Los Angeles, Calif.

The WICO Magneto

—the most perfect system of high tension ignition known. Makes starting easy, even at 40 below zero.



Sure performance in any climate or temperature. Not affected by rain, hail, snow or sleet. The perfect replacement for old style battery-equipped engine.

Makes All Jobs Easy and Cheap

No need to do the hard, back-breaking work—no need to pay high prices for poor labor—you can show \$1,000 more profit every year you have a WITTE working on your place. Investigate now!

All sizes 1 1/2 to 30 H. P. Easy Terms. Scrap the Old One—Pay a Little of It Down on the New WITTE.

Ask for FREE Catalogue

Our Big or if interested, ask about Log and Tree Saws, 3 in 1 Saw Rigs, or Pump Outfits.

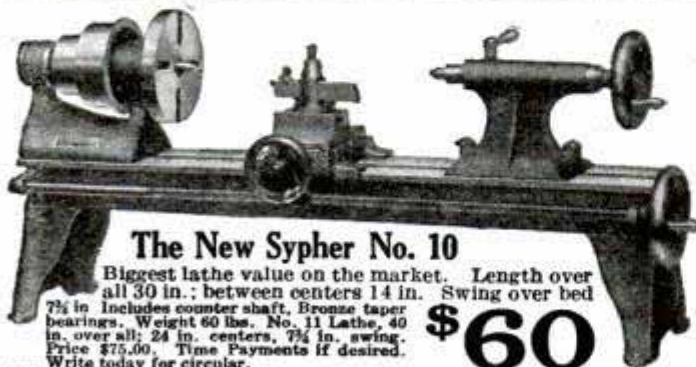

The New Sypher No. 10

Biggest lathe value on the market. Length over all 30 in.; between centers 14 in. Swing over bed

7 1/2 in. Includes counter shaft. Bronze taper bearings. Weight 60 lbs. No. 11 Lathe, 40 in. over all; 24 in. centers, 7 1/2 in. swing. Price \$75.00. Time Payments if desired. Write today for circular.

\$60

The Sypher Mfg. Co. Dept. D Toledo, Ohio

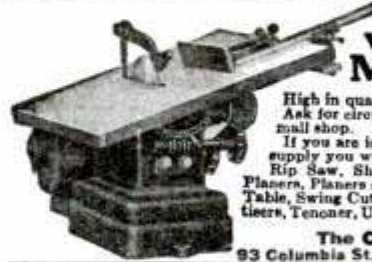

CRESCENT WOODWORKING MACHINERY

High in quality, moderate in price. Ask for circulars describing bench machines for the mill shop.

If you are interested in the larger machines we can supply you with Band Saws, Saw Tables, Self Feed Rip Saw, Shapers, Jointers, Variety Wood Workers, Planers, Planers and Matchers, Disk Grinders, Cut Off Table, Swing Cut Off Saws, Boreers, Hollow Chisel Mortisers, Tenoner, Universal Wood Workers. Ask for circulars.

The Crescent Machine Co.,
93 Columbia St. Leetonia, Ohio

"Best Pen I Ever Had—and costs less!"

That's what users of the Postal say. New filling method—easiest ever devised. Holds 4 times usual amount of ink. Transparent (always know how much ink you've got!). Unbreakable. Only \$2.50! Sent C. O. D. Order now and try it! Money back if you don't like it. Postal Pen Co., Inc., Dept. P. M. 12, 25 W. 43rd St., New York City



WADE AMATEUR MECHANICS, REPAIR SHOPS, INVENTORS, STUDENTS

BENCH LATHE

A real machine tool for the home work bench—capacity 4" dia. x 12" length. For Metal—Wood—Composition Materials. Turning—Facing—Boring—Drilling—Winding—Thread Cutting. Accurate—Strong—Quiet—Compact. Slide-rest has travel entire length of bed. Lead-screw inside bed. No. 1 Lathe, plain head-stock, \$25.00. No. 2 Lathe, back-gear headstock, \$35.00. Extra for lathes with 18 inches between centers, \$7.00. Complete line of accessories at equally low prices. Write for free catalog.

THE GEROLD CO.,

Dept. P-29,

120 Liberty St.,

New York

FREE New Book
FACTORY PRICES
 Direct-to-You
 Factory Prices

Save $\frac{1}{3}$ to $\frac{1}{2}$

New FREE book quotes **Reduced Factory Prices**. Introduces sensational **5-Year Guarantee Bond** on Stoves, Ranges, Furnaces. 200 styles and sizes. Beautiful porcelain enamel ranges and combination gas and coal ranges in soft grey and delft blue.



Mahogany porcelain enamel heating stoves. Cash or easy terms—as low as \$3 down, \$3 monthly. 24 hr. shipments. 30 day free trial. 360 day approval test. Satisfaction guaranteed. 26 years in business, 600,000 customers. Write today for your copy of this FREE book.

Heating Stoves **\$2720 up**



Ranges **\$375 up**

KALAMAZOO STOVE CO., Mrs.
 391 Rochester Ave. MICH.

"A Kalamazoo Direct to You"
 Trade Mark Registered

One Hour each evening

10 evenings

A few simple exercises, practiced quietly for an hour or so each evening, and before you know it you're playing popular tunes on your easy fingering

BUESCHER

True Tone Saxophone

Then! Popularity plus; the glad hand of welcome everywhere you go, and the smiles of those whose smiles are worth while. The man who can help others to have a good time is the man who is in demand.

You Can Teach Yourself

With the aid of the three primary lessons given free on request with each new saxophone you can teach yourself. It's not hard. You just blow normally for a full, rich, true tone. Fingering is almost as easy as a one-finger solo on the piano. And a little practice may reveal talents which will soon make you famous and rich.

Take One Home on Trial. Easy Terms

Try a Buescher, any Instrument you choose, in your own home for six days. This is a most liberal offer. If you like the instrument, pay a little each month. Play as you pay. Without obligation, mail coupon below for beautiful literature on any instrument, and details of trial plan. Get Started! Now!

BUESCHER BAND INSTRUMENT CO.
 Everything in Band and Orchestra Instruments
 1822 Buescher Block Elkhart, Indiana

Clip the Coupon NOW!

BUESCHER BAND INSTRUMENT CO. 344
 1822 Buescher Block, Elkhart, Ind.

Gentlemen: Without obligating me in any way please send me your free literature. I am interested in the instrument checked below.

Saxophone Cornet Trumpet Trombone Tuba

Mention any other..... How old are you?.....

Do you play any instrument?..... What?.....

Write plainly Name, Address, Town, State in Margin Below

Sewage Disposal
 for Country Home, Camp, or



any building in unsewered districts. Protect health and increase property values with **SAN EQUIP SEPTIC TANKS**. Perfect sanitation. Thousands in use. No failures. Ask our specialists for Free Plan Sheets.

CHEMICAL TOILET CORPORATION
 864 Free St. Syracuse, N. Y.
 Makers also of sanitary waterless toilets.

MAKES \$18.08
 In few hours

Without experience E. Lube earned \$18.08 in one afternoon with our beautiful dress goods, silks and wash fabrics. No capital needed. We show you how to succeed. Write for samples and complete selling instructions.

The National Importing Company
 Dept. M-6, 573 Broadway, New York City

Men Earn \$90 A WEEK!
 WEARING THESE
HUTCHINS PANTS

Sensational prices and wonderful quality make Hutchins made-to-measure trousers and knickers sure-fire sellers. You merely take orders, we deliver. Guaranteed finest quality, beautiful materials. Men eager to buy at amazing low prices—\$6.45, two pairs for \$12. Your big profit in advance.

NO EXPERIENCE REQUIRED

Even inexperienced men earn \$90, \$100 and more every week taking orders. Get your tailored pants FREE and cash in big on this opportunity.

Send No Money—Just name and address. Beautiful samples sent you FREE. But act at once. Do not delay. Start right out making big money. Address **HUTCHINS PANTS CO., Dept. W-19, 316 East Fifth St., Cincinnati, O.**

Double Rigid
Double Rapid



Saves Time!
Saves Your Face!

GET next to Gem Double Life Blades! Let your face revel in double-cool, double-clean, double-quick Gem shaves!

Gem Blades are double-thick and double-reinforced! They won't bend! They won't quiver! They're double-keen! They smooth away the whiskers at the dermal line!

Double-protected, double-sealed—they're backed by a double-satisfaction guarantee! Sold everywhere.

P. S.—Double your shaving joy with a Gem de Luxe Razor. It's scientifically right, perfectly balanced. If you have an old Gem Razor that isn't doing its bit, send it to our service department, our guarantee means something. Send it to the

GEM SAFETY RAZOR CORPORATION
Brooklyn, N. Y.

GEM
Double Life
BLADES



sore throat

**Soothing
and
Healing**

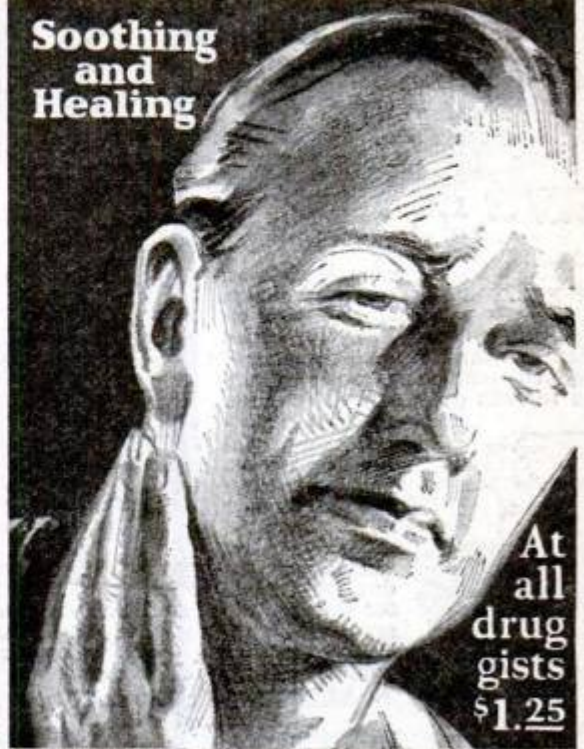

At
all
drug
gists
\$1.25

Absorbine Jr.
THE ANTISEPTIC LINIMENT

**END the
SMOKE NUISANCE**

with the reliable Crown Smoke Preventor built expressly for large industrial boilers by the country's foremost combustion engineers—separate type for each boiler.

CROWN SMOKE PREVENTORS

are comparatively inexpensive yet absolutely eliminate smoke and make a worthwhile coal-saving. Our engineers give full directions for installing—ordinary steam-fitter can handle job. Write for folder S12. Distributors wanted.

CROWN FUEL SAVER CO. RICHMOND, IND.

YOUR CHRISTMAS TREE



should be crowned with

**the new
ELECTRIC
ANGEL-CHIME**

Made of brilliant nickled metal, eight in. high, six angels uphold three differently tuned bells. Plug in on any 110-120 volt tree light set. Glistening Star of Bethlehem or any regular tree light bulb revolves at top of tree.

All **\$1.50**
Assembled
Guaranteed Safe

THE KEYDEL COMPANY No Heat Post-paid
Dept. J 6564 Benson Street Detroit, Mich.

A successful shave is
made up of three things—

a good brush,
a good lather,
and a good razor.

We will supply the first
requirement with a

**WHITING-
ADAMS**

Vulcan
Rubber-Cemented
Shaving Brush

The other two are up to you.
This famous name on a shaving
brush is a guarantee that
you are getting a good brush.



WHITING-ADAMS
BOSTON
BRUSH MAKERS FOR 118 YEARS

Beautiful HOUSES \$900
and BUNGALOWS

CAN BE BUILT FOR AND UP
This and many others in my new book,
Building Plans for Modern Homes, will
save you hundreds of dollars. One of the
most complete and comprehensive books
of plans ever published by any architect.
New edition just off the press. Nearly 600
floor plans and photographs of Colonial
houses, bungalows, etc., costing from
\$200 up; gives sizes and cost to build.
Sent postpaid for \$3.00.



FREDERICK H. GOWING
ARCHITECT
101 Tremont St., BOSTON, MASS.

Which color do you want ?

Send dealer's name and 20c for 40c sample of waterproof
Valspar-Enamel. Red—light, deep. Blue—light, medium, deep.
Green—medium, deep. Ivory, Yellow, Orange, Gray, Brown,
Black, White. Valentine & Co., 450 4th Ave., New York.

NEW! A BIG HIT!

The Little
Checkwriter
with the
Big Protection



Salesmen!

At last! A checkwriter at every-
body's price! Sells for \$12.50. Does
more than larger machines costing
hundreds! Our salesmen
cleaning up!

The Arnold Features

1. Pocket size convenience.
2. Handsome nickel plated alu-
minum.
3. Light weight. Easy to op-
erate.
4. Prints and cuts characters in
acid proof ink.
5. Unlimited capacity. Low cost.
Easy to ink.
6. Guaranteed for 5 years. Nothing to get out of order.

FREE SAMPLE OFFER! Salesmen! Here's the biggest selling
proposition of the year for you. Wonderful opportunity with very
liberal commissions to district managers and salesmen.

THE ARNOLD CHECKWRITER CO., Inc., Dept. 18
FLINT, MICHIGAN

ST. LOUIS

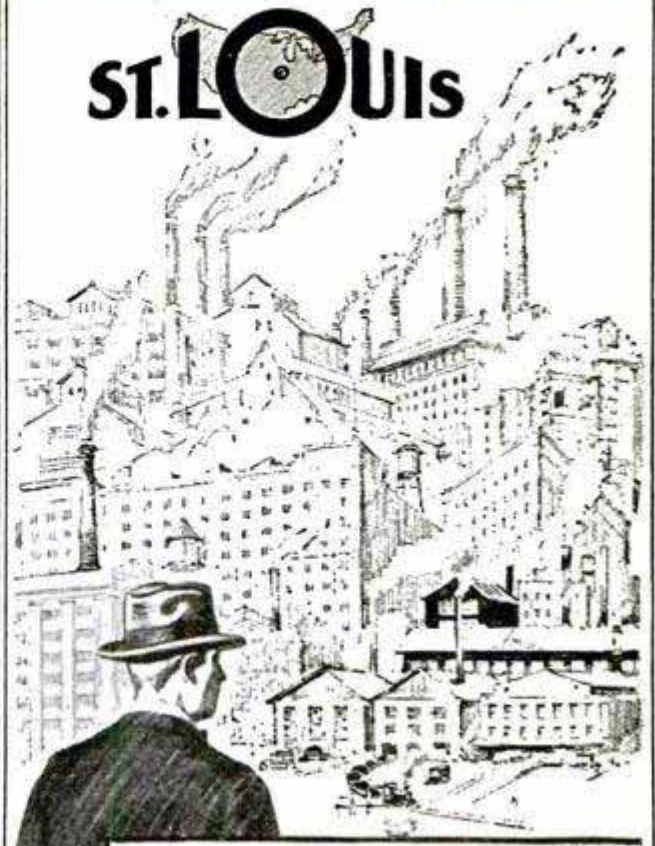

**211
Different Kinds of
Industries**

St. Louis has factories in 211
different kinds of business. Al-
most every line of manufacture is
represented. Only eight per cent
of the city's industrial force is
employed in its largest branch of
industry.

This wide diversity of industries
acts as a constant balance and
makes St. Louis strong in times
of business depression. It assures
stability of labor and production.

There is a westward trend of indus-
try. Modern business is moving toward
the center of the country. This has re-
sulted in 196 new industries coming
to St. Louis in the last six years. The
central location of St. Louis makes it an
economical distribution point. Your
factory in St. Louis would have a dis-
tinct advantage over competitors not so
favorably located.

Send for our booklet
"Why St. Louis Grows."
It tells the full story.

Address Dept. 33

ST. LOUIS

CHAMBER OF COMMERCE
ST. LOUIS, U.S.A.

MORE
Heat

The CROWN Fuel Saver will give *more heat, intenser heat*, than you ever before succeeded in getting from a given amount of coal—and will lower your coal bills.

CROWN FUEL SAVER

mixes RED HOT OXYGEN
WITH GASES OVER
FURNACE FIRE BED.

SAVES 20% of FUEL

You can have the cosiest, warmest home this winter by simply attaching the Crown Fuel Saver to the feed door of your heating plant.

By doing so you will save at least 20% of the coal you usually pay for—get decidedly more heat from the coal you burn—reduce the number of firings—and keep every room livable and comfortable.

The CROWN Pays for Itself

in comfort alone—in healthful heat that conquers cold and dampness. The Crown pays for itself in actual money. For, we absolutely guarantee the Crown to save at least 20% of the coal you ordinarily use, or we will refund its purchase price without argument.

A 20% coal saving is big enough to make it worth while for you to investigate the inexpensive Crown Fuel Saver.

Proved by 11 Years' Use

The Crown Fuel Saver has proved its merit as a coal-saver and heat producer in thousands of homes, apartments and factories. Write today for full description and for special low price of Crown with money-back guarantee. Do it today. You'll be lots more comfortable this winter with a Crown on your heating plant—and you'll make a substantial money-saving.

CROWN FUEL SAVER CO.
412 N. 10th St. RICHMOND, IND.

DISTRIBUTORS WANTED—The Crown Fuel Saver and the Crown Smoke Preventor for industrial power plants offer a worthwhile opportunity for ambitious men. These devices cover every need in the home and industrial heating field. Write for details of our exclusive territory franchise.

\$351⁰⁰ CLEARED IN ONE DAY

So writes W. H. Adams of Ohio in August 1925. V. A. Marini of California reports \$11275 sales in three months. Jacob Gordon of New Jersey \$4000 profits in two months." Alexander of Pennsylvania "\$3000 profits in four months." Ira Shook \$365 sales in one day. Bram bought one outfit April 5 and 7 more by August 28. Iwata, bought one outfit and 10 more within a year. Mrs. Lane of Pittsburg says "sold 8000 packages in one day. J. R. Bert says "only thing I ever bought that equaled advertisement." John Culp says:

"Everything going lovely. Crispette wrappers scattered all over town. It's good old world after all." Kellogg, \$700 ahead end of second week.



WE START YOU IN BUSINESS

Furnish secret formulas, raw material, and equipment. Little capital required; no experience needed.

Build a Business of Your Own

No limit to the sale of Crispettes. Everybody likes them. It's a delicious food confection. Write for facts about a business that will make you independent. Start now, in your own town.

Profits \$1000 a Month Easily Possible

Send postal for illustrated book of facts. It contains enthusiastic letters from others—shows their places of business, tells how and when to start, and all information needed. Free. Write now!

LONG-EAKINS COMPANY

1228 High Street

Springfield, Ohio

A SCHOOLBOY CAN NOW "KEEP BOOKS"



Bookkeeping troubles made so easy with a So-Easy Loose Leaf Outfit. Binder, 200 sheets (used to use in your business, A-Z index. Price \$3.00. SPECIAL for 10 Days. Send \$2.50 for book. I will include samples of 60 stock forms and "How to Find Errors in Trial Balances."

B. MOHLER, Box 453, CHICAGO, ILL.

Plumbing and Heating Supplies



Save up to 40%

Buy now

Bath Room COMPLETE \$58²⁵ UP

Full line of plumbing and heating supplies at big savings. All made of finest materials brand new and perfect.

EVERYTHING GUARANTEED
Hot water and steam heating plants. Water supply systems. Radiators, fittings, etc.

HOT WATER PLANT 700 ft. Rating \$71.15

Send us sketch of your rooms for estimate or tell us your wants. Price list on request.

B. Karol & Sons Co. 800 S. KEDZIE AVE. DEPT. 20 CHICAGO

You can make \$100 a week

Yes, you can make \$100 a week. You can do as well as H. T. Pearl who made \$750 in one month. You can begin like R. L. Marshall who made \$80 in five hours. You don't have to invest any money. Experience is unnecessary—yet you can start right in to make big money. In a short while you can enjoy an income of \$5000 a year for the easiest, most pleasant and fascinating work you ever did.

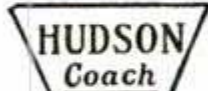

Hudson Coach
Hudson Coach
GIVEN!



We want men and women to represent us everywhere. Wonderful plan. 350 Household Necessities direct from factory to home. Spare time or full time returns amazing profits for easy work. We furnish everything you need to start. In addition to big earnings we offer you a brand-new Hudson Super-Six Coach. Write at once for details of this money-making proposition. We'll send FREE PROOF that you can make \$100 a week in this pleasant, dignified, permanent business.

Write quick for details

The American Products Co.
Dept. 5649
Cincinnati, Ohio.

Agents—Just Out!



NEW AMAZING INVENTION
One device makes window washing 75 per cent easier. Washes, dries, polishes windows in a jiffy. Every housewife wants it. No more ladders to climb, no mussy rags or sponges to wring. Hands never touch water.

Make \$90.00 a Week Easily
Sells fast. Simply show it and take orders. Make 100 per cent profit. No experience needed. We show you how. Send for Catalog of this and 47 other Quality Rubber Products. Direct from Akron, the Rubber City. FREE Outfit to hustlers. *Write quick. **Kristee Mfg. Co., 412 Bar St., Akron, Ohio**



Print Your Own

Cards, stationery, circulars, tag, labels, paper. Complete Outfits, \$8.85 up, Job Presses \$11 up, Rotary \$149. Card Cutters, \$3. Save money. Print for others, big profits. All easy rules sent. Write for catalog presses, type, paper cards, ink etc. **THE KELSEY CO., H-37, Meriden, Conn.**



M-m-m!
TENDER STEAK

- Meat Tenderer
- Mince Knife
- Cleaver
- Ice Tool
- Food Chopper
- Fish Scaler
- Nut Crumbler

Ideal Fiber Cutter tenders meat to juicy tastiness. Housewives all say, "Just what I want." Tested and Approved by Good Housekeeping Institute. Two minute demonstration sells it.
AGENTS—Year'Round Seller
This handy kitchen aid has no dull season. Needed every day. 100 per cent profit. Agents make \$8 to \$20 a day. **Boorem, Pa., writes: "Made \$25 clear profit today."** You can do as well. Work spare or full time. Our time-tested sales plan shows you how. Write for details at once.

THE TYLER MFG. CO., Dept. M-6, Muncie, Ind.

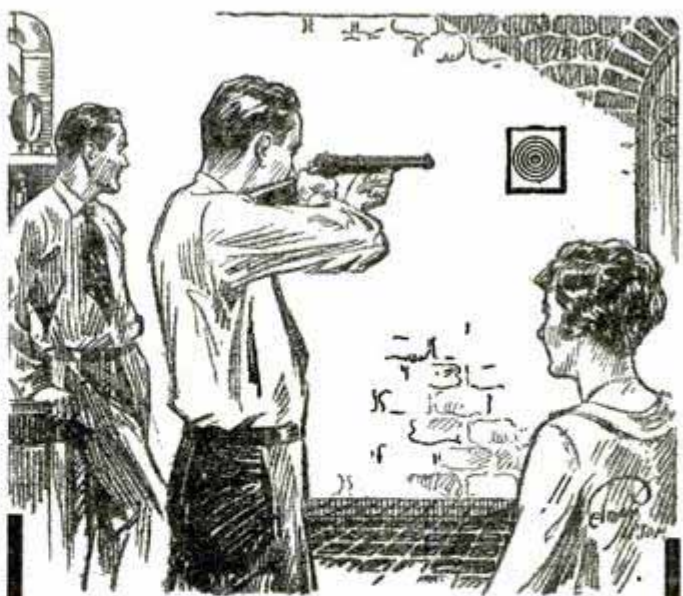

Outshoot your friends with a Crosman Pneumatic .22

Here's the rifle that has taken the country by storm—thousands sold in few months. Up to full 50 yards accuracy of this rifle will surprise you and your friends.

Home target shooting

Set up target in cellar, attic or yard. No smoke or shells to clutter up floor. Almost noiseless. Disturbs nobody. Do sharp-shooting even at night.

"Power without Powder"

Adjustable Power

Deep penetration for field or hunting, lighter power for practice in cellar, yard or attic, with same unsurpassed accuracy. Force is compressed air under tremendous pressure—same force that stops railroad trains.

Needs no cleaning

Round barrel of blued steel is deeply rifled with scientific precision. Absence of powder leaves barrel bright and shining always. No powder-deposit in barrel to pit rifling or impair flight of bullet. You can pick off small game one after the other without startling other game nearby.

Economical Bullet is spool-shaped, ungreased, with rounded nose. Five shots for a penny—one-third the cost of .22 powder cartridges.

A Real Gun The Crosman is 35 inches long; weighs 5½ pounds. Knocks down to fit suitcase; only one screw to remove. Heavy solid walnut stock with pistol-grip and steel butt-plate give excellent balance; handles just like any high-grade rifle and is the pride of expert riflemen.

Order Now Crosman Pneumatic rifle \$15 (West of Rockies \$17.50)—Bullets, per 1000, \$2.25 (West of Rockies \$2.40)—target holder with bell attachment \$2.00—Paper targets 50c per 100—lined gun case \$2.25—all prepaid. Go to your dealer. If he cannot supply you, send check or money-order.

Crosman Arms Company, Inc.
469 St. Paul Street, Rochester, N. Y.
Canadian Address: 70 W. King St., Toronto
Dealers: Write for proposition.

Please Mention Popular Mechanics

Fastest Cutting

Saws Fifteen Cords a Day!



**Men—
Let Me Send You My
Greatest LOG SAW Offer!**



It's easier now than ever before to own this fastest-cutting, easiest-moved, most powerful Log Saw. Now, you can make big money sawing firewood, stove-bolts, ice, shingle timber, etc. Write today for full details of this most wonderful offer. Know how easy it is to make big money sawing fifteen cords of wood a day with no hard work.

350 Saw Cuts a Minute—

nearly six each second. Just think of it—now you have a log—in a few seconds it's all sawed up into lengths you can use—without any hard work! The OTTAWA has balanced crank shaft, power force feed, friction clutch.

Make BIG MONEY—

Wood selling at \$3 a cord brings owner \$45 a day. Saw your own wood—go into the wood business. Don't let the lack of ready money stop you. Remember, we sell on very easy terms. More in use than all others combined.

Puts the OTTAWA Working for YOU!

I average \$20 profit a day with my OTTAWA. — J. Schill, New York. "My OTTAWA has earned \$700 for me." — S. Graham, Wisconsin. "I can make more money with the OTTAWA than by farming." — D. Goff, Missouri.



Cuts Up Branches



Cuts Down Trees Level With Ground

OTTAWA 4.H.P. LOG SAW

30 Days to Try—one whole month to use the OTTAWA at your own sawing. Shipped on trial only—backed by 10-year guarantee. Prove to yourself how easy you can saw 15 cords or more a day—at a cost of 1 1/2¢ a cord.

FREE

Send me your name and address on postcard today, so I can send you my wonderful new edition of the "Wood Sawing Encyclopedia." Educational, instructive. Be sure to investigate—will help you to make big money.

HARRY OVERMAN, Pres. OTTAWA MFG. CO.
1742-P Wood St., Ottawa, Kans. Room 1742-P, Magee Bldg., Pittsburgh, Pa.

To Save You Freight—and get your machine to you a few days after you order, I ship from: Ottawa, Kan.; Pittsburgh, Pa.; St. Paul, Minn.; Albany, N. Y.; Memphis, Tenn.; Indianapolis, Ind.; Pueblo, Colo.; Ft. Worth, Texas; Portland, Ore.; San Francisco, Cal.



Wood Sawing Encyclopedia



New Plan!
makes it easy

\$50.00 to \$100.00 Weekly

Selling Shirts Direct to Wearer.
No capital or experience needed. Spare or full time. Established 1885. Represent a real manufacturer.

WRITE FOR FREE SAMPLES
MADISON SHIRT MILLS, 562 BROADWAY, NEW YORK

Earn \$100 a Week
Profits in Advance

Sell Gibson extra fine men's made-to-order all-wool suits at \$31.50, direct to wearer. Regular \$55 values. **Biggest commissions paid in advance.** We deliver and collect. 6 x 9 cloth samples (over 100 styles—all one price) and complete outfit in handsome carrying case, furnished to ambitious men who are willing to hustle and earn \$100 weekly. Write today.



W. Z. GIBSON, Inc., 161 W. Harrison St., Dept. Z-516, Chicago

Mr. Brush Salesman

Unusual opportunity is offered for aggressive, ambitious, hustling men to sell an old established high grade guaranteed, fastest selling line of Sanitary Twisted in Wire Brushes, sold direct to the home. We have openings for experienced brush men as managers in all territories. We want live wire, energetic Go-Getters. We pay larger commissions than any other Brush House in the Country. If you want to earn some real money, it will pay you to write us immediately for our proposition.

WIRE GRIP SANITARY BRUSH CORP., 15 Mercer St., New York City

DEAFNESS IS MISERY GOOD HEARING A JOY



Millions of people know that, but Multitudes of persons with defective hearing and Head Noises are again enjoying conversation, go to Theatre and Church because they use Leonard Invisible Anti-septic Ear Drums, which are Tiny Megaphones fitting in the Ear entirely out of sight. No wires, no batteries, no head piece. They are Unseen Comforts and inexpensive. Write for booklet and sworn statement of the inventor who was himself deaf.

A. O. LEONARD, Inc., Suite 161, 705th Ave., New York

WHITE FLAME

BURNERS make your old kerosene lamps and lanterns give a brilliant white light better than electricity or gas. Doubles your light. Saves oil. **NO MANTLE TO BREAK.** Guaranteed Safe and Reliable. Delights every user. Send now for complete sample postpaid 50 cents, stamps or coin, 3 for \$1.25. **Money Back If Not Satisfactory.** Live Representatives Wanted. Exclusive Territory.
WHITE FLAME LIGHT CO., 68 Clark Bldg., Grand Rapids, Mich.



NEW AUTOMATIC ADDER, \$3.50

Makes adding easy. It's accurate, quick, durable and easily operated. Capacity 8 columns. Saves time, brain work and errors. 75,000 pleased owners. Fully guaranteed. Price \$3.50 delivered. With metal operating bands, \$5.00 delivered. Agents wanted.

J. H. BASSETT & CO., Dept. 279, 1458 Hollywood Ave., Chicago, Ill.



ALL FREE

10 year guar. Watch with chain and ring, large Eastman Roll Film Camera or 22 cal. Hamilton Rifle yours for introducing finest assorted liquid perfume at 16¢ a bottle. Send for 20 bottles and choose gift as per offer in our catalog. We trust you—just write to **BELL PERFUME CO., Dep. B153, Chicago, Ill.**



SEND NO MONEY

Genuine Full Cut Diamonds

Terms If Desired — 6 Months to Pay. Outside U. S. Cash with Order.
\$25



This Reg. Trade Mark guarantees you genuine diamonds.

No. 6598—Any initial (raised gold) or Eastern Star, Rebecca, Mason, Shrine, K. of C. emblem instead of initial if desired. Send number of ring, size of finger, initial or emblem desired and ring will be sent for inspection.

Ask for Free Catalog
BUFFALO JEWELRY MFG. CO.
"The Mail-Order House"
Dept. P (or at your Jeweler's)
501 Washington St., Buffalo, N. Y.

No Chips

No. 6132—Solid Gold Men's Initial or Emblem Ring. 2 Genuine Diamonds 4-100 each **\$25**

14-Kt. White Gold Top. Gold Emblem (any Lodge) or any initial (Old English) yellow or white Gold, in-laid in Genuine

HOPE RUBY
Also, in Black Onyx



No. 6598—Ladies' Ring.... **\$15**
Genuine Black Onyx with Genuine Full Cut Diamond. 14-Kt. White Gold.

Great New Invention

for seekers of

Health Power Beauty



Elco Health Generators at last are ready for you! If you want more health—greater power to enjoy the pleasures and delights about you, or if more beauty is your desire—write! Ask for the book on these inventions which has just been prepared. It will be sent to you without cost. It tells you how Elco Health Generators aid you in leaving the lethargy and hopelessness of bad health and weakness behind forever. Re-vitalize yourself. Bring back energy. Be wholly alive. Write today!

10 Days Free Trial—Write for FREE BOOK

EASY \$100 a Week

FUGO FIRE EXTINGUISHER

Unusual opening for live agents in every locality. Make \$5000 or more a year—easily. Fugo—the instantaneous automatic fire extinguisher—is needed and wanted in every home, store, theatre, garage, shop, school, automobile, etc. Cheapest fire protection available today. Within reach of all.

1 Qt. Size \$5.00 2 Qt. Size \$7.50

Recharged in a jiffy.

Amazing 30-second demonstration clinches sale—each one sold sells others. Territory going fast. Write at once for wonderful proposition that will **MAKE YOU BIG MONEY.**

THE NATIONAL FORMETAL CO.
6535 Metta Ave., N. E. Cleveland, Ohio

NEW MAGNETIC DISCOVERY

BUILDS HEALTH



An electro-magnetic appliance has been perfected that builds robust health and vitality. This appliance, known as the Vit-O-Net Electro-Magnetic Blanket, eliminates poisons, relieves pain and promotes rest and sleep. Dissolves congestions responsible for many ailments. Endorsed and used by hundreds of physicians and hospitals. Successfully used for such cases as Rheumatism, Nervousness, Neuritis, Blood Pressure, Catarrh, Kidney troubles, etc. The manufacturers will send free to any one interested, copy of Health Document revealing valuable health secrets. Write to Vit-O-Net Mfg. Co., Desk 5126, 4105 Ravenswood Avenue, Chicago, Illinois. Representatives wanted.

ions responsible for many ailments. Endorsed and used by hundreds of physicians and hospitals. Successfully used for such cases as Rheumatism, Nervousness, Neuritis, Blood Pressure, Catarrh, Kidney troubles, etc. The manufacturers will send free to any one interested, copy of Health Document revealing valuable health secrets. Write to Vit-O-Net Mfg. Co., Desk 5126, 4105 Ravenswood Avenue, Chicago, Illinois. Representatives wanted.

\$100 a week Selling Shirts

Fred Frel, Ill., writes: "I earned \$110 first week selling Carlton Shirts direct to consumer." You can too. No capital or experience required. We pay 25% cash commissions daily and big extra bonuses. WRITE FOR FREE SAMPLES.

CARLTON MILLS, Inc., Shirt Mfgs.
114 Fifth Ave., Dept. 106-D, New York City

AGENTS 500% PROFIT

GENUINE GOLD LEAF LETTERS

guaranteed to never tarnish. Anyone can put them on stores and office windows. Enormous demand, large profits. Paul Clark says: Smallest day \$28.70. R. L. Reel made \$920 in two months. Write today for free sample and liberal offer to general agents.

METALLIC LETTER CO., 433-B N. Clark St., CHICAGO



These great new inventions generate *High Frequency Violet Ray, Mechanical Vibration, Medical Electricity and Ozons.* Combined or separate.

They operate on the electric light in your home or on their own motive power at less than 50 cents per year. Elco Health Generators are positively the only instruments which can give you in one outfit Electricity, Violet Ray—Vibration and Ozone—the four greatest curative agents. Send coupon below. Get the Free Book NOW!



For All These:

- | | |
|-------------|-----------------|
| Rheumatism | Asthma |
| Gout | Hay Fever |
| Lumbago | Sore Throat |
| Neuralgia | Catarrh |
| Sciatica | Deafness |
| Headache | Insomnia |
| Neuritis | Pain |
| Nervousness | Development |
| Circulation | Skin Disease |
| Weakness | Pimples |
| Paralysis | Scalp Disorders |
| Eye Trouble | Obesity |

MAIL the COUPON for FREE Book!

Do not put this paper down without sending the coupon. Don't go on as you are with pains and with almost no life and energy. You owe it to yourself to be a better man or woman. You were put here to enjoy life—not just to drag through it. So do not rest another day until you have put your name on the coupon here. That will bring the whole story of these great new inventions. Do it today—now.



Lindstrom & Company

30 West Lake Street. Dept. 13-59, Chicago, Ill.
Please send me your free book, "Health—Power—Beauty" and full information on your 10-day Free Trial Offer.

Name.....
Address.....
.....

The Old Reliable Credit Jewelers **LOFTIS BROS. & CO.** Dept. 6894 State St. Chicago, Ill.

DIAMONDS

GENUINE DIAMONDS GUARANTEED AT IMPORTERS' PRICES

Ideal Christmas Gifts CASH OR CREDIT
 These Diamonds are finest quality, blue white gems, radiantly beautiful, set in solid 18 karat white gold mountings, artistically pierced and engraved. Satisfaction guaranteed or money back. Goods sent for your free examination on request—order now!
CREDIT TERMS: Pay one-tenth down; balance weekly, semi-monthly, or monthly at your convenience. All goods delivered on first payment.

Special Christmas Value
 Jocelyn Diamond Dinner Ring. Beautiful solid 18-k white gold ring with 3 perfectly matched blue white Diamonds, \$175 a week.
 17-Jewel Elgin No. 15 Green gold, Elgin watch, 25-year quality case; 12 sizer, gents' dial, \$300 \$301.43 down \$3 a month.

Christmas Catalog Free!
 Big 132 page book, illustrating our Diamonds, Watches, Jewelry, Silverware, and gift articles for all occasions, sent absolutely free. Write today.

Diamond Wedding Rings
 in solid 18-k white gold; 3 Diamonds, \$22.50; 5 Diamonds, \$32.50; 7 Diamonds, \$42.50; 9 Diamonds, \$52.50; 12 Diamonds, \$67.50. In solid platinum with 3 Diamonds, \$50; 5 Diamonds, \$70; 7 Diamonds, \$90; 9 Diamonds, \$100; surrounded by Diamonds, \$200.

No. 855 Ladies' Wrist Watch
 Solid 14-k white gold case, engraved, fancy wing ends, 15-Jewel movement, guaranteed, \$30. \$300 a \$3.00 down \$3 a month

Our References: Any Bank or Banker in U. S. A.

EDWARDS

WILL SAVE YOU MONEY ON

METAL ROOFS

We own our own steel mills, roll our own sheets, make them into high-grade REO METAL SHINGLES, Sidings, Ceilings and Roofings of every type and style for every kind of building. We control every operation from the raw material to the finished roof and we sell direct from our factories to the user. Not a dollar to divide with anybody but the customer! You get better value for less money.

OUTLAST THREE ORDINARY ROOFS
 EDWARDS METAL ROOFS are weather-proof, lightning-proof, fire-proof! The galvanizing bends with the metal. No tools required.

LOW-COST ALL-METAL GARAGES
 Any size. Any style. Portable. Ready to erect. Complete with frames, doors, sash and hardware. Ornamental, durable, economical. Blue-prints and complete instructions FREE. Write today. Get our low prices and Free Samples. Ask for Roofing Book No.150 or for Garage Book No. 150

THE EDWARDS MFG. CO.
 1209-1250 Butler St. Cincinnati, O.

FREE Samples & Roofing Book

Sport Bodies for Fords

AT FACTORY PRICES!

This Model in Grey Prime **\$39.50**

Write for Booklet A-2 Showing Other Models.

SPORT FACTORIES, AURORA, ILL.

Tire AGENTS WANTED

Use and introduce **MELLINGER CORD TIRES** 15,000 MILES GUARANTEED Lowest Wholesale Prices in America. Shipped prepaid on approval. Make big money all or part time. No capital or experience. Sample sections furnished.

YOUR TIRES FREE! Simply send name today for valuable FREE BOOK; tells how thousands have gone into big business. **SPECIAL AGENTS' OFFER.** Wholesale Prices and FREE SAMPLE KIT. Write nearest address.

MELLINGER TIRE & RUBBER CO.
 Dept. 415, Kansas City, Mo. Dept. 415, Philadelphia, Pa.
 Dept. 415, Oakland, Calif. WRITE NEAREST OFFICE

ENINGER WILL TRUST YOU

SEND 20c IN STAMPS FOR CATALOGUES → BIG MONEY SAVING FOR YOU

Used and rebuilt motorcycles \$25 to \$100, used bicycles \$9.50, tandems \$30. All machines fully guaranteed. New bicycles and motorcycles at factory prices, save dealers' profits. Motorcycle and automobile tires \$3. Complete line frames, engines, supplies.

DENINGER PRICE CUTTER, ROCHESTER, N. Y.

PAY AS YOU RIDE

Catch Fish!

Eels, Mink, Muskrats with our new folding galvanized **STEEL WIRE TRAP.** Write for our **FREE TRAP OFFER** and Bargain Catalog. \$1 Box of our famous Fish Bait FREE to introduce our traps.

WALTON SUPPLY CO., 3500 JUNIATA AVE., ST. LOUIS, MO.

STOP FORD CRANKSHAFT END-PLAY!

C-A ADJUSTABLE BEARING corrects and prevents end-play without removing motor. Eliminates many troubles. Easy to install—simply drop pan. Only \$3.75. Ask your dealer or sent prepaid by **ADJUSTABLE BEARING CO., Dept. P, 405 Virginia Ave., Indianapolis, Ind.**

MOTORCYCLES

RELIABLE STANDARD MAKES that you can **DEPEND** on. Enjoy the glorious experience of going wherever you like—when ever you like. The price is within your means—35% to 50% less than others. These machines are slightly used, thoroughly overhauled or rebuilt. Send for catalogues.

MYEROW BROS.,
 15 Berkeley St. Boston, Mass.

MOTORCYCLES

LESS THAN HALF COST

Ace, Indian, Cleveland, Harley-Davidson, Henderson Motorcycles and Sidecars, new, used and rebuilt. **Rider Agents Wanted.** Write for FREE trial offer, agent's free outfit and big bargain bulletin. **New American Bicycles** in different styles and colors. Write for illustrated catalog giving our money saving prices.

AMERICAN MOTOR CYCLE CO.
 2047 W. Chicago Ave., Dept. 1235 Chicago



Why It Makes Puncture Repairs Permanent

The Shaler Patch-&-Heat Unit is the secret. It's a little tin pan full of prepared solid fuel that creates just enough heat to



VULCANIZE the raw rubber patch on the bottom of the pan firmly to the tube. It comes to you all in one piece, like a cartridge for a gun. No

patch to cut to fit. No cement, no mess, no fuss.

To make a repair, you clamp one of these little tin pans over the puncture with the Shaler Clamp, furnished with each outfit, and light the fuel. In five minutes take off the pan and throw it away. That's all. The repair is part of the tube because it is heat-welded (VULCANIZED).



Buy the Complete Outfit, including Vulcanizer and 12 Patch-&-Heat Units, for only \$1.50, wherever auto supplies are sold. Slightly higher in Canada and far West.

C. A. SHALER CO., Waupun, Wis., U. S. A.

You-and This New Machine Can Earn \$500 a Month



Operate a Tire Repair Shop 70,000,000 Tires in use. America's greatest opportunity for men with small capital. We furnish everything—\$100 and up. Easy payments. We train you FREE right at home. Start making money at once. Write today for Free Book of Opportunity.

Haywood Tire Equipment Co. 1344 S. Oakley, Chicago

SHAW MOTOR ATTACHMENT MAKES YOUR BIKE A MOTORCYCLE!

A high grade 2 1/2 H. P. motor attachment quickly clamped on any bike frame. Speed 4 to 40 miles an hour. 90 to 125 miles per gallon of gas. Special Low Price Now! Write today for Complete Description and Special Low Prices on SHAW Motor Attachments and the SHAW Complete Motorbicycle. SHAW MANUFACTURING COMPANY Dept. 37 Galesburg, Kansas



"Independent" GOLD POINT \$2
Lever, Self-Filler Stylopen
"Makes Writing a Pleasure"
Jumbo, \$3.50; Red, \$3.00; Black
J. C. ULLRICH & CO., 161 Washington St., N. Y. Est. 1884 Agents Wanted

Be a Taxidermy Artist
Marvelous Book Sent FREE
You can now learn Taxidermy, the wonderful art of mounting birds, animals, tanning skins, etc. Learn at home, by mail. The free book tells how. Mount your own trophies. Decorate home and den. Hunters, trappers, nature lovers, you need taxidermy. Interesting, fascinating, big profits. Join our school. 100,000 students, Success guaranteed. Get our free book without delay. Send right now—today.
N. W. School of Taxidermy. 1779 Elwood Bldg., Omaha, Neb.

Sensational Typewriter Offer



The World's Only Ball Bearing Typewriter

NEVER has there been such a typewriter bargain on as easy terms! A genuine Silent Ball Bearing L. C. Smith at a 40% savings!

Only the L. C. Smith has all these features:

Ball bearings (636 of them) at all points of wear. All the writing visible all the time. Non-shift carriage. 2-color ribbon. All the latest operating conveniences. Beautiful—renewed.

If you decide to keep it only \$3⁰⁰ DOWN BALANCE EASY TERMS

Guaranteed 5 Years

Money cannot buy a better typewriter. U. S. Government bought 50,000. The choice of railroads, big corporations like the Standard Oil Co., etc., because of its exclusive ball bearing feature. Easiest running, longest wearing of typewriters.

Send No Money!

Just mail coupon. Without delay or red tape, typewriter will be shipped you. Use it 10 days. See how speedy and easy it runs—the perfect work it turns out. If not delighted, return at our expense. You'll want to keep it. You can, for \$3 down and \$5 monthly. Now is the time to buy. \$3 worth of extras free. Send coupon now before offer is withdrawn.

40% SAVED by Using this Coupon
SMITH TYPEWRITER SALES CORP.
11C-360 E. Grand Ave., Chicago

Ship me the L. C. Smith, F. O. B. Chicago. On arrival I'll deposit \$3 with express agent. If I keep machine, I'll send you \$5 a month until the \$66.70 balance of \$69.70 price is paid; the title to remain with you until then. I am to have 10 days to try the typewriter. If I decide not to keep it, I will repack and return to express agent, who will return my \$3. You are to give your standard 6-year guarantee.

Name.....
Address.....
City..... State.....
Employed by.....

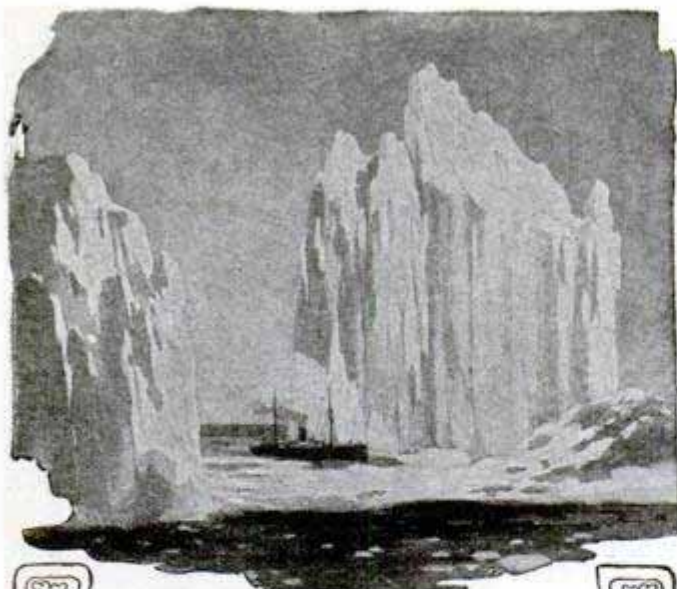

With the "Trouble-Shooters" of the North Atlantic

ICE-BERGS—towering, ponderous, deadly mountains of ice drift southward from the ice fields of the Arctic into the traffic lane of trans-Atlantic steamers.

Locating and destroying them is the perilous and never-ending duty of the United States Coast Guard cutters.

Shell fire and high explosives, however, often fail to blow the bergs from the sea, and warnings are then broadcasted by radio to every ship whose course lies through the danger zone.

Smooth power, unfailing dependability over long periods and under all conditions of service are qualities demanded in the radio batteries used in this dangerous naval service.

The fact that Burgess Batteries meet those requirements recommends them to you for your own receiving set.

Ask Any Radio Engineer

BURGESS BATTERY COMPANY

GENERAL SALES OFFICE: CHICAGO

Canadian Factories and Offices:
Niagara Falls and Winnipeg



BURGESS RADIO BATTERIES

Get These Coils!

T. R. F. Kit
List \$12.00



—and greatly improve the
performance of your set!

The Aero Coils composing this kit are extremely supersensitive, due to the fact that they have a much lower high frequency resistance than other types of inductances.

The use of Aero Coils in place of other inductances has never failed to improve set performance. They prove their supersensitivity by tremendously increasing power, by improving quality of tone, and by their extreme selectivity.

If you would obtain best results from any circuit, be sure to use Aero Coils. Order from your dealer or direct from us.

Big 8 page 4 colored layout system (actual size blue prints) and complete instructions for building the Aero-Dyne Receiver free with each kit. Extra copies, 75¢ each.

AERO PRODUCTS, Inc.

Dept. 107, 1772 Wilson Ave., Chicago, Ill.

Year's Income in 1 Month

Agents Everywhere to Appoint Subagents and Handle Sale of

CHRISTMAS NOVELTY

which previous years prove will net large income during December. Every store and office a prospect. Sold day or evening. Easy method of display. Cash sales; no order taking. Active subagents make \$25 per day. Wire or write territory you can handle.

CONSOLIDATED CO., 67-V West Van Buren Street, CHICAGO

fix it yourself

Cheer up—now you can mend metalware as easily and perfectly as a mechanic! All you need is a touch of heat and Kester Metal Mender.

The pleasure of watching the bright, flowing solder, plug a hole or mend a break is only exceeded by the satisfaction of knowing you have done something useful.

Your hardware dealer can supply you with a can of this household solder.



Free sample
upon request



KESTER METAL MENDER

CHICAGO SOLDER COMPANY
4201-337 Wrightwood Ave., Chicago, U.S.A.
Est. 1899

A & B Battery \$2 Charger ONLY

SATISFACTION GUARANTEED



Charges any type of storage A or B battery, using a few cents worth of ordinary house current, either alternating or direct. Cannot injure battery. Complete directions enclosed. Anyone can operate. No expensive "extras" to buy. Why pay \$10.00 to \$15.00 for a charger when you can get this splendid GUARANTEED R. B. Charger by mailing us

two dollars (bills, money order, check or stamps) plus ten cents in stamps or coin to pay mailing costs. Charger will be sent postpaid. If you are not satisfied, return within 5 days and we will refund your money.

Order at once—**TODAY**

R. B. Specialty Company

308 East Third St. Dept. E-1 Cincinnati, Ohio

American RADIO Now—
50% DISCOUNT ON RADIO!
BIG NEW 1927 CATALOG-FREE

Dealers, Agents, Set Builders—get our big 1927 Catalog—225 nationally advertised lines. Lowest prices in America! Largest, most complete stock. Radio's latest developments. It's FREE—send for your copy now. American Auto & Radio Mfg. Co., Inc. 1423 McGee St., Kansas City, Mo.

Radio Blueprints

Blueprints for the most popular sets described in Popular Mechanics Magazine can be obtained for a charge just sufficient to cover the cost of production and mailing. The sets for which blueprints are available are:

Simple One-Tube Receiver	April 1926	15c
One-Tube Pocket Receiver	July 1925	10c
Two-Tube Loud Speaker Set	May 1925	10c
Three-Tube Cockaday Receiver	April 1925	10c
Three-Tube Low-Loss Short Wave Set	Oct. 1925	10c
Four-Tube Loop Set	Aug. 1925	10c
Four-Tube Portable Loop Set	Aug. 1926	15c
Five-Tube No-Battery Set	July 1925	10c
Five-Tube Browning-Drake Receiver	May 1926	15c
Six-Tube Self-contained Receiver	July 1925	10c
Six-Tube Perfect-Tone Receiver	Nov. 1925	10c
Six-Tube Counterphase Receiver	Feb. 1926	15c
Six-Tube Portable Loop Set	June 1926	15c
Eight-Tube Superheterodyne 1927 Model	Oct. 1926	75c
Set of blueprints including drilling templates		
B-Battery Eliminator	Mar. 1926	15c
Non-Radiating Unit	May 1926	15c
Simple Tube-Tester and Chart	July 1926	15c

Address the **RADIO DEPT.**
Popular Mechanics Magazine
200 E. Ontario St., CHICAGO

Back numbers of the magazines describing the construction of the sets can be obtained from our Circulation Department, price 25 cents each.

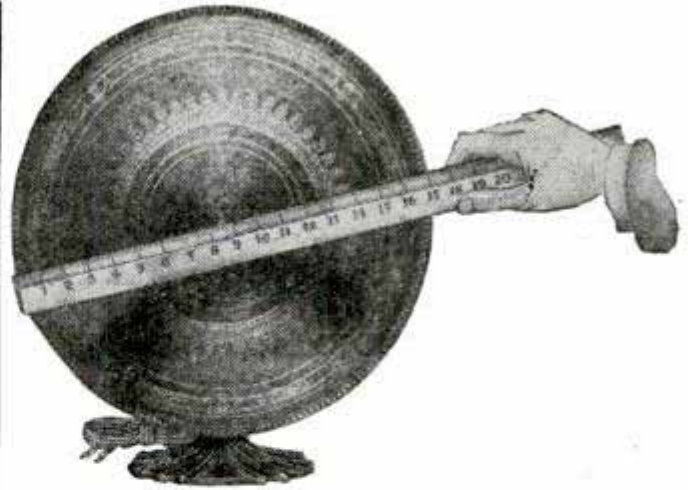

No Skimping

FULL size cone—17 inches in diameter. Made of the finest materials money can buy. Mounted on sturdy bronze finish base protected by felt pads.

Exclusive direct-drive unit—adjustable. Not one, but *eight* points of contact from unit to cone. Full 5-foot cord. Expensive wooden box packing insuring perfect delivery. Many other features.

More Tower Cones have been purchased since March 31st than any other make during the same period.

On Sale from Coast to Coast

TOWER MFG. CORP., Boston, Mass.

\$9.50
The Tower cone

SM PARTS THAT ARE BETTER

220 AND 221 AUDIO TRANSFORMERS



S-M 220—the big, husky audio transformer you hear in the finest sets—the only transformer with the *rising* low note characteristic that means real quality—not only on paper—but when you hear it. It is a power job—yet this finest of audio amplifying devices is sold, with a guarantee, for but \$6.00.

The S-M 221 is an output transformer that will bring out the low notes on your present set. Used between the last audio tube and the loud speaker—it eliminates blasting and will increase speaker capacity for handling strong signals without distortion. \$6.00.

INTERCHANGEABLE COILS



Designed for extremely low losses and permanent uniformity. Space wound with enameled wire upon threaded moulded bakelite forms and sold under a guarantee of accuracy of less than one-half of one percent. Made in several models—for use wherever the best in coils is required—and in a variety of ranges from 18 to 1500 meters. Prices, \$2.50 to \$3.25 each, depending upon type. Universal 6 contact socket, \$1.00. Send for descriptive circulars.

210 AND 211 LONG WAVE TRANSFORMERS



Accurately measured and tested. Actual amplification to the fraction of one percent is predicted in the tests that these transformers have to pass. Type 210 is an untuned iron core transformer and the 211 a sharply tuned air core filter. Available peaking at any frequency between 40 and 65 K. C. for 199 or 201A tubes, price \$6.00 each.

631 STAGE SHIELD

An aluminum shield, $7\frac{1}{2}$ by 5 by $3\frac{3}{4}$ inches—for oscillator, detector, R. F. amplifier and other circuits. Pierced for a condenser, coil socket, tube socket, choke, bypass condensers and lead wires. It opens at the bottom allowing easy wiring and the top seals it tightly from outside interference. May be used in any standard circuit to improve results. \$2.00.

All prices 10% higher west of the Rockies.

See them at your Dealer

SILVER-MARSHALL, INC.
840 West Jackson Blvd., Chicago, U. S. A.



Easy to Solder This New Way

Pat. Applied For

Indispensable for all soldering work. Simple—Speedy—Economical.

3²⁵

Complete

Press-to-Feed Electric Soldering Iron

One hand does the work of two. Speeds up radio set construction. Simplifies all kinds of soldering work. Far better than a blow torch. Solder will not melt until it reaches Soldering Point. Porcelain insulation prevents heat from entering handle.

AGENTS—DEALERS—JOBBERS

This newly invented electric soldering iron offers big money making opportunity. Order a sample today \$3.25. Discounts in quantities on request. Write to

ILLINOIS STAMPING & MFG. CO.
220 N. Jefferson St., Dept. 19, CHICAGO

TYPEWRITER PRICES REDUCED

FREE TRIAL

ON ALL
STANDARD MAKES



Big bargains, easy payments on late model Underwoods, Royals, L. C. Smiths, Remingtons, etc. — perfect machines expertly re-manufactured by the "Young Process", guaranteed like new for five years. Shipped direct from our factory to you at big saving.

Our big illustrated catalog sent free and without obligation to buy. Write for yours today.

Young Typewriter Co., Dept. HO-C
654 W. Randolph St., Chicago, Ill.

RADIO DEALERS

SET BUILDERS!

Get the new 1926-27
Van-Ashe Catalogue.

Shows all latest hook-ups with diagrams;
also every part needed in building any set.

It's a complete set-builder's catalogue
and hand-book. Sent for 25c
coin or stamps.

Dan-Ashe Radio Co.

206 North 10th St.

ST. LOUIS, MO.

30 DAYS FREE IN YOUR HOME

Tested and approved by all of Radio's Highest Authorities



Send Coupon for Amazing Special Offer!

NOTE: This offer is made to prospective buyers by famous big Radio Corporation, one of America's oldest reliable manufacturers of fine sets—seventh successful year. Many satisfied users in every state. Postal or coupon brings testimony of nearby users and proof Miraco's outperform sets costing up to 4 times as much. Very easy to install and operate.

BEAUTIFUL - BIG - POWERFUL Ultra Selective **MIRACO** Ultra's

Retail \$ **49.75**
LIST Price
now only **49.75**
GET SPECIAL OFFER One Year GUARANTEE

AMAZING SPECIAL OFFER to User-Agents who will allow friends to listen to their Miracos.

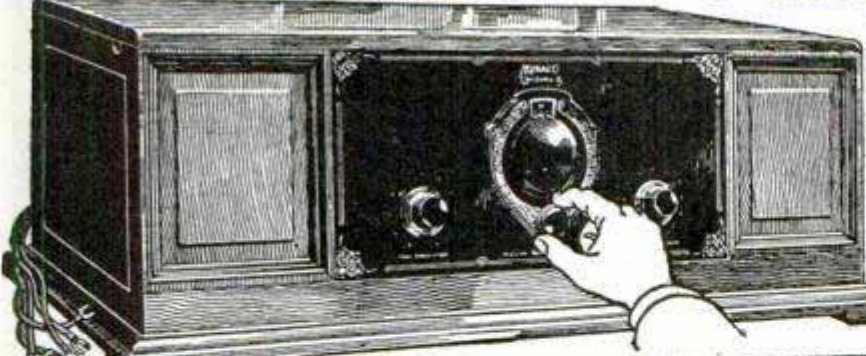

Built like—to look like—and perform like \$200 sets

Real Single Dial Control! Magnificent Big Powerful Miraco "Unitune-5" Get Special Offer and Amazing Low Price!

The celebrated Miraco Ultra-5—U.S. Navy type circuit, has also been adapted to Single Dial Tuning—without sacrifice of selectivity, volume, clearest, power, tone, or distance getting **quintuple**! In the magnificent big Miraco Unitune-5, above shown, you turn one vernier knob for stations everywhere. Beautiful hand-robbed, piano hinged, solid walnut cabinet, 28 in. long, 15 in. deep, 10 in. high. Sloping Bakelite panel is walnut finished to match. Also offered on 30 days free trial!

Coast to Coast and foreign Reception Certified by Miraco users Notice!



Enormous sales of the fine Receivers resulting from delighted users so highly endorsing them to friends to gain evidence to add hosts of costly new features, latest refinements and up-to-the-minute improvements such as you might expect to find only on much higher priced sets. Miraco's this year are still better—more beautiful—more selective—more powerful for less money than ever before.

USER-AGENTS WANTED . . . WRITE!

Reports from users everywhere leave little for us to add. These are only a few of the many in our files and which we receive daily. Send coupon for plenty of additional proof and testimony of nearby users.

HAS NO EQUAL FOR TONE, VOLUME, DISTANCE. North Wadwood, N. C. Miraco best pocket set I ever saw shipped. Words cannot express the wonderful tone quality volume and distance. First night received 47 stations on loudspeaker. Up to last night, the 5th day, I have received exactly 100 stations! Farthest is KGO, Oakland, Calif. on loudspeaker. Also Puerto Rico, Cuba and Canada. Francis D. Lott.

TONES QUALITY PLEASES EVERYONE. Philadelphia, Pa. Everyone that hears the Miraco is very pleased with its tone, distance, clarity, etc. I found it during my trip to the International Convention at KGO, Oakland, Calif.: CYB, Mexico City, Mex.; G. H. W. Cuba; and 104 American stations from coast to coast. Lawrence Ribberg.

WISCONSIN HEARS COAST TO COAST. Racine, Wis. I got station 210 London last Wednesday night on my Miraco. Heard a clear and unmistakable tone. Heard also heard WJX, Havana, Cuba; CYZ, Mexico City and 104 American stations from coast to coast. Lawrence Ribberg.

SELECTIVITY—CUTS THROUGH STRONG LOCALS. Detroit, Mich. More than 100 stations on my Miraco. I can cut through WJL, WCL, WJH, WJL, WJL, very strong local stations in my home and a quarter of a turn. In every way it is simply perfect. Charles Paul.

UTAH ENJOYS COAST TO COAST PROGRAMS. Heber City, Utah. The Miraco can't be beat at any price. Coast to coast it sure does and more. I have had stations in New York and Cuba in the east, and scores of other stations on the west coast. I have logged up to 100 stations and they all come in wonderfully. Monte Giles.

MIRACOWINS AGAINST 3 OTHER MAKES. Pearland, Texas. I tried three other makes and the Miraco is the best of them all. Received KFI, Los Angeles, Calif. on loudspeaker. O. R. Richards.

Neandorles, Texas. Only Miraco I have heard stations from Cuba to San Francisco and from Mexico City to Pittsburgh. Walter M. Frankie.

COAST TO COAST LOUD AND CLEAR. Goshute, Minn. We logged over 30 stations and get over 100 miles on the loud speaker the first night—our first experience using radio again. The third night we got WJX Jacksonville, Florida and KFLA Los Angeles, Calif., on the loudspeaker. Neighbors say Miraco is the best they have ever heard. O. R. Wolf.

MIRACO BEATS A SUPER EIGHT. Cobalt, Ontario, Canada. Miraco is one of the best radios in all the north country. There is no one better with a big Super eight and our Miraco beat it. W. Sommer.

BEATS COSTLY SETS WITH MORE TUBES. Lexington, O. I have given Miraco a thorough try out and find it to do all you claim. 25 stations logged so far; getting power on every week. This includes coast to coast, Canadian, and Mexican stations. The selectivity is remarkable. Others here in town have more expensive and elaborate sets, but do not even do this. J. L. Temple.

MIRACO OUTPERFORMS THEM ALL. Kansas, Mo. I've heard a lot of Miraco sets. Miraco is best all around. I am proud of mine. Comes in fine and clear. No noise. Get lots of distant stations. Surely an satisfied. Orrey Sharpe.

LIKES IT BETTER THAN \$150-\$250 SETS. Westfield, Ill. Miraco sure is a wonderful set. I get the stations easily without noise—that's one of the things I like about the Miraco. I've had three other sets that have ranged from \$110 to \$200 each but Miraco beats them all. My friends all like the Miraco. I have had stations all over the U.S.A. I live in Mexico City and Havana, Cuba any time they are on the air. Alex Kinder.



Big Powerful New

Unitune 5 MIRACO Ultra 5

28 in. long 27 in. long
TRADE MARK REGISTERED
ULTRA-SELECTIVE LONG DISTANCE 5 TUBE SETS EASY ON BATTERIES
Unless Trial Proves Your Miraco the Most Selective, Clearest Toned, and Most Powerful Distance Getter—Don't Buy it!

No need to wear out expensive batteries burning 6, 7 or 8 tubes when users everywhere are reporting that the big latest Miraco 6-tube sets actually are **unsurpassed** (even at much higher prices) for razor-edge selectivity, extreme long distance reception, clear natural tone and powerful loud speaker volume combined with great economy in use of battery current! Enjoy a powerful Miraco 30 days in your home—at our risk—and be convinced! Your verdict final—absolutely no strings to this. Save or make a lot of money on sets and accessories this season by sending **IMMEDIATELY** for our Amazing Special Offer! Deal Direct with a Big Reliable Corporation Remember this offer is made direct to you by a big responsible manufacturing corporation—one of the oldest and most successful set-builders in the industry—a concern which has grown to immense size thru recommendations of its many thousands of satisfied customers who bought after trial.

Our Factory Prices Save You Up to One-Half! We deal direct by mail with users, agents and dealers, thereby effecting great savings which are reflected in amazingly low prices. Everything we sell is high-grade. Don't confuse Miraco's with small, cheap sets. You'll be Proud of Your Miraco In its big, handsome, expensive-looking solid walnut cabinet with sloping front, you'll be proud to have friends examine and hear your Miraco. In construction, appearance and performance, every inch a high-priced set. Handsomely gold illustrated genuine Bakelite front panel and genuine Bakelite knobs—finished in grained walnut. Finest parts obtainable—the kind used in \$200 sets. Bakelite sub-panel. Many exclusive features. Each Miraco reaches you completely assembled, rigidly tested, splendidly packed and factory guaranteed for one year. Easy to install and operate—full instructions supplied. Send NOW for testimony of nearby users and Amazing Offer!

What a \$3,000,000 Federal Reserve Bank Says:
"For years the Midwest Radio Corporation of this city have been very satisfactory customers of this Bank, one of the largest in Southern Ohio. The Midwest organization was one of the very first to engage in the manufacture of radio sets, and to us their success is evidenced by the sound and steady expansion of their business which we have observed year after year. We are personally acquainted with all officers of the Corporation and from experience know them to be men of honor, integrity and ability. We consider them to be both morally and financially responsible. They have a reputation for fair and square dealings." THE PROVIDENT SAVINGS BANK & TRUST CO. Member Federal Reserve System. Capital and Surplus over \$3,000,000.
Pioneer Set Builders
7th Successful Year Cincinnati, O.

Midwest Radio Corporation All the Proof you want is waiting for You!

Coupon or postal brings reports from hosts of users in your vicinity and elsewhere proving that Miraco sets at rock-bottom money-saving factory prices, outperform sets costing up to four times as much. You can also buy speakers, tubes, batteries, etc., at big savings from us! Get our proposition before spending money elsewhere.

MIDWEST RADIO CORPORATION
Pioneer Builders of Sets
Cincinnati, O.
407-R Miraco Building
Without obligation, send free literature, testimony of users, AMAZING SPECIAL OFFER and full particulars of your big money-saving factory-price proposition on Guaranteed Miraco sets and all radio supplies. () User () Dealer () Agent

NAME _____
ADDRESS _____



INGERSOLL Wrist Watch

Recently reduced to... **\$3.50**
 New model this year. Tonneau-shape; silvered metal dial. Wrist Radiolite, telltime in the dark, \$4.00



For Christmas an Ingersoll

When you give an Ingersoll watch you make a gift that is appreciated all out of proportion to its cost. For there's no gift like a watch, nothing used so much, consulted so often, carried so long. And Ingersoll Watches, made for over 30 years, have a reputation for dependability and enduring service that is worldwide and thoroughly deserved.

• INGERSOLL WATCH CO., Inc.
 New York Chicago San Francisco



The New YANKEE

Recently reduced to **\$1.50**
 More closely cased, antique bow and crown, new dial and other new features of grace and beauty. Sturdy and dependable.

2000 RADIO BARGAINS Here

The Guide to Radio Prices and Radio Quality

Our vast resources and radio experience have been utilized to assemble in one gigantic institution, the best and newest things in radio. The Randolph catalog is the great radio market place—a masterpiece of merchandising that beats our house—

The World's Largest Exclusive Radio Mail Order House

Catalog Contains Over 2000 Items, from the most beautiful, fully equipped console radio set, down to the smallest part or tool, for the set builder—kits, parts and supplies of every type and style. All beautifully illustrated and interestingly described. Also valuable data of today's most fascinating and most wonderful achievement—RADIO.

5-TUBE SETS AS LOW AS \$24.90—Latest 1927 Models
 All Randolph sets are sold at amazingly low prices. No matter what kind of set you want—no matter how little you want to pay—you can select YOUR SET AT YOUR PRICE from the Randolph catalog.

WE SAVE YOU MONEY Because we handle radio exclusively and sell a tremendous volume of everything in Radio, we can concentrate our buying power for the benefit of our customers.

SEND FOR BOOK TODAY We cannot begin to tell all about this wonderful Radio Book. Simply send letter or postal and this bargain catalog of guaranteed radio sets and supplies will come to you absolutely FREE.

RANDOLPH RADIO CORPORATION
 180 N. Union Ave. Dept. 182 Chicago, Ill.



Save 1/3 to 1/2

AGENTS! EXPERIENCE UNNECESSARY



Science has finally produced it. An instantaneous metal cleaner—neither sloppy liquid nor messy paste. Dry magic floss. Touch it to nickel, copper or brass. The metal shines bright and clean instantly! No hard rubbing! Lightning Silver Cloth does same for Silverware. Lightning Furniture Floss instantly cleans and puts high lustre on Furniture. No liquid! Lightning Products all approved by Good Housekeeping Institute. Agents making up to \$30 a day!

AMAZING DISCOVERY ABOLISHES METAL AND FURNITURE POLISH

Imagine! Touch tarnished articles with a Lightning Polishing Cloth or Floss and you make them bright as new. Demonstrations positively astonish! Every one a sale! Agents collect real money on every call.

Makes a Sensational Demonstration!

Everybody Buys These Products. Housewives buy the Lightning Silver Cloth and Furniture Floss. Autoists buy Lightning Polishing Floss. Sell all three to stores and offices in big quantities. Nothing else like them. Sure big, quick MONEY GETTERS.

Sample Free! Exclusive territory. Real cooperation. Triple profit. Answer this ad at once. Make big money. Easy! Quick! Don't delay. Write NOW! FREE test sample and proposition by return mail.
B. V. LIGHTNING PRODUCTS CORP., 1773 Greenleaf Ave., Chicago

RADIO BOOK FREE

Tells how you can make big money in world's newest and greatest field. Presents lifetime opportunity in Radio. Right now we want live agents and dealers in every locality, \$60 to \$100 a week easy.

40% TO 60% PROFIT

FREE Simply send name for this big illustrated book explaining liberal profit proposition and how to get latest radio goods at wholesale. Also prices on parts, sets and accessories and amazing special offers—all free. Write today.

STANDARD RADIO CO. 1402 Walnut Street KANSAS CITY, MO.



Be sure You get these CONN FEATURES



R. E. CLARK,
solo trombonist
U. S. Marine
Band, uses a
Conn.

EXCEPTIONALLY easy playing; beauty of tone; perfect scale; absolutely dependable mechanism, are features of every Conn instrument for band and orchestra. As world's largest builder of band instruments Conn has developed improvements and patented features which enable you to make faster progress, quick success in a big way. The world's foremost artists use Conns. And Conn features COST NO MORE!

Free Trial, Easy Payments on any Conn cornet, trombone, saxophone -- everything for band or orchestra. Write now for Free literature and details of trial offer; mention instrument.

C. G. CONN, LTD.
1231 Conn Bldg., Elkhart, Ind.

CONN

BAND INSTRUMENTS
WORLD'S LARGEST MANUFACTURERS

FREE 1000 illustrations **ELECTRIC FIXTURE CATALOG!**

Write today for your copy. Save 50% direct from Manufacturer. No Middleman's Profit. **OUR SPECIAL: 8 Room Electric Set, ready to hang, \$24.50—Other bargains.**

UNITED LIGHTING FIXTURE CO.
83 Flatbush Ave. Dept. P, Brooklyn, N. Y.

Papier Mache Deer Head Forms

Ready to attach horns, draw skin over face—have a perfect job. We make forms turned right, left sneaks to fit the north or south deer. Moose, elk, caribou, goat, open mouth rug heads.

New illustrated circular

Papier Mache Specialties Co.
Reading, Michigan

World's Greatest Utility Light
Burns Air!

300 CANDLE POWER—with new built-in Utility Pump. Handiest, most practical light invented. Storm-proof, rain-proof, bug-proof. Ideal for city, town, country—indoors, outdoors—anywhere. Bright, white light—20 times brighter than wick lanterns at half the cost. Burns 96 per cent air—4 per cent fuel, gasoline or kerosene. Lights with match. Clean, odorless, safe to operate. Guaranteed.

AGENTS! Make \$60 to \$100 a week. No experience or capital required. Outfit Free to workers. Exclusive Territory. Write quick!

30 DAYS FREE TRIAL
Try 30 days at our risk. Send for special money-saving offer and catalog giving all details FREE. Write now.

THE AKRON LAMP CO.
112 Lamp Bldg., Akron, Ohio

Ten Minutes More for Breakfast

And time to smile at the Wife. If you shave with Barbasol. Quick, cool, clean. No brush. No rub-in. Try it—three times—according to directions. 35c and 65c tubes.

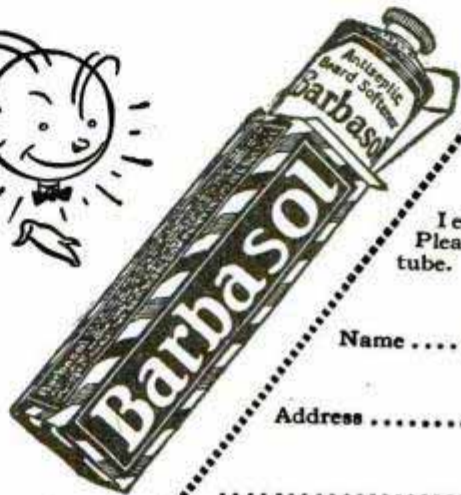

The Barbasol Co.
Indianapolis Ind.

I enclose 10c. Please send trial tube.

Name

Address

P-M-12-26

For Modern Shaving

Earn a REAL Movie Machine

FOR HOME USE
Write Today for Our Easy Plan
PILGRIM CO., 267 Spring St., Dept. P, Medford, Mass., U. S. A.

Diamonds Here at 60% of Market Price

Free Bulletin lists diamonds as low as \$60 per carat, also Gems of Finest Quality at higher per carat charges, but proportionately Low Bargain Prices. This 3/4 to 1-16 carat correctly cut diamond, a snappy blazing solitaire at \$88.50. This 76 year oldest largest Diamond Bargaining Firm in all the world lends money on diamonds. Thousands of unpaid loans and other bargains. Many from big cash deals direct with European Diamond Cutters. Must sell NOW.

WHY PAY FULL PRICES
Costs Nothing to See

Any Diamond sent for absolutely free examination at our risk. No obligation. No cost to you. Latest Listings—Unpaid Loans. Sent Free. Describes Diamond Bargains in Detail, gives cash loan values guaranteed. Explains unlimited exchange privilege. Write today for your copy of Diamond Bargain List. Use blank below, clip ad and mail.

\$68⁵⁰
3/4-1/16 Carat Correctly Cut

Name

Address

Tear out and mail today to—
Jos. De Roy & Sons, 1951 De Roy Building Pittsburgh, Pa.
Only Opposite Post Office

"I MAKE \$25.00 A DAY SURFACING FLOORS"



Parr was making \$7 a day. Now he's making \$25 to \$40 a day.

WITH THIS MACHINE

Start in a small way and make big money. That's what Parr did and thousands of others have done. Like you they read an advertisement just like this and accepted the wonderful opportunity to get behind an electrically driven American Universal Floor Surfacing Machine and build up a big profitable business of their own.

They are men from factories, stores, and offices, young and old alike, who were looking for a future and an opportunity to make real money. They are now making from \$25 to \$40 a day with one American Universal Floor Surfacing Machine which does the work of six men and earns six mens pay. All started with just one machine, but many are now operating six or more machines and have become floor surfacing contractors on a large scale.

**EVERY NEW FLOOR MUST BE SURFACED
EVERY OLD FLOOR NEEDS RE-SURFACING**

There is surfacing work to be done in every new and old business or residence in your vicinity. If you are willing to don a pair of overalls, you can make from \$25 to \$40 a day every working day in the year—Winter and Summer, month in and month out.

NO EXPERIENCE NECESSARY

Any intelligent man can learn to operate the electrically driven American Universal Floor Surfacing Machine in a very short time. It actually does in a day the work of six men scraping by hand and does much better work than can be done by hand.

Write now for particulars. Let us tell you how you can become an American Floor Surfacing Machine contractor. You can secure this information absolutely free without any obligation on your part.

THE AMERICAN FLOOR SURFACING MACHINE COMPANY
Originators of Floor Sanding Machines
523 South St. Clair Street TOLEDO, OHIO



SAVE 1/2 ON PLUMBING & HEATING SUPPLIES

CATALOG FREE

90 pages. Beautifully Illustrated—Warranted high quality or money back. Get our Catalog before you buy.
STANLEY PLUMBING SUPPLY CO., Inc.
1000 Spring Garden St. PHILA., PA.



Palmolive Shaving Cream
"5 New Delights for Men"



Real MOVIES

—Make them yourself with

VICAM Standard MOVIE CAMERA

Camera, Tripod, Projector and 2 Magazines Complete outfit for taking and showing standard size pictures. Equal to biggest cameras. Loads in daylight. Projects on wall or sheet.

\$37

Send 10c in Stamps for illustrated **BOOKLET**
VICAM PHOTO APPLIANCE CORPORATION
1224 Belmont Avenue, PHILADELPHIA



Going to Rain to-morrow? Consult a

Tycos Stormoguide

If your Dealer cannot supply You, write

Taylor Instrument Companies
ROCHESTER N.Y.
Canadian Plant, Tycos Bldg Toronto

There's a Tycos or Taylor Thermometer for Every Purpose



A Motor Boat—for half the cost! The Super Elto clamps on any open boat—gives



all motor boating pleasures at amazingly small cost. Powerful, speedy, reliable. Light and portable. Write today for intensely interesting catalog!

The Super Elto
Elto Outboard Motor Co.
Ole Evinrude, Pres.
Dept. 66 Mfrs. Home Bldg.
Milwaukee, Wis.

"Starts With a Quarter Turn"

Make Your Tires PUNCTURE-PROOF
 IN ONE MINUTE
Agents AND DISTRIBUTERS
Wanted

580 NAIL & SPIKE PUNCTURES WITH NO AIR LOSS

25¢ PER TIRE (in Ford Sizes)



GALACITE * will repair a puncture in ONE MINUTE without taking the tire off the wheel or rim; and in addition it will make the tire Puncture Proof for life. GALACITE* seals instantly and permanently, punctures, leaks, porous places and leaky valves. No more flat tires, no more getting out and changing tires in bad weather. No soiled clothes. A scientific laboratory product. Tested in every part of the United States. **Backed by a MONEY BACK GUARANTEE** to do everything we claim. Guaranteed not to injure tube, valve or tire; on the contrary it preserves and lengthens the life of tube and tire, often

INCREASING TIRE MILEAGE FROM 10,000 TO 12,000 MILES

Take a hammer and drive as many nails into a tire as you wish, 50—100—500, it makes no difference. GALACITE* seals the punctures permanently, as soon as they are made. We guarantee it for one year, but it will last indefinitely.

CAR OWNER AGENTS WANTED
EARN \$5,000 TO \$10,000 A YEAR

TREMENDOUS PROFITS. Agents and Distributors everywhere to demonstrate and sell to car owners, garages, filling stations. Work all or spare time in your own home town or traveling. GALACITE* sells itself. Every customer becomes so enthusiastic that he helps you sell his friends. A revolutionary invention that will make you independent. You can also manufacture and sell GALACITE* PUNCTURE PROOF INNER TUBES.

ACT QUICK SEND NO MONEY. Just your name and address will bring complete particulars by return mail. Get this information right now. Test it out. Get started while the field is still uncrowded.

C. F. JOHNSON & CO. Dept. 390, 19 W. Jackson Blvd. CHICAGO, ILLINOIS, U. S. A.
 *Galacite Trade Mark Reg. Copyright, 1925

I Offer You \$8.00 a Day and a

Write quick for new proposition. We offer \$8.00 a day and a new Chevrolet Coach for demonstrating and taking orders for Comer Suits. Spare time. No experience required. Sample outfit free. Write now.



COMER MFG. CO., Dept. W-5120, DAYTON, OHIO

MYERS ELECTRIC IRON CORD HOLDER

A wonderful invention. Keeps cord out of way while ironing. Grips the ironing board. Tested and approved by Good Housekeeping Institute.

AGENTS WANTED
 Sample 50 cents postpaid

C. A. MYERS CO.
 6339 Woodlawn Ave., CHICAGO, ILL., U. S. A.



\$2000 in Three Months

88c profit on \$1 order. Sold by mail 2000 orders in 3 months. Let me send you, free, all ads and letters and tell you how I did it.

QUINCY CO., 389 Quincy Bldg., CHICAGO

Your Daily Profits \$6 to \$12

Marvel lamp of all times. Years in advance of others. 800 candle power. Equals safety, brilliancy of electricity, 1-tenth the cost. 20 times brighter than ordinary lamps. Easy to operate. No soot. No smoke. No odor. Guaranteed.

Outfit Free No capital or experience necessary. Hixon, Iowa, made \$123 in 10 days. Profits paid daily. We deliver and collect. Write for Choice territory and Free Outfit.

SUNSHINE SAFETY LAMP COMPANY
 A-121 Factory Building -- Kansas City, Missouri



IF YOU CAN USE AN EXTRA \$20.00 BILL

write for this

FREE BOOK



You can save \$20.00 in no time by using **SMOOTH-ON No. 1** to do your own household repairing—and in addition you will have that proud "I-did-it-myself" feeling.

Here is what one enthusiast did with two 35-cent cans:—A \$25 lamp stand loose in base, two big leaks in heating furnace smoke pipe, loose hammer handle, and three loose hooks in tiled bath room wall were all put into good usable condition at an average cost of 10 cents each for the seven repairs—and \$20.00 easily saved over what would have been paid to professional fixers or for new parts.

By using Smooth-On to make dozens of the simple repairs necessary in every home, you can save enough to pay your radio upkeep, buy yourself or your wife a camera, a bull pup or some other pleasure-giving article that you would otherwise hate to spend the money for.

The free Smooth-On Repair Book will show you how an astonishing number of home and automobile repairs are as easy for you to make as for somebody else.

Mail the coupon for a free copy and get Smooth-On No. 1 in 7-ounce or 1 or 5-pound can from any hardware store.

SMOOTH-ON MFG. CO.
 Dept. 37, 574 Communipaw Ave. JERSEY CITY, N. J.



Do it with SMOOTH-ON

SMOOTH-ON MFG. CO., Dept. 37,
 574 Communipaw Ave., Jersey City, N. J.

Please send the free Smooth-On Repair Book.

Name

Address

Return this coupon for a FREE copy of Booklet

SEND NO MONEY
ONE FULL YEAR TO PAY

DIAMONDS
Pick Yours Now!
We Deliver and Trust You

Again country's foremost diamond merchants lead in startling offers. Look over these bargains, at almost unbelievable low prices. Read descriptions. Your opportunity to secure the gem you longed for. Easy Terms—lower than cash prices.

Your Guarantee
We have faithfully served the public for nearly 100 years. Make your selections. Our money back guarantee fully protects you. Order from this ad. on 10 days' free trial.

Send No Money Now!
Keep your money in your pocket. Select the gem you want and wear it for 10 days. No. 1—Ladies' 18 kt. white gold ring, genuine blue white diamond, \$49.50—\$1 weekly. No. 2—Ladies' 18 kt. white gold ring, blue white diamond, blue sapphire at each side, \$59.50—\$1 weekly. No. 3—Ladies' friendship ring, 18 kt. solid white gold, 3 snappy, genuine blue white diamonds, 4 blue sapphires, \$53.50—\$3.50 monthly. No. 4—Gents' 18 kt. solid white gold, genuine blue white diamond, \$69.75—\$4.65 monthly. No. 5—Ladies' 14 kt. solid white gold wrist watch, 15 jewels, 2 genuine diamonds, 4 blue sapphires, \$98.25—\$2.50 monthly.

Million Dollar Bargain Book—FREE
Contains up-to-the-minute gift suggestions at startling low prices and very liberal terms—write for a copy now!

FREE MILLION DOLLAR BARGAIN BOOK

J.M. LYON & CO. INC.
Dept. 1012 2 Maiden Lane
New York, N.Y.

OFFER NO. 1
\$49.50
\$1 Weekly
OFFER NO. 1

OFFER NO. 2
\$59.50
\$1 weekly

OFFER NO. 3
\$53.50
Monthly

OFFER NO. 4
\$69.75
\$4.65 Monthly

OFFER NO. 5
\$98.25
\$2.50 Monthly

WITTE Log Saw

Wico Magneto



LOW PRICE EASY TERMS

COMPLETE outfits, everything you need when you go into timber. No extras to buy. Saws 15 to 25 cords a day. Cheapest to operate—runs all day at cost of 2c an hour per H-P. Burns any fuel with big surplus of power for any work. **USE IT FOR OTHER WORK.** Completely equipped with WICO magneto, speed and power regulator, throttling governor and 2 fly-wheels so can be used for any other jobs—pumping water, grinding grain, etc.—an all-purpose outfit that will work every day in the year. Only 3 minutes to change from log saw to tree saw—10 seconds to clamp to tree. Fastest felling ever known. Fells trees from any position.

Lifetime Guarantee

FREE BOOK Simply send name today for NEW catalog, lower prices special offers, and how to make money with these rigs. Tells all about engines, sawing outfits and pumps.

WITTE ENGINE WORKS
6744 Witte Building KANSAS CITY, MISSOURI
6744 Empire Building PITTSBURGH, PA.
6744 Witte Building SAN FRANCISCO, CALIF.

"3 HOURS SHIPPING SERVICE"

66 Miles on 1 Gallon

Amazing, New, Auto Gas Saver
All Makes. Spare or full time. Factory Agencies Wanted Everywhere

1 FREE TO INTRODUCE
BIG PROFITS to any MAN WITH CAR

CRITCHLOW, Inventor, T-805, WHEATON, ILL., U.S.A.

Cross it out

~~Resoling 2 p. of shoes \$3.00~~ **\$1.00**

STEELON RUBBER SOLES
In all it will cost you if you use

The most practical shoe sole. Waterproof, light, more durable than leather. Easy to put on. Comes in sheet form. You may cut to any size. Good also for rubber boots, tires, heels, etc. Complete with repair outfit, only \$1.00 postpaid. Send for this money saver today.

INVENTION SALES CO., Room 655, 19 W. 34th, N. Y. C.

Lighting Fixtures
READY TO HANG
(Direct from the Manufacturer)

Completely wired, including glassware. Send for New Catalogue No. 27. Just reduced prices. Special proposition to DEALERS.

ERIE FIXTURE SUPPLY CO.
STA. A ERIE, PA.

Direct at Factory Prices

Sample \$1.18 3 for \$3.00 Postpaid

Hand Forged Razor Steel Blades
Send for our 100-page FREE List and "HOW TO USE A RAZOR."

Maher & Grosh Co.
106 A St., Toledo, Ohio

A Genuine \$2 Knife for \$1.18 Postpaid
Handy shaped Blade makes this knife best for mechanics, sportsmen and farmers; light but strong; re-sharpened easily. Stag handle. German silver finish; blades file tested, hand forged from razor steel and warranted.

El Diablo RAZOR STEEL **No. 57**

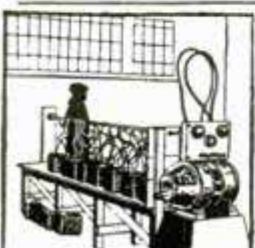

\$150 to \$300 PROFIT MONTHLY EASY WITH **ONE DAY BATTERY CHARGING**

Why not have a moneymaking One Day Battery Charging business of your own? Over 12,000 shops are making \$150 to \$300 every month selling One Day Charging. Every car needs it, especially in winter. Just \$35 cash completely equips your shop for HB One Day Charging. Small monthly payments on balance. 30 days' free trial in your shop on moneyback guarantee. No experience needed to operate an HB. Try its moneymaking possibilities in your shop at our risk. Write for free Bulletin 126.

HOBART BROS. CO. Box M 112, TROY, OHIO

ONLY \$16.50 MONTHLY - PAID BY INCREASED PROFITS

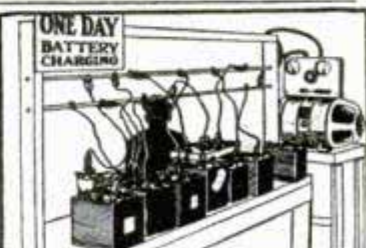



WHAT MOVES ANDY'S EARS?

What makes Andy's ears, eyes and nose move? A real mystery. Your friends will never know what makes Andy wiggle so. It's a secret—lift one end of stick tape and put in a live fly. The fly causes the movement. Made of heavy cardboard and lithographed in bright colors. 4 1/2" mounted on stand, 3" wide.

Each..... **35c**

MYSTIC CHINESE RING

Lucky charm ring, said to protect wearer from harm and bring good luck. Unique design. Heavily silver-plated. Split shank fits any finger.

Each..... **Only 25c**



INVISIBLE INK

Can't be seen unless you know the secret—makes no mark! Great fun for jokes; invaluable for confidential messages, postals, etc. 3 for 40c.

Per bottle, only..... **15c**

SQUIRT ROSE

The flower in your coat looks so fresh. Every one is tempted to inhale the delightful perfume. Then press the bulb. Geewhilkens! How they jump! Long rubber tube easily reaches pocket of coat or trousers; bulb large enough to make a dozen shots with one loading. Each **25c**, or 3 for 65c.

Prompt shipment, prepaid. Stamps accepted.

Dan Taylor & Co. CINCINNATI, OHIO

Include 10c extra and ask for catalog of latest magic, puzzles, plant curiosities, wonderful novelties, etc., otherwise unprocurable. Remit by money order, check, coin or stamps.

MOVIES



We'll swap you your name and address for our catalogue on the greatest real home MOVIE-MACHINES in the world with dazzling models as low as \$3.75 postpaid. And say folks! We've also got the slickest regulation film at ridiculously low prices - and we don't have to tell you our films are the best. Let's not miss this opportunity - Write TODAY—NOW

PARAMOUNT MFG. COMPANY
Dept. MC Boston, Mass., U. S. A.

100 SCALE PLANS



for building old and modern ship models. Free catalog of plans, books, prints, maps and other things that smack of the sea.

SEA ARTS GUILD, 405-A Eleventh Avenue, MILWAUKEE, WIS.



Big Money

Made by agents selling our wonderful Facial Soap, Perfumes, Toilet Articles, Spices, Extracts, etc. Free cake of soap and agents' terms mailed to any address.

LACASSIAN CO. Dept. 455 ST. LOUIS, MO.

Makes Old Ford a Tractor

We furnish everything for converting Ford Auto Chassis with Engine into a handy Farm Tractor. Just right for truck growers, small farms, nurseries, etc. Pulls 16" Plow, Discs, Seeds, Cultivates; Runs Belt Machinery. We also build Garden Tractors and Cutter Bar Mower Attachments.

Handles Easily Turns in 15' Circle



Write for Free Particulars. SHAW MFG. CO., Dept. F, Galesburg, Kan.

Renulife
VIOLET RAY

How Men and Women Find New Life

When you feel tired, sluggish, nervous, depressed, your blood is full of poison and waste tissue. When you feel alert, rested refreshed, full of vigor, your blood is free from poison.

The condition of your blood determines your physical and mental condition. This is the scientific reason why Renulife Violet Ray Generators successfully combat disease and restore the body to new health and vigor.

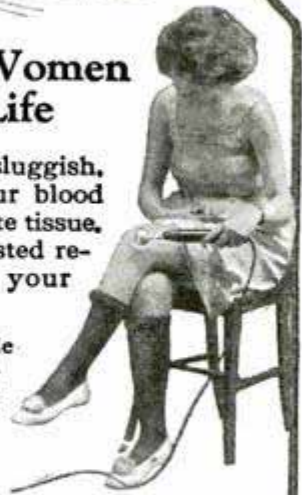

Renulife Supplies Life-Giving Oxygen

A few minutes pleasant application of Renulife Violet Ray taken after a hard day's work, sweeps away fatigue poisons from your system banishing pain and nervousness and by invigorating the blood, helps nature overcome the various ailments listed below, and many others.

Operates From Any Light Socket

The Renulife Health Generator has been perfected after years of exhaustive scientific study of High Frequency Violet Ray Electric Current. Renulife is absolutely shockless—as gentle as a ray of sunshine. Over 85,000 of these instruments are in use—it is a time tested product, BACKED BY A RIGID GUARANTEE.

FREE Book and TREATMENT Offer

Mail the coupon today. We will send you Free our new interesting Renulife booklet, also details of our Free treatment offer.

Check any ailments on which you want information

- Asthma
- Bad Circulation
- Blackheads, Pimples
- Bronchitis
- Catarrh
- Colds
- Constipation
- Dandruff
- Deafness
- Dyspepsia
- Eczema
- Hay Fever
- Insomnia
- Lumbago
- Pain
- Nervousness
- Neuralgia
- Neuritis
- Prostatic Trouble
- Rheumatism
- Skin Disorders
- Sore throat
- Sprains

Any others? _____

RENULIFE ELECTRIC COMPANY
1203 Renulife Building, Detroit, Michigan

Without obligation, please send me details of your FREE TRIAL PLAN, in accordance with your offer in Popular Mechanics.

Please send FREE Book.

Name _____ (Please Print)
Address _____
Town or City _____ State _____

AGENTS WANTED—Write to Salesmanager

\$1 Brings You ANY OF THESE WONDERFUL XMAS GIFTS!



X 60



X 61



X 62



X 63



X 64



X 65



X 66



X 67



X 68

"SMALLER ADS—BIGGER VALUES—EASIEST TERMS"—OUR MOTTO. Send \$1.00 NOW! Mention gift desired. That's all! NO RED TAPE—STRICTLY CONFIDENTIAL! PROMPT SHIPMENT MADE! Pay balance next year TEN easy monthly payments. 30 DAYS' TRIAL—Money back if dissatisfied—RUSH YOUR ORDER TODAY!

X 60—18 Kt. white gold cluster, seven fiery brilliant blue-white diamonds. \$52.50. \$5.15 monthly

X 61—18 K. white gold, hand engraved and pierced, fiery blue-white diamond. \$45.00. \$4.40 monthly.

X 62—Newest square prong ring. 18 K. white gold, fine blue-white diamond. \$50.00. \$4.90 monthly.

X 63—18 K. white gold ladies' three stone ring. THREE fine blue-white diamonds. \$42.50. \$4.15 monthly.

X 64—Gent's 18 K. white gold ring, two blue sapphires, fine blue-white diamond. \$47.50. \$4.65 monthly.

X 65—Georgious dinner ring, beautifully pierced and engraved, 18 K. white gold. Three fine blue-white diamonds. Two blue sapphires. \$46.75. \$4.57 monthly.

X 66—Ladies' new oval shaped wrist watch, solid white gold, four genuine diamonds, four blue sapphires. 15 J. guaranteed movement. \$38.75. \$3.77 monthly.

X 67—Gent's strap watch, jeweled movement, white metal case. Black enamel inlay. \$14.50. \$1.35 monthly.

X 68—Jeweled Elgin octagon watch. Chain and Knife FREE. Furnished in presentation gift case. \$21.00. \$2.00 monthly.

FREE CATALOG AND GIFT

Beautiful art CALENDAR for 1927 sent FREE with catalog illustrating SILVERWARE, IVORYWARE, CAMERAS, DIAMONDS, JEWELRY, ETC—thousands of gift suggestions on our famous PAY-AS-YOU-PLEASE PLAN—to every adult answering this ad.

O.F. BALE & CO.

EST. 1888

21-65 Maiden Lane New York



Harmonicas Make a Happy Christmas

Everyone delights in receiving a musical instrument that he can play; and anyone can play a Hohner Harmonica.

If you want to give happiness with your gifts at Christmas-time give Hohner Harmonicas—a happy thought!

Leading dealers everywhere carry the complete line of Hohner Harmonicas—50c. and up.

The Free Instruction Book, containing favorite musical selections arranged for the harmonica, is available at dealers or direct. M. Hohner, Inc., Dept. 181 114 East 16th St., New York.



Delivered to You Free

for 30 days trial on approval. You can have your choice of 44 Styles, colors and sizes of the famous RANGER Bicycles. Express prepaid. Factory-to-Rider Prices save you \$10 to \$25 on your bicycle.

\$5 a Month if desired. Many boys and girls easily save the small monthly payments. Parents often advance first payment.

best quality, at factory prices, express prepaid.

Lamps, wheels and equipment, low prices. Send

No Money, do business direct with makers.

Mead CYCLE COMPANY

DEPT. 110 CHICAGO

Write today for free Ranger Catalog, factory prices and marvelous easy payment terms



Make Your Open Ford or Chevrolet a Splendid Enclosed Sedan—Easy!



Strong! Light!
Handsome!
Reasonably Priced!

"ACME"
Sedan Tops

Make a well-built, distinguished-looking Sedan at a price within easy reach. Built to give permanent satisfaction! See your Local Dealer, or write direct for Descriptive Circular B-1 ACME BODY-TOP CO., Aurora, Ill.



HON. W. T. RAWLEIGH
President and Founder

WANTED AT ONCE!

700 Men for Rural Localities

1500 Men and Women for Towns and Cities,
who are industrious, capable, steady

The largest industry of its kind in the world (established 1889) will help you start a profitable, permanent business of your own.

We have thousands of reports showing that capable persons with no previous business or selling experience and practically no capital are making

Profits from \$25 to \$100 Per Week

every week and month the year around in every state and province.

Thirty million Consumers now use our 150 Food Products, Flavoring Extracts, Spices, Soaps, Toilet Articles, Medicines and other Household Necessities. Everything positively guaranteed to sell and give complete satisfaction or money refunded.

Rawleigh's Sales and Service Methods get the most business everywhere with the least effort. Best values in quality, quantity, and price mean everyone is satisfied.

Practically no capital needed. We supply everything and teach you exactly how to conduct your business.

Ford Car for Rural Retailing and Fine Outfits for Towns and City Districts

If you have health, steady habits, and can furnish business references showing that you are capable and trustworthy and if you would be satisfied with clear monthly profits of from \$100 to \$400 and often more, the year around, write for full particulars. Give age, occupation, and state when you could start, in the first letter.



THE W. T. RAWLEIGH COMPANY, Dept. IL8256
FREEPORT, ILL., U. S. A.
Capital and Resources Over 15 Million Dollars
Four Big Factories and Many Branches Throughout America

BOYS Look, Movie Machines

for the family sell as low as **\$5.00**
We carry WESTERN and COMEDY FILMS only.

Write now for free catalogue on machines and films.
GLOBE SUPPLY CO., P. O. Box 2722, Dept. P, Boston, Mass.

NEW DISCOVERY

AUTO STROP BLADE RENEWER—FOR AUTO STROP
BLADES ONLY—Positively Make Dull Blades New.
25¢ Postpaid—Agents Wld.—MCKenye—Box 9—LONG BEACH, CALIF.

Information on any book free. Write Popular
Mechanics Press, Chicago, Ill.

PIMPLES

Cleared up—often in 24 hours. To prove you can be rid of Pimples, Blackheads, Acne Eruptions on the face or body, Barber's Itch, Eczema, Enlarged Pores, Oily or Shiny Skin, simply send me your name and address today—no cost—no obligation. **CLEAR-TONE** tried and tested in over 100,000 cases—used like toilet water—is simply magical in prompt results. You can repay the favor by telling your friends; if not, the loss is mine. **WRITE TODAY.**
E. S. GIVENS, 429 Chemical Bldg., Kansas City, Mo.

OXO-GAS

OIL BURNERS

OXO-GAS oil burner for ranges One of 20 types for all purposes.

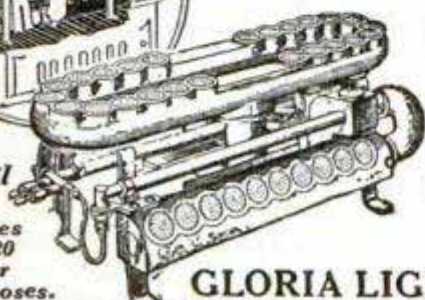

For Furnaces, Ranges, Heating Stoves, Etc.

OXO-GAS, the cheapest, cleanest, most efficient fuel known to science, is made from kerosene or distillate, and air, mostly air. Burns with a pure blue flame of high heating intensity, as silently as city gas. Over a million in use. Manufactured by the oldest (est. 1906), highest rated and most responsible corporation. Ask any bank. Send for Catalog illustrating and describing twenty different distinctive designs of oil burners for Furnaces, Cook Stoves, Heating Stoves, Base Burners, Hot Water Heaters, etc.

Agents Wanted Some choice territory for OXO-GAS agencies still open to thoroughly responsible parties. Your own locality may yet be unassigned.

GLORIA LIGHT COMPANY, 111-12 N. May St., Chicago, Ill.

XMAS GIFTS

Send \$1.00

VALUES NOT FOUND ELSEWHERE

A FULL YEAR TO PAY
10 Days Free Trial

"Royal" terms make buying easy! Just pin \$1 to your order and your selection comes to you parcel-post prepaid, on 10 DAYS FREE TRIAL; pay postman only \$1 more on delivery. After free trial pay balance in 12 easy, equal monthly payments.

SATISFACTION ABSOLUTELY GUARANTEED
OR ALL YOUR MONEY REFUNDED

ALL TRANSACTIONS STRICTLY CONFIDENTIAL
NO INTEREST NO EXTRAS

Wear While Paying—Write For Your Selection Today
FREE—"Royal" Book of Gems
 Write today for your copy



GG13—Exquisite Floral design, 18K White gold lady's Ring, hand-pierced, generous size, genuine blue-white Diamond. **\$37.50**
\$2.96 a month



GG7—Unusual! Especially beautiful 18K white gold, Lady's Dinner Ring, 3 genuine blue-white diamonds and 2 genuine French-blue sapphires. **\$42.50**
\$3.38 a month



GG1—Lady's Ring, 18K White Gold, Lace Design, hand-engraved genuine blue-white Diamond. **\$47.50**
\$3.79 a month



GG14—Great value! Gem's 14K green gold mounting, white gold top, genuine fiery blue-white diamond. **\$27.50**
\$2.13 a month



GG4—Lady's beautiful hand-pierced 18K white gold hexagon top Ring, exquisitely radiant, genuine blue-white diamond. **\$56.75**
\$4.56 a month



GG16—Newest design, Gem's 18K white gold hand-engraved, massive Ring, specially selected, genuine blue-white diamond. **\$75.00**
\$6.08 a month



GG2—Extraordinary value! Attractive bow-knot design, lady's Ring, 18K white gold, first quality genuine blue-white diamond. **\$22.50**
\$1.71 a month



GG8—Exquisite Wedding Ring, hand-engraved 18K white gold, set with 3 genuine blue-white diamonds. **\$19.75**
\$1.48 a month



GG5—Think of it! 3 genuine blue-white diamonds, set in richly hand carved and pierced, 18K white gold lady's ring. **\$29.50**
\$2.29 a month



GG15—Special offer! 4 genuine diamonds, 4 sapphires in this beautiful 14K white gold, rectangular shaped, Lady's Wrist Watch; 17 jewel ruby and sapphire movement, lifetime guarantee. "A gem of a gift." **\$39.75** \$3.15 a month. **GG17—**Above without diamonds and sapphires, **\$22.00**, \$1.67 a month.

ROYAL DIAMOND & WATCH CO.
 ESTABLISHED 1895
 ADDRESS DEPT. 1718 170 BROADWAY N.Y.

PARKS

WOODWORKING MACHINES

Cabinet Shop Special

\$290

with Motor



You ought to have this handy Parks in your shop. It is a compact, complete machine designed just like a big production outfit at one-fifth the cost. Includes 8-inch circular rip and cross cut saw with polished cast-steel saw table, 16-inch band saw with tilting table for bevel-sawing, 6-inch jointer, and motor operating from any light socket. Just plug in and go to work! Fits in a corner of your basement. Does any kind of cabinet and joinery work. Add lathe, shaper and other attachments any time at small cost. For the man who does "odd jobs" in his off time this Parks is a big money maker. Turn out as much as a four-man shop working by yourself.

Write for circular and Parks complete catalog of handy woodworking machinery.

The Parks Ball Bearing Machine Co.
 1500-1540 Knowlton St. Cincinnati, Ohio
 Canadian Factory: 208 Notre Dame East, Montreal, Can.

ENVELOPES Only \$2.75 a Thousand

Your return address printed on corner. 5000—\$10.00, 10,000—\$17.50. Good grade. No. 10—\$1.00 extra a thousand.

Reason for low price. Buy big quantities—print with special envelope machinery. Write copy plain. Quick service if you send order now.

A. MOHLER Box 453 CHICAGO, ILL.

KRAG BAYONETS 12 inch Blade



with SCABBARD 40c each Postage Extra

Useful for many purposes around Farm, Home, Camp, etc.
 Shipping weight 2 1/2 lbs.

HAND GRENADE BAG 40c



Size 10x10 inches inside. Made of Fine quality Canvas. Can be used for hundreds of purposes. Makes a Dandy School Bag. Postage Extra

45 Cal. Shot Gun, \$4.75; 45 Cal. Carbine, \$4.50; Krag Carbine, Cal. 30-40, \$15; Krag Rifle, \$12.50.

Terms Strictly Cash. No C. O. D. Shipments.
 Catalogue Free on Request.

W. STOKES KIRK, 1627-P. M., North 10th St., Phila., Pa.

TRADE MARK

"Red Devil"

Glass Cutters



RED DEVIL MEANS GLASS INSURANCE

BETTER be safe than sorry! Always SAFE when you use a Red Devil Glass Cutter—it CUTS! No. 48 has 6 Hand Honed Wheels—a sharp one always ready.

"It's All in the Wheel!"

LONDON P. SMITH, INC.
 106 Coit Street, Irvington, N. J.

Over 3,000,000 Users Endorse
New Kerosene Light
Beats Gas or Electricity



MAKE your home bright and cheerful, saving one-half on oil. Scientific tests prove this wonderful new Aladdin 5 times as efficient as the best round wick open-flame lamps. 60 candle power pure white light for 50 hours on a gallon of common kerosene. No odor, smoke, noise or pumping up. Won't explode. **Guaranteed.**

10 Days' Free Trial

Prove to yourself by free trial that Aladdin has no equal as a white light. If not satisfied return at our expense. **Get Yours Free** We want one user in each locality to whom customers can be referred. In that way you may get your own without cost. Be the fortunate one to write first for ten day free trial and learn how to get one free.

AGENTS WANTED To demonstrate the Aladdin in territory where oil lamps are used. Experience or capital unnecessary. Many agents average five lamps a day and make \$500 a month. Write quick for territory and samples.

\$1000.00 Will be given to **REWARD** anyone showing us an oil lamp equal to this Aladdin in every way. (Full details of this offer given in circular.)

THE MANTLE LAMP COMPANY OF AMERICA
500 Aladdin Bldg., 609 W. Lake Street, Chicago, U. S. A.

New and Used Auto Parts
at 30 to 80% Saving

Our stock of new and used replacement parts is the largest in the world. No matter what you need, write to us for prices. You will save from 30 to 80% and parts can be obtained from us which it is impossible to get elsewhere.



Get Our Big Parts Book—FREE

Our Big 80-page Parts Catalog is the largest book of its kind ever issued. Everything for the automobile at cut prices—less than regular wholesale.

An enormous volume of business and quantity purchases make our low prices possible. Nationally advertised products. All new except where specified—Timken Axles and Bearings—Brown-Lipe Transmissions—Pistons—Rings—Hayes and Firestone Wheels—Rims—Tires—Tubes—also a complete line of Accessories. If it's for an auto, you will find it listed in our big parts Book.

Write Today for Your Copy—It's FREE

WARSHAWSKY & CO.

World's Largest Replacement Parts House
1915-35 So. State St., Dept. PM-12, CHICAGO, ILL.

"A Lyon & Healy Sax is easy to learn to play! My son gets one for Christmas"—Noah Beery



"Give me the clear, mellow tones of a Lyon & Healy Saxophone. I like the looks of the instrument, its simplicity, its strong construction. And it is certainly easy to learn to play! The sax is great for boys, too. Every boy wants a real, man-size saxophone. My son 'Pidge' gets a Lyon & Healy Sax for Christmas"

Noah Beery

Noah Beery, the swash-buckling Sergeant in Famous Players' "Beau Geste," and other feature films, knows from personal experience that

the fellow who gets ahead is the one who can do things. That's why he is giving his own son (pictured here with Wally Reid's boy) a saxophone for Christmas—starting him right on the road to pleasure and popularity.

What accomplishment have you? Do you play the saxophone? No matter what your age we can teach you quickly, easily. Why envy the other fellow his good times, popularity, leisure, extra spending money, when you can enjoy the same things, too?

Easy to Learn Our Way

You can quickly learn to play a Lyon & Healy Saxophone because—with sixty years' musical experience to guide us—we have simplified the fingering, made it easy for you to play, easy to produce full, rich tones. The Lyon & Healy is the choice not only of noted amateurs like Wm. Haines, but of leading professional players as well, because of its extremely accurate adjustment and improvements in key-action for hair-trigger finger work. Experts are astonished at its new, amazing beauty of tone. Warm and sonorous as the human voice, crystal-clear and true to pitch—no other sax can approach it in tone quality. Remember, it is made and guaranteed by the most famous music house in the world!

You Can Pay as You Play

Now you can own one of these wonderful instruments and pay in small installments, at the rate of only a few cents a day. Many earn enough playing for dances and parties to meet their payments. Mail coupon today for full details. Don't delay!

Free Trial! Free Instructions!

Learn about our FREE Trial and FREE Instructions offer! Discover for yourself the advantages of our special "Easy to Play While You Play" plan by mailing this coupon today! Fun, popularity, friends, money, travel are yours when you play a Lyon & Healy Sax. Let us teach you quickly, easily. Act now!

Lyon & Healy

Everything Known in Music

247 South Wabash Avenue

Chicago

FREE!



The real facts about saxophone playing, its opportunities for pleasure and profit—told frankly in this fascinating book.

Send for a FREE copy today!

Mail the Coupon today

LYON & HEALY, Inc., Factory Sales Division
247 S. Wabash Ave., Chicago

Please send me FREE, details of your "Free Trial, Free Instructions offer," your "Easy Payment Plan," also a copy of the new Saxophone Book.

Name.....

Address.....

City..... State.....



PA INVENTORS.

**JUST
ACROSS
STREET
FROM
U.S. PAT.
OFFICE.**

At the right is a view of my drafting and specification offices where a large staff of experienced experts are in my constant employ. All drawings and specifications are prepared under my personal supervision.



PROTECT YOUR IDEAS Take the First Step Today

If you have a useful, practical, novel idea for any new article or for an improvement on an old one, you should communicate with a competent Registered Patent Attorney AT ONCE. Every year thousands of applications for patents are filed in the U. S. Patent Office. Frequently two or more applications are made for the same or substantially the same idea (even though the inventors may live in different sections of the country and be entirely unknown to one another). In such a case, the burden of proof rests upon the last application filed. Delays of even a few days in filing the application sometimes mean the loss of a patent. So lose no time. Get in touch with me at once by mailing the coupon on the opposite page.

Prompt, Careful, Efficient Service

This large, experienced organization devotes its entire time and attention to patent and trademark cases. Our offices are directly across the street from the U. S. Patent Office. We understand the technicalities of patent law. We know the rules and requirements of the Patent Office. We can proceed in the quickest, safest and best ways in preparing an application for a patent covering your idea. Our success has been built on the strength of careful, efficient, satisfactory service to inventors and trademark owners located in every state in the Union.

Clip this Coupon and Mail

TENTS

Write for these FREE BOOKS

NO CHARGE for Information On How to Proceed!

The booklet shown here contains valuable information relating to patent procedure that every inventor should have. And with it I will also send you my "Record of Invention" form on which you can sketch your idea and establish its date before a witness. Such evidence may later prove valuable to you. Simply mail the coupon and I will send you the booklet, and the "Record of Invention" form, together with detailed information on how to proceed and the costs involved. Do this NOW. No need to lose a minute's time. The coupon will bring you complete information entirely without charge or obligation.



STRICT SECRECY PRESERVED

All communications, sketches, drawings, etc., are held in strictest confidence in strong, steel, fireproof files, which are accessible only to authorized members of my staff. Feel free to write me fully and frankly. Your case will have my personal attention. It is probable that I can help you. Highest references. But FIRST—clip the coupon and get my free book. Do THAT right now.

**CLARENCE
A. O'BRIEN**

*Registered
Patent Attorney*

70-R Security Savings and
Commercial Bank Bldg.,
Washington, D. C.

Clarence A. O'Brien

Registered Patent Attorney

Member of Bar of: Supreme Court of the United States; Court of Appeals, District of Columbia; Supreme Court, District of Columbia; United States Court of Claims

Practice confined exclusively to Patents,
Trademarks and Copyrights

Please send me your free book, "How to Obtain a Patent," and your "Record of Invention" form without any cost or obligation on my part.

Name.....

Address.....

It Now!

(Important: Write or Print name clearly)

PATENTS TRADE-MARKS AND COPYRIGHTS

Have You An Idea?

Our Offer: FOR THE PROTECTION OF YOUR INVENTION YOUR FIRST STEP

Before disclosing an invention the inventor should write for our blank form

"RECORD OF INVENTION"

This should be signed and witnessed and returned to us together with model or sketch and description of the invention for

INSPECTION and INSTRUCTIONS

No Charge for the Above Information

Our Four Books Mailed Free to Inventors

Our Illustrated Guide BOOK

How to Obtain a Patent

Contains full instructions regarding U. S. Patents. Our Methods, Terms, and 100 Mechanical Movements illustrated and described.

Our Trade Mark Book

Shows value and necessity of Trade Mark Protection. Information regarding *Trade Marks and unfair competition in trade.*

Our Foreign Book

We have Direct Agencies in Foreign Countries, and secure Foreign Patents in shortest time and lowest cost.

Progress of Invention

Description of World's Most Pressing Problems by Leading Scientists and Inventors.

We Regard a Satisfied Client as our best advertisement, and furnish anyone, upon request, lists of clients in any state for whom we have secured patents.

*Highest References—Prompt Attention
—Reasonable Terms*

VICTOR J. EVANS & CO.

PATENT ATTORNEYS

Main Offices: 956 9th St., N. W., Washington, D. C.

Opposite U. S. Patent Office



Our New York Office
Suite 1007 Woolworth Bldg.



Our Philadelphia Office
Suite 714-15 Liberty Bldg.



Our Washington Office
Victor Building



PATENTS TRADE-MARKS AND COPYRIGHTS

IMPORTANT

TO HAVE YOUR CASE MADE SPECIAL AND AVOID DELAY YOU SHOULD HAVE YOUR CASE MADE SPECIAL IN OUR OFFICE to secure protection, save correspondence and secure early filing date in Patent Office. To secure special preparation of your case send \$25.00 on account with model or sketch and description of invention.



MAIN OFFICE, VICTOR J. EVANS & CO.—VICTOR BUILDING, WASHINGTON, D. C.

Our Lawyers Practice in all U. S. Courts and defend Clients in Suits involving Patents, Trademarks and Copyrights

All Communications and Data Strictly Confidential. Interference and Infringement Suits Prosecuted

OUR ORGANIZATION OFFERS PERSONAL SERVICE By Experienced Patent Lawyers, Solicitors and Draftsmen

**FREE
COUPON**

**VICTOR J. EVANS & CO.
PATENT ATTORNEYS**

NEW YORK OFFICES
1007 Woolworth Bldg.

CHICAGO OFFICES
1114 Tacoma Bldg.

PHILADELPHIA OFFICES
714-715 Liberty Bldg.

PITTSBURGH OFFICES
514 Empire Bldg.

SAN FRANCISCO OFFICES
Hobart Bldg.

MAIN OFFICES: 956 9th Street, N. W., WASHINGTON, D. C.

Gentlemen: Please send me *Free of Charge* your books as described on preceding page.

Name.....

Address.....



Our Chicago Office
Suite 1114 Tacoma Building



Our Pittsburgh Office
Suite 514 Empire Building



Our San Francisco Office
Suite 1010 Hobart Building

PATENTS

Booklet Free **Highest References**
Promptness Assured **Best Results**

Send drawing or model for preliminary examination of Patent Office records.

ALL BUSINESS GIVEN PROMPT AND PROPER ATTENTION

Listed Patent Lawyer in the latest editions of the Rand-McNally Directory of Bankers and Attorneys, of Chicago, Ill.; The Baggott & Ryall Directory of Attorneys, New York City; The Lawyers Guaranteed Directory, Detroit, Michigan; The Lawyers and Bankers Quarterly, published by the Legal Directory Publishing Company of St. Louis, Mo.; the American Lawyers Annual, Cleveland, Ohio.

WATSON E. COLEMAN,
REGISTERED PATENT LAWYER

644 G Street, N. W., Opp. U. S. Pat. Office
WASHINGTON, D. C.



United States Capitol

PATENTS

Don't Lose Your Rights To Patent Protection

Before disclosing your invention to anyone send for blank form "EVIDENCE OF CONCEPTION" to be signed and witnessed. As registered patent attorneys we represent hundreds of inventors all over the United States and Canada in the advancement of inventions. The form "Evidence of Conception," sample, instructions relating to obtaining of patents and schedule of fees sent upon request.

LANCASTER & ALLWINE

480 Ouray Bldg.

WASHINGTON, D. C.

Originators of forms "Evidence of Conception."

PATENTS

As one of the oldest patent firms in America we give inventors at lowest consistent charge, a service noted for results, evidenced by many well known patents of extraordinary value. *Book, Patent-Sense, free.*

LACEY & LACEY

Established 1869

646 F St., Washington, D. C.

PATENTS

To the Man with an Idea

I offer a comprehensive, experienced, efficient service for his prompt, legal protection and the development of his proposition.

Send sketch, or model and description, for advice as to cost, search through prior United States patents, etc. Preliminary advice gladly furnished without charge.

My experience and familiarity with various arts frequently enable me to accurately advise clients as to probable patentability before they go to any expense.

Booklet of valuable information and form for properly disclosing your idea free on request. Write today.

Richard B. Owen, Patent Lawyer
9-303 Owen Bldg., Washington, D.C.
41-E Park Row, New York City

TRADE-MARKS REGISTERED

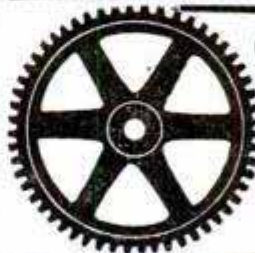

GEARS ALL KINDS SMALL

The most accurate made and prices reasonable. We carry a complete line of gears in stock for immediate shipment. Can also quote on special gears of all kinds. Send us your inquiries.

WRITE FOR CATALOGUE 10

CHICAGO STOCK GEAR WORKS
105-109 S. Jefferson St., CHICAGO

PATENTS

Trade Marks, Copyrights, Patent Litigation Handbook with illustrations, 100 mechanical movements. Sent free on request.

ALBERT E. DIETERICH
formerly member examining corps U. S. Patent Office
PATENT LAWYER and SOLICITOR

621-A, Ouray Bldg.
27 Years' Experience Washington, D. C.

INVENTORS PROTECT YOUR IDEAS

Before disclosing your invention send for our Evidence of Invention Blank. This should be signed and witnessed and returned to us with a model or sketch and a description of your invention for our Inspection and Instructions which are free.

Also send for

Our guide book "How to Get Your Patent" which is sent free upon request. This book includes full instructions regarding U.S. Patents, Trade Marks, our Terms, Methods, etc.



Terms Reasonable Best References

WRITE TODAY

RANDOLPH & COMPANY
300 Victor Bldg., Washington, D. C.
Please send me FREE OF CHARGE your Evidence of Invention blank and your guide, "How to Get Your Patent."

Name.....
Street.....
City..... State.....

RANDOLPH & CO.

300 Victor Bldg. Washington, D. C.

Have You An Invention?

If so the WORLD PROGRESS will send you upon request sample copy Free containing SUGGESTIONS TO INVENTORS as to Inventions Needed. We invite manufacturers to address us regarding inventions they want.

Subscription for one year 60 cents

WORLD PROGRESS PUB. CO., Inc.
Room 203 Victor Bldg. WASHINGTON, D. C.

BLUE BOOK ON PATENTS

AND PRIORITY RECORD BLANK GRATIS.

MONROE E. MILLER, PATENT LAWYER
411-2 Ouray Building, WASHINGTON, D. C.
ELECTRICAL AND MECHANICAL EXPERT



Inventors and Mechanics
Send 2 cent stamp for Gear or Material Catalogs
COLBURN GEAR & MFG. CO.
98 Holmes St., Quincy, Mass.



BUCHSTEIN'S FIBRE LIMB
is soothing to your stump—strong, cool, neat, light. Easy payments. Braces for all deformities.
D. BUCHSTEIN CO.
610 3rd Ave., So. MINNEAPOLIS, MINN.

Send for Catalog Today

Joy-STOMACH for SUFFERERS

I positively guarantee Macerated Wheat to relieve the worst cases of stomach trouble and banish constipation or it costs you nothing. Acid stomach, headaches and colds disappear. For more than 25 years Macerated Wheat has proved its benefits all over the world. Not a drug, but Natural Raw food. Prepared ready to eat. People like it. Makes a good meal or side dish. Soothing to a weak stomach as a poultice to inflammation. Stays down and nourishes. Testimonials without number. Write for convincing proofs or better still, send \$1 cash or check for week's supply.

BYRON TYLER, ESTABLISHED 1899, 172 GIBRALTAR BLDG., KANSAS CITY, MO.

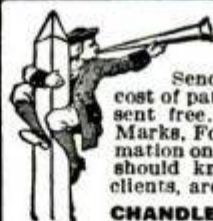

PATENTS

Send us sketch or model for advice and exact cost of patent. Our book "How to Obtain a Patent" sent free. It tells how to apply for Patents, Trade Marks, Foreign Patents, Copyrights, etc.; gives information on Patent Procedure; tells what every inventor should know. Thousands of Inventors, who are our clients, are our reference.

CHANDLEE & CHANDLEE, 25 Years' Experience
473 7th St. Washington, D. C.

WANTED

New electrical specialties which can be made and sold in quantities through Electrical Supply Jobbers and Dealers, to factories, hotels, apartment houses, homes, etc. Something that is either a current consuming device itself or which would be desirable and convenient or economical for use with them. The device must be patented or patentable. The inventor or owner must send complete description—a copy of patent if any has been obtained, or a copy of patent applications—a working model of the invention—cash price of all of the rights to the invention.

The Company that is the author of this advertisement has been in business nearly thirty years; has an international sales organization. Send your replies to BROCKLAND & MOORE, Inc., Advertising, 609 Federal Commerce Trust Bldg., St. Louis, Mo. P. S. In case you have not applied for a patent on your invention, the manufacturer suggests that for your own protection, you make drawings and write out a full description of your invention together with the date that you conceived the idea. Have these papers made in duplicate and have two people who know you appear with you before a notary public, and witness the fact that to the best of their knowledge and belief the invention is yours. Send the duplicate copy of this affidavit to us at the above address. If interested, you will receive a letter from us; otherwise we will return your papers and model.



REGISTERED TRADE MARK
CHEMCRAFT

Be an Amateur Chemist!

Have Days of Real Fun and Learn the Wonders of Chemistry!

YOU can work hundreds of surprising and useful chemical experiments with CHEMCRAFT, Your Own Chemical Laboratory. Make soap, inks, dyes and paints; test water, food, soil and metals; perform astonishing tricks of chemical magic; experiment with chemical sorcery and produce many magical changes. It's all wonderful fun; keeps you interested and shows you practical things about the wonders and mysteries of chemistry.

Get a CHEMCRAFT outfit—then your fun will begin. It's the original and the best chemical set. Contains more and better experiments; more chemicals and apparatus. Five dandy sizes to choose from!

Sold in all Good Toy Stores
No. 0, 75c No. 1, \$1.50 No. 2, \$2.50 No. 3, \$5.00 No. 4, \$10.00
(West of Denver, Colo., and in Canada, add 10%)

Each outfit complete with safe chemicals, apparatus and big book of instructions. Ask for CHEMCRAFT by name and do not accept a substitute. If more convenient, we will send your set prepaid upon receipt of price.

CHEMCRAFT JUNIOR

A fine set for boys who want to try chemistry. You can make ink, dye cloth, test water and do lots of magical tricks. Always sold for 50 cents, but if you send us 25 cents and the names and addresses of five boys who haven't Chemcraft, we will send you Chemcraft Junior.

Big Book Free! Chemcraft Chemist Club Magazine, full of stories, fine experiments and chemical news. It's Free—Just write for it.

Porter Chemical Co.
113 Summit Avenue
Hagerstown, Md.



PLANERT'S SKATES

"Merry Xmas"



With the Best of Gifts

WHAT FINER GIFT than Planert's "Northlight" or "Winner" Skates? They will give real delight on Christmas morning and enduring pleasure through many winters to come.

Tell Mother or Dad you want Planert's because they are "The World's Best" Tubular Skates. Every pair guaranteed.

Be sure to order early while Santa's stock is complete. At your dealer's or direct.

F. W. PLANERT & SONS, Inc.
Mfrs. of Quality Skates for Over a Quarter Century

939-41 N. Robey St., Chicago, U.S.A.

PLANERT'S RACER - HOCKEY - RINK
"WINNER" For Men, Women, Boys and Girls "NORTHLIGHT" SKATES
Price \$7.50 and up

JOIN PLANERT'S BOOSTER CLUB
Free Membership
\$500
IN CASH PRIZES
Write today to Contest Editor, Dept. 108—939 N. Robey St., Chicago, Illinois, for contest plan, and get **Free Booklet on Hockey Rules**

LOOK FOR THESE TRADE MARKS ON THE SKATES YOU BUY!

American Poultry Journal



Oldest, Largest and Best

9 MONTHS' TRIAL 25 cts.

1 Year 50c 3 Years \$1 5 Years \$1.50

Averages over 100 pages per issue—tells how to feed, house and breed; how to secure high egg production; how to hatch and rear poultry successfully. Established 1874. Only 25c for 9 mos. Stamps accepted.

American Poultry Journal, 14-523 Plymouth Court, Chicago

FREE Book HOW TO FEED CHICKS AND CARE FOR

Gives Money Making Secrets of Poultry Raising. Tells how to hatch, care for and feed chicks until fully grown. Gives plan of Poultry and Brooder Houses. Describes Miller's "IDEAL" INCUBATORS with Patented Egg Turning Trays. Oil and Coal Burning BROODERS. Eggs for hatching—Baby Chicks—BARGAIN PRICES. WRITE TODAY!
J. W. MILLER CO., Box 12, Rockford, Ill.



FOY'S BIG BOOK, in Colors

A complete guide to successful Poultry and Squab Raising. Low prices on CHICKS, Breeding Stock and PIGEONS.
Write Today! FREE!

FRANK FOY, Box 18, Clinton, Iowa



HOW A BOY BUILT UP A GREAT SQUAB FARM



Started small in backyard when at school with no money, now has \$30,000 plant, ships to New York 150 bbls. squabs yearly, receiving \$75 to \$100 a barrel. You can do the same. Send for this book. Price is fifty cents but we will mail it to you for the names and addresses of four of your friends and your own name and address. Write today!

Plymouth Rock Squab Co., 634 A St., Melrose High., Mass.

Fits Hand Like a Glove

EVERY AGENT'S AUTO MITTEN DUSTER

Chemically treated yarn MITTEN DUSTER, for auto and home use. Dusts, Cleans and Polishes. Agents are Cleaning Up Big. Costs you 25c each, less in gross lots, sells for 75c. Sample and Selling Instructions 50c Postpaid.
Send for Free Details and Sample Case Offer.
NATIONAL FIBRE BROOM CO., Dept. P. M., St. Louis, Mo.



\$150 to \$300 PROFIT MONTHLY FROM HB ONE DAY BATTERY CHARGING

Over 12,000 shops are making great big profits every month from One Day Battery Charging. Every car needs One Day Battery service—why not have this moneymaking business coming to you? Only \$35 cash puts an HB One Day Charging outfit in your shop, complete ready to operate. Easy terms on balance, quickly paid by your increased earnings. No experience needed, outfit runs itself. 30 days' free trial in your shop on absolute moneyback guarantee. Prove for yourself in your shop at our risk that HB One Day Charging will pay you \$150 to \$300 monthly. Write for free Bulletin 26.
HOBART BROS. CO. Box M-12 TROY, OHIO

MAKE YOURS THE BUSY SHOP WITH HB ONE DAY BATTERY CHARGING

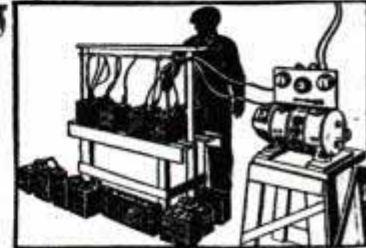

P·A·T·E·N·T·S

Just as it is important that you protect your idea with a patent, so it is imperative that your patent covers your invention completely. The one best way to assure this is to retain a reliable, experienced patent attorney

MUNN & CO. PATENT ATTORNEYS

Associated since 1846 with the Scientific American

1572 SCIENTIFIC AMERICAN BLDG.
24 West 40th Street, New York

523 SCIENTIFIC AMERICAN BLDG.
Washington, D. C.

1312 TOWER BUILDING
Chicago, Ill.

520 VAN NUYS BUILDING
Los Angeles, Cal.

655 HOBART BUILDING
San Francisco, Cal.

Ask for free copy of "Patents—A Book of Facts Every Inventor Should Know" and for "Inventor's Diary." Send for it NOW.

LUMINOUS PAINT

Make Your Watches, Clocks, Etc., Visible by Night The very latest discovery in the scientific world. Hitherto, practically unobtainable LUMINOUS PAINT, which, applied to the surface of any article, emits rays of white light, rendering it perfectly visible in the dark. THE DARKER THE NIGHT, THE MORE BRILLIANT IT SHINES. Quite simple to use. Anyone—you can do it. A little applied to the dial of your watch or clock will enable you to tell the time by night. You can coat the push buttons or switch plates of your electric lights, match boxes, and innumerable other articles; make your own Luminous Crucifixes, Luminous Rosaries, etc. Small bottle, price 25c. Larger sizes, 50c and \$1 postpaid.

Serpent's Eggs Exploding Cigarettes
Box contains 12 eggs. When lit with a match, each one gradually hatches itself into a snake several feet long, which curls and twists about in a most life-like manner.
Price per box, 10c postpaid, 3 for 25c.

CIGARETTE MAKER
Roll your own and save money. Makes them better and quicker besides saving more than half. Use your favorite brand of tobacco. Neat, useful and handy. Pocket size, weighs 1/4 oz. Made entirely of metal, nickel-plated. Price 25c postpaid.

MIDGET BIBLE
GREAT CURIOSITY
Smallest Bible in the World. Size of a postage stamp. 200 Pages. Said to bring good luck to the owner. A genuine work of art. Must be seen to be appreciated. Make good money selling them to friends, church acquaintances, etc. PRICE 15c each, 3 for 40c, 12 for \$1.35, 100 for \$7.50. Also obtainable in Leather Binding, with gold edges. Price 50c each, 3 for \$1.25, \$4.50 per doz. Magnifying Glass for use with Midget Bible, 15c.

STAGE MONEY
With a bunch of these bills, it is easy for each person of limited means to appear prosperous by flashing a roll of these bills at the proper time and peeling off a genuine bill or two from the outside of the roll, the effect created will be found to be all that can be desired. Prices, postpaid: 40 Bills 20c, 120 for 50c, or 53.50 thousand postpaid.

Wonderful X-Ray Tube
A wonderful little instrument producing optical illusions both surprising and startling. With it you can see what is apparently the bones of your fingers, the lead in a lead pencil, the interior opening in a pipe stem, and many other similar illusions. A mystery that no one has been able to satisfactorily explain. Price 10c, 3 for 25c, 1 dozen 75c. Johnson Smith & Co.

Good Luck Ring
Quaint and Novel Design
A VERY striking and uncommon ring. Silver finish, skull and crossbones design, with two brilliant, flashing gems sparkling out of the eyes. Said by many to bring Good Luck to the wearer, hence its name, Good Luck Ring. Very unique ring that you will take a pride in wearing. ONLY 25 CENTS.

JOHNSON SMITH & CO.
Dept. 801 RACINE, WIS.

Ado Luxe Edition of our new 1927 CATALOG, mailed on receipt of 25c. Handsome binding. Bigger and better than ever. Only book of its kind in existence. 500 pages of all the latest tricks in magic, the newest novelties, puzzles, games, sporting goods, rubber stamps, unusual and interesting books, curiosities in seeds and plants, etc., unprocureable elsewhere. Remit by Stamps, Coin, Money Order, Check, etc. Unused U.S., Canadian and Foreign Stamps also accepted.

Popular Watch Charms
JUST LIKE ORDINARY CIGARETTES. BUT SUCH REAL STARTLERS! The box contains ten genuine cigarettes of excellent quality. They appear so real, but when each cigarette is about one-third smoked, the victim gets a very great surprise as it goes off with a loud BANG! A great mirth provoker yet entirely harmless. Price 25c per box.

Mystic Skeleton
A jointed figure of a skeleton 14 in. in height, will dance to music and perform various gyrations and movements while the operator may be some distance from it. 10c & pd.

Novelty Badges
Kissing Permit 10c Garter Inspector 10c
Two very novel metal badges, nickel plated, that you can wear, giving you fun out of all proportion to their trifling cost. 10c, each badge, 3 for 25c, or 75c per doz. postpaid anywhere.

MAGIC FLUTE
Wonderfully Sweet Toned and Musical
The Magic Flute, or Human-stone, is a unique and novel musical instrument that is played with nose and mouth combined. There is just a little knack in playing it which, when once acquired after a little practice, will enable you to produce very sweet music that somewhat resembles a flute. There is no fingering, and once you have mastered it you can play all kinds of music with facility and ease. When played as an accompaniment to a piano or any other musical instrument, the effect is as charming as it is surprising.

Female SEX Indicator
Hold the MAGIC INDICATOR over a man's hand—instantly it moves in a straight line, backward and forward. Hold it over a woman's hand and it describes a complete and continuous circle. The same action can be obtained over a letter written by a man or woman, etc. It is fascinating; baffling. We have never been able to figure out how it's done, but we've never seen it fail. Many novel and entertaining feats can be performed with the Sex Indicator. For example, similar results can be obtained with animals, cats, dogs, rabbits, over birds, chickens, canaries, etc. Also used to predetermine the sex of chickens and birds, etc., in fact it is sold as a patented egg tester in Europe. Price 25c, or 3 for 85c, pd.

BLANK CARTRIDGE PISTOL

Protection against Burglars, Tramps & Dogs
Prices 50c \$1.00 Post-paid
Well made and effective; modelled on latest type of Revolver; appearance as real revolver without danger to life. It takes standard 22 Cal. Blank Cartridges obtainable everywhere. Price 50c, superior quality, \$1.00 post-paid. Blank Cartridges, by express, 50c per 100 Holder (Cowboy type) for Blank Cartridge Pistol, 50c Johnson Smith & Co., Dept. 801, Racine, Wis.

BOYS! BOYS! BOYS! THROW YOUR VOICE

Into a trunk, under the bed or anywhere. Lots of fun fooling the teacher, policeman or friends.
THE VENTRILO
a little instrument, fits in the mouth out of sight, used with above for Bird Calls, etc. Anyone can use it.
Never Fails. A 16 page course on ventriloquism, the Ventrillo, ALL FOR 10 CENTS

K.K.K.

Everything about the Ku Klux Klan told in a clear, fearless manner. Book tells all—How it started and was oppressed in 1871—The New Ku Klux Klan—How Organized—How Members are Enrolled—Oath of the Klan—Questions for Candidates—Creed—Objects of the Order—Obedience—Fidelity—Pledge of Loyalty—Ku Klux Klan and the Masons—The Jews—The Masons—Real K. of C. Oath—The Negro Ku Klux Klan, etc., etc. Latest and most complete book on the Klan published. Price 35c, Postpaid. Stamps or Coin

LOOK 35c Look Wonderful instrument. Greatest thing yet. Nine separate articles in one. Everybody delighted with it. Odd, curious and interesting. Lots of pleasure as well as very useful. It is a double Microscope for examining the wonders of nature. It is also an Opera Glass, a Stereoscope, a Burning Lens, a Reading Glass, a Telescope, a Compass, a Pocket Mirror, and a Laryngoscope—for examining eye, ear, nose and throat. It is worth all the cost to locate even one painful cinder in the eye. Folds flat and fits the pocket. Something great—you need one. Don't miss it. Sent by mail, postpaid. Price only 35c or 3 for \$1.00

HOT DOG! SENSATIONAL NEW NOVELTY
It is made of rubber like a small balloon. Contains a curious chemical that acts in a most remarkable way. Squeeze the deflated balloon with the hand and it suddenly becomes quite warm and fills itself up with air. It is SELF-BLOWING. Play all sorts of jokes with it. Lay it on a chair; place it secretly underneath anyone; underneath anyone's pillow; drop it in someone's pocket, and after a short time, when friction causes the chemicals to act, a large and superbly colored balloon develops. Each Hot Dog in a small box. Quite harmless, but loads of fun. 15c, each, 3 for 40c., \$1.35 doz. postpaid.

Female SEX Indicator
25c
Hold the MAGIC INDICATOR over a man's hand—instantly it moves in a straight line, backward and forward. Hold it over a woman's hand and it describes a complete and continuous circle. The same action can be obtained over a letter written by a man or woman, etc. It is fascinating; baffling. We have never been able to figure out how it's done, but we've never seen it fail. Many novel and entertaining feats can be performed with the Sex Indicator. For example, similar results can be obtained with animals, cats, dogs, rabbits, over birds, chickens, canaries, etc. Also used to predetermine the sex of chickens and birds, etc., in fact it is sold as a patented egg tester in Europe. Price 25c, or 3 for 85c, pd.

JOHNSON SMITH & CO., Dept. 801, RACINE, WIS.

COMIC CELLULOD BUTTONS



These Comic Celluloid Buttons provide subjects for pleasant jokes and amusing conversation and thus smooth the way to a more familiar acquaintance and cordial friendship. There are seventy different titles altogether, all very wittily worded and quite unobjectionable. Wear one and see the effect. All four Buttons illustrated above will be sent postpaid to any address for **ONLY 20c** or a **dozen**, all different, for **45c**.

AUTOMATIC KEYLESS DIME BANK LOCKS

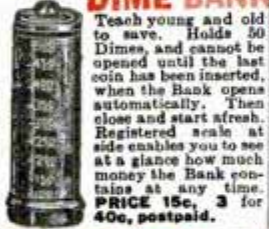

Teach young and old to save. Holds 50 Dimes, and cannot be opened until the last coin has been inserted, when the Bank opens automatically. Then close and start afresh. Registered scale at side enables you to see at a glance how much money the Bank contains at any time. **PRICE 15c, 3 for 40c, postpaid.**



25c Postpaid

Every Boy His Own Toy Maker

Greatest boys' book written. Tells how to make a Pinhole Camera, a Canoe, model Railroad, a Telephone, boomerang, Telegraph instrument, Box Kite, Talking Machine, Microscope, Electric Motor, Electric Door Bell, Water Wheel, Paddle Raft, a pair of Skis, a Dog Sled, Bird House, Rabbit Yard, etc. 64 pages, 150 illustrations. **PRICE, 10c postpaid; 3 for 25c postpaid.**



INVISIBLE INK

The most confidential messages can be written with this Ink, for the writing **Makes No Mark.** Cannot be seen unless you know the secret. Invaluable for many reasons. Keep your postals and other private memorandums away from prying eyes. Great fun for playing practical jokes. **Only 15c a Bottle; 3 for 40c.**



REAL PISTOL

Shoots Blank Cartridges



Pull the trigger and it goes off with a loud bang. Pistol is break-open type; illustration shows position for loading. Made entirely of high grade steel, nickel plated, octagon barrel, handsomely engraved handles, complete in box with cleaning rod. **PRICE \$1.75.** Also furnished with **pearl handles, \$2.50. BLANK CARTRIDGES, 50c per box of 25.**

Miniature Watch Charm Pistol

Exact reproduction of a real pistol; actually fires **Real BLANK CARTRIDGES** of miniature size. Illustration is actual size. **1 1/4 inches long**, with ring at end for attaching to watch chain. Loads like a regular pistol. **Price** as above.

RESURRECTION PLANT



LIVING FERNLIKE PLANT of a dark green color. Simply place the plant in saucer of water, it will open up and start to grow in 20 minutes. When taken out it will dry up and go to sleep until placed in water again. Fine house plant—summer or winter. **10 cents each or 3 for 25c., 75c per doz., postpaid.**

One of the most wonderful plants known. Possesses the strange power of turning in a few minutes from an apparently lifeless, dry herb to a **BEAUTIFUL**



Microphone Transmitter Button



\$1.00 POSTPAID

You can easily make a highly sensitive detectorphone by using this Transmitter Button to collect the sound waves. You can build your own outfit without buying expensive equipment. It is simple and inexpensive. You can install an outfit in your home and hear conversations being held all over the house. You can connect up different rooms of a hotel. This outfit was used by secret service operatives during the war. It is being used on the stage. It is ultra-sensitive and is the greatest invention in micro-phones. You can mount the button almost anywhere—card board boxes, stove pipes, still cabinets, on the wall behind a picture frame, etc. Button is so light and small it cannot be detected. Persons can be overheard without suspecting it. You can listen in on conversations in another room. A deaf person in the audience can hear the speaker. Connected to phonograph, piano or other musical instrument, music can be heard hundreds of feet away. Button may be used to renew telephone transmitters; often makes an old line "talk-up" when nothing else will. The ideal microphone for radio use; carries heavy current and is extremely sensitive. Amplifies radio signals. Countless other similar uses will suggest themselves. Experimenters find the Button useful for hundreds of experiments along the lines of telephones, amplifiers, loud speakers, etc. Many fascinating stunts may be devised, such as holding the button against the throat or chest to reproduce speech without sound waves. \$5.00 is given to anyone who sends in a new suggestion for the use of the Button providing the manufacturers find it suitable for use in their literature. **PRICE \$1.00 POSTPAID ANYWHERE.**

Send remittance (Postage Stamps accepted) for all articles listed on above and previous page to

MAGICIAN'S OUTFIT

Apparatus and Directions for a Number of Mysterious Tricks Enough for an Entire Evening's Entertainment

ANYONE CAN DO THEM 75c



It is great fun mystifying your friends. Get this Conjuror's Cabinet, and you will be the cleverest fellow in your district. It contains the apparatus for seven first-rate tricks, including The Disappearing Rose, that, when placed on the lapel of your coat, vanishes from sight at will; the Magic Vase and Ball Trick in Wooden Ball is placed inside, and upon replacing the lid has disappeared and is found in someone else's pocket; The Magic Nail with which you can apparently cut your finger almost in two; the Wonderful Card Trick (a card is placed in an envelope, and when open an entirely different card is found); The Disappearing Coin Box a coin is placed in the little wooden barrel, and, when opened again, is found to have vanished entirely, or can be made to change into a coin of another denomination; The Famous Dissolving Penny Trick: The Glass Goblet and Vanishing Coin Trick (a coin is dropped into a glass of water, and when the water is poured out the coin has vanished). With the tricks described above we send full printed instructions for performing each trick, so that anyone can readily perform all the tricks to the great amusement of their friends or the public. Any boy of ordinary intelligence, with this Cabinet of Tricks in his possession, can give a parlor entertainment not inferior to some regular magicians. Besides the tricks contained in the Cabinet, there are many other feats and illusions fully explained with full printed instructions for which you easily make or procure the necessary apparatus. This unexcelled Cabinet of Tricks for **ONLY 75 CENTS POSTPAID TO ANY ADDRESS.**

Great Fire Eater
Most Sensational Trick of the Day!



With the Fire Eater in his possession any person can become a perfect salamander, apparently breathing fire and ejecting thousands of brilliant sparks from his mouth, to the horror and consternation of all beholders. Harmless fun for all times, seasons and places. If you wish to produce a decided sensation in your neighborhood don't fail to procure one. We send the Fire Eater with all the materials, in a handsome box, the cover of which is highly ornamented with illustrations in various colors. **Price of all complete only 30 cents, postpaid.**

SQUIRT ROSE

25c



A REAL STARTLER. This is the most popular of all squirt tricks. The flower in your coat looks so fresh and sweet that everyone is tempted to inhale the delightful perfume. Then is the moment to press the bulb. Geewh! likens! Don't they jump? There is a very long rubber tube that easily reaches to the pocket of your coat or trousers, and the bulb is large enough to make a dozen shots with one loading. **PRICE 25c each, or 3 for 65c postpaid.**

PISTOL, OPERA & FIELD GLASS

PRICE POSTPAID, \$1.00



LOOK!

Thus it is likely to prove itself very handy in an emergency. On pressing the trigger it opens up, as shown in the illustration at the right, revealing nine most useful articles—Opera and Field Glass, Telescope, Mirror, Magnifying Glass and Burning Lens, Reading Glass, Sun Dial, Sun Compass, etc. In the handle of the revolver there is a place for various pocket necessities, such as First Aid Articles, Buttons, Pins, etc. The Pistol is of sheet metal, blued finish, that can be carried comfortably in pocket. **PRICE \$1.00.**

SURPRISE MATCHES

More fun than fighting with your wife. Look just like ordinary matches. Put up in boxes just like regular Safety Matches. As the victim tries to light one he gets quite a surprise. **PRICE 10c per box, 3 boxes for 25c, or 12 for 75 cents.**



SEEBACKSCOPE

By merely placing this clever instrument to your eye, you can see what is going on behind your back, and sometimes you see very interesting things when no one thinks you are looking. Why it is just like having eyes at the back of your head. **PRICE ONLY 25 cents, postpaid, 3 for 50 cents.**



NEW BOOK ON ROPE SPLICING

A most practical handbook giving complete and simple directions for making all the most useful knots, hitches, rigging, splices, etc. Over 100 illustrations. All about wire rope attachments, lashing, blocks, tackles, etc. 37 Heraldic Knots illustrated. Of great value to mechanics, riggers, campers, boatmen. **Price 20 cents postpaid.**

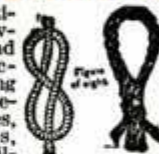

The "Little Giant" Typewriter
A First Class Writing Machine For \$1.50

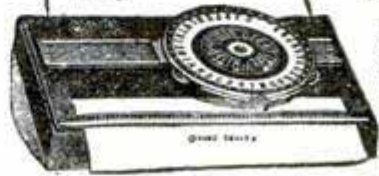

A perfect little typewriter for \$1.50. There are thousands of persons who would like to use a typewriter but whose needs and business do not warrant the expense attached to the purchase and use of a fifty or seventy-five dollar machine. To such persons we confidently recommend our Little Giant. It is strongly made, but simple in construction, so that anyone can quickly learn to operate it, and write as rapidly as they would with pen and ink. The letters of the alphabet most frequently used are so grouped as to enable one to write rapidly, the numerals 1 to 10, and the punctuation marks being together. With this machine you can send your best girl typewritten love letters, address envelopes, make out bills, and do almost any kind of work not requiring a large, expensive machine. With each typewriter we send a tube of ink and full printed instructions for using the machine. **Price complete \$1.50 by mail postpaid to any address in the world.**

Play a Tune



On Your
Favorite
Stringed
Instrument



in 10 Minutes!

No Knowledge of Music Necessary
No Tiresome Practice

Now you can pick up your favorite stringed instrument and play a tune almost instantly, even if you don't know one note of music. These wonderful Ferry E-Z Player Instruments take all the work out of learning to play. No expensive lessons. No complicated musical signs and symbols. Play by numbers instead of notes (or by notes if you wish). Just press the numbered keys and you are playing tunes. Hundreds are playing Ferry E-Z Player Instruments who could never learn the old way.

Amazing New Invention

This is not merely a system of instruction—it is a new device invented by a musician that revolutionizes stringed instrument playing. Ferry E-Z Player Instruments give clearer, truer tones, are easier to finger and anybody can play.

Famous Vaudeville Star, Trixie Friganza, writes: "I learned to play a tune in 3 minutes and had never touched a stringed instrument before." John Matise wrote: "Played tunes on Guitar the same day and am delighted. Anyone can play." Leonard Cleary: "In only a few days I have had my money's worth in fun. It certainly is one fine instrument."



Send for FREE Book Tells about new Ferry E-Z Player "Instruments and how you can play in 10 minutes. Also Free Catalog of special bargains in musical instruments. No obligation. Send for this Free Book now! Your friends will be astonished at your learning to play so quickly. You will be popular and always sure of a good time. Send coupon today.

Choose Your Instrument

What is your favorite stringed instrument? Send for this Free Book, and choose the one you would like to play. You can play it in 10 minutes! Send coupon now!

FERRY & Co. Dept. 1779, Chicago, Ill.

Send me Free Book on Ferry E-Z Player Instruments and tell me how I can play tunes in 10 minutes. No obligation.

My favorite stringed instrument is a

Name

Address

City.....State.....

RAISE BELGIAN HARES

NEW ZEALAND REDS—Chinchillas—Flemish Giants
MAKE BIG MONEY—We supply stock and pay you
following prices for all you raise: Belgian Hares \$2 each—New Zealands \$3 each—Chinchillas \$4 each—Flemish Giants \$5 each. 32-page illustrated book, catalog and contract, also copy of Fur Farming magazine, tells how to raise skunk, mink, fox, etc., for big profits, all for 10c. Address:

OUTDOOR ENTERPRISE CO., Box 25, Holmes Park, Mo.



5 and 6 Tube \$29.50 up

LAUREL and SINCLAIR RADIO Sets

The lowest-priced high quality radio receiving sets on the market. Extraordinary selectivity, coast to coast reception. Five-tube and six-tube sets from \$29.50 up. Many superior features of design and construction to bring better, stronger, clearer reception. Beautifully finished console cabinet designs if desired. Console cabinets only, \$17.50 to \$35. Write for free booklet and confidential discount sheet for dealers and salesmen.

Laurel Overhead Valve Systems for Fords
Laurel overhead valve, cylinder-head permits 65 m. p. h. speed for Fords, save gas, increase power. Low cost, easy terms. We specialize in racing cars and racing heads. Write for circular on money-making LAUREL specialties.

LAUREL MOTORS CORP., Dept. M2, Anderson, Ind.

Leonard Banked
\$218.00
in Two Days

Think of it, \$218.00 profits in two days supplying Ford owners with the most amazing gas saving device of this age, the Weeks' Super Carburetor.

You can always interest the Ford owner when you show him how to save gas. They will buy "in a jiffy" when you demonstrate the "Super" to them and show them how they can make their

Ford Run on 8c Gas

Not only does the "Super" cut gas consumption to a fraction, but it also eliminates carbon, creates amazing pick-up, instant starting, quiets Ford motors, stops oil pumping and increases the life of your car considerably.

How Much Money Do You Want to Make?

As a Weeks' Super Carburetor agent your earning capacity is limited only by your efforts. Hundreds of men, no different than you, who found it difficult to make a living, achieve amazing success with us. Get out of the rut and into the big money class. \$6,000 to \$10,000 a year can be made.

Free Sample and Territory Offer

Our workers are provided with a FREE sample so they can convince themselves of the merits of the Weeks' Super Carburetor. You owe it to yourself to find out full particulars about this big money making proposition and FREE sample without obligation. Remember, time is money—don't delay—send name today.

WEEKS' SUPER CARBURETOR CO.

426-1658 Eleventh Street Milwaukee, Wisconsin

MAKE YOUR FORD Into The "LARK"



and new manual of other distinctive sport body patterns from \$3.50 up—"RKO" Steel "Swing-Le" trons, Tops and Windshields. ORDER RIGHT NOW.

KUEMPEL COMPANY, 79 Kuempel Bldg., GUTTENBERG, IOWA

Leather Jerkins \$3.95

For absolute protection against the coldest weather get one of these genuine leather jerkins. Warmly lined with ALL WOOL khaki cloth. Leather will not crack or harden after wetting. Sizes 38-40-42. Only \$3.95 postpaid, C. O. D. 10c extra. Order today. Satisfaction or money refunded.



KIRTLAND BROS.
90 Chambers Street Dept. 10 NEW YORK

Information on any book free. Write Popular Mechanics Press, Chicago, Ill.

30,000 Mile Ford Pump



Only \$700

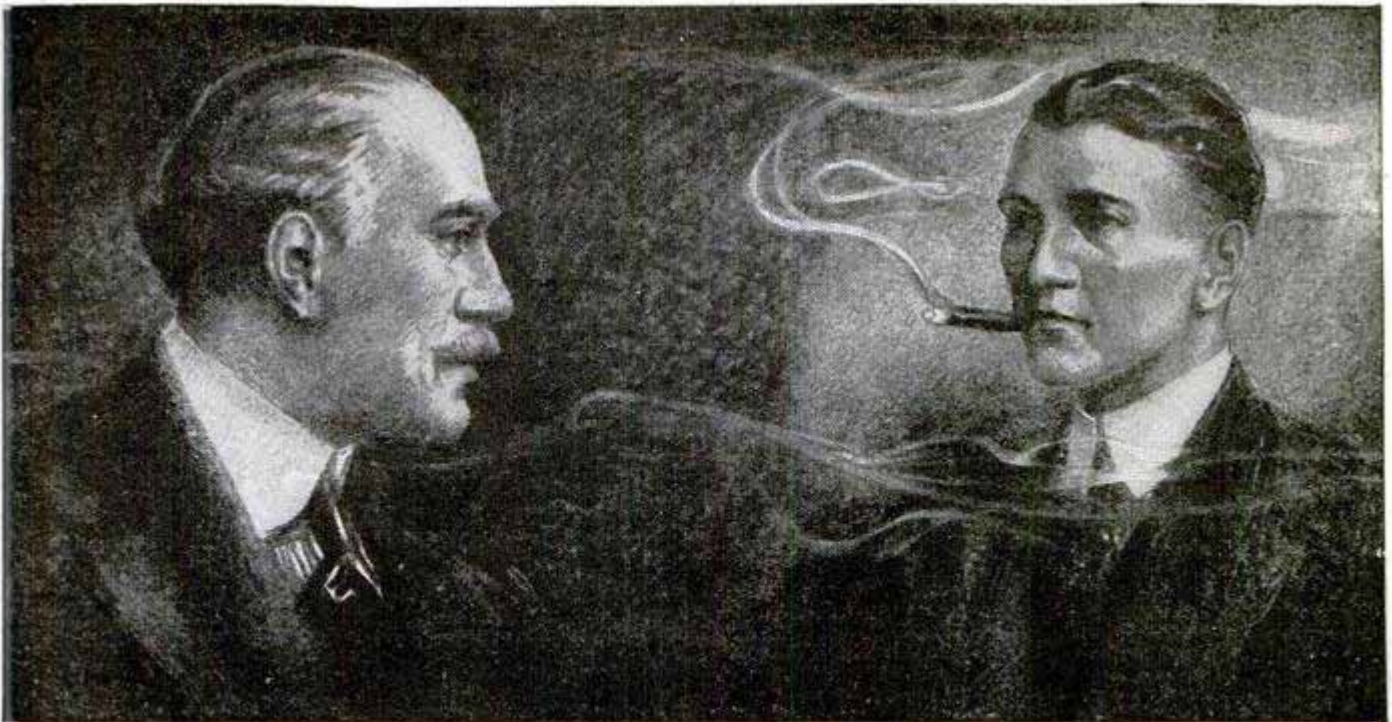

Tobacco Is Hurting You

Look at the facts square in the face, Mr. Tobacco User. You may think tobacco is not hurting you.

That is because you haven't as yet, perhaps, felt the effects of the nicotine poison in YOUR system. For you know that nicotine, as absorbed into the system through smoking and chewing tobacco, is a slow working poison. Slow, yes—but sure.

Tobacco is lowering your efficiency. It slows a man down. Makes it harder for you to concentrate your mind on your work. You haven't near the amount of "pep" and energy you would have if you stopped using it. There's many a man twice as old as you in years who's twice as young in energy, simply because he lets tobacco alone.

Some day you will realize to what an alarming extent tobacco has undermined your system.

When your hands begin to tremble—
and your appetite begins to fail—
and your heart seems to "skip a beat" now and then—
and slight exertion makes you short of breath—
then you have a right to suspect that
TOBACCO is getting the upper hand.

Any well-informed doctor will tell you that these are only a few of many symptoms of tobacco poisoning.

And YOU know that the use of tobacco in any form is an expensive, utterly useless habit. You know you ought to quit.

Tobacco Habit Banished Let Us Help You

It doesn't make a particle of difference whether you've been a user of tobacco for a single month or 50 years, or how much you use, or in what form you use it—whether you smoke cigars, cigarettes, pipe, chew plug or fine cut or use snuff—Tobacco Redeemer will positively remove all craving for tobacco in any form in a very few days. Not the slightest shock to the nervous system. Your tobacco craving will usually begin to decrease after the very first dose—there's no long waiting for results.

Tobacco Redeemer contains no habit-forming drugs of any kind and is marvelously quick, scientific and thoroughly reliable.

It is in no sense a substitute for tobacco. After finishing the treatment you have absolutely no desire to use tobacco again or to continue the use of the remedy. It helps to quiet the nerves and make you feel better in every way.

Results Guaranteed A single trial will convince you. Our legal-binding, money-back guarantee goes with each full treatment. We will refund every cent you pay for the treatment if after taking it according to the easy-to-follow directions, it should fail to banish the tobacco habit completely.

SEND Coupon for Free Proof Let us send you our free booklet on the deadly effects of tobacco, together with testimonial letters from men all over the country telling how they have been absolutely freed from the tobacco habit by this simple home treatment. You could not ask for stronger proof that Tobacco Redeemer will free you from the habit than the evidence we will gladly send on request. Just mail the coupon—or a postal will do.

NEWELL PHARMACAL CO.

Dept. 300 Clayton Station St. Louis, Mo.



Free Book Coupon

NEWELL PHARMACAL CO.

Dept. 300 Clayton Station St. Louis, Mo

Please send, without obligating me in any way, your free booklet regarding the tobacco habit and proof that Tobacco Redeemer will positively free me from the tobacco habit or my money will be refunded.

Name

Street and No.

Town..... State.....



Lowest initial cost!
Lowest upkeep!
No garage bills!
No traffic delays!

Real Fun Always on Time

—and you save money with these two pals

INDIAN PRINCE
THE SOLO SINGLE

INDIAN SCOUT
THE SOLO TWIN

WHY be a slave to stuffy, crowded trains and trolleys? Hop on one of these famous Indian Pals and know the comfort and convenience of zippy healthful outdoor motoring—at less than carfare cost—a cent a mile or less.

Motoring with a "kick"

Easy handling—perfect balance—restful comfort—snappy get-away—lightning-like pick-up—and all the speed

INDIAN PRINCE
The Solo Single
You can learn to ride it in 5 minutes. Light yet sturdy. 90 miles per gallon gas. Less than 1c per mile operating cost.

Price with complete electrical equipment \$225
F. O. B. Springfield, Mass.

INDIAN SCOUT
The Solo Twin
Twin-cylinder smoothness, acceleration and power. Maximum comfort and safety. 65 miles per gallon gas. 1c per mile operating cost.

Price with complete electrical equipment \$285
F. O. B. Springfield, Mass.

and power you want, at your finger tips. That's motoring at its best. That's what you get in the Indian Prince and the Indian Scout.

Easy to own

Let your nearest Indian Dealer demonstrate the Indian Prince and the Indian Scout and tell you about his pay-as-you-ride plan. Mail coupon below for free illustrated catalogue describing these two famous Indian Pals.

DEALERS: A few good territories open. Our proposition is a winner for ambitious men. Write now.

Indian Motorcycle Co.

DEPT. P-12 SPRINGFIELD, MASS.

INDIAN MOTORCYCLE CO., Dept. P-12
Springfield, Mass.

- Send me your illustrated Catalogue describing the Prince and the Scout.
- Check this if you are interested in our money-making proposition to dealers.

Name

Address

FREE

NEW 1927 **Radio Catalog**

WRITE TODAY TO

Chicago Salvage Stock Stores

509 S. State St. Dept. PM Chicago, U. S. A.



MORE THAN a score of new circuits—all the latest and best. Complete parts at prices that mean big savings for you. And all the latest parts and accessories as advertised in current radio magazines. The largest, most complete and up-to-date radio stock in the world. Yours to choose from in this new catalog. Write for your copy.



\$100 to \$125 PROFITS WEEKLY

New line of quality toilet goods sells like wildfire. No experience required. All you do is take orders from this beautiful sample case. Finest perfumes, soaps, facial creams, bath salts, face powders—wonderful products at prices that appeal to all women. Just send name and address for FREE CATALOG.

NATIONAL SOAP & PERFUME CO.
512 W. Huron St. Dept. A-12 CHICAGO



\$675
Post Paid

BIG MONEY — SELL SHOES

A Splendid Shoe At A Low Price

Long Counter Arch supporting the foot in our Brockton, Union Made, double sole-Calfskin-Munson last-shoe. Featuring Oak Tan leather sole. Leather Insole. Solid leather Heel Base. Inverted Storm Welt. Goodyear Welt Process. Made in Brown or Black. Rubber Heels. Order a pair and judge us by our product. We ship, C.O.D. or send money order. Write for agents' proposition.

Devon Shoe Co. Inc. West Somerville, Mass.

STOP CHASING RAINBOWS

Become a distributor of our World Famous Products. Goods used up between trips. Every item in daily demand. Repeat business assured. We back you with 50 years' experience and unlimited co-operation. Our products backed by \$10,000,000 Company are known and used everywhere.

A FEW DOLLARS WILL START YOU

All you need is a desire to work and make good. We show you how. Any average man, satisfied with \$35.00 to \$50.00 a week to start, can establish an income for life with us.

THE J. R. WATKINS CO., Dept. 260, Winona, Minn.

WRITE FOR INFORMATION TODAY

FREE This 84 Page **WONDER BOOK** *Send For It TO-DAY*

You must have this latest guide to Radio prices and Radio quality. All of our vast resources and radio experience have been utilized to assemble for you in one gigantic institution, the best and newest things in radio. The Randolph catalog is indeed the radio market place of the world—a masterpiece of merchandising that befits our house—THE LARGEST EXCLUSIVELY RADIO MAIL ORDER HOUSE IN THE WORLD.



RADIO Bargains

OVER 2000 ITEMS

RADIO KITS

From the most beautiful, fully equipped console radio set, down to the smallest part or tool for the set builder—kits, parts and supplies of every conceivable type and style. 5, 6, 7 and 8 tube sets, with three dial, two dial, and the newest and most popular single simplified control. All sets are assembled in beautiful, genuine mahogany and walnut cabinets in a choice of latest types and designs. A complete line of "B" batteries, eliminators, including the famous Raytheon Eliminators; latest types loud speakers, cone speakers, "A" power units. Everything in radio at money saving prices.

Include the following well known circuits, designed and approved by the world's foremost radio engineers: Madison Moore Super; Victoreen Super; Silver Marshal Six; Sargent's Infrazyne; Remler Super; Short Wave Kits; 9-in-Line Super; New Acme Reflex; Cockaday; Neutrodyne; Browning-Drake; all classes of radio frequency, Popular Mechanics and other Superhets.

Save 1/3 to 1/2

We Save You Money because we handle radio exclusively and sell a tremendous volume of everything in Radio. Volume purchases regulate prices.

We command rock bottom prices from manufacturers, and in many cases we contract for entire factory output of exclusive products. You will benefit by our great volume of purchases and sales, by securing anything you may want in radio at a substantial saving.



Beautiful hand rubbed, two-toned mahogany finished cabinet, size 18 x 19 x 36. Built-in loud speaker.

Columbia Grand 6-Tube Console Set

Here's a sensational bargain in a console radio with built-in loud speaker and adjustable unit. Spacious compartment for all batteries, etc. Very latest type 6 tube tuned radio frequency receiver. Low loss modified straight line frequency condensers. Has three stages of low ratio audio amplification. Designed to accommodate new power tube. Equipped with X-type sockets. Beautiful gold etched panel with handsomely engraved designs. Price of set with accessories..... **\$42.65**

This set with all accessories, which include 2 45-volt "B" batteries, 100 Amp. Hr. storage "A" battery, 6 201A tubes, aerial and ground equipment—everything complete, nothing else to buy..... **\$65.95**

These sets are typical examples of the bargains in our catalog. You may order direct from this page, sending P. O. money order or draft for full amount. We ship freight or express, charges collect. We guarantee to back up every article with our own, as well as manufacturer's, assurance of good quality at the right price.

We have Popular Mechanics 1927 Super as shown in Popular Mechanics at a Special Offer Price

Symphonic Five

Brown Spanish leatheroid finish cabinet with gold engraved walnut panel to match. Contrasted beautifully with the black fine tuning knobs. Two small knobs control volume and clarity. The volume control is of the finest smooth slow variation type. Roller bearing. Condensers are of the modified straight line frequency type, substantially constructed and of latest design. All is sub-panel mounted, using the new X-type socket. Latest development in solenoid coils. Two stages of low ratio audio amplification with high grade transformer offers the true amplification required for both low and high notes.

\$24.90 Without Accessories

The set complete with five type X201A tubes, two 45 volt "B" batteries, one 100 Amp. Hr. storage battery, complete aerial equipment, one battery cable attached, including cone speaker of the same type as pictured.. **\$54.75**



Columbia Senior Six

Beautiful table set. New localized control. One hand to tune with, three rotating drums easily controlled and easily logged. Dark finish etched panel mahogany finished hand-rubbed cabinet. Size 7x22.

6-tube set, giving tremendous volume, wonderful tone quality, latest straight line condensers, solenoid coils; sub-base mounting and new amplification. Designed to sell for over \$100.00 Price, without accessories..... **\$36.50**

Set complete with two 45-volt "B" batteries, 100 amp. hr. Storage "A" battery, one 4 1/2 volt "C" battery, six type X201A tubes, complete aerial kit, attached battery cable, quality cone speaker or Victor horn type loud speaker..... **\$65.45**

YOU MUST HAVE THIS BOOK

Space limitations here prevent our telling you more about the Randolph Catalog. Simply fill out and mail the coupon—or you may send a postal or letter—and this truly remarkable Radio book will come to you **ABSOLUTELY FREE.**



This Coupon Brings the Great RADIO Book FREE

RANDOLPH RADIO CORPORATION
180 N. Union Ave., Dept. 199
Chicago, Illinois

Send me—free—your 84-page, 1927 Radio Book.

Name.....

Street and No.....

R. F. D..... Box.....

City..... State.....

MAIL COUPON NOW

Randolph Radio Corporation
180 North Union Avenue - Dept. 199 - Chicago, Ill.

LIGHTING MATCHES WILL MAKE YOU \$300 to \$2500 a Month

Amazing "Sure-Fire" Demonstration

Sells by thousands new automatic attachment that Sworn Public Tests prove makes Fords run 43.8 to 68 miles on 1 gallon of gas. This simple, but sensational demonstration easily convinces and astonishes even the skeptical. Agents everywhere report wonderful results. Mr. R. K. Waite ordered 1000 devices in 1 month. Profit \$3000.00. Mr. Clyde B. Jones sold 63 devices in 1 day. Profit \$189.00. No experience necessary—the thrilling demonstration sells it for you.

Makes Fords Run on 94% Air

Not a cheap, flimsy device, but a nationally advertised, proved attachment that actually saves Ford owners \$100.00-\$300.00 every year. Saves its cost in gas and oil within three weeks. Sold on 30 days' trial. Used by Nationally Known Companies who recommend and endorse it. One demonstration never fails to bring big returns.

Get Free Blancke Plan

that starts you in your own big, profitable business without capital or previous experience. Start to make big money—beginning now! Write today without fail.

Blancke Auto Devices Co.
Dept. 805-T
157 E. Erie St., Chicago, Ill.

Cadillac and Delco Light now use as Standard Equipment The most static Carburetor Control under Blancke License.

A Home and Income for You in Sunny Florida

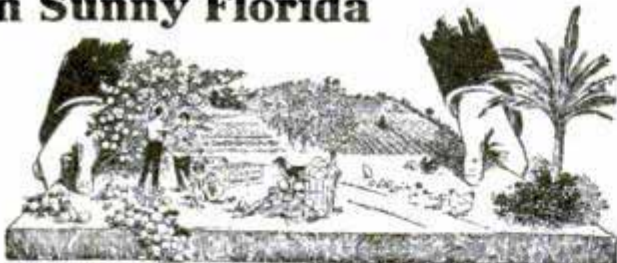

Be Independent—Own a Grapefruit and Orange Grove—A Truck or Poultry Farm. Increase Your Income

THE RIGHT LAND IN THE RIGHT LOCATION AT THE RIGHT PRICE WE HAVE IT—Any Size Farm

These splendid lands are suburban to Tampa, the metropolis of South Florida. Here you find the most healthful, the most delightful climate in North America. For fifteen years we have been right here helping develop Hillsboro—the banner agricultural County of Florida, and we are still here to serve you and to help you obtain the farm you want, on very easy payments extending over 2 or 3 years' time to suit.

\$300.00 to \$500.00 Per Acre Profit

This is not an unusual return for truck farmers in the Famous Tampa district. All kinds of vegetables can be grown. Big prices are paid for early potatoes, Winter cabbage, Bermuda onions, tomatoes, celery and dozens of other vegetables during the Winter and early Spring, when the north is covered with ice and snow. Strawberries, Melons and other small fruits, also yield large profits.

Write for Facts About Sunny Florida. IT COSTS YOU NOTHING TO LET US PROVE TO YOU that we have the land you want—in the location you want—at a price you can afford to pay and on the easiest terms you can imagine. Let us show you. Fill out and mail us the coupon today and receive our large descriptive book FREE!

NORTH TAMPA LAND CO.

404 Zack Street Tampa, Florida

 Coupon for FREE Book on Florida
 NORTH TAMPA LAND CO.
 404 Zack St., Tampa, Fla.
 Please send me your large illustrated Book, "The Call of the Southland," on choice Citrus Fruit and Truck Farms suburban to Tampa, Florida.
 Name.....
 St. No.....
 City.....
 State.....
 Please mention Popular Mechanics

6 VOLT "A" AND 150 VOLT "B" ELIMINATOR

Guaranteed to work any set up to eight tubes or any set in this magazine.

\$37⁵⁰

All "A" and "B" eliminators have automatic relay control and work from set switch. No set changing is necessary. Like our "B" eliminator, they operate from 110-135 Volt A. C., any cycle.

100 Volt "B" eliminator, 20 milliamps	\$ 7.75
100 Volt "B" eliminator, 60 milliamps	10.98
135 Volt "B" eliminator, 60 milliamps	16.98
150 Volt "B" eliminator, 60 milliamps	17.98
40 Volt "A" 199 eliminator, 65 milliamps	11.00
6 Volt "A" 201A Automatic Relay for "A" & "B"	17.50
	4.50

Every unit comes to you complete with a two-year written guarantee. No extras to buy. Guaranteed to be equal or superior to any eliminator regardless of price. Use it for ten days to convince yourself, and if not satisfied return it in good condition and your money will be refunded. "B" eliminators will be shipped on receipt of one dollar deposit.

Big Catalog on Sets Now Ready

UNION SERVICE COMPANY
Morris Heights P. O. Box 23 New York, New York



\$5,000 A Year

Without previous experience selling Surety, the original powdered hand soap, direct to users and dealers. We assure your success. Everyone everywhere demands SURETY, the GENUINE product. Don't waste your time on something inferior but write today for FREE SAMPLE and exclusive territory.

SURETY MANUFACTURING CO.
26 W. Washington St., Dept. 12, CHICAGO



"Been on a vacation Bill?"

"No, Jim — I've stopped smoking. Gained six pounds in a week. You know how I used to smoke—a package of cigarettes and a cigar or two a day—it sure had some hold on me. But I'm cured—

took a scientific home tobacco treatment—fixed me up in two weeks.

"Wasn't hard on me at all—noticed improvement the first day—I feel like a new man. It didn't interfere with my work—didn't leave any druggish after-effects—the money I saved in the last two weeks has paid for the treatment alone.

"Why don't you take it! It has cured men like you and me for over forty years—it is a doctor's individual prescription that sure fixes you up. Just send the coupon for full information NOW. No obligation. All correspondence is strictly confidential."



"A Doctor's Prescription"

The Keeley Institute, Dwight, Ill.

Please send me, without any obligation on my part, your free booklet which will tell me how to rid myself of the tobacco habit.

Name.....
 Town.....
 Street..... State..... PM-12

PATENTED SUBANTENNA!

The Amazing, New UNDERGROUND ANTENNA SYSTEM Eliminates ALL Interference Increases Distance — Kills Static

Science Now Offers a Positive Means to Enjoyable Long Distance Reception

How often, when perhaps for days you have anticipated listening to a certain program from some distant station your set has failed you—all because of the condition of the air. And too, how often "man-made" static, such as leaky power lines, a nearby electric motor or some other nuisance has spoiled your radio evening.

Indeed, there has been a dire need for some means of overcoming these obstacles. And now it has actually been accomplished, and not by muffling or killing the sensitivity of the set as some devices do, but by filtering out the unwanted impulses. SUBANTENNA is the answer, for it not only cleans up the reception before it reaches the set, but it actually gives greater distance, bigger volume to weak signals and finer selectivity. Send the coupon at once for full particulars and special Trial Offer.



Almost unbelievable, yet entirely true: SUBANTENNA positively makes every night a good radio night. For, no matter what the season, the condition, or the weather, you get clean, clear reception, free of the harsh, annoying crackles and crashes that make distant reception a miserable impossibility with a regular antenna.

Get Distant Music Clear as Local

No longer need static, air noises, arc lamps, leaky power lines, street car trolleys and other disturbances spoil your radio enjoyment. For now, you can bring in station after station with the clearness of a crisp, cold winter night. SUBANTENNA—the new underground pick-up system—gets nothing but the pure radio waves.

Use Filtered Ground Waves. Not Noisy Air Waves

Being buried in the ground and shielded, SUBANTENNA is sensitive only to the continuous broadcast wave. The intermittent impulses such as static, power line crashes, etc., are filtered out and grounded before they reach SUBANTENNA. Hence, you not only get clear reception from this new wonder system, but you get greater distance, because the radio signal is not held back by the interfering noise level.

Not Just a Wire. Nothing Else Like It

SUBANTENNA is not just a wire. It is a patented device consisting of a specially treated wire, uniquely insulated and sheathed in a lead jacket, and containing three specially constructed pick-up or building-up coils. Nothing else will do what SUBANTENNA does. And it's the only device of its kind in the world.

Make This Test

Select a night that is unusually bad for distant reception. First connect your set to your regular aerial. Then connect it to SUBANTENNA. If you do not get the results we promise, we agree to promptly refund your money.

Send Coupon for TRIAL OFFER

Right now—decide to tear down your aerial; that unsightly, inefficient combination of sticks and wire that is obsolete. Just send the coupon and we'll mail you full particulars of SUBANTENNA—the first and only really practical system of radio reception. Mail the coupon NOW—for special TRIAL offer. Clip at once!

CLIP AND MAIL NOW

CLOVERLEAF MANUFACTURING CO., 2715 South Canal Street, Chicago

At once—send me full particulars of SUBANTENNA, also tell me about your special introductory TRIAL OFFER. This does not obligate me in any way.

Name.....

Address.....

Cloverleaf Mfg. Co. 2715 South Canal St., CHICAGO



Every One

KING Perfect

GOOD instruments make good players. Own the finest. King band instruments bring you the applied results of 30 years' acoustical research and practical experience. They meet every professional standard. Your complete satisfaction flatly guaranteed. Learn more about these unusually fine instruments. Complete information, together with a ten day free trial offer, sent on request. Other instruments taken in trade.

KING Band Instruments

The H. N. WHITE Co., 5211-82 Superior Ave., Cleveland, Ohio
 I am interested in _____ Instrument
 Name _____
 Address _____
 City _____ State _____



for boys and girls **KANGRU-SPRINGSHU** age 5 to 12 years

\$2.75 2 pairs for \$5.00

Trade Mark

Add 50c West of Rockies

Children Love This Amazing Toy

Children's natural activity makes them wildly enthusiastic over Kangaroo Springshoes. It's like dancing on air. New thrills and fun added to all the old games. Simple, easy and SAFE. The real health-toy recommended by doctors. A smooth surface not necessary—will go where roller skates cannot. Strong and durable—nothing to get out of order. A Christmas gift prized above all others.

ASK YOUR DEALER—or mail coupon

LITTLEFIELD MFG. CO. 703 N. Halsted St., Chicago

Enclosed is \$..... for..... prs. Kangru-Springshus with the understanding that money will be refunded if not satisfactory.

Name..... Age.....
 Address..... Weight.....
 City..... State.....

You Can Build This \$100.00 Ship Model for \$4.98



COLUMBUS FLAG SHIP "SANTA MARIA"
Size: HEIGHT 25 in. WIDTH 11 in. LENGTH 27 in.

Let the World's Largest Builders of Ship Models Help Build Your Model

After receiving hundreds of letters from Home Mechanics asking our advice as to how to build ship models we have decided to try out a plan wherein every one may own a beautiful \$100.00 Ship Model at a cost of \$4.98. We will furnish you with the completed parts, cut and fitted and ready to be put together. The only tool necessary is a small hammer. The parts include hull, decks, railings, steeps, keel, side balconies, decorated stern, rudder, stand, brass name plates, cannons, port rings, anchors, shields, rubbing strips, masts, yard arms, sails, crow's nests, flags, lamp and holder; complete set of rigging, including pulleys, string, staples, brads and glue. Full directions with every boat and parts are cut to fit. Anyone can put model together in less than three hours. You may order Santa Maria parts as pictured, or Mayflower parts at this price. **Make one for a Xmas gift.**

If you are a dealer write for our prices on completed models, and parts.

MINIATURE SHIP MODELS
3216 BARING STREET PHILADELPHIA, PA.

Miniature Ship Models,
3216 Baring Street,
Philadelphia, Pa.

Please send me the completed parts of your Ship Model
.....c..... and tted,
Name of Model here
ready to be put together. I will pay Postman \$4.98, plus
Postage (a few cents).

Name.....

St. or R. F. D.....

City.....

State.....

WET CELLARS MADE DRY from the Inside!

DAMP musty cellars are unsanitary, a danger to health and a poor place to store valuable material.

Where water or moisture seep in through cracks or porous spots in the floor or walls, you can make and keep your cellar dry and sweet—a fit place to work, free from odor, mold and rust—by filling the cracks and coating the moist surface with Smooth-On No. 7.

This is the one practical waterproofing that you can apply yourself, easily, from the inside, to wet or dry surface and with every assurance of thorough watertightness, even in the wettest seasons.

Excellent also for patching concrete floors, waterproofing garage, stable and washroom floors, brick walls, cisterns, septic tanks, water troughs, fountains, fish ponds, swimming pools, manure pits, etc.



Write for
FREE BOOK

About 25 pounds of Smooth-On No. 7 are required for each 100 square feet of surface covered, and no experience is necessary. Complete instructions on this package.

Sold in 5-pound cans and 25, 50 and 100-pound kegs.



SMOOTH-ON MFG. CO., Dept. 37,
574 Communipaw Ave., Jersey City, N. J.
Please send the free Smooth-On Repair Book.

Name

Address.....

**Return this coupon for
FREE copy of Booklet**

If You Give a Movie Camera Be Sure it Uses Standard Film

Christmas looms! What finer, what more practical, what more joyous gift than a motion picture camera.



When you buy this Christmas gift supreme, be sure that the camera you purchase will give you real professional pictures like those shown in the theatres. You want pictures that can be preserved—pictures of cherished scenes—the baby's first toddling steps and rapid growth—family activities—travel, sports. To do this you need a standard size film camera. (35 mm.). The famous DE VRY is the only 35 mm. standard, automatic movie camera on the market under \$300.

Here is a camera, automatic and so simple that a child can operate it. Made of finest materials. It will last a life time. But the price is only \$150. It can be bought on easy terms from any De Vry dealer.

DeVry
Standard-Automatic
MOVIE CAMERA.

FREE BOOK You are invited to send for our new book "New Facts About Amateur Motion Picture Photography." There is no obligation.

THE DE VRY CORPORATION

Dept. 12K 1111 Center Street CHICAGO, ILLINOIS



PAWOODS CIRCLE CUTTER

(Patented)

Junior cuts holes 1/8 to 2-1/2 inches No. 2 cuts holes 1 to 4 inches

A time saver for hand-drill or machine use. For radio, automobile mechanics, carpenters, plumbers, electricians, engineers and anyone desiring to cut holes in hard rubber, bakelite, veneers, brass, and sheet steel. Sent postpaid anywhere in U.S. Junior \$1.00—No. 2 \$1.50.

GENERAL HARDWARE MFG. CO., 35 Warren St., New York



SAY! LISTEN!

A New Pair of Pants Matched to Your Coat and Vest

Just doubles the life of your suit. We can match almost any suit. 70,000 patterns. Sample is sent for your O. K. before making. All made to measure. Send piece of cloth or vest for matching.

ACME PANTS MATCHERS

Dept. A-23 20 W. Jackson CHICAGO

Enclose return postage if vest is sent.

\$20,000—Specialty Salesman—\$20,000

Want State distributors at once. No investment. Call on merchants, banks, wholesalers and manufacturers only. \$20,000 a year easily possible on greatest merchandising plan ever conceived. Unit of sale, small profits tremendous. Man capable of handling executives only kind considered. Wire or write today. Aerial Electric Co., 128-36 W. Kinzie St., Chicago

Chicago Man Discovers Gasoline Miracle!

What is this strange new miracle guaranteed to give 334 gal. of gas at only four-fifths cent a gal., instantly remove all carbon, increase power, speed, pep? Sworn proof backs our guarantee. Nothing ever like it. Not a mechanical device or gas dope. Use it only every 10,000 miles. Costs practically nothing. It is called MOTOR-MYSTERY, discovered by the eminent scientist, L. Forgrave. Starting in action. Astounding in results. Save \$200 yearly. Thousands of users and testimonials. **TRY IT FREE** Send no money. We trust you. Write quick for **FREE TRIAL, \$100 WEEK SALARY GUARANTEE** to producing Agents.



You All Know Him
Agents \$100⁰⁰ A Week Salary Guaranteed

M-M LABORATORIES
6935—A28 N. Clark St. Chicago, Illinois



SEND FOR THIS RADIO FOLDER!

Contains seven hookups for B-Eliminators published in a prominent radio magazine.

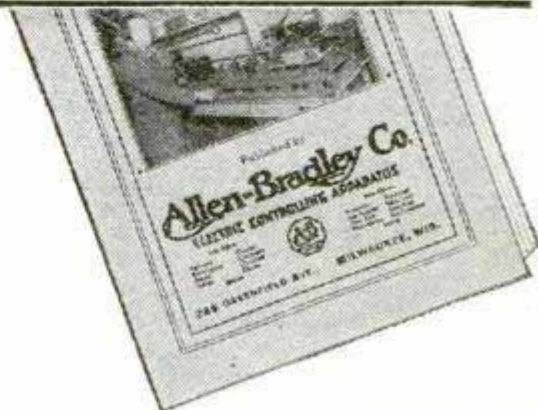

When You Build a B-Eliminator Use Bradleyohm-E for Variable Resistors and Bradleyunit-A for Fixed Resistors

ALWAYS insist that Bradleyohm-E and Bradleyunit-A are included with your B-Eliminator kit, if you want to be assured of perfect voltage control. The leading manufacturers of B-Eliminators have long since adopted these Allen-Bradley variable and fixed resistors as standard equipment for their B-Eliminators. In fact, Bradleyohm-E is used almost as universally as the Raytheon tube, itself.



Bradleyunit-A

Solid molded fixed resistor that can be soldered. Unaffected by temperature or moisture.

You cannot afford to risk the use of inferior substitutes for the scientifically-treated discs used in Bradleyohm-E. This remarkable variable resistor handles the strenuous requirements of B-Eliminator service without the slightest strain. Ask your dealer for Allen-Bradley Perfect Radio Devices, today.

Bradleyohm-E

Variable resistor made in several ranges. Sold in checkered carton.



Allen-Bradley Co.,
280 Greenfield Ave.,
Milwaukee, Wis.

Please send me, FREE, your radio folder with seven B-Eliminator hook-ups.

Name

Address

"I Made \$1,000 a Month from the New Food Sensation Greaseless Doughnuts"

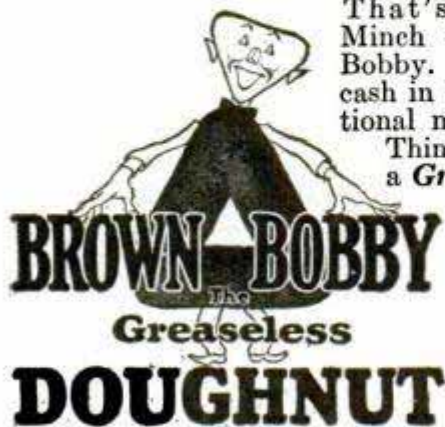

That's what Thomas Minch did with Brown Bobby. You, too, can cash in big on this sensational new food product. Think of it! Actually a Greaseless Doughnut!

Mrs. Nelson, Rockford, Ill., makes Brown Bobbys at home. "Sold 90 doz. last week. Will sell 3 times that many this week. Wonderfully easy."

Fair Store, Chicago, says: "It's a great money-making device." "The demand for Brown Bobby is beyond my wildest expectations," writes Jas. O'Connor, Chicago. So it goes everywhere. Investigate!

Big Profits for YOU!

Millions of greasy doughnuts are sold daily, hard as they are to digest. What a mammoth market for Brown Bobby! Cooked without a trace of grease to a golden brown—crisped to a feathery lightness—Brown Bobby is positively the food sensation of the age. No one thought a doughnut could be made without grease. But WE did it. And YOU can get in on the first easy profits.

Simple, Easy and Sure

Get this! With one simple, inexpensive, electrically operated machine, you can turn out a full dozen Brown Bobbys every 3 minutes—cost, less than 1c each. No baking skill required. Just add water to our patented "Mix." No bother. No boiling grease. No odor. A child can do it. Big money for women making Brown Bobbys at home. Tremendous opportunities in every town for a thriving business on a surprisingly small investment. Wherever there are hungry people, Brown Bobby is a sure hit. In lunch rooms, drug stores, wherever food is sold Brown Bobby offers a chance for amazing profits. Special openings for Brown Bobby Specialty Doughnut Shops in every town.

Write Quick! Be the first in your locality to get the first easy profits. Whatever your present line-up, let us present you a plan that will be feasible and full of opportunity for a steady, paying business. Just mail the coupon! Get the facts now. Profits are waiting.

FOOD DISPLAY MACHINE CORP.
28 E. Jackson Blvd., Dept. 13-59, CHICAGO, ILL.

Food Display Machine Corp., Dept. 13-59
28 East Jackson Blvd., Chicago, Ill.
Gentlemen: Please send me the plan by which I can cash in on Brown Bobby, the Greaseless Doughnut. It is understood that this obligates me in no way whatever.

Name.....
Street.....
City.....State.....

Big Sale
8 DAY WATCH
Only \$6.95
SEND NO MONEY
\$15.00 Value



Runs 8 Days With 1 Winding

Exact Size

Here's an exceptionally sensational watch offer. This sale establishes a new low price for this famous eight-day watch. Think of it! Wind it and be sure of perfect time for eight days. It's the only watch of its kind. It's no larger than an ordinary watch—it's a wizard of a timepiece. You'll be proud to own one. Sets a new record in dependable timekeeping at a low price. Easily worth \$15.00. Get yours for only \$6.95 while they last. We are almost giving them away at this price, but we want new friends and customers for our other jewelry offers.

READ THIS REMARKABLE GUARANTEE
5 DAYS' We guarantee this watch is all we claim or your money back after 5 days' trial and examination; also to keep perfect time and to give entire satisfaction.

NOT A NOVELTY—A REAL TIMEKEEPER
Built for real dependable timekeeping. Has 6-jewel lever with exposed balance wheel which shows action of movement. Stem wind and stem set. Solid nickel, hinge back case. Silver finish dial. These features make this 8-day special an attractive ornament besides being useful.

YOU CAN GET YOURS ALMOST FREE
Those who order at once will receive six merchandise coupons, having a value of one dollar each. You easily sell these to your friends and keep the six dollars collected—then your watch will only cost you 95 cents.

HOW TO ORDER—SEND NO MONEY
Don't send a cent now! Just send your name and address. We ship your 8-day watch and six one-dollar merchandise coupons by return mail. Pay postman \$6.95 plus a few cents postage. If not pleased after 5 days' trial, return watch and get your money back. Act quickly while supply lasts. You take no risk.

DISCOUNT WATCH CO. 22 W. 48th St., NEW YORK



MAKE MONEY QUICKLY

raising guinea pigs, squabs, etc., at home in spare time. Highest prices paid to raisers. Market guaranteed. No experience necessary. Free illustrated booklet.

Mutual Food Products Co., 1459 Broadway, New York



Imperial Sanitary Floor
Put on like Plaster
Wears like Iron
-waterproof
fireproof
resilient
noiseless
dust-less

Base and Floor one solid piece

A composition material easily applied in plastic form over practically any kind of floor. Laid about 3/8 inch thick. Imperial floor does not crack, peel or come loose from foundation. A continuous, fine-grained, smooth, non-slipping surface. No crevices to gather grease, dirt, dust, disease germs or moisture.

Ideal Floor for Kitchen, Pantry, Bath Room, Laundry, Porch, Garage, Restaurant, Theatre, Hotel, Factory, Office Building, Railroad Station, Hospital—wherever a beautiful, substantial floor is desired. Several practical colors. Full information and sample FREE of your first and second choice of colors.

Imperial Floor Co., 79-83 Halstead St., Rochester, N. Y.
A Success for 15 Years

LYNCH METALLIZED

WARRANTED FIXED RESISTORS

THE vital importance of a silent, accurate resistor cannot be overestimated. Comprising a concentrated metallized deposit one-thousandth of an inch thick, upon a glass core and sealed forever within the tube, each Lynch Resistor is warranted absolutely noiseless, permanently accurate, dependable! Guaranteed accuracy—10%; in production they average 5%. .25; .5; 1; 2; 3; 4; 5; 6; 7; 8; 9; 10 Meg., 50c. .025; .09; 1 Meg., 75c. Single mounting, 35c; Double, 50c. If your dealer cannot supply you, send stamps, check or money order. We ship postpaid same day order is received.

Dealers—Get on our mailing list; we keep you posted on new developments. Write us today!

ARTHUR H. LYNCH, INC.



4-26-A
250 W. 57th Street
New York, N. Y.

Big Xmas Sellers

Make \$1,000 between now and Xmas! Easy sales. Big list of holiday combination offers. Big season just ahead! Write today for list 18N.

C. I. TOGSTAD CO.
25 S. Clinton St. Chicago, Ill.

200 Sheets and 100 Envelopes \$1.00
Printed in Rich Dark Blue
Your Name and Address Included

TYPE IS CLEAR GOTHIC

Personal Christmas cards 60c per doz. Calling cards 60c per 100. Send cash, money order or stamps. Write or print plainly. Orders for Christmas delivery must be in by the 10th of December.

STANDARD PRESS, 3658 Diversey Ave., Chicago, Ill.

THE WOTEN GASOLINE ENGINE

Air-cooled—Water-cooled. One H. P. in 20 pounds. Handiest little engine ever made. Ideal wherever power is needed. Also the Metalumen Model Airplane Engine, one-half H. P. in 3 1/2 pounds. The market demands them in thousands. Generous agency propositions on request. Complete line of small gasoline and steam engines, battery chargers, etc. Catalogue Free.



DYNAMIC MANUFACTURING CO.
First Nat'l Bank Bldg., Dept. 7, CHICAGO

Gas Blow Torch and Solder Iron Heater



Connects to any gas jet or gas connection. No air attachment necessary. Heats solder iron in less than a minute. For home use, repair shops, electricians, plumbers, laboratories, manufacturing plants, foundries, etc. A wonder for the mechanic's work bench and radio builders. A Blast 8" long, 1" in diameter—Intense Heat. Postpaid \$1.00; Canada \$1.40

Tri-une Company, Dept. 802C, 215 S. 15th Ave., Maywood, Ill.

for Foot Protection

Herman Shoe No. 19 is designed and made especially for men who spend most of each day on their feet.

A good-looking gun-metal calf shoe on the genuine Munson Last, with built-in leather arch support and storm proof rubber welt. Exactly the same shoe that we make for the New York Police Force, built to give long wear and genuine foot protection.

Foot specialists report to the Foot Protection Bureau that they absolutely endorse this famous shoe for absolute comfort, foot support and ease.

Let us send you the name of a nearby dealer who can show you these shoes. Send for illustrated folders.

JOSEPH M. HERMAN SHOE CO.
Dept. 34 MILLIS, MASS.

Established 1879

Makers of the Herman Official Boy Scout Shoes, and of more than 4,000,000 pairs of shoes for the U. S. Government.

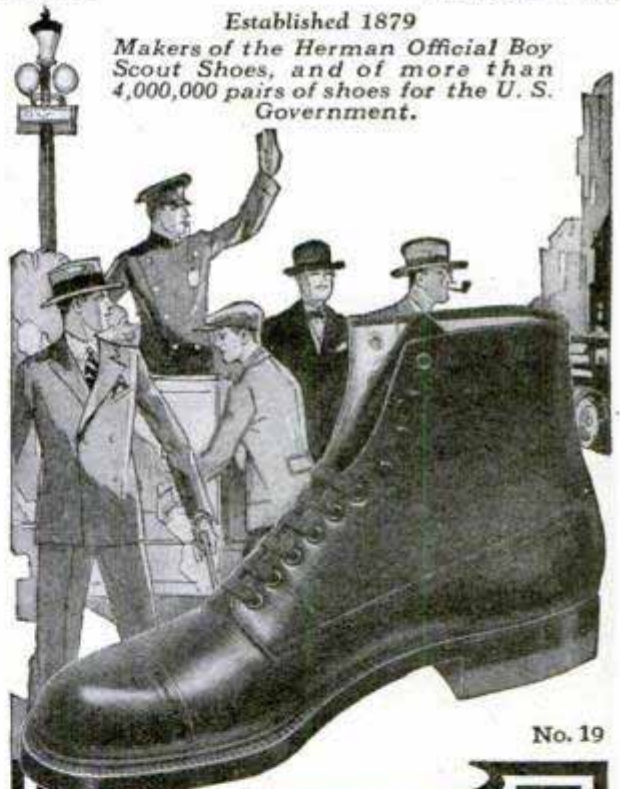

No. 19

HERMAN POLICE SHOE

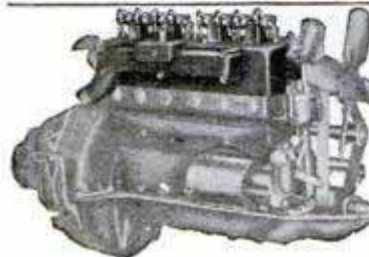

Fords Go 65 Miles an Hour!

with LAUREL Overhead Valve cylinder head. Increases FORD power 50 percent. Saves gas and oil. New model 40-S fits all FORDS including new 1927 model. Equip your car with LAUREL, the original overhead valve system. Beware of imitations. Only \$35 cash, balance easy payments. We specialize in racing heads and complete race cars. Write us.

LAUREL and SINCLAIR RADIO Receivers

Lowest-priced high quality 5 and 6 tube sets on the market. Coast to coast reception. Embody latest radio engineering ideas. Write for literature. Big moneymaking proposition for dealers and agents.

LAUREL MOTORS CORP., Dept. M, Anderson, Ind.

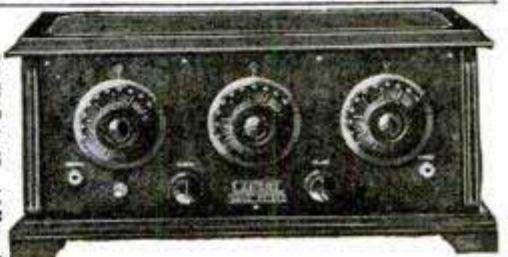

Made in both power drive and hand drive models.

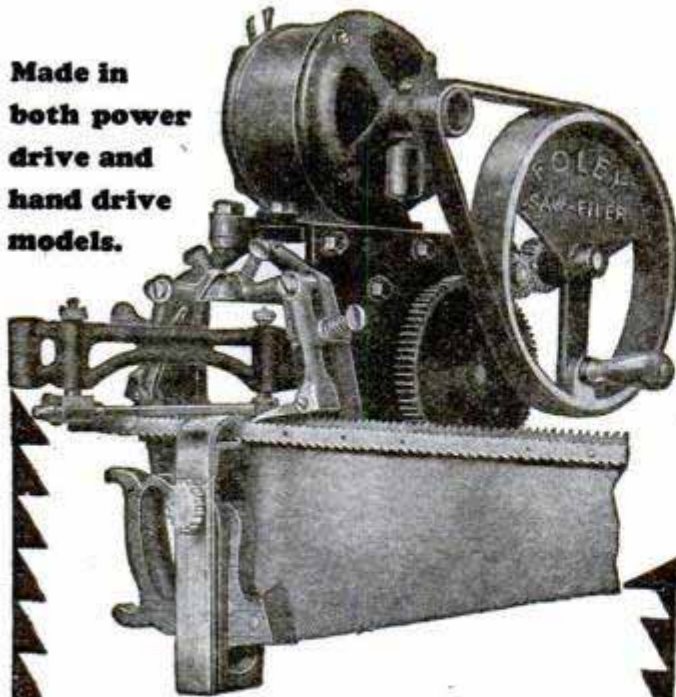

\$15 to \$20 a Day Profit IN YOUR OWN BUSINESS

HERE'S a business that's not overcrowded with competition, a cash business—no credit losses—a business for whose service there is a big, steady, year 'round demand everywhere, a business that requires very little capital to start—a clean, dignified business.

Think of the many people in your community who have saws that need to be filed frequently—carpenters, contractors, butchers, factories, farmers and many homes. You can now file saws *automatically* with machine-precision—with the

FOLEY AUTO MATIC SAW FILER

With it one man can do four to six times as much work as the most expert hand filer, and so accurately that saws will cut better than new. It files hand saws, band saws, back saws and circular saws. It is very easy to operate.

You get 50c or more for filing each saw, and \$1.25 to \$1.50 for retreating saws. You can file 6 to 8 saws in one hour with one machine. The Foley quickly pays for itself and goes on earning profits year after year.

30-Day Money-Back Guarantee

Use the Foley for 30 days in your own shop. If after this fair trial you are not satisfied, your money will be refunded. Send the coupon now for full information.

Foley Saw Tool Company,
210 Foley Bldg.,
914 East Lake St.,
Minneapolis, Minn.

Send me full information on Foley saw filing equipment.

Name.....

Address.....

City..... State.....

Big 3 ft. Telescope

Has unusually powerful lenses—magnifying over 8 times. Makes people and objects miles away seem close. Brings new pleasures to home, farm, camp, travel, sport. See moon and stars as never before. New Ferry "Wonder" telescope has 5 sections—opens out over 3 ft. long, measures 12 inches closed. Big, strong and powerful yet light, compact, easy to carry. Body and draws fully brass bound with knurled edges. Brass covered with black leatherette, draws made of special, smooth finish fibre, easy to slide in and out. Brass safety caps at each end to keep out dust. Powerful lenses are special clear achromatic European optical glass.

Free

YES ABSOLUTELY FREE!
Handsome leatherette covered Carrying Case light, strong, complete with strap. Case is 12 in. long, 2 1/2 in. in diameter. Protects from dust and damage. Handy for farmers, auto tourists and hikers.

3 ft. long open
12 in. long closed
— FIVE SECTIONS —
8-power Lenses
— Read These Letters Thousands of Delighted Users

"I am delighted with the 'Wonder' telescope. Today I have been watching submarines 3 miles off the coast."
—Philip Brush
"I can see across the Mississippi 3 miles and see people fishing."
—M. L. Thorn.
"I am nearly 80 years old and if I could not get another would not take \$10 00 for it."
—A. R. Walker
"I can tell time on the church clock 5 miles away."
—Edward Foster
"Could tell color of aeroplane 4 miles away."
—Mrs. L. M. Yarbrough
"I saw a Light House 18 miles away."
—Clyde Scribner.
"Can see men working 7 miles away."
—S. M. Gearhart.
"I could see windmill more than 4 miles away."
—Raymond Cosanova.

Send No Money

Sign and mail coupon below and Ferry Wonder 3 ft. Telescope with free Carrying Case will come by return mail. Pay postman special bargain price of \$1.85 plus few cents postage. Satisfaction guaranteed or your money back. Send coupon today!
FERRY & CO., Chicago, Ill.

**Ferry & Co., Dept. 5779
3224 N. Halsted St.,
Chicago, Ill.**

Send me 3 ft. Ferry Wonder Telescope and Free Carrying Case. I will pay postman \$1.85 plus postage on arrival. If I am not satisfied you will refund my money.

Name _____

Address _____

City _____ State _____

Catalog of Things You Want Sent Free



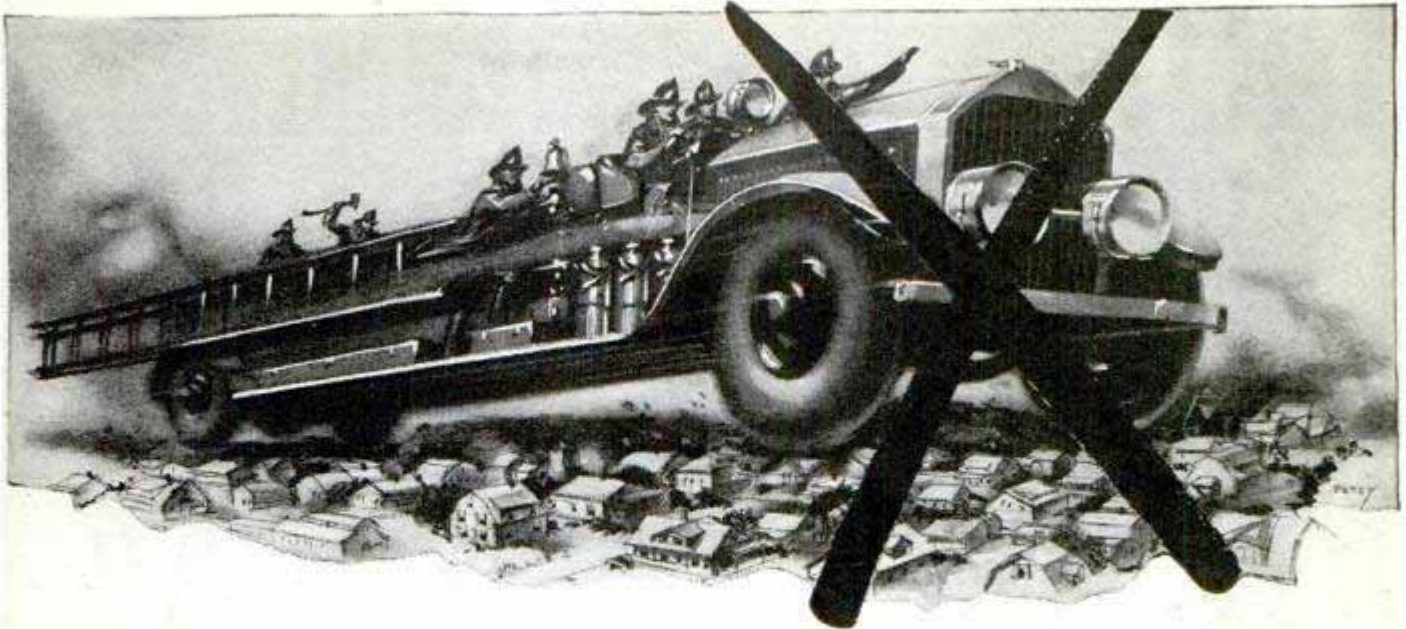

VOLUNTEERS WANTED at \$360 a Month

AMERICA'S new way to fight fire will pay you at least \$12 a day. All you need to earn \$360 a month to \$6000 a year is the ability to follow our instructions.



L. D. Payne
Iowa
\$5,000 to \$10,000 a year.

Payne took our plan and averaged \$20.77 a day, his first 217 days—\$4,500! De Pries, who never made more than \$85 a month before, has made \$7,000 in one year.

A \$550,000,000 Loss

Fire takes a toll of 1,700 lives every year, and \$550,000,000 in property. No building is safe from this constant menace. Only a few have insurance. No one wants to see the savings of a lifetime wiped out. No business can afford the loss of time, trade and reputation which fire causes. Fire protection is a vital need.

No wonder Fyr-Fyter representatives sell over \$2,000,000 worth of Fyr-Fyters yearly! No wonder they are one of the highest paid selling organizations in the country! No wonder T. S. Gill writes: "I am firmly convinced that any man joining the Fyr-Fyter force and working eight hours a day will soon show earnings of \$5,000 a year!"



Frank De Pries
Ohio
\$100 to \$200 every week.

Fyr-Fyter is the most perfect fire prevention device ever invented. It shoots hundreds of quarts of vapor from one quart of liquid. This wonderful new chemical is absolutely harmless to rugs, clothes, furniture and human beings, but it snuffs out fire like a blanket. It amazes everyone who sees it. Fyr-Fyters are approved by the Underwriters' Laboratories. There is a size for every need.

You can sell one every hour, easily. Greene made 47 calls and sold 35. Thousands of factories, homes, stores, farms, hotels, garages, etc., in your territory need Fyr-Fyters. Just a few sales a day will pay you \$300 a month or more.



Louis George
Illinois
Another man in the \$10,000 class.

Every fire alarm speeds up your sales. Every new building means easy, extra profits. Farms are one of the richest fields. Homes alone, can pay you \$4,000 a year. Autos, trucks, and garages are another source of income. Factories, institutions often buy in large quantities.

One city block is capable of sales running into thousands of dollars. Viles made a \$1,700 sale. Brady took a \$4,200 order. Baker, Oregon, 68 years old, who can only work occasionally, often makes \$25 to \$30 a day. We train you quickly at home. Simply write orders. We deliver and collect.

Send For This Free Plan

This new way to fight fire can mean a fortune to you in a few years. \$10,000 a year is possible. Do you want it? Do you want a home of your own, a fine car, a bank account, independence . . . a permanent, growing business of your own . . . and a wonderful future? Is this opportunity worth a 2 cent stamp? Will you let us send you the full Fyr-Fyter plan, free and without obligation? Then mail the coupon below.



N. C. Viles
Wis.
Another \$10,000 man.

FYR-FYTER CO.

Device Approved by the Underwriters' Laboratories

1385 Fyr-Fyter Bldg. DAYTON, OHIO

GARAGE MEN AND MECHANICS MAKE \$3 TO \$12 A DAY EXTRA!

A brand new Fyr-Fyter at an amazing new low price provides ideal fire protection for autos and trucks. Only a few dollars—they sell fast. Sell one to every motorist you meet—every car you work on—every auto in your garage! Make \$3 to \$12 a day just in odd moments!

Simply take orders. We deliver and collect. Mail coupon at once, for full plan, free and without obligation.

FYR-FYTER CO.,
1385 Fyr-Fyter Bldg., Dayton, Ohio.

Without obligation send me your free book "Building a Permanent Income as a Fyr-Fyter Representative."

Name.....

Address.....

City..... State.....

The Biggest Little Tools Made!



12" or 18"
between
centers;
6" swing;
speed range
180 to 1750
R. P. M.

The *Baby Grand* Lathe

—with plain head as shown or with back-geared head. A practical, precision lathe for skilled mechanic or amateur. Arranged for wood turning, metal turning, or both. Not a toy!



Baby Grand Grinder

6" high; wheels 4" dia.; $\frac{1}{2}$ " face. Will keep those edge tools in perfect cutting condition. Unusual value and serviceability combined with low price make this the biggest little grinder made.

Practical
Tools for Prac-
tical Men

Baby Grand Drill

Capacity 0" to $\frac{3}{8}$ " drills. Wide speed range, versatility, handiness, plus a maximum of drilling efficiency make the Baby Grand supreme in its class. Comes complete with chuck as shown.



Write today for prices and complete information on the full line of Baby Grand Tools
The Watson Mfg. Co., Building 112 Watson Toledo, Ohio

Shoot the Best Gun

The NEW BENJAMIN is the finest air rifle ever made. Unlike all others. Has amazing accuracy—shoots hard and far. It's the original American genuine AIR operated rifle. One to six pump strokes compress air to any desired degree of power. Same force as in air drills and air hammers except you control the shooting force. Never loses force—no springs or levers to get out of order. Makes crack shots quickly, inexpensively. Gives years of delightful recreation with utmost safety. At your dealer's, or sent postpaid for \$5.00.

Shoot 5 Days FREE

We give you five days, ammunition supplied, to test the NEW BENJAMIN. If in this time you don't believe it to be the finest air rifle you've ever seen or used, and if you don't believe it is the one and only air rifle for you, return it, postpaid, and your money will be refunded at once.

The NEW BENJAMIN AIR RIFLE

America's Original Air Rifle

\$5 at your dealer's or sent postpaid direct from factory on FREE Trial as above if dealer does not handle it—write for our wonderful offer.

Get This Book and Details FREE

BENJAMIN AIR RIFLE & MFG. CO.
645 N. Broadway, St. Louis, Mo.

Please send your amazing offer and free copy of "The Shooter's Art," telling how to become a crack shot, how to hold, aim, and handle guns and guide others in use of guns.

Name _____

Address _____

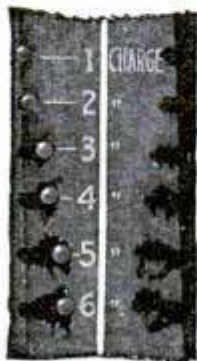
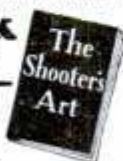

Build and Sell SHIP MODELS



Make \$25.00 to \$35.00 profit on every one you sell. Big demand everywhere. We furnish hull block 20 in. long of Hendrick Hudson's famous "Half Moon" cut and shaped accurately to scale, with complete patterns of all rigging and parts and full simple instructions. Only \$3.00 cash with order pay balance of \$9.50 on delivery. Money back guaranteed.

Write quick for photos.

BOON SHIP MODEL WORKS, 1005 Union Tr. Bldg., Cincinnati, O.

CARD CASE FREE



Beautiful Leatherette Case given free with each order for 100 printed high grade business or calling cards. Any number of lines printed. Satisfaction guaranteed. \$1.00 postpaid. Order now or write for free samples. Premier Stationery Co., 10 N. Bethel St., Baltimore, Md

Master-Lite Pocket Lighter



Winner for Agents
No Wind Can Blow it Out!

Guaranteed for life. Sells on a flash demonstration to consumers & dealers at big profits. Everlasting repeat business. 50c in stamps brings convincing sample with sure fire selling plans. For triple gold plated Master-Lite send \$1.00 for sample. MASTERLITE MFG. CO., Dept. 1612 110 East 23rd St., New York



Auto Owners Wanted

To Introduce and Use HYDRO Insured TIRES. Hydro Agents make money selling the only Tires in the World Insured for One Year against all road hazards regardless of mileage. HYDRO TIRES sell fast because they have no competition in price; no rival in quality; no imitation in appearance and no equal in the insured protection to the user. Insurance Policy with every tire. Are made by the only tire factory in America selling its own product through authorized Salesmen-Agents. We offer opportunity of lifetime to establish profitable tire business of your own. No capital required. Sales kit and advertising helps furnished. Exclusive territory granted. Write today for catalog and complete information about the Hydro Agency Plan.

HYDRO
Insured TIRES

The Most Beautiful Tire in America

HYDRO-UNITED TIRE CORPORATION, Address Dept. PM 10, POTTSTOWN, PA.

Own this TYPEWRITER!

GENUINE UNDERWOOD TYPEWRITER

ONLY \$3.00 DOWN AND it's yours

UNDERWOOD

Now is the time to get your typewriter! Be up-to-date—know the pleasure and convenience of having one in your own home. You'll be amazed at the uses everyone in your household will find for this real Underwood typewriter.

Every One Can Use a Typewriter

Every member of the family will use and enjoy it! Act now and get this ace of writing machines! Don't send a cent—but do get our big special offer—our valuable book on typewriters and typewriting—*free*. You can learn to write on this standard-keyboard machine in one day. A week after the expressman has brought it, you'd feel *lost* without it. A trial will *prove* it—and doesn't cost you a penny!

Send No Money Now

We don't want a penny now. Nor any money at all unless this proves the typewriter bargain of your life. The trial is *FREE*. If you buy, our easy terms make it a pleasure to pay. There's no excuse now, for not

owning a typewriter—and the finest make! We include all tools, cover, etc., all complete, all ready to write. Write us now. Deal direct; we are the largest factory of the kind.

If you know typewriters, you know the perfect work and the ease and speed of an Underwood. If you have never owned a typewriter, start with the finest! You can try this one at our risk. But, the time to act is *NOW*. Don't miss out on this present bargain offer. Don't do longer without the convenience of a typewriter.

Free Trial Offer

Our plan gives you the opportunity of a *thorough trial* before you buy. You run no risk whatever. You start to pay for your typewriter *after* you have found it the only machine for you! But get the facts before this lot of machines is all in use. Clip the information coupon before you turn the page. It will pay you! Note the very useful book you will receive *free*! Write for full particulars at once.

EASY TERMS FREE!

Pay Like Rent

You pay only \$3 down you get the machine. The balance is divided into such small monthly payments that you will never miss them. We have made it very easy for you to own a typewriter now.

FREE! Get our typewriter book free: Lowest prices and terms. We also give free with each machine a typewriter manual giving valuable instruction for learning rapid typing, useful pointers for all who use a typewriter, business forms, social correspondence, work for others, etc. Also all tools *FREE*. Clip coupon *NOW*.

Mail to SHIPMAN-WARD MFG. CO.
2129 Shipman Building, Chicago

Please send me full offer, with Typewriting Manual *FREE*, prices, terms, etc., and full information about your *FREE* course in touch Typewriting. All without obligation; this is *NOT* an order!

Name _____

St. or R. F. D. _____

P. O. _____ State _____

A·B & C Radio Power from your light socket

SILITE TRICKLE CHARGER

.6 ampere charging rate.
Absolutely noiseless—no
bulbs—makes a power unit
of your battery.

\$10.00

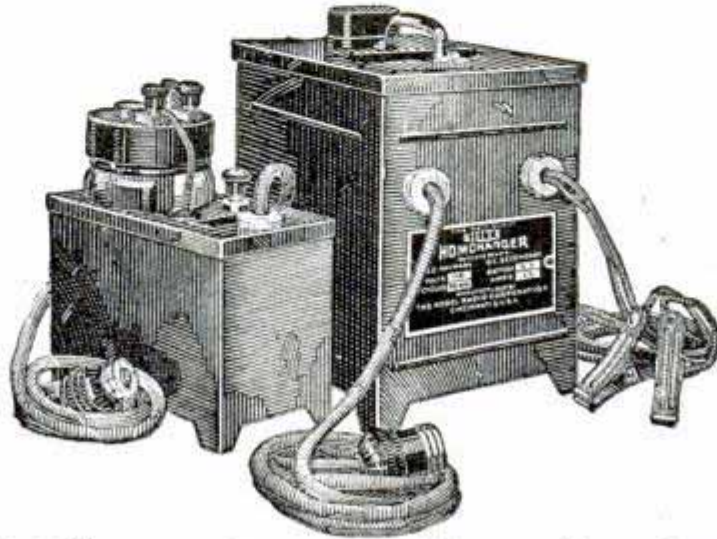

SILITE HOMCHARGER

Charges at 2½-3 ampere.
Absolutely noiseless—no
bulbs—can be used while
set is operated.

\$19.50

Your battery troubles are over at last! Now ALL radio power is in your light socket, for ALL circuits, A, B, and C.

Silite, the marvelous new metallic glass rectifying element, provides perfect rectification of light socket current into "A" battery power. Leave the Silite Trickle Charger permanently connected to your storage

battery and on charge—then forget battery charging forever. Silite Trickle makes a power unit of your battery—insures constant, never-falling "A" current that operates your set at highest efficiency. For very large sets, where a higher charging rate is necessary, Silite Homcharger is recommended. Either Model may be used while the set is operated.

Kodel A & B Transifiers

Kodel A and B Transifiers actually supply all A, B, and C current direct from the light socket—no batteries of any kind are needed. Just plug the Transifiers into the wall socket and turn on your receiver—smooth, uniform A, B, and C power operates your set as it has never operated before. Watch the new life, new pep it gives your set—the longer range, the much greater volume. Transifiers give quiet, noiseless reception that was never

before possible, even with fresh, new batteries.

Vastly different from and superior to the ordinary power units, Transifiers consume electric current only while you operate the set—maintenance cost is much less—it costs less than one-half cent for every hour the set is operated, for all A, B, and C power.

Ask any radio dealer to show you the Silite Chargers and Kodel Transifiers.



- MODEL 10 "A" TRANSIFIER—Supplies 2, 4, or 6-volt "A" current direct from the light socket. For sets using up to 10 tubes \$42.50
 MODEL 10 "B" TRANSIFIER—22½ to 150 volts "B" current; 4 to 10 volts "C" current for any size set. Operates power tubes \$42.50
 MODEL 61 "B" TRANSIFIER—22½ to 90 volts noiseless "B" power for sets up to 6 tubes \$28.50
 (Bulbs extra)

["Behind the Scenes in a Broadcasting Station" an interesting 24-page booklet, will be mailed free on request, together with literature describing Silite Chargers and Kodel Transifiers.]

THE KODEL RADIO CORPORATION

517 E. Pearl St. • Cincinnati, O.

Owners and Operators of Broadcasting Station WKRC



*Battery Chargers
Power Units*

KODEL

*Radio Receivers
Loud Speakers*

POWER SPECIALISTS SINCE 1912

21 Jewel
Santa Fe Special
on credit

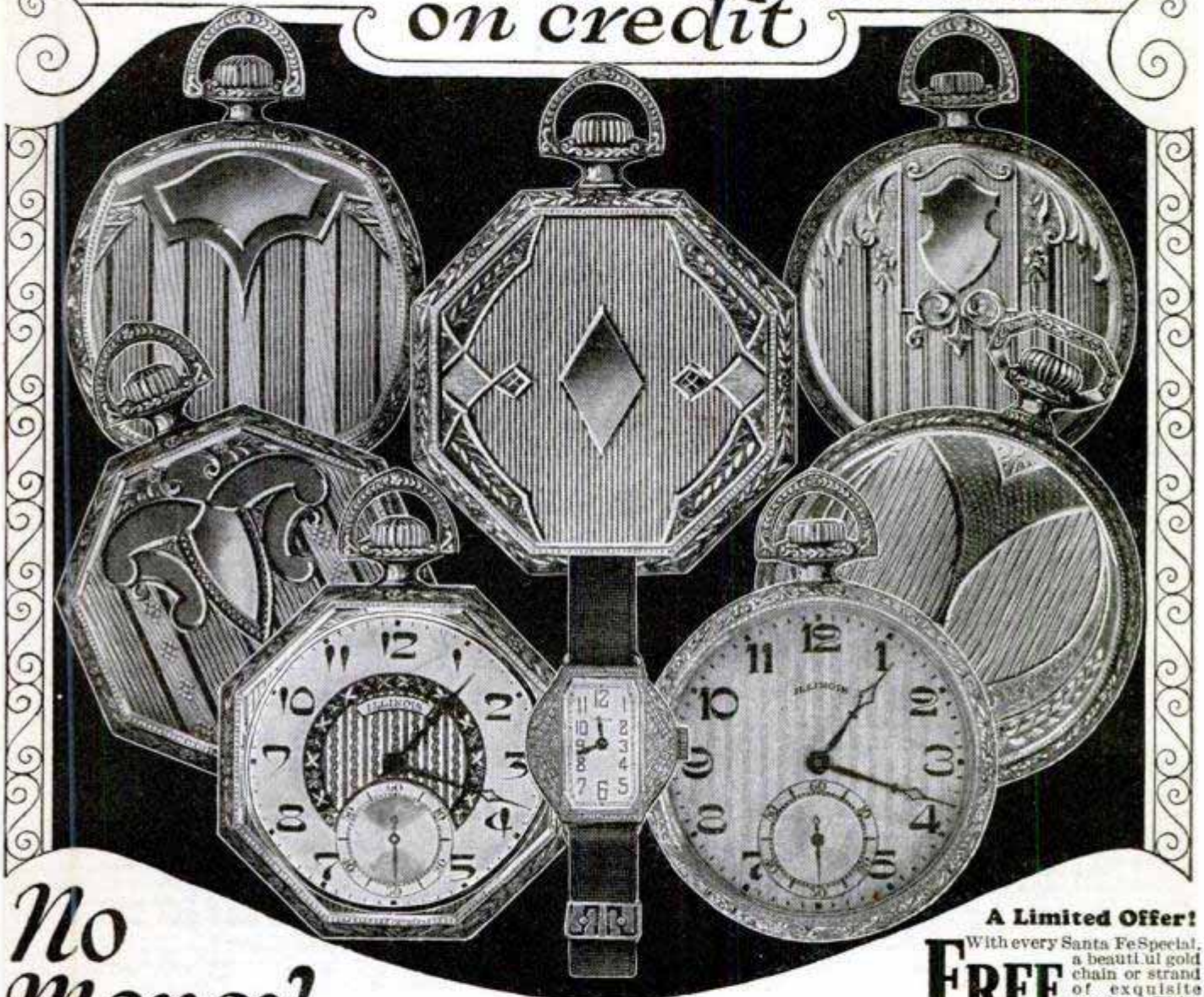

**No
 Money
 Down**

WE will send this famous watch direct to you, express prepaid, on **FREE** Approval. Examine watch and be convinced it's the best watch buy you ever saw. You save $\frac{1}{3}$ to $\frac{1}{2}$ your money by purchasing a Santa Fe Special Watch. We trust you—wear watch while paying for it.

A Limited Offer!
 With every Santa Fe Special, a beautiful gold chain or strand of exquisite pearls. Write while offer lasts.
FREE

Mail Coupon for FREE Watch Book →

Clip the coupon, fill out and receive the **FREE WATCH BOOK**. All the newest watch case designs in white or green gold, fancy shapes and thin models, are shown. Read our easy payment offer. Select the watch you would like to see; we will send it to you on approval, express prepaid. Wear the watch 30 days **FREE**. Return at our expense if not fully satisfied.

SANTA FE WATCH COMPANY

Dept. C 6 Thomas Building Topeka, Kansas
The Home of the Great Santa Fe Railway

SANTA FE WATCH CO.

Dept. C 6, Thomas Building
 Topeka, Kansas

Please send prepaid and without obligation your Watch Book Free, explaining your "No Money Down" Offer on the Santa Fe Special Watch.

Name.....

Address.....

WRITE FOR THIS

LADIES SOLID GOLD
DIAMOND RING

Diamond
Sapphire
Bracelet

\$15.00



Genuine blue white diamond onyx ring. Perfect cut. 14K. white or green gold, richly carved and hand pierced. **Special \$4.95**



When you buy from K. Burns & Son you buy direct from the importer and cutter saving yourself 3 profits.

Ladies' Diamond Ring



Fine full cut blue white diamond of rare brilliancy set in 14K. white gold ring, beautifully carved and pierced. **\$9.50**

Diamond Mounted Bar Pin, \$6.50

14K. pure solid white gold. Artistic Lace work design. Greatest value ever offered.



Blue White Diamond Love Bird Engagement Ring

Large perfect diamond of rare brilliancy, 18K. white gold Platinum Top Love Bird mounting. We will send this ring to you with the privilege of examination. **\$48.00**



14K. Solid Gold Ladies' Wrist Watch

Jewel adjusted. Guaranteed dependable timekeeper. Platinum finished dial. Beautifully engraved design blue sapphire crown. **\$11.50**

Diamond & Sapphire Flexible Bracelet

Handsomely pierced lacework design. 14K. solid white gold, platinum faced. Two oblong shape synthetic blue sapphires and a full cut genuine blue white diamond. **\$15.00**

Write today for our Free Catalog

K. BURNS & SON Est. 1889
641 BROAD ST., NEWARK, N. J.

PLAY THIS HAUNTING "JAZZITHA" The one string Hawaiian Guitar



Have you seen the latest Jazz instrument? Everybody is talking about the curious, unusual "Jazzitha." If you hear it you will want to own one.

The simplest instrument in the world to play. Absolutely no instructions or lessons necessary. Music is written in numbers. The numbers on finger board correspond with Music numerals. "Boy"—what Music! In ten minutes you'll have everybody stepping. If you want your friends to sit up and take notice get yourself a "Jazzitha." Take it wherever you go. You're sure to have the time of your life. Be original—be the first one in your "crowd" to introduce this weird Jazzitha. Play all the latest song hits. Makes an ideal gift. The Jazzitha is made of fine grained hard wood with specially designed metal sound box. Handsomely decorated and beautifully finished in lacquer—19 inches in length—comes with bar and pick.

\$1.47

Send No Money

Just your name and address when Jazzitha and sheet music arrive, pay postman only \$1.47—plus a few cents extra for postage. Outside of U.S. send check or money order in advance.

FREE—with every instrument we will include 3 extra Jazzitha strings worth 25c.

JUST OUT 5 Books of popular song hits—5 latest songs in each book written in numbers - - - - 25 each

THE JAZZ STUDIOS

2512 41st Ave., Dept. 536, LONG ISLAND CITY, N.Y.



9 CORDS IN 10 HOURS



The farmers best helper for 46 years. Thousands save money and backaches every year. **YOU CAN TOO.** Send for free catalog showing low prices. Address Dept. 115, **FOLDING SAWING MACHINE CO., 2633 S. State St., CHICAGO, ILL.**

NEW VEST POCKET ADDING MACHINE

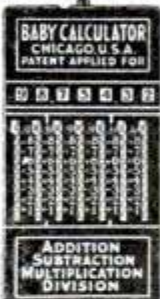

ADDS, SUBTRACTS, MULTIPLIES, DIVIDES
Does work of \$300 machine. Guaranteed 5 years. NOT A TOY.
Made of steel and indestructible. Million dollar capacity. Fits in pocket. Will not make mistakes. So simple child can operate it. Everybody should carry one for figuring.

FREE TRIAL \$2.50 Total Cost

SEND NO MONEY—Just name and address. We will ship Calculator immediately. On delivery pay postman \$2.50 (Plus few cents Postage). (If outside U. S. send cash). If not satisfied after 10 day trial you get your money back. **THOUSANDS OF SATISFIED USERS.**
This is lowest priced practical calculator made. "Why pay more for inferior imitations?" Order from this ad.

Mail Coupon Today—

BABY CALCULATOR SALES COMPANY
Dept. 41, P. O. Box 1118, CHICAGO, ILL., U. S. A.

- I am enclosing \$2.50—send adding machine prepaid.
- Send Adding Machine C. O. D. \$2.50 plus postage.

Name.....
Address.....
City..... State.....

AGENTS Write for big commission and territory proposition.

Boils 50 Gallons In Less Than Hour

No Other Compares With This **Improved Oil Burner**

Use Ordinary Kerosene or Coal Oil **[Burns Outdoors as Well as Indoors]**

THE most remarkable Kerosene Burner ever built. Boils down apple cider, maple syrup, molasses, etc., in half the ordinary time. Ideal burner for dairies, butchers, indispensable on the farm. **PRODUCES TERRIFIC HEAT WITH SILENT BLUE FLAME**

NO NOISE SMELL SMOKE SOOT



So efficient it produces twice the amount of heat of City gas at half the cost. So simple anyone can install and operate. Double generator assures continuous operation without shut-downs. Nothing to wear out, starts in a jiffy, will last a life time. Every burner guaranteed fully. Write for special introductory price. Free descriptive catalog.

HOME MANUFACTURING CO.
Dept. B-23, 18 E. Kinzie Street, CHICAGO



One Dial LONG DISTANCE 5 TUBE RADIO

\$25.00

EVERYBODY, including experienced radio engineers, said—it cannot be done. But we did it—produced a high grade, long distance single dial control radio to operate a loud speaker to retail for \$25.00—and yet allow liberal discount to agents.

This marvelous instrument is the result of five years' hard work by an organization of trained radio engineers. It is no experiment—thousands are in use—the results speak for themselves.

There Will Be a Radio in Every Home

Thousands have been waiting for just such a radio—a real long distance, powerful instrument—but at a price they can afford.

It is here, and live, wide-awake salesmen will recognize their opportunity immediately—they won't lose a single minute writing for full information.

Just as there are 100 Fords to one high-priced car, just so will there be 100 Vikings to every \$75.00 and \$100.00 radio—think what this means to men who get in on the ground floor right now.

A \$25 Radio Which Will Equal a \$75 Radio

Put a Model 599 Viking, which retails for \$25.00, alongside any radio retailing for \$75.00 and even more. Compare them for ease of tuning—only one dial to

tune on the Viking—distance received, volume and tone. The results will make any man say, "I'll save that \$50.00."

Radio is today the biggest and quickest selling line—thousands are being sold—salesmen have made unheard-of profits. But here is a far greater, a far more interesting radio proposition than anyone ever dreamed of.

Agents Wanted Make \$100.00 a Week

You Should Make \$100.00 a Week Easily

You can't help it—many will make more. Some will control a county—others will control many counties. We have the liveliest radio selling plan of today—instruments of all prices—a radio price to fit every pocket book.

Any man who will follow our teaching cannot help but add big money to his present income and start to do it immediately. If you want more money here is your chance, but you'll have to act quick—others will jump at this chance.

Sell Radio in Your Spare Time—Evenings

You don't even have to give up your present position. The only time radio can be sold is in the evening—by demonstration. So here is a chance to add to your present income. During the past five years we have trained 4364 men in this very profitable business.

You'll be the first one with a real low priced long distance radio—your price will startle everybody—the results will be even far more startling. Once you demonstrate you're sure of a sale. No one can think of investing \$75.00 to \$100.00 in a radio when this instrument will equal the results and your retail price is only \$25.00. Just think of the advantage you have. Sell a radio for only \$25.00, and yet make a handsome commission.

Territory is Going Fast— Better Write Today

Someone is going to get the big profit on the sale of these instruments in your community—is that someone going to be you? Write today for our 100 page book which fully de-

scribes not only this wonderful instrument but also a full line of radio at all prices. It's FREE for the asking.

Use This Coupon

H. A. Fischer,
118 W. Austin Ave., C
Chicago, Illinois.

I am interested in selling your 5 tube set in this territory. Please send me your 100 page radio book, FREE.

Name.....
Address.....City.....
County.....State.....

SEND FOR 100 PAGE FREE BOOK

FROST-FONES

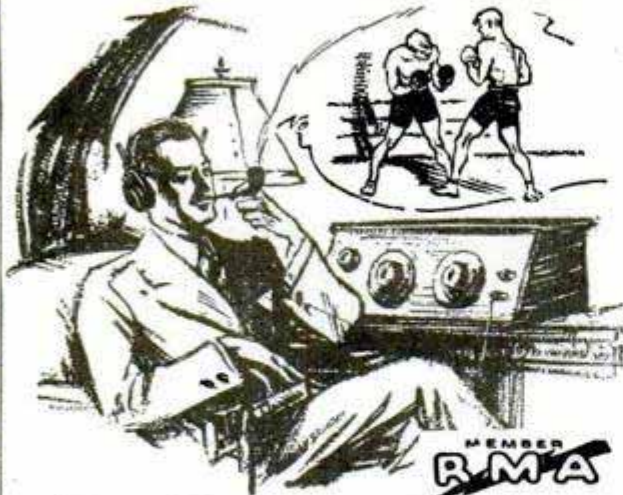

For Clearness, Quality and Distance

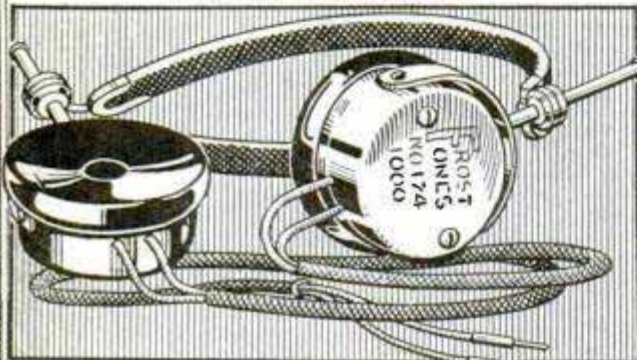

When there is something on the air that especially interests you and you do not want to miss a word, use a pair of **FROST-FONES**. You will get a quality of reception that you cannot get any other way—a clear, pure, natural and undistorted tone. Compare **FROST-FONES** with other makes, at your dealer's, and be convinced.

Prices, \$3.00 to \$6.00

FROST-RADIO Super-Variable Resistance Units

These new high resistance units give a continuous graduation of resistance, smoothly, without steps or jumps. They are non-inductive, noiseless and wear-proof in operation. Even after long continued use there is no variation in resistance. Type 880 has two terminals and Type 890 three terminals, each supplied in a number of resistances. See them at your dealer's. Both types - - - \$1.25



Type 880

FROST-RADIO PAN-TAB JACKS

The Pan-Tab represents the finest in material and workmanship ever put into a radio jack. Springs are heavier and the contacts more positive. Frame is nickel plated brass, hand buffed to a high finish. Prices 65c to 90c at your dealer's.



HERBERT H. FROST, Inc.

160 North La Salle Street

New York CHICAGO Los Angeles

FREE!

This 84 PAGE RADIO BOOK

SAVE 1/3 to 1/2



The World's Largest Exclusive Radio Mail Order House

will send you—**FREE**—this wonder catalog of radio bargains containing over 2000 items of everything in **RADIO**, including all the latest **Sets, Kits, and Parts**, at rockbottom prices that **Save you 1/3 to 1/2**

5-TUBE SETS AS LOW AS \$24.90

LATEST 1927 MODELS
Table and Console models with built-in loud speakers. Beautiful, genuine mahogany and walnut cabinets. 5-6-7- and 8-tube sets at amazingly low prices.

SEND FOR BOOK TODAY

We cannot begin to tell all about this wonderful Radio Book. Simply send letter or postal, and this **wonder radio catalog** containing over 2000 radio bargains will come to you **absolutely free**. Write Today.

RANDOLPH RADIO CORP.
180 N. Union Ave., Dept. 183, Chicago, Ill.

RADIO FREE

New catalog of 5 and 7 Tube Sets and Kits
The new and improved Hetro Magnetic Receiver
—send for trial offer and proofs. \$35.00 UP

MERCURY ELECTRIC CORP., 2030 GRAND AVE., N.Y.C., N.Y.



WEAR IT AS A RING—USE IT AS A RADIO!

Just think of it! You can get music from your finger tips with the **ROSS RADIO RING**. Brings in local stations clearly. Over one million buyers last year at one dollar. Money back guarantee. See for big catalog.

AMERICAN BAZAAR Inc., Dept. P12, 840 Broadway, New York City

50c

SOLDERALL

METAL IN PASTE FORM



The Only Convenient metal solder

Every Electrical Connection needs Solderall for perfect reception

The SOLDERALL CO., NEWARK, N.J.

25c



THIS 68 PAGE RADIO CATALOG

FREE

Contains 75 Radio "Hook" Files, 200 Illustrations, 650 articles, 8 page Log Book of all U.S. Broadcast Stations.

"Build your own with 'RASCAL' Parts"
RADIO SPECIALTY CO., 98 E. Park Place, New York, N.Y.

**A Christmas Gift
that will last forever...**
Unconditionally Guaranteed

First Cost is Last Cost!
These Handsome Pens,
positively the equal of any at
\$8.50, are sold by
Mail Only—from
Maker to YOU—at

\$
Only 2.50

Never will you be charged for any repairs, regardless if the Newark Pen is broken through accident or misuse. Never another cent of cost.

Will Last a Lifetime

The nib is made of 14-kt. gold, tipped with the best grade of hard iridium which can't wear out. Nothing can affect the super-smooth writing point. Glides over the roughest paper—yet can make 4 carbon copies. Truly a manifold pen!

Has a hand-turned barrel, cardinal red or flashing black, artistically chased. Heavy 14-kt. gold filled mountings. A pure gum sack of large ink capacity. Never-clogging; never-leaking. In every sense the equal of any \$8.50 pen at a price which is **less than a store-keeper's profit on such a pen.** Made by experts with 25 years experience and sold **ONLY** by mail—from Maker to You.

FREE Premium—Get Pen for Nothing

Send no money. Just mail the coupon below. You will receive a Newark Pen and 5 premium cards, each worth 50c on the purchase of another pen. You can give them away if you wish. But you can easily dispose of these cards at 50c each. **YOUR PEN WILL THEN COST YOU NOTHING.**

Your choice of men's or women's models. They make ideal and useful gifts that compliment both the giver and the recipient. Show it to friends—write with it for 5 days—you'll be surprised and delighted, or we'll refund your money.

SEND NO MONEY

Mail This Coupon

5 Days Free Trial

NEWARK PEN CO., 276 N. J. R. R. Ave., NEWARK, N. J.

Please send me via Parcel Post collect, a Newark Pen and five premium cards which I may dispose of at 50c each. I will pay the postman \$2.50 plus postage, and if I am not satisfied after five days use, you guarantee to refund my money.

X indicates my choice:

Men's.... Women's.... Red.... Black.... Medium Nib.... Fine Nib.... Coarse Nib....

Name.....

Address.....

Town..... State..... P. M. 12



PEN ACTUAL SIZE



PEN ACTUAL SIZE

"Birds-eye" view of the new two-dial hook-up of the Daven Bass Note Circuit. The last word in tone quality.

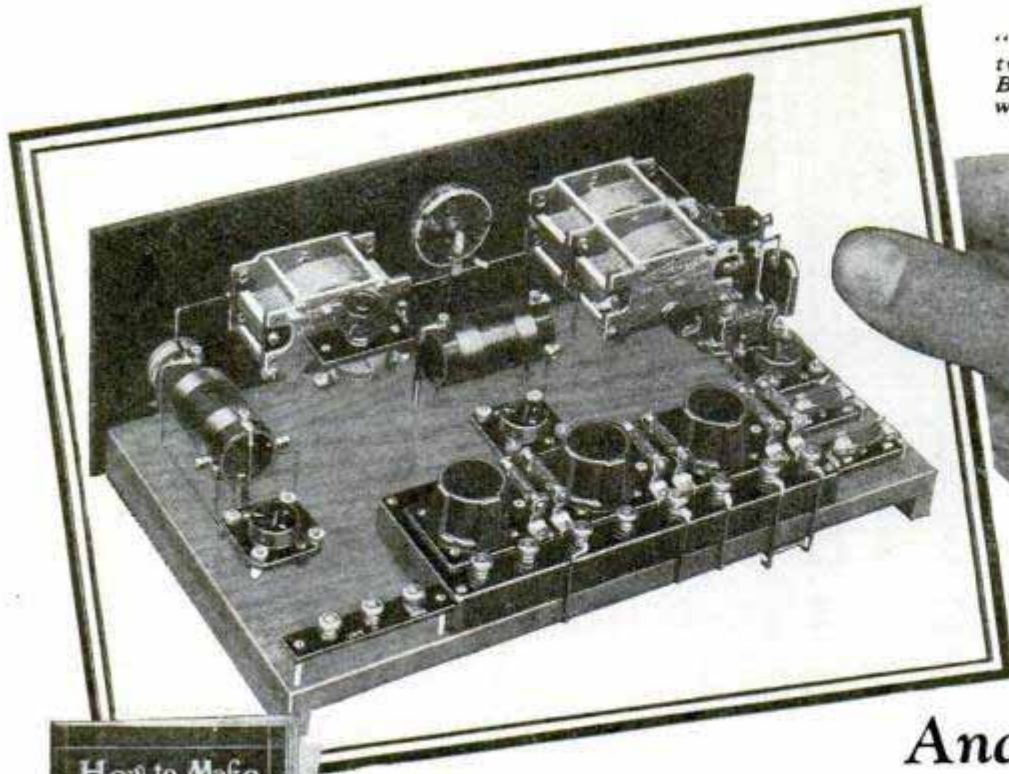

And Now—

the Bass Note Circuit in a 2-dial hook-up

CLEARER than ever—even more selective—and always that crystal purity of tone—from highest soprano down to deepest, richest bass. The same astonishing Daven Bass Note Circuit—with new refinements added.

For instance, two tuning dials only—instead of the usually accepted three. A Radio Frequency choke coil that prevents the radio waves from entering the audio amplifier. A special compensating condenser that increases selectivity, especially in long-distance tuning. And a brand new layout, requiring less base space and a smaller, neater panel.

READ "HOW TO BUILD THE BASS NOTE CIRCUIT"

A brand new booklet that tells you in the simplest, clearest way how to make yourself a Daven Bass Note Receiver. And a wiring diagram of an altogether new type—a boy can follow it clearly—shows you quickly how to assemble the parts. 25c at any Daven Dealer's—or 30c by mail. And it's worth ten times as much in the new kind of radio reception it will help you obtain. Get your copy NOW—while the edition is plentiful—later on, you might have to wait for another printing.

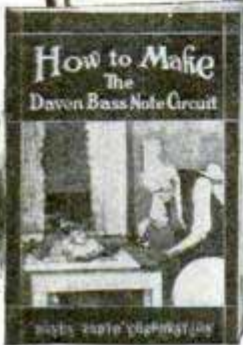

25c at Daven dealers,
30c by mail



DAVEN GLASTOR

the new Transparent Resistor. Enduring, noiseless, changeless. Complete range of resistances.



DAVEN HI-DUTY GLASTOR

Specially designed for B-Eliminators. Will carry highest currents known to radio.

DAVEN

BASS NOTE CIRCUIT

for COMPLETE Radio Reception



NEW 8th EDITION DAVEN MANUAL

This valuable Book explains Daven Amplification in full detail, and shows how to apply it to your set. 25c at dealers', 30c by mail.

Complete Daven Catalog Free on Request.

"The Sine of Merit"

DAVEN RADIO CORPORATION

TRADE MARK "Resistor Specialists" REGISTERED

162 SUMMIT ST.

NEWARK, N. J.

CORONA

for
CHRISTMAS

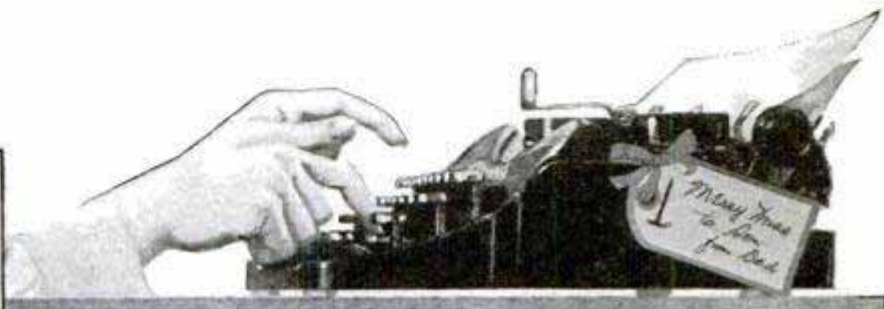

No other portable typewriter has all these modern features

Standard four-row keyboard — the same as all office typewriters — no shifting for figures.

Visible writing — you can see what you are writing without raising your head an inch.

Full width carriage — takes a No. 10 envelope — just like any office typewriter.

Self-spacing carriage return — right out where you want it for quick action.

Adjustable paper guide — you can insert each sheet in exactly the same place, so that the margins always remain uniform.

Flaten knobs — on both ends of carriage.

Automatic ribbon reverse — and twelve-yard, two color ribbon.

Variable line-spacer — no other portable has one.

Stencilling device — Corona is noted for its clean stencil cutting.

Shift key — on both sides of keyboard.

Type-bar action — exactly the same principle as that employed on all the best office machines.

Double carriage release — you can release with either hand.

Both back spacer and margin release — on the keyboard.

Models and Prices

The price of this standard keyboard Corona is \$60 with case. Other models at \$50 and \$55. Special keyboards available for all foreign languages and technical writing. Dealers will accept used typewriters as part payment.

THE BOY who grows up without a Corona is missing something out of life. Give your boy a Corona this Christmas — see how quickly he learns to express himself clearly, concisely, on paper.

Coronatyping helps him to think; it quickens his imagination; it stimulates his interest in writing; and especially, if he is away at school, it inspires more letters back home. Try it and see!

And make sure that you get Corona. The latest model is like the standard office typewriters in everything but price and weight. It is the most popular "personal" typewriter in the world. It has over 700,000 owners, more than all other makes of portables combined.

Look for "Corona" in your phone book; you'll find there a dealer who will gladly bring this latest model Corona right to your home or office for examination. Phone him — or, if you prefer, just mail the coupon below.

L C Smith & Corona Typewriters Inc

Sales offices in principal cities of the world. Established 1903

Also manufacturers of the L C Smith Typewriter, the ball-bearing office machine

L C Smith & Corona Typewriters Inc

732 E. Washington Street, Syracuse, N. Y.

Send me latest information about Corona.

What allowance would you make on my.....typewriter

Model..... Serial No.....

Name.....

Address.....

DEVITT 8" COMBINATION SAW

13 TOOLS IN ONE

Saw table raised, showing Emery wheel, saw guard and drill attachment.



Planer attachment on saw table.

Showing Sanding disc attached.



Table tilted for beveling.

Dado head attached for grooving.

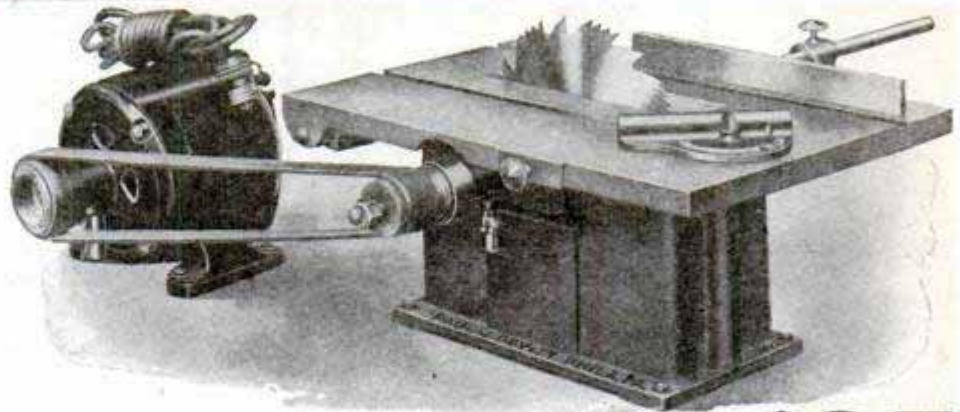

YOU save a great deal of money, time and space by buying a Devitt 8" Combination Saw. Why buy special tools for beveling, grooving, buffing, etc.? The Devitt Combination Saw will rip, cross cut, bevel, miter, groove, mortise, tenon, drill, rabbet, grind, buff and polish. The attachments are easily and quickly adjusted. The saw and motor when set up ready for work occupy very little room. The 1/4 H. P. 60 cycle 110 volt A. C. motor can be run from a light socket and provide power for other purposes when the saw is not in use. A cut up to 2 1/4" can be made with the 8" Combination Saw without planing. The ideal machine for shop, factory or home, complete with attachments: 12"x16" table, 8" Combination Saw, iron pulley for saw table, 12" ripping fence, adjustable cut off miter gauge, motor-specifications as above, 1 1/4" endless leather belt, wood pulley, 8 ft. cord and plug, 6" buffing wheel, 3/4" 3 jaw drill chuck, 5" emery wheel, 8" sander, saw guard, and 2" dado insert. \$35.00 F. O. B. Phila. Height 16", shipping weight, 100 lbs. (Planer attachment to fit on table top will smooth pieces up to 2' wide, \$12.00 extra F. O. B. Phila.)

\$35

F. O. B. Phila.

Write for our beautifully illustrated 4 page circular.

PAUL J. DEVITT 1102 South 2nd Street PHILADELPHIA, PA.

FORDS

no freezing no boiling!



Great Gas Saving

No need for winter fronts, summer pumps, or gas saves. The wonderful **Airlock does all three.** An absolutely genuine article which prevents freezing or boiling in any climate running or standing. It fuelizes and decarbonizes besides. Installed like a motometer. Makes an amazing demonstration. Sells like machine guns fire. Agents with Fords make \$50 daily. Free trial always. Address

AIRLOCK PRODUCTS
Box 588 Burnett, California

Send me Agents free trial offer of your sensational Airlock.

Name..... (Print plainly)

Address.....

MOTORCYCLES



Price \$10 and up purchased through our Co-Operative Plan for as low as \$1.00 down and \$1.00 per week
Indians Harley-Davidsons Ace Henderson and Clevelands

Motorcycles shipped to all parts of the world

WALKER-INDIAN CO., 188 Mass. Ave., BOSTON

An Xmas Hit!

Wbley Air Pistol

The Ideal Gift for Beginner and Expert Marksmen

FEEL THE HEFT OF IT! Looks, feels and shoots like a fine automatic.

Beginners perfect their aim quickly because a Wbley makes no noise or dirt and practicing anywhere at any time is possible. **ECONOMY AND ACCURACY** make the **WEBLEY AIR PISTOL** an excellent gift—it is the only air pistol guaranteed to group shots at 10 yards within 1 inch. **POWERFUL** enough to kill small game. Procurable in two calibres 1.77 and 22.

See the new **WEBLEY AIR PISTOL** at your dealers—or sent direct by mail including cleaning brush and supply of pellets for \$15.

Write for descriptive booklet, "P. M."

Also makers of W. & C. Scott **MAGNUM** Shotguns and **MAGNUM** Rifles and Double Rifles. Full line at our New York Salesrooms.

Sole U. S. Agents

W. & C. SCOTT ARMS CO., Inc.
100 East 42nd St., New York

Just Out! **30 Days FREE TRIAL** *1927 Models*



**1-Dial
5-Tube
\$57⁰⁰
Retail Price**

ON ANY

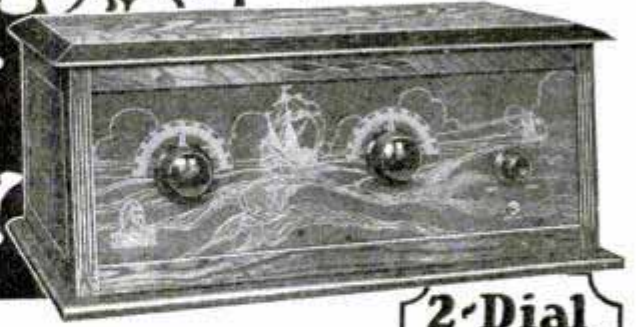

**2-Dial
5-Tube
\$47⁰⁰
Retail Price**

Westingale RADIO

NOW!—you can put a NEW 1927 Model Westingale, 5-tube Radio in your own home and use it to your heart's content on 30 DAYS TRIAL. Entertain your family and friends. Listen to the music, concerts, sports, news, market reports from stations all over the country. Compare it with other sets for beautiful appearance—wonderful performance and low price—and if you are not convinced that Westingale gives you the greatest measure of Radio satisfaction and the best value for the money—YOU DON'T HAVE TO KEEP IT.

Why not have the NEWEST Radio? Why pay high prices? Why take chances when you can put either of these last minute Westingale Models in your home for 30 Days' Trial on the absolute guarantee that if you don't find it the most beautiful and the most satisfactory Radio set for the money, you have ever seen or heard—you don't have to keep it.

The Last Word in Guaranteed Radio Sets and the Biggest Values Ever Offered

Agents Make Big Money

We want agents in every locality to demonstrate and take orders for these amazing, low-priced, last-minute Westingale Radio Models. The easiest kind of work. Just like play. Quick sales and big profits. No radio experience necessary,—we show you how. This is your chance to get into the RADIO business for yourself without capital. Build a money making business of your own or a profitable side line in your spare time.

\$50 to \$100 a Week—Easy FULL OR SPARE TIME

No home is complete without a good radio. Millions will be sold this fall. Get a Westingale set on 30 Days' Trial,—use it as a demonstrator and get your share of these profits. Demonstrate to your neighbors and friends, and see how the beautiful appearance, simple control, powerful performance and remarkable low price of Westingale models make them sell on sight.

Your Own Radio FREE

We also have a plan whereby you can put a Westingale set in your home on 30 Days' Trial and make enough demonstrations in your spare time to get your own set without cost before the trial period is up.

Special Discount to Agents

To quickly introduce these two wonderful new 1927 Westingale Models we are offering, for a limited time, a big reduction, way below retail prices on the FIRST Westingale outfit placed in each community. Don't wait. Be first in your locality and mail the coupon or a post card today for our FREE Radio catalog, special discount offer and full particulars.

Westingale Electric Company
Dept. 120 1751 Belmont Ave., CHICAGO, ILLINOIS

Big—Powerful—Dependable 5-Tube, Coast to Coast Sets

Every late feature,—every new, worth-while idea is built into these two 1927 Westingale Models—yet 15 unnecessary parts and many feet of useless wiring have been discarded to simplify—improve—perfect them and eliminate your radio troubles. All we ask is a 30-Day Trial at our risk to convince you that this ultra simplicity really puts Westingale Radios years ahead of all others in powerful reception,—wonderful loud, clear tone—dependable service and EASY control.

The Utmost in Distance, Volume and Attractive Appearance

Built in the new style, big, massive, period type cabinets, hand rubbed brown Walnut finish. The front panels enhanced with beautiful Spanish Galleon design, embossed in dull gold, these new Westingale Models are as pleasing in appearance as they are in performance. Either the 1-Dial or 2-Dial Model will reach out and bring you music, concerts, speaking, sports or market reports from hundreds of broadcasting stations all over the country with enough volume to fill your home. Unbeatable for performance, appearance or price.

Don't buy a radio until you get our FREE Catalog which fully pictures and describes these two newest of all radio models and explains our 30-DAY TRIAL OFFER. Don't wait—a special introductory discount for those who write quick. Mail the coupon today. Get posted before you buy.

Mail Today—Don't Delay

WESTINGALE ELECTRIC CO.
Dept. 120—1751 Belmont Ave.,
Chicago, Illinois

Please send me your FREE Catalog on the new 1927 Westingale Radio set. Also full particulars of your Special Discount offer on the first outfit placed in each community.

Name

Address



"Don't you wish YOUR engine was the 'take-apart' kind?"

Dorfan Loco Builder Engines come in wide and narrow gauge models. This is the new Dorfan wide gauge Engine "3930."

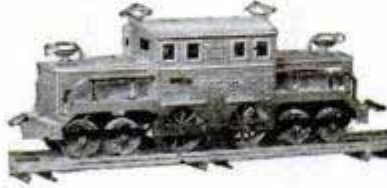

Boys—Here's an Engine worth waiting for!

HOW many times have you wished you could take your electric engine to pieces? How many times have you *tried*—and had to send it away to be fixed—because it just wouldn't go back together again for you?

Here's an engine that *you can take apart*—often as you want to! And then put it together again—with no tool but a screw driver—and find that it runs again just the same as before! Doesn't that sound like lots more fun than just watching your train go around the track?

Go to the store where your toys usually come from and ask to see Dorfan Loco-BUILDER Electric trains. There are Dorfan passenger trains and freight trains of many styles. Ask to see the Dorfan Loco-BUILDER Electric Engine separately. Ask to see the neat outfits containing all parts with which to make a Dorfan Loco-BUILDER Engine. With each engine comes a sheet of simple directions which any boy can understand and follow. If you already have an electric train, a Dorfan Loco-BUILDER Engine will make your outfit complete. Ask your dealer *today* to show you Dorfan Electric Trains. *Catalog Free—write us for it.*

Dorfan

LOCO-BUILDER
ELECTRIC TRAINS

BIG PRIZE CONTEST FOR BOYS!

SHOW this ad to your dealer and ask for Free Entry Blank for the Dorfan Prize Letter Contest. 100 big prizes—radio sets, watches, cameras, canoes, bicycles—attractive prizes of all kinds, and 2000 Dorfan Licensed Engineer Diplomas. Costs nothing to enter. Every boy stands a chance to win. Closes January 15th. Get Entry Blank *today*.

THE DORFAN COMPANY

Dept. PM-12 137 Jackson St., Newark, N. J.

DEALERS: Wire or write for Entry Blanks. No boy can enter contest without one.

PROVED!

40,000 Radio Users
Demonstrate Reliability
and
Wonderful Performance

\$12.50

40,000 in Use



FERBEND "B" ELIMINATOR

Second successful year. Constant flow of unsolicited testimonials prove its splendid performance. Amazingly low in price—high in value. Equal or superior to any "B" Eliminator, regardless of price.

Ask Your Dealer—or Send Direct
Shipment made direct on receipt of price, or C. O. D. if preferred. Use for 10 days to convince yourself—if unsatisfactory write us within that time and purchase price will be refunded.

SEND ORDER TODAY.



**FERBEND
ELECTRIC
CO.**

415 W.
Superior
Street
Chicago,
Ill.

Complete

Replaces "B" Batteries. Operates direct from socket on 110-120 volt A. C. lighting circuit. Delivers up to 100 volts.

Users Are Enthusiastic

Fort Riley, Kans. Am getting wonderful results with my Eliminator and good reports from those I have sold.—Floyd M. Farwell, Wire Chief, Sig. Det.

Amsterdam, N.Y. The Eliminator is great. Have advised all my friends to get it for I know none could work any better or give more satisfaction.—Reg. Firth.

Montreal, Quebec, Can. I have sold all six of your Eliminators and every one is pleased with it. It is one of the best on the market regardless of price.—Alfred A. Michand.

RADIO DRILL



This drill was designed particularly for the amateur experimenter and manufacturer of radio equipment and is adaptable for any work within the range of its capacity.

It is equipped with a swinging adjustable table, ball thrust spindle, chuck capacity 0 in. to 1/2 in., and has belt-shifter on tight and loose driving pulleys.

Manufactured by

H. & D. MACHINERY CO.
P. O. Box 2 Whitman, Massachusetts.

INCREASE YOUR BANK ACCOUNT

Sell Archer
Made-to-Order
Shoes

 Sell Archer Made-to-Order Shoes. 86% of all women should wear them. Big commissions paid daily. Your repeat orders make extra profits. No capital or experience necessary. We teach you the business. Prompt deliveries. Built-in Arch which supports the bones of the foot and strengthens muscles. Double your income. No other proposition has so many exclusive advantages. Dept. Z-3126. THE C. W. ARCHER SHOE COMPANY, Cincinnati, Ohio.

AMERICAN SCROLL SAW



It's Easy to Build Things
When You Use This Saw

You will like its sturdy, mechanically correct construction; the ease of operation; the smooth, absolutely square cut. Cuts fibre, bakelite, wood up to 1" and metal up to 3/4" thick. A real tool to make your radio sets, scooters, cabinets, experimental work and lots of useful things around the house, etc. Can be motor-driven.

**IT'S A REGULAR TOOL
And the Price Is Right**

For details write to Dept. A-115

Delta Specialty Co. 858 Third Street
MILWAUKEE, WIS.

The New 21 Jewel Burlington Bull Dog

for Rough Service

HERE is the ideal watch for rough service. A masterpiece—with 21 ruby and sapphire jewels—handsome, sturdy, 100% dust proof—and it comes in a heavy 14 karat Gold Strata case. Adjusted to the Second—to Temperature—to Isochronism—to Positions. Built for absolute accuracy under all conditions and so strong in every part that it practically removes all chances of breakage. Note the tight fitting extra cap placed over the movement making it doubly dust proof! No matter what your work is—whether firing on a locomotive, working in a mine, on a farm or in a lumber camp, this is the watch for YOU—and you will be astonished to find such a wonderful watch so low priced!

Rock Bottom Price

Easy Payments — Sent on Approval

This masterpiece among watches is sold direct to you, at our rock bottom price, on easy monthly payments. And it is sent on approval. No obligation to buy unless you are perfectly satisfied. When you can so easily secure a watch that you can absolutely depend upon under all conditions, why deprive yourself of this great satisfaction one day longer than necessary?

Mail the coupon below for our free book and liberal offer! Do it NOW! It costs you nothing to FIND OUT!

Beautiful Burlington Book

"An Education in Watches"

Sent Free!

Don't choose ANY watch until you have seen this beautiful book. It contains in colors the most complete and varied assortment of watch styles and exquisite designs ever shown under one cover! In addition to the "Burlington Bulldog" you will find the new Burlington Supreme, in many beautiful shapes and in white and green gold; the new 18 karat gold Lady Burlington—the new square strap watches for men—special watches for doctors, nurses, etc., in fact, a watch for everyone! You will also learn from the Burlington Book just how to judge the real value of a watch and how to avoid purchasing watches that are over priced. You owe it to yourself to FIND OUT! Remember—the book is free. Just fill out the coupon and mail it TODAY!

BURLINGTON WATCH COMPANY,

Dept. 13-59 19th St. & Marshall Blvd., Chicago

Canadian Address: 62 Albert Street, Winnipeg, Manitoba

Please send me [without obligation and prepaid] your free book on watches and full explanation of your liberal approval offer on the Burlington Watch.

Name.....

Address.....



Get a Model Airplane
for Christmas!

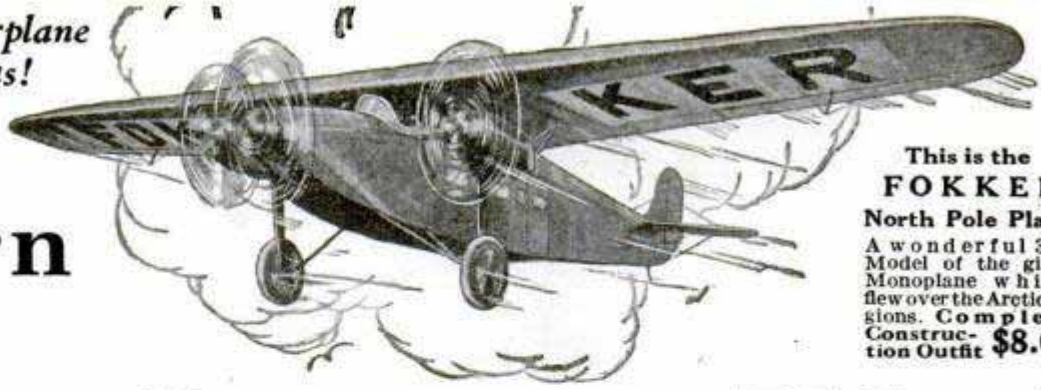

This is the
FOKKER
North Pole Plane
A wonderful 3 ft.
Model of the giant
Monoplane which
flew over the Arctic re-
gions. Complete
Construc-
tion Outfit \$8.00

Learn How Airplanes Fly!

BUILDING and Flying a Model Airplane is the most interesting thing you ever did; shows you all the parts of real planes, how they are constructed and covered, what each part does, what makes them fly, how they "take off" and land, and many other things real aviators must know.

Build and Fly an Ideal Model Airplane

Ideal Models are true copies of real machines, the ones you see and read about every day. They are designed in exact proportion and have the same constructional features. Anybody can build one. Ideal Model Airplane Construction Outfits show how and contain everything required to build the complete Model, including Plans, Drawings, Diagrams, Building-Flying Instructions and all parts and materials.

The Models are wonderful; equipped with rubber-tire disc wheels, hand-carved wooden propeller, aluminum radiator and engine cowling, ball-bearing propeller shaft and other parts—even the insignia marking of the real machines are included. Every Model is

Guaranteed to Fly in the Air when correctly constructed. There are several perfect Models to choose from. Read the specifications for each and pick the one you are going to build.

Plans for Model Airplanes

Complete 3 ft., Scale Drawings with Building-Flying Instructions for Fokker, DeHavilland, JN4D-2, NC-4, Bleriot, Taube, Nieuport or Cecil Peoli Racer, sent postpaid for **25c** each (All 8 for \$1.50)



This is the DeHavilland World Flyer

An exact duplicate, 1/14 actual size, of the famous plane which flew around the world. Complete Construction Outfit..... **\$7.50**



This is the JN4D2 Curtiss Training Plane

A perfect Model, 1/12 actual size, of the airplane used for training Aviators and the one most frequently seen in the air. Complete Construction Outfit..... **\$7.00**
Special Complete Construction Outfit for Building a 6 ft. Model "JN" Plane..... **\$25.00**
(By Express Only—Charges Collect)

NC-4 Naval Seaplane: A beautiful 4 1/2 ft. Model of the famous Navy Plane which flew across the Atlantic Ocean. Complete Construction Outfit..... **\$10.00**

Nieuport Monoplane: 3 ft. Model of this French Scouting Plane. Complete Construction Outfit..... **\$6.00**

Bleriot or Taube Monoplanes: Perfect 3 ft. Models of either of these graceful flyers; both easy to build. Complete Construction Outfit..... Each **\$5.00**

Cecil Peoli Racing Airplane: Not a Model, but a record-making racer that will fly more than 2,000 feet. Complete Construction Outfit..... **\$4.50**

Ideal 3 ft. Racer: Another racing airplane that will go more than 600 feet. Ready for flight in 15 minutes. Complete Construction Outfit..... **\$3.00**

Every Boy's Ideal Airplane

Beautiful, strong Monoplane, 3 1/2 ft. size; easy to build; guaranteed to fly. Complete Outfit ready to assemble **\$6.00**



IDEAL Model Airplanes and Racing Airplanes are sold in Toy, Sporting Goods, and Department Stores. Ask for them by name. If not obtainable, we will fill all orders direct upon receipt of price. West of Denver, Colo., and in Canada, add 50 cents to each price above.

AIRPLANE CATALOG

Tells about all Ideal Model Airplanes and Racing Airplanes; also lists hundreds of Parts, Supplies and Materials for Model Builders. 48 pages, most complete catalog published. Get a copy now..... **5c**

IDEAL AEROPLANE & SUPPLY CO. 408 West Broadway NEW YORK CITY



FREE! BIG CANARY CATALOG

Amazing Bargains. Singing Canaries, beautiful Parrots, Fancy Birds, Gold Fish. Bargains in Cages and Supplies. All Guaranteed. Write

CHICAGO BIRD and CAGE CO.
422 S. State St., Dept. 126, Chicago

AGENTS MAKE BIG MONEY SELL FIBRE BROOMS

New Patent Fibre Broom; Sweeps, Dusts, Mops. Big Demand, Quick Sales, Good Profits. Send for Free Sample Offer and Selling Instructions.
NATIONAL FIBRE BROOM CO., Dept. P. M., ST. LOUIS, MO.

Handy Tools for Handy Men!

Men everywhere find it easy to build things of wood with Boice-Crane Machines. New 64-page illustrated booklet explaining how to perform many wood-working operations sent postpaid upon receipt of 10c. Also shows complete line of Boice-Crane Circular Saws, Jig Saws, Band Saws, Mortisers, Jointers, Lathes, Drills and explains our money-back guarantee.

14" Band Saw
Table 12"x14" tilts 45 degrees. Saws 7" stock. Uses blades 3/16" to 1/2" wide. Bronze bearings



Handisaw Model 2
Does ripping, mitering, grooving, sanding, grinding and drilling with ease and accuracy. Table 10"x13". Saw 7" dia. Cuts 2 1/8" stock. Dados 3/8"x3/8". Cuts moulding.



8" Bench Lathe
Does turning, drilling, sawing, sanding, grinding and jig sawing in wood or soft metal. Swings 8". Capacity between centers 19". Metal-working model fitted with compound sliderest. All Boice machines driven by 1/4 to 1/2 h. p. motor attached to light socket. Machines sold with or without motor. Send 10c for Booklet NOW.

W. B. & J. E. Boice
Dept. P. M., 12-B, Tol'do Ohio

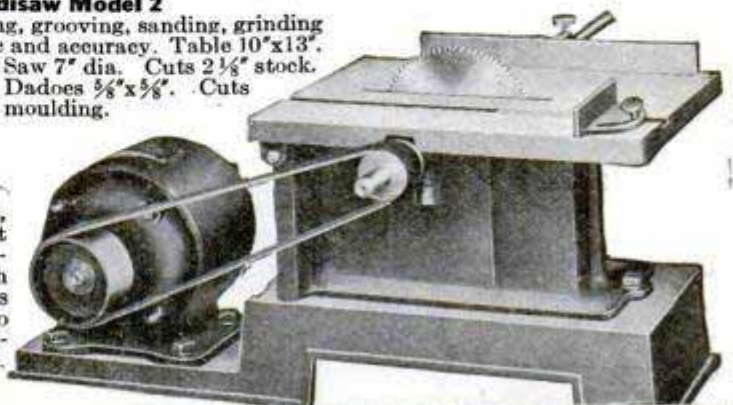

SPECIAL HOLIDAY OFFER

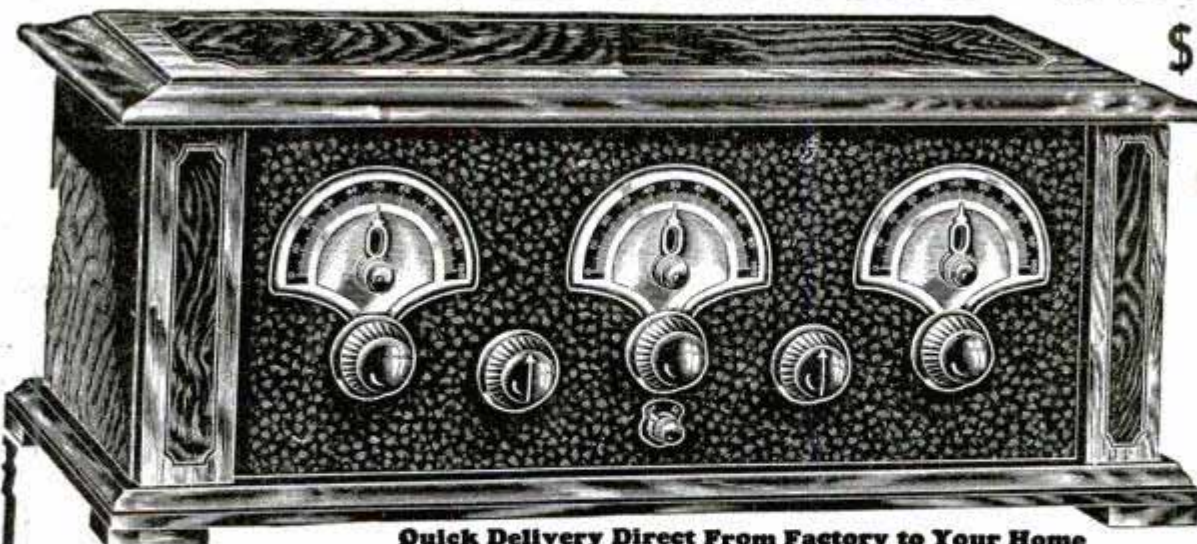

\$24⁹⁵

Wonderful
Five
Tube
Set

Quick Delivery Direct From Factory to Your Home

The Radio Set You Want at the Price You Want to Pay

A 5-Tube Set Superior to Most 6 and 7-Tube Sets in Tone Quality, Volume and Distance Getting

Take advantage of this unusual opportunity and special Holiday Offer

Nowhere will you find a value to compare with this remarkable new 1927 design 5-tube radio set. DIRECT FROM FACTORY to you at a tremendous saving. Embodies the newest forward steps in radio, such as U. S. Standard low loss coils, straight line frequency condensers, handy Vernier dials with etched metal plates. Gives you the best radio reception at low cost. A set you can buy complete cheaper than you can build. Direct from our own factory. The Barawik Company is one of the oldest radio specialty institutions in America, numbering 200,000 customers. Every item sold is of high standard. Buy from radio experts and save money. A remarkable 5-tube radio set—finer, better built and producing superior results. It is both rich and attractive looking, and for easy tuning, clear, sweet, natural tones, and distant reception. It is everything you will expect. Takes all tubes including the new power tubes.

Perfect Reproduction It stands alone in tone quality, as comparison with any set at any price will reveal. Is the choice of expert musicians who recognize finest distinctions of harmony and tone. Its beautiful, natural, well-rounded tones reproduce the human voice, whether in song or speech, as clear as a bell. Musical programs are reproduced in sweet, perfect tones, delightfully and harmoniously.

Artistic Cabinet Exceptionally fine hand-rubbed walnut finish cabinet. An ornament to any room. A truly distinctive, dignified cabinet in keeping with other Barawik qualities.

The Greatest Value Today—Look at These Prices! Quality considered our prices are lowest. Nowhere is there value to equal these prices.

101YY5000—Set only, no accessories..... **\$24⁹⁵**

Complete with All Accessories For Storage Battery. Operation Including: 5 201A type tubes, 2 45-Volt "B" Batteries, 1 Fine Loud Speaker, 1 6-Volt Storage Battery, 1 Complete Antenna Equipment, 1 "C" Battery, 1 Fine Head Set. Complete. **\$56.95**

301YVS001—Shipping weight, 120 lbs..... **\$51.50**

301YVS002—For Dry Cell Operation Including: 5 192 type Tubes, 2 45-Volt "B" Batteries, 1 Fine Loud Speaker, 3 Dry Cell "A" Batteries, 1 "C" Battery, 1 Fine Head Set, Complete. Shipping Wt. 45 lbs. **\$51.50**

Mail your order today direct from this ad and get your set before the holidays. Anyone can set up this outfit in an hour or so. Transportation charges extra.

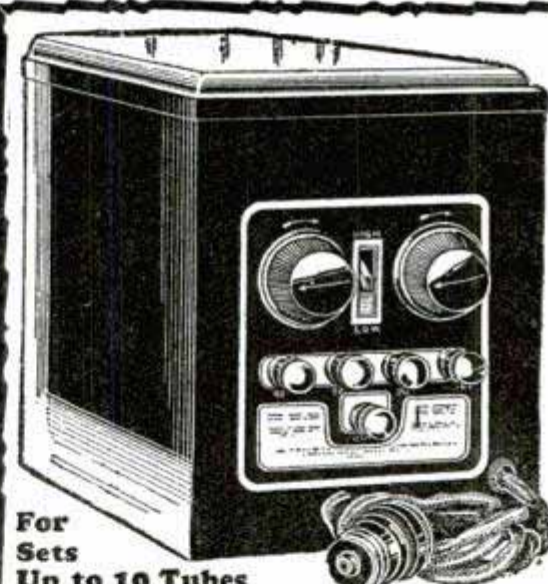

Genuine Raytheon "B" Eliminator Delivers Up to 180 Volts. 50 Milliamp Capacity at 150 Volts.

One of the leading "B" eliminators, of highest quality materials from expensive finish of real green Duco on case to genuine Raytheon tube. Filtering system of 1000 volt high-test condensers and extra capacity choke coils completely remove all hum out of the alternating current. Connect to your light socket, 110-volt, 60-cycle, A. C. current; uses few cents of current a week; pays for itself in replacing "B" batteries. Reception is clear, long distance easy to get due to constant output. Furnished completely assembled, ready to use, and fully guaranteed. Send your check or money order today. C. O. D. orders accepted with 25% deposit.

For Sets Up to 10 Tubes

103YY575

FREE RADIO GUIDE

GET YOUR FREE COPY TODAY—NOW!

\$26⁹⁵

Postage 30c extra.

Mail your order for the Barawik Special 5-tube set and eliminator today and insure delivery to your home before the holidays. Also mail the coupon or write us a letter or postcard and we will immediately mail you free the new 1927 Barawik Radio Guide, with its 164 pages of everything interesting for the Radio fan. This will give you plenty of time to do your holiday shopping and get back your orders in time. Never in the history of radio has such a tremendous collection of radio and electrical supplies been presented to the public. Build the set of your dreams now. Get the set or parts and accessories you have always longed for. You can do it, for our low prices will make the most expensive articles reasonable in price. A New Feature—A new special Amateur section under the direction of F. J. MARCO, 9ZA. Ask about it.

The Barawik Co.

540-551B Monroe St., Chicago, Ill.

Mail Coupon Now. Get this Guide into your hands before you buy another part. It will mean money in your pocket. Write today; also please send names of other radio fans.

MAIL TODAY
BARAWIK CO., 540-551B Monroe Street, Chicago, Ill.
Send me my copy of your new 164-page Radio Catalog and Builder's Guide for 1927—FREE.

Name
Address
Friend.....
Address



This Dental Laboratory Expert earns \$20 a day!

What's the use of training for the old, overcrowded trades? If you're going to prepare for big-salaried jobs or a profitable business of your own GET INTO THE FASTEST GROWING PROFESSION—"Laboratory Dentistry." Biggest opportunity for success of the century, because there are ten times as many jobs as men to fill them, because there are a dozen cities crying for Laboratories for each EXPERT capable of operating one!

Easiest, pleasantest work you ever saw! Your own boss, money and success yours from the very beginning. You can start with a "shoe-string." We prepare you in a few months to run a business of your own, to do any job. Common schooling, ability to use your fingers ALL YOU NEED! Free R. R. Fare to Chicago, Cleveland, Detroit, Boston or Philadelphia for a limited time!

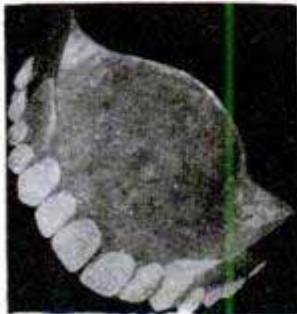

Jobs Up to \$125 a Week!

In a business where there are many times as many jobs as Experts, salaries are high, hours are easy, opportunities are everywhere! Dentists recognize the high-standing of our graduates. No books here—learn with tools and instruments. Start quick—get ready in a few months for your big opportunity! Mail Coupon today!

FREE!
R. R. Fare
TO
Chicago
Cleveland
Detroit
Boston
or
Phila.

Rubber Plates

Learn to make partial upper or lower plates with soldered, cast or wire clasps, with palatal bars; with lingual bars. McCarrie-trained Students learn to make full rubber plates of every type, including Vulcanite base-plates, butted gums, carved gums, etc.

CROWNS

Here's only a small part of your practical training in Crown-work: Two-piece, seamless, open-face, Richmond, cast-base porcelain, Carmichael, split-pin, carved (swaged) cusp, cast cusp, etc.

BRIDGE WORK

Complete training in both fixed and removable bridgework. Interchangeable teeth, gold dummy, Sanitary porcelain dummy jobs—Roach, Giltmore, Bischoff and all forms of cast-clasp work is taught—not with books but in actual Laboratory.

METAL BASE DENTURES

Cast bases of Aluminum, Watt's metal, etc., are included in your training. Both centrifugal and air pressure casting machines are used. Free Book contains complete list of subjects in course.

64,000 DENTISTS NEED LABORATORY WORK!

Only a few hundred Laboratories in all the U. S.—most of them in the larger cities. Dentists can't afford to do their own mechanical jobs. They can buy the services of a Laboratory Expert at about \$3.00 an hour and sell their own time at \$6 to \$15 an hour. Dentists will encourage you to learn mechanical Dentistry, start a "Lab" of your own, give them quicker service than sending their work to other cities. Dentists can't wait and keep their patients waiting.

WE HELP YOU OPEN A LABORATORY OF YOUR OWN!

Many of my graduates open a Laboratory of their own. To encourage more men to go into this wonderful Mechanical profession, we will help you find a good location for your Laboratory, and help you make a success of it. Write for complete information on how you can find yourself in a profitable business of your own after you become a Dental Laboratory Expert.

INTERESTING BOOK—FREE!

Right this minute there are openings for 150 Dental Laboratory Experts in locations where they can do a business of \$5,000 to \$20,000 a year. But you can't cash in, take advantage of these OPPORTUNITIES until you're Trained. Catalog tells you how quickly and easily you can get ready, how hundreds of others have SUCCEEDED! Tells you how you learn in a few months BY DOING ACTUAL LABORATORY JOBS in the world's greatest Dental Laboratory Schools. Brings you FREE R. R. Fare offer and other big inducements. Write for free Book today!

EARN while you LEARN!

Day students make all or part cost of course by part-time night work. Night students can find plenty of good jobs "to see them thru."

We'll help you!

McCarrie School of Mechanical Dentistry

1338 S. Michigan Ave.
Dept. 59 Chicago, Ill.

McCarrie School of Mechanical Dentistry
1338 S. Michigan Ave., Dept. 59, Chicago, Ill.

Without obligation, please send me your Free R. R. fare offer and free Book with complete information about how I may become a Mechanical Dentist. How you will help me open a Laboratory, how you will help me find a job while I take my training, etc.

Name.....
St. No. or R. F. D.....
City..... State.....

Do You Want the Best in Radio?

—then will you read this, please?

**IT'S ONLY NATURAL TO WANT THE BEST—
BUT USUALLY IT'S A PROBLEM TO FIND IT**

In the past you had to take a chance—but the new **Counterphase Power-Six** has history behind it—and the reputation of a firm who have never put out a product that was not a continued outstanding success.

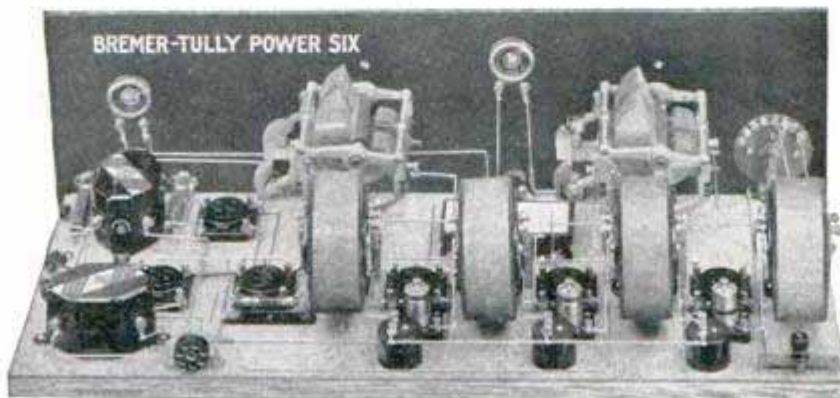

THE ESSENTIAL PARTS FOR THE COUNTERPHASE POWER-SIX ARE AVAILABLE IN KIT FORM

The **Power-Six** is the B-T patented Counterphase Circuit improved, simplified and up-to-the-minute with the latest developments.

It's more efficient, easier to build, easier to operate and giving the finest reception known to radio.

This is our latest improved model of the Counterphase-Six, as described on pages 303-4-5 of the February, 1926 issue of *Popular Mechanics Magazine*—sufficient proof of our ability and record as manufacturers of high-grade radio sets and parts.

You ought to know more of this set. Read the coupon below.

The **Power-Six "Kit"** includes four Torostyle coils, 5 condensers, 3 chokes, 4 resistances, color diagrams and instructions.

These parts purchased individually would cost \$45.10—price of kit, \$41.50.
(If your dealer cannot supply you, we will ship prepaid on receipt of list price.)

Better Tuning, 10th Edition, gives full information on B-T Sets, Kits, B-Power Units, with discussions and advice that will save money. It's always worth reading.

BREMER-TULLY MFG. CO. 520 SO. CANAL STREET
CHICAGO, ILLINOIS

SPECIAL OFFER—Good With This Coupon Only



Before spending money for a B-Eliminator, read *Better Tuning*. It explains many things you should know.

BREMER-TULLY MFG. CO., 520 So. Canal St., CHICAGO, ILL.

We would like to know whether *Popular Mechanics* subscribers read Radio ads. To anyone who sends us this coupon with 10c we will mail a copy of *Better Tuning* and a diagram in colors showing complete instructions for building the Power-Six, the regular price of which is 90c.

- 10c enclosed—
send booklet
- Send free
circulars

- Include
diagrams
- I am interested in a
factory-built set only

.....
(PRINT NAME)

.....
(ADDRESS)



Last Call!

TO GET This AMAZING CONTRACT That...



I'll Guarantee To Keep You in Razor Blades for Life!

GOING—Going—Almost Gone!
My sensational offer to send you a *written guarantee* that I will keep you in razor blades for life is about to expire! Promptly on the stroke of midnight, Dec. 31st, it will be withdrawn. And nothing like it will EVER BE OFFERED AGAIN!

KRISS-KROSS—the remarkable invention that makes my extraordinary guarantee possible—marks such an amazing advance in new shaving comfort and economy that it deserves to be called much more than a stropper. KRISS-KROSS is a super-stropper—a blade rejuvenator! Almost literally it makes a new blade out of an old one every day—makes hundreds of keen, quick shaves blossom where only one grew before. Until you've seen KRISS-KROSS—and tested its uncanny ingenuity, you'll never know how really sensational this introductory offer is!

365 Shaves a Year From ONE Blade!

KRISS-KROSS employs the diagonal stroke, same as a barber uses. Never before has anyone captured the secret of successfully reproducing this stroke automatically. Eight "lucky leather grooves" do the trick in 11 seconds with a precision it takes a master barber years to attain. But that's not all. KRISS-KROSS embodies still another feature that has hitherto baffled mechanical reproduction. It stropps from heavy to light. Adjustable, automatic jig notifies you when your blade is ready with the keenest cutting edge steel can take.

No wonder that this super-stropper prolongs the life of any make blade, single or double edge, for weeks, months and years! Think what it means! No more bother about remembering to buy new blades! No more "raking" with dull ones. KRISS-KROSS coupled with my startling offer below, solves your blade problem for all time. Keep velvet-smooth shaves forever. And think of the economy!

Sensational Offer

And now for my smashing offer! To introduce KRISS-KROSS stropper to those who have not yet seen it, I am giving with it,

Sold Only Through Authorized Representatives

Rhodes' KRISS KROSS

RHODES MFG. CO., Inc. STROPPER
Dept. W 371, 1418 Pendleton Ave., ST. LOUIS, MO.

Wonderful Xmas Gift
KRISS-KROSS Stropper and Razor in the neat holly box make an ideal Xmas gift. Unique and different. Exactly what a man would choose for himself.

an astonishing new kind of razor Free! Really 3 razors in one! Adjustable, surprising and unique! This 3-way razor, with 5 special process blades, completes the outfit which I guarantee to keep you in razor blades for life! Here's how the plan works. Use the blades and keep renewing them with KRISS-KROSS super-stropper. If one of them goes back on you for any reason (except rusting or nicking) return them and I'll recondition or replace them with new ones. No strings. No red tape. I give you amazing guarantee in writing. It is an ironclad agreement to keep you in razor-blades for life!

Send Special "Final Chance" Coupon Today for Free Offer

Write at once for information on this astonishing new invention and blade-guarantee offer which was originated some time ago, purely for introductory and advertising purposes. Since its inception KRISS-KROSS has leaped to first place as the World's Leading Mechanical Stropper. Now the introductory period is past—and with it passes the offer of the blades-for-

life guarantee! But there is still an opportunity to secure it, if you act quickly! Get complete details at once. No obligation. Just clip and mail the coupon today!

AGENTS — \$175-\$400 a Month

Make big money with KRISS-KROSS! Free razor boosts sales amazingly. N. C. Paige made \$104 in 3 days. Emil Ham made \$50 his very first day. Others average \$30 to \$66 a day. Every man buys on sight, SPARETIME workers, OFFICE and FACTORY men make \$6 to \$12 extra a day showing KRISS-KROSS to friends and fellow employees. S. Kantala made \$154 extra working evenings 3 weeks. Get details at once. Check bottom of coupon and mail it tonight!

Rhodes Mfg. Co., Inc.,
1418 Pendleton Ave., Dept. W371, St. Louis, Mo.

Without obligation please send me full details of your special introductory offer to keep me in Razor Blades for LIFE. Also send me full description of KRISS-KROSS stropper and FREE adjustable razor.

Name.....
Address.....
City..... State.....

Check this space if you are interested in making money as an authorized KRISS-KROSS representative.