

POPULAR MECHANICS

MAGAZINE

WRITTEN SO YOU CAN UNDERSTAND IT

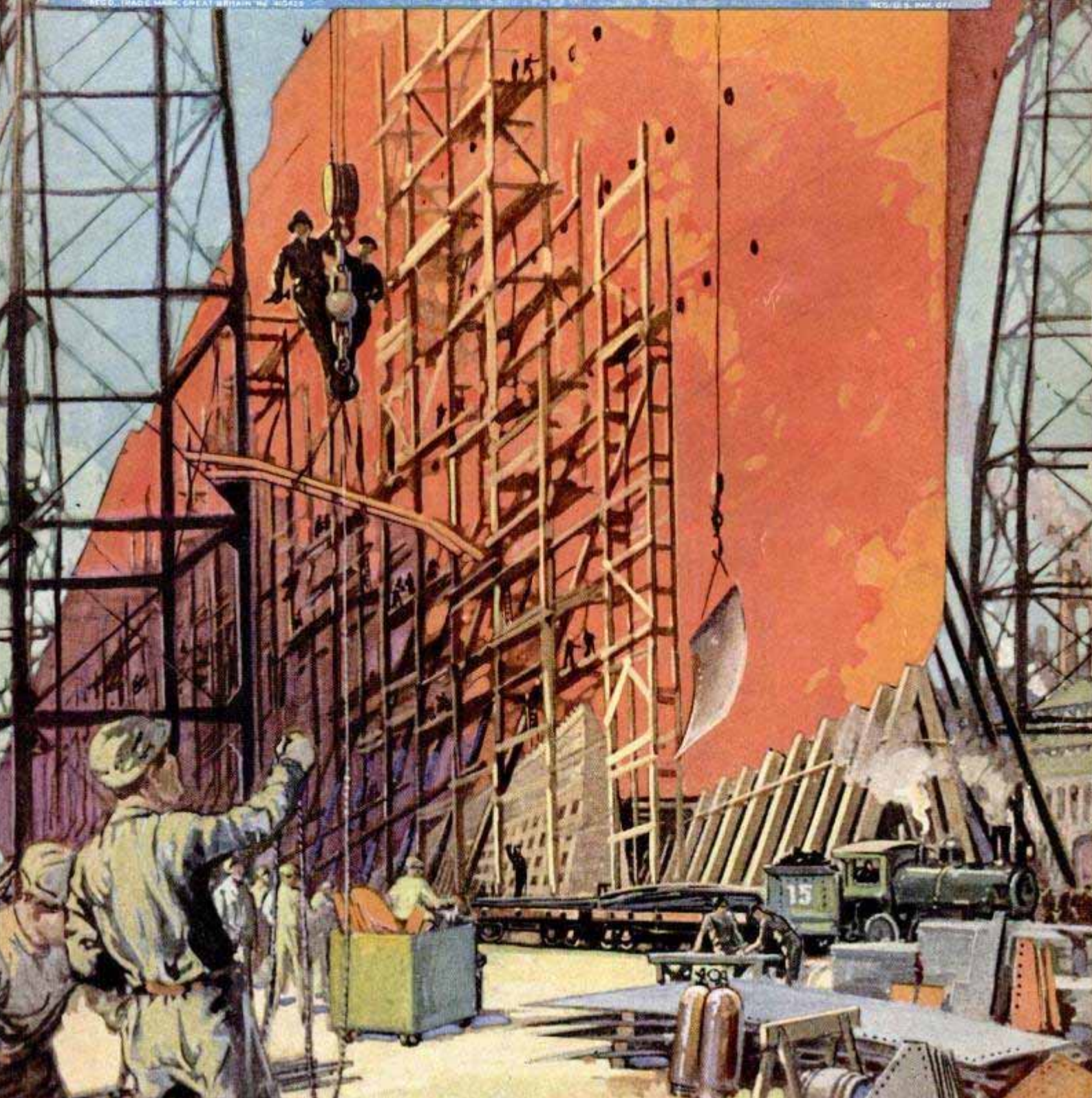

ATKINS

METAL CUTTING SAWS

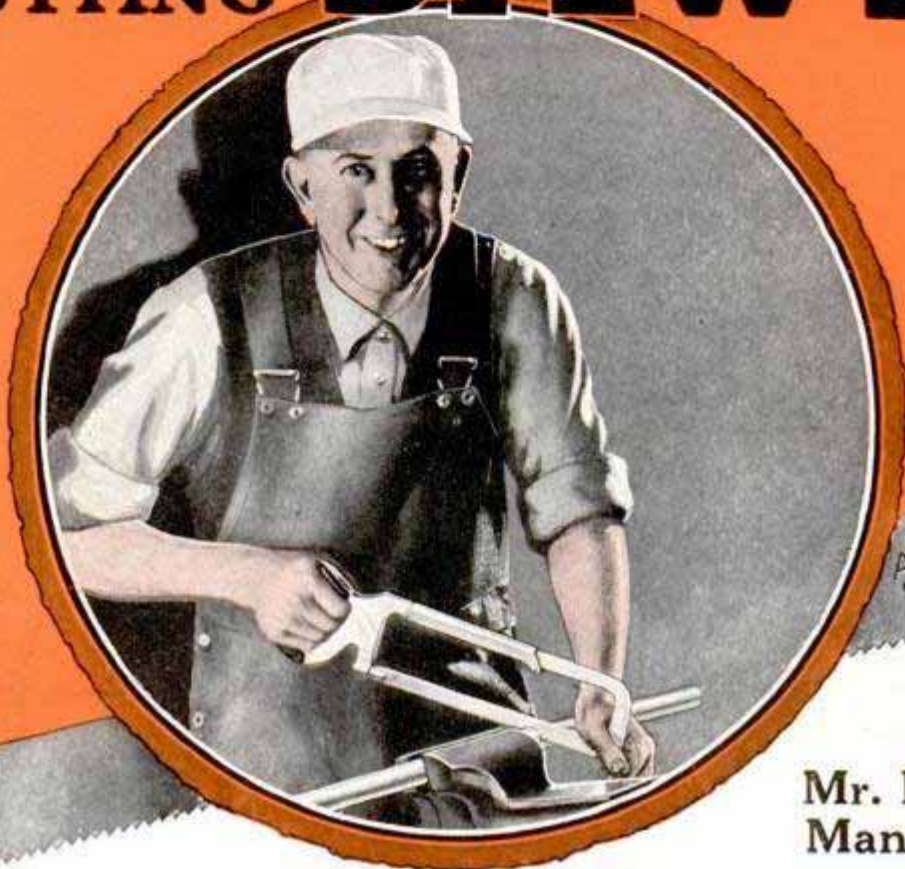

ATKINS - SILVER
MADE IN U.S.A. - STEEL

Mr. Happy
Man Says—

“ATKINS ‘Silver Steel’ to Cut Metal”

Announcing a wonderful new ATKINS “Silver Steel” Hack Saw Blade for hand use. Tests show it will cut six times as long or as much metal and twice as fast as any hack saw blade you ever used.

ATKINS “Silver Steel” Blades for metal cutting are a development you should know about and be using NOW. If your hardware dealer cannot supply them, write us and tell us what metal you are cutting, and we will see that you are supplied.

E. C. ATKINS & CO., Est. 1857
Dept. P, INDIANAPOLIS, IND., U. S. A.

Leading Manufacturers of Highest Grade Saws for Every Use; Saw Tools, Saw Specialties, Plastering Trowels, and Machine Knives.

ATKINS - SILVER
MADE IN U.S.A. - STEEL

A WARM HOUSE
IN THE MORNING

HARDIN-LAVIN PIPELESS FURNACE

ALL-CAST SAVE HALF-INSTALL YOUR OWN

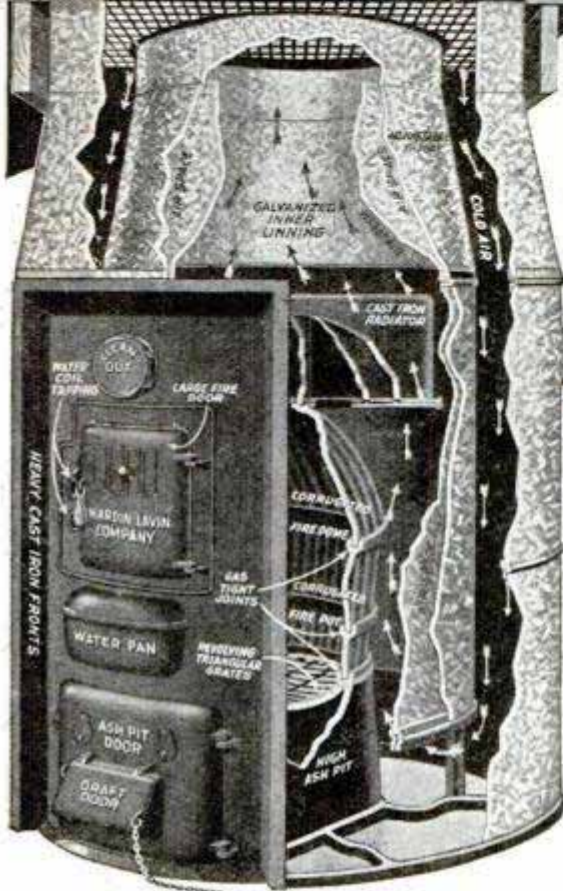

The Hardin-Lavin Company, ever since the firm was founded 50 years ago, has specializing outfits and supplies. We now offer a new improved model, all-cast pipeless furnace at a remarkable low wholesale price.

Burns Any Fuel, Needs Less Attention

This superior, all-cast pipeless furnace burns any kind of fuel with equal satisfaction. Designed to give the utmost in heating results. No other pipeless furnace will give you more heat from the fuel used than will this new model. Hardin-Lavin.

Heats the Whole House

Insures quick as well as economical heating. It has specially designed firepot that keeps the fire just as hot at the outside edges as at the center. Forever does away with the inconvenience of a stove and gives you a complete pipeless furnace heating plant at less than the cost of the average heating stove.

Special
at
\$62.95
For 5 Room
Size

Double Casing — No Heat Lost

A double air-and-asbestos-insulated heavy galvanized casing incloses the furnace. Ample air return insures good circulation. You get wholesale price and bonded guarantee. Order today and save.

	Firepot	Heating Capacity	Special Price
PM-88	18 in.	10,000 ft.	\$ 62.95
PM-89	20 in.	14,000 ft.	72.75
PM-90	22 in.	18,000 ft.	86.80
PM-91	24 in.	28,000 ft.	99.25
PM-92	28 in.	40,000 ft.	132.95

HARDIN-“Furnaceola” LAVIN SMALL—BEAUTIFUL—EFFICIENT THE NEW HOME HEATER



Furnace Heat for Homes and Stores without Basements

More Heat—Less Cost

\$67.50

The Hardin-Lavin “Furnaceola” represents the latest development of a strictly high class furnace that can be set on the first floor and yet heat the whole house to a uniform temperature. Designed to take the place of old style, inefficient heaters in homes, stores, offices, churches, etc., where there is no basement.

Furnace Heat, Stove Economy

Constructed just like a high class furnace. Circulates moist air to the farthest corner of every room in any weather. The “Furnaceola” has heavy outer jacket, open bottom and top, for rapid air circulation. Holds fire full 24 hours under test. Burns any fuel. Can be equipped extra with magazine for burning only hard coal. Will heat 6 or 7 good-sized rooms with no more fuel than old style stove. Size: 47 inches high over all. Floor space occupied 22x22 inches. Takes 7-in. stove pipe.

- PM-1061—Cast iron dull finish.....\$67.50
 - PM-1057—Grain mahogany porcelain enameled..... 74.50
 - PM-1058—Grain walnut porcelain enameled..... 74.50
 - PM-1059—Full blue porcelain enameled..... 74.50
 - PM-1060—Full gray porcelain enameled..... 74.50
- Shipping weight 315 pounds. Stove pipe extra.

Grade A Quality Guaranteed Plumbing Outfits

—at **WHOLESALE!** We help you plan and install. Send us your blue print or rough sketch of room arrangement and we will figure without obligation the exact cost of bathroom, kitchen and laundry plumbing; heating plant, water supply system or complete equipment.

Deferred Payments—In addition to highest grade goods at wholesale and the many other Hardin-Lavin advantages of easy installing features, free plans, etc., we have now also made arrangements so that you can **BUY ON EASY TERMS**. Nowhere else can you find this complete combination of quality goods, wholesale prices, exclusive features, and budget plan of payment.

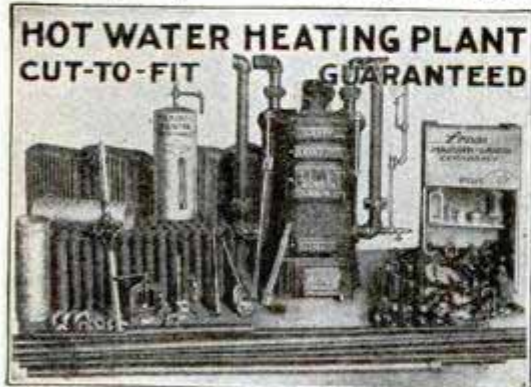

Hot Water Heating Plant as low as \$200.00 complete.

Bonded Guarantee Protects You

Every system or fixture is backed by our bonded guarantee, million dollar plants and 50 years' reputation for highest quality goods at lowest possible prices.

Mail Coupon Today

We are helping thousands to save money and make money. Our free Bargain catalog explains how. Send for your copy today. Our outfits are cut to fit the exact job. Installing plans, diagrams and complete instructions free so that any handy man can do the installing.

All orders are shipped from our Chicago plant the day they are received. It means a lot to know that you will get prompt service and square dealing.

FREE Bargain Catalog

Gives illustrations, complete descriptions, sizes and wholesale prices on heating outfits of all kinds, water supply systems, complete bathroom outfits and plumbing supplies, fittings, pipe, etc. All at wholesale.

**Hardin-Lavin Company,
107-17 W. Pershing Road,
Chicago, Illinois.** P.M.-11-26

Gentlemen: Please send me your free bargain catalog with special wholesale prices and easy terms. I am interested in:

- Hot Water Heating Plants
- Steam Heating Plants
- Pipeless Furnace
- Warm Air Furnaces
- Water Supply Systems
- Bathroom Outfits

NAME

ADDRESS

CITY STATE

EST. 1876
HARDIN-LAVIN COMPANY
When in Chicago visit our new plant at
107-17 W. PERSHING ROAD CHICAGO, ILL.



Seldom counted in— often counted out—perhaps it's *Comedones*

DINNERS, dances, theatre parties—such social events were seldom Dick's. Evenings usually found him home, alone. Dick couldn't understand why Tom got so many invitations—while he got so few. Not for a moment did he guess that the reason was *comedones.*

* * *

A great many young men suffer from *comedones*—commonly called blackheads. Skin can't be clean-looking, fresh, wholesome, if these disfiguring formations are present. What's more, you may not even be conscious of comedones. You may never guess. But your friends notice them.

TEAR OFF, SIGN AND SEND

THE POMPEIAN LABORATORIES
Dept. 84, Cleveland, Ohio

Gentlemen: I enclose a dime (10c) for special trial tube of Pompeian Massage Cream.

Name

Street
Address

City..... State.....



Use at Home
after Shaving

Pompeian Massage Cream helps you overcome comedones. It gives you a clean, clear, ruddy complexion. It gets into the pores where *comedones* form, rolls out all dirt and oily secretions, and stimulates a healthy circulation by keeping the skin clean and the pores open.

Try this treatment after you shave: Spread Pompeian Massage Cream generously over your face—and *rub*. Continue to rub until the cream rolls out. Note how dark the cream looks. That's the pore dirt.

Don't have a dirty skin. Don't let *comedones* form. Use Pompeian Massage Cream every day. It means a healthy, wholesome skin. It means more joy in living. Use Pompeian regularly at home after shaving—then you'll get the full benefit. Your face will look and feel like a million dollars. At all druggists.

**SEND FOR
10-DAY TRIAL
TUBE**

For 10c we send a special Trial tube containing sufficient Pompeian Massage Cream to test thoroughly its wonderful benefits. Positively only one tube sent to a family on this exceptional offer.



For Men!

Popular Mechanics Magazine

200 E. Ontario Street, Chicago, U. S. A.

H. H. WINDSOR, Founder

H. H. WINDSOR, Jr., Editor and Publisher

London: Hachette & Cie.,
16-17 King William Street, Charing Cross, W. C. 2

Paris: Hachette & Cie.,
111 Rue Reaumur

Melbourne: Gordon & Gotch
509-513 Little Collins St.

ISSUED MONTHLY

SUBSCRIPTION:

SINGLE COPY, 25 CENTS

In United States and its possessions, also Canada, Cuba, and Mexico, per year, postpaid - \$2.50

To all other countries in the Postal Union 3.00

All subscriptions are discontinued at expiration. Please examine the date printed on your wrapper.

Entered as Second Class Matter Sept. 15, 1908, at the Post Office at Chicago, Illinois, under Act of March 3rd, 1879.

Entered as Second Class Matter at the Post Office Department, Canada.

Published monthly by POPULAR MECHANICS CO.

Copyright, 1926, by Popular Mechanics Co.

Copyright in Australia. Copyright in France

Vol. 46

Contents for November, 1926

No. 5

Adding Machine—vacuum feet for	783	Ferris Wheel—sliding cars on	734
Advertising		Fireboat—tiny, protects summer resort homes	719
black and white service car for day and night	778	Flags—of thirty-five nations in world-peace symbol	780
imitation of auto crash	776	Flowers—cut in evening live longer	794
Airplane		replica of railway system designed in	787
carriers in French navy	749	Fur—romance of the polar fur fleet	722
falling in flames	779	Games	
Japanese mystery plane passes tests	747	Indian boys played marbles long ago	757
pushed by propellers	769	of letters aid in writing	812
single-engine bombing plane	736	Gases—poison tested in soap bubbles	775
Airship		Germes—to aid plant growth raised in laboratory	798
altitude in fogs measured by echo	796	Glacier—razes high mountain	816
metal dirigible for navy	729	Gold—pumping lake dry to find gold	743
Alaska—mapping from the air	726	Golf—stroke guide for putts	730
Archery—from surfboards latest sport	726	Gun—snaps photo of thug as it shoots	713
Automobile—Accessories—trunk folds under seat	747	Hanger—serves as clothes brush	785
Automobile Racing—cross-country racing auto	812	Heater—electric for rooms	784
Automobiles—Design		Heating Plant	
levers on auto pedals help cripple	782	heat cabinets save fuel	786
skylights in auto top	780	tank on register keeps proper humidity	720
Automobiles—Lighting		Helmet—present type of steel hat best	817
glareproof mirror for auto	718	Horses—jump through fire at riding meet	769
light for auto motor meter	784	Hotel—roadside inn has bungalows for rooms	709
Automobiles—Lubrication—special auto chassis oilers	817	House Plan	880
Automobiles—Radiator—alarm honks warning of over-		Household Devices	814
heated motor	760	Jack—helps lay wood floors	775
Automobiles—Tires—Epsom salts aid making	747	Jewelry—made of rubber	775
Automobiles—Windshield—fluid in wiper	769	Ladle—one-man push button metal ladle	812
Aviation		Lettering—gold, stamps big and little objects	746
German air liners insure passengers	713	Light	
flyers must have license	746	bath treatment room resembles seashore	754
Balloon—pocket-size weighs ninety-nine pounds	784	red, in winter gives effect of warmth	785
Baseball—idea for curves gained from clamshells	757	Lighting—floodlight banks and jails for protection	776
Bees—camera counts bees while scale weighs them	732	Locomotive—oil-electric engine power house on wheels	760
Bicycle—propelled by oars	744	Map—on steering column easily read	712
Boats and Boating—collapsible canvas	785	Mask—double-walled rubber	744
Boots and Shoes—rubber oversoles for shoes	768	Microphone—for home use	816
Botany—plants possess "sixth sense"	774	Milk—lock handle for cans	810
Bottles—capper for glass	776	Model	
Box—inlaid, contains eleven thousand pieces	734	knife-carved model engine has moving parts	743
Bridge—to cost seven million dollars	782	of insects as big as dogs	797
Camping—tent and bed combined	710	plane flies fifteen minutes	767
Cave—man-made on beach	759	plaster racing car	775
Clamp—improved for hose	757	ships that made history reproduced	735
Clothes Closet—rotary of steel	729	story of horse's evolution in	713
Concrete—paints and stains beautify	781	tiny vertical engine	794
Copper—single crystal seventeen inches long	808	Monkeys—captured with rum	810
Corn—suit and shoes of cornhusks	810	chimpanzees four times as strong as man	712
Crib—folding auto for child	800	Monument	
Diamonds—digging in the wilds	818	cast of Lincoln made in outdoor studio	813
Doorstop—rubber tired	747	marks scene of Indian battle	794
Education—school for doctors on train	718	shaft records deeds of western pioneers	801
Eels—answer dinner bell	782	to unknown British boy scout given by Americans	823
Egyptology—letters to Egyptian king brought to light	809	Mothballs—condensed gas from coal made into	713
Electric Battery—tester doesn't drip	757	Motorboat—in Venice canals	710
Electric Blower—for bathers	751	Motorcycle	
Electric Light		celluloid guard shields rider's whole body	824
hinged guard for bulb	798	detachable sidecar on cycle serves as boat	726
lamp makes own electricity	754	side wheels on aid in turns	711
safety for miners	709	Moving Pictures—Klieg light made harmless	813
that lights if tilted	794	Music	
Electric Railroad—fastest interurban line	778	jazz makers of other days	811
Electricity		roll editing saves natural expression	795
first engine used by Edison still in use	808	soft calms animals	801
forces fish to use safety ladders	733	National Academy of Sciences—at Washington	803
new clay and metal mixture aids electrical work	734	Navigation—fighting derelicts of sea	762
Eraser—in spring reel of typewriter	774	Navy—fires dead ahead	721

Cigarette and
match box combined 798

[Continued on Page 4]

[Contents—Continued]

Ocean—temperature on coast rises fifteen degrees	736
Octopus—man wrestles with to test its strength	753
Office Supplies—code check for restaurants	810
Ornament and Decoration—running brook in restaurant	768
Pail—folding canvas camping	735
Parachutes	
plane landed by giant	705
secrets of taught at school	752
Pencil—holder	748
Petroleum	
floating top on oil tanks to prevent fires	753
mines in place of wells for oil proposed	784
Phonograph	
chance bit of cheese improves	709
twin tonearms on	758
Photography—tricks in	799
Photography (Aerial)—camera pierces smoke	761
Plow—motor, one-wheel, works close to tree	746
Police—shadow box to end third degree	817
Radio	
first test of wireless aided by relay operator	768
programs in hospitals help patients	728
Radio Aerial—model house wired for radio	833
Radio Apparatus—multiple connector for experimental	
circuits	828
Radio Application	
guns and radio in peace time protect ships in fog	783
radio eye enables you to see stars in studio	777
Radio Battery	
testing dry cell batteries	836
correct C-battery voltage important	833
Radio Broadcasting	
making German radio plays realistic	837
signal fading worst at 300 miles	754
Radio Cabinet—of striling design	829
Radio Condenser—fixed condenser kinks	834
Radio Construction—plug-in coils for short waves	833
Radio Gridleak—button and match make variable grid-	
leak	838
Radio Operation	
device to reduce interference and static	836
how to eliminate squeals and howls	832
Radio Receivers—set tunes from 15 to 550 meters	825
Radio Switch—power control switch	838
Railroad	
greatest feat of railroading in Mexico	770
progress	795
rail defect detector	800
Rats—catching live rats by hand	778
Razor—sharpener for	728
Red Cross—work	788
Refrigerator—iceless of earthenware	796
Safety Movement	
clown teaches children fire dangers	824
mock graves on boulevard teach safety	729
Sander—twin belt saves labor	750
Saws and Sawing Rigs	
double saw to cut notches	727
motor saw fits any bench	780
Scaffold—for window sills	783
Scales—for weighing boats help decide races	737
Screwdriver—of seven edges	813
Searchlight—on hotel roof	768
Self Defense—how to defend yourself	738
Shaving—box for traveler	823
Ships	
from clipper ship to motor liner	714
zinc corrosion plates for	816
Shipwreck—rumble from ocean clue to lost ship?	823
Signal—by windmill substitute for phone	798
Silk—fishing for	730
Siren—two-tone airplane aids landing	721
Ski—walking on calm water	731
Skyscraper—latest ideas in architecture in	727
Sleep—sound period less than five minutes a night	796
Smoke—screen tank to hide troops	708
Smokers' Accessories	
cigarets and matches in one package	798
private train piped for tobacco smokers	737
Snow—fight in Alps to clear auto roads	708
Soda Fountain—one-man walks Belgian streets	718
Soil—rain and snow fertilize	711
Speed—portable court for speeders saves trial delay	737
Stamping Press—branding press for walnuts	758
Steel—new hard to lower cost of machinery	710
Street Traffic Regulation	
congestion relief with arcades in buildings	748
traffic markers placed with air compressor	708
Sun—measuring heat of to aid weather forecasts	748
Survey—towers higher than trees aid	750
Table—3,000 pieces, made of wood and metal	767
Telephone—exchange in New York	761

Toys	
hobbyhorse run by rocking	787
playhouse a family heirloom	795
Trapdoor—in fire station shields sleeping rooms	757
Trees—big stump serves as register for tourists	743
Tunnel—dug around tunnel without halting traffic	712
Turkey—where your turkey comes from	755
Umbrella—folding for auto	752
Violin—played with keyboard	711
Vise—for bending small pipe	751
Vital Statistics—chart shows population gain	751
Voltmeter—made from discarded base tube	828
Washing Machine—engine for	730
Watch—strap clasp on wrist	784
Weather—how today's gets mapped	745
Wheels—of paper for cars	779
Winch—electric, freight car puller	736
Zebra—harness broken team	720

AMATEUR MECHANICS

Automobiles—Fuel—supercharger for small auto	860
Box—ornamental cigaret holder	846
Cooker—lard can steam cooker	845
Culverts—sling for transporting single-handed	856
Footstool—small, convenient on train	855
Ford Car—improvised spring perch holder	846
Furnace—swinging door	848
Garage—keeping doors snug	843
Gas Station—compressed air forces gas from hose	844
Guns—how to take care of	839
Heating Plant—register screen	843
Lamps—draining vapor	856
Magnifying Glass—spectacles make	845
Mask—false eyes make comic design	855
Milk—insulated box for the milk bottle	844
Moving Pictures—motor runs toy projector	859
Musical Instrument—lightweight mute for trombone	845
Roof—platform for paint pail	860
Ship—build your own ship model	849
Sign Painting—tool box	846
Silhouettes—how to make spatter	847
Soot—cleaning chimney with zinc	855
Taboret—how to make a sewing basket	857
Tire—keep up balloon pressures	858
Wax—preparing floor	860
Wire—straightening	859

SHOP NOTES

Ammonia—safety rules for working around	864
Automobiles—Repairing—water jacket repaired with-	
out welding	872
Baseboards—proper application of	872
Belt—installing new in factory	870
Bottles	
bumpers for	874
milk-bottle carrier	878
Brick—cleaner from hacksaw blades	879
Carburetor—metal float for special fuels	870
Cistern—how to build the form work for a concrete	867
Clamp—on triangle holds French curve	879
Comb—for shop sweeping brush	863
Compressed Air—saving time in testing air	865
Copper—hammered copper work	873
Drill—handy press accessory	863
jig for center drilling keyways	871
Glue—for cardboard	876
Grinder—homemade	879
Holder—swiveling work	866
Lubrication—acid test for oil	866
Masonry—eliminating air leaks in stone foundations	869
Motor Truck—side hitch for	869
Outboard Motor—use for power	861
Packing—piling round bar stock	876
Photography—light-proof door for photographers	875
Pneumatic Tool—absorbing the shock of an air hammer	871
Poultry—injector for administering capsules	868
Pump—winter shelter for pump and engine	866
Receptacle—can saves varnish	864
Safety Devices and Measures—pulley guard	871
Saws and Sawing Rigs—increasing usefulness of saw	864
Tap—extension handle on tap	878
Tractor	
attaching packer to tractor when plowing	876
to guide tractor with a door spring	863
used to wind up fence wire	865
Varnish—rubbing down	879
Woodwork	
embossing	877
mirror helps do dado work	878

786

Radiator

746

Stamping outfit for load sellers

DRAKE'S PRACTICAL MECHANICAL BOOKS

THEY WILL RAISE YOUR PAY—

ORDER ON 5-DAY TRIAL

The books listed below will perfect you in your chosen trade—pave the way to the big positions. Written in non-technical language—easy to read and understand. *Every book covers its subject completely. An entire course of instruction condensed into one volume.* Your choice sent postpaid—you benefit 5 days—money refunded in full if not entirely satisfactory. Order direct from this page.

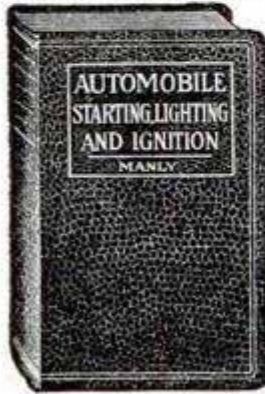

Automobile Books

- Automobile Starting, Lighting and Ignition, by Manly... 700 pp. \$3.00
- Books' Automobile Handbook. \$2.00
- and Motor Car, Truck and Tractor, by Manly... Cloth \$1.50
- Automobile Battery, Care and Repair, by Manly... Leatherette \$2.00
- Motorcycle Handbook, by Manly \$1.50



Shop Practice Books

- Sheet Metal Workers' Manual... \$2.00
- Oxy-Acetylene Welding and Cutting... Cloth \$1.25
- Slide Rule and Logarithmic Tables. \$2.00
- Handbook for Millwrights... Cloth \$2.00
- Machine Shop Practice... Cloth \$2.00
- Mechanical Drawing and Machine Design... Cloth \$2.00

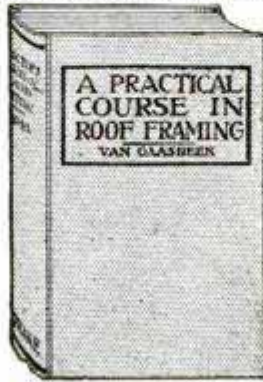

Carpentry Books

- Cloth Binding
- Modern Carpentry, 2 vols. \$3.00
 - The Steel Square, 2 vols. \$3.00
 - Modern Estimator... \$1.50
 - Timber Framing... \$2.00
 - Builder's Architectural Drawing... \$2.00
 - Concretes... \$1.50
 - Practical Bungalows... \$1.00
 - Roof Framing, by Van Gasbeek... \$1.50

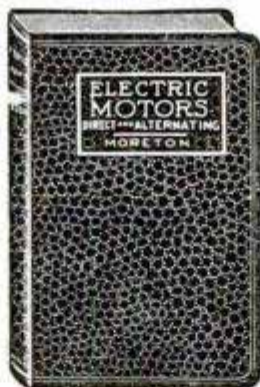

Electrical Books

- Telephony, Including Automatic Switching, by Smith, 450 pp. Leatherette \$2.50
- Practical Applied Electricity... \$2.00
- Wiring Diagrams and Descriptions. \$1.50
- Armature and Magnet Winding... \$1.50
- Electric Motors, D. & A. \$1.50



Painting and Decorating

- Ross Crane Book of Home Furnishing and Decoration... Cloth \$3.00
- House Painting Methods with the Brush and Spray Gun, by Vanderwalker, Cloth... \$2.00
- Interior Wall Decoration, by Vanderwalker... Leatherette \$4.00
- The Mixing of Colors and Paints, by Vanderwalker... Cloth \$2.00
- A Show at Sho' Cards... Cloth \$4.00
- Sign Painting, by Atkinson... Cloth \$4.00
- Strong's Book of Designs, Leatherette \$4.00
- Modern Painter's Cyclopaedia. Cloth \$2.00
- Automobile Painting... Cloth \$1.50
- New Hardwood Finishing... Cloth \$1.50
- Wood Finishing, Plain and Decorative... Cloth \$2.00
- Owen's Paint Guide... Cloth \$1.00

Steam Engineering

- Swingle's Handbook for Steam Engineers and Electricians. Leatherette... \$4.00
- Examination Questions and Answers for Marine and Stationary Engineers. Leatherette... \$2.00
- Steam Boilers... Leatherette \$2.00
- Swingle's Catechism of Steam, Gas and Electrical Engineering. Leatherette \$1.50

Modern Languages

- By Prof. P. S. Allen, U. of Chicago
- French without a Teacher... Cloth \$1.25
 - Spanish without a Teacher... Cloth \$1.25
 - German without a Teacher... Cloth \$1.25
 - Everyday French... \$1.25
 - Everyday Spanish... \$1.25

ORDER DIRECT FROM THIS PAGE—ON OUR MONEY-BACK PLAN

The books listed above are only a few of the many in our catalogue, which you will receive promptly after filling out and mailing us the attached coupon. For quick action order direct from this page—cross name of each book wanted and send in with price quoted. We prepay postage and send the books on our money-back plan.

FREDERICK J. DRAKE & CO.

PUBLISHERS

1008 Michigan Ave., Chicago

Drake Books Are For Sale at All Book Stores

Mail Coupon For Free Catalogue
Your Guide to Home Study

FREDERICK J. DRAKE & CO.
1008 Michigan Avenue
Chicago, Ill.

GENTLEMEN:—Please send me free, postage paid, your illustrated catalogue which lists and describes 200 Practical Mechanical Books for Home Study.

My name is

and my address

.....

I Was a Bookkeeper Now General Sales Manager —Would Not Take \$10,000 for My Training

"When I first enrolled for LaSalle training," writes R. B. Cook, a Chicago man, "I was a bookkeeper. Before I was half way thru my training I was promoted to Collection Manager, with an increase of 50 per cent in salary. Later I became Credit Manager of another concern. This move was a very decided promotion.

"My next advancement was to the position of Office Manager. In each of these positions I was successful, and this fact paved the way to my present position. Two years ago I was offered the post of Assistant Credit Manager with my present concern, which I accepted. Within two years I was made General Sales Manager, which position I now hold.

"This, Mr. Chapline, is my five-year record as a LaSalle member, and this was made possible thru your splendid training and the various services which I have used with much profit. Furthermore, it accounts for my enrollment in a second LaSalle course.

"Two years ago I wrote you that I would not part with the knowledge LaSalle training had brought me, for \$10,000. Today I can say that I would not part with it for several times that amount."



Nothing extraordinary about Cook's achievement. During only six months' time as many as 1,248 LaSalle members reported definite salary-increases totalling \$1,399,507, an average increase per man of 89 per cent.

The records of these men are all set forth, in brief, in a book entitled "A Geography of Success." It's a book well worth having, and it's yours for the asking. The following experiences are typical:

"Half way thru course—have had 3 promotions."

"Income increased from \$1,500 to \$6,000 a year."

"Promoted—salary increased 233 per cent."

Send for Salary-Doubling Plan

What's to prevent your equalling such

records—setting new records of your own? The coupon just below this text will bring you full particulars of the LaSalle *salary-doubling plan*—without the slightest obligation. Whether you adopt the plan or not, the basic information it will place in your hands, without cost, is of very real and definite value.

If a successful career is worth a 2c stamp and two minutes of your time, check the field of advancement that appeals to you, fill in your name and address, and place the coupon in the mail TODAY.

LASALLE EXTENSION UNIVERSITY

The World's Largest Business Training Institution

CLIP AND MAIL

LASALLE EXTENSION UNIVERSITY

Dept. 1164-R

CHICAGO

I shall be glad to have details of your *salary-doubling plan*, together with complete information regarding the opportunities in the business field checked below. Also a copy of "Ten Years' Promotion in One," all without obligation.

- | | | |
|--|---|---|
| <input type="checkbox"/> Business Management: Training for Official, Managerial, Sales and Departmental Executive positions. | <input type="checkbox"/> Railway Station Management: Training for position of Station Accountant, Cashier and Agent, Division Agent, etc. | <input type="checkbox"/> Modern Business Correspondence and Practice: Training for position as Sales or Collection Correspondent, Sales Promotion Manager, Mail Sales Manager, Secretary, etc. |
| <input type="checkbox"/> Modern Salesmanship: Training for position as Sales Executive, Salesman, Sales Coach or Trainer, Sales Promotion Manager, Manufacturer's Agent, Solicitor, and all positions in retail, wholesale, or specialty selling. | <input type="checkbox"/> Banking and Finance: Training for executive positions in Banks and Financial Institutions. | <input type="checkbox"/> Business English: Training for Business Correspondents and Copy Writers. |
| <input type="checkbox"/> Higher Accountancy: Training for position as Auditor, Comptroller, Certified Public Accountant, Cost Accountant, etc. | <input type="checkbox"/> Industrial Management: Training for positions in Works Management, Production Control, Industrial Engineering, etc. | <input type="checkbox"/> Effective Speaking: Training in the art of forceful, effective speech, for Ministers, Salesmen, Fraternal Leaders, Politicians, Clubmen, etc. |
| <input type="checkbox"/> Law: Training for Bar; LL.B. degree. | <input type="checkbox"/> Modern Foremanship and Production Methods: Training for positions in Shop Management, such as that of Superintendent, General Foreman, Foreman, Sub-Foreman, etc. | <input type="checkbox"/> Commercial Spanish. |
| <input type="checkbox"/> Commercial Law: Reading, Reference and Consultation Service for Business Men. | <input type="checkbox"/> Personnel and Employment Management: Training in the position of Personnel Manager, Industrial Relations Manager, Employment Manager, and positions relating to Employee Service. | <input type="checkbox"/> Expert Bookkeeping: Training for position as Head Bookkeeper. |
| <input type="checkbox"/> Traffic Management—Foreign and Domestic: Training for position as Railroad or Industrial Traffic Manager, Rate Expert, Freight Solicitor, etc. | | <input type="checkbox"/> C. P. A. Coaching for Advanced Accountants. |

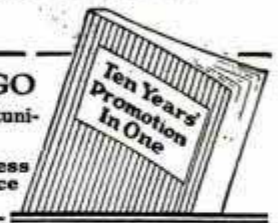

Name..... Present Position.....

Address.....

PLUMBERS & STEAM FITTERS



A new set—just out! A practical, illustrated, Reference Library and Study-Course for Master Plumbers, Journeyman and Apprentice Steamfitters, Gas Fitters and Helpers, Sheet Metal Workers, Draughtsmen, Master Builders, Engineers and all Building Trade Students. This valuable set of handy, pocket-size Guides explains in practical, concise language and well-done illustrations all the principles, advances and short cuts of the Plumbing and Heating trade—based on modern practice. Contains careful, detailed instructions on how to figure and estimate various jobs. Use **FREE COUPON** below to examine, without obligation, this valuable work.



AUDELS PLUMBERS & STEAMFITTERS GUIDES-4 Vols. \$6
1670 Pages—3642 Trade Illustrations

\$6 A Set

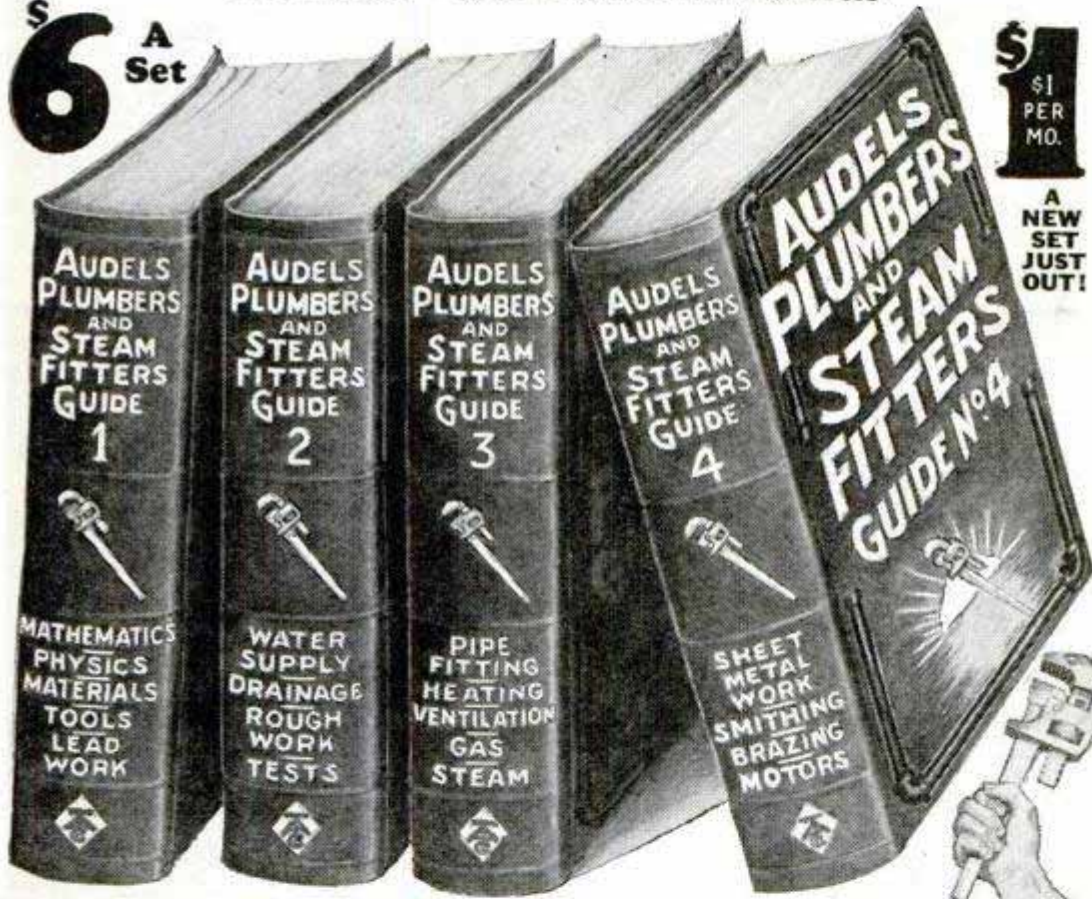

\$1 PER MO.

A NEW SET JUST OUT!

INFORMATION

Guides give complete instructions and practical modern data on the following important subjects:

MATHEMATICS—symbols, arithmetic, mensuration, trigonometry, tables.
PHYSICS—specific gravity, pressure, expansion, hydraulics, pumps.
MATERIALS—iron, steel, copper, brass, lead, tin, antimony, bismuth, zinc, asphaltum.
SHEET METAL—lead, tin, plate, galvanized, brass, bronze.
PIPE—wrought iron, steel welded, threads, tests, tubes.
TOOLS—square, level, plumb line, scriber, caulking, tap borer, pipe threading, torches, fire pots, etc.
SOLDERING—soft soldering, tinning.
JOINT WIPING—preparing joint, wiping, judging solder.
BENDING—distortion, tools used, hot and cold bends.
BEATING—lead flashing, gutter corners, etc.
SANITATION—cold water supply, syphonage, air pockets, circulation, etc.
HOUSE DRAINAGE—sewer, drain, stacks, traps, venting.
SEWAGE DISPOSAL—purification, cesspools, septic tanks, filter beds, disposal.
FIXTURES—bath, lavatory, shower, urinal, kitchen, storage tanks.
PIPE FITTINGS—hubs, spigots, laying length, cast soil fittings.
ROUGHING IN—layout for work, drainage, piping methods.
ACCESSORIES—valves, cocks, valve grinding, floats, tubing, thread fitting.
SOIL PIPE—joints, packing, caulking, wrought pipe, tools.
SCREWED PIPE FITTINGS—dimensions, forged, malleable brass, bends, joints, flanges.
DRAINAGE FITTINGS—recessed joints, properties of.
PIPE FITTINGS—threading offsets, elbows, pipe bending, assembling.
HEATING AND VENTILATION—steam, low pressure, vapor systems, vacuum, hot water, circulation, furnaces.
REFRIGERATION—ammonia compression, management of machines, various methods.
WATER SUPPLY—wells, city main, pumps, piping methods, tanks, repairs.
GAS AND GAS FITTING—producers, meters, fittings, pressure, flow, underwriters requirements.
SHEET METAL WORK—geometry, problems, patterns, mitering, bench machines, wiring, burring, edging, tucking.
BRAZING—Heating methods, brazing copper, lead burning.
WELDING—oxidation, various methods, blow pipe, thermit.
BLACKSMITHING—Forges, firing, fluxes, anvil work, forming, swedging, tempering.

Pocket Size—Easy to Carry and Read
FLEXIBLE BINDINGS—GOLD EDGES

These great self-educators teach the plumbing, heating and steamfitting trade in an easy step-by-step manner. There are thousands of practical examples, covering the entire trade—as well as new methods, new ideas, efficiency plans, short cuts, time and money saving suggestions. A practical and valuable Daily Helper on every plumbing job. Every point made clear with easily read text and clear illustrations and diagrams.

Complete Course for Home Study and Reference



Audels Plumbers and Steamfitters Guides give you, at a low price COMPLETE inside trade information and instruction. You can gain a thorough, practical knowledge of the trade by half an hour a day of easy reading. The definitions, tables, diagrams, descriptions, explanations, rules, sketches and illustrations will be found easy to follow and to apply to daily work.

Send No Money—Nothing to Pay Postman!

Send coupon now—today! Not a cent to pay until you have examined books. No obligation unless satisfied. This is your big opportunity for advancement.

FREE EXAMINATION COUPON

THEO. AUDEL & CO., 65 W. 23d St., New York.

Please send me (postpaid) for free examination, AUDEL'S PLUMBERS and STEAMFITTERS GUIDES, 4 numbers. If satisfactory, I will send you \$1 within 5 days and \$1 monthly until \$6 is paid.

Name.....
Address.....
Occupation.....
Reference..... 11T30

NOW FREE



B. W. COOKE
Directing
Engineer

I WILL TRAIN YOU AT HOME



CLIP COUPON
5
BIG OUTFITS
Free
OF EXTRA COST

EARN up to \$150 a Week!

If you're earning a cent less than \$60 a week, *clip coupon now*. Get the **PROOF** that you can be on your way to **BIG PAY** as an Auto Expert **QUICK!** See for yourself how fascinating this training is—how easily you can master Auto Work right in your own home—and how **quickly** you can get in line for the **big Auto Jobs** that pay up to **\$150 a week and more**—or a Money-Making Auto Business of your own! Remember these Instruction jobs come to you **ABSOLUTELY FREE** and without obligation. *Clip coupon now.*

I'll train you AT HOME Get these free Instruction Jobs now. See how thorough, how complete "JOB-WAY" Training is—includes all Electrical work—Ignition, Starting, Lighting—all Mechanical, also Welding, Brazing, Vulcanizing—also Business Course, Salesmanship, Advertising—How to keep simple Books—also Students' Magazine, also 5 working Outfits. Nowhere else can you get this original genuine, copyrighted B. W. Cooke "JOB-WAY" Training.

This Big Auto Book Also FREE Coupon brings this startling, revolutionary Auto Book, too, absolutely Free! Shows how hundreds of men have reached Big Pay in amazingly quick time! Shows what you can do. Send for it now!

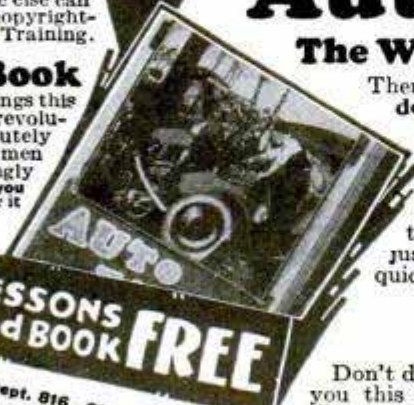

TO PROVE

that "JOB-WAY" is "PAY-RAISE" Training

Clip coupon now. I'll send you **absolutely FREE OF CHARGE**—with positively *no obligation* on your part—6 "JOB-WAY" Instruction JOBS! and my big book. I want you to *SEE* for yourself just why "JOB-WAY" Training is bringing so many men **Big Money** in such *remarkably quick time*. I want you to see how men *without a day's previous auto experience*—and only *common schooling* become Garage Owners, Superintendents, Managers, and earn up to **\$150 a week and more!** I want you to see why Hundreds of men have found "JOB-WAY" Training to be such interesting, most practical money-making training!

That's why I make you this unusual offer—with absolutely no strings on it and **not a single penny's charge**. Clip coupon now and I'll rush your jobs to you *absolutely Free!*

Be An Auto Expert

The World's Biggest Business Needs You!

There are so many tremendous Opportunities in this gigantic Auto Industry that I want every ambitious man *who really wants* to make more money, to have these 6 Instruction Jobs, just to see how easily and quickly I can boost his pay

way up. Just think! **Seven thousand Millions of Dollars** are paid to Auto men every year for *upkeep alone*—**Nineteen Million Dollars a day!** Think what that means to you—the Big Pay Opportunities open to you as an auto expert! It's the one field for the man who wants a **BIG pay check!** Learn all about it now!

Act Quick!

Don't delay a minute. Send coupon right now while I can still make you this special offer of 6 Auto Instruction Jobs absolutely free—as well as my Big Auto Book, free too! Act now!

SEND ME LESSONS and BOOK FREE
B. W. COOKE, 1916 Sunnyside Ave., Dept. 816, Chicago
Send me **absolutely FREE** and without any obligation on my part, 6 Auto Instruction Jobs. Also your Auto Book **FREE** and full particulars of your 5 Outfits Offer.
Name
Address
Town State

B. W. COOKE Directing Engineer
Chicago Motor Training Corporation
1916 Sunnyside Ave. Dept. 816 CHICAGO, ILL.



Salary Increased 300% in few months

Chief draftsman of big company received big increase even before he had completed his course with the I. C. S.

"AT THE time I started my I. C. S. course I was working in a paper mill," writes A. J. Hutchins, Chief Draftsman of the American Strawboard Co.

"Before I had completed the course I was called upon to make drawings in one of the company's largest mills and was appointed Superintendent of Construction at a 300% increase in salary."

Every mail brings letters from students of the International Correspondence Schools telling of increases in salary due to spare-time study.

Jesse G. Vincent was a toolmaker before he enrolled with the I. C. S. He is now Vice-president of the Packard Motor Car Company. Walter Chrysler, President of the Chrysler Motor Corporation, is also a former I. C. S. student. So is "Eddie" Rickenbacker, the famous flying ace, who is now President of the Rickenbacker Motor Company.

An I. C. S. course enabled Fred W. Southworth to leave a poorly paying job that he had held for twenty years and get a position as a salesman. In six months he also had increased his salary more than 300 per cent.

Aubrey B. Carter, another I. C. S. student, is now Secretary to the U. S. Comptroller of the Currency in Washington. He was a telegraph operator when he enrolled with the I. C. S.

George A. Griebel is another man who lifted himself out of the rut by spare-time study. He was a stone cutter earning \$15 a week when he enrolled with the I. C. S. He now has his own architectural and engineering business in Cleveland and his income is "between \$10,000 and \$15,000 a year."

If the I. C. S. can help these men to get out of the rut and make good, it can help you too. If it can raise the salaries of other men, it can raise yours! At least find out how.

Mail the Coupon for Free Booklet

INTERNATIONAL CORRESPONDENCE SCHOOLS
Box 5608-E, Scranton, Penna.

Oldest and largest correspondence schools in the world

Without cost or obligation on my part, please tell me how I can qualify for the position or in the subject before which I have marked an X:

- | | |
|---|--|
| <input type="checkbox"/> Mechanical Drawing | <input type="checkbox"/> Structural Drafting |
| <input type="checkbox"/> Draftsmen's Course | <input type="checkbox"/> Ship Drafting |
| <input type="checkbox"/> Architectural Drawing | |
| <input type="checkbox"/> Electrical Engineering | <input type="checkbox"/> Architect |
| <input type="checkbox"/> Electric Lighting | <input type="checkbox"/> Architects' Blueprints |
| <input type="checkbox"/> Mechanical Engineer | <input type="checkbox"/> Contractor and Builder |
| <input type="checkbox"/> Machine Shop Practice | <input type="checkbox"/> Concrete Builder |
| <input type="checkbox"/> Railroad Positions | <input type="checkbox"/> Structural Engineer |
| <input type="checkbox"/> Gas Engine Operating | <input type="checkbox"/> Chemistry <input type="checkbox"/> Pharmacy |
| <input type="checkbox"/> Civil Engineer | <input type="checkbox"/> Automobile Work |
| <input type="checkbox"/> Surveying and Mapping | <input type="checkbox"/> Airplane Engines |
| <input type="checkbox"/> Metallurgy <input type="checkbox"/> Mining | <input type="checkbox"/> Agriculture and Poultry |
| <input type="checkbox"/> Steam Engineering <input type="checkbox"/> Radio | <input type="checkbox"/> Mathematics |
| BUSINESS TRAINING COURSES | |
| <input type="checkbox"/> Business Management | <input type="checkbox"/> Salesmanship |
| <input type="checkbox"/> Industrial Management | <input type="checkbox"/> Advertising |
| <input type="checkbox"/> Personnel Organization | <input type="checkbox"/> Better Letters |
| <input type="checkbox"/> Traffic Management | <input type="checkbox"/> Show Card Lettering |
| <input type="checkbox"/> Business Law | <input type="checkbox"/> Stenography and Typing |
| <input type="checkbox"/> Banking and Banking Law | <input type="checkbox"/> Business English |
| <input type="checkbox"/> Accountancy (including C.P.A.) | <input type="checkbox"/> Civil Service |
| <input type="checkbox"/> Nicholson Cost Accounting | <input type="checkbox"/> Railway Mail Clerk |
| <input type="checkbox"/> Bookkeeping | <input type="checkbox"/> Common School Subjects |
| <input type="checkbox"/> Private Secretary | <input type="checkbox"/> High School Subjects |
| <input type="checkbox"/> Spanish <input type="checkbox"/> French | <input type="checkbox"/> Illustrating |

Name.....

Street.....

Address.....

City..... State.....

Occupation.....

If you reside in Canada, send this coupon to the International Correspondence Schools Canadian, Limited, Montreal

The International Correspondence Schools are the oldest and largest

Aviation Booms!

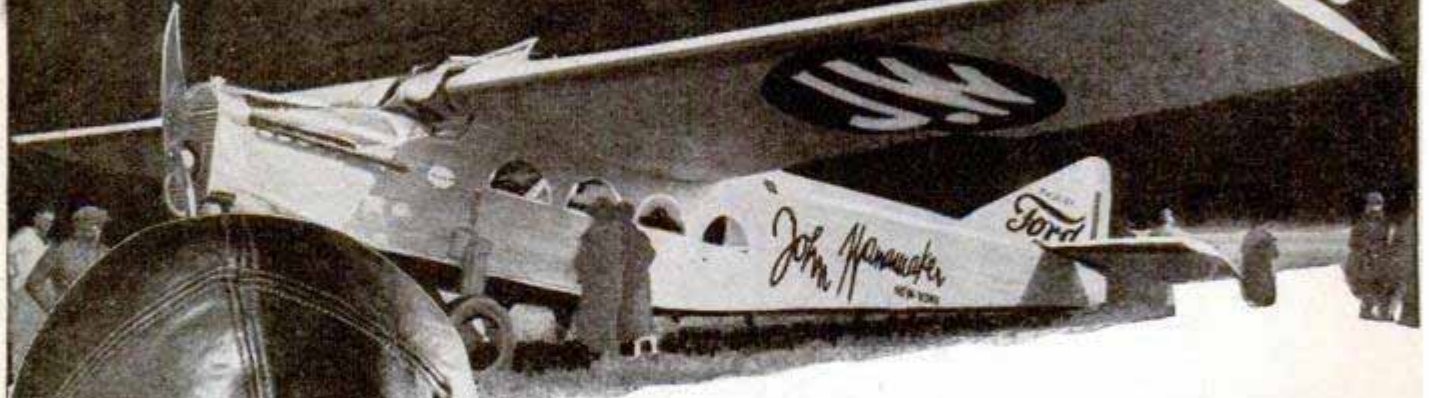

If You Want Thrills- Popularity-Big Pay LEARN AVIATION QUICK!

Aviation, With All Its Fascinating Adventure, Demands Red-Blooded Young Men! And Will Pay Them Magnificent Sums! Read How Aviation's Best-Known Pioneers Will Help YOU to Qualify for One of the Big Jobs! Send Today for Your Copy of Our FREE Illustrated Book, Listing and Describing Positions That Pay \$4000 to \$10,000 a Year!



AVIATION, the most thrilling of all 20th century professions, is growing so swiftly that one can hardly keep track of all the astonishing new developments. Air-mail routes have just been extended to form a vast aerial network over the entire U. S. Air-lines and airplane factories are springing up all over the country. Men like Henry Ford are investing Millions in the future of commercial Aeronautics in America! The possibilities are so tremendous that they stagger imagination!

Everything is set for the greatest boom in history. The fortunes that came out of the automobile industry and out of motion pictures will be nothing compared to the fortunes that will come out of Aviation! There is just one thing holding it up:—lack of trained men! Even in the beginning thousands will be needed—and generously paid. The opportunities open to them cannot be over-estimated. Those who qualify quickly will find themselves on the road to undreamed of money—success—popularity—and prominence!

Start by Becoming an Aviation Expert This Easy Way

Think what Aviation offers you. Thrills such as you never had before! The praise and plaudits of the multitude. Ordinary salaries from \$75 to better than \$400 a week! And a chance to get in on the ground floor where rewards will be unlimited!

Get into this thrilling profession at once while the field is new and uncrowded. Now—by a unique new plan—you can quickly secure the basic training for one of these wonderful high salaried

jobs, at home, in spare time. Experts will teach you the secrets—give you all the inside facts that are essential to your success. And, better yet, the study of Aviation is almost as fascinating as the actual work itself. Every Lesson is chock-full of interest—and so absorbing that you actually forget you are studying. But best of all are the ultimate rewards you are fitting yourself to gain!

Send for FREE Book

Send the coupon for our new, free book, just out—"Opportunities in the Airplane Industry." It is vitally interesting, reads like a romance and tells you things about this astonishing profession you never even dreamed of. This book is so fascinating it could easily sell for a dollar. We offer a limited number FREE. Write for yours today.

AMERICAN SCHOOL OF AVIATION
Dept. 1358, 3601 Michigan Ave., Chicago, Ill.

Prepare for One of These BIG PAY JOBS

Aeronautical Instructor,
\$60 to \$150 per week
Aeronautical Engineer,
\$100 to \$300 per week
Aeroplane Inspector,
\$50 to \$75 per week
Aeroplane Salesman,
\$5000 per year and up
Aeroplane Builder
\$75 to \$200 per week

American School of Aviation,
Dept. 1358, 3601 Michigan Ave.,
Chicago, Illinois.

Without any obligation please send me FREE book "Opportunities in the Airplane Industry." Also information about your course in Practical Aeronautics.

Name.....

Address.....

City..... State.....

Learn Electricity

in Great Shops!

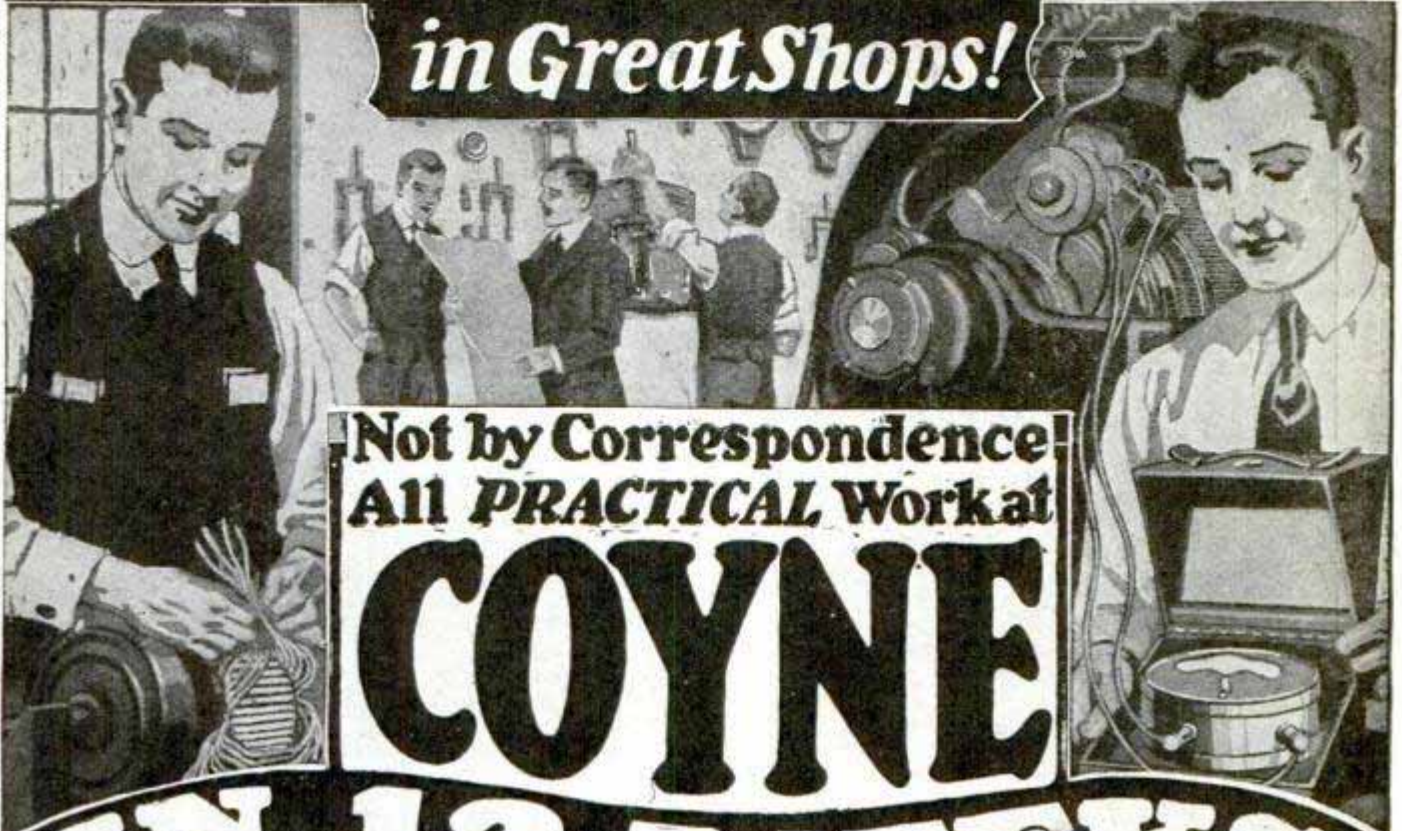

Not by Correspondence!
All PRACTICAL Work at

COYNE

IN 12 WEEKS

EARN BIG PAY

MAKE \$200 to \$800 A MONTH

Why work for small pay? Why make \$25.00 or \$30.00 or even \$40.00 a week in a hard job doing dirty, disagreeable work, and never sure of your job? With COYNE ELECTRICAL TRAINING you can make \$200.00 to \$800.00 a month. You will do pleasant work, and many jobs give you an opportunity to travel. Advancement will be quick—steady work the year around. YOUR SERVICES WILL ALWAYS BE IN DEMAND ANY PLACE, or you can own your own business.

**No Books — No Lessons
— You Do Actual Work**

I don't teach you a lot of useless theory. I give you a useable knowledge on the same kind of Electrical Machinery as used in Power Houses, plants and big industrial businesses.

**You Don't Need Education
or Previous Experience**

I don't require that you have a lot of book learning. You don't need advanced education or any previous education to master my course. Put your faith in me and I'll make you independent and happy.

COYNE ELECTRICAL SCHOOL

Dept. 86-72 1300-1310 W. Harrison St.
CHICAGO, ILL.



H. C. Lewis, Pres.

My Employment Department will assist you in securing a part time job to earn living expenses while training, and will assist you to a big pay job on graduation and any time thereafter for life.

Get My Free Book

This big handsome new book size 12x15 with over 150 actual photographs will be sent absolutely Free if you send coupon now.

**Free Railroad Fare
and Two Big Courses**

For a short time I will pay your RAILROAD FARE to Chicago from any part of the United States, and besides, I'll include my RADIO and Automotive Electrical Course. All given Free with my big NEWLY ENLARGED ELECTRICAL COURSE for a short time only.

**Earn While
You Learn**

H. C. Lewis
President
COYNE

Electrical School

1300-10

W. Harrison St.

Dept. 86-72

Chicago, Illinois

Dear Sir:—Please send me absolutely FREE your big new book and full particulars of your special offer of two extra courses FREE and Free Railroad Fare.

FREE RAILROAD FARE

Name _____

Address _____

Town _____

State _____

MAIL THIS COUPON NOW!



11001 5M1 0V10



\$2500 Reward!

For the Capture of an Unknown Man

Twice he had entered the St. Clair Mansion. What was he after? Who? What was in danger?

Berteau, the famous detective, had warned St. Clair that *the mysterious marauder would come again*. And now—a noise in the passage! The creak of an opening door. A shot in the dark! A capture!

Is this wounded stranger the mysterious intruder? Who could tell? Yet Berteau identified the man without hesitation and won the \$2500 reward.

How did he do it? Easy enough for the Finger Print Expert. He is the specialist, the leader, the *cream* of detectives. Every day's paper tells their wonderful exploits in solving mysterious crimes and convicting dangerous criminals.

More Trained Men Needed

The demand for trained men by governments, states, cities, detective agencies, corporations, and private bureaus is becoming greater every day. Here is a real opportunity for YOU. Can you imagine a more fascinating line of work than this? Often life and death depend upon finger print evidence—and big rewards go to the expert. Many experts can earn regularly from \$3,000 to \$10,000 per year.

Learn at Home in Spare Time

And now you can learn the secrets of this science at home in your spare time. Any man with common school education and average ability can become a Finger Print Expert in a surprisingly short time.

Course in Secret Service

FREE

UNIVERSITY OF APPLIED SCIENCE
Dept. 13-58—1920 Sunnyside Ave., Chicago, Illinois

Gentlemen:—Without any obligation whatever, send me your new, fully illustrated, FREE book on Finger Prints and your offer of a FREE course in Secret Service Intelligence and the Free Professional Finger Print Outfit.

Name

Street Address

City and State

For a limited time we are making a special offer of a professional Finger Print Outfit, absolutely Free, and Free Course in Secret Service Intelligence. Mastery of these two kindred professions will open a brilliant career for you.

Write quickly for fully illustrated free book on Finger Prints which explains this wonderful training in detail. Don't wait until this offer has expired—mail the coupon now. You may never see this announcement again! You assume no obligation—you have everything to gain and nothing to lose. Write at once—address

University of Applied Science

Dept. 13-58 1920 Sunnyside Avenue, Chicago, Illinois



New Way to Learn ELECTRICITY

at Home in Spare Time

HERE'S BIG NEWS for men interested in Electricity. If you are now earning less than \$40 a week, here's the **QUICKEST** way to an Electrical Expert's job at \$60 to \$125 a week. The first announcement of our new, rapid, simplified way to train you at home in spare time, with **Lessons, Job-Tickets and Outfits**. Lessons which take the mystery out of Electrical principles—**Job-Tickets** which apply what you learn in lessons, and give you step-by-step directions for doing actual Electrical work. **Outfits** of standard tools and materials with which you **DO THE JOB**. Read this sensational announcement. It opens the way to a better job and bigger pay.



with Lessons

1.

The Laws of Electricity made easy to understand—in simple language—written for the man who has had only common schooling. This training starts with the simplest principles of Electricity and progresses by easy stages until it gives you Electrical Engineering subjects, Electrical Drafting, Automotive Electricity and Radio.

New Way to Start!

Find out if you like Electrical work—find out if our lessons and job-tickets are **EASY** to master. Don't take our word for it—**SEE** for yourself before you decide. **START** with the **COUPON**, below. We'll send you 5 Job-tickets absolutely **FREE**—the same material sent to new students when they pay their money and enroll—to prove that you can learn at home in your spare time—to prove this training is honest, complete, simple.

with Job-tickets

2.



A wonderful new system originated at the American School. After you have the theory from the lessons, we virtually send you "out on the job" with job-tickets and outfits. The job-tickets are illustrated and give one-step-at-a-time directions for doing practical work. They show which materials and tools to use and tell you shortcuts and new ideas used by **EXPERTS!**



with Outfits

3.

Seven outfits of standard tools and materials now supplied without extra charge to every student. With lessons to explain **WHY** and Job-Tickets to tell you **HOW**, this valuable equipment enables you to get a **PRACTICAL** slant on Electricity—**QUICK!** Every student is furnished these outfits.

1. Soldering Furnace
2. Electric-light Wiring Equipment
3. Bell Wiring Equipment
4. Voltmeter and Compass
5. Transformer
6. Radio Receiving Set
7. Standard Power Motor



This \$10 Power Motor included in Outfits given to our students

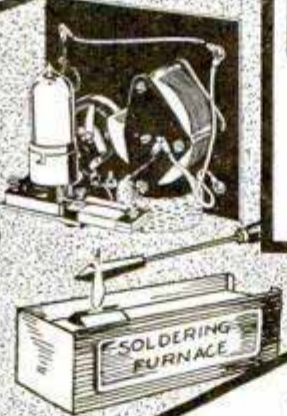

Success for You in Electricity—or Your Money Refunded!

When we accept your enrollment for this wonderful home-instruction in Electricity we give you an agreement in writing that we will help you find a well-paid Electrical position within 60 days after you finish, or every penny you have paid will be refunded.

5 Job-tickets FREE

FREE Job Service

We can often aid students to find a beginner's job soon after enrolling.

American School Now beginning its 30th year of service. Chartered as an Educational Institution. Not one dollar in profits has ever been paid out; every cent received for tuition has been returned to our students in instruction and service. Over 200 educators, executives and engineers have prepared the instruction we offer.

Send no Money!

Chief Engineer DUNLAP
Electrical Division, American School,
Dept. E-874-A, Drexel Ave. & 58th St., Chicago
Send me, please, 5 Job-Tickets, absolutely Free, and facts about the great Electrical business.

Name.....
Street No.....
City.....State.....

American School Dept. E-874-A, Drexel Ave. and 58th St. **Chicago**

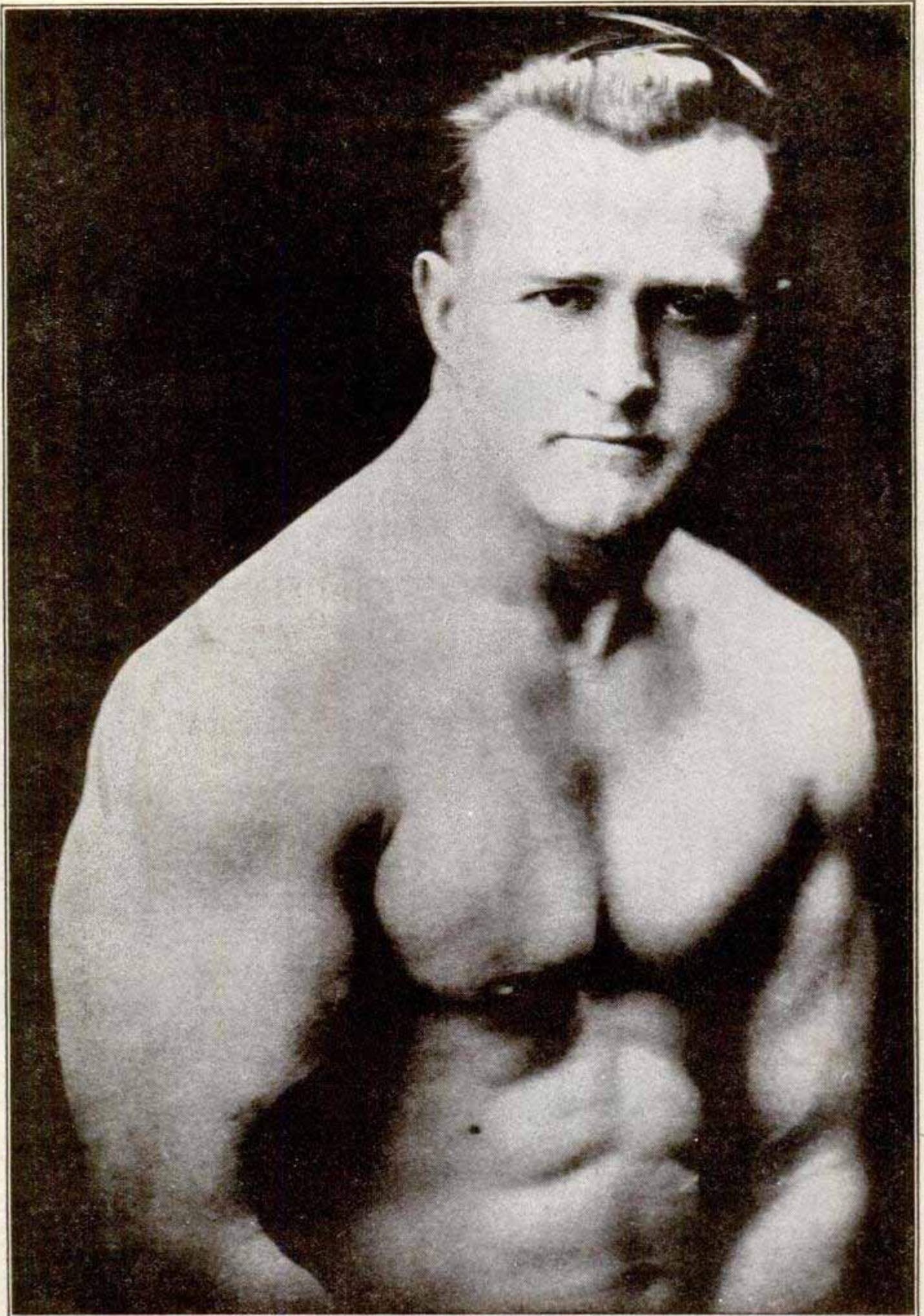

EARLE E. LIEDERMAN, *The Muscle Builder*
Author of "Science of Wrestling," "Muscle Building," "Secrets of Strength," "Here's Health," "Endurance," etc.

Earle Liederman Says:-

- 1 "He Can Make Anyone Strong"
- 2 "He Can Put One Inch on Your Arm in 30 Days"
- 3 "He Can Put Two Inches on Your Chest in 30 Days"
- 4 "He Will Give You a Physique To Be Proud of"
- 5 "He Will Add Many Healthy Years To Your Life"
- 6 "He Will Make You The Popular Idol of Your Gang"
- 7 "He Will Take The Wrinkles Out of Your Spine"

He Doesn't Promise— He Guarantees

He has done all these things and more for thousands of others. That's why he backs up his statements with an iron-clad guarantee. You want muscle—you want health and you want the pep that only supermen have. You can have them all—almost as quick as a wink!

Put Him to the Test

An ounce of action is worth a thousand words. Make him prove that he can put one inch of muscle on your arm and two inches on your chest in less than 30 days. Make him prove that he can make anyone strong. Make him prove that he can give you a physique to be proud of. Make him prove that he will add many healthy years to your life. Make him prove that he will make you the popular idol of your gang. Make him prove that he will take the wrinkles out of your spine. He likes to be challenged because he is sure he can make good. Put him to the test. His guarantee protects you against risk.

You Can't Lose

If Liederman doesn't make good every promise, you are out nothing. He takes all the risk. He has guaranteed to make physical marvels out of all sorts of muscleless men, for years—that's why they call him the muscle builder. You'll call him that, too, before 30 days.

He Never Fails

He discovered the secret of muscles and health. And he knows how to give help to others. He doesn't give you a lot of "don't's." He tells you what to do. He gives you the "know-how" of strength getting. That's why he never fails.

Send For My New
64 Page Book

"Muscular Development"

IT IS FREE

It contains forty-eight full-page photographs of himself and some of the many prize-winning pupils he has trained. Many of these are leaders in their business professions today. He has not only given them a body to be proud of, but made them better doctors, lawyers, merchants, etc. Some of these came to him as pitiful weaklings, imploring him to help them. Look them over now and you will marvel at their physiques. This book will prove an impetus and a real inspiration to you. It will thrill you through and through. The book is yours. He wants you to have it with his compliments. Keep it. This will not obligate you at all, but for the sake of your future happiness and health, do not put it off. Send today—right now before you turn this page.

EARLE E. LIEDERMAN

Dept. 2011, 305 Broadway, New York City

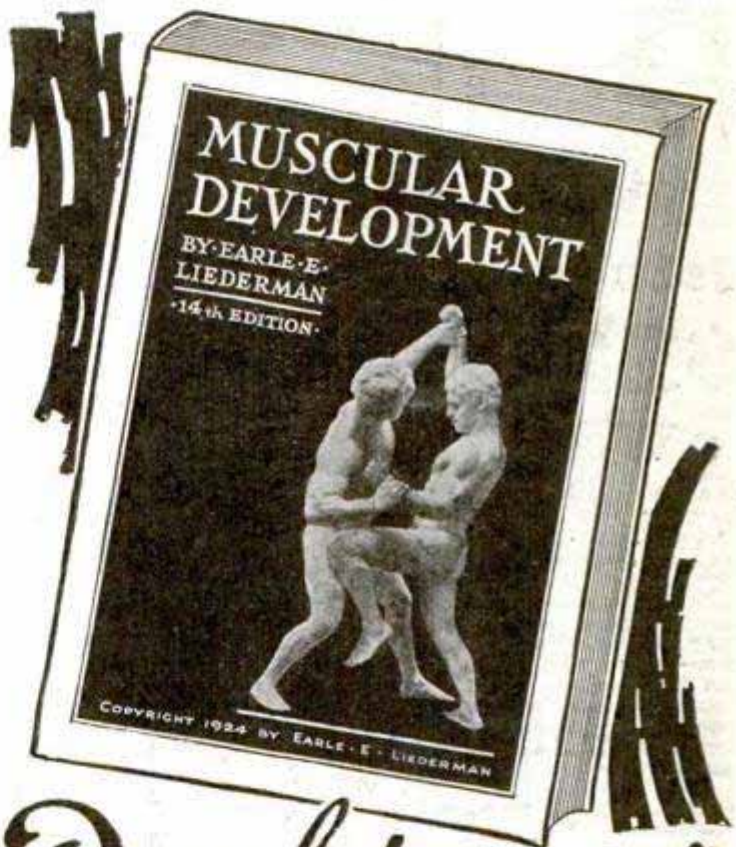

It
Is
F
R
E
E

DON'T
SEND ONE
PENNY

—
YOUR
NAME
AND
ADDRESS
ON A
POSTAL
WILL DO

EARLE E. LIEDERMAN,
Dept. 2011, 305 Broadway,
New York City.

Dear Sir: Without any obligation on my part whatever please send me a copy of your latest book, "Muscular Development."

Name.....

Address.....

City..... State.....

(Please write or print plainly.)

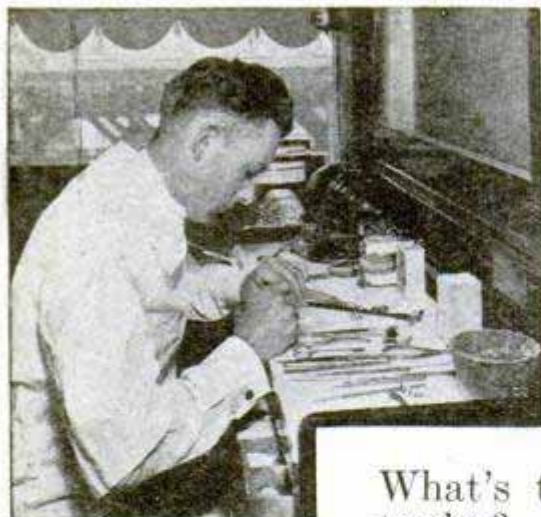

This Dental Laboratory Expert earns \$20 a day!

What's the use of training for the old, overcrowded trades? If you're going to prepare for big-salaried jobs or a profitable business of your own GET INTO THE NEWEST PROFESSION — "Laboratory Dentistry." Biggest opportunity for success of the century, because there are ten times as many jobs as men to fill them, because there are a dozen cities crying for Laboratories for each EXPERT capable of operating one!

Easiest, pleasantest work you ever saw! Your own boss, money and success yours from the very beginning. You can start with a "shoe-string." We prepare you in a few months to run a business of your own, to do any job. Common schooling, ability to use your fingers ALL YOU NEED! Free R. R. Fare to Chicago, Cleveland, Detroit, Boston or Philadelphia for a limited time!



Jobs Up to \$125 a Week!

In a business where there are many times as many jobs as Experts, salaries are high, hours are easy, opportunities are everywhere! Dentists recognize the high-standing of our graduates. No books here—learn with tools and instruments. Start quick—get ready in a few months for your big opportunity! Mail Coupon today!

FREE!
R. R. Fare
TO
Chicago
Cleveland
Detroit
OR
Boston

Rubber Plates

Learn to make partial upper or lower plates with soldered, cast or wire clasps, with palatal bars; with lingual bars. McCarrie-trained Students learn to make full rubber plates of every type, including Vulcanite base-plates, butted gums, carved gums, etc.

CROWNS

Here's only a small part of your practical training in Crown-work: Two-piece, seamless, open-face, Richmond, cast-base porcelain, Carmichael, split-pin, carved (swaged) cusp, cast cusp, etc.

BRIDGE WORK

Complete training in both fixed and removable bridgework. Interchangeable teeth, gold dummy, Sanitary porcelain dummy jobs—Roach, Gilmore, Bischoff and all forms of cast-clasp work is taught—not with books but in actual Laboratory.

METAL BASE DENTURES

Cast bases of Aluminum, Watt's metal, etc., are included in your training. Both centrifugal and air pressure casting machines are used. Free Book contains complete list of subjects in course.

64,000 DENTISTS NEED LABORATORY WORK!

Only a few hundred Laboratories in all the U. S.—most of them in Chicago and New York. Dentists can't afford to do their own mechanical jobs. They can buy the services of a Laboratory Expert at \$3.00 an hour and sell their own time at \$6 to \$15 an hour. Dentists will encourage you to learn mechanical work, start a "Lab" of your own, give them quicker service than sending their work to other cities. Dentists can't wait and keep their patients waiting.

WE HELP YOU OPEN A LABORATORY OF YOUR OWN!

Many of my graduates open a Laboratory of their own. To encourage more men to go into this wonderful profession, we will help you find a good location for your Laboratory, and help you make a success of it. Write for complete information on how you can find yourself in a profitable business of your own after you become a Dental Laboratory Expert.

INTERESTING BOOK—FREE!

Right this minute there are openings for 150 Dental Laboratory Experts in locations where they can do a business of \$5,000 to \$20,000 a year. But you can't cash in, take advantage of these OPPORTUNITIES until you're Trained. Catalog tells you how quickly and easily you can get ready, how hundreds of others have SUCCEEDED! Tells you how you learn in a few months BY DOING ACTUAL LABORATORY JOBS in the world's greatest Dental Laboratory Schools. Brings you FREE R. R. Fare offer and other big inducements. Write for free Catalog today!

EARN while you LEARN!
Day students make all or part cost of course by part-time night work. Night students can find plenty of good jobs "to see them thru."
We'll help you!

McCarrie School of Mechanical Dentistry

1338 S. Michigan Ave.
Dept. 37 Chicago, Ill.

McCarrie School of Mechanical Dentistry
1338 S. Michigan Ave., Dept. 37, Chicago, Ill.

Without obligation, please send me your Free R. R. fare offer and free Book with complete information about how I may become a Dental Laboratory EXPERT. How you will help me open a Laboratory, how you will help me find a job while I take my training, etc.

Name.....
St. No. or R. F. D.....
City.....State.....



J. E. GREENSLADE
President of the National Salesmen's Training Association.

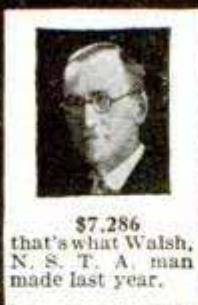

\$7,286
that's what Walsh, N. S. T. A. man made last year.



\$1,000 IN 30 DAYS
made by Hartle, a R. R. Mail Clerk for ten years.



\$13,500 FIRST YEAR
is what A. H. Ward made after taking this sales training.



BECOMES PRESIDENT
C. V. Champion's income for year to exceed 5 figure mark.

\$5,000 to \$10,000 a Year
for Men Who Read This Ad

Let Me Make You a Master Salesman!

This New Easy Way

I DON'T care what you are now or what you think. The Association of which I am president will take you in short, easy steps and make a Master Salesman of you, put you in the same class with the big pay men who have all the good things of life.

Many have thought that Salesmen were "born." And that idea has kept many men from succeeding. But this Association of Master Salesmen has proved that any man can be taught the rules and principles that make men Master Salesmen. And you know as well as I do that Salesmen top the list of money-makers. They are the producers and you can be one of them.

Easy as A, B, C

If you are as intelligent as the ordinary farmhand, postal clerk or stenographer, you can quickly master the simple A. B. C.'s of Selling. There are certain ways of approaching a prospect to get his undivided attention, certain ways to stimulate keen interest, certain ways to overcome objection, batter down prejudices, outwit competition and make the prospect act.

You can learn these principles at home in a short period of pleasant, inspiring study. And once you have mastered these secrets of Master Salesmanship, you can take advantage of the employment department of the Association without charge. They will help you select and secure a position as soon as you are qualified and ready.

This is a real opportunity, for during the last year the Association received calls for 49,880 salesmen from many of the leading sales organizations in America. And these men are the same as you see above—men

who make from \$5,000 to \$10,000 a year in salary and commission.

These are only four out of hundreds of similar records in the Association files. Our members make good because the Association has specialized for eighteen years in teaching the Art and Science of Salesmanship and teaches the most unusual principles ever laid down for quick success.

The book you see below has been the starting point for thousands of men who are now successful salesmen. This book, "Modern Salesmanship," is now FREE.

Rush the Coupon

If I were asking ten or twenty dollars for this book you might hesitate. But I am not. It is Free. And since it may mean the turning point in your life, when you leave forever behind you the drudgery and low pay of routine work for the fascinating, big pay job of the salesman, it certainly is worth your time and the two cents you will have to spend to get this amazing book and read for yourself the astonishing facts given between its two covers. You have everything to gain and not one cent to lose. So mail the coupon today, sure.



Dept. S-12

N. S. T. A. Building, Chicago, Ill.

NOW SENT FREE

The book that has shown thousands the way to amazing salary increases.

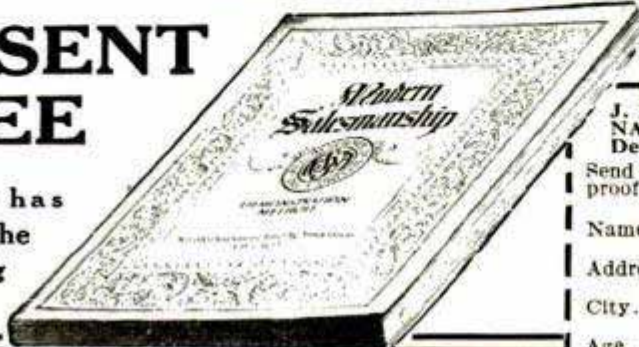

J. E. Greenslade, President
NATIONAL SALESMEN'S TRAINING ASS'N
Dept. S-12, N. S. T. A. Building, Chicago, Ill.

Send me FREE your book "Modern Salesmanship," and proof that I can become a Master Salesman.

Name.....

Address.....

City..... State.....

Age..... Occupation.....

Are you ever

Do YOU say "who" when you should say "whom"? Do you say "between you and I" instead of "between you and me"? Do you mispronounce common words in your speech or use them incorrectly when you write? . . . Many a man has been held down all his life and suffered untold embarrassment because of mistakes in English.

ashamed of

You do not need to make these mistakes any longer. Right at home, in spare time, in the privacy of your own room, you can make up the education you missed in the days that you should have been at school. The International Correspondence Schools will teach you, just as they have taught thousands of other men, by a simple new method which shows you instinctively which word to use and how to use it.

your English?

Mail the coupon today for Free Booklet

The International Correspondence Schools are the oldest and largest correspondence schools in the world.

INTERNATIONAL CORRESPONDENCE SCHOOLS
Box 5611-E, Scranton, Penna.

Without cost or obligation on my part, please tell me how I can qualify for the position or in the subject before which I have marked an X:

BUSINESS TRAINING COURSES

GOOD ENGLISH

- | | |
|---|---|
| <input type="checkbox"/> Business Management | <input type="checkbox"/> Salesmanship |
| <input type="checkbox"/> Industrial Management | <input type="checkbox"/> French |
| <input type="checkbox"/> Personnel Organization | <input type="checkbox"/> Advertising |
| <input type="checkbox"/> Traffic Management | <input type="checkbox"/> Better Letters |
| <input type="checkbox"/> Business Law | <input type="checkbox"/> Show Card Lettering |
| <input type="checkbox"/> Banking and Banking Law | <input type="checkbox"/> Stenography and Typing |
| <input type="checkbox"/> Accountancy (including C.P.A.) | <input type="checkbox"/> Civil Service |
| <input type="checkbox"/> Nicholson Cost Accounting | <input type="checkbox"/> Railway Mail Clerk |
| <input type="checkbox"/> Bookkeeping | <input type="checkbox"/> Common School Subjects |
| <input type="checkbox"/> Private Secretary | <input type="checkbox"/> High School Subjects |
| <input type="checkbox"/> Spanish | <input type="checkbox"/> Illustrating |

TECHNICAL AND INDUSTRIAL COURSES

- | | |
|---|--|
| <input type="checkbox"/> Electrical Engineering | <input type="checkbox"/> Architect |
| <input type="checkbox"/> Electric Lighting | <input type="checkbox"/> Blue Print Reading |
| <input type="checkbox"/> Mechanical Engineer | <input type="checkbox"/> Contractor and Builder |
| <input type="checkbox"/> Mechanical Draftsman | <input type="checkbox"/> Architectural Draftsman |
| <input type="checkbox"/> Machine Shop Practice | <input type="checkbox"/> Concrete Builder |
| <input type="checkbox"/> Railroad Positions | <input type="checkbox"/> Structural Engineer |
| <input type="checkbox"/> Gas Engine Operating | <input type="checkbox"/> Chemistry <input type="checkbox"/> Pharmacy |
| <input type="checkbox"/> Civil Engineer | <input type="checkbox"/> Automobile Work |
| <input type="checkbox"/> Surveying and Mapping | <input type="checkbox"/> Airplane Engines |
| <input type="checkbox"/> Metallurgy <input type="checkbox"/> Mining | <input type="checkbox"/> Agriculture and Poultry |
| <input type="checkbox"/> Steam Engineering <input type="checkbox"/> Radio | <input type="checkbox"/> Mathematics |

Name.....
Street Address.....
City..... State.....
Occupation.....

Persons residing in Canada should send this coupon to the International Correspondence Schools Canadian, Limited, Montreal, Canada

Learn to Write

I Teach by Mail

I CAN make a good penman of you at your home during spare time, no matter where you live or how poorly you now write. My simplified system has shown thousands of others the way to good penmanship during the past twenty years — it can and will do the same for YOU!

Beautifully Illustrated Book "How to Become a Good Penman" FREE!

It contains general information, with testimonials and beautiful specimens of penmanship showing what others have accomplished by the Tamblin System. (Your name elegantly written on a card if you enclose stamp for postage.) WRITE TODAY. Address

F. W. TAMBLIN
418 Ridge Bldg., Kansas City, Mo., U. S. A.

F. W. Tamblin

MUSIC LESSONS FREE

IN YOUR OWN HOME

You can read music like this quickly

Write today for our FREE booklet. It tells how to learn to play Piano, Organ, Violin, Mandolin, Guitar, Banjo, etc. Beginners or advanced players. Your only expense about 2c per day for music and postage used. **American School of Music, 51 Lakeside Bldg., Chicago**

IF YOU STAMMER

Write for my free book "Millard's Advanced Natural Corrective Course" and a free copy of my speech magazine. 10,000 cases successfully treated. Est. 24 years. Largest school for stammerers in world. Millard Inst. of Normal Speech, 2317 Millard Bldg., Milwaukee, Wis.

"BECOME A LIGHTNING TRICK CARTOONIST"

Send \$1.00 for Laugh Producing Program of 23 Trick Drawings with Instructions. Catalog of Chalk Talk Supplies Free. **BALDA ART SERVICE, Dept. 1, Oshkosh, Wis.**

GOVT. POSITIONS

\$35 TO \$75 WEEKLY

- | | |
|---|---|
| <input type="checkbox"/> Railway Mail Clerk | <input type="checkbox"/> Meat Inspector |
| <input type="checkbox"/> P. O. Clerk | <input type="checkbox"/> Special Agent (investigator) |
| <input type="checkbox"/> Forest Ranger | <input type="checkbox"/> Stenographer-Typist |
| <input type="checkbox"/> File Clerk | <input type="checkbox"/> Immigrant Inspector |
| <input type="checkbox"/> Matron | <input type="checkbox"/> City Mail Carrier |
| <input type="checkbox"/> General Clerk | <input type="checkbox"/> U. S. Border Patrol |
| <input type="checkbox"/> Chauffeur-Carrier | <input type="checkbox"/> Typist |
| <input type="checkbox"/> Skilled Laborer | <input type="checkbox"/> Seamstress |
| <input type="checkbox"/> Watchman | <input type="checkbox"/> Steno-Secretary |
| <input type="checkbox"/> Postmaster | <input type="checkbox"/> Auditor |
| <input type="checkbox"/> RFD Carrier | |

Mr. Ozment, Dept. 111, St. Louis, Mo.

Send me particulars about positions marked "X" —salaries, locations, opportunities, etc.

NAME.....
ADDRESS.....

FREE!



These Instruments FREE of Extra Cost

All instruments shown here and others—SIX BIG OUTFITS—sent to all our students free of extra cost under short time special offer. **Clip coupon now**—find out all about this big unequalled offer while you still have time to take advantage of it. Our training is intensely practical—these instruments help you learn to do the practical work. Receiving sets, from simplest kind to thousand-mile receiver. Many other big features.

My Radio Training Is the Famous "Course That Pays for Itself"

Spare time earnings are easy in Radio when you know it the way we teach you. Increase your income almost from the start of your course thru practical knowledge we give you. We show you how to hold the job, then our big Free Employment Department helps you get one. Free Book "Rich Rewards in Radio" tells how.

Howard B. Luce of Friedens, Pa., made \$320 in 7 weeks during his spare time. D. H. Sutt of Newport, Ark., writes, "While taking the course I earned in spare time work approximately \$900." Earl Wright of Omaha, reports making \$400 in a short time while taking his course—working at Radio in his spare time only! Sylvester Senso, 207 Elm Street, Kaukauna, Wis., made \$500. And when your training is completed you're ready to step into a real big Radio job like C. C. Gielow, Chief Operator of the Great Lakes Radio Telegraph Company; E. W. Novy, Chief Operator of station WRNY; Edward Stanko, Chief Operator of Station WGR; and hundreds of other N. R. I. trained men. The National Radio Institute, originators of Radio Home-Study Training, established 1914, today offers you the same opportunity these men had, under a bond that guarantees you full satisfaction or money refunded. It's your big chance to get into Radio!—mail coupon for FREE Book and proof!

"MEN! Here's the 'dope' you've been looking for—

How TO GET INTO THE RADIO BUSINESS"

J.E.S.

\$50 to \$250 a Week in Work That is Almost Romance

If you're earning a penny less than \$50 a week, clip coupon now for FREE BOOK! New book, profusely illustrated, tells all about the Radio Profession, thousands of openings—in work that is almost romance! YOU can learn quickly and easily at home, through our tested, improved methods, to take advantage of these great opportunities! Why go along at \$25 or \$35 or \$45 a week, when you can pleasantly and in a short time learn to be a Radio Expert, capable of holding the big jobs—paying \$50 to \$250 a week?

Clip Coupon for Free Book

Don't envy the other fellow who's pulling down the big cash! Our proven home-study training methods make it possible for you, too, to get ready for a better job, to earn enough money so you can enjoy all the good things of life. Most amazing book ever written on Radio tells how—thousands of interesting facts about this great field, and how we can prepare you, quickly and easily in your spare time at home, to step into a big-pay Radio job. You can do what thousands of others have done through our training. **GET THIS NEW FREE BOOK. SEND COUPON TODAY.**

J. E. SMITH, President

National Radio Institute
WASHINGTON, D. C.

Dept. OT-7

NOW!
Special
Short Time
Offer
6
BIG
OUTFITS

Radio
Needs
Trained
Men

National
Radio
Institute,
Dept. OT-7,
Washington,
D. C.

Dear Mr. Smith:
Without obligating me in any way, send me your big FREE BOOK, "Rich Rewards in Radio," and all information about your practical, home-study, Radio Course.

Name..... Age.....

Address.....

Town..... State.....

SEND THIS COUPON TODAY



Quick, Easy Way to Become an Artist



SCORES are now learning to draw who never dreamed they could. Wonderful quick method makes it easy for anyone to learn illustrating, Commercial Designing and Cartooning at home in spare time.

Earn big money as an artist. Good artists are in tremendous demand by Magazines, Advertisers, Newspapers, Department Stores, etc. Salaries from \$50 to over \$300 a week are gladly paid them! And now you can easily become an artist. Now you can easily prepare to enter this fascinating big paying field.

No Talent Needed

The simplicity of this method is astonishing. You will be amazed at your rapid progress. From simple straight lines and curves, you soon learn to make drawings that sell. It's just like a game—learning to draw at home this way. All your work receives through the mail the individual criticism of successful Art Instructors. It's fun learning—and almost before you realize it, you are able to make real professional drawings.

Coupon Brings FREE BOOK

A new, handsomely illustrated book has just been printed, which gives all the most up-to-date information on the scores of wonderful opportunities in Commercial Art and shows how this startling easy method enables you to enter this field. It tells about our students—their successes—what they say—actual reproductions of their work—how they made big money even while studying. This attractive book will be sent without cost or obligation. Send for it. Mail coupon now. WASHINGTON SCHOOL OF ART, Rm. 3011-D, 1115-15th St., N. W., Washington, D. C.

WASHINGTON SCHOOL OF ART,
Room 3011-D, 1115-15th St., N. W.,
Washington, D. C.

Please send me without cost or obligation your new book on art, "Quick Easy Way to Become an Artist," and details of your Attractive Offer.

Name.....
Mrs., Miss or Mr.

Address.....

City..... State.....

Young outdoor men wanted



To a few sturdy young men—lovers of fresh air and sunshine—who want to get away from the grind of indoor work—John Davey's national organization, The Davey Tree Expert Company, offers an exceptional opportunity. Constantly increasing demand will create a limited number of openings. Those young men selected will be thoroughly trained by the Company and given a permanent position if they make good. If you are single, between 20 and 30 years of age, free to travel, healthy, industrious, having a good practical education, and able to furnish satisfactory references, you have a good chance to qualify. Pay is good at start, advancement assured on merit. We want only men who desire permanent employment in a growing organization and will accept only clean, sturdy young men, thorough Americans, not afraid of vigorous outdoor work. Write for additional information and qualification blank to serve in place of personal interview. The Davey Tree Expert Co., Inc. 637 Federal Bldg., Kent, Ohio.

Welding

Become a Welding Expert! Then earn top wages or go into business for yourself. We train you at Home, in your Shop, or on the Job. "Kerr's Training Course for Welders" is a thorough course in practical experience, covering all metals. It trains you in WHAT TO DO and HOW TO DO IT. Write at once for terms and enrollment card. (State if you have the use of a welding outfit.)

KERR'S WELDING SCHOOL Dept. 2, 752 N. Broadway
LOS ANGELES, CALIF.

Learn Photography at HOME

Earn \$3,000 to \$10,000 a year. Prepare quickly during spare time. Also earn while you learn. New easy method. Nothing else like it. Send at once for free book, "Opportunities in Modern Photography" and full particulars. Special offer open now. International Studios, Inc., Dept. 1358, 3601 Michigan Ave., Chicago, U. S. A.

LEARN WATCHMAKING

and become independent. We help you secure a position.

Easy to learn. Send for FREE CATALOG.
ST. LOUIS WATCHMAKING SCHOOL, Dept. 5, ST. LOUIS, MO.

BE A JAZZ MUSIC MASTER

Play Piano By Ear

Play popular song hits perfectly. Hum the tune, play it by ear. No teacher—self-instruction. No tedious ding-dong daily practice—just 20 brief, entertaining lessons, easily mastered.

At Home in Your Spare Time

Send for FREE BOOK. Learn many styles of bass and syncopation—trick endings. If 10c. (coin or stamp) is enclosed, you also receive wonderful booklet "How to Entertain at Piano"—and many new tricks, stunts, etc.

Niagara School of Music
Dept. 900, Niagara Falls, N. Y.



Send for this Free Book

ELECTRICITY

Complete Study Course and Pocket Library \$10

SHIPPED FREE

A set of **HAWKINS GUIDES** is a true friend to the electrical worker. It tells you how to do any job the right way—without guessing or taking chances.



Hawkins Guides put all the facts about modern electrical engineering at your finger tips. Therefore your chances for advancement in the electrical field are unlimited.

HAWKINS GUIDES DOUBLE YOUR VALUE



Electricity is king! It is the ruling force of today—transportation, communication, light, heat, power—indeed every modern activity is dependent on electricity. Industry is crying for electrical men that know their jobs!

Hawkins Guides teach you all you need to know about electricity in easy, step-by-step lessons. Daily spare time reading of the Guides will greatly increase your value to yourself and your employer in a few weeks. Hundreds of our friends have written us and told us this!

READERS OF HAWKINS GUIDES KNOW HOW



"You can't stump him on an electrical job." "He certainly knows his business." "Certainly have to hand it to him for knowing how." —These are the things employers say about our friends who are readers of **Hawkins Guides**. No matter what question or problem comes up the Ready Reference Index enables you to give an expert answer at once.

HAWKINS STARTS YOU WHERE OTHERS LEFT OFF

Why should you work at low wages when easy reading of **HAWKINS GUIDES** will give you the money-making knowledge of the expert? Easy daily reading of the Guides will teach you in a few months what it has taken the expert a lifetime to learn!

With **HAWKINS GUIDES** in hand you have a running start to success in the electrical field. You will actually begin where others left off!



NOW!

This coupon is your golden opportunity. Tear it out—send it now!

FOR EXAMINATION!

REAL ELECTRICAL EDUCATORS

"Hawkins Guides at \$10 is the best investment I have ever made. Am able to take up almost any electrical job and have never gone to an electrical school."—**B. Roessler, Oenaville, Texas.**

AS EASY AS A. B. C.

"Everything in Hawkins Guides is very plain and anybody can read and understand them as easy as A. B. C."—**J. Knight, Tobyhanna, Pa.**

OTHER ENTHUSIASTIC READERS SAY

"Worth ten times their price." "Helped me to two raises in four months." "Better than a school of instruction." "Studied them when I was laid up and got further ahead than if I had been on the job."

Hawkins Guides Explain These Points So You Can Easily Understand:—

Magnetism—Induction—Experiments—Dynamos—Electric Machinery—Motors—Armatures—Armature Windings—Installing of Dynamos—Electrical Instrument Testing—Practical Management of Dynamos and Motors—Distribution Systems—Wiring—Wiring Diagrams—Sign Flashers—Storage Batteries—Principles of Alternating Currents and Alternators—Alternating Current Motors—Transformers—Converters—Rectifiers—Alternating Current Systems—Circuit Breakers—Measuring Instruments—Switch Boards—Wiring—Power Stations—Installing—Telephone—Telegraph—Wireless—Bells—Lighting—Railways. Also many Modern Practical Applications of Electricity and Ready Reference Index.

Hawkins Guides—10 POCKET SIZE NUMBERS

Each number easy to carry around and read in spare time. Big type and clear diagrams. Easy to study and learn. Durable, flexible binding—gold edges. 3,500 pages—4,700 illustrations. Shipped free for examination. Pay only \$1 a month if satisfied. Price of set, complete, \$10.

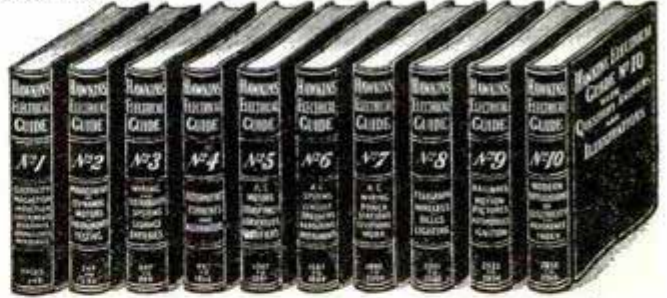

EXAMINE GUIDES FREE!

Let the Guides themselves demonstrate their practical value to you—as a study course, reference work and complete electrical library. You are the judge. Simply send this coupon. No obligation unless you are entirely satisfied. Tear out on dotted line—fill in—mail it NOW!

\$1 PER MO.

FREE EXAMINATION COUPON Theo. Audel & Co., 65 W. 23rd St., New York City
Please send me (postpaid) for my approval **Hawkins Electrical Guides**, 10 numbers (price \$1 each). If satisfactory I will mail you \$1 in 7 days and further mail \$1 monthly until purchase price of \$10 is paid.

Name

Address

Occupation

Employed by

Say Good Bye to Poor Pay!



Several Hundred more trained men needed NOW.

Several thousand more will be needed soon.

Your ONE BEST Opportunity to rise above small pay.

AGE NO BARRIER!

VERY PROFITABLE TRADE NOW OPEN TO ALL

Those looking for a Real Opportunity—good salaries, steady work, dignified and pleasant—demand great now and always will be—a chance to establish a business of your own if desired—can count their search at an end when they merely send us their name to receive full information about

MECHANICAL DENTISTRY

This is not a *new* trade. Dentists today do not have the time to make plates, bridges, crowns, etc., so they employ a mechanical dentist or send this work away to a dental laboratory. There is thus a wonderful demand for Mechanical Dentists—and the demand is only beginning!

IN THREE MONTHS

Easily learned by actual practice—no classes whatever—no previous training required. Ages range from 16 to 50. Opportunity, good pay, and advancement for all! Bodee training is recognized as best by dentists everywhere owing to our 34 years' experience at this work. Bodee-trained men have the ability, skill and knowledge to enable them to easily lead the field.



JUST COMPARE

Compare this with what you are now doing or with the best you can find in any other line! Then compare the unrivalled training we have developed in 34 years' teaching experience—step by step—every point thoroughly covered—no time or effort wasted!

\$3500 to \$5000

A YEAR

Compare also the very reasonable cost with the high charges of the newer and smaller schools which have sprung up!

EARN WHILE YOU LEARN

For those who need financial assistance while in training we secure whole or part-time positions to meet their expenses.

OTHER ASSISTANCE

Besides providing the best of training at the lowest possible cost, securing jobs for students who need to earn while learning, giving free R. R. fare, etc., we help you secure good board at moderate price, conduct a Placement Bureau to select suitable positions for graduates and should

FREE

R. R. FARE

To make this exceptional opportunity equally available to all, we pay the student's railroad fare to our nearest school.

you desire to open a laboratory of your own, we assist you in securing a suitable location and equipping your laboratory.

Send AT ONCE for Bulletin 2 giving all details and interesting information

BODEE DENTAL INSTITUTE

NEW YORK PHILADELPHIA BUFFALO BROOKLYN
1755 Broadway 1305 N. Broad St. 501 Washington St. 85 Court St.

LEARN BY DOING
Every phase of all branches of
ELECTRICITY
taught by
Actual Practice
In America's foremost institution for trade training
No Books Used
Individual Instruction
Start Any Day
Write for FREE 64-page catalog
THE NEW YORK ELECTRICAL SCHOOL
44 West 17th St., New York City

Learn to **PAINT SIGNS and SHOW CARDS**
We quickly teach you by mail, or at school, in spare time. Enormous demand. Big future. Interesting work. Oldest, foremost school.
EARN \$50 TO \$200 WEEKLY
John Vassos, N. Y., gets \$25 for single show card. Crawford, B. C., says: 'Earned \$200 while taking course'. Send today for free information, samples and guarantee.
DETROIT SCHOOL OF LETTERING
154 Stimson Ave. Est. 1899 Detroit, Mich.

PIANO JAZZ
By Note or Ear. With or without music. Short Course. Adult beginners taught by mail. No teacher required. Self-Instruction Course for Advanced Pianists. Learn 259 styles of Bass, 684 Syncopated Effects, Blue Harmony, Oriental, Chime, Movie and Cafe Jazz, Trick Endings, Clever Breaks, Space Fillers, Sax Slurs, Triple Bass, Wicked Harmony, Blue Obligato, and 247 other Subjects, including Ear Playing. 133 pages of REAL Jazz, 25,000 words. A Postal brings our FREE Special Offer.
Waterman Piano School, 1826 W. Adams St. Los Angeles, Cal.

LEARN WATCH REPAIRING
Be a watchmaker—you can learn this profitable trade by correspondence in a few weeks in your own home by the DeSelms Chart System. After you complete the course you will know a watch from A to Z. You will know just what the matter is and how to repair one. When you graduate you will be a practical watchmaker and repairer and competent to fill any position. Positions for our graduates. Ask for our Free Book. It explains our system and terms.
THE DeSELMS WATCH SCHOOL
LOGANSPORT, INDIANA

Book on Law Free
Write today for this new book. It tells you how a law training will shorten your road to success. It also carries a vital and inspiring message to every ambitious man! Find out about the opportunities that await the law trained man. Find out how you can learn law right in your own home. No obligations. The book is absolutely FREE. Write Today. now while we are making a special reduced tuition offer.
American Correspondence School of Law
3601 Michigan Ave. Dept. 1358 Chicago, Illinois

Can You Do This Easy Step?

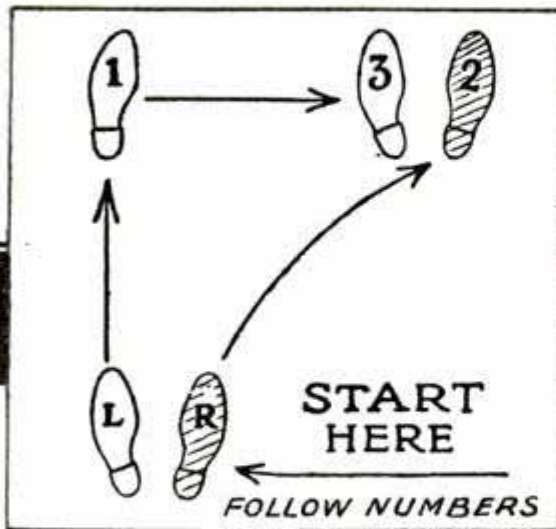

Then I Can Make You a Good Dancer in Ten Days

By **ARTHUR MURRAY**
World-Famous Dancing Authority



NO matter if you don't know the first thing about dancing—try the simple step illustrated above. If you can do it, give me only 10 days and I'll make you a graceful, finished dancer—or else I won't charge you a penny! Through my simple method you can learn any of the latest steps in a single evening! No expensive fees. No waste of time. No music or partner! No spectators to embarrass you. You learn at home through the same simplified method that has delighted New York's "400." In just ten days you'll be able to do the fox trot, waltz, tango and Charleston.

Whirlwind Popularity

You'll never regret being an accomplished dancer! Think what it means to be popular, sought after, admired! The dances I teach you in my course are not only the standardized steps, but also the brand new ones—the peppy, zippy Charleston that has captivated society, the sensational, modern dances that have swept the world!

The sooner you learn to do the new dances, the sooner you start upon this sure path to popularity, the sooner you get some real fun out of life. You'll always be welcome everywhere. Better still, you'll be in great demand—for everyone wants to dance with the good dancer, the one who knows all the latest steps!

And when you learn by my method—when you have the Murray foundation—it will be easy for you to learn *any* dance. Once you have my training, you will be able to follow any music with ease and grace—you will be able to master quickly and easily any dance step after having seen it just once.

Five Lessons FREE

Let me prove that I can make you a finished dancer in ten days. Let me send you five lessons from my course—absolutely free! Just mail the coupon (with 10 cents to cover cost of printing and mailing), and those valuable lessons will be forwarded at once. Also a free copy of my interesting new book, "The Short Cut to Popularity."

Don't wait. Clip and mail this coupon NOW. Arthur Murray Studio 667, 7 East 43rd St., New York City.

**ARTHUR MURRAY, Studio 667,
7 East 43rd Street, New York City**

You may send me the FIVE FREE LESSONS. I enclose 10 cents (stamps or coin), to pay for postage, printing, etc. You are to include free "The Short Cut to Popularity."

Name.....

Address.....

City.....State.....

BOYS

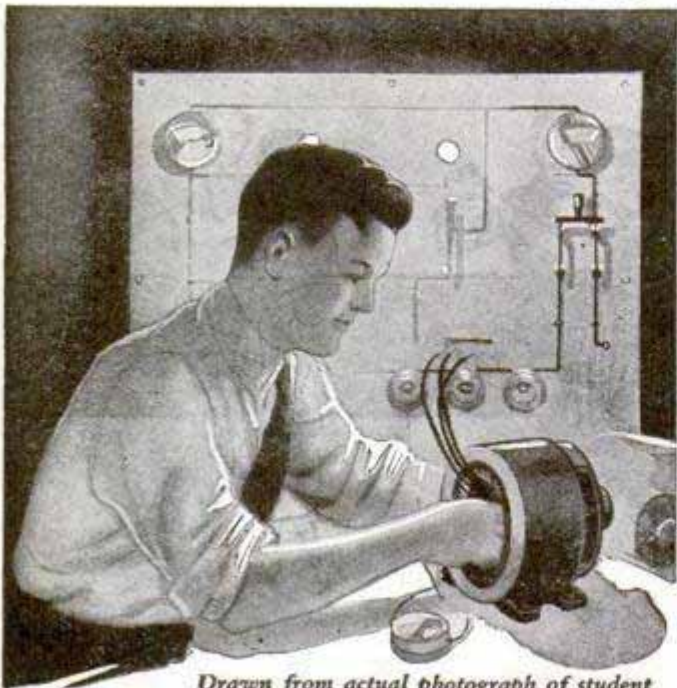

Drawn from actual photograph of student doing spare time electrical work

Learn Electricity Make Big Money

How would you like to earn two or three dollars every evening after school and prepare yourself for a fine big job at the same time? Here's the opportunity of a lifetime for you fellows who like Electricity. Begin right now to prepare yourself for a regular man's size job in this fascinating field. Your chances for a big success are simply wonderful—the pay is big (thousands of men earn \$70 to \$200 a week) and advancement comes swift and sure.

I Will Train You at Home

With my easily earned, spare time Electrical Course I will train you at home like I have trained hundreds of other boys who are now big successful men. It will not interfere with your school work and you can earn more than the small cost of the course doing odd electrical jobs in your spare time. The Course pays for itself. I will show you how to get this work and how to do it. Some of my boy students make \$10 to \$15 a week this way.

Tools, Apparatus and Radio Course —Given Without Extra Charge

Send me the coupon below and I will tell you all about the big outfit of tools, apparatus and instruments and a new Radio Course that I am giving to my students for a limited time. I will send you my big interesting Electrical Book and a sample lesson, too—all Free. You will be tickled with the things I will send you Free. Mail the coupon right now.

L. L. COOKE, Chief Engineer
Chicago Engineering Works
Dept. O18 CHICAGO

Look What This Boy Is Doing

"Although the School term is coming to a close, and I am pretty busy with my examinations, I manage to keep up with my electrical studies and work.

"I guess I forgot to tell you I am now in business for myself. Am doing fine, but owe it all to you. If it had not been for your Course, I, being under age, could not have secured my license in this town. But I got it, and now have all the work I can do, averaging \$20 to \$30 a week, thru spare time work.

"I went out on a job tonight after school, on which I made \$9 and brought home another on which I made \$2.50—\$5.50, for 4 hours' work and no material furnished by me."
ROGERS SMITH,
1215 Chestnut St.,
Greenville, N. C.

Use This "FREE BOOK" Coupon

L. L. COOKE, Chief Engineer,
Chicago Engineering Works,
Dept. O18 2150 Lawrence Avenue, Chicago

Send me your Big Outfit Offer, your big Electrical Book, Sample Lesson and particulars of your Electrical Course and Extra Radio Course. This will not obligate me in any way.

Name.....

Address.....
This Coupon only for use of boys 15 years old or more.

Wrestling Book 10c

Learn at Home



Men, Boys be perfect physically. Learn right in your own home from **WORLD'S CHAMPIONS** how to be an expert **WRESTLER**. Learn secret trick holds, blocks, breaks and pinning holds. Learn how to defend yourself against bigger, stronger men. Learn Jiu-jitsu. Also most wonderful course in **PHYSICAL CULTURE** ever discovered. The world renowned **FARMER BURNS** AND **FRANK GOTCH** are authors of these splendid lessons. Learn to be a real athlete. You can if you'll try. Have a beautiful attractive body that all will admire. Surprise your friends, and the "bully" with your great ability. Learn to protect yourself, your mother, sister or sweetheart. Have perfect health, ability.

Only 10c

Send only 10c coin or stamps, for \$2 page book, **ILLUSTRATED**, giving full particulars. Tells the secrets of the big Champions; gives many tricks, holds and other valuable information. A costly book which we send for only 10c—the cost of packing and postage. Don't miss it. Don't delay. **SEND TODAY—THIS MOMENT.**

Farmer Burns School, 1778 Railway Exchange Bldg., Omaha, Neb.

LEARN WATCH REPAIRING



You can learn by our modern and original system of instruction every part of the **Watch Repairing Trade** at home as good or better than at a shop. You can earn money while learning and secure a well paying position or start in business after completing our course of instruction. Good watch repairers are always in demand and earn from \$50 to \$75 per week. For particulars apply to the **Wisconsin School of Watch Repairing**
166 Mason St., MILWAUKEE, WIS.

Learn to Mount Birds



Learn at home by mail, to mount birds, animals, game heads; tan furs, make rugs and robes. Complete lessons. Easily and quickly learned by men, boys and women.

FREE Write today for Free **Taxidermy Book**. Tells all about it. Every Sportsman, Hunter, Trapper and Nature lover should know this wonderful fascinating art. Save your trophies. Big profits. Success guaranteed. Our school is 20 years old—100,000 graduates. Investigate today. Write for Free Book.

Northwestern School of Taxidermy 9778 Elwood Bldg., Omaha, Neb.

BE AN ARTIST

WE CAN TEACH YOU DRAWING in your own home during your spare time. Twenty-five years of successful teaching proves our ability. Artists receive large salaries.

Write Today for Art Year Book

SCHOOL OF APPLIED ART
ROOM NO. 2 BATTLE CREEK MICH.



Comedies, Dramas, Musical Comedies and Revues, Minstrel Choruses, Songs, Black face plays. Everything for Burnt Cork Shows and All Amateur Entertainments. Monologs, Dialogs, Speakers.

PLAYS

Vaudeville Acts How to Stage a Play Make-up Goods

CATALOGUE FREE

T. S. DENISON & CO., 623 So. Wabash, Dept. 9, CHICAGO



SAXOPHONE MUSIC Catalog

Just out—complete catalog of latest jazz hits, also standard saxophone solos, duets, trios, quartettes—2,000 selections. Largest general dealers of saxophone music and supplies in the world. **Expert repairing.** Send for free catalog today.

FINDER & URBANEK Inc., Dept. 2057, 1322 West Congress St., Chicago



See How Easy it is to Quickly Become a Powerful Speaker

THERE is no magic, no trick, no mystery about becoming a powerful and convincing public speaker. I will prove that you can quickly become a powerful speaker. By an amazing five-minute test I will show you how to discover whether you are one of the 7 men out of every 9 who have this "hidden knack" and do not know it.

Why Powerful Speakers Are Always Leaders

It is the man who can put his ideas into convincing speech—the man who can sway others at his will and dominate one man or a thousand who is sought out and asked to fill big, important, high-salaried positions. He is a leader; he stands head and shoulders above the mass. I am going to prove that you can be such a man by simply bringing out your "hidden personality."

What 15 Minutes a Day Will Show You

- How to talk before your club or lodge.
- How to address board meetings.
- How to propose and respond to toasts.
- How to make a political speech.
- How to tell entertaining stories.
- How to make after-dinner speeches.
- How to converse interestingly.
- How to write better letters.
- How to sell more goods.
- How to train your memory.
- How to enlarge your vocabulary.
- How to develop self-confidence.
- How to acquire a winning personality.
- How to strengthen your will-power and ambition.
- How to become a clear, accurate thinker.
- How to develop your power of concentration.
- How to be master of any situation.

It is Amazingly Easy to Quickly Become a Powerful Speaker

You do not need a college education nor any previous voice training to become a powerful speaker. I will show you the secret that causes one man to rise from an obscure position to the head of a great corporation; another from the rank and file of political workers to national prominence; an ordinary trades-union member to the national leadership of great labor unions; a timid and retiring man to change suddenly into a popular and much applauded after-dinner and banquet speaker. Thousands have accomplished just such amazing things, due to this simple, easy, yet effective training.

You Become a Good Speaker—Or I Don't Want a Penny

I will guarantee to make you a powerful, convincing, and easy speaker within a few weeks if you will give me 15 minutes a day in the privacy of your own home. I know what I have done for thousands of others, therefore if I cannot make you a powerful speaker, your training will not cost you a penny.

Amazing Book Free—Mail Coupon

If you will fill in and mail the coupon at once, you will receive a remarkable new book called "How to Work Wonders with Words."

Now Sent FREE

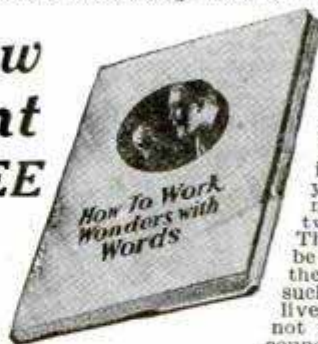

This book gives you an amazing test, by which you can determine for yourself in five minutes whether you are one of the seven men out of every nine who possess the "hidden knack" of powerful speech, but do not know it. Decide for yourself if you are going to allow 15 minutes a day to stand between you and success. Thousands have found this to be the biggest step forward in their lives. If it has played such an important part in the lives of many big men, may it not be yours? Then mail the coupon at once.

North American Institute

3601 Michigan Ave., Dept. 1358, Chicago, Ill.

North American Institute,
3601 Michigan Ave., Dept. 1358
Chicago, Ill.

Please send me FREE and without obligation my copy of your famous book, "How to Work Wonders with Words."

Name.....

Address.....

City.....State.....



DRAWING is a way to FORTUNE

ALI HAFED, a Persian farmer, sold his acres to go out and seek his fortune. He who bought the farm found it contained a diamond mine which made him fabulously rich. Ali Hafed overlooked the great opportunity at his door to go far afield in search of wealth—which illustrates a great truth.

Do You Like to Draw?

If you do, it is almost certain that you have talent, a talent which few possess. Then don't follow Ali Hafed's example and look further for fortune. Develop your talent—your fortune lies in your hand!

Earn \$200 to \$500 a Month and More

Present splendid opportunities in the field of illustrating never excelled. Publishers buy millions of dollars' worth of illustrations every year. Illustrating is the highest type of art and it is fascinating as well as profitable.

The Federal Course includes illustrating, cartooning, lettering, poster designing, window card illustrating, etc. No one artist is competent to give instruction in all these branches. That's why the Federal School has established its "Master Course," in which every subject is written by a specialist. No other School can offer a course nearly comparable. No other institution in the country has such an array of artists as are on the Federal Staff.

Federal Course Gets Results

Its authors include such nationally known artists as Sid Smith, Neysa McMein, Fontaine Fox, Charles L. Vinton Bull, Clare Briggs, Norman Rockwell and over fifty others. Exclusive lessons and drawings especially prepared by them are included in the Federal Home Study Course. They guide you from simple sketches to complex illustrations having a high market value.

Mail in the coupon below today and we will send you our free illustrated booklet, "A Road to Bigger Things."



Federal School of Illustrating

Federal School of Illustrating, 11136 Federal School Bldg., Minneapolis, Minn.

Name _____ Age _____

Occupation _____

Address _____

ELECTRICITY

Practical-Technical TRAINING

Great demand for practical-technical electricians and engineers. Fascinating work. Rapid advancement. Thousands of positions open. Finlay trained men earn \$10 to \$25 a day and more. Send today for latest catalog, beautifully illustrated, explaining One and Two year courses in Electrical Engineering. Also 12 weeks course in Practical Electricity. Degrees and certificates of efficiency awarded.



Courses to suit your needs

Finlay condensed method now in 24th successful year trains head and hand. Completely equipped shops and laboratories. Faculty of trained experts. Students assisted to positions.

EARN \$10 to \$25

FINLAY ENGINEERING COLLEGE
113 Finlay Bldg. Kansas City, Mo.

Deagan Xylorimba Free trial!



Become a crack Xylorimba player right in your own home. Easy to play. Learn in a few hours with our 14 free complete lessons. Earn \$80.00 to \$200.00 a week!
FREE LESSONS—A YEAR TO PAY
Free trial, easy payment plan. Earn while you learn. Write for details special free trial offer.
J. C. DEAGAN, Inc., Dept. 1356
1770 Berteau Ave. Chicago, Ill.



You Can Do It!

Noted Violin Maker sells Patterns, Easy Instructions, Supplies. **MAKE YOUR OWN!**
C. C. FRASER
625 Stark Street SAGINAW, MICH.



SHORTHAND IN ONE MONTH

Boyd—the Wonderful, New, Easy System. Writers hold World's record. 100 to 150 words a minute in 30 days guaranteed. New Principles—dictation first week. Best for Court Reporting and Secretaries. Also Typewriting, Bookkeeping and Commercial Law. Send today for Catalog and Money-Back Guarantee.
CHICAGO HOME STUDY SCHOOLS, 802 Reaper Block, CHICAGO, ILLINOIS



Wonderful, new device, guides your hand; correct your writing in few days. Big improvement in three hours. No failures. **Complete outline FREE.** Write C. J. Ozment, D-34, St. Louis, Mo.

Skin Troubles

Cleared up—often in 24 hours. To prove you can be rid of Pimples, Blackheads, Acne Eruptions on the face or body, Barbers' Itch, Eczema, Enlarged Pores, Oily or Shiny Skin, simply send me your name and address today—no cost—no obligation. **CLEAR-TONE** tried and tested in over 100,000 cases—used like toilet water—is simply magical in prompt results. You can repay the favor by telling your friends; if not, the loss is mine. **WRITE TODAY.**
E. S. GIVENS, 428 Chemica Bldg., Kansas City, Mo.

Give Me 5 Days and I'll Give You a *Magnetic Personality* Let Me Prove It — **FREE!**

I CAN so magnetize your personality that people will be drawn to you at once, irresistibly.

I can show you how to use the amazing principle of instantaneous magnetic control to win quick success in your business or profession.

I can place in your hands the key to supreme power and happiness—give you a great new confidence in yourself—overcome almost at once any timidity or self-consciousness you may have.

I can give you a glorious new magnetic personality so that you can influence the minds of others, attract people to you instantly, be popular and well-liked wherever you go!

Let me prove it. Give me 5 days, and if in that time you do not experience a new surge of personal power, if you do not find yourself making friends wherever you may be, if you do not discover yourself on the road to happiness, wealth, success—the test will cost you nothing whatever. You are the judge.

What Is Personal Magnetism?

No leader of men has long survived without it. No great orator or musician or actor can hold audiences spellbound without it. No salesman, no business man, can win an outstanding success without it. Personal magnetism! It is your greatest capital—greater by far than wealth, than good looks. It is you, made magnetic! It is you, with a personal-

ity so fascinating and irresistible that people are drawn to you as steel is drawn to a magnet!

My Method Releases Your Personal Magnetism

No long course of study. No tedious mental exercises. Just a simple, clear, age-old principle that releases instantly the full sweep of your magnetic potentialities—and makes

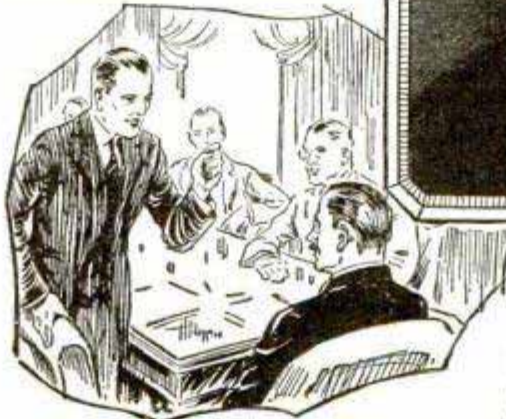

Think what personal magnetism will mean to you in business, in your contact with men and women. You will win! You will get what you want!

you almost a new person. A principle that never fails to work, because it conspires with Nature to make you the dynamic, forceful, fascinating person you were intended to be.

The fundamental principles of Personal Magnetism have been put into a beautiful extra large size volume under the title of "Instantaneous Personal Magnetism." This book gives you the key to a magnetic personality in only five days—or it costs you nothing. That is my free proof offer to you.

The study and scope of Personal Magnetism is as broad as life itself. "Fires of Magnetism," "Sex Influences," "The Magnetic Voice," "Physical Magnetism," "The Magnetic Eye," "Oriental Secrets," "Rapid Magnetic Advancement," "The Magnetic Mind," and "Magnetic Healing" are only a few of the



subjects covered in this amazing book.

Remember My 5-Day Free Proof Offer! Send Off the Coupon TODAY

Merely mail coupon below and this remarkable volume, with cover in handsome dark burgundy cloth, gold embossed, will be sent you by return mail. If you aren't stirred and inspired in the 5-day free period, return it and it costs you nothing. Otherwise keep it as your own and remit only \$3 in full payment. You are the sole judge. You do not pay unless you are delighted. Clip and mail this coupon NOW. Ralston University Press, Dept. 13-T, Meriden, Conn.

RALSTON UNIVERSITY PRESS,
Dept. 13-T, Meriden, Conn.

All right—I'll be the judge. You may send me the volume "Instantaneous Personal Magnetism" for 5 days' FREE EXAMINATION in my home. Within the 5 days I will either remit the special low price of only \$3.00, in full payment, or return it without cost or obligation.

Name.....

Address.....

City..... State.....

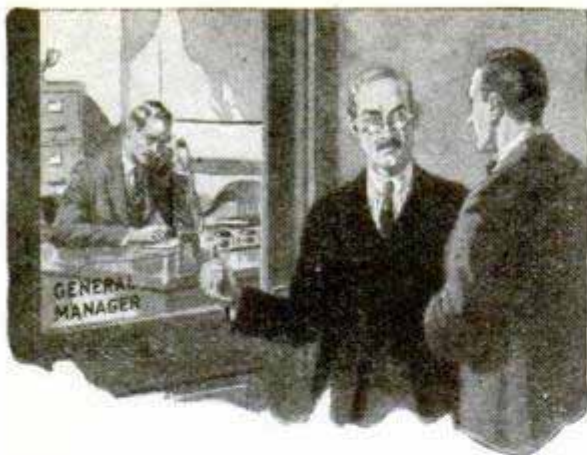

—“and now he’s in the firm”

“I REMEMBER when he first came here. The Boss put him to work helping Charley Moore.

“He didn’t know much about the business then, but I noticed that he was quick to learn and that he was always studying those I. C. S. textbooks in his spare moments. The fellows laughed at him and said he was wasting his time. But he smiled that quiet smile of his and kept right on.

“Pretty soon we saw that the Boss was taking an interest in his work, and the next thing we knew he was made foreman—then assistant superintendent—then superintendent—then general manager—and now he’s a member of the firm.

“It goes to show what spare-time study will do for a man. I might have his job today if I had only studied with the I. C. S. when he did.”

If you want to make more money, show your employer you’re trying to be *worth* more money. If you want a bigger job, show him you’re willing to *prepare* for it.

There’s a simple, easy way to do it. For 35 years the International Correspondence Schools have been training men and women right in their own homes whenever they had a little time to spare. Thousands of men and women have stepped up in just this way. More than 180,000 are studying now. Ten thousand are starting every month.

Can you afford to let another priceless hour pass without finding out what the I. C. S. can do for you? Here is all we ask—without cost, without obligation, mark and mail this coupon.

INTERNATIONAL CORRESPONDENCE SCHOOLS

Box 5613-E, Scrant’n, Penna.

Without cost or obligation, please tell me how I can qualify for the position or in the subject before which I have marked an X:

BUSINESS TRAINING COURSES

- | | |
|---|---|
| <input type="checkbox"/> Business Management | <input type="checkbox"/> Salesmanship |
| <input type="checkbox"/> Industrial Management | <input type="checkbox"/> Advertising |
| <input type="checkbox"/> Personnel Organization | <input type="checkbox"/> Better Letters |
| <input type="checkbox"/> Traffic Management | <input type="checkbox"/> Show Card Lettering |
| <input type="checkbox"/> Business Law | <input type="checkbox"/> Stenography and Typing |
| <input type="checkbox"/> Banking and Banking Law | <input type="checkbox"/> Business English |
| <input type="checkbox"/> Accountancy (including C.P.A.) | <input type="checkbox"/> Civil Service |
| <input type="checkbox"/> Nicholson Cost Accounting | <input type="checkbox"/> Railway Mail Clerk |
| <input type="checkbox"/> Bookkeeping | <input type="checkbox"/> Common School Subjects |
| <input type="checkbox"/> Private Secretary | <input type="checkbox"/> High School Subjects |
| <input type="checkbox"/> Spanish | <input type="checkbox"/> Illustrating |
| <input type="checkbox"/> French | <input type="checkbox"/> Cartooning |

TECHNICAL AND INDUSTRIAL COURSES

- | | |
|---|--|
| <input type="checkbox"/> Electrical Engineering | <input type="checkbox"/> Architect |
| <input type="checkbox"/> Electric Lighting | <input type="checkbox"/> Architects’ Blueprints |
| <input type="checkbox"/> Mechanical Engineer | <input type="checkbox"/> Contractor and Builder |
| <input type="checkbox"/> Mechanical Draftsman | <input type="checkbox"/> Architectural Draftsman |
| <input type="checkbox"/> Machine Shop Practices | <input type="checkbox"/> Concrete Builder |
| <input type="checkbox"/> Railroad Positions | <input type="checkbox"/> Structural Engineer |
| <input type="checkbox"/> Gas Engine Operating | <input type="checkbox"/> Chemistry <input type="checkbox"/> Pharmacy |
| <input type="checkbox"/> Civil Engineer | <input type="checkbox"/> Automobile Work |
| <input type="checkbox"/> Surveying and Mapping | <input type="checkbox"/> Airplane Engines |
| <input type="checkbox"/> Metallurgy | <input type="checkbox"/> Navigation |
| <input type="checkbox"/> Steam Engineering | <input type="checkbox"/> Agriculture and Poultry |
| <input type="checkbox"/> Radio | <input type="checkbox"/> Mathematics |

Name.....

Street.....

Address.....

City..... State.....

Occupation.....

Persons residing in Canada should send this coupon to the International Correspondence Schools Canadian, Limited, Montreal, Canada.

Business

Master the fundamentals of marketing, law and business, employment psychology, advertising, purchasing, accounting, etc. Practical help for the business man who aims to broaden his vision and be more efficient. You may start these Home Study courses any day. Send for catalog.

The University of Chicago

107 Ellis Hall

Chicago, Illinois

BE A PLUMBER and HEATING EXPERT

Here’s the opportunity of a lifetime for men who want to learn a real trade. Thousands of trained plumbers making from \$75 to \$150 a week.

A few short week in our shops will fit you for any branch in the plumbing field. Here you learn lead wiping, building and construction work, jobbing, estimating, blue prints and specifications.

No books, all actual, practical work under the supervision of master plumbers.

Plumbers’ opportunities are everywhere. In the cities, small towns and the country. Send for our free booklet on how you can earn your expenses while learning.

ILLINOIS PLUMBING WORKS SCHOOL

512-514 N. La Salle St.

Dept. 5,

Chicago, Ill.

Anyone CAN LEARN

No talent or experience necessary. Fascinating work. Pays big money. Complete instruction book tells about: Alphabets, Colors, How to Mix Paints, Show Cards, Window Board and Wall Signs, Ready made letters, Gliding, Tricks of the Trade, also gives 100 Alphabets and Designs. Book bound in flexible imt. leather-gold edges, and four half bearing Show Card Pens. Sent postpaid \$3.00, C.O.D. 110c ex. Ogilvie Pub. Co., 57 Rose St. Dept. 50, N.Y. City

EARN MONEY IMMEDIATELY—WE FURNISH EQUIPMENT TO “TART”!

Learn Advertising at HOME

Some of the highest paid men in the world are advertising men. You can learn easily and quickly at home during your spare time. Bigger opportunities now in advertising than ever before. Constant demand for our graduates at big pay.

Send for **FREE** Book. Giving interesting information and vital facts—just what you want to know about advertising. Write today!

PAGE-DAVIS SCHOOL OF ADVERTISING
Dept. 1358 3601 Michigan Ave., Chicago, U. S. A.

Learn Watchwork, Jewelrywork and Engraving A fine trade commanding a good salary, and your services always in demand. Address **Horological**, Dept. P, Bradley Institute, PEORIA, ILLINOIS, for our latest catalog.

STAMMERING
fully explained. Quick, easy cure guaranteed. Information, diagnosis, phonograph record and catalog free. America’s foremost school. Established 1894.
153 Stimson Ave. THE LEWIS INSTITUTE, Detroit, Mich.

TELEGRAPHY

(Morse and Wireless) and RAILWAY ACCOUNTING taught thoroughly. Big salaries; great opportunities. Oldest, largest school. Enrolled by Telegraph, Railway, Radio, and Government officials. Expenses low—opportunities to earn large portion. Catalog free. **DODGE’S INSTITUTE**, Jones St., Valparaiso, Ind.

Laugh If You Like—!



— But I Did Learn Music Without a Teacher

IT was at a little social gathering. Everyone had been called on to entertain and all had responded with a song or with a selection on some musical instrument. And now it was my turn.

I had always been known as a "sit in the corner." I had never been able to either sing or play. So they all murmured as I smiled confidently and took my place at the piano. Then I played—played as no one else had played that evening. First ballads, then classical numbers and popular tunes.

For the first time in my life I was the very center of attraction.

They had listened—dumfounded. For a moment, now that I had finished, they remained silent. Then thunderous applause! Then questions.

"How did you do it?" they chorused. "And you're the one who didn't know a note!" "Why didn't you tell us you were taking lessons privately?" "Who was your teacher?"

For a moment the questions overwhelmed me.

"Teacher? I never had one," I replied. "I learned by myself, at home."

They laughed in disbelief.

"Laugh if you want," I countered. "I did learn music without a teacher."

"Until recently I didn't know one note from another. I loved music. But I couldn't afford a private teacher. And I couldn't bear the thought of monotonous exercises. Anyway, I thought a person had to have talent to become a musician."

"You all know how I've just sat around while the rest of you entertained. Time after time I longed to be able to play"

"Then one night I sat at home alone, reading a magazine. Suddenly my eye caught a startling announcement. It told of a new, easy method of quickly learning music—right in your own home—and without a teacher. It sounded impossible—but it

made me wonder. After all, I decided, 'it doesn't cost a cent to find out.' So I signed the coupon, and—well you know the rest."

The course, I explained to them, was more helpful than I ever dreamed possible. It was amazingly simple—even a child could learn to play this quick, easy way. I chose the piano. And from the very beginning I was playing *real notes, catchy tunes*—just like a regular musician! It was just like a fascinating game!

Now I can play anything—jazz or classical. I am never at a loss to entertain. No more dreary hours of solitude for me. And I even play in an orchestra and make money having a wonderful time!

You, too, can learn to play your favorite instrument by this easy "at home" method that has helped almost half a million people to increased pleasure and financial gain. You don't have to know a thing about music—progress is rapid because every step is easy to understand. Pick out the instrument you want to play. The U. S. School of Music does the rest. And it costs just a few cents a day!

Free Book and Demonstration Lesson

Our wonderful illustrated free book and our free demonstration lesson prove how any one can learn to play his favorite instrument quickly and for just a fraction of what old slow methods cost.

If you really want to learn to play—if new friends, good times, social popularity and increased income appeal to you—act now! Sign the coupon and send it before it's too late. Instruments supplied when needed, cash or credit. U. S. School of Music, 711 Brunswick Bldg., N. Y. C.

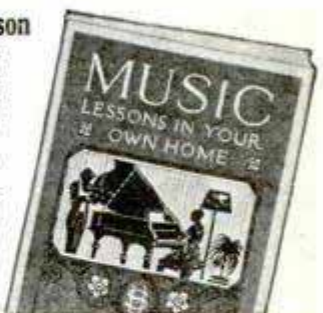

U. S. SCHOOL OF MUSIC
711 Brunswick Bldg., New York City

Please send me your free book, "Music Lessons in Your Own Home," with introduction by Dr. Frank Crane. Demonstration Lesson and particulars of your Special Offer. I am interested in the following course.

Have You
Inst.?

Name.....

Address.....

City.....State.....

Pick Your Instrument

Piano	Drums and Traps
Organ	Harmony and Composition
Violin	Sight Singing
Clarinet	Ukulele
Flute	Piccolo
Harp	Trombone
Cornet	Guitar
Cello	Hawaiian
Saxophone	Steel Guitar
Mandolin	Voice and Speech Culture
	Automatic Finger Control
	Piano Accordion
	Banjo (5-String, Plectrum and Tenor)

**I GOT \$63⁰⁰
FOR ONE CARTOON**



Learn Cartooning at Home

"I THINK that the lessons and methods of the Washington School are the best that one can find in the field of Cartooning," says Michael Perts. "They teach not only to draw cartoons but also to draw them so that they could be reproduced. While studying the course I have been able to sell a large number of my cartoons to local newspapers and a week after I received my Diploma I made \$63 for one big poster. Needless to say that money earned in the course of study and immediately after the completion of the course exceeded many times the sum paid for tuition. The Washington School will always have my sincere appreciation and I shall not fail to recommend its course to anyone who is seriously interested in learning cartooning."

What better proof of the practical cash value of this amazing course! Yet Michael C. Perts is only one of many who have found this quick at-home way of learning Cartooning extraordinarily easy—and mighty profitable, too!

Personal Instruction Method

You, too, can learn to draw cartoons—no matter if you have never before touched a drawing pencil. You learn right at home in spare time. Yet the lessons are so prepared and corrected through our personal instruction method that your instructor seems right at your very elbow! It's actual fun learning Cartooning this easy way. And it's fun that pays you big dividends in friends, popularity and big money rewards. This training can be secured on a very liberal monthly payment plan.

Millions of Dollars Were Spent on Cartoons

last year. More will be spent this year. Good cartoonists easily earn from \$50 to \$250 a week. Start now and quickly prepare yourself for this pleasant big paying field.

Send for FREE Book

A wonderfully interesting little booklet which describes this quick easy method in detail and gives you the experiences of many of our students, will be sent to you absolutely FREE. Simply mail the coupon TODAY to Washington School of Cartooning, Room 3011-D 1113-15th St., N. W., Washington, D. C.

**WASHINGTON SCHOOL OF CARTOONING,
Room 3011-D, 1113-15th St., N. W., Washington, D. C.**

Please send me, without obligation, your illustrated FREE BOOKLET on Cartooning.

Name.....
(State whether Miss, Mrs. or Mr.)

Address.....

City..... State.....

If under 16 years, please state age.....

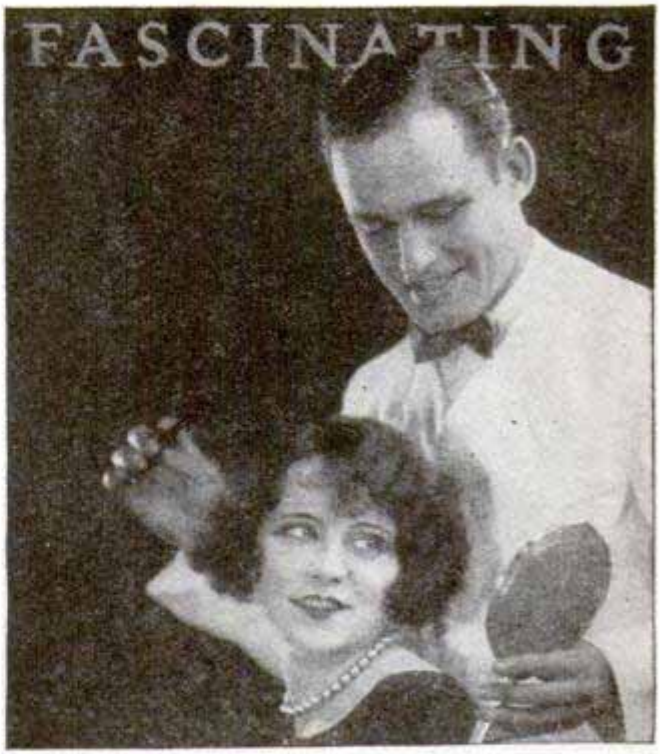

... and, perhaps you, too, due to the lack of money, time and education necessary to master a trade, wonder what to get into *quickly* and make the most out of. Haven't you *overlooked* the very thing you are looking for? 60,000 Moler graduates *know* Modern Barbering is easy to learn, *quick* to earn, *clean* and **FASCINATING!** **FIND OUT!** Write for catalog "B-11."

Address the Branch of the **MOLER SYSTEM OF COLLEGES** nearest you. (Street address not needed)

- | | | |
|------------------|------------------|---------------------|
| Chicago, Ill. | Denver, Colo. | Dallas, Tex. |
| New York, N. Y. | New Orleans, La. | Houston, Tex. |
| St. Louis, Mo. | Omaha, Nebr. | San Antonio, Tex. |
| Kansas City, Mo. | Milwaukee, Wis. | Seattle, Wash. |
| Cincinnati, Ohio | Atlanta, Ga. | Tacoma, Wash. |
| Cleveland, Ohio | Fargo, N. D. | Toronto, Ont., Can. |
| Detroit, Mich. | Memphis, Tenn. | |

LEARN PIANO TUNING AT HOME

Send for FREE copy of the 28th ANNIVERSARY EDITION of our book "Winning Independence." Read how students master TUNING with our Tune-A-Phone, and WHY our graduates head the profession in all parts of the world. With Bryant's patented devices, tools, charts, and lessons, one learns quickly and easily. Low tuition, easy terms, Diploma granted. **MONEY-BACK GUARANTY.** \$10 to \$25 a day, exceptional opportunities, and an idea! profession await you. **BRYANT SCHOOL OF TUNING (71) Bryant Bldg., Augusta Michigan**

No Better Christmas Present for \$2.50

than a year's subscription to **Popular Mechanics Magazine** Containing 4500 Pictures and 3600 Articles

Much of it Interests Everybody
Most of it Interests Anybody
All of it Interests Somebody

Order through your Newsdealer or address the Publisher
POPULAR MECHANICS COMPANY
200 East Ontario Street, CHICAGO, ILL.

Tools FREE

of ANY Extra Charge

Also a Drafting Table

Act NOW!



This is NOT a "Student's" Outfit but an Imported Set of Professional Drafting Instruments, a Chief's Drafting Table, and Standard Supplies.

Yours for the Asking!

No Extra Cost Whatever. No Conditions except to Reply Promptly. This offer Open

to All who Speak Up NOW!

I need YOU with 100 firms BEGGING ME to send them more DRAFTSMEN. Many offer to take BEGINNERS, at \$50 a WEEK. Graduates can start at \$90 and \$100! GET BUSY!

Every industry in this country is using draftsmen in droves! In twenty-five years, I've never been so hard-pushed to turn out enough new men. In fact, it's the shortage that brings you this wide-open offer of all instruments—a real drafting table—full working outfit—complete, standard supplies—even paper and pencils and ink! No extra charge for any of them. That's how I hope to get the required men in record time.

Drafting is the field for any man who wants to get somewhere. For men who want to be heard from. Want work that counts, and pay that makes working worth while and life worth living.

This Opportunity Doesn't Call for Cash, so Don't Pass It Up for Lack of Ready Money

Please don't beat yourself by thinking of your finances at this time! It isn't money I want now—it's men. You, if you mean business. What I am after is your application. Once I get that, you'll get action. I'll have you ready to draft for important pay—in any engineering or industrial line you like—before you know it. So get my proposition in front of you this week! Then, if you do enroll, you're in line for my free outfit offer.

WELL PAID JOBS are soon sighted by men under Dobe training! They get offers before they're through. Are often spoken for months ahead of graduation. And I have students from 17 years of age to 51 at present time! So: first of all, and right now, send this coupon for my new free book Successful Draftsmanship; fully illustrated; explains everything.

I'll teach you draftsmanship by practical methods that make a man easily and quickly finish the whole course. I use modern methods; I employ every short-cut; but I leave nothing out that you have to know to earn \$3500 to \$10,000 a year as a practical draftsman.

LEARN AT HOME but on the same kind of actual drafting room jobs we assign you from our own drafting rooms. It isn't hard to do. Drafting isn't "drawing." You don't need "talent." If you are interested and can read and write, I guarantee to make you a good draftsman. (Dobe-trained men are draftsmen and chiefs in big concerns all over the country—and many have made good abroad.)



YES!

That's Chief Draftsman Dobe's answer to "Can I Succeed in Drafting?"

YES!

Does Dobe really turn out practical draftsmen in a few months?

YES!

Is there always such a big call for men who can draft as Want Ads in the newspapers show at the present time?

YES!

Do I actually get all instruments and supplies without one dollar's extra cost?

YES!

FREE TOOLS COUPON

CHIEF DRAFTSMAN DOBE

1951 Lawrence Ave., Div. 13-58, Chicago

Send me free and postpaid Successful Draftsmanship Book and material telling all about your home course, terms, etc.

Name..... Age.....

Address.....



High School Course in Two Years!

You Want to Earn Big Money!

And you will not be satisfied unless you earn steady promotion. But are you prepared for the job ahead of you? Do you measure up to the standard that insures success? For a more responsible position a fairly good education is necessary. To write a sensible business letter, to prepare estimates, to figure cost and to compute interest, you must have a certain amount of preparation. All this you must be able to do before you will earn promotion. Many business houses hire no men whose general knowledge is not equal to a high school course. Why? Because big business refuses to burden itself with men who are barred from promotion by the lack of elementary education.

Can You Qualify for a Better Position

We have a plan whereby you can. We can give you a complete but simplified high school course in two years, giving you all the essentials that form the foundation of practical business. It will prepare you to hold your own where competition is keen and exacting. Do not doubt your ability, but make up your mind to it and you will soon have the requirements that will bring you success and big money. **YOU CAN DO IT.**

Let us show you how to get on the road to success. It will not cost you a single working hour. Write today. It costs you nothing but a stamp.

American School

Dept. H874, Drexel Ave. and 58th St., Chicago

American School

Dept. H874, Drexel Ave. and 58th St., Chicago

Send me full information on the subject checked and how you will help me win success.

- | | |
|------------------------------|----------------------------|
| Architect | Business Law |
| Building Contractor | Lawyer |
| Automobile Engineer | Machine Shop Practice |
| Automobile Repairman | Mechanical Engineer |
| Civil Engineer | Shop Superintendent |
| Structural Engineer | Employment Manager |
| Business Manager | Steam Engineer |
| Cert. Public Accountant | Foremanship |
| Accountant and Auditor | Sanitary Engineer |
| Bookkeeper | Surveyor (& Mapping) |
| Draftsman and Designer | Telephone Engineer |
| Electrical Engineer | Telegraph Engineer |
| Electric Light & Power | High School Graduate |
| General Education | Wireless Radio |
| Vocational Guidance | Undecided |

Name

Address

PREPARE FOR AN ART CAREER

—thru the *only* school operated as a department of a large art organization. Commercial Artists trained the "Meyer Both Way" earn as high as \$10,000 per year. We today have hundreds of students who had previously studied in other art schools. Why? Because your instruction is based upon our everyday experience in meeting the art needs of leading advertisers. Home study instruction. Write for illustrated book telling of the success of our students.

MEYER BOTH COMPANY
Michigan Ave. at 20th St., Dept. 16, Chicago, Ill.

ELECTRICAL ENGINEERING

Course for men of ambition and limited time. Over 4000 men trained. Condensed course in Theoretical and Practical Electrical including the closely related subjects of Mathematics and Mechanical Drawing taught by experts. Students construct motors, install wiring, test electrical machinery. Complete course

IN ONE YEAR

Prepare for your profession in the most interesting city in the world. School established 1893. Send for catalog
BLISS ELECTRICAL SCHOOL
421 Takoma Ave. WASHINGTON, D. C.



LAW in Spare Time

- Learn law and earn more money. Qualify for a high salaried executive position or prepare to enter the practice of law. Study at home through the Blackstone Course prepared by 80 prominent legal authorities including Chief Justice William H. Taft.
- Blackstone graduates practicing law everywhere. LL. B. degree conferred. Magnificent 25 volume law library furnished immediately upon enrollment. Moderate tuition fee. Low monthly terms. Money Back Guarantee. Write today for free copy of our 128-page book, "The Law Trained Man."

BLACKSTONE INSTITUTE, Inc.
Dept. 58 4753 Grand Boulevard Chicago
America's Foremost Non-Resident Law School

LANGUAGE POWER

Masterly English wins friends, increases chances for success. Sherwin Cody's wonderful new invention gives you language power in only 15 minutes a day fascinating spare-time study at home. No rules to memorize. Learn correct English this new, easy way. Write for free book today.

SHERWIN CODY SCHOOL OF ENGLISH
511 Searle Bldg. Rochester, N. Y.



FOREST RANGERS

Men wanting forest ranger, mail clerk, or other government positions, write for particulars.
MOKANE, 236, DENVER, COLO.

Learn to **PAINT SIGNS and SHOW CARDS**
We quickly teach you by mail, or at school, in spare time. Enormous demand. Big future. Interesting work. Oldest, foremost school.
EARN \$50 TO \$200 WEEKLY
John Vassos, N. Y., gets \$25 for single show card. Crawford, B. C., says: "Earned \$200 while taking course." Send today for free information, samples and guarantee.
DETROIT SCHOOL OF LETTERING
150 Stimson Ave. Est. 1899 Detroit, Mich.



Take this short cut to Success
In Electricity

Oscar Werwath Pres

\$50 VALUE
 Complete
 When You
 Enroll

Free

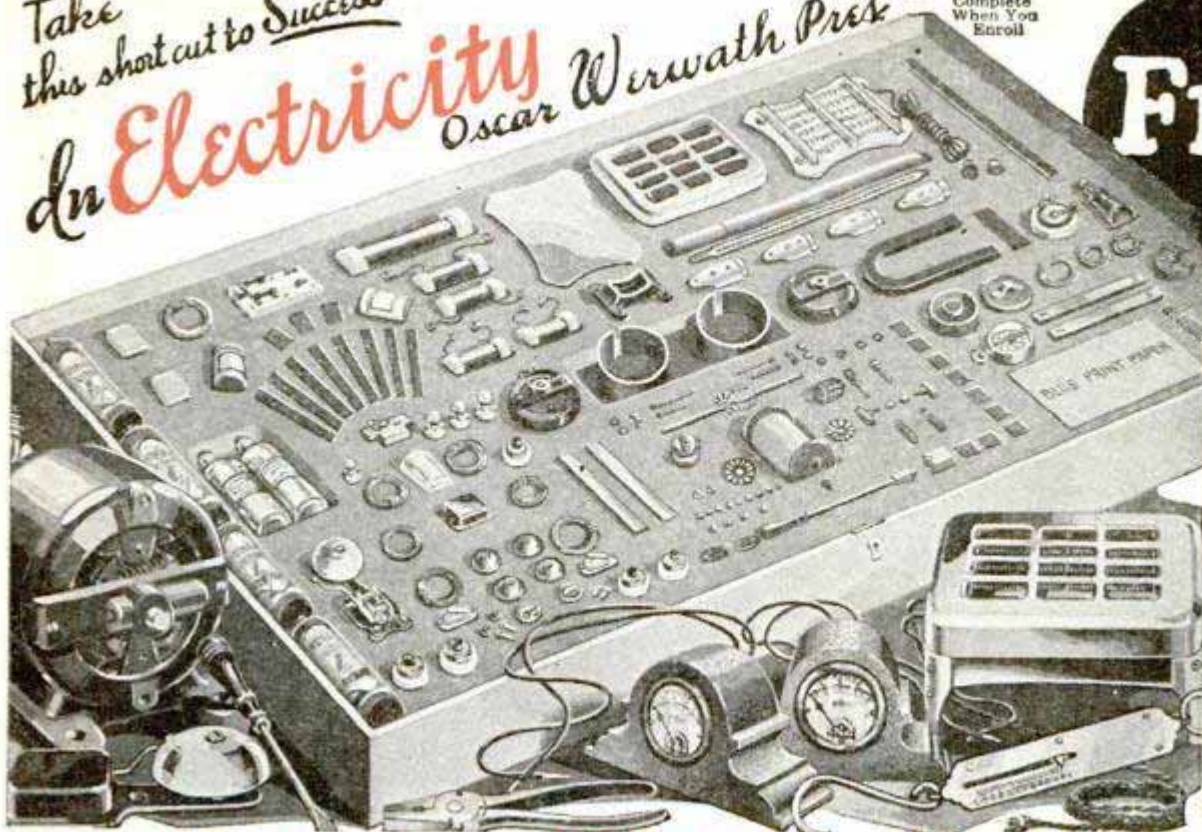

See What This Man Has Done



500% Increase in Salary

Your course was the best investment I ever made. My earnings have increased 500% per month. With my increase in pay I could pay for the course every other month and not miss it.
HUGH M. FRIEL
 Wilmington, Dela.

I want to get together with YOU! Write me tonight. I will give you an Electrical Expert's Outfit FREE and train you at HOME in spare time. Even my beginners often get \$50 a week. ACT!!

HERE'S HOW S. OF E. MEN SUCCEED



EVEN UNCLE SAM asks for S. of E. men when he has a hard electrical job. Above is huge Nordberg engine for Panama Canal for which S. of E. men made the Acceptance test.



PRESIDENT of your concern is what many S. of E. men prefer. We help and advise you to start in business for yourself. New opportunities in every town.



30 DAYS FREE Resident training is my reward when you finish your course, if you wish to accept. Complete details when you send coupon.

I'M IN TOUCH with the electrical industry every day, men, and take my word for it, there's never been anything like the present. Concerns are asking for men every day. Our training satisfies you or **MONEY-BACK**. I help you get the job, too.

ELECTRICITY is booming! and the shortage of trained men is the only reason we're making this special offer. Every kind of concern you can think of depends on Electricity and new opportunities open every day—power plants, electric railroads, electric refrigeration, battery and central stations, etc.

CONCERNS are looking to me to supply them with men. No matter what you are doing now, or how much money you have, we can train you without disturbing your present work. We bring complete expert's equipment right to you and give you the training you need to get a *real* job. Even screw-driver electricians make record money now. But my men, with expert training get the call for really important jobs. Just a few fascinating hours a week right at home.

BE INDEPENDENT with an electrical training. In a few months you are a graduate **ELECTRO-TECHNICIAN** with signed diploma that opens the door for you anywhere in the electrical field. S. of E. men are everywhere succeeding. The big concerns like Harnischfeger Corp'n., Cutler-Hammer, Allis-Chalmers, Commonwealth-Edison all endorse our training and try first to get our men.

NO SPECIAL TALENT or training is required for success and big money in Electricity. There's a right way to do everything in electricity. We give the tools and equipment and show you the right way. When you get on the *real* job you're right home because it's no different. Many of our boys are in their teens—some are men past 50—but *all* multiply earnings with this easy training. Give me a chance to do it for you.

GIVE ME A CHANCE TO SHOW WHAT I CAN DO FOR YOU!

"I guarantee to stand behind you and make you a success in **ELECTRICITY**. For 22 years I've helped men get a start. Just give me a chance. Mail the coupon today—without fail."

OSCAR WERWATH, President.



SCHOOL of ENGINEERING of Milwaukee

SCHOOL OF ENGINEERING OF MILWAUKEE
 Dept. H386, Box 572, Milwaukee, Wis.

Send me **FREE** and postpaid without obligation your big 72-page book telling about S. of E. training and opportunities for me in electrical work. Also details of your employment service and money-back guaranty.

Name.....

Address.....

City..... State.....

DON'T FAIL TO MAIL ME!



Adventure! Romance! Thrills! Become a Newspaper Writer!

New "Copy Desk" Method Makes It Easy to Learn at Home—and Opens Door to Fascinating, Money-Making Career

If you want to write—if you love adventure, excitement, romance, mystery—if you want to broaden your experience, cultivate your mind, and pave the way to bigger, better things—here at last is the chance you have been waiting for. Here is your opportunity to prepare yourself—**right at home, in spare time**—for that most thrilling of all professions—newspaper writing.

This marvelous course—conducted by practical newspaper men of long experience—gives you a thorough, practical, all-round training in every branch of this fascinating subject. Whether you want to enter the newspaper profession, or whether you want to carve out an independent career as a writer of stories and articles for the magazines, you learn to write by actual "Copy Desk" methods which quickly prepare you for big success.

Your Door to Opportunity

There is absolutely no other course in the world like it. Every phase of newspaper work, every kind of writing for profit, is covered so thoroughly—and every step you take is made so delightfully simple and easy—that you will be amazed at how rapidly you progress. Yet the cost of the course is very moderate.

As a newspaper writer, you may travel to the ends of the earth—see rare spectacles, witness heroic deeds, meet strange peoples—hobnob with kings, statesmen, giants of art, science and industry. Because of the wide knowledge and the background of varied experience which newspaper men and women acquire, they are often selected for high-paying executive positions in the business and professional world. There is no other vocation that can give you so broad a culture, so firm a grasp on world affairs, so deep an understanding of life and humanity. No other field of experience that will equip you so surely and completely for success as a writer of stories, novels and plays.

Interesting 32-Page Booklet—FREE

No matter who you are, where you live, or what your present occupation may be—if you have ever dreamed of a career as a writer—if you want to know the thrill of touching life at all corners and of turning your knowledge and experiences into cash—you should mail the coupon at once for our new, intensely interesting booklet—"Writing for Profit," which describes in detail our practical training in writing by the Newspaper "Copy Desk" Method. The request for your copy will place you under no obligation whatever. So don't put it off. Fill in and mail the coupon—**NOW!** Newspaper Institute of America, Dept. 1411, 25 West 45th St., New York City.

Newspaper Institute of America,
Dept. 1411, 25 West 45th Street, New York City.

Please send me your 32-page Illustrated Booklet, "Writing for Profit," describing your course in writing by the Newspaper Copy Desk Method.

Name.....
(Please state whether Mr., Mrs., or Miss)

Address.....

City..... State.....

Old at 23

OLD AGE depends on **OSSIFICATION** or hardening of the arteries. An excess of starchy foods such as oats, wheat, rice, potatoes, etc., is one cause of the encrusting of the inner walls of blood vessels, producing malnutrition, **HIGH BLOOD PRESSURE**, homeliness, **OLD AGE** and **DEATH**.



DOMESTIC animals, horses, cattle, sheep, etc., eating grains (herbivora) are **SHORT** lived. **WILD** animals, eating mostly animal food (carnivora) are frequently **LONG** lived, (100 years).

Observe the deposits inside old water pipes and kettles. Similarly an excess of calcareous substances from starchy foods with earthy matter from water, clog the arteries.

Watch the people who consume large quantities of starchy foods, bread and water! They look **HOMELY** and prematurely old, are **STIFF** and **AWKWARD** in their movements, and their skins are often rough and scurfy. Suitable animal food, fruit and vegetables produce an appearance of youthfulness, grace, and refinement in coarse-looking starch-eaters.

For quick proof try only **aged persons, who have exhausted their reserve power**. Send for statements of **ELDERLY** people who have experienced a wonderful change to youthful activity after only 10 days' trial of the new system of **UNDILUTED** waterfree nutrition.

The injurious effects of water, table salt, cereals, fat, butter, sugar, etc., are explained in our booklet; also the one common underlying cause of all disease.

Write us for particulars of Government Bulletins, describing experiments on convicts, hens, cows, etc. Deficient feeding produced disease, whereas **FULL NUTRITION** corrected e. g., paralysis, blindness in hens, rats, etc.: beriberi, skin affections, etc., in men.

From sworn statements:—**PARALYSIS**. Age 61. Right hand and leg helpless three years, restored in three weeks. **ARTHRITIS**. All joints swollen from lime deposits. Knees and wrists locked immovable for eight months. Blind for two years. Can now see, walk, do home work. **CATARRH**, hay fever, and asthma, improved from the first meal. **GALLSTONES**. Age 80. Cholic every week for years, but not one attack since instruction over four years ago. **TUMORS**. Age 40. Dissolved within a year. **GOITRE**. Collar reduced 17 to 15 inches normal size. **UTERINE HEMORRHAGE**. Age 50. Bedridden three years. Now does housework. **ECZEMA**. Age 69. Skin cracked, scaling, normal in three months. **PYORRHEA**. See Reprint from "Dental Digest." **PREGNANCY**. Age 30. No nausea, no swollen feet nor constipation, delivery painless. **Waterfree Meals**. Educational Booklet 10c. **BRINKLER SCHOOL OF EATING**, Dept. 42-L, 136 West 72nd St., New York.



\$100⁰⁰ EARNED BY YOUNG ARTIST IN 2 DAYS

Well-trained artists earn splendid incomes. The Federal home-study Course is a proven result-getter. If you like to draw, send 6c in stamps for 56-page book "Your Future." State your age and present occupation. **FEDERAL SCHOOL OF COM'L DESIGNING**, 622 Federal Schools Building, Minneapolis, Minn.

"STAMMERING

Its Cause and Cure"

You can be quickly cured if you stammer. Send 10 cents, coin or stamps, for 288 page cloth bound book on Stammering and Stuttering. It tells how I cured myself after Stammering and Stuttering for 20 years. **BENJAMIN N. BOGUE**, 6939 Bogue Building, 1147 N. III. St. Indianapolis

See **Free Offer** on page 8

LEARN WATCHMAKING AND ENGRAVING

BY OUR PROFIT-SHARING PLAN OUR GRADUATES SUCCEED

One of our Iowa students started in a very small way—now doing over \$30,000 a year. Another in Wisconsin, over \$10,000 the first year. Day or night classes. Call or write for FREE BOOK

Chicago School of Watchmaking, Dept. 2201, 4844 Lincoln Avenue, CHICAGO

5 Electrical Job-Tickets Absolutely FREE

Amazing Offer

to Men Earning Less than \$40 a Week!

This opportunity is frankly directed to hard-working mechanics and clerks who want to get into Electricity but are afraid they can't learn the work. I want to prove to such men they have education enough to prepare for an Electrical position paying \$60 to \$125 a week; so I will send without cost or obligation 5 Electrical Job-Tickets to show how my new method of home-training has simplified the learning of Electricity.

New Way to Learn Electricity —with Lessons, Job-Tickets and Outfits

In the LESSONS we present the principles of Electricity so clearly they can be readily understood by men with only common schooling. Then we virtually "send you out on the job" with JOB-TICKETS and OUTFITS, a new system of one-step-at-a-time instructions for doing scores of Electrical jobs. We tell you the latest methods, the short cuts, which tools to use, etc. We supply seven (7) outfits of standard tools and materials for doing these jobs, absolutely without extra cost, to every student.



CHIEF ENGINEER
DUNLAP

Seven (7)
Outfits
GIVEN

to Every Student:

1. Soldering Furnace and Kit
2. Bell Wiring Outfit
3. House Wiring Outfit
4. Voltmeter and Compass
5. Transformer
6. Radio Set
7. \$10 Power Motor

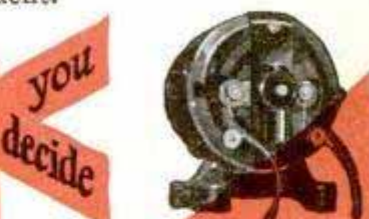

\$10 Power Motor Included

One of the Outfits I send you is this \$10 Power Motor. Same type as the big fellows in a Power Plant. I send it to you "knock-down" with Job-Tickets for assembling it, for winding the field and armature, for transforming it to a generator, for changing the voltage, etc. You can't beat that method of learning Electricity! Mail coupon for 5 Job-Tickets absolutely Free, and take the first step toward a better job and bigger pay!

Chief Engineer Dunlap,
Electrical Division American School
Drexel Ave. and 58th St.
Dept. E-874-B, Chicago

Send me 5 Electrical Job-Tickets FREE to prove I can learn Electricity at Home in spare time by your new simplified method.

Name.....

Address.....

Why I Advise Men To Go Into ELECTRICITY

Electricity offers men BIGGER PAY, more opportunities, and a brighter future than any other industry. Learn Electricity, as I help you to learn it, and you can stop worrying for the rest of your life.

Free Employment Service

has been able to place students and graduates as soon as they were qualified. There are more fine jobs in Electricity than Experts capable of filling them.

I Will Make This Contract With You

When you enroll for my complete home-training in Electricity I GUARANTEE to help you find a beginner's job as soon as you are ready for it, and a position at a substantial increase in pay after you graduate. OR I WILL REFUND THE SMALL AMOUNT CHARGED FOR THIS INSTRUCTION.

Chief Engineer
Dunlap

Learn to do These Jobs!

With my Job-Tickets learning Electricity becomes FUN! I show you the correct, expert, modern way to install bells and burglar alarms, to wire houses for Electric light, to put in outlets and switches, to repair motors, wind armatures, etc. Soon you can do these jobs for PAY in your spare time and earn a lot of EXTRA MONEY.

CHIEF ENGINEER DUNLAP, Electrical Division

AMERICAN SCHOOL DREXEL AVENUE and
58th STREET
Dept. E-874-B CHICAGO

\$5000 per Year and more readily paid to good Ornamental Iron Draftsmen

Here is the line of work for the ambitious young man! Prepare yourself for the BIG pay in America's newest and fastest growing industry. Twenty years ago Ornamental Iron and Bronze work was almost unknown. Today hundreds of factories are working to supply the demand for it, in new hotels, theatres, office buildings, railroad terminals, apartment houses, etc. The building shown here required \$200,000 worth of this material.

"Where Can We Get Trained Draftsmen?"



Is the question architects and ornamental iron manufacturers are asking today. They are too busy to train men. An ordinary draftsman does not have the KNOWLEDGE needed to do the work.

\$65.00 a Week for Beginners

On Aug. 10, 1926, a leading Chicago architect wrote us: "It is almost impossible, however, to obtain men thoroughly familiar with ornamental iron design and costs, and we would be glad to have you recommend your competent men to us. We pay \$65.00 per week for beginners, and up to twice that amount for high class experienced men."

Learn at Home in Spare Time

Get the KNOWLEDGE and you can COMMAND the big pay. The American Institute Course requires no previous experience, or higher mathematics. No books used. It gives you practical work from the word go, and individual personal criticisms by high priced successful ornamental iron draftsmen with 22 years' experience. This Course is strongly endorsed by architects and manufacturers of national reputation.

We make no charge for assisting you to a good position as soon as you can qualify.

Send Today for This Book

It gives the reasons for the splendid openings in this new and growing field, and gives complete details of how you learn the design, manufacturing and estimating of all types of ornamental iron and bronze, such as iron stairs, elevator fronts and doors, storefronts, entrances, etc. Mail the coupon NOW, giving your age and occupation.



American Institute of Ornamental Iron and Bronze

3007 Hennepin Ave., Minneapolis, Minn.
Please send book and full details of your Course.

Age..... Occupation.....

Name.....

Write your address plainly in margin

STOP USING A TRUSS

Do Away With Steel And Rubber Bands



Inner surface is made adhesive to secure the PLAPAO-PAD firmly to the body, keeping the PLAPAO continually applied and the pad from slipping. No straps, buckles or springs attached. Soft as velvet—easy to apply.

It's the Non-Slipping, yet Non-Rigid Pad and What is Within It That Counts

FREE to 5,000 Truss Sufferers

To the extent of 5,000 sufferers who may apply I will send, ABSOLUTELY FREE, a sufficient quantity of the Plapao to positively convince them that this is the only logical, common-sense way of treating rupture. Plapao is a highly astringent medication placed within the Plapao-Pad and being absorbed through the skin, creates a wonderful feeling of relief and at the same time tends to strengthen the weakened muscles and thus permanently close the rupture opening. The process of recovery is natural, so you'll have no use for a truss—you can throw it away forever! Old and young have testified under oath that the Plapao-Pads cured their rupture—many of them long-standing, aggravated cases—without delay from work. Patent allowed in U. S. and foreign countries. Awarded Gold Medal at Rome and Grand Prix at Paris.

Send No Money is sent without charge to enable you to give it a thorough test; you pay nothing for this trial now or ever. Write for it and full information today. Address Plapao Laboratories, Block 1427 St. Louis, Mo.

FREE Book on

Deafness



Write today for 168 page FREE book giving full particulars and testimonials from hundreds of grateful users whose hearing has been restored by use of our "little wireless phones for the ears."

Wilson Common-Sense Ear Drums require no medicine but effectively replace what is lacking or defective in the natural ear drums. They are simple devices, which the wearer easily fits into the ears where they are invisible. Soft, safe and comfortable.

WILSON EAR DRUM CO., Incorporated
115 Todd Building LOUISVILLE, KY.

A PERFECT LOOKING NOSE

Can Easily Be Yours



Trades Model No. 25 corrects now ill-shaped noses quickly, painlessly, permanently and comfortably at home (excepting cases caused by improper bone structure). It is the only adjustable, safe and guaranteed patent device that will actually give you a perfect looking nose. Over 90,000 satisfied users. For years recommended by physicians. 16 years of experience in manufacturing Nose Shapers is at your service. **Model 25 Junior** for children. Write for testimonials and free booklet, which tells you how to obtain a perfect looking nose.

M. TRILETY, Pioneer Noseshaping Specialist
Dept. 2668 Binghamton, N. Y.

HAIR GROWS!



when our Vacuum Cap is used a few minutes daily. Sent on 60 days' FREE trial at our expense. No drugs or electricity. Stops falling hair, cures dandruff. A postal brings illustrated booklet.

MODERN VACUUM CAP CO.
558 Barclay Denver, Colorado

See **Free Offer** on page 8

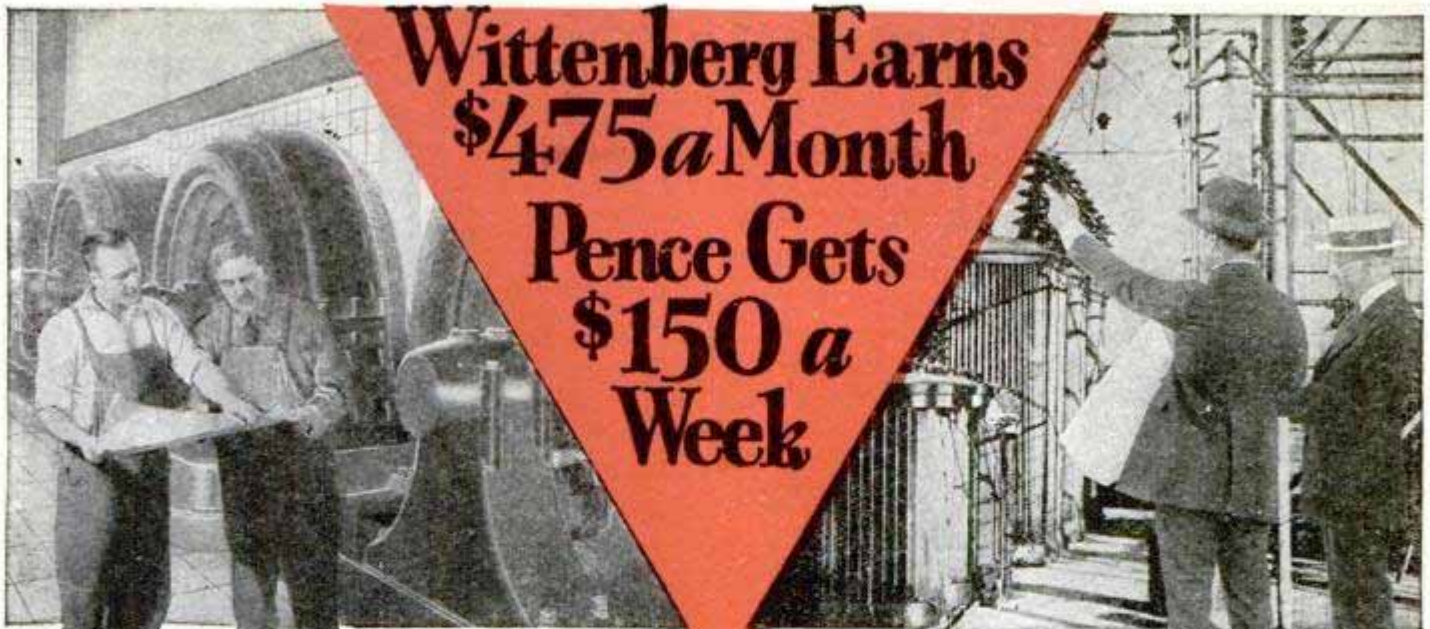

\$475 a Month

Dear Chief: I just bought a 5-passenger sedan and my income now amounts to about \$475.00 a month. Before I took your Course I never made over \$50 a month. Herman Wittenberg, 1930 Grand Concourse, Bronx, New York.

\$150 a Week

Dear Mr. Cooke: I must thank you again for my success, because it was your wonderful Course that put me where I am. I am making over \$600 a month. W. E. Pence, Albany, Oregon.

Cooke Training Did It

There's a Place for You Too, in This Big Pay Field. Electrical Experts Needed Everywhere. Let Chief Engineer Cooke Train You at Home.

CALL it luck—Call it "bunk"—Call it anything you like—But these two and many thousands of other Cooke Trained Electrical Men *are* earning this big pay. They earn from \$3500 to \$10,000 a year and the same road they took is open to you—Now!

Why stick to your no-future \$25 to \$30 a week job when these thousands of men no smarter than you and with no previous experience are jumping ahead of you—easily earning two to four times what you earn, year in and year out?

Electricity needs you. It has a place for you and thousands of other red-blooded, honest-to-goodness young fellows who want a real job and REAL MONEY and who have gumption enough to trade a little of their spare time for a chance to get it. Electricity is the world's greatest business. Over 750 million dollars are being invested in it every year. In the power house end of the industry alone, 15 thousand new and additional jobs were created last year. Electricity is an opportunity—a future—"Success"—for thousands of men. Will you risk two pennies

for a stamp to find out what it will do for you?

Chief Engineer Cooke has written a wonderful book about electricity, its opportunities for young men, and what these opportunities mean to you. It is printed in colors, has 64 pages and more than 100 pictures. It's the same book that started ten thousand other men on the road to big pay. It's free—and it may help you like it helped them. Anyway send for the book and decide for yourself. No agent will call on you—no one will bother you and you won't be obligated in any way. What you do in the next minute may mark the turning point in your life. Mail the Coupon Now, to—

L. L. Cooke, Chief Engineer
L. L. Cooke School of Electricity
Owned and operated by
Chicago Engineering Works

2150 Lawrence Ave. Chicago, Illinois

L. L. Cooke, Chief Engineer
Dept. 518, 2150 Lawrence Ave., Chicago, Illinois

I want the proof. Send me your free book on Electricity and other information regarding your training and employment service so I can decide for myself. I understand this is to be sent me by mail—not by an agent.



Chief Engineer Cooke — The man who has trained and helped many thousands of other men into big pay electrical jobs in all parts of the world.

Mail Coupon for his big free "Book of Facts"

Name.....
Address.....
City..... State.....

Play the HAWAIIAN GUITAR and be Popular!

Play all the latest hits just as the Hawaiians do. Be the most popular member of your set. Get in on all the good times. Entertain your friends—or play professionally. Be in demand everywhere. We will help you.



\$15
HAWAIIAN GUITAR
with Genuine Seal Grain
Fabrikoid Cover
FREE
when you enroll



This sweet-toned, mellow Hawaiian Guitar would cost you at least \$15 in any music store without the Genuine Seal Grain Fabrikoid Case. We can afford to give you the entire outfit free when you enroll, including picks, steel playing bar, etc., because we make them in huge quantities in our own factory. Nothing to buy—everything is furnished.

Learn in Spare Time at Home

You study in spare time—when you like—as long as you like. And even if you don't know one note from another, our method is so simple, plain and easy that you begin a piece your first lesson. In half an hour you can play it!

Famous Native Hawaiians Teach You

You receive expert instruction from such world famous players as Kolomoku, Kalaluki, Ferara and Seville. They quickly teach you the secrets of this fascinating instrument.

Complete Conservatory Course. You get 52 complete printed lessons. Nothing is omitted. Pictures explain every move. And no matter how little you know about music when you begin, no matter if you have never touched a musical instrument, you can positively learn to play by our plain, easy, picture method.

Only 4 Motions to Learn

Then you can play any music—popular songs, classical, old-time melodies, native Hawaiian airs—or real jazz—separately or with accompaniment. You'll never be lonesome after you learn to play on this beautiful Hawaiian Guitar.

Pay as You Play

We make it easy for you. You start any time—with a small first payment—then pay while learning. Write for liberal offer.

Our Written Guarantee

We guarantee in writing to teach you. 45,000 successful students. And we coach and advise you after graduation—no extra cost.

Other Courses

under famous teachers—Tenor Banjo, Violin, Mandolin, Banjo Ukulele and Ukulele.

FIRST HAWAIIAN CONSERVATORY OF MUSIC, INC.
9th Fl., Woolworth Bldg., Dept. 248, New York, N. Y.

Approved as a Correspondence School Under the Laws of the State of New York

ACT! Mail This Popularity Coupon NOW!

FIRST HAWAIIAN CONSERVATORY OF MUSIC, Inc.
9th Fl., Woolworth Bldg., Dept. 248, New York, N. Y.

Please mail full information about your 52-lesson Hawaiian Guitar Course. I am not obliged to enroll unless I want to.

Name _____

Address _____

City _____ State _____

Why Don't YOU Earn This Money?



Many Earn \$50 to \$250 a Week

Let us start you making big money with a camera. No experience needed. Spare time work, big-paying positions, or a business of your own. Opportunities everywhere in all branches: Motion Picture Camera Work, Portrait and Commercial Photography.

Camera Given

Your choice of real Motion Picture Camera or professional View Camera, genuine anastigmat lens. Experts train you at home to become Professional Photographer. Free Employment Service.



WRITE FOR BOOK

Tells how to earn big money in this fascinating work. Send for Book NOW—it's FREE.

New York Institute of Photography
12 West 33rd St., New York City (Dept. 49)



NOTE:

If you prefer to come to our New York or Chicago Studios for personal instruction, day or evening classes, write for Catalog R-45 to nearest address: 10 West 33rd St., New York, or 630 So. Wabash Ave., Chicago, Ill.

A Great Book Free with this pay-raising library

For a short time only we will give every subscriber to the New Library of Machine Shop Practice a copy of French's Engineering Drawing—the greatest book on mechanical drawing ever written. This book makes drawing as plain as day—tells you all about instruments, plans and methods—and prepares you to handle any drawing job you will ever have to do. It comes to you absolutely free with

Machine Shop Practice

9 volumes — 3065 pages — 3608 illustrations
(A combined home study course and reference library)

The New Machine Shop Library is written for practical men. It gives you the best methods for every kind of machine shop work. It explains machine tools and their operation, drawing and design, tool work, gears and grinding, jigs and fixtures, automatic screw machines and their tools and all of the mathematics you will ever have to use. It is plainly written, completely illustrated—the very best kind of help to the machine shop man who wants to advance himself.

Sent FREE

No money down—only 7c a day



FREE EXAMINATION COUPON

McGraw-Hill Book Co., Inc., 370 Seventh Ave., New York

Send me for 10 days' free examination the New Library of Machine Shop Practice. If satisfactory, I will send you \$1.50 in 10 days and \$2.00 monthly until the special price of \$19.50 is paid. If not wanted, I will return the books at your expense.

On receipt of my first payment of \$1.50 it is understood that I am to receive, free of charge, a copy of French's Engineering Drawing.

Signed.....

Address.....

City and State.....

Position.....

Employer..... P.M. 11-1-26

A FRANTIC CALL FOR MEN WHO CAN READ BLUE PRINTS OF BUILDINGS

... at \$4,000 to \$12,000 a YEAR

See how easy it is to get in the building game. Nowhere else does such simple training count for so much. Nowhere else can a man make \$4,000 to \$12,000 a year so quickly and so easily. Nowhere else are there so many countless thousands of openings as there are with contractors, builders, and real estate firms, who are constantly calling for men who can read blue prints. Six billion dollars a year is spent for building. Trained men are at a premium in this gigantic industry. Untold thousands are needed at steady salaries far above the scale wage.

90 DAYS EASY TRAINING PUTS YOU IN THE 6 BILLION DOLLAR BUILDING FIELD

NO longer is it necessary to start at the bottom of the building trades and spend years to work up. Now you can get three years' training in three months. There are no barriers to your success in the great outdoor building field. You do not need more than a common school education. We train you at home, in spare time, by the fascinating blue-print method with lessons that are as easy to read as your newspaper.

These tested plans come to you from one of the oldest and largest schools of building construction and superintendence in the country. This course is endorsed by leading contractors and master builders. These tested, practical plans and lessons are the kind of training that puts men in \$5,000 to \$15,000 jobs and in profitable building and contracting businesses of their own. You learn from actual blue print plans—from practical building experts—you learn how to read all the plans, estimate the costs and supervise the entire construction of a building—you learn everything a contractor has to know when he undertakes the construction of a building.

Amazing opportunities are open to you when you know blue prints, plans, estimating and construction. There is building superintending—the best outdoor profession on earth—that pays handsome salaries and often a bonus for efficient work. Clifford Scholl went from clerk to Ass't. Superintendent at 49% increase in salary in 8 months. Thousands of builders and contractors need men like Clifford Scholl.

Every Job Must Have A Contractor

The building field is wide open for men who want to go into business for themselves. Henry Mehl, Pa., a policeman, now owns his own contracting business. Burgert, Ill., stepped into a foremanship at 200% increase in salary. Busch, Kan., writes, "I have been offered \$300 a month several times." Boyes, Can., writes, "Your school has increased my wages 40% already." Patrick, Mich., says: "My salary has been increased 92%." Marchand, La., writes, "I am getting along fine. My salary is now increased 196%."

IF YOU LIVE IN OR NEAR CHICAGO

Visit our School for Builders, open day or evening. Thousand men attend each year. Enter any time. You can get the same training at home, by mail. Same plans; same lessons; same instructors. The Coupon brings all facts Free.

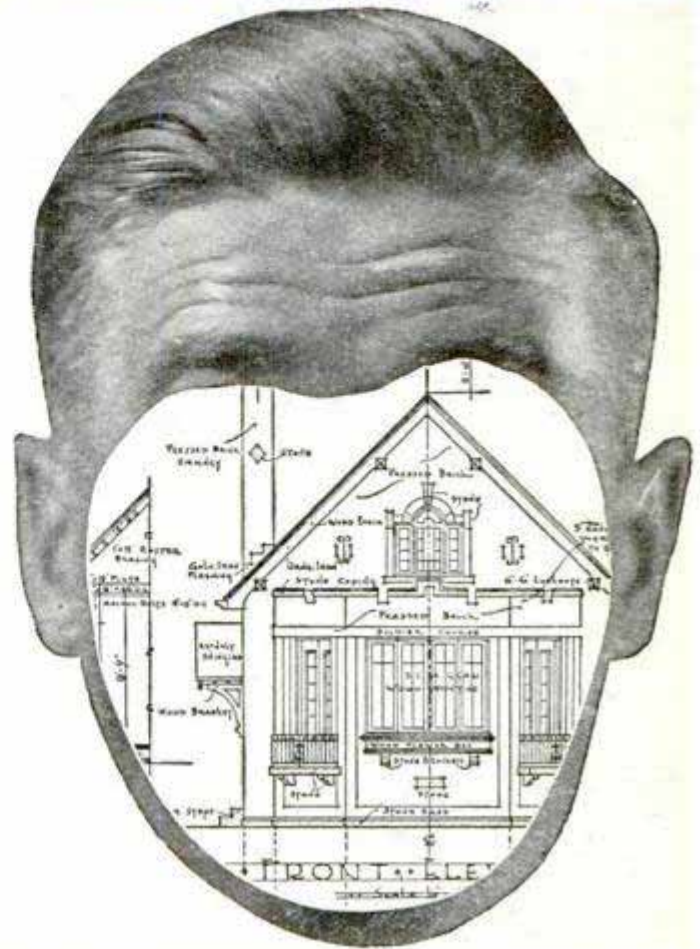

If you really want more money—if you hope to own a business of your own—get into the building business . . . no matter what your job is now. No overworking in this tremendous field—room for thousands every day. Why buck competition in crowded industries where only a few men can succeed?

Clerk or carpenter—office man or bricklayer—salesman or superintendent—it makes no difference. You can get into the building business quickly . . . easily. Or if you are in it at present, get this training now, that you must have for success.

FREE Trial Lesson

Simply mail the coupon below for an intensely interesting free book "How to Read Blue Prints," and full information. See what fascinating fun this first trial lesson is. Get these facts before you. See what amazing opportunities open up for you in the Six Billion Dollar Building Field. Don't wait or delay. Act now. Simply mail the coupon below.



Chicago Technical School for Builders

Dept. R-10, Chicago Tech Bldg., 118 E. 26th St., Chicago

Chicago Technical School for Builders, Dept. R-10, 118 E. 26th Street, Chicago, Ill.

Send me, without obligation, your free book, "How to Read Blue Prints" and full details of the course and the opportunities in the Building Field. It is understood that no salesman will call on me.

Name.....
 Address.....
 City..... State.....
 Age..... Occupation.....

Learn Autos In Detroit

BIG FREE BOOK



It's
Free

Shows the WAY to a Better Job or a Business of Your Own

*By Practical
Factory Approved
Shop Methods*

The Big New Book of the "Michigan State" will start you on your way to success. Why take small pay from uncertain jobs? Why be knocked around from this to that, and not know whether you are going to have a job tomorrow or not? You can change all that. Get our Big FREE Book and complete information about Detroit training to make the most money. Learn a trade. Know autos—how to repair them, and take advantage of the countless opportunities to make money. Pave the way for a business of your own—a business that can make you independent for life. You can do it with a few weeks training at the Michigan State Automobile School—the great auto-trade school in the heart of the auto industry.

Earn Big Money

You can earn more money. Skilled auto men are wanted everywhere at good pay. Service managers tell us that **100,000 more trained auto men are needed every year.** They don't get a tenth of that number now. Here is your supreme chance to get out of the rut of poor pay. Over 20 million cars now, and three million or more new ones every year. Think of it!

L. H. Rains (Cal.) says: "Have the Ford Agency here. Have disposed of one carload of Fords and have ten on the way now. Parts and accessory sales are about \$500 a week gross."

No Experience Required

Whether you have auto experience or not, makes no difference. Green men get this training and start at once in better jobs, soon advance to have their own business, make big money. Men who have experience also say this training puts them way ahead of other men, into the big pay class at once, saves them years of dirty work. In just a few weeks, if you start now, you can be earning this bigger pay!

No Education Needed Either

It just takes common sense, to learn by the practical methods we teach you. Ben Tamura (Hawaii) writes, "Have just started a little shop of my own and am averaging \$300 a month."

100,000 Trained Auto Men Needed Yearly

Where can you find such an opportunity as this? The Auto Business has grown in a short period to be the biggest business in the world. Its volume is above that of the steel or railroad industries. And it has more individual opportunities than any other business. A hundred thousand more trained men are needed every year, but they are not produced. So the field is getting bigger all the time. Green men can't draw the good pay. But trained men can. E. J. Asbury (W. Va.) says, "I am clearing \$50 a week just at home. Haven't even got a shop yet."

No Exaggeration

Note that we don't promise to put you on top of the world in a few weeks. We know the great need for skilled men, and the wonderful future ahead of you if you get started now. But we know it takes work. It takes real knowledge. And that we can give you. Then start in a good job and advance to big money. Auto knowledge means steady work, wherever you want to go, at good pay, and a certain future. Send the coupon for Big New Book and find out for yourself.

Factories Endorse These Courses

Auto factories endorse "Michigan State" training methods. Because they are thorough, practical. Because they put knowledge in your head and skill in your hands. Because they really fit you to make good. Harold Grenert (Mass.) says, "Two years ago I left a \$20 a week job. Now I earn \$70 as auto electrician, thanks to M. S. A. S."

Help to Get Jobs

"Michigan State" trained men are wanted, in Detroit, in your home town, in garages throughout the country. We place many of our graduates directly. This Employment Service is absolutely free. L. T. Middlebrooks (Cal.) writes, "Getting the best pay I ever received and all credit to the M. S. A. S."

Come to Detroit the Auto Center

Of course Detroit is the place to learn autos. Over three-fourths of all cars come from here. Detroit training is practical training. Stick this in your memory,—the Detroit Trained man has an immense advantage over all others. So come here as soon as you can. Come now if possible. If you can't come now, start to learn under our Home Study Plan. (This does not cost anything extra.) Then plan to come here to School later to finish in thorough "Detroit training." W. J. Anderson (Minn.) writes, "I used to be a blacksmith's helper at \$15 a month with board. Now I take in \$300 a month in my one-man garage. Soon I'll have a bigger shop and earn more."

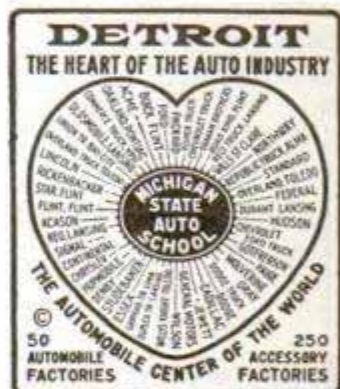

MICHIGAN STATE
311 Auto Bldg. Detroit, Mich.

100,000 Trained Auto Men Wanted This Year

Or At Home!

You can start right now to get ahead in the world! The great success-training of this world-famous "Michigan State Automobile School" can be brought to you at home. For those who cannot come to Detroit for their training, we have a special Home Study Course. This course covers the same subjects in detail as our Residence Course. You get the same practical training with the exception of the actual work on the cars. The knowledge you gain in the first week or two in the Home Study Course should enable you to get a job in a garage right away. This is your big opportunity. Don't delay. The Home Study Course is free to students who later take the Residence Course. In writing, say which course you prefer. Send Coupon for Big FREE Book TODAY and get started on the road to success.

Work with Real Tools and Learn to Use Them Right

You must have expert training to get these good pay jobs. We train you **with tools**. You learn how to use them right. You learn from real practice, how cars are made and how to repair them. You have head training too as well as hand training. The man

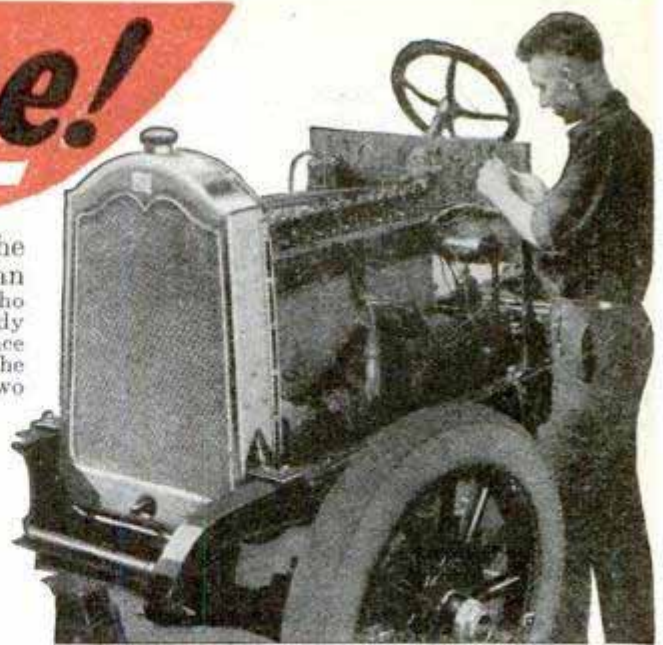

whose hands only are trained, fails when he hits the hard jobs. There are no hard jobs for Michigan State trained men, for they have the **knowledge in their heads** to guide the skill in their hands.

John Grahek (Minn.) writes, "I average \$325 a month on labor plus \$100 profit on parts and accessories."

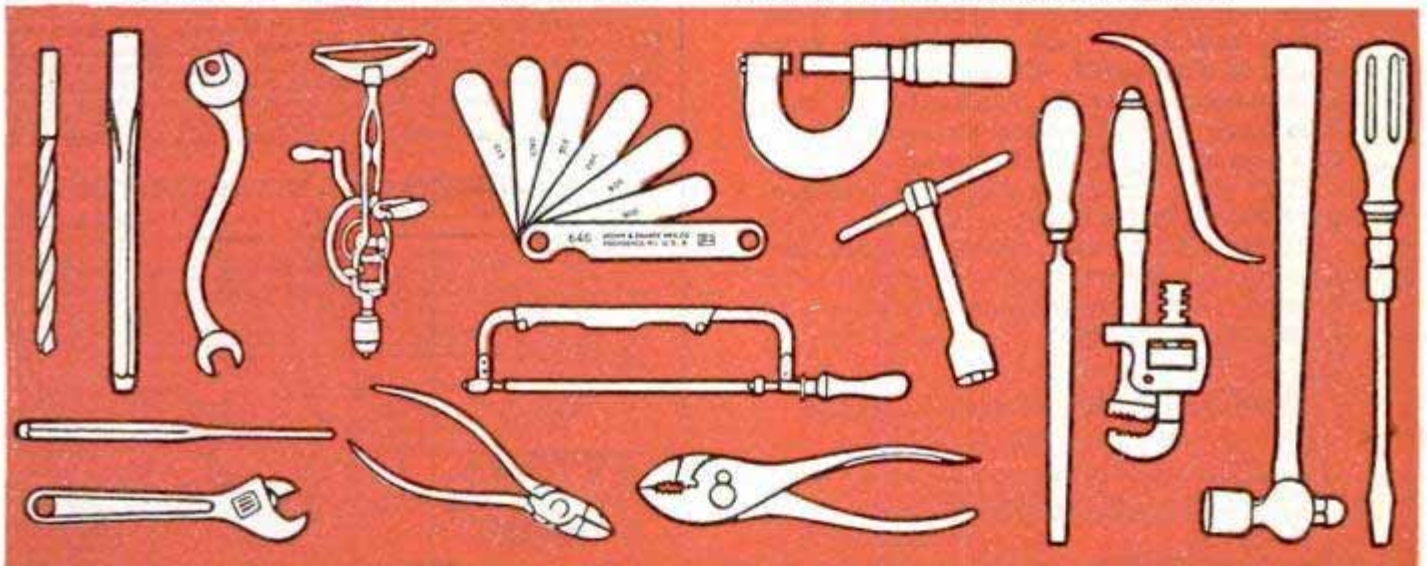

FREE Management Course

Through our close cooperation with the auto factories in Detroit, we have secured the former service manager of one of the leading manufacturers to train our students in the **business end** of running a garage. This training is worth \$100 alone. But it costs you nothing extra. It is just another one of the big advantages of Michigan State training. All students get this free Business Course. A. H. Borland (British S. Africa) says: "I consider the Business Course one of the most valuable parts. You choose most efficient instructors."

A Business for Go-Getters

The auto business is intensely interesting. There is something new in it all the time. New cars, new types of electrical systems, engines, etc. The skilled man understands these new things at once. He helps car owners when in trouble and quickly gets their confidence. **He earns big money by doing this.** Put yourself in such a place. As a green man you can never do it. But training will put you there quickly. J. T. Ghiardi (Mich.) says: "I went to two schools before going to yours, but they do not compare with old M. S. A. S." G. W. Raymond (Conn.): "Immediately after graduating I took a position at a Ford Service station, having as a helper a man who had been in the auto game for 20 years."

AUTOMOBILE SCHOOL

3729 Woodward Ave. Detroit, Mich.

Get Started Now!

Mail This Coupon Now

Get all the interesting facts. Mail the coupon for Big FREE Catalog and information concerning **your future** that you must not fail to get. It's illustrated with photos of school equipment and graduates. It tells you how you can get a good paying job—how you can go into business for yourself with little capital. Mail the coupon or send us a postcard today. **Write now.** (We do not enroll colored students, except for our Home Study Course.)

I want to Earn More Now!

MICHIGAN STATE AUTOMOBILE SCHOOL,
311 Auto Building,
Detroit, Michigan.

Send me FREE and without obligation Big New Book and complete information about Detroit-training to make the most money.

Name.....

Street or R. F. D.....

City..... State.....

I am interested in: 12 Weeks' Auto Course.
 30 Weeks' Master Course.
 Home Study Course.



ELECTRICAL EXPERTS IN DEMAND

Good positions await trained men. Salaries of \$12 to \$30 a day are paid many experts in this field.

THE Electrical field needs men. It needs them badly. Hardly a month or a year passes but what some new use for electricity is discovered. Each new use means new positions—*better positions*—for men who have trained themselves as experts in this wonderfully fascinating work.

Why don't you study electricity and prepare for a good position at a good salary?

You can do it right at home in spare time through the International Correspondence Schools. Home-study courses endorsed by Edison and Steinmetz. Successful students everywhere.

Mark and mail the coupon today for Free Booklet

TEAR OUT HERE

INTERNATIONAL CORRESPONDENCE SCHOOLS

BOX 5609-E SCRANTON, PA.

Explain, without obligating me, how I can qualify for the position, or in the subject, before which I mark X.

- | | |
|--|---|
| <input type="checkbox"/> ELECTRICAL ENGINEER | <input type="checkbox"/> CHEMICAL ENGINEER |
| <input type="checkbox"/> Electrician | <input type="checkbox"/> Pharmacy |
| <input type="checkbox"/> Electric Wiring | <input type="checkbox"/> SALESMANSHIP |
| <input type="checkbox"/> Electric Lighting | <input type="checkbox"/> Show Card and Sign Painting |
| <input type="checkbox"/> Electric Car Running | <input type="checkbox"/> RAILROAD POSITIONS |
| <input type="checkbox"/> Heavy Electric Traction | <input type="checkbox"/> ILLUSTRATOR |
| <input type="checkbox"/> Electrical Draftsman | <input type="checkbox"/> DESIGNER |
| <input type="checkbox"/> Electric Machine Designer | <input type="checkbox"/> BUSINESS MANAGEMENT |
| <input type="checkbox"/> Telegraph Expert | <input type="checkbox"/> Private Secretary |
| <input type="checkbox"/> Practical Telephony | <input type="checkbox"/> Business Correspondent |
| <input type="checkbox"/> MECHANICAL ENGINEER | <input type="checkbox"/> BOOKKEEPER |
| <input type="checkbox"/> Mechanical Draftsman | <input type="checkbox"/> Stenographer and Typist |
| <input type="checkbox"/> Toolmaker | <input type="checkbox"/> Cert. Public Accountant |
| <input type="checkbox"/> Machine Shop Practice | <input type="checkbox"/> Traffic Management |
| <input type="checkbox"/> Gas Engineer | <input type="checkbox"/> Commercial Law |
| <input type="checkbox"/> CIVIL ENGINEER | <input type="checkbox"/> GOOD ENGLISH |
| <input type="checkbox"/> Surveying and Mapping | <input type="checkbox"/> Common School Subjects |
| <input type="checkbox"/> Reading Architects' Blue Prints | <input type="checkbox"/> CIVIL SERVICE |
| <input type="checkbox"/> METALLURGY | <input type="checkbox"/> Railway Mail Clerk |
| <input type="checkbox"/> ARCHITECT | <input type="checkbox"/> STATIONARY ENGINEER |
| <input type="checkbox"/> Architectural Draftsman | <input type="checkbox"/> Textile Overseer or Supt. |
| <input type="checkbox"/> PLUMBING AND HEATING | <input type="checkbox"/> AGRICULTURE <input type="checkbox"/> Spanish |
| <input type="checkbox"/> Sheet Metal Worker | <input type="checkbox"/> Navigator <input type="checkbox"/> Math'm't's |
| <input type="checkbox"/> Automobiles | <input type="checkbox"/> Poultry Raising <input type="checkbox"/> RADIO |

Name _____

Present Occupation _____ Business Address _____

Street and No. _____

City _____ State _____

Canadians may send this coupon to International Correspondence Schools Canadian, Limited, Montreal, Canada



STOP Worrying About Your Job and your Future

Don't be satisfied with ordinary low-paid jobs that get you nowhere—that you can lose by strikes, lockouts and layoffs. If you are an American citizen, 18 years or older you can get a Government Civil Service position. Pay is from \$1900 to \$2700 to start; work is steady, hours easy, vacations with pay, and plenty of chances for quick raises to better paid positions.

Let me train you to pass the U. S. Civil Service Examination with high rating so you will be eligible for one of the first appointments in Railway Mail, Customs, Internal Revenue, Departmental Immigration, Postmaster, Post Office and Rural and other Branches. Ex-service men get the preference. Hundreds of successful students. I was a Secretary and Secretary Examiner for eight years. Write for 48 page free book. Tells all. Send postal now to Arthur R. Patterson, Prin.

PATTERSON CIVIL SERVICE SCHOOL

Dept. 811A, Wisner Bldg., Rochester, N. Y.

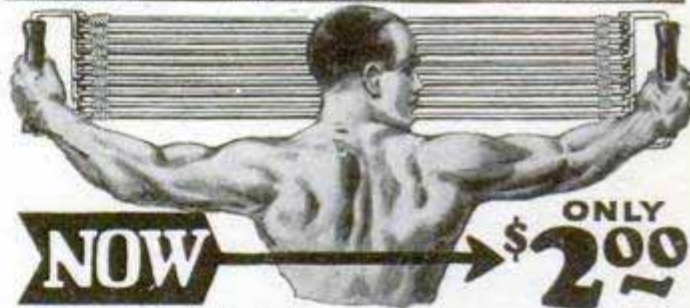

Giant Chest Expander

and Progressive Exerciser

Be a muscular Marvel. Have the muscles of a super-man. Become strong for your health's sake or to astound your friends with extraordinary feats which only men of giant strength can do.

Free instructions. The Giant Chest Expander and Progressive Exerciser is made with new, live springy rubber so as to give it long wear and great resisting qualities. Sold with a guarantee to give entire satisfaction or money back. Made two ways, either

5 Cables	or double strength	10 Cables
for	The	for
\$2	double strength exerciser has	\$4
	resistance of over	
	200 lbs.	

Order Today Send at once and get your Giant Exerciser at the present low introductory price. This price is made so low because we want everyone to enjoy muscles and strength at the lowest possible cost. Don't pay more—order from us—get the most for your money. Use coupon now.



PROGRESSIVE EXERCISER CO.,
4011 Langdon Bldg.,
Broadway and Duane Street, New York

Enclosed \$4 for your 10 cable Progressive please find \$2 for your 5 cable Exerciser.
(Check the Exerciser you want.) It is understood that if I am not satisfied with this Exerciser, I will return it within 5 days and get my money back.

Name _____
Address _____
City _____ State _____

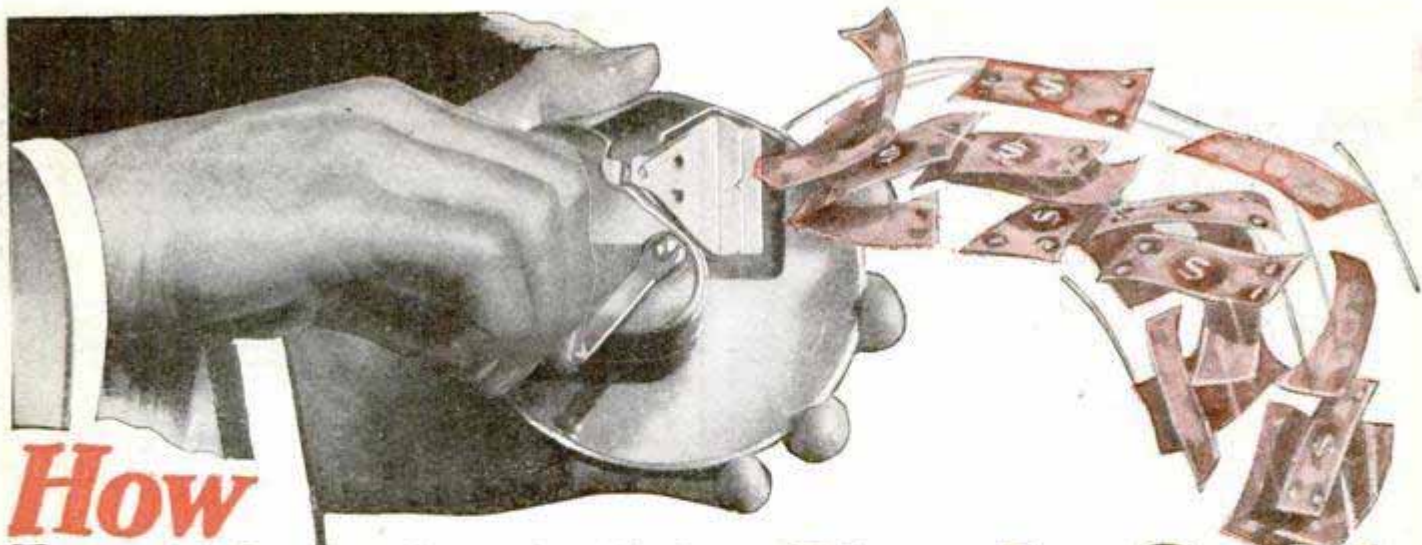

How Just Turning this Simple Crank Brings Agents \$30 to \$60^A DAY!

New Shaving Invention Proves the Most Talked-of Invention in America. Agents Everywhere Say It Simply Sells Itself! All They Do Is Turn the Crank to Demonstrate! Eager Shavers Do the Rest! Get Details of Generous Offer at Once!

NO matter how you look at it, KRISS-KROSS—the amazing new razor-blade stropper—offers you the biggest money of your life. It has put more salesmen and agents on Easy Street than any other invention ever patented. Its uncanny faculty to sell itself is the talk of the direct-selling field. Novel mechanical features capture any prospect's attention *instantly*. All you need to do is twist the operating crank a couple of times and 999 men out of a thousand will reach for it and say, "Let's see how it works!" And once they have it, it's a *rara avis* who wants to let go!

You don't have to *push* a KRISS-KROSS demonstration as you do when selling ordinary, uninteresting things like suits, shirts, dresses, toilet articles, fire-extinguishers—things that are "old stuff" to a customer the minute he lays eyes on them. KRISS-KROSS is new, clever, ingenious and *unique!* No wonder it brings salesmen \$30 to \$60 a day!

Big Profit Records Are On the Jump

Reports of KRISS-KROSS earnings continue to soar. During the month K. P. Rapf made \$602. R. C. Walker (Idaho) made \$9 his very first demonstration. J. Spencer, out in Honolulu, made \$10 in 20 minutes—or 50 cents a minute! And then there's H. King, of Massachusetts, who made \$66 in one day—and J. C. Kellogg, who cleared \$200 in 7 days at spare time alone!

Every single one of these men gives unqualified credit to KRISS-KROSS itself. Many of the biggest profit-checks go to men who never sold a thing in their lives before!

Cleverest Device Ever

KRISS-KROSS mechanical ingenuity is little short of marvelous. It stropps your blade (any make) on the diagonal just like a master barber, but with unvarying accuracy. Eight "lucky" leather grooves do the trick in 11 seconds. Automatic pressure and blade reverse. Stropps heavy at the start—light at the finish, and leaves your blade with the keenest cutting-edge steel can take! Prolongs the life of any blade for months and even years! Many cases are on record where one blade has lasted over two years and still going strong! No wonder it sells like wildfire!

Get Details—Offer FREE

Send right now for full details and information on a FREE new kind of razor you give every customer to boost sales. Wonderful opener. Adjusts 3 ways and makes every other razor seem as antiquated as a horse and buggy!

Find out about this money-making business without delay. There's not a reason in the world why you shouldn't be getting your share of these quick, easy profits. See how simple it is to make \$100-\$225 a week with KRISS-KROSS—the most unique self-seller of all time. Quick action! Clip the coupon now!



Rhodes Mfg. Co., Dept. S-371,
1418 Pendleton Ave., St. Louis, Mo.

Please send me full details of your nationally advertised KRISS-KROSS stropper, which is never sold through stores—and tell me about your unusual offer of big profits to salesmen and agents.

Name.....

Address.....

City.....State.....

Rhodes' **KRISS KROSS**
STROPPER

Dept. S-371, 1418 Pendleton Ave., St. Louis, Mo.

OWN an Auto Repair Shop



All YOU NEED is a FEW TOOLS and 8 Weeks' Training

Why not be your own employer? Why not get for yourself not merely a part of the money you earn, but all of it? McSweeney graduates who own their own garages all over the country are making big money. Thousands of splendid locations are

open everywhere. 20,000,000 car owners are clamoring for BETTER repair service—the kind of workmanship that only TRAINED Auto Mechanics can deliver.

Be Your Own Boss—Profits \$7500 to \$20000 Weekly

In every state new repair shops owned by McSweeney trained men are taking business away from old garages operated by men who don't know how—unskilled, half-baked mechanics. No other business offers such wonderful opportunities as this—the biggest industry of them all. Learn by my PRACTICAL training, by working with real tools on real equipment. No schooling required; no book study. No extras of any kind to pay for. My eight weeks' training includes everything.



70,000 Jobs Open Yearly

for men who prefer to work for Big Wages instead of going into business for themselves. Earn from \$60 to \$125 a week and more. Thousands are doing it after finishing my training. Take advantage of my great Special Offer. I have taught thousands of auto mechanics; I can teach you.

YOUR R. R. FARE and 8 WEEKS' BOARD FREE

Don't miss this remarkable opportunity. Save one-third Now. Your Money back if not perfectly satisfied. Send the coupon TODAY for my Short Time Reduced Price Tuition Offer and Big Book FREE.

McSWEENEY

AUTO, TRACTOR AND ELECTRICAL SHOPS
 9th & Walnut Sts., Dept. KV-14 1815 East 24th St.
 CINCINNATI, OHIO Dept. KV-14 CLEVELAND, OHIO

Mail This Coupon to Either Address Above
 Please send your Big Free Book and Special Offer.

Name.....
 Address.....
 City..... State.....

Home Made Candies for Profit



Our HOME STUDY COURSE of tested recipes, taught by a man who himself made a big success in the Candy Business. Candy is the only business where the little fellow has the big fellow at a disadvantage. Turn your kitchen into a small Candy Shop—start making money from almost the first day. Many now rich, started with no capital. Free book explains.

CAPITOL CANDY SCHOOL, Dept. 153-M
 631 Penna. Ave. N. W. Washington, D. C.

YOU CAN OIL PAINT

Amazing new method teaches men or women to learn after first lesson, OIL PAINT photos at home—portraits, landscapes or art subjects. Earn \$18 to \$100 and more a week. FREE OIL PAINT OUTFIT. Graduates furnished employment. Send now for free illustrated book.

PICTORIAL ART STUDIOS, Inc.
 Dept. M. P. 2926 Broadway, Chicago, Illinois

\$60,000 in Royalties

Given to the Writers of "YES, WE HAVE NO BANANAS"

They never wrote a song before. Their first attempt made them rich. You, too, can write a winning song if you can hum or strum a tune. The Biggest Hits are made by amateurs who know no music. Everyone has a song in his heart. We teach you how to write it into a popular hit. An amazing New, Simple and Practical course in song writing prepared and taught by that successful writer, Mr. AL DUBIN, author of "JUST A GIRL THAT MEN FORGET" and "A CUP OF COFFEE, A SANDWICH AND YOU." Write TODAY for FREE particulars.

N. Y. INSTITUTE OF SONG WRITING
 Dept. No. 14 1562 Broadway New York

See Free Offer on page 8

NO JOKE TO BE DEAF

—EVERY DEAF PERSON KNOWS THAT



I make myself hear, after being deaf for 25 years, with these Artificial Ear Drums. I wear them day and night. They stop head noises and ringing ears. They are perfectly comfortable. No one sees them. Write me and I will tell you a true story, how I got deaf and how I make you hear. Address



GEO. P. WAY, Artificial Ear Drum Co. (Inc.)
 80 Hoffman Bldg., 2539 Woodward, Detroit, Mich.

RESHAPE YOUR NOSE!



You can safely reshape your nose to beautiful proportions with **ANITA NOSE ADJUSTER**—painlessly, comfortably. Results speedy and guaranteed. Physicians praise it highly. No metal to harm you. Winner of Gold Medal, 1923. FREE BOOKLET Write for it today.

THE ANITA CO. Dept. 1112, ANITA Building Newark, N. J.

BUCHSTEIN'S FIBRE LIMB
 is soothing to your stump—strong, cool, neat, light. Easy payments. Braces for all deformities.
BUCHSTEIN CO.
 610 3rd Ave., So. MINNEAPOLIS, MINN.

Send for Catalog Today

Joy-STOMACH for SUFFERERS

For 27 years I have been telling stomach sufferers how to get well. Testimonials from all over the world tell of wonderful results. This information is sent without cost or obligation. Write for it today to

BYRON TYLER, Dietician. Estab. 1899
 172 Gibraltar Bldg. Kansas City, Mo.

AUDELS ENGINEERS & MECHANICS GUIDES

EXAMINE FREE!



\$12
Complete Set
8 Guides

For Every
Engineer **Machinist** **Fireman; Oiler**
Mechanic **Electrician** **Engineer Student**

T HIS Master Set is a gold mine of daily, practical helps for workers in every branch of engineering. A self-educating study course for the student; the standard reference work for the chief. Thousands of rules, tables, calculations and diagrams make it easy to read and learn. Latest inside information on theory and practice of modern engineering for reference study and review. Thousands of new short-cuts that make the job easier. Examine free! Pay \$1 a month (less than 4c a day) if satisfied that this set will help you to a better job—or make your present job easier.

AUDELS STANDARD LIBRARY
 With Questions and Answers That Solve Your Problems

EASY TERMS

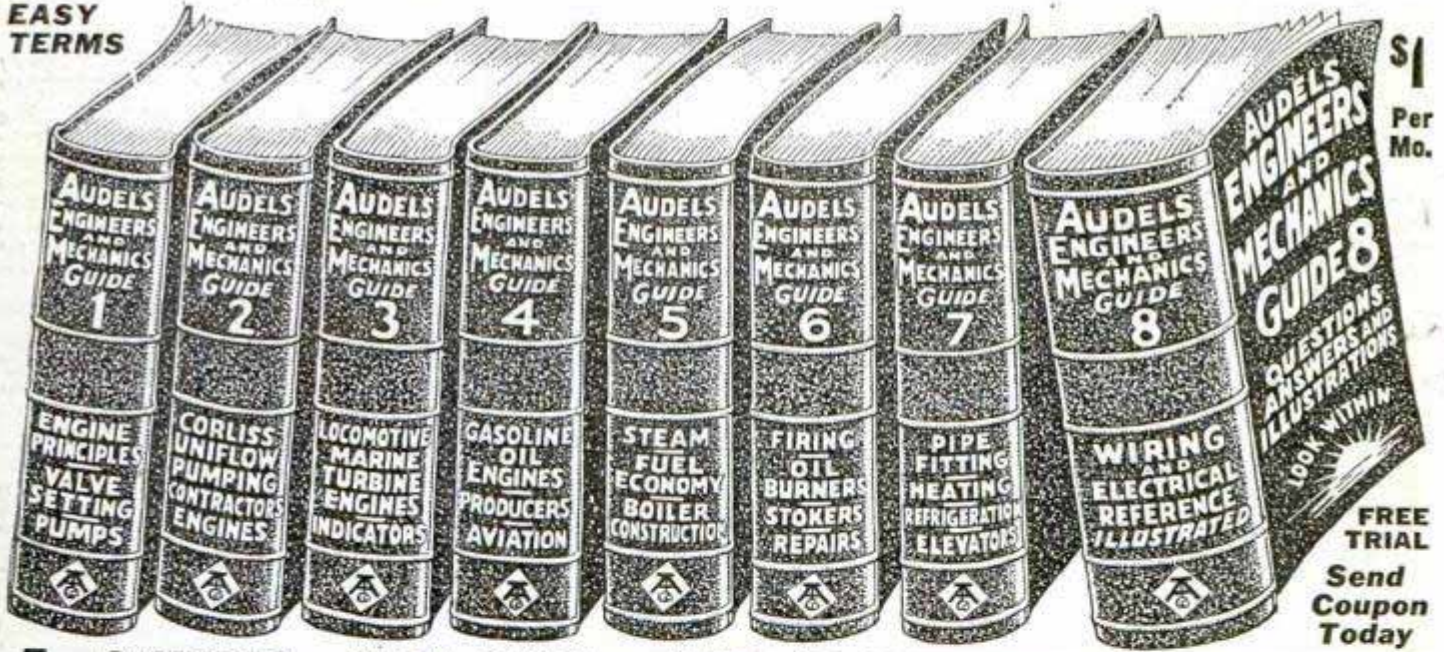

8 GUIDES—8754 PAGES—4750 ILLUSTRATIONS—POCKET SIZE

8 pocket numbers with Ready Reference Index. 8754 pages, 4750 illustrations. Easy to read. Highly endorsed. A good help in securing Engineer's License. Price \$12; terms, \$1 per month. Free Trial.

INFORMATION:— In A Handy Form. Answers to Your Questions and Problems. Here is a partial list of the subjects covered:— **Engine Principles, Valve Setting, Pumps, Corliss Engines, Uniflow Engines, Pumping Engines, Contractor Engines, Locomotives, Marine Engines, Turbine Engines, Gas Engines, Oil Engines, Indicators, Producers, Aviation, Steam, Fuel Economy, Boiler Construction, Firing, Oil Burners, Stokers, Boiler Repairs, Pipe Fitting, Heating, Refrigeration, Elevators, Dynamos, Motors, Lighting, Wiring, Electrical Diagrams, Radio, Electrical Reference and Calculations.**

FREE BOOK—FOR LIMITED TIME.

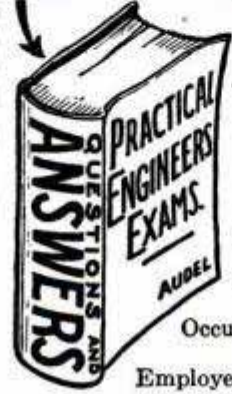

While the edition lasts, "Audel's Answers" will be included with each set of Audel's Guides. Contains special information for those who want to go before the board to get a license. Makes Engineers exams easy. Send this coupon at once.

THEO. AUDEL & CO., 65 West 23rd St., New York City.

Send me AUDELS ENGINEERS AND MECHANICS GUIDES, 8 numbers, \$12 and "Audels Answers" for free examination. If satisfactory, I will send you \$1 in 7 days, then \$1 monthly until \$12 is paid.

Name

Address

Occupation

Employed by

11T30

O. C. MILLER
 Director
 Extension
 Work
 American
 School



The American School

A million Dollar *No-Profit* Educational Institution, now offers men a *double* service—training for a specific job, then help in finding the job. For one small price, on terms of only \$5.00 a month, you are now assured of definite benefits, both in position and salary. Write for complete information—*today!*

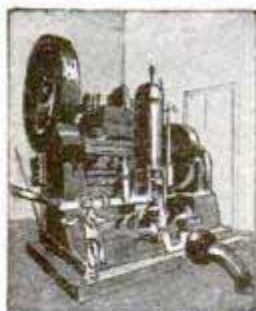

No machine can be built until the Draftsman first builds it on paper. My training prepares you for this work.



Never has the world seen anything like the building boom of today. This has created enormous demand for real Draftsmen.

5 BIG-PAY Branches

The big money in Drafting goes to men who specialize in Machine Design, or Electrical Drafting, or Architectural Drafting, or Structural, or Automotive. It is not enough merely to know *general* Drafting practice. You must know how to calculate and design and plan original work. You need many Engineering subjects to fill the kind of a Drafting position that pays \$60 to \$125 a week. The American School *now* includes this specialized training in its Drafting course.

Costly Drafting Outfit Given!

Fine, imported instruments like these help you learn Drafting quickly and easily. These standard quality, full size instruments, board, table, triangles, T square, ink, protractor, etc., given to every student without extra cost.



3 Drafting

to prove you can

We have invented a new, simplified way to teach Drafting—the first real improvement in Drafting home instruction in history. We want you to see a few of these new Job-lessons, try them, test your own ability to master them—without one penny of cost or obligation. For instance, you will see how we get away from the "copying" methods used in the past, so you develop into a DRAFTSMAN, instead of a "tracer." See for yourself the ingenious new method which compels you to think, to solve problems, to do actual Drafting-room jobs from the very first lesson!

A New, Rapid, Simplified Training

Copying drafting lessons prepares you to be only a "tracer." This new "Job-Method" gives you actual drafting-room jobs in a new one-step-at-a-time way. With pictures which you can understand almost without reading the "lessons." And that is why the American School-trained Draftsmen can qualify for a good job at big pay when they graduate.

Win Success Thru Drafting

Drafting is easy, fascinating work. Short hours. Big pay. And the Draftsman is always in line for promotion to executive positions. This training is *complete*. It includes high school subjects (if you need them) and all the Engineering and Mathematics Drafting experts require.

FREE Job Service!

The American School now offers its students and graduates, without cost, the services of an efficient employment department keeping in constant touch with employers of Draftsmen all over the U. S. We have placed hundreds of men in good, big-pay Drafting positions. We've made this training so complete, so practical, so easy to master, that our students are bound to **make good**. And so, because the demand for real Draftsmen continues to exceed the supply and because this training actually prepares men for good Drafting positions we back it with a **Free Employment Service**.

O. C. Miller, Director Extension Work

AMERICAN SCHOOL

Dept. D-874
 Drexel Avenue and
 58th St., CHICAGO

Lessons *Actually* FREE

learn at home in spare time!

Draftsmen Wanted!

\$60 to \$125 a Week!

yourself. Plan your future in Drafting. Even if you have only common schooling, even if you know nothing of Drafting, we guarantee to make you a real Draftsman or to refund your money! Special surprise offer right now to the first 500 men who answer this ad—reduced price, easy terms. Coupon brings complete information.

70,000 fine jobs advertised last year. Get ready to fill one. Get out of the rut. Make something of

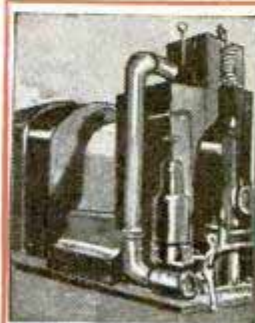

Electricity needs Draftsmen who know Electrical principles as well as general Drafting practice. I give you this training.



The demand for Draftsmen experienced in concrete and structural steel work is enormous. Many big-pay positions open.



Every great Auto factory employs Draftsmen who specialize in Automotive work—men who design bodies, plan engines, etc.

I Will Make This Contract With You

WHEN you enroll for our home-training in Drafting, we agree to give you:

1. Complete Drafting training, by the new Practice-Method.
2. Professional Drafting Outfit, as illustrated.
3. We will help you get a good Drafting position at a substantial increase in pay,

4. or we'll refund every cent of your money.



American School
—the Million Dollar Educational Institution

O. C. Miller

Coupon Brings 3 Lessons FREE!

Get them. Test your own ability to learn Drafting and get ready for a fine job and big pay.

Coupon also brings surprise offer, and complete information about your opportunities for success in Drafting. *Mail It Today!*

Read These Letters!

**City of Chicago
Department of Buildings**
Gentlemen: The same day I received my diploma I got word that I was one of the two candidates who had successfully passed the examination for Deputy Commissioner of Buildings of the City of Chicago, a position paying \$3600 per year.

There were eight applicants examined besides myself, all men well known to the architectural and engineering profession. Seven of these failed to obtain a passing grade of 70%. My grade was 84.69. Inasmuch as I failed to pass this same examination three years before, my present success is mainly due to the knowledge gained through your School.

Yours very truly,
ROBERT KNIGHT

**Liberty High School
Bethlehem, Pa.**
Dear Sirs:—This is to thank the American School for all that you have done for me since I signed up for the Drafting and Design Course.

In the eight years since then, I have gradually climbed from the position of tracer to that of Head of the Department of Machine Drawing and Design in our magnificent new \$2,000,000 High School here, at many times the salary which I received at that time.

The officials of the Pennsylvania State Department, and Dr. Wm. C. Ash of the University of Pennsylvania, all claim that our course in Drafting and Design is the best now being taught in this state. Every drafting graduate that we have turned out has proved successful, and one is now Chief Draftsman in a local steel concern. Yours sincerely,
J. S. LEAR

Has Charge of Large Jobs
"Even before I had finished my course, I was put in charge of large construction jobs in different cities. I have been doing that ever since, and the jobs are getting larger all the time. I owe my success to the American School because of the knowledge I gained in mathematics and calculations."
**ELMER L. LAMB,
1306 Smith St., Peoria, Ill**

Got His Draftsman's Job
"I wanted to let you know how I came out in getting that job at the Brownell Co., Dayton, Ohio. I was to start and have a trial at Drawing, and I am still in the Drawing room. The engineer seems to like the work I make, and also the other draftsmen. I thank the School very much for getting me in at this place, because your letter of recommendation helped me a whole lot to get the job."
**BERNARD WEBER,
730 St. Nicholas Ave., Dayton, O.**

3 Drafting Lessons *Actually* FREE

**O. C. MILLER, Director Extension Work
AMERICAN SCHOOL
Dept. D-874, Drexel Ave. and 58th St., Chicago**
Rush 3 Free Drafting Lessons, Job and Raise Offer, complete information, money-back guarantee, etc., to prove I can become a real Draftsman at home in spare time.

Name.....
Street No.....
City.....State.....

Get the Book

That Doubled Stephens' Pay in 7 Months—Boosted Everett from \$125 a Month to \$550, and has helped THOUSANDS of others

Sent Free ~ Mail Coupon!



Doubles His Pay in 7 Months
 "Mr. Cooke, I was a common laborer at \$24 a week when I enrolled with you. In seven months your training doubled my pay to over \$50 a week, and it is going up all the time. Your book, 'The Secrets of Success in Electricity' started me on the right road."
 W. H. Stephens, Electrical Contractor, Fort Edward, N. Y.

Here is an *unusual* book—different from any you have ever read. It tells how men make more money, and make it more quickly than any other way.

Thousands of men have sent for it and found it the shortest route to a better job at bigger pay. Maybe it will help you, like it helped Stephens, Everett and Lamb. But don't miss this opportunity to find out. The coupon in the corner will bring it to you right away—by special delivery mail—so you can decide right away, for yourself, just what this book can do for you.

The Key to the World's Fastest Growing Profession

"The Secrets of Success in Electricity," by Chief Engineer Cooke, tells you in simple language, all about the wonderful new opportunities in Electricity and all about its opportunities for you.

Men of all ages, with or without electrical experience, are urged to send for this book. Don't lose this chance to learn what others have done in Electricity, the greatest and fastest growing



Coal Miner Becomes Electrical Expert

"I was loading coal at \$5 a day when your book came to my attention. It changed my whole future. Now I earn more than \$550 a month counting my spare time profits. Here is a picture of the new Studebaker Special Six I just bought with my electrical earnings."

Carl Everett, L. Box 5-18, Danville, Ill.

Pay Tripled Since Enrolling

"Since starting your course, my pay has gone up to over three times what it was before. You have lived up to every promise you made to me, and done much more besides. I can never thank you enough for all you have done for me."

R. A. Lamb, 2101 W. Baltimore St., Baltimore, Md.

field in the world. 150 pictures—nearly 100 stories of success and how it was achieved—dozens of different electrical jobs and positions fully described—you get all these in Chief Engineer Cooke's big book. Clip coupon for your free copy.

No matter what you may have heard about other methods of electrical training, you don't know the whole story until you *get the facts* on what Chief Engineer Cooke offers you! You owe it to yourself to invest a two cent stamp in finding out about this amazing, practical and successful way of training.

Send for "The Secrets of Success in Electricity." Read how, in your own home, while keeping right on with your regular job, you can easily and rapidly fit yourself for a big pay position in this big pay field. Mail the coupon today—it places you under no obligation and no salesman or agent will call on you.

L. L. Cooke, Chief Engineer
L. L. Cooke School of Electricity
 Owned and Operated by
Chicago Engineering Works
INCORPORATED
 2150 Lawrence Ave., Chicago



MAIL THIS NOW!

Chief Engineer Cooke, Chicago Engineering Works, Inc. Dept. 18

2150 Lawrence Ave., Chicago

Please send me at once your free book, "The Secrets of Success in Electricity" and full particulars of your method of training men for responsible electrical positions. This request does not obligate me in any way and no salesman or agent is to call.

Name.....

Address.....

City.....State.....

Classified Advertisements

WORLD'S BEST WANT AD MEDIUM

Advertisements in this section, 25 cents per word, each insertion, minimum 10 words, payable in advance. To be inserted under proper classification in December issue, copy should be in our office October 18th.

ADVERTISING AGENCIES

ADVERTISERS—To buy, sell or to secure agents, salesmen, you can place your 24-word ad. in the following 15 leading Sunday papers for only \$15; circulation over 2,000,000: Age-Herald, Birmingham; Gazette, Little Rock; Journal, Atlanta; Star, Indianapolis; Register, Des Moines; Courier-Journal, Louisville; Times-Picayune, New Orleans; Star, Kansas City; World-Herald, Omaha; Courier, Buffalo; Enquirer, Cincinnati; Press, Pittsburgh; Commercial-Appeal, Memphis; News, Dallas; Journal, Milwaukee. Proof of Insertion Guaranteed or Money Refunded. 52-page rate book sent free. Frank W. Lenhoff Advertising Agency (established 1897), 600 North Michigan Blvd., Chicago.

FIFTEEN Dollars pays for a 24-word Want Ad in 20 big Sunday papers, additional words 62c; St. Louis Post-Dispatch, Cincinnati Enquirer, Buffalo Courier, Indianapolis Star, Pittsburgh Press, Atlanta Sunday American, Memphis Commercial Appeal, Tulsa World, Shreveport Times, Lincoln Star, Little Rock Gazette, Jacksonville Times-Union, Topeka Capital, Hartford Courant, Detroit Free Press, Colorado Springs Gazette-Telegraph, Mobile Register, Norfolk Virginian-Pilot, Butte Miner, South Bend News-Times. 32-page rate book chock-full of other bargains and valuable information mailed free. Standard Advertising Agency, The Leading Classified Agency, 923 Victoria Bldg., St. Louis, Mo.

A TEN Dollar Ad may put your proposition over. \$10 pays for a 4 line 24 word classified ad one Sunday in 10 of the largest newspapers. Reach over 7 million readers. Minneapolis Tribune, Buffalo Courier, St. Louis Post-Dispatch, Pittsburgh Press, Indianapolis Star, Atlanta Journal, Detroit Free Press, Birmingham News, Cincinnati Enquirer, Little Rock Gazette. Free catalogue showing other lists of newspapers and magazines sent on request. Ankrum Advertising Agency, 22 West Jackson Blvd., Chicago. Largest classified advertising agency in the world.

ADVERTISING: Over 25 years' experience building up advertisers. We prepare, print and place magazine, newspaper and classified advertising. Also folders, circulars and letters. Describe briefly your proposition, send your recent advertising matter, proofs of ads, etc. We will send you "Advertising Simplified," latest book of rates and valuable information. Ask Dun's, Bradstreet or any publication about us. Charles H. Touzalin Agency, 708 Union Trust Bldg., Chicago, Ill.

ADVERTISE in the classified section of newspapers and magazines, to secure help, money, or to sell. 24-word advertisement in nine big Metropolitan papers \$10.00. Nearly two million circulation. Many other bargain lists. Write for Free 58-page Directory No. 26. Brinckerhoff Advertising Agency, 37 W. VanBuren, Chicago.

ADVERTISE in 24 Big Sunday Newspapers—24 words \$15.00. 300 Rural Newspapers, 28 words \$10.00. 100 Big Weekly Newspapers, 24 words \$5.00. Lists and consultation free. National Advertising Service, Richmond Hill, N. Y.

ADVERTISE in 24 Big Sunday Newspapers, 24 words \$15.00. Excellent for securing Agents, Salesmen, and Business Opportunities. Catalog listing 1,000 leading Dailies, Weeklies, Mail Order Magazines. Everything Free. Wade Advertising, Baltimore Bldg., Chicago.

ADVERTISE—Newspapers, Magazines, Country papers—classified (Want Ads)—display space. Free catalog. Martin, 37B West 39th, New York.

ADVERTISERS Manual, complete: 1927 edition. All Foreign, American publications. Parcel Post. Publishers' rates. Country papers. Inside information for advertisers. 50c postpaid. Economics Publishing Co., 1475 Broadway, New York.

INCH Display 100 Monthly Magazines, \$4.00. Ad-Meyer, 4112M Hartford, St. Louis, Mo.

ADVERTISING in all magazines and newspapers at publisher's lowest rates. Book giving rates, closing dates, etc., 25c—refunded first order. Taylor's Advertising Service, 314-15 Brown Bldg., Rockford, Ill.

FOR ADVERTISERS

FIFTEEN Dollars pays for a 24-word Want Ad in 20 big Sunday papers, additional words 62c; St. Louis Post-Dispatch, Cincinnati Enquirer, Buffalo Courier, Indianapolis Star, Pittsburgh Press, Atlanta Sunday American, Memphis Commercial Appeal, Tulsa World, Shreveport Times, Lincoln Star, Little Rock Gazette, Jacksonville Times-Union, Topeka Capital, Hartford Courant, Detroit Free Press, Colorado Springs Gazette-Telegraph, Mobile Register, Norfolk Virginian-Pilot, Butte Miner, South Bend News-Times. 32-page rate book chock-full of other bargains and valuable information mailed free. Standard Advertising Agency, The Leading Classified Agency, 923 Victoria Bldg., St. Louis, Mo.

HEADQUARTERS for names—Mail Order Buyers, Agents, Opportunity Seekers, Juveniles, \$4.00, 1,000, 500, \$2.25. Co-operative Mailing, \$3.00, 1,000. Particulars free. Field's, 1145 East 99th, Cleveland, Ohio.

GUARANTEED Lists—agents, mail order buyers, others, secured through our own advertising or copied from original letters. 500, \$2.25; 1,000, \$4.00. Price list free. Club mailing. Demuth Company, Englewood, N. J.

ADVERTISE in a Magazine That Pulls and get your share of business. Worth subscribing for on account of highly instructive mail order articles. Sample copy free. Gilbert Sales Co., Pub., Dept. B, Milford, Conn.

MAIL Dealers—Let us mail your circulars with others of non-conflicting nature to our lists of actual Mail Order Buyers. You save time, labor, postage and expense. Reasonable rates. Special—2,000 circulars, any size, mailed for only \$5.00. Browne Sales Service, Dept. M-1958 Winnemac, Chicago, Ill.

ADDRESSING, Mailing, etc. Price list free. Wincholt Sales Co., Woodbine, 4, Penna.

YOUR Business Broadcast through C-B-C. Cheapest way for advertising. Write for particulars. P. Wetzel, Valhalla, N. Y.

ADVERTISE in India, 24 words \$15. In 12 leading English and Vernacular Dailies, Weeklies. Excellent opportunities. Cowas Agency, 2 Station Terrace, Bombay 7.

ADVERTISE in a Magazine That Pulls and get your share of business. Worth subscribing for on account of highly instructive mail order articles. Sample free. Gilbert Sales Co., Pub., Milford, Conn. Dept. E.

CUTS engraved, \$1.00 or higher. Wincholt Sales Co., Woodbine, 4, Penna.

ADVERTISE in 300 country newspapers. 28 words, \$10.00. Keator, Hartford Bldg., Chicago.

25 WORDS 88 magazines; \$1.00. Thrice \$2.00. Smith's Service, 1194, Wenatchee, Wash.

I WRITE letters, folders, booklets, complete followup for manufacturers, mail-order dealers. Long experience. Write for details. L. Taylor, 315 Brown Bldg., Rockford, Ill.

ORIGINAL Letters rented. Information free. Wincholt Sales Co., Woodbine, 4, Penna.

CUTS, Drawings \$1.50, Window Cartoons, 6, \$1.50. GPO, Bx471, New York.

SALES PROMOTION

CLINCH sales prospects by forceful letters, folders and booklets. Hewson, Advertising, Department 161, 121 North Broad Street, Philadelphia, Penna.

SALES creating letters written. G. W. Anderson, Box 1244, Phoenix, Ariz.

\$50 TO \$50,000 Daily Sales Developed During 28 years for clients by our direct mail plans, copy, campaigns. One product, 1923, an idea; this year \$100,000 orders booked. Fifty year old concern desired 50 national representatives in 1925; we produced 40 in three months. 700 dealers in 10 months at \$3 each, for another. Ten years Sales Promotion Manager Larkin Co. Submit sales problems for Free diagnosis. James C. Johnson, 118A Woodbridge Ave., Buffalo.

AUTOMOBILE SUPPLIES

MANUFACTURE Fibro-Seal, Guaranteed Puncture Plugger; Para-vulkine, No-cement Instant Weld Patch; Super-Radiolyte, 20-Minute Battery-Charging Fluid. I'm headquarters for Guaranteed Formulas for High-class Automobile Specialties and all lines. Investment small—profits enormous. No Machinery necessary. Valuable literature Free! Start a worth-while business with unlimited possibilities! Miller, Chemist, 1706-A Jetton, Tampa, Fla.

PAINT Remover; Remove the paint off your car for only a few cents. Formula one dollar. Diamond Specialty Co., Box 153, Fruitvale Station, Oakland, Calif.

VULCANIZING Auto Tires is a Paying Business. We have Plants near you from \$50 up. Catalog Free. Instruction Book \$1. Equipment Exchange, 108 East 11th, Los Angeles, Calif.

AUTO Emblems. Any Lodge. Write. North Central Distributors, Dept. J, Ashland, Ohio.

HEADLIGHT Telltales securely attached to lens. No drilling. 25c and 50c a pair. The Handy Dental Specialty Co., Somerville, Mass.

SERVICE data blue print chart—34 by 48 inches specifying, valve and ignition timing; valve, piston, ring and bearing fitting dimensions. Chart covers eighty 1926 automobile engines. \$1.50 postpaid. C. T. Schaefer, 2641 Russell Ave., St. Louis, Mo.

BATTERY Tester and inspector. Regular \$50.00 value; \$32.00. Battery Shop Equipment and Supplies at Wholesale. Adams-Barr, Columbus, Ohio.

USED Auto Parts for Any Car. Allen's Parts Co., 2001 So. 9th, St. Louis, Mo.

BARGAINS on Radiators. All standard makes radiators furnished at bargain prices. State Make and model. We guarantee satisfaction. Independent Radiator Co., 1119 Wabash Ave., Chicago.

65 MILES on 1 Gallon—Wonderful Gas Saver. All autos. 1 free. Critchlow, A-805, Wheaton, Ill.

MAGNETOS, Starters, Generators, Ignition systems, spark plugs, part, timing chains, repairing. Meinert Magneto Co., 1759 E. 21st St., Cleveland, Ohio.

AUTOMOBILES

PATENTS. Time counts in applying for patents. Don't risk delay in protecting your ideas. Send sketch or model for instruction or write for Free book "How to Obtain a Patent" and "Record of Invention" form. No charge for information on how to proceed. Communications strictly confidential. Prompt, careful, efficient service. Clarence A. O'Brien, Registered Patent Attorney, Security Bank Building (directly across street from Patent Office), Washington, D. C. See pages 140 and 141.

TOURING Atlas. Road maps of every state. Shows kind of road and distances between towns. Key to each map. Latest edition. With Popular Mechanics Auto Tourist's Handbook, 98 cents. Send no money. Just ask for "Touring Atlas" and "Tourist's Handbook." Pay postman 98 cents and postal charges. Popular Mechanics Press, Room 810, 200 East Ontario St., Chicago, Ill.

FOR FORD OWNERS

LOW-GAS alarm for Fords. \$2.00 postpaid. Fuelarm Company, Jersey City.

FORD Rebuilt Parts. We are forced to salvage a great many used Ford cars through our used car department and we have complete units and parts of every description that we can sell at ridiculously low prices—complete rebuilt motors, \$35.00; Front Axle System, complete with front spring, \$9.00; Rear Axle Assembly complete, \$15.00; Frames, \$1.50; new 1918-19 Fan Belts 10c each. These are just a few of our bargains. Send in your wants. We can take care of you. C. F. Van Sicken Motors Company, 7017 Cottage Grove Avenue, Authorized Ford Dealer, Chicago, Ill.

FORD Owners who dislike motor "bucking" in traffic, who wish to take long steep hills on high, who perhaps desire extreme speed, should use Avaco Valve Action which scientifically and simply increases valve capacity on a Ford. Durable, easily installed, inexpensive. Honest money-back guarantee. Write, Auxiliary Valve Action Company, Fitchburg, Mass.

PUT a "Bingo Thinner" on your Ford. Guaranteed best made. Thousands in use. Requires no oil. No more trouble. All Dealers or direct with full particulars—\$1.50. Agents make big money. United Machinery Company, Cincinnati, U. S. A.

65 MILES on 1 Gallon—Wonderful Gas Saver. All autos. 1 free. Critchlow, F-805, Wheaton, Ill.

FORDS: no freezing, no boiling, big gas saving. Airlock absolutely does it. Sells like machine guns fire. Free trial always. Airlock Products, Burnett, Calif.

DELIVERY bodies for Ford Model T Chassis with inclosed Cab; suitable for Contractors, Groccerymen and Farmers. Three styles. Price \$42.60. Write Daniel Zimmerman, Craigville, Ind.

UNDERSLING with "RKO" Swing Lo Irons. See "Red-I-Kut" ad page 147.

MOTORCYCLES, BICYCLES AND SUPPLIES

1923 HARLEY-DAVIDSONS, \$168; 1922, \$118; 1921, \$111; 1920, \$85; 1919, \$65; 1917, \$50; 1916, \$45; 1915, \$40; 1914, \$35. Guaranteed. Money refunded if not satisfied. Circular free. Wisconsin Cycle Sales Co., 726 National Ave., Milwaukee, Wis.

DON'T buy a Bicycle Motor Attachment until you get our prices. Shaw Mfg. Co., Dept. 27, Galesburg, Kans.

SEND for Bargain Bulletin. All makes of rebuilt motorcycles at lowest prices. Used parts half-price. Ash Motor Corporation, Rochester, N. Y.

OVERSTOCKED Used Motorcycles. 1923 Indian Chief \$95.00. 1923 Harley Davidson \$95.00. 1923 Henderson DeLuxe \$120.00. Two hundred others; write for free list. Myerow Brothers Co., 15 Berkeley St., Boston, Mass.

GOOD Second Hand Parts for Indian, Harley, Henderson, Ace and Excelsior Motorcycles. No Junk. Ship C.O.D. No Lists. J. B. Dahl, 3661-63 Archer Ave., Chicago, Ill.

AVIATION

LEARN to Fly; \$100.00 including Solo. We guarantee to solo you regardless of the number of flying hours required. Our instructors are ex-army aviators and air-mail pilots with wide experience. Our training equipment is the best obtainable. Our course requires about two weeks, depending on the individual. No bond required, no charge for breakage. Eight years without an accident. 76 students graduated in 1925. Commercial aviation is a rapid growing industry. Don't delay! Enroll now in one of the oldest and best known flying schools in America. Write for booklet, Robertson Aircraft Corporation, operators of the United States Air Mail, St. Louis-Chicago, Lambert-St. Louis Airport, Anglum, Mo.

PATENTS. Time counts in applying for patents. Don't risk delay in protecting your ideas. Send sketch or model for instruction or write for Free book "How to Obtain a Patent" and "Record of Invention" form. No charge for information on how to proceed. Communications strictly confidential. Prompt, careful, efficient, service. Clarence A. O'Brien, Registered Patent Attorney, Security Bank Building (directly across street from Patent Office), Washington, D. C. See pages 140 and 141.

SCOUT airplanes for sale; the famous Spad airplanes, single seaters, similar to the T. M. Scout, uncovered and without motor \$200.00 each f.o.b. our warehouse at San Antonio, Texas. Robertson Aircraft Corp., Anglum, Mo.

TEN lessons in the air of twenty minutes each will make you a pilot by our advanced method of training. This, together with our five weeks shop course, at \$100.00 makes America's oldest aircraft factory the most popular flying school. Work after class hours guaranteed. Special Fall and Winter evening course, including shop work, field, and flying, \$190.00. Employment furnished during the day paying \$20.00 to \$30.00 per week. Heath Airplane Company, Chicago, Ill.

THE American School of Aviation announces a new correspondence course in Mechanics of Aviation. A thorough training in Practical Aeronautics. American School of Aviation, Dept. 1861, 3601 Michigan Ave., Chicago, Ill.

AIRPLANES, Motors, supplies; 100 H.P. Gnome Rotary Motor \$75. Florida; 28 H.P. Lawrence Motor, \$125; Curtiss 90 H.P. \$500; leather helmets, \$3.75 and \$5; non-shatterable goggles, Oval \$2.50; Wide vision \$4; temperature gauge with 12 ft. tubing \$7.50; leather breeches \$12; leather coat \$18.50; airplane cloth 65c yd.; dope \$2.50 gal.; aerial camera \$100. Logan Aircraft, 716 W. Superior, Cleveland, Ohio.

COMPLETE Scale Plans with Building-Flying Instructions for following 3-foot Model Aeroplanes, 25c each postpaid: JND-2; DeHavilland; NC-4; Bleriot, Nieuport or Taube Monoplanes; Cecil Peoli Racer. Complete 48 pp. catalog 5c; listing hundreds of parts and supplies for experimenters. Ideal Aeroplane Co., 163½ Spring Street, New York.

AEROPLANE Engines. New 165 H.P. Gnome. Biggest bargain war surplus cost \$3,000.00; sale price \$40.00 at Dayton storage. Write for complete booklet describing aeroplanes, motors, parts all types. Enclose postage. Resistal goggles with extra pair clear glass \$2.60. Build your own plane wings \$7.50 each. Marvin A. Northrop, 730 Washington Ave., North Minneapolis, Minn.

"AEROPLANE Construction." Prepare yourself by taking our 10 weeks factory instruction course. Only \$50. Opportunity to earn expenses, or assemble plane of your own, while here. Attractive prices on blueprints and parts for sportplanes, also bargains in complete planes and flying instruction. Allison Airplane Co., Lawrence, Kans.

MOTORS: Curtiss OXX-6 Class A (under Fifty Hours) for Plane, Sea-Sled, Motor boat, etc., \$275.00. All Motor and Plane Spares at Best Prices. Send for Catalogue, Monumental Aircraft Co., 339 N. St. Paul Place, Baltimore, Md.

"CURTISS Pulitzer Racer" Construction Set, including Full Sized Plans and Genuine Curtiss Reed Propeller, \$1.25 Postpaid. Special Offer: Wonderful Scientific Air-Glider with Ground Launching Device, 50c. Big Catalog 5c Listing Latest Types Model Airplanes, Boats and Supplies. W. Phipps, 267 Wilson Ave., Brooklyn, N. Y.

AIRPLANES, How to build them and be sure they will fly. Learn the two most powerful influences on the stability and operation of an airplane. Get our free information, blue prints and propeller literature. Crawford Airplane Mfg., 2225 American Ave., Long Beach, Calif.

START building an air propelled sled now. Heath propellers, individually designed by America's oldest aircraft engineers, will give you real results. Inexpensive. Propeller circular 4c; motorcycle biplane circular 4c. Heath Airplane Company, Chicago, Ill.

28 HORSEPOWER airplane motors new and slightly used; \$90 and \$125. Also 90, 120 and 200 H.P. suitable for Speed Boats. Propellers \$3.00 to \$25.00. Leather coats \$5.00 and \$12.50. Smith Machinery Co., Box 153, Houston, Tex.

AIRPLANE, boat, sled propellers. "Aerodrive" sled, boat blueprints \$1.00. Leather helmets, \$3.00. Aircraft supplies list 5c. Ostergaard Aircraft, 4629 No. Narragansett, Chicago.

EARN \$3,500 to \$10,000 a year. Prepare for flying. Complete ground course in mechanics of aviation. Write for free catalog. Western Airplane Corporation, Desk K-11, Monadnock Block, Chicago.

AEROPLANE Construction and Operation. A book used in Government schools. Teaches both flying and airplane building. Folding charts and many illustrations. All features of construction treated. By John B. Rathbun, Aeronautical Engineer and Aviation Instructor. Send no money. Pay postman \$2.50 and postage. Popular Mechanics Press, Room 810, 200 East Ontario St., Chicago, Ill.

LEARN Aviation at America's foremost school. Earn your tuition if you lack the cash. Send 25c to Box 502, Peoria, Ill., for full particulars.

"SOMETHING New!" Full-Size Control Set for home training in Flying. With Instructions, \$5. Allison Airplane Co., Lawrence, Kans.

THREE foot model aeroplane. Price \$1.00. Circulars free. Aero Shop, 3050 Hurbit Ave., Detroit, Mich.

KING Bird, three place luxury plane. Write Western Airplane Corporation, Suite 403, Monadnock Block, Chicago.

BOOKS AND PERIODICALS

"THE Personal Liberty Course"—A clever combination of mirth, information and instruction for quickly overcoming fear, bashfulness and physical complexes in men. No drugs, no gymnastics. Full particulars free, sealed. The Gardener Pep Club, Box 607, Station C, Los Angeles, Calif.

CURIOUS Books, Unique Novelties, Stunning Pictures, Samples, 10 cents Prepaid. Linds, 214 W. 34th Street, New York.

TRIAL reading, circulating magazine clubs. Name favorite. Spencekirk Agencies, West Los Angeles, Calif.

"MASTER-KEY," 410 Pages, \$2.75. Bargain list 10c. Phipps Library, 1014 Belmont, Chicago.

SHOP Notes for 1926. Get your copy now. Only a limited edition. Contains all the articles published in the Shop Notes department of Popular Mechanics Magazine during 1925. Send No Money. Just write a postal and we'll send 1926 Shop Notes and any one of the other following numbers: 1908, 1912, 1913, 1914, 1915, 1916, 1917, 1919, 1920, 1921, 1922, 1923, 1924, 1925. Pay the postman 98 cents and the postage when he hands you the two books. Popular Mechanics Press, 200 E. Ontario St., Room 810, Chicago, Ill.

HYPNOTISM Wins, 25 Easy lessons and 248 page illustrated reference guide \$2.00. "Mindreading" (any distance) Genuine, Wonderful, \$1.00. Popular Institute, C430 Milwaukee Ave., Chicago.

STARTLING! Important! Truth about death, hell, immortality, eternity! 10c. Exponent, Orlando, Florida.

FREE—Send for my Newthought, Self-culture, Occult, Mystic and Scientific book literature. Martens Publisher, Burlington, Iowa.

SCIENTIFIC Books. Send for descriptive circular. Levi Bryant, 543 East 47th St., Chicago, Ill.

ENCYCLOPAEDIA Britannica, New International, Book of Knowledge, Harvard Classics, etc., Half Price. Dalton Riggs, Crilly Bldg., Chicago.

WHERE'D Cain Get Wife? 15 pages, 20c. Jabe Studio, Kansas City, Mo.

PITMANIC Light-Line Shorthand Book, 25c. Marr, Teacher, Nashville, Tenn.

BOOKS: Write for our sales and exchange plan. Kiburn, Spring Valley, Minn.

HYPNOTISM easily learned. Guaranteed lessons \$1.00 COD. Wineholt Assn., Woodbine, 24, Penna.

OUTDOOR Opportunities. Instructions for raising and selling rabbits, guinea pigs, milch goats, silver foxes, ferrets, white rats, white mice, dogs, cats, pigeons, pheasants, bantams, canaries, bees, frogs, mushrooms, ginseng, and golden seal. All profitable on town lot. Send No Money. Simply write a postal and say: "Send me Outdoor Opportunities." Pay postman \$1.50 and postal charges. Popular Mechanics Press, Room 810, 200 East Ontario St., Chicago, Ill.

PICTURES AND POSTCARDS

25 BEAUTIFUL Hand-Tinted Personal Xmas Cards and Envelopes, 4x5. Name in raised Gold Letters. Postpaid \$1.85. Samples Free. Maguire's, Al. Boulder, Mont.

COLORED view cards. Dozen 15 cents. H. W. Conard, 2418 Travis, Houston, Tex.

ART Pictures, Books and Novelties. Catalog 10c. Howard Sales Co., Dept. 15, 1188 Folsom St., San Francisco, Calif.

TRUE-BLUE friends everywhere. Exchange postcards, stamps, etc. Fascinating, entertaining, instructive. Year, \$1; half, 50c; quarter, 25c. Hundreds listings, 10c. Ed Erlerson, Elroy, Wis.

HAND colored scenes 5x7, mounted, 60c; 3 for \$1.20. 1 free. Butler Nature Prints, Houghton, Mich.

75 BEAUTIFUL Art Pictures and Bathing Beauties 25c (coin). Photo Sales Co., 3242 Rlchton, Suite 400, Detroit, Mich.

ART—photos 4 \$1.00. Cartoon lesson \$1.00. GPO, Bx471, New York.

RELIGIOUS Photos, Books, Novelties, Samples 25c. Photo Institute, McAdoo, Pa.

JOIN Live Postcard Club; Membership lists including Catalog, 10c. Harvey Teeple, Decatur, Ind.

GAMES, ENTERTAINMENTS AND PLAYS

COSTUMES for Hire—Amateur Plays, Minstrels, etc. Finest equipment. Send 25c in stamps for Jack Weber's Best Minstrel Joke Book and Price sheets on all theatrical goods. Address Dept. "C," Chicago Costume Works, Inc., 174 W. Randolph Street, Chicago, Ill.

PLAYS, musical comedies and revues, minstrel music, blackface skits, vaudeville acts, monologs, dialogs, recitations, entertainments, musical readings, stage handbooks, make-up goods. Big catalog free. T. S. Denison & Co., 623 S. Wabash, Dept. 11, Chicago.

VENTRILOQUISM taught almost anyone at home. Small cost. Send 2c stamp today for particulars and proof. George W. Smith, Room 8-124, 125 N. Jefferson Ave., Peoria, Ill.

LEXINO Card Games. Fascinating—educating. 50c postpaid. Lexino, 1216 Colusa, Berkeley, Calif.

NOVELTIES, CURIOS, ETC.

BOYS sell the aeroplane propeller wheels. Something new. Made of wood 12 inches long. Everybody wants one on their car. Sell for 50c. Send 6 cents postage for one. Aero Shop, 3050 Huribut Ave., Detroit, Mich.

MAGIC TRICKS, BOOKS AND JOKER NOVELTIES

MAGIC—Tricks, Books and Supplies. For Amateurs as well as the great professionals. Anyone can learn through our instructions. Feature Acts in Mind-Reading, Spiritualism, Rope Ties, etc. Large Illustrated Professional Catalog, 20c. Chicago Magic Co., 140 So. Dearborn St., Dept. B, Chicago, Ill.

BOOKS, Magic, Mysteries, Magic Tricks, Novelties. Catalog Free. Singer, 553, Hancock, Wis.

FOR something different, send 10c for "Fun-Magic-Mystery." New 80-page Book of 500 Tricks. Also contains Catalog largest line Magic Tricks and Supplies in South, at lowest prices. Send 10c today! Lyle Douglas, Station A, Dallas, Texas.

MYSTERIES—Mind-Reading Guide, 25c; Clairvoyance, 25c; Palmistry, 25c; Black Arts Book, 25c. G. Elsea, Bowling Green, Ohio.

FOUR Modern Miracles and Large Illustrated Catalogue 25c. One Dollar's Worth for 25c. Mysterious Chelsea, Station R, Box 24-M, New York.

12 DIFFERENT Joke Cards, 10c. Nassstrom, 474 Midway, Pontiac, Mich.

FREE with \$25 order die box. Send 20c for our large catalogue of tricks, wigs, sensational escapes. Oaks Magical Co., Dept. 548, Oshkosh, Wis.

SEVEN Magical Delusions and Catalogs—25c. Gilmaglio, Morgan Park, Ill.

CARD tricks, Coin tricks, Hypnotism, Ventriloquism. 64 page books. Complete guides, 10c each. Geo. Fenner, 2401 Jefferson, Louisville, Ky.

WONDERFUL Bargain in Magic Tricks and Illusions. Famous Needle Trick only \$1.50, sample trick 20c. Get our free catalog. F. & R. Co., Dept. F, Hoboken, N. J.

FOUR Modern Miracles and Large Illustrated Catalogue 25c. One Dollar's Worth for 25c. Mysterious Chelsea, Station R, Box 24-M, New York.

FREE—Our puzzle, trick, game, joke, Novelty Catalog. Wright & Son, 601-G Ind. Ave., Peoria, Ill.

125 CARD Tricks, 25c. Catalogue free. Wineholt Sales Co., Box 4, Woodbine, Pa.

READ sealed messages in dark; messages retained by audience; burned message appears on blank slate; spirit message appears on slate in sitter's presence; spirit rappings; spirits appear in the dark; answer questions written on folded papers while blindfolded. All this you can do with directions in "Behind the Scenes with the Mediums." 69 best secrets of mediums fully exposed. The best because most baffling, yet all easy to do. Send No Money. Just write a postal. Pay postman \$1.50 and postal charges. Popular Mechanics Press, Room 810, 200 East Ontario St., Chicago, Ill.

STAMP COLLECTING

MAGNIFICAROCIOUS 10c Snap, With Approvals. Over 111 dif. stamps. Some from far-off heathenish man-eating lands, of guarded secret rites and fever jungles, where white men seldom tread. Also many issued during money panic. That scarce Liberia, Hidden Hyderabad, Remote Travancore, Quaint Cochín with bumper shoot watermark, Old Canada, Hong Kong (George), Bandit ridden Albania, Huge stamp from land of ginger and Capt. Kidd's travels, Ceylon (isle of rare spices), Malay (tiger), Nyassa (all rubberneck), Gabon (savage with snickersneez), Congo (lady), Venezuela (large map stamp). Also Mammoth costly Catalogs. Fine approvals for adults furnishing reference. Stamps bought, Payn Stamp Company, 945 Grande Vista Drive, Los Angeles, Calif.

ARABS! Bandits! Head-Hunters! Egypt (sphinx); Malay (tiger); Tunis (Arab); Turkey (sacred mosque); Belgium (battle between angel and "old horns"); Congo (head hunter)—All of these mysterious and remarkable stamps are contained in our Famous Phantom Packet—55 fine varieties (to approval applicants only) for 8 cents. Nothing like it; order at once! Pacific Stamp Co., Box 138, Helena, Mont. Extra! Send us, with your order for the Phantom Packet at 8c, the names of three friends who collect stamps; we will give you, free of charge, a scarce set of 11 dif. Albania—bandit land! Supply limited; write immediately!

500 DIFFERENT Stamps for 25c! Big Collection 500 Different Stamps from Bosnia-Herzegovina, Crete, Epirus, Hong Kong, Iceland, Kenya and Uganda, Liberia, Malta, Nyassa, Tanganyika, Wallis and Futuna, Zanzibar, and other "hard" countries. Catalogue value \$10.00. Price only 25c to Approval Applicants! Special Bargains: 1,000 different 70c; 15 triangle stamps 49c; 100 Africa 50c; 100 Asia 60c; 100 Balkan States 35c; 100 British Colonies 25c; 100 French Colonies, 30c; 100 Portuguese Colonies 50c; All 8 packets for \$3.00! Illustrated Lists Free. Loma Stamp Co., 2221 Madison Ave., San Diego, Calif.

O-O-O-O-H, Boys! What a Thrill! The Fenway "Jungle" Packet!—Contains scarce stamps from jungle and cannibal-land! Included are: Abyssinia, Congo head hunters, Kenya and Uganda, Nyassa camels, Mozambique, Ivory Coast, Upper Volta, Togo, Ubangui, Tanganyika, Fiji Islands (cannibals!) and other savage lands. This wonderful packet from far-away countries to new approval applicants for only ten cents! Fenway Stamp Co., 161 Massachusetts Ave., Boston, Mass.

MYSTERY Packet — Stamps from Lands of Cannibals, sun-worshippers, wild savages, including Albania, Herzegovina, Antioquia, Chad, Congo, Cochín, Cape Good Hope, Guedelupe, Gold Coast, Kouang, Theou, Malay, Siam, Togo, Ubangui, Volt; (many unused) and other mysterious, far-off places, 105 stamps, all different, 5 cents to approval applicants! Big illustrated lists free. C. D. Reimers Co., 104 Flatiron Bldg., Fort Worth, Tex.

ANCHERS \$\$\$ Outfit—only 12c! Fine triangle stamp; set German stamps with (pre-war) value forty million dollars (interesting!); perforation gauge, mm. scale; small album; airmail set; scarce stamp from smallest republic on earth; newspaper set; packet good stamps from Travancore, Johore, Dutch Indies, etc. Entire outfit for 12c to approval applicants! (Nice pocket stock book, value 25c, with every order!) Ancher Stamp Co., 148½ Clerk St., Jersey City, N. J.

\$1.00 FREE. Black U. S. Postage. Given Away with each order. Pioneer Stamp Album with 500 illustrations, 150 different stamps from 40 countries, Syria, Lebanon, Helaz, Liberia, New French Colonies, British, Portuguese Colonies, South Africa, Australia, 500 hinges, 36 page illustrated catalogue. All for 15c. Big Commission to Agents for the Best approval sheets of stamps ever offered. Write for sample outfit. Hussman Stamp Co., Dept. M, 620 Olive St., St. Louis, Mo.

GUARANTEED the greatest bargains ever offered in our Mammoth Illustrated price list 2c or Free with Manor Packet of over 130 different stamps, mostly scarce and obsolete, such as Zanzibar, Victoria, Rouad, Sarawak, Cyprus, Malta, Kenya, Cayman, Turks, Wallis, Sierra Leone, Sudan, Johore, Syria, Palestine, Iraq, Belgian Congo, Nyassaland, Nigeria, So. Rhodesia, and 12 mint Azerbaijan, 25c to Approval Applicants Only. Pennsylvania Stamp Co., Manor, Pa.

FREE—A Monstrous Menagerie! The ferocious tiger; the kangaroo, leopard, oxen, camel, ant-eater, snake, caribou, swan, giraffe, flying horse, screaming eagle, wild elephant, etc. This wonderful packet of hard-to-get stamps—all containing pictures of curious birds, beasts and reptiles—free to approval applicants enclosing 5c postage! Big illustrated lists also free. Write today! Mystic Stamp Company (Dept. 8), Camden, N. Y.

1,000 DIFFERENT stamps, only 60c. Guaranteed to please or money back. "Washington Stamp News" tells stamp collectors about new United States stamps that are to be issued. Sample copy, 2c. C. E. Nickles, 201 Seaton, N. E., Washington, D. C.

1,000 MIXED. Mostly Philippines and Orient, very few from United States and Europe. Many old Spanish and United States surcharges, Philippines and Old Philippines. Byproduct our agency saved 24 years. 65c or 5,000 for \$3.00. U. S. Currency, stamps or money order accepted. Burt Subscription Agency, Box 1341, Manila, Philippine Islands.

16 ARMENIA, 16c; 11 Albania, 11c; 3 Abyssinia, 6c; 10 Azerbaijan, 20c; 26 Ailenstein, \$1.00; 6 Angola, 6c. Frederick Jackson, Dos Rios, Calif.

300 DIFFERENT Germany, 75c; 25 Luxemburg, 25c; 6 Haiti, 7c; 40 Denmark, 12c; 23 Epirus 30c. Frederick Jackson, Dos Rios, Calif.

260 DIFFERENT 10c. Approvals. Panhandle Stamp Co., 1905A Fillmore, Amarillo, Texas.

WHILE They Last!—11 Different unused Albania, only 12c to approval applicants. Stamp Shop, 515 West 175th Street, New York.

\$1.25 CATALOGUE—no Europeans—25c with request for 50c approvals. Sargent Stamp Co., 40 Monroe Ave., Grand Rapids, Mich.

SNAPS—200 different stamps, 10c; 60 different United States Stamps, 12c. With each order we give free our price list of sets, packets, albums, etc., and our pamphlet which tells "how to make a collection properly." Queen City Stamp Company, Room 38, 604 Race, Cincinnati, Ohio.

25 UNUSED Stamps, all different, 2c. 100 Different foreign, 7c. 25 Japan, 5c. Bargain lists free. Stanton, Natick, Conn.

500 DIFFERENT Stamps, Egypt, Sudan, Syria, Lebanon, Allanites, Palestine, Iraq, Arabia, Persia, Somalia, Eritrea, Abyssinia, Alexandria, Port Said, British, French, Portuguese Colonies, etc. Value \$10, post free \$3. Bazar Agency, Box 20, Port-Tewfik, Egypt.

FREE—26 different unused Foreign stamps. Denver Stamp Co., Denver, Colo.

200—200—200—200 ALL different stamps; 200 hinges; approval sheet to hold 200 stamps; perforation gauge, millimeter scale and ruler; duplicate stamp container—all for only 15c to approval applicants. Edgewood Stamp Co., Milford Conn.

BEST one-cent approvals in America. F. P. Hand, 1117 So. 60th St., Philadelphia, Pa.

FREE Hungary Charity No. 565 to 567 and a surprise packet given to those requesting for my 1, 2, and 3c approvals, and also my 50% discount. Chas. W. Schmidt, P. O. Box 4832, Frankford Station, Philadelphia, Pa.

STAMPS, 100 varieties, Africa, Brazil, Peru, Cuba, Mexico, etc., 10c. 50 different U. S. 25c; 1,000 mixed, 40c; 1,000 hinges, 10c. List free. C. Stegman, 5941 Cote Brillante, St. Louis, Mo.

500 DIFFERENT only 25c (regular price 50c), many unused, from British, French, Italian and Portuguese Colonies, Chile, Fiume, Guatemala, Persia, Siam, etc., to all approval applicants. Big bargain lists free. Victoria Stamp Co., London, Can.

SPECIAL, 50 Varieties French Colonies, very fine, to Approval Applicants only, 10c. Richard Lamprecht, Valparaiso, Ind.

PACKET of 23 stamps, no two countries alike. Packet hinges. Set of \$1 and \$2 U. S. Rev., all for 5c. P. M. Miami Stamp Co., Toledo, Ohio.

FREE! Loose Leaf Postage Stamp Album at rate of 8 pages each month given with subscription to monthly Journal. Send 2c stamp for prospectus. United Stamp Co., Marquette Bldg., Chicago, Ill.

STAMPS, 100 all different. Postage 2c. Lists free. P. M. Quaker Stamp Co., Toledo, Ohio.

110 NEW Europe All Different, a wonderful collection cataloguing several dollars, free to collectors requesting our Net Approvals. Postage 2 cents. Badger Stamp Co., Milwaukee, Wis.

24 VARIETIES Cuban stamps, 10 cents. List of 8,000 low-priced stamps free. Address Chambers Stamp Co., 111P, Nassau St., New York City, N. Y.

110 DIFFERENT Stamps, many unused, high values, free to collectors requesting our Net Approvals. Postage 2 cents. Christensen, Milwaukee, Wis.

COVERTCO Packet, 250 varieties unused and used stamps 15 cents. Covert Stamp, 39 State, Rochester, N. Y.

20 UNUSED stamps free. All different. Postage, 2c. P. M. Fisk Stamp Co., Toledo, Ohio.

1,000 ALL different stamps \$1.00. New price list of all United States stamps free. Voorhees, 7 South Dearborn St., Chicago.

SOMETHING different. Revenues, telegraphs—locals. Side lines—No postage. Immense stock all countries. Stamps one cent upwards. Dandy premium to applicants. Reference required. Vanderhoof, 1114 Logan, Denver, Colo.

UNITED STATES—Send on approval. Send me your want list. Ref. Please. M. Hanna, New Kensington, Pa.

TRINIDAD—Tobago, Two Complete Unused Sets, Trinidad Nos. 208-210, Trinidad and Tobago Nos. 101-105, 8 different scarce "Official" Stamps. Catalogue \$2.52 for 62c. G. S. Mollineux, Ridgely, N. J.

STAMPS on approval 1/4c up. Free premium. Herbert Keigwin, Middletown, N. Y.

SESQUICENTENNIAL Specialty! "Exhibition," "Charity," "Coat-of-Arms," "Pictorial," "Airmail," "War Sufferers," six wonderful sets; packet beautiful British, French, Portuguese Colonies; 100 different foreign. Big value, 15c, to approval applicants. Deering, 38 Fairmount, Marlborough, Mass.

STAMPS—1,000, 25c; 500 different, 35c; 1,000, 90c; 2,000, \$3.75. Album holds 2,000 stamps, 60c. Micheal, 4444 Clifton, Chicago.

100 DIFFERENT U. S. stamps 40c; no cut squares. Approvals all countries; send reference to M. L. Cook, 527 West 46th Street, Chicago, Ill.

STAMPS sent on approval at 70% discount. Reference required. Emory Renoll, Hanover, Pa.

12 DIFFERENT Angola, China, Ecuador, Egypt, Honduras, Mozambique, Peru, Salvador, Venezuela or Victoria 10c. Fred Onken, 630 79th Street, Brooklyn.

50 UNUSED French Colonials 14c; approvals. Koehler, 612 Meredith St., Dayton, Ohio.

GENUINE Confederate States \$1 Bill Free with 20 different unused stamps for a dime. B. Nagle, 1101 Marion, Reading, Pa.

200 STAMPS 15c. Approvals; reference please. Harvey Teepie, Decatur, Ind.

WHOLESALE quality stamp packets. Ask Hartman, 3803 Humboldt St., Denver, Colo.

MAGNIFICARCIOS Packet Foreign Stamps. Beauties from Distant Lands. (Many Richly Colored, unusual designs) free for 2c. Gray Stamp Company, Toronto, Canada.

1,000 MIXED U. S. and Foreign Stamps 25c. Phil Lunsted, Cape Cottage, Me.

100 DIFFERENT, Also 25 French Colonies, 10c to Approval Applicants only. Floyd Marsh, 524 Hamilton Ave., Indianapolis, Ind.

PROCURE Russian stamps from Philatelic International, 1, Tverskaja, Jamskaja 3, Moscow, U. S. S. R. American Branch, P. O. Box 388, San Francisco.

FREE! 25 different United States with 60% discount approvals to reliable parties. Seidenberg, Baroda, Mich.

STAMP Collector's Complete Outfit only 25c includes book telling "How to Collect Stamps"; Album (fully illustrated); 106 different stamps from Algeria, Chad, Gabon, Sudan, Ubangi, etc.; "Free Stamps" coupon and trial approvals. Harry Ioor, 802 State Life Bldg., Indianapolis, Ind.

ILLUSTRATED album, 50 different foreign stamps, packet hinges, perforation gauge, hints to collectors, and big illustrated price list—complete outfit, all for 10c to approval applicants. Special: 1,000 unused stamps only 50c. W. Betts, Clearfield, Penna.

FREE 40 Czecho Slovakia Stamps to approval applicants. 2c Stamp. Lightbown's, Osborne Rd., Southsea, England.

FIFTY Different Fine Stamps from Angola, Azores, Cameroons, Congo, Gabon, Senegal, Madagascar, Sudan, Togo, Ubangi, etc. Only 7 1/2 cents, to introduce approvals. Fennell Stamp Co., Dept. M, St. Louis, Mo.

ILLUSTRATED Album, Packet Stamps, Hinges, etc. 10c to Approval Applicants. George Linn Company, Columbus, Ohio.

5 DIFFERENT Sets French Colonies 7c. Lufbery, Port Orange, Fla.

PREMIUM 25 U. S. Only with Approvals; postage 3c; reference please. St. Elmo Stamp Co., 4814 N. Claremont Ave., Chicago.

105 CHINA, etc, 2c. Album (500 Illustrations) 5c. Bullard, Sta. A. Boston.

WANTED. U. S. Match and Medicine, Narcotics and Newspaper Stamps. Wineholt Stamp Co., Woodbine, 26, Penna.

500 DIFFERENT, 20c; 1,000, 35c; 2,000, \$1.27. Price List free. Wineholt Stamp Co., Woodbine, 26, Penna.

FREE. 200 different stamps to approval applicants. Auburn Stamp Co., 767 Irving, Syracuse, N. Y.

500 DIFFERENT 20c, 1,000 35c. Marko, 3027 Logan, Chicago, Ill.

FREE—Canadian \$1 Stamp to Approval Applicants. Stanley Munday, 112 Irvine Avenue, Westmount, P. Q., Canada.

FREE 1,000 All Different Free. Catalogue over \$23.00. Particulars 2c. Alamo Sales Co., Box 694, College Station, Texas.

222 DIFFERENT Stamps 22c. Ralph Mack, Sr., Goshen, Ind.

100 DIFFERENT unused 20c with approvals. Reference. Scott's 1927 catalog \$2.15. Clarkson, Ridgewood, N. J.

PRECANCELS 110 diff. 25c. M. Grooser, 1525 North Lawndale Ave., Chicago, Ill.

APPROVAL Stamp Packet Sent Free. Cornish Co., Schenectady, N. Y.

CONFEDERATE prints, Airmails, 20 unused, Big Lists; 5c. Buckley, 1037 Philadelphia Drive, Dayton, Ohio.

FRENCH Colonies Free—Jungles, Tigers, Native Chief. 2c postage. Empire Stamp Co., Toronto, Canada.

EXCHANGE stamps, etc. Club organized 1908. Interesting booklet, 10c. Ed Erickson, Elroy, Wis.

1,000 HINGES and Confederate Bill 8c, only to real applicants for approvals. Peter Bros., 962 S. Boulevard, Atlanta, Ga.

1,000 NICELY mixed stamps postfree .25; 1,000 hinges, .10; 2,000, .17. Price-lists free. Sunshine Stamp Company, Box 823, Salt Lake, Utah.

50 VAR. Scandinavians 10c. Gronberg, Box 5441, Philadelphia, Pa.

UNITED STATES and Foreign Money. Medals. Catalogue and Villa Bill 10 cents. Alexis Mengelle, Colorado Springs, Colo.

FREE stamps to approval applicants. W. E. Harriott, 1420 Crawford, Boone, Iowa.

100 ALL different stamps Free to new approval applicants. 100 Danzig 60c. Vanancy Stamp Co., 1644 So. Karlov Ave., Chicago, Ill.

BIG Surprise packet free to approval applicants. Robinson, 7144 Cornell, Chicago.

300 DIFFERENT, 12c; 1033, \$1.00; 2,000, \$2.95; 3,000, \$7.45; none better; returnable. 150 stamps 4c to approval applicants. Lists free. R. W. St. Benno, Glen Ellyn, Ill.

103 DIFF. New Zealand, etc., 3c! Lists Free! Supreme, 2335-7 S. Turner, Chicago.

ZANZIBAR, Abyssinia, Travancore, Herzegovina, Quilmane, Mozambique, Stamps. Menagerie Collection, Album, 10c. Liberty, 3974 Arsenal, St. Louis, Mo.

CHILE—15 var. 10c postpaid. Good stuff. Allion, Angola, Ind.

TRIANGULAR Stamps—One Nyassa, one Liberia and one Fiume for 5c. Eight Portuguese Colonials added for good measure. Crowder Company, Waverly, Baltimore, Md.

200 DIFFERENT 8c, 100 U. S. 25c. United States Stamps; Packets, Lists Free. Midwest Stamp Co., Kemper Bldg., Kansas City, Mo.

FREE. Good Set to Approval Applicants Sending Postage. J. Maxfield, Box 315, Amsterdam, N. Y.

200 DIFFERENT stamps 10c; 1,000 Hinges 10c. R. H. Carlton, 380 W. So. Temple, Salt Lake, Utah.

1/4c AND up approvals. Carl Schulz, 7638 Norton, Hollywood, Calif.

RARE COINS

OLD Coins, Large Fall Selling. Catalogue quoting prices paid for coins, ten cents. William Hesslein, 101A Tremont Street, Boston, Mass.

3 SMALLEST Copper, Silver and Gold Coins in World, 60c. 100,000 German Marks, 10c. \$5—20 Confederate 1681 Bills, 15c. 5 Copper Coins, Different, and Lists, 10c. Al. E. Bonsal, Richmond, Ind.

OLD Money Wanted. Do you know that Coin Collectors pay up to \$100.00 for certain U. S. Cents? And high premiums for all rare coins? We buy all kinds. Send 4c for Large Coin Folder. May mean much profit to you. Numismatic Co., Dept. H, Ft. Worth, Tex.

GET Profit and Pleasure in collecting Old Coins. Send 10c for Sample Old Coin, together with my Large Illustrated Coin Catalogue. You'll be delighted with it. Send for it right now. B. Max Mehl, Professional Numismatist, Mehl Bldg., Dept. P., Fort Worth, Texas. Largest Rare Coin Firm in U. S.

UNITED STATES, Large Cent, two-cent bronze, three-cent nickel and Bargain List, 25c. Fifteen dates large cents, \$1.00. George Coffin, Greenwood Mountain, Me.

RARE Coins Bought and Sold. Stocks, Bonds, Notes, 3 Curies, 2 Coins and Price List, 10c. Geo. Best, Cedar Rapids, Iowa.

CALIFORNIA gold, \$4 size, 27c; \$ 1/2 size, 53c; three-cent-piece and catalogue, 10c. Norman Shultz, Box 746, Salt Lake City, Utah.

44 DIFFERENT Coins \$1.00. 44 Different Bills \$1.00. Otto Oddehon, Independence, Mo.

40 OLD coins all different \$1.00. 100 different coins \$3.00. 100 good Foreign coins mixed \$1.25. 10 different dates Half-Dimes \$1.25. 10 different dates 3c pieces 75c. Monroe Half-Dollar Uncirculated \$1.00. List Free. Claud Denney, Box 315, Dallas, Texas.

CALIFORNIA gold Quarter 27c; half 52c; 1803 cent 50c; \$ 1/2, Washington, \$1; Columbus 75c. A. Wylie, Wheaton, Ill.

PAPAL coin 75-100 years old, 25c. Durso, 25 Mulberry, New York City.

\$2 TO \$500 Each Paid for hundreds of Old or Odd Coins. Keep All Old Money, it may be very valuable. Send 10 cents for Illustrated Coin Value Book, 4x6. Get Posted. Guaranteed Prices. We Buy and Sell. Clarke Coin Office, LeRoy, N. Y.

30 VARIETIES coins, 35c; 10 Confederate bills, 35c; 10 Mexican bills, 30c; 10 German bills, 25c; Catalogue free. Nagy, 8P South 18th, Philadelphia.

BILLION Mark German Government Bond, \$1.00; ten Bonds, \$3.00. American Sales Co., Box 1278P, San Francisco.

FOR BOYS

BOYS: Wind and assemble your own electric motor. Very interesting and educational. We furnish all parts and complete instructions for \$1.50. Write for circular. Hudson Valley Specialty Company, P. O. Box 642, Poughkeepsie, N. Y.

DESK Clocks: Make your own. Blue prints ten cents. Eight styles for a quarter. Guaranteed works reasonable. Great for Schools. Also works for Grandfather Clocks with or without chimes. Clock Co., Ruffner St., Philadelphia.

WOODWIN Electric Motor, high speed from one dry battery. Postpaid one dollar complete with starting switch nicked fan and grooved pulley. Ritter Manufacturing Co., 314 Washington Street, Brooklyn, N. Y.

ENTERTAINMENT for Boys! Our latest Movie Machines and durable Steel Toys are just the thing for real play. Catalogue Free. D. F. Elder & Co., Dept. C, Chelsea, Mass.

BOYS and Girls, Earn Xmas Money. Write for 50 sets St. Nicholas Christmas Seals. Sell for 10c a set. When sold send us \$3.00 and keep \$2.00. No Work—Just Fun. St. Nicholas Seal Co., Dept. 43PM, Brooklyn, N. Y.

CAMERAS AND PHOTO SUPPLIES

PHOTOGRAPHIC equipment and accessories of every description are listed and illustrated in our 228-page catalogue. It will pay you to secure a copy which is issued free, as our prices are low. We also deal in used goods which are sold under the same guarantee as new goods. Ask for our Bargain Book. Central Camera Co., Dept. E111, 112 S. Wabash Ave., Chicago, Ill.

KODAK Film—Special Trial Offer—Your next roll developed 5c, prints 3c each. Beautiful 6x10 mounted Enlargement 40c. Sameday Service. Fleet Photo Service, 1210 G., N. W., Washington, D. C.

FILMS Developed. Special Trial Offer. Any Size Kodak film developed 5c, prints 3c each. Trial 6x10 Enlargement in handsome folder 40c. Overnight Service. Roanoke Photo Finishing Co., 209 Bell Ave., Roanoke, Va.

11x14 COLORED enlargement free. Printing, developing, enlarging, and tinting. Prices low. Good service. Bender, 1915 So. 29 St., Lafayette, Ind.

MODERN Photography in all its branches now taught by mail. New Successful Method. Students earning \$300.00 while learning. Big opportunity. Write for particulars and unusual offer open for short time. Dept. 3431. International Studios, Inc., 3601 Michigan Ave., Chicago.

KODAK Films—Special trial offer: your next Kodak film developed, 5c—prints, 2c each. Moser & Son, 1917 St. James Ave., Cincinnati.

VALUABLE instructions on trick photography 25c. Art catalog free. Victor Matusek, 1518 West 21st St., Chicago.

\$5.00 FOR Photographs—This price paid for photographs if they meet our requirements. Perhaps one of your pictures will bring this amount. For particulars, address Redkrafts, Dept. 11, Denver, Colorado.

HAVE You a Camera? Write for Free sample of our big magazine, showing how to make better pictures and earn money. American Photography, 116 Camera House, Boston, 17, Mass.

MAKE \$75 to \$250 weekly; Motion Picture, Portrait and Commercial Photography. Camera Free. For Special offer, write New York Institute of Photography, Dept. 49A, 10 W. 33rd St., New York.

UNEXCELLED Gloss Prints. Trial Offer. Your Kodak Film Developed and printed only 10c. F R B Photographers, Dept. "C," 1503 Lincoln Ave., Cincinnati, Ohio.

\$150. Eastman Hawkeye Aerial, L type, for airplane; new; original price \$600. Plates 4x5. Fort, Widener Bldg., Philadelphia.

BARGAINS in Kodaks. Ray, 296 5th Ave., New York.

CALENDARS from Your Films—Send us any negative with 25c and we will make for you a 1927 calendar with the picture from your film artistically mounted. Frank Seoble, Photographer, 68C Sleepy Eye, Minn.

MOTION PICTURES

FILMS—Features, comedies, weeklies. \$3.00 up. Exchange Privilege. Projectors, Supplies. Lowest Prices. Howard Keiber, 623 W. 170th St., New York.

\$\$\$ FOR Ideas. Photoplay Plots revised, criticized, copyrighted, marketed. Send for free booklet. Universal Scenario Company, 244 Security Bldg., Santa Monica and Western Ave., Hollywood, Calif.

NEW and Rebuilt Machines for Big Theatres—Schools—Churches—Traveling Shows. Also Films—Supplies and Complete Theatre Equipments. Bargain List Free. Monarch Theatre Supply Co., Dept. P, Memphis, Tenn.

SEND \$2.00 for startling new Cinometer. Gives exact exposure for all Movie Cameras or lenses. Fits pocket. Free Bargain List of Motion Cameras. Bass Camera Company, 109 North Dearborn Street, Chicago, Ill.

FILM—Million Feet for Sale. Cowboy—Drama—Comedy and Feature Specials. Mix—Hart—Chaplin and best Movie Stars. \$3.00 per reel up. Genuine List Free. We supply the World. Dept. G, Monarch Films, Memphis, Tenn.

SACRIFICING New \$150 Sept spring motor Movie Camera and leather case, \$37.50. Eastman negative Film 2 1/2 cents foot. Printer \$25. Movie Projector \$37.50. Motor driven suit case Projector \$85. Movie Films \$2 reel. Ray, 296 5th Ave., New York.

MOVIE films. Complete stories in two reels (2,000 Ft.) \$5 per subject. Remittance with order. Independent Films, 177 Golden Gate Ave., San Francisco, Calif.

PHOTOPLAYS wanted at once. Big money for good, original ideas. What have you? Write for folder M. Photoplays of America, Delta Bldg., Los Angeles, Calif.

SCENERY TO RENT

WORLD'S Most Beautiful Settings for operas, plays, minstrels. Amelia Grain, Philadelphia.

EDUCATIONAL AND INSTRUCTION

YOU can have a business profession of your own and earn big income in service fees. A new system of foot correction; readily learned by anyone at home in a few weeks. Easy terms for training; openings everywhere with all the trade you can attend to. No capital required or goods to buy, no agency or soliciting. Address Stephenson Laboratory, 1 Back Bay, Boston, Mass.

DRAFTING Taught—To limited number, reasonable rates. Edwards, Draftsman, 4323 South Marsalis, Dallas, Texas.

ARTIFICIAL Marble sanitary flooring instructions, ornamental casting, concrete, plaster, papier-mache decorations, garden furniture, statuary, Rubber-moulds, 17 years instructing the public; particulars and illustrations free. Chris. Mahler, Huntington, N. Y.

PROFESSIONAL pointers in Humorous Cartooning. Write Freeburn, Artist, Hicksville, Ohio.

FIREMEN, Brakemen, Baggage men, (white or colored), sleeping car, train porters (colored), \$150—\$250 monthly. Experience unnecessary. 810 Railway Bureau, East St. Louis, Ill.

\$115—\$100 MONTHLY paid—Ry. Station—office positions. Free passes, experience unnecessary. Write Baker, Supt., (ABT) Star Bldg., St. Louis, Mo.

USED educational matter. Lowest prices; terms. Catalog free. Mention Subject. Fred Goetz, 410-A Sansome, San Francisco.

USED Educational Matter bought, sold, exchanged. Bargain Catalogue Free. Handling 799 Broadway, New York.

USED educational matter of all kinds. Sold on repurchase basis. Big saving. Money-back guarantee. List free. (Courses bought.) Lee Mountain, Pisgah, Ala.

ARE You Interested in Writing short stories, poems, songs, photoplays, For Profit? Then send for our new edition of actual letters from prominent editors, who want your manuscripts. It's Free if you send for it now. Address M. Mendelsohn, Editor, Dept. 102, Writer's Digest, 22 E. 12th St., Cincinnati, Ohio.

SHORT Stories, Novels, articles, marketed for subscribers. No reading fees. Details on request. The Plotweaver, Dept. I, Hollywood, Calif.

MEN wanting forest ranger positions, \$1,500—\$2,400. Write for particulars and list Natl. forests, Mokane, A-21, Denver, Colo.

EARN \$25 weekly, spare time, writing for newspapers, magazines. Experience unnecessary. Details Free. Press Syndicate, 981, St. Louis, Mo.

WORLD-ROMIC System, Masterkey 5,000 languages. Pioneers, \$1.98; Arabic, Chinese, French, German, Italian, Japanese, Russian, Spanish. Languages, 8 West 40th, New York.

SHOCARD writers, Artists, Pressmen—Mix 500 beautiful colors (proportions). Prepaid \$1.00. Art Publishers, 2033-37 College, Indianapolis, Ind.

SEE New York Institute of Photography Advertisement under Trade and Technical Schools.

MEN, get Forest Ranger job; permanent; \$125—\$200 mo. and home furnished; hunt, fish, trap, etc.; experience unnecessary. For details write Norton, 226, McManis, Denver, Colo.

DOUBLE Entry Bookkeeping mastered in 60 hours with 8 keys; guaranteed; diplomas. International Bookkeeping Institute, Dept. 8, Springfield, Mo.

LEARN Watch, Clock and Jewelry repairing at home. My four book course complete \$3.00. James Koch, Watchmaker and Jeweler, 1015 Market St., Marcus Hook, Pa.

INSTRUCTION books, all kinds. Catalogue free. Wineholt Book Co., Woodbine, 4, Penna.

A SIMPLE and visible Process for the permanent preservation of any perishable body. Guaranteed. 609, G.P.O. New York.

SHORTCUTS in figures. The quickest ways of working all problems. Instructions for drilling yourself to become rapid with figures. Complete, yet simplicity itself. Send No Money. Just write a postal for "Shortcuts in Figures." Pay postman \$1.25 and postage. Popular Mechanics Press, Room 810, 200 East Ontario St., Chicago, Ill.

ANSWERS to mathematical problems of office, store, shop, bank, farm, or factory. Explains and simplifies every principle of arithmetic, mechanics and mensuration. Over 2,000,000 sold. Send No Money. Just ask for "Ropp's Calculator." Pay postman \$1.00 and postage. Popular Mechanics Press, 200 E. Ontario St., Room 810, Chicago, Ill.

RADIO OUTFITS AND SUPPLIES

TROUBLE-SHOOTING. Do you know the key to the knowledge of any electrical circuit? You can find correct answer in a booklet written by nationally known authorities on Radio and Electricity. Ask your radio dealer for "Practical Guide for Every Radio Builder and Owner," or send 10c today to Universal Test Equipment Co., 2939 N. Oakley Ave., Chicago, Ill.

LATEST guaranteed Crosley Radios at bargain prices. Musicones \$9.00. Super Musicones \$10.75. J. Noid, 27 Chestnut St., Schenectady, N. Y.

RADIO Foot Ball Score Card. Follow Each Play. Send 25 cents. Ed Weber, 7036 Crandon Ave., Chicago, Ill.

600 MILE Radio, \$2.95 Postpaid. Needs no tubes nor batteries. Over 200,000 sold. Order direct from this ad. Crystal Radio Company, Wichita, Kans.

RADIO Accessory Agents—We manufacture a first class quick selling Radio "B" device with two year guarantee. Thousands in use. Write. Kinley Electric Co., 2663 Main St., Buffalo, N. Y.

800-VOLT four microfarad condensers \$2.40. All capacities condensers and resistances. The Radio Club, LaPorte, Ind.

B.M. 201-A TUBES 79c Postpaid. Unsurpassed for Distance and Volume. Improves Any Circuit. Guaranteed. Trellcott Co., 2118 Hale, Louisville, Ky.

RADIO Tube 6 volt—Wonderful reception; fully guaranteed or money refunded, \$1.00. Barker, 620 West 125th St., New York.

FOR Sale or Trade—Fifteen dial Omni-graph transmitter. Like New. Address C. L. Brown, Chippewa Lake, Ohio.

50H CHOKE \$2.00; 50H Choke \$1.75; 20H Choke \$1.00. 280V Transformers from 110V, \$2.00. Write for list. Radio Parts Sales Co., Box 24, Orange, N. J.

MANUFACTURE Crystals—Big profits—particulars free. Box 313, Wichita, Kans.

EUROPEAN broadcasts on two tubes. Blue prints 50c. Triangle, 5124 Sheridan Road, Chicago.

TRADE AND TECHNICAL SCHOOLS

GET a Foreman's Job in any trade. Train yourself to earn more money. Become an expert Blue Print Reader. You can do it in spare time. My training will give you advancement in a few weeks. Write now—tell me what trade you want—I will send my plan at once. Carroll Runsey, 165 Drexel Bldg., Philadelphia, Pa.

TELEGRAPHY—Both Morse and Wireless—taught thoroughly and quickly. Tremendous demand. Big salaries. Wonderful opportunities. Expenses low; chance to earn part. School established fifty years. Catalog free. Dodge's Institute, Fern St., Valparaiso, Ind.

LEARN Bricklaying at home or in school run by contractors. Catalog free. Associated Building Employers, E499, A. B. E. Building, Grand Rapids, Mich.

BRICKLAYING. Best paid, Best future. Start now, prepare for Spring business and better pay, at non-profit Contractors Association school. Write or Call. Detroit Bricklaying School, 1944 E. Woodbridge St., Detroit, Mich.

MAKE \$75 to \$250 weekly; Motion Picture, Portrait and Commercial Photography. Camera Free. For Special offer, write New York Institute of Photography, Dept. 49A, 10 W. 33rd St., New York.

MEN wanted to learn machine and tool making. We give you actual practice. G. & L. Machine Works, 1926 So. Wabash Ave., Chicago.

SEE our display ad on page 81 this issue. Chicago Painting School, 150 W. Austin Ave., Chicago, Ill.

BUSINESS OPPORTUNITIES

MANUFACTURE New Fast Selling Novelties, toys, preparations. Mail Order, Agent's Goods. Free list reliable patterns, processes, commercial information. Manufacturer's Bureau, 3937A Tracy, Kansas City, Mo.

VALUABLE Mail Order Information for Stamp. Win. Bickley, Lockland, Ohio.

QUIT Slaving for the other fellow and Hire Yourself as Boss! Manufacture These Biggest-Selling Specialties, 300 to 900% profit. Investment Small. No Machinery Necessary. I'll tell you how to make: Fibro-Seal. Guaranteed Puncture Plugger; Para-Vulkae, No - Cement - Instant - Weld Patch, Super-Radiolyte, 20-Minute Battery Charging Fluid; Guaranteed Metal Polishing Cloth; Non-Thermic Ice Saver Cloth; Tufnit—Prevents Runs in Silk Hosiery; Fly-Nox, Instant Fly-killing Spray. Valuable Literature describing these, also sixty others. Free! Write today! Miller, Chemist, 1706-C Jetton, Tampa, Fla.

ATTENTION! You can have a business of your own. Establish and operate New System Real Estate Business, brokerage and insurance agency in your community. Office at home. Earn \$5,000 year. Representatives wanted everywhere. Send stamp free booklet. Hayes Realty Association, Cincinnati, Ohio.

PATENTS. Time counts in applying for patents. Don't risk delay in protecting your ideas. Send sketch or model for instruction or write for Free book "How to Obtain a Patent" and "Record of Invention" form. No charge for information on how to proceed. Communications strictly confidential. Prompt, careful, efficient service. Clarence A. O'Brien, Registered Patent Attorney, Security Bank Building (directly across street from Patent Office), Washington, D. C. See pages 110 and 141.

ENTER a new business. Earn \$3,000 to \$6,000 yearly in professional fees making and fitting a foot specialty, openings everywhere with all the trade you can attend to; easily learned by anyone at home in a few weeks, at small expense; no further capital required, no goods to buy, job hunting, soliciting or agency. Address Stephenson Laboratories, (1) Back Bay, Boston, Mass.

BE Independent—add water to concentrated, high grade food products, beverages, flavors, new household, auto and chemical preparations—market under your own brand. We furnish labels, containers and the concentrated products ready to dilute. Clean cut, permanent, profitable business. Concentrating Co., 1129A East 31st, Kansas City, Mo.

GUARANTEED Mail-Order Plan. Successful. Double Income. Legitimate. Stamped envelope brings information. W. E. Johnson Co., P-5428 South Wells, Chicago.

COMPOSITION Floor Making earns industrious men \$12 and more daily if used as trade. Or make business of it with profits up to \$15,000 yearly. We teach everything; show opportunities; explain how to make good. Openings everywhere. Write Seal Tile, Dept. C, Hollis, N. Y.

\$3,000 TO \$5,000 Yearly. Want it? Others are making it. Send check or money order today for our invaluable books "How to Sell Real Estate," \$3.00—and "How to Conduct Real Estate and Insurance Business," \$1.50. Absolute satisfaction guaranteed. Free circulars. Realty Book Co., Dept. 52, Cleveland, Ohio.

MAKE Big Money Safe and Lock Expert. Wayne Strong, 3706 1/2 Lan Franco, St., Los Angeles, Calif.

MINIATURE Die - Casting Machines \$50.00. 318 Reed St., Erie, Pa.

SIGNS and Showcards Easily painted with Letter Patterns. Large variety of Styles and Sizes. Write for free samples. John Bahn, a2120 Neva Ave., Chicago.

WE Start You in Business, furnishing everything; men and women, \$30.00 to \$100.00 weekly operating our "New System Specialty Candy Factories" anywhere. Opportunity lifetime; booklet free. W. Hillyer Ragsdale, Drawer 4, East Orange, N. J.

PATENTS Procured; Trade Marks Registered—A Comprehensive, experienced, prompt service for the protection and development of your ideas. Preliminary advice gladly furnished without charge. Booklet of information and form for disclosing idea free on request. Richard B. Owen, 30-Owen Bldg., Washington, D. C., or 41-R Park Row, New York.

MAKE toys and novelties at home. Big profits. Instructions and illustrations, 25c. Astrolite Company, Sharpsburg, Pa.

MAIL Order News contains latest money-making schemes, opportunities and suggestions showing big profits. Complete instructions how to start profitable Mail Order Business of your own. Everything explained. Sample copy of this big magazine 25c. None Free. Established 23 years. Mail Order News, 360 Bristol Bldg., New York.

RESPONSIBLE manufacturer wants competent men to manage office and salesmen. \$300 to \$1,500 necessary; will allow expenses to Trenton if you qualify. Address Manager, 536 Forst Richey Bldg., Trenton, N. J.

EARN \$15.00 Daily. Qualify as an Expert Automobile Refinisher, Retrimmer, Cleaner, Interior Decorator. Make automobile specialties. Modern Trade Practice Quickly Learned at Home—Endorsed Everywhere. DeWilde, Sheboygan, Wis.

MECHANICS, painters, carpenters, start furniture refinishing, painting, handyman shop on nearly nothing; winning plan brings customers quickly. John Braceland, 1439 So. Ninth, Philadelphia, Pa.

MIRRORS Resilvered at Home. Costs Less 5 cents per square foot; you charge 75 cents. Immense profits plating like new, brass worn-off autoparts, reflectors, tableware, stoves, etc. Outfits furnished. Details Free. Sprinkle, Piater, 127, Marion, Ind.

SCHEMER, Alliance, Ohio, 36p monthly, prints mammoth \$-getters. Subscriber reports \$25,000 from three; another \$10,000 from one. Try your luck. Year, \$1.00; 3 months, 30c.

DELAWARE Incorporator, Charters; Fees Small; forms. Chas. G. Guyer, 901 Orange St., Wilmington, Del.

START Magazine, 24 pages, 6x9, \$2.50. Plan 10c. Dolsen, 36 Liberty, Brooklyn.

MAKE Money at Home—making toys. We show you how. Send \$1 for complete working drawings and instructions. DeKalb Designing Co., Decatur, Ga.

I MADE \$30 a Week Home. French Breadmaking. 15 years' experience; Free Booklet tells. Ashbrook 67, Marengo, Ohio.

MONEY in Cleaning Upholstery. Experience unnecessary. We furnish material and instructions. Diehl Cleaning Co., 2125 Parker Ave., Detroit, Mich.

MAIL order Stamp and Coin business doing over \$200 a month (mostly profit) for sale. Customers list 5,000. All over world. Stock catalog value over \$10,000. Will sell for \$1,500. Owner, 962 S. Boulevard, Atlanta, Ga.

MANUFACTURING space; extremely low cost, lease or buy. Labor, shipping, living conditions ideal. Lake Erie Grape Belt, Columbia Postal Supply Co., Silver Creek, Chataqua County, N. Y.

\$200 PER month spare time. Nothing similar ever offered. Any location. Surface not scratched. Mail order or salesmen or both. 900% profit at least. Every auto owner must buy at least once per year. Established 1920. Cost fortune to develop, offered for one dollar but investigate first. Proco, 728 Filbert St., Pittsburgh, Pa.

DEALERS—Buy Battery Shop Equipment and Supplies at Wholesale. Get circular No. 131. Adams-Barr, Columbus, Ohio.

WRITE today for particulars of our free publishing proposition; let us show you how to give premiums in a mail-order business of your own; big opportunity. P. E. Junier Sales Service, 117 Pleasant St., Fairhaven, Mass.

TATTOOING Supplies, Illustrated Book free. Manufacturer's Prices. "Waters," 965 W. Putnam, Detroit.

66 MILES on 1 Gallon—Amazing, New, Wonderful Vapor Humidifier—Gas Saver—and Quick Starter. For all autos, trucks, tractors. Use Winter and Summer. Exclusive Factory Representatives wanted everywhere. 400% profits. I free to introduce. Critchlow, K-805, Wheaton, Ill.

CHRISTMAS novelty sold merchants. Exclusive territory to financially responsible representatives. Big demand. Big money. Consolidated, 67A West Van Buren, Chicago.

MAIL order Booklet, where to buy Books, Novelties, Specialties, 10c. Harvey Teeple, Decatur, Ind.

MANUFACTURE something different, competitionless. Genuine (not fakes) Mexican tamales, delicacies, confections. Enormous demand. Unlimited possibilities. No formulas. Easy training courses. Particulars 10c (coin). Guerrero, Bolivar 78, Monterrey, Mexico.

WANT More Money? Start Little Mail Order Business. Samples and Plan Free. Mailing Charges 10c. Snydaun, 10748 112th St., Richmond Hill, N. Y.

CAPITAL secured for invention, any business proposition. Inexpensive, reliable method. Interstate Service, Elizabeth, N. J.

LEARN to sew and remodel furs. Complete course sent by mail. Investigate today. Mabel Horn, 263 Prospect Ave., Oshkosh, Wis.

LEARN to Manufacture—It pays big profits. We teach you how. Start spare time. Few dollars. At home. We show you how to sell. Write for free circular. Hearinger System, 2002 Wyoming, St. Louis, Mo.

DON'T buy your products, manufacture them. We sell formulas for all lines at one dollar each. Oakland Formula Co., Oakland, Calif.

LOOKING for patented article made from aluminum die castings. Will arrange for manufacture if exclusive sale given. Continental Investment Co., 40 Clinton St., Newark, N. J.

Do PUTS your name on mailing list year. Receive offers from wholesale supply houses everywhere. Kentucky Agency, Covington, Ky.

YOUR own mail order or local business. Opportunities galore. Free particulars, Fayette Specialty Co., Conneville, Penna.

REPAIRING beaded bags brings big profits. 50 bead faces in 50 assorted colors, usual sizes; send \$1.00 for each bunch. Gustav Staffen, Kochstrasse, Munich, Bavaria.

SELL Pro-Tex-Chex. A Check Protector. Sample 25c Postpaid. Goldstein Bros., Santa Cruz, Calif.

MEN and women everywhere. Earn good steady income at home. Learn Photo-Retouching by easy quick method. Write, American Art Studio, 23 Seminary Ave., Auburn, N. Y.

EARN big money in your spare time operating profitable steady business by mail or locally. Complete details 25 cents (no stamps). P. O. Box 680, Johnstown, Pa.

600 WAYS to Make Money; 3,700 Formulas—Plans. "Encyclopedia Business Opportunities." 3 Volumes \$1.25. Catalog Free. Ideal Book Shop, Park Ridge, Ill.

MARBLE mixing instructions, covering wood or cement flooring 1/2 inch thick, fire-proof, waterproof, low cost, sanitary, all colors. Particulars and illustrations free. Marble and flooring samples 12c. Chris. Mahler, Huntington, N. Y.

SMALL fortunes being made in uncrowded Baby Chick Industry. \$3,000 to \$5,000 first year not unusual. Business keeps growing; unlimited demand. Valuable booklet explains fully, tells what to do, how to do it. Send 25c to cover mailing, etc. Limited supply—Write Now! Wellington J. Smith Co., 551 Davis-Farley Bldg., Cleveland, Ohio.

CHEMICAL Expert will furnish Formulas and Trade Secrets. All lines. Lists Free. W. L. Cummings, Ph. D., 238 Gordon Ave., Syracuse, N. Y.

UNPATENTED Ideas Can Be Sold. I tell you how and help you make the sale. Free particulars (Copyrighted). Write W. T. Greene, 810 Jenifer Building, Washington, D. C.

SELL, direct by mail. Use sales compelling letters, folders, booklets! Prepared by Hewson, Advertising, Department 162, 121 North Broad Street, Philadelphia, Pa.

LEARN the collection business. Good income, quick results. Interesting booklet, "Skillful Collecting" free. National Collectors Assn., Long St., Newark, Ohio.

EARN \$10 daily silvering mirrors, plating and refinishing metalware, autos, chandeliers, bedsteads, headlights. Outfits furnished. E. Deed Laboratories, 1133 Broadway, New York.

DON'T gamble in mail order business. Be sure. Free circular puts you wise. MacRae, M40 Oregonian Building, Portland, Ore.

\$750,000,000 MAIL-ORDER business in 1925. Many grow rich in this great trade. Sell merchandise, information, patented articles, various preparations. Breniser's Famous Mail-Order Handbooks tell how. Eleven brochures \$3. One book with complete catalog, 25c; none free. Breniser, (Established 1906) 335 Walnut, Philadelphia.

MAKE—Sell Your Own Goods. Formulas, Processes. All kinds. All lines. Catalog, circulars free. B. Thaxly Co., Washington, D. C.

NOW that you have read all these offers, send 25c for Detailed Information. (None free.) "How" and "What" to Sell by Mail; through Agents; or Direct! We want 100,000 Representatives! Opportunity is knocking—Answer! Surety Service, Dept. 10, 551 Harvard St., Rochester, N. Y.

TELEGRAPHY

TELEGRAPHY—Both Morse and Wireless—taught thoroughly and quickly. Tremendous demand. Big salaries. Wonderful opportunities. Expenses low; chance to earn part. School established fifty years. Catalog free. Dodge's Institute, H St., Valparaiso, Ind.

CHEMISTRY

FORMULA by Richards means the best. Your chemical problem solved and working process furnished \$5.00. Write me. W. Steadman Richards, Consulting Chemist, Box 2402, Boston, Mass.

STANDARDIZED formulas at prices you can afford to pay. Big money makers. Write for lists. Fenway Laboratories, Box 1937, Boston, Mass.

CHEMICAL Analysis, Processes, Technical Information. Robert Henderson, Laboratory, Madison, Me.

CHEMICALS for experiments; Get list. Service Laboratory, Box 182, Iowa City, Iowa.

FORMULAS AND TRADE SECRETS

FORMULAS. Guaranteed Best Chemical Science can devise. Stamp brings big bunch valuable literature describing Latest Reliable Processes for Manufacturing All Lines. Don't Buy till you've received these Profitable Propositions. No recipe-book trash. 29 years giving satisfaction. Miller Chemist, 1706-U Jetton, Tampa, Fla.

EASY money maker, just like I use myself; why not you? Particulars for red stamp. W. P. Stump, Hemet, Calif.

500 FORMULAS including Luminous Paint—Renewing Dry Batteries—Resilvering Mirrors—Gas Tonic, Puncture Plugger, etc. Catalog Free. Ideal Book Shop, Park Ridge, Ill.

300 TO 500% your profit! Formulas for making auto polish, carbon remover, non-freezing compound. Anyone for \$1.00. Employ agents to sell for you I show you how. Niles Formulas Ocean Grove, Mass.

10c—ANY Formula—10c. Dime Information Bureau, Colorado Springs, Colo.

MAKE—Sell Your Own Goods. Formulas, Processes. All kinds. All lines. Catalog, circulars free. B. Thaxly Co., Washington, D. C.

FORMULAS, Processes, Trade Secrets. We furnish the very best for all purposes. \$1.00 each, no stamps. R-D Company, Box 1298, Fort Worth, Texas.

EASY money maker, just like I use myself; why not you? Particulars for red stamp. W. P. Stump, Hemet, Calif.

SAWDUST and Chemicals makes Sanitary flooring. Directions \$1.00. Universal Supply Co., Auburn, N. Y.

SPECIAL Flavoring extracts. In bottles or tubes. Immense profit. Supplies cheap, obtained anywhere. No machinery required. Directions \$2.00. Great Western Supply Co., 622 Marengo Ave., Forest Park, Ill.

BESTALL Chemical Wood Stone—For public building, kitchen and bath room flooring. Can be molded in dolls, souvenirs and novelties. Circular free. Maxlin Chemical Co., Maxlin Building, New Castle, Ind.

AVOID Competition Entirely new plan and formula Mail order specialty \$1.00. Act quickly. Berg, 259 West 152nd, New York.

SPECIAL formulas for Manufacturing and Business purposes. Any one you want, including full manufacturing instructions and where to get all supplies, sent for \$5. Satisfaction guaranteed. Announcements of latest formulas for quick-selling seasonal products sent monthly without charge. Write today. National Information Bureau, 316E Shepherd Building, Grand Rapids, Mich.

ANY desired formula \$1.00 guaranteed. Laboratories, 233P, Champaign, Ill.

15,000 FORMULAS in "Scientific American Cyclopaedia of Formulas." Includes following and many others: accidents and emergencies, agriculture, alloys and amalgams, artists' materials, beverages, cements, glues, pastes, mucilages, bleaches, renovating, coloring metals, dyeing, glass, heat treatment of metals, household formulas, ice cream, confectionery, chewing gum, lapidary work, exterminating vermin, lubricants, paints, varnishes, photography, condiments, canning formulas, rubber, soap, candles, soldering, toilet preparations, perfumes, waterproofing, fireproofing, writing materials. Send No Money. Just write a postal. When postman hands you book, pay \$5.50 and postal charges. Popular Mechanics Press, Room 810, 200 East Ontario St., Chicago, Ill.

NO More Punctures! It seems too good to be true. We will sell our formula with full instructions for only \$1.00. Be the first in your locality. Ever Right Co., Dept. 10, 1311 Columbus Ave., Bay City, Mich.

3,000 FORMULAS and Recipes for \$1.00. Not a cook-book. Worth while Formulas, Trade Secrets, etc. 368 pages. E. Kephart, 415 East 73rd, New York City.

CONCRETE Waterproofing Processes, making Hard, Light Colored Dampproof concrete building blocks. Concrete Machine Co., 5 Main St., St. Louis, Mo.

500 VALUABLE Formulas, 25c. Circular Free. Harvey Teeple, Decatur, Ind.

AGENTS WANTED

HERE! There! Everywhere! Stylemor Shirts—America's fastest selling, most popular shirt line, brings you \$50-\$100 weekly, easy! Exclusive territory insures big money. Beautiful sample outfit brings quick easy profits. Free shirt—cash bonuses. Experience or capital unnecessary to clean up in big way. All you do is rake in the money. You are paid the minute the order is signed—we do the rest, deliver postage prepaid, and collect the balance. Low prices, high quality, quick service, make repeat orders a reality—not a pipe dream. Stylemor shirts, with 175 different color patterns, also pajamas, lumber jack and flannel shirts, make up the line that sells to everyone because there is a price and style to suit every one. Write today for big free outfit that means dollars and dollars to you. Don't wait! The big fall market is red-hot. Stylemor Inc., 81 W. Van Buren, Dept. 111, Chicago.

WE are offering Permanent Positions to reliable men and women, as well as an excellent income from side-earnings to part time workers. During our 35 years in business we have appointed over 516,000 agents who supply our household necessity to our customers in every country in the world. Many of our agents have been with us over 30 years and have achieved Financial Independence. Increasing local demands and repeat orders make it necessary to appoint more local representatives in many localities in the United States. No experience or capital required. A straightforward, dignified business. Why not represent the largest and best known house of its kind in the World? Send us your address and the Manager of our Appointment Bureau will send you full particulars, free samples for Trial Tests in the homes of your locality, etc. M. A. Winter Co., 9 Winter Building, Washington, D. C.

\$15 DAILY—Paid in Advance. Free Slicker Raincoat for You, Too. Amazing earnings introducing latest sensation, Franklin Collegiate Slicker Raincoats. Sell on sight. Only \$3.95. Six popular colors; Copenhagen Blue, Lipstick Red, Jade Green, Oiled Yellow, Natural Olive, Royal Grey; guaranteed absolutely waterproof. Stores ask \$10 to \$20—imagine your big sales with low price of \$3.95, (and your profit is \$1 on every sale). Every man, woman and child wants a Franklin Collegiate; they're the rage now; Get your share of the big profits! Complete sample line sent Free. Hurry before some other hustler in your territory discovers this live proposition. Write quick for big Free Sample Outfit. Franklin Products Corp., Dept. M-161, 1036 VanBuren, Chicago.

I WANT a Partner-Agent to Take Care of my business in your town. I furnish everything, including world's finest line of 175 household products, and I split the selling price with you 50-50. Beautiful sample outfit makes selling easy; food products; household necessities; things people eat; highest quality—lowest prices; quick sales—permanent repeat business; \$25,000.00 bond guarantees quality. I pay largest commissions. Get my amazing offer for your locality of "free" Chrysler Closed Car. Write or wire C. W. Van De Mark, Vice-Pres., Health-O Products Co., Health-O Bldg., Dept. 100-P, 117 Duane Street, Cincinnati, Ohio.

YOU Can Make Big Money Every Day of the year selling our wonderful new line of Pure Food Products and Household Necessities. No experience or money required. We furnish samples and leads so that first sales are easily made. Every new customer adds steadily to your weekly income. You can earn \$3,000.00, \$5,000.00, even \$10,000.00 a year. Positions now open in several valuable territories throughout the United States. Apply with references and be prepared to start work at once. Federal Pure Food Company, A2309 Archer Ave., Chicago, Ill.

BOYS! Girls! Make \$1.50 an hour after school, selling Luminite Radium Pendants. Show the way to all lights—electric, gas, lamps or candles, 20% brighter than all others. Guaranteed five years. Put one in a dark room of any neighbor and three to twelve will be sold. Send \$1.50 for first dozen and sell for \$3.00. Or send your name and address and pay postman \$1.50 plus 10c postage. No risk. Money refunded on all unsold by the world's largest producers of Guaranteed Luminous Accessories. Address Luminite Corporation, 6 Scott Street, Newark, N. J.

WHY not sell us your spare time, \$2.00 an hour, \$19.70 daily easy Full Time. Introduce 12 months Guaranteed Hosiery—47 styles, 39 colors for Men, Women, Children, including latest "Silk to the Top" Ladies Hose—No capital or experience needed. We furnish samples. Silk hose for your own use Free. M. H. Mathews, Card 53611, Cincinnati, Ohio.

AUTO owner tire agent wanted each locality to use and take orders for hand-made Mellinger cord and balloon tires; guarantee bond 15,000 miles; shipped prepaid on approval; get your tires free; no capital or experience required; make \$100 to \$300 weekly. Write for wholesale prices and sample kit. Address Mellinger Tire Co., Dept. 400, Kansas City, Mo., or Dept. 400, Philadelphia, Pa., or Dept. 400, Oakland, Calif.

MARVELOUS New Invention, 400% Profit. Liquid Quick Mend for Hosiery and Fabrics. Tremendous Demand. Over 100 other fast sellers. Local and General Agents. J. E. Johnson Co., Dept. 447, 69 E. So. Water St., Chicago.

STARTLING Selling Plan! \$1.25 premium free to every customer on \$2.00 sale of 8 ounce Vanilla, 6 ounce Shampoo and 4 ounce Lemon Lotion. Details and samples free. C. I. Torgstad, Dept. 188, 29 S. Clinton, Chicago, Ill.

AGENTS \$1. Returns \$3. Your Profit \$2. Wonderful pocket Adding Machine with Magic Writing Pad. Particulars Free. Typewriter Supply, 905 Hersh Bldg., Pittsburgh, Pa.

ONLY 1 Sale Daily Means \$135 per Month Profit! Full or spare time. New \$5,000 Accident and Sickness Policy, \$25 Weekly Benefit, Premium \$10 yearly. Tremendous demand—amazing profits. \$100,000 guaranteed with State. Write quick for territory and special contract. Underwriters, Dept. 702, Bonnell Bldg., Newark, N. J.

GOLD Initials, easily applied on Automobiles. Biggest moneymaker today. Cost 5c, you get \$1.50. No experience needed. Free samples. "Ralco," Monograms, 1013 Washington, Boston, Mass.

AT Last! Diamond Rival Discovered! Amazing blue white Rajah Gem astounds jewelry world and deceives experts! Beautiful Sample case Free! \$100 weekly! Write Quick! Rajah Diamond Co., Dept. F-7, Salisbury, N. C.

AGENTS, \$72 a week—take orders for Novelty Guaranteed Cutlery. Knives, Razors, etc. Big commissions. Exclusive territory. Big money for spare time. Write for sample outfit. Novelty Cutlery Co., Dept. 431, Canton, Ohio.

66 MILES on 1 Gallon—Amazing, New, Wonderful Vapor Humidifier—Gas Saver—and Quick Starter. For all autos, trucks, tractors. Use Winter and Summer. Exclusive Factory Representatives wanted everywhere. 400% profits. I free to introduce. Critchlow, O-805, Wheaton, Ill.

A BUSINESS of Your Own—Making Sparkling Glass Name and Number Plates, Checkerboards, Signs, Big Book and Sample Free. E. Palmer, 512 Wooster, Ohio.

\$50,000. PICTURE Man Friedman made canvassing. Beginners can make \$100.00 weekly with my sales talk. Experienced men make more. Free book, "Profits in Portraits" explains. Samples Free. Picture Man Friedman, Dept. 8A, 541 W. Lake, Chicago.

MANUFACTURE Very Latest, Biggest-selling Advertised Specialties yourself—No Machinery; investment small—All lines. Stamp brings Valuable Interesting Literature explaining how others sell your products and big bunch lists Guaranteed Formulas. 300 to 1,200% profit to you. Reliable Information Only. No "Master Formula" trash. Miller, Chemist, 1706-V Jetton, Tampa, Fla.

CALIFORNIA Rosebuds selling like hot cakes. Agents coining money; new stuff. Big profits. Catalog free. Mission Factory PM, 2328 West Pico, Los Angeles, Calif.

AGENTS—Sworn Proof \$12.85 Daily in Advance. Bonus besides. Introduce finest line New Guaranteed hosiery you ever saw. Beats store prices. 126 styles, colors. Amazing new sales plan a wonder. You deliver or we deliver—as you like. Make \$25 a week in spare time. Auto furnished. No capital or experience necessary. Selling like wild-fire. Samples furnished. Write quickly. Wilkitt Hosiery Co., Dept. 1231, Greenfield, Ohio.

PERFUMED Beads from California. Fast Sellers. No Competition. License unnecessary. Big margin. Hire subs. Clean up. Mission, 519PM, 232Sw. Pico, Los Angeles, Calif.

AGENTS—New Plan. makes it easy to earn \$50.00 to \$100.00 weekly, selling shirts direct to wearer. No capital or experience needed. Represent a real manufacturer. Write now for Free Samples. Madison Company, 566 Broadway, New York.

AGENTS—Brand new aluminum handle cutlery set. Wonderful premium to each customer. Many agents taking 12 orders a day. \$72 week. Going big. Write quick for samples. Jennings Company, Sample 431, Dayton, Ohio.

AGENTS \$60 a week and new automobile. Introduce finest line, latest style, hosiery. Guaranteed to wear four months. Pay you daily in advance. Extra bonus besides. No experience needed. Samples furnished. We give you extra fine silk hose for your own use. Write for special offer. Jennings Hosiery Co., Dept. 1831, Dayton, Ohio.

SENSATIONAL Profits! Mexican Blue-Flash Gem matches finest Diamond; absolutely deceives experts; sells on sight! The only guaranteed low-price diamond substitute! Write quick for free \$5 Sample Case proposition! Mexican Gem Company, Box P6C, Mesilla Park, N. Mex.

AGENTS—Brand new line guaranteed Cutlery. Knives and Razors. \$72 a week. Extra commission. Exclusive territory. Samples furnished. Write quick. Novelty Cutlery Co., Dept. 631, Canton, Ohio.

MAKE \$75 to \$100 Every Week. Just taking orders for the Longwear line of men's and women's guaranteed all leather shoes at factory prices. Selling like wild-fire. Write for samples. Longwear Shoe Company, Dept. F, Minneapolis, Minn.

FREE Ties or a Beautiful 31 Piece Monogrammed Dinner Set, or both, with each order for full box of our Guaranteed Hosiery; Ladies All Silk Hosiery 25c; over 35 Hosiery and Neckwear Styles; from 37% to 117% commission, 10% Bonus; over 50 colors. State experience and give three references to see Samples. We deliver. S. Q. S., Desk H, Lexington, Ky.

WOMEN—\$2 an hour spare time; new idea sanitary necessity; sells on sight; every woman buys; new feature never before used; designed by physician; revolutionizes old uncomfortable methods; pay every day; no deliveries, no collections, no experience or capital required. Particulars mailed in plain envelope. Don't delay; Write Mrs. Mary P. Coleman, Meriden, Conn.

REAL Selling Sensation! Tremendous earnings whole or part time! Patented Hot Water Bottle. Invention needed everywhere. Big commissions. Extra bonus. We deliver. Write quick, C-1117 Lobl Corp., Middleboro, Mass.

AGENTS: Make \$500.00 before Xmas. Pay daily. No investment. Rhinestone Initial Buckles and novelties. Big Xmas and all year sellers. Exclusive territory. Chaton Novelty Co., 606 Blue Island, Chicago.

STARTLING Invention. New Shock Absorber for Fords retails at \$3.00. Big profits easy. Exclusive distributors wanted. M & M Mfg. Co., 11 Station C, Omaha, Nebr.

ALL Year Round Sales with our big complete guaranteed line. Shirts of all kinds, including silks, union made work and flannel shirts, overalls, coveralls, work pants, play suits, leather coats and vests, flannel blouses and lumberjacks. Our Booklet teaches how to make quick, easy sales Direct to Wearer. Full co-operation. Complete selling outfit Free. The Nimrod Shirt Co., 4922-28 Lincoln Ave., Dept. 8, Chicago.

AGENTS—N-R-G Laundry Tablets, the old reliable moneymaker for live agents. Millions sold—200% profit—sales waiting for you. Clothes washed spotlessly clean in 10 minutes without rubbing. Free samples. N-R-G Company, 239 W. Superior, Chicago.

GENUINE Gold Leaf Letters anyone can put on Store windows. Guaranteed to never tarnish. Large Profits. Enormous Demand. Free Samples. Write today. Metallic Letter Co., 438-D North Clark, Chicago.

AGENTS, Salesmen, Crewmen, You'll Have the Devil's own time finding a better seller than "Zippo." Splendid profit on snappy 50c "Go-Getter" repeat article that sells on a ten-second demonstration. Works while you watch it! Demonstrates value while others waste time making claims. New development! Greatest scientific triumph of the age. It's the berries. Write immediately for complete proposition. Karam-Smith Company, 611 F St., Fort Wayne, Ind.

MEN and Women make \$10 to \$20 a day. Christmas Greeting Cards in Box Assortments are tremendous sellers. We publish a magnificent assortment of 21 Steel Engraved, Colored, Panelled, Bordered Cards and Folders with envelopes. Sells for \$1.00. Cost you 50 cents. A value never equalled. Start early. Write for particulars and free samples. Waltham Art Publishers, 7 Water St., Dept. 70, Boston, Mass.

EARN \$45 to \$85 extra a Week. Selling beautiful Shirts. Commission in advance. We deliver and collect. Write quick. Fashion Wear Shirts, Dept. P-942, Cincinnati.

SALESMEN—Are You Making Enough Money? Let us show you how to make Big Profits with Jiffy Washing Tablets. No experience required. Write for Free Sample and Plans. Jiffy Soap Products Co., Dept. A, Dayton, Ohio.

GET Our Free Sample Case—Toilet articles, perfumes and specialties. Wonderfully profitable. La Derma Co., Dept. A, St. Louis, Mo.

DO you want good live agents—fellows who can get the business? Ask me how others are doing it. I'll gladly render the necessary assistance without cost to you. Address, M. L. Rund, Mgr. Classified Advertising, Popular Mechanics Magazine, Chicago.

\$75 WEEKLY. Man or Woman Wanted with ambition and industry, to distribute Rawleigh's Household Products to steady users. Fine openings near you. We train and help you so you can make up to \$100 a week or more. No experience necessary. Pleasant, profitable, dignified work. Write to-day. W. T. Rawleigh Co., Dept. IL8253, Freeport, Ill.

AGENTS wanted—To sell Ray-O-Lite cigar and gas lighters. Big earnings. Sample 50c. Rapid Mfg. Co., 799-E Broadway, New York.

REMNANT Store, Bethel, Ohio. Greatest Dry Goods Bargains on Earth. Agents and Dealers.

MILLIONS stolen. Remarkable new \$5.00 Check Protector stops forgery. Inks, protects two colors. Sensational sales, profits. Write. Safety Devices Corp., Grand Rapids, Mich.

AGENTS—Clever Invention! Inkspoon makes every pen a fountain pen. Fast office seller; big profit, demand increasing everywhere. Exclusive territory offered. Sample free. H. Marui Company, Tribune Bldg., New York, N. Y.

GET set for life with regular income. Join 42 year old company. Many representatives with us 5 to 25 years. Make \$25 to \$75 weekly supplying free premiums with quality household products. Great Eastern Coffee & Tea Co., Dept. S-1040, St. Louis, Mo.

OVER 100% Profit. Self Lighting Gas and Cigar Lighters; Everybody interested, repeat business. Sell individuals, dealers, subagents. Particulars Free. P. Bernhardt, 127 West 30th St., New York.

BOSTON Maid Frocks for Women and Children—nationally known—famously popular. From mill to wearers \$3.50 to \$20. Great income producers for men and women agents. Write for selling outfit. Bosworth Mills, B-14, Melrose, Mass.

OUR Luminous Crucifix Shines in the Dark. Every one amazed at the wonderful effect. Easily demonstrated. Easily sold. W. G. Hannan Co., Dept. B, 2539 So. State St., Chicago.

WILLIAMS' No-Water Hand Soap. In tubes, has taken Auto owners by storm; washes dirtiest hands perfectly clean without water; easy demonstration makes quick sale. 150% profit. Williams Co., Dept. 265 Montclair, N. J.

SALESMEN Selling to Men. We have logical side line for you that will sell along with any other line you may now be handling and probably make more money for you, provided you are now selling to men. Get full facts at once by addressing Salesmanager, 844 West Adams, Dept. 624, Chicago.

PRIVATE Brand Toilet Articles, Food Products, Household Specialties. We pack these goods for you under your private label. With your name on goods you get all the repeat business. Appoint sub-agents to work with you. Highest Quality Merchandise. Over 200% profit. Write immediately for our attractive offer. Supply Department, National Scientific Laboratories, 1904W Broad, Richmond, Va.

AGENTS—Make a dollar an hour. Sell new kind of sharpeners. Sharpens all knives and tools quickly. Demonstrating sample free. Premier Mfg Company, Dept. 61, Detroit, Mich.

THANCO Vanilla—Bottle Yourself! Concentrated; add water; free labels. Crushes petition! 500% profit. Immense seller, homes, bakeries, stores. Write Thomas Manufacturing Company, Indianapolis, Ind.

MAKE more money; Embossed Show Cards for every line of business. Write for details and sample. Embossed Show Card Co., 9410 Euclid Ave., Cleveland, Ohio.

BIG pay to agents selling Mother Hubbard Food and Household Specialties and Toilet Preparations. Mother Hubbard Co., 558 Congress, Chicago.

AGENTS—Good steady income; business of your own; new useful product; small investment. Interstate Service, Elizabeth, N. J.

\$320 PROFIT First Three Days' Sales for Zindel, Illinois, with Morey Quick Action Auto Rim Tool. Profit \$2 tool. Exclusive territory for hustling agents. Earn \$10 to \$50 cash daily. \$75 to \$300 weekly year round. M. Morey Rim Tool, Blissfield, Mich.

1,000 LIVEWIRE Mo. Agents, Salesmen, Opportunity Seekers, Mo. Beginners. Addresses printed on gummed paper \$3.00. Geo. Wargo Service, 811X Porter, Streator, Ill.

SALESMEN: Write your name and address on a postal and mail to us. We'll show you sure earnings of \$20.00 a day. Will you risk one minute and a one cent stamp against \$20.00? Mind you, we say we'll Show you. Address Dept. 1045, William C. Bartlett, Inc., 850 W. Adams St., Chicago.

66 MILES on 1 Gallon—Amazing New, Wonderful Vapor Humidifier—Gas Saver—and Quick Starter. For all autos, trucks, tractors. Use Winter and Summer. Exclusive Factory Representatives wanted everywhere. 400% profits. 1 free to introduce. Critchlow, S-805, Wheaton, Ill.

AGENTS—Sell men's neckwear; wonderful proposition. Astor, 318-M Broadway, New York.

\$5,000 A YEAR is easy with our high-grade proposition. Pearl made \$750 one month; Albers \$47 one day. Superior sales plan; exclusive territory; automobile free. Write quick. American Products Company, 6324 Monmouth, Cincinnati, Ohio.

THREAD-CUTTING Thimble 25c. Seller Sample 15c. Irvel, 3973 Elston, Chicago.

COUNTRY agents make 45 to 90% selling our automatic poultry watering valve. The Dry-Not Mfg. Co., 66 Wheelock Pkwy., St. Paul, Minn.

SELL Handy Personal Stickers. Sales Easy. Profits Big. Stow, Deposit, N. Y.

SELF Threading Needles find sales in every home. Fine side line; big profits; easily carried. Sample free. Prentice-Lee, 145 East 23rd St., New York.

\$100 WEEKLY selling "Style Tailored" shirts, neckties and work clothes direct-to-wearer. This unbeatable combination means selling everyone. No capital or experience required. Write quickly for Free Outfit. Howard Shirts, 1213 VanBuren, Dept. M30, Chicago.

RAINCOATS—Full line, all prices. Also leather and sheep-lined coats. Big catalog free. Commissions 25% with bonus. Hydro Raincoat Co., 718 Independence, Chicago.

FREE Shoes for You! Big advance commissions besides. Take orders for men's—women's shoes and hosiery. 100 styles \$4.95 up—sell instantly. We deliver and collect. Spare or full time. Costly Outfit Free. Castle-Blair, S320 So. Michigan, Chicago.

SELL Men's—Women's—Children's Shoes direct to wearer. Large Commissions. Extra monthly Bonus. Pleasant work. Actual Samples. Bloomer Shoe Co., Dept. N11, Alton, Ill.

SELL Necessities—Everybody needs the "Business Guide" with free legal service. Wells cleared \$620.00 one month. Outfit free. Prof. Nichols, Box 13, Naperville, Ill.

AGENTS: \$11.80 Daily in Advance. Introducing New Insured Hosiery for Men, Women, Children. Must wear or replaced free. Nyland made \$595.00 one month; Edwards, \$460.00; Mrs. Bone, \$425.45. Why not you? Even spare time should pay \$3.00 an hour. 57 styles, 39 colors including latest "Silk to the Top" ladies' hose. No experience needed. We furnish samples. Silk hose for your own use Free. New Plan. No matter what you are now doing, write quick. Macochee Hosiery Company, Card 25611, Cincinnati, Ohio.

YOU can be your own boss with our Key-Check outfit. Good for \$5 a day stamping names on pocket key checks, fobs, etc. Sample check with your name and address, 20 cents. Pease Die Works, Dept. M, Winchester, N. H.

HANZO removes the grime in half the time. Unique sales plan nets you \$2.50 every ten minutes. Free samples, advertising circulars. Staple article used by millions. Grab this coin-coaxer. Free sample waiting. Hanzo Company, 765 Waveland Ave., Chicago.

\$60-\$200 A WEEK. Genuine Gold Letters for store windows. Easily applied. Free samples. Liberal offer to general agents. Metallic Letter Co., 438-B North Clark, Chicago.

HERE'S a Delicious Food Product you can sell to homes for cash. \$3 profit on dozen cans. Repeat sales certain. Send for Free Recipe Booklet and Selling Plan. Cream of Chocolate Co., 40 Central, Waltham, Mass.

WE pay \$48 a week, furnish auto and expenses to introduce our Soap and Washing Powder. Buss-Beach Company, Dept. A42, Chippewa Falls, Wis.

AGENTS Wanted. Pocket Puzzles—200% Profit. Sample and Catalog Free to Agents. Western Puzzle Works, Saint Paul, Minn.

AGENTS to sell the new Waterproof Featherweight All-Purpose Coat. Weighs only 26 ounces. Latest styles and colors. Men's \$6.50; Women's \$5.95. Highest commissions. Write today for sales plan. Featherweight Coat Co., 5703 Euclid Ave., Cleveland, Ohio.

BECOME Your Home Town's Leading Business Man. You can make \$100.00 weekly selling our guaranteed food products, paints, oils, shirts, hosiery, etc., direct to consumer in towns and country. Every article a repeater. No experience necessary. Exclusive territory for men and women. Loverin & Browne Co., 1615 S. State St., Chicago.

MIRRORS Resilvered at Home. Costs Less 5 cents per square foot; you charge 75 cents. Immense profits, plating like new; brassy worn-off autoparts, reflectors, tableware, stoves, etc. Outfits furnished. Details Free. Sprinkle, Piater, 128, Marion, Ind.

TAKE It Easy! You don't have to work your head off this fall if you take orders for Carlton's ready-to-wear dresses, \$35 to \$75 commissions easy in 5 half days! Every woman, every home, means a sale. 90% repeat orders. No selling experience needed by our plan. Sample line actually Free to First applicant in each town. Write quick! Carlton, Inc., 337 S. Franklin St., Dept. 853-A, Chicago.

SELL Sanitary Rubber Goods, Stepins, Shadow Skirts. Every woman buys. Free Sample offer. American Rubber Products, Dept. 108, Pittsburgh, Pa.

REFLEX Visor stops glare. Made for all cars. 200% profit. Send 50c for sample. Reflex Visor Co., 673 Wrightwood Ave., Chicago.

MAKE and Sell "Vanilla Flavoring." Enormous Profit. Guaranteed Formula 50c. Catalog Free. Clover Laboratories, Park Ridge, Ill.

AGENTS — 500% profit selling genuine gold window letters; Scripts. Experience unnecessary. Free sample. Premier Letter Co., 121 N. Francisco, Chicago.

\$16 A DAY Easy—I start you in auto accessory business; no investment; no experience necessary. Landin, 3433 Montrose Ave., Chicago.

IT'S a winner. Combined cigarette and match case. Holds package of cigarettes and a box of matches in compact flexible container. Sells on sight for 75c. Costs \$3.60 dozen, \$36.00 gross. Write for particulars. All-In-One, Box 64, A-11, Minneapolis, Minn.

CAN you sell Ford size tires at \$3.50 each? Write for plan. Details free. American Accessories Co., Station 231, Cincinnati, Ohio.

PORTRAITS, photo pillow tops, frames, sheet pictures, medallions, merchants' signs, food products, photo jewelry, guaranteed hose, toilet requisites, luminous crucifixes. Catalog 50 specialties free. 30 days' credit. Jas. C. Bailey Co., Dept. C11, Chicago.

DISTRIBUTORS, Salesmen, Energetic Men wanted every city to job Easy-Mend; new household product, thru agents and stores; can earn \$3,500—\$5,000 yearly; whirlwind seller; repeats 8 to 20 times yearly; successful campaign, sales talks, circulars free; few dollars capital starts you. Facts sent free. Thos. Barnett, Pres., 1811-B Mondamin, Des Moines, Iowa.

FORDS; no freezing, no boiling, big gas saving. Airlock absolutely does it. Sells like machine guns fire. Free trial always. Airlock Products, Burnett, Calif.

\$18 TO \$25 daily. Biggest selling line of 2-piece suits, \$9.95 and \$12.50; 3-piece wool suit, \$17.95 (regular \$28.00 value). All-wool overcoat, \$18.50. Splendid raincoats, slickers and boy's suits. Biggest commissions. Free outfit. "Jim" Foster, Inc., Dept. 638-D, 2250 S. Spaulding Ave., Chicago, Ill.

MOCCASIN Manufacturer Wants Agents Everywhere to sell a complete line of moccasins to wearers. Entire new line. No competition, repeat orders. Get details. Daley Moccasin Co., Fort Covington, N. Y.

GREAT neckwear line now free! Features finest quality neckwear at factory prices. Collect big commissions daily. Write for Free tie offer and Free outfit. Nawco Neckwear, Desk 11-A, Covington, Ky.

MAKE \$75.00 weekly selling Val-Style Hats to women, Latest Paris Styles. Exclusive materials. Below-store prices. Daily commissions. Free hat offer. Val-Style Hat Company, Dept. 156, Cincinnati, Ohio.

FIBRE Brooms—detachable handles, fine finish. Good profits, repeat sales. The Fibre Broom People, 147 New Jersey Ave., Brooklyn, N. Y.

WANTED: Local and State Representatives for famous ready made Artistic Signs, price tickets, etc. No competition. Full protection. Large profits. For particulars write Artistic Signs, 799R Broadway, New York.

BIG Money and Fast Sales. Every owner buys Gold Initials for his auto. You charge \$1.50; make \$1.35. Ten orders a day easy. Write for particulars and free samples. American Monogram Co., Dept. 40, East Orange, N. J.

AGENTS: 500% profit. "Happy Home Make Shampoo" builds your own big business. Martin of Indiana made \$75.00 in one day. Missouri man made \$750.00 one month. Exclusive territory. Geo. A. Schmidt & Co., Dept. P, 236 W. North Ave., Chicago.

NEW \$3.50 Automatic Adder. Fast seller—Big Profits. Exclusive territory for live-wire sellers. Bassett Company, 1458-C Hollywood Ave., Chicago.

AGENTS — Sell Pure Linen Imported luncheon sets; big commission in advance. We deliver; a great new money maker for men or women agents. Belfast Linen Co., G431 S. Dearborn, Chicago.

"AMAZING New Cleaner." Cleans Everything. Sells like wildfire. Quick Repeater. 300% Profit. Miller, New York, made \$1,000 in 6 weeks. Beck, Illinois, \$98.00 in 2 days. Premium sales plan and Free Samples make selling easy. Work full or spare time. Write quick. Bestever Products Co., 1945E, Irving Park, Chicago.

\$2.15 AN Hour for your full or spare time! You can make that much distributing famous Royce Flavoring Extracts, Rare Perfumes, Complexion Aids, etc.—225 preparations. Quality unexcelled since 1879. Permanent, profitable business easily established. Write for personal interview. The Abner Royce Company, M-18, Royce Bldg., Cleveland, Ohio.

WE Start You Without a Dollar. Soaps, Extracts, Perfumes, Toilet Goods. Experience unnecessary. Carnation Co., Dept. 2480, St. Louis.

AGENTS—Make a dollar an hour. Sell Mendets, a patent patch for instantly mending leaks in all utensils. Sample package free. Collette Mfg. Co., Dept. 404, Amsterdam, N. Y.

GOLD Leaf Window Letters and Script Signs. No experience; 500% profit. Samples free. Consolidated, 69U—West Van Buren, Chicago.

AGENTS wanted to sell Men's Hats direct from Factory. Send for Catalogue. Model Hat Mfg. Co., Dept. 5, East Orange, N. J.

AGENTS—Send for Free Sample "Fret-not" Washday Wonder. Big Profit. You don't have to talk; if she doesn't buy at sight, leave sample. Exclusive territory. Credit given. Empire Specialties Co., 1549 N. Wells, Dept. 101, Chicago.

AGENTS make \$100 week placing advertising Cigar Lighters with glass front. Every dealer wants one. Write for free plan. Drake Mfg. Co., Dept. M, Milwaukee, Wis.

EVERYBODY uses Toilet Preparations. Sell Dainty, Exquisite, Delicately scented Duo Compacts, Perfumes, Powders, Creams and Lotions, Flavoring Extracts and Specialties. Duo Co., TP-1, Attica, N. Y.

AGENTS make \$3.00 an hour taking orders for our 40 Fascinating Kitchen Specialties. No competition. Write Quick. General Products Co., Dept. 7-K, Newark, N. J.

GIVE Away finest laundry soap Free. You'll make \$10 daily easy by new selling plan. Big repeat business. Write quick. Wolverine Soap Co., 28 Wolverine Bldg., Grand Rapids, Mich.

AGENTS—Steady income. Large manufacturer of handkerchiefs and dress goods, etc., wishes representative in each locality. Factory to consumer. Big profits, honest goods. Credit given. Send for particulars. Freeport Mfg. Co., 59 Main St., Brooklyn, N. Y.

POLMET—The Wonderful Polishing Cloth that cleans all metals without liquid, paste or powder. Approved by "Good Housekeeping" and "Modern Priscilla"—sells fast at 25c. Sample free. Gale & Co., Inc., 15 Edinboro St., Boston.

AGENTS — Stamping names on Pocket Key Protectors; sample Check with your name and address. 25c. Stamping Outfits. Emblem Checks, Check Fobs, Name Plates. Hart Mfg. Co., Desk 2, 303 Degraw St., Brooklyn, N. Y.

AGENTS — \$90 a Week — \$2 to \$5 an hour spare time. Make this with the celebrated line of Ho-Ro-Co Soaps, perfumes, toilet articles and specialties; over 200 items. Big profit makers. La-Em-Strait Hair Dressing selling like hot cakes. Write for Free Sample Case offer. Ho-Ro-Co Mfg. Co., 791 Ho-Ro-Co Bldg., St. Louis, Mo.

THE Big Season is on; start now. Supreme Shirts give 100% satisfaction. Proposition and Kit Free. Supreme Shirt Co., 276-M Fifth Ave., New York.

NEW Inventions—First agent made \$185 first week. 500% profits. Free Sample Windshield Coating, also other real money makers. Safe-Vu Co., Dept. B, 707 Market, St. Louis, Mo.

AGENTS—Sell 5c fast selling candy specialties to stores. Big profits. Lorrac Products Co., Albany, N. Y.

MANUFACTURER lamb wool polishers, dusters. Newhall, 358 Broad St., Lynn, Mass.

SELL by mail! Big Profits! Books, Formulas, Novelties, Bargains. Particulars Free. Elfco, 523 South Dearborn Street, Chicago.

66 MILES on 1 Gallon—Amazing. New, Wonderful Vapor Humidifier—Gas Saver—and Quick Starter. For all autos, trucks, tractors. Use Winter and Summer. Exclusive Factory Representatives wanted everywhere. 400% profits. 1 free to introduce. Critchlow, R-805, Wheaton, Ill.

"AGENTS." Big Money Selling New Household Cleaning Set. Washes and dries windows. Sweeps, scrubs, mops. All complete only \$2.95. Over half profit. Write Harper Brush Works, 132 3rd St., Fairfield, Iowa.

LIVE Agents Wanted to Sell No-Kik Starter Switch Control for Fords. Stops back-firing and prevents breaking Bendix. A fast seller and a good money-maker for you. Send \$3.00 for sample. Warmac Manufacturing Co., 815 Webster Avenue, Scranton, Pa.

"MAGNAKLOTH" taking autoists by storm, one rub absorbs dust from the car or furniture, quick sale, big profits. National Service Co., Dept. "P," Pierre, S. Dak.

BIG Business Producer. A Dollar Bottle of our Famous Vanilla and a One Dollar set of LaBonne Pearls both for one dollar. You make 50c. Big Flash, Best Quality Goods and Everybody buys. Catalogue Free. Mystol Co., Dept. H1, Glens Falls, N. Y.

REAL money for you. Our combination aluminum cooking set easy to sell. No delivering, no collecting. Make \$10 to \$15 daily. Espy-Riddle Co., Dept. 2, 2325 Carson Street, Pittsburgh, Pa.

PATENTS. Time counts in applying for patents. Don't risk delay in protecting your ideas. Send sketch or model for instruction or write for Free book "How to Obtain a Patent" and "Record of Invention" form. No charge for information on how to proceed. Communications strictly confidential. Prompt, careful, efficient service. Clarence A. O'Brien, Registered Patent Attorney, Security Bank Building (directly across street from Patent Office), Washington, D. C. See pages 140 and 141.

BIG Profits! Great Demand! Rich's pure fruit Concentrated Soft Drinks. Every home, store, soft drink dealers buys. Sample free. Sol P. Rich Co., 622 S. Sangamon, Chicago.

SELLING Like Blazes! Eleven piece toilet goods assortment at \$2.25 with two-piece carving set Free to your customers. 100% profit. Davis Products Co., Dept. 56, 1321 Carroll, Chicago.

AGENTS—Men and Women to sell self-threading Needles; a sale in every home. Earn \$50 weekly easy. Sample and particulars 10c. Henco Co., 246 Fifth Ave., New York.

BIG Money Monogramming automobiles. \$1.40 profit on \$1.50 sale. Particulars and samples free. Evans Products Company, Midian Avenue, Windsor, Conn.

GOLD-LEAF Sign Letters; make and sell; 1,000% profit. Particulars, Johnston Co., Quincy, Ill.

AGENTS—Here's a New One. "Best-ever Powdered Hand Soap." Sells like wildfire. Marvelous Discovery. Removes grease, paint, ink, oil, in fact anything from the hands. Cannot harm skin. 150% Profit. Great Repeater. Agents simply coin money. "Free Samples Get the Business." Write immediately. Bestever Products Co., 1937 E. Irving Park, Chicago.

70c PROFIT on \$1.00 Sale. Auto, Furniture and Glass Cleaner. Your Name on Label. Exclusive rights. Free sample. Mfg. E., 213 Griswold, Detroit, Mich.

BROIL and Save the Juices with the Dundee Dripless Smokeless Broiler. Prevents indigestion and aids those suffering from it. Saves 75% fuel. A necessity in every home. Particulars: Dundee Mfg. Co., Inc., 157 Summer St., Boston, Mass.

NEW Wonderful Seller. \$1.40 profit on every \$1.50 sale, monogramming autos; free samples. Monogram Co., B99, Worcester, Mass.

SELL Columbia Records. Particulars. Weisburd Company, 1237 Hoe Ave., New York.

MAN in each town to plate auto parts, reflectors, bathroom fixtures, refinish beds, mirrors, chandeliers; by new method. No capital or experience required. Simple plan of manufacturing at home starts you in big money-making business. Outfit furnished. Free particulars and proofs. Gun Metal Co., Ave. H, Decatur, Ill.

NEW Duplicator; typewriting, handwriting, drawings, in colors. Complete \$5.00 sample \$3.60 postpaid. Argus Mfg., 37A Barclay, New York.

HANDY Ink Booklets—a fine writing ink in Book form. Mail Order Men or Agents. Wonderful convenience. Get particulars for selling and sample 10c. Merry Specialty Co., Dept. A, Somerville, N. J.

INSTANT Weld. Repairs largest punctures without cement or heat. Lenn's profit one day. \$56. Write quick. Free sample; territory going fast. Tourists' Pride Mfg. Co., Desk T, Minneapolis, Minn.

BIG Double Strength Extracts in immense demand. Build big permanent business. Also mighty attractive line toilet preparations, household specialties, etc. Duo Co., EX-1, Attica, N. Y.

FREE! \$7 pen Write for Plans. Murray & Spors, Lesueur Center, Minn.

AMAZING invention mends socks, shirts, sheets and thousand other articles. Banishes darning and sewing. Sells on sight. 50% to 200% profit. Free outfit. New-Way Laboratories, Desk C-32, Mt. Healthy, Ohio.

"LIQUID-LEATHER" Fills Holes in Shoes, Rubbers, Tires. Dries Instantly. Pliable, Waterproof. Just Imported from France. Tube Retail 75c—Cost 35c. Sells Housewives, Sub-Agents. Nulife Leather, Hartford, Conn.

AGENTS—Sell "No-Splash" 4 Strainer Water Filter. Big profits! Fast sales! Lowest prices. 6 dozen, \$1.80 postpaid. Jones Mfg. Co., 243E2 Franklin Street, Boston, Mass.

DOUBLE your profits by manufacturing the products that you sell! Any formula you want \$5. Satisfaction guaranteed. Announcements of latest formulas for quick-selling reasonable products sent monthly without charge. Write today. National Information Bureau, 316T Shepard Building, Grand Rapids, Mich.

GOLD Sign Letters. \$9.75 for Thousand. Non-Tarnishable. Free sample. Catalogue. Foil Sign Works, 438 Broadway, Denver, Colo.

YOU Can Make Good Durable Paint and Varnish 40c per gallon. Write Dept. 2 Emmelmann Bros. Mfg. Co., Indianapolis, Ind.

REPLATE brassy worn-off Automobile parts, Reflectors, Bath Room Fixtures, Worn Spoons, Forks, etc., with pure silver. Looks like new. Use U-Kan-Plate Polish. Positively no mercury. \$1.00 half pints. Post Paid. Satisfaction Guaranteed. Agents wanted. Dept. A, U-Kan-Plate Co., Philadelphia.

\$1 PER hour selling Dirt-Solve Washing Powder. Big repeater; exclusive territory. Premiums for customers. Sample free. Goodspeed Products Co., Rutland, Vt.

AGENTS—Best seller; Jem Rubber Repair for tires and tubes; supersedes vulcanization at a saving of over 800 per cent; put it on cold, it vulcanizes itself in two minutes, and is guaranteed to last the life of the tire or tube; sells to every auto owner and accessory dealer. For particulars how to make big money and free sample, address Amazon Rubber Co., Philadelphia, Pa., Dept. 505.

AGENTS: Take orders for men's underwear with Free outfit. Earn \$55.00 weekly. Amazing nationally advertised values. Daily commissions. Write or wire to-day. Imperial Underwear Co., Dept. 540-M, Piqua, Ohio.

SOLICITORS I have the greatest, fastest household and Auto specialties ever presented. Investigate. Harmon Specialty Co., 183 Menahan St., Brooklyn.

15c ON every 25c sale means big daily profits. Box 500, Shreveport, La.

SELL Needle Threaders. Threads needles in the dark. Sample 25c. G. Jensen, 2300 Nicolet, Minneapolis, Minn.

CHRISTMAS Novelty sold stores day or evening. Every store a prospect. Clean up big in December. Active agents make \$25.00 per day. Consolidated, 65-A West VanBuren, Chicago.

KLEENZIT Kieening Pencil—New, different, instant appeal to housewives and tailors. Sell like hot cakes. Removes spots from clothes without leaving marks or rings. 50c seller—big profit. Agent's sample 25c. Write quick. Exclusive territory. Argyle Specialty Co., Dept. P, Argyle, Wis.

WANTED—County Agents and Representatives to market the 3A Garage Door Holder. All owners of private garages are instantly attracted by its Simple, Automatic Action. Write for attractive proposition. Knowlson-Stevenson Co., Ann Arbor, Mich.

DISTRICT Agents—Sell \$23.50 suits and overcoats, all wool, one price. Wonderful values, liberal commissions in advance; money back guarantee; 9x13 swatch outfit free. Write R. P. Harvey, Mgr., Box 00, Chicago.

AUTOMOBILE Specialties. Guaranteed formulas for all latest money makers. Lowest prices. Write for free lists. Murphy, Chemist, Tujunga, Calif.

AGENTS sell package candy to retail stores full or part time. Write Smaklets Co., 1822 Newport Ave., Chicago.

COSTS 2c sells for dollar. Sample 10c (coin). Baggs, 3239 Archer Ave., Chicago.

AGENTS—New Fall line sells on sight. Send for particulars. Largest line in Country. Hosiery, Lingerie, Neckwear. Monarch Co., 630 Market, Philadelphia, Pa.

AGENTS—New, whirlwind seller to business men. Free sample case for workers. Mohler, Box 453, Chicago.

AGENTS—Slickers, raincoats, \$3.95. \$1.00 commission. Thousands sold. Easy money. Free samples. Super Built, Box 453, Chicago.

SELL Pocket Adding Machines. Sample \$1.40 C.O.D. Wineholt Distributing Co., Woodbine, 54, Penna.

AGENTS, energetic men and women, everywhere, earn \$25 to \$50 weekly with Flosfork, new every day health necessity; whirlwind seller, every man, woman, child buys; free folder tells how to start money coming fast. Ogden, Mfg'r, P. O. Box 4330 P, Philadelphia, Pa.

66 MILES on 1 Gallon—Amazing. New. Wonderful Vapor Humidifier—Gas Saver—and Quick Starter. For all autos, trucks, tractors. Use Winter and Summer. Exclusive Factory Representatives wanted everywhere. 400% profits. 1 free to introduce. Critchlow, L-805, Wheaton, Ill.

LARGEST Custom-Made Shirt Manufacturers in America require additional salesmen and saleswomen; also District Managers. Competition in custom made shirts is negligible. Good Agents create permanent business. Dept. 61, Hudson Valley Mills, 520 Broadway, New York.

FREE Sample. "Rain Shield Wiper." Retail \$1.00—Cost (25 cents). Sold Clear and Rainy Days. No Cloth—No Paste—No Attachment. (1) Rub keeps windshield clear 48 hours. Experience Unnecessary. NuLife Corporation, Hartford, Conn.

AGENTS to make \$25.00 per day, selling Men's Silk hose, at \$13.00 per Gross. Send \$1.10 for sample dozen. Postpaid. Men's silk neckwear \$15.00 per Gross. Send \$1.35 for sample dozen. Postpaid. Lewis Hosiery Co., 12 N. 3rd Street, Philadelphia, Pa.

AGENTS—Mesco Corn and Callous Remover will build you a steady repeat business. Send today for pocket-size trial outfit. The Moss Co., 299 Searle Bldg., Rochester, N. Y.

MAKE—Sell Your Own Goods. Formulas, Processes. All kinds. All lines. Catalog, circulars free. B. Thaxly Co., Washington, D. C.

CANVASSERS, Streetmen, Agents—Buy our absolute necessity for 2c; sell for 25c. Everybody must buy. We undersell them all. Hundreds of other items. Send 30c for seven different samples. Catalog Free. Mills Sales Co., 13 East 16th St., New York City.

AGENTS: Our gold-eyed Needle Cases are wonderful sellers; immense profits; \$50 to \$300 weekly; proof and particulars free; sample outfit 15c; factory prices. Paty Needle Co., 231 Davis Square, Somerville, Mass.

AGENTS! \$1 an hour selling E. Z. Clean washing compound; sample and particulars free. Real Quality Products Co., Findlay, Ohio.

AGENTS sell Budd's Cleaning Compound. Something new. Contains Soap; Best repeater; exclusive territory; large profits; POUND sample and agents terms 20 cents. Budd, 1608 E. 66th, Cleveland, Ohio.

ALL-YEAR-ROUND profitable business selling wonderful new water softener and cleaner. Removes grease, oil, ink and dirt quickly. Every home and business place a live prospect. 100% profit. Big repeat orders. Exclusive territory. Write for free sample. Seacoast Laboratories, Sea Bright, N. J.

CHRISTMAS greetings. Box assortments. Big sellers. Magnificent line in engraved and paneled cards. All envelopes fancy tissue lined. Sells \$1. Costs you 50c. Dept. 500 Midland Arts Co., Camden, Ohio.

SELL Your Own Products—free list describes worthwhile new novelties, toys, preparations, agent's specialties that are easily manufactured. Cash in while they are new. Investigate today. Barter, 3937A Tracy, Kansas City, Mo.

AGENTS—Big Seller—\$20 Daily Easy selling Taylor Caps—made-to-measure—every man buys—some want 2 or 3 caps. Samples Free and Cap free to agents. Write quick for fast money making proposition. Taylor Cap Manufacturers, Dept. P-40, Cincinnati, Ohio.

AGENTS New Invention. Holdtite Food Tong. Holdtite Dish Washing Tong. Housewives Buy Them on Sight. 300% to General Agents. Exclusive Territory Being Assigned. Hurry! Both Tongs Prepaid 50c. \$11.52 invested retails for \$50.40. National Products Distributing Co., 316 5th Avenue North, Seattle, Wash.

AGENTS. Buy Direct—Neckties and Hosiery and Make 200%—300% Profit. Ties, \$1.75; \$2.00; \$2.25 doz. All Rayon Silk Hose, \$2.25 doz. 10% with order. Bal. C.O.D. Master Knitting Co., New Haven, Conn.

AGENTS. Monroe's never tarnish letters are winners. Samples ten cents. Monroe Sign Corporation, New Haven, Conn.

PENNANTS and Pillows: Colleges, Schools, Clubs, Lodges. Students and agents get busy. American Pennant Co., 66 Hanover St., Boston, Mass.

AGENTS: Sell needle threaders; 400% profit. 10c seller. 4c for sample and particulars. Gebhard Mfg. Co., 688 So. 16th St., Newark, N. J.

CHRISTMAS Cards. Our dollar genuine steel engraved Christmas greeting card proposition is a knockout for agents. Big profits. Send fifty cents for sample. The National Engraving Co., 307-309-311 Sixth Avenue South, Minneapolis, Minn.

CHRISTMAS Novelty postcards—Something new. Selling big. Sample 10c. Art Printers, West New York, New Jersey.

AMAZING new invention; millions will buy them; mail ten cents for sample. Universal Novelty Company, 6734 N. Bouvier St., Philadelphia, Pa.

NEW metal-polishing mitten, 45% to Agents. Garde, Cromwell, Conn.

AGENTS—Make money during your spare time selling Basket Ball, Football and Athletic Supplies. Write for details. Nuebling, Reading, Pa.

\$50.00 SUIT given Free to our active Agents. Chance to make \$5.00 an hour selling Wall and Auto Emblems. Biggest Fall-Winter Profit Maker! No competition. Get Free sample—amazing plan. Crafts, 3314MS Lawrence, Chicago.

AGENTS—Sell quality face creams for manufacturer; good proposition. Pay weekly. Stewart Co., Canastota, N. Y.

SELL Oriental Perfumes, Bridal Bouquet, Hindu Rose, Flor Amour, Bokul and make 100% Profit. Romola Perfumery, Inc., 111 Romola Bldg., 2934 Michigan Blvd., Chicago.

\$20 DAILY: Self-threading needles; sell on sight. Package. Self-Selling plans 10c. Send now. Newmyre, Eiters, Penna.

FURNITURE refinishing, polishing, painting, handyman shop; wonderful profits; start yours on nearly nothing. John Braceland, 1457 So. Ninth, Philadelphia, Pa.

MCDONALD Polishing Cloth cleans gold, silver, nickel. Sample, terms, 13c silver. Daniel McDonald, 18 Agawam St., Lowell, Mass.

AGENTS, this is your opportunity—rubber specialties, dresses, undergarments, sleeping apparel, combined for big earnings. Dept. 969, B. & G. Mfg. Co., Pittsburgh, Pa.

NEWEST Invention! Abolishes kinks, snarls and automatically coils telephone, electric iron and lamp cords. Housewives, business men, companies actually buying 5 to 50. Salesmen get free sample. Never-knot, Dept. B-11, McClurg Bldg., Chicago.

2 WONDERFUL Inventions! Startling plan gives customer free gold-plated device making phonograph sound similar to Orthophonic Victrola. Other abolishes needles. Bradley sold 35 in 36 calls. Everplay, Desk B-11, McClurg Bldg., Chicago.

EARN \$10 daily silvering mirrors, plating and refinishing metalware, autos, chandeliers, bedsteads, headlights. Outfits furnished. E. Decie Laboratories, 1133 Broadway, New York.

AMAZING new device. Sharpens everything that cuts. Sells to 4 out of 5 Homes, Garages, Shops, etc. Many now making \$3 to \$9 an hour. Write for details and Free Outfit Offer. Central States Mfg. Co., Dept. P-10, St. Louis, Mo.

\$14.50 DAILY Easy—Pay in Advance. Introducing Chieftain Guaranteed Shirts, 3 for \$4.95. No experience or capital needed. Just write orders. We deliver and collect. Full working outfit Free. Cincinnati Shirt Company, Secy, 15815, Cincinnati, Ohio.

AGENTS, both sexes, we manufacture and control new household article. Fast seller. Big profits. Exclusive territory. Write now. Connolly, 123 Liberty St., New York.

AGENTS: Big Money Monogramming by Transfer method. Catalog Showing Over 50 Styles and Particulars Free. Motorists' Accessories Co., Mansfield, Ohio.

HIGH-GRADE SALESMEN WANTED

WANTED—Tailoring Salesmen, make \$60 to \$125 per week. Biggest merchants in many towns have started with our line. We are the largest made-to-measure tailoring house in the country, furnishing elaborate sample equipment, including 500 all-wool fabrics. You make your own profits from \$8.00 to \$15.00 on each order. Guaranteed absolute satisfaction, perfect fit, best workmanship, or no sale. Write for our line and all accessories to be sent free. Tell us all about yourself. Address N. O. Perry, Sales Manager, Box 483, Chicago, Ill.

EARN \$10 daily silvering mirrors, plating and refinishing metalware, auto, chandeliers, bedsteads, headlights. Outfits furnished. E. Decie Laboratories, 1133 Broadway, New York.

METAL Signs sell to every business man and manufacturer in your territory. New illustrated handbook just off press makes expert knowledge and heavy samples unnecessary. A novice can earn \$10—\$50 per week to start. This 64-page leather-covered pocket-size book illustrates in eleven colors, completely describes and prices every kind of metal sign. Liberal commissions paid promptly. Stout Sign Co., 2335 Sullivan Ave., St. Louis, Mo.

MAKE \$100 Weekly in spare time. Sell what the public wants—long distance radio receiving sets. Two sales weekly pays \$100 profit. No big investment, no canvassing. Sharpe of Colorado made \$953 in one month. Representatives wanted at once. This plan is sweeping the country—write today before your county is gone. Ozarka, Inc., 431 N. LaSalle Ave., M. Chicago.

GET Pay Every Day: Distribute nationally known food products to established users. World's largest Company will back you with surprising plan. Write the J. R. Watkins Company, Box 17, Winona, Minn.

SALESMEN—Salary and expenses guaranteed against commissions while you learn to sell our specialty. A business of your own. Box 221, Iowa City, Iowa.

SALESMEN—New line, new field, \$6.50 profit every sale; sell Radium Health Products, a scientific, drugless treatment needed in every home; the \$2,500,000,000 spent yearly for health assures you a permanent and profitable business with no dull seasons; pleasant, fascinating work; exclusive territory. Write Radium Applicator Co., 339P Riley, Buffalo, N. Y.

SALESMEN—Tremendous Repeater. Used by Millions. \$20 profit on ten \$3.50 sales. Merchants' repeat orders build permanent business. Auto Bonus. Territory. Full or Side Line. Hustlers wanted only. Elec Products, Dept. L-9, Washington, D. C.

SALESMEN—We assure More Sales per day and Most Profit per week selling Franks Ashwell. Many sales dozen lots or more. Brand new and acknowledged best and fastest selling specialty offered. Extra Special for Advertising Novelty Salesmen. Sample \$1.00. (Refunded if returned). Investigate. Afo Mfg. Co., 71 Nassau St., New York.

TAILORING Salesman—\$100—\$150 week selling union hand-tailored made-to-measure suits, overcoats—\$23.50—\$29.50. Liberal commissions advanced. Wood & Co., 651 S. Wells, Chicago.

GOLD Wave Aerial, Greatest Side Line out. Guaranteed to bring in more stations—gives greater distance and selectivity. Reduces static to a minimum. Sells all dealers handling radio. Unlimited field. Big commissions and re-orders. Luxem & Davis Mfg. Co., 6231 Broadway, Dept. 63, Chicago.

SALESMEN, Distributors: We are placing proved office appliance line on the market nationally. Attractive opportunity open for representation. Davis Co., 10 Tremont Street, Boston.

SALESMAN: Want \$6,000 the first year? Write me today. Strong retail line; nationally advertised. Company established 26 years. Liberal advances to producer. Geo. R. Williams, Manager 1317, Liberty Bldg., Cleveland, Ohio.

SPECIALTY Salesmen to handle only scientific razor blade sharpener made. Demonstrated in 2 minutes to men anywhere, stores, offices, homes. 100% profit. Sample 50c. Morgan-Meek, 629 E. Vernon, Los Angeles.

BECOME Your Home Town's Leading Business Man. You can make \$100.00 weekly selling our guaranteed food products, paints, oils, sdirts, hosiery, etc., direct to consumer in towns and country. Every article a repeater. No experience necessary. Exclusive territory for men and women. Loverin & Browne Co., 1600 S. State St., Chicago.

WE want territory men to demonstrate and sell our Gem Commercial Lighting Units. Attractive proposition. Ad-Lee Co., 825 Wabash Ave., Chicago.

HUMANIZED motion window displays are the sensation of the advertising world; quickest money makers for salesman and distributor; write for details. Geraghty Company, 465 West Chicago Ave., Chicago.

\$100—\$200 WEEKLY. Retailers' live-wire specialty. \$10 weekly guaranteed against com. Reliable house. Guarantee dealers turnover or money back. Pay you to investigate. Appleton Specialty Co., Cedar Rapids, Iowa.

SERVE Humanity. Our representatives make \$4,000 yearly, up. No other proposition just like ours. System Bible Co., Dept. 600, 209 S. State, Chicago.

\$40.00 WEEKLY. Demonstrate startling new principle of cooking in patented cooking utensils in your locality. Attracts every housewife. Something new—different—no competition. Nationally endorsed. Only line of its kind carrying Bonded Guarantee. Bonus paid extra. We deliver and collect. Interest on deposit plan for selling Outfit new feature of protection. 100% door-opener Free. Write for particulars. Burnmore Utensil Corp., 300 West 13th St., New York.

GOLD Leaf Window Letters and Script Signs. No experience; 500% profit. Samples free. Consolidated, 69V—West Van Buren, Chicago.

SALESMEN—Become Independent. Own Your business, experience unnecessary selling our \$7,500.00 Accidental Death; \$50 Accident; \$25 Sick Weekly Benefits—\$12.50 Yearly. Other Amounts proportionate. Guaranteed steady income from renewals. \$250,000 Deposited Insurance Department. Universal Policy, Dept. A, 30 Clinton St., Newark, N. J.

MAGIC Moving Window Salesman. It's Real changeable letter system has actually boosted users' sales 200% to 400%. None but dead dealers indifferent. If you can spot a winner, get the facts and begin pocketing \$100 weekly. Display Products Company, P. O. Box A5123, Gateway Station, Kansas City, Mo.

NO competition, sales producer makes \$50 a day. Experience bonds or insurance helpful. Box 447, Bemidji, Minn.

SIDELINE Salesman—Make \$5 to \$10 every day in year selling printing. 40% commission. Easy to sell. Write for portfolio. Roby Printing Specialty Co., 903 Wyandotte, Kansas City, Mo.

TAILORING Salesmen! Don't waste your good time trying to sell "ready made's." Leave them to the local dealer. Don't try to sell at more than \$23.75. It can't be done! Investigate the new Hudson line for Fall. One price, \$23.75. Made to Measure Only. All wool. Over 100 swatches in the line, all beauties. Outfit Free. Write quick, stating experience, territory and references. Hudson Tailoring Co., Dept. 207, 501 W. Adams St., Chicago.

SPECIALTY Salesmen easily earn \$15 first day. Absolute necessity. Money-saving features sell every office and store. Tens-second demonstration. Pocketful lasts all day. Remarkably easy selling plan. Self-feed D. Co., 152 West 42nd, New York.

SALESMEN: Want \$6,000 this year? Write us today. Strong retail line, nationally advertised. Company established 26 years. Liberal advances to producer. Continental Co., 1317 Liberty Bldg., Cleveland, Ohio.

LET us help you make \$200 to \$400 a month. Wanted—Ambitious men to run a business on our capital. Over 500 every-day necessities, known everywhere—used by millions for 43 years. Recognized the best. In big demand—easy to sell—good repeaters—we guarantee satisfaction. Double your profits under our new selling plan. Experience not necessary. Write Dept. 54, John Sexton & Co., Box H. H., Chicago.

WANTED—Experienced tire Salesmen to sell very attractive priced cord tires. 30x 3 1/2 and 29x1.40. On commission basis. Akro Cord Tire Co., Akron, Ohio.

CALIFORNIA Rosebuds selling like hot cakes. Agents coining money. Absolutely new. Big profits. Catalog free. Mission Factory SP, 2328 West Pico, Los Angeles, Calif.

CALENDAR salesmen: Our line is the only one that covers entire field. Calendars—Fans—Signs—Pencils—Blotters—Aluminum—Wood—Celluloid. Remembrance advertising for every merchant. Full or part time. Dept. 226, Model Calendar Co., South Bend, Ind.

MINUTES Pay Dollars demonstrating wonderful three pound Calculator. Retail \$15.00. Work equals \$300 machines. Adds, subtracts, multiplies, divides automatically. Five year guarantee. Big demand; large profits, experience unnecessary. Write quick for liberal trial offer and protected territory. Lightning Calculator Co., Dept. F, Grand Rapids, Mich.

ANY Salesmen Can Sell Them! Merchants everywhere use punchboards. Someone sells them, why not you? Collect big commissions daily. Newest, largest, elaborate catalog sent upon request. Lincoln Sales Co., 9 So. Clinton, Chicago, Dept. D.

FOUR \$7.50 sales to merchants net you \$20.00 daily. Sayers Systems, 2803 Sheffield Ave., Chicago, Ill.

TAKE orders for coffee, sugar, flour, meats, canned goods, staple groceries also paints, radio sets, tires, auto and tractor oils. No capital or bond required. We deliver and collect. Permanent business. Big pay. Write at once, Hitchcock-Hill Co., Dept. 50, Chicago.

\$60-\$200 A WEEK. Genuine Gold Letters for store windows. Easily applied. Free samples. Liberal offer to general agents. Metallic Letter Co., 438-A North Clark, Chicago.

HELP WANTED

DON'T prepare for any Civil Service Examination without seeing our catalogue. Free. Columbian Correspondence College, Washington, D. C.

BECOME a Landscape Architect. Uncrowded profession of wonderful opportunity for money-making. Easily mastered by mail. Earn while you learn. Write for book. American Landscape School, 56-E, Newark, N. Y.

MR. BRUSH Salesmen—Old Established New York Brush Manufacturers require the services of men in all territories to sell their extensive line of Sanitary Twisted in Wire Brushes. We pay larger commission than any other Brush House in the country. Write immediately for our proposition. Wire Grip Sanitary Brush Corporation, 15 Mercer Street, New York.

WOULD you risk a 1c postal against the chance to make \$5 to \$15 daily during the next four months introducing an absolutely new line of Insured Hosiery, guaranteed 12 months. Your Pay Daily. Monthly bonus extra. Magnificent sample outfit furnished. If so, send name and address now to Macoshee Textile Company, Card 26011, Cincinnati, Ohio.

GOVERNMENT Jobs. Become Railway Mail Clerks. Men 18-35. \$1,900. Common education sufficient. Particulars with sample coaching—Free. Write immediately. Franklin Institute, Dept. C-16, Rochester, N. Y.

MEN to train for locomotive firemen on railroads nearest their homes—everywhere; beginners \$150-\$250 monthly; promoted, locomotive engineer, \$3,000-\$4,000 yearly. Best paying positions on railroads. Railway Association, Desk M1, Brooklyn, N. Y.

SILVERING Mirrors, French Plate. Easily learned; immense profits. Plans free. Wear Mirror Works, Excelsior Springs, Mo.

ALL men—women wanting Government Positions, \$140-\$225 monthly, should get our "Exam Coaching" immediately. Write, Ozment, 101, St. Louis, Mo.

YOU Are Wanted. Men—Women 18 up. Get U. S. Government Life Jobs. \$95.00 to \$250.00 Month. Steady work. Short hours. Paid summer vacation. Pull or experience unnecessary. Common education sufficient. We coach you without leaving home. 32 page book with full particulars Free. Write immediately. Franklin Institute, Dept. C-3, Rochester, N. Y.

WANTED—Boys—Men 16 up. Become expert automobile Mechanics and Auto Electricians. \$25.00-\$60.00 week. Learn at home while earning. Sample lessons Free. Write immediately. Franklin Institute, Dept. C-400, Rochester, N. Y.

U. S. GOVERNMENT wants men. \$1,700-\$1,900 and up at start. Railway Mail clerk examination coming. Let our expert (former Government examiner) prepare you for this and also Rural Carrier, Post Office, Customs, Internal Revenue, and other branches. Write today for free booklet. Dept. 8, Patterson Civil Service School, Rochester, N. Y.

MEN wanting to prepare for forest ranger or railway mail clerk examinations Write Mokane, A-23, Denver, Colo.

\$158.00-\$225.00 MONTH. Railway Mail Clerks. Particulars with sample coaching—Free. Write immediately. Franklin Institute, Dept. C-16, Rochester, N. Y.

WE Start You in Business, furnishing everything. Men and women, opportunity to earn \$35 to \$100 weekly operating Ragsdale's original "New System Specialty Candy Factories" anywhere; wholesale or retail. Big commercial candy book free. W. Hillier Ragsdale, Drawer 350, East Orange, N. J.

MIDDLE-AGED Man: It will not injure your health. Pocket Book or Reputation. Stamp for Particulars. N. E. Badgley, 1063 W. Madison, Chicago, Ill.

MEN Wanted—prepare as firemen, brakemen, colored train or sleeping car porters, wire for application blank; experience unnecessary; first class roads, no strike. Name position wanted. Railway Institute, Dept. 33, Indianapolis, Ind.

\$158.00 MONTH. Railway Mail Clerks. Steady. Particulars with sample coaching Free. Franklin Institute, Dept. C-16, Rochester, N. Y.

BUSINESS SERVICE

BUSINESS Problems Solved—all kinds—where to buy, how to sell, increasing business, advertising, getting agents, special formulas for all kinds of products, etc. Complete solution of problem \$5, particulars free. Satisfaction guaranteed. All confidential. Write today. National Information Bureau, 316F Shepard Building, Grand Rapids, Mich.

BUSINESS problems analyzed. Manufacturers and Mail order dealers. Advertising, merchandising ideas. Complete service, any subject. Arvor Business Service, 245 West 112th Place, Chicago.

MAKE 'Em Pay—My system will make them pay their bills. Write for the acid test. Literature free. Burleigh L. Horr, Horr Omelia Block, Rhinelander, Wis.

REPRESENTATION in Washington, D. C. Mail address, information, anything. Anytime. Service, 223 Victor Bldg.

DRAWINGS and tracings for all purposes: mechanical, electrical, patent, and otherwise. Send sketch for estimate. Triangle Drafting Service, 5124 Sheridan Road, Chicago.

INFORMATION

FOREIGN Service—With mining, oil, electric, railway, fruit, sugar and other companies in Latin America. Send ten cents for further particulars. Foreign Service, Box 69, Station D, New York City.

TENDERFOOT prospectors—Any five questions on mining \$1.00. Jack Hosford, Sierra Madre, Calif.

ESCAPE from Sacks, Rope Ties and Chains. Easy with these complete instructions. Give an entire evening's entertainment and mystify the "wise ones." Let them tie you hand and foot, place you in a bag and seal the bag. In a minute you are out. Complete instructions in "33 Rope Ties" and "Sack Escapes." Send No Money. Pay postman \$1.50 and postal charges for these two books. Popular Mechanics Press, Room 810, 200 East Ontario St., Chicago, Ill.

TYPEWRITERS AND SUPPLIES

100 TYPEWRITERS Free. Overstocked. Rent rebuilt Underwood or Remington \$3.00 month. If you pay its value in rental, we give machine free. Particulars free. Pittsburgh Typewriter Exchange, 915 Hersch Bldg., Pittsburgh, Pa.

UNDERWOOD Typewriters—only \$3.00 down. Easy monthly payments. Low prices at less than manufacturers. 10 days' free trial. Rebuilt, all worn parts replaced. Just like a new machine. 5-year guarantee. Write for a big free catalogue B-151. Shipman-Ward Mfg. Co., 1518 Shipman Bldg., Chicago, Ill.

TYPEWRITERS, all standard makes, thoroughly re-manufactured by the famous "Young Process" and shipped direct from factory to you on 10 days' trial. Guaranteed 5 years. Easy monthly payments. Write today for free catalog. Young Typewriter Company, Dept. 575B, 654 W. Randolph St., Chicago.

HIGH grade Carbon Paper and Typewriter Ribbons at lowest prices. Write for Particulars and price list. Nelson Carbon & Ribbon Co., Elmhurst, Ill.

TYPEWRITERS—all makes; wonderful values; guaranteed. Typewriter Bargain House, Ada, Okla.

TYPEWRITERS, adding and calculating machines at less than half manufacturer's price. Bargains. Free Guarantee. Ford Company, 929 Broadway, New York.

REMINGTONS Visible \$8-\$25; Underwoods, Portables. Motorcycles \$15-\$75. Knights, 1512 Locust, St. Louis, Mo.

TYPEWRITERS, all standard makes, \$10 up. Fully guaranteed. Free trial. Write for complete illustrated lists. Northwestern Typewriter Exchange, 121 N. Francisco Ave., Chicago.

PRINTING, ENGRAVING AND MULTIGRAPHING

250 EACH Hammermill Bond Letterheads. Envelopes, \$3.00. Samples, Midland Press, 543 West Hickory, Kankakee, Ill.

ENVELOPES printed, \$5,000. \$8.80; 1,000, \$2.50; 24 pound, 6%. A. Kuhlman, 1806 Sycamore, Cincinnati, Ohio.

EVERYTHING Printed! Samples for stamp. Franklinpress, B-32, Milford, New Hampshire.

\$3.00 DELIVERED. 500 Watermarked Bond Letterheads, 8½x11, and 250 envelopes, money with order. Job Printing Specialty. National Printing Company, Goshen, Ind.

PRINTING—250 Bond letterheads or envelopes, \$1.25. Classic Service, Warren, Pa.

500 MULTIGRAPH Letters with Printed Head \$2.35. Samples. Carlsons, 8743 Essex Ave., Chicago.

"NEARGRAVURE" Process—Get samples—See the Difference. Soliday's, Knox, Ind.

CIRCULARS 5,000 5½x8½ \$10. 5,000 3x6 \$5.50 3½x6 four-page folders, \$14. Postpaid. Samples. Garrison Press, Harrisonburg, Va.

GUMMED Labels or Advertising Stickers \$1.00 per thousand. Wm. H. Sirdevan, Ravenna, Ohio.

225 BOND letterheads, envelopes, billheads, cards, \$1.25 each. Combination, \$4.00. Economic Press, Leonia, N. J.

DISTINCTIVE—Artistic Business Stationery that Creates Confidence. 1,000 Letterheads or Envelopes \$3.00. Samples. Moulton Printing Company, 1410-P East 8th, Kansas City, Mo.

250 BOND Letterheads or Envelopes, \$1.00. Glenwood Art Press, Govans, Baltimore, Md.

MULTIGRAPH typewriting business correspondence, two dollars thousand. Hammermill Bond Letterheads, four dollars. Mayera Corporation, Monmouth, Ill.

WE print Stationery, Booklets, Catalogs, Circulars, Samples. Commercial Press, Batavia, Ohio.

PRINTING—Lowest Prices in America. Samples free. Pitts, Amana, Iowa.

PERSONAL Stationery: 100 Envelopes and 200 Sheets exquisite bond paper, each with your name and address, \$1.00 Postpaid. Brookside Press, 146 Mt. Joy Place, New Rochelle, N. Y.

GOOD Printing—250 20-lb. bond letter heads, 250 envelopes, prepaid, \$2.50. Eastern Printer, Greenville, Tenn.

250 BUSINESS Cards, \$1.00; 500 Letterheads or Envelopes, \$1.95. Acorn Press, Newport, Ky.

1,000 LETTERHEADS or Envelopes, \$3.00. Sent Prepaid. Samples Free. Monitor Press, Morrisville, Pa.

ARTISTIC Printing; low prices. Samples free. Acorn Press, Sidney, Iowa.

GUMMED Labels, 500 name and address, 2 lines 35c. 3 lines 55c. Catalogue. Eastern Label Co., B. Clintonville, Conn.

250 WATERMARKED Bond Letter Heads or envelopes, \$1.50; 500, \$2.25. Pfleger Bros., Hackensack, N. J.

HAMMERMILL Bond letterheads or envelopes 200—\$1.00, 1,000—\$3.50. Free samples. Zippo, 3597 East 118, Cleveland, Ohio.

YOUR Name and Business address imprinted on Pencils; most resultful advertising. Samples free. Direct-prompt service. (No agents.) S. Musial & Co., 10-12 Lincoln St., Yonkers, New York.

COMMERCIAL Printing. Prices Right. Samples Free. The Fox Press, Frankfort, N. Y.

QUALITY Book Printing at reasonable prices. Cloth, Board, Paper, Bindings. Meador Publishing Company, 27 Beach, Boston.

5,000 WATERMARKED Bond Letterheads \$10.00. 5,000 Typewritten Letters \$12.50. Sample Printing and Price Lists on request. M. Rosenberg Co., 145 Greene St., New York.

1,000 LETTERHEADS or Envelopes, printed, postpaid \$2.95. 4605 Wells Street, Milwaukee.

GUMMED Labels, with name, business and address, 500, 30c; 1,000, 50c. P. Wetzel, Valhalla, N. Y.

QUALITY Printing—1,000 Letter Heads and Envelopes \$3. Harlem Press, 132 West 26th Street, New York City.

QUALITY Printing! Reasonable Prices! Send for Free Standardized samples and prices. Folders, Circulars, Catalogs our specialty. Ernest Fantus, 525 South Dearborn, Chicago.

PRINTING OUTFITS AND SUPPLIES

USED Presses, Supplies. C. Whitfield, Ballentine, Norfolk, Va.

PRE-USED Printing Presses, Type supplies. List for 2c stamp. Popular Bargains, Richland, Pa.

PRINT your own cards, stationery, circulars, paper, etc. Complete outfits \$8.85; Job Presses \$11, \$29; Rotary \$149. Print for others, big profit. All easy, rules sent. Write for catalog presses, type, paper, etc. Kelsey Company, F-11, Meriden, Conn.

DUPLICATORS AND DEVICES

PORTABLE "Stencil-Duplicator," 8x11 \$7. Copies like \$150 mimeograph. F. Gerwin, Dale, Okla.

YOU can make 50 to 100 copies of a letter, notice, etc., at a cost of three cents on a Hoyer Quality Duplicator. Write for free trial offer. The Hoyer Duplicator Co., 14 S. Wells St., Chicago, Ill.

ADDING MACHINES

FREE Trial. Marvelous new Adding Machine. Adds, Subtracts, Multiplies, Divides, automatically. Work equals \$350.00 machine. Price only \$15.00. Speedy, durable, handsome. Five-year guarantee. Used by largest corporations. Write today for catalog and free trial offer. Lightning Calculator Co., Dept. E, Grand Rapids, Mich.

NEW \$3.50 Automatic Adding Machine. Adds, Subtracts, Multiplies. Absolutely accurate. Capacity \$999,999.99. Fully guaranteed. 75,000 pleased users. Makes adding easy, positive, quick. Eliminates Mistakes. Saves Time. Postpaid \$3.50. Bassett Co., 1458 B Hollywood Ave., Chicago.

RUBBER STAMPS

MUSIC stamps, rubber printing toys, rubber type catalogue 25c. W. Karstaedt, Dayton, Ohio.

RUBBER stamps and stamp supplies. Mail orders filled promptly. F. D. Hale, Manufacturer, 64 Tonnets Ave., Jersey City, N. J.

MAILING LISTS

99% GUARANTEED Mailing Lists. Accurate. Reliable. Guaranteed. The kind that produces business; compiled for every possible business or individual. Lists of every kind of any business or individuals compiled for your individual needs anywhere. Catalogue and information on request. National List, 847 Broad, Newark, N. J.

AUTO and Real Estate owners, musicians, infants, business and professional men, male wage earners under 30, paid up installment buyers. Gregory, 106 S. Hays Ave., Jackson, Tenn.

CIRCULARIZE original letters. Guaranteed business getters. Write, Aldrich, Alma, Nebr.

FOR SMOKERS

NATURAL Leaf Smoking Tobacco. Aged in bulk, two years old, mellow and sweet; 5 lbs. \$1.00; 10, \$1.75. Satisfaction guaranteed. Farmers' Union, Mayfield, Ky.

5 LBS. Extra mild, 2 year old, air cured, burley smoking, \$1.25. Hickory Ridge Farms, Fulton, Ky.

SEND 10c, Silver or Stamps, for sample package 20 fine cigarettes. Large pocket tin Special Blend smoking tobacco also sent for 10c. Direct-to-smoker. French Tobacco Company, Dept. 26, Statesville, N. C.

100 REGULAR 5c Cigars, \$3.50 C.O.D. Wineholt Mail Order, Woodbine, 77, Penna.

HAV-A-TAMPA, Admiration, El Producto, Garcia Grande, and 13 other leading brands of Cigars sold direct to consumer. All leading brands of Cigarettes handled. Bulletin 44 free upon request. Trade supplied. Richard Lavery, Asbury Park, N. J.

BOATS AND LAUNCHES

REVERSE gear need overhauling? \$2.00 monthly pays for it. Wm. H. Barker, Pond St., Quincy, Mass.

BUILD Your Own Boat during your leisure time this winter; plan now. 55 models, new designs. Send 25c for complete catalog. Brooks Boat Co., Inc., Rust Ave., Saginaw, West Side, Mich.

BOAT Building Plans for amateurs. Rowing, sailing, speed, cruising. Free catalog. The Rudder, 9 Murray Street, New York.

SHIP Models—Worth-while—Easy to make. Decorative ships. Picturesque Barbary Pirate Felucca and Beautiful Spanish Treasure Galleon (both 17th century). Instructions so simplified that any handy person can make these models with a few household tools almost without expense. No personal knowledge of ships or naval architecture required. New book only one of its kind. Pay postman \$2.50 plus postage when book is delivered. Popular Mechanics Press, Room 810, 200 E. Ontario St., Chicago.

HUBBELL Marine Coolers convert Ford engines into marine motors. Booklet free. Ford speedboat, easily built, blueprint and directions, sixty cents. C. C. Hubbell, 14B Cottage St., East Norwalk, Conn.

BOAT Building Plans for amateurs. Rowing, sailing, speed, cruising. Free catalog. The Rudder, 9 Murray Street, New York.

MAKE 16' Rowboat; blueprint 30c. Weesho-Uco, 31st Office, Detroit.

FOR Sale—1x5 Marine Steam Engine. Governor, Lubricator, Throttle, \$65; fine condition. Geo. Doeberl, 77 Landon St., Buffalo, N. Y.

GUARANTEES Waterproof Joints—Stan-z-all Waterproof Joint Glue. Used for making boat models and for general use. 30c for 1/4-lb. trial size. L. W. Ferdinand & Co., 152 Kneeland St., Boston, Mass.

BUILD your own boat. Do your own concrete work. Two new books tell how to make 21 kinds of boats and 173 articles from concrete. Each book filled with pictures. Send No Money. Just write a postal and say, "Send Popular Mechanics Boat Book and Concrete Handbook." Pay postman postage and \$1. Popular Mechanics Press, Room 810, 200 E. Ontario St., Chicago, Ill.

RAZORS AND BLADES

RENEW your old safety razor blades quickly and easily. Make new blades better. Apply Nura to your strop or strop-ter, and see the difference. Nura makes blades last indefinitely. Straight razors seldom, if ever, need honing. Stop buying blades. Will not injure strop. Guaranteed. Send 50 cents, no stamps. Nura Co., Box 342, Rochester, N. Y.

FINE Razor with free strap \$1.77 C.O.D. Mervin Wineholt Co., Woodbine, 99, Penna.

GUNS, SPORTING GOODS, ETC.

ARE you a rotten shot? Hunting season should find you prepared to fill the bag. Our new shotgun peep sight, \$2.50 postpaid, will make you a good shot. Booklet "Wing Shooting Made Easy," description and testimonials on request. Wilbur Gun Sight, P. O. Box 185, Times Square, New York City.

MAKE your Decoys Life-Like. The "Pitts Adapter"—easily attached—makes heads turn naturally. Send 50 cents for sample. Tuerc Mfg. Co., 32 N. Jefferson St., Chicago, Ill.

FOR THE HOME

VALUABLE sample enables you to test wonderful waterproof qualities of Valspar. Even boiling water doesn't injure it! Choice of Clear Valspar, Valspar Stain in transparent colors and solid-covering Valspar-Enamel. Ideal for cars, boats, machines, radio cabinets, furniture, floors and all wood and metal surfaces, outdoors and indoors. Send 20c for 40c sample (stating color desired) and prove Valspar's extraordinary qualities. Valentine & Co., Dept. B, 450 Fourth Ave., New York, N. Y.

MEN! Women! Earn \$1 an Hour at Home. Weaving Colonial Rugs, genuine fluff rugs, fancy fabrics, from new and other materials. Home weavers always busy. You learn in 30 minutes. We guarantee it. Looks now at reduced prices. Liberal Pay-As-You-Weave terms. Solve Your more-money problem by writing for Free Loom Book today. Union Loom Works, 480 Factory St., Booneville, N. Y.

GRANDFATHER'S Clock Works. \$5.00. Build your own case; Instructions free; make good profits selling your friends. Clock works with chimes for old or new cases. Write for full particulars. Clock Co., Ruffner St., Philadelphia.

ARIZONA Table Delicacies packed for Holiday Gifts. Assorted Boxes. Four Dollars delivered. Send for price list. Triple L Company, Box 767, Chandler, Ariz.

16 YARDS Remnants and 75c worth of Notions all for \$1.95 C.O.D. Order Now. Mervin Wineholt Co., Woodbine, 99, Penna.

REFRIGERATING Machine, Homemade. Operates successfully. Gives better service than ice. This and 328 other practical articles in our book "Home Mechanics." Just ask for this and "Handbook for Women" containing 394 valuable household helps and pay postman 98 cents and postage for the two books. Popular Mechanics Press, Room 810, 200 East Ontario St., Chicago, Ill.

CEDAR chests only \$11.65—"Red-I-Kut" complete with rich copper trim—you assemble and save half—send for pictures. Kuempel Furniture Company, Guttenberg, Iowa.

SHIP Models, by Capt. E. A. McCann. Instructions and full-scale drawings for making models of Pirate Felucca and Spanish Galleon. 150 pages—only book of its kind. \$2.60 postpaid. Sea Arts Guild, 405W 11th Ave., Milwaukee, Wis.

HONEY-Hot Cakes for Health, Vitality. Ten Pounds Extracted Honey, Guaranteed satisfactory. \$1.95 delivered. Wintergreen Farm, Valleywells, Texas.

SOMETHING New, East India Sandalwood Soap. "The Soap with the Oriental Perfume." Six cakes only \$1. Chas. A. Philidius, 510 East 120 St., New York.

FURNITURE. Make Furniture at Home. Popular Mechanics books tell how to make all pieces. "Mission Furniture and How to Make It, Book 1, Book 2, Book 3." Send No Money. Just write a postal. Pay postman postage and \$3. Popular Mechanics Press, Room 810, 200 E. Ontario St., Chicago, Ill.

WATCH REPAIRING

WATCHES Carefully Repaired at Lowest Prices. Estimate given upon examination. Ralph Pile, Somerset, Penna.

WATCHES; all makes repaired by experts. Write International, Box 5P, Fordham Station, New York.

ANTIQUES, WAR RELICS AND INDIAN GOODS

EGYPTIAN Antique Jewelry, Tutankhamen Souvenirs, silver shawls, scarabs, postcards, price list free. Pharaoh's Store, Found Stefan, Luxor, Egypt.

INDIAN deer killing bows \$2.50. Hunting arrows 75c. Cow boy lassoes \$3.50. Thousand article catalogue 10c. Indian-craft P. Company, 466 Connecticut, Buffalo, N. Y.

SEND 5c for fine, new list Indian relics, antique firearms. F. E. Ellis, Webster Groves, Mo.

FOR Dens, Relics from Europe's battlefields; also medals. Illustrated catalogue 25c, with Sample War Photos, International, 1889 Albany Ave., Brooklyn, N. Y.

FLINTLOCK pistols, rifles, powderhorns, daggers, swords, Indian curios. Lists free. Nagy, 08 South 18th, Philadelphia.

PHONOGRAPHS AND SUPPLIES

BUILD your own Phonograph. We furnish everything. Catalog sent free. American Phonograph Co., 3752 Belmont, Chicago.

MUSIC AND MUSICAL INSTRUMENTS

SONGS—Jokes—Plays—Operettas. Monologs, Wigs, Make-Up, 2, 3 and 4 Part Songs. For Amateur Shows by Schools, Colleges, Glee Clubs, Lodges, Churches, etc. These Books a Great Help. Amateur Minstrel Guide (150 Pages) \$1.50. Burnt Cork 50c. Phunny Puns 50c. Darkey Dialect Discourses 50c. Stump Speeches 50c. 25 Roaring Parodies 50c. 52 Page Catalog Free. M. Witmark & Sons, Dept. F, 1650 Broadway, New York.

SHARPS and Flats—Free. Very interesting. Send for it Today. Harry L. Alford, 192 No. State St., Chicago, Ill.

VIOLINS, Deep, Mellow, Soulful—on credit. Easy terms for wonderful instrument. Get details today. Gustav F. Henning, 2424 Gaylord St., Denver, Colo.

"MUSIC Composed" to words. Bauer Bros., (formerly of Sousa's Band), Oshkosh, Wis.

WRITE Songs. Big money and reputation. Write for information. J. Gordon Pub. Co., 201 N. Hoyne Ave., Chicago.

PLAY Piano by Ear. A Sound System. Write for Free Booklet. You'll be glad you did! Boucher's Harmony Studio, 126 Sparks St., Ottawa, Can.

CORNETISTS—Trumpetists—Saxophonists—Clarinetists. Get "Free Pointers." Name instrument. Virtuosi School, Buffalo, N. Y.

REAL Jazz Piano Lesson, Latest Hits, taught quickly at home. Booklet and Sample Lesson Free. Address Studio, 7 United Schools of Popular Music, P. O. Box 1959, Boston, Mass.

SONG Poem Writers Address Monarch, 1472 Broadway, New York.

VIOLINS—Genuine handmade masterpieces. Get Details. John Lehto, 935 14th, San Pedro, Calif.

I WANT Song Poems. Casper Nathan, 2544 N. Racine, Chicago.

SONG Poem Writers—Send for proposition. Ray Hibbeler, D1, 2104 N. Keystone Ave., Chicago.

SONG Poem Writers—Stamp brings "Song Writers' Guide." Wm. Van Beaver, 81-1239 Elm St., Green Bay, Wis.

PATENT ATTORNEYS

PATENTS. Time counts in applying for patents. Don't risk delay in protecting your ideas. Send sketch or model for instruction or write for Free book "How to Obtain a Patent" and "Record of Invention" form. No charge for information on how to proceed. Communications strictly confidential. Prompt, careful, efficient service. Clarence A. O'Brien, Registered Patent Attorney, Security Bank Building (directly across street from Patent Office), Washington, D. C. See pages 140 and 141.

PATENTS Procured; Trade Marks Registered—A comprehensive, experienced, prompt service for the protection and development of your ideas. Preliminary advice gladly furnished without charge. Booklet of information and form for disclosing idea free on request. Richard B. Owen, 30-Owen Bldg., Washington, D. C., or 41-R Park Row, New York.

"INVENTORS' Guide" sent free on request; this book contains illustrations of patented inventions and gives valuable information and advice for all who have original ideas or improvements. Frank Ledermann, Registered Attorney and Engineer, Woolworth Bldg., 1712, New York.

UNPATENTED Ideas Can Be Sold. I tell you how and help you make the sale. Free particulars (Copyrighted). Write W. T. Greene, 807 Jenifer Building, Washington, D. C.

PATENTS. Booklet free. Highest references. Best results. Promptness assured. Send model or drawing for preliminary examination. Watson E. Coleman, Patent Lawyer, 644 G. Street, Washington, D. C.

INVENTORS: Send sketch or model for advice and exact cost of patent. Ask for our Free book: "How to Obtain a Patent." Tells what every inventor should know. Established twenty-eight years. Highest references. Prompt service. Reasonable charges. Chandlee & Chandlee, 474 Seventh, Washington, D. C.

MILLIONS spent annually for ideas! Hundreds now wanted! Patent yours and profit! Write today for free book—tells how to protect yourself, how to invent, ideas wanted, how we help you sell, etc. American Industries, Inc., 500-Victor Bldg., Washington, D. C.

INVENTORS having ideas to patent: Write for Booklet explaining Co-operative Plan for handling your applications. Tells how to sell and safeguard your inventions at lowest cost. Ralph Burch, Patent Lawyer, Jenifer Bldg., Washington, D. C.

MONROE E. MILLER, Ouray Bldg., Washington, D. C. Patent Lawyer; Mechanical, Electrical Expert. Booklet and Priority Record blank gratis.

RICHARD E. BABCOCK, Patent Lawyer, Washington Loan & Trust Bldg., Washington, D. C. Booklet.

ESTABLISHED 1864. Milo D. Stevens Company. Free Booklet, Patents, Trade-Marks, Copyrights. Offices, Monadnock Block, Chicago; Barrister Building, Washington, D. C.

PATENTS, Trade-Marks, Copyrights, and Patent Litigation. Write for advice and instructions how to proceed, costs, etc. Hand Book with illustrations of 100 Mechanical Movements sent free on request. Albert E. Dieterich, Patent Lawyer and Solicitor, 621-B Ouray Bldg., Washington, D. C.

PATENTS—Send for form "Evidence of Conception" to be signed and witnessed. Form, fee schedule, information free. Lancaster and Allwine, Registered Patent Attorneys in United States and Canada, 221-Ouray Bldg., Washington, D. C.

PATENTS—Write for our Guide Books and "Record of Invention Blank" before disclosing inventions. Send model or sketch of your invention for Free Inspection and Instructions. Terms Reasonable. See advertisement on pages 142 and 143. Victor J. Evans & Co., 934 Ninth, Washington, D. C.

EDWARD C. SASNETT, Formerly a Principal Examiner United States Patent Office. Strictly Personal Service. McGill Building, Washington, D. C.

INVENTIONS patented; Trade - Marks Registered; Reasonable charges; prompt service; plain advice; request particulars. Jaynes & Jaynes, 700 Kellogg, Washington, D. C.

"INVENTOR'S Advisor," the valuable Patent book with 139 mechanical movements and illustrations, sent free upon request. MM. Labiner, Patent Attorney, 3 Parkrow, New York.

PATENTS Procured. Prompt Service. Personal, careful and efficient service. Highest references. Moderate fees. Send sketch or model for actual search and advice. George P. Kimmel, Master of Patent Law, 55N. Legal Bldg., Washington, D. C.

INVENTORS—Write for our Guide Book, "How to Get Your Patent" and Evidence of Invention Blank. Send model or sketch of your invention for our prompt examination and instructions free. Randolph & Co., Dept. 430, Washington, D. C.

PATENTS—Trade-marks obtained. Information free. O. A. Michel, Registered Attorney, Box 624-B, St. Louis, Mo.

LACEY'S Patent Sense. Valuable book free. See ad page 144.

PATENTS. Trade marks, copyrights, Prompt, personal, reliable service. Over 35 years' active practice. Write for terms. Book free. Address E. G. Siggers, N. U. Bldg., 918 F Street, Washington, D. C.

IF you have a practical, useful invention to sell, write Chartered Association American Inventors, Barrister Building, Washington, D. C.

PATENTS, Trade-Marks, Designs. This firm has 27 years' experience and gives expert personal service at reasonable rates. We properly protect your invention. Write for free information and exact cost of procuring patent before proceeding. John B. Thomas & Co., 992 F St., N. W., Washington, D. C.

U. S. AND foreign patents, trademarks; moderate rates. 22 years' experience. George C. Heinicke, 32 Union Square, New York; registered in U. S. and Canada.

PERCY S. WEBSTER, 203 Saving and Loan Building, Stockton, California. Long established organization. Patent booklet free.

FOR INVENTORS

PATENTS. If you have an invention which you wish to patent you can write fully and freely to Munn & Co., for advice in regard to the best way of obtaining protection. Please send sketches, or a model of your invention and a description of the device, explaining its operation. All communications are strictly confidential. Our Handbook on Patents is sent free on request. This explains our methods, terms, etc., in regard to Patents, Trade Marks, Foreign Patents, etc. "Scientific American" contains Patent Office Notes, Decisions of interest to inventors and particulars of recently patented inventions. Munn & Company, Solicitors of Patents, 1523 Scientific American Building, 24 W. 40th St., New York; 524 Scientific American Bldg., Washington, D. C.; 1313 Tower Bldg., Chicago, Ill.; 666 Hobart Bldg., 582 Market St., San Francisco, Calif.; 521 Van Nuys Building, Los Angeles, Calif.

INVENTORS—Write for our Guide Books and "Record of Invention Blank" before disclosing inventions. Send model or sketch of your inventions for our free inspection and instructions. Terms reasonable. See advertisement on pages 142 and 143. Victor J. Evans & Co., 157 Ninth, Washington, D. C.

PATENTS. Time counts in applying for patents. Don't risk delay in protecting your ideas. Send sketch or model for instructions or write for Free book "How to Obtain a Patent" and "Record of Invention" form. No charge for information on how to proceed. Communications strictly confidential. Prompt, careful, efficient service. Clarence A. O'Brien, Registered Patent Attorney, Security Bank Building (directly across street from Patent Office), Washington, D. C. See pages 140 and 141.

PATENT Reports \$15. Engineer, 765 East Tenth, Los Angeles, Calif.

IF you have a practical, useful invention to sell, write Chartered Association American Inventors, Barrister Building, Washington, D. C.

WANTED; Specialties of electrical or mechanical nature, patented or not, that can be marketed through automotive accessory hardware, electrical trades. If specialty meets Delta quality standard, will buy outright or manufacture on royalty basis and market it through our established channels under nationally known Delta trade-mark. Send full information and drawings. Delta Electric Company, Marion, Ind.

PATENTS Procured; Trade Marks Registered—A comprehensive, experienced, prompt service for the protection and development of your ideas. Preliminary advice gladly furnished without charge. Booklet of information and form for disclosing idea free on request. Richard B. Owen, 30-Owen Bldg., Washington, D. C., or 41-R Park Row, New York.

PROTECT your patents, trademarks in case of infringement. Guaranteed by strongest bonding company, surplus \$4,000,000. Patent & Trademark Protection Co., Drawer 1345B, St. Louis, Mo.

I SELL Patents. Established in 1909. The only man in America who has spent the past 25 years exclusively at this work. An experience highly valuable to you. If you have a good patent to sell. Charles A. Scott, 773PM Garson Avenue, Rochester, N. Y.

PATENTS Wanted—We buy and sell practical patents. Big opportunity, undeveloped field. Describe briefly. M. Okamura, Box 1290, Honolulu, Hawaii.

UNPATENTED Ideas Can Be Sold. I tell you how and help you make the sale. Free particulars (Copyrighted). Write W. T. Greene, 805 Jenifer Building, Washington, D. C.

I AM in touch with hundreds of moneyed men and manufacturers who wish to buy good inventions. Write Hartley, 38 Court St., Bangor, Me.

MAIL copy of patent or description of invention. Central Sales Agency, Independence, Mo.

OBTAIN your patent through us; we finance the application. Patents Bureau, Times Bldg., St. Louis, Mo.

LACEY'S Patent Sense. Valuable book free. See ad page 144.

GET your own patents. Legal blanks, complete instructions \$1. Cutting Sons, Campbell, Calif.

INVENTORS Universal Educator—contains 900 mechanical movements; 50 perpetual motions. Tells how to obtain and sell patents. Suggests new ideas. Explains how to select your attorney and avoid patent sharks. Price (revised edition) \$1.50 postpaid. Albert E. Dieterich, 621-Ouray Bldg., Washington, D. C.

PATENTS wanted, cash or royalty basis. Send description, Box 123, Dowagiac, Mich.

INVENTIONS developed to commercial basis. Non-infringing devices designed. Basic claims suggested. A. Papini, Leonia, N. J.

PATENTS FOR SALE

OUTRIGHT or royalty, U. S. patent, masonry spacing and facing elements. M. Green, 545 5th Ave., Homestead, Pa.

OUTRIGHT—Royalty; Tuck Gauge No. 1,547,965. Offers invited. Ella Seybert, 407 Orchard St., Glen Osborne, Sewickley, Pa.

ROYALTY Basis. Patent covering 4 small articles. Trade-marked, proven sellers. Approved Good Housekeeping Institute. Splendid patent protection. K. H. Rawles, 1923 E. 29th St., Oakland, Calif.

PATENT pending on interesting new mathematical toy. Novelty manufacturers write. Jos. H. Jacobs, Paxton, Mont.

OUTRIGHT, Steering spindle bolt. Can be applied to Ford, Dodge, Chevrolet and Overland. Geo. A. Lishka, 617 Lincoln Ave., Kenosha, Wis.

25-CENT Articles. DeFrees, 1036 W. 90th St., Los Angeles, Calif.

FOR Sale—Patent Tobacco pipe. Dr. John Kercher, 6859 Dorchester Ave., Chicago.

OUTRIGHT, Canadian patent for holding price card. Patented Feb. 16, 1926. Address C. E. Brigel, 415 Sycamore St., Cincinnati, Ohio.

PATENT No. 1,594,071—Hobby Horse—for Sale. Nick Schleich, 1612 Third Ave., North, Great Falls, Mont.

OUTRIGHT, newly patented stop device for phonographs. G. W. Eichelberger, Box 3306, Goose Creek, Texas.

MILK Closure Fastener for milk cans. Interested parties please communicate with T. B. Smith, Pocatello, Idaho, P. O. Box 949.

FOR Sale—Patent No. 1,594,623. Antiskid-mat. Essential device for motor-vehicles. Fred Lunberg, 6153 S. Bishop St., Chicago, Ill.

FOR Sale—Patent on Oil and Sewerage Separator. New Process; recovers oil absolutely; separates waste—Municipal, Industrial Sewers and Shipboard operation; continuous, automatic; upkeep trivial. See machine in operation. Johnathan Kindle, Pitman, N. J. All or Half Enters.

OUTRIGHT—easily operated door stop. Holds door in any position without scratching or marring floor. Lansing Restaurant Supply Co., Lansing, Mich.

COIN Dispenser. Drinks, confections. Marker. Perforating, hides, etc. Exponent, Orlando, Fla.

FOR sale outright or royalty. Cheese box or tub fastener. Paul Jentzsch, Medford, Wis.

WHY let your patents lie idle? Tell our two million five hundred thousand readers about it! The majority of our readers are especially interested in new ideas and inventions. Ask me to tell you how other inventors successfully sold their patents. M. L. Rund, Mgr., Classified Advertising, Popular Mechanics Magazine, Chicago.

SURVEYING INSTRUMENTS

LARGEST stock of new and used surveying instruments in the country direct from factory. Satisfaction guaranteed or money refunded. Wissler, 619 N. Broadway, St. Louis.

TRANSITS. Levels, telescope compasses. Burnett, 36 Euclid Ave., Ludlow, Ky.

INVENTORS. A good shop to have your models made. Burnett, 36 Euclid Ave., Ludlow, Ky.

DRAWING INSTRUMENTS AND DRAFTING SUPPLIES

CATALOG 1. New illustrated catalog on Drawing Stands and Drafting Tables. Suitable for Schools, Drawing Classes, Artists, Draftsmen and Engineers. The Washburn Shops of the Worcester Polytechnic Institute, Worcester, Mass.

DRAFTING. Learn Mechanical Drawing. Big demand for men. Pocket-size. Start at beginning and learn by a series of simple lessons. Send No Money. Just write postal for "A Practical Course in Mechanical Drawing." Pay postman postage and \$1. Popular Mechanics Press, Room 810, 200 E. Ontario St., Chicago, Ill.

MODELS AND MODEL SUPPLIES

PATENTS. Time counts in applying for patents. Don't risk delay in protecting your ideas. Send sketch or model for instruction or write for Free book "How to Obtain a Patent" and "Record of Invention" form. No charge for information on how to proceed. Communications strictly confidential. Prompt, careful, efficient service. Clarence A. O'Brien, Registered Patent Attorney, Security Bank Building (directly across street from Patent Office), Washington, D. C. See pages 140 and 141.

SPECIAL machine builders, tool and die makers, inventor's models, production work of all kinds. Dept. L, Quality Hardware & Machine Co., Ravenswood and Thorndale Avenues, Chicago, Ill.

INVENTOR'S models and machine work. Reasonable prices. Louis Uhler, 543 Napoleon, Detroit.

MODELS. Experimental work, tools, Dies, Stamping, Production Work. Most effective; least cost. Great Lakes Tool Manufacturing, 3947 Lake Street, Chicago.

MODELS. Tools and Dies, and General Manufacturing, new invention, our specialty. Logan Machine & Manufacturing Co., 126 S. Clinton St., Chicago, Ill.

HULIT & Co. General Model Makers, 625 W. Jackson, Chicago, Ill. Specializing in high-grade model work on inventions of merit. Complete Equipment, Experienced Workmen.

MODEL steam engines and boilers. Boat and boiler fittings. Send 10c stamp for catalog. Refunded with first order. Model Machine Shop, P. O. Box 5, Station Y, New York City.

MODEL-MAKING. Inventions developed. Write for estimate. Stearns, Paxton, Ill.

QUALITY Models. Reasonable Prices. Bennie Nortwed, Ethan, S. Dak.

WE make working models for inventors and do experimental work and carry a complete stock of brass gears and model supplies. Send for catalogue. The Pierce Model Works, Tinley Park, Ill.

MODEL Steam Engines, Boilers and Model Pipe line fittings. Model Making Supplies. Send 20c for this year's illustrated catalogue and hand book. Bathe Mfg. Co., Dept. D., 5214 Woodland Ave., Philadelphia.

QUALITY models made of inventions. Estimate free. Nortwed's Model Machine Shop, Ethan, S. Dak.

EXPERT Model Work. General Manufacturing in Metal, Fibre, Hard Rubber, Casein, Pyralin, etc. Satisfaction guaranteed. Swanberg, 5124 N. Kildare Ave., Chicago.

LET our experience be your guide. Models that are models; Tools and equipment for economic manufg. Patterns of all types; manufacturing in all branches. Satisfaction guaranteed. United Machinery Company, Cincinnati, U. S. A.

FOR MEN

WEALTH and success are not accidents. Definite, inexorable psychological laws govern them absolutely. To succeed, one must follow them. There is no other way. Get our free booklet—"Why Most Men Fail." Mack Institute, Wabash Sta., PM-2, Pittsburgh, Pa.

CARPENTERS. Ideas for those who like to tinker with tools, and for professional carpenters. 40 articles on saws and sawing, 17 on benches and bench equipment, 22 on doors and door hanging, 18 on lumber, 13 on mitering, 74 on tools, 22 on shop equipment, and many others—366 in all, and 229 illustrations. Send No Money. Just write a postal. Pay postman postage and \$1.50. Popular Mechanics Press, Room 810, 200 East Ontario St., Chicago, Ill.

FOR MECHANICS

WORLD'S greatest screwdriver \$1.50. Has power of 20" straight handle screwdriver. Works in close quarters. Two bits furnished. Satisfaction or your money back. Representatives, Lane Uniqare Tool Co., Dept. P.M. 11, 423 So. Dearborn St., Chicago.

DIESEL Engines—Marine, Locomotive, Stationary. Growing importance of the Diesel Engine cannot be overestimated. This new book should be in the hands of every student of mechanical engineering. 500 pages, 280 illus. Pay postman \$5 and postage when he delivers book. Popular Mechanics Press, Room 810, 200 E. Ontario St., Chicago.

MANUFACTURING

METAL-CRAFT—Eventually—Metal-Craft. Competent Engineers, Designers and Producing Organization await your commands on dies, stampings, die-casting, deep pressing, screw-machine and wire products. Plating, Enameling, Burnishing, Assembling, Wrapping and Packing to your specifications. Large completely equipped plant which guarantees prompt, efficient service. It is not the quality of raw materials alone, nor the precision in manufacture, and not just the service rendered that has given Metal-Craft the good reputation they bear—but all of these, as a constant certainty. In Combination. Estimates promptly furnished. Metal-Craft Manufacturing Company, Chicago, Box 259-W.

OUR factory will make your models, manufacture your articles as well as build your tools, dies and fixtures. Standard Die & Specialty Co., 1932 Austin Ave., Chicago, Ill.

PATTERNS, wood and metal. Models, tools and dies. Brass, bronze, aluminum and iron castings. Screw machine work, production work of all kinds. Write Modern Machine & Pattern Co., Terre Haute, Ind.

SPECIALISTS in general manufacturing, metal specialties, stampings, etc. Expert experimental, model, tool and die work. Engineers and Designers. Advisory and sales service for inventors. National Advisory & Service Corporation, 1903 West 9th Street, Los Angeles, Calif.

MACHINE work of any kind wanted by well equipped shop. The Greaves-Klusman Tool Co., Cincinnati, Ohio.

WOOD articles manufacture. Model supplies; patterns, lumber, mouldings, tools. The Woodcraft, 105 West, 100 Street, New York.

A CAPABLE American Inventor—Improving, Designing, Inventing of Ideas, Inventions and Patents. Address H I P, 722 Mace St., Greensburg, Pa.

WIRE goods made to order. Cooley Mfg. Co., 530 N. Western Ave., Chicago.

WE design and build special machinery, tools, dies, jigs and fixtures. Experimental work. Light stamping, quantity production. Reliable Machine Co., 400 West 23rd St., New York City.

MINIATURE Die - Casting Machines \$50.00. 318 Reed St., Erie, Pa.

FOR MANUFACTURERS

WOULD like to hear from manufacturers who are looking for good inventions. Hartley, 38 Court St., Bangor, Me.

MACHINERY, TOOLS AND SUPPLIES

SURPLUS Machinery from our plant at extremely low prices. Lathes, Drill presses, Shapers, Milling machines, Hack saws and small tools. Ask for list. Electro Platers Supply Co., 547 Considine Ave., Cincinnati, Ohio.

FOR Sale by The Patterson Tool & Supply Co., Dayton, Ohio. One Seybold "Hal-yoke" 38" Belt Driven Paper Cutter with two knives, in operative condition, \$600. One used Curtis & Curtis No. 5, 3 3/4" Cutting Off Machine, \$100. One Lansing New Reversible Hoist, Single Drum with Snubber, 6 H.P. Novo Gas Engine, \$350. One 42" Gas heated, Motor driven Mangle, new, \$75. One new 14" American (Chicago) Lathe, 6' Bed, Oil Pan, Double Back Gear, 3 Step Cone, Compound Rest, Power Cross Feed, \$350.

16" SMITH and Mills Crank shaper, \$300.00; 20"x10" Bradford engine lathe, \$275.00; 10" Drill press with chuck, new, \$19.25; No. 60 Hand auto cylinder grinder, \$750.00; Geared chain hoists, one ton, \$27.50; 1/4 H.P. New motors \$15. Write for complete machinery and supply catalog. Cincinnati Machinery Supply Co., 218 E. Pearl St., Cincinnati, Ohio.

CONCRETE Building Block Machines and Molds. Catalogue free. Concrete Machine Co., 5 N. Main St., St. Louis, Mo.

OTHERS have successfully sold their machinery through our columns—so can you. Ask me for proof. M. L. Rund, Manager, Classified Advertising, Popular Mechanics Magazine, Chicago.

ELECTRICAL

MOTORS—1/4 and 1/2 hp., split phase and repulsion induction. Toy Motors. Electrical, Industrial books, Catalogue 10c. Manhattan Co., 333b W. Manhattan Blvd., Toledo, Ohio.

ENGINES, MOTORS AND DYNAMOS

HERE is your opportunity to obtain grinders and buffers, brand new; they are full 1/4 H.P., 110 volt, AC, 60 cycle, with cord and plug, with 6" emery wheel on one side and 6" buffer on the other, enclosed dust proof motor. We only have a limited number left at \$15.75 each. Cash with order. Brand new 1/4 H.P., 110 volt, AC, 60 cycle, motors with pulley at \$10.00 each. Immediate shipment. General Distributing Co., Security Storage & Van Co., Duluth, Minn.

ALTERNATING current motor bargains, single and three phase. All sizes, all kinds, both new and rebuilt. Send for new price list. Guaranteed makes only. General Electric, Wagner, Westinghouse, Century. Motors bought, repaired exchanged. Hyre Electric Co., 615 MT So. Dearborn St., Chicago.

STEAM engines One H.P., \$18; 1/2, \$12. Boy's wonderful Christmas presents. James Chambliss, Bessemer, Ala.

MOTORS—\$2.98—Good, practical, twentieth horsepower, 115 volt alternating-direct current. Order now. Pay postman, Perry Trading Co., Dept. M11, 815 Lake Ave., Racine, Wis.

MOTORS—New GE 110 or 220 volt 60 cycle Single Phase 1/4 HP, \$11.90; 1/2 HP, \$28.50; 1 HP, \$38.50. Mail \$3 check or money order. We will ship COD anywhere. Motor Specialties Co., Crafton, Penna.

GOVERNORS for Auto Engines. Let us show you how to make a power plant for the shop or farm. A. C-S Governor Co., 215 W. Manchester, Los Angeles, or Springville, N. Y.

DYKE'S Automobile Encyclopedia. Latest 14th edition. Information on repairing and adjusting every part of all motor cars. How to find trouble, and fix it. Send No Money. Pay postman the postage and \$6. Popular Mechanics Press, Room 810, 200 E. Ontario St., Chicago, Ill.

DO you want an electric lighting plant on your farm, with your gasoline engine and one of our 1,000 Watt, 32 volt, Westinghouse generators? You can have electric lights in your house, barns, etc., at a very low cost. Run your washing machine, cream separators, etc. The cost of the above generators are \$48.00 each. Write for bargain catalog on engine driven lighting plants. General Distributing Co., Security Storage Bldg., Duluth, Minn.

MOTORS: Alternating Current 1/4 Horse, 110 V., 1,750, \$6.50. New Direct Current 1/4 Horse, 110 V., 3,300 speed, \$7.75. Special lot 32 V., 25 Amp., new farm lighting plants with engine, \$55.00. Also other bargains. Queen City Electric Co., 1736 Grand Ave., Chicago, Ill.

BENDING MACHINES

THE famous Hossfeld Wrenchless Universal Bender is the last word in bending machines; bends metal, cold or hot, into most any conceivable shape, including Eye-bolts and Automobile Spring Eyes. Bends up to 1" bars or 1 1/4" Pipe cold. Used by the largest corporations, yet so inexpensive that even a farm shop need not be without one. Send for Circular. Hossfeld Mfg. Co., Box 344, Winona, Minn.

BLACKSMITHS

BLACKSMITHS. Make More Money in Job Shop or Factory Doing Hard Jobs Easy. Be a Master Machine and Plow Blacksmith and Expert Tool Dresser and Tempering to a Standard with Collard Tempering Charts. All for One Dollar. Samples Free. W. M. Toy, Sidney, Ohio.

FOR SALE—MISCELLANEOUS

ADDRESSOGRAPHS. Letter Folders, Multigraphs, Envelope Sealers, Duplicators, less than half price. Guaranteed. Pruitt Co., 117 No. Market, Chicago.

\$5-\$6 FOUNTAIN pens. Gold points, Iridium tips, \$2.50. Guaranteed. Paris Company, 227 Smith, Rockford, Ill.

BUY—Exchange—Sell! Many of our readers have for sale or exchange the article you are looking for—and lots of them are looking for the very items you want to turn into cash. Get together! Let our two million five hundred thousand readers know your wishes—they'll help you! Send your ad today to M. L. Rund, Manager Classified Advertising, Popular Mechanics Magazine, Chicago.

MAKE a Telescope: Join ranks of enthusiastic group of amateur astronomers. Fascinating subject treated in new book, only one published in America. "Amateur Telescope Making." Pay postman \$2 and few cents postage on delivery. Popular Mechanics Press, Room 810, 200 E. Ontario St., Chicago, Ill.

WANTED—MISCELLANEOUS

MAIL us your discarded Jewelry. Gold, Crowns and Bridges, Watches, Diamonds, Silver, Platinum, and old False Teeth. Money promptly mailed. Goods returned if offer refused. United States Smelting Works, (The Old Reliable), Dept. 71, Chicago.

REAL ESTATE, FARM AND ORCHARD LANDS

POULTRY Bargain. \$800 Needed, 50 Acres, Furnished and Equipped. Splendid 6-room house, good-sized barn, poultry house; 50 fruit trees. For quick settlement, cow, pigs, furniture, incubator, machinery, crops included, low price \$2,000, only \$800 needed. Details in Illus. Catalog Supplement. Free. Strout Agency, 255-P, 4th Ave., New York City.

HERE'S your land. \$10 down and \$10 a month buys twenty acres of my best land near lakes and towns in central Michigan for \$400, or ten acres for \$250. Write at once for free picture book. G. W. Swigart, P-1276 First Natl. Bank Bldg., Chicago.

10 ACRES orange belt; trucking, citrus, \$1,500. Developments. Terms. Exponent, Orlando, Fla.

ATTENTION—"Get acquainted." Cash for your property. Farm, Hotel or Retail Store, no matter where located; confidential service. Hayes' Business Agency, Cincinnati, Ohio.

OREGON Homesteads (late opening) and lands offer exceptional opportunities. Map and details \$1.00. Frank Thompson, Sheridan, Oreg.

SELL your property quickly for cash, no matter where located. Don't pay big commission. Particulars free. Real Estate Salesmen Co., Desk B, Lincoln, Nebr.

PECAN-Orange-Fig Groves "On the Gulf" Monthly payments. Guaranteed care. Big, quick returns. Suburban Orchards, Dept. M, Biloxi, Miss.

OZARK land; ten acres near White River and proposed Dixie Dam, \$100; \$5 monthly. Alvin Zimmerman, 1800 N. Fifth, Kansas City, Kan.

FORTY Acres Ogenaw County, Michigan, \$200; terms. Brack, 4672 Allendale, Detroit, Mich.

DOGS AND PETS

RAISE guinea pigs. Pay better than poultry or rabbits; easy to raise; little space required. We guarantee market. Particulars and booklet how to raise free. Cavies Distributing Co., 3102 Grand Ave., Kansas City, Mo.

PEDIGREED Pups High Class, Police, Airedales, Collies, Chows, Danes, Wire Hair, Maplewood Kennels, Medway, 3, Mass.

BEAUTIFUL registered Bull Pups, \$15. Bulldogs, 501 Rockwood, Dallas, Texas.

FOR Sale. Varmet dogs, Fox hounds, Rabbit hounds, trained or untrained. J. Thomas, Booneville, Miss.

HUNDRED Hunting Hounds Cheap. Supplies. Catalogue. Kaskakennels, P.M.M.C.L. Herick, Ill.

FERRETS For Sale. Walter Soldan, 46 17th Street, Wheeling, W. Va.

FOXES, raccoons, muskrats, skunk, ferrets, rabbits, squirrels, mink, opossums. B. Tippman, Caledonia, Minn.

PEDIGREED Racing Homers to breed from \$10 per pair. R. L. Zimmerman, Lexington, Ky.

RAT and Fox Terrier pups, purebred, small sized, males \$7.50, females \$5.00. Joseph Berg, Hendrum, Minn.

FOR Sale—Highly pedigreed, eligible registration, English bull and police pups, fine specimens. Heighway, Bluffton, Ohio.

FOXES, raccoons, muskrats, skunk, ferrets, rabbits, squirrels, mink, opossums. B. Tippman, Caledonia, Minn.

RABBIT Sale—Pedigreed. \$2.00 up. Illustrated book, 10c. Maikranz Rabbitry, New Bethlehem, Pa.

PERSONAL

WEALTH and success come only to them who follow the psychological laws of success. You can't succeed if you don't know how. Get our free book "Why Most Men Fail." Mack Institute, Wabash Sta., P.M., Pittsburgh, Pa.

HOW to make herb medicines from roots, barks, flowers, revealed in our Herb Doctor Book, 19c. Shawnee, 145 West 112th Street, Chicago.

ASTROLOGY—Stars tell life's story! Send birthdate and dime for character reading. M. Kiegan, 90 Adelaide St., Winnipeg, Man.

ETIQUETTE. 378 pages of clear type covers all subjects. Send No Money. Just write a postal asking for "Etiquette, An Encyclopedia of Good Manners and Social Usage." Pay the postman \$1.25 and postal charges. Popular Mechanics Press, Room 810, 200 East Ontario St., Chicago, Ill.

POSITIVE evidence of Spirit life and power. A new study. Descriptive literature free. R. C. Hill, 602 W. Jefferson, Detroit, Mich.

SEND 25c coin and your date of birth for forecast of your vibrations for 1927. Arzel Snyclare, Numerologist, Box 25, Patton, Calif.

ASTROLOGER will read your life. Test prediction for one year, 20c, dimes or stamps. Send year and birthdate. Money back, if dissatisfied. G. Niemeier, 621 McConnell Terrace, Atlantic City, N. J.

TOBACCO or Snuff Habit Cured or no pay. \$1.50 if cured. Remedy sent on trial. Superba Co., N3, Baltimore, Md.

HYPNOTISM and Auto Suggestion. Learn how to hypnotize other people, yourself and animals. Learn clairvoyance, mind reading and telepathy. Clearly explained in "Practical Lessons in Hypnotism and Auto Suggestion." Send no money. Pay postman postal charges and \$1.25. Popular Mechanics Press, Room 810, 200 East Ontario St., Chicago, Ill.

WONDERFUL health book for only 10c (publisher's price \$1.00). Appreciated by every reader, sick or well. Teaches health the natural way, also suggest reliable self treatment of disease. Address, Author, Box 437, Seattle, Wash.

UNUSUAL Horoscope Consisting of Extensive four page Special Horoscope, and Astro Analysis. Send 50c and birthdate. Money returned if dissatisfied. Prof. Bolles, Box 125, Cranford, N. J.

FORTUNE telling and character reading, by numbers, palmistry, chiromancy, oraculum, astrology, horoscope, kabala, tea leaves, and cards. All in one 250-page book, illustrated. Easy to learn. Send no money. Write a postal for "Fortune Telling and Character Reading." Pay postman postage and \$1.25. Popular Mechanics Press, Room 810, 200 East Ontario St., Chicago, Ill.

MISCELLANEOUS

WEEDS—Cut them with cutter bar on Shaw Garden Tractor. Also plows, cultivates and runs belt machinery. Low prices. Immediate delivery. Shaw Manufacturing Company, Department C, Galesburg, Kans.

TATTOOING—learn tattooing with my outfits. Send for circulars; they explain everything. Sergt. Bonzey, 367 South Main, Providence, R. I.

I CATCH from 45 to 50 foxes in from 4 to 5 weeks' time. Can teach any reader of this magazine how to get them. Write for particulars. W. A. Hadley, Stanstead, Quebec.

ARTIFICIAL Eyes. Booklet free. Denver Optic, 579 Barclay, Denver, Colo.

CUTS anybody can make. Simple, cheap process. \$1. Specimens, particulars, 2c stamp. M. Day, Windfall, Ind.

MIRRORS Resilvered at Home. Costs Less 5 cents per square foot! you charge 75 cents. Immense profits plating auto parts, reflectors, tableware, stoves. Refinishing metalware, etc. Outfits furnished. Write for information. Sprinkle, Plater, 288, Marion, Ind.

BE a Trick Cartoonist or Chalk Talker. Send One Dollar for Clever New Program. Easily Mastered. Leon Horn, 205 Thirteenth S.W., Washington, D. C.

HOMEOPATHIC and Biochemic preparations sent postpaid to all parts of the world. Manual and booklets free. Halsey Bros. Co., 645 St. Clair St., Chicago, Ill. Established 1855.

"**AUTOMOTIVE Trade Training**" is a book containing complete course for auto mechanics. Used in dozens of schools. Have your own school at home. Send No Money. Just pay postman postal charges and \$4. Popular Mechanics Press, Room 810, 200 East Ontario St., Chicago, Ill.

MEXICAN made pistol holders, cartridge belts; horse hair goods, lariats, sombreros. List free. Ingersoll Leather Co., 307 Fannin, Houston, Texas.

AMATEUR Cartoonists: Make money in spare time with new cartoon selling plan. Write Smith's Service, PM1194, Wenatchee, Wash.

MINES and Minerals. Fortunes in Minerals and Ores. Information and ore specimens 25c. Minerals identified \$1.00. Specimens for sale. Buskett, Joplin, Mo.

50 cents, silver, for patent door support, doors always swing free, no binding on threshold, address L. G. Lehman, Elgin, Iowa.

NEW salesboards, bargains, write Interstate Company, Box 700, Minneapolis, Minn.

BUILD yourself an electric clock! Instructions and blueprints of a novel model everyone can make, \$1. Particulars free. Albert Delbig, Electrical Engineer, 1690 Park Ave., New York.

OVERCOATS \$8.00. Men's, slightly used street suits \$8. All sizes. Beautiful Fur Coat, Ladies \$45. Fur Jackets \$25. Resale Shop, 1834 North Halsted, Chicago.

LOCKSMITHING. 500 tricks of the trade; how to make keys; how to open locks and safes; safe drilling; how to set combinations; key-cutting tables; umbrella work; everything you should know to become a lock expert. Copiously illustrated. Only complete book on subject sold at reasonable price. Send No Money. Just write a postal for "Locksmithing." When postman hands you book, pay \$1.50 and postal charges. Popular Mechanics Press, 200 East Ontario St., Room 810, Chicago, Ill.

PLAY A SAW!

I'll Teach You in 24 Hours

C. J. MUSSEHL
Pioneer Artist on the Musical Saw, has taught thousands to become Experts, Vaudeville Stars and High-Priced Entertainers.



Be Popular! Amaze Everybody— Play for Fun or Money

Wonderful music from a saw—sweet and mellow like a rare old violin. Tone effects that are positively startling—all so unexpected that nothing compares with it in winning instant popularity in your social group or as a salaried entertainer. *And it's so easy!*

Just to prove how quickly you can learn, I'll send you a genuine "Musical Saw" (special temper, process patented) for **FIVE DAYS' TRIAL**. I guarantee that in 24 hours you can play tunes like "Old Black Joe" and "Home, Sweet Home." Then the latest jazz and song hits, operatic and classical music. Amazingly simple—no notes to read, no dreary practice.

Thousands Successful by My Method

Just three short, simple lessons reveal every secret of my 12 years' success as a professional saw musician—secrets with which I have taught thousands. Many of my pupils are on the vaudeville stage, playing in dance orchestras, making big money as entertainers. Let me prove that you, too, can quickly play like a professional—amaze your friends and always be in demand at parties and entertainments.

PHONOGRAPH RECORD of Saw Solo and Duet FREE!

Two beautiful selections, amazing to anyone who has never heard the Musical Saw's sweet tone. Send 10c to cover handling and postage. Or if you do not want the record, ask only for my big **FREE Trial Offer** with which all my pupils have made their start to fame and money.

I'll Loan You The Saw 5 Days Free!



Robert S. Alter, broadcasting celebrity, has delighted audiences of six leading stations, including an appearance from WSN "Steamship LEVIATHAN."



"Bud" Gamble is paying his way around the world with the Musical Saw. Is now in Europe.



Charles Guglielmi booked to play saw solos in Broadway (New York) motion picture theatre.

Mail Coupon



C. J. Mussehl, Pres.
Mussehl & Westphal
258 W. Water St.
FORT ATKINSON, WIS.

- Without obligation to me, send me, postpaid:
- Full particulars about **FREE Trial Offer**.
 - Phonograph Record. (Send 10c, stamps or coin, to cover handling and postage if you want record.)

Name.....
Address.....
Town and State.....

Mussehl & Westphal Fort Atkinson, Wis.

LEARN CARTOONING



The Landon PICTURE CHART method of teaching makes ORIGINAL drawing easy to learn. Hundreds of sketches like the above explain every step in creating ORIGINAL heads, figures, animals, etc.

Successful Cartoonists Earn Big Salaries

The cartoonists who draw "Freckles and His Friends," "Winnie Winkle," "Regular Fellers," "Cicero Sapp," "Guss and Gussie," "Mom 'n Pop" and hundreds of other artists, including Dorman Smith, Ethel Hays and Edwina, credit their start to the Landon Course of Cartooning. They learned to draw through the Picture Chart Method in their spare time, at home, and are now earning from \$75.00 to \$300.00 and more per week. Send 6c in stamps today for sample Picture Chart and full explanation of this wonderful course and information showing possibilities for you. *Please state your age.*

The Landon School
138 National Bldg., CLEVELAND, OHIO

"THERE'S MONEY IN IT"

AT HOME LEARN TELEGRAPHY AT HOME

MORSE AND WIRELESS

TEACH YOURSELF in half usual time, at trifling cost, with the wonderful Automatic Transmitter, **THE OMNIGRAPH**. Sends unlimited Morse or Continental messages, at any speed, just as an expert operator would. Adopted by U. S. Government, and leading Universities, Colleges and Telegraph Schools. 3 Styles. Catalog free. **OMNIGRAPH MFG. CO., 13-19 Hudson St., NEW YORK**
If you own a Radio Phone Set—and don't know the code—you are missing most of the fun.

MEN WANTED
TO LEARN
Motion Picture Projection
\$2,000 to \$4,000 a Year

Quickly learned. Short hours, big pay. Best equipped school in Michigan. Projectionists for Movie Houses and Road Shows.

MOVIE OPERATORS SCHOOL
61 Sproat Street, DETROIT, MICHIGAN

WANT WORK AT HOME?

Earn \$18 to \$60 a week **RETOUCHING** photos. Men or women. No selling or canvassing. We teach you and furnish **WORKING OUTFIT** given with each enrollment. Limited offer. Write today. **Artcraft Studios, Dept. 50, 3900 Sheridan Rd., Chicago**

See Free Offer on page 8

PATENTS

Booklet Free Highest References
Promptness Assured Best Results

Send drawing or model for preliminary examination of Patent Office records.

ALL BUSINESS GIVEN PROMPT AND PROPER ATTENTION

Listed Patent Lawyer in the latest editions of the Rand-McNally Directory of Bankers and Attorneys, of Chicago, Ill.; The Baggott & Ryall Directory of Attorneys, New York City; The Lawyers Guaranteed Directory, Detroit, Michigan; The Lawyers and Bankers Quarterly, published by the legal Directory Publishing Company of St. Louis, Mo.; the American Lawyers Annual, Cleveland, Ohio.

WATSON E. COLEMAN, 644 G Street, N. W., Opp. U. S. Pat. Office
REGISTERED PATENT LAWYER WASHINGTON, D. C.

TRAVEL - for 'UNCLE SAM'

RAILWAY MAIL CLERKS
MAIL CARRIERS—POSTOFFICE CLERKS
\$1700 to \$2700 a Year for Life

No "lay-offs" because of strikes, poor business, etc.—sure pay—rapid advancement. City and country residents stand same chance. Common sense education sufficient—no political influence.

STEADY WORK

Cut coupon and mail it before turning the page.

MEN — BOYS
18 to 45

Use Coupon Before You Lose It

COUPON

FRANKLIN INSTITUTE, Dept. C-174, Rochester, N. Y.
Rush to me, entirely free of charge, (1) A full description of the position checked below; (2) 32-page book, "How to Get a Government Job"; (3) Free Sample coaching lessons.

Railway Mail Clerk (\$1900 to \$2700) Customs Positions (\$1140 to \$1860)
 Postoffice Clerk (\$1700 to \$2300) Internal Revenue (\$1140 to \$1860)
 City Mail Carrier (\$1700 to \$2100) Rural Mail Carrier (\$2100 to \$3300)

Name

Address

You, Too, Can Realize Your Dreams

By Developing a Strong Rich Voice

More than 20,000 men and women all over the country have developed powerful, beautiful voices by Physical Voice Culture. You, too, can build up a voice that will be the marvel of your friends, and your key to success and fame.

Read the letters on this page from men and women who have realized their dreams by this wonderful, scientific method. You can study right in your own home—and the cost is nominal—only a very small amount each month as you study.

100% Improvement Guaranteed

Men or women singing in the home—the opera or concert singers—choir singers—all can improve their voices 100%, at the very least, by Physical Voice Culture.

We absolutely guarantee 100% improvement or your tuition will be gladly refunded. You alone are to be the judge.



Gives Physical Voice Culture Credit for Grand Opera Voice

Each 24 hours brings me a stronger and better hold on my voice. I feel like telling you of it each day when I think back to six years ago when catarrh had just about finished my hearing and voice. * * *

I joined the Los Angeles Opera Company this Spring and we will have five Operas ready in September. * * *—Bert Longtre.



Harry Lompierre Finds the "Right Way"

* * * Last year, I cancelled an entire season's bookings to apply myself diligently to your idea.

Today my voice is completely new. Formerly, I could sing only a fair "F" (fifth line). Now I can sing high "B" flat, with a rich, resonant, manly tone.—Harry Lompierre.

For obvious reasons the names signed to these letters have been changed. But the letters are all true and the real names of writers will be sent on request.



Church Singer Delights Congregation

I cannot help but say "Thank God" for everything you have done for me. As I sang in church yesterday people turned to see who was singing.—Carolyn Baker



Singer Triumphs Over Discouragement

Did you think one year ago that I would now be singing as high as high "C"? I am very sure that I didn't.

I often think of that hopeless first letter I wrote to you and I want to thank you for the help you have given me. * * *

—Mrs. Mary Brown.

Inspiring Book Now FREE

Send Coupon

The coupon will bring you a Free copy of "Physical Voice Culture"—a valuable new book on voice building. This may be the first step in a great career for you. Send the coupon TODAY!

Perfect Voice Institute, Studio 13-58
1920 Sunnyside Ave., Chicago, Ill.

Please send me, FREE and without any obligation, Prof. Feuchtinger's new book, "Physical Voice Culture." I have checked the subject in which I am most interested.

- Weak Voice
- Singing
- Stammering
- Speaking

Name _____

Address _____

City _____ State _____

Perfect Voice Institute, 1920 Sunnyside Ave., Studio 13-58 Chicago

RUSSELL PATTERSON



Makes a
\$150
Drawing
in a
Few Hours!

—and now teaches you his original methods in a series of 20 snappy lessons—brimful with sparkling interest from the very start—a departure from the purely conventional. This training constitutes the last word in Humorous Illustration, teaching a New Art for a New Age—a pleasant relief from the old style, standardized instruction. Learn to draw the dashing, peppy types that are all the rage as exemplified by Mr. Patterson's numerous contributions to magazines. Let him teach you his clever technique. What profession could compare with this in its irresistible appeal or sheer earning power? Write now for full information.

Russell Patterson School of Humorous Illustration
Michigan Ave. at 20th St., Dept. 12
CHICAGO - - - ILLINOIS

How Do You Cross Your T's?

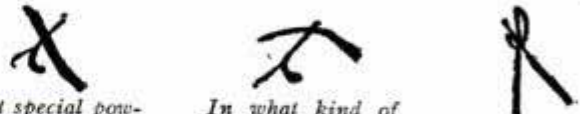

What special power of personal magnetism does this downward T-stroke reveal?

In what kind of work will people who curve their T-bars achieve the greatest success?

What type of man — or woman — should this writer marry?

Hidden Secrets About Yourself Revealed by Your Handwriting

WOULDN'T you like to know what your handwriting tells about you? Wouldn't you like to find out what qualities it discloses, what characteristics, what hidden talents and abilities? Wouldn't you like to discover the secrets it holds regarding your love life and marriage?

What serious fault of character does this T disclose?



Does an uncrossed T like this reveal any latent talent that the writer doesn't suspect?

Private Reading By Louise Rice

Don't go through life blindly. Let Louise Rice, America's foremost graphologist, give you a complete personal and confidential reading of your handwriting. Let her show you the honest truth about yourself—as the infallible science of graphology reveals you. Banks constantly seek her advice. She has guided thousands to greater happiness and success. She surely can do the same for you.

FREE—Interesting illustrated booklet giving fascinating secrets of handwriting and full details of private reading offer. Send for it today.

Louise Rice, Dept. H-5211, 132 West 31st Street, New York City

Music Lessons UNDER MASTER TEACHERS At Home

A Complete Conservatory Course By Mail

Wonderful home study music lessons under great American and European teachers. Endorsed by Paderewski. Master teachers guide and coach you. Lessons a marvel of simplicity and completeness.

Any Instrument Write telling us course you are interested in—Piano, Harmony, Voice, Public School Music, Violin, Cornet, Mandolin, Guitar, Banjo or Reed Organ—and we will send our **FREE CATALOG** with details of course you want, under master teachers. Send NOW.

University Extension Conservatory, 331 Siegel-Myers Bldg., Chicago, Ill.



Wanta Play Banjo?

C. McNeil—Earn money thru famous McNeil Banjo Course. Easy as A B C with **CHORD-CHART SYSTEM** and phonograph record by Chas. McNeil, 5 years with Brunswick. Easy payments. Write for Free Book and Banjo offer!
CHICAGO TENOR BANJO INSTITUTE
Dept. 1358 1621 N. Lincoln St., Chicago

See Free Offer on page 8



TRAVEL—ON "UNCLE SAM'S" PAYROLL RAILWAY MAIL CLERKS \$1900 to \$2700 a Year Mail Coupon Before You Lose It

FRANKLIN INSTITUTE, Dept. C-176, Rochester, N. Y.

Sirs: Rush to me without charge: (1) Sample Railway Postal Clerk and Mail Carrier coaching lessons; (2) tell me how to get a U. S. Government job; (3) send 32 page book with full particulars.

Name _____
Address _____

Steady Work—No Layoffs—Paid Vacations—Common Education Sufficient
MEN—BOYS, 18 UP—RUSH COUPON

Foundry Man—then Office Man—at \$12 a Week His Salary in 1924—\$9,000!



COULSON B. HYDE
General Auditor
Eureka Vacuum Cleaner Co.
Detroit, Mich.



Plant of Eureka Vacuum Cleaner Co., Detroit, Mich.

And—as General Auditor of the Eureka Vacuum Cleaner Co.—he is still climbing!

COULSON B. HYDE, molder in a local foundry, was discontented. He checked the words "Higher Accountancy" on a LaSalle coupon, signed his name, and mailed it in.

It brought him a free book, but a book worth many times its weight in gold—for in it he found the opportunity that started him toward bigger things.

Today he is General Auditor of the Eureka Vacuum Cleaner Company; and in his letter of May 12, 1925, he writes: "My compensation for the past year was \$9,000, and I fully expect to double that the coming year."

Tremendously inspiring, Mr. Hyde's career! "I quit the job at the foundry," he writes, "for a position in the office of a local baking company—at \$12 a week—where I applied the principles of the accounting I was studying.

"Three years later I resigned the position as cashier to go into public accounting with a local accounting concern. This led to my connection with

the Eureka Vacuum Cleaner Company.

"Naturally I am a great booster for LaSalle and take pleasure in recommending it to anyone who is interested in doubling or trebling his salary. *It can be done.*"

Send for Free Copy, "Accountancy, the Profession that Pays"

The book that showed Coulson B. Hyde what he must do to go from \$12 a week to \$9,000 a year is yours for the asking. The title of that book is "Accountancy, the Profession that Pays."

If this 64-page book can place you on the direct path to greater earning power—as it has done for literally thousands of LaSalle-trained men—you'll agree that it would be cheap at \$100—even \$1,000 a copy. . . Yet LaSalle will send it to you free.

Balance the two minutes that it takes to fill out the coupon against the rewards of a successful career—then clip and mail the coupon NOW.



**Repeated Promotions—
Now General Auditor and
a Stockholder in Company**

"Since C. B. Hyde started with our company in 1919 as a bookkeeper, he has had several promotions, until today he holds the position of Manager of our Auditing Department.

"In reward for his faithful service we made him a stockholder in our company on January 1st of this year. His work is most satisfactory, and I only learned today that he acquired the basic principles of his auditorship thru the course he took with your University. If every student becomes as proficient as he in his work, then you are making it possible for many men to hold much better positions." (Signed)

FRED WARDELL,
President
Eureka Vacuum Cleaner Co.

LASALLE EXTENSION UNIVERSITY

THE WORLD'S LARGEST BUSINESS TRAINING INSTITUTION

FIND YOURSELF THRU LASALLE!

LA SALLE EXTENSION UNIVERSITY Dept. 1164-HR

CHICAGO

Other LaSalle Opportunities: LaSalle opens the way to success in every important field of business.

If more interested in one of the fields indicated below, check here:

- | | |
|--|--|
| <input type="checkbox"/> Business Management: Training for Official, Managerial, Sales and Departmental Executive positions. | <input type="checkbox"/> Modern Foremanship and Production Methods. |
| <input type="checkbox"/> Modern Salesmanship. | <input type="checkbox"/> Personnel and Employment Management. |
| <input type="checkbox"/> Traffic Management—Foreign and Domestic. | <input type="checkbox"/> Railway Station Management. |
| <input type="checkbox"/> Industrial Management. | <input type="checkbox"/> Commercial Law. |
| <input type="checkbox"/> Law: Training for Bar; —LL.B. degree. | <input type="checkbox"/> Expert Bookkeeping. |
| <input type="checkbox"/> Modern Business Correspondence and Practice. | <input type="checkbox"/> Business English. |
| <input type="checkbox"/> Banking and Finance. | <input type="checkbox"/> Commercial Spanish. |
| | <input type="checkbox"/> Effective Speaking. |
| | <input type="checkbox"/> C. P. A. Coaching for Advanced Accountants. |

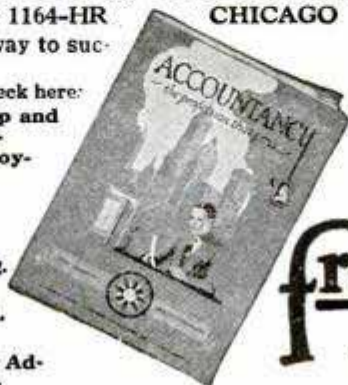

Opportunities in Accountancy—Check below and we will send you an outline of our salary-doubling plan, together with a copy of "Accountancy, the Profession that Pays," also copy of "Ten Years' Promotion in One," all without obligation.

Higher Accountancy:

Leading to position as Auditor, Comptroller, Certified Public Accountant, Cost Accountant, etc.

free!

Name

Address

mail Present Position.....

coupon NOW Age

HAJNOS—Navy Hercules

Performs Startling Feats of Strength

The United States Navy is proud of its strong man John J. Hajnos. It delights in having him demonstrate his extraordinary powers wherever he goes—wherever his ship takes him. His physique is held up as an example of what young men can become if they have the desire to be strong. His feats of strength are so unusual, so startling that, whenever he exhibits, he draws extraordinary crowds. The papers are full of Hajnos when he strikes a town. He is always sensational. One day he is bending great iron bars. Another day he is pulling automobiles through the streets with his teeth. In the picture shown here he is lifting a fellow "gob" in a chair, with his teeth. Always and everywhere he arouses enthusiasm for the U. S. Navy, and he is regarded as a real asset in encouraging young men to enlist.



Photo by International Newsreel Corporation.

Reprinted from the Chicago Herald Examiner.

The Navy Shows Its Strength

J. J. Hajnos, sailor, of the U. S. S. West Virginia, displays his strength for the benefit of recruiting officers. He is shown lifting J. F. Kaska, 175 pounds, with his teeth.



Hajnos declares that not only has Lionel Strongfort's Course piloted him to Herculean strength, but that he has brought out the best that was in him of mental and spiritual qualities. He is now a real 100 per cent man inside and out.

How Hajnos Became Strong

John J. Hajnos was not always a giant. He was like many another kid of ordinary strength. In fact he was something of a weakling—so much so that he realized that he had to do something to brace up his body and attain manly strength—and he did the thing that thousands of other young men have found so beneficial in building up health and developing their muscular system—he took up the modern science of health and strength development—

STRONGFORTISM

He learned about the marvelous physical development attained by the world's greatest strong man, Lionel Strongfort, director of the Strongfort Institute, Newark, New Jersey. On his advice he adopted his course in Strongfortism and followed Strongfort's advice faithfully and persistently. Wonderful results! From the start Hajnos experienced a feeling of new-born energy and vigorous health. Gradually his internal muscles were developed, and then his wonderful external muscular strength began to manifest itself, and day by day, week by week, month by month, Hajnos was transformed into a giant in physique and power and today he ranks with the strongest men in the world—perhaps the strongest man.

"MY ONLY TEACHER"

Hajnos repeatedly writes of his gratification and thankfulness that he took up STRONGFORTISM, and strongly advises others to take the course.

"You know," says Hajnos, in a letter from the U. S. Battleship West Virginia, June 6th, 1924, "that I am always in debt to you for what you have done for me, and I want you to know that I always look up to you as my only teacher and the man who has made me what I am, now nationally known as the 'Hercules of the U. S. Navy.'"

READ THIS

Hajnos Thankful for Strongfortism, Exhibits Before Big Audience

Dear Mr. Strongfort: San Pedro, Calif., February 7, 1925.
I take great pleasure in dropping you another line to tell you I am getting on all right, still gaining in strength and vitality. I am sending you a clipping of the Los Angeles Illustrated Daily News, illustrating my recent exhibition there.

I have also performed in San Francisco, in the Civic Auditorium, to an audience of 7000 people, and the performance was perfect and delighted everybody. I had personal congratulations from prominent people.

I am well satisfied with what I am so far, but I am still craving for more.

I am always glad to have you use any of my pictures or letters in behalf of Strongfortism, for I am always thankful to you for the great aid Strongfortism has been to me, and with your further aid and advice I will show the world what it has done for me and the good it will do. I remain,
Your pupil, JOHN J. HAJNOS.

See Additional Facts About STRONGFORTISM on Next Page

Listen to Me, Young Fellow!

You Can Get Rid of Your Weaknesses

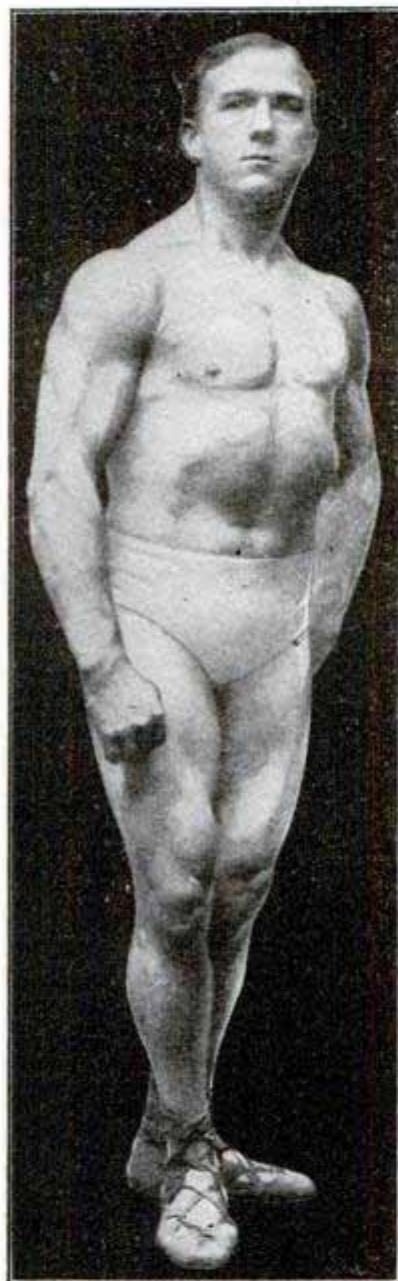

STRONGFORT
Builder of Men

You need not be discouraged and down with the blues because of your weakened physical condition, your ailments, your lack of manliness. I have put thousands on their feet after they had been dragged down so deep they thought they could never be real men again. I gave them stamina, pep, vigor, energy, ambition. I built them up inch by inch—internally and externally—by my original methods until they became outstanding men, full of snap and “go” and steam. And tens of thousands of letters in my office tell of their restoration to health, the rejuvenation of their whole muscular system, the awakening of their mentality and the joy and happiness that came through all these.

Don't Be Despised—Let Me Make a He-Man of You

Don't stand by and see your body tottering and growing weaker and flabbier day by day, unfitting you for every physical function, making a sorry spectacle of you in everything you undertake. Don't do it—if you want to be a man—a real he-man—a man who will be noticed in a crowd by both men and women. Don't be a weakling when you can be a healthy, powerful, muscular fellow with a grip like iron, a knockout punch, a chest that denotes strength, and a face that pictures buoyant health and happiness. Battle against weakness and disease and annoying ailments. It's your fight—and you can win it! I can help you! I will help you! I have performed wonders in restoring weak men to health and strength. Thousands will testify to this fact. Read the opposite page. See what one of my pupils has become—the Navy's outstanding strong man. John J. Hajnos first enrolled as a pupil under me February 2, 1922. From a youth of ordinary strength—I might say weakness—he was so developed that he now performs almost incredible feats of strength. Hajnos writes: “I hope I may be the means of inducing other young men to avail themselves of your wonderful Course and your ability to develop the human physique.”

STRONGFORTISM

Science of Health and Strength

It was through the methods I used in developing my own body until I won the world's record as the finest specimen of muscular development and championships in feats of great strength, in Europe and in the United States, that I constructed the science of STRONGFORTISM. It is through it that I reclaim wrecked and weak men, make them into new beings and give them a body and arms of which they can boast. I require you to use no apparatus. No drugs or medicines are prescribed. No inconvenient hours are required. Only a little of your time in the privacy of your own home is necessary to follow my easily understood instructions—and, oh man, how glad you'll be that you listened to me, once you've started on my course. It means a new day for you, that's sure as you're alive.

You can banish your weakness. You can be a man to be feared in physical combat. There is no doubt about it. I can prove it if you'll just sit down and tell me frankly that you are willing to guide by what I tell you.

SEND FOR MY FREE BOOK

Send for your copy of my extraordinary book and you will learn facts that will astonish you and help you out of your sorry plight.

The experience and research of a lifetime are contained in my wonderfully instructive book, “Promotion and Conservation of Health, Strength and Mental Energy.” It will tell you frankly how you can make yourself over into a vigorous specimen of vital manhood with 100% pep, power and personality. It will show you how to be true to the best that is within you. Just check the subjects on the consultation coupon on which you want special confidential information and send to me. Send for my FREE book right now—TODAY.

— Clip and Send this Coupon —

FREE CONSULTATION

ABSOLUTELY CONFIDENTIAL

Mr. Lionel Strongfort, Strongfort Institute, Dept. 253, Newark, N.J.—Please send me absolutely free my copy of your book, “PROMOTION AND CONSERVATION OF HEALTH, STRENGTH AND MENTAL ENERGY.” I have marked (x) before the subjects in which I am most interested.

- | | | |
|---------------|-----------------|-------------------------|
| .. Colds | .. Weak Back | .. Weak Heart |
| .. Catarrh | .. Weak Eyes | .. Great Strength |
| .. Asthma | .. Flat Chest | .. Lung Troubles |
| .. Headache | .. Despondency | .. Poor Circulation |
| .. Rupture | .. Emaciation | .. Round Shoulders |
| .. Thinness | .. Rheumatism | .. Skin Troubles |
| .. Pimples | .. Nervousness | .. Stomach Disorders |
| .. Insomnia | .. Constipation | .. Increased Height |
| .. Overweight | .. Short Breath | .. Muscular Development |

Name.....

Age..... Occupation.....

Street.....

City..... State.....

LIONEL STRONGFORT

Physical and Health Specialist for over 25 Years

STRONGFORT INSTITUTE

Dept. 253, NEWARK, NEW JERSEY, U. S. A.

Money-Making Tools

To those who enroll in near future—tools **FREE** of any extra cost whatever. Also, a drafting table! Act now!



I need YOU with 100 firms BEGGING ME to send them more DRAFTSMEN. Many offer to take BEGINNERS, at \$50 a WEEK. Graduates can start at \$90 and \$100! GET BUSY!



Drafting is the BIG field, men. Every industry you can name BEGINS with the draftsman. Without mechanical drawings—by the thousands—every shop in the land would be STOPPED.

In fact, it is the SERIOUS SHORTAGE of draftsmen that brings this offer: *I will furnish all instruments, supplies, even to the table, to those who start now!*

PAY AS YOU GO Don't give me the excuse that you have no ready money for this golden opportunity. I am not so interested in cash; I want your application. I want at least 200 men to start *right now*. I want them ready to recommend by Spring! We will get a flood of letters saying "send us draftsmen," from every sort of industrial and engineering concern, and we *must* make good.

The first week's pay envelope of many a Dobe-trained draftsman has held enough to cover the entire cost of the course! Most students learn evenings, keeping on with their old work until ready to step into somebody's drafting room. The first month equips you to take on simple drafting jobs on the side. It helps you learn; I gladly permit this.

Well-Paid Positions Every Way You Turn

A draftsman soon forgets the days when he used to wonder where to get a job. Instead, he asks "What line of work interests me most?" And "What part of the country suits me best?" Twenty of my graduates went to Florida this year; three are in Japan; last month one wrote me from Ceylon. And I wish we had the count of how many Dobe draftsmen have become chiefs!

Positions loom up almost as soon as you are enrolled in a Dobe class! We receive requests *daily* for junior men—for men only partly through our course. "We'll take a *beginner*," some concerns write us, "so long as he is a Dobe-trained man and has begun *right!*"

IT'S EASY and interesting to learn drafting.

For drafting isn't "drawing"! You don't need any "talent." A draftsman uses *tools* for every line and every curve. You couldn't make them crooked if you tried! That's why drafting is so easily learned—and so interesting. *For you do everything by rule.* So, I guarantee to make *anyone* a finished draftsman; if you can read and write, you can learn this line. One of my students is 51 years old; another is just seventeen. *But they'll all be making a grown-up salary by Spring!*

WARNING! The special offer of tools is for immediate action. Don't expect me to hold it open indefinitely. Clip the coupon *now* for free book:

CHIEF DRAFTSMAN DOBE, Div. 83-58
1951 Lawrence Avenue
Chicago

Special Tool Offer

Send me FREE and POSTPAID Successful Draftsmanship Book and material telling all about your home course, terms, etc.



Name.....Age.....
Address.....
P. O..... State.....



Play Piano BY EAR

-in 90 days!

YOU can play real tunes from the start. No notes to puzzle you—no tiresome scales to practice. You need not know a thing about music. Even if you have never touched a piano, if you can hum or whistle a tune, we can teach you to play all popular song hits *by ear* at a very small cost. No need now to spend years practising under old time method. My new and original system teaches you easily and quickly. Write at once for

Free Booklet

to show you how easily it can be done. This wonderful home course is offered at a ridiculously low cost. A little practice gives amazing results. You can sit down and play any Popular Jazz piece that you hum. Write us today.

ILLINOIS SCHOOL OF MUSIC OF CHICAGO
659 Hearst Square Chicago

Send NOW for FREE Book

SALESMEN:

Write your name and address on a postal and mail to us. We'll show you sure earnings of \$20.00 a day. Will you risk one minute and a one cent stamp against \$20.00? Mind you, we say we'll SHOW you. Address Dept. 1046.

WILLIAM C. BARTLETT, Inc., 850 W. Adams St., Chicago

See Free Offer on page 8



Every Boy His Own Toymaker

Greatest boys' book ever written. Tells how to make a Steam Engine, Telephone, Magic Lantern, Boats, Kites, Balloons, electrical and mechanical toys, traps, fishing tackle, sleds, stilt, diving board, Bird Houses, etc. Fully illustrated 10c 200 kinds, Iron, Wood and Wire Puzzles. Sample leader and Catalog 10c. WESTERN PUZZLE WORKS, SAINT PAUL, MINNESOTA.



Have Fun Making Money

Yes, You Can—Anybody Can make a lot of money right at home and, what's more, have real fun doing it. We show you how, we furnish everything necessary on an easy basis.

Costs Nothing to learn about our plan, all details are given you free. Write today for beautifully illustrated idea book telling all about our methods which have made so many women independent. Learn how easy it is to make from ten to fifty dollars per week in the most delightful home work you can imagine. Don't miss this opportunity. **Write Now. It's FREE**

Fireside Industries
DEPT. 66-S • ADRIAN, MICH.



Do This To An Old Tire and Make \$150 Every Week!

Simply Drive Nails Into an Old Tire in Front of Big, Interested Crowds and Make from Ten to Twenty Sales an Hour! This is Absolutely the Most Startling, Spectacular, and Thrilling Demonstration You Ever Saw! Just Think—No Matter How Many Nails You Drive Into an Old Tire It Won't Puncture—It Won't Leak a Bit of Air—You Can Pull the Nails Out, and Drive Right Away!

Mr. O. S. Nelson of Mitchell, South Dakota, a chemist of unusual ability, has discovered an amazing new way to make any tire puncture proof! So startling is this new invention, so marvelously successful, that salesmen are piling up big, liberal commissions for just a few hours' work. Every auto owner, whether he drives a Ford or a Cadillac, is interested—he detests the fuss and bother of changing tires on the road and mending tubes.

Punctures Sealed While You Drive

This wonderful new, scientific discovery is called Aer-Pruf. An old tire, after being treated with Aer-Pruf, was punctured with 857 nails without a single leak! Aer-Pruf seals punctures instantly while you are driving, so that you never know you have a puncture. Not only that, but it seals slow leaks, valve leaks, and porous tubes. It prevents rim cuts and broken side walls. It doubles tire mileage because it prevents driving with partly flat tires—the biggest cause of tire trouble. It has no injurious effects on casing or

tube. Will last the lifetime of the tube.

J. O. Bright sold fourteen sets in two hours—profit \$29.40, or over \$100 a day! W. R. Wock started out with demonstration samples. Then he secured some good territory and writes that he disposed of 700 sets in only three weeks' time.

We grant you Exclusive Territory Rights so that you can appoint sub-agents who will earn a splendid income for you. A good sub-agent should make you, at the very least, \$5 a day clear. If you appoint only three sub-agents, your profits from their work would be \$15 a day—\$400 a month—\$4,800 a year! And that is besides your commissions on your own work!

FREE Sample Offer

Right now we are making a big special offer to send you a FREE Sample Set of Aer-Pruf and to pay you for the time required to test the sample if you are not amazed and delighted with it! You never before heard of such an unusual offer! Investigate this offer today. Just send the request blank for full details.

AER-PRUF MFG. CO.

S-3187 Logan Bldg.

Mitchell, South Dakota



Frank Ryman says, "Have punctured all four of my tires at least four hundred times and they still stand up." Buford Houska says, "One of my Aer-Pruf treated tires was punctured 150 times by actual count on a long trip. It is still standing up under full pressure."

Makes Old Tires Like New

Aer-Pruf doubles Tire Mileage, making an old Tube practically as good as new. C. A. Anderson says, "My old tires had to be pumped up every day until I had them treated with Aer-Pruf. They stayed up after that."

Aer-Pruf goes wherever the air goes, sealing up any and every leak—big and little punctures, slow leaks, valve leaks, and porous tubes.

Aer-Pruf Mfg. Co.
S-3187 Logan Bldg.,
Mitchell, South Dakota.

Please send me full details of your
FREE Sample Offer.

Name.....

Address.....

City..... State.....

Make That Dream Come True!

Haven't you often pictured yourself playing the Hawaiian Guitar, a happy crowd around you, everybody enjoying and admiring your playing? Now you can reach your goal—and play all the latest hits just as the Hawaiians do!



You can play the **HAWAIIAN GUITAR** just like the Hawaiians!

\$15
HAWAIIAN GUITAR
with Genuine Seal Grain
Fabrikoid Cover
FREE
when you enroll

Complete Conservatory Course

52 complete lessons. Pictures explain every move. Our method is simple, practical and interesting—only 4 motions to learn. No tiresome scales and exercises—you play a real piece your very first lesson.

Expert Instruction by Native Hawaiians

Get the advantage of expert instruction by Kolomoku, Kalaluki, Ferera and Seville—every one famous as both player and teacher. Even if you never touched a musical instrument in your life, under their direction you make rapid headway—you will be astonished when you see how easy it is!

This Sweet Toned Hawaiian Guitar

in genuine Fabrikoid Case—and complete playing outfit including picks, steel playing bar, etc.: sent you free when you enroll. Retailers ask \$15 or more for a similar outfit without the case. Remember, there are no extras—we furnish everything with the course.

Learn In Spare Time

Pick up your guitar at any time and play. Your lessons are always handy—you can always refer to them. You are never hurried or forced. And no waiting for a class to form—start now—go ahead as fast as you like.

Pay as You Play

Small first payment starts you. And the entire 52-lesson course comes to just a few cents a lesson! Begin now.

We Guarantee

in writing to teach you. And after graduation we coach and advise you without charge. Over 45,000 successful graduates.

Tenor Banjo

and other courses—Violin, Mandolin, Banjo Ukulele, Ukulele—under well-known instructors. Write for information.

FIRST HAWAIIAN CONSERVATORY OF MUSIC, INC.

9th Fl., Woolworth Bldg., Dept. 348, New York, N. Y.

Approved as a Correspondence School Under the Laws of the State of New York

SEND THIS COUPON FOR LIBERAL OFFER!

First Hawaiian Conservatory of Music, Inc.
9th Fl., Woolworth Bldg., Dept. 348, New York, N. Y.

Please mail full information about your 52-lesson Hawaiian Guitar Course. I am not obliged to enroll unless I want to.

Name _____
Address _____
City _____ State _____

Don't Envy The Plumber BE ONE!

\$11.00-\$16.00 PER DAY and work **EVERY** day, is the Plumber's wage.

Every skilled workman will tell you that Plumbers have the best of it. WINTER and SUMMER the Plumber is busy at top wages. No skilled Plumber is ever out of a job—compare his opportunities with any trade, plus the opportunities of having your own shop.

We teach you Plumbing with **TOOLS** (not books) under Licensed, Master **PLUMBERS** in one of the finest equipped schools in America. We make you a Plumber, every branch is taught thoroughly—Lead Work—Blue Print for plan reading—all other tricks.

LEARN IN 8 to 12 WEEKS without previous experience.

If you are making less than \$50.00 a week you owe it to yourself to investigate. Get **FREE** catalog that tells in pictures and words how we teach this trade. Special rates now.

KANSAS CITY SCHOOL OF PLUMBING
2030 Troost Ave. KANSAS CITY, MO.

Drum Lessons With the Outfit



With each genuine Ludwig Trap Drum Outfit we furnish an instruction method. Ludwig drum sets from \$32.50 up. Call on your music dealer or write us for full particulars. Send for free catalog.

World's Largest Makers of Drums and Banjos

LUDWIG & LUDWIG
1611 N. Lincoln St. Chicago, Ill.

See **Free Offer** on page 8

Big Money for You as an Automobile Mechanic

These four practical books, written by five well known teachers of automobile practice, will teach you right in your own home during your leisure time just what you need to know about automobile troubles and repair. They will teach you automobile construction, maintenance and repair as experts know them and will help you to earn an expert's pay.

Practical Automobile Library: Four Books—\$1.50 in 10 days and \$2 monthly for 6 months—only \$13.50 in all!

Hundreds of question-answering diagrams—hundreds of clearly-marked illustrations—make the books plain and readily understandable. All the explanations and descriptions are clear, simple, direct. Every chapter is packed with definite, step-by-step, how-to-do-it information. Here is your opportunity to enter a big-pay field.

Sent **FREE**

Send **No Money** Mail the Coupon

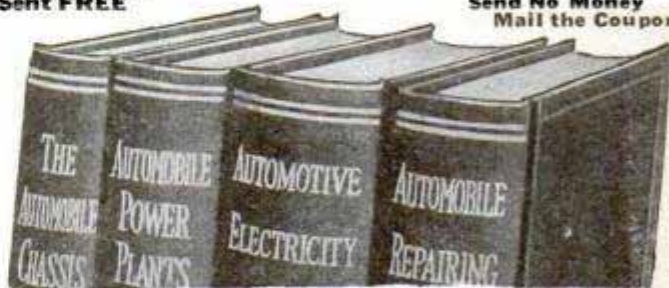

FREE EXAMINATION COUPON

McGraw-Hill Book Co., Inc., 370 Seventh Ave., New York

Send me for 10 days' free examination the New Practical Automobile Library. If satisfactory I will send you \$1.50 in 10 days and \$2.00 monthly until the special price of \$13.50 is paid. If not wanted, I will return the books at your expense.

Signed _____
Address _____
City and State _____
Position _____
Employer _____

10 Thousand OIL BURNERS At Half Price

Amazing Advertising Offer To Introduce Improved Burner

Now, if you will act promptly you can own a new, improved oil burner at a cost so marvelously low it will astound you. No strings to the offer. No if's or but's. For 10,000 of the new improved Oliver Burners for ranges and heating stoves are going to be placed in representative homes at half price—as part of a gigantic advertising campaign.

NEVER before in oil burner history has such a sensational bargain been offered! And it is made now only because we want people to actually see how many advantages this improved device has over old, crude burners.

FOR EVERY STOVE AND RANGE

There is an Oliver burner model to fit every stove and range. Absolutely safe. Odorless, wickless. Installed in fifteen minutes. No holes to drill. No changes whatever to make. Lasts a lifetime. And complete heating satisfaction is guaranteed.

Now you must act at once to take advantage of this lifetime opportunity. 10,000 stove burners may seem like a great many. But remember, over 275,000 Oliver Burners have already been sold. They will go fast at this sensational price. Get rid of the dirt and drudgery of coal and wood forever. Have clean, quick, odorless oil heat for cooking or heating. Send no money. But get the full details, and register yourself for the opportunity to get a modern Oliver Stove Burner for only a few dollars, by sending in the coupon—right now. Don't miss your chance. ACT!

OLIVER OIL GAS BURNER

OLIVER OIL BURNER CORPORATION

P-131 OLIVER BLDG.

ST. LOUIS, MO.

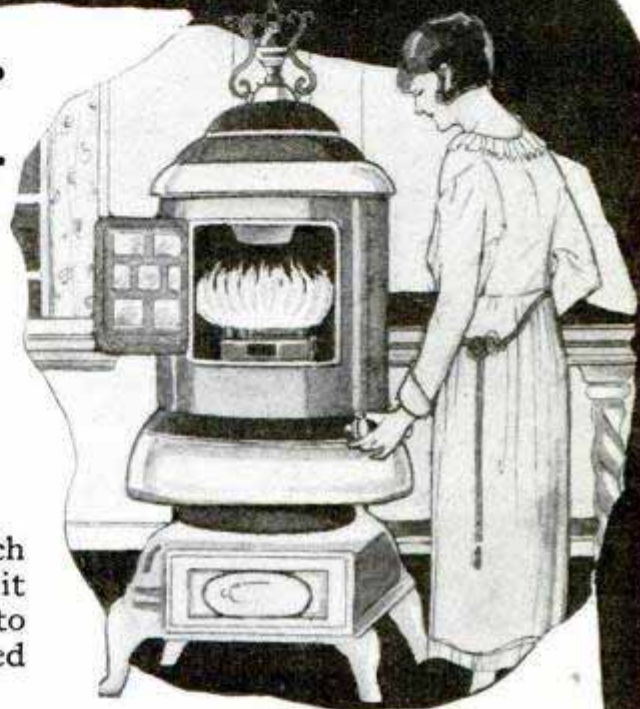

**AGENTS
WANTED**

Write for confidential Sales
Plan

SPECIAL COUPON OFFER

Oliver Oil Burner Corporation,
P-131 Oliver Bldg., St. Louis, Mo.

I understand this coupon entitles me to half price on your improved range or heating stove burners. Send me details. This does not obligate me in any way whatever.

I am interested in a burner for my

..... heating stove range

Name.....

Address..... County.....

Town..... State.....

SPECIAL COUPON OFFER



"There's One Man We're Going to Keep"

"Ed Wilson, there, is one of the most ambitious men in the plant. I notice that he never fools away his spare time. He studies his International Correspondence Schools Course every chance he gets.

"It's been the making of him, too. He hasn't been here nearly so long as Tom Downey, who was laid off yesterday, but he knows ten times as much about this business.

"I'm going to give him Tom's job at a raise in salary. He's the kind of man we want around here."

HOW do you stand in your shop or office? Are you an Ed Wilson or a Tom Downey? Are you going up? Or down?

No matter where you live, the International Correspondence Schools will come to you. No matter what your handicaps or how small your means, we have a plan to meet your circumstances. No matter how limited your previous education, the simply-written, wonderfully-illustrated I. C. S. textbooks make it easy to learn.

This is all we ask: Without cost, without obligating yourself in any way, put it up to us to prove how we can help you. Just mark and mail this coupon.

INTERNATIONAL CORRESPONDENCE SCHOOLS

Box 5610-E, Scranton, Penna.

Without cost or obligation, please tell me how I can qualify for the position or in the subject before which I have marked an X:

BUSINESS TRAINING COURSES

- | | |
|--|---|
| <input type="checkbox"/> Business Management | <input type="checkbox"/> Salesmanship |
| <input type="checkbox"/> Industrial Management | <input type="checkbox"/> Advertising |
| <input type="checkbox"/> Personnel Organization | <input type="checkbox"/> Better Letters |
| <input type="checkbox"/> Traffic Management | <input type="checkbox"/> Show Card Lettering |
| <input type="checkbox"/> Business Law | <input type="checkbox"/> Stenography and Typing |
| <input type="checkbox"/> Banking and Banking Law | <input type="checkbox"/> Business English |
| <input type="checkbox"/> Accountancy (including C.P.A.) | <input type="checkbox"/> Civil Service |
| <input type="checkbox"/> Nicholson Cost Accounting | <input type="checkbox"/> Railway Mail Clerk |
| <input type="checkbox"/> Bookkeeping | <input type="checkbox"/> Common School Subjects |
| <input type="checkbox"/> Private Secretary | <input type="checkbox"/> High School Subjects |
| <input type="checkbox"/> Spanish <input type="checkbox"/> French | <input type="checkbox"/> Illustrating <input type="checkbox"/> Cartooning |

TECHNICAL AND INDUSTRIAL COURSES

- | | |
|---|--|
| <input type="checkbox"/> Electrical Engineering | <input type="checkbox"/> Architect |
| <input type="checkbox"/> Electric Lighting | <input type="checkbox"/> Architects' Blue Prints |
| <input type="checkbox"/> Mechanical Engineer | <input type="checkbox"/> Contractor and Builder |
| <input type="checkbox"/> Mechanical Draftsman | <input type="checkbox"/> Architectural Draftsman |
| <input type="checkbox"/> Machine Shop Practices | <input type="checkbox"/> Concrete Builder |
| <input type="checkbox"/> Railroad Positions | <input type="checkbox"/> Structural Engineer |
| <input type="checkbox"/> Gas Engine Operating | <input type="checkbox"/> Chemistry <input type="checkbox"/> Pharmacy |
| <input type="checkbox"/> Civil Engineer | <input type="checkbox"/> Automobile Work |
| <input type="checkbox"/> Surveying and Mapping | <input type="checkbox"/> Airplane Engines |
| <input type="checkbox"/> Metallurgy | <input type="checkbox"/> Navigation |
| <input type="checkbox"/> Steam Engineering | <input type="checkbox"/> Agriculture and Poultry |
| <input type="checkbox"/> Radio | <input type="checkbox"/> Mathematics |

Name.....

Street.....

Address.....

City..... State.....

Occupation.....

Persons residing in Canada should send this coupon to the International Correspondence Schools Canadian, Limited, Montreal, Canada.

How to Earn

\$50
to
\$100
a Week!



in Show Card Making!

Hundreds earning \$25 a week in spare time, \$50 to \$75 in full time—making clever, original, sales-building show cards. Learn in few months—right at home—through complete, simplified method. No special ability needed. Earn even while you learn.

Every store owner needs distinctive show cards. Demand ever-increasing. Opportunities steadily multiplying. Start now. Prepare yourself quickly to make show cards of every description. Find market in your own neighborhood. Later expand business. Good show card writers earn as much as \$125 a week—top-notchers even more! Send TODAY for free illustrated descriptive booklet and full details of startling offer.

WASHINGTON SHOW CARD SCHOOL

Room 3011-D, 1117 - 15th St., N. W., Washington, D. C.

OPPORTUNITIES IN Salesmanship

Become a Salesman

Every phase of business revolves around selling. The trained salesman is in demand—he can fix his own hours, choose his own field, control his own pay. His income depends only upon his results—there is no limit to what he can earn. We train you to sell successfully thru the LaSalle problem method under supervision of expert salesmen. Train in your spare time. Low cost; easy terms. 64-page booklet, "The Modern Salesman, Ambassador of Progress," free. Send for it today. LaSalle Extension University, Dept. 1164-S Chicago



FREE

See **Free Offer** on page 8

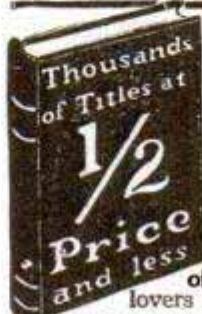

ANY BOOK IN PRINT Delivered at your door. We pay the postage. Standard authors, fine editions, new books, all at biggest savings. Be sure to send postal for Clarkson's catalog. **FREE** Write for our great book catalog. This catalog is a short course in literature and is so used by some of America's leading universities; 300,000 book lovers buy from it. Free if you write now.

DAVID B. CLARKSON THE BOOK BROKER
1121 CLARKSON BUILDING, CHICAGO, ILLINOIS

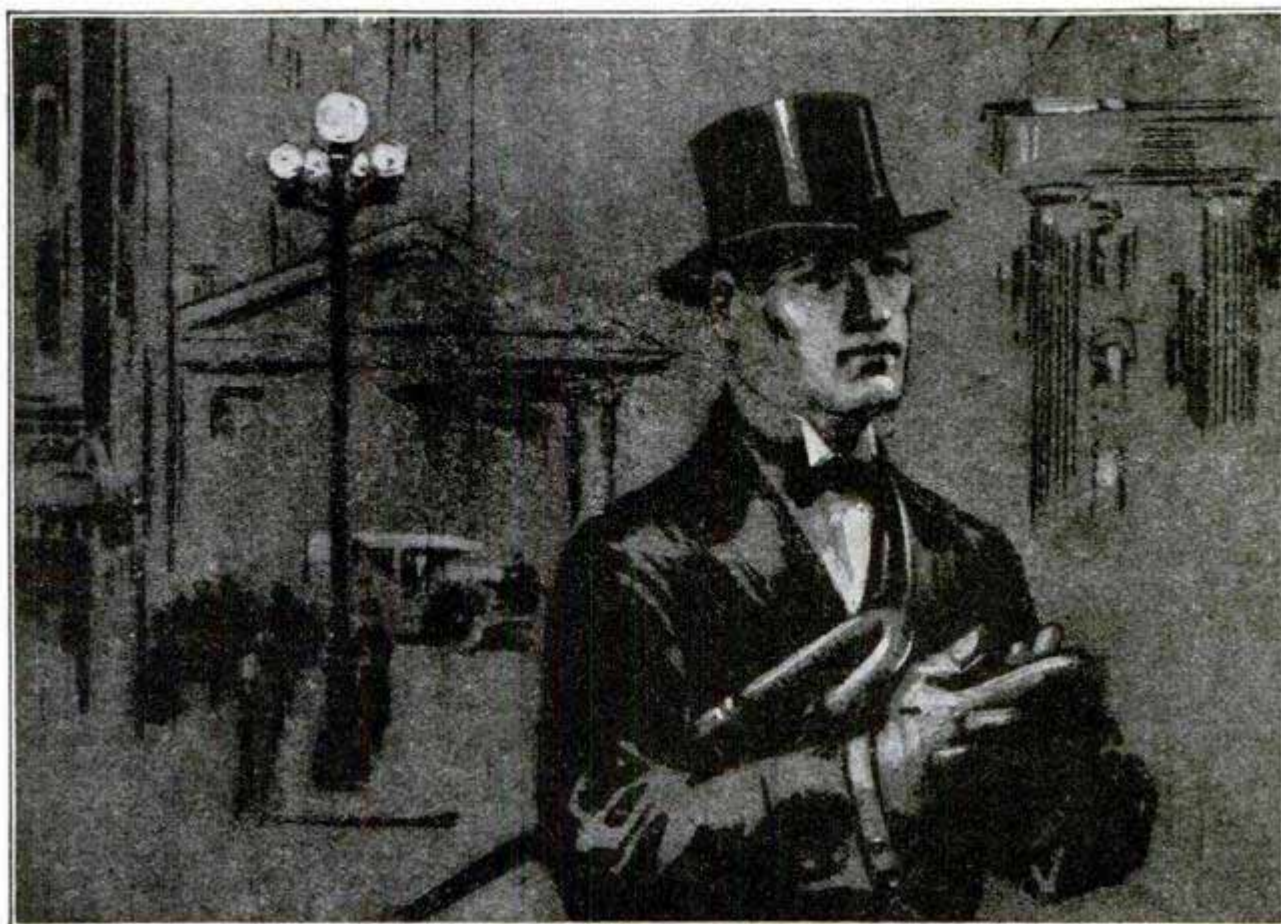

Follow this Man!

Secret Service Operator 38 Is on the Job

Follow him through all the excitement of his chase of the counterfeit gang. See how a crafty operator works. Telltale finger prints on the lamp stand in the murdered girl's room! The detective's cigarette case is handled by the unsuspecting gangster, and a great mystery is solved. Better than fiction. It's true, every word of it. No obligation. Just send the coupon.

FREE The Confidential Reports No. 38 Made to His Chief

And the best part of it all is this. It may open your eyes to the great future for YOU as a highly paid Finger Print Expert. More men are needed right now. This school has taken men just like you and trained them for high official positions. This is the kind of work you would like. Days full of excitement. Big salaries. Rewards.

Earn \$2500 to \$10000 a Year
You study at home in spare time

No advance education is needed. Any man who can read and write, and think can make good. A wonderful book tells all about what others have done. Shows pictures of real crimes and the men who solved them. We'll send you a FREE copy with the free reports. Get the special offer now being made. Mail the coupon.

UNIVERSITY OF APPLIED SCIENCE
1920 Sunnyside Ave., Dept. 93-58, Chicago, Illinois

UNIVERSITY OF APPLIED SCIENCE

1920 Sunnyside Ave., Dept. 93-58 Chicago, Illinois

Gentlemen:—Without any obligation whatever, send me your new, fully illustrated Free book on Finger Prints and your offer of a FREE course in Secret Service Intelligence and the Free Professional Finger Print Outfit.

Name.....

Address.....

.....Age.....

See the World FREE!



Taste Romance and Adventure In the Far Lands of the Earth

How often you've longed to see for yourself the awe of Egypt's pyramids—the beauties of the gorgeous Mediterranean sunset—the squalor of China's ancient cities!

Spend a few years, or the rest of your life, tasting high adventure on the seven seas and in all the world's great ports—roving the earth's highways and byways! You can do it FREE—all your expenses paid—and earn a good salary besides!

Only one profession will carry you around the world at will, travelling like a gentleman, but that's the most interesting and pleasant work there is—Radio Operating! Easily and quickly learned, there's no other profession like it for the man who wants the experiences and pleasures of world-travel. Radio operators are needed—all sea-going ships like the one shown here must carry from one to half a dozen or more.



Take a Look Beyond the Skyline Without a Penny's Expense

Radio operators aboard ocean liners live luxuriously—they rank as officers of the ship. Meals, a private cabin, all other living needs are furnished free, and besides the operator draws a good salary. You can learn quickly and easily at home in your spare time to be a Radio operator through our practical training methods. Take a look at the FREE BOOK which tells how—mail coupon below.

This U. S. Government-recognized school has been training successful operators since 1914. Our graduates are all over the world. We maintain an Employment Department to put you on your own ship. The world-famous NATROMETER, our own patented invention, obtainable only by students of this Institute, is recognized as the best and easiest way to learn the Radio code. A few short months, with the aid of the famous Natrometer and our quick home training, and you too can be a fully qualified Radio operator, sitting in your cabin like the one shown above, bound out for Liverpool or Nagasaki!

Read the Free Book that tells all about this fascinating profession and our practical Government-recognized methods of training you for it. Send coupon TODAY—no obligation. Special tuition offer now on for limited time includes world-famous Natrometer free of extra cost with your course! Act at once.

**NATIONAL RADIO INSTITUTE
WASHINGTON, D. C.**

SPECIAL OFFER COUPON

National Radio Institute,
Dept. OT-77, Washington, D.C.

Gentlemen: Without obligating me in any way send me your free book and information about your special limited Natrometer offer.



World-Famous Natrometer

Name.....

Address.....

Know the School

By the Emblem

The Right Education

First it must give the ability to make a living, second the power to earn something for the support of society, and third it must prepare the individual to live a full life.

Business Education does all of these things—quickly, economically and surely. A good business education may be had in a private school in a short time at small cost.

We will send free our interesting Booklet E, "The Sure Way to Success," and list of Accredited Schools. Write today.

National Association
Accredited Commercial Schools
1618 Mallery Building, Chicago.

LAW

THIS BOOK

FREE!



Study at Home

Become a lawyer.

Legally trained men win high positions and big success in business and public life. Greater opportunities now than ever before. Earn \$5,000 to \$10,000 Annually!

We guide you step by step. Degree of LL.B. LaSalle law graduates practicing in every state. We furnish all text material, including 14-volume Law Library. Low cost. Easy terms. Valuable, interesting 96-page book free. Send for it NOW.

LaSalle Extension University, Dept. 1164-L, Chicago

See Free Offer on page 8

Learn Watchwork, Jewelrywork and Engraving A fine trade commanding a good salary, and your services always in demand. Address **Horological**, Dept. P, Bradley Institute, PEORIA, ILLINOIS, for our latest catalog.



Raise Poultry

MAKE BIG MONEY

Results QUICK — Part or Full Time
Take up poultry raising. It's easy, interesting, healthful, and very, very profitable. Easy to sell all you can produce—at big prices. Our new, up-to-the-minute course, prepared by Harry M. Lamon, former Govt. expert, gives all short cuts to success. Thousands making big money with our methods. Free book, "How to Raise Poultry for Profit," will open your eyes. Write for a copy today.

National Poultry Institute Dept. 411 Washington, D. C.

Magic

Learned Easily
at Home

Astonish
Your Friends!



Dr. Harlan Tarbell
Master of Magic
who has mystified
magicians as well as
laymen with his mar-
velous magic.

Gain the magnetic popularity that makes you the center of any crowd. Business and social success is assured the man who can perform mystifying tricks. You can earn big money on the side or as a professional, as well as being the most popular person in your crowd. Why envy others' skill? You can learn Magic yourself, quickly and easily.

**The First
and Only
Course
in Magic**

*ever offered to the
public teaching
Real Professional
MAGIC*

read
*what the Great
Madame
Hermann says:*

My Dear Dr. Tarbell: I have read with interest your course in Magic. It is the most original and perfect work of its kind I have seen. I highly recommend it.
—A. Hermann

**Earn \$250 to
\$1000 a Month**

even sleight of hand, generally supposed to require long practice, is NOW made simple to learn. For Dr. Harlan Tarbell, one of the really Great Magicians, has finally opened up the secrets of his profession in a completely illustrated course offered at a merely nominal cost. Through the wonderful Tar-

bell system you will be able to mystify and entertain your friends. After that Dr. Harlan Tarbell takes you through the entire maze of sleight of hand, card tricks and elaborate stage diversions. The apparently superhuman doings of the accomplished magician becomes as simple as ABC.

Great Special Offer!

There is a tremendous demand for magic entertainment. Clubs, Lodges, Charity and Social affairs—all will pay high fees to the man who knows Magic. Dr. Harlan Tarbell really gets as high as \$250 for a half hour's work right now. Opportunity everywhere to make money aside from your regular occupation. Salesmen find it a tremendous asset. Find out all about this unprecedented opportunity to learn Magic. Learn about the great Special Price and Easy Payment Offer we are making Now, for a limited time only. The coupon brings full details without any obligation. *Mail it TODAY.*

Tarbell System, Inc.
1920 Sunnyside Ave., Studio 13-58 Chicago, Ill.

Mail This Coupon NOW!

Tarbell System, Inc., Studio 13-58
1920 Sunnyside Avenue, Chicago, Illinois

Gentlemen: Without any obligation send me your free literature and information all about your wonderful "Tarbell Course in Magic." Also tell me about your great Special Price Offer and Easy Payment Plan—offered NOW for limited time only.

Name.....

Address.....

.....Age.....

Pain and Disease

Quickly Conquered by

VIOLET RAY



Let us tell you how thousands of men and women suffering from rheumatism, neuritis, paralysis, nervousness, skin diseases, headaches, constipation, sprains, prostate trouble, goitre and many other ailments, even hay fever and asthma, have found quick relief—new health and vitality with this marvelous, scientific invention. Pains vanish almost instantly.

Violetta

Ten Days FREE Trial

For Health—Beauty—Vigor
Endorsed and used by hospitals, sanitariums and physicians. Every home can now have one. Saves hours, days, months of suffering. No medicine. Painless, pleasant treatment. Only the violet ray can penetrate to every nerve affected. Simple, safe, painless—anyone can use VIOLETTA. Why suffer pain and poor health when you can try VIOLETTA 10 days FREE.

This Book FREE

Tells all about violet rays—how this marvelous discovery by Nikola Tesla, the electrical wizard, now brings this mysterious curative power to all. Contains many astounding testimonials from our thousands of satisfied users. Send for the facts and our liberal trial offer today. Mail the coupon now.

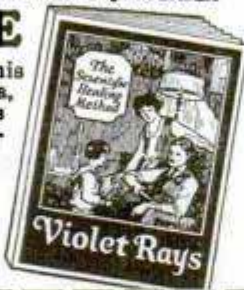

VL-REX CO., Dept. 211
2304 Warren Avenue, Chicago

VL-REX CO., 2304 Warren Ave., Dept. 211 Chicago
Please send me your free book on Violet Rays and details of your 10 days' free trial offer.

Name.....
Address.....
City.....State.....
Ailment.....

Learn How to BOX

JIMMY DeFOREST BOXING COURSE

Teaches by mail the same System he taught Champion JACK DEMPSEY



In 20 weeks, under the System of Jimmy DeForest, World's Greatest Trainer and Maker of Champions, you will master the priceless knowledge that made Jack Dempsey his millions, and fortunes for a host of other Jimmy DeForest-trained ring stars. Every 6 months 30 are selected from all classes and recommended to leading promoters for boxing engagements. That's how pupils are brought to the front at once. Boys who were once rank amateurs are today earning big money; weaklings have been made strong, courageous; men have learned the art of self-defense. Send today for the now famous book, "The Golden Age of Boxing," greatest book of its kind ever written; full of valuable information, photos of great fighters and pupils who became successes over night. Enclose 10c to cover cost of mailing, etc. Write now.

JIMMY DeFOREST BOXING COURSE 347 Madison Ave., Box 611, NEW YORK CITY



BE AN OFFICER in the U.S. Coast Guard \$1700 Up to \$7,500 Yearly

\$780 yearly at the U.S. Academy while training. You rank Ensign to Captain in service. Age requirement 18 to 24. Write Dept. N, for information. COAST GUARD PREPARATORY SCHOOL 4000 G. Ave. N. W. Washington, D. C.

See Free Offer on page 8



BART SUPPLIES

Quality art materials at lowest prices. Save on everything you need. Convince yourself—send today for catalog. BART SUPPLIES, 424 Eustis Bldg., MINNEAPOLIS, MINN.

BE A RAILWAY TRAFFIC INSPECTOR

Joseph Suess writes: "Immediately after finishing my course in Traffic Inspection, which took only a few months, I was given employment and helped in every way, never losing a single day's work. The Institute gives a thorough and efficient training and then helps the graduate to a pleasing, permanent position."

PAYS UP TO \$250.00 Per Month EXPENSES INCLUDED

YOU GET A POSITION, without waiting, without extra expense, as soon as you complete the training. This position must pay not less than \$120.00 per month to start, sometimes more, or we refund every cent you have paid us. Moreover, we place our graduates in positions all over the country.

We arrange all the details and can make this generous offer because of our eight years' experience in supplying the growing demand for Railway Traffic Inspectors. We must supply many more trained men in the next few months. Easy, pleasant work with unusual opportunities for advancement. Travel; see the country or remain near home. Something new every day. Report to important railway officials.

Send coupon for details; how you can prepare in three months spare time training at home; how any average man can qualify. Learn why you take no risk in securing a position.



Standard Business Training Institute Buffalo, N. Y.

Standard Business Training Institute, Buffalo, N. Y.
Send me, entirely free, Booklet No. D-204, giving full particulars about course in Railway Traffic Inspection.

Name.....
Street.....
City.....State.....

YOUR LIFE IS IN YOUR OWN HANDS



Give Me the chance to help you.

When you choose a Trade that you expect to follow for your future welfare—choose one that will pay you and give you the comfort and pleasure that you and every other fellow craves. Choose one that will pay you

The Highest Wages of All Trades

and the most interesting work with a great future in any community—You are not taking a chance—Good men in these lines are wanted everywhere and I will train you to go in business for yourself at small cost—

"In the face of an ever increasing need for their services, based on the need for preservation and decoration of old buildings, as well as upon new structures, the last census revealed a shortage of painters in the United States of close to 25,000."

Yours very truly,
AMERICAN PAINT JOURNAL COMPANY.

"Give us more good all around decorators—they won't need to beg for jobs. There are plenty of common brush hands, but too few good men."

J. P. RISING,
Pres. Master Painters' Assn.
of the U. S. and Canada

A Sound Solid Investment in Success America Actually Needs 25,000 Decorators Right Now.

You men who give sane, serious thought to your future, your success, and the welfare and happiness of your family—consider the tremendous proportions of this big money-making business. You don't have to go farther than your dooryard to see a part of America's great sign painting and billboard industry—millions of dollars there for expert men! Tens of thousands of new homes demand more and more decorators and paperhangers—a mammoth field alone! The mercantile world demands many hundreds of show-card writers—at very satisfying wages. Today over twenty million cars swarm our highways—85% of the world's motor vehicles, and every one of them needs paint. What a wonderful field for the man who is trained in these sound, stable jobs.

Skilled Men Always in Demand

Know your work and you will never need to look for it. I guarantee to make an expert of you if you give me a few weeks of your time. Thousands of men will be needed by spring. Learn now and get one of these Big Pay JOBS. Don't keep plodding in that underpaid job if you ever expect to get ahead. Start NOW. Send for my Big Free Catalog. That's the first step. Every course I teach is practical. Big money makers. Anyone can learn. No experience, no talent, no higher education is needed. Your success is assured the moment you begin. Prices are low during my 25th Anniversary Offer.

Real Business Openings

Every day there are big opportunities to go into business for yourself—with little or no capital—and it's clean, healthy, fascinating work! But get started now—it's the expert, trained man who makes good—and, fortunately for you, the training is easy and short. Read about my Big 25th Anniversary Offer!

Read This Special 25th Anniversary Offer.

To all students who enroll now in my fall classes I will pay the Railroad fare to Chicago and in addition give a complete course in Blue Print Reading and Estimating FREE.

Chicago Painting School
147 W. Austin Ave.
DEPT. 14 CHICAGO ILL.

Choose Your Course Now!

Short, Easy, Master Training by Practical Master Methods

SIGN PAINTING IN 12 WEEKS

Free Hand Strokes, Gold, Silver and Aluminum Leaf on Glass. Wood and Metal, Muslin Banner Work, Cut-in Lettering.

DECORATING IN 12 WEEKS

Mixing and Blending Painters' Colors, Calculating, Staining, Plain Painting, Wood Finishing, Enameling, Stippling, Drawing, Designs, Free Hand Work, Stencil Work, Striping, Stucco Work, Tiffany, Glazing, Starching, Waxing, Flower Decorations, Landscape Decorations, Still Life and Mural Decorations, Graining, Marbling and Graftex.

PAPERHANGING IN 6 WEEKS

Making Paste, Hanging Walls, Hanging Ceilings, Matching Patterns, Mitering Corners, Plastering and Patching Walls, Canvas Work.

GRAINING AND MARBLING IN 6 WEEKS

Graining in Hard Oak, Quartered Oak, Mahogany, Walnut, Birds'-Eye Maple, Plain Maple, Ash, Fancy Doors, Parquet Flooring, Black and Green Marble, Black and Gold, Italian Siena, Vermont and Tennessee Marble, Onyx, Granite and many other marbles.

SHOW CARD WRITING IN 10 WEEKS

Free Hand Single Stroke Lettering by Brush and Pen, Script, Old English, Egyptian and Fancy Alphabets, Air Brush, Stencil Work, Actual Layouts, Scroll Work, Color Harmony.

AUTO PAINTING IN 8 WEEKS

Priming, Putty Coating, Rough Stuff Painting, Flat Coat Work, Color Varnishing, Glazing, Duo Spraying, Striping, Finishing.

SEND THIS TODAY!

MR. HARRY GLICK, Principal
CHICAGO PAINTING SCHOOL
147 W. Austin Ave., Dept. 14, Chicago, Ill.

Dear Sir: Send me your free Catalog, describing your courses, and Special offer with no obligation on my part.

Name.....

Street.....

City..... State.....

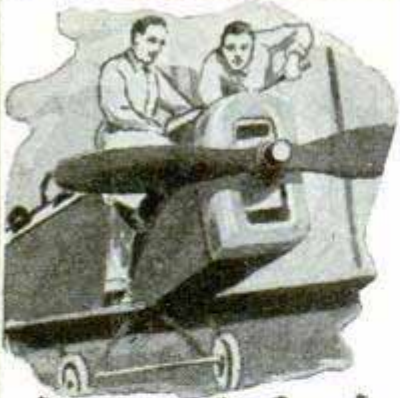

Airplane Mechanic
\$85⁰⁰ to \$125⁰⁰ a week

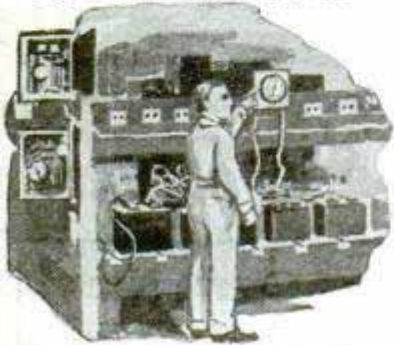

Batteries \$300⁰⁰ a month



E. J. Sweeney

President

The Million Dollar
Sweeney Trade School

You work on latest type equipment and become a skilled man in a great new business. Mechanics and ground men always assured of interesting, profitable, steady work.

MEN

Get This New
72-Page
Book
Today
FREE

TELLS
ABOUT
SEVEN
GOOD
TRADES

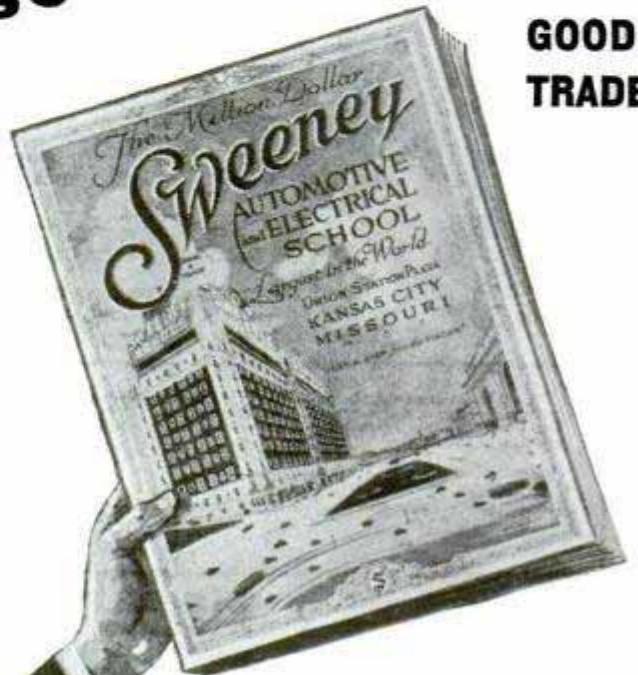

Sweeney Flying School

teaches flying with skilled instructors, fine planes, a great flying field, all equipment. All the time in the air necessary to make you a skilled pilot.

If you want to be a pilot, fit yourself for government mail or commercial service, exhibit at fairs, etc., here's your chance. SWEENEY GROUND SCHOOL is a thorough course in practical airplane mechanics. You don't have to take flying unless you want to. Airplane mechanics are in great demand. Five men on the ground needed to keep one man in the air. Learn by doing. Construction and repair of planes—all about motors—re-covering wings, etc. Mechanics and engineers earn from \$50 to \$125 a week. Riggers earn \$50 to \$75.

Sweeney

Aviation—Automotive
3131 SWEENEY BLDG.

WANTED

THE MILLION DOLLAR SWEENEY SCHOOL



with over 65,000 graduates, trains you in a good trade. What appeals to you? Auto repairing—bus line driving—garage—repair shop—tire shop—welding—radio broadcasting—auto painting, or does opportunity call you FROM THE AIR? Do you want to be a pilot—or airplane mechanic? Write me today—GET THE FACTS—about wages—profits—opportunities and HOW THE SWEENEY SYSTEM is equipped to give you successful training. Auto Mechanics make \$50 to \$100 a week. Learning is easy by the Sweeney System of Practical Training. Use tools not books. Be an auto mechanic—driver—truck driver—repair man—tire man—demonstrator. Own your garage or repair shop. Run a welding and vulcanizing shop. You can learn these trades separately or in a combined course.

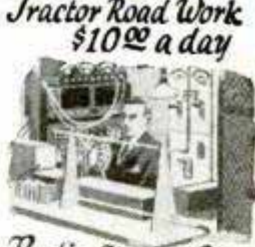

Here's proof that Sweeney School is the recognized authority. Telegram from Oklahoma: "Need teacher auto mechanics. Salary \$1600. Wire reply." Another from Arkansas: "Can you recommend teacher? Wire answer."

Sweeney System "Learn by Doing"

If you are mechanically inclined, if you like to work with tools, you will learn under the "SWEENEY SYSTEM" by actually doing the work on the most complete gas engine and electrical equipment. Over \$200,000 invested. \$50,000 Radio Station

WHB. You'll get dirty and greasy, but you'll learn through the SWEENEY SYSTEM OF PRACTICAL TRAINING that fits you for the big pay jobs waiting for Sweeney Trained Men.

Send for This Big FREE Book

That's the first step. It obligates you to nothing but gives all the facts. Tells all about different mechanical trades. Shows how men LEARN BY DOING. How we teach with TOOLS—not books. Tells all about wages and opportunities. Fully illustrated; pictures of men at work. Takes you through the million dollar school—one of the sights of Kansas City—on Union Station Plaza—right by the great Liberty Memorial. Men come from all over the world to this school. Read letters from happy graduates, making good. Special section devoted to flying—pictures of planes and hangars and Sweeney Students at work. Clip coupon—or postcard will do—but DON'T PUT IT OFF. This book costs me a dollar but I send it absolutely free. No colored students accepted.

RADIO STATION WHB

mey
—Electrical School
KANSAS CITY, MO.

EMORY J. SWEENEY, President
3131 Sweeney Bldg., Kansas City, Mo.

Please send me your FREE 72-page catalog and full details of your courses leading to BIG PAY JOBS. I am interested in

- () Flying
- () Airplane Mechanics
- () Auto Mechanics
- () Welding and other trades
- () Batteries
- () Vulcanizing

Please mark X opposite subject in your mind.

Name..... Age.....
Address.....
Town..... State.....
MARK X IN SUBJECT THAT INTERESTS YOU

Swear Off Tobacco



Tobacco Tells on Nervous System



Tobacco Ruins Digestion



Tobacco Stunts Boy's Growth



Tobacco Robs Man of Vitality



Tobacco Steals from You the Pleasures, Comforts, Luxuries of Life

Tobacco Habit Banished Let Us Help You

Quick Results

Trying to quit the tobacco habit unaided is often a losing fight against heavy odds, and may mean a serious shock to your nervous system. So don't try it! Make the tobacco habit quit you. It will quit you if you will just take Tobacco Redeemer according to directions.

It doesn't make a particle of difference whether you've been a user of tobacco for a single month or 50 years, or how much you use, or in what form you use it. Whether you smoke cigars, cigarettes, pipe, chew plug or fine cut or use snuff—Tobacco Redeemer will positively remove all craving for tobacco in any form in a few days. Your tobacco craving will usually begin to decrease after the very first dose—there's no long waiting for results.

Tobacco Redeemer contains no habit-forming drugs of any kind and is marvelously quick, scientific and thoroughly reliable.

Not a Substitute

Tobacco Redeemer is in no sense a substitute for tobacco, but is a radical, efficient treatment. After finishing the treatment you have absolutely no desire to use tobacco again or to continue the use of the remedy. It helps to quiet the nerves, and will make you feel better in every way. If you really want to quit the tobacco habit—get rid of it so completely that when you see others using it, it will not awaken the slightest desire in you—you should at once begin a course of Tobacco Redeemer treatment for the habit.

Results Absolutely Guaranteed

A single trial will convince the most skeptical. Our legal, binding, money-back guarantee goes with each full treatment. If Tobacco Redeemer fails to banish the tobacco habit when taken according to the plain and easy directions, your money will be cheerfully refunded upon demand.

Let Us Send You Convincing Proof

If you are a slave of the tobacco habit and want to find a sure, quick way of quitting "for keeps" you owe it to yourself and to your family to mail the coupon below or send your name and address on a postal and receive our free booklet on the deadly effect of tobacco on the human system, and positive proof that Tobacco Redeemer will quickly free you from the habit.

Newell Pharmacal Company
Dept. 300, Clayton Station, St. Louis, Mo.



Free Book Coupon

NEWELL PHARMACAL CO.,
Dept. 300, Clayton Station, St. Louis, Mo.

Please send, without obligating me in any way, your free booklet regarding the tobacco habit and proof that Tobacco Redeemer will positively free me from the tobacco habit or my money will be refunded.

Name.....

Street and No.....

Town..... State.....

To Men Getting Bald I Say!

No matter how fast your hair is falling out—no matter how much of it is already gone—I make this amazing guarantee! I'll end dandruff—stop falling hair—grow new hair in 30 days—or you don't pay me a cent! No strings attached! No "Ifs," "Ands" or "Maybes"! New hair or no pay! And you are the sole judge!



By ALOIS MERKE.

Founder of the Merke Institute, 5th Avenue, New York.

SAVE yourself from baldness! Stop falling hair! Grasp this "no risk" offer to grow new healthy hair in 30 days!

Here's My Contract!

If your hair is rapidly falling out—if your appearance is spoiled by approaching baldness—if you have tried countless expensive hair treatments unsuccessfully—it makes no difference. My contract stands! I'll grow new hair in thirty days—or the trial costs you NOTHING.

Here's My Secret

Years of training and research and day after day experience in treating thousands of cases of loss of hair at the famous Merke Institute, Fifth Avenue, N. Y., have taught me many valuable facts about the hair—and this, the most amazing of all—that in most cases of baldness the hair roots are not dead, but merely **dormant**—asleep!

You're wasting your time—you're throwing away money—when you try to reach these dormant roots with ordinary hair tonics, oils, massages and salves. For such measures treat only the **surface skin** and **never even get** to the roots, the **real source** of trouble. How could they ever **possibly** grow new hair?

My Method Reaches the Roots

It's no use trying to make a tree grow by rubbing "growing fluid" on the bark. You **must** get to the roots!

And that's just why my scientific treatment is so tremendously beneficial! It penetrates **below** the surface of the scalp. It quickly reaches the **cause** of the trouble—the dormant, starving hair roots. It awakens them. Hair begins to sprout again. It takes on new life and color. It becomes

stronger and thicker. And in a surprisingly short time—sooner than you ever imagined possible—you have a new healthy growth of hair—OR I PAY ALL COSTS OF THE TREATMENT MYSELF.

And best of all, my system is so simple that it can be used in any home where there is electricity without the slightest discomfort—and for just a few cents a day!

New Hair or No Cost!

Thousands claim seeming miracles for my treatment. I don't. I admit some cases of loss of hair are hopeless. Only remember this—these cases are so very rare and so many hundreds of others have regained luxuriant hair through my method, that I am willing to let you try it for 30 days—AT MY RISK!

Then if you are not absolutely delighted—say so. And I'll mail you a check immediately—refunding every cent of your money—and the treatment will have cost you NOTHING!

Free Booklet Tells All

The very fact that you have read this announcement shows that you are anxious about the condition of your hair. So why not investigate? Find out for yourself. If you will merely fill in and mail the coupon I will gladly send you without cost or obligation a wonderfully interesting booklet which describes in detail my successful system, which is growing new hair for thousands all over the country. In addition it tells all about my iron-clad guarantee, which enables you to take my treatment without a penny's risk. Clip and mail the coupon today. Allied Merke Institutes, Inc., Dept. 1611, 512 Fifth Ave., New York.

EVIDENCE!

Hair Coming Back

"Having used your Thermocap Treatment for 30 days, I find a new growth of hair coming back on bald spot. It is growing in very fine. The Thermocap is a Treatment that everyone who is losing his hair should buy."

G. H. P., Portland, Me.

Dandruff Leaves Entirely

"I want to tell you how wonderful your treatment is. The first week my dandruff left entirely, and by the third week a new growth of hair could be seen all over my head."

Mrs. H. S.,

Port Angeles, Wash.

Partly Bald for 10 Years

"I have been partly bald for the last 10 years and have used your treatment only four weeks to date, but I can already see a new crop of hair coming in."

J. A. K.,

Anderson, Ind.

Allied Merke Institutes, Inc.,
Dept. 1611, 512 Fifth Avenue,
New York City.

Please send me without cost or obligation a copy of your book, "The New Way to Grow Hair," describing the Merke System.

Name

Address

City..... State.....

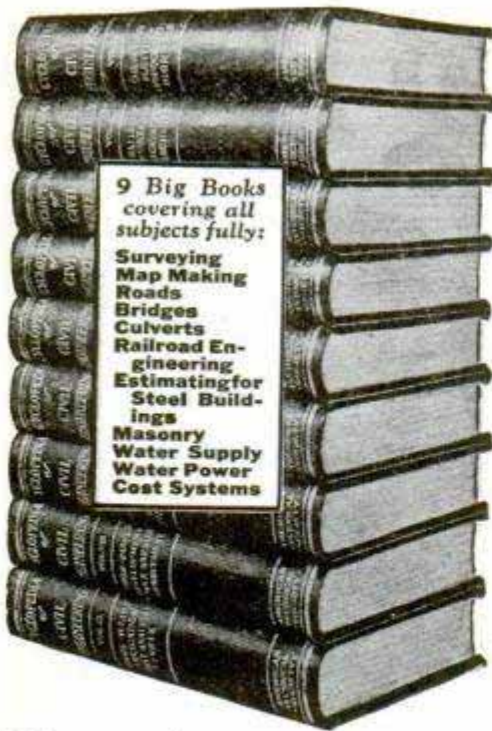

Want to make more money?
Be a Civil Engineer

Here is an easy way to learn. You hold your future in your own hands. If you have a grammar school education, and want the advantages of knowledge usually gained in college, you will welcome this new system of reading at home. No long hours of grinding study; just the meat of every subject told in such a simple way that anybody can understand.

These books were prepared by men who were experts, they are full of boiled down facts and easily learned methods which save time and study.

Civil Engineers are more important than ever: steel buildings, bridges, highways, railroads and harbor projects make Engineering more important than almost any other profession.

If you want to get ahead—try this easy way
We Ship Nine Books FREE

This is a "straight-from-the-shoulder" offer to men who want a big future. If you could hear half the stories of success we receive, you would not hesitate a minute. Send for the books now; just your name and address; and we'll ship the entire set of nine volumes. Keep them ten days, then if you realize how valuable they are to you, send only \$2.00, and after that only \$3.00 per month until the small total of only \$29.80 is paid. A free membership in the American Technical Society will be included if you send NOW. This entitles you to full consultation privileges with 18 engineering experts.

The special jiffy index puts facts at your finger tips

AMERICAN TECHNICAL SOCIETY, Dept. C-819, Chicago
 You may send me, for Free examination, your nine new books on Civil Engineering. Unless I return them in ten days I will send you \$2.00 as first payment, then \$3.00 per month until the special price of only \$29.80 is paid.

Name.....
 Address.....
 City..... State.....
 Reference.....

Become an OIL PAINTER
EARN WHILE YOU LEARN Our NEW method trains you in three months to paint on Canvas beautiful Salable Pictures. Your Big Chance to become a Modern Artist. Individual Training at Home. Write for full plan.
HOME ART STUDIOS, 5220 Lakewood Ave., CHICAGO



Commercial Engineer **IN ONE YEAR**
 Big Paying Jobs crying for Trained Men

The **Commercial Electrical Engineering Profession** demands young men with combined Technical, Commercial and Real Practical Training. We take personal interest in every student. Individual instruction. Founded in 1905. Immense laboratories and shops Radio Broadcasting WSOE every day. Other courses offered: **Electrical Engineering, B. S. Degree in 3 years; Electrotechnics, 12 to 18 mos.; Light, Heat and Power Wiring, 3 mos.; D. C. and A. C. Motors and Generators, Armature Winding, 3 mos.; Automotive Electricity, 3 mos. Next Term Opens November 8, 1926.** Write now for full details. State course interested in.

SCHOOL of ENGINEERING OF MILWAUKEE R386C, 415 Marshall Street MILWAUKEE, WISCONSIN

LEARN MECHANICAL DENTISTRY **IN THREE MONTHS**
 and qualify to earn \$2,000 to \$5,000 a year. FREE employment service enables you to **EARN WHILE LEARNING** this NEW money-making Profession. Age no barrier and no previous training required. The only school in New York where students learn by doing actual work in gold before graduation. **Individual instruction.** Day or night sessions. Write NOW for free catalog P and **SPECIAL TOOL OFFER**
N. Y. SCHOOL of MECHANICAL DENTISTRY
 Penn Arcade, 147 W. 33rd Street New York
FREE RAILROAD FARE

BIG POULTRY BOOK and FREE New POULTRY BULLETIN



Worth Hundreds of Dollars. Shows how Big Men in Poultry Grew Rich—How Many Started Small, New Worth Thousands. You can do same if you follow methods outlined in **FREE BOOK**. Now is the time to make money with poultry.

FREE BOOK and New Bulletin tells what to do each month. Mention variety of poultry you like. Write today without fail.
AMERICAN POULTRY SCHOOL, Dept. 70, KANSAS CITY, MO.

See Free Offer on page 8

TELEGRAPH-RADIO

\$18 to \$35 a week while training for Radio and Telegraph Operator jobs at \$150 to \$300 per month. Write for particulars.

CHICAGO TELEGRAPH INSTITUTE
 Dept. 1-116 1338 S. Michigan Avenue, CHICAGO

Minstrel Show Guide



350 End-men's Jokes, 26 Songs, 9 Complete Sketches, 8 Monologues, 4 Stump Speeches, besides Complete instructions on stage and program arrangements, rehearsals and "make-up," from beginning to end. Price 15c postpaid.

J. C. DORN, 701 S. Dearborn Street, Dept. 39, CHICAGO, ILL.

Health Food Directory

How to select the proper foods for gaining weight; reducing; building vitality; disease resistance; constipation; building muscle, etc. Rates and tabulates standard branded foods. No other book like it. 150 pages of valuable information. Special price 25c, postpaid. Limited edition.
Macfadden Publications, Inc., Dept. P.M.11, 1926 B'way, N. Y. City

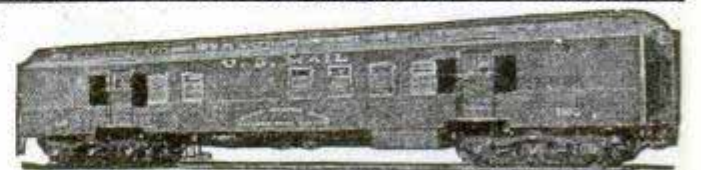

COUPON
FRANKLIN INSTITUTE, Dept. C-180, Rochester, N. Y.
 Sirs: Rush to me without charge: (1) Specimen Railway Postal Clerk Coaching Lessons; (2) **FREE** 32 page book describing U. S. Government positions open to men and boys, and full particulars telling how to get them.
 Name.....
 Address.....

Work for "Uncle Sam"

RAILWAY POSTAL CLERKS MAIL CARRIERS

\$1700 TO \$3000 YEAR

TRAVEL—See your country on government pay MEN—BOYS—17 UP SHOULD MAIL COUPON IMMEDIATELY

Steady Work. No Layoffs. Paid Vacations.

For 2 Cents BUICK Himself Will Show You How to Earn MORE MONEY



Will you spend a postage stamp to prove that you CAN tear away from small pay? That you can earn just as big money as the man who has everything he wants? Stop working for nothing right now! In an amazing short time you can be master of a real trade—earning real money. The great Detroit School of Trades—supervised by the Michigan State Board for Vocational Education—has retained D. D. Buick, pioneer of the Valve-in-The-Head Motor and one of the organizers of the Buick Motor Car Company, as chief engineer. Already Mr. Buick has graduated hundreds of men into big pay jobs. Send the coupon to him — he'll show you how you, too, can smash into the big pay class quick—and at amazing low cost.



D. D. Buick, pioneer automobile manufacturer, once was a tradesman himself, then a great manufacturer. He knows exactly what you need to fit you quick for one of the big money trades. He supervises your training personally.

Mr. Buick knows exactly what you need to fit yourself for the big jobs. Some of the biggest industries in the world cooperate with us.

This Beautiful FREE Book Shows You How

Our FREE employment placement department places hundreds of men every year in big pay work.

We have day and night classes—you can work and go to school too. Detroit is a magic city—a mammoth city of industry. What better place could you want to be trained right.

What place can offer you bigger opportunities. Right now you can forget small pay, break free from shackles. Send for this beautifully illustrated FREE book and learn exactly how quick you can be earning big wages—and how easy you can step into a real job. Send the coupon this minute.



The nation sends out a steady cry for more and more skilled tradesmen. But they must be trained—and trained right. Thousands of Detroit School of Trades graduates step at once into big money—or their own business. Joe Hansen was making 65 cents an hour and the very day our experts graduated him our employment dept. put him right out on the job at \$1.65 an hour. Now he's going to be a contractor for himself. Brooks was a low pay bank clerk—He came to this school and in an amazing short time stepped into \$1.25 an hour. Gerald Waitet, George Wells, hundreds of others have done it too. And so can you. We train by actual work—NO BOOKS.



In his great college of trades each department is a big school in itself.

D. D. Buick, Chief Engineer
Detroit School of Trades
Dept. 1126A, Detroit, Michigan

CHOOSE!

In This Great School We Teach These Big-Pay Trades

Bricklaying—\$1.50 to \$1.65 per hour
Plastering—\$1.50 per hour
Plumbing—\$1.25 to \$1.75 per hour
Carpentry—\$60.00 to \$125.00 per week
Electrical—\$10.00 to \$14.00 per day
Sign Painting—\$1.00 to \$2.00 per hour
Paper Hanging—\$10.00 and up per day
Interior Decorating—\$10.00 to \$14.00 per day
Plan Reading and Estimating—\$70.00 to as high as \$250.00 a week
Auto Mechanics—\$1.00 to \$2.00 per hour
Auto Painting—\$9.00 to \$12.00 per day
Auto Trimming—\$9.00 to \$14.00 per day
Metal Finishing—\$10.00 per day
Acetylene Welding—\$1.00 to \$2.00 per hour
Tool Making—\$70.00 to \$200.00 per week



D. D. Buick, Chief Engineer
Detroit School of Trades
Dept. 1126A, Detroit, Michigan

Send me at once your big illustrated catalogue. I want to earn big money.

I am interested in the trade of.....

Name.....

Address.....

City..... State.....

Panther or Cow?



Which do YOU want to be?

Under the silky hide of the lions, tigers, leopards and panthers long, rippling muscles and thews of spun-steel crawl and flex in eternal readiness. Their power is terrific. Their action swift and sure. Are your muscles like that? Are you a panther?

Does strength mean beef to you? A bull is strong, but can you imagine the outcome of a one-round bout between a panther and a bull? Place your bets, gentlemen! What odds would you want if you were backing the bull? You know men just like bulls.

Big-necked fellows who require an acre to turn around in. Is that your idea of strength? Are pictures of these cow-like "strong men" going to put a ring in your nose? Are you willing to be led?

It was the speed and agility of the panther that made "Gentleman Jim" Corbett heavyweight champion of the world. The heaviest tackle on the gridiron can't touch "Red" Grange when his supple body gets into action. *That's the kind of bodies I build!*

Your biceps, chest, thighs and calves are bound to get larger as your muscles gain the strength I put there. They can't help bulging in spots. Your muscles will be growing and the growth will show. But I swear you won't look like an elephant if you follow my instructions.

THE ONE TITUS AND ONLY BUILDER OF BUILDERS

I trained most of the present day trainers! I taught them what a real body was. Today they make their living—and a good one—with the muscles I gave them. All over the world products of my system of body

building have become leading physical directors, the strongest, best-developed men in their locality. You can have that reputation. Do you want it? The training that built the weight lifting champion of all Europe and hundreds of other marvels of strength can remold your body and

LET TITUS TRAIN YOU!

give you new life. Let me show you what it feels like to be a panther. Let "the daddy of 'em all" prove his right to that title by building YOUR body.

The enormous advantage of TITUS training over all other kinds lies in the perfect co-operation of brain, nerves and muscle which it alone can achieve.

This Knockout Book is FREE

Get your copy of this big new book NOW. Fill in the coupon and mail it at once. Its contents will astound you. It contains true stories more wonderful than fiction. Stories of miracles worked in muscle—miracles that can be worked by you!

Don't wait! Don't even turn the page. Tear the coupon out, and see for yourself. BETTER BUILT BODIES is FREE to you!



TITUS Dept. P-108 105 East 13th St., New York, N. Y.

TITUS, Dept. P-108
105 East 13th St., New York City

Dear Sir: Please send me without cost or obligation "Better Built Bodies," your New Big Book illustrated with scores of actual photographs of famous strong men you have trained.

Name.....

Address.....

City..... State.....

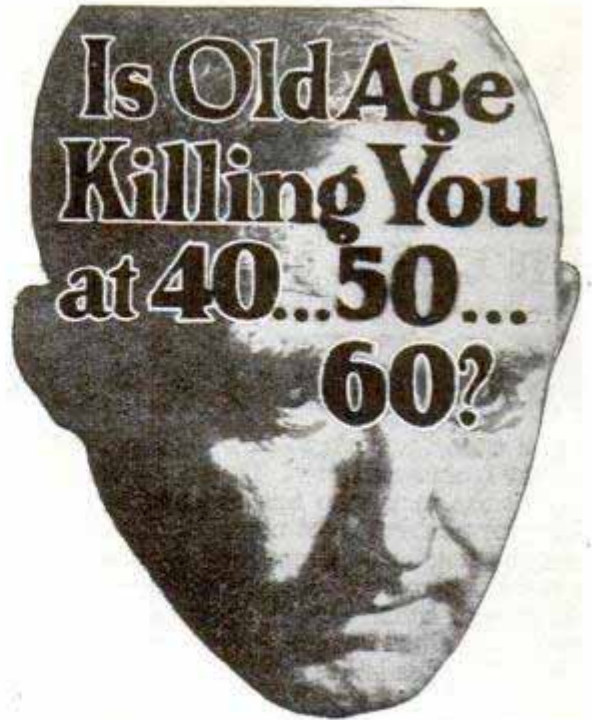

Is Old Age
Killing You
at 40...50...
60?

Are you aging too soon . . . getting up 5 to 10 times at night . . . is vitality ebbing steadily away . . . are you definitely on the down grade, half-living, blue, depressed, subject to chronic constipation, chronic fatigue, backache, foot and leg pains? Then look to the vital prostate gland.

New Facts About the Prostate Gland

In men past 40, do you know that these symptoms are often the direct result of prostate gland failure? Are you aware that these symptoms frequently warn of the most critical period of a man's life, and that prostate trouble unchecked, usually goes from bad to worse . . . that it frequently leads to years of fruitless treatment and even surgery . . . that it even threatens life itself?

FREE to Men Past 40

No man past 40 should go on blindly blaming old age for these distressing conditions. Know the true meaning of these symptoms. Send for a new, illustrated booklet, "Why many men are old at 40," written by a well-known American Scientist, and see if these facts apply to you.

Natural Method

There is little or nothing that medicine can do for the prostate gland. Massage is annoying, expensive and not always effective. Now this scientist has perfected a totally different kind of treatment that you can use in your own home. It employs no drugs, medicine, or violet rays. It stimulates the vital prostate gland in a new natural way, and it is as harmless as brushing your hair. 25,000 men have used it with remarkable results.

Swift Natural Relief

Now physicians and surgeons in every part of the country are recommending this non-medical treatment. So directly does this new safe treatment go to the prostate gland that noticeable relief often follows overnight. So remarkable are the results that you can test it under a guarantee that unless you feel 10 years younger in 6 days you pay nothing.

Scientist's Book Free

Send now for this Scientist's free book and learn these new facts about the prostate gland and old age ailments.

Simply mail the coupon to W. J. Kirk, president, 2163 Main St., Steubenville, Ohio.

W. J. Kirk, Pres., 2163 Main St.,
Steubenville, Ohio.

Without obligation, kindly send me a free copy of "Why Many Men are Old at 40."

Name.....

Address.....

City..... State.....

Western address: Suite 21-F, 303 Van Nuys Bldg., Los Angeles, Calif.

It takes *only* 8 weeks to get a big job

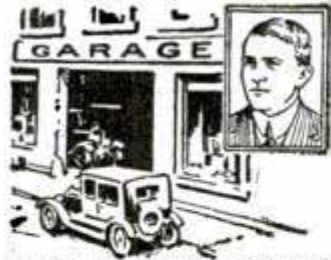

Geo. Smith owns an agency and repair shop in West Alexandria, Ohio. He makes \$200 a week.



C. E. Gillespie has charge of a fleet of trucks and tractors with the State Highway Commission, due to McSweeney training.



D. M. Collins, Williamsville, West Virginia, writes, "After finishing McSweeney training, I started in as manager of a garage at \$300 per month."

In the Auto, Tractor and Electrical Business

Read what these men are doing—here is your big chance to get "on easy street." Come to these great shops on the biggest SPECIAL offer ever made.

Big firms need trained men. The Auto and Tractor Business is on the boom. Thousands of trained men will be needed during the next few months. I get calls every day from Garages, Battery Stations, Auto Repair, and other successful concerns for McSweeney men. When the big fellows need high grade men they know where to come for them. They want McSweeney trained men.

My training is unusual. Scientific tool training—that's the secret. You do things here according to the latest engineering standards. Thousands of dollars have been spent in modern tools and equipment. You'll know a motor like a brother. That's why my men are at home with the biggest shops in the country. If you want to succeed the way Smith, Collins and the rest have—qualify by the same method.

I'LL PAY YOUR RAILROAD FARE AND BOARD YOU!

In order to fill the openings that now exist, I am making this unusual offer—FREE RAILROAD FARE, FREE BOARD. But even that is not all. I'll tell you about the rest in my letter.



McSweeney Auto, Tractor and Electrical Training Shops, Dept. KR-14. (Address shops nearest you) Cincinnati, O., or Cleveland, O.

Without any obligation send me your big free book on Autos. Also information regarding Special Reduced Price Tuition temporary offer.

Name.....
 Street.....
 City.....State.....

Send for FREE BOOK

My big illustrated training book tells how others are succeeding. It tells many things you ought to know about Autos and Tractors. Write for it and my short time Reduced Price Tuition offer NOW. It soon expires.

MC SWEENEY

AUTO, TRACTOR and ELECTRICAL SCHOOLS

9th and Walnut Sts., Dept. KR-14, Cincinnati, Ohio
 1815 East 24th Street, Dept. KR-14, Cleveland, Ohio

DO YOU LIKE TO DRAW?

It's Easy To Learn When Shown In The Right Way

Some of cleverest cartoonists and comic artists in America today learned how to draw quickly—by following **CARTOONIST EVANS' SIMPLE AND EASY METHOD**. This school is recommended by foremost cartoonists because they know the students are handled right. If you like to draw, send 6c in stamps for **portfolio of cartoons and full details**. The course is **NOT EXPENSIVE**.



The W. L. Evans School of Cartooning 821 Leader Building CLEVELAND, OHIO

See **Free Offer** on page 8

BETTER HANDWRITING

Quickly and easily learned by children and adults. Perfect penmanship assured. Write for information, or send price 98c. **VIC. HANSEN WALLACE, IDAHO**



\$150 to \$300 Monthly—One Day Battery Charging

Charge batteries in 1/3 the time required by others and get the business. Latest method recommended by the leading battery companies and approved by the U. S. Bureau of Standards. **BIG YEAR ROUND PROFITS**. Best paying business in automotive field. Requires no special experience, uses small space. **30 DAYS' FREE TRIAL**, at our risk under absolute money back guarantee. Write today for Bulletin X, giving full particulars.

HOBART BROS. CO.

Box M-11

TROY, OHIO



Work for "Uncle Sam"

MEN 18 TO 45
City and Rural Mail Carriers
\$141.67 to \$275.00 Month
Many Other U. S. Gov't Jobs Now Obtainable
STEADY WORK. PAID VACATION. COMMON EDUCATION SUFFICIENT. PULL UNNECESSARY.

Coupon
 Franklin Institute
 Dept. C312
 Rochester, N. Y.

Rush to me, **WITHOUT CHARGE**, (1) Your Copyrighted 32-page Civil Service Book. (2) Tell me how to get a position as City or Rural Mail Carrier at \$141.67 to \$275.00 a month. (3) Send Sample Coaching.

Name.....
 Address.....

MAIL COUPON—TODAY SURE

Try it 10 Days FREE
**New PHONIC
 Reproducer**

Makes
 An
 Up-To-Date
 Phonograph
 out
 of
 your
 old
 one!



Gives the New Tone and Volume of
 Latest New Phonographs for only

\$3.85
 Direct
 from
 Factory

Now at last you can say goodbye to the squeaky, nasal, rasping, metallic tone of your phonograph. Now you can have the beautiful, natural, full rounded tone of the expensive new machines which are startling the world. Yet you need not buy a new phonograph if you have an old one. The reproducer is the HEART of any phonograph—and the New PHONIC reproducer makes your old phonograph like an entirely new one. Based on the new PHONIC principle. Makes you think the orchestra or artist is in the same room.

Never Before Such Tone

Tones never before heard are clearly distinguished when the New PHONIC reproducer is used. Test it on an old record. Hear the difference yourself. Listen to the deep low notes and the delicate high notes. Hear how plainly and clearly the voice sounds. Note the natural tone of the violin and the piano, and the absence of "tinny" music. You will be amazed. The new PHONIC reproducer is ideal for dancing or for home entertainments. Its volume is almost double that of the ordinary reproducer.

SEND NO MONEY 10 DAYS TRIAL

You cannot realize how wonderful the New PHONIC is until you hear it. That is why we want to send it to you on 10 days' trial. Send no money now—just the coupon. Pay the postman only \$3.85 plus a few pennies postage when the New PHONIC arrives. Then if you are not delighted, send it back within 10 days and your money will be refunded. If sold in stores the price would be at least \$7.50. Our price only \$3.85. Over 350,000 people have dealt with us by mail. You take no risk. Mail coupon now for 10 days' trial. **BE SURE TO STATE THE NAME OF PHONOGRAPH YOU OWN.**

NATIONAL MUSIC LOVERS, Inc., Dept. 5811
 327 West 36th Street, New York

Please send me a New PHONIC reproducer for.....

I will pay the postman \$3.85 plus few cents postage. If I am not satisfied after trial, I will return your reproducer within 10 days and you guarantee to refund my money.

Name.....

Address.....

City..... State.....

**Bean Expert Repairman
 on Motors and Generators**

Repair men are in big demand—particularly men expert in armature winding. Get into this well paid line.

Learn in 3 Months

—to master this work and insure yourself a permanent income and bigger opportunities—here at this Great Electrical School. In this short time you learn the theory and actually wind all types of D. C. and A. C. armatures under expert instructors.



Write for FREE Booklet
 —giving full particulars of this 3 Months' Armature Winding Course. Write today—you will not be cbltated. Address—

SCHOOL of ENGINEERING
 of Milwaukee
 R 386A Milwaukee, Wis.

DRAW CARTONS

Turn Your Talent Into Money

Cartoonists earn from \$50 to \$300 per week—some even more. Remarkable new Circle System of Drawing teaches you in half the usual time. Send for booklet and sample lesson plate explaining full details of the Course.

THE NATIONAL SCHOOL OF CARTOONING
 623 Penton Building Cleveland, Ohio



See
Free Offer
 on page 8

MINSTRELS Musical Comedies and Reviews, with full instructions for staging. You can stage your own show with our books. Full line of plays, stage songs, crossfire, monologues, afterpieces, vaudeville acts and make-up. CATALOGUE FREE
T. S. DENISON & CO., 623 So. Wabash, Dept. 19, CHICAGO

WHAT IS A BAR BELL?

A BAR BELL is simply a long-handled dumb-bell. It has many advantages over a pair of dumb-bells. For instance, it is far easier to handle a 50-lb. bar bell than two 25-lb. dumb-bells. Again, with a bar bell you can do certain back and leg exercises where it would be awkward to handle a pair of dumb-bells. The bar bell became

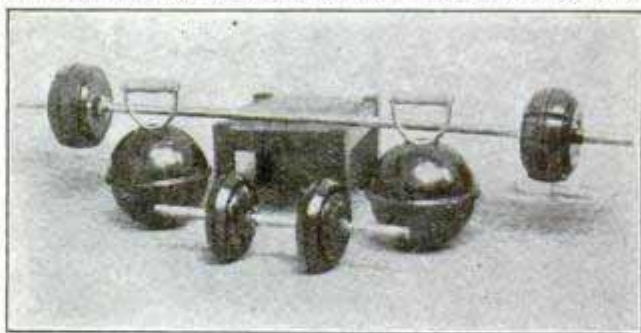

The Greatest of All Body Builders

when the adjustable feature was added—for then it became possible to employ the progressive method of exercise which has proven to be the only way in which a man of below average physique can gradually but steadily improve his build, his muscular development, and his stock of organic vitality until he becomes a physical superman—the very pattern of health, beauty.

USE COUPON FOR FREE BOOKLET

THE MILO BAR BELL CO.,
 Dept. P. M. 11-26, 2747 N. Palethorp St., Philadelphia, Pa.

Gentlemen: Please send me, without obligation on my part, your free booklet entitled "Health, Strength and Development and How to Obtain Them."

Name.....

Address.....

City..... State.....

You win, big boy!

Take it away!

We're going to say exactly that, in about three months, to somebody...maybe YOU. And then we're going to hand over *free*...AS A PRIZE...without a dime to pay on it...

This \$10,000 Hollywood Bungalow

*In the wonder city...Los Angeles!
In the Golden State...California!*

How? Who? When? What'd Mean?

YES, we know you're saying that... and perhaps a lot more. Because we've walked right into your favorite dream...that vision of living and prospering in the most livable, prosperous state of them all, California! What's more we've something real to offer that will make that dream come true.

But no more details...yet! We're taking this expensive page to find out **FIRST** if you have your aerials up, ready to tune in and listen to a great opportunity!

Give us the signal! It's the coupon in the lower right hand corner. Fill it out. Mail it. Then...put on your head phones and listen!

We will add this much. It is not a case of winning all or nothing. It's

something to sell out of California...not real estate or radios or anything like them...but something that will sell even faster. It is \$10 a crack...and you keep a big slice of the ten. There's any amount you want to go out for...from a few dollars a week to the **GRAND PRIZE**...that beautiful, ten-thousand-dollar, let-me-stay-here-till-I-die **HOLLYWOOD BUNGALOW!**

But now we're signing off until you come on the air! You'll get our wave length with this coupon. Don't oscillate! Just sign and mail it now!

LYNN GILLETTE PETERSON
728 S. Spring St., Los Angeles

I'm listening...and there isn't any static! Tell me how I can make some more money right where I am...and get a shot at that \$10,000 top-corner in Hollywood.

Name _____
Address _____

LYNN GILLETTE PETERSON

728 So. Spring Street, Los Angeles

Hawaiian Guitar FREE

Worth
\$18

When You Enroll

This Hawaiian Guitar expert and professor wants the opportunity to welcome you as a student so you will quickly learn how to play a Hawaiian Guitar—yes, you will be able to play just like the native Hawaiians. To get you started and help your musical success, which will bring you popularity, you will receive a beautiful Hawaiian Guitar, the same as the one pictured, free when you enroll. Our short cut method of instruction will enable you to play a piece almost from the first lesson. Rush coupon for full particulars today and we will reserve a gift Hawaiian Guitar for you.



Play Quickly

With our short cut method of instruction you will quickly learn how to play Hawaiian Guitar, which will bring you popularity and social success. You learn to play from notes. If you never had any musical training, you will quickly get on, because our nine experts have perfected a course of home instruction which is as simple as learning A, B, C's.

Picture and Phonograph Record Method Easy

We don't depend upon printed lessons only for your success, but we also furnish pictures of our professors playing, diagrams, charts and phonograph records for each lesson. This practically brings our professors from our studio to your own home and enables you to listen to their playing just as if they were actually in front of you. To prove this is easy, we will send you your first lesson free. Rush coupon now.

HAWAIIAN STUDIO No. 5211
of New York Academy of Music
100 Fifth Avenue, New York, N. Y.

Please rush your Free book, "How to Learn Hawaiian Guitar," and my first free lesson. Also reserve a gift Hawaiian Guitar for me. This obligates me in no way whatever.

Name.....
Address.....
City..... State.....

Practical Aviation

\$75.00 to \$200.00 weekly. Get into it NOW

Learn Practical Aviation at Home

Airplane companies are seeking men to pilot, service, and repair the thousands of airplanes that are flying every day. Men are also needed to design, build and sell airplanes.

Aviation is the booming industry—growing by leaps and bounds.

Many men will make big money in aviation in the next few years. Will you be one of them?

To get into this new industry you must know the airplane.

Learn From Men Who Know

Our course is the most complete and thorough ever published; directed by aviators who have flown hundreds of thousands of miles. They write in a way you will understand. You will learn all about an airplane; how it flies; its construction; its maintenance; and airplane engineering.

Lessons—drawings—questions easily mastered by anyone who can read and write.

Our easy payment plan aids you. We help you get a position.

Money Back Guarantee If Not Satisfied

Write for FREE Illustrated folder telling how you can get into aviation

Address Dept. D

UNITED STATES SCHOOL OF AERONAUTICS

MAYWOOD, ILLINOIS

Near the Chicago Air Mail Terminal Field

BIG MONEY IN GARMENT AND FUR DESIGNING

Earn \$75.00 to \$500.00 Per Week

MEN AND WOMEN Learn Quickly by PARRY SYSTEM

Garment-designing is a wonderfully interesting, clean, high-salaried profession. The PARRY SYSTEM of practical training is well-known and endorsed throughout the clothing and fur industries. Big demand for trained men and women. **No Previous Experience Needed** Our training will qualify you in only 8 happy weeks to hold a BIG-PAY job as an *Expert Style Creator*. **Free Railroad Fare to Chicago**—For a short time only, we'll allow you R. R. Fare when you pay tuition, if you mail the coupon promptly.

Write Today PARRY GARMENT-DESIGNING INSTITUTE Dept. 108, 19 S. Wells St., Chicago, Illinois

Mail This Coupon Now

R. H. Parry, Director, PARRY GARMENT-DESIGNING INSTITUTE
Dept. 108, 19 South Wells Street, Chicago, Illinois
You may send FREE particulars of Designing Course checked.

MEN'S GARMENTS WOMEN'S GARMENTS FURS

Name.....
Address.....

12 Wonderful Weeks in Chicago

—then *BIG PAY* for Life!

The most enjoyable 12 weeks you ever had await you here. And by far the most profitable. For this fascinating training means thousands of dollars to you. Take either Electrical or Auto course. Send coupon below now for big free book and offer.



Scene in radio department. Here you can fit yourself for commercial operator's license if you wish. We teach code as well as theory. Thoroughly practical from start to finish—as is the entire Greer training.



View of part of the interior of the bungalow for practicing house wiring—right in the Greer Shops. You learn here by real experience—with an expert always at hand to show you how.



One of the first lessons in the 'Automotive shops' is on this "split chassis." Every working part shows. Just an example of the equipment that makes Greer training so simple, easy and practical.



Using the "Weaver Crane" in the Automobile repair department. Here you learn about all up-to-date auto equipment—by actually using it. Real experience on all makes of cars, under supervision of an expert.



Learn to boss the job the Greer Shop way

ELECTRICAL ENGINEERING

Learn How to Earn \$65 to \$200 Per Week

Right now—this fall—is your time to get a jump ahead of the fellows who haven't the nerve to leave home. You are interested in Electricity. You want to make Big Money and enjoy life. Right here is your big chance.

Practical Men Needed

The demand for electrical men is growing faster and faster. More and more railroads are being electrified. Everywhere power companies are reaching out farther. They have now actually started the tremendous task of *electrifying the farms*. Think what these developments mean to you! With this Greer training you will be a valuable man. You will get bigger pay

AUTOMOTIVE ENGINEERING

If interested in autos, trucks or tractors, by all means get our big, free, auto book at once. The coupon below will bring it by return mail. You will find it full of valuable information about making your start in the auto business. Read letters—in this book—from some of the 50,000 men, who are now successful and happy—thanks to Greer training.

Real Auto Experience

You learn in the Greer Shops by actual *doing*—first on the marvelous shop equipment, and later on customers' cars, left for overhauling and repairing. Always under supervision of an efficient, friendly instructor. Every step is made simple and

easy. Individual instruction. You go ahead as fast as you are able. No one is held back by some one else being slow.

Learn Any Branch

After you have the general training needed, you may specialize in any branch you wish, such as vulcanizing, trouble shooting, starting and lighting storage batteries or general repairing. There is great demand for men who *really know*. Hundreds of Greer trained men now own their own shops. You can do the same if you wish—starting on a small scale, as soon as you finish this training. Don't miss this chance by waiting. Send the coupon *now* while you have it before you.

Greer College of Automotive & Electrical Trades

CHICAGO, ILL.

FREE Employment Service

Our employment department is ready to help you—while in training and for life. Day and evening classes. Low cost. Easy terms.

ERWIN GREER, President, Greer College
Dept. 1101, 2024 S. Wabash Ave., CHICAGO.

Please send me your FREE BOOK and offer for Electrical course
It is understood I am not obligated in any way Automotive course

Name

Address



FREE RAILROAD FARE TO CHICAGO IF YOU ACT PROMPTLY



Get into the electric wiring field—big money for you

Great demand in wiring field. These books prepare you. **KINKS**; helps; short cuts; practical, on-the-job electrical data, written particularly to help wiremen, trouble shooters, maintenance men, armature winders, electrical contractors and students. The whole wiring field covered; concrete and usable details about new and better ways for doing the kind of work you have to do.

American Electricians' Library
6 volumes, 2000 pages, illustrated, \$16.00 payable \$2.00 in ten days and \$2.00 a month

The books tell you all you must know about conduit wiring, armature winding, wiring for lighting circuits and switches, wiring for machinery, circuit troubles, circuit testing, or electrical machinery erection. Through a study of this great set you can push yourself into a big-pay job for life.

See it FREE — Send no money — ACT

FREE EXAMINATION COUPON

McGraw-Hill Book Co., Inc.
370 Seventh Avenue, New York

Send me the American Electricians' Library for 10 days' free examination. If satisfactory, I will send you \$2 in 10 days and \$2 monthly until the full price, \$16, is paid. If not wanted, I will return the books at your expense.

Name

Address

Position

Company P.M. 11-1-26

Learn



Aviation

At Home in your spare time.
Be an expert Airplane Engineer.

Earn \$3,500 to \$10,000 a Year

Practical course—takes only a few months. Write for special offer on free airplane parts and free catalog.

WESTERN AIRPLANE CORPORATION
Dept. M-11 Menadnock Block CHICAGO

Make Furniture At Home



—either for your own pleasure or to sell. It is easy when you have the instructions supplied in Popular Mechanics Home Furniture Making Library. This library consists of the following cloth-bound, profusely illustrated books of which many thousand have been sold to satisfied customers everywhere:

1. Mission Furniture—Part 1
2. Mission Furniture—Part 2

These two practical, money-saving books contain full directions and drawings for the making of all sorts of furniture, including tables, chairs, stools, davenport, electric table lamps, and many other useful and beautiful articles of furniture. Crystal clear instructions in 2 handy books; 240 pages—123 illustrations. Just follow directions and you'll be amazed at your good results. Use the furniture in your own home or sell it. One man writes he

sold over \$1,000 worth of furniture made from these books. You can do the same.

Send No Money! Just write a postal asking that Popular Mechanics Home Furniture Making Library be sent you C. O. D. When the postman delivers the books, simply hand him \$1.98 plus the few cents postage. Money refunded if not delighted.

POPULAR MECHANICS PRESS
Popular Mechanics Bldg., Room 611, Chicago, Ill.

Handbook for Farmers

861 discoveries by practical farmers, telling how to make, repair or improve the various devices and machines used about a farm or garden. 683 illustrations. "The Most Remarkable Book Ever Published for Farmers," says one authority. **Send No Money.** When the postman delivers the book to you, hand him \$1 plus the few cents postage.

POPULAR MECHANICS PRESS
Popular Mechanics Building, Room 611, Chicago, Ill.

See **Free Offer** on page 8

Let us recommend the best books to study on any subject
POPULAR MECHANICS PRESS, CHICAGO, ILLINOIS



BECOME A RAILWAY MAIL CLERK

When everybody else is worrying about his job or looking for work, the U. S. Civil Service Employee is earning good, steady pay in a pleasant occupation of his own selection. **EARN \$1900 to \$2700.** Let me train you to pass the U. S. Civil Service Examination with high rating so you can get a position quickest at \$1900 to \$2700 a year as a Railway Mail Clerk or in Customs, Internal Revenue, Departmental, Immigration, Postmaster, Post Office and Rural Branches. I have trained thousands to successfully pass the examination. Money refunded if unsuccessful in securing a position within one year after exams. Examinations coming. Write today. Mail coupon for catalog.

PATTERSON CIVIL SERVICE SCHOOL
Dept. 811 ROCHESTER, N. Y.

Patterson
Civil Service School
Dept. 811, Rochester, N. Y.

Sir, Send me without charge your catalog describing this and other U. S. Government Positions.

Name.....
Address.....

Can you fix it

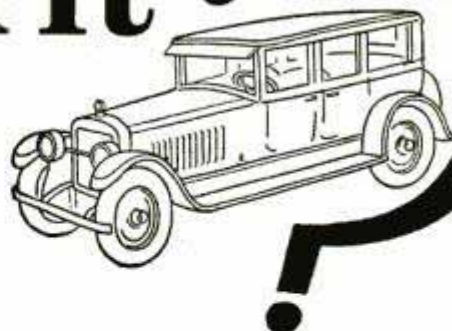

New books have "jiffy index," making all facts instantly available. You find anything you want to know in a moment in this brand new 1926 edition.

These books tell how

HERE are the most interesting, the most practical books we have ever published on automobile construction, operation and repairs. Brimful of facts, photographs and explanations so easy to understand that anyone can learn how in almost no time.

Over 2000 pages, with diagrams, blueprints and everything else needed to make anyone an authority on automobiles.

Whether you want to qualify as garage owner, auto repair expert or merely wish to know how to keep your own car 100% efficient, you will welcome these books, especially on our

No Money Offer

This plan brings this valuable information within the reach of everyone. You don't send us a single penny. You don't have to pay us anything—just send your name and address and we'll send you the complete set of 5 volumes, specially bound in Flexo covers.

Read them carefully; keep them 10 days; find out anything you want to know, and then if you want to keep them, send only \$2.00 then and \$3.00 per month until the special low price of \$24.80 is paid. There is no further obligation.

American Technical Society Membership Free

This is a great organization for the publishing and spreading of specialized knowledge—we have over a million dollars of resources, enabling us to get the co-operation of the largest automobile manufacturers and dealers, who have furnished us plans and photographs. If you send NOW for this new edition of Automobile Engineering, we will include a Consultation Membership in this great organization.

EMPLOYMENT SERVICE FREE

In addition to all this, those who send now will be entitled to the service of our EMPLOYMENT DEPARTMENT without charge. We are in daily contact with firms all over the country who need good men and are willing to pay big. This service costs you nothing. Don't miss this special offer. Send now.

Eighteen automobile experts will be ready to help you at all times. You can write or wire any time for special information. Answers will be sent to you promptly—without cost.

Don't Hesitate

There are no strings to this offer—it means just what it says. Send name and address on the coupon and ALL of the five books—the complete set—will be sent to you for examination.

Remember one fact only which you can find in these books may save you an expensive repair or help you to a better job.

Learn All About Autos

Get these five big books on this liberal offer and learn all the things you want to know about autos. Carburetors, engines, springs and spring suspension, brakes, 4-wheel drives, lubrication systems—all are fully covered.

These complete and comprehensive auto books are yours if you want them on this easy plan. Send for a set NOW; there's nothing to pay.



You don't have to read the books through; the index enables you to put your finger on the information wanted in a jiffy.

For Free Offer, Use Coupon

American Technical Society,
Spec. Dept. A-819, Chicago, Ill.

I would like to look at the 5 Auto Books described above. Send them on your FREE offer. I will examine them carefully and return them in 10 days unless I like them; in which case I will send you \$2.00 then and \$3.00 per month until the total price of only \$24.80 is paid. I am entitled to the services of your employment department without charge. You are to also send me Free Consulting Membership Certificate in the American Technical Society.

Name.....

Street.....

City..... State.....

Reference.....



Choose as Your Profession Electrical Engineering

Electricity offers a brilliant future to the young man who is about to choose his career. Never before has there been such wonderful opportunity in this great field. Big paying positions in electrical work the world over are open to trained men—men who possess specialized, practical knowledge. Come to the School of Engineering of Milwaukee—the largest and best equipped electrical school in America. Here you are trained in both theory and practice by a faculty of experts. You learn in large, finely equipped laboratories. If you have 14 high school credits or equivalent, you can become an Electrical Engineer with a Bachelor of Science degree in our institute of Electrotechnics in a short, intensive course.

**B.S. Degree
In 3 Years**

A Complete, Practical, Electrical Education

Learn by the thorough approved scientific methods which our twenty years of specializing enable us to give you. In addition to Electrical Engineering, the following complete courses are given: **A. C. and D. C. Armature Winding—Wiring and Testing—Practical Electricity—Drafting—Electrotechnics—Commercial Electrical Engineering—Automotive Electrical Engineering and Automotive Electricity.**

Earn While You Learn

By our special system you may earn part of your way while learning. Our Employment Department will secure you a position to which you may devote a part of each day, spending the remainder at the school. This plan both solves the students' financial problems and provides splendid experience at the same time. **New Term Begins Nov. 8**

Write for FREE Catalog

Write today for our free, illustrated catalog. Read about this wonderful institution and the great opportunities that lie before you. Find out about our specialized method of training and the details of our "Earn While You Learn" plan.

**SCHOOL of ENGINEERING
of Milwaukee**
FOUNDED 1905
Dept. R386 415 Marshall St., Milwaukee, Wisc.

SCHOOL OF ENGINEERING OF MILWAUKEE
Dept. R386, 415-17 Marshall Street, Milwaukee, Wis.

Without obligating me in any way, please mail free 72-page illustrated book, "Electricity and the One Best Way to Learn It," and particulars regarding the course I have marked with an X.

- ... Electrical Engineering.
- ... Electrotechnics.
- ... Commercial Electrical Engineering.
- ... Automotive Electricity.
- ... Auto Electrical Service Engineering
- ... Radio Sales and Service.
- ... Armature Winding.
- ... Light, Motor Wiring and Testing.
- ... Home Laboratory Service.
- ... Practical Electricity.

Name Age

Address

City State

Education



H. G. STEWART

\$14,400
[In 6 Months]

H. G. Stewart made that amount in a new kind of real estate business, that is giving ambitious men and women more money than they ever thought possible. Learn the secret of their success. Use the same money-making system. Start a big-profit business of your own—right at home—in your spare time—without capital or experience. Full particulars and positive proof of amazing, money-making success, **mailed free.** Send for it today.

American Business Builders, Inc.
(Authorized Capital \$500,000)
Dept. 44K, 18 East 18 Street, New York



Don't Let Anybody BULLY YOU

Learn Scientific Tricks
of Physical Mastery

By a few simple tricks you can have any assailant at your mercy quick as a flash. The astounding secrets of self-defense, used by the New York Police, are revealed in the marvelous, officially recognized system—

Captain Wallander's Course All Complete In Physical Training Manual By Capt. A. W. Wallander

Commander Physical Training, New York Police

A complete course in physical culture. Scores of gripping action photos showing just how to throw a bigger man and overpower him—disarm a hold-up thug—build up muscle—keep in fighting trim. Hundreds of health hints, too; care of the feet, prevention of colds, correct posture, walk without fatigue. This is the genuine book used by the New York Police, now available TO YOU.

Easy to Learn Let Capt. Wallander give you his great secrets and detective tricks. You'll hardly believe that such valuable knowledge could be learned so easily.

ALL YOURS IN WORLD'S MOST AMAZING COURSE

In Physical Culture and Police circles this volume is world famous. Send immediately for your copy. **DON'T SEND MONEY NOW.** Send coupon today. When volume arrives, pay the postman \$1.97, plus few cents postage. If you are not satisfied return volume and get money back. **\$1.97**

SIEBEL PRESS, 34-A W. 20th St., New York.
Send me Capt. Wallander's Physical Mastery Course as contained in the "Physical Training Manual."

Name

Address

City State

(\$2.25 U. S. Cash with order in all other countries)



Own this TYPEWRITER!

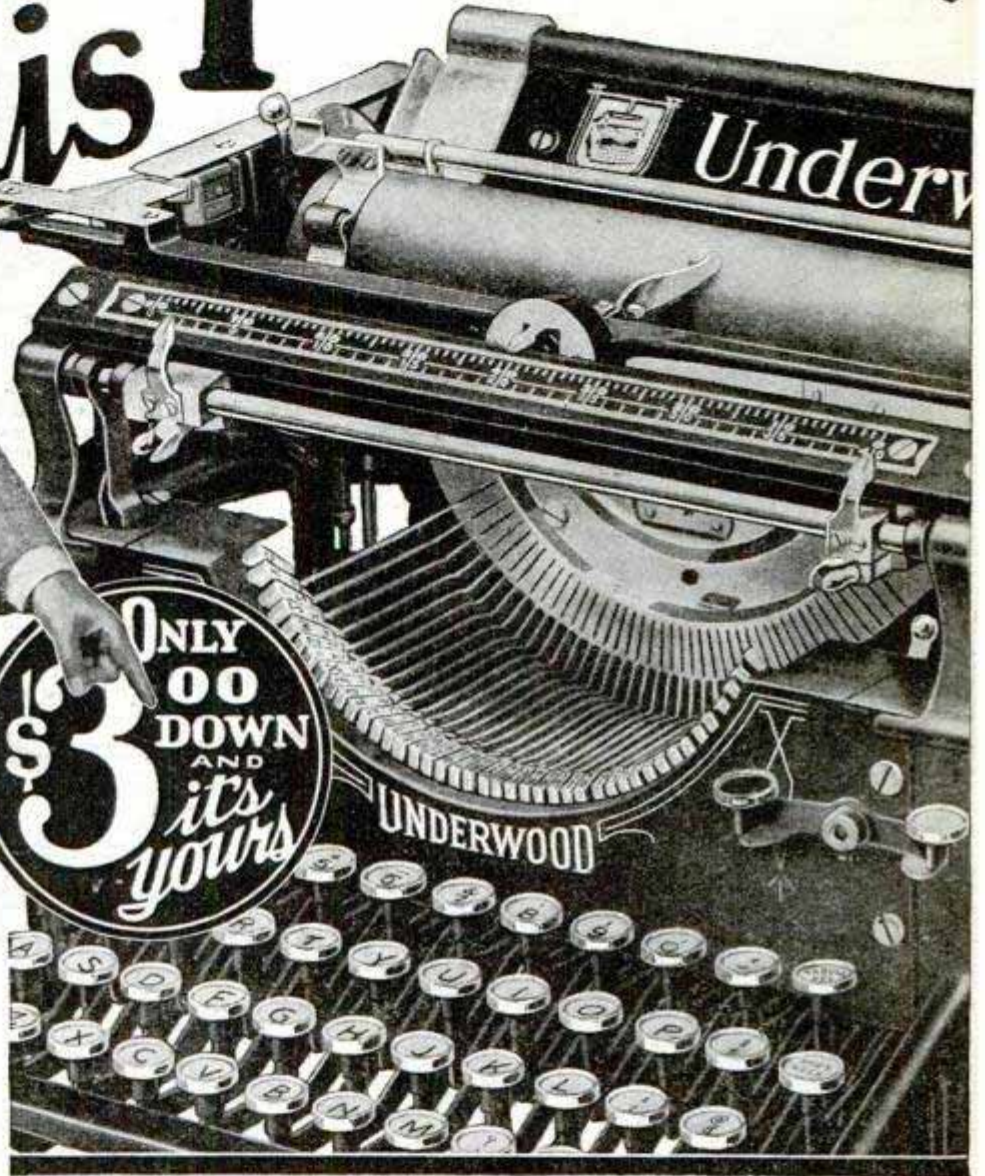

GENUINE UNDERWOOD TYPEWRITER

ONLY \$3.00 DOWN AND it's yours

Now is the time to get your typewriter! Be up-to-date—know the pleasure and convenience of having one in your own home. You'll be amazed at the uses everyone in your household will find for this real Underwood typewriter.

Every One Can Use a Typewriter

Every member of the family will use and enjoy it! Act now and get this ace of writing machines! Don't send a cent—but do get our big special offer—our valuable book on typewriters and typewriting—*free*. You can learn to write on this standard-keyboard machine in one day. A week after the expressman has brought it, you'd feel *lost* without it. A trial will *prove* it—and doesn't cost you a penny!

Send No Money Now

We don't want a penny now. Nor any money at all unless this proves the typewriter bargain of your life. The trial is *FREE*. If you buy, our easy terms make it a pleasure to pay. There's no excuse now, for not

owning a typewriter—and the finest make! We include all tools, cover, etc., all complete, all ready to write. Write us now. Deal direct; we are the largest factory of the kind.

If you know typewriters, you know the perfect work and the ease and speed of an Underwood. If you have never owned a typewriter, start with the finest! You can try this one at our risk. But, the time to act is *NOW*. Don't miss out on this present bargain offer. Don't do longer without the convenience of a typewriter.

Free Trial Offer

Our plan gives you the opportunity of a *thorough trial* before you buy. You run no risk whatever. You start to pay for your typewriter *after* you have found it the only machine for you! But get the facts before this lot of machines is all in use. Clip the information coupon before you turn the page. It will pay you! Note the very useful book you will receive *free*! Write for full particulars at once.

EASY TERMS FREE!

Pay Like Rent

You pay only \$3 down you get the machine. The balance is divided into such small monthly payments that you will never miss them. We have made it very easy for you to own a typewriter now.

FREE! Get our typewriter book free: Lowest prices and terms. We also give free with each machine a typewriter manual giving valuable instruction for learning rapid typing, useful pointers for all who use a typewriter, business forms, social correspondence, work for others, etc. Also all tools *FREE*. Clip coupon *NOW*.

Mail to SHIPMAN-WARD MFG. CO. 2128 Shipman Building, Chicago

Please send me full offer, with Typewriting Manual *FREE*, prices, terms, etc., and full information about your *FREE* course in touch Typewriting. All without obligation; this is *NOT* an order!

Name _____

St. or R. F. D. _____

P. O. _____ State _____

LEARN AUTOS IN LOS ANGELES

Auto Jobs Pay \$40 to \$125 a Week!

You are urgently needed to help repair the one and a half million autos in California. Trained auto repair men are also needed badly in every other state. The rapidly increasing number of cars means prosperity and big pay for auto men—more garages, tire shops, battery stations are needed. You can be one of the highly paid men in this fastest growing industry—if you get the right training.

YOU CAN BE An Auto Expert!

National Automotive special, practical Shop Training makes it easy for you to become an Auto Expert. In a quarter century this great institution has trained

16,000 men for bigger pay. It will help YOU make more money by giving you individual instruction on repairing Packards, Buicks, Cadillacs, Fords, etc., all types of electrical equipment, machine shop equipment, etc. You learn everything RIGHT at National.

Paul Briggs Earns \$4000 a Year

"I want to thank you for the big part National has played in helping me to success in auto work. I am now assistant sales manager and made \$4,000 this year — which is more than I would have made in three years at my former work." — Paul Briggs, Portland, Ore.

Money - Making Book

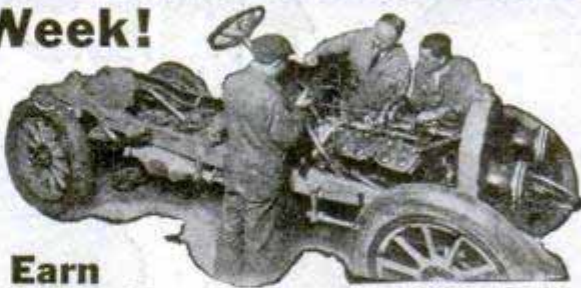

Earn While You Learn

Free employment service. Spare time jobs help pay expenses while training. All tools free. No extras. Send for big free illustrated catalog explaining how National trains you for bigger pay. Learn the opportunities for you in California. Mail coupon now.

Million Dollar Training Headquarters for Auto Experts



NATIONAL AUTOMOTIVE, Dept. 400, 4006 Figueroa St., Los Angeles, Calif.

Send me, absolutely free, your big illustrated catalog of Automotive Opportunities.

Name.....

Address.....

City.....State.....



Helpful IDEAS for Home Owners

In these two practical books, you will get 502 ideas that will be helpful in making your home a better place to live in—a home to be proud of. The ideas are for the making, improving and repairing of the devices needed about and in the home. The books are:

1. Home Mechanic's Handbook No. 1
2. Concrete Handbook No. 1

These books tell how to make most everything, from door steps to a refrigerator, and from a concrete sidewalk to a lawn fountain.

Send No Money Simply write a postal and ask that Popular Mechanics two Homeowner's books be sent C.O.D. When the postman delivers the books to you, hand him \$1.00 plus the few cents postage.



POPULAR MECHANICS PRESS

Popular Mechanics Bldg. Room 611 Chicago, Ill.

Mathematics Made Easy by ROPP'S CALCULATOR AND SHORT-CUT ARITHMETIC

Shows the Answer as Quickly as a Watch shows the Time to all Problems likely to occur in the Office, Store, Shop, Bank, Farm, or Factory. **Sold Over 2,000,000**

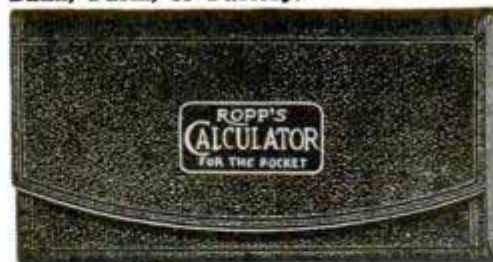

Explains and simplifies every principle in Arithmetic, Mechanics, and Mensuration.

- PRICES POSTPAID**
- Desk Size...\$1.50
 - Leatherette, Pocket Size...\$1.00
 - Cloth...\$0.50
 - Pocket Size, Paper...\$0.35

Popular Mechanics Press, Room 611, 200 E. Ontario St., Chicago

See Free Offer on page 8



"Due to your well prepared training, I received my appointment eight days after my name was placed on the register." David W. Tucker

WORK FOR "UNCLE SAM" \$1700 to \$3000 Year

RAILWAY POSTAL CLERKS MAIL CARRIERS

TRAVEL—See Your Country MEN, BOYS, 17 UP SHOULD MAIL COUPON IMMEDIATELY

Steady Work No Layoffs Paid Vacations



RAILWAY MAIL CLERKS

FRANKLIN INSTITUTE Dept. C177, Rochester, N. Y.

Sir: Rush to me without charge (1) Specimen Railway Postal Clerk and Mail Carrier Examination coaching lessons. (2) FREE 32 page book with list of U. S. Government positions obtainable.

Name.....

Address.....

ENCYCLOPEDIA BRITANNICA

in the New Form—at a saving of 40 per cent Write for full details

THE ENCYCLOPEDIA BRITANNICA, INC. 342 Madison Ave., New York City



Day Mister — You're Losing Half Your Gasoline!

For every ten gallons you buy you are losing five! That's a startling statement, but true. You are getting just half the power, half the mileage you should out of your gasoline! For now an amazing invention—a ridiculously simple little device—makes any car give twice its regular mileage to the gallon! And now the inventor will send you a sample at his own risk. Read his offer below.

Earn \$250 to \$500 a Month

AND now this amazing new invention is making fortunes for agents and distributors. Now you, too, can make big money—just telling your friends about it. J. M. James made \$120 in one day! Vernon Gaines netted \$94 in eight hours. J. W. Cronk made \$51 in just ONE HOUR! You should easily earn astonishingly big profits in full or spare time.

Fits Any Make or Model Car

Here's how this wonderful little device works—how it adds more power and mileage to any make or model car. Every carburetor is adjusted to make starting easy. But once the engine gets heated up the mixture is far too rich, resulting in a raw state and, instead of exploding, it burns. This causes a heavy deposit of carbon.

But with this startling little device in a car all this is changed. As soon as the engine warms up this device automatically begins to admit a much larger volume of air, thoroughly vaporizing all the gasoline, giving it fully 50% more power—breaking it up so that it explodes instead of burning.

A Carbon Remover

Not only does this invention save half the gasoline, but it also saves the expense and time of

having carbon scraped out—a job costing from \$5 to \$25.

Introductory Sample Offer

To introduce this new invention, Mr. Stransky, the inventor, will send a sample at his own risk. Not only that, but he will actually pay you for testing his Vaporizer if you are not delighted with it! Write at once for his proposition.

The demand for the Stransky Vaporizer is enormous. Agents handling this device are simply coining money. Every auto owner in the country—and there are twenty million of them—wants this splendid new invention the minute he sees it. You can sell from five to twenty in one demonstration. Splendid for spare time work. Many former agents are cleaning up enormous incomes as distributors and crew managers.

Just send the coupon at once for full details of our introductory sample offer. Be the man to cash in big in your community. Mail the coupon right now—today.

MAIL THIS COUPON TODAY

J. A. Stransky Mfg. Co.,
P-10 Stransky Bldg.,
Pukwana, South Dakota.
Tell me how I can get samples of the
Stransky Vaporizer at your risk.

Name.....
Street or R. F. D.
City.....State.....

**\$51 in
an Hour**

The Stransky Vaporizer is one of the biggest sales propositions of the century—you can make big money quick. But don't take our word for it. Read what these men say. J. W. Cronk made \$51 in one hour. He says: "The results of one hour's work—17 men gave me orders for the vaporizers."

\$120 in One Day!

I have found out that the Stransky will do what you said it would. I took forty orders in one day and wasn't out long. My Ford runs better than it ever did. I can save half the gas and it pulls better.—J. M. James.

\$48 in 3 Hours

My gas bill has been cut nearly in half. I have removed every particle of carbon from my engine. Since I installed it my engine runs as good as new, starts easier and quicker. I went out Saturday about three hours and secured 16 orders.—J. A. Williams.

ONE MILLION Satisfied Users

Ford Runs 60 Miles on a Gallon

I made approximately 60 miles on a gallon of gas in a Ford sedan, as I made 15 miles on one quart of gas.—O. C. Zeigler, Pa.

32 Miles with Buick

Vaporizers installed on both Buick and Ford are doing wonderful work; getting 32 miles on Buick and 51 miles with Ford.—Harvey C. Hippel.

J. A. STRANSKY MANUFACTURING CO.

P-10 Stransky Bldg.
Pukwana, So. Dakota



In This Fascinating Profession

NEVER before in the history of the country has the hotel profession progressed as rapidly as it has in the past few years. In 1926 alone 6,698 new hotels and clubs were built at a cost of over a billion dollars. A conservative survey of the employment situation in America's 4th Largest Industry shows that there will be 151,944 high-salaried executive hotel, club and restaurant positions open this year alone!

Train for a Big-Pay Position Right at Home!

Thru the Lewis Hotel Training Course you can quickly qualify for a fascinating high-salaried hotel or restaurant position. Age is no obstacle. Past experience absolutely unnecessary. A common school education is all that you need. And remember, the complete Lewis Course is taught under our absolute guarantee of "satisfaction or money back."

We Help to Place You!

Our National Employment Bureau is constantly in touch with preferred positions throughout the United States. In 6 months we placed 4,752 students in contact with well-paid positions throughout the country.

Free Book Gives Full Details

This is your chance to "make good" in a new, rapidly expanding profession that offers you fascinating work, big pay and unlimited opportunities for advancement. Don't let it slip by. Mail the coupon NOW for Free Book, "Your Big Opportunity," which gives full details about this wonderful profession.

Lewis Hotel Training Schools

Clifford Lewis, Pres.
Room B-326, Washington, D. C.

PROOF!

"I have secured the position of Housekeeper at Log Inn. I will endeavor to be a credit to your training." — Virginia M. Moran.

"Just a line to inform you that I am now Manager of the New Central Hotel. I surely have gone up the ladder some in only four months' time and received a substantial raise in salary." — Martin L. Hecht.

"Mr. Van Orman advised me a few days ago that I was to be Manager of the Hotel Orlando." — L. E. Kirkpatrick.



OPPORTUNITY COUPON

Lewis Hotel Training Schools, Room B-326, Washington, D. C. Kindly send me, without obligation, a copy of the Free Book "Your Big Opportunity," with full details of the Free Registration in your National Employment Bureau.

Name.....
Address.....
City..... State.....



Send No Money

Shop Notes

393 Articles FOR 1926 517 Pictures

This announcement has been eagerly awaited by thousands because they have learned that each yearly issue of Shop Notes contains dozens of short cuts that save time and money. Every article is written by some man who has tried the idea and found it worth money. The variety of subjects covered is one reason why so many folks buy Shop Notes each year. In many ways the 1926 issue surpasses previous numbers. The following brief list will give you an idea of the variety of subjects covered.

SOME OF THE SUBJECTS

- | | | |
|--------------------------|------------------------------|----------------------------------|
| Auto repair tools | Machine shop practice | Printer's aids |
| Farm equipment | Well drilling discoveries | Dairy equipment |
| Service station ideas | Garage equipment | Electrical equipment |
| Shop tools | Poultry raising helps | Machinist's tools |
| Blueprinter's helps | Sheet metal worker's helps | Contractor's aids |
| Merchant's shortcuts | Concrete working ideas | Small-shop machines |
| Pain's formulas | Special grinding attachments | Tool boxes |
| Ice harvester | Tree protectors | Best repair suggestions |
| Builder's equipment | Carpenter's shortcuts | Photographic discoveries |
| Emergency heating plants | Painter's equipment | Auto trailer |
| House-moving suggestions | Home-made bench saw | Welding equipment |
| Making magnetic chuck | Draftman's secrets | Overcoming dredging difficulties |
| Storage battery kinks | Store room time-savers | Septic tank |
| Merchandise display | Electrician's methods | Using twist drills |
| | Lathe fixtures | Pulley and gear speeds and sizes |

5,510 Ideas on All Shop Work

There are now 14 volumes of Shop Notes available. And this unrivaled library of shop helps may be had for a special price of \$6.50. If you do not have the back numbers of Shop Notes, you should purchase the entire library. The following are now available:

- 1908, 1912, 1913, 1914, 1916, 1917, 1919
1920, 1921, 1922, 1923, 1924, 1925, 1926

Amateur's Guide PROFESSIONAL'S HANDBOOK

Both amateurs and professionals find Shop Notes of wonderful value. The articles are so clearly written and so thoroughly illustrated that even a boy can follow them. Teachers of Manual Training should have the complete library.

SEND NO MONEY

Don't send a penny. Just fill in the coupon with your name and complete address, indicate whether you want the whole library or the special offer of 1926 Shop Notes and Lathe Handbook for 98 cents. When the books are delivered to you, pay the few cents postage and deposit price of books with postman.

SPECIAL OFFER COUPON

POPULAR MECHANICS PRESS,
200 E. Ontario St., Room 611, Chicago, Ill.

Send me, as per your special offer, the following books. I will pay postage and the price of books when they arrive. My money will be refunded if I am not satisfied. (Check what you want.)

1926 Shop Notes and Lathe Handbook, 98 cents Complete Shop Notes Library (14 vols.) \$6.50

Name.....
City..... State.....
Street and No.....



Ruptured Runner Tells Secret!

WHAT an amazing invention! I could hardly believe my eyes when I saw him on the track again, running with the same beautiful stride, appearing to be in the best of condition. Only four months before, this man, in an unfortunate accident, had been badly ruptured. And a deplorable affliction it was. I remember distinctly how the team mourned the loss and how he himself had expressed little hope of ever competing in athletics again. But there he was, sprinting up and down the track as lively as ever. You can imagine my amazement.

It was not until the following day, that I learned the real truth of the matter.

"Your operation must have been a great success," I said feeling reasonably sure that he had gone under the knife.

He smiled. "I never had an operation in my life." was the reply.

"But how on earth—?"

"Let me show you something," he broke in.

I examined the injured spot and, to my astonishment, found it almost entirely gone. And then I learned how an amazing little invention not only effectively seals rupture, giving a large degree of safety to those who exercise, but also often heals it, and puts one well on the road to recovery.

My friend, don't be a truss victim another day. Now you can throw away forever these dragging, weighty cushions or chafing leg straps. At last there has been discovered a new and entirely different way to treat rupture which does away completely with cumbersome, ineffective old-fashioned devices. You can run, jump, climb, swim, and partake of all sports in far greater security than you have ever known before. Magic Dot is the only real forward step in the non-surgical treatment during the present century. And now, because I am going to make it so easy for you to have this astonishing method, to examine it yourself without the risk of a penny, I know you will not let another day pass without taking the first step, to learn the astounding facts of this new discovery.

Surgery Not Always Necessary

For years, John G. Homan, member of important scientific organizations worked patiently to develop his remarkable invention. The final results, prove beyond question that hernia not of too long standing can often quickly, surely and safely be

healed by aid of Magic Dot. Old Fashioned trusses and similar devices exert such great pressure on the injured spot, that the free circulation of healing blood is almost completely shut off. Magic Dot, weighing less than 1-25 of an ounce, acts in support of the rupture to allow the more free circulation of healing blood.

New Revolutionary Invention

Relief and comfort *can* be yours! Just think—a tiny disk not much larger than a quarter, weighing almost nothing at all, effectively seals the hernia and makes possible a support so light that you hardly realize it is being worn. Wouldn't you like to be reasonably secure from the "coming down" of the rupture—when running, straining, exercising, sneezing, etc.—which too frequently leads to strangulation?

Try Magic Dot Free

You will be greatly surprised when you learn the details of this amazing discovery. It is not a plaster-pad or an obsolete cushion or any other makeshift sold under a trick name. So great has been its success that I am offering for a limited time to send it to anyone for free examination. I want you to test Magic Dot. I want to give you the full particulars of this offer. Simply write asking for Free literature or mail the coupon below immediately.

JOHN G. HOMAN

New Science Institute,

2130 Clay Street,

Steubenville, Ohio

JOHN G. HOMAN,
New Science Institute,
2130 Clay Street, Steubenville, Ohio.

Please send at once your free literature and free offer by which I can learn about the New Science System.

Name.....

Address.....

City.....State.....

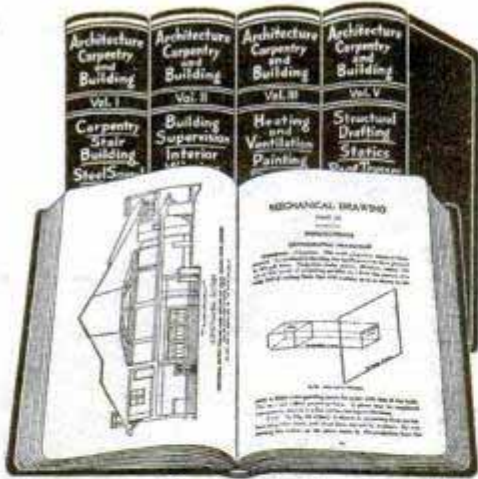

Brain Tools

For Architects, Draftsmen, Carpenters, Contractors, Builders and all who expect to build

Men who work with their hands know that headwork gets them more money.

Brain tools make the tools in your tool box at least twice as effective, and the best brain tools you can get are good books—not just any books, but books which tell you the things you want to know, and do it instantly. Carpenters make themselves contractors by learning how to estimate correctly. Contractors are able to handle bigger and more profitable jobs by learning how the big fellows do it, and architects and those who want to enter this highly paid profession earn more money by having facts and figures at their finger tips. This brand new set of five handsomely bound books covering all phases of architecture, carpentry and building, enables you to get authoritative, specialized information in a moment. No tedious long hours of reading—no hard grinding study, but instant reference to the vital facts. You don't waste a minute—the new jiffy index puts before your eyes, without wasted time, the things you want to know.

The most complete work of its kind we have ever published; nothing has been overlooked. Use of tools—building construction, heating, lighting, plumbing, architectural drawing, blueprint reading; in short, the most comprehensive and easily understood work of its kind.

These Books Sent FREE

Yes, this is true. We ship them to you without a penny of down payment. When you get them, look them over carefully—note how easy it is to find what you want to know—test the index in any way you want to and then, if after 10 days you agree that you have at hand a veritable mine of invaluable information, send only \$2.00 and keep the books. After that send us only \$3.00 per month until the small total of \$24.80 is paid. For a short time we will include with each set a complete portfolio of the five basic orders of Architecture. These 58 beautifully illustrated plates are drawn to scale and carefully figured. Size of each 11x15 inches. You'll thank the day you sent for your set.

Learning Means Earning

and here you have at hand information gathered from hundreds of experts, all for so small a sum you'll never miss the money. Use these books as others have done and you'll get many times their price in a few months. One job alone may repay you several fold. Send for your set today.

FREE EXAMINATION COUPON

AMERICAN TECHNICAL SOCIETY
Dept. G-819, Chicago, Ill.

You may send me, entirely without obligation, this handsome set of 5 volumes—Architecture, Carpentry and Building. I am to have full ten days in which to look them over and decide if I want to keep them. After which I will either send them back or send \$2.00 down and \$3.00 per month until the special price of only \$24.80 has been paid. Please include FREE the portfolio of 58 handsome plates.

Name.....
City.....State.....
Reference.....

Learn Electricity

Make your successful future a certainty. We teach by practical work and scientific methods under practical working conditions. Specialists for 15 years in training young men for

Electrical Engineering With B. S. Degree in Three Years

A place for every student regardless of age or education. Up-to-date laboratories—faculty of 90 experts; individual instruction. "Earn while you learn" system. Low tuition; athletics and student activities. Write for latest catalog and full details. New term soon starting.



SCHOOL of ENGINEERING
of Milwaukee

Dept. R386B

Milwaukee, Wis.

EXPOSED!

69 Tricks of Mediums Fully Explained

Every detail given for performing the seemingly impossible feats of famous mediums. Startling revelations that show how easy it is to fool the credulous. Many of these tricks have made the greatest magicians wonder.

You Can Do These Tricks

What makes a trick good is its simplicity. No complicated or expensive apparatus needed for these, the best of spiritualistic tricks. You can do such wonders as:

1. Produce spirit message on blank paper.
2. Read messages while blindfolded.
3. Produce spirit rappings.
4. Produce spirit voices.
5. Produce writing on blank slates.
6. Read sealed letters in total darkness.
7. Reproduce a burned message.
8. Read messages retained by the writers—and 61 other marvels used in spiritualistic seances.

Make Money Giving Entertainments

Clubs, Lodges, Sunday Schools, Churches, and organizations of all sorts are eager for entertainers who can mystify audiences with such inexplicable manifestations as these. You can make from \$10 a night up to \$50 or more, depending upon the size of the community in which you work. Anyone can do this. You need no special gifts.

Send No Money Just write a postal for our marvelous book, "Behind the Scenes with the Mediums." When postman hands you book, pay him \$1.50 and postal charges.

POPULAR MECHANICS PRESS
Room 611, 200 East Ontario Street CHICAGO, ILL.

Books on 2,000 Subjects. New catalog lists books of all sorts. FREE. Write a postal for "Books on 2,000 Subjects." Popular Mechanics Press, Room 611, 200 E. Ontario St., Chicago, Ill.

See **Free Offer** on page 8

Something For Nothing



The Milo Publishing Company is giving you a copy of "STRENGTH" FREE. In order to get this free copy, there is nothing you have to pay—nothing to buy—nothing to do except fill in the coupon below and send it in to us. This big, interesting magazine will then be mailed to you free of charge and postage cost. We are not even going to ask you to look it over or read it, for we know that when you get it in your hands you will be interested and eager to see its contents.

"STRENGTH" Is Wonderfully Illustrated

There are pictures of beautifully-formed women, muscular men, athletes, strong men, and those who have found health and happiness in its pages.

SEND FOR A FREE COPY NOW

THE MILO PUBLISHING CO. P.M. 11-26
2747 N. Palethorp St., Philadelphia, Pa.

Gentlemen: Please send me immediately, and without any obligation on my part, a FREE COPY of your great magazine "STRENGTH."

Name.....
Address.....
City.....State.....

Decide NOW to Quit TOBACCO

A Successful Tobacco Treatment Record of over 50 Years

There are two things that the average tobacco user stubbornly refuses to admit: first, that he is really a slave to tobacco; second, that it is injuring his health to any alarming extent. Not until he is convinced that he is wrong in both instances will he even seriously consider giving it up.

Most tobacco users are slaves to the habit, despite what they say to the contrary. And tobacco is harmful—seriously harmful if its use is continued over a period of years. Its active principle—nicotine—is a deadly poison. Lowers efficiency; irritates throat and lungs; weakens the heart; shortens life. These are proven facts.

So make up your mind **right now** to quit. Once you have made that important decision, we will make the actual quitting an easy matter for you.



The Keeley Home Treatment For the Tobacco Habit

Completely banishes all craving for tobacco, no matter how long or in what form or quantity you use it—cigarettes, cigars, pipe, chewing or snuff. Noticeable improvement the first day. No shock to the nervous system. No interference with your work. No druggish after-effects. Not a substitute. Contains no habit-forming drugs. Gives you renewed vigor—makes you feel like a new man.

A sane, scientific treatment, based upon the famous Dr. Keeley's private prescription, and used successfully for more than forty years. Has freed thousands of men from tobacco slavery. See how easily and quickly it will do the same for you.

MONEY-BACK GUARANTEE

If after taking the Keeley Home Treatment according to directions you can honestly say that you have any further desire for tobacco, we will refund the small cost of the treatment on request. This guarantee is backed by the old established Keeley Institute and is legally binding on us. You take no chances. You are to be the sole judge as to the effectiveness of the treatment.

THE KEELEY TREATMENT

for LIQUOR AND DRUG ADDICTIONS

Write for Literature
All replies confidential

AT DWIGHT, ILL.
for Over 50 Years.

Mail Coupon for Free Book

This book is written by a physician who has successfully treated thousands of men for the tobacco habit. It tells in plain words just how and why tobacco gets such an almost unbreakable hold on a man and explains its harmful effects. Send for it—today. It will help you to decide that the time has come for you to quit tobacco and be healthier, happier, and money ahead by so doing.

"Good-Night Tobacco"

He said, after using it 14 years

"I have been an incessant tobacco user for 14 years, continuously using it every hour I was awake. After taking the Keeley Home Treatment it has been 'Good-night, tobacco,' and I am through with it forever."

"Does the Cure Stick?"

Read What This User Says

"As I have taken your treatment for the tobacco habit six or eight years ago and found it to be an absolute cure, I have been recommending it to my friends."

"Treatment Worth \$500 to Him"

"Five years ago I smoked a pipe, cigars, cigarettes, chewed plug and fine cut. Then I took your Home Treatment, which was worth \$500 to me, as I have had no more desire for tobacco than I have to take strychnine."

The above are typical of letters, thousands of which we have received praising the Keeley Home Treatment for the tobacco habit. Originals of letters may be seen at our office.



THE KEELEY INSTITUTE, DWIGHT, ILL.

Please send me, without any obligation on my part, your free booklet which will tell me how to rid myself of the tobacco habit.

Name.....

Town.....

Street..... State..... PM-11

THE KEELEY INSTITUTE

"A National Institution"

DWIGHT, ILL.

LUMINOUS PAINT

Make Your Watches, Clocks, Etc., Visible by Night

The very latest discovery in the scientific world. Hitherto, practically unobtainable except at an exorbitant price, we have at last succeeded in producing this remarkable LUMINOUS PAINT, which, applied to the surface of any article, emits rays of white light, rendering it perfectly visible in the dark. **THE DARKER THE NIGHT, THE MORE BRILLIANT IT SHINES.** Quite simple to use. Anyone—you can do it. A little applied to the dial of your watch or clock will enable you to tell the time by night. You can coat the push buttons or switch plates of your electric lights, match boxes, and innumerable other articles; make your own Luminous Crucifixes, Luminous Rosaries, etc. Small bottle, price 25c. Larger sizes, 50c and \$1 postpaid.

JOHNSON SMITH & CO. Dept. 800, RACINE, WIS.

Serpent's Eggs

Box contains 12 eggs. When lit with a match, each one gradually hatches itself into a snake several feet long, which curls and twists about in a most life-like manner.

Price per box, 10c postpaid, 3 for 25c.

CIGARETTE MAKER



Roll your own and save money. Makes them better and quicker besides saving more than half. Use your favorite brand of tobacco. Neat, useful and handy. Pocket size, weighs 1/2 oz. Made entirely of metal, nickel-plated. Price 25c postpaid.

MIDGET BIBLE

GREAT CURIOSITY
Smallest Bible in the World. Size of a postage stamp—200 Pages. Said to bring good luck to the owner. A genuine work of art. Must be seen to be appreciated. Make good money selling them to friends, church acquaintances, etc.



PRICE 1c each, 3 for 40c, 12 for \$1.35, 100 for \$7.50. Also obtainable in Leather Binding, with gold edges. Price 50c each, 3 for \$1.25, \$4.50 per doz. Magnifying Glass for use with Midget Bible, 15c.

STAGE MONEY

With a bunch of these bills, it is easy for each person of limited means to appear prosperous by flashing a roll of these bills at the proper time and peeling off a genuine bill or two from the outside of the roll, the effect created will be found to be all that can be desired. Prices, postpaid: 40 Bills 20c, 120 for 50c, or \$3.50 thousand postpaid.

Wonderful X-Ray Tube

A wonderful little instrument producing optical illusions both surprising and startling. With it you can see what is apparently the bones of your fingers, the lead in a lead pencil, the interior opening in a pipe stem, and many other similar illusions. A mystery that no one has been able to explain satisfactorily explain. Price 10c, 3 for 25c, 1 dozen 75c. Johnson Smith & Co.



Good Luck Ring
Quaint and Novel Design

A VERY striking and uncommon ring. Silver finish, skull and crossbones design, with two brilliant, flashing gems sparkling out of the eyes. Said by many to bring Good Luck to the wearer, hence its name, Good Luck Ring. Very unique ring that you will take a pride in wearing. **ONLY 25 CENTS.**

JOHNSON SMITH & CO.

Dept. 800

RACINE, WIS.



A de Luxe Edition of our new 1927 CATALOG mailed on receipt of 25c. Handsome binding. Bigger and better than ever. Only book of its kind in existence. 550 pages of all the latest tricks in magic, the newest novelties, puzzles, games, sporting goods, rubber stamps, unusual and interesting books, curiosities in seeds and plants, etc., unobtainable elsewhere. Remit by Stamps, Coin, Money Order, Check, etc. Unused U.S., Canadian and Foreign Stamps also accepted.

Exploding Cigarettes



JUST LIKE ORDINARY CIGARETTES, BUT SUCH REAL STARTLERS! The box contains ten genuine cigarettes of excellent quality. They appear so real, but when each cigarette is about one-third smoked, the victim gets a very great surprise as it goes off with a loud BANG! A great mischief provoker yet entirely harmless. Price 25c per box.

Popular Watch Charms

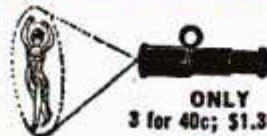

15c

ONLY 3 for 40c; \$1.35 doz.

Very pretty little curiosities and decidedly novel. Fitted with Magnifying Lenses that enlarge the picture to a very surprising degree; in fact, it seems almost incredible that a clear picture could be possible in such a small compass, and how sharp and distinct they show up when you look through. Come in assorted views—Actresses, views of Panama Canal, Lord's Prayer in type, etc.

Mystic Skeleton

A jointed figure of a skeleton 14 in. in height, will dance to music and perform various gyrations and movements while the operator may be some distance from it.

10c & pd.



Novelty Badges



Kissing Permit 10c. Garter Inspector 10c. Two very novel metal badges, nickel plated, that you can wear, giving you fun out of all proportion to their trifling cost. 10c, each badge, 3 for 25c, or 75c per doz. p.pd.

MAGIC FLUTE

Wonderfully Sweet Toned and Musical



Post Paid 25c

The Magic Flute, or Human-stone, is a unique and novel musical instrument that is played with nose and mouth combined. There is just a little knack in playing it which, when once acquired after a little practice, will enable you to produce very sweet music that somewhat resembles a flute. There is no fingering, and once you have mastered it you can play all kinds of music with facility and ease. When played as an accompaniment to a piano or any other musical instrument, the effect is as charming as it is surprising.

BLANK CARTRIDGE PISTOL

Protection against Burglars, Tramps & Dogs

Prices 50c \$1.00



Post-paid

Well made and effective; modelled on latest type of Revolver; appearance alone is enough to scare a burglar. When loaded it may be as effective as a real revolver without danger to life. It takes standard 32 Cal. Blank Cartridges obtainable everywhere. Price 50c, superior quality, \$1.00 post-paid. Blank Cartridges, by express, 50c per 100 Holster (Cowboy type) for Blank Cartridge Pistol, 50c Johnson Smith & Co., Dept. 800, Racine, Wis.

BOYS! BOYS! BOYS!

THROW YOUR VOICE



Into a trunk, under the bed or anywhere. Lots of fun fooling the teacher, policeman or friends.



THE VENTRILLO

a little instrument, fits in the mouth out of sight, used with above for Bird Calls, etc. Anyone can use it.

Never Fails. A 32 page book on ventriloquism, the Ventrillo, ALL FOR 10 CENTS



Everything about the Ku Klux Klan told in a clear, fearless manner. Book tells all—How it started and was oppressed in 1871—The New Ku Klux Klan—How Organized—How Members are Enrolled—Oath of the Klan—Questions for Candidates—Creed—Objects of the Order—Obedience—Fidelity—Pledge of Loyalty—Ku Klux Klan and the Masons—The Jews—The Masons—Real K. of C. Oath—The Negro Ku Klux Klan, etc., etc. Latest and most complete book on the Klan published. Price 35c, Postpaid. Stamps or Coin

LOOK 35c Look



Wonderful instrument. Greatest thing yet. Nine separate articles in one. Everybody delighted with it. Odd, curious and interesting. Lots of pleasure as well as very useful. It is a double Microscope for examining the wonders of nature. It is also an Opera Glass, a Stereoscope, a Burning Lens, a Reading Glass, a Telescope, a Compass, a Pocket Mirror, and a Laryngoscope—for examining eye, ear, nose and throat. It is worth all the cost to locate even one painful cinder in the eye. Folds flat and fits the pocket. Something great—you need one. Don't miss it. Sent by mail, postpaid. **Only 35c or 3 for \$1.00**

HOT DOG! SENSATIONAL NEW NOVELTY



It is made of rubber like a small balloon. Contains a curious chemical that sets in a most remarkable way. Squeeze the deflated balloon with the hand and it suddenly becomes quite warm and fills itself up with air. It is SELF-BLOWING. Play all sorts of jokes with it. Lay it on a chair; place it secretly underneath anyone; underneath anyone's pillow; drop it in someone's pocket, and after a short time, when friction causes the chemicals to act, a large and superbly colored balloon develops. Each Hot Dog in a small box. Quite harmless, but loads of fun. 15c, each, 3 for 40c., \$1.35 doz. postpaid.

Female SEX Indicator Male Sex Indicator



Hold the MAGIC INDICATOR over a man's hand—instantly it moves in a straight line, backward and forward. Hold it over a woman's hand and it describes a complete and continuous circle. The same action can be obtained over a letter written by a man or woman, etc. It is fascinating; baffling. We have never been able to figure out how it's done, but we've never seen it fail. Many novel and entertaining feats may be performed with the Sex Indicator. For example, similar results can be obtained with animals, cats, dogs, rabbits, over birds, chickens, canaries, etc. Also used to predetermine the sex of chickens and birds, etc. In fact it is sold as a patented egg tester in Europe. Price 25c, or 3 for 65c. p.pd. **JOHNSON SMITH & CO., Dept. 800, RACINE, WIS.**

COMIC CELLULOID BUTTONS



These Comic Celluloid Buttons provide subjects for pleasant jokes and amusing conversation and thus smooth the way to a more familiar acquaintance and cordial friendship. There are seventy different titles altogether, all very wittily worded and quite unobjectionable. Wear one and see the effect. All four Buttons illustrated above will be sent postpaid to any address for **ONLY 20c** or a dozen, all different, for **45c**.

AUTOMATIC DIME BANK

Teach young and old to save. Holds 50 Dimes, and cannot be opened until the last coin has been inserted, when the Bank opens automatically. Then close and start afresh. Registered trade mark. Side enables you to see at a glance how much money the Bank contains at any time. **PRICE 15c, 3 for 40c, postpaid.**

KEYLESS LOCKS

These clever locks cannot be opened unless you know the combination. No key necessary. For your locker, bicycle, tool chest, mail box, thousands of uses. Shackle and tumblers nickel plated. Weighs little over one ounce. Small, yet strong. Secret and full instructions with each lock. **PRICE 25c, postpaid.**

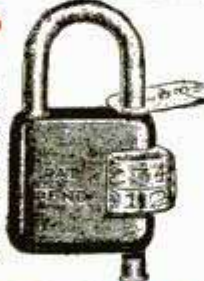

Every Boy His Own Toy Maker

Greatest boys' book written. Tells how to make a Pinhole Camera, a Canoe, model Railroad, a Telephone, Boomerang, Telegraph Instrument, Box Kite, Talking Machine, Microscope, Electric Motor, Electric Door Bell, Water Wheel, Paddle Raft, a pair of Skis, a Dog Sled, Bird House, Rabbit Yard, etc. 64 pages. 150 Illustrations. **PRICE, 10c postpaid; 3 for 25c.**

INVISIBLE INK

The most confidential messages can be written with this ink, for the writing **Makes No Mark.** Cannot be seen unless you know the secret. Invaluable for many reasons. Keep your postals and other private memorandums away from prying eyes. Great fun for playing practical jokes. **Only 15c a Bottle; 3 for 40c.**

REAL PISTOL

Shoots Blank Cartridges. Pull the trigger and it goes off with a loud bang. Pistol is break-open type; illustration shows position for loading. Made entirely of high grade steel, nickel plated, octagonal barrel, handsomely engraved handles, complete in box with cleaning rod. **PRICE \$1.75.** Also furnished with **pearl handles, \$2.50.** **BLANK CARTRIDGES, 50c per box of 25**

Miniature Watch Charm Pistol

Exact reproduction of a real pistol; actually fires **Real BLANK CARTRIDGES** of miniature size. Illustration is actual size. **1 1/4 inches long, with ring at end for attaching to watch chain.** Loads like a regular pistol. **PRICE \$1.75.**

RESURRECTION PLANT

One of the most wonderful plants known. Possesses the strange power of turning in a few minutes from an apparently lifeless, dry herb to a **BEAUTIFUL LIVING FERNLIKE PLANT** of a dark green color. Simply place the plant in saucer of water, it will open up and start to grow in 20 minutes. When taken out it will dry up and go to sleep until placed in water again. Fine house plant—summer or winter. **10 cents each or 3 for 25c., 75c per doz., postpaid.**

Microphone Transmitter Button



You can easily make a highly sensitive detectophone by using this Transmitter Button to collect the sound waves. You can build your own outfit without buying expensive equipment. It is simple and inexpensive. You can install an outfit in your home and hear conversations being held all over the house. You can connect up different rooms of a hotel. This outfit was used by secret service operatives during the war. It is being used on the stage. It is ultra-sensitive and is the greatest invention in micro-phones. You can mount the button almost anywhere—card board boxes, stove pipes, stiff calendars, on the wall behind a picture frame, etc. Button is so light and small it cannot be detected. Persons can be overheard without suspecting it. You can listen in on conversations in another room. A deaf person in the audience can hear the speaker. Connected to phonograph, piano or other musical instrument, music can be heard hundreds of feet away. Button may be used to renew telephone transmitters often makes an old line "talk-up" when nothing else will. The ideal microphone for radio use; carries heavy current and is extremely sensitive. Amplifies radio signals. Countless other similar uses will suggest themselves. Experimenters find the Button useful for hundreds of experiments along the lines of telephones, amplifiers, loud speakers, etc. Many fascinating stunts may be devised, such as holding the button against the throat or chest to reproduce speech without sound waves. \$5.00 is given to anyone who sends in a new suggestion for the use of the Button providing the manufacturers find it suitable for use in their literature. **PRICE \$1.00 POSTPAID ANYWHERE.**

Send remittance (Postage Stamps accepted) for all articles listed on above and previous pages to

MAGICIAN'S OUTFIT

Apparatus and Directions for a Number of Mysterious Tricks Enough for an Entire Evening's Entertainment **ANYONE CAN DO THEM 75c**



It is great fun mystifying your friends. Get this **Magician's Cabinet**, and you will be the cleverest fellow in your district. It contains the apparatus for seven dramatic tricks, including **The Disappearing Horse**, that, when placed on the lapel of your coat, vanishes from sight at will; **The Magic Vase and Ball Trick** (a Wooden Ball is placed inside, and upon replacing the lid has disappeared and is found in someone else's pocket); **The Magic Nail** with which you can apparently cut your finger almost in two; the **Wonderful Card Trick** (a card is placed in an envelope, and when open an entirely different card is found); **The Disappearing Coin Box** (a coin is placed in the little wooden barrel, and when opened again, is found to have vanished entirely, or can be made to change into a coin of another denomination); **The Famous Dissolving Penny Trick**; **The Glass Goblet and Vanishing Coin Trick** (a coin is dropped into a glass of water, and when the water is poured out the coin has vanished). With the tricks described above we send full printed instructions for performing each trick, so that anyone can readily perform all the tricks to the great amusement of their friends or the public. Any boy of ordinary intelligence, with this **Cabinet of Tricks** in his possession, can give a parlor entertainment not inferior to some regular magicians. Besides the tricks contained in the Cabinet, there are many other tests and illusions fully explained with full printed instructions, for which you usually make or procure the necessary apparatus. This unexcelled Cabinet of Tricks for **ONLY 75 CENTS POSTPAID TO ANY ADDRESS.**

Great Fire Eater

Most Sensational Trick of the Day! With the **Fire Eater** in his possession any person can become a perfect salamander, apparently breathing fire and ejecting thousands of brilliant sparks from his mouth, to the horror and consternation of all beholders. Harmless fun for all times, seasons and places. If you wish to produce a decided sensation in your neighborhood don't fail to procure one. We send the **Fire Eater** with all the materials, in a handsome box, the cover of which is highly ornamented with illustrations in various colors. **Price of all complete only 30 cents, postpaid.**

SQUIRT ROSE

25c A **REAL STARTLER.** This is the most popular of all squirt tricks. The flower in your coat looks so fresh and sweet that everyone is tempted to inhale the delightful perfume. Then at the moment to press the bulb. **Goowillikenz!** Don't they jump? There is a very long rubber tube that easily reaches to the pocket of your coat or trousers, and the bulb is large enough to make a dozen shots with one loading. **PRICE 25c each, or 3 for 65c postpaid.**

PISTOL, OPERA & FIELD GLASS

PRICE POSTPAID, \$1.00 **LOOK!** It is made in the shape of and looks like a regular Automatic Pistol. No one is likely to stop and ask you whether it is real or not. This is likely to prove itself very handy in an emergency. On pressing the trigger it opens up, as shown in the illustration at the right, revealing nine most useful articles: **Opera and Field Glass, Telescope, Mirror, Magnifying Glass and Burning Lens, Reading Glass, Sun Dial, Sun Compass, etc.** In the handle of the revolver there is a place for various pocket necessities, such as **First Aid Articles, Buttons, Pins, etc.** The Pistol is of most metal, blued finish, that can be carried comfortably in pocket. **PRICE \$1.00.**

SURPRISE MATCHES

More fun than fighting with your wife. Look just like ordinary matches. Put up in boxes just like regular Safety Matches. As the victim tries to light one he gets quite a surprise. **PRICE 10c per box, 3 boxes for 25c, or 12 for 75 cents.**

SEEBACKROSCOPE

By merely placing this clever instrument to your eye, you can see what is going on behind your back, and sometimes you see very interesting things when no one thinks you are looking. Why it is just like having eyes at the back of your head. **PRICE ONLY 25 cents, postpaid, 3 for 50 cents.**

NEW BOOK ON ROPE SPLICING

A most practical handbook giving complete and simple directions for making all the most useful knots, hitches, rigging, splices, etc. Over 100 illustrations. All about wire rope attachments, lashing, blocks, tackles, etc. 37 Heraldic Knots illustrated. Of great value to mechanics, riggers, campers, boatmen. **Price 20 cents postpaid.**

The "Little Giant" Typewriter

A First Class Writing Machine For \$1.50. A perfect little typewriter for \$1.50. There are thousands of persons who would like to use a typewriter but whose needs and business do not warrant the expense attached to the purchase and use of a fifty or seventy-five dollar machine. To such persons we confidently recommend our **Little Giant**. It is strongly made, but simple in construction, so that anyone can quickly learn to operate it, and write as rapidly as they would with pen and ink. The letters of the alphabet most frequently used are so grouped as to enable one to write rapidly, the numerals 1 to 10, and the punctuation marks being together. With this machine you can send your best girl typewritten love letters, address envelopes, make out bills, and do almost any kind of work not requiring a large, expensive machine. With each typewriter we send a tube of ink and full printed instructions for using the machine. **Price complete \$1.50 by mail postpaid to any address in the world.**

This Tenor Banjo FREE

WORTH \$18



When You Enroll

This handsome full size, professional tenor banjo is yours when you enroll. We want to make one thousand new friends this month. We want to present one of these wonderful, delightful instruments as a gift to each of one thousand readers of this magazine—and here's why. Before becoming a professor, and a lover of music, particularly the tenor banjo, Prof. Six yearned and yearned for the possession of a genuine, professional instrument, the same kind used by the big, successful professionals of the world. Now we want you to succeed. We want to help every music-lover that we can, attain success, and this gift offer is made to pave the way for you, and no previous musical knowledge is necessary.

We have another surprise for you! Not only do we start you on the way to popularity, success and fame by supplying you with an instrument that you can compare to any used or displayed in your town, but under personal supervision you will be given, by mail, the benefit of Professor Harry S. Six's twenty-two years' experience as director of Glee and Instrumental clubs of New York University. We don't just send you a lot of printed words and instructions and trust to luck that you will catch on. Our method is different and has proven to be the simplest devised by man—that is why we claim you'll be able to play in thirty minutes. Put us to the test.

Learn in 30 Minutes With My Picture Method

Arthur Brisbane, the highest paid journalist in the world, once said that "a single picture is worth a thousand words." He was right, for it stands to reason, when you take your instrument in hand along with the actual photographs of our professor in action as your guide, it is easy to imitate and do the right thing. But that is not all.

Phonographic Records Free

We also furnish as an additional guide, phonographic records of our professor playing the piece you are learning, along with our thorough, printed and illustrated, easy-to-read course.

Doesn't that sound easy? It is easy. If you could sit at our desk and see the letters and telegrams from our pupils you would be convinced that we have perfected the simplest, yet most highly efficient course to insure your mastery of the tenor banjo.



Don't Send a Single Cent

Investigate offer today. Don't put off until tomorrow, because you might forget and miss this wonderful opportunity. It might be the turning point in your career. Don't send a single cent. Just drop a line—use coupon or postal card will do—telling you are interested in receiving full particulars about course and to reserve one regular eighteen dollar, full size professional tenor banjo for you, which is offered as a gift. Act quickly, because there may not be enough gift banjos to go around for the million or more readers of Popular Mechanics. This does not obligate you in any way. Therefore, do not hesitate—put in your reservation now, this very minute. You will soon join our happy army of enthusiastic finished tenor banjo musicians.

EARN BIG MONEY

Hundreds have started orchestras and are making money.

FREE BANJO COUPON

New York Academy of Music
Studio 111-100 Fifth Ave., New York

Please rush all free information relative to your Tenor Banjo Course and reserve a gift banjo for me. This obligates me in no way whatever.

Name

Address

City State



Popular Mechanics New Handbooks

If you could thumb through these new books, you would want them all. They are literally jammed with practical ideas. Each one is written so clearly that a boy can understand the directions. Each is the experience of a practical man or woman. Most articles are illustrated with photographs or drawings. The practical nature of the subjects has made a wide sale for them already although they have been, on the market only a few weeks. Here are the titles of those now available:

- Popular Mechanics Lathe Handbook No. 1
- Home Mechanics Handbook No. 1
- Handbook for Women
- Popular Mechanics Concrete Handbook No. 1

Any 2 for \$1

- Popular Mechanics Boat Book
- Automobile Owner's Handbook
- Auto Tourist's Handbook
- Auto Repairman's Handbook No. 1
- Drilling and Thread Cutting

Order Several at One Time

So low is the price that it is certainly wise to order as many of these at one time as you can use. You may have any two for \$1. These books make good presents. They are splendid for boys taking manual training courses.

Free Magazine, Personal Advancement with each order.

POPULAR MECHANICS PRESS
Popular Mechanics Bldg., Room 611, Chicago, Ill.



"Learning to Fly"

PIN a Dollar Bill to the coupon and receive Murphy McHenry's course, **Learning to Fly**, a simple, thorough course in Aviation Logic with an accurate description of practical experiences in an airplane. **Learning to Fly** is invaluable to amateurs before undertaking actual air lessons—written by a trained, recognized pilot. **Learning to Fly** is interesting, deals with fundamentals, costs but \$1. Send the Coupon Now for complete course postpaid.

AIRWAY SCHOOL San Mateo, Cal.

AIRWAY SCHOOL San Mateo, Cal.

Gentlemen: Enclosed is \$1 Bill for which send me COMPLETE course entitled, "Learning to Fly" by Murphy McHenry.

NAME

STREET

CITY & STATE

FREE

This 84 Page Wonder Book of RADIO Bargains



Send for this guide to Radio price and Radio quality. All of our vast resources and radio experience have been utilized to assemble for you in one gigantic institution, the best and newest things in radio. The Randolph catalog is indeed the radio market place of the world—a masterpiece of merchandising that befits our house, the largest exclusive radio mail order house in the world.

What Our Catalog Contains

Over 2,000 items—from the most beautiful, fully equipped console model radio set, down to the smallest part or tool for the set builder—kits, parts and supplies of every conceivable type and style. All beautifully illustrated and interestingly described. And to give this book added value, we have included radio data that makes it an invaluable text book for every lover of today's most fascinating and most wonderful achievement—RADIO.

Radio Sets

In this great radio market place you will find table model sets and console types with built-in loud speakers; the newest ampliphonic console sets; new Spanish period consoles; five, six, seven, and eight tube sets, with three dial, two dial, and the newest and most popular single simplified control. All sets are assembled in beautiful, genuine mahogany and walnut cabinets in a choice of latest types and designs.

5 Tube sets as low as \$24.90

Latest 1927 Models

All Randolph sets are sold at amazingly low prices. No matter what kind of set you want—no matter how little you want to pay—you can select YOUR SET AT YOUR PRICE from the Randolph catalog.

Radio Kits

Include the following well known circuits, designed and approved by the world's foremost radio engineers: Madison Moore Super; Victoreen Super; Silver Marshal Six; Sargent's Infra-dyne; Remler Super; Short Wave Kits; 9-in-Line Super; New Acme Reflex; Cockaday; Neutrodyne; Browning-Drake; all classes of radio frequency, Super Heterodyne and every other approved popular circuit.

YOU MUST HAVE THIS BOOK

Space limitations here prevent our telling you more about the Randolph Catalog. Simply fill out and mail the coupon—or you may send a postal or letter—and this truly remarkable Radio book will come to you ABSOLUTELY FREE.

MAIL THE COUPON NOW.

Radio Parts and Supplies

The Randolph catalog also contains a most complete line of "B" Battery Eliminators, including the famous Raytheon Eliminators; the latest type Loud Speakers, Cone Speakers, a complete line of quality "A" power units—in fact, you will find listed in this wonder book every part that goes into the construction of a radio set, or any accessories you desire, at prices that mean a substantial saving to you.

Free Radio Service

Everyone has need for radio service. We employ Radio Engineers who have made Radio their life work. Their expert advice and helpful suggestions solve every radio problem of our customers.

Our Guarantee

Every article in our catalog is based on careful laboratory analyses and tests. We guarantee to back up every item in our catalog with our own as well as manufacturer's assurance of quality.

Why We Save You Money

Because we handle radio exclusively and sell a tremendous volume of everything in Radio, we can concentrate our buying power for the benefit of our customers.

Volume purchase regulates prices. We command rock bottom prices from manufacturers, and in many cases we contract for entire factory output of exclusive products. You will benefit by our great volume of purchases and sales, by securing anything you may want in radio at a substantial saving.

This Coupon Brings the Great RADIO Book FREE

RANDOLPH RADIO CORPORATION
180 N. Union Ave., Dept. 119
Chicago, Illinois

Send me—free—your 84-page, 1927 Radio Book.

Name.....

Street and No.....

R. F. D.....Box.....

City.....State.....

Randolph Radio Corporation
180 North Union Avenue, Dept. 119, CHICAGO, ILL.

Learn Electricity IN LOS ANGELES!

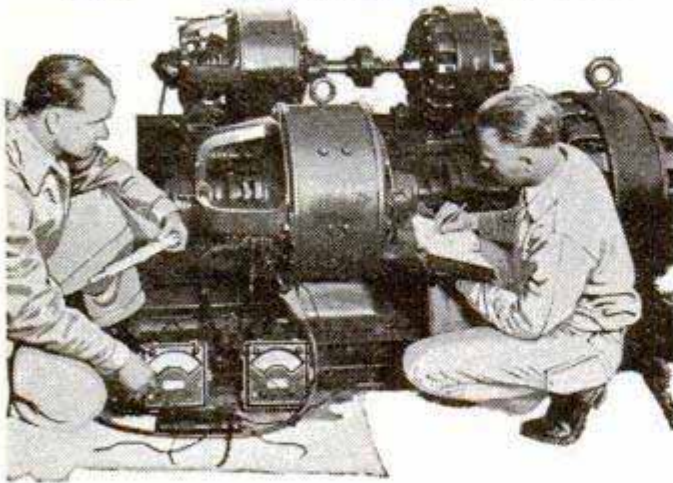

FREE Employment Service!

There are more calls for "National-Trained-Electrical-Men" than we can supply. Jobs are open now paying \$50 to \$200 a week—but you must first get the right training. Get it at National—a world-famous institution with a quarter century record of success in training big pay men. All these advantages:

1. Unlimited Training Until Competent.
2. Free Employment and Welfare Service.
3. Million Dollar Training Shops.
4. Personal, individual training guaranteed.
5. You actually perform work that employers pay big money for.
6. Official Diploma and certified record of work performed.

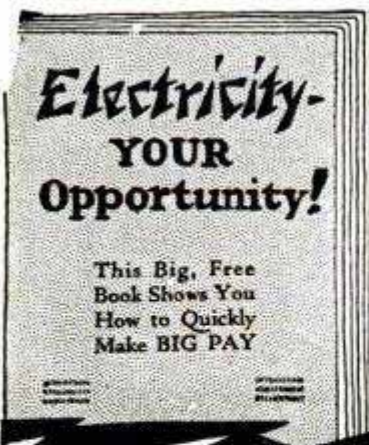

FREE

Read how National insures your success. Send for this free Electrical catalog — illustrated by actual photos of students training under instructors on a half million dollars' worth of new electrical equipment. Mail coupon now.

National Electrical

Dept. 500, 4006 Figueroa St. Los Angeles, California

Send me your big free illustrated catalog of Electrical Opportunities.

Name.....

Address.....

City..... State.....

LAW BOOK FREE

Send for it today

Whether you are a corporation president or a clerk, capitalist or wage earner—whatever your ambition is—this book will be of vital interest to you—be of direct positive value. It tells you frankly about the amazing secrets of successful lawyers and law trained men in business. It proves conclusively how a law education will quickly fit you for a better position and bigger pay. It shows how quickly you can learn at home in your spare time. It tells true stories of successful men who before taking this course slaved for practically nothing. Three year course covers preparation for bar examination. Degree of LL.B. conferred. Earn

\$5,000 to \$12,000 a Year as a lawyer or law trained man in business. Read at home—aided by reading course. **Moneyback guarantee** if not satisfied upon completion. Low fee, easy monthly terms include complete up-to-date 12 volume library by the highest authorities. Send for free book now. No obligation to you whatever.

HAMILTON COLLEGE OF LAW
1414 S. Michigan Ave., Dept. G-8
Chicago, Ill.

366 SHORT CUTS FOR CARPENTRY WORK

Popular Mechanics New Carpenter's Handbook is filled with illustrated short cuts and improved methods for doing all sorts of carpentry work and odd jobs. Each idea was discovered by a practical man in the course of his work. Each idea is practical, a time-saver, a money-saver. The **229 Pictures** are so clear that in many cases, the picture itself explains the short cut. This new book is a book for professional carpenters, for amateurs, and for boys. It is destined to be just as popular as the many other handbooks published in recent months. This new book is beautifully bound in golden brown cloth, is a handy size, and sells for the remarkably low price of \$1.50.

Send No Money Simply write a postal saying that you want Popular Mechanics New Carpenter's Handbook. It will be sent C. O. D. and you may pay the postman the price of the book and the few cents postage when he delivers the book to you. If you live outside the U. S. or if you are not at home when the postman delivers your mail, send \$1.50 with your order.

POPULAR MECHANICS PRESS
Room 611, Popular Mechanics Bldg., 200 E. Ontario Street, Chicago, Ill.

PATTERN-MAKING for Those Who Should Know

Compiled by G. H. WILLARD, a pattern maker of many years' experience, for those who wish to increase their pay—or those who wish to enter this well-paying occupation. Filled to the covers with helpful shop-kinks and actual working information. Practical instructions written in plain language, which anyone can easily read and understand. Learn at home—in your spare time. Bound in cloth, 224 pages, 312 illustrations, diagrams and working drawings, etc.

Tells About Pattern making as a trade—The Tools—Wood-Joints—4 chapters on Turning—2 chapters on the Circular Saw—2 chapters on Machine Tools—3 chapters on Simple Tools—Crooked Patterns—2 chapters on Large Pattern Work—Cross-Head Guide patterns—Sweep work—Pipe work—Stove pattern work—Molding—Machine Work—Molding Pattern Work.

CORE MAKING AND MOLDING

Part II explains the simple and complicated problems in core making and molding which every good pattern maker should know. **Tells about**—Core making, simple and complex—principles in Molding—Loam Patterns—Loam Molds. Everyone following this trade or intending to enter it should have this remarkable book. The price is so low that anyone can afford to buy it. Those who have it, wouldn't be without it.

SEND NO MONEY Just write a postal. Pay postman postage and \$1 when he hands you book.

POPULAR MECHANICS PRESS
210 E. Ontario St., CHICAGO

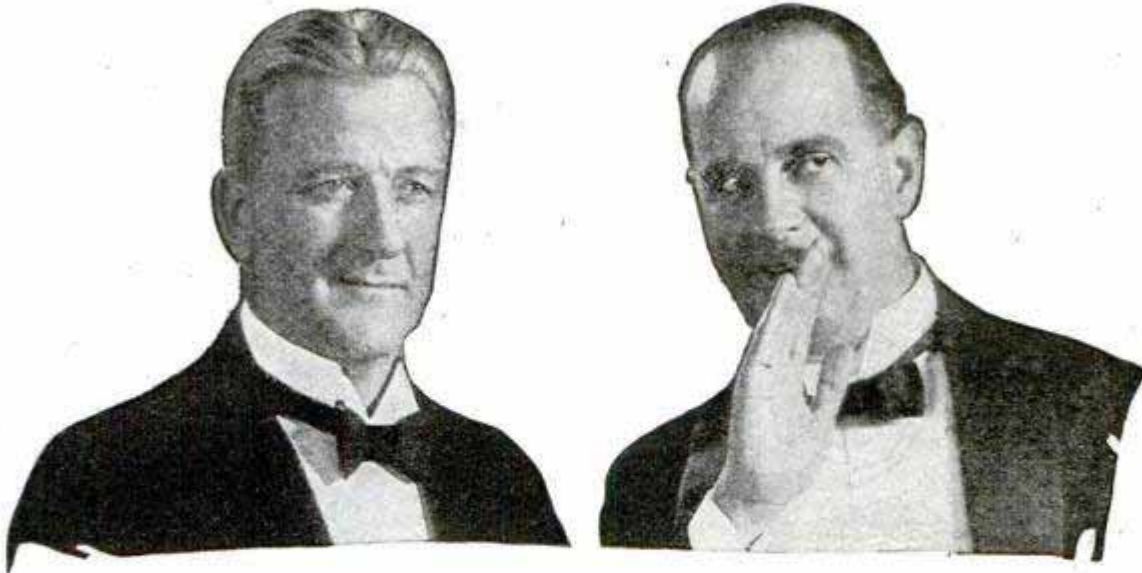

“That Man Corey is Certainly Interesting—”

They say that of him now wherever he goes—this Corey who never used to have a thing to say. Almost overnight he became one of the best-informed men of his group

I NEVER knew that Corey was so well-educated.”
“He isn't. He left school when he was a kid. Mighty interesting, though—isn't he?”

“Yes; he seems to know about everything. See how he's holding those people fascinated by what he's saying! He's quoting from Shelley, I believe.”

“You ought to hear him at a business conference. He has all sorts of information at his command. I remember when he always used to be at a loss for something to say; now he can talk better than any of us.”

“What amazes me is the way he can talk on almost any subject at all. And he seems to be familiar with all the great writers and philosophers. He must do a lot of reading.”

“I don't see how he can. He's very busy, and I'm sure he hasn't any more time to read than we have. But I wonder how he became so well-informed—almost overnight, it seems to me. It has certainly made an interesting man of him.”

Later they had occasion to speak to Corey; and they asked him about it. They weren't prepared for what he told them.

“Read?” he said. “Why, I scarcely ever get time to read at all.”

“But in this one evening you quoted from Dante, from Browning, from Kipling, from Poe! How do you do it?”

Corey laughed. “Elbert Hubbard did all my reading for me—years ago. I simply use his Scrap Book.”

“You use Hubbard's Scrap Book? What do you mean?”

“Well, you know that Elbert Hubbard began a scrap book when he was quite young. He put into it all the bits of writing that inspired him and helped him most. He searched the literature of every age and every country to find the ideas which would help him in his own work. As the scrap book grew, it became Hubbard's greatest source of ideas.”

“After Hubbard's death the executors of his estate agreed to the publication of his scrap book. I have a copy. That's why I say Elbert Hubbard did my reading for me.”

“So that's your secret! That's why you can talk so well on so many different subjects! That Elbert Hubbard Scrap Book has made you a different man, Corey!”

Examine the Famous Elbert Hubbard Scrap Book—Free

The Elbert Hubbard Scrap Book radiates inspiration from every page. It represents the best of a lifetime of discriminating reading, contains choice selections from 500 great writers.

This Scrap Book is a fine example of Roycroft bookmaking. The type is set Venetian style—a page within a page—printed in two colors on fine tinted book paper. Bound scrap-book style and tied with linen tape.

Examine it at our expense! Just send off the coupon today, and the Scrap Book will go to you promptly. When it arrives, glance through it. If you aren't stimulated, inspired, enchanted—simply return the Scrap Book within the 5-day period and the examination will have cost you nothing. Otherwise send only \$2.90 plus few cents postage in full payment.

Remember—you are the judge. Clip and mail this coupon NOW. Wm. H. Wise & Co., Roycroft Distributors, Dept. 5611, 50 West 47th Street, New York City.

Wm. H. Wise & Co.,
Roycroft Distributors, Dept. 5611,
50 West 47th Street, New York City.

Please send me for five days' free examination a copy of Elbert Hubbard's Scrap Book in the clothlined butcher paper binding. Within the five-day period I will either return the Scrap Book without obligation or keep it for my own, sending you only \$2.90, plus few cents postage in full payment.

Name.....

Address.....

City.....State.....

A few copies are available in a sturdy binding of semi-flexible basket-weave buckram for only \$1 additional. Please check in the square, at the left if you want this de luxe binding, with the same return privilege.

Muscles of Cotton or Muscles of Steel?



A cross section of one "cable" of the average exercisers. The cheapness and weakness of construction are easily seen in the diagram. Six or seven rubber bands, wrapped and padded with a cotton covering to give them the appearance of size and strength and to make them look like the McFadden,

A single cable of the McFadden Patented 10-Cable Progressive Exerciser, no thicker than others in outward appearance—yet stronger by 75 per cent, inside the thin, worn covering. Here is quality! Every McFadden cable is made of 40 strands of the best grade rubber procurable. There is no padding with extra wrappings of worn-out to attempt to produce the exerciser cheaply.

Before you go to bed tonight fill out and mail the coupon below with \$8 for this marvelous muscle-building outfit.

My Complete \$30 Outfit for the Introductory Price of Only \$8, Including My Incomparable 12 Weeks' Instruction Course.

The McFadden is All Quality LOOK at these pictures!

And they are an actual comparison. Have they fooled you? Have you thought of buying one of these padded affairs—made of cheap rubberbands? **FORGET IT!** Here's the exerciser for you. The quality exerciser that brings every muscle in your body to the very highest pitch of development.

Your arms and back and waist aren't the only places you want real muscle. **You want to develop your whole body.** My apparatus is guaranteed to add inch upon inch to your arms, back and chest. **My New Patented Stirrup Builds Legs of Steel.** This device is the only one designed to develop the leg muscles. **My Adjustable Patented Head-Gear increases your neck one inch in 30 to 90 days.** It is simplicity in itself; it is adjustable and will fit any man or boy.



HERE'S WHAT YOU GET

10-Cable Progressive Exerciser, worth	\$ 8.00
Patented Progressive Handles with 1,000 pounds resistance worth	2.00
Patented Progressive Stirrup with 1,000 pounds resistance worth	1.00
Patented Progressive Head-Gear, the only one of its kind progressive resistance and adjustable to any size head and neck, worth	3.00
12 weeks' Home Instruction Course, the most wonderful ever written—the kind you cannot get elsewhere, worth	15.00
The Michael McFadden Encyclopedia, worth	1.00
TOTAL WORTH \$30.00; COSTS YOU ONLY \$8.00	

Any of the Above Can Be Purchased Separately at the Prices Shown

You cannot buy a similar outfit anywhere at three times this price. You cannot buy an outfit as complete as this with such a course as I give you at any price.

Big Boxing Book FREE

Here's your chance to get a copy of this Big New Book with scores of pictures of professional boxers absolutely free **IF YOU HURRY!** With every set of apparatus I ship for the next twenty days I will include a copy of this book FREE.

My Guarantee Is Backed by a \$10,000 Challenge

If you are not entirely satisfied with the outfit, return it immediately and your money will be refunded without quibble or question.

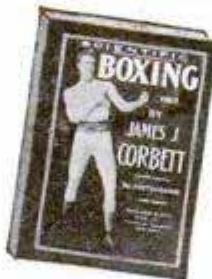

MICHAEL McFADDEN,
103 E. 13th Street, New York City

Dept. R-108

Dear Sir: Enclosed please find \$8.00 in full payment for your 10-Cable Progressive Exerciser with Patented Handles, Patented Adjustable Stirrup, Head Gear, 12 weeks' Home Instruction Course and Encyclopedia.

(Print Plainly)

Name.....
Street No.....
City..... State.....

Just Out

A NEW AND GREATER Dyke's Automobile Encyclopedia

Entirely Rewritten, Rearranged and Illustrated
Greatly Enlarged; 1238 Pages, 4143 Illustrations

A Practical Book for Everybody



The Repairman will find this book a ready reference and guide.

The Auto Owner will know how to diagnose troubles and know when repairs are done right.

The Student learns the fundamental principles, the key to a successful repairman.

This Book Will Teach You to Become

An Expert Automobile Repairman, not only on testing, adjusting and repairing engines, carburetors, clutches, rear axles, differentials, tires, etc., but an Electrical Expert on ignition, generators, starting motors, storage batteries, etc. Diagnosing any trouble will be easy.

Don't wait—Order Now!

Cloth \$6.00—Limp American Morocco \$7.50 Postpaid

Popular Mechanics Press

200 E. Ontario St.

Room 710

Chicago

Easy now to get your STEAM ENGINEER'S (OR ELECTRICIAN'S) LICENSE!

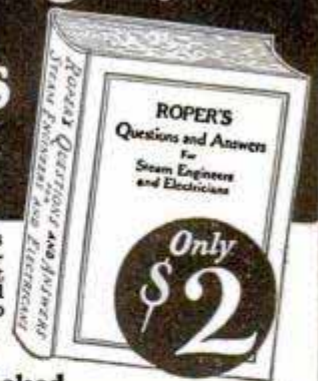

"Roper's Questions and Answers for Steam Engineers and Electricians" is a big help to the man about to qualify as steam or electrical engineer. Just revised and up to the minute. The standard work.

This book answers all questions likely to be asked

Fully covers scope of questions given by boards in stationary and marine examinations. Special sections on Diesel engine, new boiler and engine room devices, and electrical apparatus.

Send on 5 DAYS' APPROVAL—Send no Money
Over 350 pages concise information. Handy pocket size volume, in black leatherette. Pay postman only \$2.00, plus few cents postage. Money refunded if you return within 5 days.

CATALOG of Mechanical and Engineering Books FREE

All standard works on Machine Design, Mechanical Drafting, Auto Mechanics, Painting, Paper Hanging, Wood Finishing, etc. Send for it now.

DAVID McKAY CO., Pub., Dept. 211, 604 S. Washington Sq. Philadelphia, Pa.

DAVID McKAY COMPANY, Pub., Dept. 211, 604 S. Washington Sq., Philadelphia, Pa.

Send me "Roper's Questions and Answers" with your free catalog. I will pay postman \$2.00 plus postage. You to refund if I return book in 5 days.

Check here if you wish catalog only.

Name.....
Address.....
City..... State.....

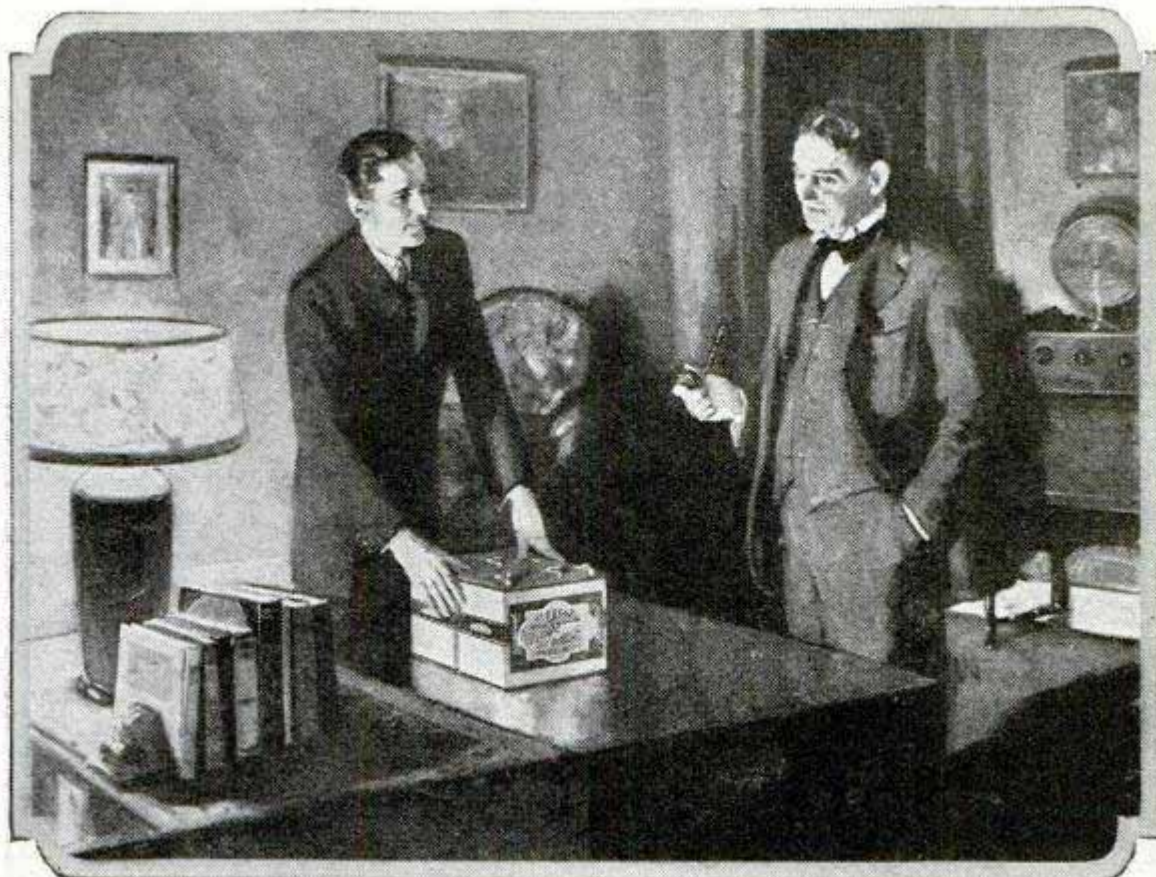

*Here's the most
economical "B" battery ever built
for radio*

IN THE production of Heavy-Duty radio "B" batteries Eveready has established a new standard of economy.

Eveready Heavy-Duty 45-volt "B" Batteries will outlast any Light-Duty 45-volt "B" two to one regardless of the number and kind of tubes used! Moreover, though lasting twice as long, they cost only one-third more!

To cap the climax of "B" battery economy, in Eveready Layerbilt No. 486, Eveready has perfected a Heavy-Duty "B"

battery of unequalled endurance and dependability—positively the best "B" battery its price can buy.

You can make no mistake in buying Eveready Layerbilt No. 486 for any set using normal voltages (45 to 135 volts).

You will be buying the utmost in "B" power dependability—the greatest "B" power operating economy—D. C. (direct current) in its purest form,

which insures pure tone quality.

With colder evenings at hand, radio reception is vastly improving. Equip your set now with Eveready Layerbilt No. 486, the greatest "B" battery ever built for radio.

Manufactured and guaranteed by

NATIONAL CARBON Co., Inc.
New York San Francisco
Canadian National Carbon Co., Limited
Toronto, Ontario

EVEREADY
Radio Batteries
-they last longer

Tuesday night means Eveready Hour—
9 P. M., Eastern Standard Time, through
the following stations:

WEAF—New York	WSAI—Cincinnati
WJAR—Providence	WTAM—Cleveland
WEEI—Boston	WWJ—Detroit
WTAG—Worcester	WGN—Chicago
WFI—Philadelphia	WOC—Davenport
WGR—Buffalo	WCCO—Minneapolis
WCAB—Pittsburgh	WCCO—St. Paul
WRC—Washington	KSD—St. Louis

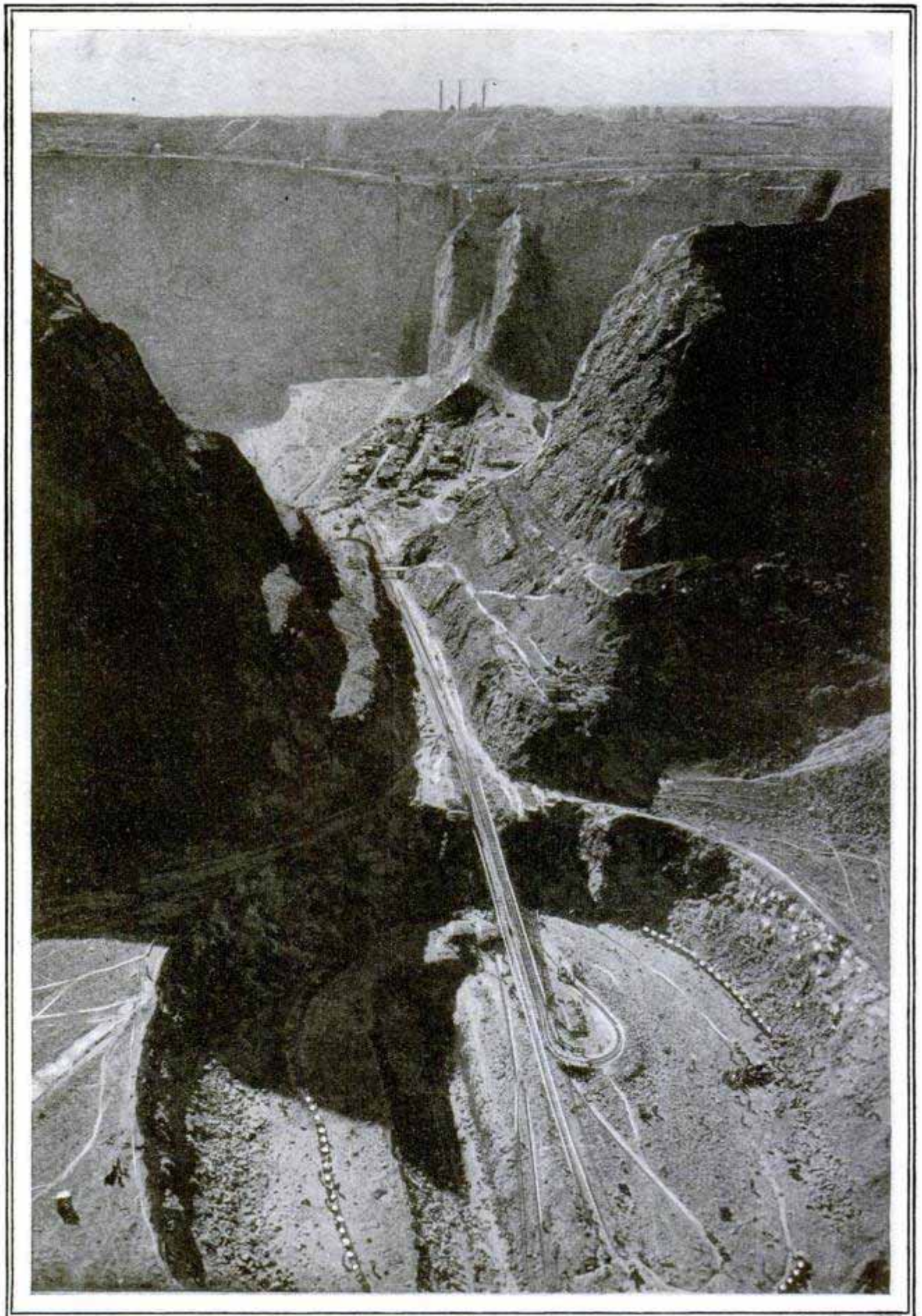

An Endless Trackway Conveys Trains of Little Electric Cars from the Depths of the Diamond Pipe at Premier Mine to the Washing Plant in the Distance—See Page 818

Popular Mechanics Magazine

REGISTERED IN U. S. PATENT OFFICE

WRITTEN SO YOU CAN UNDERSTAND IT

Vol. 46

NOVEMBER, 1926

No. 5

238 PLANE is safely landed by GIANT PARACHUTE



"PANCACKING" down from a height of 2,500 feet, an airplane equipped with a fifty-foot parachute was landed safely at a California field recently in the first test of the biggest chute yet built. Blown three miles from the field during the drop, which took sixty-six seconds, the craft landed in rough ground on a hill, damaging the undercarriage and propeller slightly. With a level landing ground, observers said, the ship could have rolled after landing and escaped damage.

The big parachute, designed by Harry D. Doucett, a chief petty officer of the navy, did not differ greatly from the smaller chutes used by flyers. It was fastened to the plane by forty feet of steel cable, and a four-point suspension at the center of balance of the ship, just forward

of the pilot's cockpit. The parachute itself, folded in a container four feet long and fourteen inches square, was carried in a compartment beneath the fuselage, back of the pilot's seat. From the suspension point in front of the pilot the cable was carried along the top of the fuselage, passing over the flyer's head, around the edge of the rudder, and forward beneath the airplane to the parachute, being held in place by light twine which would break at the slightest tug.

R. Carl Oelze, a naval-reserve pilot who was picked to make the first test descent, planned to climb to a height of 5,000 feet before releasing the parachute, but because of motor trouble was forced to shut off his engine at half that distance.

"At the height of 2,500 feet," he ex-

plained after landing, "I cast a handful of newspapers into the air—a signal to my convoy of seven sister planes that I was ready to release the lever. I counted thirty, then I ducked and jerked the release. Because of air valves in the chute, it filled slowly but steadily and I was surprised and tickled to see the cable gradually rise into position without the slightest semblance of a jerk.

"One thing I had misjudged. That was the velocity of the wind, and in giving the 25,000 spectators that lined the field every possible chance I had gone too far over into the wind. This put me past one extremity of the field, and I soon saw I was going to miss. I did my best to steer for something, and made a pancake landing on a slight hill which demolished only my landing gear. 'Wings,' the parachute, settled down to ground beside me. Five

minutes later the observers and spectators began swarming over the hill and the emergency ambulance dashed up to find me at a near-by house begging a glass of water from a surprised housewife."

While the parachute was being tested on the west coast, an equally important aviation development was revealed in the east when Henry Ford took occasion, on his birthday, to exhibit a new "flivver" plane developed by the Stout metal-airplane division of the Ford company. The new ship, a tiny monoplane driven by a small three-cylinder air-cooled motor is still in the experimental stage and its price and the details of its construction remain to be announced.

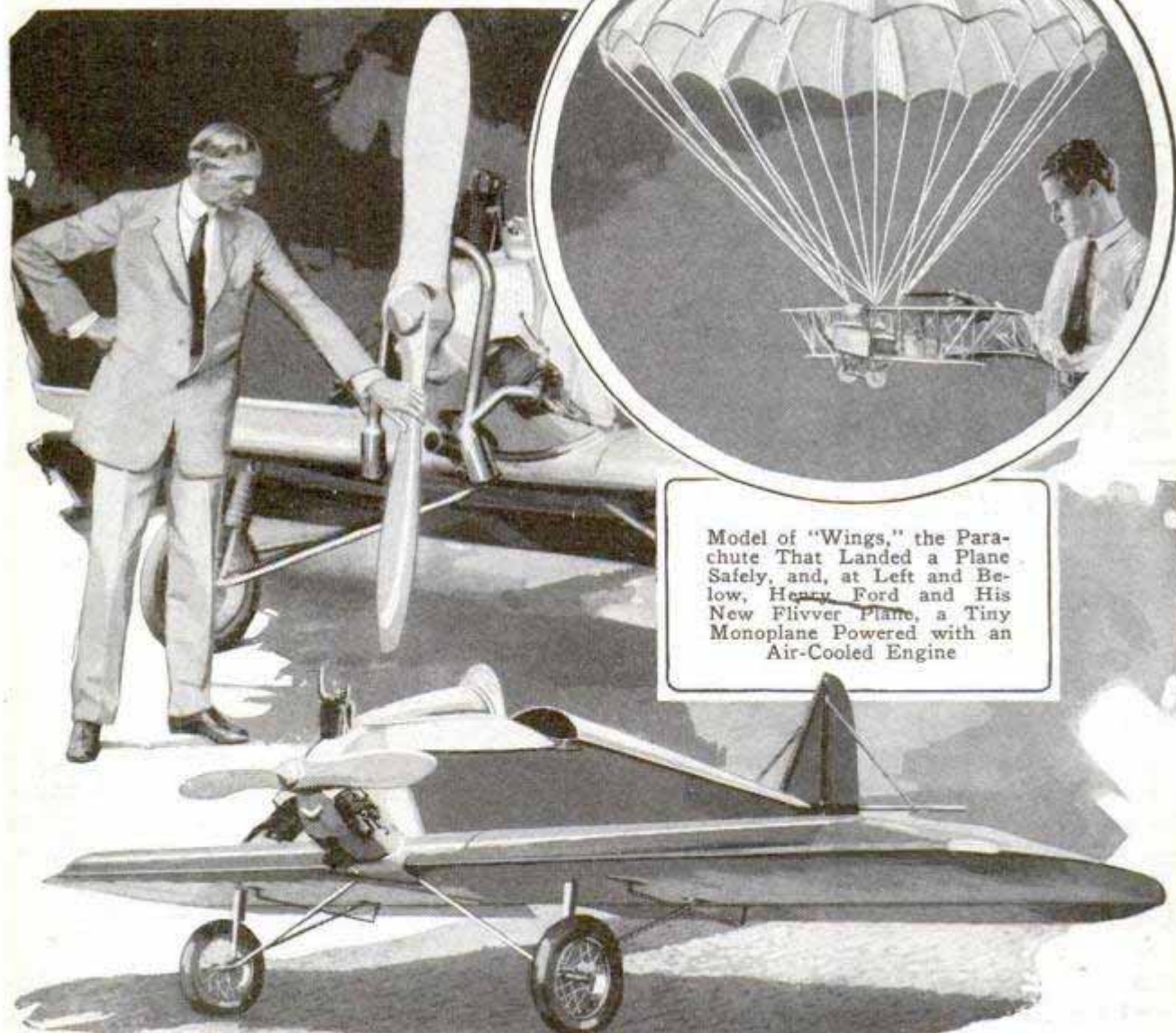

Model of "Wings," the Parachute That Landed a Plane Safely, and, at Left and Below, Henry Ford and His New Flivver Plane, a Tiny Monoplane Powered with an Air-Cooled Engine

Artist's Sketch Showing How the Giant Parachute Brought an Airplane Safe to Earth After the Motor Had Been Stalled; the Chute Is Made of Finest Silk, with Strong Rope for Shroud Lines, and Steel Cable to Attach It to the Ship; in Flight the Chute Folds Up in a Small Container

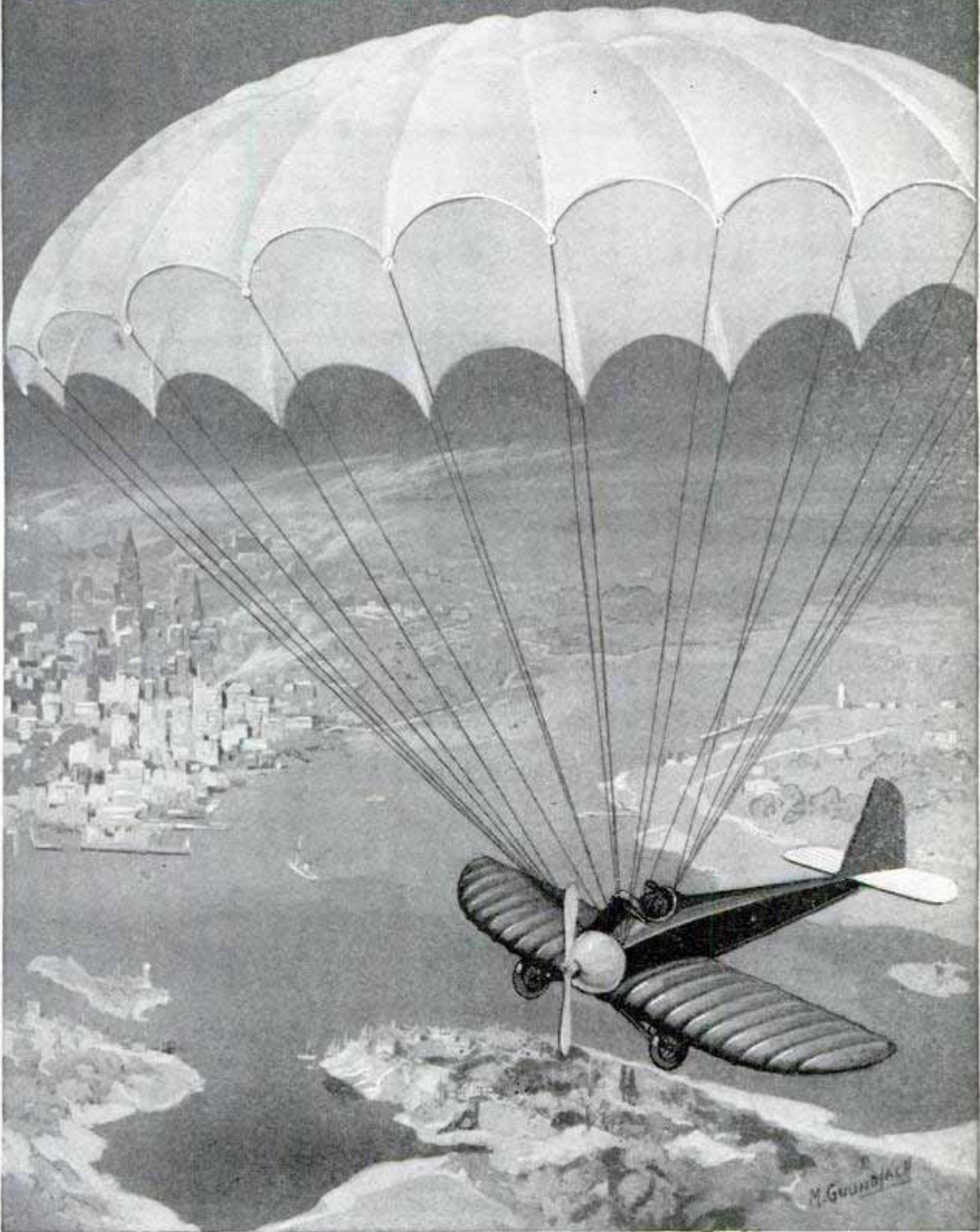

164



New Form of Metal Traffic Marker Is Easily Driven In with an Air Hammer

TRAFFIC MARKERS ARE PLACED WITH AIR COMPRESSOR

A new type of traffic marker for safety islands, or which can be used to spell out speed warnings, school-zone signs and similar information is built to last as long as the pavement itself. The marker consists of a square of heavy sheet steel, with corners bent down and buttonlike projections raised in its surface. It is driven into the pavement with a compressed-air hammer, and can be used on any type of asphalt or wood-block pavement. The markers are spaced a foot or so apart to form lines for safety zones and closer when used to form letters.

TANK LAYS SCREEN TO HIDE TROOPS IN WARFARE

An armored battle tank that shoots a smoke screen instead of bullets was tried with

success recently by the Polish army in maneuvers near Warsaw. The tank resembles the ordinary military machine of the type, but instead of a gun turret carries two streamlined containers on the roof, filled with smoke-making chemicals under high pressure. In action the tank advances first and lays down a thick screen, under cover of which troops are able to advance and prepare new trenches or execute other evolutions.

278

Resonant

FIGHTING SNOWS IN ALPS TO CLEAR AUTO ROADS

During a period of warm weather in Europe last season, there was one locality that not only escaped the heat wave but experienced some of the rigors of winter. Heavy snows fell in parts of the Swiss Alps and over the Fluela pass, drifts several feet deep being formed. It was necessary to clear the auto roads almost daily and, in places, a narrow one-way cut through the piled snow was the only means of getting in or out.

*Engadin
 from lanes to*

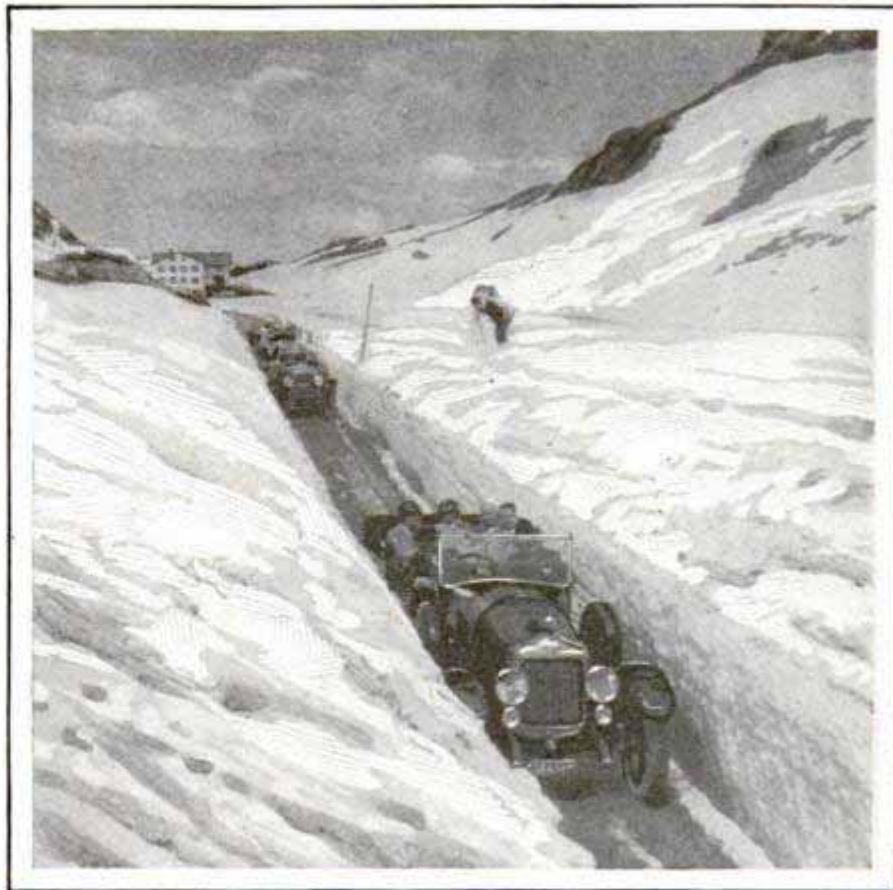

Summer Autoists in Alpine Passes Keep Cool Driving between Giant Snowbanks That Line the Road; This Is a July Scene

364

*L. Illustration.
 8/14/26 P. 165*

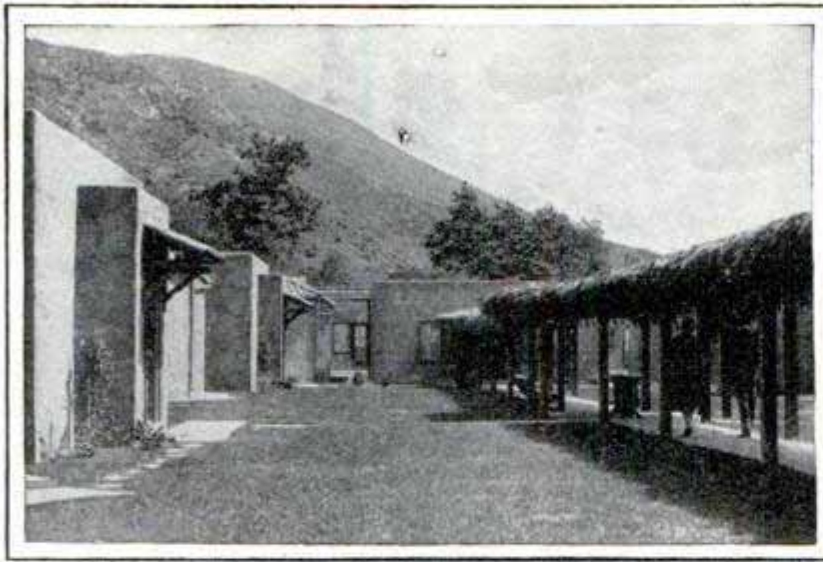

the phonograph were being treated. Later, it was discovered that the disks had an unusual hardness and more records could be stamped from them. At a



Copyright, Ewing Galloway

Roadside Inn on the Pacific Coast with Small Individual Bungalows Instead of the Usual Hotel Rooms for the Guests; Spanish Architecture Emulates the Old Missions

329
ROADSIDE INN FOR MOTORISTS HAS BUNGALOWS FOR ROOMS

Small, individual bungalows, each with private bath and garage, are the features of mission-style hotels for motorists being erected between San Francisco and Portland. The little dwellings take the place of ordinary rooms and the main building has a large dining room, office and other accommodations of the usual hotel. The bungalows face a central patio.

345
CHANCE FLIP OF BIT OF CHEESE IMPROVES PHONOGRAPH

How an Italian laborer's faulty aim with a piece of cheese made a lasting contribution to the success of his employer, a manufacturer of phonograph records, is the story told by a chemist of the bureau of standards. During luncheon time one day, the worker playfully flipped a lump of cheese at a companion. The missile fell short and landed in a tank where metallic disks used in preparing records for

Mr. William Orlum

loss to account for the change, plant officials conducted a careful inquiry to learn if the solution used with the disks had been altered in any way. The episode of the cheese came to light, and it was found that the casein the lump contained had produced the hardening of the metal.

From Compressed Air Aug. 1926
ELECTRIC LAMP FOR MINERS
354 DETECTS POISON GAS

Protection against fire-damp explosions is said to be afforded miners in an electric safety lamp a German engineer has devised. It operates through a series of small, semicircular loops of a special metal preparation placed in a little glass bulb which is sealed at its upper end by a porous stone. Under ordinary conditions, with the current on, the ends of the filament turn a dark-red color, indicating that the lamp is working as it should. But if there is poison gas in the air, the center of the filament becomes incandescent to a varying degree, depending on the quantity of the dangerous vapor present.

Described by Mr. Martiniessen, Kiel

*The hotel San Luis Obispo on Redwood Highway called
at meeting of Austrian Science Society*

Julius Rumpel
 710 POPULAR MECHANICS
 Weston Mo

**CAMP TENT AND BED COMBINED
 ERECTED IN TEN MINUTES**

24 |

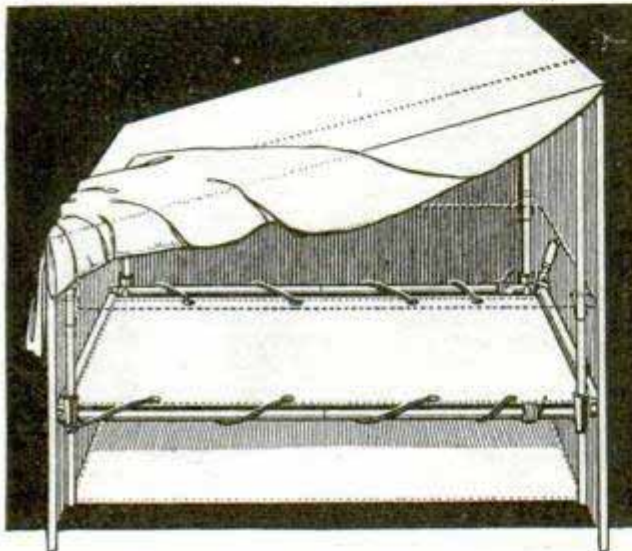
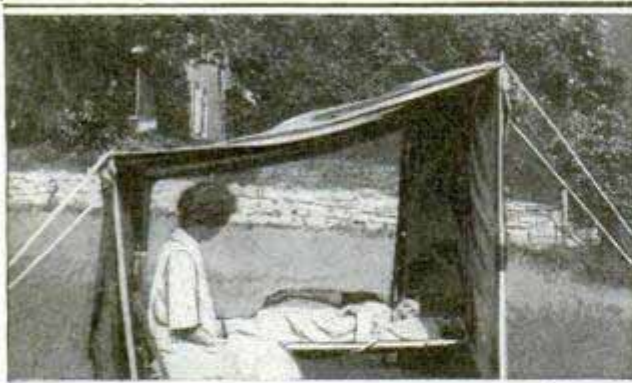

Combined Tent and Bed for the Auto Tourist; It Is Assembled or Taken Down in One Operation

For the auto tourist, tent and bed have been assembled into a single unit which is easily and quickly set up or taken down and weighs only seventy pounds. The bed frame is attached directly to the tent supports and its canvas mattress is tightened with a ratchet and may be laced so securely that it will not sag even with two persons. Each weighing 200 pounds or more, it is said. The tent provides space for dressing room and has side curtains with windows.

ARCTIC GRASS FOUND IN U. S.

368 LEFT BY GLACIERS

Grasses found flourishing recently on the peaks of Mt. Massive and Mt. Elbert, 14,400 feet above sea level in Colorado, have been identified as belonging to species found along the Alaskan coast. The only explanation for their presence in Colorado, according to Prof. A. S. Hitchcock, of the department of agriculture, who made the discovery, is that in the

*Stuck Corp, Jones
 Laughlin Bldg. Pittsburg!*

glacial age the ice from the north carried grass seeds southward and left them stranded in the Rockies. Prof. Hitchcock is collecting and classifying the 1,500 species of grass in the United States as part of the work of the government toward replanting the range lands in the west and controlling grazing.

**440 W. Lake, Chicago
 NEW HARD STEEL TO LOWER
 369 COST OF MACHINERY**

A new hard steel, which can be produced at less cost than present alloys, recently was developed by a steel mill in the Pittsburgh district and given the name of "jalcosé." Its surface is extremely hard while the interior is tough but ductile, making it suitable for automobile and machinery parts where there is severe wear, repeated shocks or great stresses. Because of the comparative softness of the interior it can be machined more easily than pure hard steel.

MOTORBOAT ON VENICE CANALS

273 REPLACING GONDOLA

Travel on Venice canals has been made more rapid lately by the use of small motorboats to supplement the traditional gondola. Some of the leading hotels have their own craft to take guests to and from



Taxicab Meters and Flags Are Used on Motorboats That Ply the Canals in Venice

stations and for rides about the city, and there are stands where the boats may be hired like taxicabs.

*1867 Park Road, N.W.
 Washington, D.C.*

*Scientific News Service
 Smithsonian Institution*

*Jones - Laughlin Bldg. Pittsburg.
 1200 N. Dearborn, Chicago*

8/28/26

Aug. 1926.

RAIN AND SNOW FERTILIZE 363 SOIL

That rain and snow do more than water the soil has been confirmed by Canadian chemists, who for several years have been measuring the nitrates absorbed from the air and brought to earth by them. They found that in the region around Ottawa the fertilizer washed into the earth out of the air was equivalent to forty-four pounds of expensive Chilean saltpeter per acre each year. Dr. Frank T. Shutt, Dominion chemist in charge of the experiments over a period of seventeen years, also spoke a good word for the much maligned soft coal. Ammonium nitrate, the form in which the fertilizer comes from the air, is given off by soft-coal fires in large quantities. Increase in the use of the coal is marked by corresponding increase in fertilizer. Forest and brush fires and lightning discharges also help increase the ammonia content of the air.

VIOLIN IS PLAYED WITH KEYBOARD

Inclosed in a decorative cabinet, a violin is played with a keyboard similar to that of a piano. It is said that tremolo effects can be produced by merely pressing and releasing the right key, and several instruments may be combined and played together, either with the keys or by means of rolls.

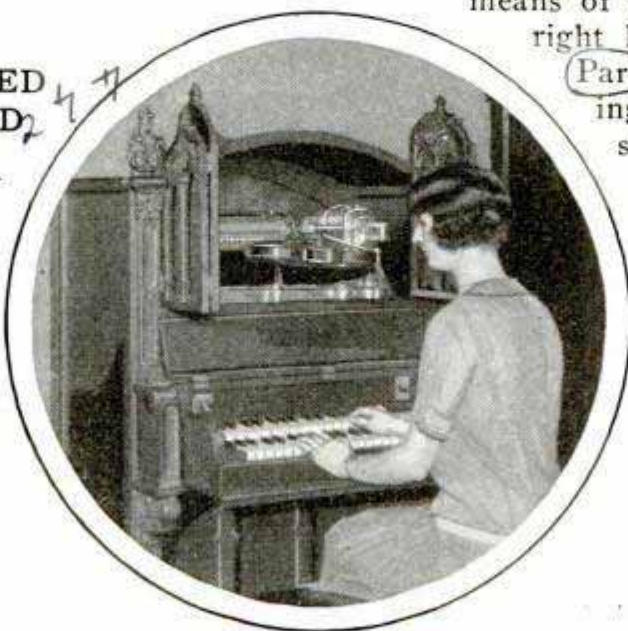

With a Piano Keyboard, This Violin Can Be Played without Learning to Use a Bow

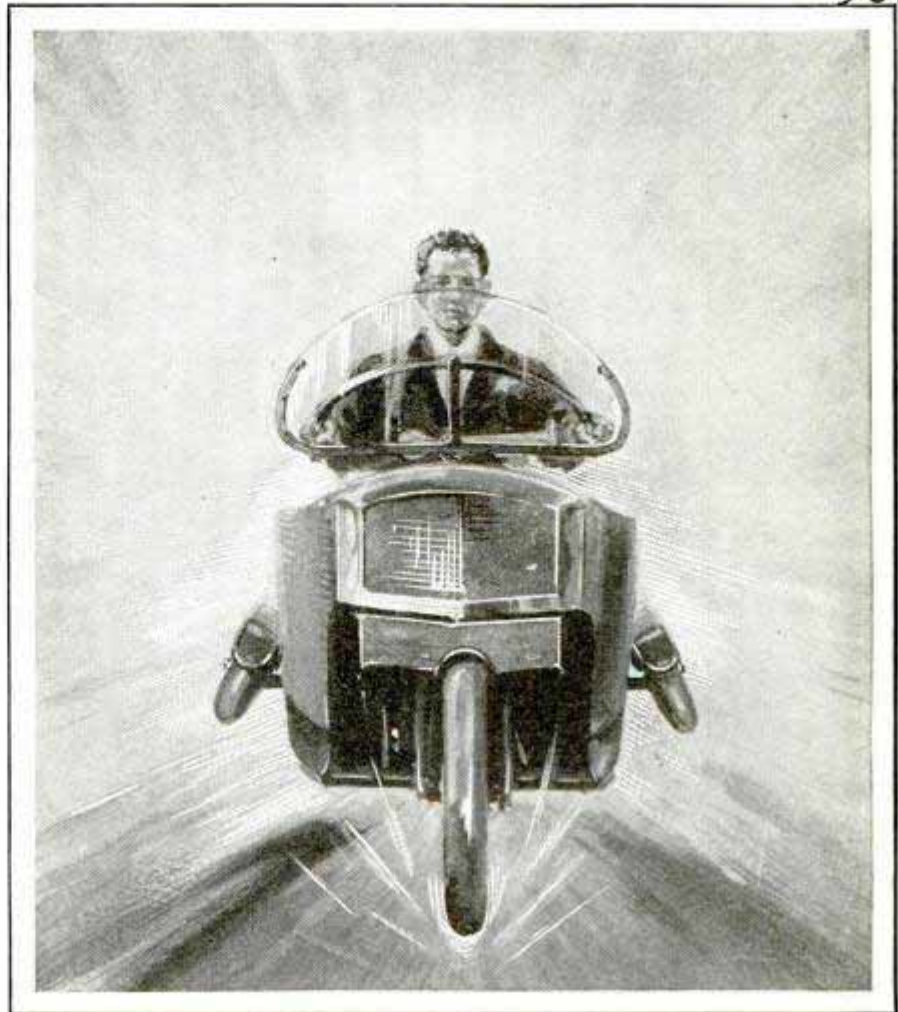

The Side Wheels of This Motorcycle Are Drawn Out of the Way When Traveling, While Providing Safety on Sharp Turns

SIDE WHEELS ON MOTORCYCLE AID IN TURNS AND STOPS 308

A two-seat motorcycle with small side wheels that can be raised or lowered by means of a lever at the driver's right hand, has appeared in Paris. The extra pair resting on the pavement helps steady the machine when it is stopped, and reduces the danger of accidents on sharp turns. The comfort of the passenger in the rear seat is also increased as the cycle cannot lean excessively.

During the past year, 524 more ships passed through the Panama canal than in 1925.

Mells Novelty Co.
221 S. 1st St.

359

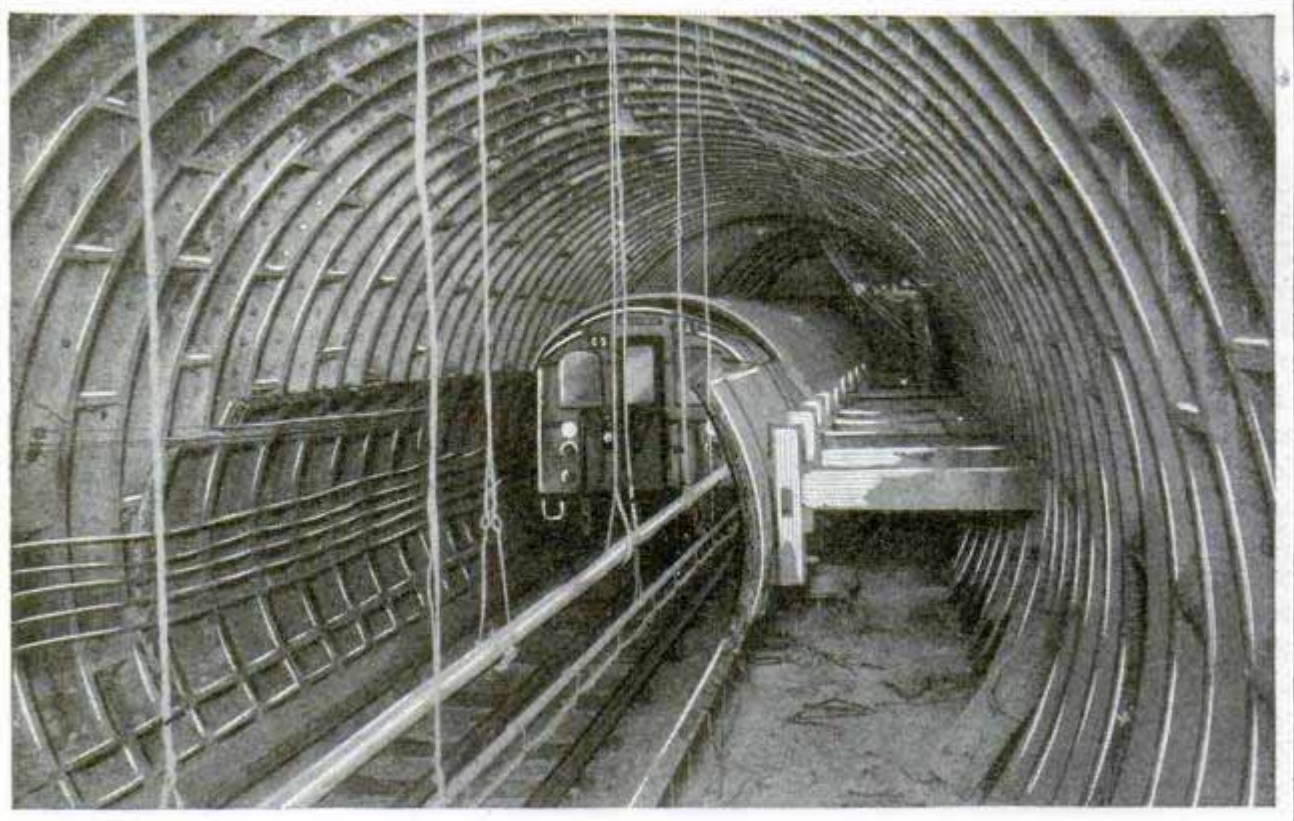

Difficult Engineering Feat in London Nearing the Close; after Building a Large Subway Tunnel around a Smaller One, the Workmen Begin Dismantling the Latter While It Is in Use

TUNNEL DUG AROUND TUNNEL WITHOUT HALTING TRAFFIC

That engineers can accomplish the seemingly impossible has again been demonstrated in a subway alteration in London. The problem was to construct a siding between two tunnels on different levels without interfering with the trains that whizzed by every two or three minutes. There was a difference of ten feet in the levels, the space between was narrow and the ground contained pockets of water-bearing sand. Furthermore, junction tunnels had to be made to connect the siding with the running tunnels. Most of the siding, except about 320 feet of lead-in section to the down-running tunnel, was bored by hand at practically the same level as the higher of the two passages along which the siding ran 720 feet. Air locks and compressed air were used to hold back the water in the sand pockets. While the junction tunnel was being constructed, the running passage was literally a tube, supported at the base and sides with timber struts to prevent collapse as the earth was removed from around it. The workers thus literally dug a tunnel around a tunnel without stopping traffic

in the inner one. To keep the compressed air from entering the inside tube, the holes in the segments through which cement had been injected when the tunnel was constructed, were plugged up. When the outer passage was completed, the sides of the inner one were dismantled and the props that had supported them were left imbedded in the concrete in which the tracks for the new bore were laid.

AUTO MAP ON STEERING POST READ AT A GLANCE



Intended primarily as a certificate-holder, a metal frame for an auto road map is fastened to the steering column just under the wheel so that the

guide may be seen at a glance while driving. A celluloid cover protects the map from the weather.

Chimpanzees are about four times as strong as a man, weight for weight.

*calif.
H. O. Pence & Son
San Luis Obispo*

*H. O. Pence & Son,
San Luis Obispo*

Adelbert Agalardi

*40 Maternal + Hero
100 Hudson, New York.*

GUN SNAPS A PHOTO OF THUG AS IT SHOOTS 367

A camera pistol that automatically takes a picture of the person or object at which it is fired has been invented by a mechanical engineer, who claims that, by the addition of magnesium flash powder to the ordinary charge, the revolver can even keep its photographic record at night. With it, he says, the picture record would identify a criminal even if the bullet missed him, while it would also be a positive record in self-defense cases, as the photo would show what the other person was doing when he was shot at. His idea is that the camera case should remain locked, with the key in possession of the police department, which would develop the films and hold the record.

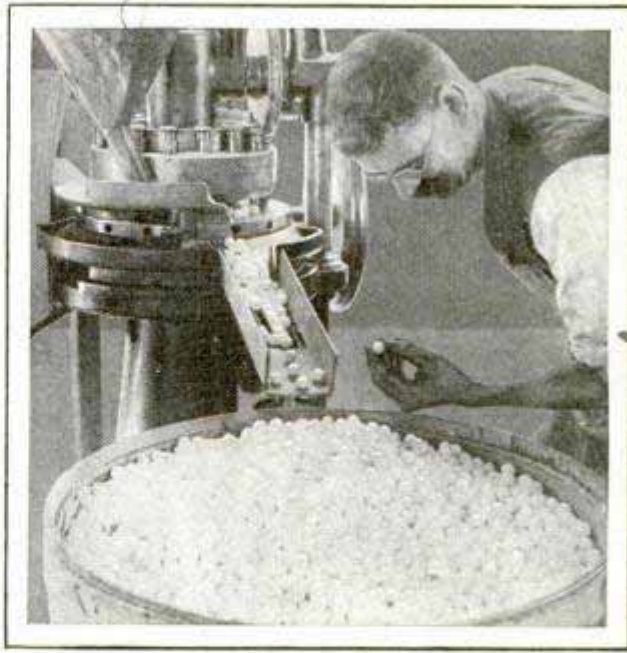

Moth Balls Falling from the Press into Basket for Packing; They Are a By-Product in Gas Making

STORY OF HORSE'S EVOLUTION TOLD IN MODELS 127

Search for the original habitat of the horse is being conducted by investigators of the Smithsonian Institution. The animal of today is believed to have descended from a five-toed midget variety that may have lived somewhere in the Arctic regions. Dr. James W. Gidley has completed a series of models showing the supposed evolution of the horse.

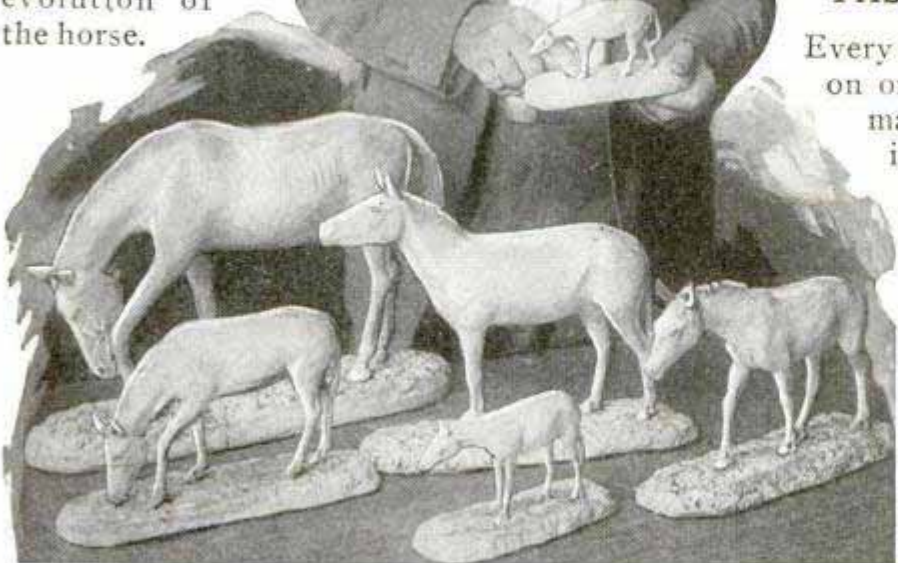
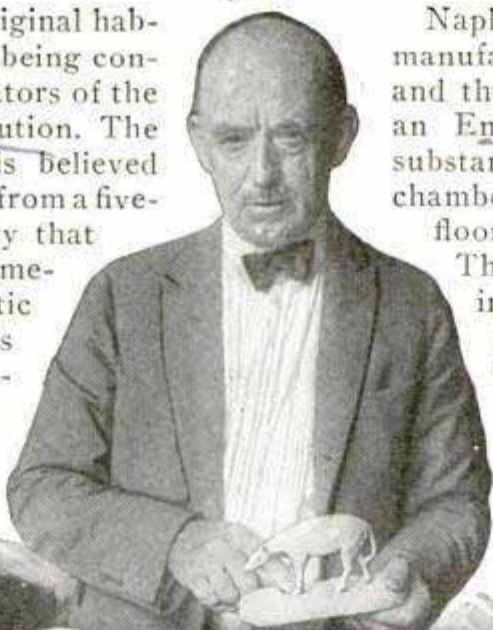

Dr. Gidley with Models That Tell the Story of the Horse's Development from Early Ancestors; Scientists Are Seeking Animal's Origin

CONDENSED GAS FROM COAL MADE INTO MOTH BALLS

Naphthalene vapor, a by-product in the manufacture of gas from coal, is condensed and the flakes pressed into moth balls at an English works near London. The substance is collected in a condensation chamber which becomes covered on walls, floor and roof with the solidified vapor. The flakes are shoveled up and pressed in a machine which quickly rolls them into the familiar round pellets for home use.

GERMAN AIRLINES INSURE PASSENGERS IN PLANES 366

Every passenger who buys a ticket on one of the seventy-five German air lines is automatically insured for \$6,000 under a new ticket system put in effect recently. The insurance company which handles the policy decided that flying in Germany was as safe as riding on a train, and charged merely the normal accident rate, instead of the extra-hazardous-occupation rate. No passenger was injured on German lines in the first half of 1926.

Luft. Hansa

*Esas Light + Cape Car Englam
Beckton
York James
8/29/26
New*

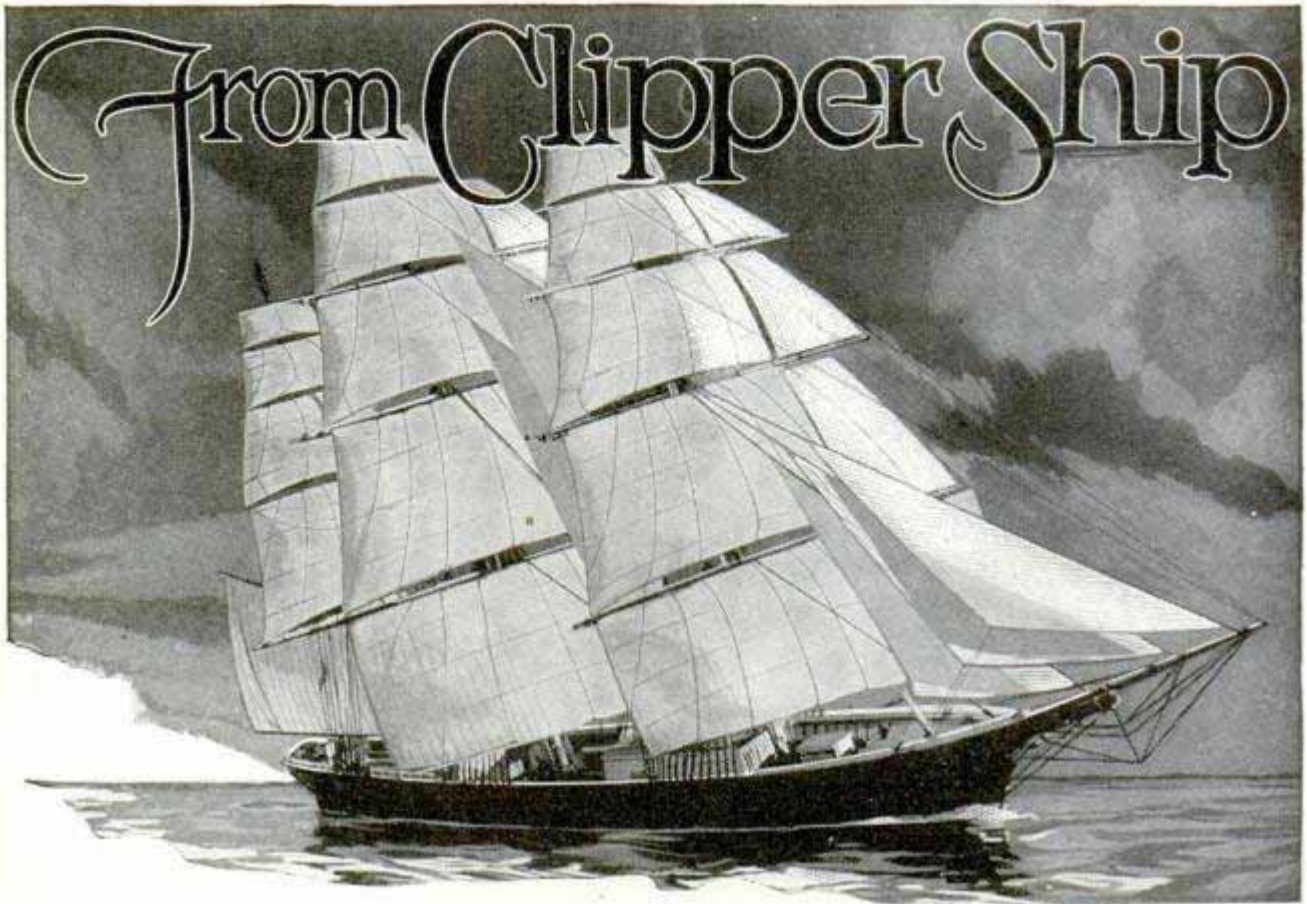

"Flying Cloud," One of the Most Famous of Donald McKay's Clipper Ships and the Fastest Sailing Ship under the American Flag, and, on Opposite Page, the Latest Diesel-Motored Liner

SEVENTY-ONE years ago the first mate of the Boston-built clipper ship "Lightning" closed his log entry for March 1, 1885, with these words: "Distance run in twenty-four hours, four hundred and thirty-six miles."

That was a record that still stands. No sailing ship had ever sailed so fast and far in a single day, and it is improbable that one ever will. But the tramp steamers had already begun to chug their way across the seas and the clipper ship, the most beautiful thing seafaring men ever invented, was already doomed, though but a half dozen years old.

Today the steamers that drove the sails from the ocean are fighting another, and a losing battle, against man's latest development, the motor ship. Like the steamer that displaced the clipper, it costs more to build than the losing boat, but it is cheaper to operate and can carry the world's freight at lower rates.

The clipper was born in the mad rush to get to the gold fields of California. Passengers paid enormous fares and the freight rates were gigantic. Under such conditions the long, narrow hulls, with

their somewhat limited cargo space, could pay dividends—and big ones—but when the world settled down to five and six-percent profits, the clipper was doomed.

The motor ship, with its Diesel engines burning heavy oil, has placed millions of tons of shipping on the seas in the last six years for the same reason—surer profits.

To Donald McKay, who came to the United States as a boy of sixteen from Nova Scotia, America owes the honor of sweeping the seas in the most glorious days of sailing ships. He built the fastest clippers that ever sailed; not one, but many of them. The "Lightning," which made her world's record on her maiden voyage from Boston to Liverpool, was one of four clippers built by McKay at the same time for a British line which had ordered them for the Australian service. One of the quartet, the "Donald McKay," only ship named after their designer, logged 421 miles on her maiden voyage that same spring. Another, the "James Baines," sailed around the world, Liverpool to Liverpool in 132 days, a record no other sailing ship ever equaled. The four were built after James Baines, the president of

To Motor Liner

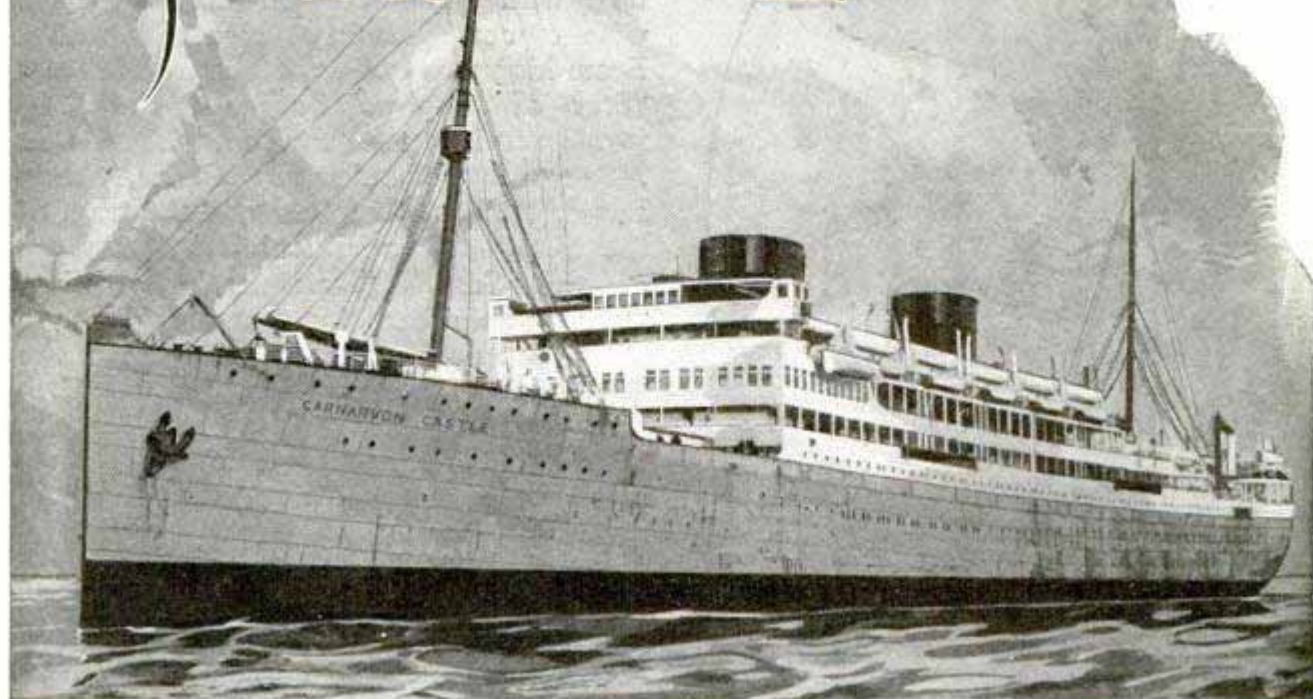

the line, had leased McKay's "Sovereign of the Seas"—one of the finest ships that ever flew the American flag—and offered space in her hold at seven pounds per ton, the shipper to recover two pounds if she didn't beat every steamer on the run to Australia. Baines kept the money.

What the speed of these fast clippers meant is better understood when it is realized that no steamer afloat at the time could have come within a hundred miles of "Lightning's" 436-mile log for twenty-four hours—in fact, there are hardly fifty great passenger liners afloat today that can better that mark. In her log for that first of March the first mate wrote, "Strong gales, bore away for the North channel [they were then 500 miles off the Irish coast], carried away the foretopsail and lost jib; hove the log several times and found the ship going through the water at the rate of eighteen to eighteen and one-half knots; lee rail under water and rigging slack."

Her sister ship, the "James Baines," was as fast, though she never logged quite so many miles in a day, but on one occasion she attained a speed of twenty-one miles an hour—a marvelous performance for a craft borne by the wind.

McKay did not create the clipper ship, but he did bring it to perfection, and built the greatest clippers that ever sailed. Before his day, sailing ships were small and broad and short, with bluff bows hammering their way through the water, and squat, square sterns—a cod's head and a mackerel tail was the shipbuilder's model. McKay's clippers were just the reverse, long and narrow, lean as a racing greyhound, with both bow and stern concave at the water line—the same flaring lines used for the racing cruisers and battleships of today.

Above the deck towered lofty masts and giant spars, carrying a vast spread of canvas. The "Great Republic," of 4,555 tons, biggest of them all, had a main yard 180 feet long and her suit of sails consumed 15,000 square yards. She inspired Longfellow's poem "The Building of the Ship."

She was doomed, though, never to set them, for while she was loading at a New York pier for her maiden trip, after having been towed down from Boston, a waterfront fire spread to her sails and the ship was so badly damaged it was necessary to scuttle her to put out the flames. Raised again, she was cut down to 3,357 tons, with corresponding decrease in her



Donald McKay, the Nova Scotian Boy Who Made the Stars and Stripes Supreme on the Seas

sail area. In spite of the cutting down, she made a voyage to San Francisco, around the Horn, in ninety-two days—only three days slower than the record. What she might have made as originally designed can only be conjectured.

It was a McKay ship, the "Flying Cloud," that set the world's record for the passage from New York to San Francisco. On her maiden voyage in the summer of 1851, carrying a cargo of gold seekers bound to the coast, she made the voyage in eighty-nine days, a record that was only equaled twice, by herself in 1854 and by the "Andrew Jackson" in 1860. On that memorable maiden trip she raced the notorious "Bully" Waterman's "Comet" and beat it by nineteen days.

The "Flying Cloud" was not a big ship, as later clippers went. She measured 229 feet long on deck, with a breadth of forty feet eight inches, and had a registered tonnage of 1,783. Beneath her bowsprit a beautifully carved figurehead showed a winged angel blowing a trumpet.

In a day when ship owners had already begun naming their vessels after themselves and members of their families, McKay's clippers not only were famous for their beauty and speed, but for the aptness with which he named them, when wise owners permitted him to do this. From his yards came "Westward Ho" and "Star of Empire," both for the California service; the "Staghound," "Ocean Monarch," "Sovereign of the Seas," "Bald Eagle," "Chariot of Fame," "Empress of the Seas," "Great Republic," "Romance of the Seas," "Defender," "Mastiff," "Glory of the Seas," and many others.

Yet the first of his great clippers, the "Staghound," was not launched until December, 1850, and the last real clipper, "Donald McKay," slipped down the ways in 1855. Into those five years a whole revolution in naval architecture was crowded. The four Australian packet ships, including "Lightning" and her three sisters, closed the era of extreme clippers. McKay continued to build medium clippers, broader of beam and with smaller masts and sails, until the Civil war turned him into a gunboat constructor of the navy. After the war he turned out three more medium clippers in 1868 and 1869, but already the market for the wooden hulls to be sailed by iron men was passing.

The change from sail to steam was fairly gradual. The clippers went within a few years in favor of slower ships with greater

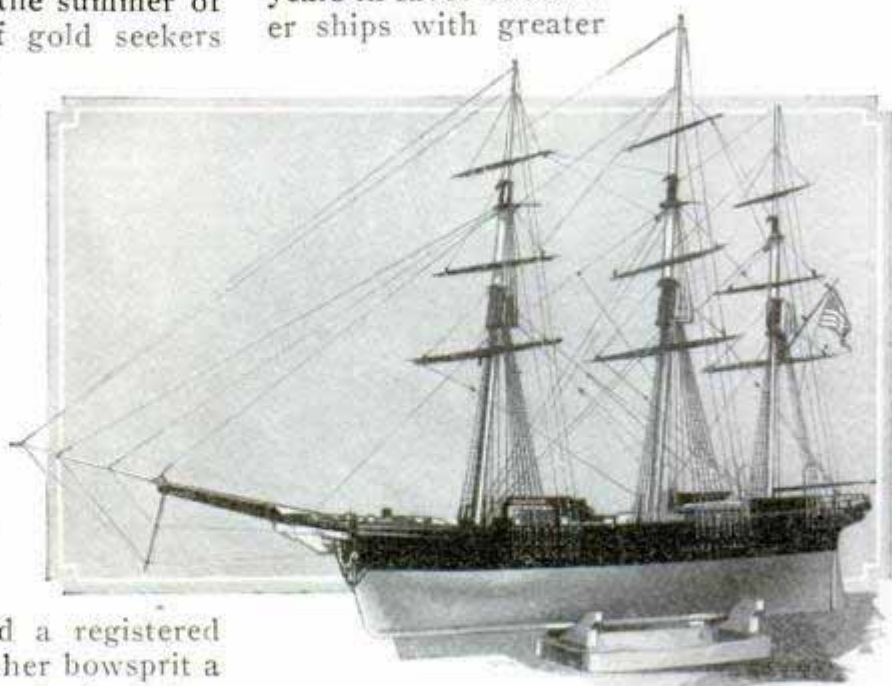

Model of "Lightning," a McKay Clipper That Holds the Record as the Fastest Ship That Ever Sailed



A Long Way from the Stately Masts and Billowing Canvas of Clipper Days; This Is the "Leviathan," Queen of the American Merchant Fleet, Leaving New York at Night

freight capacity, or else had their masts and sail area cut down to make them more economical in operation—as happened to the famous "Cutty Sark"—but it took forty years or more for steamers to really supplant the wind. The new shift, from steam to motor ships, has started at a more rapid pace. Italy, Germany and the Scandinavian countries have led, partly because of the lack

of good and cheap coal, while the change has been much slower in England. The British, however, have built several notable motor vessels, one a big passenger ship that runs between western Canada and Australi, and two others for the England-South American trade.

The Wind May Again Move the World's Commerce, but White Sails and Lofty Masts May Be Replaced by Squat Rotor Towers as on This German Ship

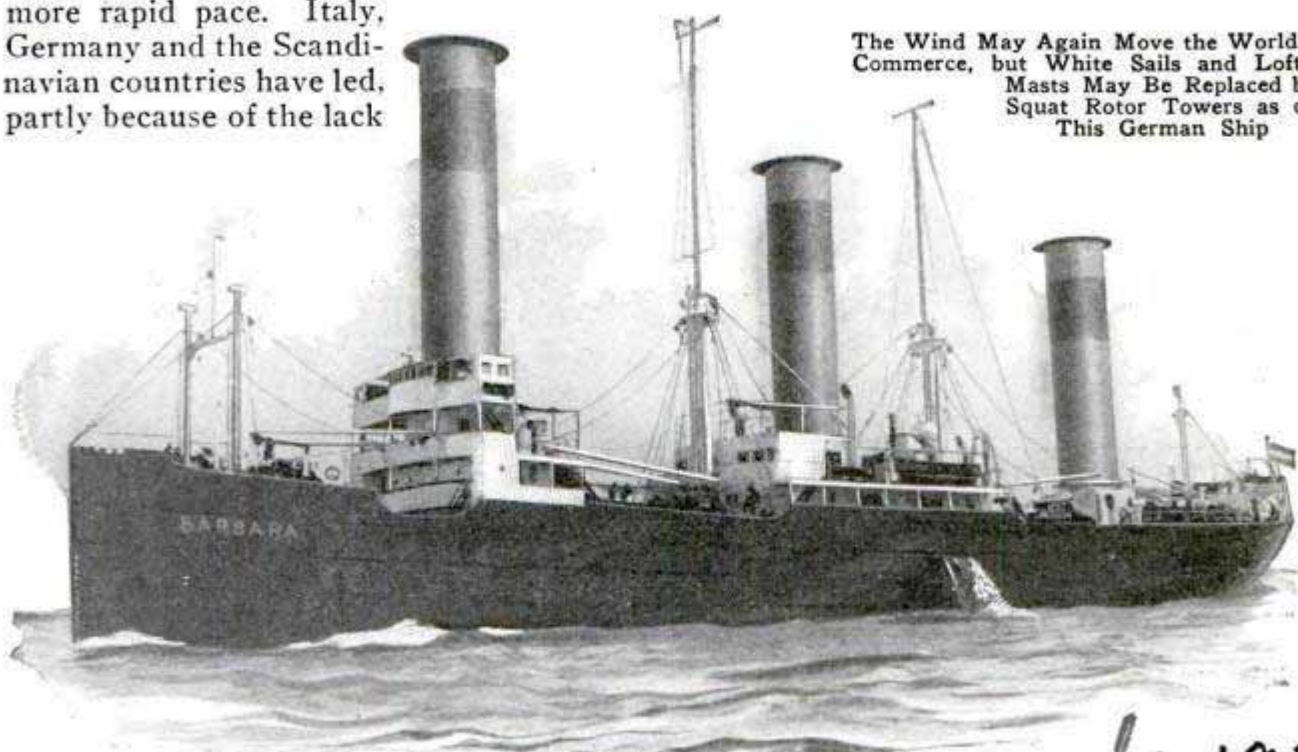

Refer to March, 1925

6613 Kelly St. Pittsburgh, Pa.

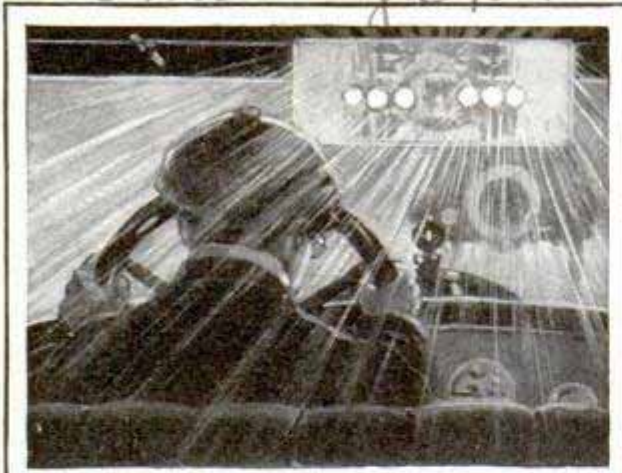

Ordinary Rear-View Mirror, and Below, Glareproof Glass That Keeps Dazzle Out of Eyes



322 **GLAREPROOF MIRROR FOR AUTO MAKES NIGHT DRIVING SAFE**

To eliminate some of the dangers of night driving a glareproof, rear-view mirror has been developed. The backing, which is prepared by a secret process, does away with sun, snow and headlight glare, and increases the mirror's effectiveness for daytime use. Images are sharp, clear, and well defined, as in a camera finder. The objects seen are in their proper colors, and appear at their actual distances. This last feature is particularly valuable, as it permits a driver to gauge accurately how far behind cars are.

35 **SCHOOL FOR DOCTORS ON TRAIN GIVES HOSPITAL POINTERS**

What would a surgeon do if the lights were suddenly extinguished while he was working on a patient in the operating room? When is an "ashes of roses" color best suited to the walls of a sick room and when is orange most effective? How can a physician tactfully induce a mother to

quiet her children who may be laughing and shouting in a sick ward, disturbing the patients, and yet not lose the woman's good will? These and other problems relating to hospital management and procedure were studied on a train carrying delegates to the American hospital convention at Atlantic City. The classes were composed of doctors from various parts of the country, and experts in that particular field of medical work were obtained to give the instruction. The plan not only proved a satisfactory employment of spare time, but the questions and studies were related to matters discussed at the convention and subsequent hospital visits.

ONE-MAN "SODA FOUNTAIN" WALKS BELGIAN STREETS

In Belgian cities, the version of an American soda fountain is the cocoa vender, who tours the streets and serves his customers in the open. The cocoa peddlers carry a pair of tanks slung to their backs, one filled with cocoa and the other with water, the latter for rinsing the glasses, of which each vender has two, the limit of customers he can serve at one time. The faucets of the two tanks are carried around under his arm to a convenient position.



Belgian One-Man Soda Fountain That Carries the Drink Direct to the Customer on the Street

Cont. E. W. Holk, 155, Boulevard Militaire, 115, Brussels, Belgium

TINY FIREBOAT PROTECTS SUMMER-RESORT HOMES

The problem of securing fire protection around lake resorts seems to have been efficiently and economically solved by a small fireboat recently developed by a westerner. The boat has enabled its builder and owner to establish himself in a business in which he earns a substantial sum during a season of four months. Lake resorts where people have summer



One of the World's Smallest Fireboats Is an Outboard-Engined Skiff Maintained for Summer Residents at a Western Lake; the Motor Pump Can Be Carried Ashore to Fight Forest Fires

homes and cabins are usually situated in forested country. Such locations seldom have adequate fire-fighting equipment. Consequently, during seasons of scanty rainfall, the fire risk is great and full fire insurance prohibitively priced. This condition is particularly true in southern California where the summer months are virtually rainless. The danger from fire at such resorts, as observed by Frank Lewis, of Los Angeles, set him thinking of ways by which the large property investments around the lakes might be protected. The fireboat shown in the accompanying illustrations is the result. And, in conjunction with it, he has developed a novel business plan whereby the owners whose property he protects pay on a monthly subscription basis. The boat is only six-

teen feet in length, and driven by a two-horsepower outboard motor. In this hull was installed a high-pressure fire pump, with a fifteen-foot length of suction hose, and 1,000 feet of two and one-half-inch fire hose. The pumping unit weighs a little over 100 pounds and the fire hose only a few ounces per foot, so that the total load carried in the boat is by no means excessive. The boat can speed around the lake at from six to eight miles an hour, and can throw water on any fire originating within 1,000 feet of the shore. Each owner pays for fire protection on the basis of \$1 on each \$1,000 valuation of the property. While this rate is cheap for the owners, it nets the fireboat man an easily earned addition to his income from fishing, which is his regular occupation.

in car of Young and Ford

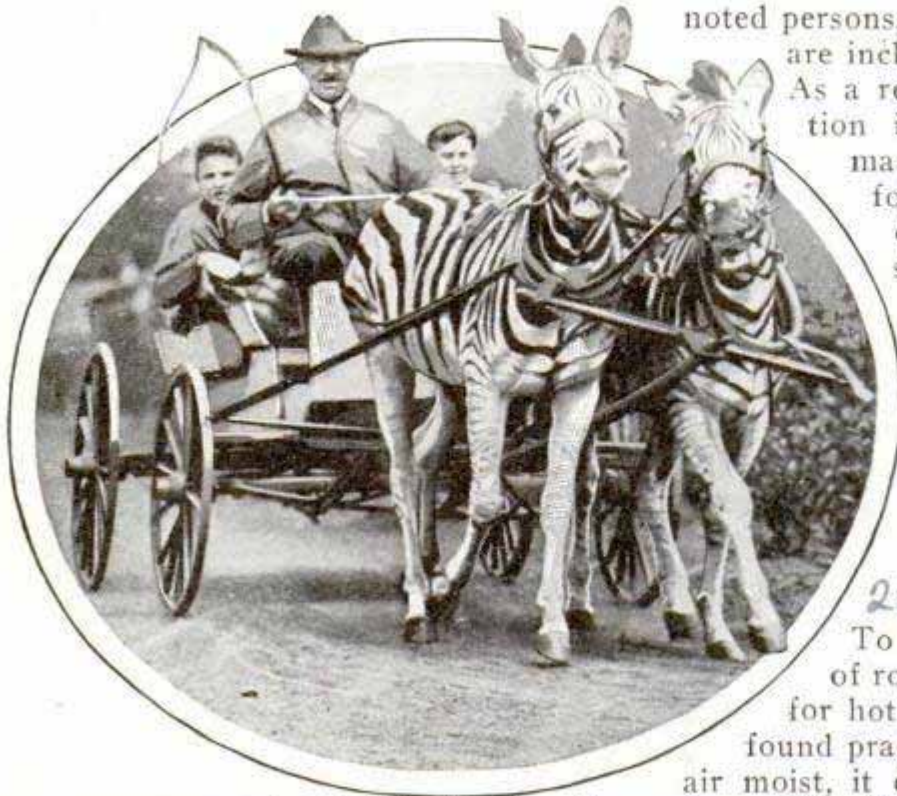

An Unusual Feat in Animal Training. Breaking a Team of Zebras to Pull a Cart

HARNESS-BROKEN ZEBRA TEAM SHOWS TRAINER'S SKILL

Few animal trainers have been able to teach zebras tricks because of the vicious disposition of the animals and their unreliability, but a policeman in Golden Gate park, San Francisco, has tamed a pair until he can drive them as a team harnessed to a light rig. The beasts are owned by the park and attract considerable attention as they canter along the roadways.

RELICS OF MAKE-BELIEVE LAND REFLECT STAGE HISTORY

In a large building on one of New York's busiest streets is housed one of the most romantic museums to be found anywhere. It is the storage place for the properties of some 800 theater productions. Rusted poniards and masks, dusty furniture, modeled carefully in historic styles, costumes, gilded odds and ends and even an assortment of imitation bathtubs are collected here, evidences of past glories before the footlights and proof of the amazing ingenuity and skill required to entertain the public. A portion of a locomotive set, one of the high lights in a famous production, models of yachts, collections of guns, Roman chariots, busts of

noted persons, and replicas of art objects are included in this historic array. As a reference source, the collection is considered valuable, as many of the chairs and tables, for instance, were exactly copied from originals and strange customs and fashions of departed days are reflected in various articles. Dampness-proof things are kept in the cellar.

TANK ON REGISTER KEEPS PROPER HUMIDITY

To insure the proper humidity of room interiors, a water shield for hot-air wall registers has been found practical. Besides keeping the air moist, it deflects the heated current toward the floor, thereby aiding in maintaining an even temperature. A screen collects dirt to protect the walls and drapes. Less heat is required when the air is sufficiently humid so that a saving in fuel can be effected with these shields.



Water Chamber Built to Fit over Hot-Air Register to Maintain the Correct Humidity

Health is promoted as dry air tends to decrease the moisture in the breathing passages, exposing them to infection. The attachments are made of oxidized copper, held by adjustable wire hooks and can be put on or removed without the use of tools.

George Merchant

Register Shields Co., Menasha, Wis.

356 W. 39th

Shubert shows - Shubert Theatrical Co. 225 W. 44th St.

Jayco Chicago agent

Service 504 Western Mutual Life Bldg Los Angeles Calif.

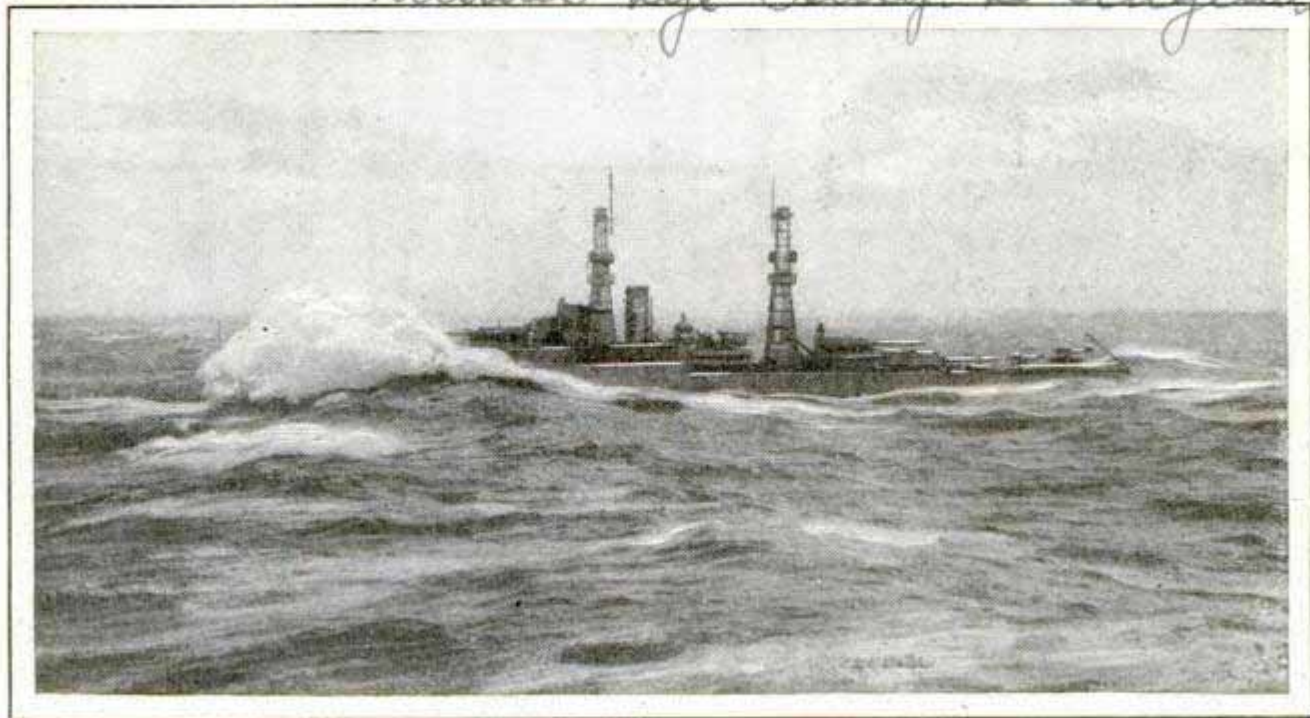

When the Guns of the "Nevada" Were Fired over the Bow, the Force of the Fire Caused the Vessel to Plunge like a Great Whale; to the Amazement of Officers, Little Damage Was Done

BATTLESHIP FIRES DEAD AHEAD BREAKING NAVAL CUSTOM

Shattering a naval precedent held in all the great fleets of the world, the U. S. battleship "Nevada," in practice not long ago, fired her main batteries dead ahead. When the shock had subsided and the ship brought to, it was discovered that, beyond broken porthole glass and slightly strained minor bulkheads, the vessel, one of the oldest dreadnaughts in the navy, had sustained the terrific test without any damage which would have prevented continuing in battle. The big guns are not fired dead over the bow or stern because there is no path of recoil for the explosions. The ship must absorb the recoil within itself. Vessels may fire to port or starboard because the ship veers far over to the side opposite the firing. This roll of the vessel absorbs the recoil energy. In this lies the primary reason why modern fleets attempt to "T" the enemy line

when they move their line at right angles across the antagonist's fleet. Shortly before the "Nevada" began the test, all hands among the turret crews were informed of what was to happen. A few points were fired from the starboard bow, the reaction shaking the ship violently. The next shot went directly over the bow. The "Nevada" lurched and buried her bow in the water rising like a great whale, then recovered.

TWO-TONE AIRPLANE SIREN AIDS IN LANDING

As a warning when landing at night and to attract attention when the craft is used for advertising purposes, a siren that produces two tones and is driven by air, has proved effective. It can be heard at a considerable distance even above the roar of the propellers, according to reports, and is easy to attach or remove.

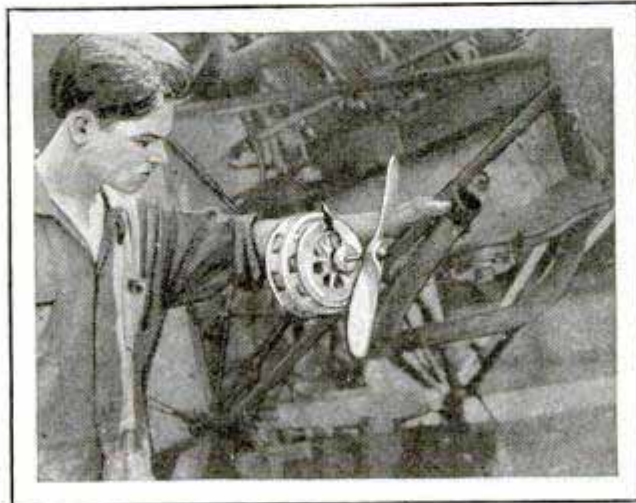

Siren and How It Is Attached to the Plane; It Shrieks a Two-Toned Warning as Craft Descends

☐ The eyes of a fly are as rigid as jewels in a watch.

*Cont. & Co. Colo, 220 S. James St
Wichita, Kansas*

Chas. W. Seay,
Asheville, N.C.

274

The ROMANCE of the

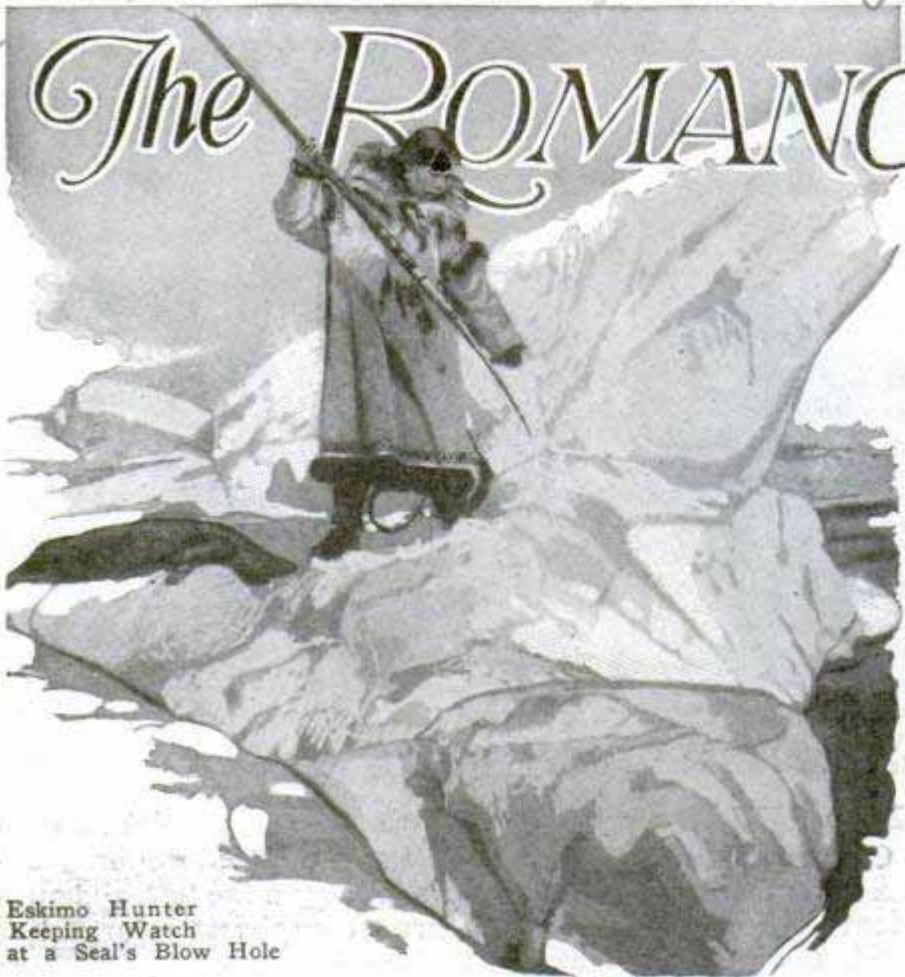

Eskimo Hunter
Keeping Watch
at a Seal's Blow Hole

travel all the way through this treacherous passage from Atlantic to Pacific, yet other vessels have penetrated deeply and returned with a cargo of furs worth a king's ransom. The polar fur fleet has recently pushed its way from Alaska to King William's land and Bathurst inlet, making conquests of passages which a generation ago would have been considered a credit to any polar explorer, but which the masters of these schooners look upon as but a part of the day's toil. They make a profitable

THAT civilization may have furs of amazing fineness, the crews of the polar fleet yearly face the hazards of the vast ice and snow wilderness of the Arctic regions for months on end. Desolation and monotony are everywhere and possible death stalks beside them as they travel through uncharted channels or cross treacherous ice packs in quest of those animals which wear pelts so prized by Dame Fashion.

While polar expeditions, using the latest scientific and mechanical means of transportation and communication, have penetrated the vast icy hinterland to the heart in search for new lands gripped by the big ice pack, the fur fleets have been putting forth greater efforts than ever to gather the rich harvest of furs known only to the Arctic, and by their persistent penetration have lifted much of the veil of mystery from these desolate and remote regions.

This is especially true of the Canadian Arctic, where fur-fleet vessels now cruise far along the northwest passage, in search of which the famous Franklin expedition of 1845 perished. Though Amundsen's expedition of 1903-06 was the only one to

round trip along these subpolar coasts in the short summer season when the ice is moving, permitting small vessels, rigidly built, to make the passage successfully. Here are found some of the world's richest peltries, since this is the home of the rare seal, the rarer white fox, and that rarest of all "water-babies," the sea otter.

Herschel island, a noted whaling base in days gone by, is the principal port in the western Arctic, and here new activities have been taking place in the race for far-away peltries in recent times, under the lash of the popular demand for these rare furs. Recently six new auxiliary schooners and steamers were making their slow way through Bering strait, ready to call at Herschel just as soon as the ice loosened. Those rich peltries of the eastern Arctic region, Hudson bay and Baffin land, are reached by Atlantic schooners leaving Montreal and Halifax early in the summer, returning before the ice seals the waters for the long winter.

In the first few days of March, following a practice that has prevailed for some 200 years, the Newfoundland sealing fleet leaves the port of St. Johns for the Banks

POLAR FUR FLEET



on its annual expedition into the Arctic. Some ten or a dozen vessels set forth on this romantic and, at times, hazardous expedition; and what a thrill must face these "swatchers for swills," as they call themselves, as they gaze across vast ice floes dotted with "white coats" as far as the eye can see, which testify to the assertion that the famous seal herds off the Newfoundland and Labrador coasts are on the increase even in face of the growing demands of civilization.

The sealing industry, exploiting the rich resource lying off the coasts of the island, is one of the most ancient of the economic activities of Newfoundland. It was started in 1763, when the first expedition ventured forth.

Although arctic fur schooners, because of the hazards of polar ice floes, are of necessity small, the vessels engaged in the sealing industry have been considerably modernized. The sailing vessels became larger year by year until they were almost entirely superseded by fast steamers, which facilitate the methods of the seal hunt. Now, though there are a few sailing vessels in the expedition, the steamer

is the most important factor and accounts for four-fifths of the catch.

In recent times, the annual seal expedition has been further brought up to date by the use of the aeroplane and radio. In olden times the seal herds were located by men in the rigging of the sailing schooners with a limited range of vision. The plane now does this "spotting" for the entire fleet and short-wave transmitters broadcast the exact location and probable number of animals in the various herds.

One of the common sights in the polar regions is a ship in the grip of the great ice pack. Deserted schooners are found often by the fur fleet crews "hove-out," or thrown on their beam ends, clear out of the water, because solid ice has formed under them. Or, the polar schooner may be caught in a moving channel of ice and crushed to pieces, forcing her crew to take to large ice cakes, leaving them stranded many miles from assistance and facing starvation.

When the polar schooner becomes "stranded" or "jammed" in large ice floes and is frozen in, if the crew toil persistently day and night, they may save their

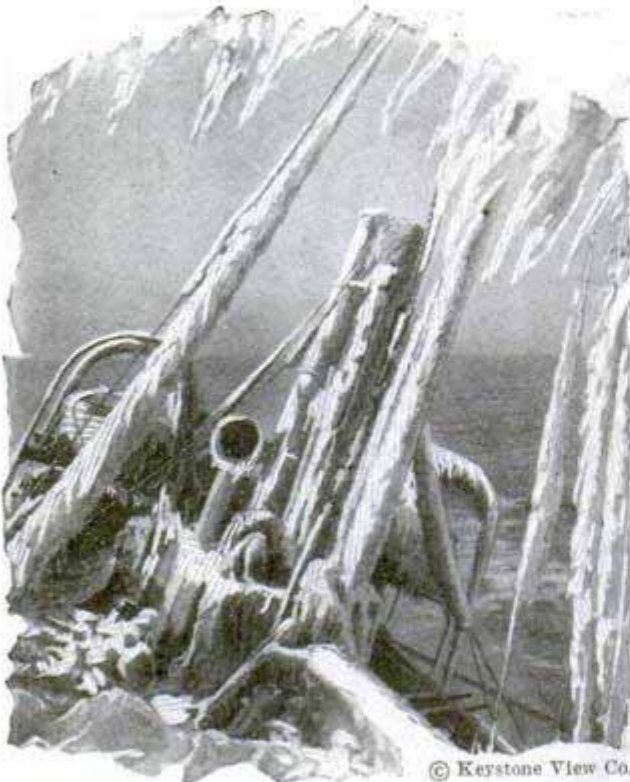

© Keystone View Co.

With Rigging Shrouded in Ice the Vessels Must Battle Constantly to Overcome the Effects of the Cold

ship and their lives. Then it is that they cut a channel to the open water from the "standing edge," or from the edge of the permanent ice that lies all winter in protected spots. They chip and bore with

chisels and pike poles, and saw ice into large blocks, which are forced under the ice field until a channel is made to open water.

Arctic travel is still a hard problem even with the present rapid advance in methods of polar exploration, including the use of airplanes, dirigibles, snow motors and other devices up to date or even dated a little ahead, with which arctic expeditions are now equipped. Capt. Roald Amundsen's late schooner "Maud" still compels admiration for her stanch resistance to the buffeting seas and grinding ice packs. Now known as the "Baymaud," the old "Maud" is a part of the famous fur fleet of the Hudson's Bay company, and is used in the western arctic trade.

The "Friendly Arctic," as Stefansson terms it, has proved none too kind to the Hudson's Bay fleet, for their schooner "Lady Kindersly" was nipped in the ice pack near Point Barrow, and had to be abandoned with all her valuable cargo of supplies and trade goods for posts from Herschel island eastward. A year later the "Bayeskimo," operated in the eastern arctic, was caught in the ice of Hudson strait and lost with her cargo while on her

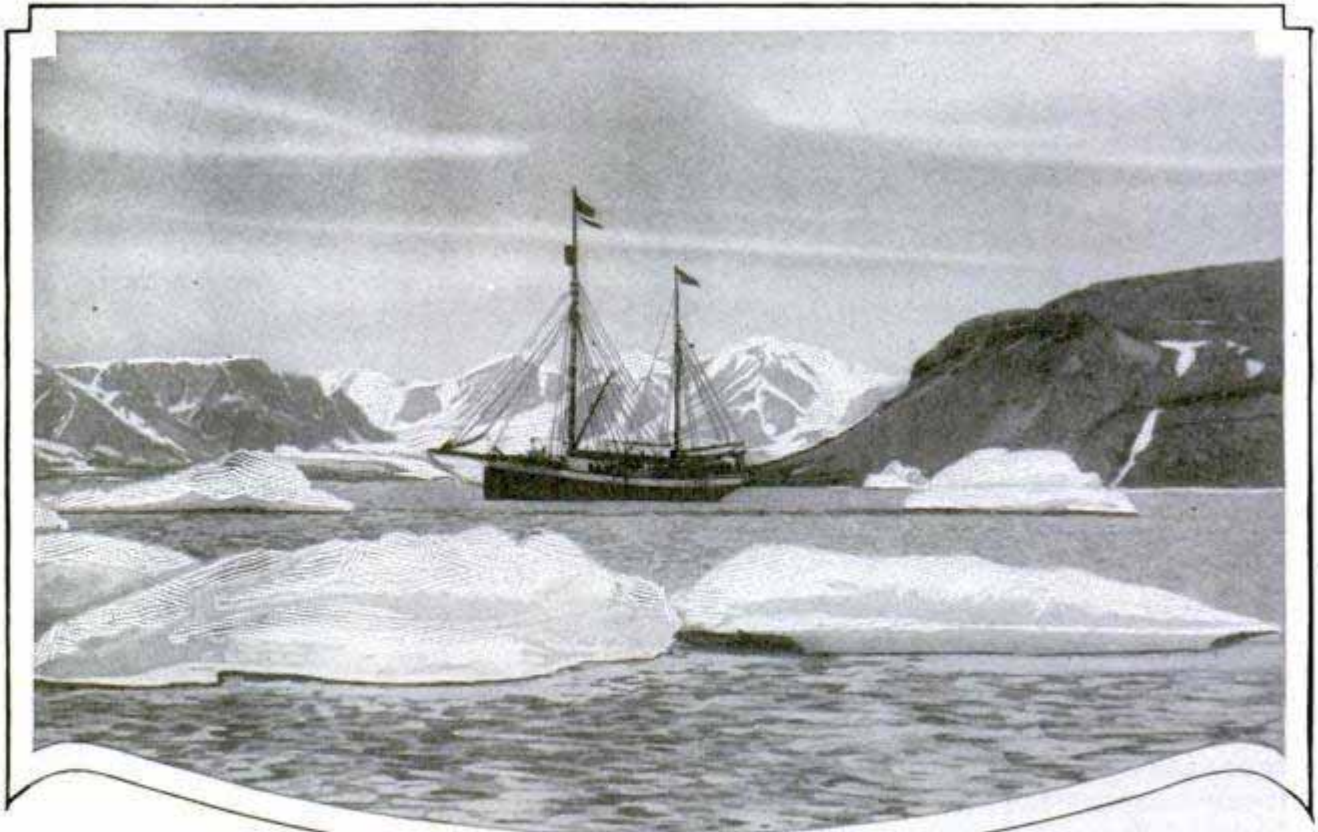

© Keystone View Co.

Icebound in a Far Northern Bay, the Ship Waits for the Floating Bergs and Fields to Move Out of the Harbor Entrance; There Is Constant Danger of Being Crushed by the Ice

way to Hudson bay, and the crew rescued from an ice floe on which they at last had taken refuge.

The large fur companies are not alone in considering the polar regions their happy hunting grounds, although the Hudson's Bay company have now pushed their way from Atlantic to Pacific, and their trading schooners make thousand-mile trips through these formerly uncharted waters. Many of the Eskimos have become rich from the sale of furs to

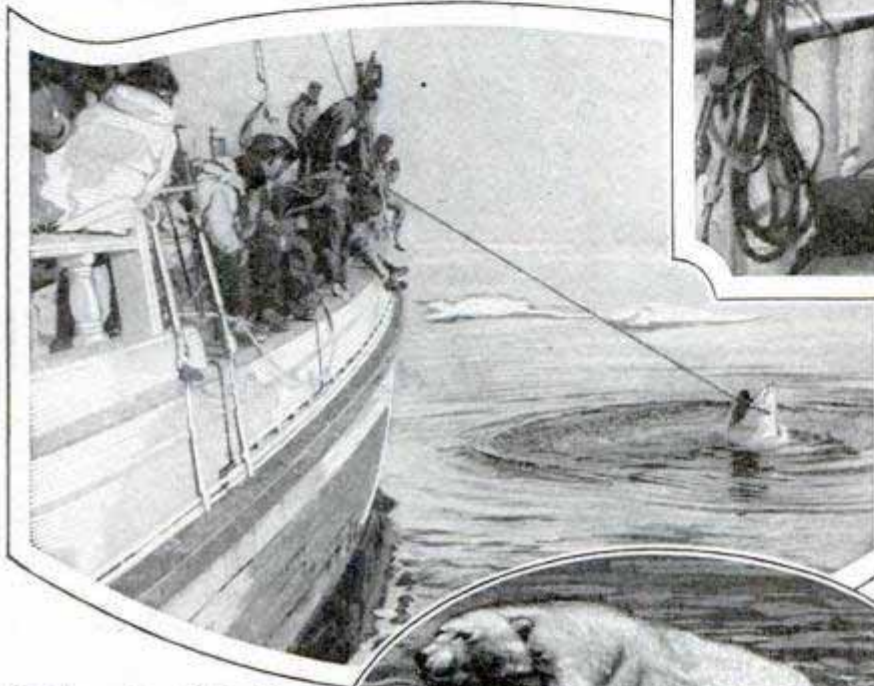

Catching the Swimming Polar Bear, Overtaken in Open Water, and Hauling It Aboard; Right, a Mother Bear Angrily Defending Her Cub as the Boat Approaches



the traders and now have their own schooners, some of them equipped with auxiliary gasoline engines.

But despite short summers and long severe winters, when the thermometer drops to fifty below zero and terrible blizzards blow, there is in the veins of the members of the polar fur fleets an irresistible attraction for these desolate regions.

ABSENCE OF FEAR IS VITAL TO BEE HUNTER 360

Good vision and an absence of fear contribute largely to the success of bee hunters who follow this unique activity with considerable profit and enjoyment in the

Ozark mountains and other parts of the country. Some men have taken as many as fifteen and twenty trees in one season in Arkansas. As each tree yields forty-five or more pounds of honey, which has a ready market, the work of the bee hunter is often well rewarded. Keen eyesight is a distinct advantage, experienced bee men declare, since it enables the hunter to detect the line

of flight from the baited hive to the tree so he can follow the insects. Journeys of several miles are often made by the bees from their own nest to the lure which has been placed for them. Some hunters beat tin pans or ring cowbells to attract the bees as they are swarming from their tree so that they can capture them and add the colony to their own apiary. Experts, those endowed with a natural "feel," are able to hive a wild swarm without using mask or gloves. A feeling of confidence and a total absence of fear are said to be the best assurance against being stung by the bees.

Christian Science Monitor
6/24/26

324



Wide World

New Tests of Skill for Archers and Surf-Board Riders Are Afforded in the Latest Beach Game, Shooting Arrows at Floating Target from Aquaplane; Riders Must Also Display Teamwork

ARCHERY FROM SURF BOARDS LATEST BEACH SPORT

Aquaplane archery is one of the latest diversions on a California beach. Two persons ride on a surf board behind a motorboat, one to steer and hold the plane steady, while the other shoots arrows at a floating target supported on pontoons. Skill is demanded of both archer and companion to score a hit.

gers, may be detached for service as a boat. It is shaped to cut through the water with a minimum of resistance and may be used with an outboard motor or oars. Only a few minutes are required to remove it or put it back.

MAPPING ALASKA FROM THE AIR UNCOVERS NEW RICHES

Unsuspected wealth in water power and timber supplies has been discovered in Alaska by cameramen engaged in making an aerial survey of the 25,000 square miles of territory in the southeastern section. Near Ketchikan, for instance, a network of hitherto unknown lakes has been revealed and a single valley there, engineers estimate, will be able to deliver 85,000 horsepower in one large hydroelectric system, promising development of pulp and paper mills. Several rolls of film sufficient for thousands of feet of airplane mosaics have been taken. The entire task is expected to require four years. The burden of the expedition this year was borne by the navy, with twelve different government bureaus watching and assisting wherever practical. The actual mapping was done from two airplanes. A third,

DETACHABLE SIDECAR ON CYCLE SERVES AS BOAT

For outing trips, a motorcycle sidecar that holds two passen-

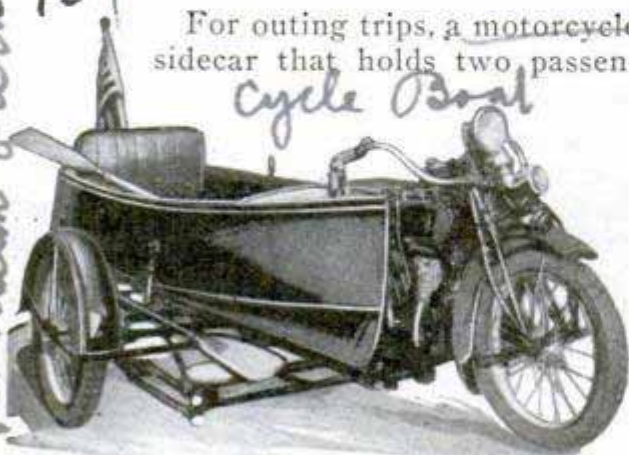

Double-Purpose Motorcycle; the Sidecar Is Quickly Transformed into a Boat When Detached

Santa Cruz.
motorcycle
Agent: A. Scala 4111 21st St. San Francisco

139
Cycle Boat
Agent: A. Scala, 4111 21st St. San Francisco

Alaska Aerial

equipped with radio and in constant communication with the others, remained at the base, prepared to take off at a moment's notice. Carrier pigeons were taken on the longer flights, but of those used only a young one on its first flight returned. The two planes, flying in line at an altitude of 10,000 feet, mapped a strip nearly 100 miles long and fourteen miles wide in an hour, as each camera photographed an area about seven miles wide at one exposure with its three lenses. The craft are amphibians, equipped for service on land, ice or snow, and were used by Lieut. Comm. Richard E. Byrd during his preliminary polar flights in 1925. The wheels fit into a pocket arrangement when the plane is in the air or on water and the motor is arranged to afford greater power and better lubrication. The mapping expedition is considered by some persons fully as spectacular as the dash over the pole. The region abounds in mountains from 10,000 to 20,000 feet high. The rougher parts of the country have defied land surveyors and lumbermen. Many of the small islands are practically inaccessible as they are surrounded by ice floes from the glaciers. The region is noted for its heavy rains.

DOUBLE SAW TO CUT NOTCHES SAVES CARPENTER TIME

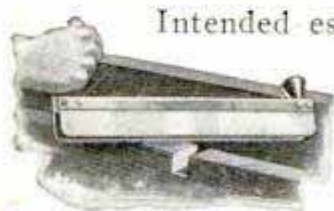

Intended especially for cutting notches in joists, a double-bladed saw is said to do rapid and accurate work. It insures a slot of uniform width and even sides, saving extra sawing and measuring.

*Paul W. Koch & Co.
19 S. Willis.*



Floodlighting at Night Brings Out the Decorative Detail Until the Building Resembles a Gorgeous Temple Set in the Sky

LATEST IDEAS IN ARCHITECTURE EMBODIED IN SKYSCRAPER

What is regarded as a step forward in architecture is seen in the new telephone building in San Francisco and in several other large skyscrapers of recent construction. Many precedents have been set aside. For instance, all "sides are front and all boundaries are of equal importance," so that the building dominates the scene from whichever point it is approached. A minute scheme of decoration has been followed, calling for the application of creative art. The structure cost about \$4,000,000, has twenty-six stories and is 436 feet high from the pavement to the base of the flagpole. An elaborate system of floodlighting at the top makes the building look at night like a fairy temple set in the sky.

The Sphere, June 26, 1926

223

Mr. C. E. Brown, Curator, Wisconsin State Historical Museum, Road, Barrow-in-Furness, Lancs. England

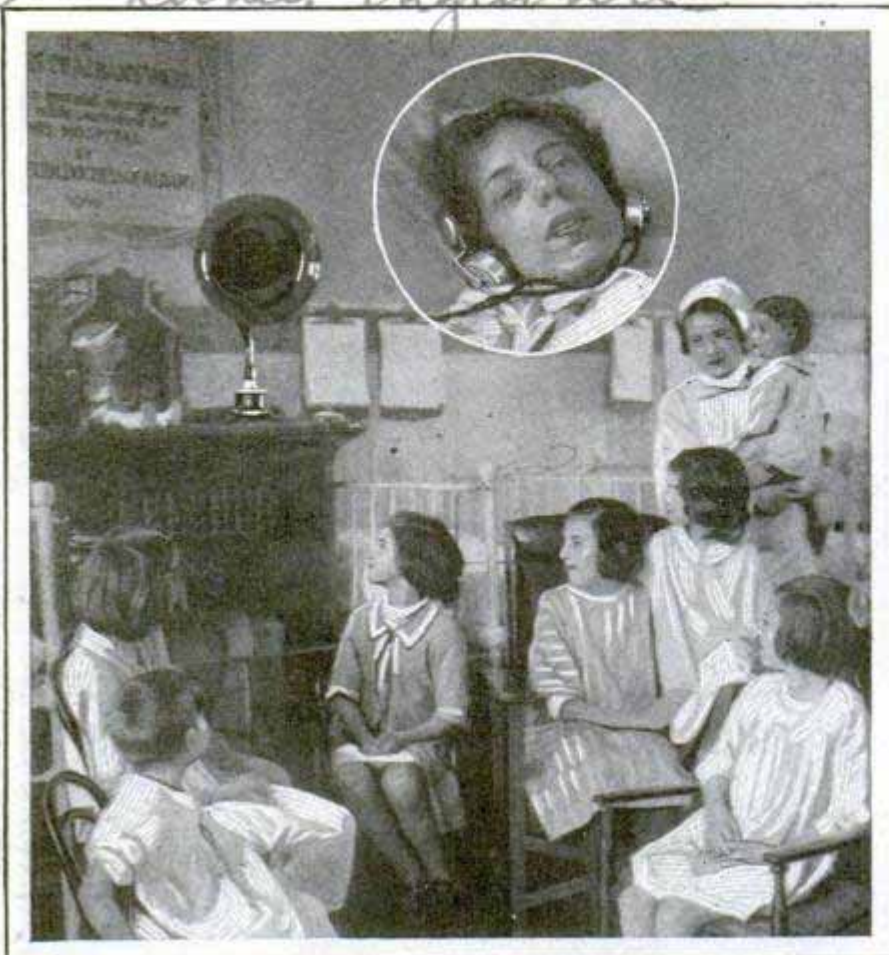

Some Radio Fans May Tire of the Programs, but Hospital Inmates, Especially the Children, Are Always Pleased with Wireless Hour

RADIO PROGRAMS IN HOSPITALS —HELP PATIENTS RECOVER

Physicians declare that radio is of great benefit in hospitals as it takes the patients' minds from their illness and develops cheerfulness. Children, particularly, enjoy the concerts, and the story hours are as popular in the sick wards as in the homes. In England, here and in other countries, many hospitals have been equipped with complete receiving outfits, including loud speakers and headphone sets that may be plugged in at the bedside without disturbing others. Several institutions for soldiers have been fitted with radio through the generosity of the public.

COPPER MINED BY INDIANS FOR TRINKETS AND TOOLS

Many years before the great smelters of today were in operation, Indian tribes of Wisconsin had learned how to extract copper ore and were pounding it into tools and ornaments. Evidence of this is found

in hundreds of relics that have been picked up in various parts of the state from graves, sites of old villages and mounds. It is estimated that more than 20,000 copper objects have been collected. The most primitive tools were employed to mine the ore. These included stone hammers and mauls for breaking up the rock, wooden wedges, paddles and shovels for removing the loose dirt, and crude wooden poles and levers for lifting the ore out of the pits. From the mines, the copper was carried by canoe, or by foot over the Indian trails, to the villages where it was manufactured. Apparently the objects were fashioned by hammering, cutting and grinding the ore. The attractive color of the metal was its chief

virtue to the Indian, aside from its ease of preparation, and investigators declare that the Wisconsin tribes did a brisk business in copper with other Indians not only in the east but that they traded as far south as the Gulf of Mexico.

SHARPENER FOR RAZOR BLADES WHETS ANY STYLE



All kinds of safety - razor blades can be sharpened in a leather-lined pincer-shaped arrangement that is held between the thumb and fingers, the blade being inserted in a narrow slot. Pressing the sides of the clamp together and tilting the razor edge slightly upward, smooths the blade's minute teeth back into alignment. A thin coating of dressing applied to the jaws preserves them and improves the blade.

C. E. Brown, Curator, Wisconsin State Historical Museum

mind S. Harper Sales Agency, 555 S. State Street

232

**METAL DIRIGIBLE FOR NAVY
 TO MAKE LONG FLIGHTS**

Using hydrogen instead of helium, the all-metal dirigible for which contracts have been let by the navy department, is expected to have a cruising radius of 2,200 miles and will carry twelve persons including a crew of four. The craft will be about one-fourth the length of the "Los Angeles" and have but one-twelfth the gas capacity. Its diameter will be fifty-three feet at the widest point. A corrosion-resisting coating will be applied to the outside. Two gasoline motors, of 200 horsepower each, will give the dirigible an estimated speed of seventy miles an hour. The operating car will be built as an integral part of the keel instead of being swung underneath.

**MOCK GRAVES BY BOULEVARD
 HELP TEACH SAFETY** 72

Tombstones with sarcastic epitaphs, describing the fate of imaginary victims buried below, are intended to spread the gospel of safety first among motorists who visit a service station on a California boulevard. The legends emphasize some of the commoner mistakes drivers make and indicate the disastrous results that not seldom will follow them.

Los Angeles, Calif

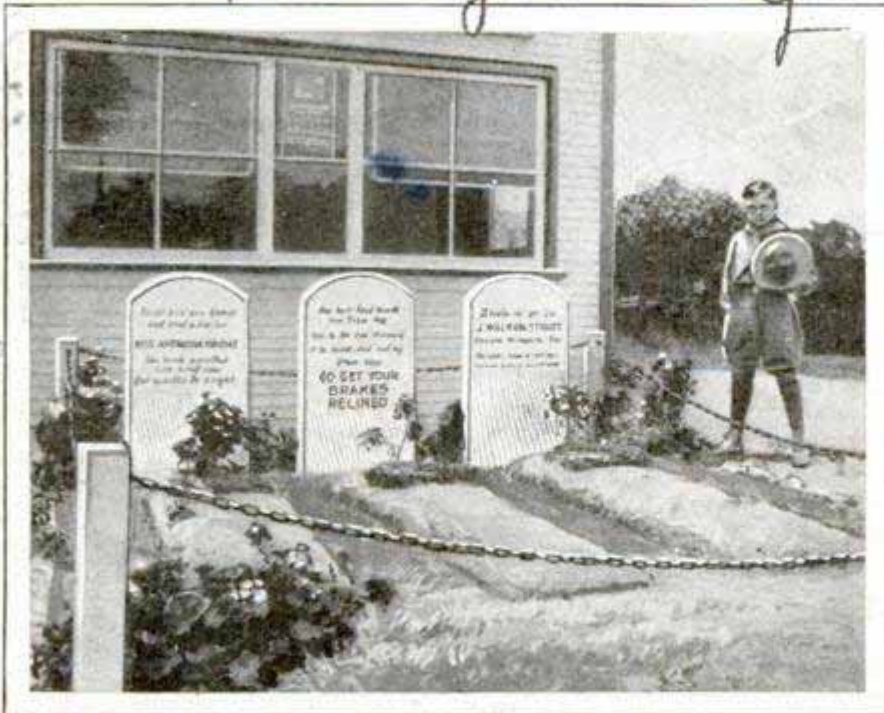

Mock Graves with Sarcastic Epitaphs outside a California Service Station Teach Driving Lessons

Com. H.E. Mc Lannan
7427 St. Vincent Drive



Saving Searches in Dark Interiors. This Revolving Closet Rack Holds Many Articles

**ROTARY STEEL CLOSET RACKS
 SERVE AS DUMB WAITER**

Troublesome searching for articles is eliminated in a revolving set of racks to lighten household duties. There are two separate fixtures, each rotating independently and fitted with an assortment of hangers, baskets and shelves for a wide variety of goods. Instead of hunting through a dark room, the user has but to turn the racks about until the article desired is found. Placed between rooms, the arrangement may serve as a dumb-waiter, saving steps from kitchen to dining room, for instance. The installation is suited to dust-protected closets and is placed high enough above the floor to permit easy cleaning.

Esq. Johnston San Pedro Cal
673 99th St

Miss
Ann

Chicago

188

Learning to Putt
 with Aid of the
 Guide; Club
 Moves Correctly
 through the En-
 tire Stroke

Courtesy P. A. Valle

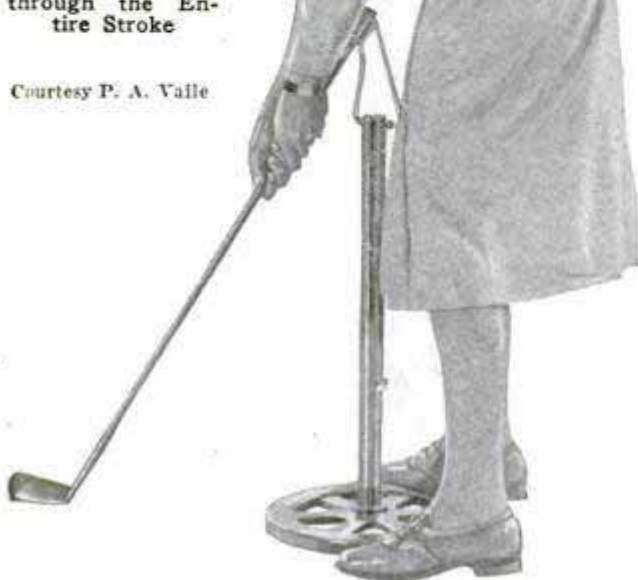

**GOLF-STROKE GUIDE FOR PUTTS
 HELPS IMPROVE GAME**

Skill at putting is considered one of the most important assets of a good golf player, and to develop proficiency in this phase of the game, an adjustable apparatus for the beginner or the experienced player is said to demonstrate the essential principles of the correct stroke in a few moments. Exercising with it is intended to familiarize the user with the proper position for the club at the moment of striking the ball and as the sphere rolls away. In the machine, the putter is moved through the entire stroke in the correct manner, as it is adjusted for such action irrespective of the user's swing. Special shots are also demonstrated with the rigging, which can be set to suit the person's strength. It follows the idea the baseball player has in swinging three bats to come through faster with one.

317

FISHING FOR SILK

Many precious articles such as gold, coral, amber and pearls are obtained from the ocean, but few persons know that some of the finest silk in the world is given

up by the sea. In certain parts of the Mediterranean, is a species of mussel, with shells about three inches broad and seven inches long, and each of them contains a small hank of delicate fiber. At first glance it attracts little attention, being soiled with mud and the remains of marine plants, but when it is washed and combed, the fibers are seen to be extremely lustrous, glistening in the sunshine in shades varying from a golden yellow to olive brown. Only workers specially skillful are engaged in the spinning process, yet once this is done successfully, the yarn may be woven into shawls and wraps, stockings, gloves and neckties as well as dresses, hats and laces. In its natural state, the mussel silk is so much sought after that it commands a high price.

**ENGINE FOR WASHING MACHINE
 IS STARTED BY FOOT**

Motive power for the washer or for various light machines in the shop is furnished by an air-cooled gasoline engine which combines several special features. One is the starting mechanism, a ratchet-controlled foot lever which turns the engine over several times with a single stroke. Another is the governor, built into the flywheel. It actuates two elec-

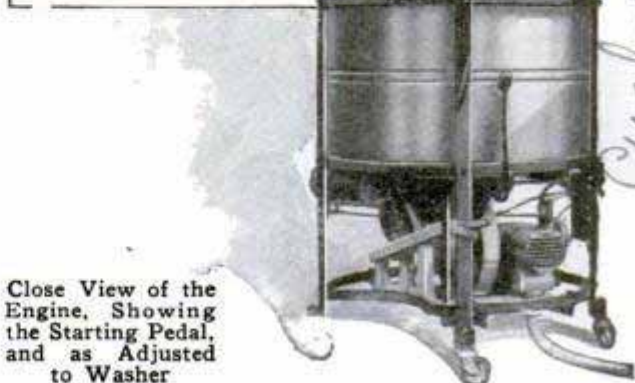
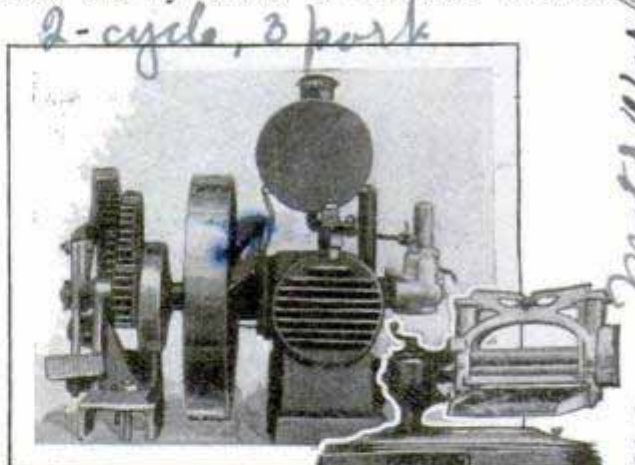

Close View of the Engine, Showing the Starting Pedal, and as Adjusted to Washer

2-cycle, 3 port

Cushman Motor Works
 Lincoln Neb.

Conk George H Holden
 Highfield View, Tipton View Road
 England

trical contacts to open or close the circuit to the spark plug. When the speed exceeds the proper rate, the governor draws the points apart, breaking the circuit and causing the engine to miss. The motor takes up but little room and consumes a small amount of fuel.

FRESH-EGG TESTS FOR HOME *384*

How to tell a fresh egg from one which has been stored or which for any other reason may not be up to standard is revealed in a recent bulletin of the Pennsylvania state college poultry specialists. A fresh egg, they say, should have a sound clean shell and show a dull "bloom," or very dull luster. The egg that has been held for some time, particularly where it may have been heated, will show a decided gloss. This is very noticeable on partially incubated eggs. A mottled shell sometimes denotes age. If decomposition has started within the egg, the shell sometimes shows a grayish tinge. Shells that are stained usually indicate the eggs have been in contact with moisture and are, therefore, of inferior quality. Eggs that have been preserved in water glass or lime will show a roughened shell, because some of the chemicals adhere to it. An egg that has been washed with acid will show a very porous shell, and processed eggs are usually detected by their oily or waxy appearance. A fresh egg, when opened, should have the following characteristics: The yolk should stand up well and have a definite shape, the white should hold together well and show a thick viscous consistency near the yolk; there should be no disagreeable odor, and the white should not have a "runny" appearance. In addition, a fresh egg will cook in any manner without falling to pieces.

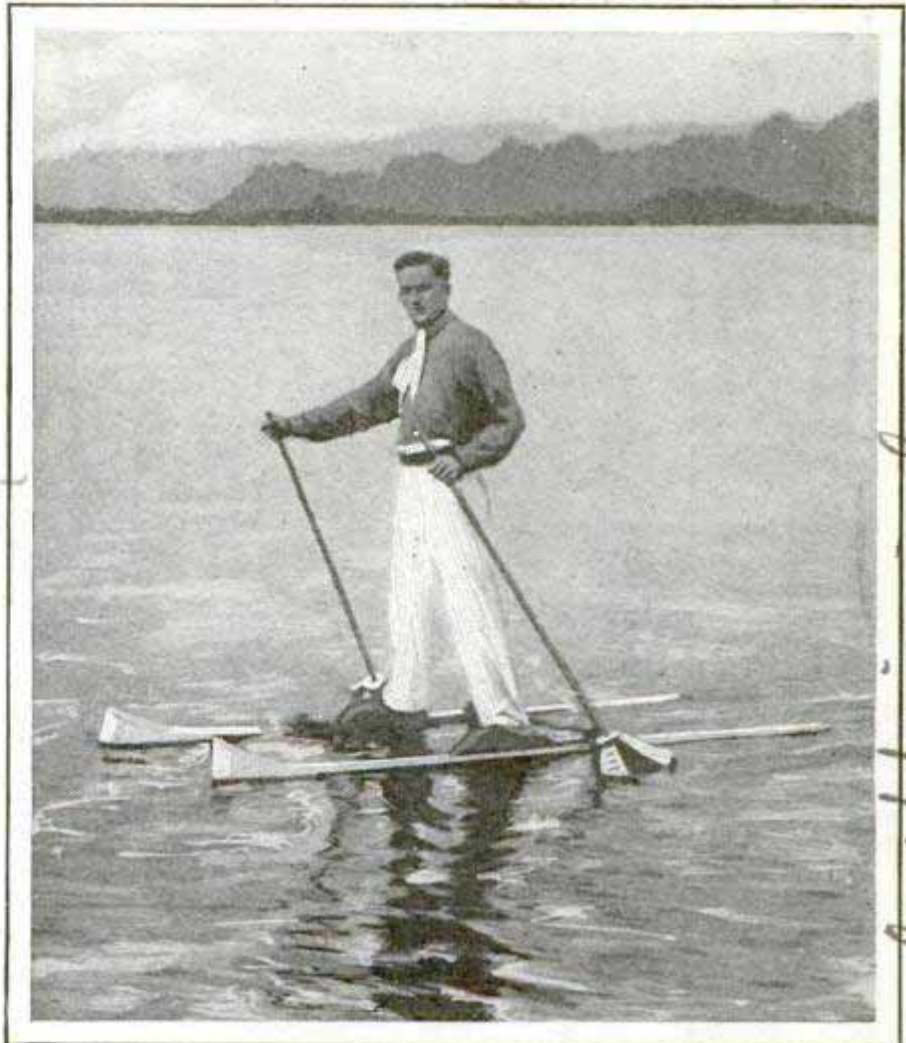

"Skiing" across the Water; Balanced Boats for Each Foot Simplify the Stunt and Poles Help in Propelling and Steadying

SKI WALKING ON CALM WATER LATEST OUTDOOR SPORT *167*

Water skis devised by a German inventor are like small boats strapped to the feet and are so balanced that they may be used with ease and safety when the weather is calm, according to reports. Poles help the wearer propel and balance himself.

WISE FOR BENDING SMALL PIPE SAVES TIME AND LABOR *1823*

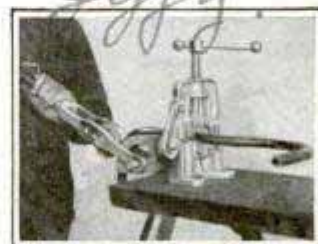

One-half or three-quarter-inch pipe may be cut, threaded and bent without removing it from a special vise now on the market.

It is adjustable for bending downward or sidewise, is said not to flatten or kink the pipe, and requires no special skill to operate.

Giffy
Paul W. Koch & Co.
 19 S. Wells St.
 Chicago

Alto Daur, Loepfingen Germany.

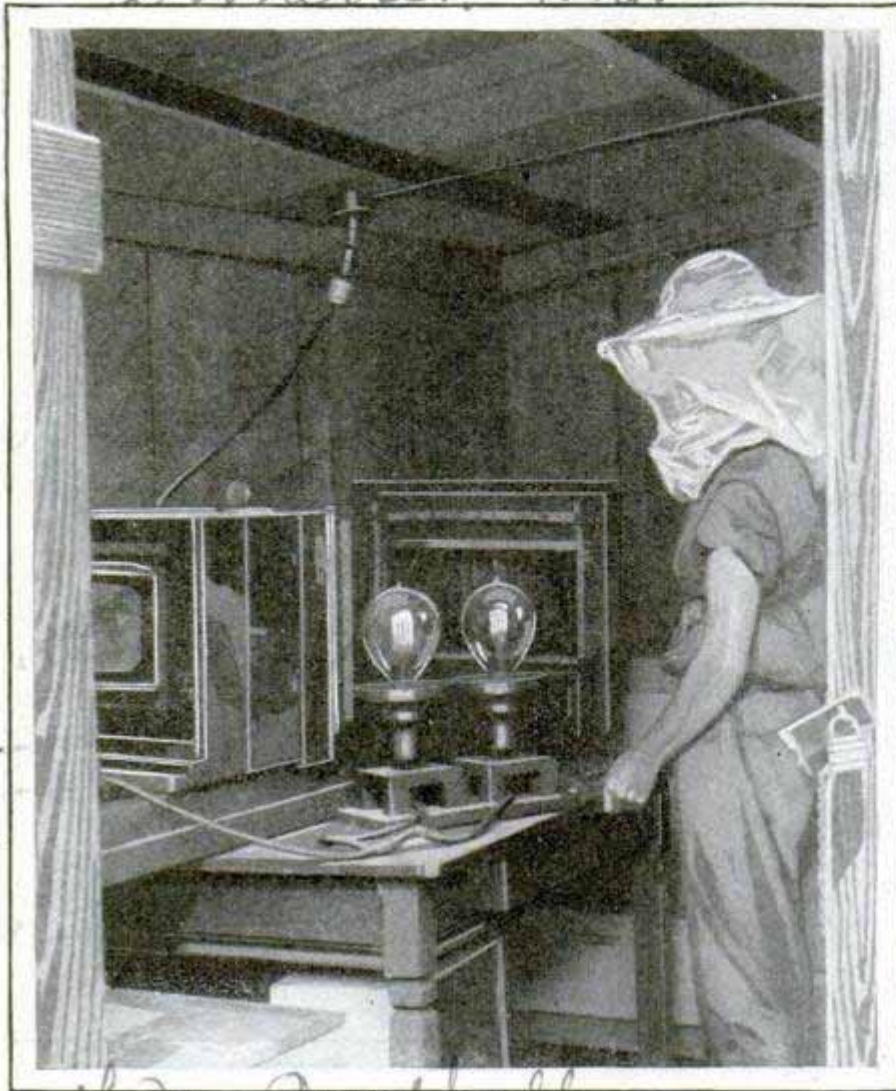

L. M. Berthoff

© Harris & Ewing

Bee Keeper at Government Experimental Farm Photographing a Hive as the Latest Method of Getting a Quick Brood Count

CAMERA COUNTS BEES WHILE SCALE WEIGHS THEM

Using a camera to record the number of brood cells in a honey beehive and a fine registering scale to keep constant check of their weight hour by hour as they bring in the nectar, government scientists are fast systematizing the work of the bees. Through their recording apparatus they obtain data which, when checked with the weather-bureau records, show the influence of sunshine, clouds, dry air, high humidity, heat, cold and other factors on the gathering of honey. They have

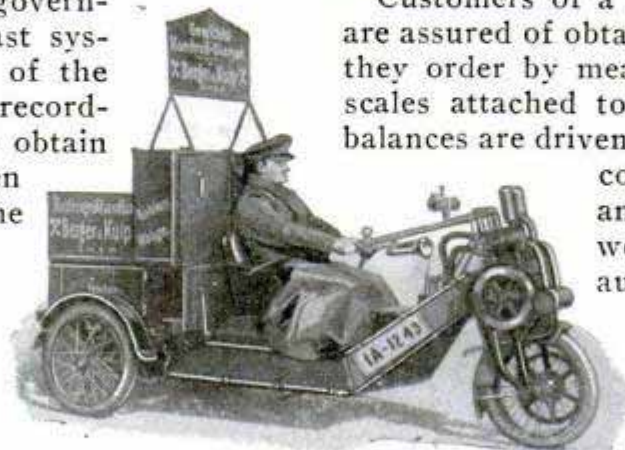

Scale Car for Weighing Coal in Germany; Balances Are Installed in Rear and Weigh Automatically

brought to maximum strength just before the six-week period starts, insuring a large surplus crop.

MOTOR COAL SCALE INSURES 1632 HONEST WEIGHT

Customers of a German coal company are assured of obtaining the exact amount they order by means of a special set of scales attached to a motor truck. The balances are driven to the house where the coal is being unloaded and as each basket is weighed, the pounds are automatically recorded by a stamp on a strip of paper. The net weight is calculated by deducting that of the baskets or bags containing the coal.

*Cont. Max A. R. Brunner
Hofmanstr. 25,
Bresden-A-21, Germany*

*Arthur J. Yates, Assistant
Engineer Pacific Power Light
Co., Patton Block
Portland, Ore*

ELECTRICITY FORCES FISH TO USE SAFETY LADDERS

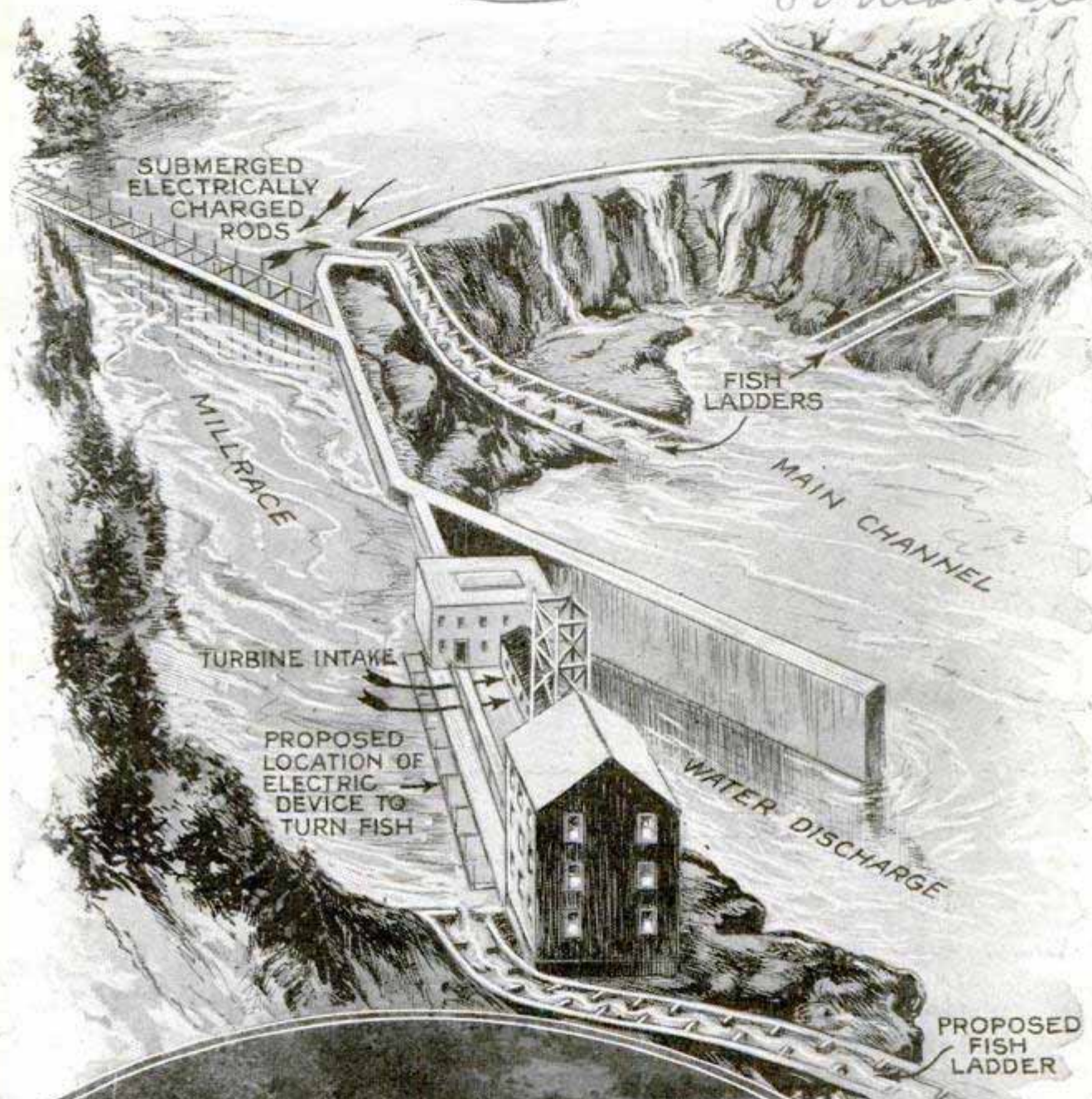

Drawing of Electric-Dam Installation on Rogue River, Oregon, to Keep Fish from Entering the Turbines, and Photograph Showing Arrangement of the Charged Rods; Shocks Drive the Fish from the Danger Area into the Ladders That Lead Downstream

*Winnipeg Beach
Canada.*

212

*The Toboggan Slide Ferris
Wheel Co. 802 Merchants
National Bank Bldg.*

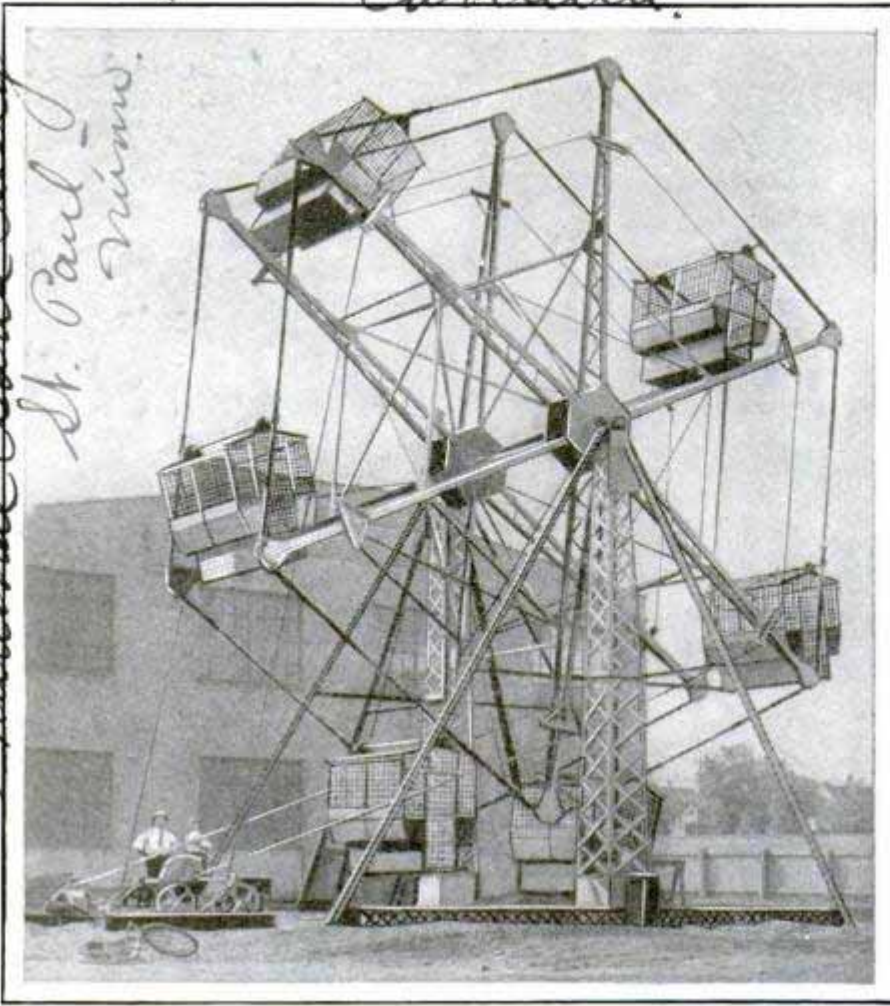

Putting a New Twist to the Staid Old Ferris Wheel; the Cars Slide Twelve Feet at Two Points in Each Revolution

SLIDING CARS ON FERRIS WHEEL PRODUCE ADDED THRILLS

Some of the thrills of a toboggan slide are enjoyed in a type of Ferris wheel with cars that slip down a twelve-foot runway at two points in each revolution. They remain swinging until the next slide. The wheel is fifty feet high, weighs twenty-one tons, and each of the six carriages holds fourteen persons.

NEW CLAY AND METAL MIXTURE AIDS ELECTRICAL WORK

Useful particularly in the chemical and electrical industries, a new substance prepared from fine clay or refractory oxides with a metal reinforcement by German experts, has peculiar properties. After firing, it becomes hard so that it gives out a ringing sound if struck. It resists sudden changes of temperature. Bricks made of it can be heated red-hot and thrown into cold water without cracking. They

Ceramic

347

can be dropped on a stone floor without breaking and can be destroyed only by crushing. The material is said to be a good heat conductor and has a variable electrical resistance so that it can be used as a heat element. It also resists chemical reactions of various kinds. Hollow tile, and tubing with a thickness of only .002 inch, have been made from it, yet it has great mechanical strength and a high degree of elasticity. A ribbon of the substance can be wound into a spiral, bent to sharp angles, yet will not break. So far, it has been used for fashioning tiles, muffles, tubes and similar hollow articles that have to be exposed to high temperatures as well as insulators for crucibles and the like.

Apparently, the combination of metal and clay by this process is not merely a mechanical one.

INLAID WOODEN BOX CONTAINS ELEVEN THOUSAND PIECES

Spare time for a period of twelve years was devoted by an Italian cabinetmaker to the fashioning of an inlaid wooden treasure chest, a foot square and eight inches high. It is made of five kinds of wood and contains 11,968 separate pieces.



Inlaid Treasure Chest with Its Thousands of Pieces in Intricate Design

*Made by Bartolo Buffo, mason
75 Limerick St. Boston, Mass.
S. 1. 1926*

*Illustrierte Technik
für Jedermann # 82, 1926.*

Hans Weidel



Perpetuating American Marine History in Models; Replicas of Famous Ships Fashioned in Realistic Detail for Collections; Models of the "Santa Maria," the "Constitution" and the "Mayflower" Have Been Made

SHIPS THAT MADE HISTORY ARE REPRODUCED IN MODELS

Several vessels that have helped to make American naval history have been realistically reproduced in accurate models by two New York craftsmen. The collection includes replicas of the "Constitution," the "Mayflower" and the "Santa Maria." The builders were metal workers and cabinet-makers before turning their talents in the direction of ship models.

SPIDERS ARE GOOD MECHANICS IN BUILDING WEBS 340.

Spiders use plumb lines, struts and guy wires with skill that rivals that of an experienced engineer, according to the observations of a French naturalist. He decided that their cunning could not be explained on the ground of mere instinct but revealed an ingenuity akin to intelligence. This was shown by the fact that each insect had a different way of making repairs. For instance, after the web had been started by dropping a plumb line to give the spider the sense of the vertical plane, an obstruction was placed in such

a way that the web sagged. The spinner sought to repair the damage by means of struts and braces arranged to pull the fiber's back to position. But not all the spiders, not even those of the same variety, proceeded with this adjustment in the same manner.

302

FOLDING CANVAS CAMPING PAIL SERVES AS MINNOW BUCKET

With a capacity of eight quarts, a collapsible canvas pail with a metal bottom

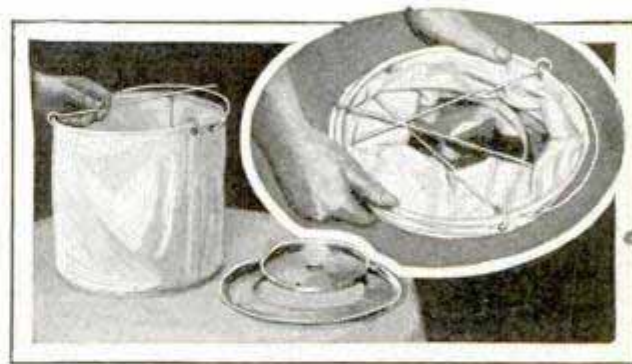

Pail Extended and Collapsed for Packing; Side Braces Keep the Canvas Rigid

can be folded down to an inch in thickness. It may be used as a minnow bucket and for many other purposes on outings.

*Mr. P. Roussy,
Presents to Academy*

Chicago

Car

*Richard James Mfg. Co.
126 N. DuSick Ave.*

Liner Emma Alexander

OCEAN TEMPERATURE ON COAST RISES FIFTEEN DEGREES

339

Always a source of perplexing mysteries, the sea has presented a new puzzle on the Pacific coast by a rise of fifteen degrees in temperature. A ship captain made the discovery while sailing off Oregon and Washington and also found evidence of an inshore current which had to be reckoned with in steering. The question has now arisen, will this warm flow be permanent or is it just a temporary result of some great earth movement on the sea bottom? A mild season in Alaska was noticed as one of the results of the warm current and fishermen reported variations in their catch because of the change in the temperature of the water. The effect of currents on climate is noticeable elsewhere. Oslo, the capital of Norway, is in approximately the same latitude as the southern part of Greenland but instead of being covered with an ice cap, that country is fruitful and populous. This is due to the warm Gulf stream which washes the shores of northern Europe.

*Duff-DeLand Airplane Co. 283
Caldensburg N.Y.*

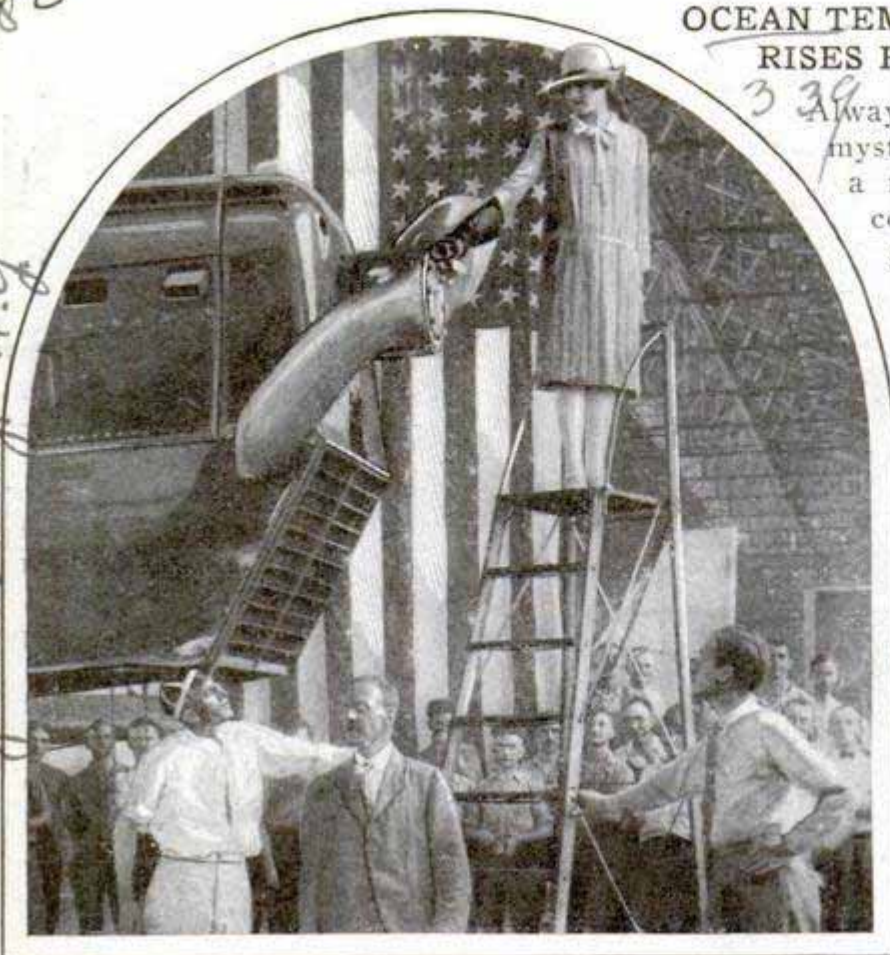

Christening the "Cyclops" the Army's Giant Bombing Plane; Engineers Predict That It Will Be Able to Make Trans-Oceanic Flights

SINGLE-ENGINE BOMBING PLANE TO FLY TWENTY-FOUR HOURS

Pachard.

Christened with a bottle of gingerale, the U. S. bombing plane "Cyclops" has been added to the army air service. This single-motor ship weighs 17,000 pounds, has 825 horsepower and is designed to carry 4,000 pounds of bombs over a cruising time of eight continuous hours, or can fly twenty-four hours without ammunition. It is planned to install a 1,200-horsepower motor with twenty-four cylinders. This will permit a speed of 135 miles an hour, and with its enormous fuel-carrying capacity, the craft should be able to make transatlantic flights with little difficulty, in the opinion of expert aeronautical engineers.

Oslo, the capital of Norway, is in approximately the same latitude as the southern part of Greenland but instead of being covered with an ice cap, that country is fruitful and populous. This is due to the warm Gulf stream which washes the shores of northern Europe.

ELECTRIC FREIGHT-CAR PULLER DOES WORK OF SIX MEN

1673



View of Puller on Small Truck and in Use in Railroad Yard Setting a Freight Car

In the operation of setting freight cars in loading or unloading positions on the tracks, an electric puller is said to do work that ordinarily requires a gang of six men and to consume but little current. It consists of a revolving winch fastened to a heavy base and winds up a cable attached to the car. It can also be used for hoisting.

Mead, Morrison, Inf Co, East 13 St, Mass

Chicago 530 W. Jackson Blvd.

Foreign
ROYAL PRIVATE TRAIN PIPED FOR TOBACCO SMOKERS 334

A pipe that comes in the public-utility class, with mains to deliver the smoke direct to the consumer, has been installed in a unique private train built for the Nizam of Hyderabad, richest and most powerful of the Indian potentates. The pipe, which is a hookah, or what is known in this country as a Turkish water pipe, is an enormous affair installed in the engine and operated by the crew. Each car in the train is connected to the tobacco-smoke mains, with a mouthpiece beside each chair, so that wherever the Nizam may chance to sit he will find his smoke ready. The ruler's traveling habits are unsettled, so the train is kept in readiness twenty-four hours a day at his own private station. Every eight hours a fresh engine is attached, and the crews report for duty at the same time.

PORTABLE COURT FOR SPEEDER SAVES TRIAL DELAYS 170

Justice travels on wheels in a California city. A portable court, housed in a special motor car, tours streets and boulevards so that the judge can rule on a traffic case a few moments after an arrest has been made. This relieves congestion of regular city dockets and helps offenders as well as saves the time required for appearing and waiting at later hearings.



Prompt Hearing of Traffic Cases Is Afforded in This Traveling Court, Convened at Roadside; Plan Works Successfully in California.

at Chglewood, Calif.

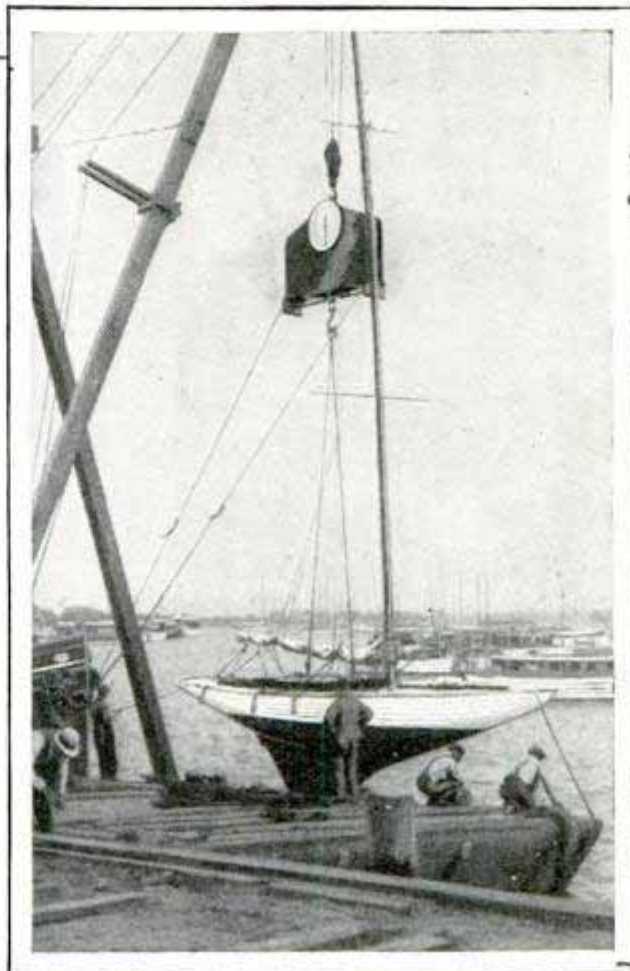

Weighing In Sloop at Belmont Harbor, Chicago, before a Race; Scale Itself Weighs Nearly a Ton

SCALES FOR WEIGHING BOATS HELP DECIDE RACES

Determining the winner in a boat race is often a complicated problem, for many factors, including length of the ship's water line, its sail area, draft and displacement must be considered. Sloops are weighed in on a big scale suspended from a crane. The balance itself weighs about a ton, is seven feet high and registers between 8,500 and 11,000 pounds on a graduated dial. The racing rules require that the boats should be fully equipped for running when attached to the scale. In the accompanying photograph, a "Class R" sailing yacht is being checked preparatory to entering a race to be run under the auspices of the Chicago Yacht club.

Com. A. Westelin, 15 N. Wells St. Chicago

49.

Mr. John Edwin
 205 Union League Bldg
 Los Angeles, Calif.

How to



No blanket rules can be set down to offer complete defense against the attacks of strong-arm bandits and bullies, but a generalization of methods of defense can be made which will serve almost every purpose. First of all, it should be remembered that all rules of fair play have no part in dealing with an adversary who is obviously outside the pale of law and order, and public decency. The problem of the person on the defensive is that of getting the best of the attacker by brain work and doing it in the quickest and most effective way.

STRATEGY is more effective than strength if one only knows how to use it in dealing with bullies, ruffians or holdup men. A frail five-foot man can, figuratively, make a whipped dog out of a seven-foot rogue if he knows how to use his brain to make up for his inferiority in physical power.

There is even a way to prevent being held up at the point of a gun which is about ninety per cent effective, if one only knows the trick. That is the simple expedient of keeping one or both hands in one's pockets while passing through locations where a holdup might be attempted. No bandit, except one bereft of his sense, or with a reckless disregard for retaining a whole hide, would ever try to hold up a man whose right hand reposes languidly in his coat pocket. The bandit has no knowledge that the hand in the pocket may not repose upon the butt of a pistol. The wise stick-up man therefore chooses for his victim one who can be told to "reach for the sky" without the possibility of bringing a trigger finger unexpectedly into action.

The element of surprise movement is just as important to an individual seeking to defend himself as it has always been with armies. Catching the enemy unawares, and upon a quarter where he never anticipated an attack, is always one of the surest ways of getting the best of him. Thus, the big bully who launches an assault upon a person of lesser physique is usually taken completely off his guard when the little fellow hauls off with a quick fist—and plants a blow squarely in the pit of his opponent's abdomen. When this happens, the fellow who received the blow usually folds up like a jackknife, and spends the next two or three minutes gasping for breath, or howling with pain. We say that such a blow "knocks the wind out of one." It does that figuratively but not literally. The jolt from even a fairly weak abdominal punch is absorbed by the intestines, the spleen and the lower part of the stomach. There are no bones to protect these vital organs from serious, or even fatal, injury. A blow of equal force could be landed upon the chest without the slightest injury to the recipient.

Defend Yourself

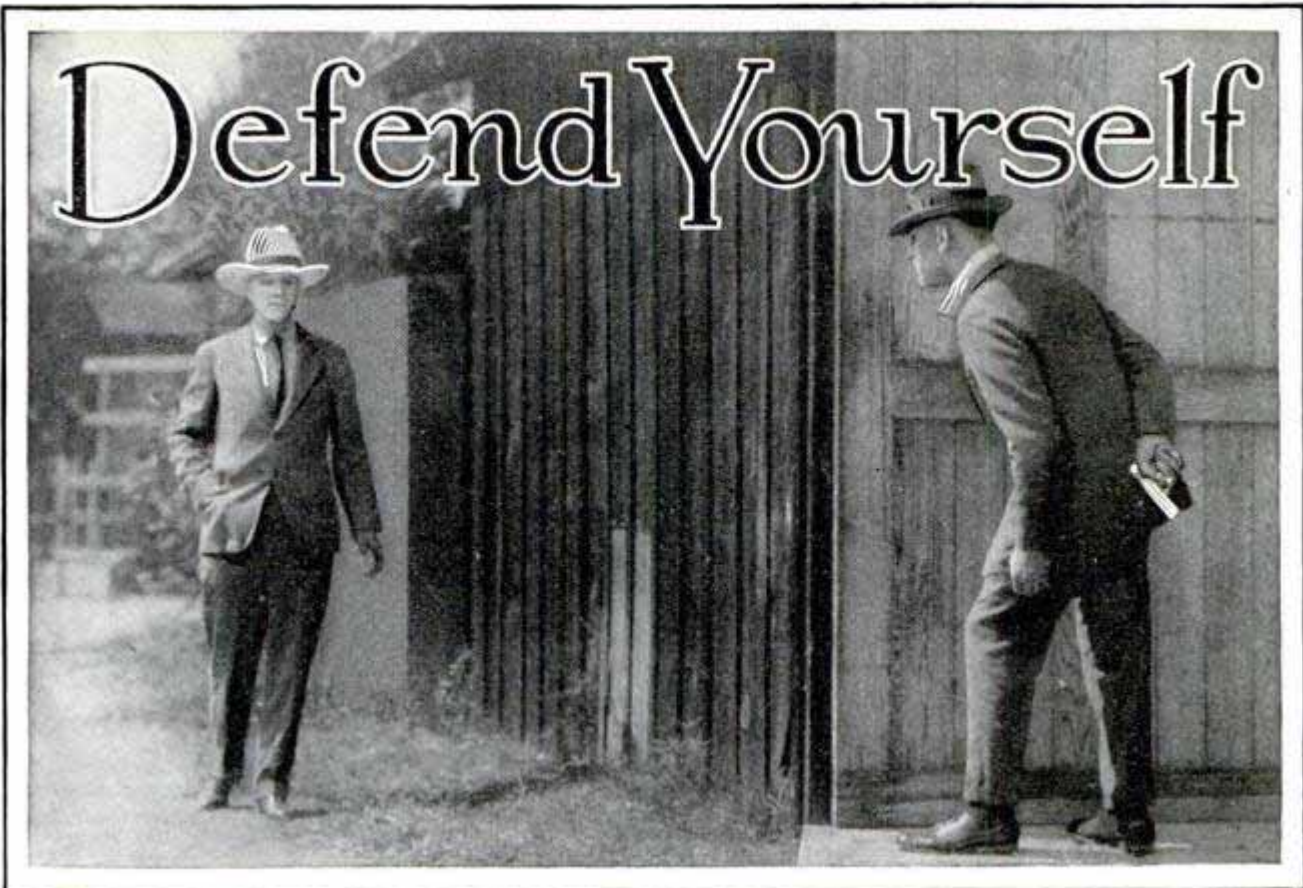

Next among body blows for putting an attacker out of combat, the groin is about the most vulnerable part of the body. Moreover, a bully or rogue seldom expects his harmless-looking victim to make use of his feet in defending himself. He is therefore taken completely off his guard, and is knocked out cold when the intended victim lets fly with the point of a shoe which catches him in the groin. If the person on the defensive wears heavy shoes, the kick is so much the more effective.

Umbrellas, canes, walking sticks, hat-pins and many other articles which people commonly carry, may be used as thoroughly efficient weapons for repelling the most vicious attacker, if one knows just how to wield them. A person who is attacked while carrying an umbrella usually makes the mistake of attempting to use it as a club. A clubbed umbrella is scarcely more dangerous than a big feather, but the same umbrella, if thrust into an attacker's face, automatically becomes a dangerous javelin. It will gouge out an eye, rip the nose, or tear into the mouth or cheeks like a sword. An umbrella with the point dressed down by a few strokes of a file also is a terrible weapon when used javelin-fashion.

The intended victim of an attacker, who carries a cane or walking stick, usually clubs down upon his opponent in an effort to defend himself. It would require a very heavy cane to inflict any serious injury by a downward swing of that instrument. An arm suddenly raised will ward off the blow completely. But, let the walking stick wielder swing his improvised weapon horizontally, like a Chinaman lets drive with a broadsword, and even a light walking stick becomes a dangerous, or even deadly, weapon. With a cane swung horizontally, the man defending himself is more apt to catch his assailant unexpectedly. The blow is aimed upon the side of the head, and a good stiff jolt there will make a huge bully see stars. It may break an eardrum, or cave in the side of the skull at a point where it is very thin. If the blow can be landed slightly below and a little behind the ear, even a light walking stick will crush the skull.

Fist blows aimed at the face are effective, but as a means of self-defense are not so good, especially since the average ruffian is usually something of a pugilist, and probably of physique superior to his intended victim. The little fellow, therefore, should endeavor to defend himself,

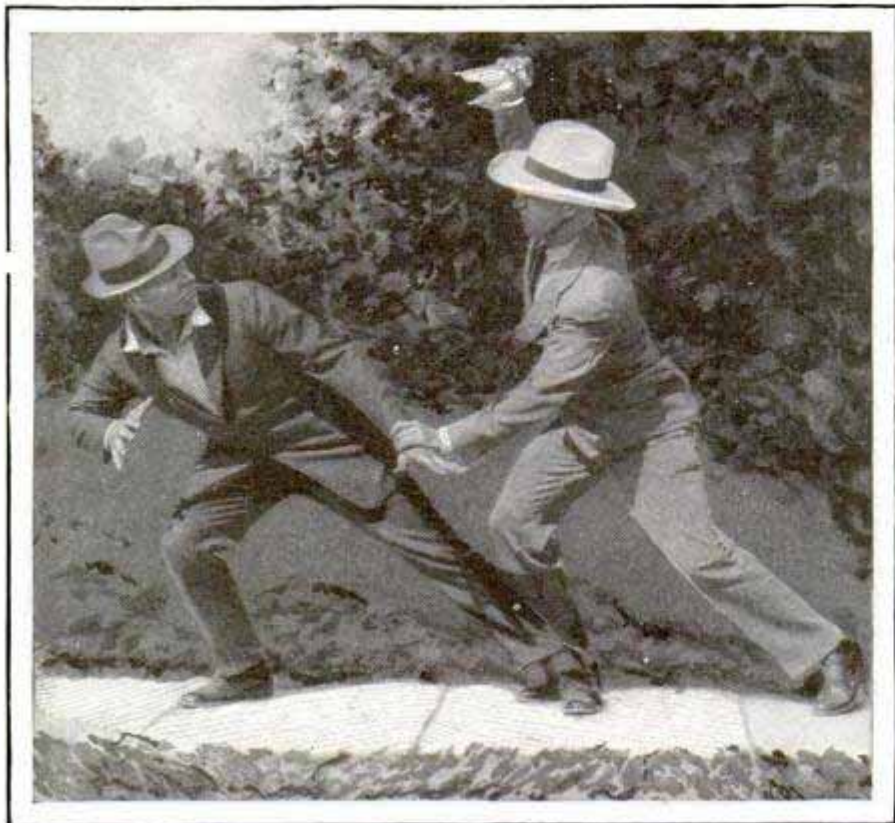

Pose Illustrating How a Quick-Thinking Citizen Used a Jagged, Broken Milk Bottle as Dagger to Rout Burglar

bearing in mind that fingernails gouging at his enemy's eyes are more apt to inflict serious injury than a small weak fist bringing up against a hard lantern jaw. Hatpins, for women who wear them in these days of small hats and bobbed hair, are, and always have been, potential weapons of self-defense. They are to the owner, when wielded in the direction of an opponent's eyes, precisely what the cat's claws are in turning an angry dog. Women and girls who are annoyed by "mashers" have the most effective means of curtailing such annoyance by the use of a little cool-headed wit. Instead of displaying antagonism, they have but to feign approval—and then pass the annoyner over to the nearest policeman.

In cases of personal combat, where the person on the defensive has been seized, or has clinched with the antagonist, the most effective defense available is to make quick and decisive use of one's teeth. A study of police records of hundreds of attack cases reveals the fact that only one person in fifty ever seems to remember to bite the assailant when there is no other available method of worsting him. Yet many instances also are recorded of persons who have completely defended them-

selves from attacks by making use of the teeth. A physically weak person can easily trim a finger off the hand of a husky rogue, or make such a dent in his hand or arm that he'll think of nothing but the pain.

Among classes of persons who frequently have occasion to act in self-defense, newspaper reporters and photographers probably head the list. They are constantly called upon to interview or photograph persons who don't desire to be interviewed or photographed. Arguments and attacks are the logical outcome. There are innumerable opportunities for such squabbles, but they are always avoided

by using a few of the repelling methods known to every newspaper man. Some of these methods are worth reciting here because they can be adopted or modified to meet the requirements of most persons in moments of urgent self-defense.

The newspaper photographer's everhandy weapon of defense is the very camera that so often gets him into trouble. Few would expect a press photographer to use his camera either as a shield or as a weapon. Thus such use of it has the tremendous advantage of surprise. A fifteen-pound camera when suddenly lifted to shield one's face from a fist blow offers splendid protection, as well as shock-absorbing qualities that will probably cause more damage to the fist than to the camera. Likewise, the same camera, when swung by the handle, becomes a weapon that will crack a head—or better still, send the opposing party scurrying beyond harm's way. The reporter's favorite weapon is a leadpencil held like a dagger against the ball of the thumb and thrust in the direction of the antagonist's face. No sane person will risk an eye against such an implement. Hence the threat in most cases ends the encounter before active warfare begins.



Umbrella Rammed against Attacker's Abdomen Is Effective and Light Walking Stick Inflicts Painful Injuries

Even Your Belt Buckle May Serve in an Emergency; Buckle Swung Hard and Horizontally against an Assailant's Head Easily May Fell Him

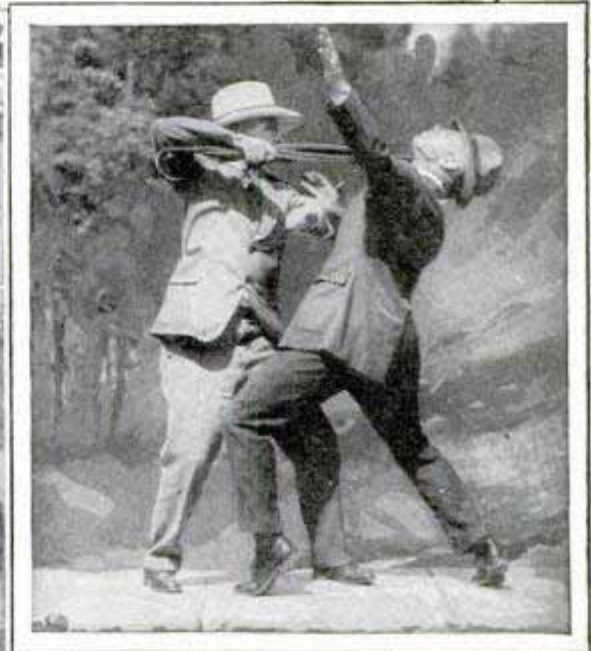

Another Form of Umbrella Attack; Using It like a Javelin

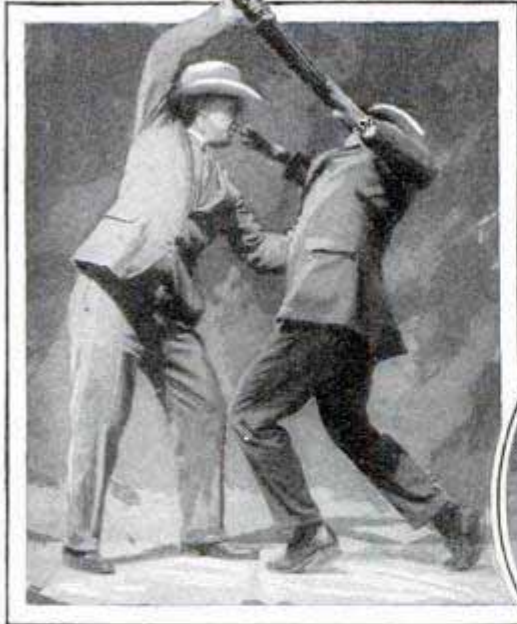

Few Attackers Can Withstand the Daggerlike Thrust of an Umbrella Point in the Face; Right, Swinging Light Cane against Assailant's Knee Cap to Cripple Him



49

In the development of improvised weapons of self-defense there are absolutely endless possibilities, depending, of course, largely upon the resourcefulness and initiative of the individual. Pins, belts with metal buckles, a shoe jerked off the foot and clubbed by the toe end, sticks, stones, tin cans, table glassware and crockery that can be conveniently broken to make a jagged edge, and many other things, are recorded among articles that have been pressed into service by persons desperately in need of means of defense. Wit and self-reliance are, indeed, the most powerful mediums for self-protection when it must be individually furnished.

Many suggestions are contained in police records of persons who have avoided indignities by means of quick thought. A few of these are listed for the valuable knowledge they may offer to others. A physician, who makes numerous calls at all hours of day and night, carries an ounce of red pepper done up in oiled paper, sewed into cheesecloth, and tied on the end of a buckskin thong.

An odd, almost humorous incident of self-defense was that of a little fellow who was set upon by a big bully as a result of

their respective automobiles having locked fenders. The bully attempted to administer a chastisement upon the driver of the other car, but got a reception entirely unexpected. The little fellow grabbed a small hand fire extinguisher off the dash of his machine, and squirted his attacker in the face with the highly volatile fluid. A policeman who arrived on the scene to investigate the traffic jam found the bullying motorist rubbing his eyes, gasping for breath, and rid of all thought of personal combat.

We would hardly think of a strand of wire as an instrument for overpowering a bandit and delivering him into the hands of the police, but at least one incident of the sort has been recorded. A man was coming home one night when he was tackled by a footpad. A sharp scuffle followed during which the intended victim of the attack became involved with a wire. Quick to think and act, he got the wire off his own feet and succeeded in taking a turn around the bandit's neck with the tin strand of metal. After that, strangling the attacker into submission and leading him to the nearest police call box was the work of a few minutes.

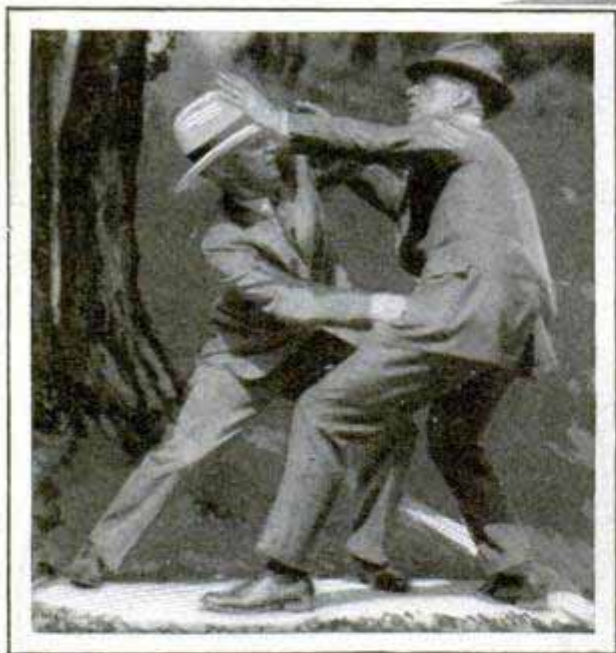

Punches to Abdomen Are Barred in the Prize Ring but Entirely Permissible and Effective against Thugs; at Right, Using a Small Piece of Hand Luggage as Shield to Ward Off Blow; a Camera or Suitcase Will Answer This Purpose

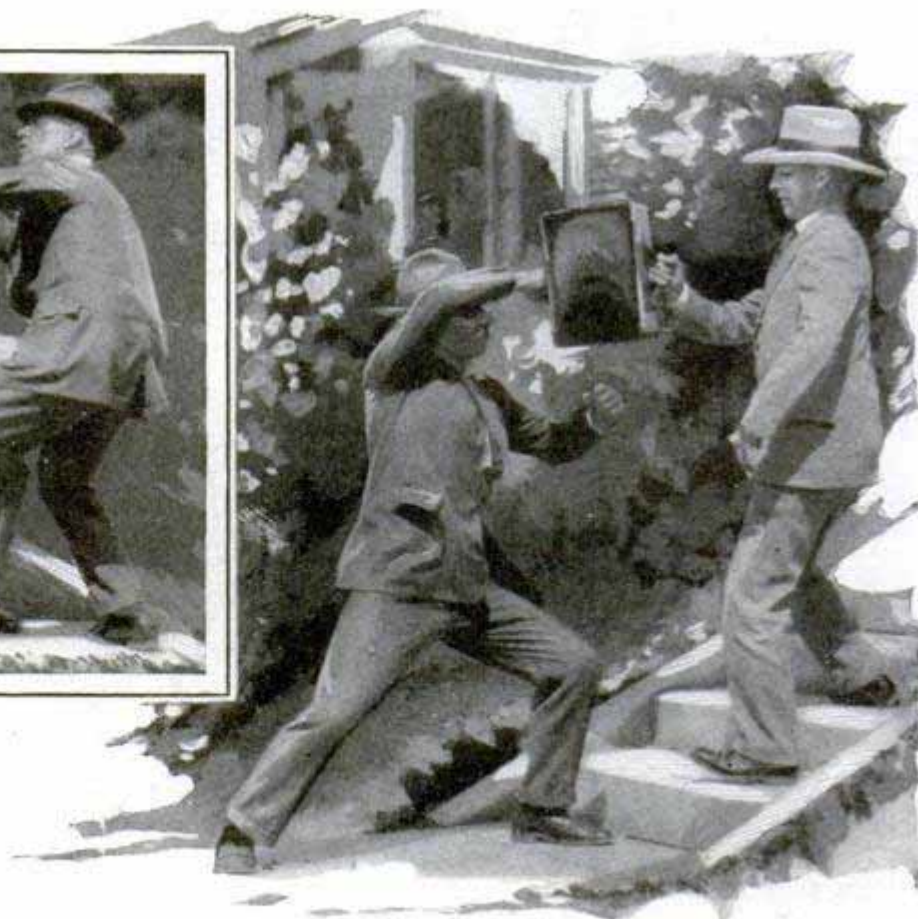

PUMPING LAKE DRY TO FIND GOLD *3/6*

Urged by reports that large quantities of gold lie at the bottom of a lake in Devil's canyon, near Quesnel, B. C., an American syndicate is preparing to drain the basin. Seepage water is to be diverted by dams and flumes and most of the main body will be carried away by a huge siphon. When all that can be removed in this way has been sucked out, holes will be bored through the bottom of the lake in the hope of striking one or more tunnels which were driven through the sides by previous miners. Two attempts have been made before to empty the lake, which is 100 feet deep at the center, by means of tunnels. A cave-in halted the first effort and, in the second, one man was suffocated by foul air. More than \$2,000,000 in gold is reported to have been taken from the bedrock above the lake shore, and Chinamen are said to have scooped out precious metal from the bottom by the simple process of using shovels attached to long handles.

CARVED MODEL LOCOMOTIVE HAS MOVING PARTS *257*

Whittled out of wood with an ordinary pocketknife, a small model locomotive has air brakes of metal that operate after the manner of the real equipment as well as a number of other moving parts. It took the man who carved it nearly a year to complete the intricate work.



Whittled from Wood with Pocketknife, This Model Engine Has Metal Air Brakes That Work

Made by Edwin Neenan, 2137 Staebler St.



Utilizing an Old Stump for a Tourist-Registry Office; There Is Ample Space for Book and Other Records

BIG STUMP SERVES AS BOOTH TO REGISTER TOURISTS

One of the features of the Denny, Creek tourist camp in Washington, is the registration booth for tourists. It is in a huge cedar stump which has been equipped as an outdoor office with a shelf for the register book and space for other records. The camp centralizes the tourists, helping to decrease the fire hazard, while the booth aids in keeping track of the number of visitors and the places from which they come.

Only about one oyster shell in a thousand contains a pearl, it is said.

Constructed by John W. Sundberg, Forest Ranger at Denny Creek Camp Ground.

19



Filling Mask and Wearing It: Principle Is Same as Hot-Water Bottle, but This Holder Fits Snugly and Will Not Slip Off Even if Person Stands

DOUBLE-WALLED RUBBER MASK HELPS RELIEVE PAIN

Fitting snugly about the face, a rubber mask that can be filled with water, is intended to overcome neuralgic pains and to be of aid in skin treatments. The article holds a pint and weighs but twelve ounces when empty. The water does not bulge at any point as it is evenly distributed, and either hot or cold may be used.

ROUTE USED BY PRIMITIVE MAN SOUGHT IN ARCTIC

342

Seeking historical information rather than riches, an expedition headed by Dr. Ales Hrdlicka, of the Smithsonian institution, has been exploring the rugged, gold-bearing regions of Alaska for trace of the routes used by primitive men in their supposed immigration from Asia. Did the small islands in the Bering strait serve as stepping stones to this continent? Where did they first establish a settlement after their crossing? What course

did they take in working their way southward? Answers to these and many other questions were sought in the journey which included a trip down the Yukon from Tanana, the route of the gold seekers of '98. One of the most interesting finds was the remains of an old stone industry. Dr. Hrdlicka found no traces of any really ancient settlements along the Yukon, it is reported.

FUEL FROM WOOD FOR AUTOS CHEAPER THAN GASOLINE

338

Motoring in Germany, where gasoline is expensive, is expected to become more popular as the result of a Berlin professor's discovery of a process for making fuel from wood. He is said to have prepared twenty gallons of it at a cost of but \$3.50, whereas an equal amount of gasoline would have cost \$11. By means of a chemical treatment, the wood is changed into an acid and then distilled into a motor fuel. Tests of the substance are reported to have been successful, and car dealers and manufacturers see an increase in their trade from this discovery.

Prof Engelhard, Berlin.
BICYCLE PROPELLED BY "OARS" GIVES HELPFUL EXERCISE

2205

Handles at the sides connected to a chain gear and actuated with a rowing movement propel a bicycle a German has invented to afford the rider beneficial exercise. It is steered by the feet which are supported on pedals near the position of handlebars in the usual wheel.

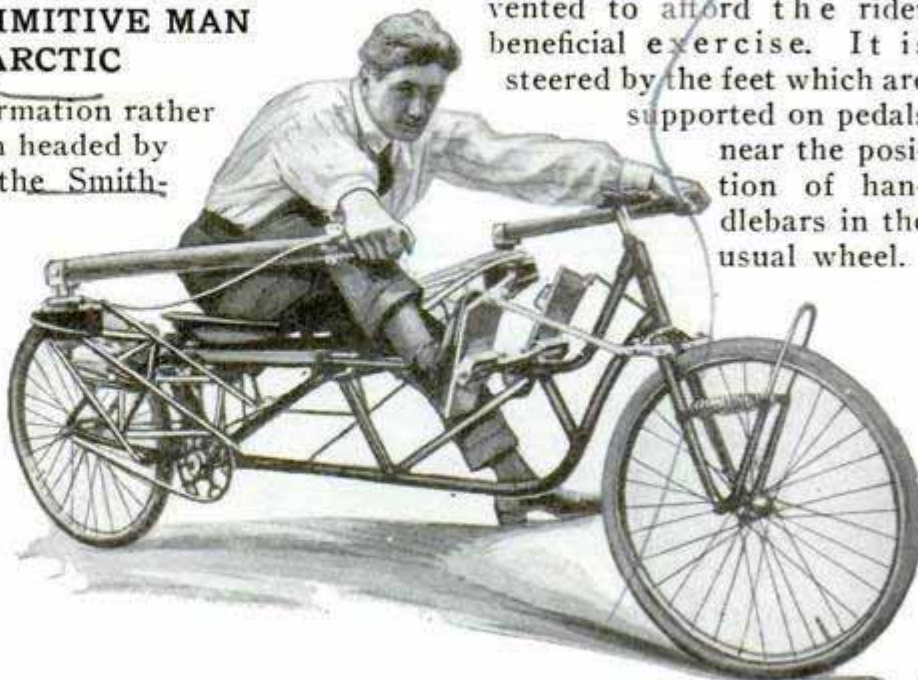

Steered with the Feet and Propelled by Arm Movements, This Bicycle, the Reverse of Usual Kind, Develops Muscle

Dr. Fritz Paules, Berlin engineer

HOW TODAY'S WEATHER GETS MAPPED FOR YOU

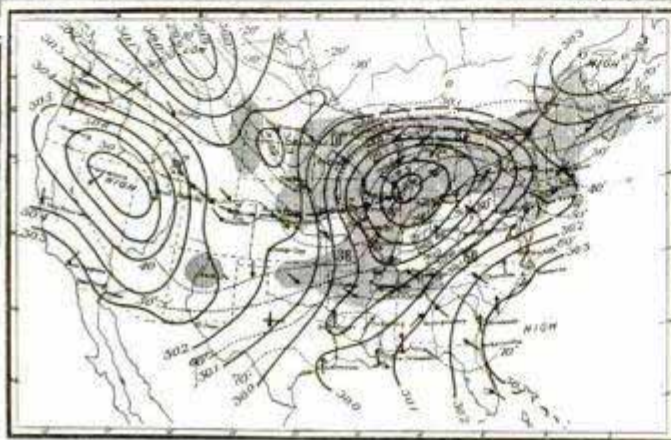
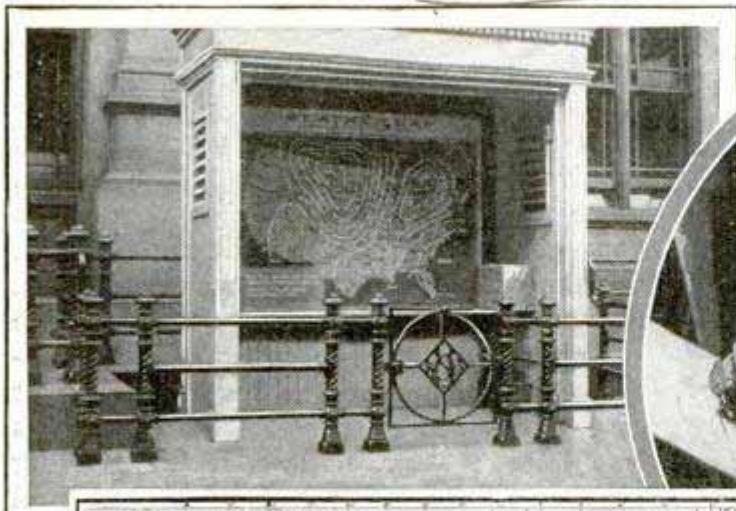

Pictogram, Box 840
Lithographer Transferring the Weather Lines to Be Published in the Daily Map; Top, Left, a Ground Glass Map Whose Lines Are Changed Daily with Colored Chalk, and Below It, a Printed Map Showing a Severe Storm Centering over Chicago and Sweeping toward the Atlantic Coast

Washington, D.C.

Long before noon each day the entire country has been told by telegraph what the day's weather outlook was at 8:00 a.m. in more than 200 selected spots, and printed maps showing the weather for the entire country are being distributed in Washington and other observatory cities. Behind that speedy gathering and distributing lies a remarkable organization and an unusual degree of efficiency. At 8:00 o'clock in the morning in the weather bureau at Washington a dozen men gather to get out the forecast and map. They include eight map makers, three printers and the forecaster. At the same moment, throughout the country, the local weather observers take their morning readings, put them into code, and file them with the telegraph companies. In preparation for that event, a nation-wide circuit of telegraph lines has been set aside a few moments after 8:00 o'clock, all linked together in an enormous chain. Each city transmits its report in order, and copies the others, so that when the chain is complete, not only Washington but each town on the line has the complete weather re-

turns for the day. The time taken is very short, because of the ingenious code used. It embraces thousands of words, yet is so simple that the forecasters in Washington can memorize its principles quickly and decode all weather reports without looking at the book. As the decoding proceeds, each of the eight map makers enters the data that belong to his sheet. Clouds, temperature, barometer readings and other information go on separate charts, and in addition all the principal information is entered on a master map which, when completed, corresponds closely to the published weather map. With all the returns entered, the forecaster takes the master chart and draws in the isobars and isotherms, the former lines connecting points of equal barometric pressure and the latter connecting points which have reported equal temperature. The isobars are important because they mark the limits of the various high and low-pressure areas which in their movement over the country determine changes in the weather. Then, the forecaster dictates his weather predictions for the next twenty-four hours.

Rev. Print

\$125.00

*Mutual Gold Stamping Association
560 W. Monroe St. Chicago*

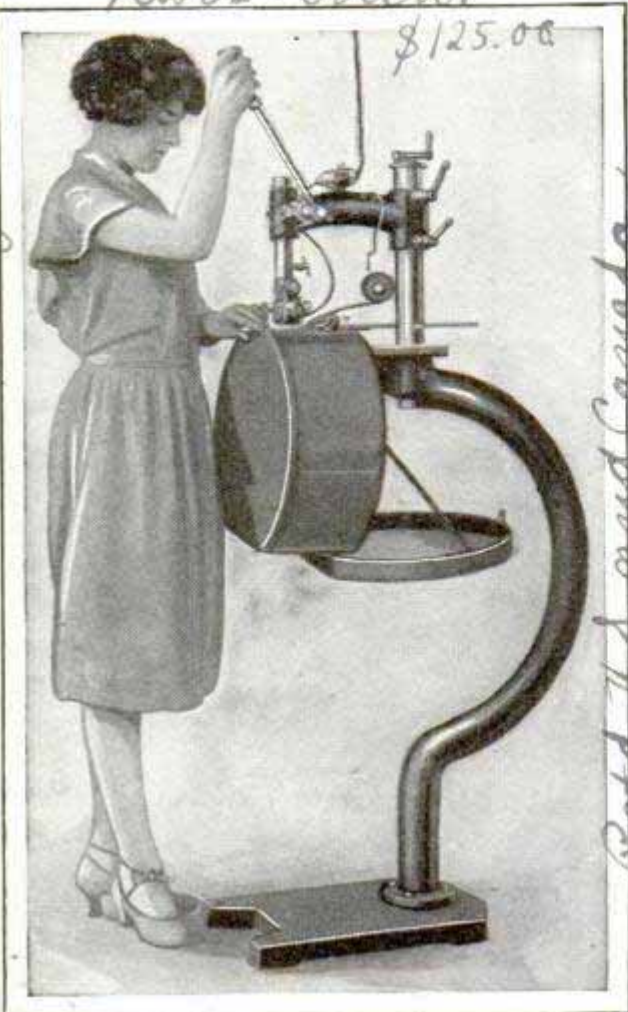

With Electric Heater for the Gold Leaf. This New Stamping Machine Will Take Large Objects

GOLD-LETTER OUTFIT STAMPS BIG AND LITTLE OBJECTS

Printing names, emblems, and other identification marks in gold on leather goods, large or small, is quickly and easily done by a patented stamping outfit which combines a number of serviceable features. These include a "three-speed" electric heating unit for the gold, which is supplied in one-hundred-foot rolls, two inches wide; two working platforms and a curved column, which permits handling a piece as large as a twenty-inch hatbox. The stamper is said to operate on rough as well as smooth leathers. A wide variety of type styles and designs can be furnished by the manufacturers of the machine.

Patd U.S. and Canada 1924

California Science Monitor 8/27/26
FLYERS MUST HAVE A LICENSE OR FACE ARREST

Complete regulation of flying above Los Angeles is undertaken by a new city ordinance which governs all kinds of aircraft and traffic. Dirigibles are required to give the right of way to free balloons, since the latter are unable to navigate a course. Pilots of all aircraft are required to take out licenses, and license numbers, three feet high, must be painted on the underside of airplane wings. Flying below 2,000 feet over the business district and 1,500 feet over residence district is prohibited; stunting and reckless flying are banned; passenger ships are required to be housed when not in use; night flying is forbidden without special permit, and inspection twice yearly, and after all accidents, is required.

SPARK PLUG WITH AIR INTAKE SUPPLIES ENGINE OXYGEN

An automobile spark plug with an air-intake tube running down the center and a valve arrangement that admits fresh air to the cylinder at each suction stroke has been placed on the market. The makers claim that the addition of fresh air to the mixture from the carburetor assists vaporization of the gasoline charge, retards oil pumping, equalizes compression, and helps keep the plug clean.

Pat. pending. Vacuum 1.50
ONE-WHEEL-DRIVE MOTOR PLOW

WORKS CLOSE TO TREES

Front wheels on a telescoping axle and a single corrugated driver of special design at the rear, are features of a fifteen-horse-

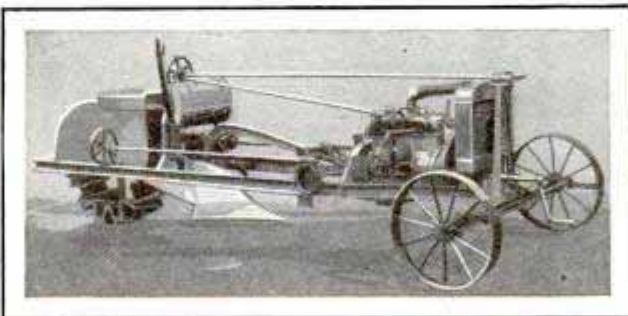

The Single Rear Wheel Enables This Motor Plow to Work within Six Inches of Trees

power motor plow devised by a western inventor. It can be worked within six inches of trees, vegetable rows or fences, according to reports, and the drive wheel runs on the hard, even bottom of the furrow, a surface favorable to efficient traction, making the comparatively small motor practical. The front axle can be narrowed to a width of only thirty inches.

*L.L. Broder,
424 Board of Trade*

*Letter
11/30/26
6th & 7th Sts.
Los Angeles Calif.
A note 338. Enclosed 13ldg.*

Sold by H. S. Miley, Laming, Mich. sets

RUBBER-TIRED DOORSTOP SAVES MARRING OF FLOORS

A doorstop designed to hold the door in any position, without marking or marring the floors, works somewhat on the principle of a window catch, with an eccentrically mounted wheel faced with a rubber tire. When not in use, the wheel, equipped with a lever that can be operated with the foot, is kept clear of the floor as a result of its eccentric pivot, whereas in use, it is pushed down to establish a firm contact.

— aut

MOTOR-CAR TRUNK FOLDS AND FITS UNDER SEAT

89

Large enough to hold camping equipment or luggage, a trunk that fits on the automobile running board can be stowed away under the rear seat when not in use, as it collapses into a flat package. When opened, it is solidly braced, keeps out dust and dirt and is shaped to fit securely upon the board, where it is held by two clamp braces without the need of any straps, ropes or other means for keeping it from falling off. The trunk, which thus is always at hand, may be obtained in a large or small size and is claimed to be suitable for any automobile.

Goldaway



Open, This Auto Trunk Has Considerable Capacity, But Collapsed, It Fits under the Rear Seat

MYSTERY SEAPLANE PASSES SEVERE TESTS IN JAPAN

276

As in motor cars, there are changing styles in aircraft. A conspicuous example of this is a recent seaplane devel-



Elevating the Tail of This New Japanese Seaplane Insures the Rudder against Damage When Landing in the Water

oped by Japanese builders. Details of its construction are being kept secret but new theories are said to have been applied in the design and operation, and the ship is reported to have successfully passed rigid official government tests under the eyes of experts. A noticeable feature is the curved rear part of the fuselage which rises to a much greater height above the water than in earlier similar types.

EPSOM-SALT VALLEY MINED TO AID TIRE INDUSTRY

376

A deposit of pure epsom salts, found a few years ago in the southern end of Death Valley, near Wingate pass, is being worked to supply the magnesium sulphate needed in manufacturing automobile tires. The epsom salts used in the tire plants make rubber casings wear longer. For a time after discovery, the deposit of pure salts remained valueless, since at that period the only customers for magnesium sulphate were the drug store and doctor, and there wasn't enough demand to make it worth while to pay the heavy transport cost necessary to bring it to market.

Whenever you find that you wish to know more about any article in the magazine, write our Bureau of Information.

*30 x 18 - 88.50
48 x 16 - 13.50*

Sta. Publ. Co. 717 N. 11th St.

*Emb. E. J. Stoddard
71 N. Baldwin Ave.
Gaines, Mass.*

MEASURING HEAT OF THE SUN TO AID WEATHER FORECASTS

77 By means of a special measuring apparatus which he has completed after years



Dr. Abbott with Instrument for Measuring Sun's Heat, to Aid in Forecasting Weather Conditions

of experimenting, Dr. Charles G. Abbott, of the Smithsonian institution, is reported to have found proof that the sun's heat varies from day to day and from year to year although atmospheric conditions may be identical. Scientific weather forecasts for longer periods may be possible as a result of these findings, it is believed, as they open a way to apply the factor of the sun's heat to future weather changes.

PLAN CONGESTION RELIEF WITH ARCADES IN BUILDINGS

Cities can develop without curtailing the skyscraper by constructing arcades, underground garages and sidewalks cut under buildings, a New York traffic expert suggests. He points out that adequate provision for "horizontal transportation" is as necessary as the installation of elevators to care for "vertical transportation," and that the plan of raised sidewalks, reached by ramps or stairs, will not be popular as people prefer to walk around an elevation rather than climb. Arcades, he declares, already have proved practical in several cities here and abroad. They provide space for many stores, relieve sidewalk congestion and are shel-

tered from unpleasant weather. By installing them inside the building line, part of the present sidewalk could be removed for additional lanes of street traffic. A uniform plan followed throughout the city center would be necessary to achieve the desired results. Parking spaces for autos in the skyscraper basements and the erection of ten or twelve-story ramp garages would remove hundreds of cars from the streets, it is suggested, and limitation of parking to one side of one-way streets would expedite traffic fifty per cent. Recommendations are made that parking be prohibited between the hours of 8:00 a.m. and 9:00 p.m., and that freight terminals be established for trucking, so that long-distance hauls during the day could be avoided. Under this arrangement, merchandise would be transported from piers and railroad platforms at night, then distributed to the individual firms the next day. The suggestion is also made that apartments at reasonable rentals be erected near the business districts so that the workers could live within walking distance of their shops and offices. This would ease the burden on all traffic lines.

PENCIL HOLDER HAS BLADE ON END OF CLIP

1082 Pencil-holder clips that have a sharp steel extension blade, which can be used for almost any purpose where a small knife is needed, have been placed on



ELECTRICITY KILLS PESTS

191 Successful tests at fighting destructive codling moths with electricity are reported from orchards and rose gardens in the northwest. Wires are strung through the trees and bushes, and a strong current, passed along for as brief a time as five minutes a day, is said to be effective in keeping the pests off.

A. E. Harrington, Chairman Traffic Committee, Broadway, New York

Pencil-knife Corp., New York

Kansas City Star 7/25/20

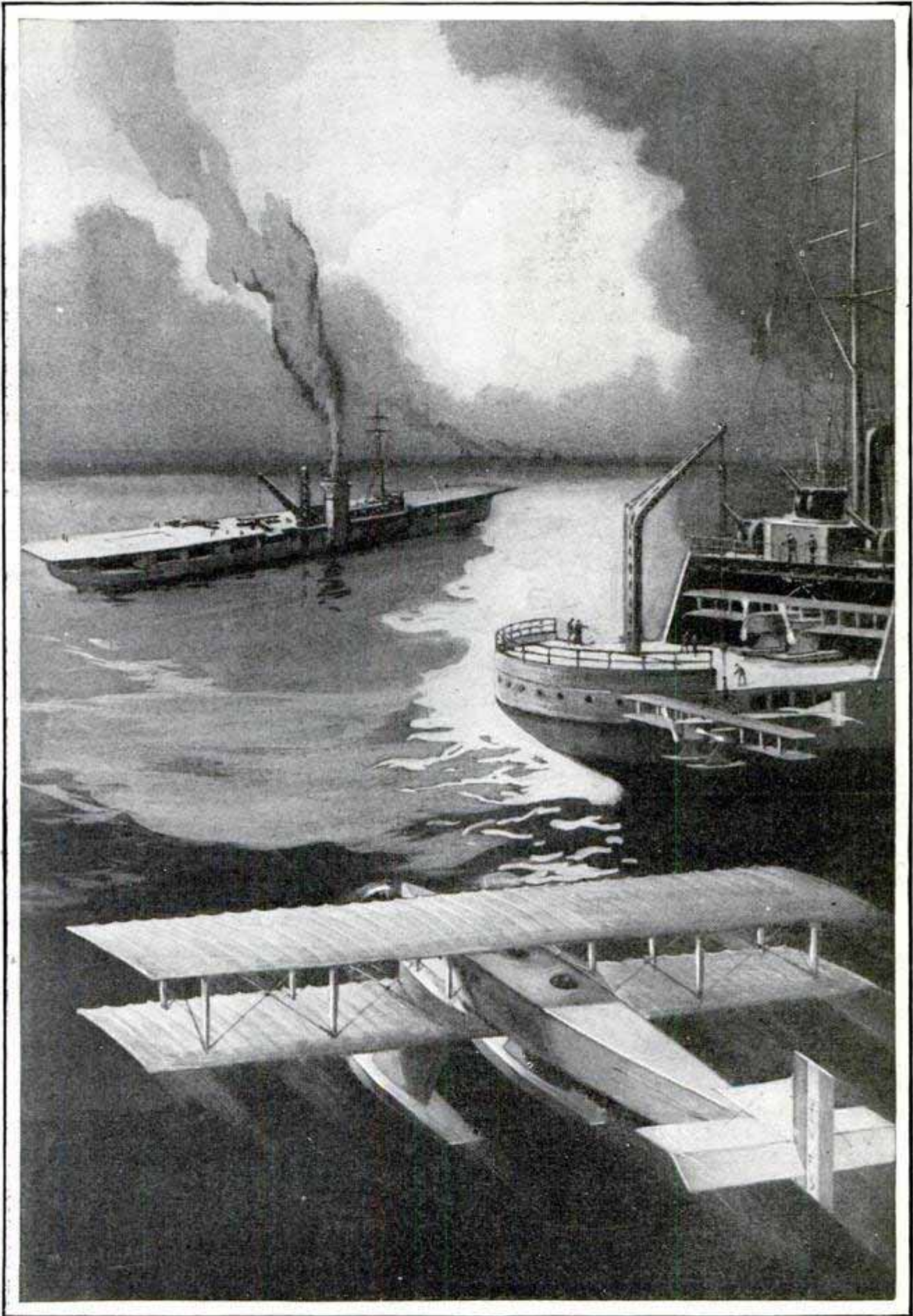

Modern Plane Carriers with Broad Landing Decks Are Supplemented by France in Her African Campaigns by Plane Transports like the One at the Right, Which Carry Large Numbers of Airships

163

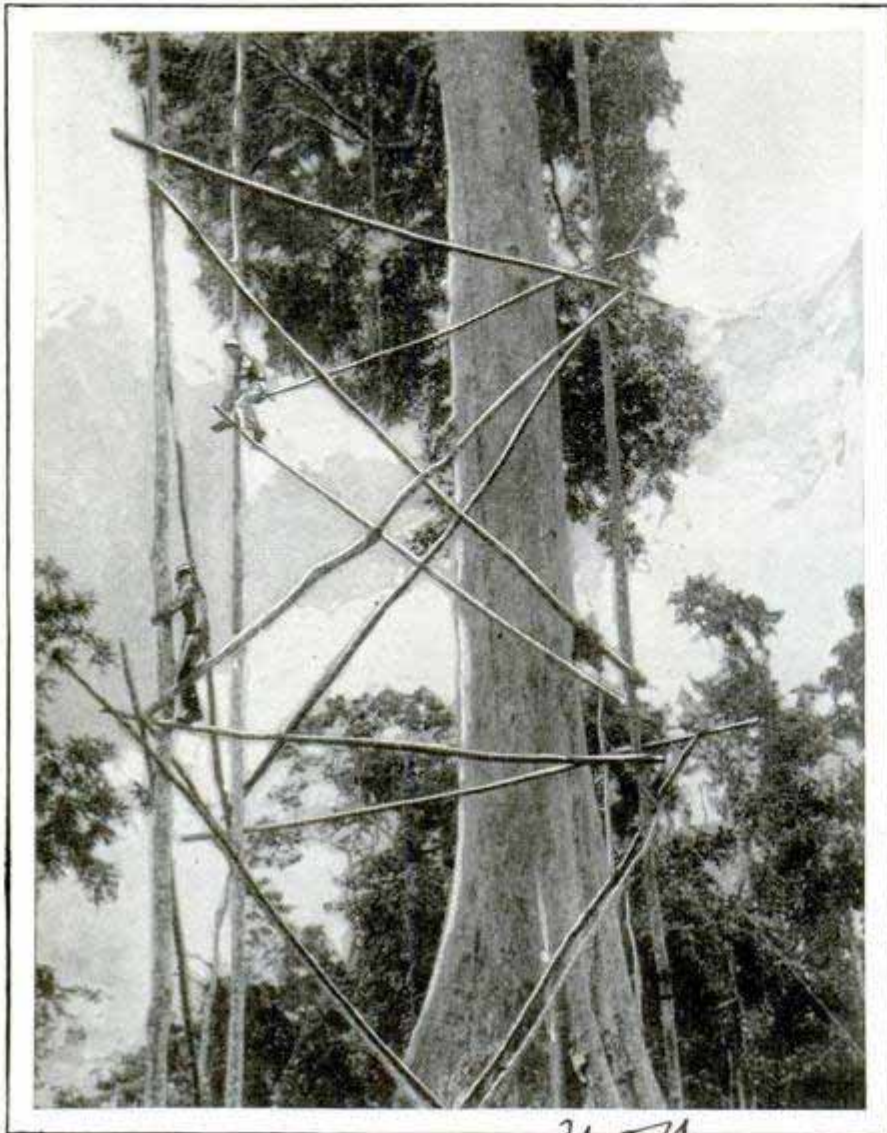

Surveyors Building a Tower around a Tree in a Philippine Jungle, in Order to Get a View across Country above the Forest

**TOWERS HIGHER THAN TREES
AID U. S. SURVEYORS**

So that readings may be taken in spite of high trees, United States surveyors in the Philippines are often forced to construct towers higher than the jungle obstacles. Two independent structures of slender poles, one for the instruments and the other for the observer, so that his movements will not disturb the equipment, are built around the tree to afford views at great distances.

**PRESENT BOBBED-HAIR FAD
MANY CENTURIES OLD**

Bobbed hair has joined the list of things that are not new, as a result of research by a French doctor who has listed three previous epidemics of feminine bobbing since the French revolution. The first

followed immediately after the overthrow of the king, when women cut their locks in memory of Marie Antoinette, and others, who were shorn before being led to the guillotine. The fad revived in 1836, when the princess of Orleans exhibited her painting of Joan of Arc, showing the famous saint, as she is always pictured, with a bob. It was known as the Joan of Arc style. Short hair, resurrected again in 1871, was then called the Ninon style, in honor of the famous seventeenth century beauty.

**TWIN-BELT SANDER
SAVES LABOR**

Vertical and horizontal sanding belts are combined in one in a motor-driven apparatus now on the market. Because of the duplex feature, it has a wide range of uses, being suitable for work on furniture, cutlery, hardware, toys, etc. It saves time and labor and produces uniform straight-grained finishes on flat or curved surfaces.

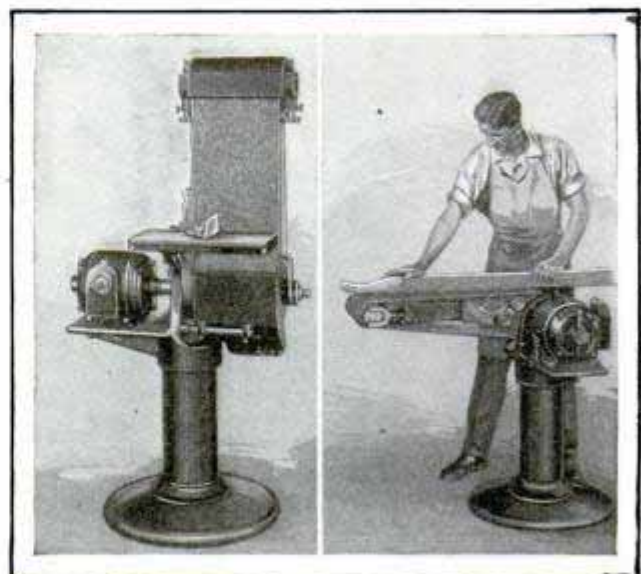

Sanding Machine Which May Be Operated Either as a Vertical or Horizontal Belt

Porter. Cable Machine Co.
Syracuse. N.Y.

642 W. Washington Blvd. Chicago

8/29/26

422 Third Ave
Pittsburgh, Pa
751
24

CHANCE STILL AIDS INVENTORS IN THEIR WORK 378

Chance still plays its role in science. Two big discoveries of recent years both are due to pure chance. In one, chemists of a powder company, after working for months seeking a new quick-drying finish for various uses, had just poured some caustic soda into a preparation, when a breakdown of the machinery suspended experiments for several days. When the time came to resume and they looked at the old solution to see if a fresh one was needed, they were amazed to find the lacquer they wanted waiting for them. The accident solved the problem by leaving the mixture until the chemical did the rest. In an automobile laboratory, a chemist conceived the idea, during experiments aiming to solve the causes of motor knocking, that the color of the explosion might have something to do with it. He asked for some colored substance soluble in gasoline. As it happened, the only one available was iodine, and, while his color scheme was wrong, the use of the iodine resulted in the working out of the theory of anti-detonants, which may bring revolutionary changes in engine design.

CHART OF BIRTHS AND DEATHS SHOWS POPULATION GAIN 2259

Vital statistics about America are presented in a novel flashing chart at the ses-
quicentennial exposition in Philadelphia. Lights go on and off to indicate births, deaths and the fluctuations in immigration and emigration. The net result of these factors, according to a summary on the map, is to give the country a net gain of one person for every period of about twenty seconds.

Names and addresses of manufacturers of articles described in this magazine will be furnished free by our Bureau of Information.



An Electric Blower That Dries the Bather Is the Latest Innovation for Swimmers

No Chicago agent
**ELECTRIC BLOWER FOR BATHERS
DRIES HAIR AND SUIT,**

Intended especially for use at indoor pools, an electric blower directs a strong current of heated air upon the bather at the turn of a switch, thoroughly drying hair, body and even the suit. The equipment is driven with power from the lighting circuit and can be moved about to any convenient place around the basin.

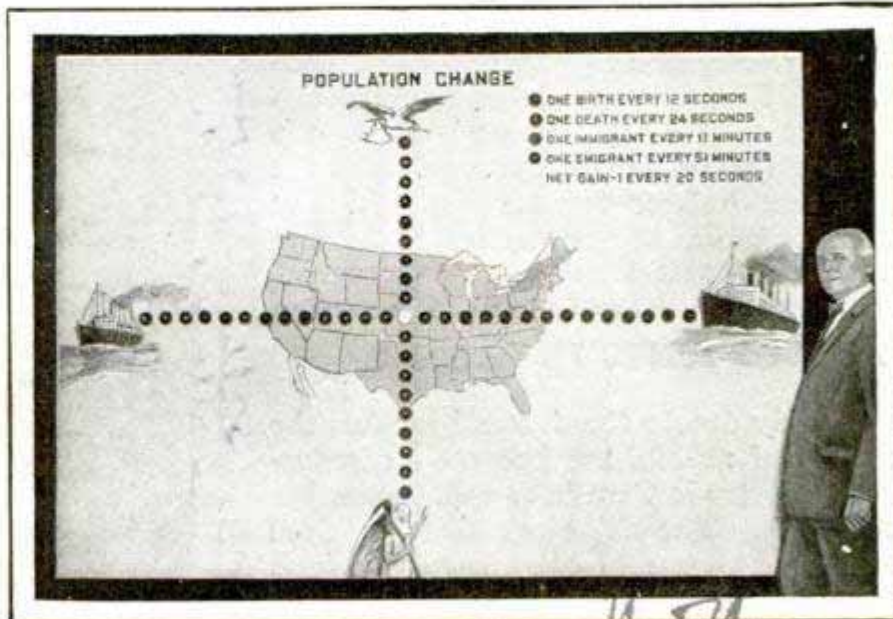

Flashing Map That Shows Population Changes in United States; the Flickering Lights Record a Net Gain of One Person Each Twenty Seconds

H. W. Reelless Mfg. Co. 422 Third Ave. Pittsburgh, Pa.

Instructor Explaining to Young Recruit the Workings of the Parachute Attached to Dummy for Test

213

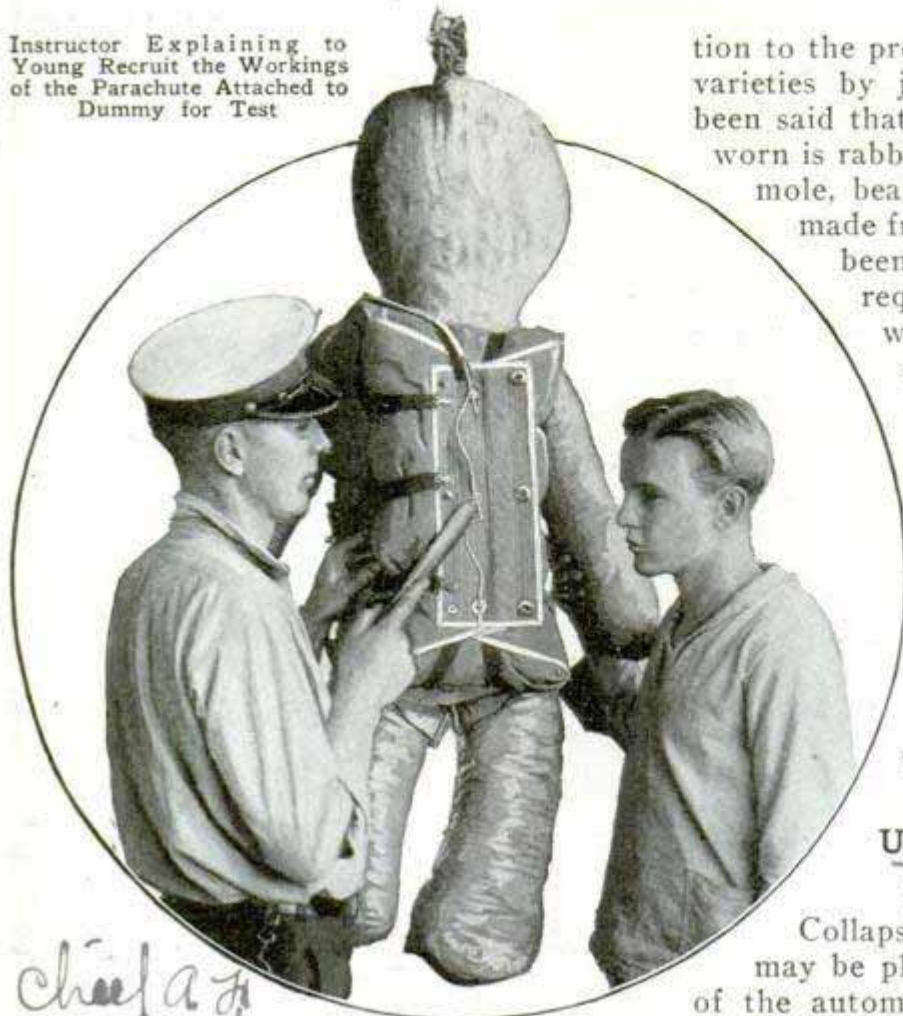

tion to the production of larger and finer varieties by judicious crossing. It has been said that about half of the fur now worn is rabbit. Successful imitations of mole, beaver, seal and chinchilla are made from the pelts after they have been treated. About forty are required to make a coat, two will produce a neckpiece and one is enough for a pair of gloves. One of the most popular varieties of rabbits is the chinchilla which has a strong resemblance to the genuine chinchilla of South America. Because of the small amount of capital necessary to start a rabbit farm, the industry is proving attractive to many persons.

UMBRELLA FOR AUTO ALSO FITS IN DESK

Collapsing into a small bundle that may be placed in a case on the back of the automobile seat, slipped into an office desk or tucked into a fair-size hand grip, an umbrella with a jointed handle is quickly raised or lowered and is said to afford as much protection as the standard-sized article. It is suitable for travelers, reducing the baggage by one unit, and school children can put it under the book strap. A tie keeps the ribs flat when the umbrella is closed.

Chief of Staff
Sharr
and

SECRETS OF PARACHUTE JUMPS TAUGHT AT SCHOOL

Before students are allowed to make parachute jumps, an instructor at the Lakehurst, N. J., training school familiarizes them with important details of the rigging, its construction, how it is released and opened, and other vital points. They are required to know how the parachute is folded, how to adjust the harness and are taught the correct way to step from the plane and just when to pull the ring that loosens the support. In first tests, dummies are often used to be sure that the apparatus will work as intended.

320 FORTUNES IN RABBITS

Largely due to the demand for fur, the raising of rabbits has become an important industry in Canada as well as in other countries. The skins are sheared, dyed and dressed out of all recognition, and the meat affords an additional source of revenue. The animals are not difficult to raise and breeders are giving their atten-

Factory. Baltimore & Howard St. Baltimore Md.

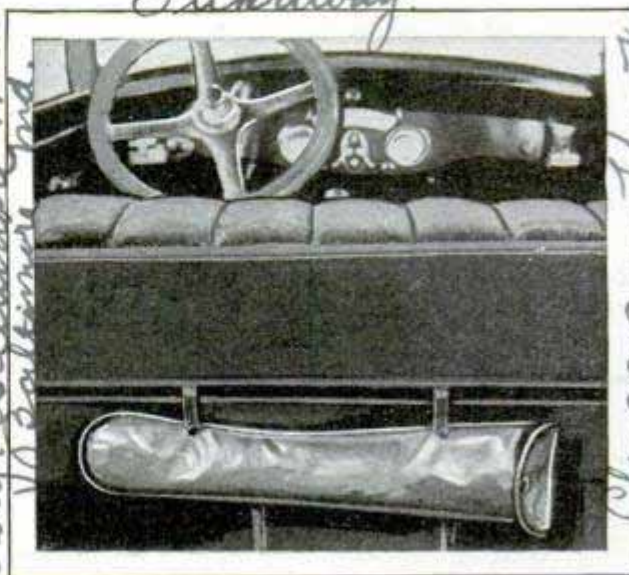

Umbrella in Compact Carrying Case Attached to Back of Auto Seat; Tie Keeps Ribs Flat When Folded

Subway
Chicago The Fair
Marchall Field

Answers 8/14/26

Siegel-Rothschild Co.
1178 Broadway

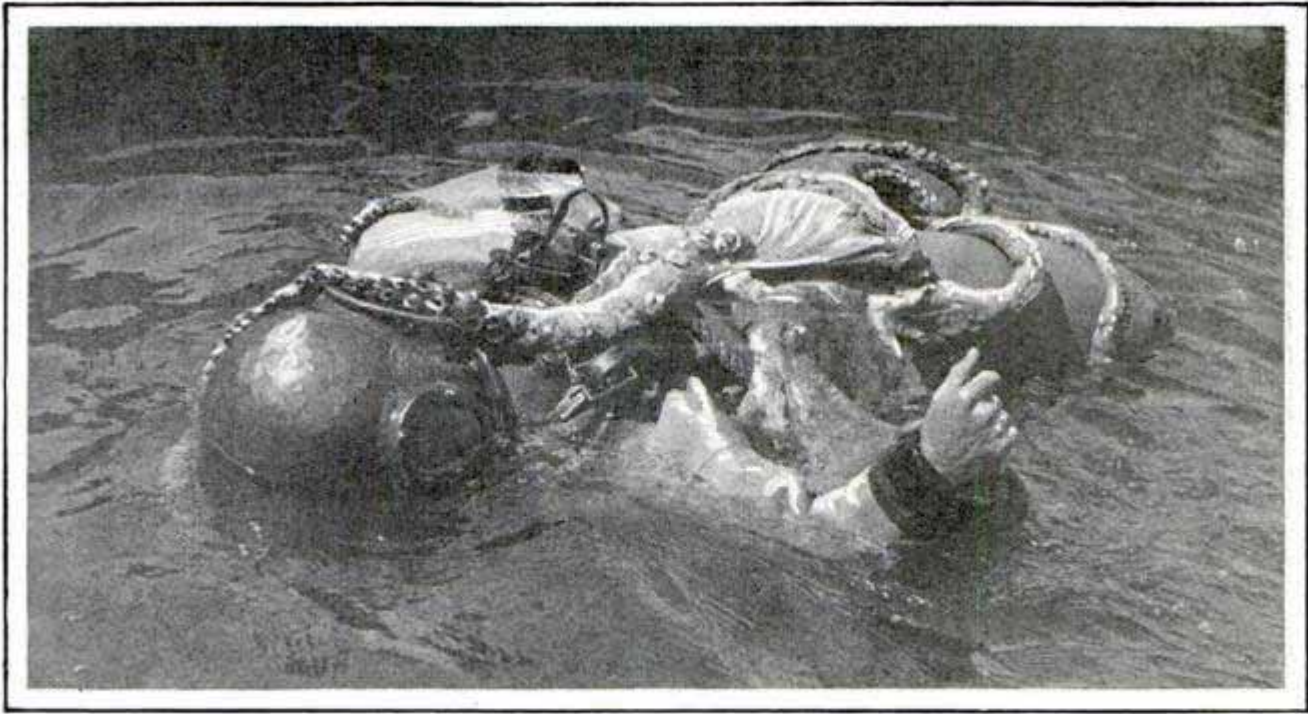

Madden in Diver's Suit, Struggling with the Octopus; Many of These Creatures Have Strength Enough to Trap a Man and Keep Him Submerged Although Their Prowess Has Been Exaggerated

MAN WRESTLES WITH OCTOPUS TO TEST ITS STRENGTH

When James Madden caught an octopus in the ocean near Venice, Calif., he decided to test the strength and fighting ability of the creature. He obtained a diving suit and engaged in a wrestling match with his prize long enough to convince him that he was glad he had worn protecting armor, for the octopus displayed considerable power in its eight tentacles. Specimens with arms several feet long have been captured.

FLOATING TOP ON OIL TANKS TO PREVENT FIRES 224

Oil tanks with floating tops, that rise and fall with the liquid level and always exclude air from the surface, are being installed in many tank farms to end the disastrous fires, usually set by lightning, which annually cause losses averaging more than \$15,000,000. The floating deck likewise practically stops evaporation, a loss that has been estimated as high as \$150,000,000 yearly. The device was made possible by the invention of a floating basket arrangement that seals the space between the top itself and the walls of the tank, acting like piston rings in an automobile cylinder. The tanks are not perfect cylinders throughout their height, so

that a rigid top would either become wedged in narrow spots or allow air to enter at others. To reach the floating deck a novel automatic ladder, folding like lazy tongs and sliding up or down on two pipes, which pass through guide sleeves in the tank deck, was devised.

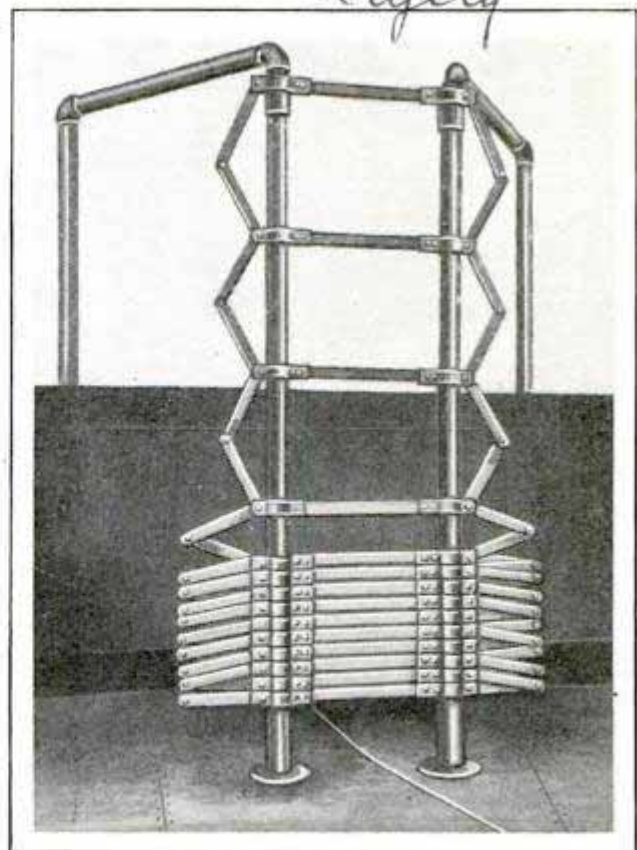

Folding Ladder, Sliding on Rods, Gives Access to Floating Deck of Fireproof Oil Tank

Columbian Steel Tank Co.

1405 W. 12th St.

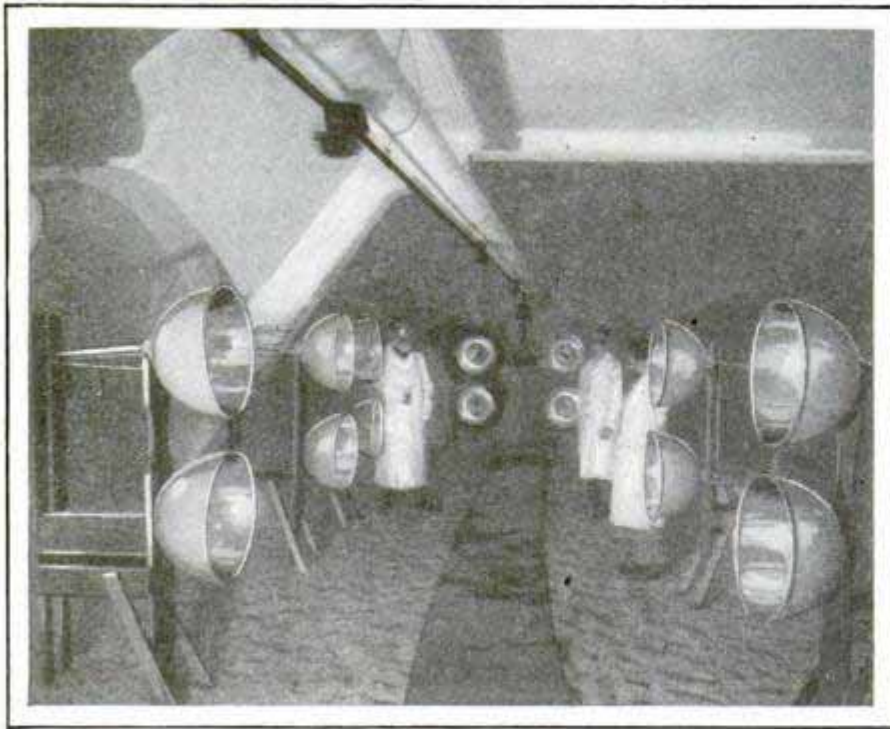

Copyright, Henry Miller

Interior of Light-Bath Treatment Room, Showing the Arrangement of Lamps and the Sand-Sprinkled Floor to Resemble Beach

LIGHT-BATH TREATMENT ROOM RESEMBLES SEASHORE

Practically all the benefits of a sun bath on an ocean beach may be enjoyed in a special treatment room in Berlin, Germany. A battery of powerful lamps furnishes the health-giving rays which physicians declare are almost as helpful as those of nature, and the beach idea is further carried out by a liberal sprinkling of sand on the floor. An advantage of the establishment is that the amount of light can be regulated to suit the needs of each patron.

286

RADIO SIGNAL FADING WORST AT THREE HUNDRED MILES

Radio programs are received with greater clarity and volume 600 miles from the broadcasting station than at 300 miles and there is less fading at the longer distance. These are the conclusions of investigators for a naval research laboratory and an electrical company, who found that a zone 200 to 500 miles from the sending station is the poorest for radio reception. A satisfactory explanation of the phenomenon has not been advanced. It is classified in the category of vagaries of radio waves. Widely scattered volunteers assisted in

General Electric Co

making the tests, which were aimed at discovering the relation between weather conditions and radio. The connection of barometric pressure and temperature with wireless results is not definite, or if it is definite, it is so complex that it is not yet understood, the researchers declare. The signals are little affected by temperature although there is an increase of static in the summer. Tests so far show that the barometer makes little difference when transmitter and receiver are at the same pressure, but when transmission is from a high to a low-pressure area, it is best

at short and long distances, but at medium distances of about 600 miles, it is best from an area of low pressure to one of high. The phenomenon apparently relates to the distribution of storm areas over the country. Some investigators have said that, if definite connection between radio and weather conditions could be established, forecasts could be issued as to the probable results of reception.

LAMP MAKES OWN ELECTRICITY AND BURNS UNDER WATER

Batteries are not needed for an electric lantern intended especially for yachts and motorboats. Current is supplied from a generator of the magneto type, a spring mechanism being actuated by winding a crank at the side. The lamp has a handle and a shoulder strap, is not affected by dampness or water, and is said to burn indefinitely by the simple operation of giving the crank an occasional turn.



*3 min light from each wachting
5 lb. wght. 5" high aluminum case*

*Shaymaker Mfg. Co.
227 Woodland Ave*

Bellevue

Where Your Turkey Comes From



By EARLE W. GAGE, *Ashville, N.C.*

THE demand for Thanksgiving and Christmas turkeys is so enormous that it is necessary to ship trainloads to our large cities. Vast ranches in the west are devoted to rearing hundreds of thousands of fowls, while giant incubating machines, the most perfect brooders, and modern scientific breeding methods are necessary to mother the delicate little turks through the perilous state of babyhood.

The first time that Thanksgiving day and the turkey were brought into intimate relation was in 1621, when Gov. Bradford, of Plymouth colony, set aside the first holiday to celebrate the ingathering of that first harvest—made by the sturdy Pilgrims who had come over in the "Mayflower" the year before. The harvest had saved the little

colony, and incidental to the religious features of the occasion, the governor sent forth four men with their flintlock fowling pieces to procure meat to grace the festive board that the settlers "might, after a more special manner, rejoice together." Ever since the turkey has been the emblem of the day. When America was discovered and explored by white men, wild turkeys were found in large numbers from New England to Mexico. History shows also that turkeys had been raised in a domestic state by the Aztecs of Mexico at a still earlier period, and that they were introduced into Europe by white explorers and were highly prized as a table delicacy upon important occasions.

The onward march of civilization, the wider use of the motor car, and other



Courtesy Dept. of Agriculture
Unruly Turks Are Kept from Flying over Fences by Tying a Paddle above Wings

evidences of progress, all have tended to work to the disadvantage of the turkey which is now found only in a few sections of the country.

Because of the decreasing production of turkeys on farms, the business of raising them on a large scale has developed into an important and profitable industry. In the unsettled sections of the west, where the range is unlimited, and the natural food is abundant, flocks of turkeys are ranged much like sheep.

On a tract of land in the vicinity of the Mojave desert, a few miles from Los Angeles, a farmer turned loose several thousand young turks raised from wild-turkey eggs brought from Virginia. The coyotes, hawks and eagles spread the glad news and congregated to take a hand in the enterprise. However, the turkeys evinced their usual disposition to stray off and dogs were sent to find them and drive them back within bounds. In spite of the handicaps of nature, this ranch had 1,500 turkeys for market, and the birds had demonstrated their ability to thrive and multiply, when given plenty of room and liberty and surroundings natural to them.

Texas is the turkey state of the Union, producing one-tenth of our annual crop of festive fowls. The Lone Star state provides an abundance of range suitable for the fowls, flocks of several hundred

being the common thing on many ranches. In the turkey-raising districts large dressing plants have been built, where thousands of birds are dressed, uniformly graded and packed in refrigerator cars for the trip to the consumer's table.

Just before the annual holidays of Thanksgiving and Christmas a turkey day is set aside. All who have turkeys to sell drive them to the central market, sometimes for twenty or thirty miles, the flocks consisting of as many as 8,000 or 10,000 fowl. Thirty men drove 8,000 turkeys thirteen miles in two days. In a drive of this kind, a wagon is driven just in front of the turkeys and a little corn is scattered to the leaders to keep them moving. Those that become lame or tired are placed in the wagon and hauled to town. At nightfall, provision is made to stop under a grove of trees where the turkeys may roost.

Cuero, Tex., "home of the famous turkey trot," and probably the largest shipping point for turkeys in the world, is the birthplace of a unique ceremony upon the last day of the turkey season. Just before the harvest festival rolls around, this community pays homage to its most famous and profitable crop and celebrates the end of the season with appropriate ceremonies. The turkey reigns as uncrowned king of the festival, and a parade is held.

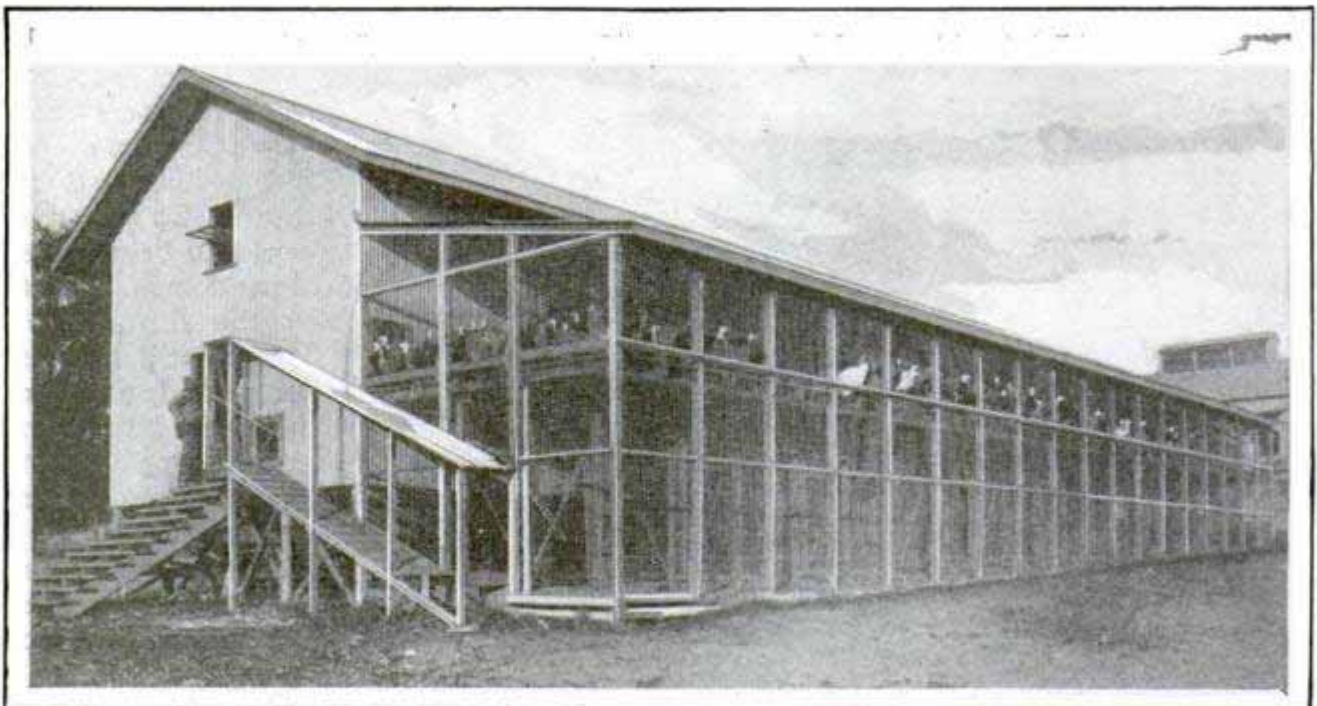

Where Hundreds of Turkeys Are Prepared for Market, a Big Dressing Station in Texas; the Birds Are Uniformly Graded and Packed in Refrigerator Cars for Long Trips

247

**INDIAN BOYS PLAYED MARBLES
TWO THOUSAND YEARS AGO**

262

Discovery of the skeleton of an Indian boy, about twelve years old, with a number of marbles, in a mound near Bainbridge, Ohio, indicates that the game was a favorite among the youths of the tribe as long as 2,000 years ago. The body had been interred in a log-cabin like structure covered with a canopy, of which molded fragments were found, and was clothed in a garment of woven fabric. Besides the marbles, other unusual relics were found, including stones carved to represent a turkey vulture and a lizard, beads, ceremonial specimens and other ornaments. The articles evidently had been placed with the body at the time of burial.

1627

**BATTERY TESTER DOESN'T DRIP
AND REACHES HARD PLACES**



Acid is prevented from dripping on carpets, clothing and floors by the sealed-bottom arrangement of a battery tester now on the market. It also has a two-foot flexible rubber tubing for reaching difficult places, such as batteries in autos, without removing them.

Hafner Mfg. Co. 3128 Carroll Ave. Chicago.

**IDEA FOR BASEBALL CURVES
GAINED FROM CLAMSHELLS**

226

The irregular course of a half clamshell, carelessly tossed aside, gave William Arthur Cummings, the originator of the curve ball, the idea of applying the principle to the baseball sphere. Watching the shell, he became convinced that a ball might be made to perform similar movements if thrown in the right way. His friends laughed at his theories, but he demonstrated his skill while pitching for Harvard in 1867. Batters of the opposing team were astounded at the ball's sudden breaks, and Cummings was heralded as the "boy wonder" of baseball.



After Fireman Has Passed Through, the Trapdoors Automatically Close, Shutting Out Drafts

**TRAPDOORS IN FIRE STATION
SHIELD SLEEPING ROOMS**

Unpleasant drafts, dirt and flies are kept out of the sleeping quarters in a fire-patrol station in Chicago by means of a double trapdoor at the opening around the pole down which the men slide when answering calls. Each leaf is closed, after the fireman has passed through, by an attachment like those on ordinary doors.

**IMPROVED CLAMP FOR HOSE
REDUCES LEAKS**

For automobile and airplane hose, a clamp has been designed that is said to be practically proof against leaks. An essential feature is a length of flexible cable which is wrapped one and one-half times around the hose, and exerts even pressure.



Inv. Paul H. Wilkinson
700 Hall of Records

Hafner Mfg. Co. 3128 Carroll Ave. Chicago

Pat. H. Corbin, Randolph Chicago

Chicago Eve. Post
8/3/26

220
70th St.
Los Angeles, Calif.

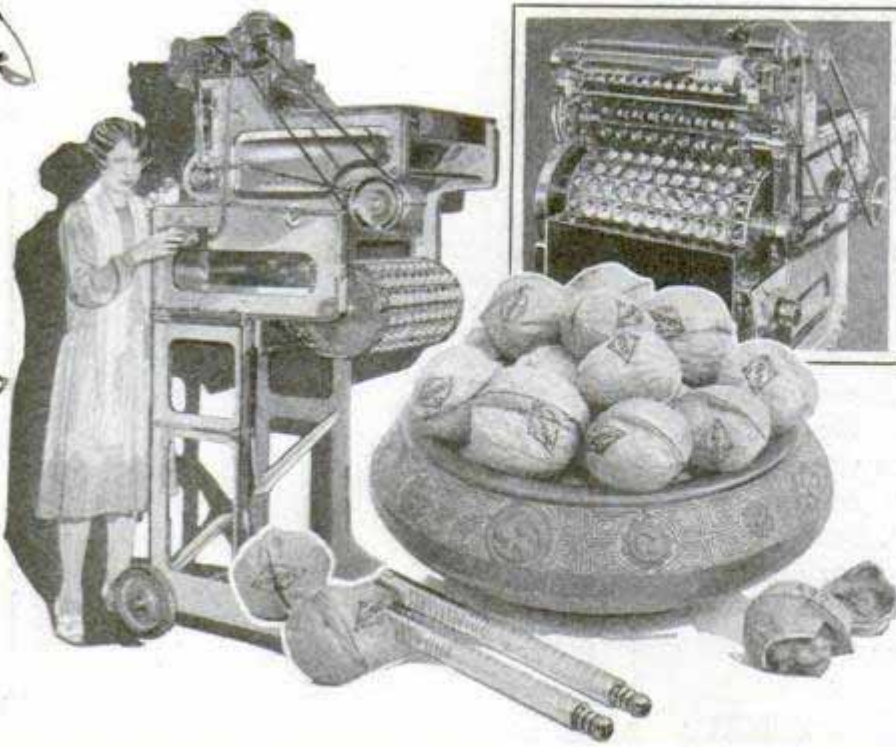

Walnuts Branded, the Stamper in Operation, and a Close View of the Rows of Cups That Hold the Nuts

BRANDING PRESS FOR WALNUTS STAMPS THIRTY A SECOND

In June, 1919, Popular Mechanics Magazine printed an announcement that the California walnut growers' association offered a prize of \$10,000 for a machine which would put its brand on walnuts. The award has just been made to two Los Angeles inventors and, in addition, they will receive a royalty of \$10,000, payable at the rate of \$1,000 a year. More than 9,000 replies to the offer were received and 100 working models submitted. The winning device, resembling in some respects a printing press, stamps the nuts to the number of 2,016 a minute, which means the equivalent of a whole 30,000-pound carload in one day, at a cost of but one-twentieth of a cent per pound. The nuts are fed into a lower cylinder which has a row of little cups to hold them in place and they come in contact with an upper cylinder bearing small rubber stamps with

not on market
used only by
Rees and Wilkinson 1946

the brand on them. Printers' ink is automatically supplied to the markers from a fountain above. Nearly three years were required to finish the model. An additional sum of \$5,000 was paid to another inventor for an improvement in the feeding mechanism.

TWIN TONEARMS ON PHONOGRAPH BETTER MUSIC

By introducing a certain interval between the tones as they are reproduced, a German musician has discovered that a more beautiful resonance and timbre are attained.

Applying this theory to the phonograph, he has equipped the instrument with two tonearms, each with its membrane and needle, which run in the same groove a short distance apart. This distance is to be regulated to the speed of the disk and the tempo of the music, but, in general, a time interval of one-fifteenth to one-twentieth of a second has been found satisfactory and with radio reception, with headphones, much less. The aim of the device is not so much to increase the tone volume as to bring out overtones and attain greater sonority, or in the inventor's words, to produce something in music similar to the "stereoscopic effect" in photography.

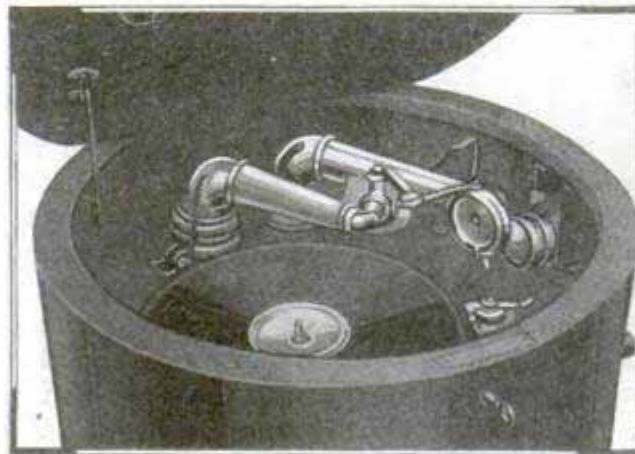

Double-Armed Phonograph Which Is Said to Produce Improved Tones and More Beautiful Resonance

If one keeps the ear close to the machine, he can perceive the lack of synchronism in the reproduced tones, but at a distance of about three feet, the two tone waves have completely melted together without loss of the improved quality resulting from the arrangement.

Henrich G. Kuchnermeister, Berlin

Illustrierte Technik
für Jederman P. 320

MAN-MADE CAVE ON BEACH RIVALS NATURE'S WORK

5352 East Ocean Blvd
Long Beach, Calif.
in rear of residence



Exterior of Cave, Showing Skylights in Floor to Aid Illumination of Inside, and Views of Interior; Realistic Stalactites, Mossy Growths and Stones Collected from Distant Regions Increase the Natural Aspect of This Artificial Cavern for Picnic Parties; Electric Lights and Cooking Facilities Are Features

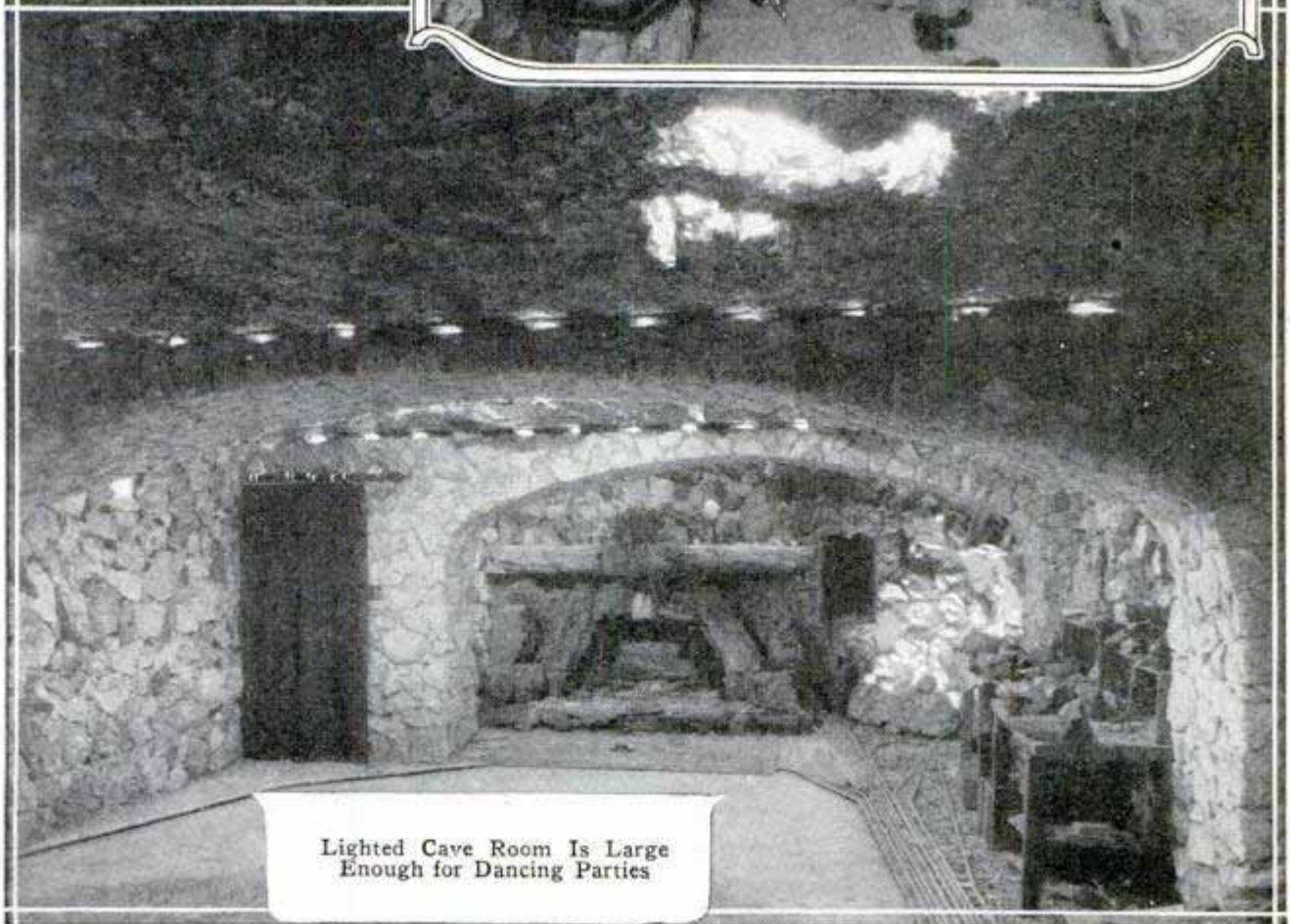

Lighted Cave Room Is Large Enough for Dancing Parties

615-23rd St
Oakland Calif

AUTO ALARM HONKS WARNING WHEN MOTOR OVERHEATS

Autovox

110



Auto-Radiator Cap with Thermostat Which Causes Horn to Blow When Motor Overheats

When the temperature of the motor reaches the danger point, a thermostat in the auto radiator cap closes an electric circuit and sounds the car's horn. The alarm may be stopped by turning a switch on the dash. The signal operates independently of water or steam in the radiator and is thus considered reliable in all cases. It may be adjusted to heat conditions of different cars and set to give the warning at any degree between 110 and 212 degrees Fahrenheit, or higher.

OIL-ELECTRIC ENGINE POWER HOUSE ON WHEELS

Introduced not many years ago, oil-electric locomotives already have been installed on eight great railroad systems and

are said to have fully met the claims of their producers. In yard and switching work, for instance, one unit of this type can do the work of two steam engines, engineers declare. It is available eighty per cent of the time, as compared with the forty-per-cent availability of the old kind, costs about half as much to maintain and is operated at a fuel expense of from one-third to one-sixth that of the steam type. Experts estimate that in one year it will effect a saving of from \$10,000 to \$12,000 on switching and yard operations over an equivalent steam engine. Interesting features are included in these efficient power houses on wheels. They are independent of an outside transmission station for power and are ready to start on any railroad system without any change in either personnel or equipment. An oil-burning engine and a direct-current generator, which supplies electrical energy to traction motors mounted on the trucks, are the two principal units of its equipment. The engine is of the six-cylinder variable-speed type, having direct fuel injection. Cylinders, cylinder heads and combustion chambers are completely water-jacketed. Ignition is produced by the heat of compression only. Absence of smoke, cinders and a reduction of noise are other satisfactory features. The oil-electric engines have proved efficient in congested areas, and on long runs are especially serviceable since they require but little water. Fifteen-hundred-horsepower locomotives of this type are to appear in the near future, it is reported, and engineers are intently watching the effect of this form of locomotion on American railroading.

General. Grand Co. 113 Broadway New York

287

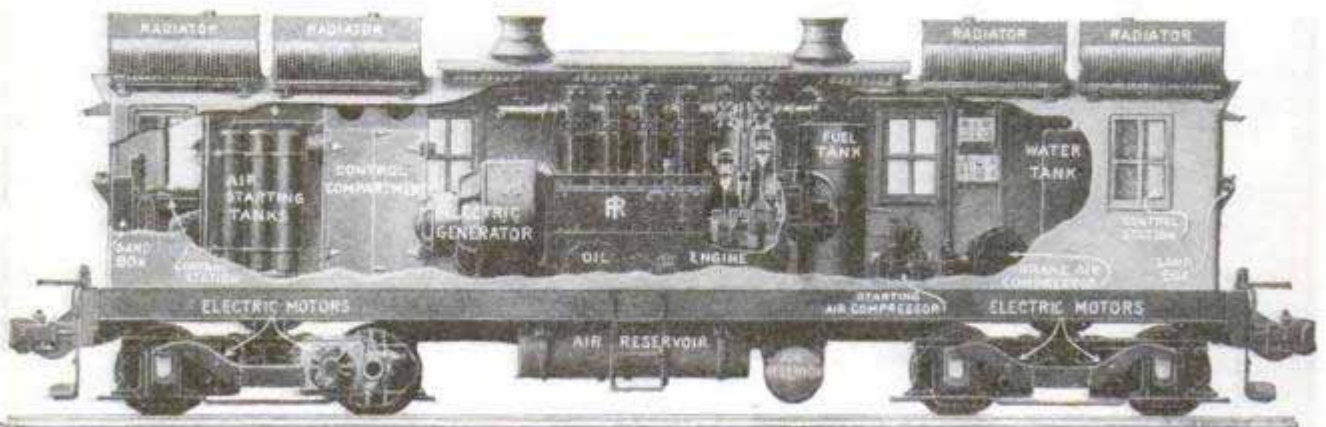

Oil-Electric Locomotive in Cross Section; There Is a Control Station at Either End; Less Noise, Absence of Smoke and Cinders and Economy Are Features Credited to These Engines

360 N. Michigan Ave Chicago

**NEW AERIAL CAMERA
PIERCES SMOKE 314**

Far greater service from aerial photography is anticipated as the result of a faster exposure process developed by army experts at McCook field to be used with special plates manufactured for taking pictures from moving airplanes. It is expected that photos of entire cities can be taken at distances of 200 miles and from an altitude of 30,000 feet. Already clear views of mountains have been obtained at a distance of 150 miles in spite of smoke. The process is being kept secret for tactical reasons, but includes treatment of the plates with a chemical which hastens the effect of an exposure and makes them sensitive to infrared rays. When the plates are used in connection with a deep-red ray filter, the infrared rays and certain blues not affecting the ordinary plate are recorded. These are the rays, it is explained, that penetrate a smoke haze. Light fogs have been pierced, but heavy mists, as yet, prove a barrier partly because the rays are affected by the amount of vapor in the fog. It is expected that further experiments will remove this trouble. To test the new plates, photos were made of the Sierra Nevada mountains from a plane 150 miles away. On the old kind, only the immediate territory in the foreground was revealed, the rest being hidden by a smoke screen. But on the new plates, the distant ranges were plainly visible, although they could not be seen at the time by the photographer.

K Panchromatic



One Nerve Center of New York City; Telephone Headquarters Building from Which 120,000 Phones Are Operated

**BIG PHONE EXCHANGE REQUIRES
SIX THOUSAND WORKERS 51**

Constructed in the "stepped-in" style of modern architecture, that has become increasingly employed in our larger cities for the sake of light and air, the huge telephone building in New York city, the nerve center of Manhattan, houses some 6,000 workers who are kept busy operating 120,000 telephones. The size of the structure is emphasized by the comparatively small buildings near the site, which is on the lower west side.

CLOTH WOVEN FROM BAMBOO 315

Bamboo is being utilized for textiles through a patented process developed in England. The stalks are first shredded in such a way that the long fibers can be spun or woven as readily as cotton or flax, and at less expense according to reports. Bamboo abounds in many tropical countries, so that raw material is plentiful.

*Process perfected by
Dr. Hanji, as described*

International

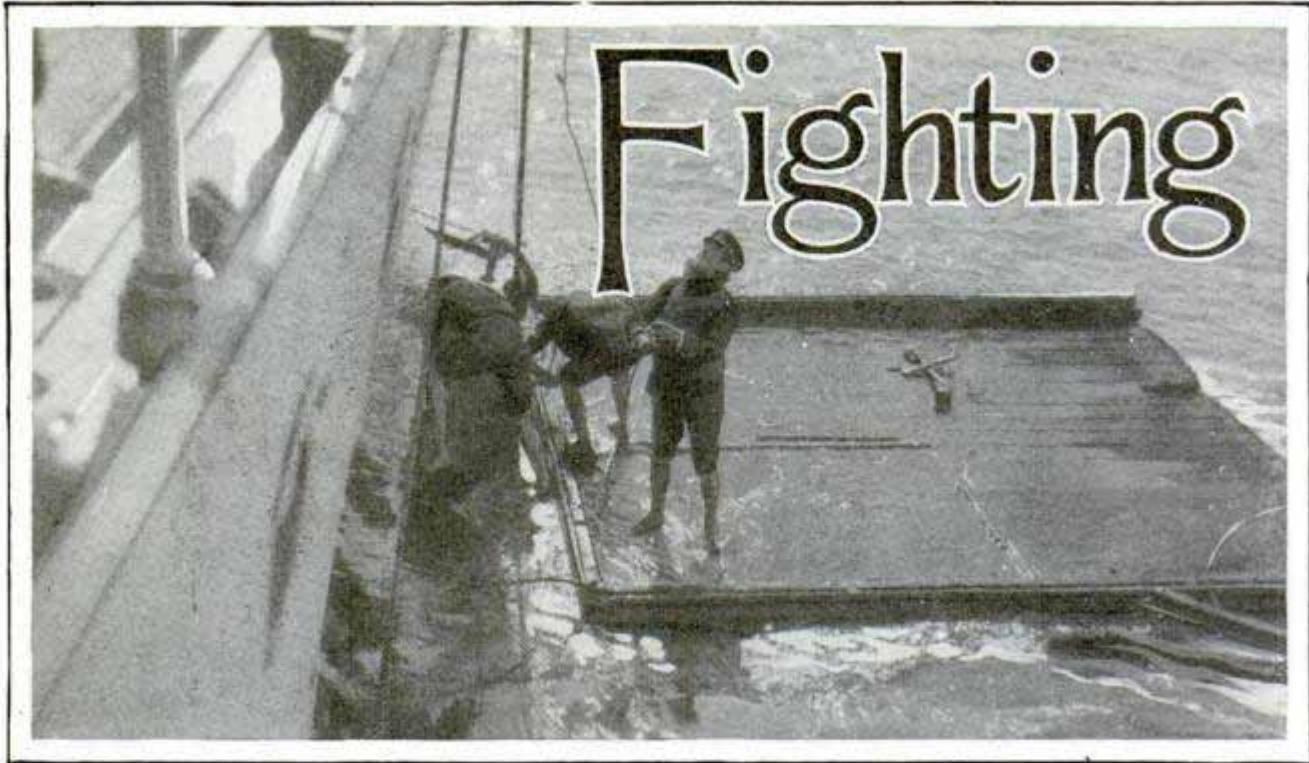

By F. A. ZEUSLER

Lieutenant Commander, U. S. Coast Guard

1904 Jackson St. N.E.
Washington, D.C.

DERELICTS—the ghostly objects that were once ships and are now neither afloat nor sunk—objects that drift with the winds and currents over the seven seas, are one of the greatest dangers to the navigator, even as great as the iceberg. The berg is usually much larger and is more apt to tear the bottom out of the ship that may run onto it, but it can usually be seen by an alert lookout except on dark nights and during foggy weather and is rarely found outside of rather clearly defined ocean areas.

The derelict, however, may be dismantled, it may be so low in the water that even the best of lookouts would fail to see it until dangerously close. It gives no warning of its presence, and may be floating in any of the oceans from the South seas to the Arctic and from the China sea to the Mediterranean. It is here today and gone tomorrow. As if animated by some restless spirit, it wanders over the ocean impelled by wind, wave and current.

The United States government has designated one of its agencies, the coast guard, to hunt down and send to rest the uneasy remains of what once were ships in order that other ships may live. The seagoing cutters of that service, in addition to the duty of enforcing the maritime,

navigation and custom laws, devote the greatest part of their time to assisting vessels in distress and to clearing the seas of dangers to navigation.

Information as to the location of derelicts is received from various sources, principally from the captains and officers of the great ocean liners and freight carriers of the world. Upon sighting a derelict, these officers immediately transmit by radio the information to the coast guard. One of the cutters of the service, the "Modoc," "Snohomish" or the "Seneca," immediately starts out on a hunt for it to tow it into port or to send it to the bottom by means of high explosives.

The success of the search depends upon a number of factors, chiefly the accuracy of the original report, the time elapsed since last seen and the weather conditions. Experience has evolved certain rules to follow, so that the hunt is by no means a haphazard operation. The commanding officer of the cutter, with the information given by the captain of the merchant vessel and his knowledge of ocean currents, estimates how far and in what direction the derelict will drift during the time it takes the cutter to reach its position. Often, upon reaching the calculated position, the derelict is not found, as a sudden

Derelicts



Waterlogged and Dismasted, This Lumber-Loaded Schooner, Found Wandering the Seas, Was Towed to Port by Coast Guardsmen to Remove Its Menace; at Left, Preparing to Destroy a Derelict Barge

storm or shift of wind may have caused it to take another direction and then an extended search must be made.

When this is necessary, the hunt is commenced from the calculated position and by a series of zigzag or rectangular courses, the cutter covers a large area, continuing, until the wreck has been found, for as much as ten days or two weeks, maintaining position at night, during foggy weather and on days of low visibility but steaming full speed during all clear weather. Often the cutter travels on courses similar to the lines of a huge spiderweb, increasing and decreasing the distance between lines of travel, according to the clearness of the atmosphere. Men are stationed aloft in the crow's-nest with powerful telescopes. All floating objects are reported by them. Passing vessels are communicated with. The "thousand eyes" of these merchant vessels are a great help in this game of hide and seek.

The derelict may be an abandoned steamer, a lumber or a fishing schooner or some other craft. Its condition varies from one waterlogged and awash to one intact in all respects, such as the mystery ships occasionally found off the Atlantic coast. One such ship was a coal schooner adrift in the Gulf stream, all sails set but flapping and the decks all in order. The

schooner's boat was astern. The cabin and men's quarters were neat and in order, a clock was ticking on the mantel, the breakfast dishes were on the table, but nary a sign of the crew.

Derelicts have been reported by vessels which, when found by the cutters, have had people on board. An instance of this occurred some years ago in the track of the transatlantic liners, when a derelict was reported by a passing vessel. A cutter was dispatched to the locality and after a search of a week found, not a derelict, but an American fishing schooner with eighteen men on board. The vessel had encountered a series of storms, losing her masts and most of her sails. She was six weeks overdue at her home port, struggling to travel 300 miles to the nearest land with only one sail and a stump of a mast as motive power, fighting storm after storm in the dead of winter. The men and their schooner were taken home and great was the rejoicing of the fishermen's families who had given them up for lost.

The speed of the derelict is governed largely by the ocean currents, the wind also having some effect. Some have been known to travel at the rate of about two and one-half knots, while one derelict, picked up by the cutter "Seneca," had drifted 285 miles in four days. Derelicts

the parallels twenty and thirty-five north and meridians thirty and seventy west, an area seldom traversed by shipping. It is believed by some that once reaching this lonely area, the derelict gradually breaks to pieces from the buffeting it receives from the storms.

Whenever the derelict hunter comes up with his quarry, he must decide whether it is to be towed to shore and beached or destroyed where it is found. The value of the vessel and the cargo, the distance to shore, the state of the weather and the conditions of the hull all enter into consideration in deciding this. The policy of

the coast guard is to save all property, if possible, and it rarely destroys a derelict if there is the least chance of saving it. The commanding officer of the cutter

makes a thorough examination of the situation, and if he finds that the derelict is in condition to stand towing, he will take it to the nearest port.

Vessels laden with lumber or other valuable buoyant cargo will be towed to port, not only because their owners should have a chance to recover the property, but another good and sufficient reason is that it is almost impossible to de-

Preparing to Mine a Derelict; the Detonator, Top, Is Being Inserted in a 1,500-Pound Mine in the Center; Below Is the Cable and a Small Mine

which have been abandoned off our Atlantic coast generally drift along with the Gulf stream and, if not removed in time, gradually find their way into the track of the transatlantic liners, going toward Europe. A recent case is that of the "Governor G. W. Parr," which was abandoned off our northeastern coast and, when last seen, had crossed the ocean and was off the coast of Africa, having passed through the steamer lanes, sighted a number of times, picked up twice by cutters to be towed to port but lost again in the severe winter gales off the Grand Banks, only to continue merrily on its original journey. According to one theory, when a derelict reaches the eastern portion of the transatlantic lanes, it jumps off the edge of the lanes and drifts to the southward and eventually reaches the Sargasso sea, that large tract of comparatively still water in the North Atlantic ocean, so named from the floating seaweed found there. It is supposed to lie between



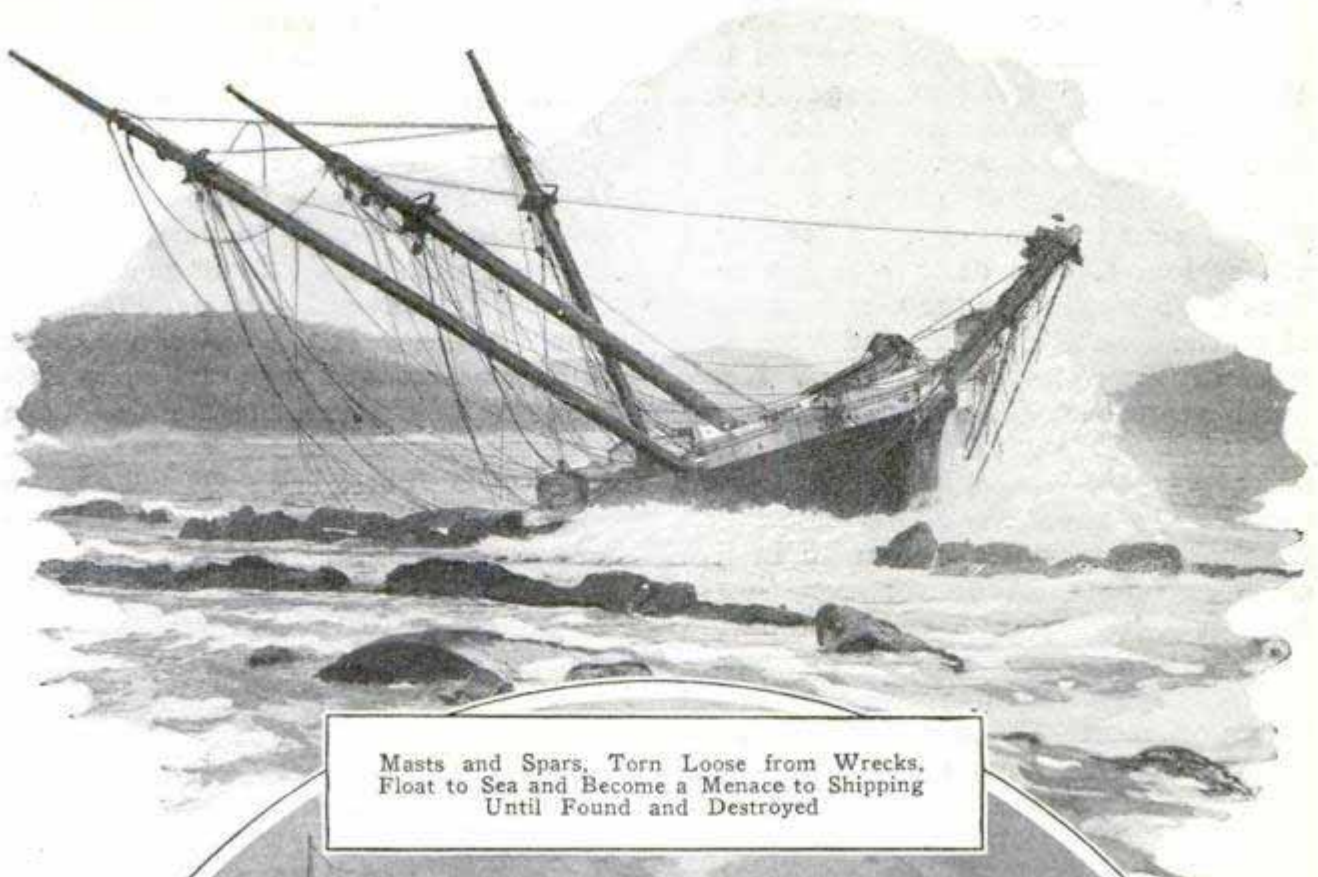

Masts and Spars, Torn Loose from Wrecks,
Float to Sea and Become a Menace to Shipping
Until Found and Destroyed

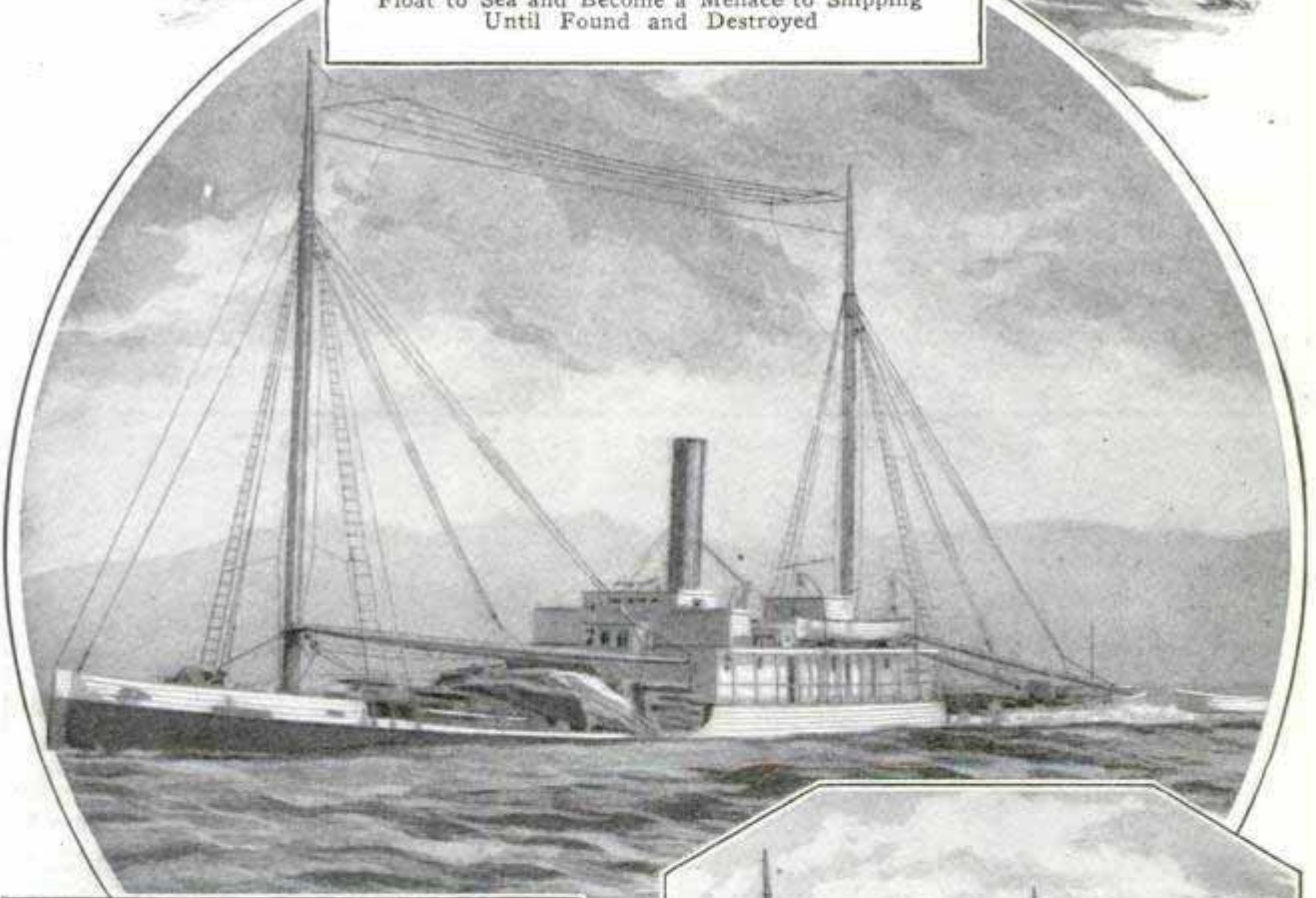

Derelict Steamer, Abandoned by Crew in
Storm, and Found Days Later by a Coast-
Guard Cutter Which Succeeded in Towing
Her to Port, Though Her Decks Were
Practically Awash; Right, Coast-Guard
Crew Preparing to Plant a Mine to Blow
Up a Sunken Barge and Remove Another
Danger to Shipping

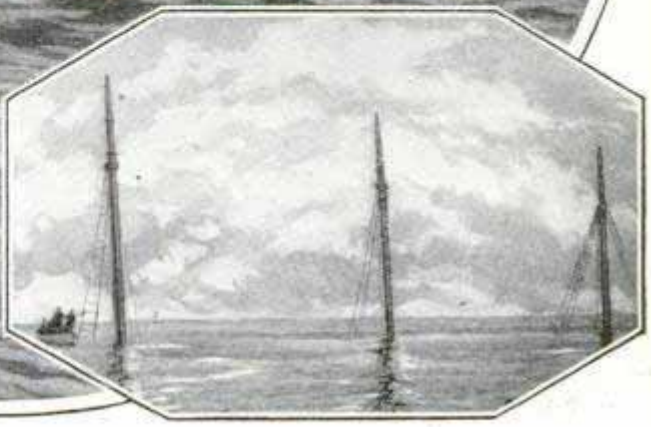

stroy a vessel loaded with lumber. When, in 1918, German submarines visited our Atlantic coast to prey upon our shipping, the submarine commanders learned what the coast guard had known years before—that any number of explosive bombs placed about the hull of a lumber vessel will seldom if ever destroy that vessel. Such craft bombed by the Germans floated on the seas as derelicts, and were subsequently towed to port by cutters. Nearly ten years before the war, a cutter off the coast of New York had exploded twenty-four mines simultaneously around such a hull without any appreciable effect, yet those same mines, blown up in like manner around the Woolworth building in New York city, would have caused untold damage to that and adjoining buildings.

Derelicts are encountered at all distances off shore. Often the tow is a long drag presenting great difficulties. Such was the experience of a cutter off the New England coast which, after a struggle of a week, towed into Boston harbor the largest derelict on record—the remains of the British steamer "Templemore," afire at sea in the track of the transatlantic liners. During the entire time of the tow the "Templemore" was on fire and many times the towline snapped and had to be fastened again to the blazing wreck. That vessel had in her hold many tons of pig

copper which melted as a result of the intense heat, but which was subsequently salvaged.

Not always does the rescuing vessel reach port safely with her prize. The strain of the tow and the seas will often weaken the derelict sufficiently to burst the hull and cause it to sink. Sometimes strong gales are encountered, such as in the case of the "Governor Parr" which broke adrift and disappeared. A few years ago a cutter on the Maine coast had the experience of having the hull of the derelict barge it was towing burst and sink. The barge was loaded with cotton wood, which, being extremely porous, swelled and burst the hull, spilling the entire cargo of logs. The hull went to the bottom in several hundred feet of water and it was only the quick work on the part of the cutter's crew in severing the ten-inch hawser that saved the vessel from serious damage.

Derelicts often turn bottom up, making them increasingly difficult to tow. Generally a hull in such a position will show one end above the surface of the water while the other end is submerged. In this position it may be expected that it will drift along in the direction of the wind and current, high end foremost. The overtaking waves break over it, giving it an impetus that seems almost incredible. Probably it is this force that so frequently

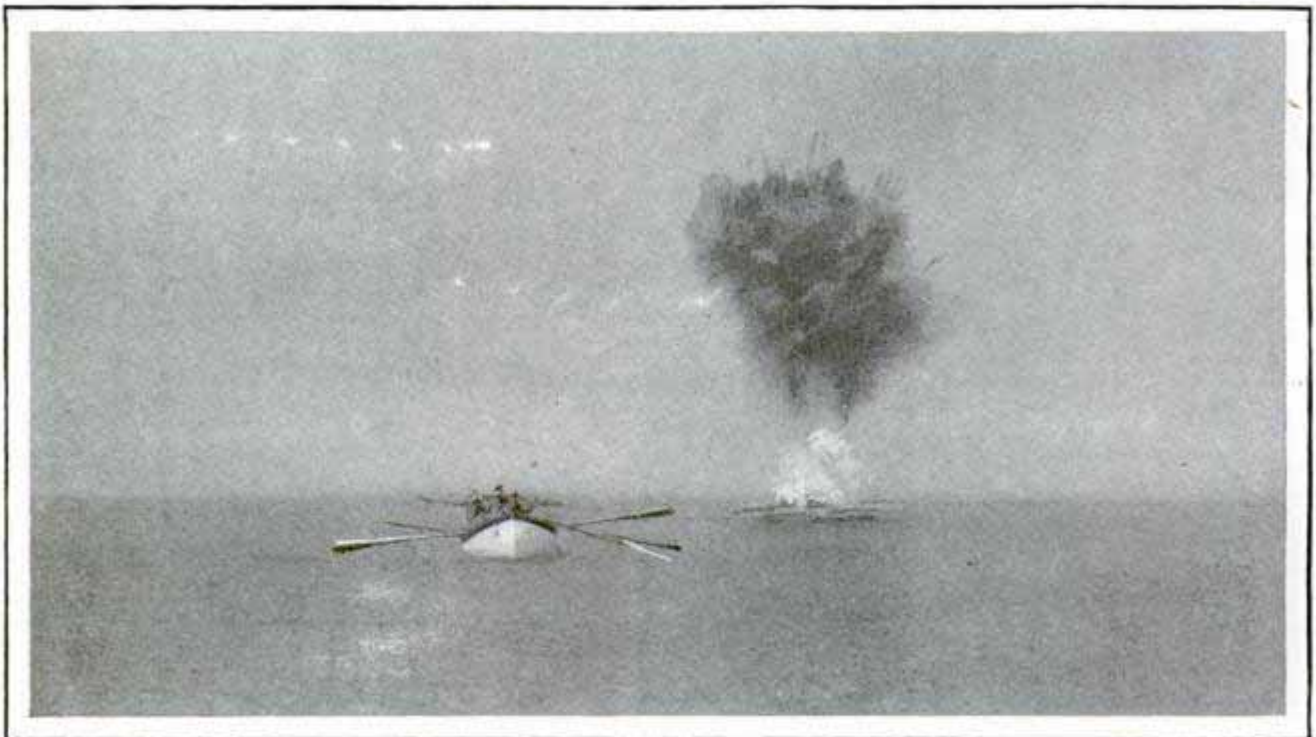

A Column of Water and Debris Leaps High in the Air as the Coast Guards Touch Off a Mine Planted in a Sunken Ship; the Work Is Attended by Constant Danger and Plenty of Thrills

*Made by W. ...
106 ...
Rochester, NY*

drives derelicts apparently counter to either the wind or current. In finding a derelict bottom up, the guardsmen climb up on the bottom and fasten a huge iron strap with an eye in one end to the keel. To this is fastened the towline. Upon nearing shore, the deepest water must be sought or the downward-pointing masts will strike against the sea bottom and block traffic until the prize can be turned right side up or the masts cut.

If it is impracticable to tow the derelict into port, the cutter will destroy it with mines. The type of explosive generally used is TNT and comes in two sizes, one a fifty-two-pound mine and the other of approximately 150 pounds. Several of these mines are placed in the cutter's boat for transportation to the derelict and planting. They are placed about the hull of the vessel, and when connected, the last mine is spliced to the mining cable, which the boat pays out from a reel as it pulls away from the wreck. When it is a safe distance away, the crew connects the ends of the cable to the firing battery in the boat, and explodes all the mines simultaneously. Not often, however, is destruction accomplished by one explosion, but it frequently happens that the operation must be repeated many times. When the destruction is completed, the cutter takes soundings of the sea bottom very carefully in the vicinity to be assured that the depth of water is ample for all ships to pass over the sunken remains.

The disposition of floating wreckage, such as rafts, trees, spars, logs of timber and parts of ships' hulls depends upon their nature and distance from the nearest available place to beach them. Ordinarily their destruction is accomplished by the use of wrecking mines, but, when possible, the spars or barks are dismantled and hoisted aboard or towed to the beach. Wreckage attached to the bottom is either hauled clear by a hawser or set loose by a mine.

In many instances cutters have disposed of derelicts by gun fire, among them the "Louisiana" which broke in two off the capes of the Delaware.



Letter sold.

Elaborate Table Top of Wood and Metal Odds and Ends; It Contains 3,000 Pieces

THREE-THOUSAND-PIECE TABLE MADE OF WOOD AND METAL

Using such odds and ends as soup bones and bits of silver and gold, an eastern craftsman has fashioned an inlaid table containing 3,000 pieces. The work required about a year to complete.

MODEL PLANE RUN BY MOTOR FLIES FIFTEEN MINUTES

Model airplanes are being constructed more and more like the real ones. This is shown in a tiny craft of English construction, fitted with a one-half-horsepower motor and capable of making flights of fifteen minutes' duration. The engine was also made by the builders of the pygmy flying machine.



Examining Model Plane Which Has One-Half Horsepower Motor

Made by apprentices at the Cromwell Aero drome

269



Where a Restaurant Is Built over a Woodland Stream; the Rivulet Runs through Center of Room; Tables on Natural Rock Floor

RUNNING BROOK IN RESTAURANT HELPS COOL INTERIOR

Diners in a California resort can enjoy a mountain atmosphere even while inside, for a brook runs through the room, creating a pleasing effect as it tumbles over a low ledge. The tables are set on the flat rocks which form the natural floor.

FIRST TEST OF WIRELESS AIDED BY RELAY OPERATOR

Volunteer radio operators, the amateurs with small sets installed chiefly for amusement, have rendered valuable aid to the larger stations on many occasions, and now it is learned that, but for the timely assistance of a relay operator, the very first attempt at sending a wireless message from a ship to shore, a quarter of a century ago, would likely have been a failure. The man who came to Marconi's aid was Jack Mitchell, now dead, operator at Siasconsett, Mass. The story is told by Henry G. Haddon, manager of the wireless office at Wood's Hole. The facts are recorded in the office diary. The test was made on the night of Aug. 16, 1901. Marconi was sending a message to President McKinley at Washington from the steamer "Lucani." Papers all over the country

were eagerly awaiting the result, but not one of them recorded the fact that, before the dispatch was completed, Marconi's sending outfit broke down. Mr. Haddon tells the story as follows: "When the break came, Jack Mitchell messaged me, 'Cut off Washington for a minute and we'll finish the message.' It looked as though the first radiogram had about forty words still to go. In a few minutes, he sent me the conclusion, signed Guglielmo Marconi. Within an hour, we were relaying the president's reply to Marconi. Meanwhile, the apparatus had been repaired and the rest of Marconi's message was coming through. Except for differences in a few words, the two conclusions were identical. The bona-fide ending stopped with me."

RUBBER OVERSOLES FOR SHOES CARRIED IN POCKET

For both men's and women's shoes, an elastic rubber sole fits snugly at front and back and is so small that a pair may easily be carried in the pocket or vanity case. A feature is the grip for the heel which keeps the rubber from slipping off.

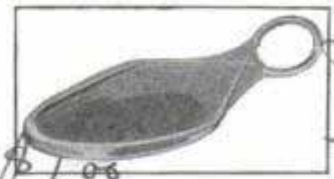

SEARCHLIGHT ON HOTEL ROOF REDUCES AUTO THEFT

Auto thefts in an eastern city have decreased fifty per cent largely due to the installation of a 43,000,000-candlepower searchlight on the roof of a hotel, officials report. Its flashing announces a theft, and police, seeing the light, go at once to the nearest patrol box where they learn the details of the crime from headquarters. The light is then directed on the section where the car was stolen.

Chicago news 8/17/26

Pennsylvania Pub Service information 8/12/26

1460 W. Madison Rd. Phila
4.34 Assoc of Chicago
John L. Es - Lyfge of Over Sole Co

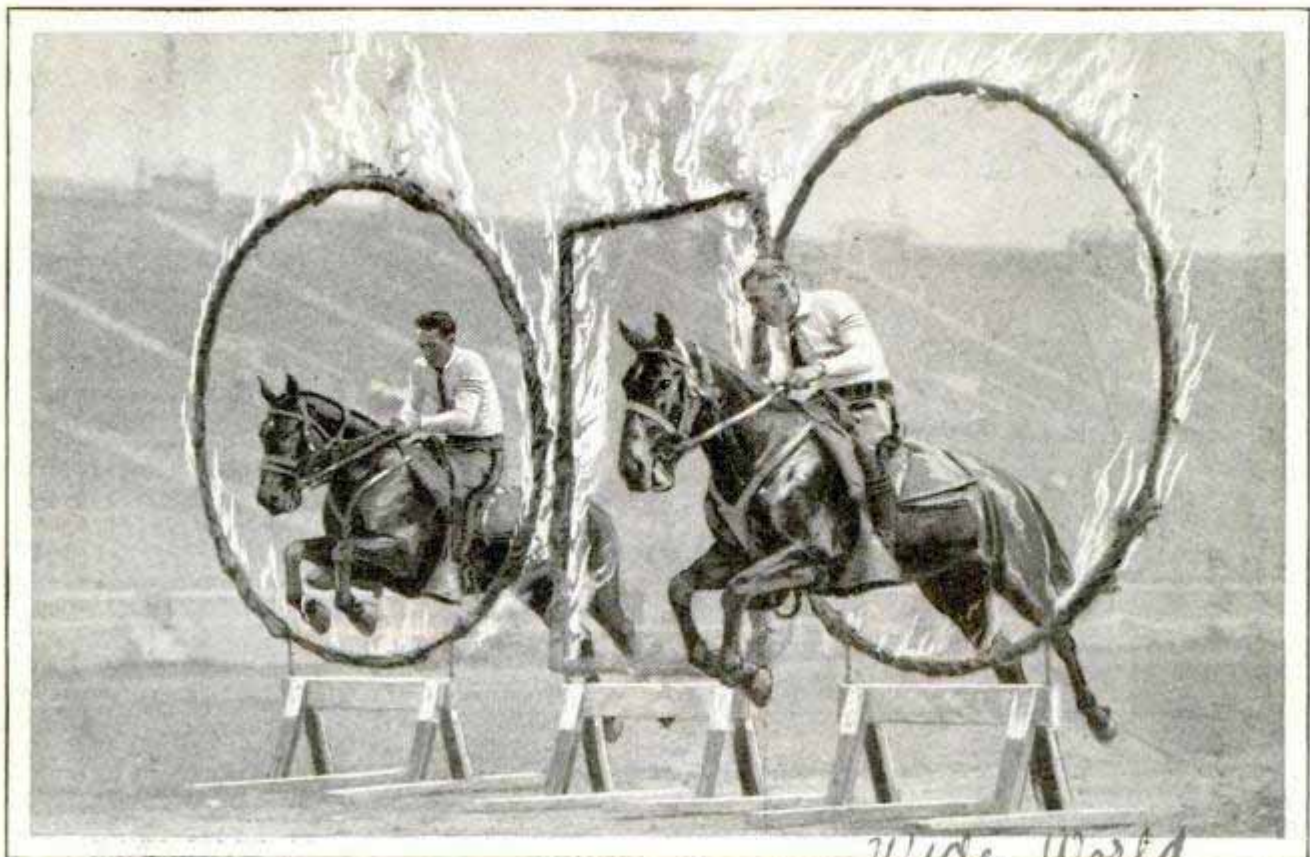

Wide World

By Careful Training, Horses Can Be Taught to Overcome Their Natural Fear of Fire to a Remarkable Degree; These Police Mounts Plunged Willingly through Blazing Hoops at Exhibition Drill

HORSES JUMP THROUGH FIRE AT RIDING MEET

Leaps through flaming hoops featured the performances of horses and riders at an exhibition police meet at the sesqui-centennial exposition. The animals displayed no fear of the fire shooting from oil-soaked wrapping around the frames which were supported on low hurdles. A rectangular piece between them, also ignited, made the effect more spectacular.

PLANE PUSHED BY PROPELLERS LESS DANGEROUS IN FALL 292

With two motors between the wings at the sides and back of the pilot and his companion, an airplane that is expected to prove less hazardous in case of falling has been designed. In the usual craft, the power plant and the propeller in front often are forced back upon the pilot in a crash, injuring or killing him. In the new style, the motors are placed to make nose-dives less likely, as the propellers push the plane. There is less noise to the passengers as well as less dirt and an unobstructed view ahead. The design also permits construction of a plane with a blunt

metal nose intended to help prevent serious damage in case of a fall. The ship is to have both land and water alighting gears, of which the former will have a brake so that the plane is expected to land or take off in twice its own length.

FLUID IN WINDSHIELD WIPER HELPS CLEAN GLASS

Fitted with a small bulb which contains a fluid that is said to keep rain and mist



from obscuring the view through the automobile windshield, a wiper now on the

market eliminates the necessity of continued movement of the squeegee arm by hand, thus helping the driver and adding to safety. Pressure on the bulb forces some of the liquid to trickle down on the glass, where it prevents rain and fog from clouding the view for several hours. So little of the fluid is needed for each application that a single filling of the container will last for weeks.

*Designed by H. E. Dunlap. Price 10/0 each
Aeronautical Engineer*

*Wesmo House, 31, Pettaford St.
Barning ham, England.*

Greatest Feat of Mexico's

By JOHN



View of Construction Line

AMONG the great railway-building enterprises this world has seen few if any are more audacious of conception, or fraught with more romance and adventure during the period of construction than the line which will open the west coast of Mexico to the commerce of the world. It will establish the first direct rail service between Mexico City and the American Pacific coast, and will put Los Angeles commercially nearer to Mexico City than it now is to Chicago.

The west coast of Mexico comprises a strip of territory approximately 1,200 miles long, where the average width across the coastal plain is about 130 miles from the beaches to the mountains. Fifteen huge rivers flow down from the mountains through valleys which, for agricultural productivity, are as rich as the famous valleys of the Nile, the Tigris and the Euphrates. This vast region, including the states of Sonora, Sinaloa and Nayarit, or an area equivalent to four American commonwealths the size of Indiana, is the richest part of the entire Mexican republic. Geographically, however, this great storehouse of untouched Mexican resources has been so isolated from the rest of the republic as to be a part of it almost in name only. Bounded by the United States on the north, by practically impassable mountain ranges on the east and south, and by an ocean with no commercially advantageous harbors on the west, that coast of Mexico has long been a sort of "no man's land" as a figure in world commerce. In spite of its enormous resources of agricultural production, minerals, fisheries, forests and power sites for

Mexican & Anglo-American
Bureau, Wilcox Bldg
2nd & Spring Sts Los Angeles
Calif. 2334

Railroading Taps Treasures

E. HOAG, 205 Union League Bldg. Los Angeles Calif.

hydroelectric development to stimulate manufacturing, the region has long lain dormant largely because it had no route of commerce to or from domestic or foreign markets.

More than two decades ago E. H. Harriman, the great American railroad builder, with the vision that characterized his monumental undertakings in the United States, discerned the commercial future of the west coast of Mexico. He visualized a western line of rails, connecting with the railroads of the United States on the Pacific coast, extending down into Mexico. Although he never lived to see his dream realized, the work was well under way, and part of the line in operation before he died. The tale is told that upon his death bed his interest in the enterprise was still so great that he had a map of the route painted upon the ceiling in order that he might study it, and direct the work.

After Mr. Harriman's death the work of completing the Southern Pacific of Mexico passed to another great American railroad builder, Mr. Epes Randolph. The years he spent attempting to carry it to completion were fraught with obstacles that would have caused a weaker spirit to give up in despair. The engineering difficulties of building the road taxed the best brains that money could hire. And, as if that were not enough to defeat the plan, then came the long years of revolution in Mexico. While Randolph was trying to build his road, one group of revolutionists after another were dynamiting bridges, burning stations, and tearing out miles of rails faster than any army of men could put them down. The work stag-

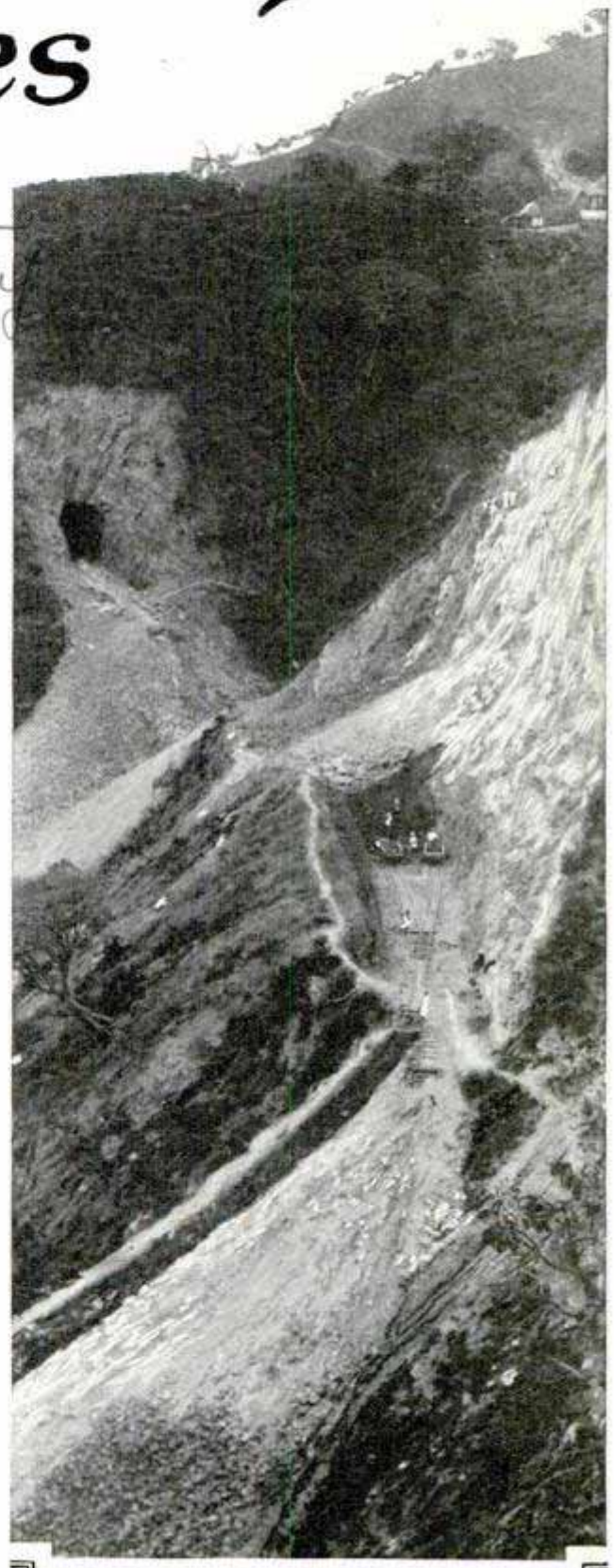

One of the Thirty-One Tunnels



Tunnel Entrance on Miravelles River Section of Southern Pacific of Mexico; Masonry Is of Permanent Construction

nated. The discouragements were such that the entire project would undoubtedly have been abandoned but for Randolph's refusal to give up.

Like Harriman, Randolph never lived to see the work completed. He is said to have died imploring his associates to carry on—and out of respect to him, and to Harriman, the road has been pushed ever since; halted only during the waning revolutionary periods of more recent years. With order and stable government established in Mexico since 1923, construction of the line has been steadily pushed ahead. Trains have been in regular service from Nogales, Ariz., over 931 miles of completed line through the states of Sonora, Sinaloa and Nayarit, to the city of Tepic, the capital of the latter Mexican state. Meanwhile a gap of 103 miles through the mountains between Tepic and La Quemada in the state of Jalisco has been the

scene of spectacular, difficult and costly road building through which trains will soon be in operation. These 103 miles through the very backbone of the Mexican continental divide will form the connecting link between the rich west coast of the republic and the central-plateau region, where most of the great cities and approximately seventy per cent of the total population of Mexico are concentrated.

The region in the states of Nayarit and Jalisco where construction work is now being pushed to completion is what the Mexicans call "barranca" country. There is no exact English equivalent for this Spanish word, but if we translate it to mean pinnacles, or land so rugged that the word mountainous falls short as a descriptive adjective, we have at least some idea of what the country is like. We may marvel at such engineering feats as the Panama canal, but down here in Mexico we find a piece of work that literally staggers the imagination. It is the task of engineering a railroad through more than a hundred miles of country where it would seem almost ridiculous

to attempt the engineering of a trail over which a herd of goats might be driven.

Engineers tell how, day after day, parties of men went out fighting their way through the barrancas on foot. Sometimes they were able to move only three or four miles. Their clothing was torn to shreds in the heavy brush, and often, after surveying many a painful mile, they would find themselves in blind canyons where the carrying through of a railroad seemed impossible. Even after the route was finally located, not a spadeful of earth could be moved until hundreds of miles of trails for the pack animals had been completed.

Obviously, railroad building through such country is an endless series of tunnels, bridges, cuts and fills.

The volcanic origin of the country further complicated the problem. Some of the lava formations through which the

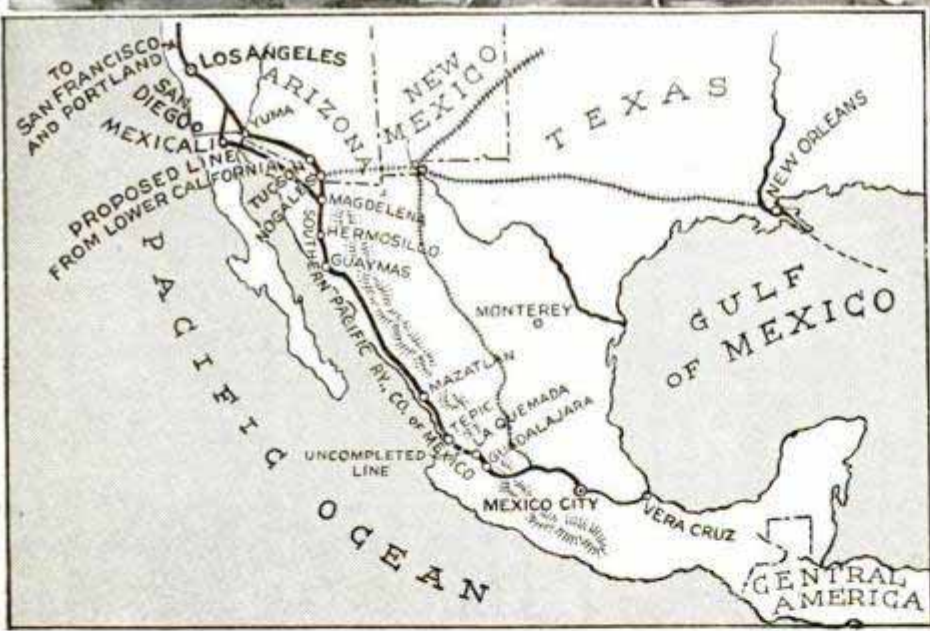

Donkey Trains Long Have Carried Freight between Central Plateau of Mexico and West Coast; Where the Railroad Crosses the Tropic of Cancer and Map of Territory Served by the Railroad; Link Complete but for Short Distance near Bottom

grade had to be run are so hard and flint-like that dynamite by the hundreds of tons was blasted before any digging could be started. In other places the lava hills and flocs are so decomposed that digging into them was like digging in an ash heap. When such lava was encountered in deep cuts, it caused endless trouble and expense because the wall slid in and filled the excavations.

The cost of building the 103-mile connecting link between Tepic and La Quemada has been terrific; about \$120,000 a

mile to be exact. More than \$12,000,000 have gone into the work thus far, and more millions will be spent before the first Pullman car makes the trip down the west coast of the Mexican republic. By January, 1927, the dream of Harriman and Randolph will have been realized under the direction of the present president of the company, H. B. Titcomb.

The expense of building the road, while great, is as nothing compared with the wealth it will produce. The population of the three west coast states—about

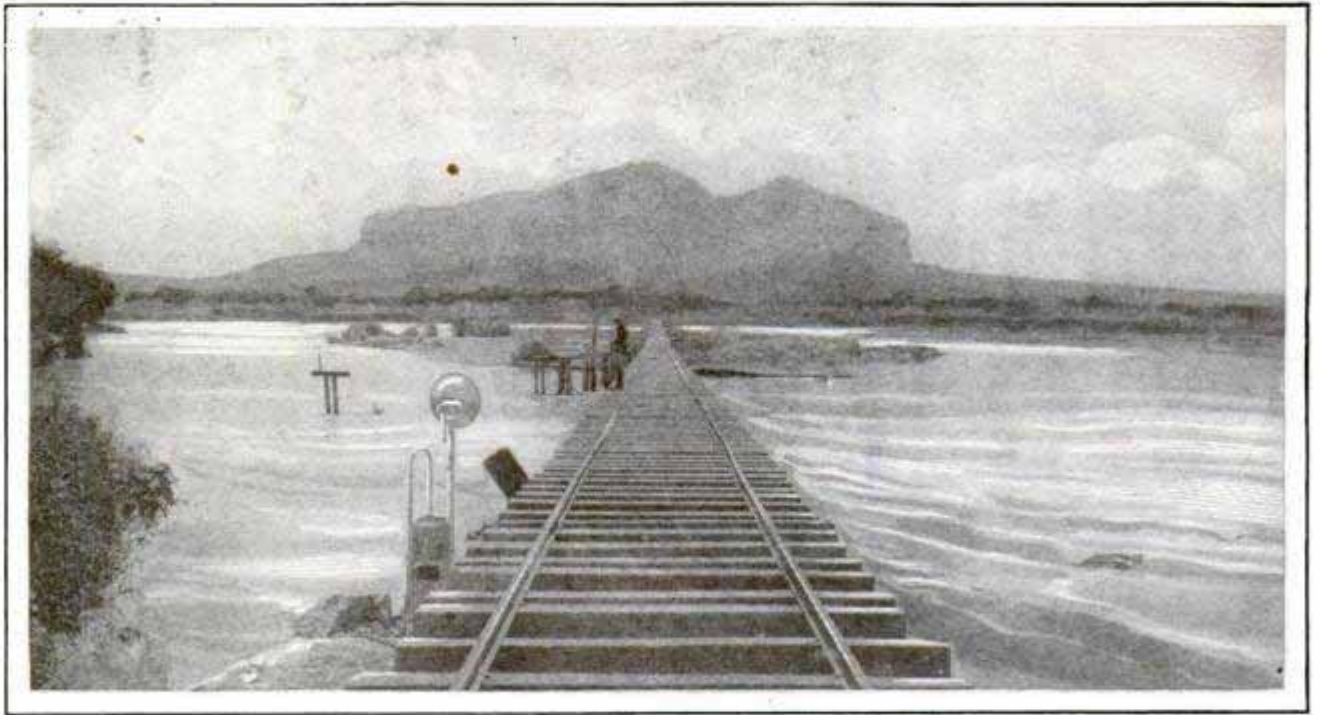

Beginning of Dam on Yaqui River, Which Is Expected to Add 850,000 Acres of Land to the Section of 150,000 Acres Now under Cultivation in the Valley

750,000—is only a fraction of those who will eventually find profitable investment or employment there. The agricultural growing season is twelve months of every year, and the soil yields abundantly of virtually every crop that can be produced in the temperate zones or the tropics.

In addition to its agricultural wealth, the west coast has mines of gold, silver and graphite, now in operation, and an almost unlimited area of mineralized country that has never been thoroughly prospected. The Gulf of California, and the coastal waters farther south, teem with more than 160 varieties of commercially marketable food fish. Oyster beds capable of supplying the demands of the entire western half of the United States also give rise to a pearl-fishing industry of importance. Forests of mahogany and tropical hardwoods require only the rail service to open them to world markets.

PLANTS POSSESS "SIXTH SENSE" SCIENTIST DECLARES

Certain species of plants have a mysterious sense that enables them to detect minute changes in the intensity of light unnoticed by the human eye, according to Sir Jagadis Bose, the well-known East India investigator. By means of delicate apparatus, he declares he has been able to determine plants' response to various

shocks administered during experiments. Many react remarkably to certain light waves far above the scale to which the human retina is sensitive, he reports. Plants sleep much the same as living persons, the scientist asserts, but the familiar closing of leaflets does not always mean slumber or insensibility but may be a restful attitude assumed when the blossom has had sufficient sunshine and rain. The mimosa, for instance, awakens gradually between eight or nine o'clock and noon, remains alert until evening and does not fall fully asleep until toward the early hours of morning.

2127 ERASER IN SPRING REEL SAVES TIME AND LOSS

Pat. pending.

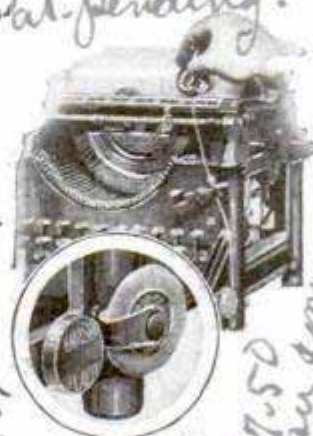

7-50
Pat. pending.
automatically rewound in the reel when the eraser is released.

Attached to a stout cord, sixteen inches long, which is wound on a spring reel, the typewriter eraser is kept readily accessible at all times and the stenographer is spared the time of putting it back into its place. The cord is

Phillips's Ribbon
& Carbon Co. Chicago, Ill.

W. Chicago, agent

Kansas City Star
July 23.
1950

WAR GASES TESTED IN SOAP BUBBLES

249
Soap bubbles are blown for serious purposes at the bureau of standards where investigators are studying the action of various poison gases used in warfare. The bubble container has been found more satisfactory than steel jackets, for its transparency permits taking photographs which show how the flame spreads during explosions, pressure, and some of the reactions of the gas. In another department of the bureau, where fire-proof tests are conducted, the interior of a one story building is destroyed almost daily in experiments with various protective materials. One of the articles examined recently was an asbestos theater curtain with an air space between two layers of the material. It was said to have shown no unusual degree of heat on the far side even after the other side had long been exposed to fire.

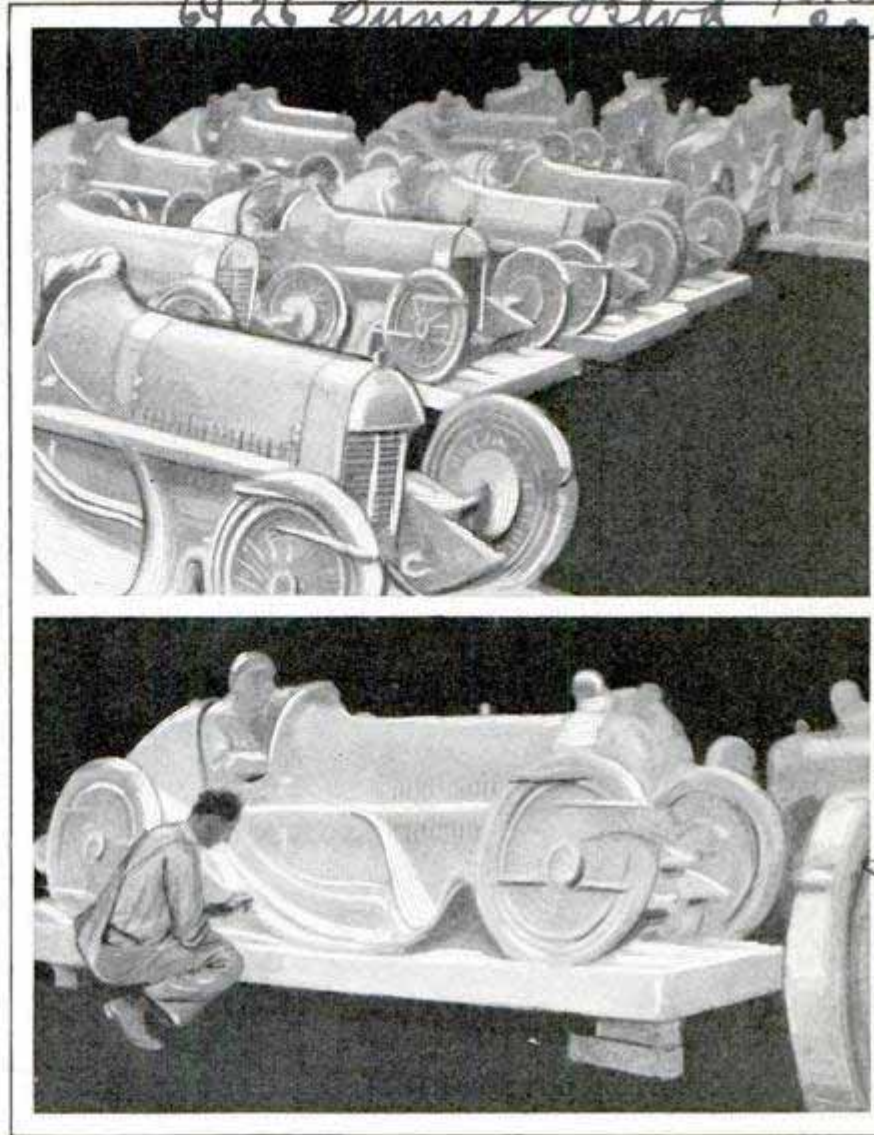

A Novelty in Outdoor Advertising; Plaster Models of Cars at Running Speed, to Suggest the Benefit of a Special Gasoline

PLASTER RACING-CAR MODELS HELP ADVERTISE GAS

Motorists in California are attracted by realistic models of a racing car set on pedestals at vantage points along the highways. The plaster replicas represent an auto in rapid passage down the track, the idea of speed suggested thereby being linked to the name of a special kind of automobile fuel.

JEWELRY MADE OF RUBBER 221

Jewelry of a rubber composition, designed especially for wear at the beaches, has become popular on the boulevards of Paris. Bracelets of many colors, imitation pearls and anklets as well as button-hole bouquets of the material are in high favor. Large ear rings were also conspicuous features there last summer.

JACK HELPS LAY WOOD FLOORS WITHOUT BRUISING BOARDS

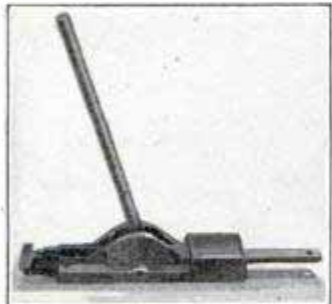

92.
While building a mountain cabin, a western woman encountered difficulty in laying the flooring without bruising the edges of the boards. She experimented with several methods

and then adapted the principle of an old-style carpet stretcher to a jack to force the flooring together. It crowds the boards into place by the operation of a lever, and is easy to handle and set up. The device is now on the market.

Edw. Mrs. Marie L. Wilson, 3519 W. Norfolk St.

Chicago Eve Post
8/2/26

Emb. L. M. Curtis, 1208. A. Cabrillo Canal, Venice, Calif

1937

Dealer

Toledo Ohio

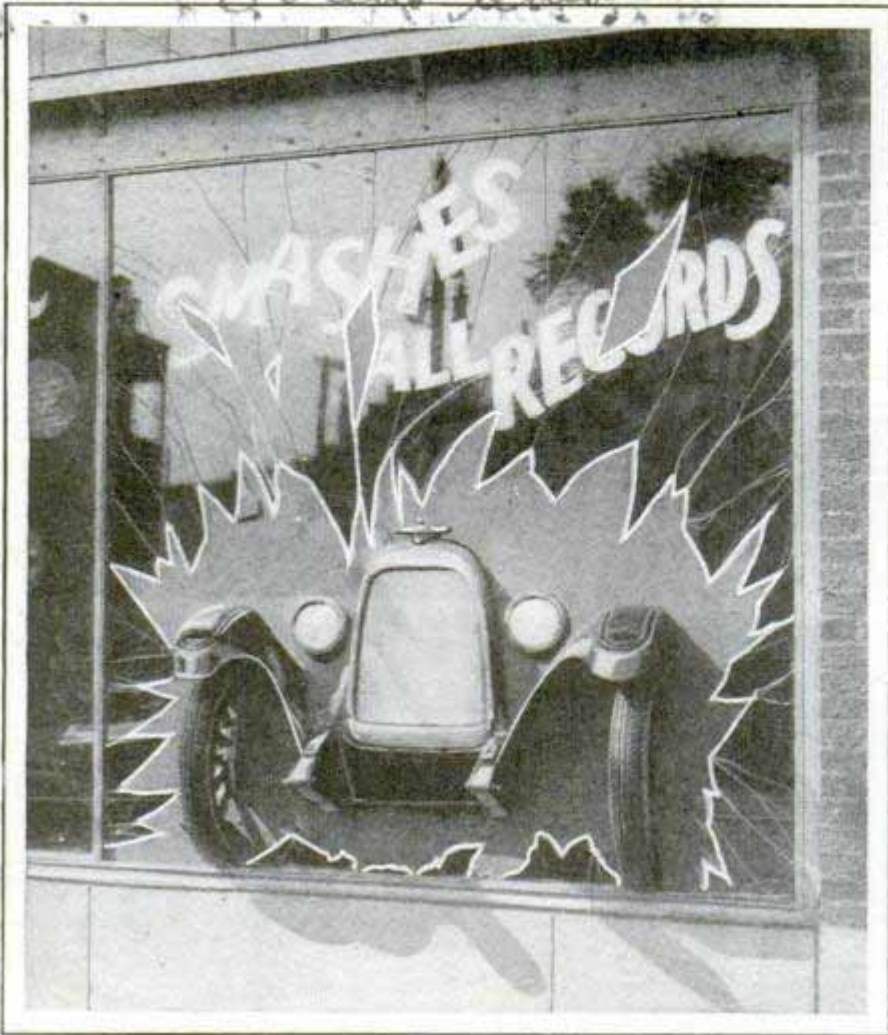

Striking Window Display Made by Attaching Front of Auto to Glass with Sealing Wax and Painting Streaks to Represent Cracks

CLEVER IMITATION AUTO CRASH PROVES EFFECTIVE DISPLAY

Paint, sealing wax and an automobile cut in two and fixed to the pane of a large show window, were skillfully used to advertise a new car model. The result gave the impression that the auto had plunged through the glass and stopped halfway, leaving the front exposed. Cracks in the pane were represented by paint, the wax sealed the bisected car to the window and the illusion was heightened by bits of glass and a barrier on the sidewalk.

FLOODLIGHT BANKS AND JAILS FOR BETTER PROTECTION

Electricity is being further adapted to the uses of man as a protector of valuables and as a means of greater security from criminals. Floodlights on jails and banks are affording this aid, according to reports from the Pennsylvania public-service in-

formation committee. Following the escape of a prisoner from a county jail in New Jersey, local officials authorized the installation of twelve 500-watt floodlighting projectors about the building. They were so brilliant and the illumination so well distributed that a spool of thread could be seen at a considerable distance if dropped from any part of the building. The sheriff considered the lights equivalent to an efficient increase in the ranks of the watchmen, as the glow made it almost impossible for anyone to escape from the jail without immediate detection. Floodlights on banks have been used for some time with equally good results, it is reported. One advantage is that the lamps are usually isolated from the bank so that persons in-

tent on robbing have difficulty in cutting them off. Furthermore, the radiance shining in from the outside lights up the interior so that it is clearly visible to watchmen or the police outside.

CAPPER FOR GLASS BOTTLES PROTECTS THE HAND



Caps are quickly and firmly placed on bottles by hand with the aid of hammer and special stamp, shaped to fit the top of the container and press the cap in place. Should the glass break during the operation,

the hand is protected by a shield of metal at the bottom on the capper.

1936

Vaughan Novelty Co. Chicago
3209 Carroll Ave.

1410 Widener Bldg
P.I.

Vaughan Novelty Co.
3209 Carroll Ave.

RADIO EYE ENABLES YOU TO SEE STARS IN STUDIO

J. L. Baird, Television Inventor, at the Transmitting Set, with Two Doll Heads, and, Lower Right, the Receiving Screen; at the Right Is a Diagram Showing How the Revolving Lenses Each Sweep across a Narrow Path of the Picture or Scene to Be Transmitted; Note the Arrangement of the Two Sets of Lenses.

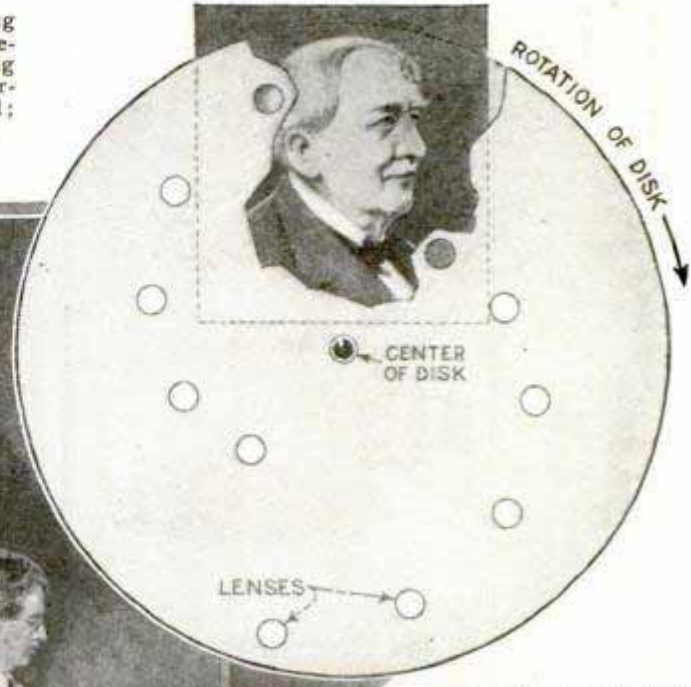
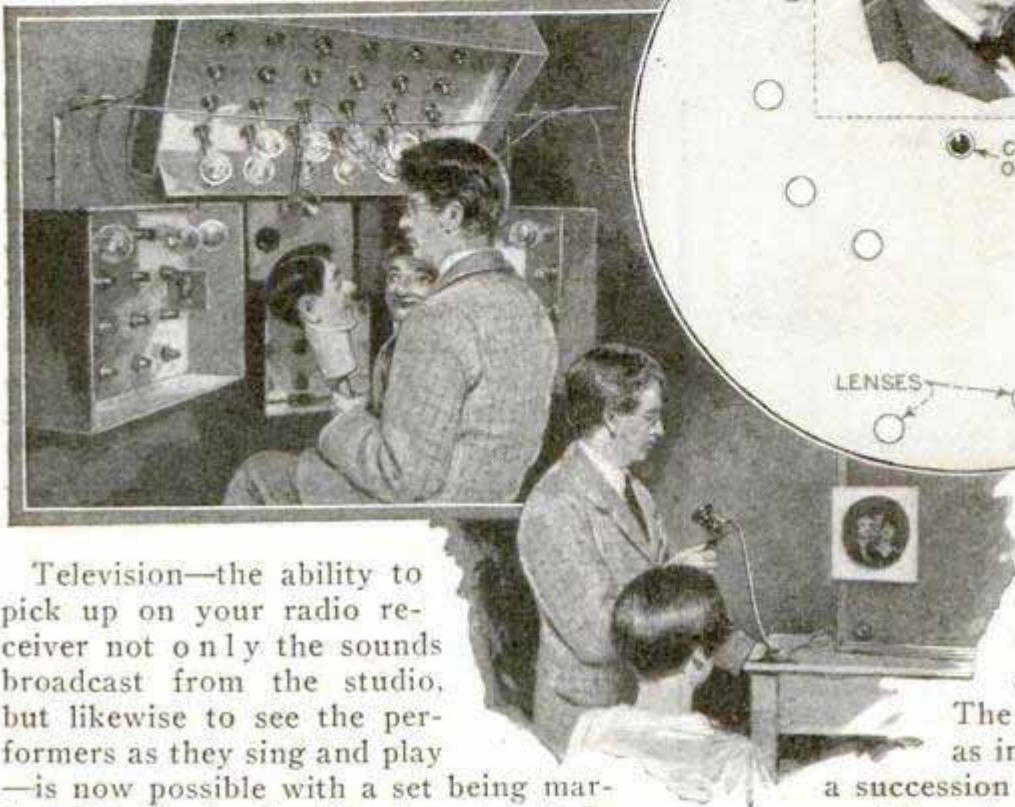

Television—the ability to pick up on your radio receiver not only the sounds broadcast from the studio, but likewise to see the performers as they sing and play—is now possible with a set being marketed in England. The inventor, J. L. Baird, has established the world's first television studio in London, with a range of fifty miles, and within that area is selling radio sets that both see and hear. His system is very much like that employed in this country by C. Francis Jenkins, Washington, D. C., inventor who demonstrated radio movies and television in his laboratory eighteen months ago. Baird, who was experimenting with telephoned vision before radio broadcasting was thought of, reached his goal at about the same time Jenkins was producing similar results in this country. He uses a revolving disk containing sixteen lenses, staggered in groups of eight. At the transmitting station, the subject takes his place before the disk and, as it revolves, each successive lens transmits an image of a small portion of his person to a photoelectric cell. Because of the staggered arrangement of the lenses, each one takes a small sweep, but they revolve so fast that, at the receiving end, where a similar lens arrangement is employed, the eye is

unable to detect the intervals between the spots of light, and sees the whole thing as a living picture.

The effect is the same as in the movies, where a succession of pictures pass so rapidly as to give the illusion of life and motion. By combining an ordinary broadcasting outfit of microphone and transmitter, with the television apparatus, and employing the regular radio receiver in the home, along with the television, which has a small screen on which the pictures are seen, Baird furnishes both music or speech and actual sight of the performers. For the present, the pictures appear in black and white, like ordinary movies, but as soon as funds are available for further experiments, the inventor hopes to solve the problem of colors.

While Baird was installing his first receiving sets in England Jenkins was carrying his work in this country a step forward by successfully broadcasting complete daily weather maps. He believes the time is near when ships at sea will be equipped to receive weather maps giving far more information than can be transmitted in the code messages. By the map method the ship officers could see the location of every storm area and follow its course day by day around the world.

Admiral Cracker.
8/2/26 P. 390

198



Bringing Up a Load of Rats, and Expert Catching One with Bare Hands in Paris Sewer

CATCHING LIVE RATS BY HAND AIDS FIGHT ON DISEASE

m. Hayre

With a box over his shoulder and no aid save his bare hands, a rat catcher in Paris clammers into sewers and other unpleasant places in search of the rodents. He seizes the animals alive, pushes them through the funnel-shaped opening in his box, where they are held prisoners, and kills them later. Rigorous campaigns against rats are being prosecuted in nearly every large center in order to prevent the spread of contagious diseases and to reduce losses of food and other produce. In spite of all attempts to exterminate them, their numbers do not seem to decrease greatly, and some estimators declare that, in most localities, there are more rats than human beings.

370

FAST INTERURBAN LINE TOPS FIFTY-MILE SCHEDULE

The honors for the fastest regular electric-railway schedule in America, which have been held by the Galveston-Houston electric company for the 50.41-mile trip between the two cities, changed hands recently when the North Shore line at Chicago established a new high-speed service to Milwaukee. Traveling the 88.24 miles in two hours flat, trains on the new schedule maintain an average speed, including time lost in nine stops, of 44.12 miles an hour, while their actual running speed, exclusive of stops, is 51.9 miles an hour. Both records are about four miles an hour better than the marks of the Texas company. No allowance is made by the donors of the speed trophy for cars which are forced to run part of their route on city streets, through traffic. Few electric companies have their own city right of way, and are consequently slowed up by other traffic. The North Shore line, using the elevated structure within Chicago and a new cut-off north of the city to miss the densely settled north-shore towns between Chicago and Waukegan, has unusual opportunities for great speed. One car line runs at a rate of 38.5 miles an hour between Kansas City and St. Joseph, Mo., but the city tracks bring the average down to 31 miles.

BLACK-AND-WHITE TOWING CAR FOR DAY-NIGHT SERVICE

228

To emphasize the fact that twenty-four-hour service is available, the towing and

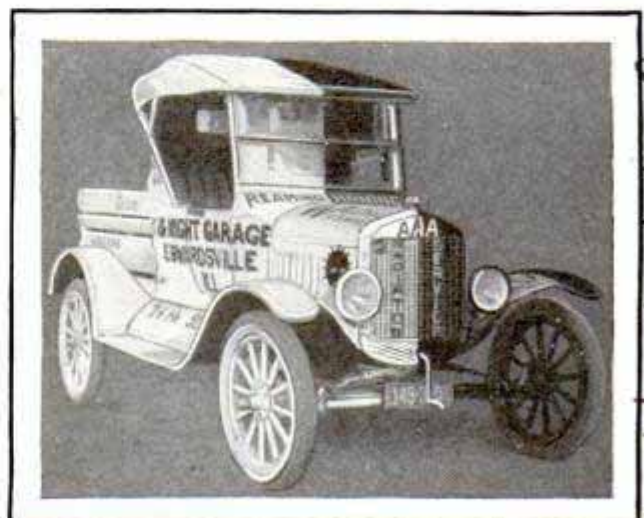

"Clown" Auto Advertising Day-and-Night Service

at Edwardsville
d. h.

*Ant. H. ...
Edwardsville, Ill.
Croker Place
Edwardsville, Ill.*

trouble cars of an Illinois garage are painted black on one side and white on the other. The idea is further developed by sun, moon and star decorations and a number of signs, stating what tasks the shop performs and what articles may be purchased.

CAR WHEELS OF PAPER 199

Paper used in the manufacture of railway-car wheels is known as calendered rye-straw board. It is sent to the shops in circular sheets and over each of these sheets is spread a coating of flour paste. A dozen sheets are placed one on the other and the lot subjected to pressure of 500 tons or more. After two hours' pressure these sheets, which have now become a solid block, are kept for a week in a drying room after which a number of blocks are pasted together, pressed, and dried for a second week. A third combination of layers is then made, after which there is an entire month of drying. To complete the wheel, there are required a steel tire, a cast-iron hub and a wrought-iron plate. Paper which has received the treatment described may be used for almost any purpose for which metal or wood is used if not too much exposed to dampness.

YOUNG SEALS GIVEN HAIRCUTS TO KEEP COUNT OF HERDS 115

Haircuts for seals is the latest fashion note from the Pribilof islands. According to Capt. A. A. Anderson, of the bureau of fisheries, 10,000 one-year-old male seals are to be sheared this year so that the census takers can more readily estimate the increase next year. The plan is adopted because only a certain percentage may be killed each season.



When Fireworks in Airplane Exploded Prematurely; Long White Streak Made by Falling Star Shell; Parachute Seen at Right

AIRPLANE FALLING IN FLAMES REGISTERS WEIRD PICTURE

An airplane set ablaze by a premature explosion of fireworks, its fall from a height of 5,000 feet and the parachute leap of one of the two occupants, were registered by camera film during a lucky time exposure. The photographer had planned to "shoot" the display and had just opened the shutter when the accident occurred. The burning plane made a streak of light, punctuated by successive bursts of fireworks. A brilliant blue-white star shell was recorded as a long white trail and one of the aviators was seen as a small speck just below the flaming machine. He appeared again lower down on the picture after his parachute had opened. Although both flyers landed safely, one died two days later from burns.

Whales have been known to fight for two days after being harpooned.

Emb. Edwin Jarvis, The Washington, D.C. Harrowed!

128



Symbol Adopted by Los Angeles Rotary Club in Campaign for International Friendliness

FLAGS OF THIRTY-FIVE NATIONS IN WORLD-PEACE SYMBOL

Emblematic of the world-wide spread of Rotary clubs, a symbol adopted by the Los Angeles organization in its campaign for international good will, bears thirty-five flags. There is a banner for each of the lands to which the club's movement has been carried.

DANGER IN STINGS OF INSECTS AND HOW TO TREAT BITES

Noxious insects indirectly take their toll of human life every year, and while those that sting may inflict more pain, those that bite may be a greater menace, since they are likely to carry harmful bacteria. The sting is a weapon and although its poison may be "clean," that is, free from germs, in certain species of wasps and bees there are two distinct poison sacs, containing entirely different substances which mix only as they are injected and react to pro-

duce an effect closely akin to that of the toxins of bacteria. Changes in the blood and disturbance of surrounding tissues result, temporarily throwing out of action the defensive mechanism of the injured part and leaving it at the mercy of a germ invasion. Scratching is a common source of infection. The temptation to do so may be lessened by applying ammonia or bicarbonate of soda. The biting equipment of various insects is often covered with germs from stagnant pools, garbage and filth. Because mosquito bites are more common than wasp stings, the danger of infection is proportionately increased. Common toilet soap, moistened and smeared on the bite will usually relieve the itching. Glycerin is even more effective. The house fly does not sting or bite, but carries germs that may lodge in scratches.

2212

MOTOR SAW FITS ANY BENCH AND TAKES SMALL SPACE

Weighing but fifty pounds and occupying less than one and one-half cubic feet of space below the workbench or table, a motor-driven circular saw, operated from a lighting socket, saves time and is exceptionally useful to the amateur. It is quickly bolted into position for running, the only steps necessary being to bore three holes and cut a narrow slot for the saw.



Lake Linden, Mich.

Michigan Electric Mfg Co.

SKYLIGHTS IN AUTOMOBILE TOP PERMIT BETTER VIEW

Windows of unbreakable glass have been installed in the top of a closed car of English manufacture, to give tourists a less obstructed view of the scenery. Shades are provided on the inside so that light and heat from the sun may be excluded if desired.

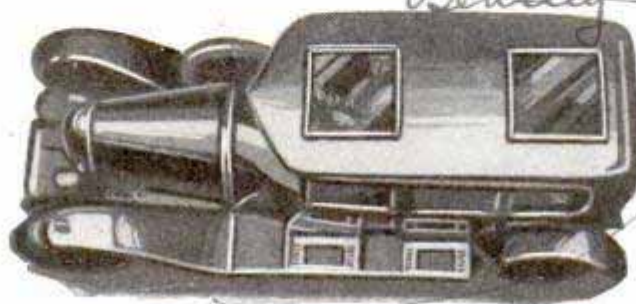

Auto Top with Skylights for Upward View

255

Kansas City, Mo. 8/18/26

Unbreakable Triples - Triples Safety Glass Co., N.Y.

240 Hollywood Beach Fla.
Hollywood by the Sea
Or Florida

PAINTS AND STAINS BEAUTIFY ROUGH CONCRETE

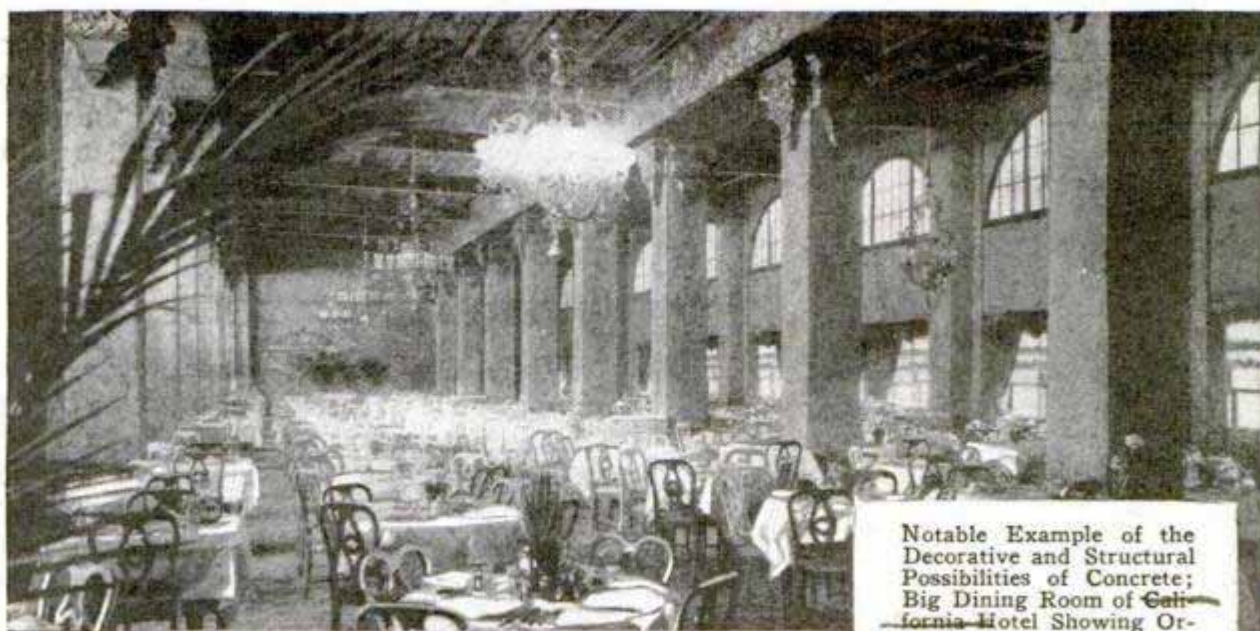

Notable Example of the Decorative and Structural Possibilities of Concrete; Big Dining Room of California Hotel Showing Ornate Cement Rafters; View of Exterior and the Lounge with Its Elaborately Ornamented Concrete Trimmings; Patterns from Molds Are Handsomely Colored

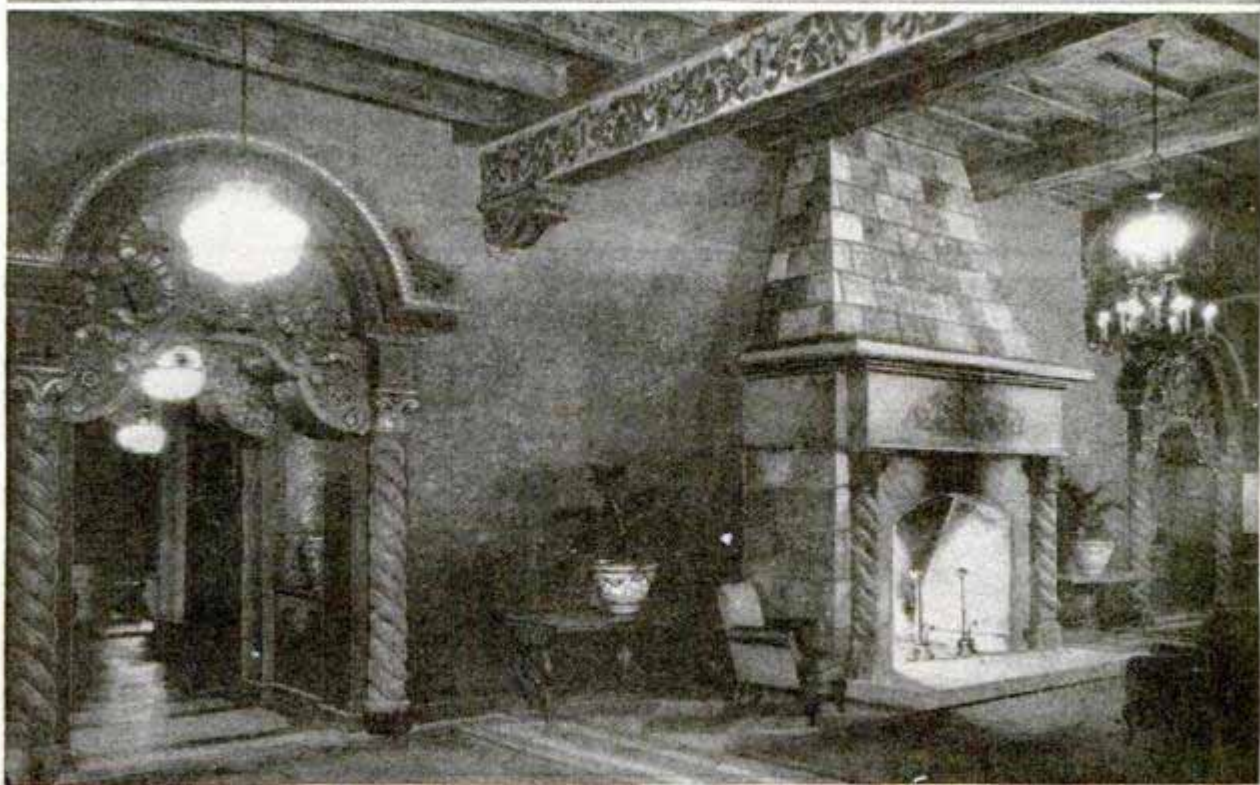
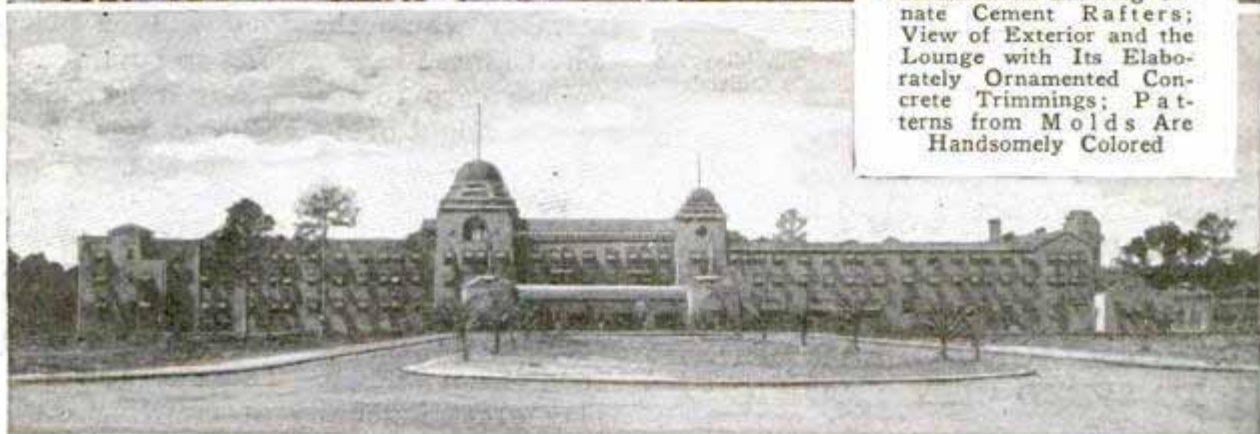

Decorator Adelphi Vollmer New York

782

3611 Prospect Av.
POPULAR MECHANICS

LEVERS ON AUTO PEDALS HELP CRIPPLE DRIVE CAR

By means of hand levers attached to the pedals of his automobile, a cripple de-

*Letter reled
5/29/27*

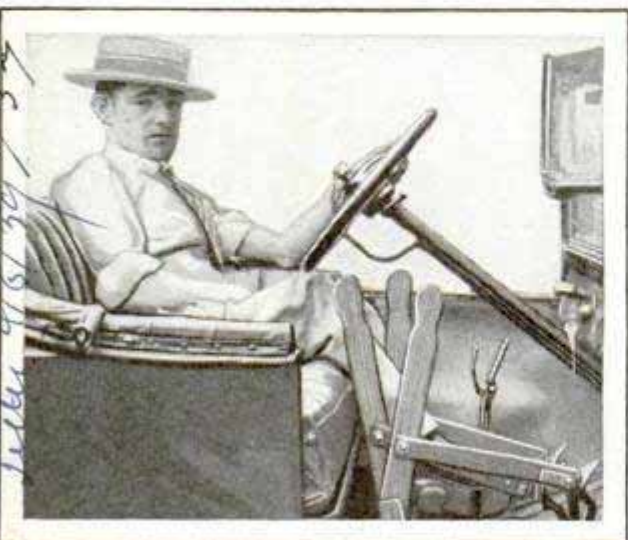

Levers with Which Cripple Operates Automobile; He Proved His Skill before a Jury of Traffic Officials

*Steve Charles
Horace Hoates
P.O. Mary Edmond
5/29/27*

prived of the use of his legs, is able to drive with little difficulty. In applying for an operator's license, he demonstrated to traffic officials the efficiency of his equipment.

SEVEN-MILLION-DOLLAR BRIDGE TO SPEED CITY TRAFFIC

1919 Guests at a Rotary club dinner in New York recently caught a vision of the huge bridge that is to be erected between Howlandhook, Staten island, and Elizabeth, N. J., when a model of the structure was unveiled. The gigantic link, it is expected,

will be finished during 1928. It is to cost approximately \$7,000,000, will be 8,500 feet long, sixty feet wide and will carry six lanes of traffic, two for pedestrians and four for vehicles. Some 35,000 autos and other vehicles can be handled hourly, it is estimated. Another large bridge is under way from Tottenville, Staten island, to Perth Amboy, New Jersey.

297 EELS ANSWER DINNER BELL

While fish generally are regarded as among the least intelligent of living things, studies conducted by Prof. H. M. Kyle, an English naturalist, show that they display evidences of emotion and mentality usually associated with higher forms of life. Many species in captivity are punctual at feeding times and appear to remember where the food will be placed. The Chinese have a gong to summon the golden carp to meals, but it is believed that the sight of the keeper causes the fish to gather rather than the bell, for they have no aural apparatus to differentiate between tones. Eels likewise assemble at the proper feeding time, but whether they respond to the sound of the signal, the sight of the attendant or the odor of the food is not known. These creatures display great ingenuity at crawling out of tanks. One in the London zoological gardens, unable to climb up head first, had turned around, thrown its tail over a ledge and managed to escape. Another showed a decided preference for a particular tank other than that in which it had

M. A. H. D. C.

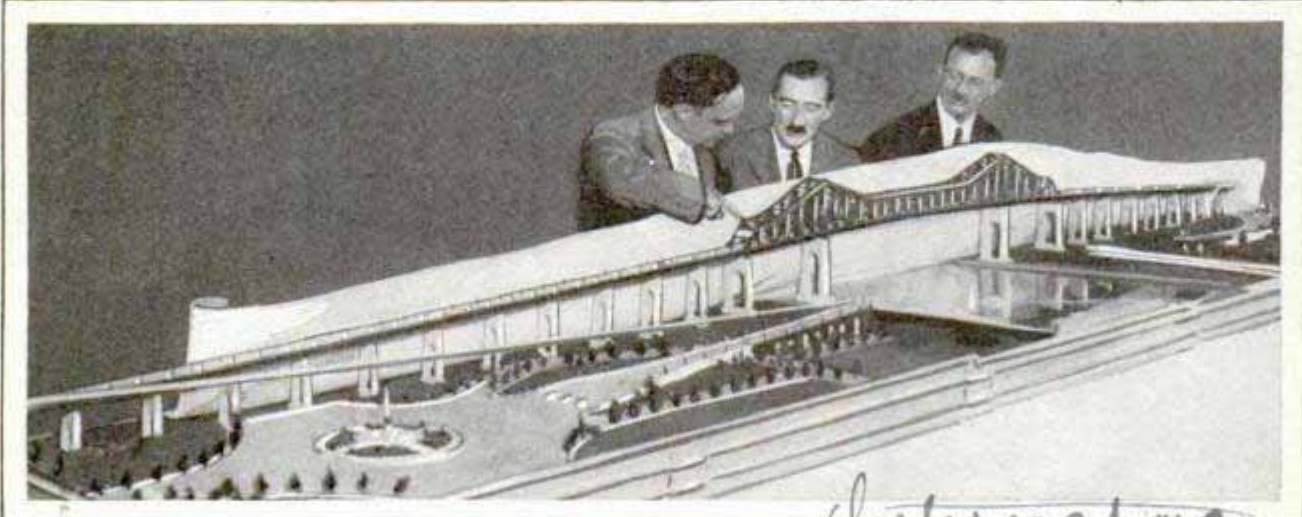

Model of the Bridge to Be Built between Staten Island and Elizabeth, N. J.; Four Traffic Lanes Will Be Devoted to Vehicles and Two to Pedestrians; Over All, the Bridge Will Be 8,500 Feet Long

Internationa

200 West End Ave New York

96

been first placed and on two occasions traveled to that particular place, ignoring another tank on the way. Fishes often exhibit envy especially over choice morsels of food, Prof. Kyle declares.

COLOR OF DIAMONDS ALTERED BY EXPOSURE TO RADIUM 300

Yellow diamonds, comparatively cheap and plentiful, can be changed into valuable blue-white stones through exposure to radium, a New York investigator has discovered, according to reports. His tests have been conducted for four years and in that time, none of the altered gems has reverted to its original hue, but there is no way of telling definitely whether the change will be permanent. About \$8,000 worth of the substance was required to change one diamond in four days. The scientist admits that the process is yet too costly to be commercially practical and is somewhat dangerous to the workers.

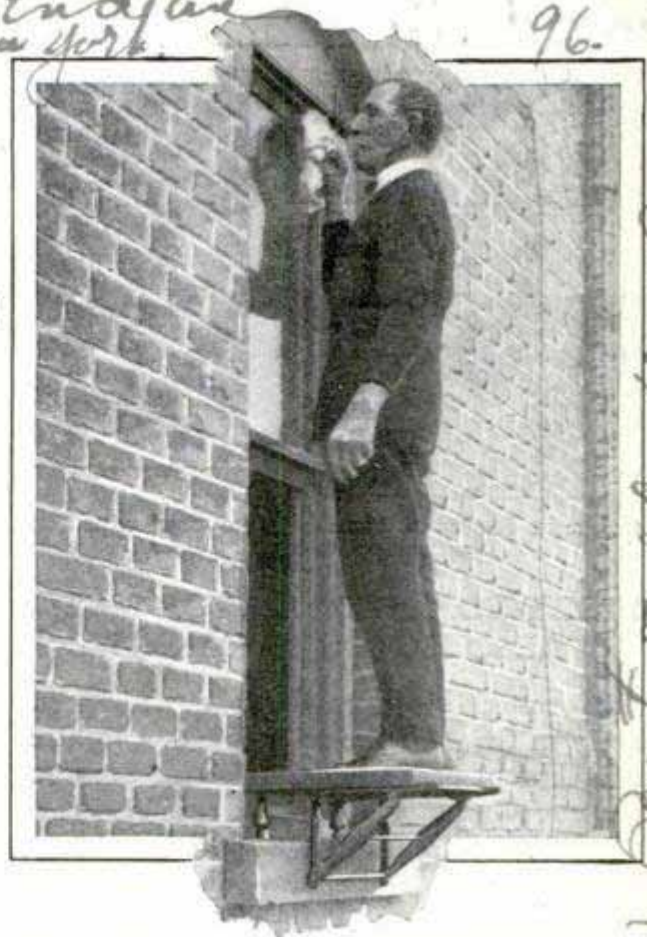

Window-Sill Platform for Safe and Easy Washing Outside of Panes; Can Be Used with a Belt

GUNS AND RADIO IN PEACE TIME PROTECT SHIPS IN FOGS 296

Wireless and artillery, the "war twins," have been adapted to a useful peace-time duty for the protection of those who go down to the sea in ships. A steady bombardment off the coast of Scotland, tells how successfully this has been brought about by remote radio control and ignition of an explosive mixture of acetylene and air. The firing is part of a fog-warning system installed on a sand bank at the entrance of the river Clyde. When the mists roll in, menacing shipping, impulses are sent from a radio transmitting station, a mile and a quarter from the guns. The sending set is synchronized with the receivers to prevent interference. The radio waves strike a valve on the receiver, open it and release and explode a mixture of gas and air.



Calculator Propped Up on Vacuum-Tipped Legs

SCAFFOLD FOR WINDOW SILLS PREVENTS ACCIDENTS

Washing the outside of windows is simplified and made safer with an adjustable scaffold that rests on the sill. It may be adapted to various thicknesses and constructions of walls, is strong and rigid, and is said to be capable of carrying 1,000 pounds with safety.

252

VACUUM FEET FOR CALCULATOR

Adjustable to different heights, a two-legged stand slipped under the adding machine raises it to an angle where the operator may more easily strike the keys. There are vacuum cups on the ends of the supports so that they will not be likely to slip and scratch polished surfaces.

H. Brimeley, 1001 Ames Ave St Paul, Minn

Christian Science

Monitor 8/12/22

Nelson & Duin Co,

Toledo Ohio

21 Wilbur Ave

Electro-schalt-Werk

784 Long Island N.Y.

Isottingen, Germany

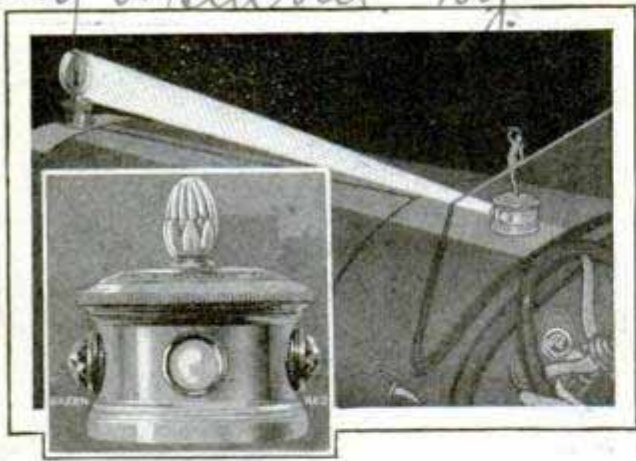

Ornament Holder in Place on Auto Cowl with Light Illuminating the Motor Meter

LIGHT FOR AUTO MOTOR METER ALSO HOLDS ORNAMENT

Mounted on the cowl of the car immediately in front of the windshield, a lighting attachment projects a brilliant beam upon the motor meter so that it can be clearly read at night, and also supports an ornament if desired. Besides the bright front glow, there are red and green jewels at the side which will provide the usual courtesy lights.

Ducfold - \$5.00

STRAP CLASP ON WRIST WATCH PREVENTS DROPPING

Loose strap ends are eliminated and the danger of dropping the watch reduced in a wrist clasp which is easily adjusted by means of a spring pin bar fitting in holes at the side of a metal hinge. This is curved so that it lies flat on the wrist and is practically concealed when the strap is in place.



POCKET-SIZE BALLOON WEIGHS NINETY-NINE POUNDS

So compact that it can be fitted into a soldier's haversack when folded up, a small balloon weighing but ninety-nine pounds fully equipped, has been introduced for short, thrilling rides and jumps. A horizontal propeller is mounted above

the carrier for the pilot and may be turned and maneuvered by pulling on ropes. Inflated with gas, the bag is twenty-one feet in diameter and can be sent over trees and buildings while making a landing. A height of 840 feet has been attained, and the balloon has remained in the air two and one-half hours, according to reports of tests made by the inventor.

ELECTRIC HEATER FOR ROOMS ALSO WARMS WATER

Added to the familiar type of reflecting electric heater, an attachment has been devised by a German inventor for warming water. It is provided with connections that may be joined to the house mains if desired, or the water heater may quickly be removed and the reflector used alone. The arrangement is said to be especially suitable to heating small quantities of water for shaving and other uses.



MINES SUNK FOR OIL TO SERVE AS STORAGE TANKS

Digging mines into oil-bearing rocks instead of drilling holes has been proposed as a more efficient method for recovering the liquid mineral. The plan, as described by an eastern engineer, is to cut tunnels, not into the oil rock itself, but into the strata above or below it, the latter if possible. From these shafts, small holes would be bored into the layers containing the oil, pipes inserted in them and the product pumped to the surface. It has been suggested that these underground shafts would serve as storage basins for the oil, from which it could be collected at any time desired. Under the present boring system, it is said that only about one-fifth of the oil flows or is pumped to the surface, the rest being trapped in cavities of the porous rock.

*Motor meter \$3.50
The Hadley Co. Chicago
31 N. Dearborn*

*1 no. Norman Meadowcroft
Aircraft engineer, New York*

*Geo Ranney
New York*

Cleveland, Ohio
Water Bureau

ELECTRICITY KILLS GERMS IN WATER

Purification of water by electrocuting the injurious bacteria, instead of killing them with chemicals that leave an unpleasant taste, has been recommended by attaches of the water bureau of an eastern city. Their method consists in sending a direct current and high-frequency alternating charges through the settling basins by means of special electrodes. Tests have shown that water from Lake Erie, after being treated in this way, was free from bacteria and sterilized. The common way of purifying drinking water for towns and cities is to treat it with chlorine or other chemicals to kill harmful bacteria. The substances are supplied in amounts proportioned to the consumption of water, but where contamination is likely from heavy rains or backing up of sewage, extra-large quantities are often put into the water as a precaution. An unpleasant taste is usually the result. This would be avoided with the electrical treatment, it is said.

FOLDING COAT HANGER SERVES AS CLOTHES BRUSH

Bristles on a collapsible coat hanger convert the article into a serviceable brush and, since the accessory folds up flat, it is especially convenient for travelers. Part of the hanger affords a comfortable grip.



Hans Koch,
Stutzengrün i. Sa.



Packing the Folding Boat and Demonstrating Its Light Weight; a Canvas Covering Is Stretched over the Ribs

COLLAPSIBLE CANVAS BOAT FITS IN TRUNK

The framework of a patented German boat is dismantled into short lengths, which, with the canvas covering, can be stowed away in a trunk for easy carrying. Strength and light weight are also features of the craft. It seats two persons and is made of duralumin, weighing only twenty-two pounds.

RED LIGHTS IN WINTER GIVE EFFECT OF WARMTH

Colored lights help keep theater patrons warm in winter and cool in summer, according to reports from managers. It has been found that the use of reds and yellows in cold weather produces a feeling of warmth, while greens and blues suggest the outdoors and other cooling ideas.

Vancouver, B.C.
Theatre

"HEAT CABINETS" BEAUTIFY HOME AND SAVE FUEL

2054

844 - Rev. Chicago

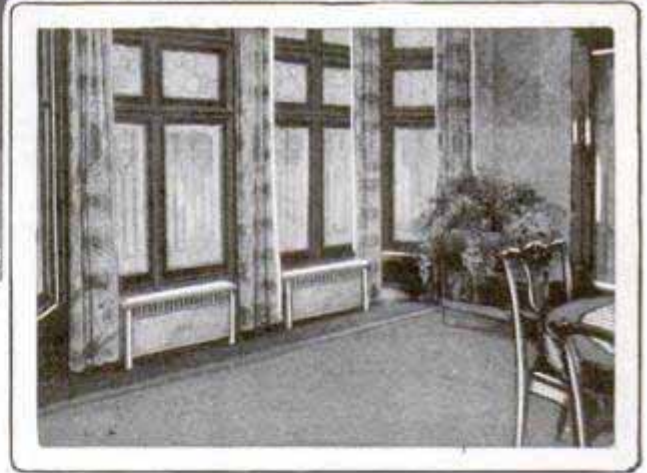
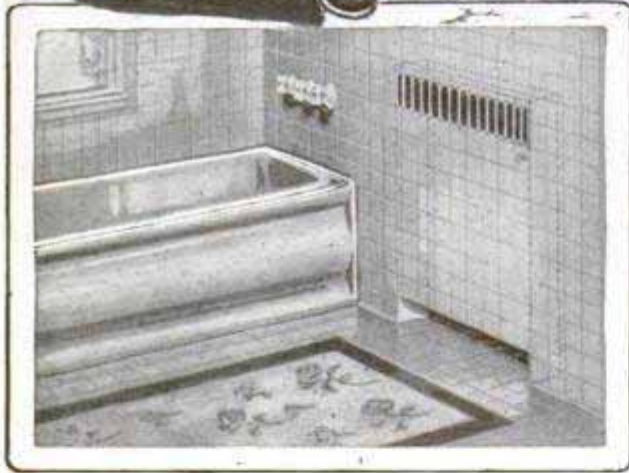
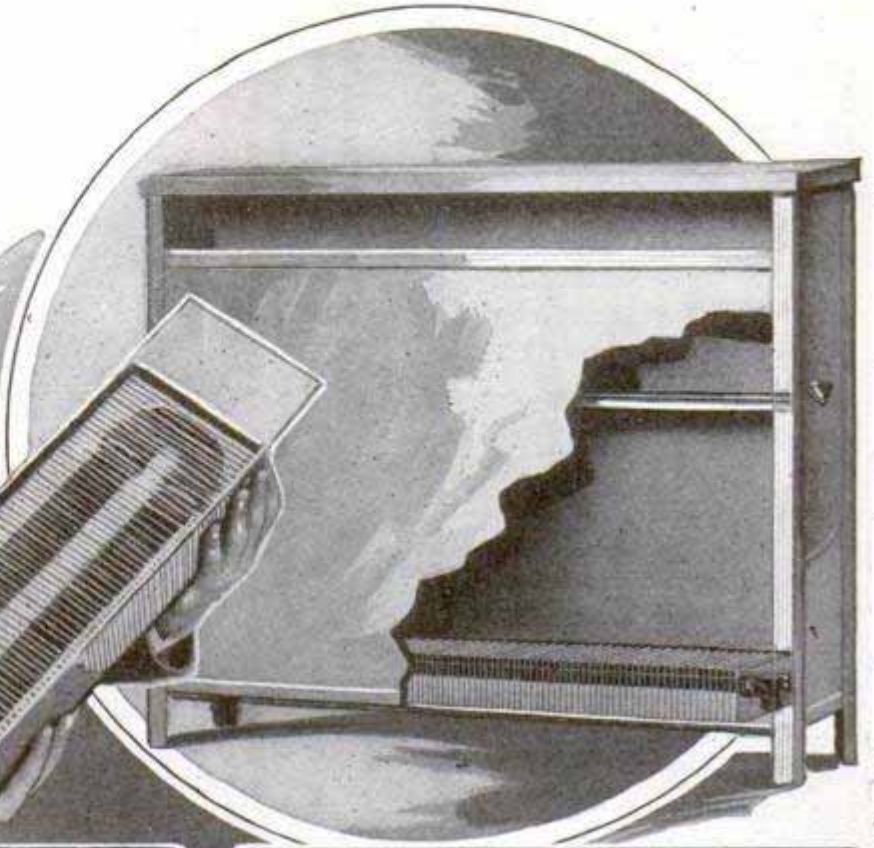
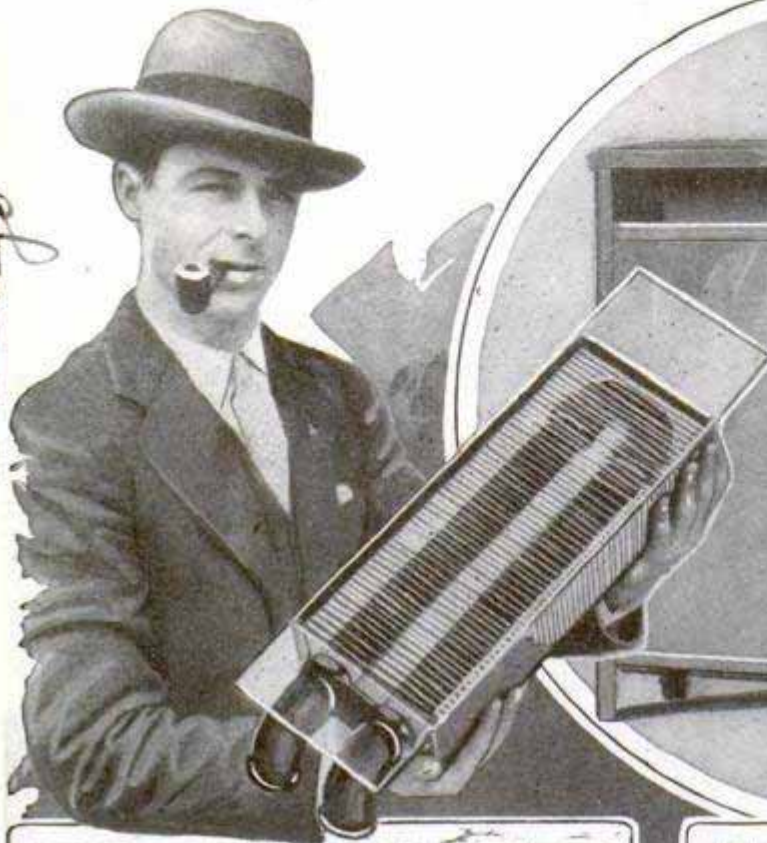

Introducing a Variation of the Usual Type of Radiator; Heating Pipes Pass through Series of Copper Fins Which Give Off Warmth; Cut-Out View of Cabinet and Typical Installations

Claimed to be more efficient than cast-iron radiators, a "heat cabinet," recently invented, occupies virtually the same space as the familiar radiator, but can, if desired, be built into the wall to save floor space. It introduces a radically new idea in heating. In the base a comparatively small amount of pipe passes through a series of closely spaced copper radiating fins, which draw the heat from the pipe rapidly and give it up to the air. The air current enters at the bottom and passes up between the fins. Above them, in the space which would be filled up with the pipes of the

usual radiator, there is a chimneylike air chamber, through which the heated air passes, escaping into the room through a grill at the top. A damper is provided to shut off the air current, and when that is done it is claimed that the device immediately ceases to radiate heat, since the copper unit remains at a constant temperature without giving off heat, except in an air current. The device is being marketed for use with hot water, steam, vapor or vacuum-heating systems, and comes in various sizes, based on the equivalent heating values of cast-iron radiators. The

St. Paul, Minn

cabinets of the room-type heaters come unpainted, in order that they may be decorated to match the room. The prices, according to the makers, are less than for an iron radiator with shield. Because of the arrangement of the grill at the front, it is claimed that all the heated air is thrown out into the room, preventing soiling of the walls.

268

TREE ROOTS THAT POISON PLANTS

Walnut and butternut-tree roots are poisonous to plants, and even weeds whose roots come in contact with them, according to Prof. A. B. Massey of the Virginia experiment station. He declares that there is a substance in the bark of the tree roots which injures others that touch it. This material is not distributed widely through the soil, he declares, but old settlers in various parts of the country have reported that good crops will not grow for several seasons in a newly cleared walnut or butternut area. Gardeners have observed that tomatoes and potatoes will not thrive under the trees and, in Vermont, the failure of a virile weed to grow near butternut trees is noticeable. In Indiana, the leading tomato state of the Union, the harmful effects of the two trees growing in fence rows or in the fields are frequently of economic importance to growers of this vegetable, and in various parts of the country the death of certain weeds and even young apple trees in the vicinity of walnut and butternut trees has often been observed.

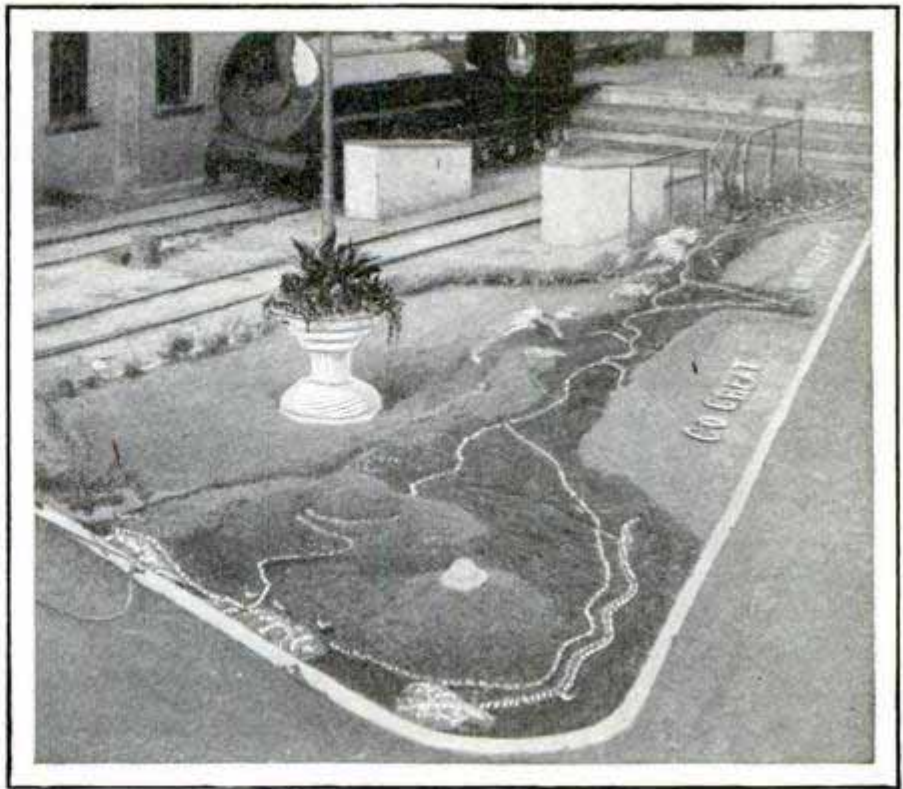

Map of Railroad Traced in Flowers for Garden Ornament; the Design Required Nearly 40,000 Plants

REPLICA OF RAILWAY SYSTEM DESIGNED IN FLOWERS

155

Shopmen employed by a western railroad devote part of their noon hour to care for a flower garden they have set out in unique fashion. It represents the entire route of the system, nearly 40,000 plants being used to trace the design. Tunnels, mountains and other features are depicted in the 118-foot plot.

HOBBYHORSE RUN BY ROCKING GIVES CHILDREN EXERCISE

192

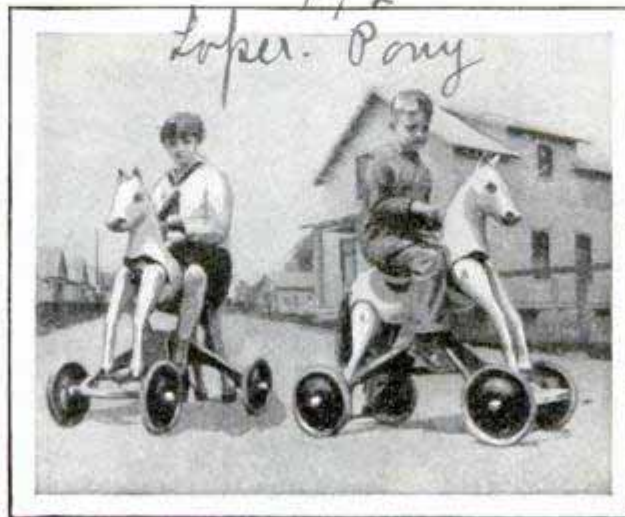

Riding the Hobbyhorses That Move on Wheels as Child Shifts His Weight

Rocking backward and forward on a hobbyhorse a western inventor has devised for outdoor or indoor play, propels it at a moderate rate of speed. The rider is seated over a main bearing at the center, and as the weight is shifted, cranks actuate the front and rear wheels. The motion gives children an added thrill.

*Sold by J. C. Penney Co. Chain stores
370-7th Ave.*

132 *Comdr. Carl O. Isaacs,*
Assistant Director, Roll Call
American Red Cross, Washington, D.C.

In the TRACK of DISASTER



A Red Cross Tent Springs Up in the Midst of Tornado Ruins, Ready to Serve Emergency Rations to Relief Workers and Victims of the Disaster Who Are Drawn to Its Flag

THE first mighty concussion that ripped open the great naval munitions depot at Lake Denmark a few weeks ago was heard for fifty miles or more around, and left a trail of shattered windows and tipsy houses more than a score of miles across.

The column of smoke and dust that was flung a thousand feet in the air above the bursting shell stores had hardly reached its height before Red Cross flags were flapping in the breeze of a score of towns and villages, doctors had established emergency dressing stations, victims were being treated, field kitchens were being stoked in preparation for dinner and relief work was under way.

All that was done without any one ordering it, in fact, before the National Red Cross headquarters, hundreds of miles away in Washington, knew that there had been an explosion. For that is the way the disaster relief of the Red Cross works. Like the marines that "landed and have the situation well in hand," the local Red Cross units frequently have the emergency in hand before the telegraph can get word to the capital that help is needed.

Some 3,600 local chapters, each one, as a rule, embracing a county; something more

than 40,000 trained nurses enlisted for special duty, and a mobile force of practically all the doctors and surgeons in the land explain the Red Cross' ability to cope with flood, fire, tornado, explosion, earthquake or other disaster, greater or lesser, while it is still taking place.

There may be a peaceful, well-behaved little river flowing through your town, that never has gone on a rampage, but the chances are that the local Red Cross chapter has considered the possibility of a flood some day, decided just whose homes and stores are likely to be affected, who will have to be fed and lodged and clothed, how many will need medical treatment, and, more important still, whose house will have to be rebuilt so that the owner can get back on his feet again.

For the Red Cross' interpretation of disaster relief does not end with tying up the physical wounds, feeding the victims for a few days in an open-air kitchen and then going home about the time the story is moving off the front page, to go back next to advertising on some inside sheet of the daily paper. About that time, when the photographers and reporters have all left, the Red Cross is just settling down to



Rolling Kitchens, Manned by Army Cooks, Helping the Red Cross in a Texas Flood, and a Trained Nurse

work, and when the last unit leaves, conditions will be restored, insofar as possible, to just what they were before the disaster.

Take the case of the hundreds of farmers who were left in ruins when a tornado swept across southern Illinois some eighteen months ago, leveling several towns and a broad swath of prosperous farm land. The Red Cross was on the scene, by train, automobile and airplane, within a few hours. From near-by warehouses, tents, cots, bedding, medical supplies and food poured into the zone. Within a few hours the homeless were under cover and fed, the injured were being treated in emergency hospitals by scores of volunteer Red Cross doctors and nurses, and the dead were being cared for, too.

But days later, when the last emergency-relief measure was over, when the towns had begun to rebuild, the real Red Cross job started. Out into the country swept motor caravans, each with from fifty to 100 men, carrying tools, supplies, and their own tents and traveling kitchen. They swept the devastated territory from one side to the other, and at each farm they stopped, cleared the fields of debris, made temporary repairs to wrecked barns and houses, and, in some cases, even helped with the plowing and furnished the seeds, in order that the farmer might be sure of



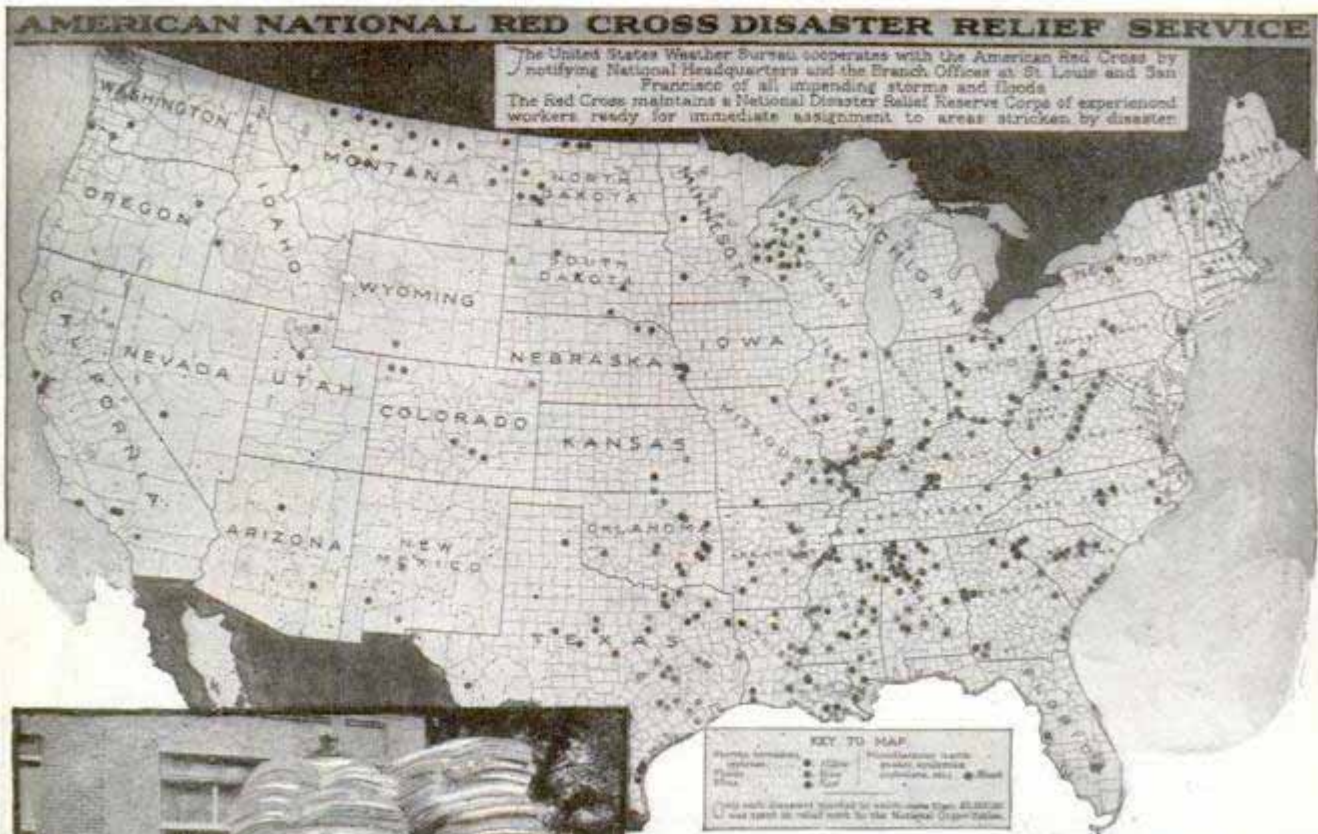

Above is the Red Cross Disaster Map, whose colored dots show the distribution of storms, fires, tornadoes, earthquakes and other emergencies in which the National Organization has rendered relief; at the left is a truckload of blankets and mattresses being rushed from the Red Cross warehouse to the relief of sufferers from a devastating tornado; enormous supplies of tents, bedding and medical stores are maintained at many strategic points

Red Cross Workers Were Among the First to Reach the Airship "Shenandoah"



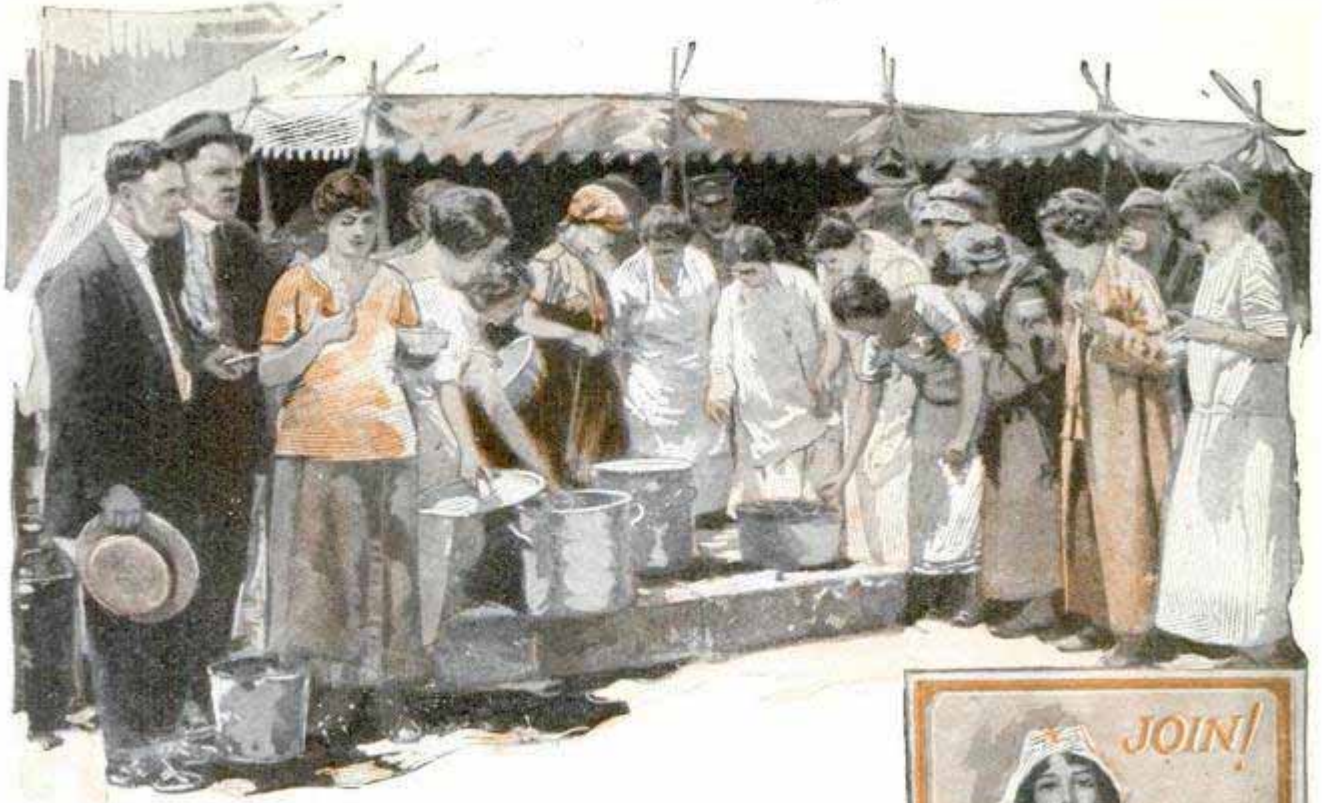

making a crop. In one day, one of the caravans could do as much work as the farmer alone could accomplish in a season.

The work of the emergency-repair caravan is followed closely by other assistance, looking toward permanent rehabilitation. While the emergency workers are still in the field, a careful survey is being made to determine what will be needed to get everyone back on his feet. The farmer who is in difficulty is given financial awards from the relief fund to buy live stock, farm implements, feed and seed, as well as furniture, clothing and material and labor for the rebuilding of his house, barns and fences.

In towns and villages the same effort is made. Instead of the farmer's live stock, seed and implements, the sufferer may even have a store or other business replaced, if that is necessary to restore him to the self-supporting position he formerly occupied.

Widows and orphans of the disaster get special attention, the first receiving support and vocational education, and the children getting trust funds to maintain and educate them until they

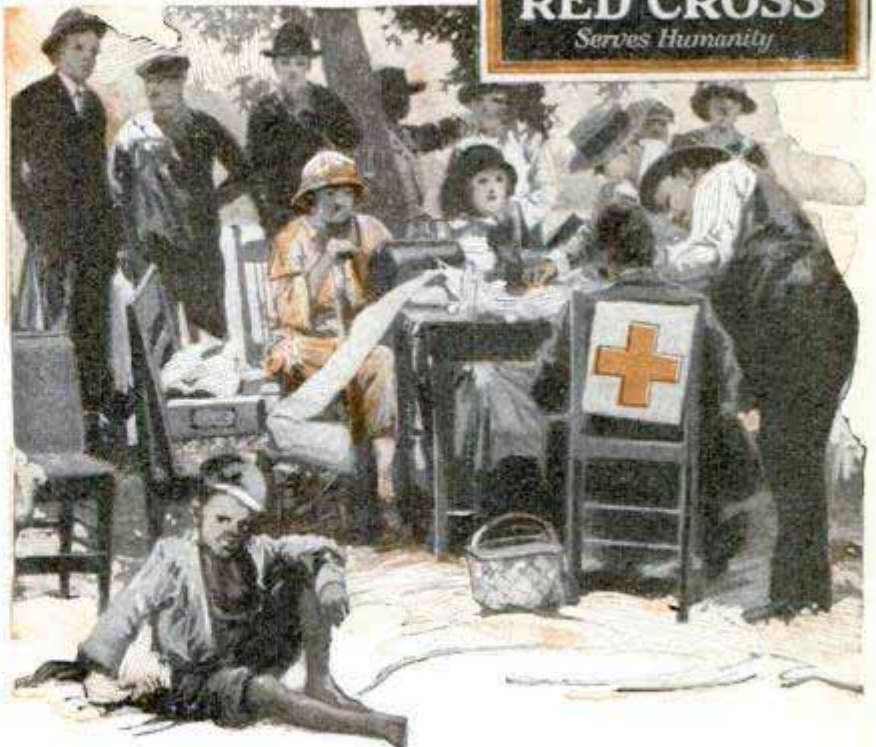

An Emergency Field Kitchen, Top; the Poster to Be Used in This Year's Roll Call, and a First-Aid Station



are old enough to earn their own living. Many of these trust funds cover a period of several years.

It is by its first emergency work, however, that the Red Cross is best known. The speed with which its supplies and workers get into action is often amazing. Frequently the disaster itself has been anticipated by days through constant watch of weather reports. It is seldom that a flood, unless due to a bursting dam, can catch the Red Cross unprepared, and even then it is only a question of a few hours until relief is on the ground. Earthquake zones are well known, and relief plans for all of them are prepared against emergency. The same is true with the tornado and cyclone belts, which can be plotted and studied. The particular requirements of each type of emergency—based on the study of some 850 disasters coped with since the organization was formed in 1905—are known. For example, medical aid is the predominant need after a tornado, whereas food, tents and clothing are most needed by flood and fire victims.

With the country divided into three

districts, each under an assistant national director, and with more than 300 trained volunteer disaster workers who can be mobilized anywhere on short notice, the problem of organizing relief is simplified. The local chapter is first on the job, quickly followed by newcomers with first-aid stations, canteens, food depots, tent cities and anything else needed.

Less than an hour after the first quake shock in Santa Barbara, a tent flying the Red Cross flag was in action. The injured naturally gravitated to this refuge, and a doctor who happened to be in town on a holiday was hard at work.

Not far away women and girls are preparing emergency rations, ranging from canned beans to cocoa, for the army of volunteer workers, hastily organized by a reserve officer, and who are now tearing at the debris to rescue the injured and remove the dead. A bricklayer, arriving from nowhere, has already constructed a field oven, and stoked it with parts salvaged from the ruined front of a near-by store. On the oven, coffee is cooking in tub lots, side by side with a tub of hot dogs. The cooks are a boy who belongs



Murphysboro, Illinois, as It Looked after the Tornado Last Year, When a Large Part of the Town Was Wiped Out, and, at Top of Page, as It Was Rebuilt with Red Cross Aid



to the naval reserve and another boy whose worldly goods are safely buried under the ruins of a wrecked house. A flivver covered with collegiate mottoes is busy delivering the food to the relief workers throughout the town.

All of that happened in the first hour. Apparently it is a haphazard growth, but close inspection shows that someone is directing things. The food supplies, for example, increase faster than consumption. Telegrams are being sent and received, covering every phase of the disaster. A fully manned relief train rolls in from Los Angeles, with a hospital unit equipped to care for more sufferers than have yet been discovered. Tent streets begin to appear, and no matter what emergency arises, it is being met.

That is just one disaster, and there are approximately 100 a year, of one kind or another, which require Red Cross aid. That figures out a disaster for every three and a fraction days, or about two disasters a week, in round numbers. Some of them are small, affecting only a few people, and others involve thousands and cost millions to meet. The cost, regardless of its

size, comes out of the fund provided each year in the annual membership roll call, extending from Armistice day, Nov. 11, to Thanksgiving.

Although its assistance has been given in more than 800 disasters since its incorporation in January, 1905, the work of the Red Cross did not really enlist nationwide support until the war. A couple of million boys under arms learned first-hand what the Red Cross meant, and millions at home came into intimate contact with it.

Out of that wartime work grew the present vast organization of local chapters, some 3,600 in all, and the millions of volunteer workers who rolled bandages, prepared medical supplies, handled messages from the front and looked after the needs of the families of soldiers willingly continued their efforts when peace was restored.

There is no other institution quite like it—prepared to give emergency relief at a moment's notice at any point, in the United States as well as abroad. Great disasters overseas, such as the Japanese earthquake, have been met with Red Cross aid as readily as a similar tragedy at home.



The Rehabilitation of Murphysboro Is Typical of the Work Done by the Red Cross to Restore Each Disaster Survivor as Nearly as Possible to the Same State He Occupied before the Emergency

at Spokane, Wash

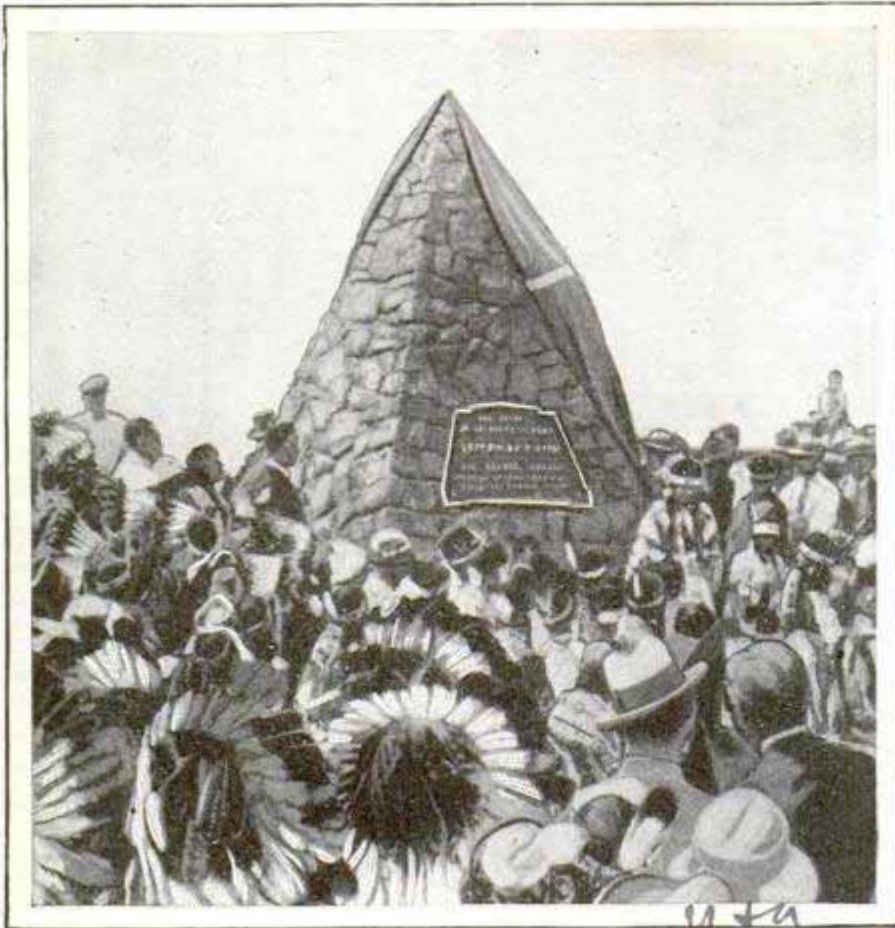

Stone Monument Erected on Site of Battle of Spokane Plains, One of the Last Big Fights between Indians and Whites

SCENE OF BIG INDIAN BATTLE MARKED BY MONUMENT

To commemorate the battle of Spokane plains, the last big fight between the Indians and the whites in the Pacific northwest, a stone monument was dedicated during the second national Indian congress. Some of the descendants of the warriors who participated in the battle attended the ceremonies. The monument was unveiled by Princess America I, great-great-granddaughter of an Indian chief.

TINY VERTICAL-ENGINE MODEL SHOWS INVENTOR'S SKILL

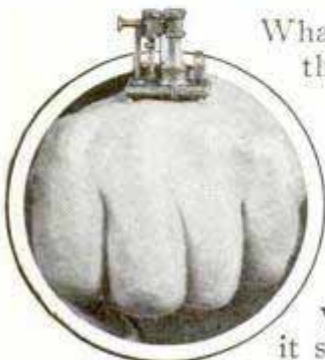

What is believed to be the smallest working model of a vertical engine has been constructed by a California inventor. Its size is apparent contrasted with the man's hand it stands on.

G.C. Schmidt,
San Francisco, Calif. | Letter recd-

FLOWERS CUT IN EVENING LIVE LONGER

Flowers, cut the evening before they are to be used and kept overnight with their stems submerged in water, will last longer than those cut in the morning, according to James H. Burdett, director of the national garden bureau. Care should be taken that the blossoms themselves are not in the water. Cutting the flowers benefits most plants and improves the second crop of blossoms. Annuals, for instance, such as zinnias, cosmos, larkspur, snapdragons and marigolds, will produce a more bountiful crop of blossoms by cutting. If the flowers are not removed, they fade and form seeds,

and this halts the blooming. The perennials will not stand such frequent cutting, as most produce only one or two crops, but if the first is cut back, the second is usually a better one.

LAMP THAT LIGHTS IF TILTED SAVES TURNING SWITCH

Inclosed in a ball-shaped shade, an electric lamp especially for the sick room, nursery or reading table, is lighted or extinguished simply by tilting it forward or backward. This movement actuates a small adjustable switch within the holder and saves the trouble of pressing a wall button. It is noiseless, directs the rays where they are most needed and protects the eyes from glare.



Tark Co, 8 W. 40th, New York.
In their natural state, diamonds are usually of a dull-lead color.



Three Scenes from Railway History Emphasizing the Changes of Less Than Fifty Years; Pioneer Wood-Burning Locomotive at Left, Coal-Fired Unit in Center and, at Right, Electric Train

**FROM CORDWOOD TO KILOWATT
TALE OF RAILWAY PROGRESS**

Transportation's rapid changes are illustrated on the suburban lines of the Illinois Central railroad at Chicago. Less than fifty years ago, the engines burned cordwood and a speed of twenty miles an hour was considered remarkable. Coal brought faster schedules, but steam is now largely supplanted by electricity in a trolley system with motor cars in place of locomotives. The three great "periods" in the railroad's history were represented in an exhibit showing a pioneer engine with a later coal burner and one of the electric trains lately put into service.

notes and from them decides where to put the expression lines, words and other printed matter that will appear on the duplicate rolls. These marks are glued to the master roll in raised rubber type and duplication made by a modified printing process. Under skilled editing, copies as good as the original will result.

**PLAYHOUSE WITH TEN ROOMS
IS FAMILY HEIRLOOM**

Built along true architectural lines, a playhouse has served three generations of an eastern family. It contains ten rooms and an attic and still is in good condition.

*Mrs. C. H. Young
Worcester, Mass.*

**MUSIC-ROLL EDITING
SAVES NATURAL
EXPRESSION**

261

One of the less familiar professions is that of editing music rolls for player pianos after the original has been prepared for duplication. The master roll is generally made directly by an electrical apparatus connected to the piano which the artist plays. The editor reads the perforations on the roll just as the musician reads the

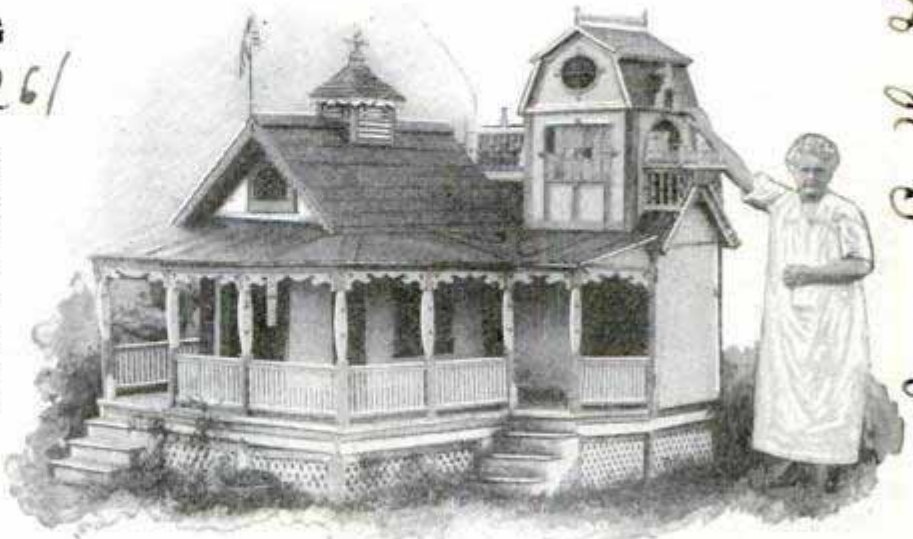

Built like a Real House, This Plaything Is Still in Good Condition after Many Years of Use

*A.C. Lubbranson
Lubbranson Co.*

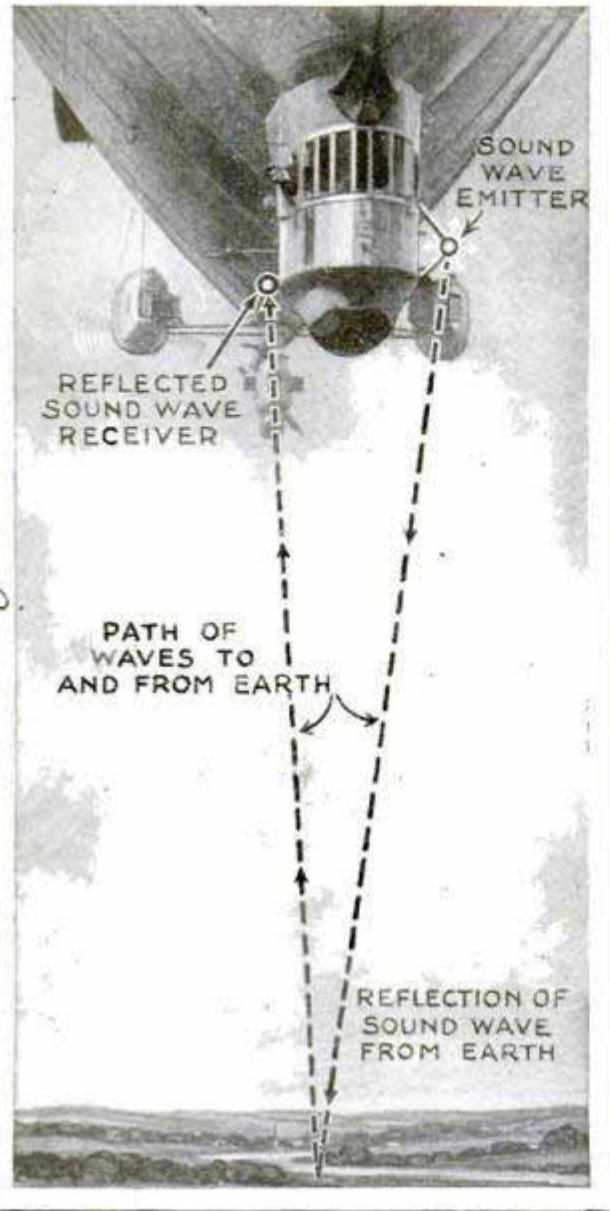

Dirigible Equipped with Altitude "Sounding" Apparatus and Diagram of Action

AIRSHIP'S ALTITUDE IN FOGS MEASURED BY ECHO

Almost every aircraft is provided with a barometer or similar instrument for determining height, but many of these have proved unreliable beyond a certain altitude and many accidents in fogs and in darkness have resulted. A German inventor has adapted the echo method of sounding on steamers to the airship and the airplane with good results, it is reported. The method is essentially the same as that used on water. Sound waves travel from an emitter on one side of the ship, strike the ground and are reflected back where they are registered on a receiver at the other side of the craft. From the time interval between emission and recep-

tion of the sound, the altitude of the ship is found by a simple calculation. Tests have proved the "echophone" reliable.

SOUND-SLEEP PERIOD LESS THAN 346 FIVE MINUTES A NIGHT

From 14,448 measurements of the soundness of sleep of twelve young men subjects at the Mellon Institute for Industrial Research, it was found that they slept without stirring for an average of only a little more than eleven minutes at a time, and, in half of the observations, the average rest period was less than five minutes in length. These facts were determined by having the subjects sleep in special beds equipped with apparatus that recorded any movement such as a change in the position of the limbs or the head. The sleepers retired at eleven o'clock and arose at seven in the morning. Factors designed to produce sound sleep, such as quiet and good ventilation, were carefully watched. In only one of the observations was the period of quiet more than three hours long. The observers concluded that the average healthy person sleeps much less soundly, that is, with much shorter intervals without noticeable movement than is commonly supposed. Fatigue after a day of hard work interfered with sleep in at least one observation. Some subjects rested more during the first half of the night, while others enjoyed greater benefits from the last half and other periods. The tendency of the subjects was to exhibit less activity during the first hour of slumber after settling down to rest, but this steady rest began any time from ten minutes to two hours after retiring.

ICELESS REFRIGERATING DISH KEEPS BUTTER FRESH

2102 Housefriend



Butter and other foods are kept from spoiling in hot weather in a dish having a dome-shaped top containing a water chamber. The

cover is of earthenware, sufficiently porous to produce evaporation, thus reducing the temperature inside the dish.

Swia G. m. b. H.
Lorenzhausen b.

Capt. H. J. Wilkins, Esq. 4, Crouchwood Road,
 Brixton, S.W. 9, London, England.

2290

1935
INSECT MODELS ARE AS BIG AS DOGS

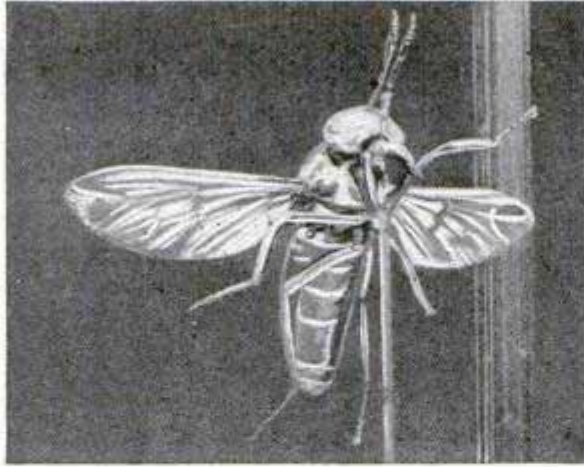

How the Fierce West African Horse Fly Looks When Enlarged Twenty-Eight Times

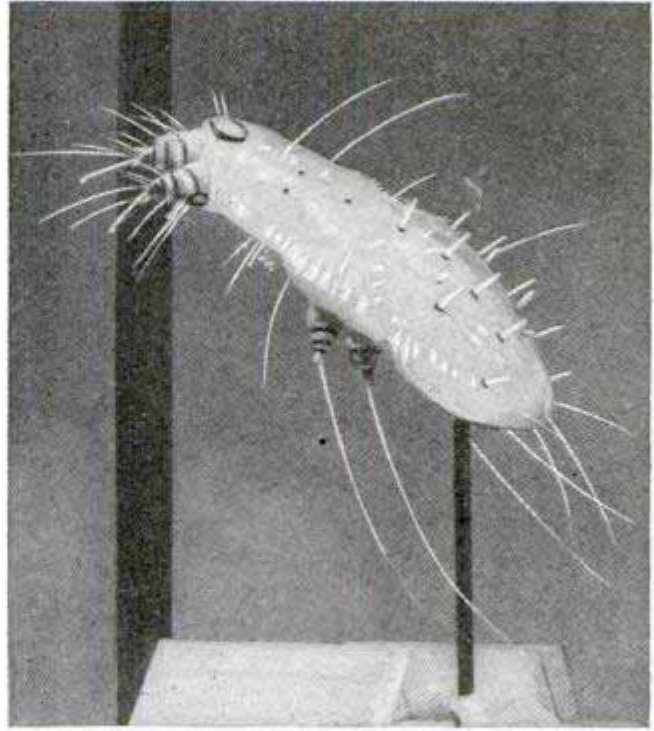

Itch Mite, the Tiny Insect That Causes an Unpleasant Skin Affection on Persons

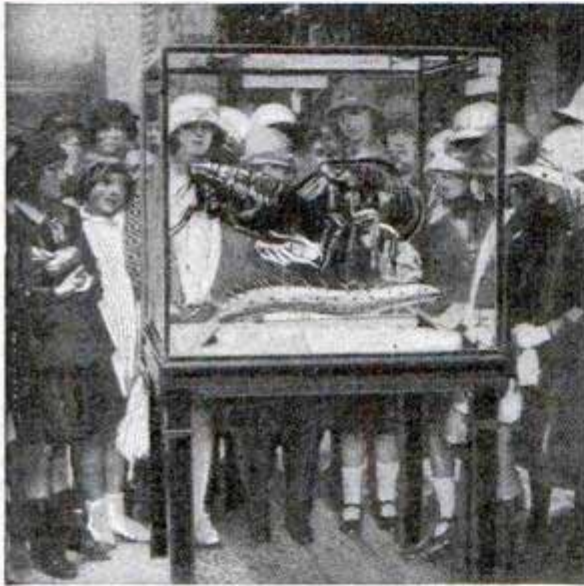

School Children Examining Models in Natural History Museum at South Kensington, England



Two-Foot Model of Sand Fly Has Nearly 2,000 Hairs Set in Natural Fashion

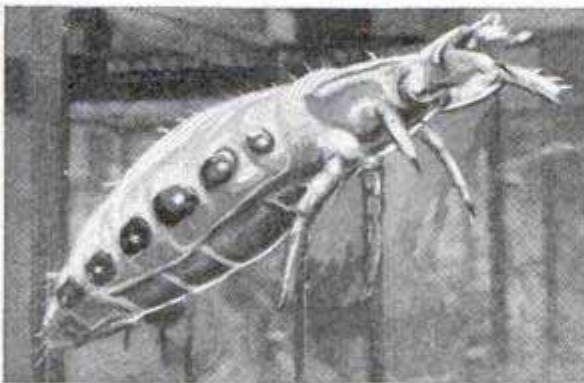

Replica of Louse, a Typhus Carrier, 1,000 Times Larger than the Original



Mosquito, the Yellow-Fever Germ Carrier, as It Looks Enlarged Twenty-Eight Times

GERMS TO AID PLANT GROWTH
RAISED IN LABORATORY

263 Investigators at the university of Wisconsin have been making experiments to find the best strains of germs which will aid the development of peas, soybeans, alfalfa and other crops. For some time, it has been known that inoculation of the seeds of these plants cause little nodules to form on the roots and that these protuberances take nitrogen from the air, transforming it into growth-producing material. Some bacteria seem to be more effective than others in producing the nodules. The aim of the scientists is to isolate a strain that can be depended upon to achieve the desired effect in the most abundant manner.

HINGED GUARD FOR LIGHT BULB
55 HAS HANDLE AND HOOK

Electric-lamp bulbs on extension cords are easily inserted and well protected against breakage in a safety unit that combines a handle and hook at the top for holding the light. One side of the guard is on hinges so that it may be opened quickly for the insertion or removal of a bulb without taking off the entire shield. The other side is shaded, if desired. The two lock securely together and cannot be disengaged accidentally.



Lamp Bracket Open and Closed, the Insulated Handle, and the Hook That Is Attached to Objects

Cigarets on One Side, Matches on the Other in a Single Handy Package for Smokers

BOX OF CIGARETS AND MATCHES
IN ONE PACKAGE

Cigarets and fourteen matches with an ignition surface are sold in one package under an arrangement devised by an English inventor. This saves pocket room and insures the smoker a light. The match compartment can be refilled in case the original supply gives out.

SIGNALS SENT BY WINDMILLS
AS SUBSTITUTE FOR PHONE

Countryfolk in Holland still use their windmills for purposes of communication as they did during the times of William of Orange and the Spanish invasion. By moving the wheels slightly and turning them to different angles, a message is spelled out in code and relayed many miles, sometimes to another mill below the horizon. Private codes are used, but there are common signals for calling a doctor or policeman, for instance, or for the miller to signal that he is waiting for grist from the farmers.

Cont. H. Journeer, Esq.
Thundersley Essex England.

Crouse-Hinds Co
Syracuse, N.Y.

209
Combination match and cigarette case sold by all in one box 64
Munich, Minn.

187

407 A Dearborn, Chicago

Unable to locate

University of Wisconsin
Madison Wis

200 Mr. Oscar Lewis, 110 ...
No. 810.
San Francisco, Calif.

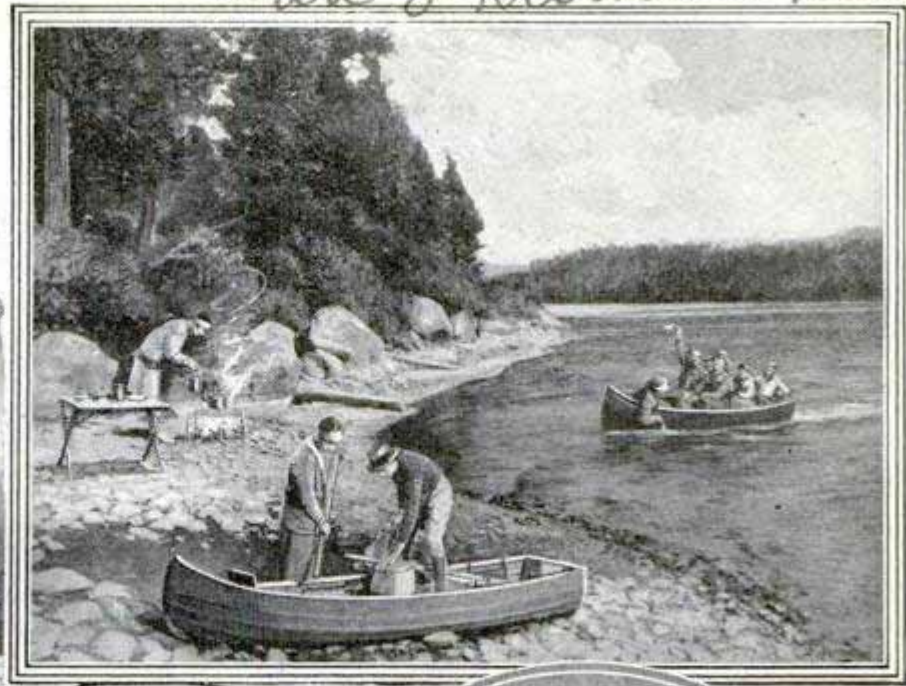

Finished Picture Is at Upper Right; the Others Are Studio Poses of the Groups, to Express the Desired Action

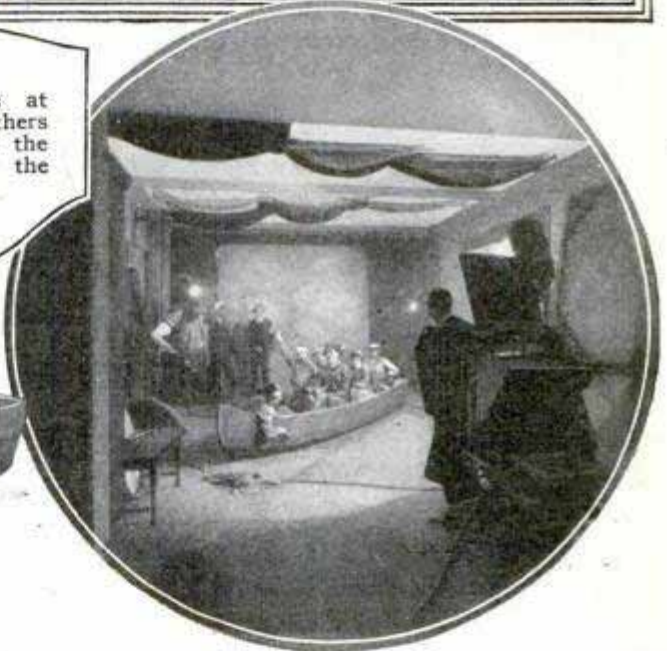

TRICKS IN PHOTOGRAPHY SERVE ARTIST AND ILLUSTRATOR

Without leaving his studio except to obtain pictures of appropriate backgrounds, the camera artist is able to produce a wide variety of views by the use of composite photography. It is a form of trick work such as is employed in making the thriller scenes for the movies, but besides yielding realistic results, it saves time and cost and enables the photographer to turn out a high-grade picture, since he has the advantages of good lighting, accurate focusing and other favorable conditions. The process consists chiefly in photographing several pictures at once to obtain a single view. For instance, it is desired to produce a camping scene.

Groups are posed under the lights of the studio to show a boat in the water, a cook-stove in operation and other typical action views. These are then reduced to proper size to fit the background, pasted on and the whole photographed after retouching to conceal any marks or discrepancies. Some studios have large equipments of special settings and keep lists of men and women whom they may call upon to pose for various purposes.

☐The Popular Mechanics' Bureau of Information offers its free service to all readers of our magazine. Names and addresses of manufacturers and dealers in articles described, and any other details in our possession will be furnished promptly by addressing the bureau.

Utica NY

97

\$13.50

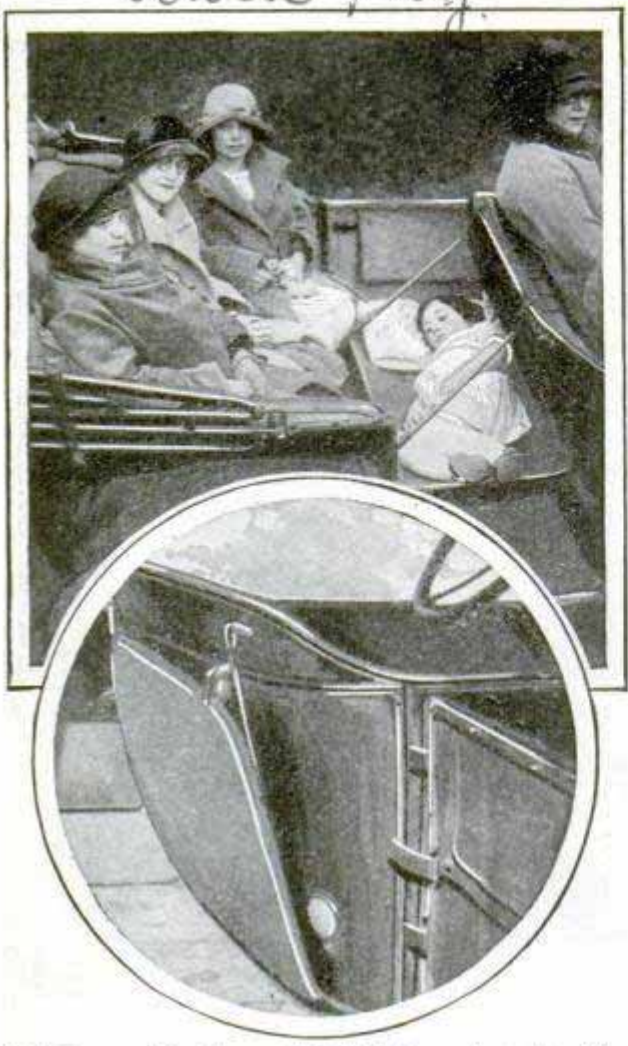

Crib Lowered for Use and Folded Up against Auto-Seat Back Where It Is Out of the Way

FOLDING AUTO CRIB FOR CHILD HAS POCKETS FOR TOYS

Folding flat against the rear of the front seat when not in use, a fabric crib affords a comfortable place for a child up to seven years old to ride in the automobile. The cover is detachable for laundering, and there are pockets for holding milk bottles, toys and other articles for the comfort and amusement of the youngster.

FOOD PRICES ON CAFE DISHES SIMPLIFY FIGURING BILL

256

Patrons of sidewalk cafes in Paris do not have to wait for checks and are protected from errors in charges, as the price of the foods is stamped on the dishes in which they are served. If, for instance, a second cup of chocolate is desired, the emptied container will be set to one side, and the new one is printed with the price of the two cups. When the customer is ready to pay, he need not depend on the

memory of the waiter or scan a bill of fare, since he can determine the amount of his bill by simply adding up the figures on the dishes.

BUMP TESTS FOR MOTOR-CAR TIRES INSURE QUALITY

Auto tires for government use are given a severe test for endurance at the bureau of standards. They are mounted in stationary bearings with the tread against a revolving flat rim on which are three cleats arranged to give the tire 9,000 bumps for every mile the rim turns. Each tire is subjected to forty-eight continuous hours of this testing, receiving 27,000 bumps an hour or 1,296,000 in all. Pressure can be regulated, and some of the tires are said to have proved their ability to stand up satisfactorily under the equivalent of a load of one and one-half tons.

RAIL-DEFECT DETECTOR TELLS OF HIDDEN FLAWS

By means of an electric tester, devised by a Japanese inventor, defects in railroad rails are said to be quickly and accurately located and, at the same time, their presence recorded on a moving roll of paper. The apparatus is connected to an ordinary inspection car and is said to be simple to adjust and operate.

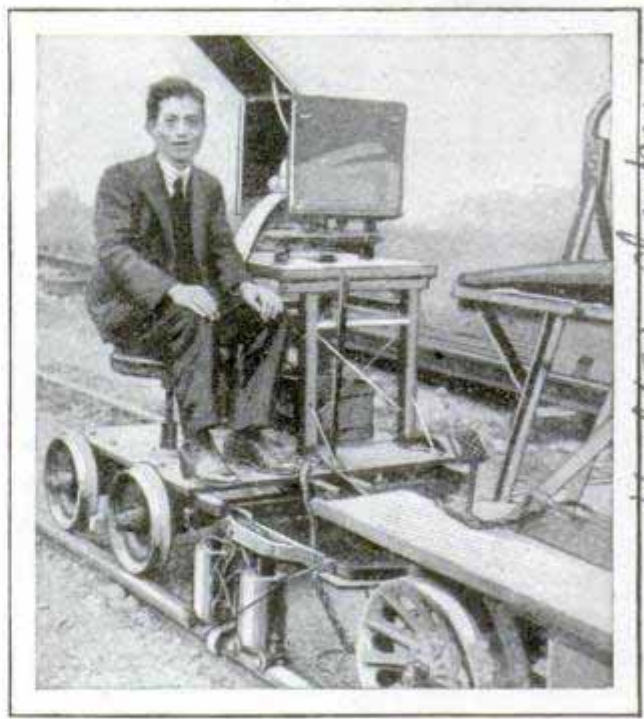

Rail Tester in Operation behind an Inspection Car on Japanese Line; Note Attachment to Rails

Government Railway Dept. Imperial Japanese

National Geographic Society
Washington D.C.

SHAFT RECORDS DEEDS OF WESTERN PIONEERS

Dedicated to the early explorers who helped win the northwest for the United States, a memorial shaft, 125 feet high, has been erected near Astoria, Oreg., one of the oldest white settlements on the Pacific. In a colorful frieze that winds from the top of the column to the bottom, sketches depicting scenes of pioneer days have been carved. The pictorial pattern is 525 feet long and was formed by placing a layer of white cement over a colored one, applied to the rough fluted surface of the shaft. The designs were cut through the outer layer, exposing the colored material below. The column was

erected in memory of Capt. Robert Gray, the discoverer of the Columbia river, Lewis and Clark, the daring adventurers who crossed the Indian-infested plains, and John Jacob Astor, trader, who founded Astoria. A spiral stairway leads to an observation platform on top of the shaft. Astor established the settlement after a perilous trip across the country and intended that it should be a central depot between the Great Lakes and the Orient for his huge fur business. The post prospered for a time, but

later was seized by the English. It was restored to U. S. in 1918.

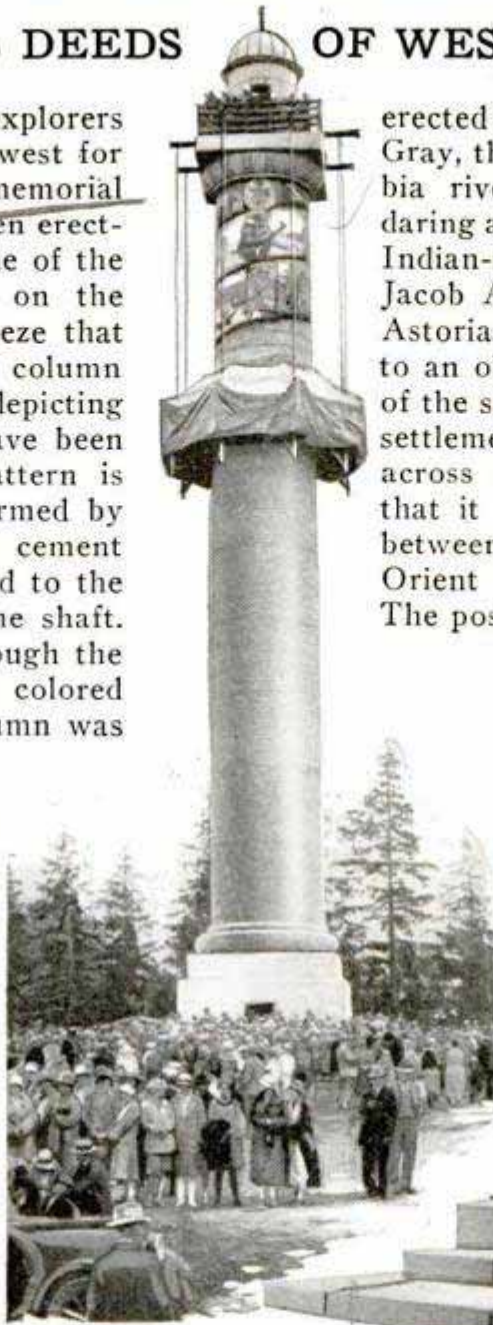
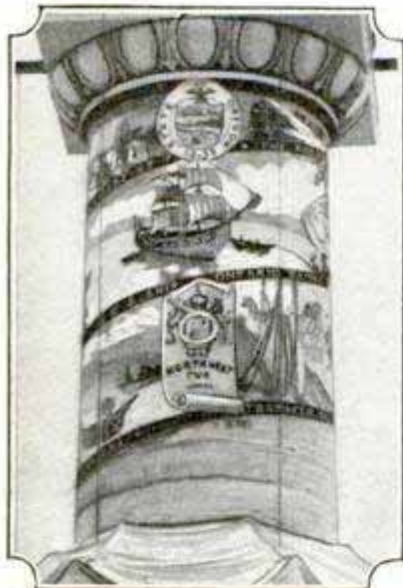

Shaft Partly Finished, Showing Arrangement of Pictures, and, in Center, Dedication Ceremonies; Right, Another Monument Dedicated at Site of an Old Indian Village

SOFT MUSIC CALMS ANIMALS
ZOO TESTS SHOW 280

Experiments with caged animals have indicated that lions are apparently fond of piano music when the upper and middle notes are struck, but they roar when the base keys are played loudly. Tigers exhibit a similar aversion to the shrill notes of the fife. This is believed to be due to the fact that the tiger's ears are extremely sensitive and certain vibrations cause the animal to suffer pain. These reactions substantiate reports of persons traveling in the jungles being saved from wild beasts by music. In some countries where oxen are still used for labor, the beasts seem to

work better when the driver sings, and it is also customary for the Arabs to sing to their camels on long journeys.

190 RICHES IN RUBBISH

Waste from factories using wool was generally burned, but now much of it is sold for fertilizer. Worn-out sponges are carbonized and employed in the manufacture of iodine. Old bones are utilized as ivory substitute, sawdust is converted into fuel, and thousands of dollars are salvaged from the sweepings of dental and jewelry workshops. Even the chimneys and the clothing of the workers yield precious fragments of metal.

Ruby Henton in:
Our Shrub Animal

Kansas City Star 7/25/26

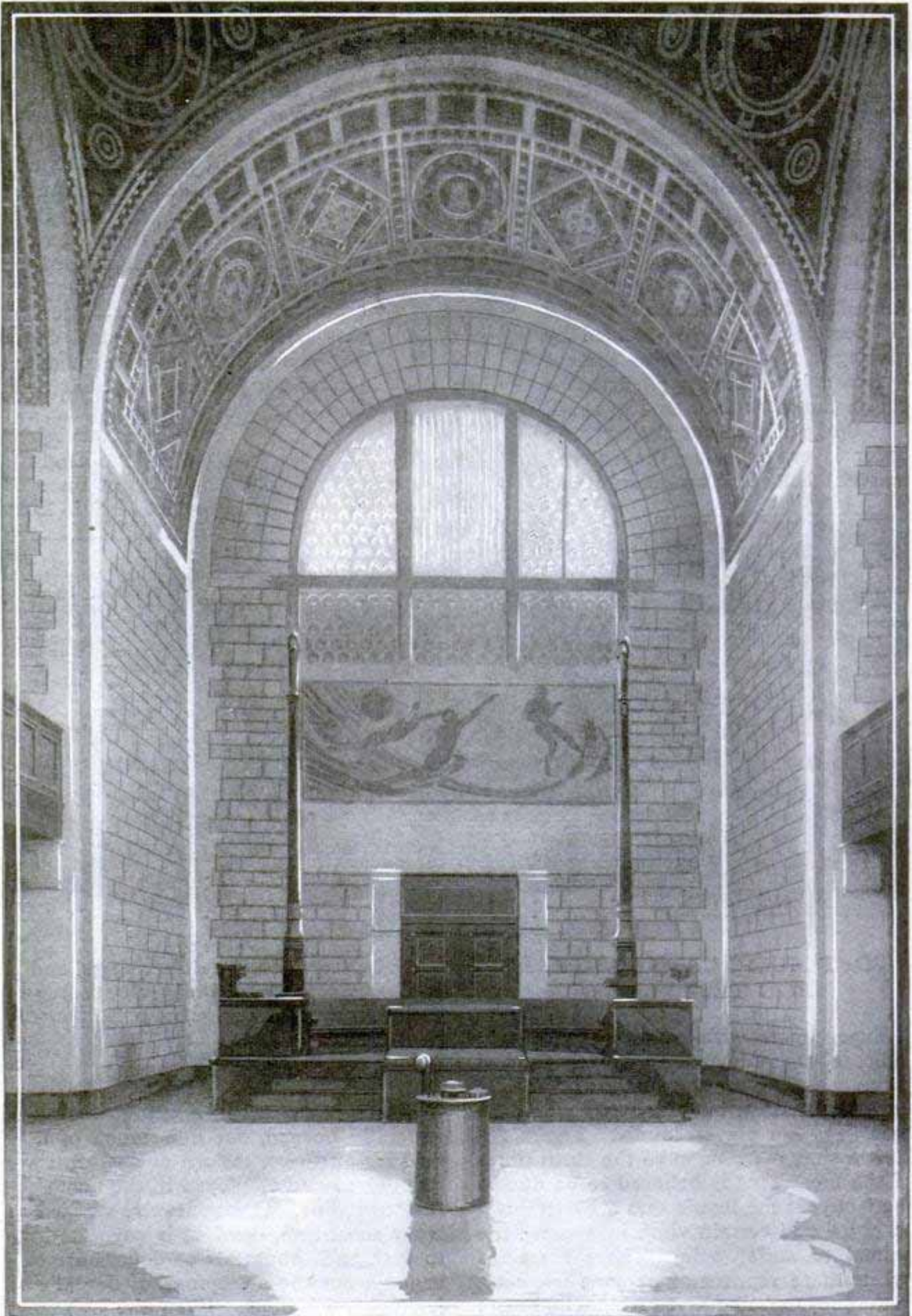

Copyright, Underwood & Underwood

Portion of Auditorium Interior, National Academy of Sciences; Walls Are of Acoustic Tile and Mural Paintings in Soft Colors Describe Man's Search for Truth through the Ages

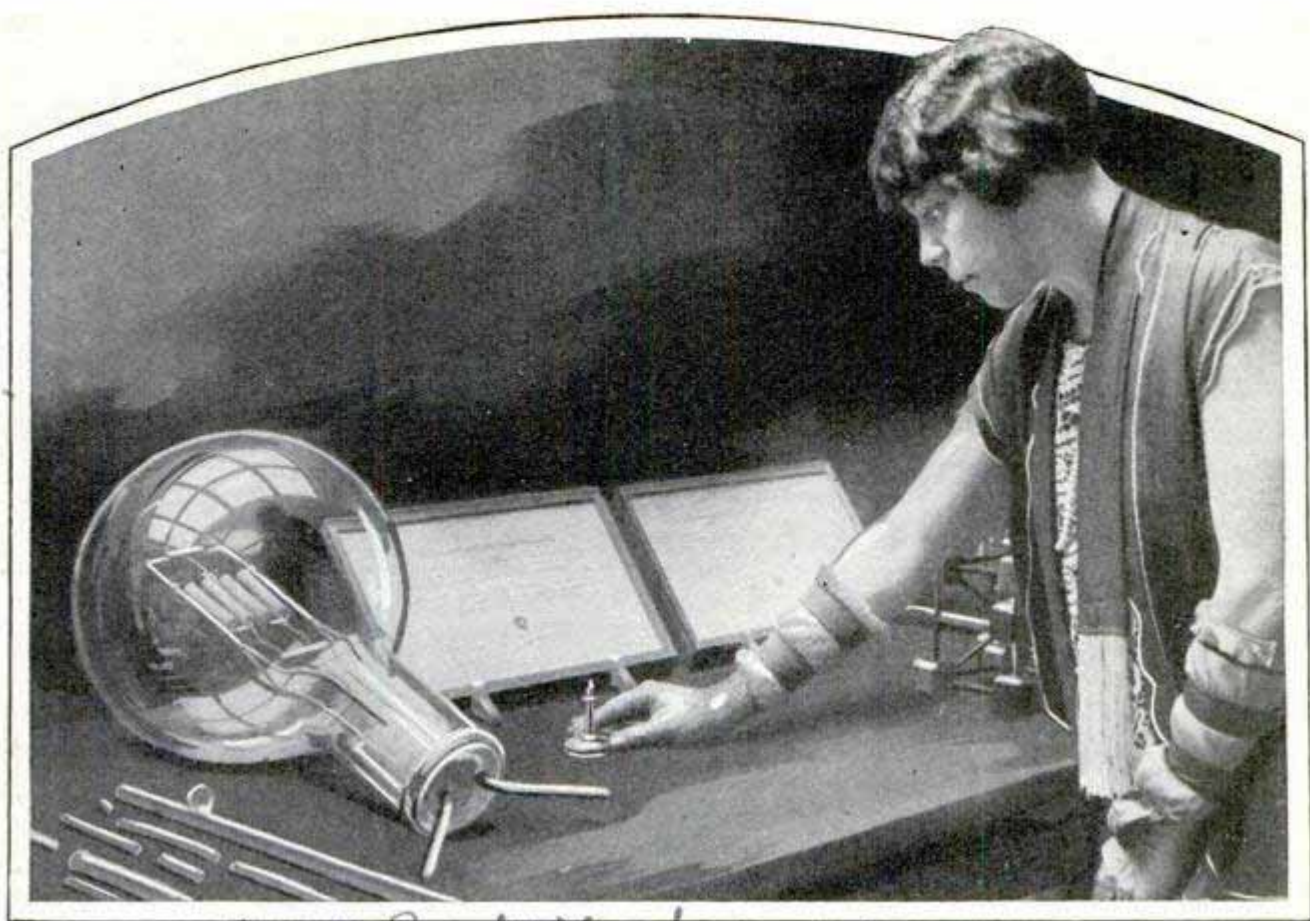

© Henry Miller *News Picture Service*
 Contrast in Electric Bulbs; the Large One Gives About 2,000 Times the Light of an Ordinary Forty-Watt Lamp; the Small One Is Used for Surgical Purposes

Where You Can See Your Voice and Bend a Six-Inch Bar of Iron

Science Building at Nation's Capital Is Equipped to Reveal the Hidden Wonders of the Universe

By OTTO WILSON, *Museum Bldg Washington 20c*

"IF I could only see it for myself!" How often that exclamation has come to our lips when we have been reading of some new, startling, perhaps epoch-making discovery. Not until we can see the demonstration with our own eyes or handle it with our hands does it really come home to us.

But our desire is not half so keen as is that of the scientist himself to make us understand some of the strange truths he is revealing. He moves in a land of everlasting romance, watching the inner workings of the universe. It is one of his deepest regrets that he cannot make the passing world see and appreciate the wonders that strike his vision.

To throw one more frail bridge across the gap which separates the public from this modern wonder world, the National Academy of sciences has set aside practically one whole floor of its magnificent building, which was opened at Washington two years ago.

It is not a dead museum, with glass cases and hands-off signs on all sides. You operate these mechanisms yourself, with no guide standing by to restrain or explain. A simple card tells you briefly what the device illustrates, and another, perhaps, how to set it going.

Wandering among these strange-looking devices, I have tried to imagine what the spirit of some wise man of the ancient

2260

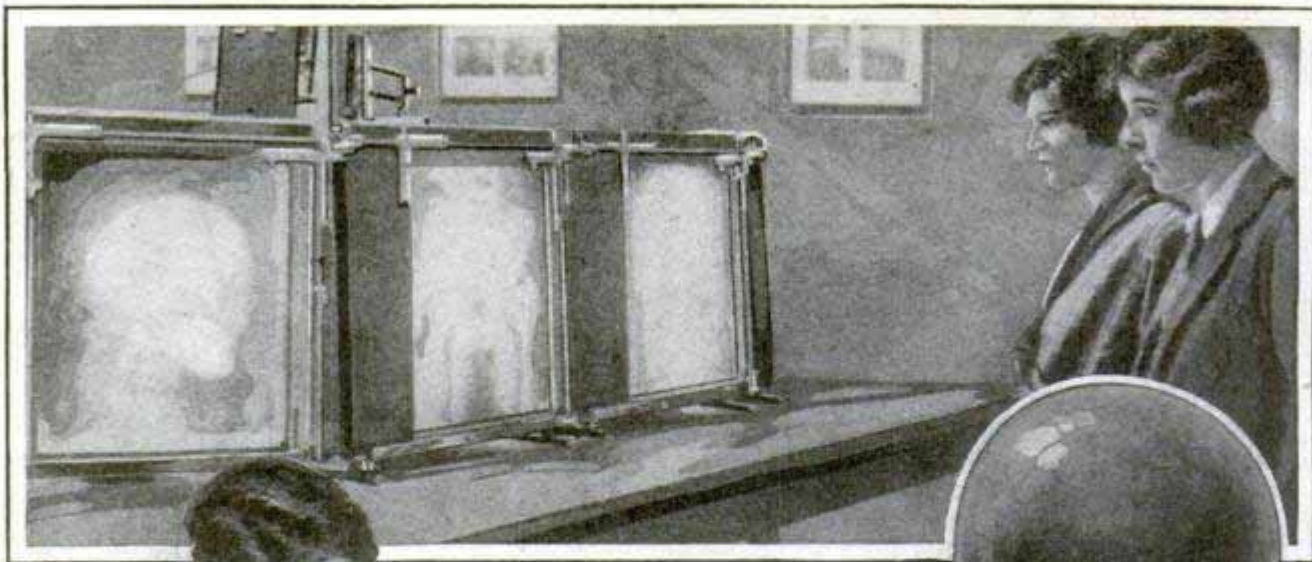

© U. & U.

Special Plates and Tubes Which Illustrate Clearly Effect of X-Rays on Body



Copyright, Henry Miller

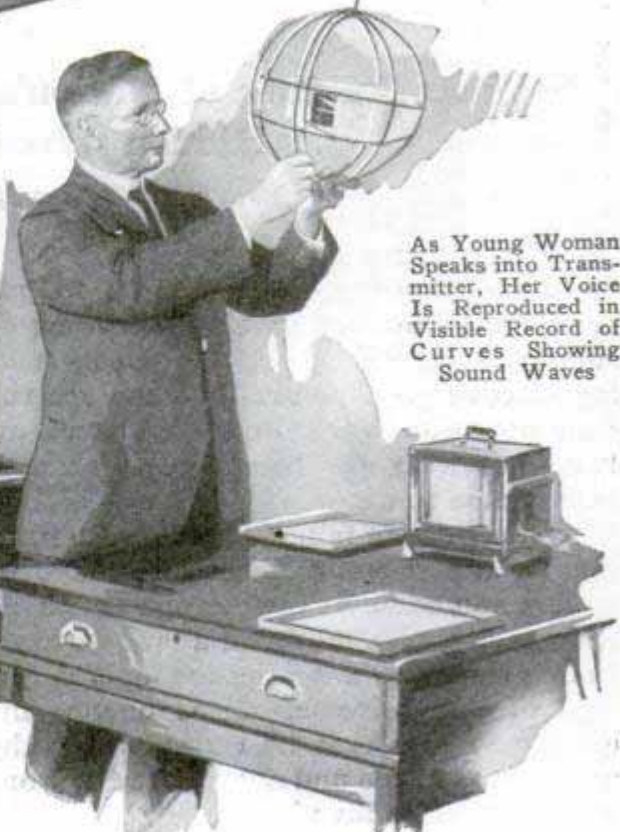

As Young Woman Speaks into Transmitter, Her Voice Is Reproduced in Visible Record of Curves Showing Sound Waves

Another View of Big and Little Electric-Light Bulbs, and Balloon Outfit for Determining Weather Conditions at High Altitudes. The Sphere Is Sent Up Until Expansion of Hydrogen in It Causes It to Explode, the Recording Apparatus Falls Safely to Earth on a Parachute Support and Is Returned to the Weather Bureau, Where Experts Open It and Examine Chart. Explorations by This Means Have Been Made to a Height of Over Nineteen Miles

Greeks would feel if they were explained to him. I have given myself the pleasure of acting as his guide, and opening to his gaze the vision of a creation unimaginably great and unimaginably small, as set off against the cramped little world in which he moved and thought.

"Do you see this little bulb?" I have fancied myself saying to him. "By its help one man can talk in an ordinary voice and another ten thousand miles away can hear him.

"Here is an artificial eye, far more potent than our natural eye. With it we can look through solid flesh and see the bones of a living body.

"By this machine I can measure and watch in action a pressure so gentle that a man's breath would seem like a raging tornado by the side of it. Across the hall is a set of mirrors which shows me how much I bend an iron bar six inches thick by pressing my thumb down on it.

"If this lamp were connected, I could instantly produce a blaze of light, simply by pressing a button, which would blind you just as the sun would do. It is the largest electric-light bulb ever made, two thousand times as powerful as those we use in our homes for ordinary light. We use it in making pictures that move like people in real life.

"Here is a piece of perfect glass. It is twelve or fourteen inches through, and yet you would have to look sharply, if you did not know it was there, to see that there was anything between your eyes and this pencil I hold on the other side of it. Here is a grating ruled with thousands of fine lines to the inch—so fine that they split a sunbeam into its natural colors. Here is a mechanism that tells us, simply but surely, what a star hundreds of trillions of miles away is made of."

But our visitor from the past would not even know what a star was. To explain any one of these numerous devices fully it would almost be necessary to begin at the beginning and review the whole long line of discoveries of our modern era.

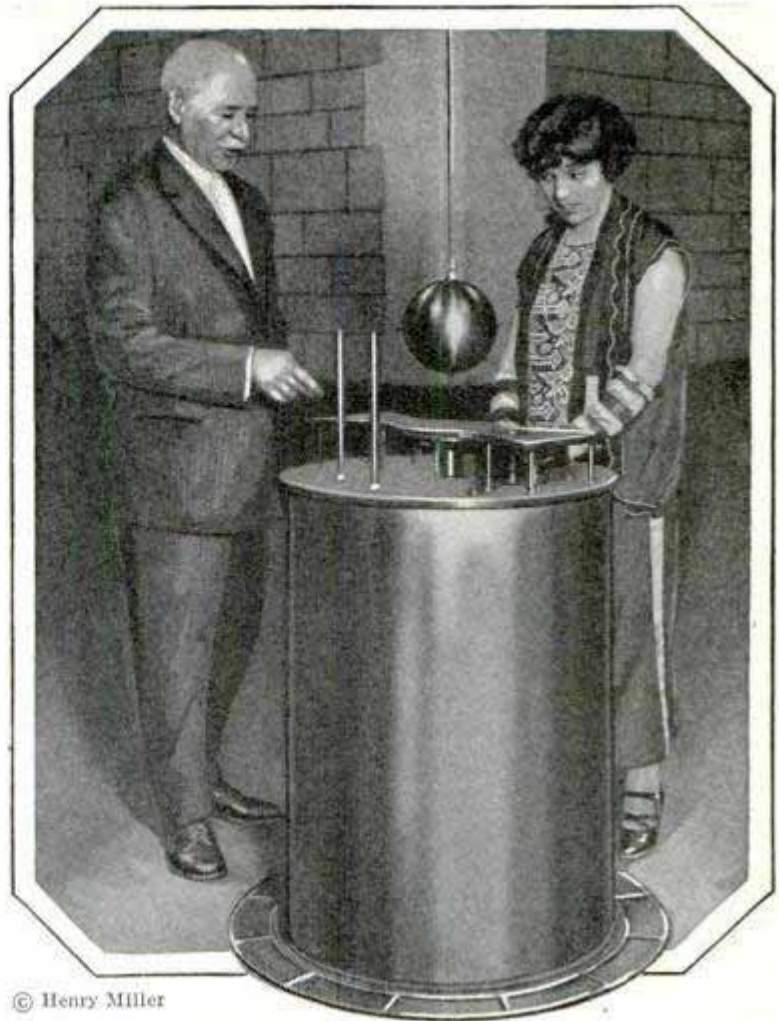

© Henry Miller

Where the Sun and Its Spots Are Reflected, Formed into a Spectrum and Studied without Injuring Eyes

It will be simpler to describe the more striking of these exhibits as if to a contemporary, to one of the tens of thousands of visitors that throng to the capital city every summer. Even from the outside you will see that this beautiful white-marble palace is like no other of the capital's many fine public structures.

Across the whole front of the building runs an inscription in strange characters. They are Greek, and the inscription means, "The search for truth is in one way hard and in another easy. For it is evident that none can master it fully nor miss it wholly. But each adds a little to our knowledge of Nature and from all facts assembled there arises a certain grandeur."

As we go up the steps and through the entrance halls we have quick evidence that this is no ordinary structure we are visiting. Through a wide doorway we see, in the central hall of the building, something which no other place in the country, perhaps in the world, can show.

Suspended by a long wire from the cen-

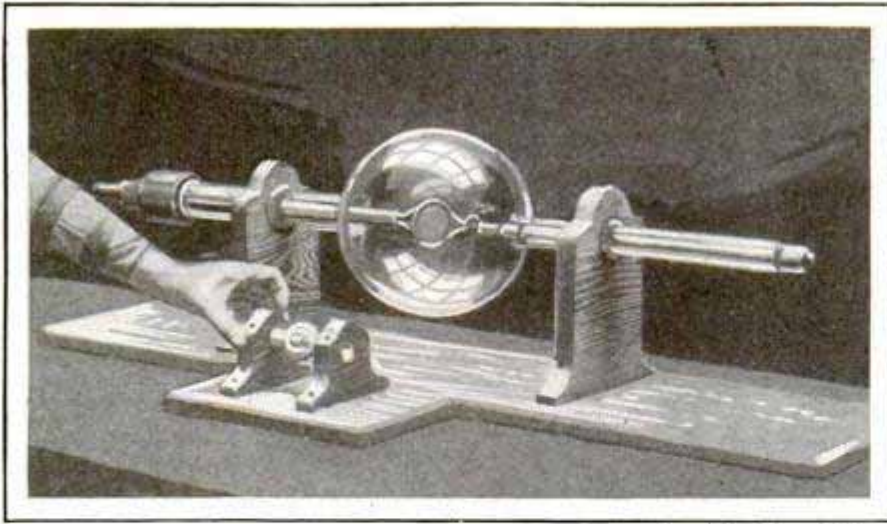

Big and Little X-Ray Tubes; the Larger Has Fifteen Times the Output of the Ordinary Kind in Medical Use

Copyright, Henry Miller

ter of the dome above, a polished brass ball swings silently to and fro. It regulates no clockwork or other machinery, and there seems to be no reason for its motion aside from the mere swinging itself—which is indeed the case.

It is a Foucault pendulum. In 1851, a renowned French scientist, J. B. L. Foucault, set out to demonstrate a law of the pendulum. He suspended a finely adjusted ball, similar to the one in front of us, and set it going. No human hand touched the ball or its wire, no air currents swayed it, yet gradually, inch by inch, it changed the direction of its swing. Or, rather, it did its best to keep swinging always in the same direction. It was the rotation of the earth on its axis that really made the pendulum change its motion. Now an attendant stops the swinging ball and invites us to become really acquainted with the sun. On the standard which holds the dial plate

over which the pendulum passes is a round white disk. Upon it, if no clouds intervene, the sun presents us with its photographic likeness.

In the center of the dome above is set a mechanism worked by a small motor so that the sun's image is constantly reflected downward in one spot, although the sun itself is moving across the sky. On the surface of the white disk are some little gray flecks of dust. You want to

brush them off with your handkerchief. But if you tried that out you would have your difficulties. For each of those flecks is a direct reflection of a mighty whirling storm of solar gases which could swallow a planet many times as large as the earth.

You have heard often of the solar spectrum. By pressing a button and looking in an eyepiece, when the attendant has moved into place a finely ruled metal grating, you see it before you. Brilliant, vivid, glowing, the rainbow bands of color stretch out before you like mighty columns of light. Nothing this wondrous building has to show, I think, is quite so beautiful as this spectrum when the sun is shining brightly.

Surrounding this central hall on three sides are six or eight smaller rooms, with varied exhibits. In one is a

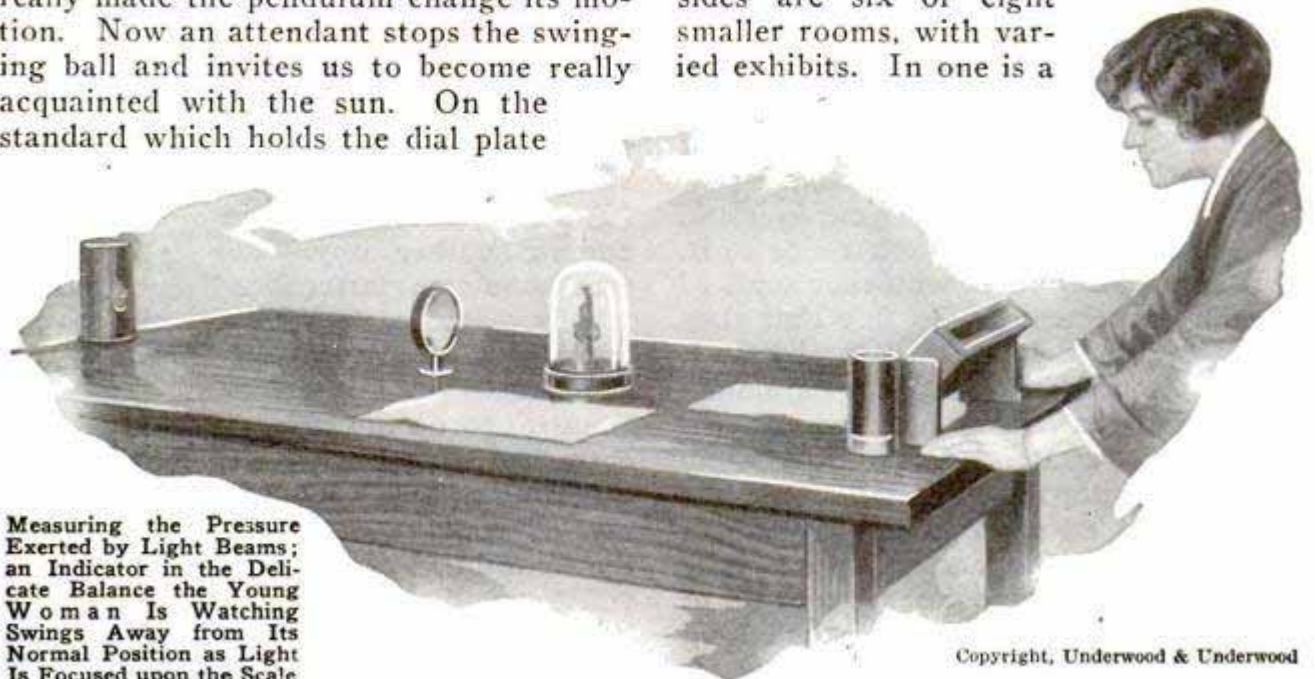

Measuring the Pressure Exerted by Light Beams; an Indicator in the Delicate Balance the Young Woman Is Watching Swings Away from Its Normal Position as Light Is Focused upon the Scale

Copyright, Underwood & Underwood

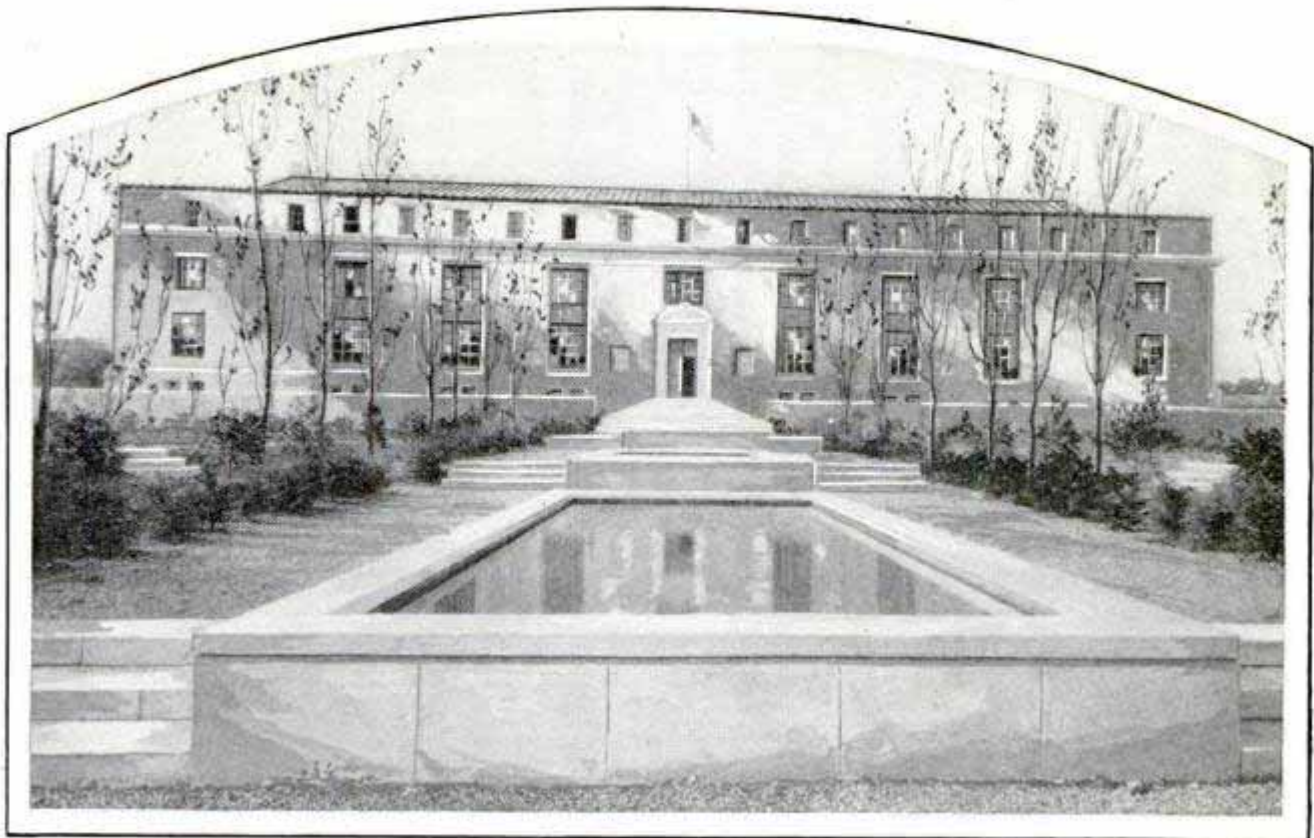

Copyright, Underwood & Underwood

Exterior of National Academy of Sciences Building, Where Marvelous Exhibition of Instruments Is Housed. The Structure Is Located near Lincoln Memorial

machine that shows us the pressure of light, actually at work. At one end of a table you press a button. A motor starts throbbing, and a small electric light on one corner sends out a beam of light through a slit in the metal cylinder inclosing it. The beam strikes a tiny mirror in the center of the table and is reflected onto a scale at the end of table.

In a moment a powerful light at the other end flashes up. By means of a lens it is focused on the edge of a thin silver plate in the center of the table, suspended by a thread of quartz. Its pressure turns the plate, which twists the quartz thread, to which the mirror is attached. This also turns, and the first-mentioned beam, reflected from the mirror, moves along the scale several inches. The light pressure thus made visible before our eyes is about twenty microdynes, a card tells you, or five ten-billionths of an ounce.

In one corner of the room stands a tall glass tube, three or four inches in diameter. "This," said an attendant, "is really our greatest 'circus' stunt." He switched off the ordinary light and pressed a button which lighted up the tube with a beautiful, soft, violet glow.

"Look at my teeth," he said and grinned broadly. The two rows of teeth shone out as if covered with phosphorus—except one false tooth, which was black. He took a handful of silver coins from his pocket. They were darkly tarnished, like a silver teapot that has stood long unpolished. He pointed to a screen of colored flowers. They too glowed with phosphorescent light, and continued to do so even when the light from the tube was switched off. A ghastly blue haze hung through all the air around, but disappeared when I held a card between my eyes and the lighted tube.

This, in short, was the ultraviolet light which stage magicians have learned to use to produce weird effects, and which our darkened ships employed to send each other signals quite invisible to the lurking submarines of the nights of 1918.

We must hurry on. But we must not pass by this long, black, boxlike tube on our right. It illustrates what may well turn out to be one of the most significant discoveries in our efforts to form a conception of the grouping of the innumerable star suns around us.

It was the great Herschel who suggested, more than a century ago, that the spiral

2260

nebulæ might really be vast assemblages of stars, so far off that they seemed like light clouds in our telescopes. He coined for them the term "island universes."

But it was a suggestion only, and the evidence, until recently, seemed to be tending against the idea. It was only a year or so ago that Dr. Edwin Hubble announced from the Mt. Wilson observatory in California that he had fairly conclusive proof that these nebulæ really were great universes of suns.

In the edge of the largest and brightest of the spirals, that in Andromeda, Dr. Hubble, with the aid of the giant 100-inch reflector at Mt. Wilson, had been able to resolve the misty light into separate individual stars. Among them were some which varied regularly in brightness, in precisely the same manner and over the same periods as certain variable stars in our own galaxy, or universe.

The faintness of the variables in the edge of the Andromeda spiral indicated that they were somewhere near a million

light years away, far too great a distance for them to be included in our own system. They must therefore belong to another universe, that of the spiral formation itself. It is awe-inspiring to remember that there are estimated to be some 700,000 or 800,000 spiral nebulæ in the skies. Each one presumably is a separate universe containing billions of suns.

From the sublime to the ridiculous is only a step. As we pass again into the central hall we find ourselves suddenly in the company of a group of high-school boys and girls talking all sorts of foolery into a mouthpiece. They are really watching the sound waves of their own voices.

Many things in this temple of science we have not touched upon. But certainly there is enough to make us appreciate more fully than before the profound meaning in the inscription around the dome:

"To Science, Pilot of Industry, Conqueror of Disease, Multiplier of the Harvest, Explorer of the Universe, Revealer of Nature's Laws Eternal Guide to Truth."

SINGLE CRYSTAL OF COPPER SEVENTEEN INCHES LONG

933

Weighing slightly more than twelve pounds, seventeen inches long and two and one-eighth inches in diameter, a single crystal of copper has been prepared at an eastern research laboratory. It was withdrawn from the furnace at the rate of but a quarter of an inch an hour to permit the atoms to arrange themselves in regular manner throughout the entire piece. One of the outstanding properties of the single-crystal copper is that it will conduct electricity thirteen per cent more efficiently than the ordinary metal, which is composed of tiny crystals in chaotic arrangement. Another property of the single crystal is that a rod of it is easily

bent, but when this is done, it is immediately broken up into small crystals and becomes as hard to bend as ordinary copper.

FIRST ENGINE USED BY EDISON STILL IN SERVICE

222

The original steam engine used by Edison in 1881 to make electrical current for lighting purposes is still in daily service at a laundry in Mount Carmel, Pa. It is said to be in good condition and is the sole means of operating the plant's heavy machinery. Edison drew up the specifications for it and made the installation. Mount Carmel was the second town in the world to be electrically lighted. It was equipped shortly after a system had been installed at Sunbury.



One of the Magic Products of the Scientist's Laboratory, a Single Crystal of Copper

Henry Bartlett, New Bureau General Electric Co. Schenectady N.Y.

Emb. Nelson W. Williams Mt. Carmel Pa. Mt. Carmel News Editor

LETTERS TO EGYPTIAN KING ARE BROUGHT TO LIGHT

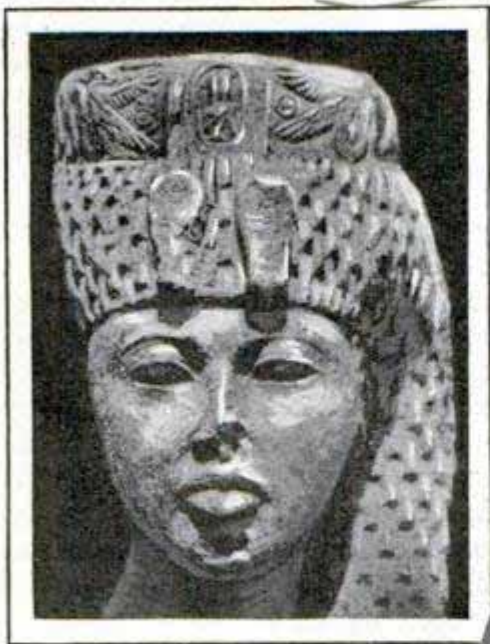

At Upper Left, Queen Tiy, Mother of Akhnaton, King of the Egyptians, Appearing at Right; and Below, the Letters, Written in Cuneiform Script on Clay Tablets

Courtesy American Museum of Art



Dating back more than 3,000 years, a series of letters have been found written on tablets of clay, which are as well preserved as if composed yesterday. They are known as the Amarna letters and two of the series of letters addressed to the Egyptian ruler of the time have been acquired by the Metropolitan Museum of Art. The letters written to Akhnaton, who was known as the heretic king, are of special interest as they are almost the only source of our knowledge of ancient near-east diplomacy, especially as regards the relations of Egypt with her neighbors of Asia. They were written on clay tablets which measure only a few inches in the largest dimension. The script is the so-called cuneiform or wedge-shaped writing, each tiny wedge being made by the scribe in the soft clay with the end of a reed stylus. After the letters were written in enduring form, they were baked hard and the writing was thus preserved for centuries. One of the letters has been translated and reads as follows:

"To the King of Egypt thus speaks Ashur-uballit, King of Assyria: May it

be well with thee, thy house, thy wives, thy chariots, and thy warriors! I have sent my messenger to thee in order to see thee and to see thy land. That which my father hath not sent have I now sent to thee. One splendid chariot, two horses and one . . . of beautiful lapis lazuli have I sent to thee as thy gift. The messenger whom I have sent to thee to see . . . let him see and then go! Thy desire and the desire of thy land let him learn and then go!"

**SUN SHINING THROUGH BOTTLE
225 STARTS FOREST FIRE**

Empty pop bottles have been instrumental in starting forest fires in the California preserves, it is reported. The glass acts as a magnifier, concentrating the sun's rays and, if the heat is sufficiently intense and dry grass is near, a small blaze is started that may rapidly develop into a serious fire. Airplane-patrol service forces have been made aware of this added hazard and take extra care in surveying sections visited by tourists.

*Chicago Evening Post
11/3/26*

196



John Merton Wearing Suit, Shoes and Hat Woven of Cornhusks, Dyed to Produce Design

SUIT AND SHOES OF CORNHUSKS COST TWENTY CENTS

At an expense of only twenty cents for thread, a Missouri man has made himself a suit, hat and pair of shoes from cornhusks. The material was cut in strips and woven into a sort of fabric. A design was worked in pieces dyed red and blue. The question of buttons for the coat was solved by using corncobs.

LOCK HANDLE FOR MILK CANS ELIMINATES USE OF WIRE

As a substitute for cumbersome wiring, or other methods of fastening, a milk-can cover, lately introduced, has a handle that locks securely to the edges of the container and will not come off unless released in the regular way. This is done by pulling the handle. To lock the top, one of the lugs on



I. V. Silveira,

Box 330,

Calif

the cover is placed in a slot on the can and the other side is pressed down firmly. This arrangement protects the contents in case of accident.

MONKEYS CAPTURED WITH RUM BY AFRICAN NATIVES

199

An easy way to capture monkeys has been discovered by African bushmen. They place a bottle of native liquor under a tree where the monkeys play. The animals, attracted by the odor, drink and become intoxicated, then fall asleep. They awake in cages. Twenty-nine taken in this way were recently brought to this country by George M. Bistany of the Bronx zoo. He declared that they dance, play and sometimes fight when under the influence of the drink.

New York Sun

CODE CHECK FOR RESTAURANTS HELPS KEEP ACCOUNTS

366

Most restaurant pay checks simply state the amount due from the patron, but a special form, recently devised, is intended to show which dishes are the most popular and how much is being spent for that particular article. In addition to punching the total due to the cashier, the waiter perforates the slip at the names of the various kinds of food. These are conveniently arranged and cover practically every item likely to be included in the restaurant menu. For table service, a hand punch is employed. At counters, a special perforator with a holder for a pad of checks is placed where it is accessible to several attendants.



ELECTRICITY DRIES DATES

242

Moisture absorbed by dates after picking, is removed at a western packing plant by placing the fruit on trays in small rooms into which electrically heated air is blown under slight pressure. The system is said to have been helpful last season because late rains threatened to spoil much of the crop.

4317 McVigley av.
Pres. M. P. Schmitt

Service Systems Co.
Los Angeles, Calif.

Ethylene gas

General Electric Co
Schenectady, N.Y.

204
Herbert & Hojas
THE JAZZ-MUSIC MAKERS OF OTHER DAYS

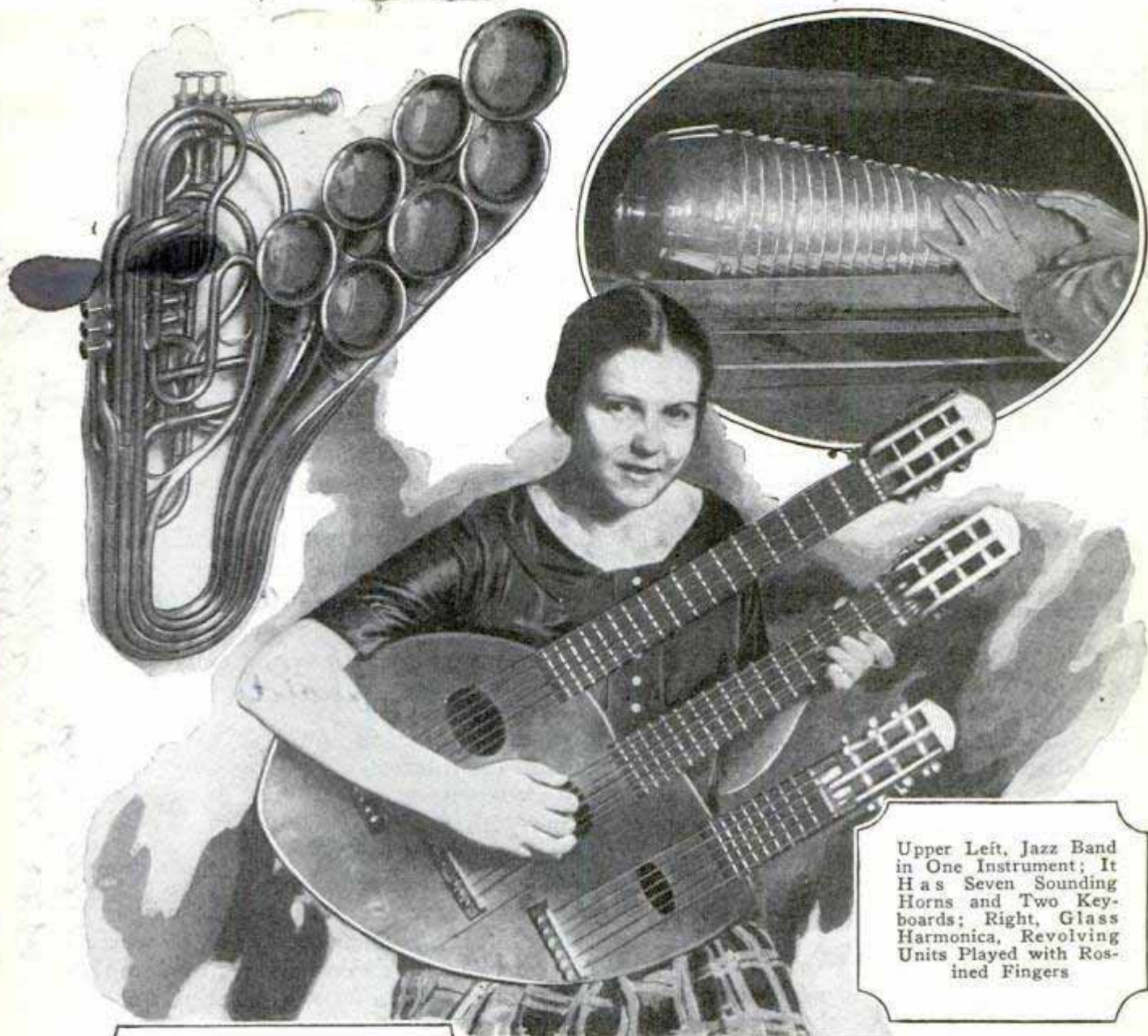

Upper Left, Jazz Band in One Instrument; It Has Seven Sounding Horns and Two Keyboards; Right, Glass Harmonica, Revolving Units Played with Rosined Fingers

A Piece Popular in the Nineteenth Century, the Triple Cithara, Suggesting the Double Guitars and Banjos of the Present-Day String Bands

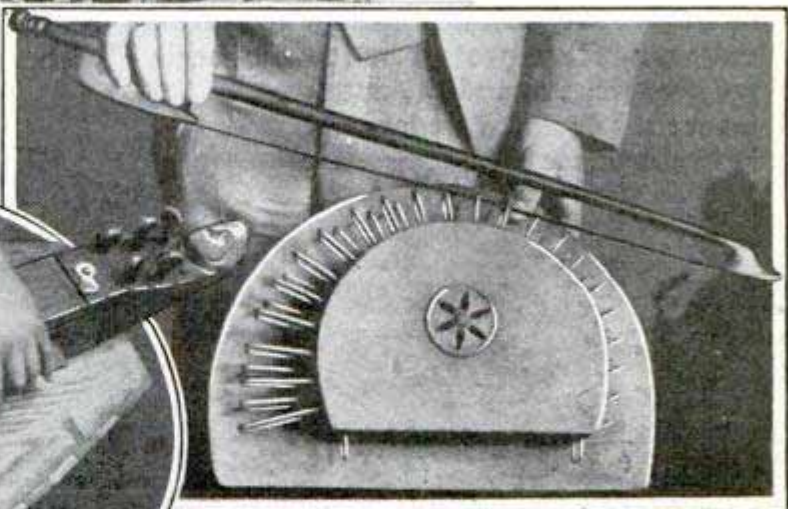
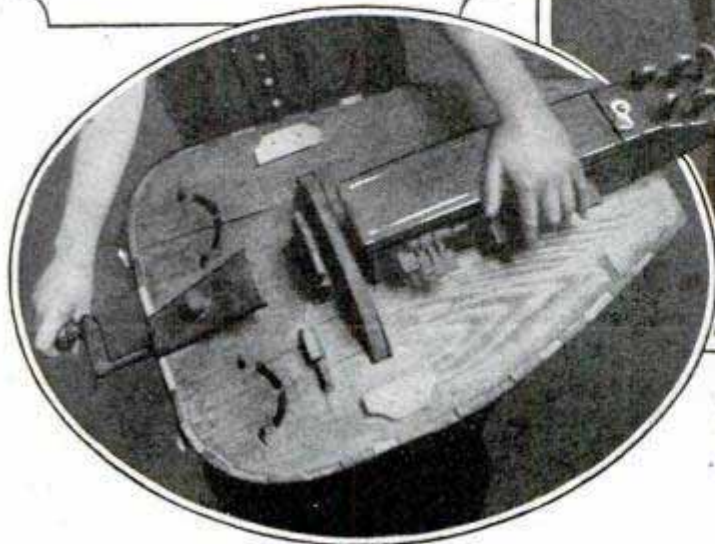

At the Left Is the Turning Lyre of the Seventeenth Century, the Possible Forerunner of the Hurdy-Gurdy and Its Sprightly Tunes; Above, an Oddity Even among Antiques, the Nail Violin Played by a Russian Musical Director

Wickliffe Ohio
**PUSH-BUTTON METAL LADLE
 CONTROLLED BY ONE MAN**

1859

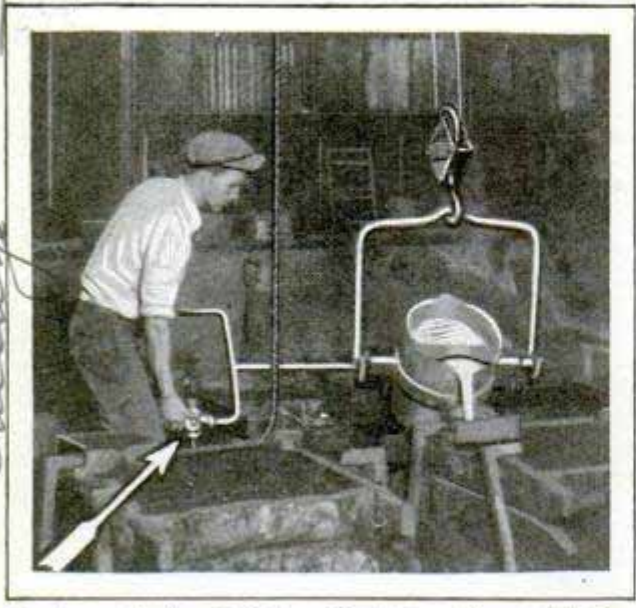

Pouring a Ladle of Molten Metal from Suspended Carrier Equipped with Handlebars to Simplify Operation

Running on a rail attached to the ceiling of the foundry, a metal pouring ladle now on the market can be raised by means of a push-button control attached to the handlebars beneath the operator's thumb so that it can be manipulated by one man. The carrier can be pushed by hand or moved electrically.

shielded as much as possible to prevent punctures, as the course of the race lay far from repair stations.

**SAFE SUBSTITUTE FOR IODINE
 IS NON-POISONOUS**

Potassium permanganate is being recommended as a satisfactory substitute for iodine in treating cuts and bruises. It is said not to burn or smart on application, keeps indefinitely in the dry state and eliminates the danger of overdoses, as it is not poisonous. For ordinary usage, half a teaspoonful of the crystals dissolved in a cup of water is sufficient, but a teaspoonful is recommended for ivy poisoning. In severe cases, such as snake bite, the dry crystals are pressed directly into the wound or into small incisions about it.

Kansas City Star 7/25/26

**GAME OF LETTERS AIDS YOUNG
 IN LEARNING TO WRITE**

Formation of letters and words is made an interesting and instructive game with a set of cut-out pieces of thirteen different shapes. There are ninety-eight units to the outfit, from which nearly 250,000 words can be spelled. The pieces are of durable material and form letters in script, not in the usual capital styles of the ordinary blocks, so that the child becomes familiar with the characters he will use in writing.

1940

Alphabets

POPULAR

about 30¢

© C. A. Oldroyd

William Parley, 38-39, Wearney St., Birmingham, Eng.

**CROSS-COUNTRY RACING AUTO
 HAS PROTECTED TIRES**

Designed for traversing rough country as well as for speed, a Belgian racing car combined several interesting features. Heavy mudguard protectors for the wheels were conspicuous and the auto's lines were calculated to decrease wind resistance. The tires were

138

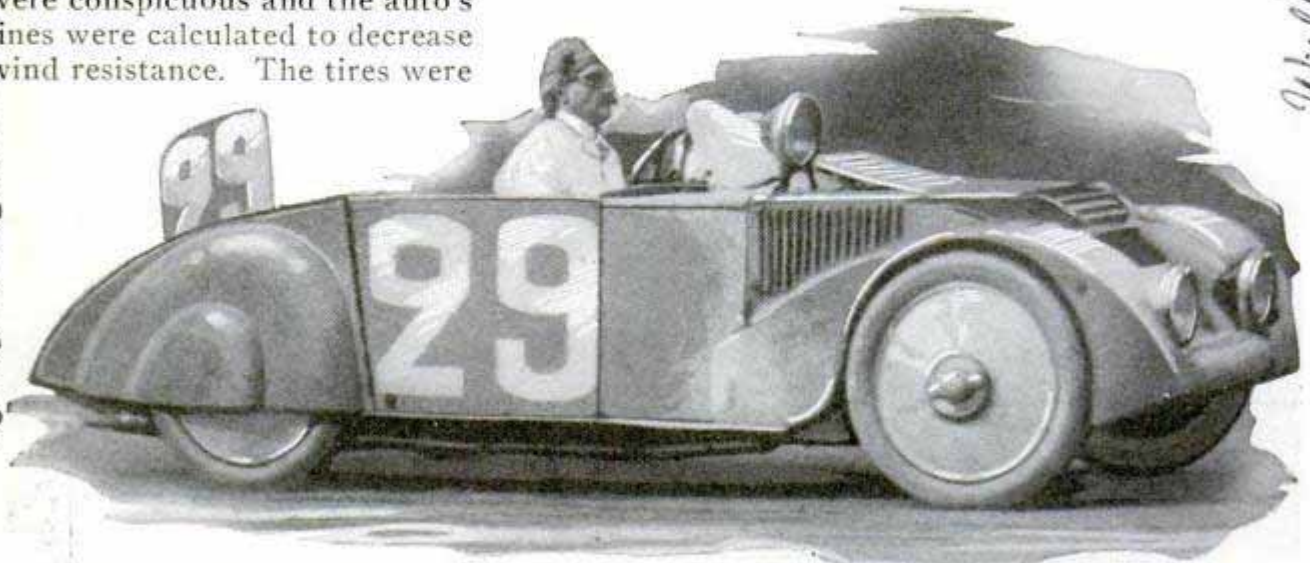

Designed for Heavy Going as Well as Speed; Belgian Racing Automobile with Its Guarded Tires and Streamline Body to Decrease Wind Resistance; Note the Protected Headlights and "Spot" near Driver

Introduced at Belgium's Grand Prix

80 E. Jackson Blvd. Chicago

Charrard and Walker car

**KLIEG LIGHT MADE
-HARMLESS
BY SCREEN** 290

Injurious effects to the eyes caused by the short violet rays from the lights used in motion-picture studios, can be avoided, the bureau of standards has suggested, by placing a screen of glass in front of the arcs. This shield is to contain a small percentage of a chemical, cerium oxide, and is intended to absorb the short light rays that injure the vision. A sheet of common window glass, about one-fourth of an inch thick, would prevent some of the harmful rays from reaching the eyes, the investigators declared, but the specially treated screen was found more effective. Adoption of the suggestion would necessitate the use of white or yellow-flame carbon electrodes in the arc lights and the film would have to be prepared in such a manner as to become sensitive to the red and yellow region of the spectrum the bureau scientists believe.

956

**SCREWDRIVER OF SEVEN EDGES
FITS ON KEY RING**

Seven working edges, ranging from one-eighth to three-fourths of an inch in width, give a key-ring screwdriver now on the market more than ordinary usefulness.



It is all metal and the part corresponding to the handle affords wrenchlike turning leverage so that it is almost as effective as a larger tool and will function in difficult places where the common type could not easily be used.

*Wash Sales Corp.,
4809 N. Ashland Ave*

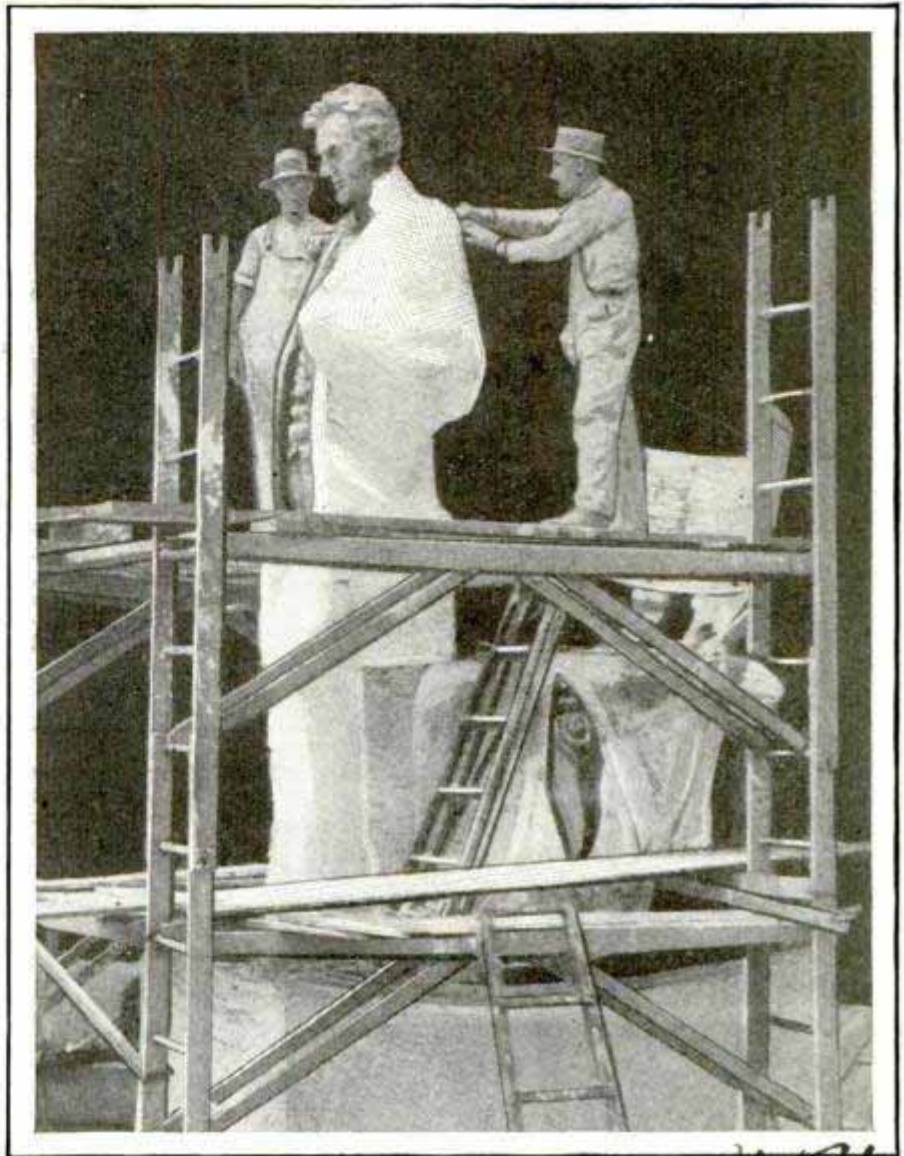

Fashioning Molds of Famous Lincoln Statue Directly from the Bronze in Chicago Park; Plaster Was Removed in Sections

**CAST OF LINCOLN MONUMENT
MADE IN OUTDOOR STUDIO** 20

Because the original molds could not be found, craftsmen prepared a duplicate of the famous St. Gaudens statue of Lincoln for the sesquicentennial exposition, directly from the bronze monument in Lincoln park, Chicago. An outdoor studio was constructed of canvas and scaffolding and the plaster casts molded in sections, preparatory to making the copy of the figure. This statue, showing the great president standing, was unveiled in 1887 and is the better known of the two Lincoln monuments by St. Gaudens in Chicago. In the other the figure is seated. It was recently erected in Grant park.

☐ Natives of Africa use 800 languages and dialects.

2162

To Save Work



Rubber Safety Handle on Electric-Cord Plug, Prevents Shocks and Burns and Reduces Breakage of Wires

For Lifting Ice-Cream Cans, This Handle Clamp Grips the Raised Collar and Holds Tightly as Container Is Removed



Marred Floors and Bothersome Noise Are Eliminated by Using This Rubber-Insulated Chair Tip



Automatic Toaster Shuts Off Current When Bread Is Browned Sufficiently, Saving Electricity and Scorching; Levers at Side Regulate the Operation



Gas Supply, for Cooking, in Cylinders Outside of House



Combination Cleaning Crayon and Chemical Brush Pad for Removing All Kinds of Spots

2162

in Your Home



Strainer and Immerser for Cooking Greens Fits on Saucepan Rim



Electric Water Purifier of Convenient Home Size, Operates from Lamp Socket and is Said to Remove Chlorine Taste and Odor While Consuming but Little Current



Traveling Dining Room for the Birds; This Sheltered Feed House, Suspended on Cable, is Drawn In for Filling, Then Pulled Back, Away from House Where Birds May Gather without Fear

Sore Knees Are Prevented While Scrubbing Floors by This Soft-Rubber Pad Which Also Protects Clothing



Electric Heating Unit for Liquids Slips into Basin
about 2.50



Handwritten notes on the right margin, including 'about 2.50' and other illegible scribbles.

Washington St E. Slattery June
Cordova Alaska

83



Drawing, Showing Housewife Using Microphone Installation to Call Maid, and Diagram of Circuit

MICROPHONE FOR HOME USE — SUBSTITUTE FOR BUZZER

Essentially like the microphone used in radio transmission, a small unit for home or office saves steps and the confusion that often results from a buzzer. The operator speaks his orders into it just as he would into a telephone mouthpiece. Servants or clerks thus learn what is wanted without having to make a trip in response to the signal. The outfit is simple to install and may be connected to the buzzer wires already in use. A battery of not more than six volts should be used, in order to prevent burning out the carbon in the transmitter.

COSTLY CHINESE DRUG MADE BY SYNTHETIC PROCESS

Solution of a medical riddle that has perplexed investigators for more than forty years is reported from the university of Illinois in the discovery of a process for making ephedrin, a valued Chinese drug, synthetically. In the natural state, the product is obtained from a plant and is considered beneficial in treating nasal troubles and as a substitute for adrenalin. High costs prevented marketing it extensively and, during the last twenty years, many efforts had been made to prepare the drug by chemical processes.

GLACIER RAZES HIGH MOUNTAIN IN ALASKAN RANGE

194
Clouds of what appeared to be smoke, rising from a peak not far from Cordova, Alaska, led to reports that a volcano was in action. Investigation showed that there was no eruption, however, for the supposed smoke was dust caused by slides of soft shale from a mountain 3,000 feet high being pushed over by a glacier. The ice mass had changed direction. Its terrific pressure against the base of the spur had dislodged the upper strata. It is believed that the lofty peak, in time, will be reduced to a mere hill.

CORROSION PLATES FOR SHIPS 185 PROTECT STEEL HULL

To prolong the life of the steel hulls of vessels, zinc plates, bolted to the keel opposite the propeller are said to be effective. They take up the chemical action produced by the blades revolving in contact with the salt water, an effect similar to that which occurs in a wet-cell battery. The zinc units function as positive plates so that the corrosion on the steel is minimized. The strips last several years.

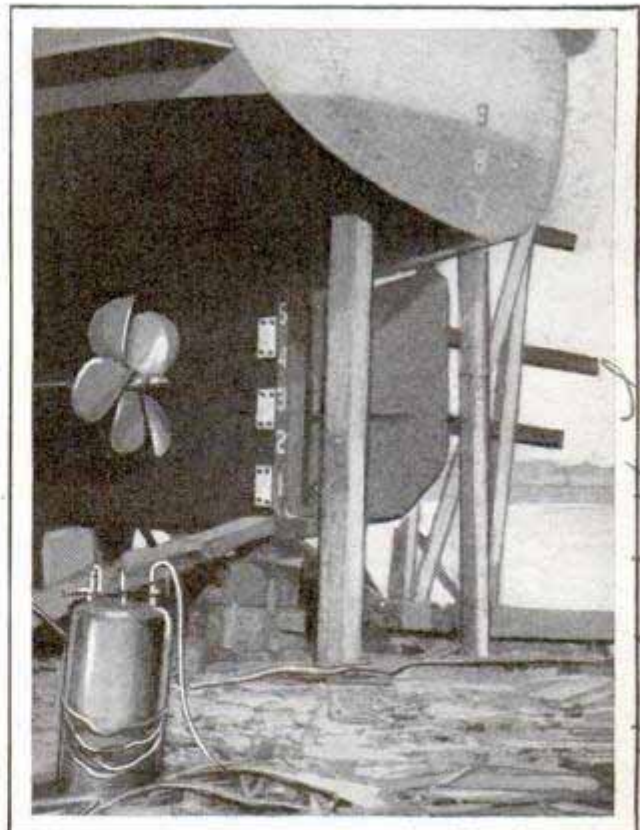

Protecting Plates Are White Squares to Left of Figures on Hull; They Prevent Corrosion

Chicago I saw portable Bldg. Edwin J. Kelly

under direction of Prof. Roger Adam 718

Howard A. Israffis, Richmond, Ohio student.

Comb. Herbert H. Lemmon 105 Longton St., Bay City, Mich.

SHADOW BOX FOR PRISONERS TO END THIRD DEGREE

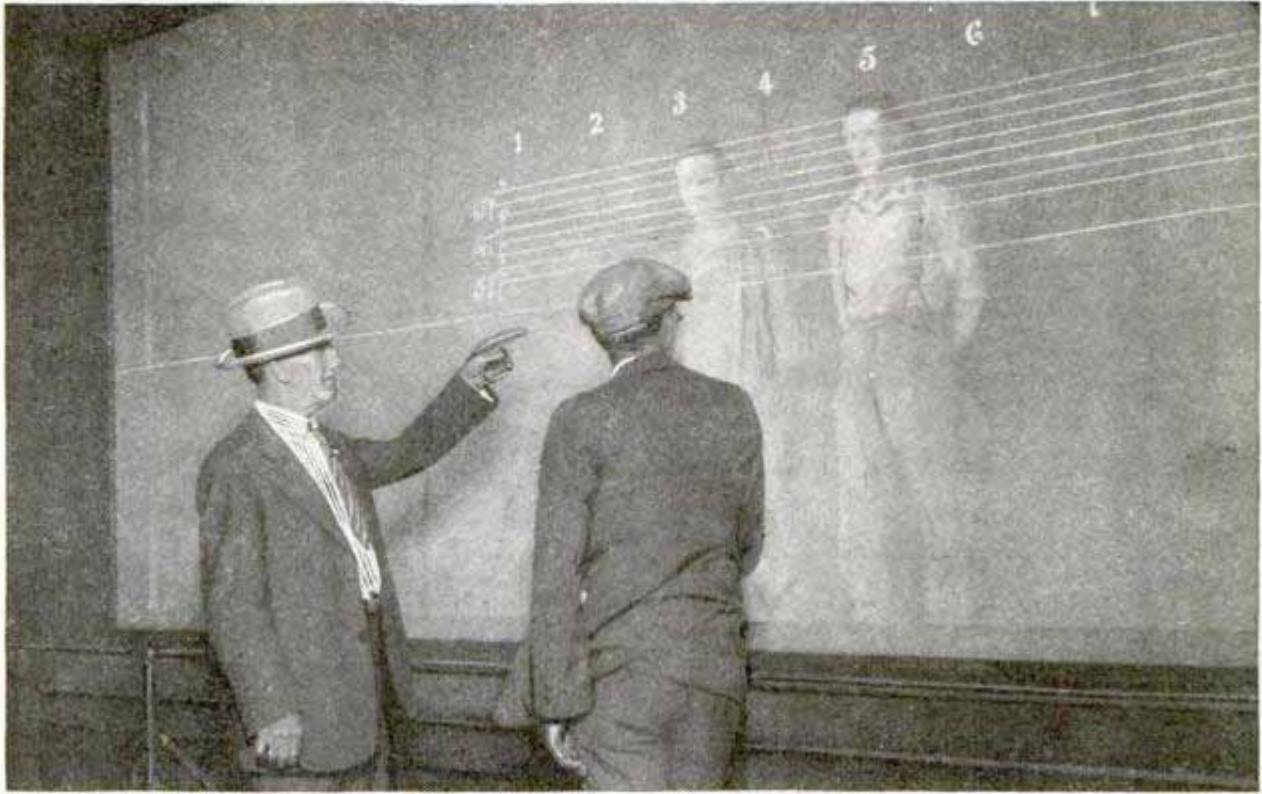

Questioning Men behind the Shadow Screen; There Is a Numbered Space for Each, and Cross Lines Give Height Measurements; Suspects Cannot See Their Questioners

As a substitute for violent third-degree tactics, Los Angeles police have been using a shadow box in questioning suspects. Prisoners stand on a low stage, with a curtain in front, and lights are so arranged that the persons on the platform cannot see anyone on the other side of the drop, but the police have a clear view of the suspects' faces and can study their mannerisms and movements unwittingly revealed. It is thought that this arrangement may help in obtaining confessions from prisoners, as the men are not so likely to assume the mask of defiance or indifference which has often been found hard to break in an open interview.

**PRESENT TYPE OF STEEL HAT
BEST HEAD PROTECTOR**

"Tin hats" of the type used during the war to protect the heads of American soldiers from rifle bullets and shrapnel are not to be discarded by the army, according to a recent announcement, as they have been found more efficient than other styles. Experiments were made with helmets similar to those used by spearmen in medie-

*Tests made at
Infantry School.*

val days, with others like the Germans wore and still others resembling the helmets worn by the Crusaders. Under strenuous tests with machine-gun and rifle fire, the present type proved superior, according to the findings of the infantry board and recommendations were made that this kind be retained.

**SPECIAL AUTO-CHASSIS OILERS
SIMPLIFY LUBRICATION**

2125
Oiling the auto chassis with one hand and in a few minutes is said to be simple with the aid of special valve oil cups and an improved can. Motor oil is used instead of grease, the cups being fitted with a valve which supplies the lubricant as needed. The spout of the can is shaped so that the cup lid can be opened with it, flushing and filling the holder with one easy motion.



*Direct Lathe & Grinder
Corp. Brighton District*

*621 W. Washington
St. Chicago*

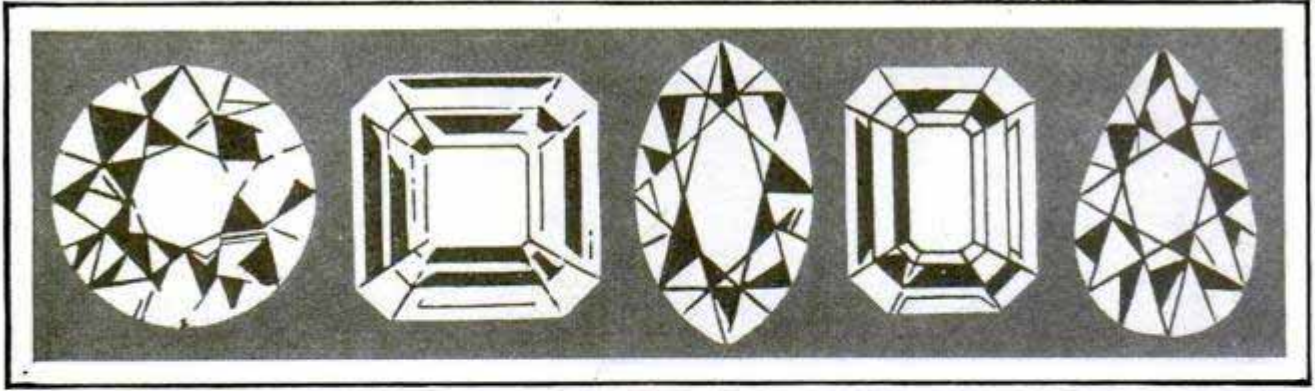

Five Standard Ways of Cutting a Diamond; from Left to Right, Round Brilliant, Emerald-Cut (Square), Marquis, Emerald-Cut (Oblong), and the Pendeloque, Popularly Known as Pear-Shaped

Diamond Digging in the Wilds

Strange Stories and Tragedies of the World-Old Search for the Queen of Gems

ONE of the strangest mile-long foot races ever run was staged one day last spring when thousands of men and women toed the mark under a blazing south African sun waiting for the starting gun in a dash which brought to a few great fortune and to the vast majority bitter disappointment. The occasion was the opening of a new diamond field. For miles along the sun-parched veldt, the hordes had gathered, coming by automobile, buggy, huge Boer vans drawn by oxen, lumbering plains wagons and on foot. They met in a desolate land where hardly a blade of grass or a stunted bush could be found. There were no wells or springs for miles, and hucksters selling water in small casks at \$1 each did a land-office business.

A mile away lay the future diamond mines, a roughly circular bed of blue clay extending down to unknown depths—a true "diamond pipe," once the vent of some long-extinct volcano through which the boiling blue-clay mud had simmered up from below. Each man and woman along the starting line, toeing the mark laid down by the wardens, carried four

small stakes to mark the corners of the hoped-for claim.

The reason for the stampede, which drew workers from other diamond fields, farmers from the veldt and clerks and adventurers from distant cities, was the accidental discovery of \$70,000 worth of diamonds, lying on the open ground. The government opened the pipe for mining, and



Diamond Sorters with a Vast Fortune in the Rough Dumped on the Table before Them; a Scene from a Diamond Mine

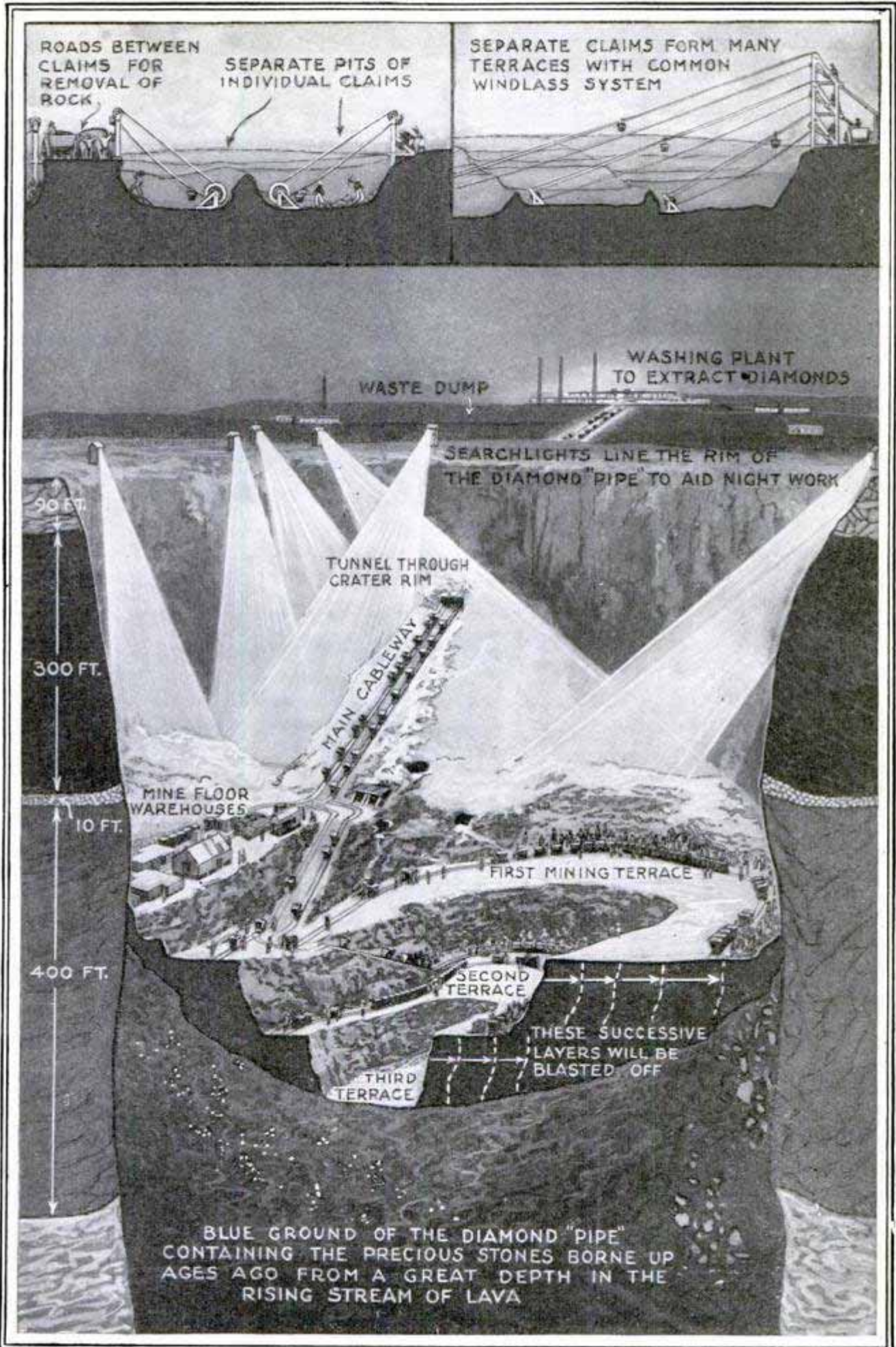

laid down the rules for claims. Eventually all the separate claims probably will be sold to one of the big operators and merged in one, for bucking the world's diamond syndicate is a losing game. The supply of diamonds on the market is strictly limited to what the world can absorb, in order to keep up the prices.

Diamond mining is like no other form of wealth extraction. The south African mines, richest ever found, are invariably the "pipes" through which the crystallized carbon, manufactured in the intense heat of the center of the earth and compressed under the vast weight of the surface land, was forced upward along with boiling blue mud, to cool and remain for untold centuries until accidental discovery by man. The diamonds found in this country, in the Ozarks of Missouri and Arkansas, are of entirely different origin, appearing usually in mountain-stream beds. Where they came from no one knows.

Once a pipe is found and the first claims staked out, the work of getting out the soft clay begins. As dug from the mine it is of puttylike consistency, but when dried and rotted in the sun it can be crumbled and washed away. Portions of the diamond-bearing clay are left between the claims at the start, to serve as roads over which the mined earth can be hauled to the drying grounds. Later the roads are blasted away, tall spars erected all around the deepening pit, and tramway buckets, running down to each claim, haul the material to the surface. A big pipe is covered by a network of tramway lines, each individually owned.

System arrives when the big operators step in, buy up and consolidate all the claims. In the center of the pipe they sink a fifty-foot pit, and begin blasting away its sides, working steadily outward toward the rim. When the work has progressed

far enough, another pit is sunk, and a second terrace started, followed later by a third, and if the pit is large enough, even more.

Electric railways replace the crude aerial skips, and tunnels are driven through the rim rock to form an easy grade to the drying fields and the washing plant. Giant searchlights, spotted about the rim, light the mine by night, so that work never ceases. Fences, electrically charged, armed guards, barbed-wire entanglements and other safety measures discourage thefts, and the workers, usually natives enlisted for periods of months or a year, are herded into fenced villages, searched night and morning, and guarded as closely as though in prison.

South Africa has strict laws against illicit diamond buying, but in spite of laws and the precautions taken, "I.D.B's.," as the buyers are called, continue to flourish, for a stone worth thousands, even in the rough, is easily hidden and hard to find.

One of the largest of the diamond mines—the Premier, of Wesselton—was not so very long ago a rubbish heap for a near-by township. How the diamonds are extracted is an interesting story. The blue clay holding the gems is dumped into bins and conveyed in electrically driven cars, running on an endless track, to the floors of the receiving

grounds. In the famous de Beers mines, these grounds stretch for four miles, and each floor can take 50,000 truck loads. In this clay, the rough diamonds may be as big as walnuts, but they are invisible even to people walking over the ground.

Now, the blue stuff is broken up and hauled to washing machines. There revolving arms on a vertical shaft, tipped with great steel teeth, force the diamonds to one side, while the thin mud is shot from the center through an outlet. The diamonds are put into trucks with locked

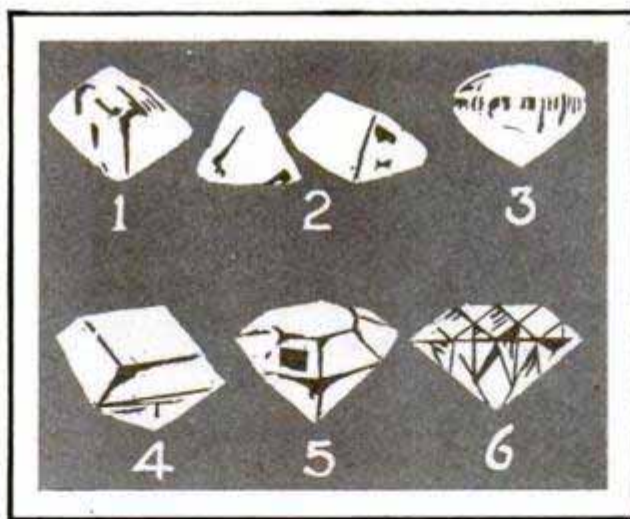

Stages in Cutting: Rough Diamond, Rough-Sawed, First Shaping, Lopped Four-Square, Eight-Square and the Finished Brilliant

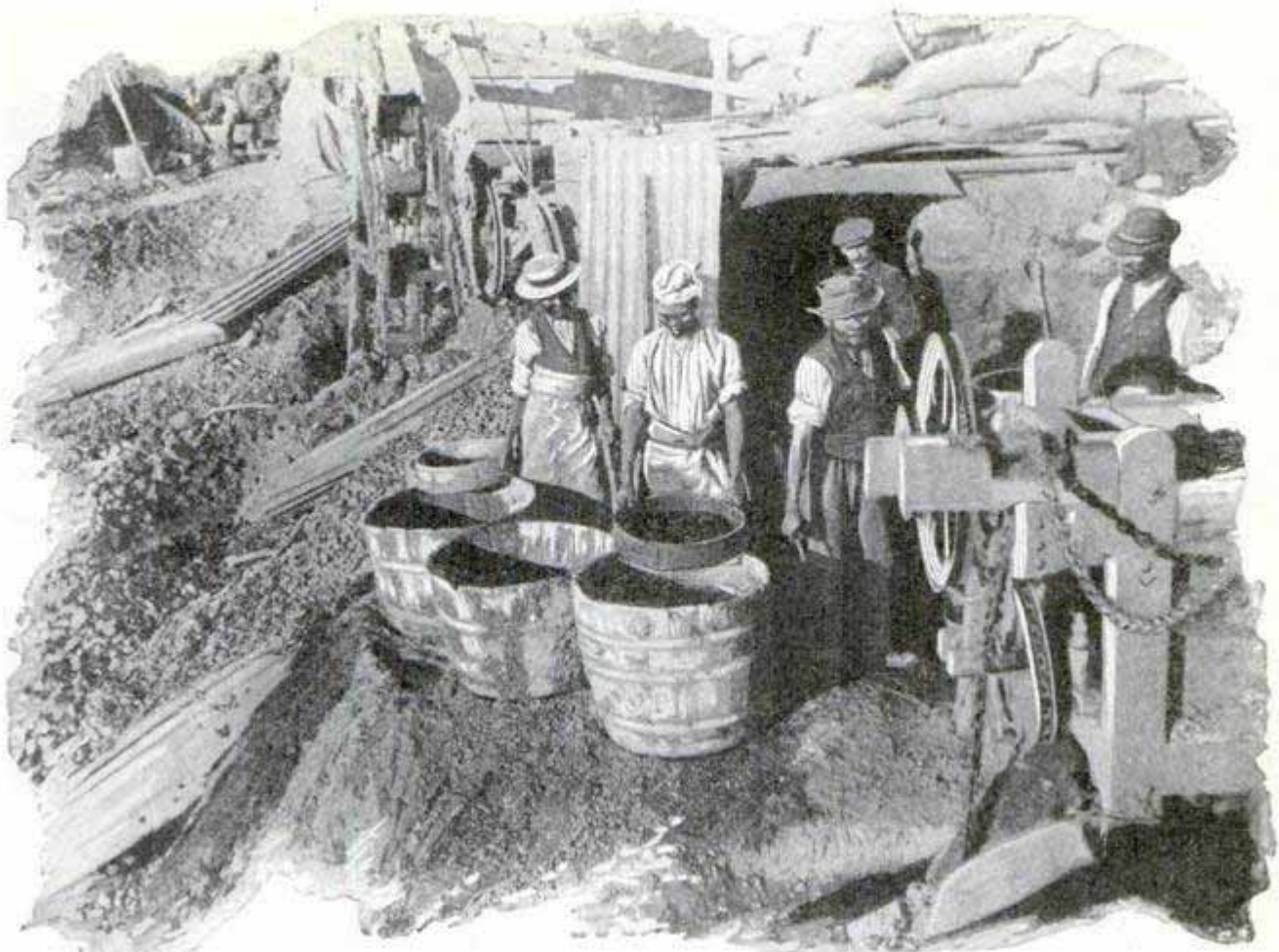

Kaffir Workers Washing Diamonds Out of the Blue Earth at a Crude Diamond Mine; in the Big Syndicate Plants This Is Done by Machines That Automatically Rescue Every Tiny Stone

covers, and taken to the pulsator, to be sifted into five sizes.

A curious story is told of the origin of this diamond searcher or "greased pulsator," which is an agitated canvas unerringly picking out gems from the dirt passed over it. An engine man was oiling machinery when he happened to thrust his greasy hand into a heap of crushed blue clay. On going to wash his hands, he found the blue dirt had vanished, leaving the diamonds sticking to the grease on his hands. This was the origin of the pulsator which does not miss a diamond even if no larger than a pin's head.

When the diamonds have been separated, an armed guard takes them from the sorting table to the general offices of the mine where they are handed over to the valuers. These experts clean the gems by boiling them in nitric and hydrochloric acids.

Now comes the business of sorting the stones, in size, color and purity, before shipping them to New York or London. The finest stones are known as "pure

goods, brown goods and spotted goods." Next in value come those known as "pure cleavage, broken stones, naats or manacles," and lastly the flat triangular crystals called "bort" or "carbonado" without which America would never have had the Panama canal, bort being used to point the diamond rock cutters and drills for the excavation of the Culebra cut.

The purest diamonds scintillate with brilliant prismatic hues, and are colorless, transparent crystals known as "white stones." But they are very rarely found, for more often the digger finds them "smoked" with brown, gray and yellow tints, showing that mineral impurities are imprisoned in the crystals. Nevertheless, an impure diamond may be many times more valuable than a pure one, if it shows a red, green or blue glow. But these colored diamonds are not popular with the digger because they resemble the bits of colored and valueless quartz he daily throws away, and when he does find a colored or "mongrel diamond" he torments himself with the thought that he may have

cast on to the scrap heap many like it. "A blue diamond," said a digger recently, "pinches the pipe," meaning that the promising pipe or bed of stones, will yield no more valuable gems after a blue diamond has been found.

One can make the diamond radioactive so that it will shine in the dark and turn olive green in hue. The method of doing this is to imbed the stone in radium bromide, and the luminosity lasts for twenty years. Diamonds will also shine in a dark room after they have been exposed to sunlight. Sir William Crookes exposed a diamond to a high-tension electrical charge, passed through a vacuum tube, and found it phosphorescing in brilliant colors.

Many of the most famous diamonds are associated with stories of stark tragedy, and shrouded by superstition that they bring bad luck. Take the famous Regent or Pitt diamond which now dazzles the eyes of women who see it under a glass case in the salons of the Louvre, Paris. It was found by a slave in the Partaal mines of India, 225 years ago. To hide it, he cut his leg and concealed the stone in the bandages. It was a 410-carat gem of priceless value, and the slave ran for the coast, where he crept on board a ship, giving the English skipper the diamond in return for his liberty and a small sum. Once out at sea, the skipper threw the poor slave overboard, and later sold the diamond for \$5,000 to a prominent dealer. The captain spent his ill-gotten loot in

drink and died in delirium. From the dealer, the diamond passed to Thomas Pitt, governor of the Anglo-Indian Fort St. George, who paid \$81,600 for it. Pitt cut the stone and had it polished at a cost of \$25,000, selling the dust alone for \$75,000. Then it became a French crown jewel, and when the revolution broke out, it was hidden in a ditch, but a thief revealed its whereabouts to save himself from being guillotined. Napoleon Bonaparte used the gem to raise a loan from the Dutch government.

The Orloff diamond (194 carats) was stolen by a French sailor from the eye of an idol in a Brahmin temple. From him, it was stolen by a ship's captain who murdered him to get possession of the great jewel. Finally, Prince Orloff bought it for \$4,500,000 and presented it to Catherine the Great of Russia. Then there is the ravishing Sancy diamond of 53 carats, last known to be in the palace of an Indian prince. It passed successively through the hands of Charles the Bold, de Sancy, the queens Elizabeth and Henrietta Maria of England, Cardinal Mazarin, and Louis XIV. It was stolen in the French revolution, but came to light in the hands of a king of Spain, from whom it went to a Russian prince.

The Nizam of Hyderabad paid \$2,000,000 for the famous Victoria diamond, which weighed 180 carats. But the largest diamond ever found is the Cullinan gem of 3,025 carats, from the Premier mines.

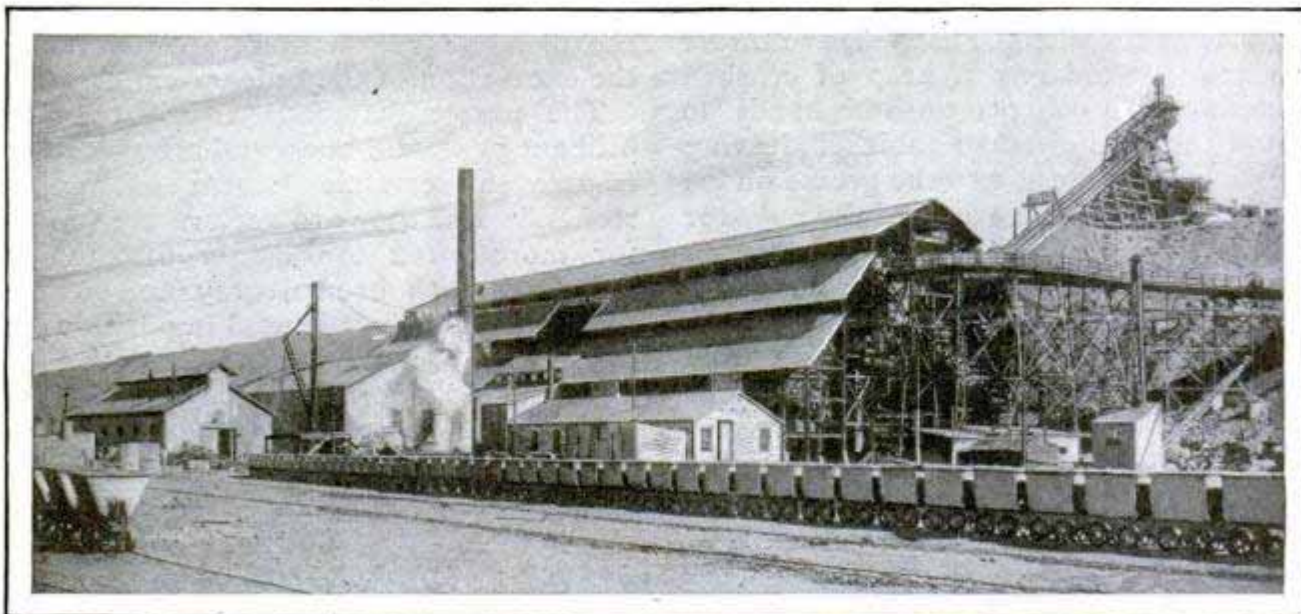

A Train of Locked Cars of Diamond-Bearing Earth En Route to the Washing Plant, at Kimberley, the World's Most Famous Mine; Note the Stored Diamond Earth in the Background

RUMBLE FROM OCEAN'S FLOOR CLUE TO LOST SHIP?

Can sunken ships be located by means of the noise they produce in scraping over the ocean's floor? The possibility is suggested in an odd discovery by Lieut. T. J. Maher while making government coast surveys at the mouth of the Columbia river. A continual rumble was noted in one of the delicate sound-recording instruments being used to determine the depth of the waters. The gauge was taken apart, thoroughly inspected and re-assembled to make sure that the noise was not caused by a defect, but the rumble continued. Lieut. Maher decided that the sounds likely were produced by the grating of a ship's hull on the floor of the sea. Search of the records furnished no clue to any ship sunk at that place, but it was decided to use drag lines to establish the source of the sounds.

Dafette & Corp. Carlin 208 Jay St. Brooklyn, N.Y.

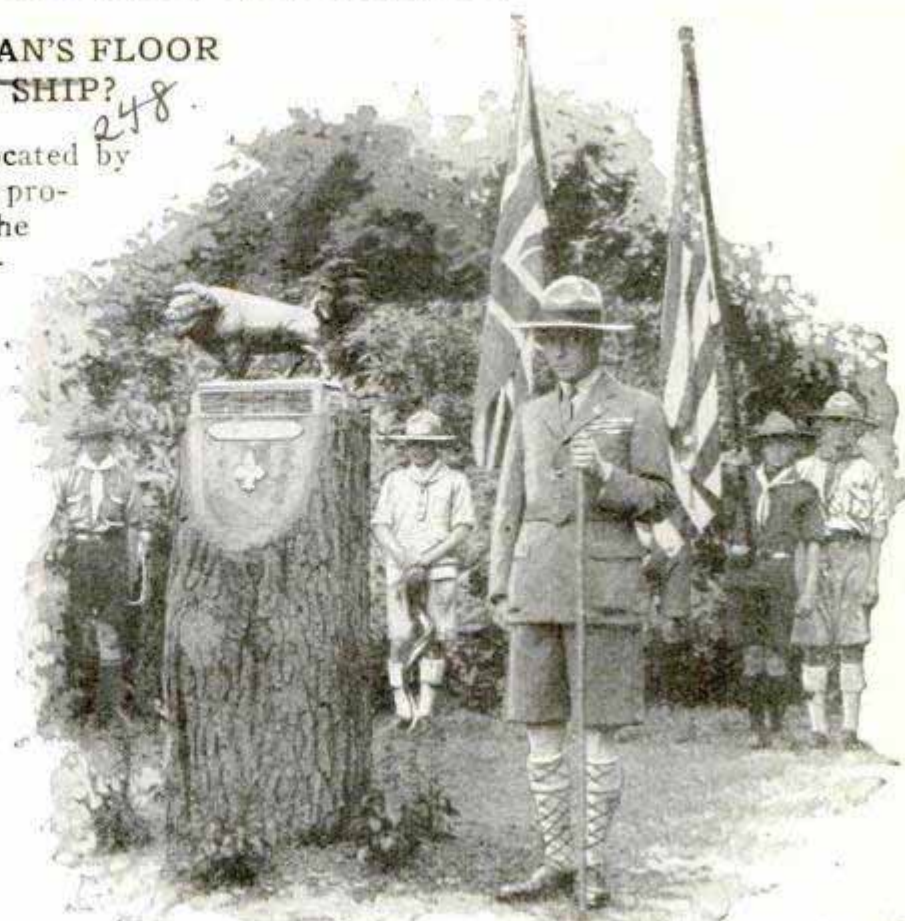

Prince of Wales beside Bison Statue Presented to British Boy Scouts in Memory of Unknown Lad Who Helped American Tourist

UNKNOWN BRITISH BOY SCOUT HONORED BY AMERICANS

Years ago, an unknown boy scout helped an American tourist. His kindly action is reported to have led indirectly to the establishment of the scouts in the United States. In memory of this lad, a bronze statuette of a bison was presented last Fourth of July to the scouts of Great Britain from those of America. It was received from Ambassador Houghton by the Prince of Wales on behalf of the British organization. The monument stands in Gilwell park, near London.

SHAVING BOX FOR TRAVELER — HOLDS COMPLETE OUTFIT

Many so-called pocket shaving outfits carry only part of a set, but a metal, marble-finished cabinet now on the market has space for razor and extra blades, cream and brush too. The entire assembly takes up but little room in the traveling bag.



CEMENT IS TESTED WITH FOGS PRODUCED IN LABORATORY

Fogs rivaling those occurring in nature are directed against cement samples in a laboratory for testing and curing the material. The room is equipped with atomizers which blow a current of compressed air through a stream of water. The thin mist created can be regulated to varying degrees of density. A steel door prevents the fog from entering adjoining rooms.

Portland Cement Association
33 W. Grand Ave.

☐ We want all our readers to write us freely and often whenever they wish additional information on articles published in this magazine. Address Bureau of Information, Popular Mechanics, Chicago.



Where Fun and Instruction Are Combined; Clown Giving Children a Lesson in Fire Prevention and Hazards of Matches

CLOWN AS CHILDREN'S TEACHER WARNS OF FIRE DANGERS

School children receive impressive lessons in the perils of fire, and the best ways to prevent them, from lectures delivered by an expert in clown costume. To illustrate his points, he uses a miniature fire engine and two gigantic matches.

HIVE OF BEES KEPT IN OFFICE TO STUDY INSECTS' WAYS

Interesting records of bees' activities are kept by a college professor who has a hive of them in his office. A hole in the window sash provides access to the box which rests on carefully adjusted scales connected to an automatic recorder. Temperature, barometric pressure and percentage-of-sunshine figures are also kept. From this information charts are prepared, showing the movements of the bees from day to day and month to month. On sunny mornings, the weight of the hive

drops about two pounds between eight and eight-thirty o'clock. That is the time when some 10,000 bees go forth on the first foraging expedition of the day. As they return, the weight increases five or six pounds, reaching the heaviest point at sunset. This is partly due to the presence of the bees and to the large amount of water in the nectar. The workers get rid of much of this by vigorous fanning with their wings. In the afternoons, when the sun shines, there is another drop in weight as the young bees leave for half an hour or so of exercise. Other slight drops, which are not regained, occur when large numbers of old bees die. Many are tempted out by the first warm days and have not strength enough to return. Sometimes 500 or 600 will die in the path of duty daily. One of the mysteries in the life of the bees is how they are able to anticipate the approach of a rain. About fifteen minutes before a shower, they come flying home, sometimes as many as 7,000 pouring through the narrow opening to the hive in ten minutes and looking like a cyclonic funnel as they do so. The shadow of the clouds or cooler air may give them warning, some investigators believe.



Motorcycle Shield Adjusted, Showing How It Protects Legs as Well as Face and Shoulders

CELLULOID GUARD SHIELDS RIDER'S WHOLE BODY

With celluloid windows and a strong sheet-iron frame, a shield for the motorcycle rider guards his entire body from rain, snow and wind. It is intended to afford unobstructed vision and will not interfere with the operation.

Prof. Haver. 235
Ypsilanti Mich
normal school

Bavarian
invented

This Set Tunes from Fifteen to 550 Meters

By FRANK L. BRITTIN

ONE of the most interesting receivers Popular Mechanics radio laboratory has ever experimented with, is a simple three-tube set employing five interchangeable coils of the plug-in type. Bringing in distant stations on the short rebroadcast waves in the daylight as well as after dark, with great volume on the loud speaker, this set proved a real surprise. But it can be instantly changed over for the standard broadcast wavelengths as well by merely changing the coils.

Several of the larger broadcasting stations in this country as well as abroad are now sending their programs on two separate wavelengths. For example KDKA, Pittsburgh, operates on a regular wavelength of 309 meters and at certain times rebroadcasts the same program on 64 meters so that it may be picked up by its sister station KFKX, Hastings, Nebr., and rebroadcast on 288 meters. The short waves do not seem to be greatly affected by daylight or atmospheric disturbances and cover a very wide range,

often being picked up in south Africa with good volume on amateur short-wave receivers. WGY, Schenectady, N. Y., broadcasts experimental programs at irregular intervals on waves between 15 and 105 meters; 2YT, Poldhu, Ireland, on about 94 meters with experimental programs, and G2-NM, London, on about 44 meters, is often heard after

11:00 p.m. Several of the Australian, European and South American stations may also be heard on waves between 30 and 50 meters.

The three-tube set to be described is easy to build, and, as the front panel is only 7 in. wide and 18 in. long, takes up very little space. The front-panel and subpanel layouts are clearly shown in the illustration on the color page; it is important that the detector-tube socket be of the shock-absorber type for eliminating microphonic noises. The grid condenser and leak are mounted in spring clips so as to be readily removable, one end of this mounting being screwed to the detector-socket grid post. For the short waves, a .0001-mfd. grid condenser and a gridleak of from 6 to 9 meg. will give the best results. On the ordinary wave bands, when using either of the two larger coils, better results will be obtained with a .00025-mfd. grid condenser and a gridleak of from 2 to 6 meg. resistance.

In a set of this type every effort must be made to obtain short leads. To this end, the a.f. transformers used are constructed with removable bands or brackets; the latter being reversed and the transformers turned upside down so as to bring the terminals close to the sub-panel.

The base for the plug-in coils is shown in its proper position, and the primary coil mounted

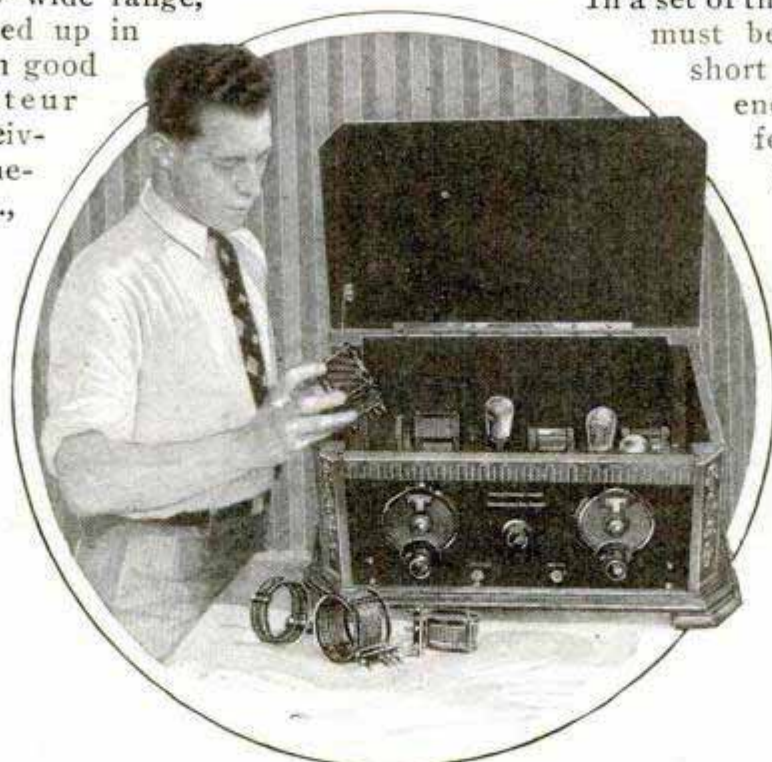

Completed Receiver, in Which Various Types of Interchangeable Coils Are Used

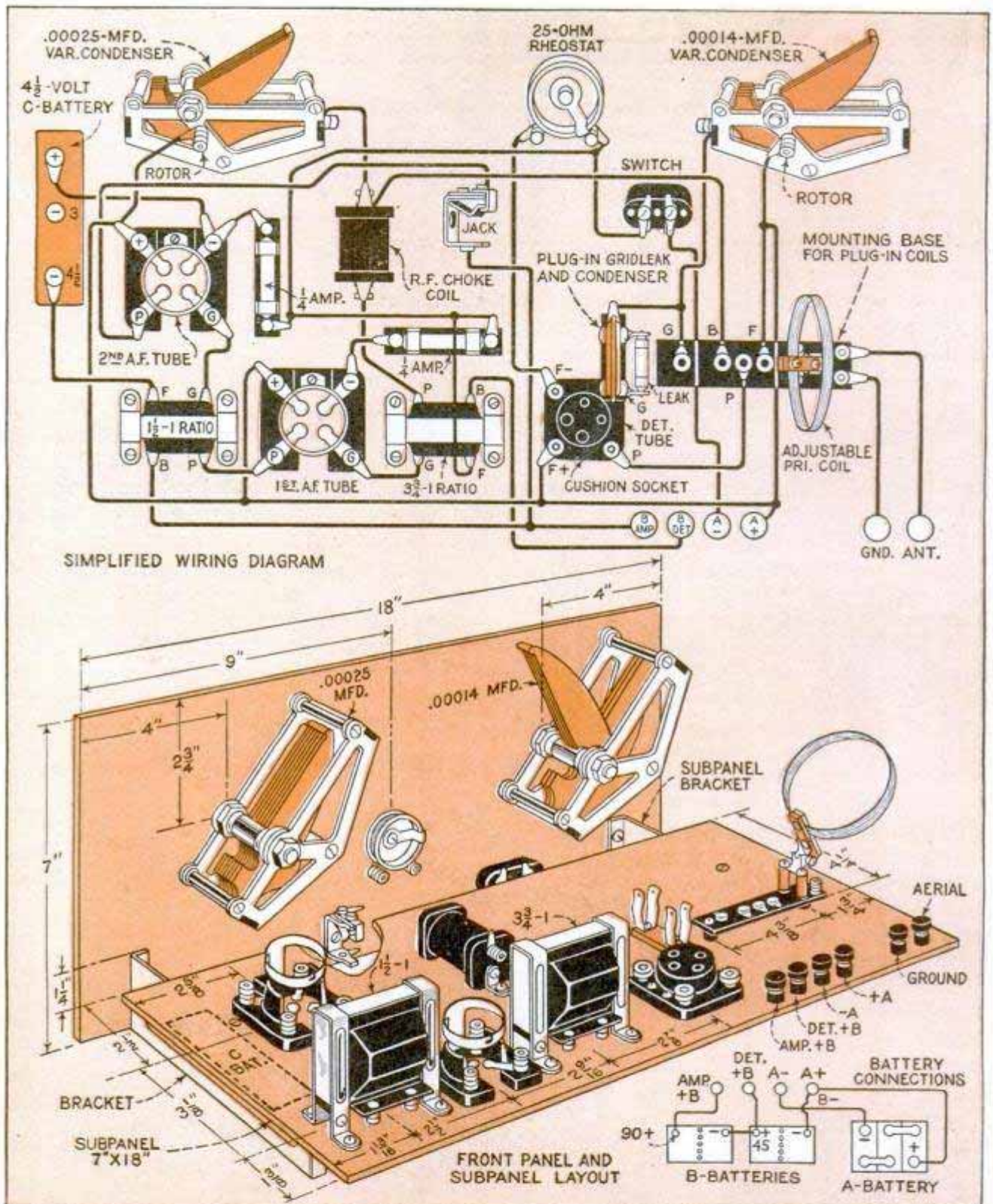

Above, Simplified Wiring Diagram, with All Instruments in Their Relative Positions; Below, Front-Panel and Subpanel Layouts with Battery Connections Shown at Lower Right

on this base may be adjusted for the best coupling with either a short or long aerial. This coil is permanent on the mounting; the plug-in coils are complete units, each consisting of a grid and plate inductance. The circuit used is of the "fixed tickler" capacity-controlled type, which is best suited for short-wave reception and also

gives excellent results on the standard broadcast wavelengths when the proper coils are used. The wiring diagram is given above the instrument layout, and is extremely simple to follow. Soldering lugs should be used under all terminals. A schematic diagram is supplied for those who prefer it to the simplified form.

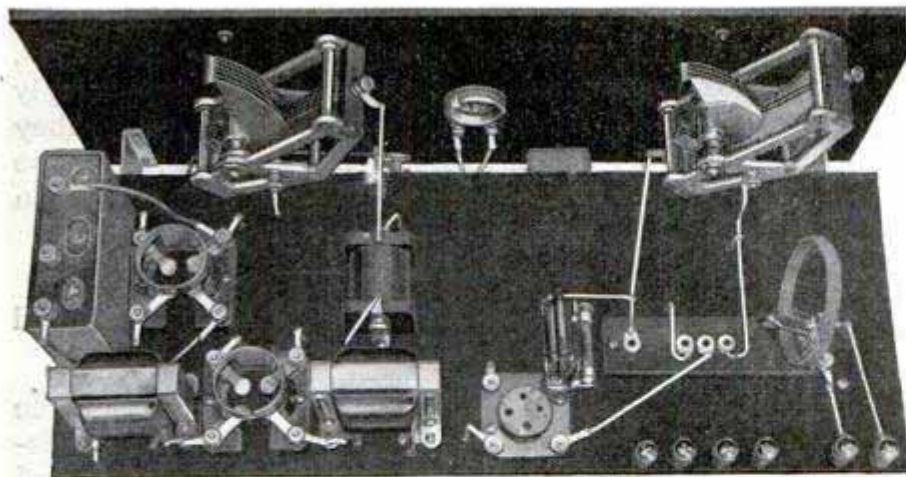

Looking Down on Subpanel: Right, Under-Subpanel View, Showing Ballasts and Method of Wiring

Before wiring the set, carefully examine the photos of the completed set; the upper one shows the method of running the wires through the subpanel, and the direction of these wires can be easily followed by referring to the under-subpanel view below. The rheostat controls the detector tube only, and $\frac{1}{4}$ -amp. ballasts are used to control the filaments of both amplifier tubes. These ballasts are mounted on the underside of the subpanel by means of short brass machine screws. At the rear edge of the subpanel a strip of brass, $\frac{1}{16}$ by $\frac{1}{2}$ by $2\frac{1}{2}$ in., bent to form a bracket, is mounted as a support for the subpanel at the center. If the set is to be mounted in a cabinet, see that there is clearance for the adjustable primary coil, so that, when placed in a horizontal position, it will not touch the side of the cabinet. Now, with the receiver wired and ready for operation,

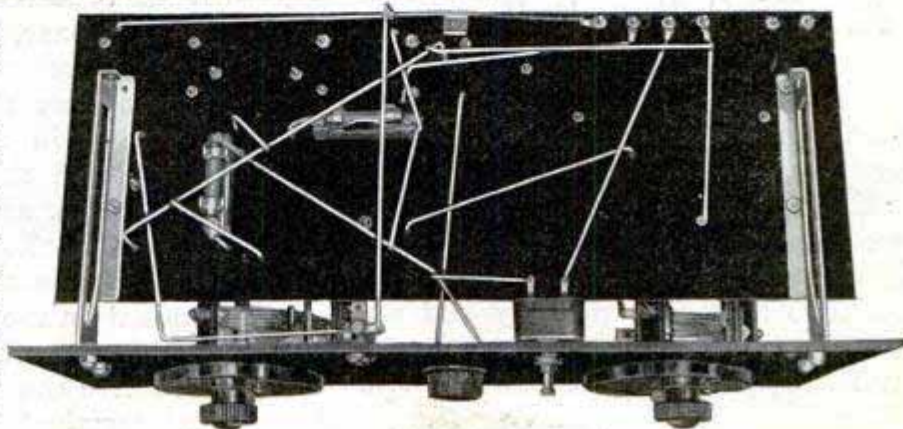

connect the batteries and place the tubes in the sockets. Three 201-A, or similar tubes, are used; plug in one of the larger short-wave coils and test out the set. Facing the receiver, the condenser at the left is the tuning control and the one at the right the feedback control. This feedback is not critical and

the set will be found easy to tune. If the set howls, the capacity of the grid condenser must be raised and the value of the gridleak lowered.

When balancing the set, it is well to disconnect the aerial; then try various combinations of grid condensers and gridleaks, as tubes vary and short-wave sets are inclined to go into oscillation with a bang or howl, instead of the usual hiss. If the set is still "touchy" on the low waves, it may be necessary to change the detector, grid return, or bias, to negative instead of positive, as it now is. However, this is not likely to be necessary. When the best

MATERIAL LIST

- | | |
|---|--|
| 1 front panel, 3-16 by 7 by 18 in. | 1 Aero coil No. 4, 125 to 250 meters. |
| 1 subpanel, 3-16 by 7 by 18 in. | 1 Aero coil No. 5, 235 to 550 meters. |
| 2 Benjamin subpanel brackets. | 1 $4\frac{1}{2}$ -volt C-battery, large type. |
| 1 spring-suspended socket, X-type. | 1 Sangamo fixed condenser, .0001 mfd. |
| 2 sockets, any good low-loss, X-type. | 1 Sangamo fixed condenser, .00025 mfd. |
| 1 Jefferson a.f. transformer, type 41, $1\frac{1}{2}$ to 1 ratio. | 4 gridleaks, cartridge type, 2, 6, 7 and 9 meg. |
| 1 Jefferson a.f. transformer, type 41, 3.75 to 1 ratio. | 1 combination grid condenser and leak mounting, removable-clip type. |
| 1 Karas S.L.F. condenser, .00025 mfd. | 6 binding posts with engraved tops. |
| 1 Karas S.L.F. condenser, .00014 mfd. | 4 2-ft. lengths of round, tinned-copper busbar wire. |
| 1 Samson r.f. choke coil. | 3 doz. soldering lugs, long, round-hole type. |
| 2 Daven ballasts, $\frac{1}{4}$ amp., or Amperites of same value. | 12 6-32 round-head brass machine screws, 1 in. long. |
| 1 open-circuit jack, short type. | 12 6-32 round-head brass machine screws, $\frac{1}{2}$ in. long. |
| 1 25-ohm rheostat. | 4 6-32 round-head brass machine screws, $\frac{3}{8}$ in. long (nickelplated). |
| 1 push-pull filament switch. | |
| 1 set Aero short-wave coils, 15 to 133 meters, complete with mounting base. | |

grid condenser and gridleak have been found, check the short-wave coils and make sure that the set can be made to oscillate smoothly from maximum to mini-

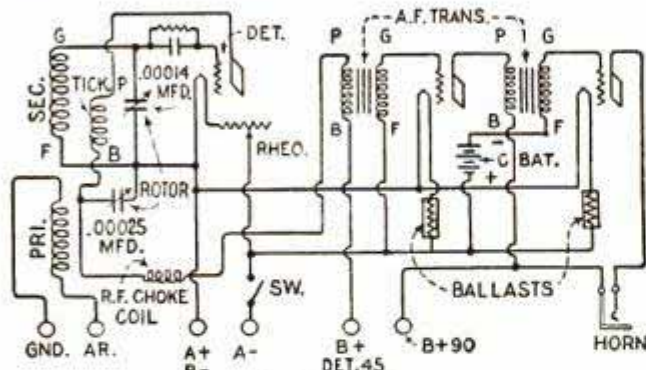

Schematic Circuit Diagram

mum on the tuning condenser, without howling.

Either a long or short aerial may be used for short-wave reception; one wire 50 ft. long gave excellent results. If the aerial is long, the primary coil must be loosely coupled or the set will not work uniformly on all wave bands. The coupling is loosened by moving the primary coil farther away.

A large wiring diagram may be had from Popular Mechanics Radio department, 200 E. Ontario street, Chicago, for 15 cents. Specify blueprint No. 115.

Handy Multiple Connector for Use in Experimental Circuits

Multiple connectors for making quick connections in experimental hookups save time and enable the experimenter to try out a variety of circuits. They may be made of brass wire, wound in the form of a spring. The coils are closely spaced and the ends turned into eyes with a pair of pliers. The connector is then mounted

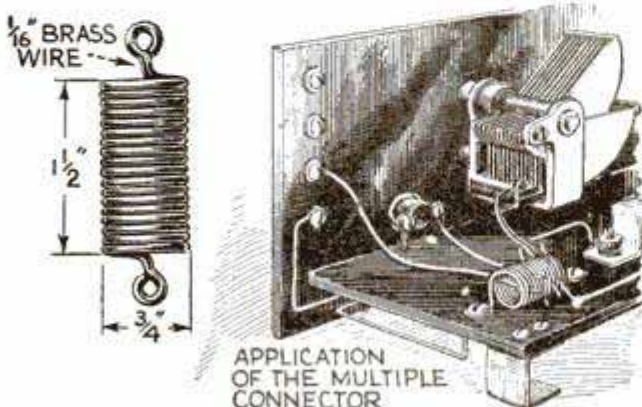

Detail of Coil-Spring Connector, and Mounted on Set with Leads in Position

on the baseboard at any convenient point by means of two small screws. The wires, terminals and connections are simply forced down between the coils, where they hold firmly. The best size for average use is made of 16-gauge brass wire, wound in a 3/4-in. coil, about 1 1/2 in. long.

Socket Voltmeter Made from Discarded Tube Base

A useful socket voltmeter can be made from a small pocket voltmeter and a discarded tube base. The glass is removed from the base, leaving the wires from the filament prongs intact. Two small disks of wood are then turned down, one to fit snugly in the top of the socket, as shown, and the other slightly larger to form a cap, and the disks are glued together. Holes are then drilled in the disks, one just large enough to take the terminal on the case of the voltmeter, and the other, in the edge of the larger disk,

to receive the cord terminal of the voltmeter. Small pieces of metal tubing, to which the tube-prong terminals have been soldered, are then forced into these holes. The inside of the tube base is filled with wax, which can be taken from the top of a discarded B-battery if desired. Before the wax has cooled, the wooden disks are forced down on top of and into the base. Forcing the voltmeter terminals into the metal-lined holes completes the instrument, and it may now be plugged into the sockets of the receiving set. The rheostat is then turned up until the voltmeter needle gives the proper reading for the tube that is to be used. Checking the tubes in this manner does away with all guesswork and greatly prolongs the life of the tube by removing the danger of excess filament voltage.—L. M. Curtis, Venice, California.

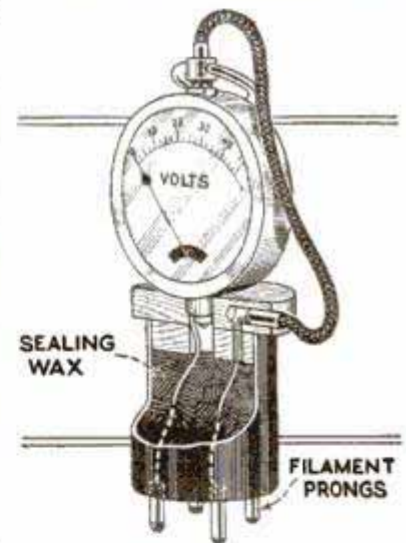

to receive the cord terminal of the voltmeter. Small pieces of metal tubing, to which the tube-prong terminals have been soldered, are then forced into these holes. The inside of the tube base is filled with wax, which can be taken from the top of a discarded B-battery if desired. Before the wax has cooled, the wooden disks are forced down on top of and into the base. Forcing the voltmeter terminals into the metal-lined holes completes the instrument, and it may now be plugged into the sockets of the receiving set. The rheostat is then turned up until the voltmeter needle gives the proper reading for the tube that is to be used. Checking the tubes in this manner does away with all guesswork and greatly prolongs the life of the tube by removing the danger of excess filament voltage.—L. M. Curtis, Venice, California.

A Radio Cabinet of Striking Design

By EDWIN M. LOVE

THE unusual is achieved in the radio cabinet described here—beauty of design combined with strength and durability; yet so simple is the construction that the most inexperienced amateur can build it. While arranged especially for a 7 by 18-in. radio panel, a shorter one could be used by widening the battery boxes at the ends, or a longer, by extending the cabinet itself. The speaker shell is for a 12-in. cone speaker. (See Fig. 1.)

The front panels of the battery boxes, detailed in Fig. 2, are simple rectangles of 1-in. stock, carefully squared to 6 by 8 in. On the face side of each, cut a rabbet, $\frac{3}{16}$ in. deep (or whatever thickness the panel is) and $\frac{1}{4}$ in. wide; and remembering that the two must be made as a pair, chisel out a notch in the upper end $\frac{1}{2}$ by $\frac{1}{2}$ by $\frac{3}{4}$ in., to carry the ends of the loose upper rail.

The two end panels, shown in Fig. 3, are $\frac{3}{4}$ by $8\frac{3}{4}$ by 8 in. Make the back of pine, $\frac{3}{4}$ by 8 by 28 in., and the bottom, $\frac{3}{4}$ by $9\frac{3}{4}$ by 30 in.

Nail the ends to the back and the front panels to the ends, inclining the nails in various directions to increase their holding power, and the bottom to the lower edges, allowing it to project $\frac{1}{4}$ in. at the ends and front; or, if preferred, tack the parts together and insert $\frac{3}{8}$ -in. hardwood dowels in holes bored from the outside.

Now cut four $\frac{3}{4}$ by $\frac{3}{4}$ -in. strips, $7\frac{1}{4}$ in. long. Glue these inside the front panels and back, perpendicular to the bottom

and $4\frac{1}{2}$ in. from the ends, inside measurements. Apply glue to both parts, for this is the only way to be sure that all the effective gluing surface is used. Across the tops of these cleats glue and nail spreaders of $\frac{3}{4}$ by $\frac{3}{4}$ -in. stock.

Cut a piece of 1 by 1-in. net stock, 18 in. long, and plow a $\frac{3}{16}$ -in. groove, $\frac{1}{4}$ in. deep, $\frac{1}{4}$ in. from the front face, to receive the lower edge of the bakelite panel. Cut this to fit between the front panels, and glue in place on the bottom.

For the vertical panel strips or stiles, use stock $\frac{1}{4}$ in. by $1\frac{1}{8}$ in. Flush with the panel edge of each front battery panel,

glue on a stile; and glue flush with the back edges of the end-pieces their stiles. These need only be weighted in place until the glue is dry. Nails are unnecessary. For the corners, miter one edge of each to fit. Tack these in place by toenailing from the top ends

and through the lower ends where the base mold will cover them. Allow one member to dry before gluing on its mate.

Now glue the upper and lower rails in place, using stock $\frac{1}{2}$ in. wide for the upper and 1 in. for the lower. Cut these pieces long enough to require firm pressure to force them back, but not so tightly as to crush the edges of the stiles.

When all is dry, smooth the joints, and miter around the ends and front of the bottom a base mold, 1 in. wide. This mold can be made by hand, by following the steps indicated in Fig. 7, making two suc-

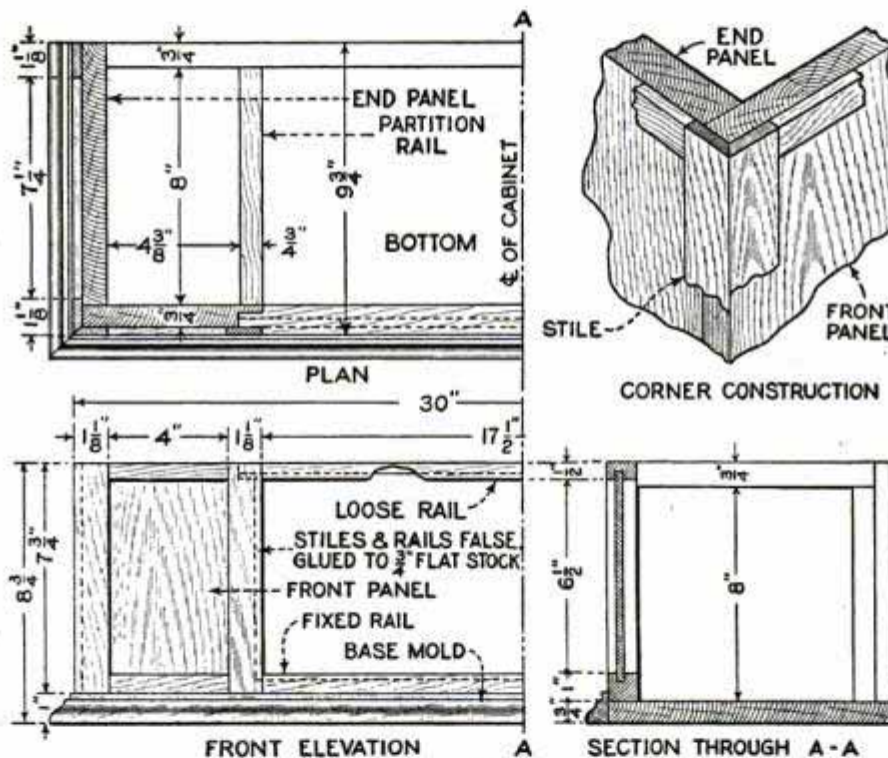
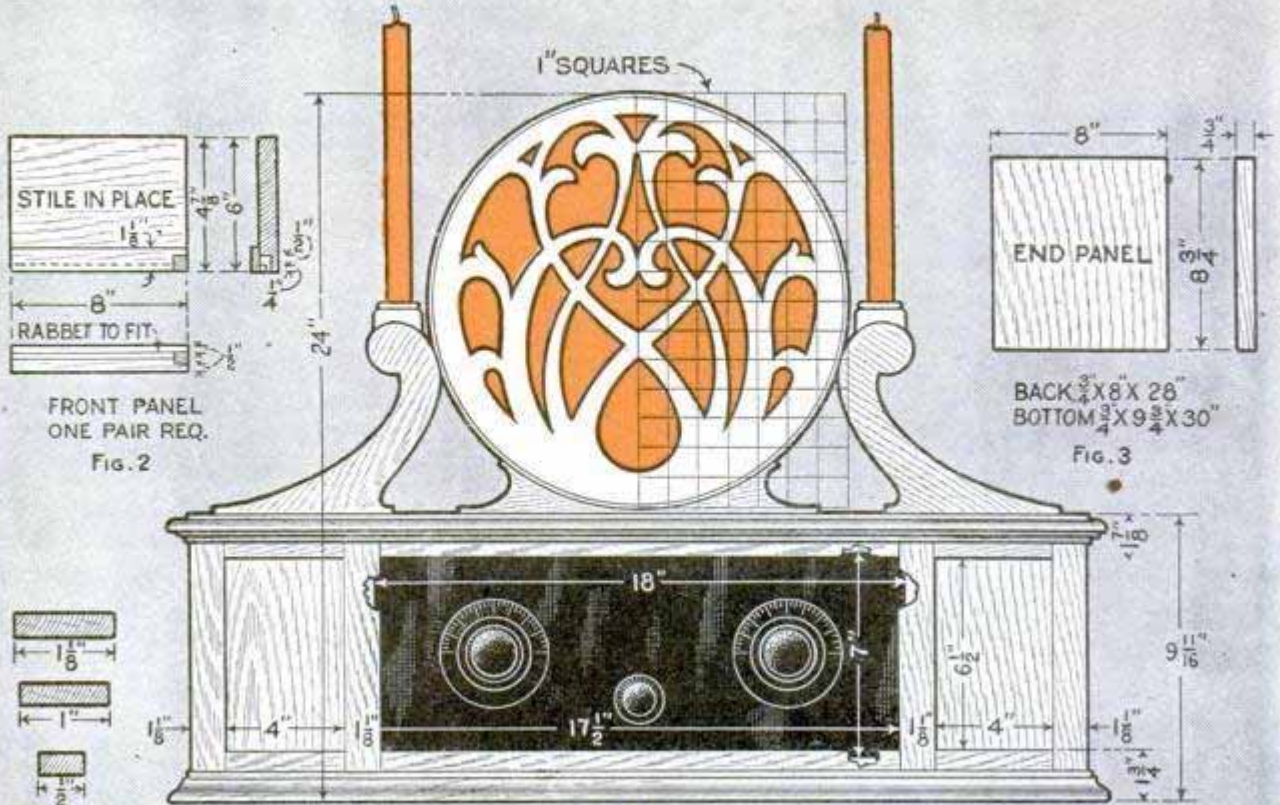
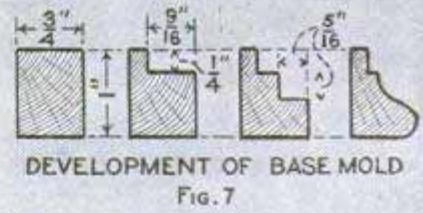
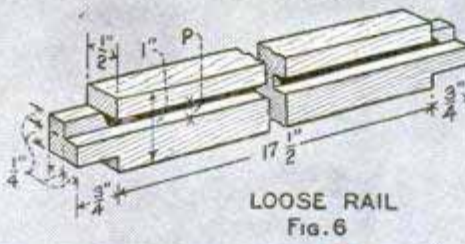
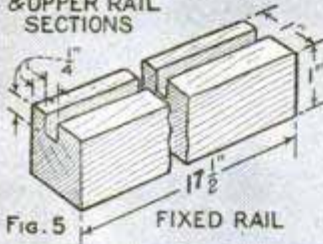

Fig. 4



STILE, LOWER & UPPER RAIL SECTIONS



cessive rabbets and finally working out the curved part, or a suitable mold may be purchased at a picture-framing shop.

Make a loose rail, as in Fig. 7, 19 in. long, $\frac{1}{2}$ by 1 in., with a $\frac{3}{16}$ by $\frac{1}{4}$ -in. groove $\frac{1}{4}$ in. from the face edge, and a $\frac{1}{2}$ by $\frac{1}{2}$ -in. tenon centered on each end.

The lid is $\frac{3}{4}$ by $9\frac{3}{4}$ in. by 2 ft. 6 in. It can be made of solid stock, if well seasoned, but a five-ply piece is far better, as it will not warp. Only the upper side need be figured material (see Fig. 8).

Make a $\frac{1}{2}$ by $\frac{3}{4}$ -in. nosing mold, which is mitered around the ends and front, dropping down from the top face $\frac{3}{16}$ in. to show a margin. This may be tacked with 1-in. brads, driven through the cove, since otherwise it is quite difficult to keep it in place until the glue is dry. As this leaves a thin edge of the mold projecting below, the surface must be built up by gluing to the underside a $\frac{3}{16}$ by 1-in. strip, running it all around. The back strip carries the hinges.

Make the speaker grill of $\frac{3}{8}$ -in. three-ply stock. Lay out a piece of tracing paper, 7 by 14 in., in 1-in. squares, and, following the intersections shown in Fig. 1, draw one-half the design. Notice that all lines of the stems are continuations of the rim circles and tangent to them. No two stems are the same width, and they vary in width throughout their length. The leaves spring from the stems on a tangent.

Draw a 14-in. circle on the stock, and divide with a vertical diameter. Trace the half design, turn the pattern over, and trace the other half. Bore holes through each part to be removed and use a bracket saw to cut them out. Smooth the edges with a fine file and sandpaper, being careful not to chip the corners.

Obtain three strips of $\frac{1}{8}$ -in. veneer, 45 in. long, one $5\frac{1}{4}$ in. wide, the others $3\frac{3}{4}$ in. If veneer is hard to get, gauge a piece of 1-in. stock, and ripping alternately from one edge and the other, cut a thickness. Smooth the stock, and repeat. Plane off

high spots in the veneers thus produced. Make a back of three-ply stock, 14 in. in diameter, and cut out a disk $12\frac{1}{2}$ in. in diameter.

Lay the finished grill, face downward, on $\frac{3}{8}$ -in. strips on the shop floor, or on some other surface where nails can be driven. Drive several nails against the edges of the cut-outs, so as to

brace the grill for edgewise pressure. Have ready a stout cord, and bend around the grill the wide piece of veneer.

It may be necessary to soak the stock in water before it will bend to the sharp curve. Cut off the surplus length and bind the cord around the veneer until it is drawn tightly against the grill edge. Bend a

second piece of veneer, $3\frac{3}{4}$ in. wide, around the inside, and cut off the extra length.

The joint need not be closer than $\frac{1}{16}$ in. Bend a third piece of the same length and width inside of that.

Now take out the liners and coat the inside of the outer veneer with liquid glue. Coat one side of a liner, slip it into place, with the joint at the top, coat it inside, and coat the third piece, which in turn is put inside. They will not fit snugly together at this stage and the upper edge will be lopsided. Press the liners down against the grill, and slip in the back disk. Bind the veneer tightly against this, as well as the grill, which should bring it to a disk throughout. Then slip blocks, 3 in. wide, through the opening, press to the sides and wedge up with other blocks, until the veneers are well clamped together. Weight the assembly to eliminate possible twists, and allow to dry thoroughly.

After the glue has set, remove back, grill and clamping blocks. If there are any appreciable openings between the layers of veneer, mix thin glue with plaster of paris and run down into the spaces. Cover the back of the grill with tightly stretched silk, or fine-mesh bronze screen, using $\frac{1}{4}$ -in. tacks to hold it on, and glue the grill into the shell. The back is held

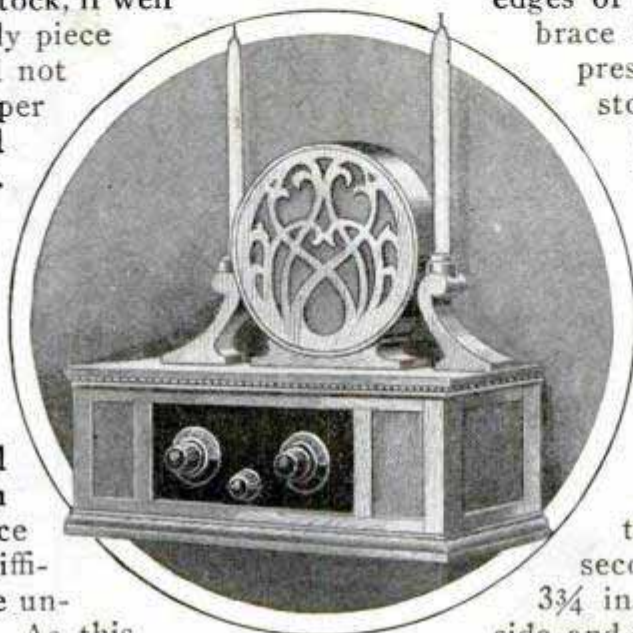

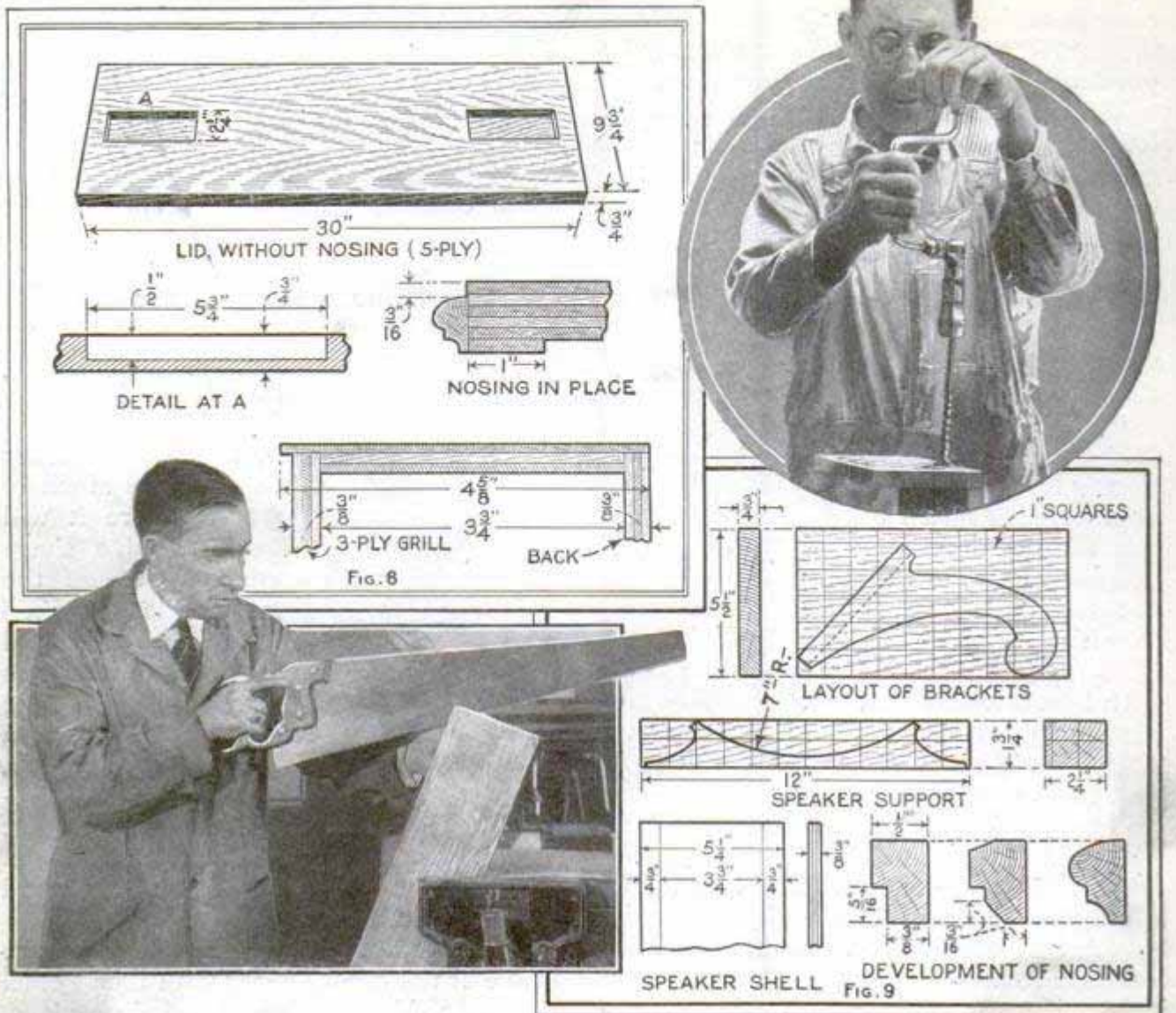

on with small screws after the speaker is installed. Joint off the shell until the projection is $\frac{1}{8}$ in., and round the corners.

Make the bracket pattern as shown in Fig. 9. If the brackets are to be sawed out by hand, use 1-in. stock, make six, and round off the corners of the curves to a radius of $\frac{1}{8}$ in. Glue together in groups of threes. Smooth with a file and sandpaper. If they are cut with a bandsaw—any mill will cut them very cheaply—glue up the three thicknesses before cutting. The speaker support is made from stock $1\frac{3}{4}$ in. net by $2\frac{1}{4}$ in.

Lay out the upper surface of the lid for the bracket mortises, $2\frac{1}{4}$ by $5\frac{3}{4}$ in., 1 in. from the ends, and centered on the width. Stand the brackets on these spaces and trace around with a fine-pointed pencil. Then, with a sharp chisel, cut $\frac{1}{8}$ in. inside, and hollow out to a depth of $\frac{1}{2}$ in.; trim to the line, trying the brackets occasion-

ally to see if they fit. Size the ends, and glue into the mortises.

Center the speaker support between the brackets, gluing and nailing it, and boring for the wires. Put the shell in position, and nail it to the support. A tack may also be driven into each bracket.

To furnish sockets for the candles, fit to the tops of the brackets pieces of $1\frac{1}{2}$ -in. round stock, bored with $\frac{3}{4}$ -in. holes.

Remove all traces of glue, and sand well before staining. This design is suitable for either plain or two-tone finishing, or for gesso and polychrome work.

ⓘ Squeals and howls caused by body capacity may be eliminated by shielding the back of the front panel with tin or copper foil. This foil must not short any instrument; ground the shield and the cores of the amplifying transformers to the negative terminal of the A-battery.

*Aero Products Co.
214 N. Desplaines St.
Chicago*

Correct C-Battery Voltage Important

Correct C-battery voltage in the audio-amplifier circuit of any receiver is important. The battery should have the proper voltage in order that the amplifier tubes may receive the correct grid bias; an incorrect value will cause distortion. The C-battery voltage should be increased if the B-battery voltage is raised, as in the practice of adding a power tube in the last stage. Assuming that the normal total B-battery voltage was 90 before the power tube was added, and a 4½-volt C-battery was used, the power tube should have a plate voltage of 135 and at this voltage a 9-volt C-battery must be used. The proper C-voltage for the tube is specified by the manufacturer and should be followed carefully for best results.

964-A
Model House Wired for Radio

This model home, correctly wired for radio, was recently designed by one of the large radio manufacturers. The positions of the various sets and loud speakers as well as the method of wiring are clearly shown in the illustration. Note the outlets in the baseboards, and the remote-control switches and battery compartment on the second floor. The loud speaker, in the living room, may be plugged into the porch circuit if desired.

Positions of Sets and Loud Speakers; Switches and Battery Compartment

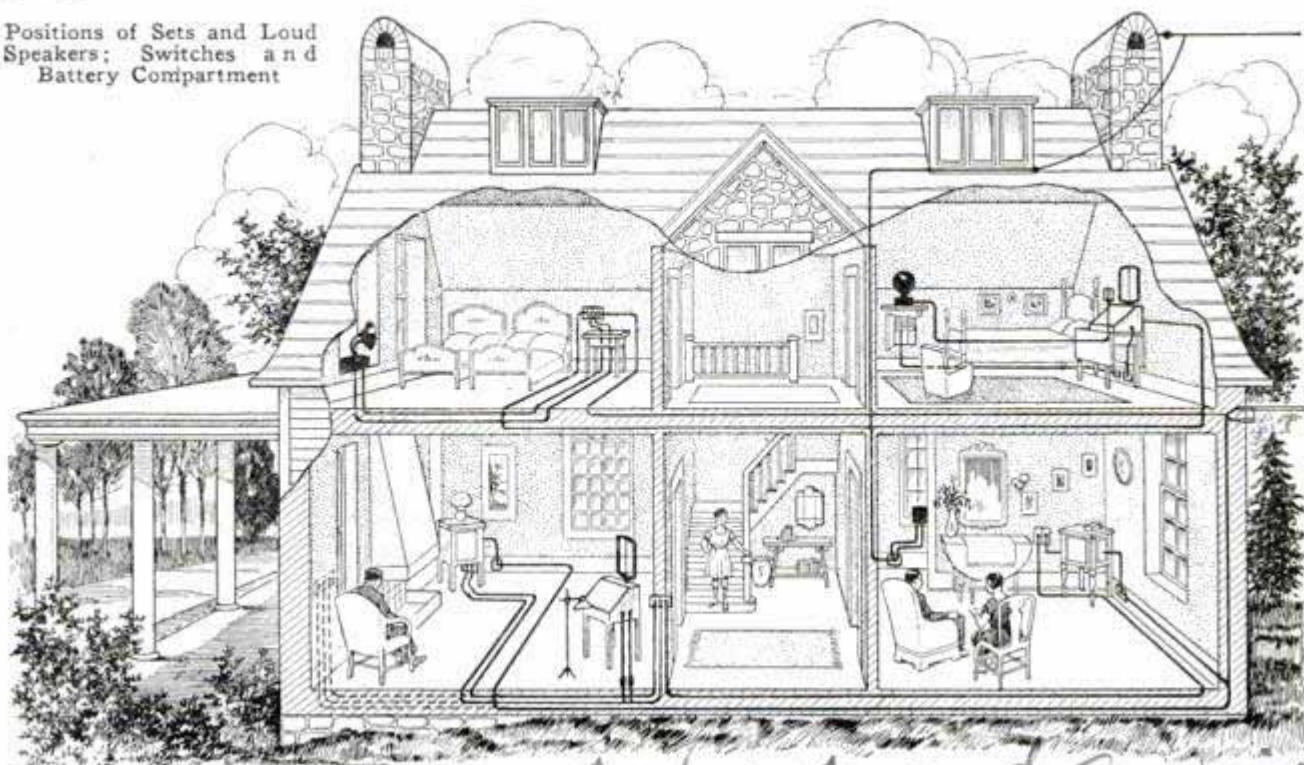

The aerial, from the point where it enters the building, is inclosed in conduit in the walls. Many new homes and apartment buildings are now being wired for radio, and this model home was designed for the purpose of properly guiding the builder.

876-A
Plug-In Coils for Short Waves

Plug-in coils are now available for short-wave receivers. The set shown in

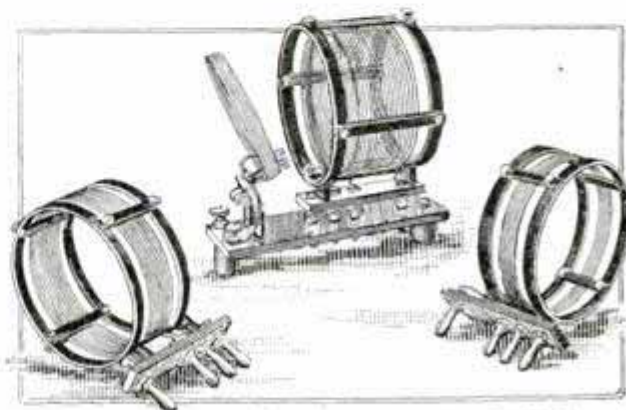

Interchangeable Plug-In Coils, Showing Coil Plugged into Mounting at Rear

the illustration consists of three interchangeable coils and a mounting on which is placed an adjustable primary coil. The coupling of the primary coil may be set for best results with either a long or short aerial. The interchangeable coils each have a grid and plate inductance and cover a range from 15 to 130 meters. Coils to 550 meters may be obtained if desired.

*Radio Corporation of America
203 Broadway New York*

Fixed-Condenser Kinks

By WM. CALVERT

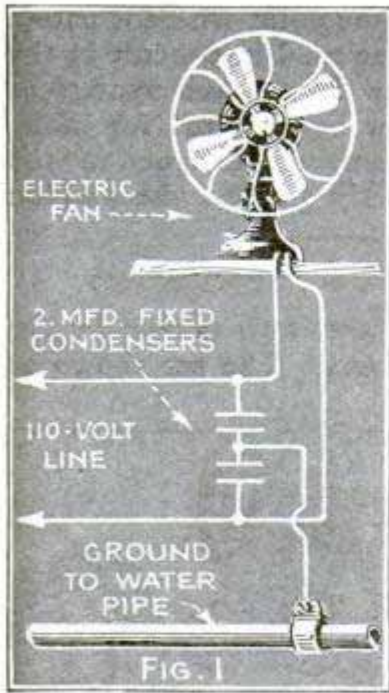

THE fixed condenser is a necessary adjunct to most receiving circuits, but the part it plays is not always clearly understood by the average builder. They are often used at random by the experimenter, many times with surprising results. When properly used, fixed condensers are a specific remedy for many inefficient sets and may also be used to eliminate troublesome interference.

While pointing out the various purposes for which they may be used, it may be of interest to take one apart and see how it is made. Available in all sorts of shapes and capacities, the construction is practically the same in all types; alternating sheets of tin or copper foil and mica,

make up the unit, the capacity depending on the size and number of the metallic sheets, the kind of insu-

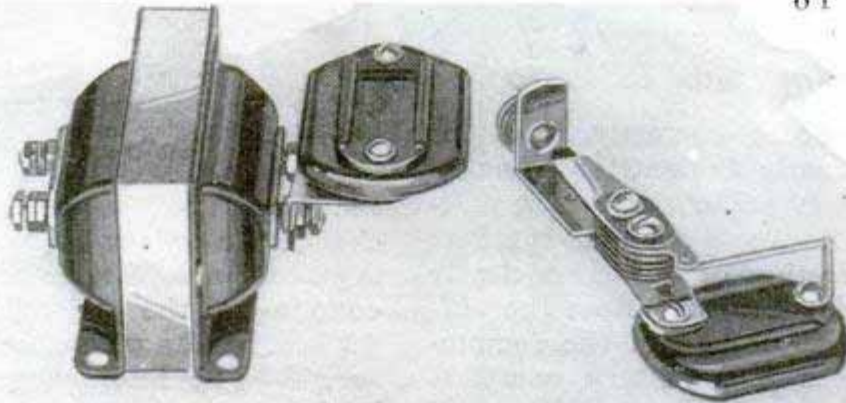

lating material and the method of construction. The capacity is carefully measured by the manufacturer and stamped on the unit; if carefully made and protected from moisture this capacity does not vary. The small types shown in the illustration are specially designed for radio use; larger types capable of withstanding high voltages may be used for eliminating interference from electrically operated devices, such as electric fans, motors and battery chargers.

The method is clearly shown in the illustration, Fig. 1; two 2-mfd. condensers are connected in series across the power line near the apparatus that is causing the trouble. The center point, or common connection between the two condensers, is then grounded

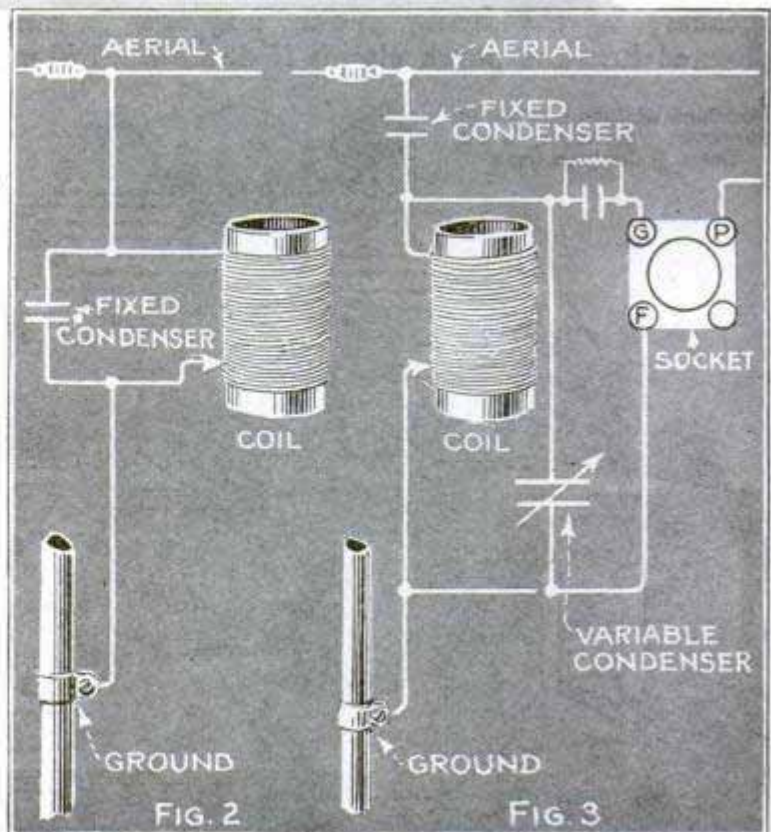

to a water pipe, as shown in the diagram. When connecting fixed condensers of the small type in radio sets, never apply the iron directly to the condenser; use soldering lugs and fasten them to the condenser by means of short brass machine screws. If the condenser is to be fastened to some piece of apparatus, such as a transformer, it is advisable to use short metal strips drilled to take the binding posts and machine screws, as shown in the photo. A .0005-mfd. condenser placed across the secondary of the last a.f. transformer will often eliminate the high-pitched whistle in the loud speaker caused by the a.f. amplifier. In some cases it is advisable to place the condenser across the primary of the transformer; try both positions for best results. Shunting the loud-speaker jack with a condenser, as shown at right, will often give better results in tone, permitting the speaker

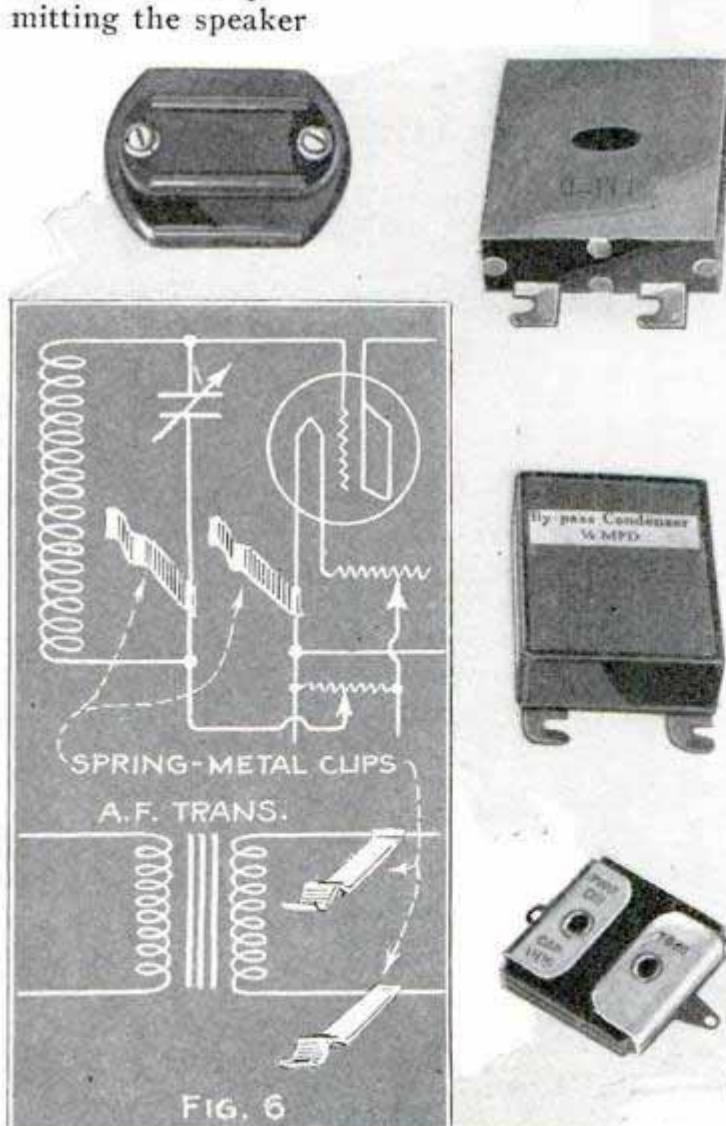
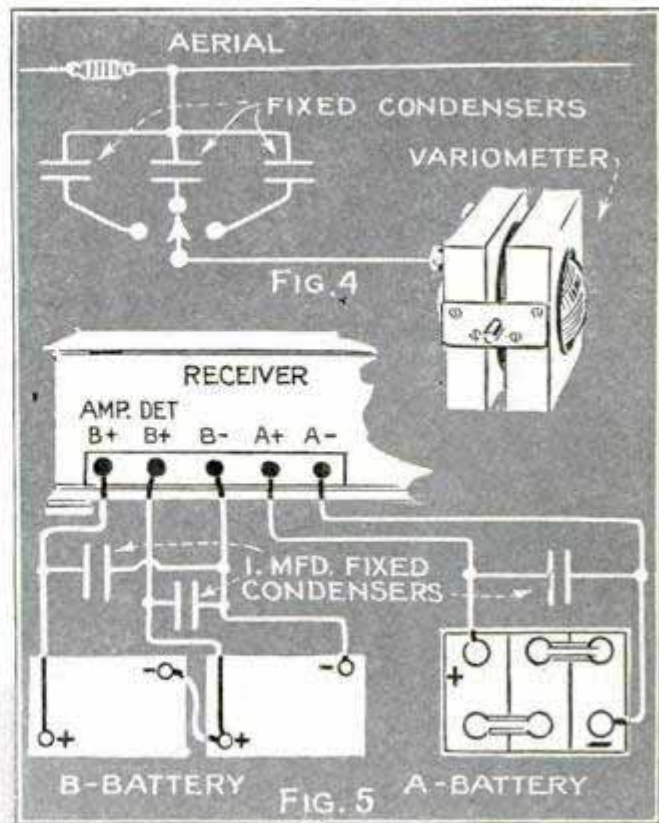

to reproduce a wider range of frequencies; this condenser may be .001 to .006 mfd.

The experimenter often wishes to reduce or increase the capacity of variable condensers, or change the inductance value of coils; this is easily done with fixed condensers. By shunting a fixed condenser across the inductance, as shown in Fig. 2, the wavelength of the circuit will be raised; if this condenser is variable the wavelength may, of course, be varied at will. However, in most cases, with simple sets, it is only necessary to raise the wavelength to a certain point and a fixed condenser of suitable capacity may be used as shown.

For reducing the inductance value of a circuit for shorter wavelengths, a fixed condenser

may be used in series with the coil and antenna, as shown in Fig. 3, and even more flexibility may be obtained by employing several capacities, as shown in Fig. 4, a switch being used to change from one capacity to the other. In tuned circuits of this type such a method is advised to easily adapt the set to aeri-als of various lengths. It is common practice now to place the various batteries at a distance from the set in order that they may be out of sight. They are often placed in the basement or in a near-by closet; long leads are necessary in either case and the result is a loss of selectivity as well as noisy operation due to the pick-up of the leads. This may be remedied by the use of fixed condensers for by-passing the various batteries; these by-pass condensers should be placed across the leads at the set and not at the batteries, or the effect will be lost. By-pass condensers of either .5 or 1 mfd. may be used for this purpose. Fixed condensers are not expensive; they are one item used in the construction of a radio set that has dropped lower in price than any other. In the early days precision condensers cost as high as \$25; now even better units may be obtained for from 40 to 75 cents.

Device Designed to Reduce Interference and Static

A small instrument designed to assist in tuning the set so as to eliminate interference and reduce static has appeared on the market. It is especially recommended for warm-weather reception when static interference is most prevalent. It is composed of a tuning coil which is balanced by a small variable condenser, providing an additional means of tuning for any tube or crystal set, excepting sets which are operated on a loop. The numbered terminals on the instrument are for the various connections given in the diagrams. One way of using the unit is by induction and the other by absorption; the latter method is

The capacities required for most circuits are always specified, although the experimenter often finds that a greater or less capacity than that specified is needed. The change of capacity required, may be due to the experimenter's location, the use of parts other than those called for, or the placing of parts on the baseboard. In cases of this kind, it is usually necessary to try a number of condensers before the correct capacity is found. To facilitate this testing operation, a pair of small clips, made of light spring metal, may be bent in the form shown in Fig. 6 and soldered to the busbar wires, thus doing away with the necessity of soldering and unsoldering each condenser tried.

All fixed condensers are not adaptable to this method, but for those that may be clipped in and out of the circuit, these little clips are very useful. If the condenser is constructed so that it cannot be used in this manner, short lengths of busbar wire may be soldered to the circuit leads instead of the clips; lugs are then soldered to the ends of the short wires so that the condenser may be screwed in position with short brass machine screws. It is a simple operation to remove the screws and put in a condenser of different capacity.

advised for the reduction of static, although it slightly reduces the volume. The induction method will assist and improve the volume, it is claimed.

Testing Dry-Cell Batteries

Dry cells vary in amperage according to the make, but the usual cell should register from 30 to 35 amp. when fresh. An ammeter should be used for testing dry-cell A-batteries, and is to be left in the circuit just long enough to obtain the reading. Care should be taken that the meter is connected properly. If connected backward, the pointer will be deflected off the scale in the wrong direction. If the reading is below 10 amp., the cell is worn out.

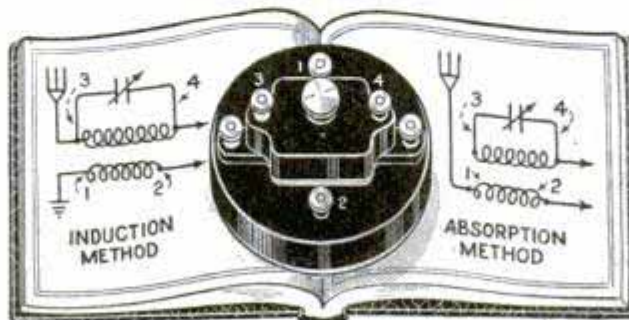

Interference-Eliminating Device, Showing Two Ways in Which It May Be Used

Leslie H. Muter Co. 614 Greenwood, Chicago 927-02

10/10 - Dr. Mrs. Dr. Alfred Eschenberg,
 Berlin & Friedrichs, Konstantin
MAKING THE GERMAN RADIO PLAY REALISTIC 20.
 - Oswald

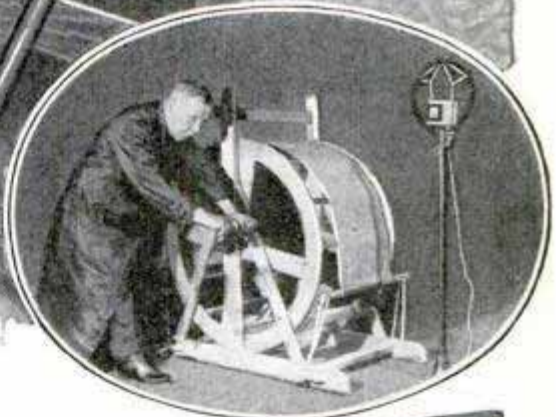
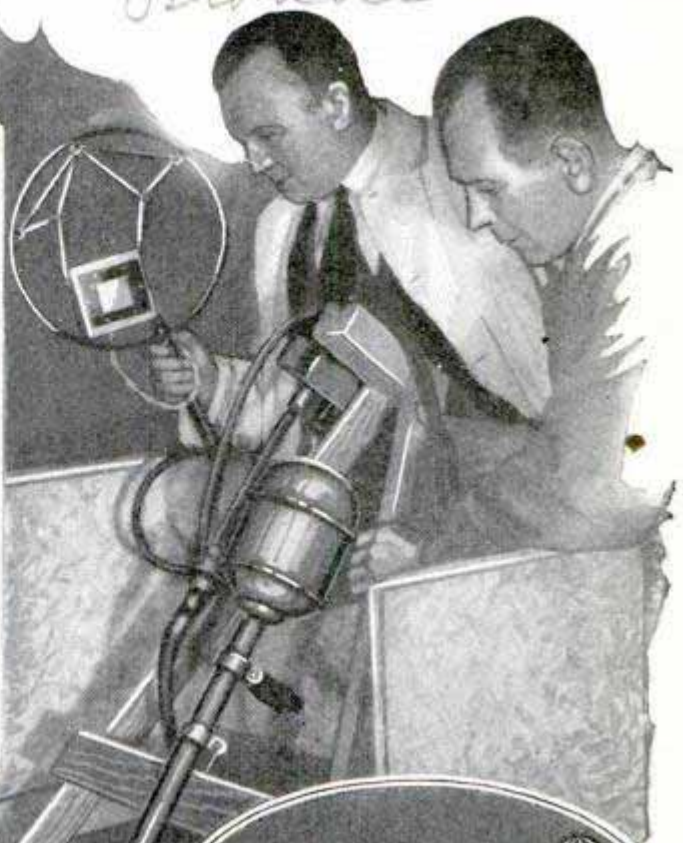

Above, Flowing-Water Arrangement for Imitating Rain, Falling Water and Dashing Waves; Right, Motor-Driven Device for Imitating the Noise of a Ship Propeller; Insert, Wind Machine Consisting of Cloth Stretched over a Wooden Drum; When Rotated, the Spokes on the Drum Brush against the Cloth Producing the Effect of Soft Breezes or High Winds

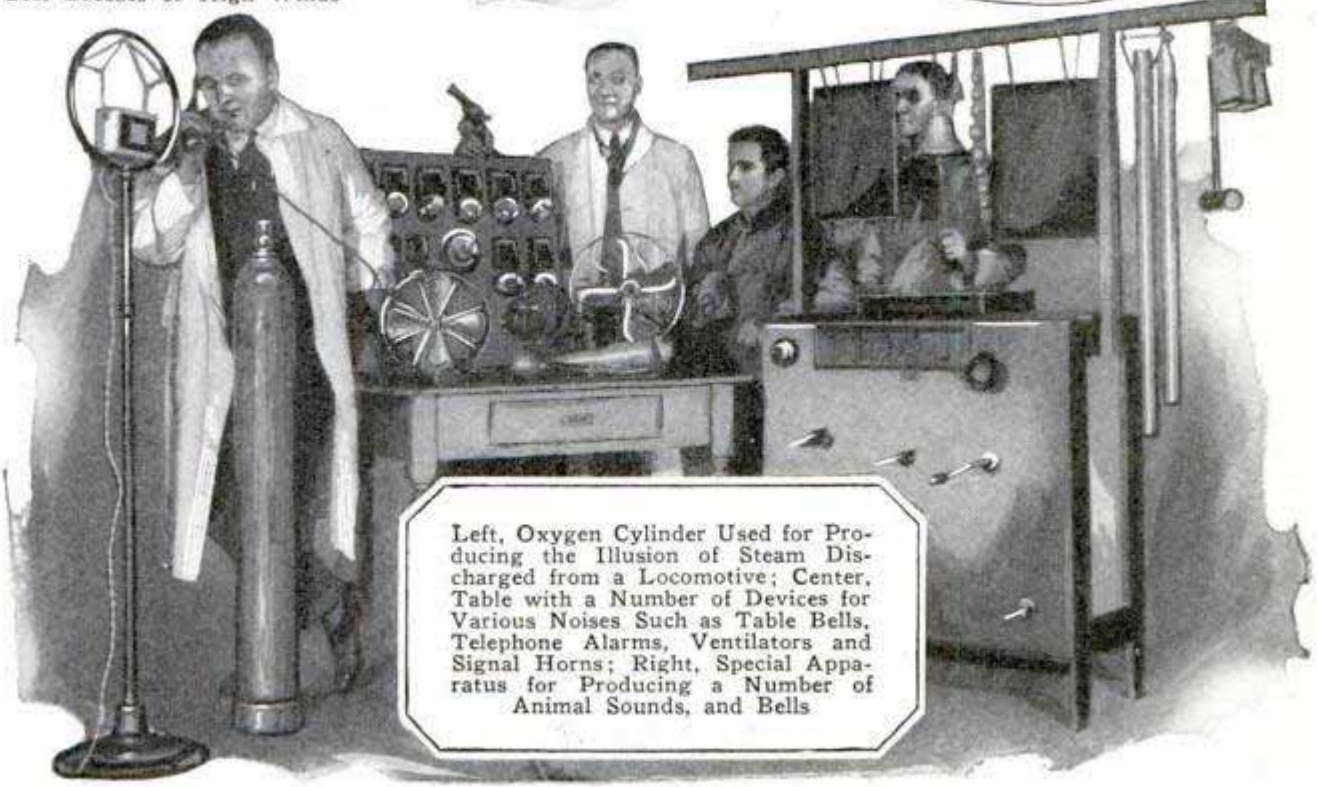

Left, Oxygen Cylinder Used for Producing the Illusion of Steam Discharged from a Locomotive; Center, Table with a Number of Devices for Various Noises Such as Table Bells, Telephone Alarms, Ventilators and Signal Horns; Right, Special Apparatus for Producing a Number of Animal Sounds, and Bells

Simple Power-Control Switch

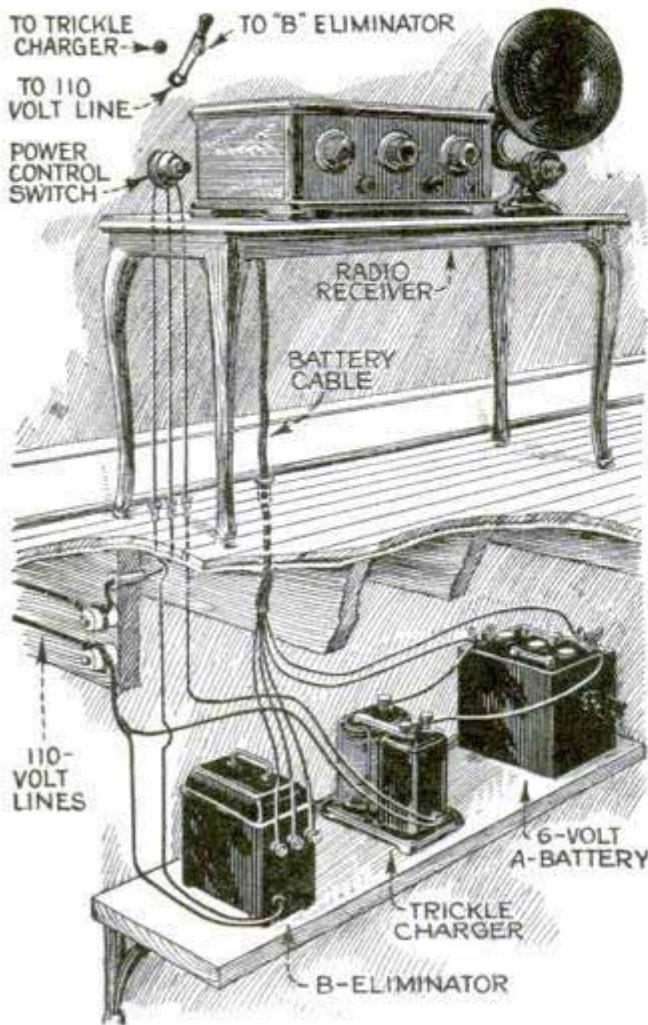

Simple Power-Control Switch for Trickle Charger and B-Eliminator with Connections

A simple power control for trickle chargers and B-eliminators may be obtained by means of a switch mounted on the wall, or at some other convenient place near the set. Power-control devices are now on the market, but for those who prefer to make their own, this simple switching device will give good service. The equipment consists of a three-point switch, of either the snap or push-button type, and the illustration shows the connections clearly. The switch lever and contact points merely illustrate the action of this snap switch and are not a part of the hookup. If the house has a cellar, it is always desirable to place the batteries, charger and eliminator there. When tapping the 110-volt line, one side is connected directly to the trickle charger, and to the B-eliminator; the other side of the line goes to the post on the bridged contacts of the control switch. The remaining two posts on the switch are connected, one to

the other input wire on trickle charger, and the second to the wire on the B-eliminator. With a snap-switch the eliminator and charger will alternate on or off with each snap of the switch. If the flush push-button type of switch is used, pressing one button will shut off the charger and connect the eliminator, in which position the set can be operated. Pressing the other button will shut off the eliminator and connect the charger. It will be seen that the filaments of the tubes must be operated independently by the filament switch on the set, or by turning the rheostats to the off position, if the set is not equipped with a switch.—E. J. Bachmann, Fullerton, Pa.

Button and Match Make Variable Gridleak

The radio fan can always find use for a variable high resistance; and nothing could be simpler to make than the unit shown in the drawing. It can be used either as a gridleak or for the resistance-coupled amplifier. It is also handy for stopping howls in a.f. amplifiers, and for controlling volume. The construction is shown in the illustration, and the cost is practically nothing, as the unit is made from a match, a button, a bit of brass sheet and a little India ink. The head is cut from the match, leaving the stem $1\frac{1}{4}$ in. long; starting from the end of the match, about $1\frac{1}{4}$ in. is heavily coated with India ink and allowed to dry. The sheet brass should not be too thick and should have a bit of spring to it; the manner of cutting and shaping it is clearly shown. The button is $\frac{1}{2}$ in. in diameter and a hole is cut or drilled in it as shown. When the unit

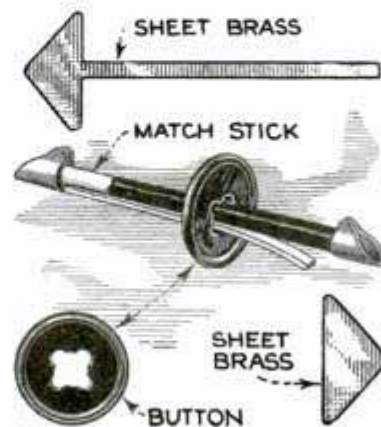

is completed, sliding the button up or down changes the amount of brass in contact with the inked surface and thus varies the resistance. The unit is remarkably quiet and has proved satisfactory in use.—Watson Brown, Iuka, Miss.

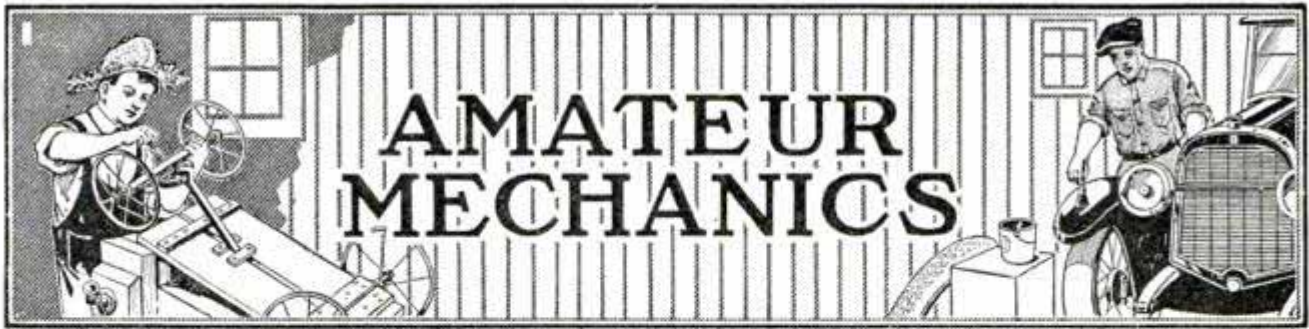

How to Take Care of Your Guns

By BOB BECKER

OF all the items in a hunter's outfit nothing requires so much attention as his gun or guns. Rubber boots can be taken off and tossed in a corner. Wet clothing can be hung up to dry without fear of rust or damage. Shells will keep from year's end to another without attention, but once a gun has been used afield the hunter's day is not ended until the weapon has been cleaned thoroughly and properly.

Without question, more shotguns and rifles are partly or completely ruined by lack of attention or unintelligent cleaning than by using the weapons too much. And, in the long run, that precious ingredient known as "elbow grease" is the thing that keeps one's gun rack looking well. A lazy man has dirty guns. The true sportsman keeps his guns

clean and shining and thereby lengthens their life. After using rifles, pistols and shotguns on a variety of game from Alaska on the north to the swampy tropics of the Amazon and Bolivia on the south (where improper or careless cleaning methods quickly and completely ruin a gun), I recommend the following procedure if one wishes to keep his armory full of shining, straight-shooting, unfouled weapons: Never leave your gun dirty overnight, especially if it is both wet and dirty; use patent cleaners equipped with brass-wire gauze if the barrels are very dirty; use a nitro solvent to remove residue in the barrel; don't spare the oil when cleaning any gun or preparing the weapon for storage, and use plenty of elbow grease.

There are three things which the hunter has to keep in mind when caring for his weapons. First, the removal of all powder resi-

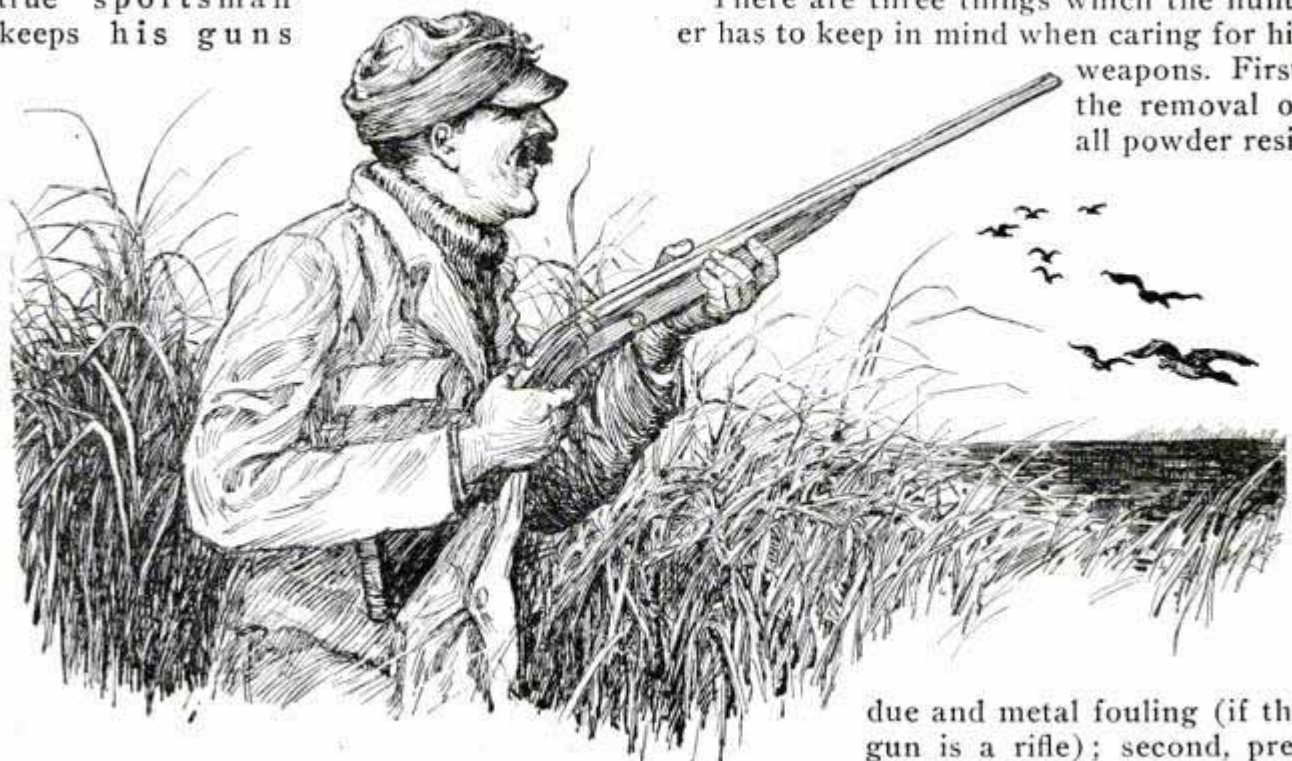

due and metal fouling (if the gun is a rifle); second, pre-



vention of rust, and third, proper oiling. The first is the most difficult feat and the one in which most gun owners fail.

To clean a shotgun proceed as follows: Take the gun apart and give attention to the barrel or barrels first of all. If you have been shooting in the rain, wipe off most of the water and then assemble a cleaning rod to attack the residue in the chambers. Here is where a bottle of nitro solvent is of great value. Run a small piece of woolen cloth through the slot in the cleaning rod, moisten it thoroughly with nitro solvent (which can be purchased in practically every sporting-goods store) and vigorously scrub the inside of the barrel. If the gun is particularly dirty, use a brass wire-gauze cleaner after an application of solvent, then dry flannel patches.

After you have run three or four of these flannel patches through the barrel they appear to come out clean, but the wise man will moisten another piece of cloth with nitro solvent and attack the bore again. The result often surprises the gun owner who thinks the chambers are free from fouling, as this second applica-

tion of solvent will often reveal a black stain upon the flannel patches which means that even though the barrels appear bright and shiny, there remains upon the steel an almost invisible wash or plating left by the smokeless powder. All of this must be removed before the gun is oiled and set aside as a finished job. After this solvent treatment, the gun owner should follow with dry pieces of flannel until the last one comes out clean. Then moisten one with a thin gun oil



and scrub the bore in order to leave a coating of protective oil on the steel. If the gun is to be set aside for some time, it is best to finish with a heavy grease. Just to play safe and to make sure that I have removed every speck of fouling from the guns I have used, I always go back to them one or two days after cleaning and check up by running flannel patches through the barrels.

In the care of rifles, even more attention must be given the clean-



ing and oiling job than in treating shotguns. This applies to small-bore guns, such as the .22-caliber, and to the high-power big-game guns, where metal fouling is a factor to be dealt with. In cleaning and caring for a .22 rifle, the most popular small gun in the United States, nitro solvent (No. 9) should be used freely. Use a small woolen rag in a slotted wiper soaked in solvent, or if the fouling has become caked in the bore, pour a small amount of the liquid through the barrel before introducing the cleaning patch. Start the rag from the breech of the gun and not from the muzzle. Another point to keep in mind is that the cleaning patch should be allowed to follow the rifling of the barrel. If you force a swab time after time across the rifling you may ruin it. This means the shooting qualities of your gun are gone, as perfect rifling is essential to accuracy. Likewise, even a slight burr on the muzzle of the arm will impair its accuracy. Hence the rule to clean the bore from the breech and not from the muzzle, where one is likely to inflict a careless knock with the cleaning rod. In cleaning a .22 rifle which, contrary to popular belief, is one of the most difficult bores to keep clean and in perfect condition due to the action of smokeless pow-

der, the gun owner should swab the bore with as many small wool patches as are needed to finish with an unstained piece. The rule is: Use elbow grease until they show white.

Corrosion and not erosion is the menace of high-powered guns and hundreds of finely made guns go into the scrap heap every year because the shooter-owner does



not understand how to combat the corrosion evil, which, in simple language, means that by failure to thoroughly remove the metal and powder fouling in a barrel it is attacked by these steel destroyers and completely ruined.

Ammonia is one of the powerful allies of the rifle owner, if he will only use this common cleaning fluid. Ammonia naturally comes into this cleaning operation because the fouling in the bore of a high-power rifle is usually acid due to the combination of powder and primer explosion. This fouling is very tenacious. No mere scrubbing with woolen rags removes it, nor will the common thin gun oils touch it as a rule. To remove this residue from the bore of a high-power rifle, where there are no lumpy bits of metal fouling, strong ammonia, containing not less than 28 per cent ammonia gas, is required. Thoroughly scrub the bore with several pieces of

wool cloth soaked in this fluid and then run two or three through the barrel to dry it. Follow this treatment with two oily patches, and the bore should be in good shape. However, the next day better repeat this treatment so as to be sure that the barrel is absolutely clean.

The hunter who goes afield to shoot smokeless-powder shells with lead-alloy bullets encounters another difficulty when it comes time to clean his weapon. He must not only remove the fouling which comes from the powder but the lead deposits which have been laid down in the bore by the bullets. This condition is called "leading." Sometimes you will see it in the form of tiny lumps or scales, and sometimes you won't see it at all, as it takes

the form of a well-nigh invisible plating. To remedy this condition, first clean the bore with ammonia by scrubbing it thoroughly with pieces of flannel rag soaked in it. Then dry it by running several more patches through the barrel. Next smear several cleaning patches with mercurial ointment and scrub the bore with them, finally running a rag heavily coated with ointment through the barrel so that the bore will be thickly greased when you put it away. After 24 hours this procedure should be repeated.

If a rifle barrel has been neglected for some time and rust has taken hold, there is a chance that the bore may be restored by the use of a metal anti-fouling solution and a rust remover. Place the gun in a vertical position, pour through it 1 qt. or more of boiling-hot soap suds. Then scrub it vigorously with a flannel patch moistened with soapy water. Run two or three dry rags through the bore, and you are ready for the next step.

A rubber cork, which fits the chamber of your rifle snugly, is necessary for this operation. Cork the chamber and then fill it with a metal anti-fouling solution, which your druggist can mix for you. It must be freshly made and kept tightly corked until you feed it to the rusty rifle. The solution is made up as follows: Ammonia containing 28 per cent gas, 3 oz.; water, 2 oz.; ammonium persulphate, $\frac{1}{2}$ oz., and ammonia carbonate, 100 gr.

This is rather a ticklish solution as it will "eat" your stock if any of it is spilled on the wood. So, watch your step when you are pouring it into the bore. Also, it rusts steel if allowed to evaporate on it. The solution should be left in the bore not more than 30 minutes. Then attack the bore with cleaning patches until it is dry and finally use a new stiff brass-bristle brush to loosen up the fouling that remains. This treatment is then repeated.

Next comes the use of a rust remover, which can be purchased at a sporting-goods store. Several patches of flannel covered with this dope should be run through the barrel. Use plenty of elbow grease on this operation and then clean the bore with dry patches, oil it up and you are ready to see if the old shooting iron is going to shoot straight or bend bullets around trees. If its shooting qualities are not evident after this operation, better chuck the barrel into the scrap heap and get a new one.

Just one more part of the rifle or shotgun which needs a little attention if you have pride in your gun cabinet. This is the stock. Don't smear it with gun oil if you wish to preserve the luster of its finish. Raw linseed oil, a flannel rag and a minute or two of vigorous rubbing is the successful combination for gunstocks. But for every minute put in on the stock, hours must be expended on the bore and other steel in a gun.

Keeping Garage Doors Snug

To prevent the sliding garage doors from swinging in the wind, equip them with the features shown in the photo. Two small iron rollers are set near the end, just far enough away to permit the door to move easily back and forth. At the center two broad iron straps are riveted to short iron rods set in the cement. Note that each end of the straps is curved out slightly. This

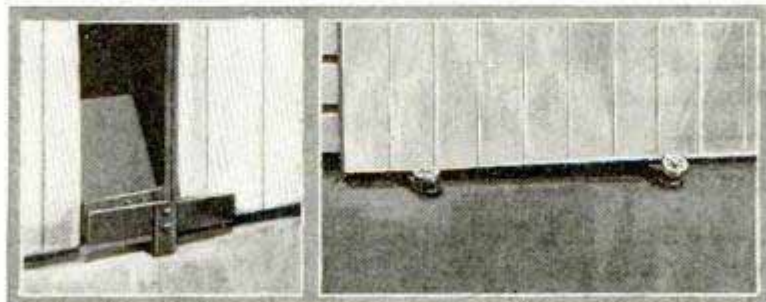

Fasteners on Sliding Garage Door Prevent It from Swinging in the Wind

squeeze fastener does not interfere with driving the car in and out and effectively prevents the doors from swinging.

A Register Screen

To prevent pencils, buttons, coins, and the like from falling into the hot-air registers, I cut pieces of ordinary screen - door netting, and fitted them into the openings. They will not interfere with circulation.—F. J. Pease, Wauwatosa, Wis.

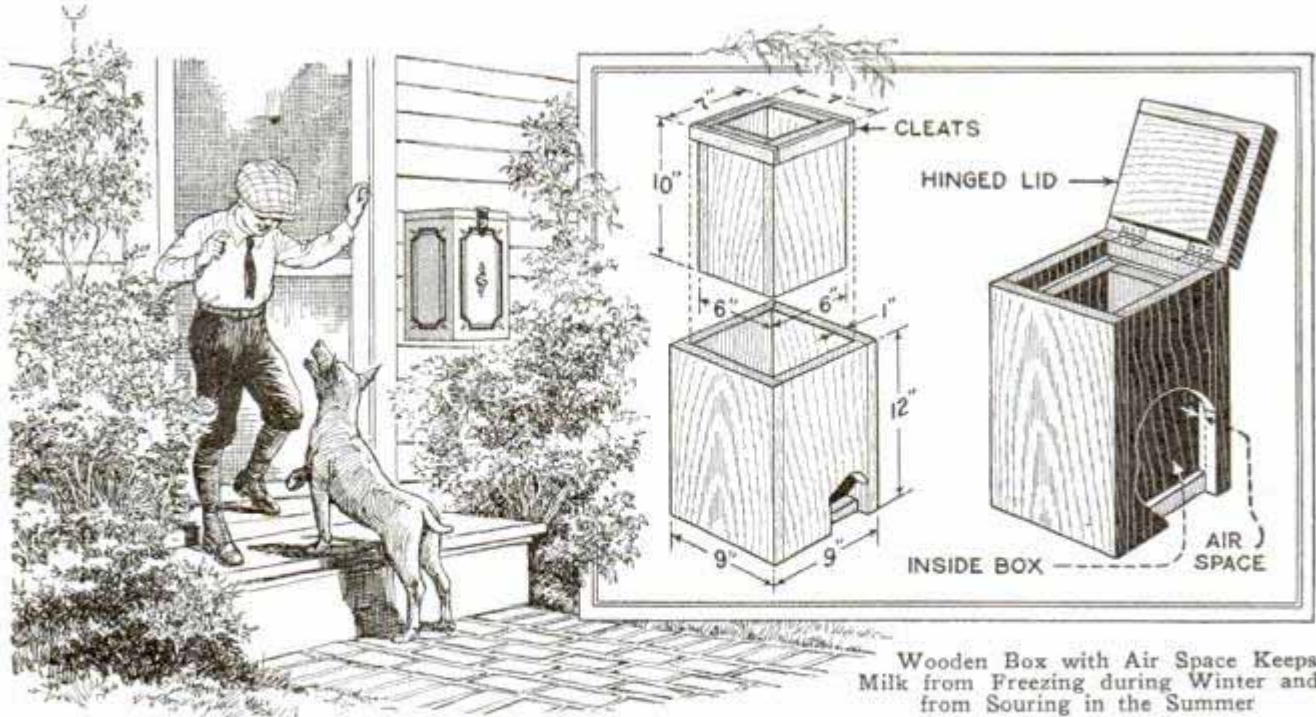

Insulated Box for the Milk Bottle

For years we have had considerable trouble during the winter in preventing our milk from freezing on the porch, and keeping it from souring during the summer, before the bottle was taken into the house. To eliminate this trouble, I made a box out of 1-in. lumber, 9 by 9 in. in outside measurements, and 12 in. deep with the top open. For the inside I made a box without top or bottom, 6 by 6 in. and 10 in. deep, with a rim around the top of sufficient thickness to fill up the space between the two boxes after the smaller one was set firmly into the large one. This left a dead-air space between the two boxes. For the top, I took a 1-in. board, 9 by 9 in. in size, with a 1 in. board tacked underneath it to allow it to slide inside of the larger box at the top. This formed the lid, which permitted it to be opened or shut easily. During the winter, when the weather was 10° above zero, although left out in the open all day, the milk did not freeze, and this summer it has kept nicely with the temperature at 50 and 60°.—W. H. Snyder, Pocatello, Idaho.

Compressed Air Forces Gas from Hose

Gasoline stations owning their pumps can overcome the present method of draining the hose into the auto tank by the use of compressed air. The air is used directly from the tire-filling apparatus and will

force out the last drop of gas from the hose. Disconnect the hose and fit a one-way gate check valve to the connection at the pump, so that no gasoline can be forced back into the pump. Then add a short nipple ahead of this check, drill and tap a 1/4-in. hole in the pipe from the air hose. The gasoline hose can be attached to the end of the large nipple in the regular manner, either by threading on the coupling or by a hose clamp and bolts. A spring shut-off cock should be inserted in the air line at a convenient point at the pump. In use, the gasoline is fed into the automobile tank in the usual manner, but instead of lifting the hose to allow it to drain, the air cock is depressed. This allows the air to flow into the hose and force out the residue, but the check in the gas line prevents the air from forcing the

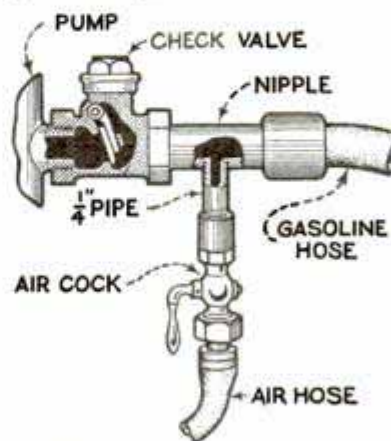

gas into the pump and back into the supply tank. As soon as the gas is out of the hose, the cock is closed.—L. B. Robbins, Harwich, Mass.

☛ To boil milk without risk of scorching it, the pan should be well rinsed in cold water before putting in the milk.

A Lard-Can Steam Cooker

A low-pressure steam cooker can be made at home out of a 45-lb. tin lard can. Those made out of black iron cannot be used. Select one in good shape, with a tight-fitting lid. Take a clean tomato can about No. 2 or 3 size to make the water filler and gauge. This is easily shaped and soldered to the lard can as shown. If you wish to use two packs, you need eight $\frac{3}{16}$ or $\frac{1}{4}$ -in. stove bolts, 1 in. long, and sixteen washers. The first row of bolts is evenly spaced around the can, 2 in. from the bottom, measuring on the outside of the can. Put them in as shown in the detail and solder the washers and bolt heads to the can. Make one or two jar racks, as shown, using No. 9 wire for the rim, and $\frac{3}{16}$ -in. copper tubing to make a neat joint. Solder the ends together. Use square-mesh galvanized cloth or netting, twisting the wires onto the rim so that there will be no sag. The wire hoops for the rack should be about 1 in. smaller than the inside of the lard can. If you wish to use pints when canning, make two racks. The water line should be about $\frac{1}{4}$

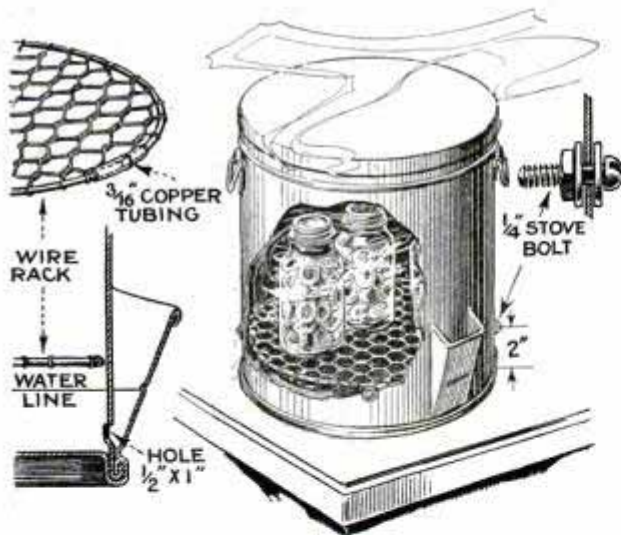

Low-Pressure Steam Cooker Made from Forty-Five-Pound Lard Can

to $\frac{1}{2}$ in. below the bottom of the jars. If the bottom of the lard can should leak, solder it all around the inside of the seam. Cut a $\frac{1}{2}$ by 1-in. hole about $\frac{1}{4}$ in. from the bottom before soldering on the water gauge.—Geo. H. Cappel, Wilmer, Ala.

☐ Always mix starch with soap water; this will prevent the iron from sticking and will give the linen a higher gloss.

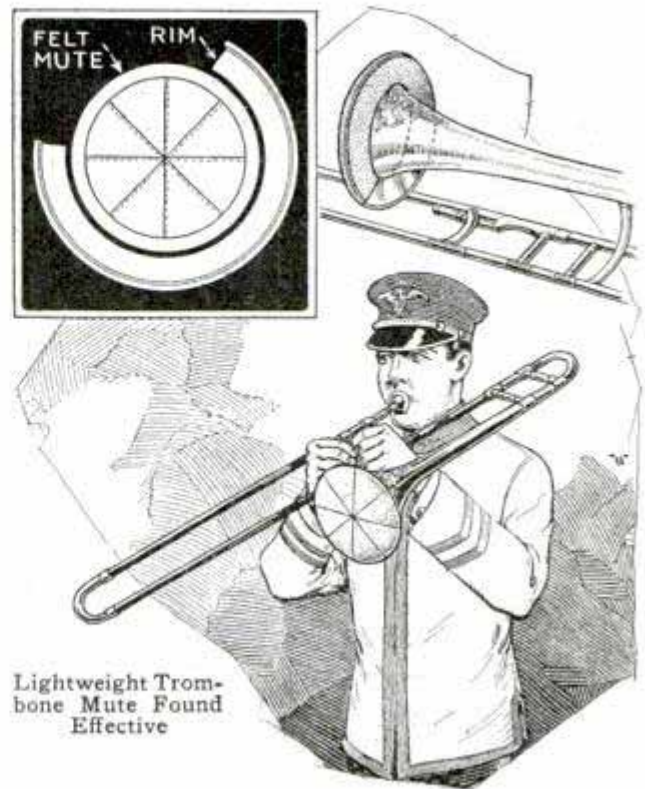

Lightweight Mute for Trombone

Trombone players will find the lightweight mute shown in the drawing of considerable value. It is made of felt of any color, although green has been found especially well suited for this purpose. The bell on my trombone is 7 in. in diameter, so I made the mute 8 in. across and of two thicknesses. Draw a circle, 12 in. in diameter, on a piece of felt and out of this disk make the rim that holds the mute in place on the bell. This strip is 2 in. wide and runs two-thirds of the way around the bell. Sew the outside of the rim to the outside of the center piece. When finished, the rim will stand out cone-shaped. The practicing musician will find this an ideal mute.—Irvin L. Oakes, Pleasant Hill, Ohio.

Spectacles Make Magnifying Glass

An old pair of spectacles can be changed to form a small magnifying glass, which is generally useful. The two eye wires are bent so that they are parallel, and exact focus is obtained by bending the nose piece so that the glasses can be pulled apart or brought together for more or less magnification.



Sign Painters' Tool Box

Sign painters and window letterers are often inconvenienced when working on a stepladder, because the top rung does not afford sufficient space for their colors and brushes, and the least disturbance of the ladders causes them to fall off.

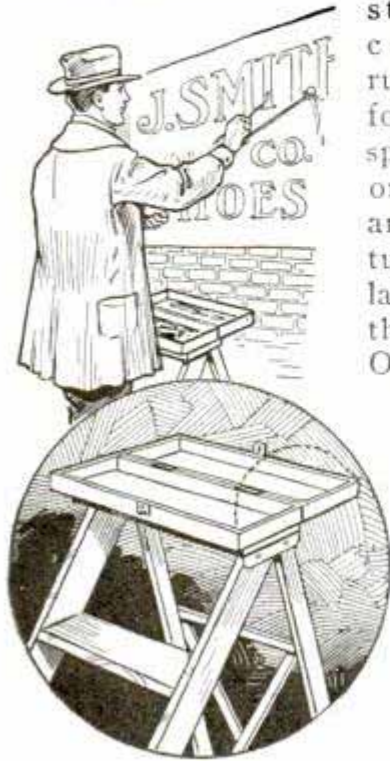

One sign painter overcame the difficulty by attaching a material box to the top of the ladder as shown in the drawing.

When closed, it provides a top step as on an ordinary ladder, but opened, reveals all the materials safely kept and with ample working space.—G. E. Hendrickson, Argyle, Wis.

Improvised Spring-Perch Holder

When driving over a rough place, the part of the rear-axle housing to which the rear-spring perch of a Ford truck is attached, broke, causing the end of the spring to drop down and rest on the housing. Not wishing to pay the price asked for a new piece, the owner repaired the truck quite cheaply in the following way:

A bar of steel, having a diameter equal to that of the rear-axle housing, was obtained, and a piece cut off, making sufficient allowance for the lap and bend near the end. One end of the bar was lapped back, making that end thick and rigid. Then a hole for the perch was drilled near the end at which the bend was made. The doubled

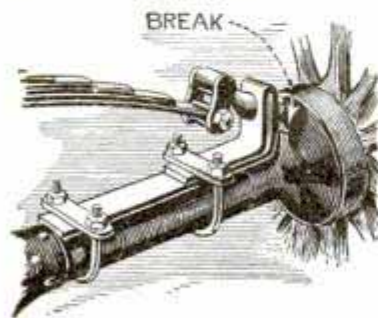

end was bent again to form a right angle, as shown in the drawing. It was also necessary to give it a slight bend where it rested against the top of the brake housing. Two U-bolts and two short straps were then made to fit the housing. The U-bolt next to the perch was made a little longer than the other one, because the doubled end of the strap necessitated the use of a longer bolt. The whole outfit was assembled as shown, and all nuts were tightened. While this repair did not allow the spring to return to its former position it saved the owner time and money.—B. Kennedy, McCool, Miss.

Ornamental Cigaret Holder

For the library or den a novel cigar and cigarette holder can be readily made from a block of soft pine and the cover of a discarded book. The bound pages are carefully removed from the covers and the pine block is cut to the exact size and shape of the bound pages. Four holes, neatly spaced and of a size sufficiently large to accommodate cigars and cigarettes, are cut through the block, which is then glued firmly to the back and one side of the cover. If desired, half of an aluminum soap box may be fitted snugly into each of the holes to improve the appearance. The words "Cigars," "Cigarets," "Ashes" and "Matches," carved or painted between the holes, will add to the ornamentation, and appropriate wording may be placed on the outside cover. A slight staining of the ends and front edge of the block completes the holder.—L. M. Curtis, Venice, California.

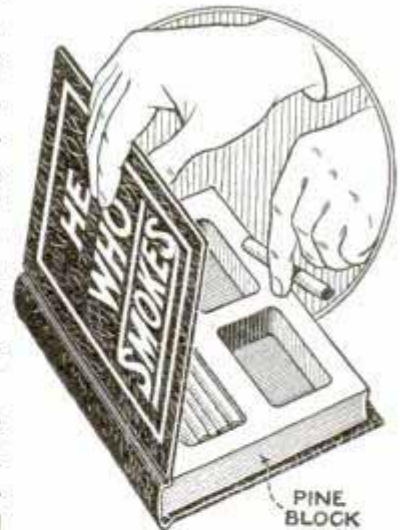

☛ If you sprinkle a carpet with salt before beginning to brush it, the dust will not rise; incidentally, the salt will improve the appearance of the carpet.

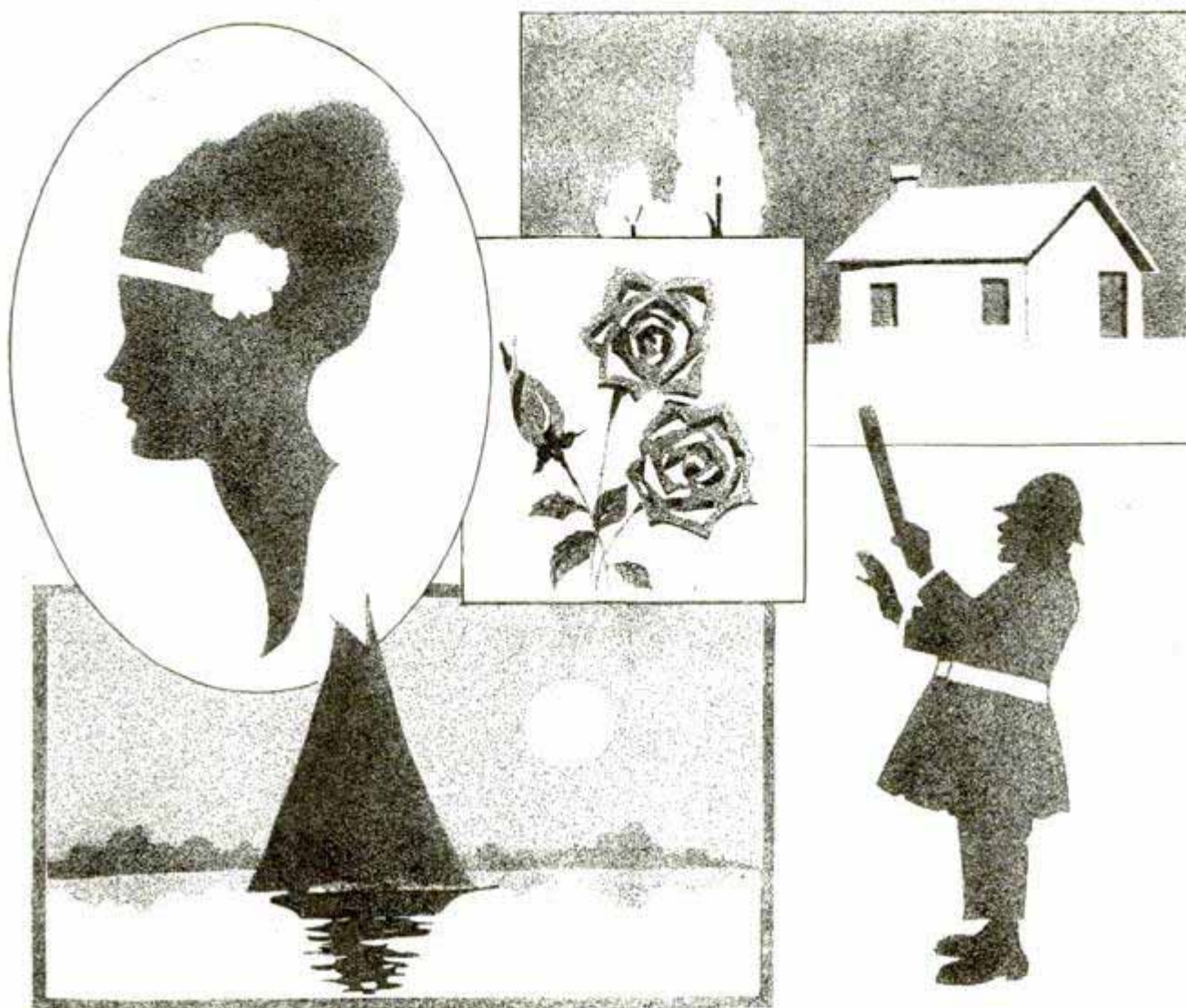

How to Make Spatter Silhouettes

Anyone Can Make Attractive Pictures by This Method
Using Only an Old Toothbrush and a Knife

NO special equipment is required for the making of "spatter-work" silhouettes. The method described here is very simple and anyone can easily make very good silhouettes in this way. All you need is an old toothbrush, a penknife and some thin cardboard. Draw the outline of the desired silhouette on the cardboard and carefully cut around the picture with the knife. The cardboard should be laid on an old magazine and the cutting done with the point of the knife, which should be very sharp. Follow the outline exactly, as the value of a silhouette depends entirely upon the correctness of its outline.

The paper upon which the silhouette is to be made is placed on the drawing board with the cardboard stencil directly over it.

Pins are used to hold them in place. Locate the pins as near the picture as possible so the stencil will be held close against the paper. Otherwise the silhouettes will be fuzzy around the edges.

The ink-spray or spatter treatment is applied with the toothbrush and knife. The drawing board should be placed on end while the spattering is being done. Pour a few drops of black drawing ink on the bristles of the brush and hold about 3 in. from the stencil. Draw the blade of the knife quickly across the bristles. This causes the ink to be thrown onto the paper in a fine spray. Any degree of "darkness" can be had, from a light gray to almost black.

For plain silhouettes, where but one

tone is required, one stencil only is needed. But for more elaborate ones of two or three tones as many stencils as tones are needed to make the picture. The



Two-Tone Silhouette of Lady's Head and Manner of Spattering by Drawing Knife Blade over Inked Toothbrush

lady's head and the policeman illustrated are made with one stencil. The yacht picture is a two-tone silhouette and two stencils were required. The landscape and the floral sketch were made with one stencil, the black parts being laid in after the spattering was done.

In the two-tone silhouette of the marine scene, the sky only was cut out of the first stencil. This left the boat, moon and water covered. This stencil was only lightly spattered over. This rendered the sky in a light gray. The boat only was cut from the second stencil and this heavily spattered which made the boat and its shadow very dark. Notice the head and the house. In the former the object was cut out, while in the latter every thing was cut out but the object. This reverses the combination and produces an entirely different style of picture. Many different combinations can be worked out to produce different effects and very artistic pictures can be made with four or five tones.

Old postal cards are good to use in small work in making the stencils. Outline the object on the card and cut out as already

described. The point of the knife must be very sharp to insure a clear outline. Profile photos can be used to make silhouettes of your friends.

Do not put very much ink on the bristles of the brush at one time, for, if heavily loaded, it will be apt to throw some big spatters which will spoil the work. The blade of the knife should be drawn rapidly across the bristles so as to throw a fine spray. Do not remove the stencil until the ink is perfectly dry.

Swinging Furnace Door

To eliminate the necessity of closing the furnace door each time a shovelful of coal is thrown in, a swinging door of heavy sheet iron will be found useful. One edge is bent around an iron rod, which serves as the hinge. Both ends of this rod are threaded and nuts screwed on. Holes a trifle larger in size than the diameter of the rod are drilled in the sides of the furnace and the rod is pushed into these holes. The nuts are then screwed against the sides to hold the rod securely in place. When feeding the fire, the shovel is simply pushed against the swinging door, its load deposited in the furnace, and the shovel withdrawn, the door shutting automatically.—E. K. Wehry, Cedar Rapids, Iowa.



Heavy Sheet-Iron Swinging Door in Furnace Found Convenient

Build Your Own Ship Model

by
J. Earle
Miller

Part I of this article appeared in the October issue

SHAVE the bow lines down to the edges of the lifts, but do not finish the bow at this stage, since a wooden stem piece must later be fitted here.

The deck lines may be cut down to size before or after the hull carving, following outline, marked side view of rough hull. The main, or well deck, in the space between the forward end of the stern section and the rear of the forecastle, is slightly curved, being $\frac{3}{16}$ in. deeper at a point 5 in. forward from the stern section, than it is at the ends. Extreme care is not necessary in cutting down, because the surfaces will be covered by the deck planking.

If clear white basswood is available, it makes excellent decks, but a selected piece of clear white pine will do in its absence. The deck plank-

ing is $\frac{3}{16}$ in. thick, and the pieces for well, quarter, and forecastle decks are cut slightly wider than the hull so that they may be trimmed down after being glued in place. Cut out the four pieces, lay them in place and, at each end, mark the points where the edges, after they are finished, will come. Measure in $\frac{3}{8}$ in. from these points, and connect the inner marks with curved lines corresponding to the curvature of the hull. Then halve the distance between these lines at each end, and connect the centers with a straight line. On either side of this straight line lay off parallel lines $\frac{3}{16}$ in. apart. With the point of a knife, score the edge curved lines and the other straight ones lightly, and then, with a well-sharpened pencil, run lines in the knife cuts. Next, at

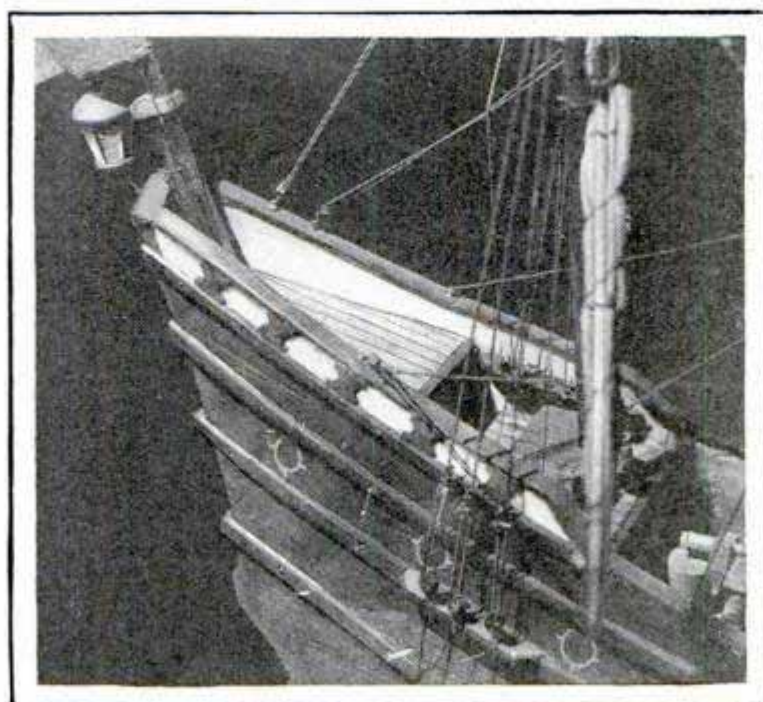

View of Quarter, Showing Rake of Bulwark and Quarterdeck, Also Deck-Plank Lining

distance between these lines at each end, and connect the centers with a straight line. On either side of this straight line lay off parallel lines $\frac{3}{16}$ in. apart. With the point of a knife, score the edge curved lines and the other straight ones lightly, and then, with a well-sharpened pencil, run lines in the knife cuts. Next, at

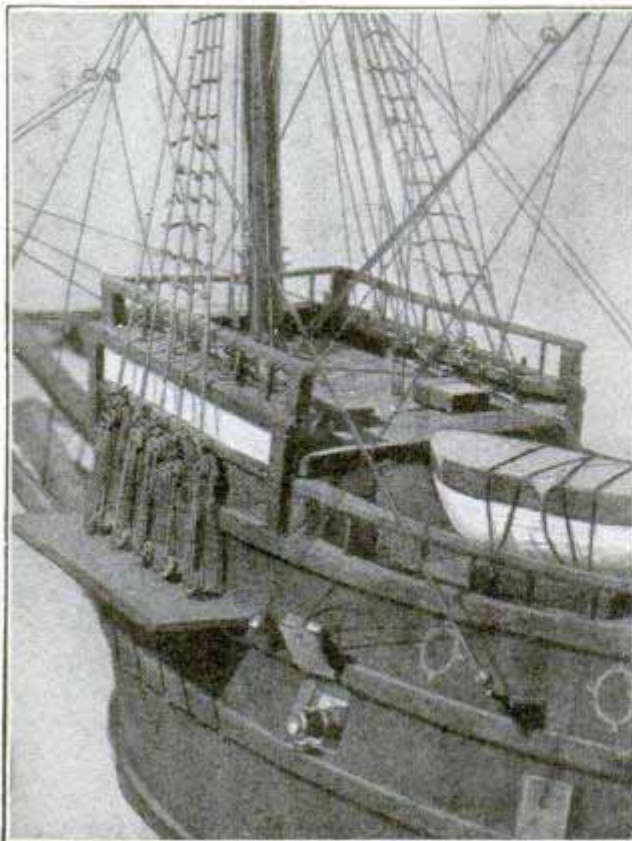

look old and well worn. After the shellac has dried, glue the decks in place and then trim the edges down to meet the hull lines. It is not necessary to clamp them on and wait for the glue to set. They can be nailed in place with small brads or pins, cut down to brad size, and later the heads can be countersunk and puttied over.

After the decks are in place, the next step is to make the bulwarks around the fore'stlo top and stern superstructure. Cut a piece of $\frac{3}{16}$ -in. thick white pine or

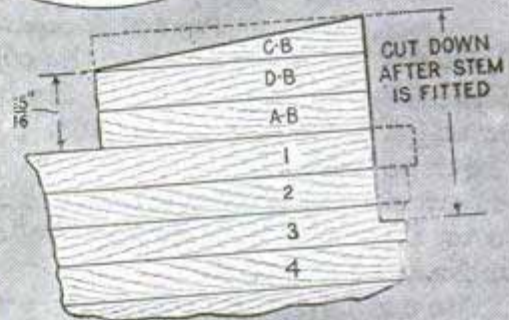
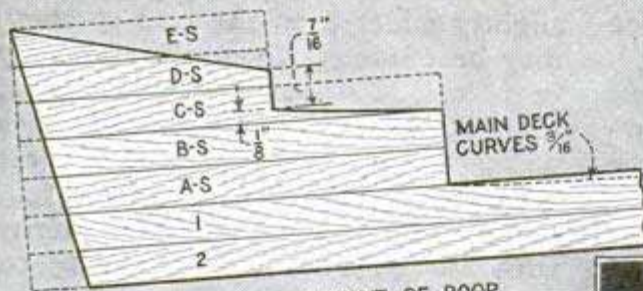
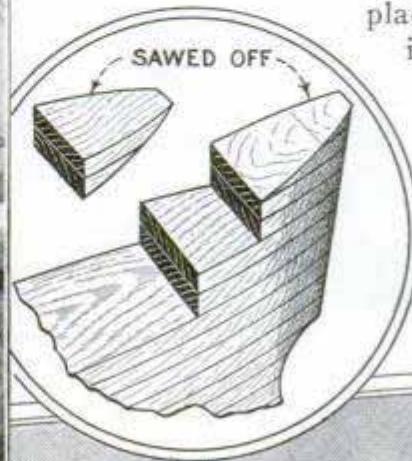

LAYOUT OF POOP

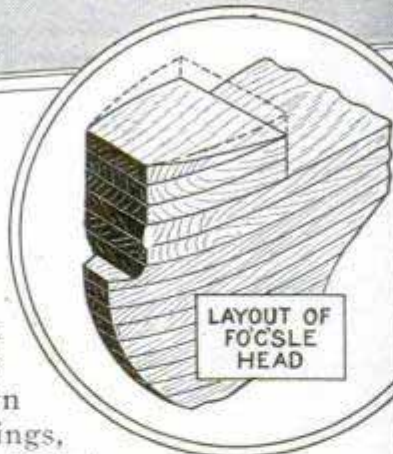

Upper Left, Fo'c'slo Head and Deck on Finished Model; Center, Poop and Fo'c'slo Layout; Lower Right, Photo of Stern

intervals of 2 in., cut and pencil in cross marks in the planking, as shown in one of the drawings, to represent the end joints.

If you wish to show the deck spikes they can be pricked in with a needle point and brought out with a sharp pencil. After all the deck planks are marked, sand the surface clear of dirt and then shellack it. The sanding process will dust over the pencil marks in the grooves and dim their newness, so that the shellacked surface will

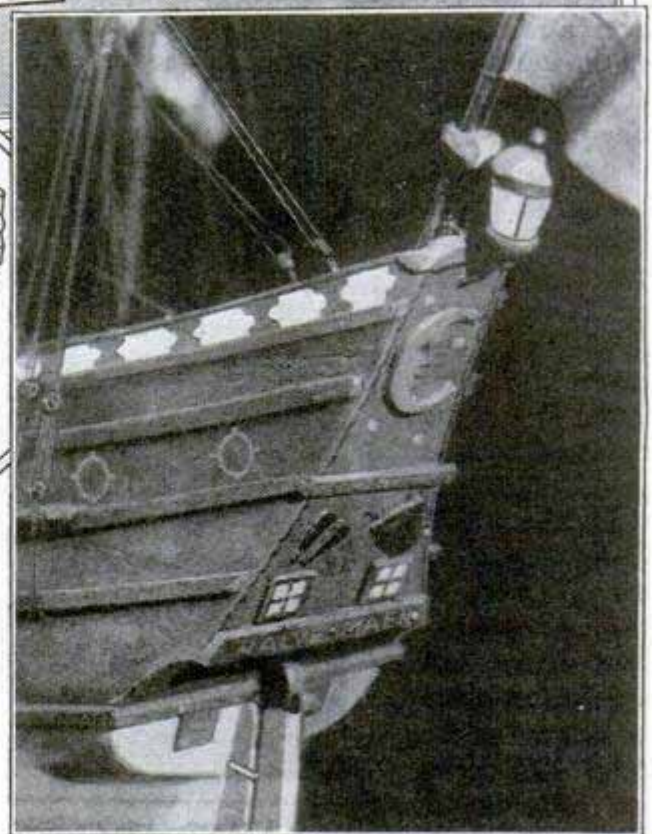

basswood, a little longer and wider than the stern, and glue and nail it to the stern, with the top edge projecting 1 in. above the deck, and the lower edge just even with the point where the superstructure ends and the stern curves inward before starting the straight downward rake to the keel. With a half-round file smooth off the lower edge to conform to the stern curve, and trim down the edges to match the sides of the superstructure. The 1-in. projection above the stern of the poop-deck furnishes the rear bulwark, and the flat piece itself gives a better surface on which to paint the decorations of the stern, than would be the case if the end grain of the hull wood was left bare.

Next cut and fit the side bulwarks. Holding a sheet of plain paper against the

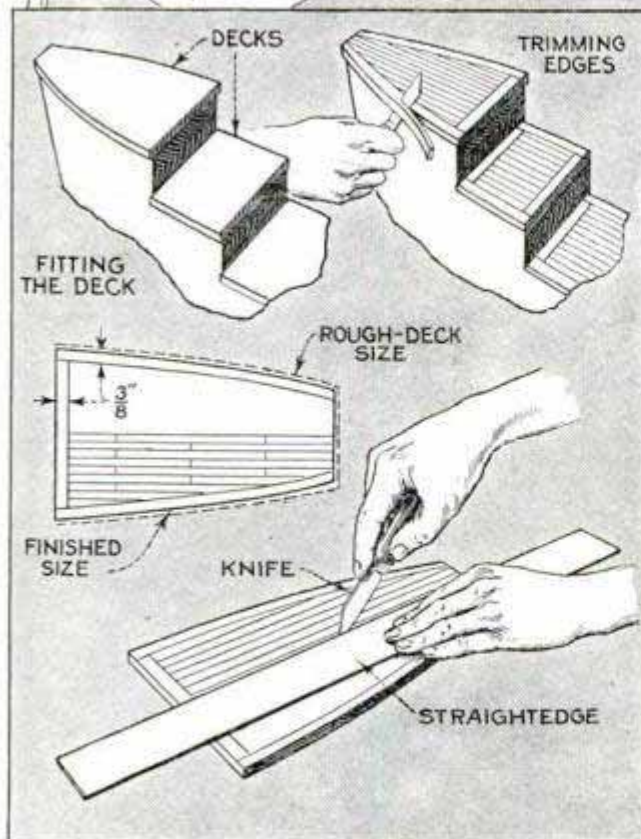
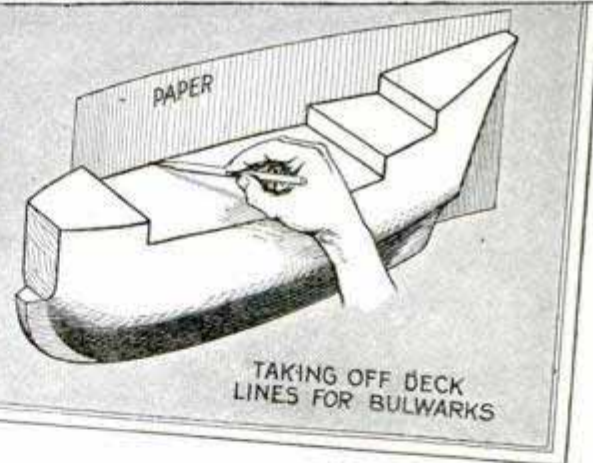
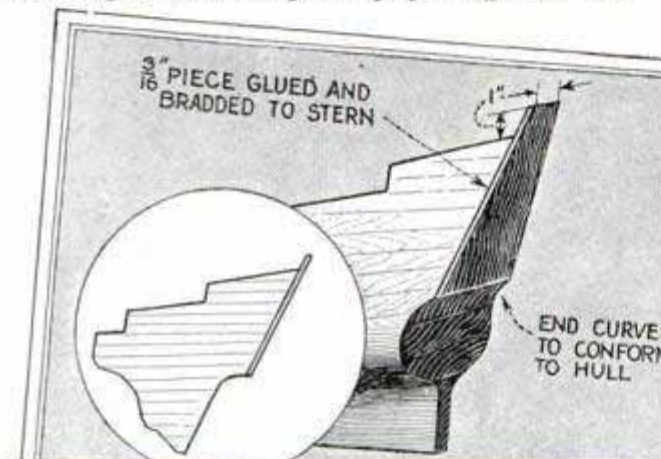
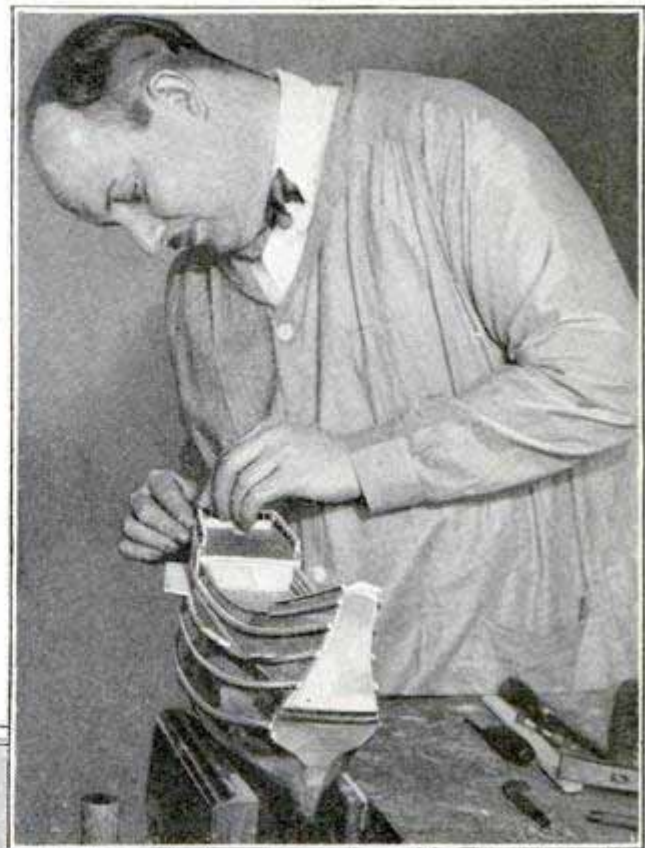

Above, Photo Showing Half-Finished Hull; the Drawings Illustrate Details of Hull Construction

side of the ship, the deck lines can be traced on it, to give the lower edge of the bulwarks. They should be sawed out of $\frac{1}{4}$ -in. soft white pine, and carved down to $\frac{1}{8}$ in. in thickness, after being glued in place. The bulwarks take considerable curving to fit the hull lines, which accounts for the need of the extra $\frac{1}{8}$ in. of material. After they have been sawed out and fitted, take several ordinary pins and drive them down through the bulwarks, then coat the lower edges of the strips with glue. Starting just aft of the fore-castle, pin the bulwark strip in place, allowing its outer edge to project slightly past the hull line. At intervals of 1 or $1\frac{1}{2}$

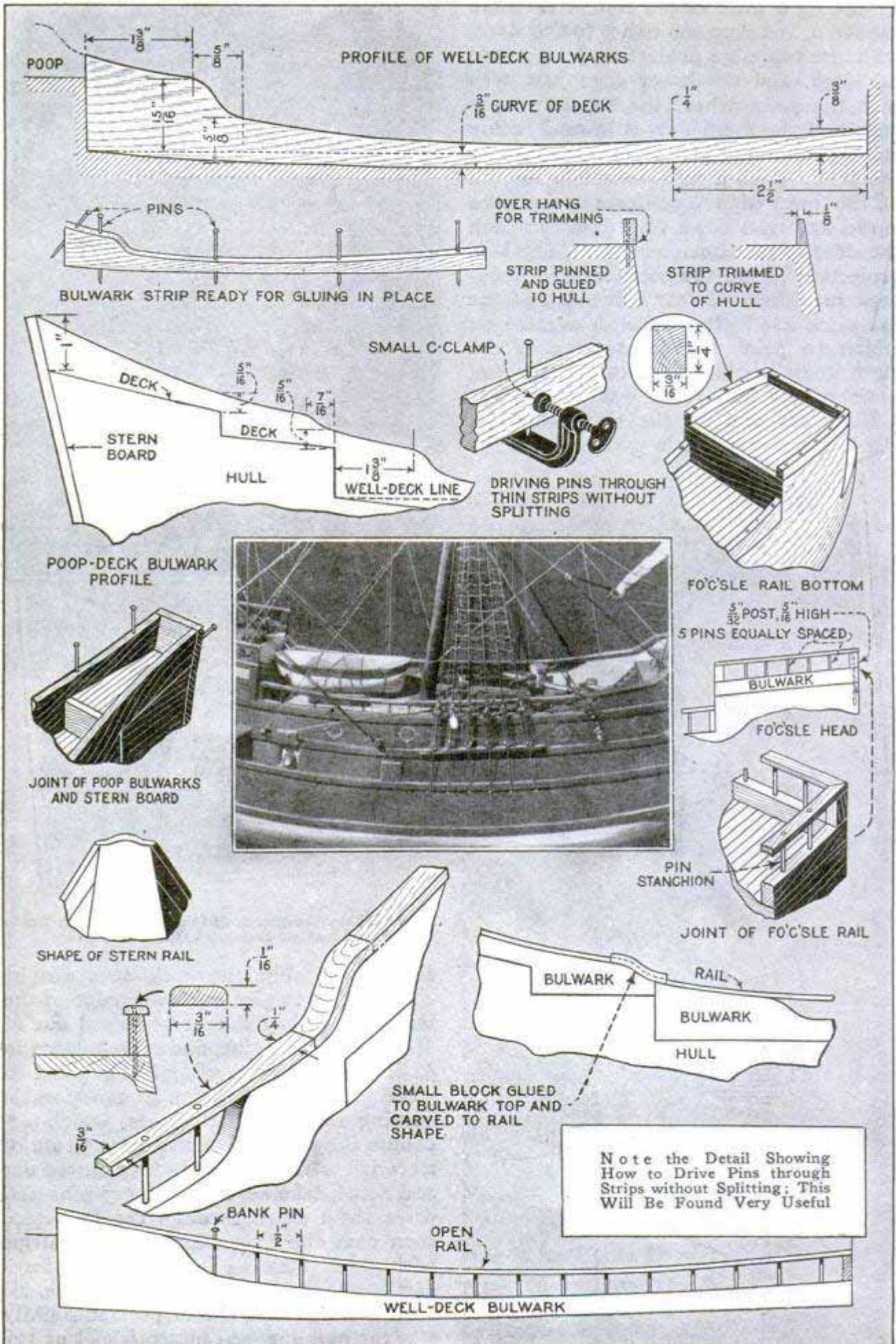

in., working toward the stern, drive in additional pins, bending the bulwark strip to fit the hull line, but always allowing it to project slightly, so that it may later be shaved, filed and sanded down to fit. When you reach the break of the quarterdeck, where it rises above the main deck, drive a long pin down to hold the bottom of the bulwark strip in place, then bend the top in to follow the hull curve, and, with a pin driven diagonally back into the quarterdeck structure, bind it in place. The second bulwark strip, above the quarter and poopdeck, requires less bending, but is placed in the same way, and pins or brads are then driven through the stern bulwark, to

ture of the forecastle. Cut them to size and length and drop them in a kettle of boiling water for a half hour, by which time they will be pliable enough to be glued and pinned in place.

The rails on top of the solid bulwarks aft, and the open rails of the well deck and forecastle come next. Those on the solid bulwarks are $\frac{1}{16}$ by $\frac{1}{4}$ in., cut from white pine, and with top corners slightly rounded with sandpaper. The top rail of the stern bulwark is whittled out from a strip $\frac{1}{4}$ in. thick, and the curving rails at the break, where the bulwarks drop from the poop to

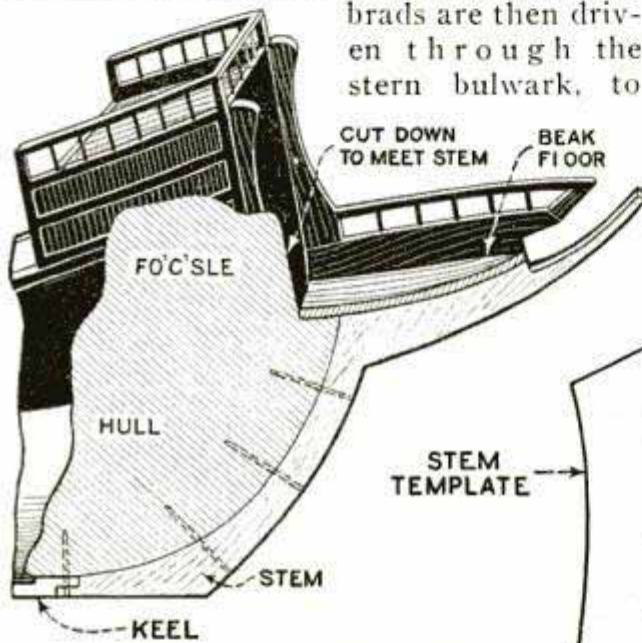

Full-Size Template of the Stem and Detail of How It Is Fitted

tie it to the side strips. After the bulwarks are in place, carve the outer surface down to fit the hull lines and then, with a knife, shave off the inside until the bulwark has been reduced to $\frac{1}{8}$ in., at the top at least. The shaving process will reduce the overhang and widen the deck space.

The forecastle bulwarks, around the two sides and front, are $\frac{1}{4}$ in. high and $\frac{3}{16}$ in. thick. The

strips that are to go along the sides of the bulwarks must be bent to conform to the curva-

the lower level of the quarterdeck, are whittled out and fitted in the same way. Next, glue the straight rails along the bulwarks from the stern to the break, and then cut the long pieces, which stretch from the break to the forecastle. Before gluing them in place, the portion that is to be left as an open rail, can be shaved down to $\frac{3}{16}$ in. in width, since it has no solid bulwark to project over. Mark the open-rail section, and at $\frac{1}{2}$ -in. intervals drill holes through it with a No. 60 drill. Then cut two small pieces, $\frac{1}{16}$ in. thick, $\frac{1}{8}$ in. wide and $\frac{3}{8}$ in. long, and glue one on top of the bulwark and to the forecastle on either side, on which the rails will rest. Glue the rails in place, and you are ready to put in the stanchions of the open rail-

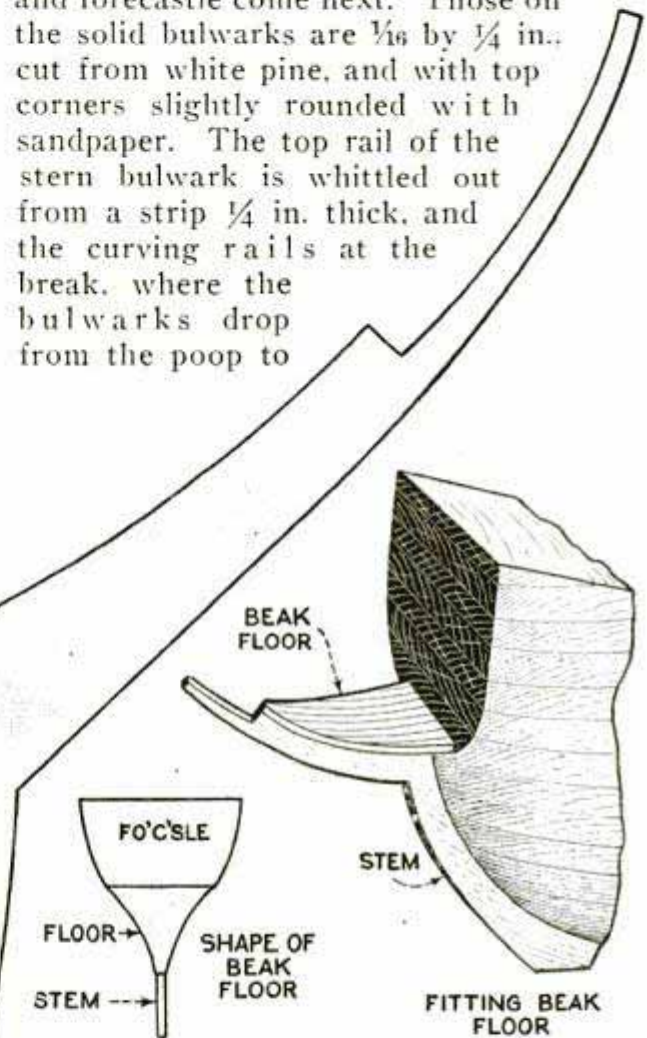

ing. These are made from the long, heavy pins known as "bank pins." Cut them off $\frac{5}{8}$ in. from the point, lay the tops away for future use, and use the point sections for stanchions. Push them through the holes drilled in the rail, slip a $\frac{3}{8}$ -in. block between bulwark and rail, and drive the pins down into the bulwark. If the latter shows a tendency to split, take one of the small metal clamps and tighten it on the rail at the point where the pin is penetrating. After the pins are all driven down flush with the rail top, they may be countersunk slightly, and the holes filled with putty or a prepared crack and crevice filler.

The fo'c'sle bulwark rails are made in the same way, except that the corner posts are of wood, $\frac{1}{8}$ in. square and $\frac{3}{8}$ in. high. Clamp the posts in a vise and carefully drive small pins down to help the glue hold them in place. Then glue the rails on top and add the pin stanchions.

The next step is to build the beak, which, in these old ships, still retains distinct traces of its ancestor, the fighting beak of the Roman galleys.

Using the template on page 853, lay out the stem on a piece of white pine or basswood, $\frac{3}{16}$ in. thick, turning the template in such a way that the grain of the wood will run as straight as possible with the thin fore-end, to which the deck of the

beak must later be fastened. The stem is designed to project slightly under the hull, and later the keel will be joined to it and continue aft.

Glue and pin the stem to the hull and then, with a handsaw, cut the bow straight down from the front end of the forecastle to the level of the stem top. Next saw out the beak floor from $\frac{3}{16}$ -in. white pine, and mark the deck planking in the same manner as for the main decks. Glue the floor in place and you are ready to start building up the bulwarks. Their lower edges, where they join the floor, are beveled at an angle of about 30° , so as to give them an outward flare. They can be cut from $\frac{1}{4}$ -in. white pine, and at the rear end $\frac{5}{8}$ in. is whittled down to a thickness of $\frac{1}{16}$ in., to bend around and join to the hull, as shown in the detail sketch. It will be necessary to steam them by boiling. A half dozen of the small clamps will not be too many to hold them as they are bent, glued and pinned in place.

The figurehead of the lion comes next. It is carved from $\frac{3}{8}$ -in. soft wood. Cut a strip to the proper length and height and lay out the lines shown in the figurehead drawing (actual size) on this page. The space under the belly and back of the hindlegs is carved out, but the pairs of legs are not separated. Instead they run through the full width, for greater strength.

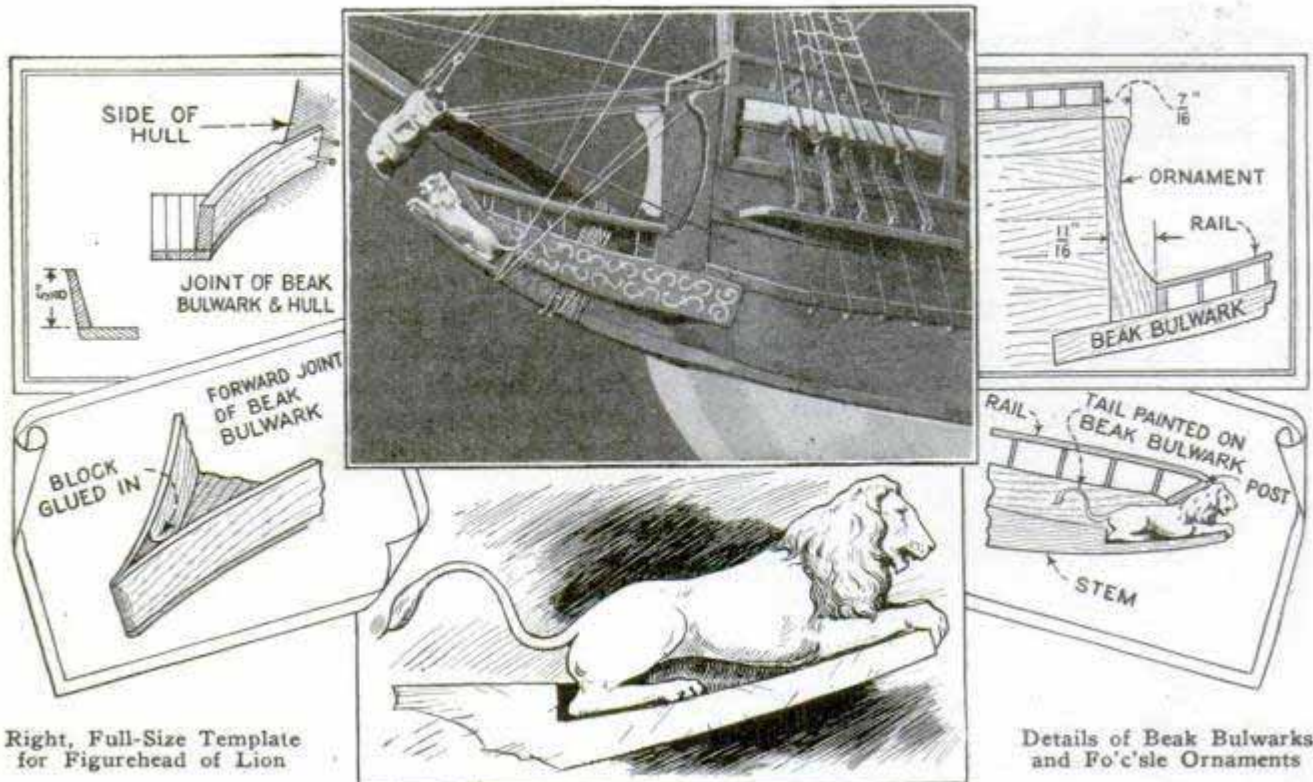

Right, Full-Size Template for Figurehead of Lion

Details of Beak Bulwarks and Fo'c'sle Ornaments

Glue the figurehead in place on top of the projecting end of the stem and beneath the front end of the bulwarks. A small stanchion, $\frac{1}{8}$ in. square and $\frac{3}{8}$ in. long, fastens on top the bulwarks and extends along the lion's back to form the forward support of the beak rails.

The ornamental extensions of the bulwarks up the sides of the forecastle come next. They are from $\frac{1}{2}$ -in. stock, carved out to fit the curves of the hull, and brought down to a finished thickness of $\frac{1}{8}$ in. Their side view is shown in the detail, and further dimensions are valueless, since they can best be fitted to the hull and beak by cut-and-try methods. The rails from these pieces to the strip above the lion's back, and the pin stanchions, are added in the same way as those on the other decks.

(To Be Continued)

False Eyes Make Comic Design



This pair of false eyes can be made by anyone. The eyes themselves are made from two oval pieces of heavy white cardboard, about $1\frac{1}{4}$ in. long by 1 in. wide. Soak them in water until pliable and then lay between two spoon bowls, pressing the two, until the paper becomes convex, with a weight. Let the paper dry

for 24 hours. Paint the convex sides like eyes and glue between them a wire bow as shown. Drill a small hole in each pupil. Place this pair of glasses on your nose so that they cover your eyes completely. You can see through the holes well enough to get about and the disguise will prove very comical, especially if the eyes are made to represent crossed eyes or are of different colors.

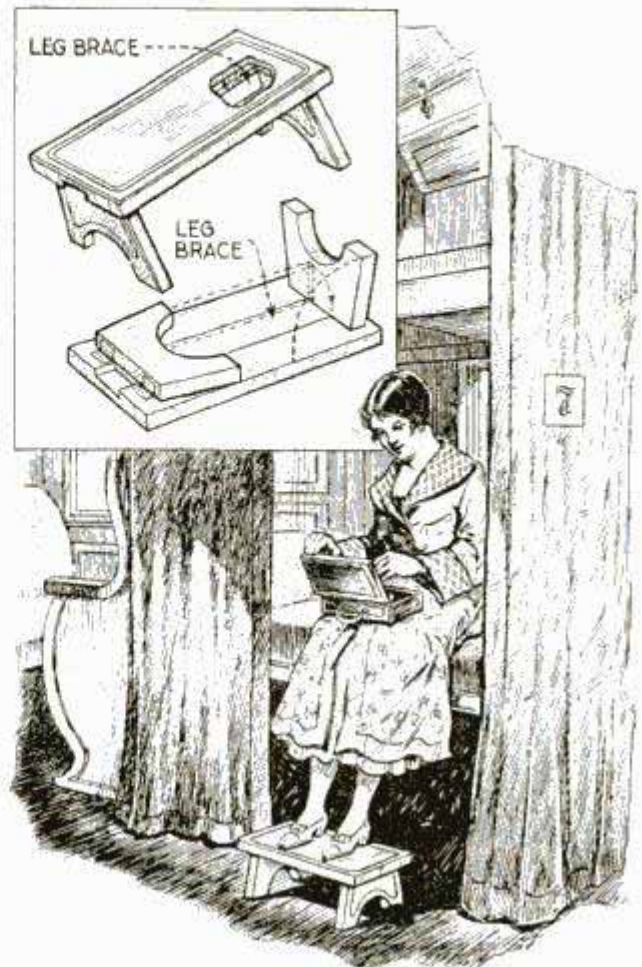

Small, Collapsible Footstool Found Convenient When Sitting on Pullman Berth

Small Footstool Convenient on Train

A rather short woman whose feet could not touch the floor when she sat on the berth of a railroad coach, carried with her a little collapsible footstool. The construction of the stool is shown in the drawing. It is about 8 or 10 in. long, 6 in. wide and about 3 in. high. When in use, the sides are braced and held in position by a 1-in. strip of wood, which is hinged to the underside of the top. When the stool is collapsed, this strip is pushed into a groove cut for this purpose, so that it is flush with the underside of the top, and then the sides are folded in. The legs can be made more or less ornamental.

After burning soft coal all winter, the chimney is so dirty that a fire in it may occur. An easy way of cleaning it is to throw a piece of sheet zinc about 4 by 4 in., into the furnace when there is a hot fire. This will change the soot into small white flakes so light that the draft blows them out of the smokestack.

Draining Vapor Lamps

Vapor lamps burning kerosene or gasoline depend upon clean fuel for the best operation. Dirty liquid must be removed before it carbonizes or clogs the delicate

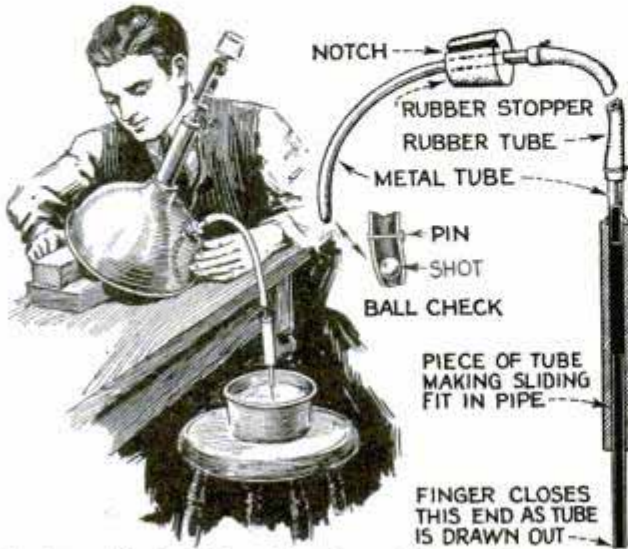

Getting All the Dirty Gas Out of Vapor Lamps with a Siphon

jet in the burner. Getting all the gasoline out of the lamp by inverting it is almost impossible, but by using a siphon, as shown in the drawing, the job is easy. A siphon can be made as follows: Straighten out two old generator tubes and force out the asbestos filling with a steel wire. Saw off one tube so that it will reach the bottom edge of the fount by curving it sufficiently and will project a short way above the fount. Slightly pinch the lower end so that a lead shot, dropped in the tube from the top, will travel easily down the tube, but will not come out of the small end. Then drill a fine hole through the tube, $\frac{1}{2}$ in. above the bottom, and rivet a piece of pin through the tube, as indicated. This forms a check valve, as shown in the detail. Push the tube through a rubber stopper with a notch cut in the side to make an air intake to the fount. When properly adjusted the check valve should nearly touch the bottom of the fount with the cork in place. Then fit about 2 ft. of rubber tubing to the top of this tube. Make a suction pump from a 4-in. length of brass tubing with an inside diameter just large enough to let the generator tubing slide up and down in it. Solder a short piece of the smaller tubing in one end and in the other end insert

a 4-in. length of generator tube that has been straightened perfectly. The flanged end may be used for the plunger and can be filed down to make a snug fit. The operation of the siphon is as follows: Tip the lamp at an angle on the table and arrange a pan at a lower level near by. Insert the first tube and let the suction pump hang over the pan, always at a lower level. Push the plunger of the lamp almost in and, placing the finger over the opening, pull the plunger out sharply nearly its entire length. Repeat this two or three times, and the liquid will be drawn up and flow by itself out of the open end of the plunger. Each time the plunger is drawn out it pulls the liquid up, which cannot return because of the check valve. Two or three such operations will fill the tube so that the siphon is started. To work properly, the generator tube must be a good fit in the brass tubing.—L. B. Robbins, Harwich, Mass.

Sling for Transporting Culverts Single-Handed

Moving culverts or tubes made of corrugated steel is quite a heavy task for one man when they are 16 or 18 ft. long. However, an easy method of doing this is shown in the drawing. Drive your wagon over the culvert and straddle it. Lift up the rear end and set a stick or brace under it. Next fasten a chain around the culvert and the rear axle. When you let the

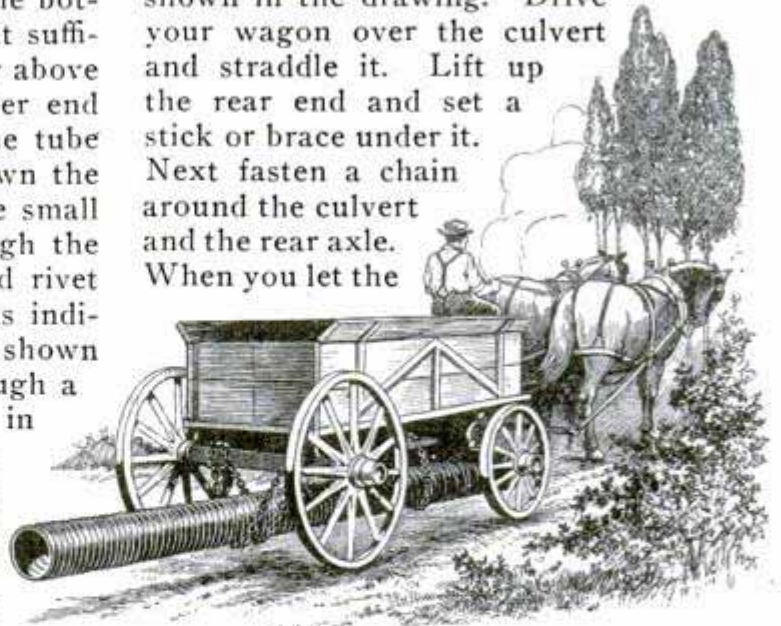

Moving Long Culverts Is No One-Man Job, But This Method Is an Easy One

culvert down it will be suspended beneath the wagon as shown in the illustration. A chain may then be fastened around the culvert and the coupling pole of the wagon.

How to Make a Sewing-Basket Taboret

By EDWIN M. LOVE

THE combination of a sewing basket and a taboret results in the easily built, yet attractive and useful piece of furniture illustrated here. It may be of hardwood, stained and varnished to match the room furnishings, or may be of soft wood finished in enamel.

For the top, glue up two widths of 1 by 8-in. stock, putting in three $\frac{3}{8}$ -in. hardwood dowel pins, 3 in. long. After drying scribe a circle of $8\frac{1}{4}$ -in. radius, and lay out the hexagon illustrated by stepping around the circumference with dividers set to the radius. Saw out carefully, and smooth the edges to dimensions. Glue and nail with fine brads around the top edges, a $\frac{1}{2}$ -in. half-round mold, joined at the corners by cutting the ends to an angle of 60° . Show a margin of $\frac{1}{8}$ in. above and below this molding, as indicated.

The mold is easily made by squaring up a strip to a rectangular section $\frac{1}{4}$ by $\frac{1}{2}$ in., afterward planing off the corners to make a half-octagon, and finishing by removing these corners and sanding. After applying to the top, it may be found that one piece projects beyond its mate. In working it down, slope gradually.

While the top stock is drying, make the sides. These are of $\frac{3}{8}$ -in. three-ply panel veneer, cut with the grain of the outer plies running vertically. Make them $5\frac{5}{8}$ in. long and 7 in. wide, the joint edges being beveled to an angle of 60° . It will be found very handy to cut an angle template of 1-in. stock to press against the saw in cutting. With a fine-toothed saw, and careful guiding, no planing of these edges will be necessary; but if the plane is used, avoid rounding or cutting the angles out of true.

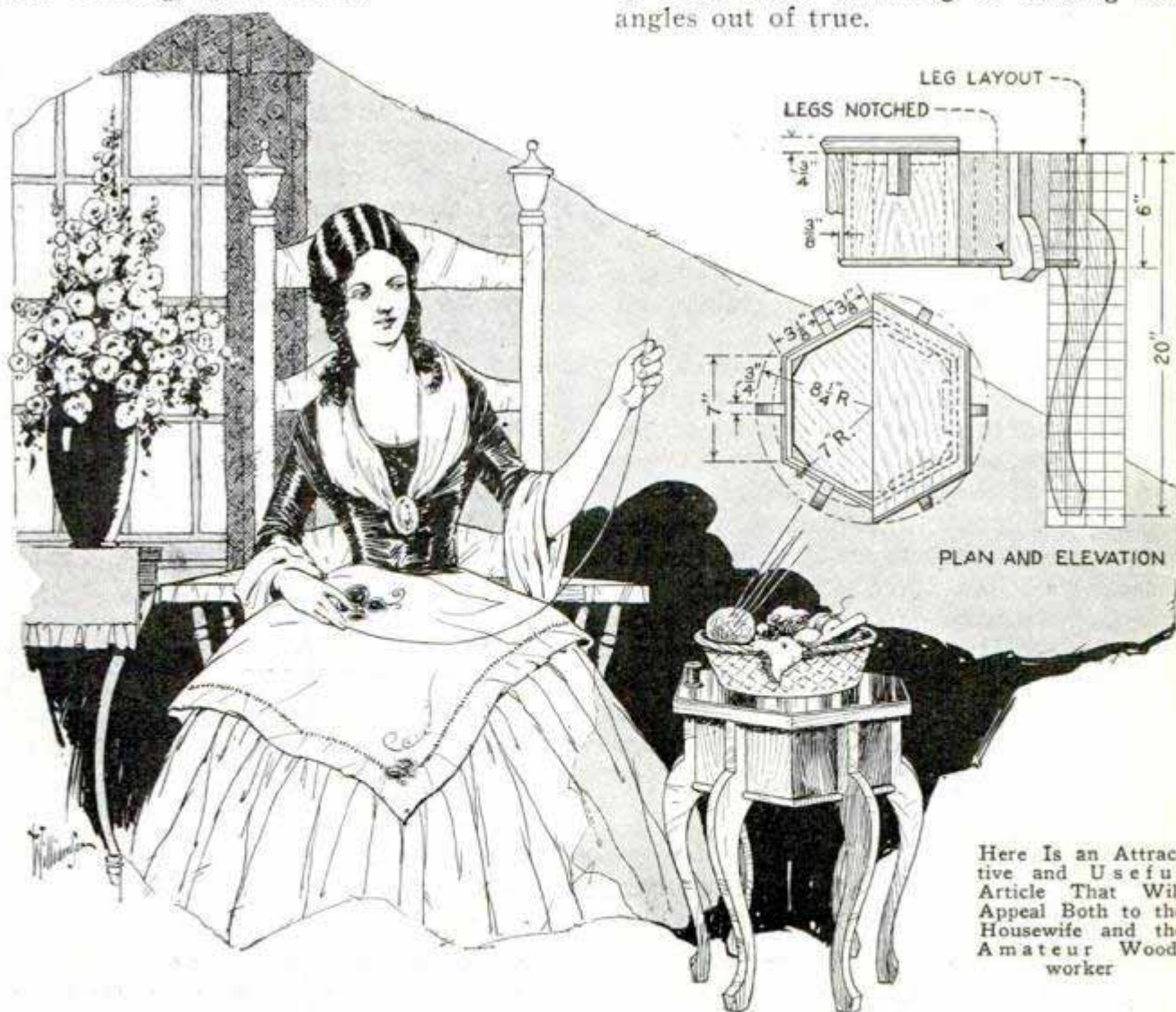

Here is an Attractive and Useful Article That Will Appeal Both to the Housewife and the Amateur Woodworker

Make six hardwood corner beads of triangular section, as shown, to reinforce the corner joints of the box. The two 1-in. sides make an angle with one another of

Prepare a template for the leg layout by dividing a 4 by 20-in. rectangle of cardboard into 1-in. squares, upon the lines of which the outline intersections can be located as they are in the drawing. When a smooth outline is obtained, cut out, and trace the six legs on 1 by 6-in. stock, nesting them together for economy of material, but keeping the grain vertical. They may be cut out with a compass saw and smoothed with spokeshave, woodrasp and sandpaper. Notice that they notch under the bottom.

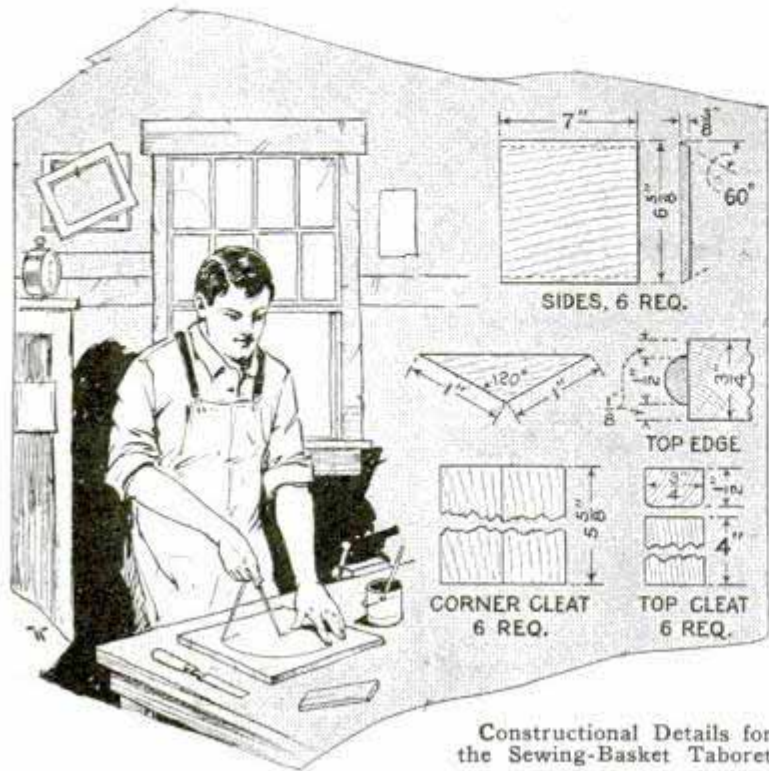

120°. Rip two of these down the center to allow of spreading for the partition.

Glue, and nail with brads, one bead to the inside of each joint edge of two of the sides. Take care that they line accurately. Then unite the other sides, and insert the $\frac{3}{8}$ by $5\frac{5}{8}$ -in. pine partition, gluing and nailing in the half beads.

Use a single piece of $\frac{3}{8}$ -in. stock for the bottom. After the glue in the box has set (the top is shaped while waiting for this), smooth off top and bottom edges and place on the bottom material. With a sharply pointed pencil trace around the box, and with scribes set at $\frac{3}{16}$ in., scribe a second outline. Mark the bottom and one side to make certain that in assembling they will mate, since a possible irregularity of the box would otherwise mean an uneven projection of the bottom. Cut out, following the outer line, and work a half-round on the edge. Then nail in place on the box assembly.

The legs are centered on the box sides. Bore and countersink on the inside for No. 10 wood screws, two holes for each leg, keeping them $\frac{1}{4}$ in. below the top and above the bottom. Outside, square down guide lines for the leg faces, and notch the projecting edge of the bottom. Try the legs in place and mark the screw positions. Drill small holes to prevent the screws from splitting the legs, and attach with glue as well as with screws.

Set the taboret on a smooth floor. If all legs do not touch, set scribes to the shortest and scribe all legs. Cut off the long ones.

Now lay the top face down on the bench and invert the stand upon it. Having moved the stand to show an even projection of the top all around, trace the outline with a pencil. Screw six $\frac{1}{2}$ by $\frac{3}{4}$ by 4-in. cleats $\frac{3}{8}$ in. inside these lines, to serve as guides in holding on the removable top. Sand thoroughly, sponge with a damp cloth to raise the grain, and sand with 00 paper. Finish as desired.

Keep Up Balloon Pressures

Balloon tires, to a much greater extent than high-pressure tires, are sensitive to the slightest loss of pressure. A loss of 5 or 10 lb. in the balloon tire not only re-

MATERIAL LIST

- | | |
|--|---|
| 1 piece, 1 by 8 in. by 4 ft., hardwood, S4S, sanded. | 1 piece, $\frac{3}{8}$ by 16 by 18 in., three-ply panel veneer. |
| 1 piece, 1 by 6 in. by 5 ft., hardwood, S4S, sanded. | 1 piece, $\frac{3}{8}$ by 6 by 16 in., pine, S4S, sanded. |
| 1 piece, $\frac{3}{8}$ by 16 by 16 in., hardwood, S4S, sanded. | 2 doz. No. 10 1-in. flat-head wood screws. |
| | A few 1-in. brads. |

duces its life, due to the greater flexing load imposed on the walls of the casing, but makes steering harder and increases the tendency to shimmy. It pays, therefore, to watch the tire pressure closely, checking it twice a week or oftener. Many motorists have found that the tire mileage is greatly increased by carrying pressures two or three pounds above that recommended by the manufacturer of their car. For example, on one well-known six the pressures recommended are 30 lb. for the front tires and 35 for the rear. It has been found by experience, however, that a pressure of 38 lb. both front and rear not only results in easier steering, but in a reduction in tire wear of from 30 to 50 per cent, without any appreciable loss of riding comfort. Of course, the increase in pressure must not be carried to extreme. Two or three pounds above the pressure recommended is enough, and the car owner will do well to consult his dealer or service manager about the matter, as they can give him the results of many other owners' experience, as well as that of their own demonstrators.

Straightening Wire

Wire can be easily drawn out in perfectly straight lengths in the following way: Cut it off in 2-ft. lengths, chuck one end in the hand drill and the other end in a small vise, as shown in the illustration, and give the wire a number of turns, which will straighten it out immediately. Of course, one must bring the wire under tension while twisting it, and its size, condition and flexibility determine how



Easy Method of Straightening Wire with a Hand Drill and a Vise

many twists to give it. It was found that No. 14 copper bus wire, such as is extensively used in wiring radio sets, could be straightened by giving it five or six twists. —E. R. Haan, Chicago.

Toy Moving-Picture Machine

The photo shows a toy moving-picture machine with a motor drive. The motor

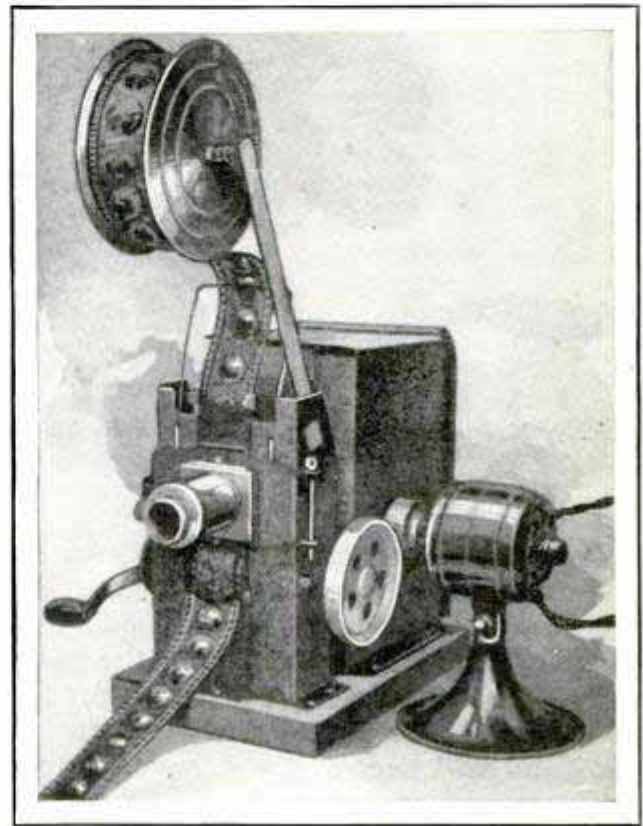

Improved Motor-Drive for a Toy Moving-Picture Machine.

is taken from an electric fan, the guards and blades being removed and a cork wheel mounted on the shaft. The wheel is made as follows: Take the spool of an A-130 Kodak film, saw it $\frac{9}{16}$ in. long and trim the end so that you can mount the flange from the discarded end on it. From a cork, $1\frac{1}{2}$ in. in diameter, cut a wheel $\frac{1}{2}$ in. thick and mount it between the flanges of the spool. Then mount the spool on the shaft of the motor and place the motor so that the cork wheel is in contact with the flywheel of the moving-picture machine. It will be better to fasten the moving-picture machine to a table or bench by means of a couple of screws to prevent it from twisting. It is not necessary to fasten the motor, as it will stay in any position placed. —Carl Osborn, Charleston, S. C.

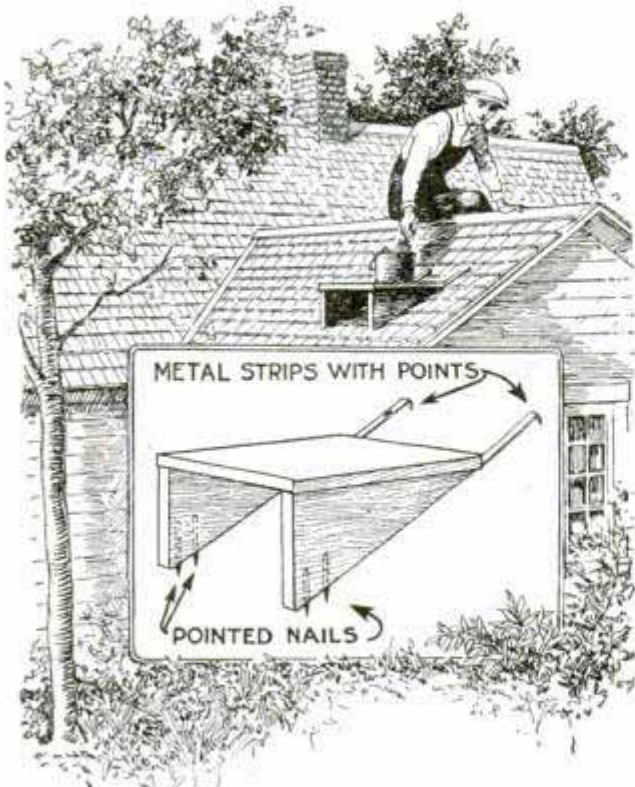

Quickly Made Support for the Paint Pail Allows Worker to Use Both Hands

Roof Platform for Paint Pail

If you have ever tried to paint the ridge boards on the roof, or some point projecting above it, you know how difficult it is to keep your balance and hold the paint pail at the same time. A platform for the pail, that can be placed anywhere on the roof and will keep the pail level, can be made in a few moments. Cut out two pieces of board of such a shape that the top edges will be horizontal when the long, or bottom, edges rest on the roof. Nail a wide board across the top of these boards to make a platform. Fasten a narrow strip of metal to the bottom of each side and sharpen the ends of the strips to points and bend them downward. Drive two or three nails into the bottom edge of the sides near the wide end and file the heads to a point. These nails should slant somewhat toward the rear. By pushing the pointed metal strips under the shingles

and pressing the points down into the shingles, the platform is prevented from rising, and the sharpened nails at the rear keep it from slipping down. This makes a level platform on the roof and the painter can work freely with both hands.—L. B. Robbins, Harwich, Mass.

Preparing Floor Wax

Many amateurs who have had trouble in using floor wax seem to think that it is possible to use it just as it comes from the can. This is the cause of all gray spots, which are due to uneven work by using wax that has not been properly treated. For best results, floor wax should be reduced as follows: Remove a small quantity from the can, add a little linseed oil, and add turpentine sufficient to reduce to a thin paste. This should be done no matter what the wax is used for. A more even job can be done and the work of polishing will be much easier.

Supercharger for Small Auto

Racing cars as well as several of the more expensive European cars are fitted with superchargers, which are devices that put the air supply of the car under some pressure instead of depending on the vacuum created in the cylinder, as is the case with the ordinary auto carburetor. This pressure system gives a decided increase

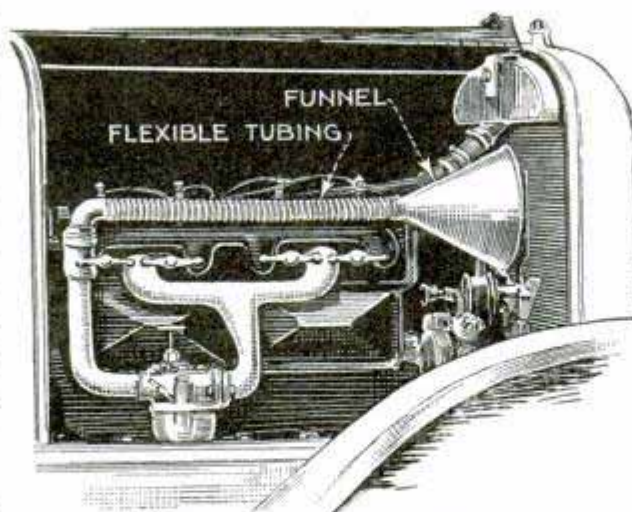

Increased Speed and Power, and More Mileage per Gallon Are the Results of This Installation

in speed and power as well as greater gas economy. These superchargers are too complicated and expensive for the average small-car owner, but anyone can make a simple device that uses the air thrust from the fan to create the necessary pressure. It consists of a large funnel, fitted close behind the fan to catch the air and connected to the air inlet of the carburetor by a piece of flexible tubing such as used on exhaust heaters. This arrangement also brings warm air into the carburetor.

*The Best - P. H. Weber Co.,
Racine Industrial Plant*

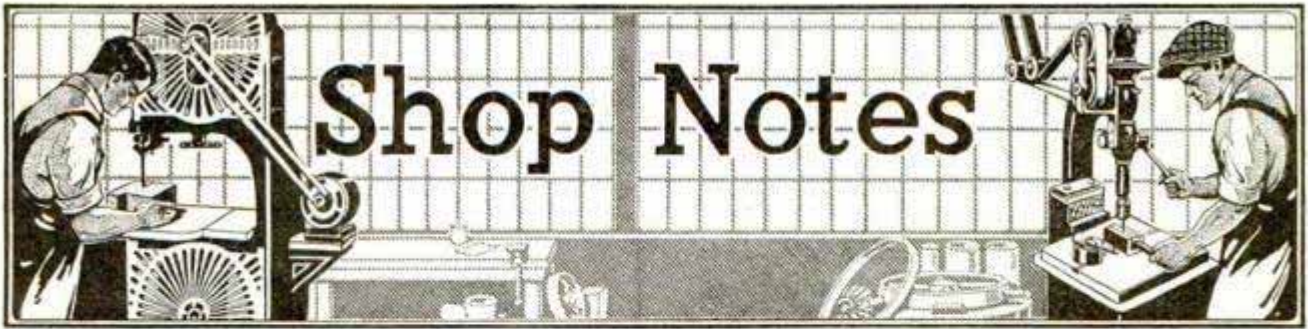

All Shop Notes published in 1925, in book form—Fifty Cents—from our Book Department

Use Your Outboard Motor for Power

By LAWRENCE B. ROBBINS

AN outboard boat motor is seldom used for more than three or four months of the year, but the man who likes to tinker and build things during the winter days can utilize it as a serviceable power plant for his basement or barn shop. It will function perfectly in driving small machinery, such as drills, bandsaws, bench lathes, etc., and if properly installed and operated can do the motor no harm. The only accessories needed will be an automobile radiator and fan and some garden

hose; also a bit of blacksmith work and simple pipe fitting. This latter may be hired done, but the handy man should be well able to prepare every part himself.

A solid wall should be selected upon which to build the motor support. It should be at right angles to the countershaft or machine to be operated. Cut out two wide planks, about 1 ft. taller than the height of the radiator and 1 ft. wide. Slightly taper them and spike or bolt them to the wall and floor with the smaller end

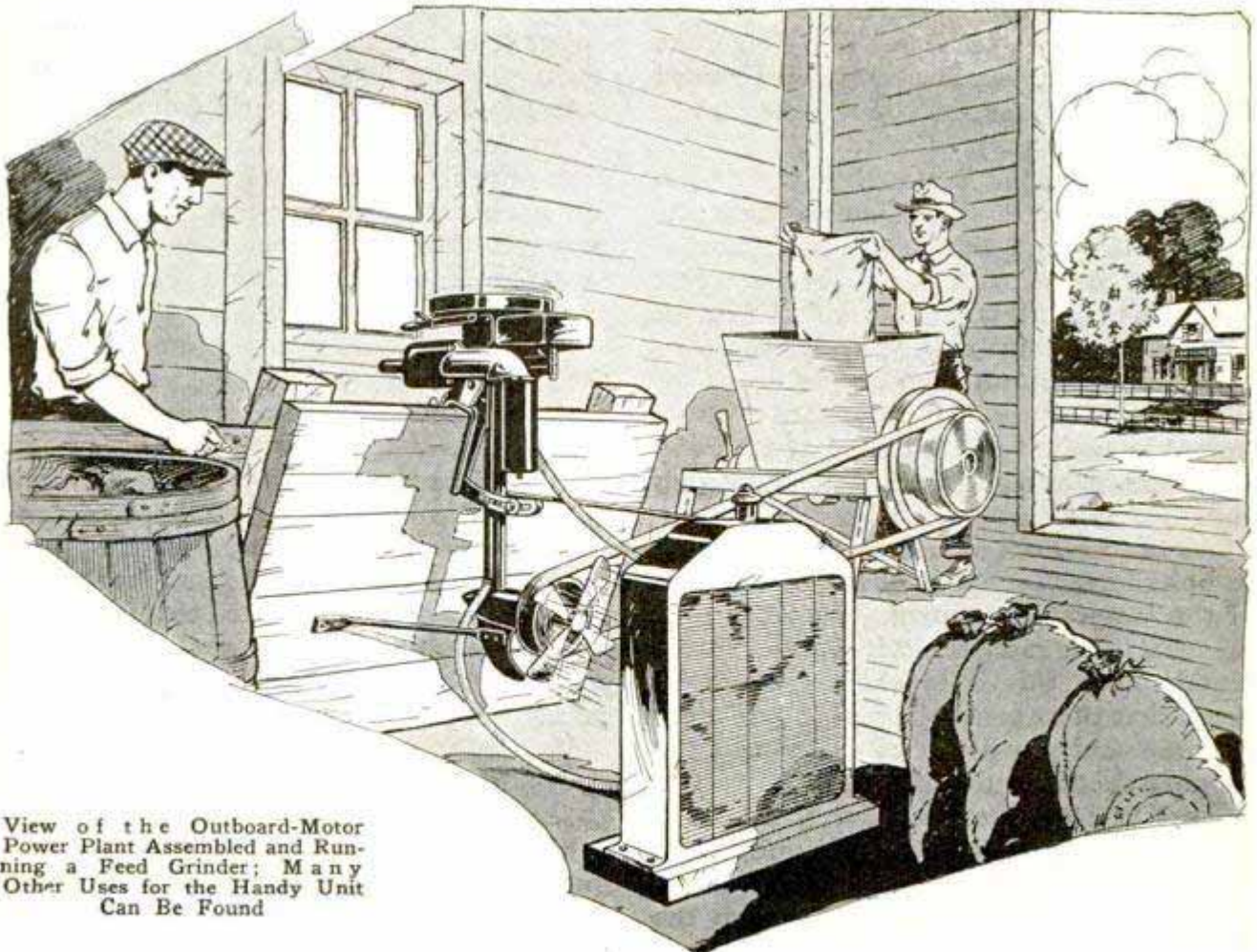

View of the Outboard-Motor Power Plant Assembled and Running a Feed Grinder; Many Other Uses for the Handy Unit Can Be Found

down. Place them at least 2 ft. apart, parallel and vertical, and then spike solid planks horizontally across the front. Let

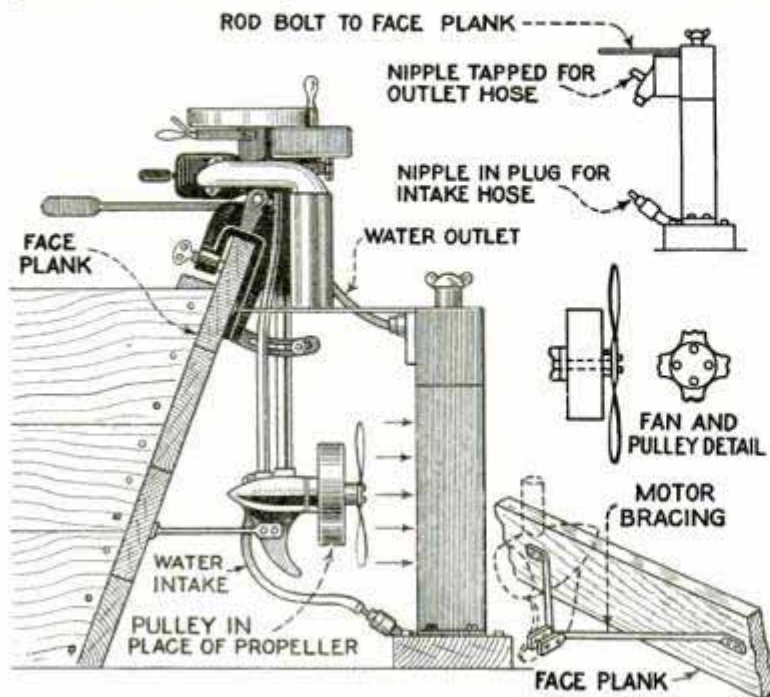

Side Elevation, Showing the Various Construction Details; There Is Very Little Work Necessary

the top edge of the uppermost plank project somewhat above the ends of the upright boards so the motor can be clamped to it without interference. If wide planks are unavailable, smaller ones can be used as in the drawings, in which case corner posts are necessary.

Place the motor in position and clamp it solidly in place. Then plumb the vertical shaft from all sides and fasten temporarily in place with small battens and cords. Next, drill two small holes through the end of the fin or skeg under the propeller and fashion two angle irons of solid round stock, as indicated. These should be heated and flattened at each end and bent at angles which will allow two ends of the irons to be bolted to the fin. Then the two other ends of the iron can be bolted near each side of the face planks of the support, as shown. Be very careful that the motor shaft is absolutely plumb when this is finished. It will be noted that the steering handle should clear the wall and the depth of the top of the support should allow for this.

Next remove the propeller and substitute a small-diameter solid-iron pulley. To conform with the particular motor being used, it may be necessary to rebores the pulley hole and cut a new keyway, or it

may mean that the entire propeller and pinion pulls out. In this case, a new pinion must be fitted to the pulley and the complete installation made. In either case, the work will not be found difficult. Then drill the pulley hub to match the holes in the fan and bolt the latter to it, as shown. Twist or arrange the vanes to blow air away from the motor when the pulley is revolving in its proper direction.

Plug the inlet and outlet pipes of the radiator so no leaks can occur and then drill and tap the pipes in suitable places for two $\frac{1}{2}$ -in. nipples. Spike blocks to the floor in front of the fan and mount the radiator on them with lag bolts. Then make a long tie-rod, to secure the top of the radiator to the face planks in a solid manner. The hose connections are then made to the two nipples on the radiator as follows: Tap the water-intake opening at the bottom of the shaft housing and insert a short piece of pipe or a nipple, and do the same to the outlet opening at the cylinder water jacket. Then clamp a hose from the inlet to the bottom of the radiator and from the outlet to the top of the radiator. This completes the circulatory system. The revolving fan blows air through the radiator and prevents the water from becoming overheated as it is pumped around through the engine, pipes and water jacket.

Belt up the pulley to the machines, fill the radiator with water, the gasoline tank with fuel, and you will be ready to run the plant. Crank it just as if it was on a boat, and regulate the speed by the usual spark and throttle controls. See that the running parts are well oiled, and this little outfit will be found to do good work. Of course, a small pulley belted to a large one on the machine will allow the motor to run at near normal speed and develop its maximum power.

If such an outfit is used in a shop with doors and windows open, the exhaust gases will not be noticeable. If the room is tight, on account of the weather, the gases should, by all means, be carried off. This can be easily done by the placing of a tin funnel over the muffler opening and

connecting it to a line of common rain pipe, 2 in. in diameter, and leading it outdoors through a window or the chimney.

Comb for the Shop-Sweeping Brush

One of the minor annoyances of machine-shop life is the way steel cuttings stick in the brush when the floor is swept. A nail or a piece of wire is often used to clean the brush, but this takes so much time that we decided to make up a regular comb for the purpose, and this is shown in the accompanying drawing. Two end-pieces, sharpened at one end, are attached to the brush loosely with screws. These two pieces hold a rod, drilled with a row of holes to take short pointed wires, which form the teeth of the comb. The pieces should be securely soldered or welded together. Have the comb laid back on the handle when the brush is in use. When the cuttings have been swept into a pile ready for removal, the brush is cleaned by turning it over to allow the comb to fall down, so that the pointed ends can be dug in the floor and the brush rocked back and forth. This causes the comb to pass



Comb Attached to Brush Cleans It of Metal Cuttings through the brush and clean it thoroughly of all sweepings that may have stuck in it. —Harry Moore, Montreal, Can.

Handy Drill-Press Accessory



Adjustable Stand near Drill Press for Holding Long Work Reduces Labor

The adjustable steel horse shown in the photo has proved a valuable accessory to the drill press in a Denver steel shop, where it was originated to hold up the back end of long work being drilled. Two sections of $\frac{1}{2}$ by $1\frac{1}{2}$ -in. steel bar, about 6 ft. long, are bent to form the ends of the frame, and two pieces of the same material, 16 in. long, are riveted across the end of these, to serve as braces. Four sections of the bar are also riveted lengthwise to the legs. The two uprights, which support the roller feeder, are perforated with numerous holes so that the top can be adjusted to any height desired by simply moving two cotter keys up or down. —Jos. C. Coule, Denver, Colo.

How You Can Guide Your Tractor with a Door Spring

When plowing with a tractor, where the one front wheel runs in the furrow, no guiding is necessary. But when the steering wheel is thrown partly around by the front wheels striking a depression or a bump on the surface, the former will not return to the straight-ahead position. To remedy this, a short leather strap, with a ring attached, was buckled around the rim of the wheel and a screen-door spring was attached to a point on the frame directly opposite to this ring. One end of the spring is snapped to the ring and each time the wheel is thrown either to the right or to the left, the spring returns it.

Increasing Usefulness of a Saw

The saw shown in the drawing should be used before its merit can be fully appreciated. It is a crosscut saw of the usual

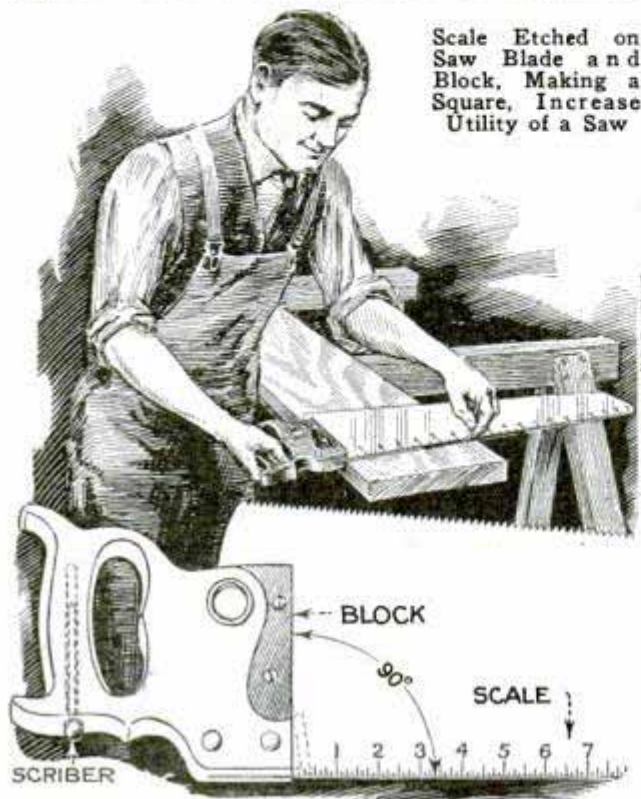

kind, but with the back edge ground straight, and the handle set so that its inner edge forms a right angle with the back of the saw. Instead of a new handle, filler pieces may be fitted to the original handle, as indicated by the shaded section in the sketch. Further convenience may be had by addition of a scriber and a brass tube for holding it in the handle, and by etching a scale on one side of the saw at the back. The saw can be used as a square, having double the range of the generally used universal square. It is much easier to handle than the large carpenters' square, and it saves one tool to carry around and look after when working on a staging.—Herbert A. Freeman, Willimantic, Conn.

Safety Rules for Working around Ammonia Pipes

When opening a pipe joint where ammonia has been carried, care should be taken not to open the joint wide instantly. Fumes linger in such pipes in sufficient quantities to become dangerous when lib-

erated in a room suddenly. Flanged joints should be loosened and very slightly opened by means of a thin wedge or screw jack and, if any fumes are detected, the joint should be closed immediately until they are drawn off or it may be left slightly open so that the fumes may pass off gradually. It is best not to loosen the bolts of a flange joint more than barely enough to separate the joint in case there might be pressure within the pipe, which would cause disaster if liberated suddenly. Screw joints should have the union slightly loosened and the joint broken loose before the union nut is entirely unscrewed. A towel saturated with vinegar held over the face should be used when loosening or working with ammonia-pipe joints especially in confined rooms.

Can Saves Varnish

A varnish can which preserves the contents, is used in a vehicle factory. It had been found wasteful to pour the varnish into small cans as it rapidly deteriorated if not used up within a short time, and as the cans must be carried around the factory some of the varnish was spilled. The special can shown in the illustration holds about 4 gal. of varnish and is made of fairly heavy metal. It is round in shape with a cover piece, soldered about 2 in. below the top, and a handle on the side.

A cowl-shaped trough is soldered inside of the top of the can. A cork is fitted in a hole in the cover. When the varnish is required, remove the cork and tip the can until enough liquid flows into the cowl. The cork is replaced and the can placed upright



so that the varnish floats on top of the cover. As soon as the work in hand is finished, the cork is removed to allow any unused varnish to run back into the can.

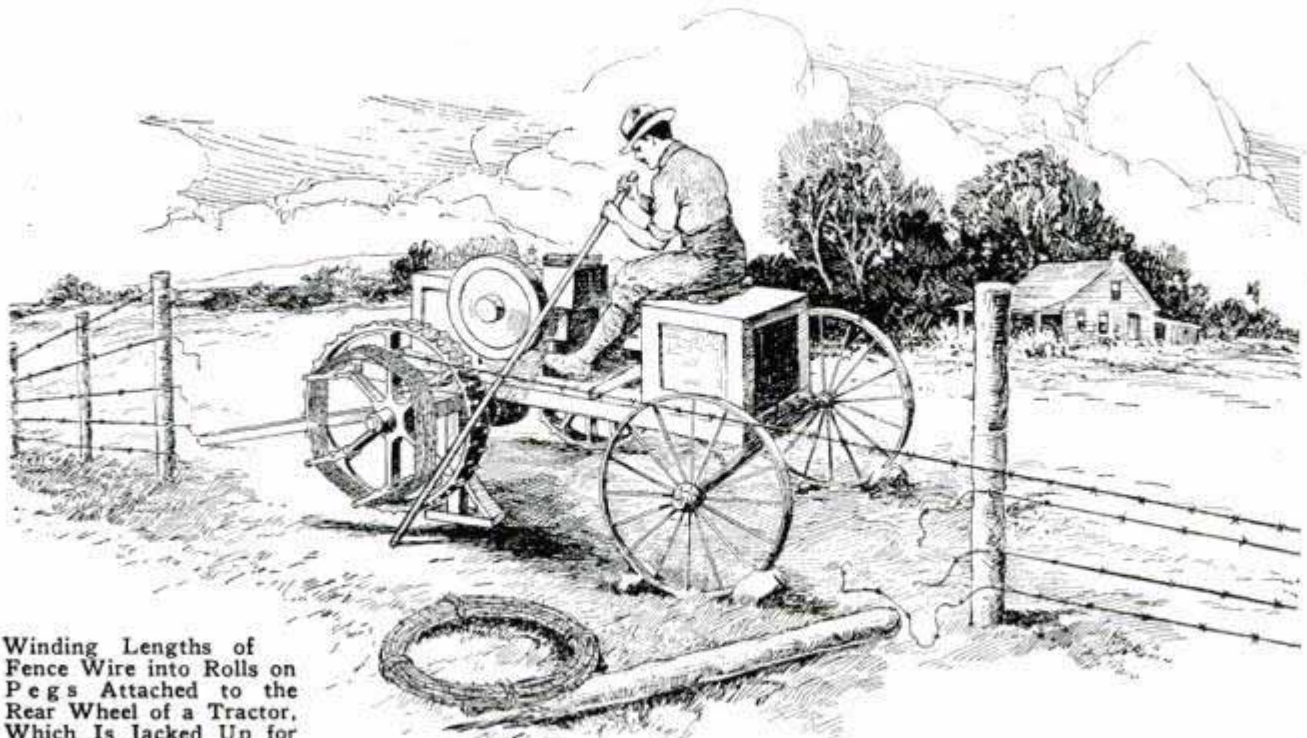

Winding Lengths of Fence Wire into Rolls on Pegs Attached to the Rear Wheel of a Tractor, Which Is Jacked Up for This Purpose

Tractor Used to Wind Up Fence Wire

I built the small farm tractor described in the August, 1917, issue of Popular Mechanics, and it has been of considerable use to me for several years. Last year I conceived an idea about a device on the tractor for winding up barbed wire. Winding it by hand is a mean job, but with the aid of this attachment the work can be done in a short time. To each spoke of one of the rear wheels a short length of iron rod is clamped to extend outward as shown in the drawing. In use, the tractor is set at one end of the fence and is jacked up. The wire is loosened from the posts and one end is attached to one of the winding pegs. The wheel is then revolved, which winds the wire around the pegs. You can wind a length of wire about a half mile long in this way. When the roll is completed, tie it up with short lengths of wire, loosen a few pegs and slip them toward the center of the wheel, which will permit you to remove the roll of wire. When using

the tractor for this purpose, guide the wire with a 5 or 6-ft. length of iron pipe as indicated and keep one hand on the clutch at all times so that if the wire gets caught or tangled the winding can be stopped at once before the wire breaks or other damage is done.—Luther Strosnider, Onaga, Kans.

Saving Time in Testing Air

The time required to test the air on railway cars has been shortened by a method devised by an employe of a western road. He attached a short length of hose to the tester, mounted as usual on the triple-valve exhaust port, and connected the other end of the hose to the retainer pipe. By the use of a small petcock between the hose and air gauge both cylinder and retainer may be tested without the necessity of moving the gauge.

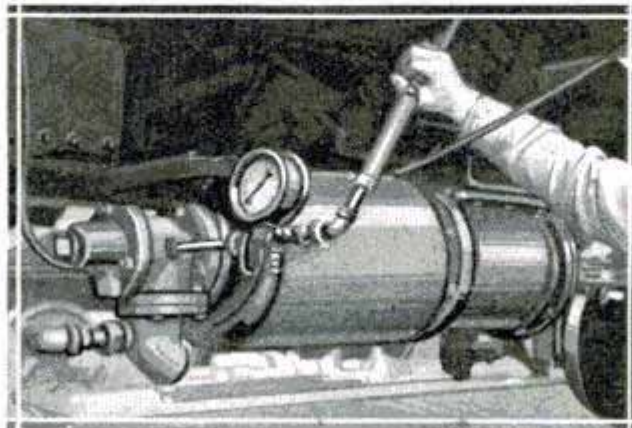

Method of Testing Air Cylinder and Retainer on Railway Car

☞ To prevent chickens from catching cold, put some spirits of camphor in their drinking water, 10 drops to each quart of water, about once a week.

Two-Man Jobs Are Speeded Up by Swiveling Work Holder

Many shop operations could be finished more easily and quickly with the help of

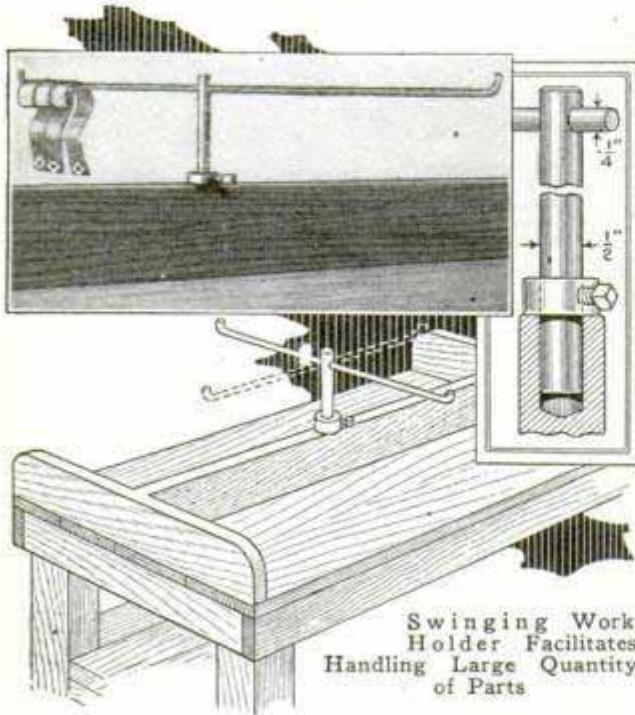

a holder similar to the one shown in the illustration. It is used in connection with a job of brazing nuts on the ends of flat-spring hooks. Removing the surplus metal and retapping the hole are the next operations. These are done on the same bench at the opposite side. The holder is used to facilitate the passing of the work from one operator to the other. The center board is drilled with a $\frac{1}{2}$ -in. hole to a depth of about 6 in., to take a piece of steel the same diameter, this piece being drilled through near the top to take a rail made of $\frac{1}{4}$ -in. rod, which is driven tightly into the swivel post and then turned up slightly at each end. A collar with a set-screw is fitted to the post and, when assembled, it rests on a couple of washers placed on top of the board, to protect it from wear as the holder is turned. The method of using the holder is as follows: The operator engaged in brazing the nuts hangs each piece

when finished on the part of the rail at his side of the bench; the first being placed at the extreme end, as shown in the photo, so that by the time this side of the rail is full, the end pieces are cool enough to be handled by the operator on the opposite side. Both operations consume about the same time; by the time one side of the rail is filled, the other is empty and all the second operator need do to get another batch is to swing the holder around a half turn when the empty rail is again presented to the first operator ready for filling. It has been found that by working this way there is no possibility of mixing up the work as often happened before. When the holder is not required, the post is lowered and the rail laid parallel with the center board out of the way.

Acid Test for Oil

The presence of acid in lubricating oils is detrimental and the following simple test to discover it is recommended. Dip blue litmus paper in the oil, and if the color changes to red, there is acid present. The litmus paper should be soaked in rain water before the test, for if the water happens to be alkaline, it will neutralize the acid absorbed by the paper and the oil will show a neutral condition when it really contains considerable acid.

Winter Shelter for Pump and Engine

The farmer who finds difficulty in keeping his pasture engine and pump protected against severe cold, will find the idea illustrated in the photo serviceable. The shed used to protect the pump consists of a framework inclosed and roofed with corn stalks, bound together in

bundles and held in place with a wire both inside and outside. With the wind thus kept out, the interior will get quite warm when the engine is running, thus making for more efficient operation.—Dale R. Van Horn, Walton, Nebraska.

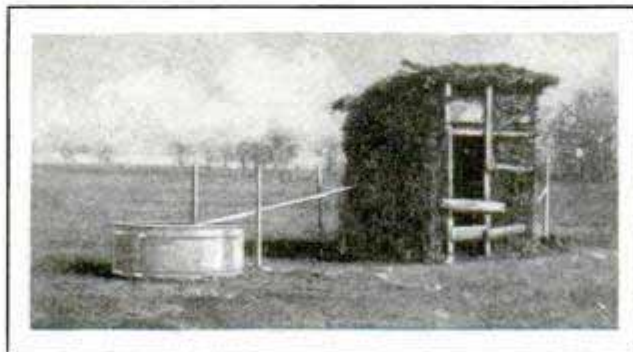

Corn-Stalk Shed Shelters Pasture Pump and Engine during Cold Weather

How to Build the Form Work for a Concrete Cistern

By ROY M. SINGER

THERE are many localities where it is necessary to store water. Generally some arrangement is used whereby rain water falling on the roof of a house is let into a cistern and pumped from the cistern as it is needed. The cistern may be made either of wood, steel, or concrete. Concrete cisterns are meeting with a good deal of favor because of the fact that the materials are to be had in practically every locality and because nearly anyone can build them.

Where deep cisterns are built, the form work is simple, because such cisterns are generally built with wide mouths. For shallow cisterns, however, the situation is

different. It is easy enough to erect the forms for a shallow cistern, but taking out the form work is quite a different matter. The sketches shown here illustrate a type of form work designed especially for shallow cisterns with narrow mouths, and it is especially adapted to withdrawal from a narrow space.

In building a cistern of this type, the bottom and walls are put in place first, then the form work for the top is set, as shown in the sketches. The form work consists of a central post to which a barrel head is attached by hooks; spanning the space between the cistern wall and the barrel head are set 2 by 6-in. pieces cut

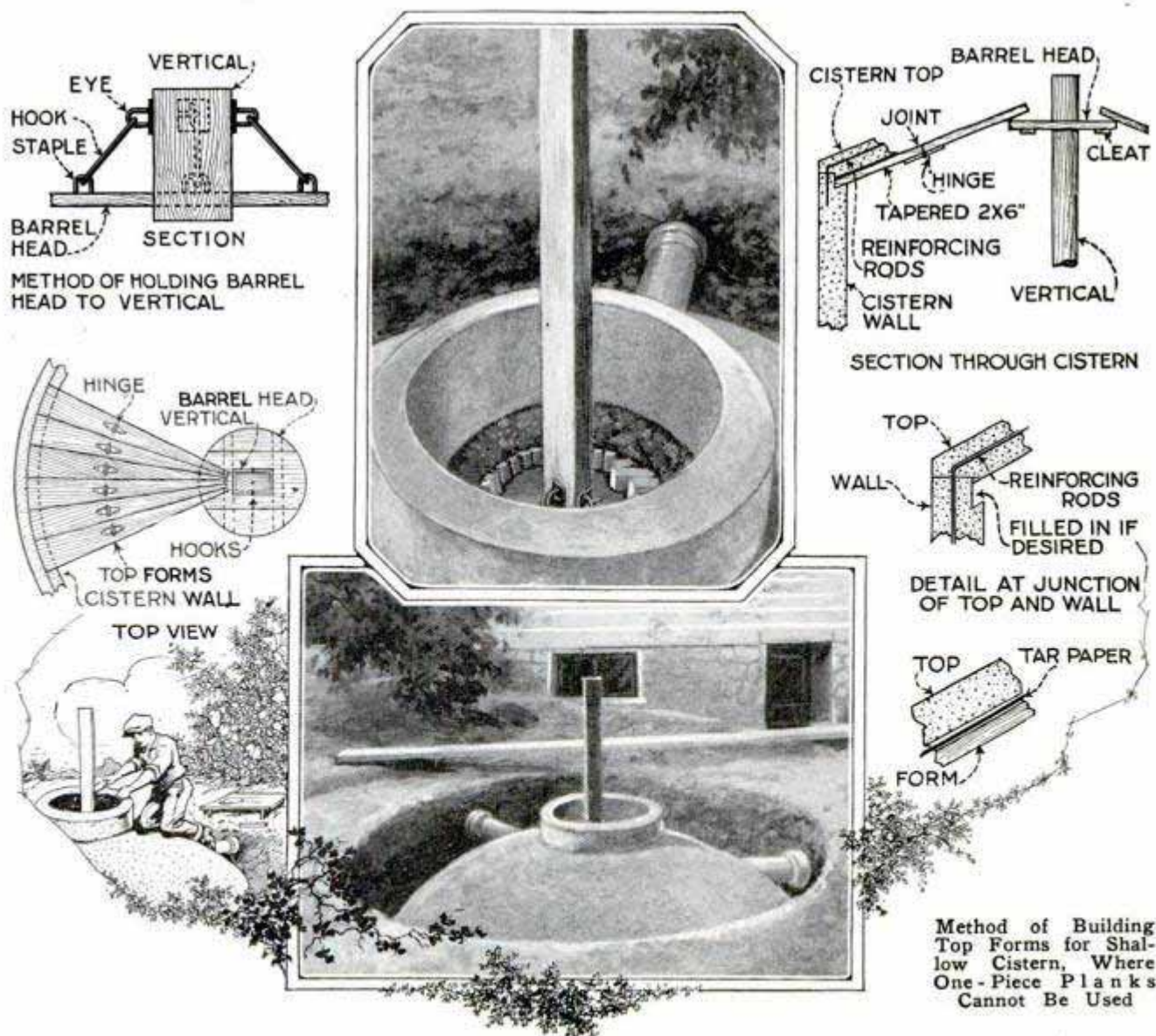

Method of Building Top Forms for Shallow Cistern, Where One-Piece Planks Cannot Be Used

tapered to fill the circle. These pieces are hinged in the center and it is the hinges that permit the easy withdrawal of the form from the cistern. After the form work has been set up and the top of the

mouth of the cistern is wider than the barrel) and removed from the cistern, the post then withdrawn, and the job is done. Where a shallow cistern is built it would be impossible to withdraw the forms from

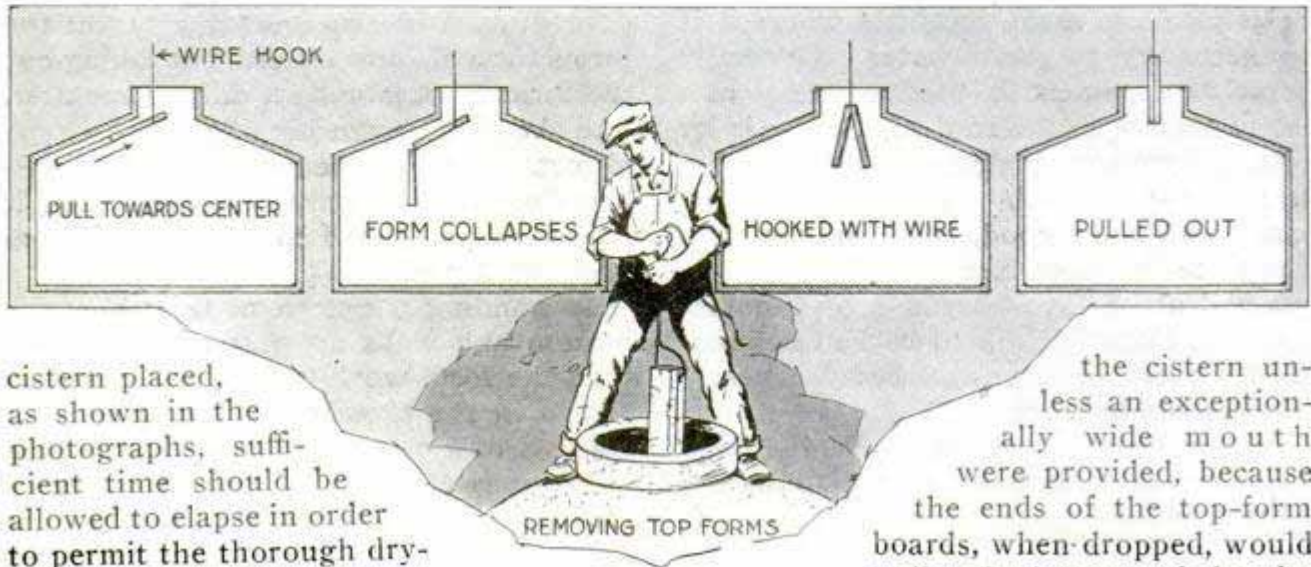

cistern placed, as shown in the photographs, sufficient time should be allowed to elapse in order to permit the thorough drying of the top of the cistern.

The form should be left in place for at least ten days.

When it becomes time to remove the forms, a wire is attached to the barrel head and the hooks holding the barrel head to the post are loosened. The barrel head is then allowed to slide down on the post until it falls free of the tapered pieces. It will be found that the 2 by 6-in. lengths will stick to the top of the cistern, due to the fact that they are held in place by the notch at the cistern wall and by the adhesion between the underside of the top of the cistern and the wood form. This adhesion may be overcome by placing tar paper upon the form before the top is poured; thus there will be a layer of tar paper between the form and the top of the cistern and the form will not stick.

Now attach a wire to one of the tapered pieces so that it can fall into the cistern, then work it out of the notch in the cistern wall by jiggling it back and forth. It may then be pulled toward the opening. The manner of removing it is best illustrated by the detail drawing. It will be seen here, that as the piece is pulled toward the opening, it collapses at the joint, and the wire may then be pushed farther along until the joint is reached, whereupon the form may be removed. After all the top forms have been taken out, the barrel may be pulled up (be sure that the

the cistern unless an exceptionally wide mouth were provided, because the ends of the top-form boards, when dropped, would strike the bottom of the cistern before the upper ends could be passed through the top opening. This method of hinging overcomes the difficulty.

Time-Saving Device Administers Capsules to Poultry

Every poultry raiser finds it necessary at times to treat his stock for worms. The usual remedy is nicotine sulphate in 2-gr.



Improvised Injector for Administering Capsules to Poultry Does the Work in a Short Time

capsules and the usual method of administering the capsule is to insert it into the bird's beak and then work it down with the fingers. Frequently the operation is not successful and the bird ejects the capsule to be picked up by another already treated and then the result is at least one dead bird. To avoid such accidents and to make the operation quick and easy, a California poultryman has improvised an instrument, with which a hundred or more birds may be treated in the same time as five by the old method. The instrument is a slightly curved hard-rubber tube, or nozzle, about 5 in. long. Cut into the end of the tube so it will fit over a No. 2 capsule. A wire injector fitting the top of the hole for the capsule is placed in the tube. The top of the wire is attached to a button, while a spring is provided around the wire. Press the button to move the injector and release the capsule. Release the pressure on the button and the spring around the wire will pull the injector back into place. To use the instrument the capsule is put in place, the tube is inserted through the open beak of the bird, the injector is pressed out and the tube is then withdrawn. The operation requires about five seconds, while, without the device, it sometimes takes five minutes.—Geo. B. Bowers, San Diego, Calif.

Side Hitch for Motor Truck

There are many other than just hauling jobs that the truck will perform when equipped with devices adapting it to these jobs. The drawing and photo show how a side hitch can be attached to a truck. It can be used, without damage to the truck, for jobs that do not require too heavy strain, such as stretching fence wires where the line of posts prevents a direct pull from the rear end of the truck; pulling a plow along a bank, ditch or gulley, when filling these openings; pulling a road blade to trim off the side of the graded road, etc. The pieces required and their forms are shown in the drawing. The pulling bar is made of a piece of $\frac{1}{2}$ by 3-in. machine steel, forged with the eye at the inner end around a U-bolt. The bolt passes through the side of the frame of the truck with two nuts on the inner side. A right-angle bend is given the pull-

ing bar to allow the front wheel to clear both the bar and the chain, which connects it to the front end of the truck

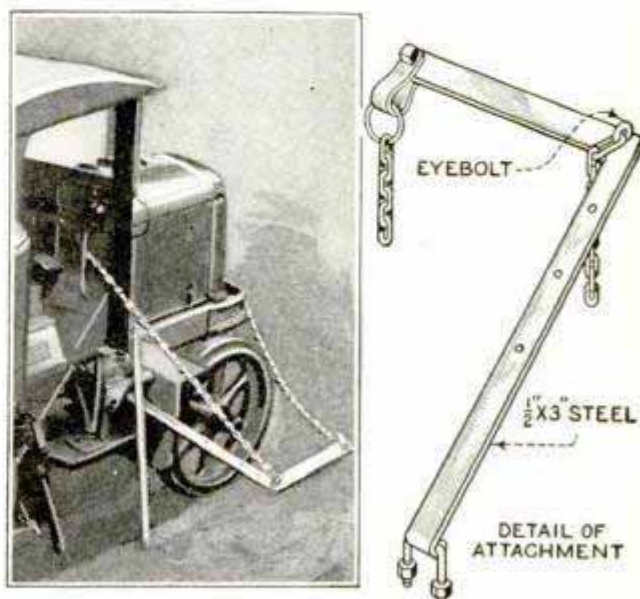

Handy Hook Attached to Side of Farm Tractor Pulls Light Implements

frame. The chain, attached to the dash and bar by means of the eyebolt, allows adjustment for height such as the tool being pulled, or as the work may require. It also allows the bar to be folded and hooked in a vertical position when not in use.—G. G. McVicker, North Bend, Nebr.

Eliminating Air Leaks in Stone Foundations

It is rather difficult to make a really air-tight job at the top of stone foundations. The heat loss caused by such leakage is considerable and causes cold floors in spite of all that is done to prevent it. A good method of preventing this trouble is shown in the accompanying illustration. A 2-in. board is nailed to the plate, as indicated, the top of the foundation having been cut back to permit this. The sealing board is set in grout, and after it is in place one or two coats of paint should be applied, as this will help to close all small cracks.

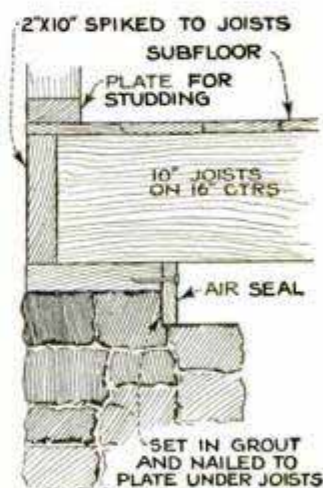

A Serviceable Homemade Grinder

As can be seen, the grinder and buffer shown in the drawing is built up almost entirely from pipe fittings and old Ford connecting rods. A floor flange and a tee, screwed to the flange with a short nipple, form the base. The tee is reamed out to take a short length of pipe and

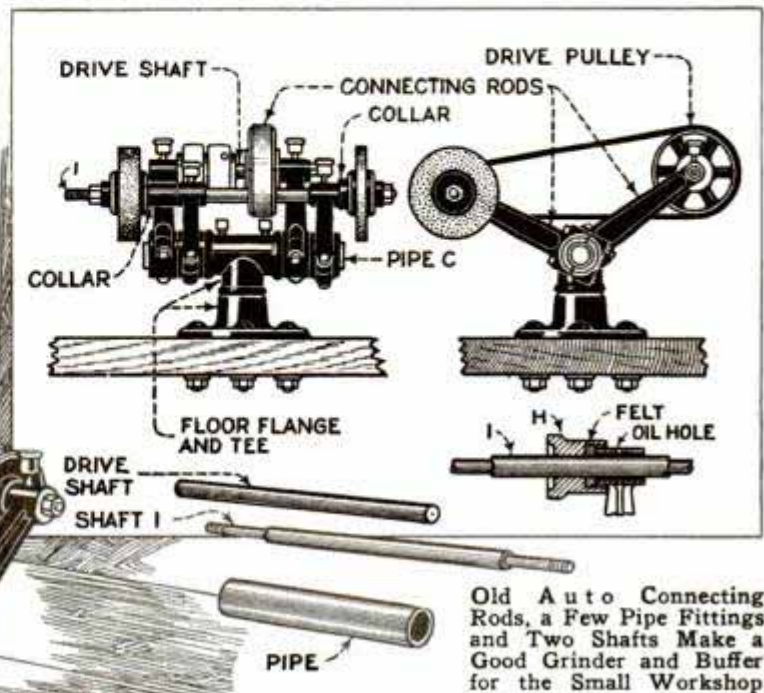
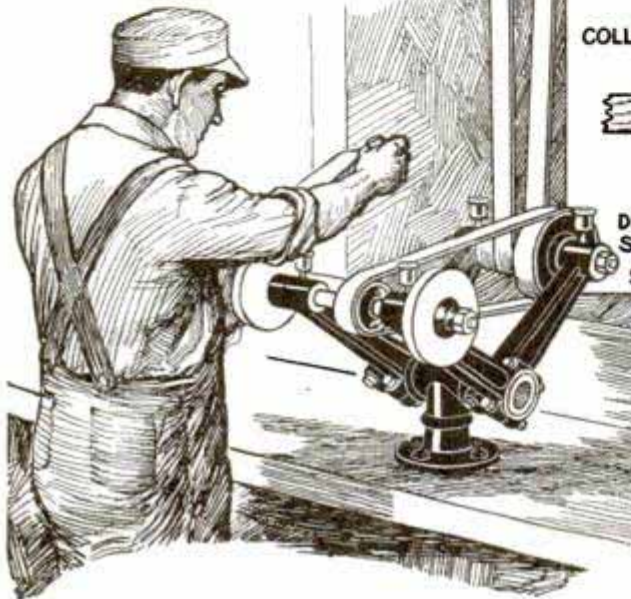

setscrews are used to hold the pipe C in place, on which four connecting rods are fitted to hold the grinder arbor and the driveshaft. The lower bearing surfaces of the connecting rods are screwed up tight on the pipe C, to make the arbor and driveshaft parallel. The upper bearings are fitted with grease cups. The drive-shaft is provided with tight and loose pulleys and also a drive pulley. Another pulley is fitted on the arbor in line with the drive pulley, and also two collars having an overhang to inclose felt dust washers, which are placed as shown in the detail. The arbor shaft I is turned down for the grinder and buffer, and the ends are threaded for nuts with which the wheels are held on the shaft securely.—Geo. H. Cappel, Wilmer, Ala.

Installing New Belt in Factory

In a factory where I was doing a small job, a long and heavy leather belt, about 18 in. wide, was being installed. The method used to get the belt in position was novel to me as it removed most of the

difficulty usually encountered when doing such a job. Both ends were cut square and one end was fastened to the old belt. The roll of new belting was placed on top

of the old belt so that it would unwind when the latter was turned. The shafting and pulley were turned over slowly, allowing the new belt to run over the pulley on top of the old belt. When the new belt was run out, the clamps were put on, the rods tightened and the old belt cut off, leaving the new one in place with a perfectly tight joint, ready for the joint fasteners.—J. E. Noble, Toronto, Can.

Metal Float for Special Fuels

Special fuels for automobile use are frequently compounded with benzol. The benzol dissolves the shellac from the cork float of the carburetor and the cork becomes saturated. A clogged float and a constantly dripping carburetor are evidence of this condition. Loss of gasoline is expensive and also a possible source of fire. To prevent this trouble a metal float should be used in the carbu-

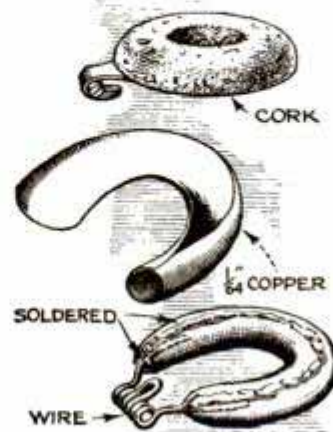

retor. The method of making this float is shown in the drawing. The copper used should be approximately $\frac{3}{64}$ in. thick; this is cut semicircularly and formed around a bent rod, working from one end around the circle. The ends are brought together and the seams held by overlapping and soldering them. The hinge is also soldered to the float. After completion of the float it is a simple matter to bend the wire until the gas reaches the proper level.

Jig for Center-Drilling Keyways

Many machine parts, like gears, cams, sleeves, etc., are held to shafts by means of setscrews bearing on the key itself. In such cases it is imperative that the tapped hole is central with the keyway, or else part of the locking effect is lost. We use a very simple jig for this work. It consists of three parts; the body, a bushing and a screw. The body is made of $\frac{3}{4}$ -in. round stock, bent as shown; the bushing is $\frac{1}{2}$ in. in diameter and is sawed up the center and spread out to form a V-shape. The jig is slid into the keyway and the bushing is pushed

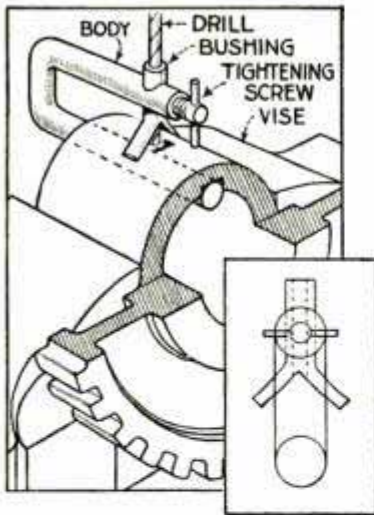

down to draw the body up in the keyway firmly; then the screw is tightened. Only one-size hole can be drilled, of course, but as this is always central, it can be enlarged with another drill to the size required. We

hold such work in the vise and square it up with the side of the jig.

Take 8 oz. canvas and stretch it on a frame with galvanized tacks. After painting the underside and allowing it to dry, wet the upper side with water and then paint it while damp. This insures good waterproofing.



Lightening the Task of Handling a Heavy Air Hammer by Burlap Padding and Heavy Rubber Tube

Absorbing the Shock of an Air Hammer

Holding a heavy air hammer, driven by 40-lb. pressure, and cutting rivets with it all day is no light task for three men, yet there is a method of making the work easier than it would be with the naked hammer, as turned out by the manufacturer. To soften the jar and rub of the machine, it is wrapped thickly in burlap, while the wearisome jar of the butt, against the operator's body, is lessened by a 6-in. section of air hose, such as is used in coupling railroad cars, which is held by two small bolts through the hose and the butt of the hammer.—Jos. C. Coyle, Denver, Colo.

Pulley Guard Saves Hands

To prevent workers from getting clothing and hands between a pulley and the belt, the novel guard shown in the illustration has been found practical. It is a good precaution especially if the belts have to be thrown off frequently or the belt is used as a safety device and throws itself off when the machine is jammed.—Auguste Mathieu, Chicago, Ill.



Broken Water Jacket Repaired without Welding

With the coming of an unexpected cold snap, many motorists discover a cracked

using zinc chloride dissolved in distilled water as a flux. Use a hot iron and make sure that the entire surface of the "V" is tinned before filling it up flush with the surface of the jacket. Scrape away the

surplus solder, file smooth and enamel, and you will have a permanent and invisible repair job. If welded, either electrically or with acetylene, the finished job would be lumpy. This method can also be used to repair an aluminum crankcase when a rod has gone through it, if you can recover the pieces. In the case of aluminum, make the screws from a piece of aluminum rod and finish the job with a good grade of aluminum solder.

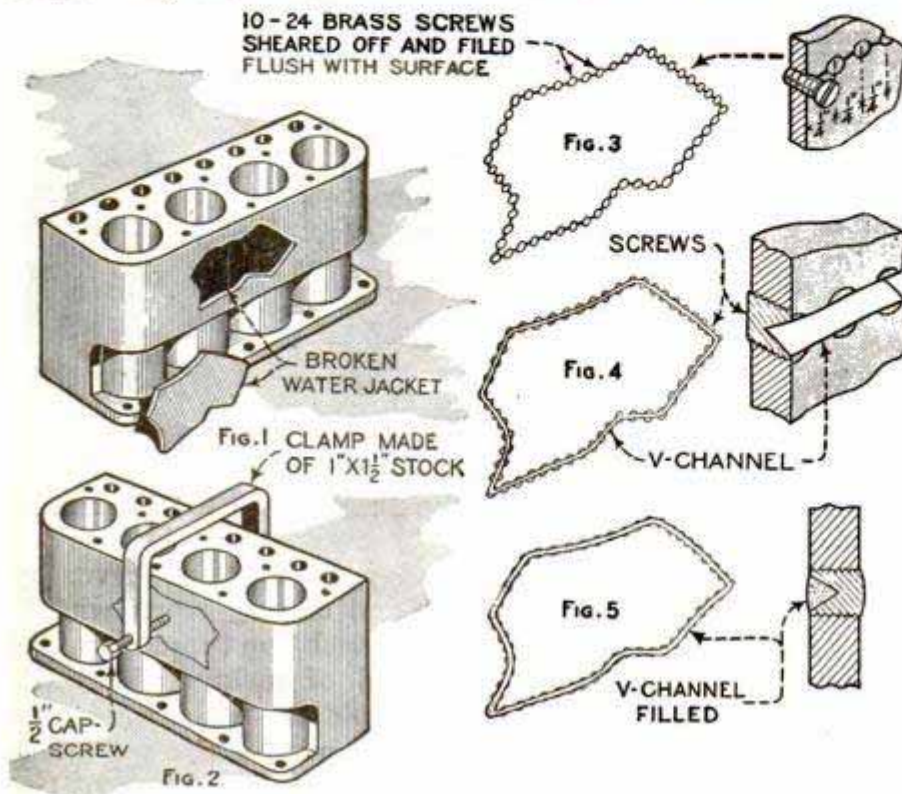

Cracked Water Jacket on Automobile Repaired by Simple Method Using Screws and Solder

water jacket. This usually means a new block or an acetylene weld, a costly job in either case. However, any external break can be permanently repaired by the following method. Fig. 1 shows a cylinder block with a section of the jacket broken out entirely. Fig. 2 shows the piece restored and held in place with a specially made, strong clamp. Around the entire crack, drill and tap holes about $\frac{1}{4}$ in. apart for 10-24 screws. Next tin a quantity of 10-24 brass screws and screw them in so they will be flush with the inside of the water jacket. Tinning the threads of the screws will prevent the possibility of a leak around the threads. Chisel off all the screws flush with the surface and remove the clamp. Now make a fairly deep V-channel with a diamond chisel along the entire line of the crack. If your motor has a removable cylinder block, place it in an oven or over a slow fire until pure lead just melts, or apply the flame of a blowtorch evenly around the casting until the metal sizzles under a wet finger. Then fill up the V-groove with half-and-half solder,

Proper Application of Baseboards

Defects in plastering are frequent, and when the plaster has been "dubbed off" a few inches above the floor, the carpenter has to adopt some means of holding the baseboard straight. A good method is shown in the illustration. A 16-penny spike is driven into the

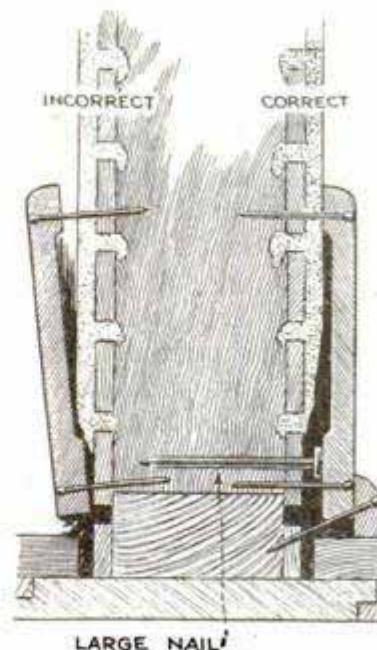

The incorrect method is shown at the left for comparison.—H. H. Siegele, Emporia, Kans.

2-in. plate on which the studs are set, so that the head is flush with the surface of the plaster, as shown at the right in the drawing. The baseboard can then be nailed on, care being taken not to drive the spike in any farther.

You Can Do Hammered-Copper Work

By DICK HUTCHINSON

THERE are few amateur mechanics who have not at one time or another looked at a pretty piece of hammered-copper work, and wished that they could duplicate it. Not that the thing looked hard, but that it was apparent that there must be some "tricks of the trade" that were necessary to know before tackling the job. It is the purpose of this article, which is the first of several, to teach the amateur how to wield the ball-peen hammer in the most effective manner. Of course, the hammering of sheet copper into any desired shape requires skill, and this demands diligent practice and effort, but the actual fundamental operations are really simple enough.

While it is the general impression that a large assortment of expensive tools is required for this kind of work, such is not the case. The following tools will pretty thoroughly cover the requirements for any ordinary work, and might as well be acquired at once: A small anvil or a block

of steel with a smooth and true surface, an 8-oz. ball-peen hammer, a small bench vise, a pair of tin snips, a good cold chisel, an assortment of punches (nail sets are best and cheapest) which can be ground to suit the work at hand, an assortment of small files, 10 cents' worth of liver of sulphur, a small bottle of transparent lacquer, a good camel's-hair brush and a few sheets of jewelers' emery or polishing paper from a supply house.

Before beginning work, lay a sheet of the emery paper over several thicknesses of blotting paper, emery side up, and proceed to polish both faces of the ball-peen hammer by rubbing back and forth over the emery. The blotters afford a cushion for the emery paper, and make a better surface on the hammer face. A good surface is necessary, since the smallest scratch on the faces will show on the finished piece of work.

The first operation to be described is the shaping of a copper bowl, or what is termed cupping. The general impression, I have found, is that a bowl is shaped by hammering over the outside. This is not the case, as will be seen in a moment.

Obtain a piece of 16-gauge soft sheet copper, and from it cut a disk 5 in. in diameter. Hold the disk in the left hand

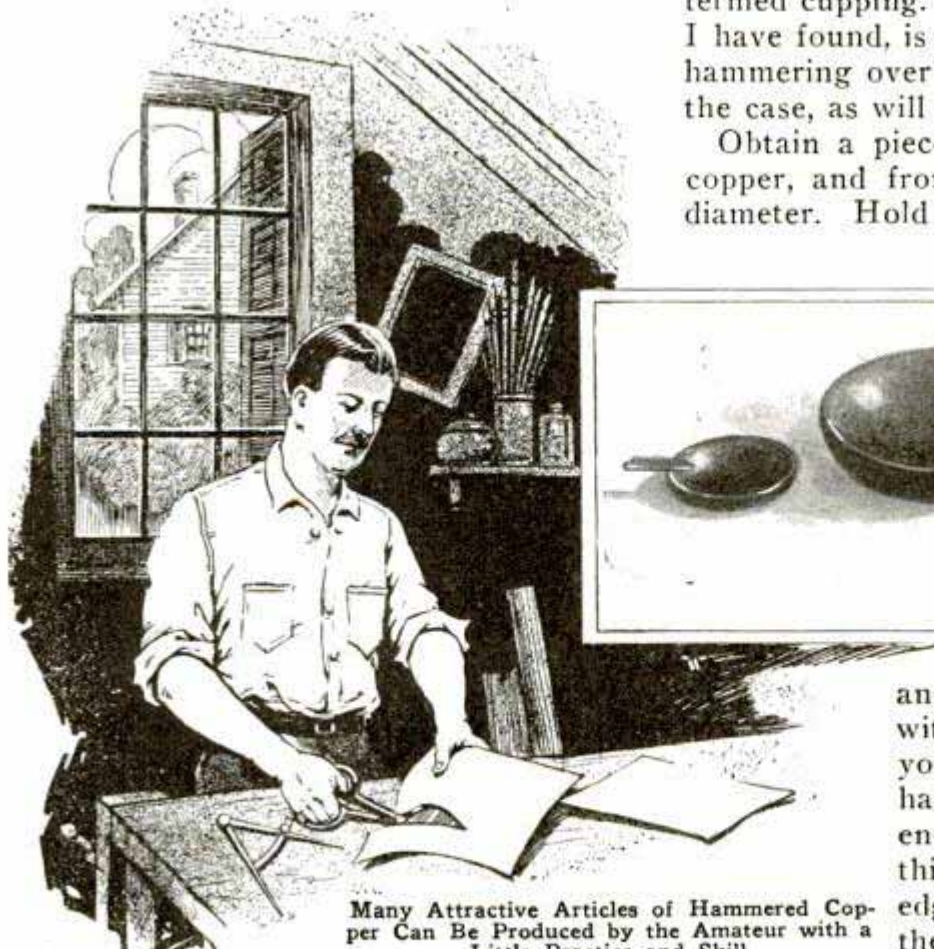

Many Attractive Articles of Hammered Copper Can Be Produced by the Amateur with a Little Practice and Skill

and place it on the anvil with the edge farthest from you slightly raised. Begin hammering, with the ball end of the hammer, about a third of the way in from the edge. With each blow of the hammer drive the metal

toward the edge. Go completely around the disk in this manner, hammering over a strip about $\frac{1}{2}$ in. wide. Starting inside the first strip hammered, go around the disk again in the

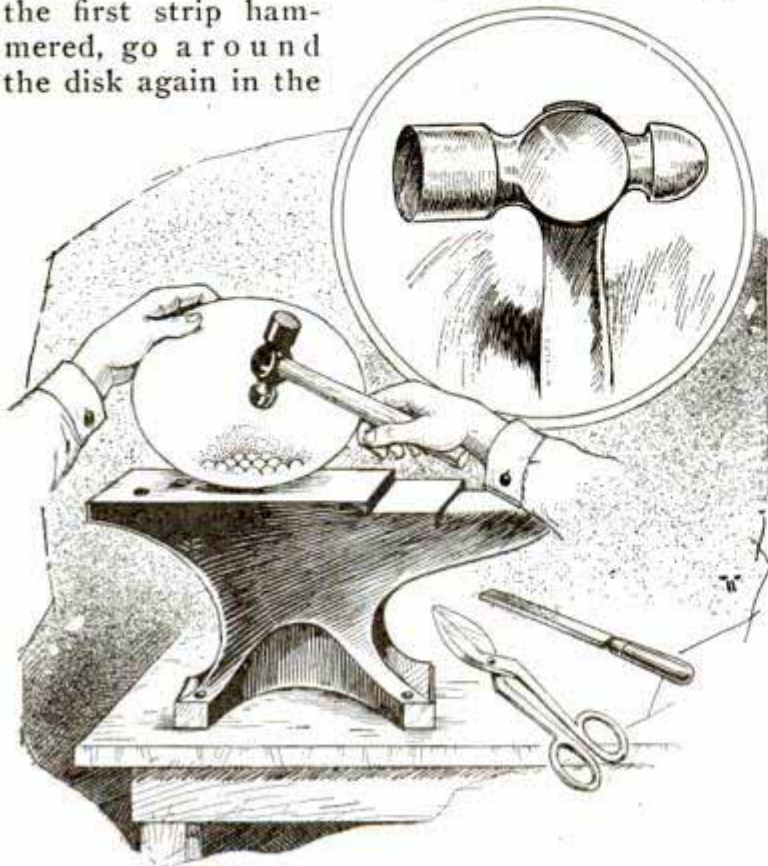

The Type of Hammer Used, and the Method of Starting the Cupping of the Copper Disk

same manner, and then, laying the disk flat on the anvil, circle around the inside until the center has all been hammered. Now tip the disk up on edge and hammer the part outside the first strip and up to the edge, this time driving the metal toward the center. Care must be taken not to strike the very outside edge, as this will expand the top of the bowl and make it lopsided.

The bowl should now be placed over a fire and heated to a cherry-red, then immediately plunged into a pail of cold water. This anneals the metal, which becomes hard and brittle under the hammer. The piece is now ready for the second hammering, which is done in exactly the same way as before. Repeat the hammering several times, or until the bowl is about 1 in. deep. The piece must be annealed between each hammering. The bowl can be trued by placing it over a ball of the correct size, and hammering it very lightly on the outside. When the edge has been trued by means of a file the bowl is ready for coloring.

Dissolve about $\frac{1}{4}$ oz. of the liver of sulphur in a quart of water, and, after cleaning the metal thoroughly with soap and water, immerse the bowl in the solution and allow it to remain until the desired color is attained, then remove, wash under running water and allow it to dry. This solution will produce colors running from a reddish-brown to a deep blue, depending on the time the article is left immersed. Burnish the high lights (the raised portions) with a piece of fine jewelers' emery paper, polish with a piece of clean, soft rag; then, with the camel's-hair brush, spread a thin coat of lacquer over the entire surface, and the bowl is completed.

The ash trays shown in the accompanying photos are produced by this method, and a little experiment and practice will enable the amateur to turn out many original designs along this line. The beginner must not be discouraged if his first attempt does not look as good as the work of the professional. In this work, as in all where manual skill is necessary, patience and perseverance are essential. More elaborate pieces will be described in subsequent articles.

Bumpers for Bottles

For several years I have been annoyed by the occasional breakage of stain, shellac and acid bottles when handled by the boys in the shop. I have now solved the problem by cutting sections of old inner tubes to fit the bottles. Some of the larger bottles often had the bottoms cracked by being dropped into the cases or by being set down with too great force. They are now fitted with rubber pads, the same size and shape as the bottom of the bottle, and these are shellacked or cemented on.—A. S. Peterson, Lihue, Kauai, T. H.

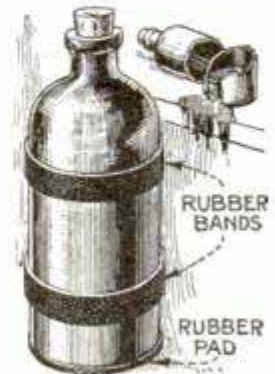

Light-Proof Door for Photographers

A door that really shuts out the light from one room to another is always sought by photographers, laboratory workers and others engaged in work where daylight is not desired. Most light-excluding doors depend upon interlocking systems that shut one door while the other is opened, but for simplicity,

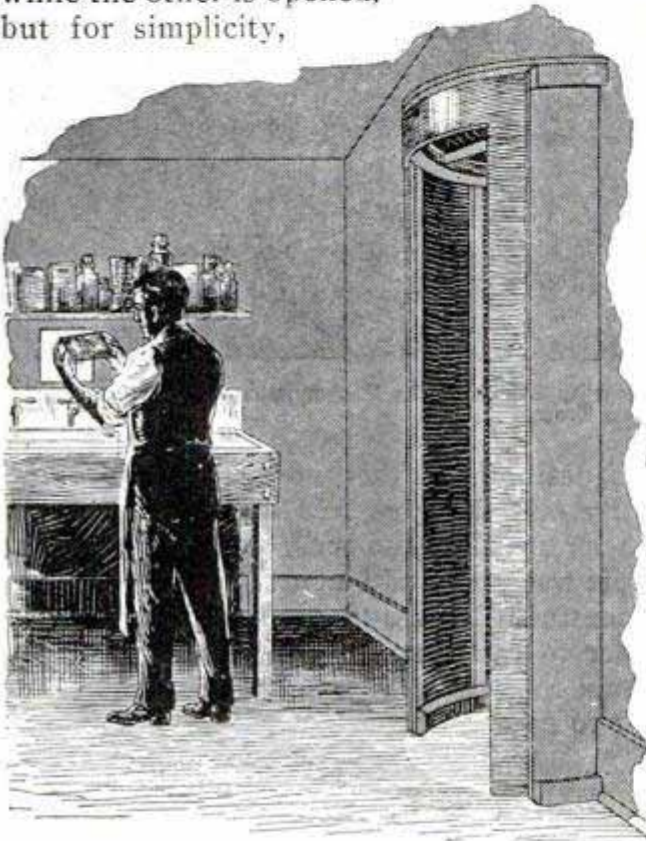

the one shown in the drawing will be found highly satisfactory. Any man handy with tools can build it.

It is of the revolving type and is made by arranging light-excluding material on a frame built on two wheels. Its construction is as follows: Get two light wagon wheels of the same diameter, and a third wheel slightly larger, so that one of the smaller wheels will just turn clear inside of it. Arrange the door opening so that it is 1 in. wider than the diameter of the smaller wheel plus twice the thickness of the rim of the larger wheel. It is best to run it from floor to ceiling. If not, a ceiling will have to be built above the door to shut out the light from the top. Remove the spokes and saw the large wheel in four equal parts. Nail one section to the door jamb at the top and the bottom on each side of the door and cover the inside surface with light wallboard.

If the latter does not conform to the curve, it will be necessary to insert two or three upright strips vertically, mortising

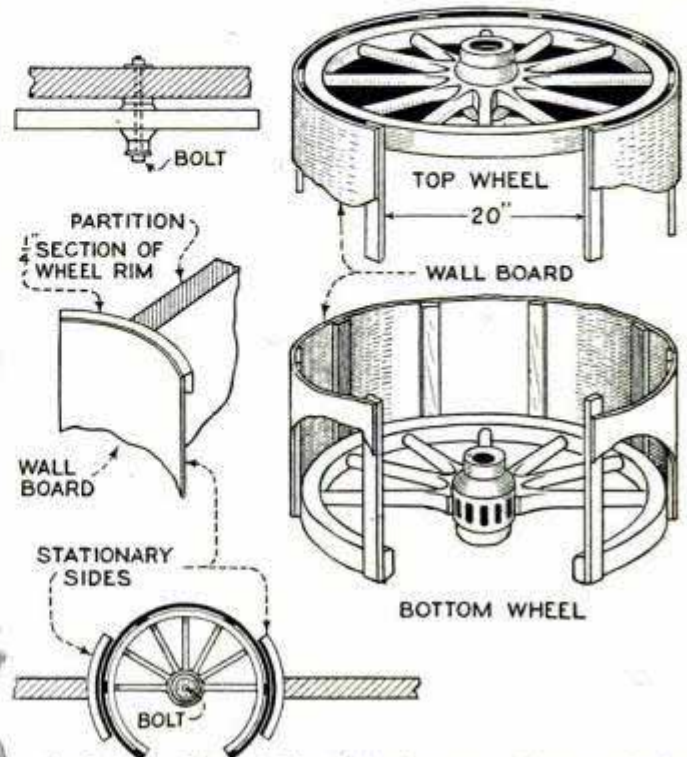

Excluding Light Effectively from a Photographer's Dark Room by Using a Revolving Door, Which Is Pivoted on Wagon Wheels

them into the concave surface of the rims. When covered, these walls will be at right angles to the wall of the room and somewhat concave. Start the door by pivoting one wheel to the ceiling with a heavy lag bolt and the other to the floor. They must be centered exactly between the side walls so that they will turn with equal clearance between the walls. Connect them with wooden uprights, 1 ft. apart and mortised into the rims. One upright is left out to provide the door opening. When the frame is completed and revolves evenly, cover it with wallboard, letting the edges come as close to the ceiling and the floor as practicable. Saw out the section of the rim, between the door-opening uprights, from the bottom wheel and remove half of the spokes. Cover the edges of the revolving door with felt weather strip. A strip of this, run vertically on each side of the door opening in the revolving section, will also help exclude the light as the door revolves. The door is operated by turning the cylinder until the opening shows, then step in and push the door around. Painting the interior or the side-walls and the revolving section black will also help to eliminate the light.

Attaching Packer to Tractor When Plowing

When plowing the stubble ground for fall wheat, time can be saved by attaching the packer behind the plow as shown in the photo. Usu-

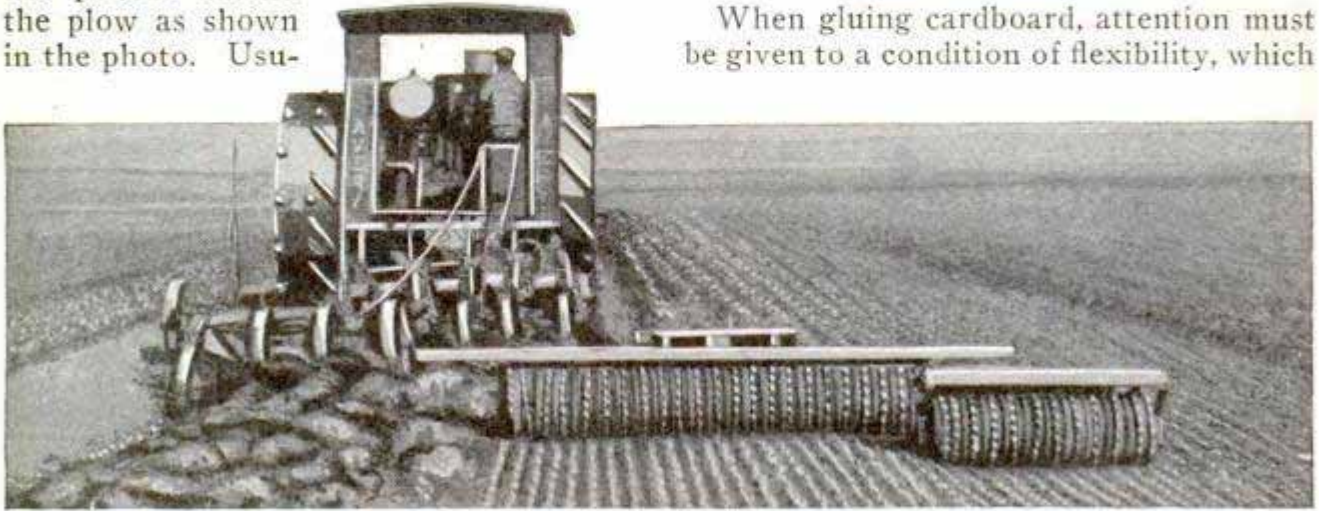

Saving Time When Plowing Stubble Ground for Fall Wheat by Attaching the Packer behind the Plow, Both Being Drawn by a Tractor

ally a side draft is caused by hitching another implement to the side of the tractor, especially with a two-plow outfit. However, with a three-plow outfit, or a larger one, the side draft may be largely equalized by running the tractor closer to the furrow, or even in the furrow. The two right wheels may be operated in the furrow and the plow hitch set over so that the proper draft line is obtained. A timber of 2 by 8-in. oak is attached rigidly to the frame or drawbar of the tractor, and is allowed to extend over to the plowed side some 5 or 6 ft. outside of the drive-wheel. The outer end is attached to a point near the front of the tractor frame with a chain, or cable, so that the draft will not come on the attaching bolts at the rear. The packer is equipped with an extension tongue, and it is better to have a front truck. This extension tongue allows the packer to follow behind the plow and to one side. Various holes in the draft timber will allow the hitch of the packer to be made so that it will not interfere with the plow when turning corners. The greatest draft is needed for the plow, and thus, to equalize the side draft, the plow has to be hitched over to the left of the center much less than the packer is hitched to the right. The more plows the tractor operates, the farther over the timber draft bar should extend, and thus the more

packers can be attached. The whole attachment may be constructed at home with a few simple tools.

Glue for Cardboard

When gluing cardboard, attention must be given to a condition of flexibility, which

is desirable in this work. To any quantity of flake glue add sufficient water to soak up the glue well, pour off some of the water and add a small quantity of turpentine. Then add 2 parts of starch powder to each part of flake glue by weight, mix the whole to a thick mass and allow it to cool before using.

Piling Round Bar Stock

Many serious accidents have occurred by piling round shafting carelessly. The



usual practice is to lay sticks between each tier and wedge the outside lengths to prevent rolling. The wedges often become loose when removing a length of shaft and allow the whole pile to start rolling. The system of piling shown in the accompanying illustration will prevent the heaviest shafting from rolling and is simple and cheap. Cross-pieces of flat stock are bent as shown and used between successive tiers, three to four for each tier, depending on the length. The piles are arranged according to sizes and may be safely run up very high.

Embossing Wood Is Simple Operation

By HAROLD JACKSON

THE accompanying illustrations show how to make and use a simple little tool with which you can emboss very beautiful and attractive designs on furniture you are making or on any woodwork that you may happen to be doing. A design or border of some kind worked out with this tool will make your work look

more finished and give it a professional appearance. Phonograph doors,

six-penny nail should be used. On coarser, a sixteen or twenty-penny spike is best.

Cut the point off the nail and file two grooves in the end of the nail at right angles to each other. Use a three-cornered saw file to make these grooves. This will make four points on the nail as shown in the insert.

The desired design is lightly drawn on the work with a pencil. Be sure that your pattern outline is perfectly straight and correct before you start to emboss. The tool is used as shown. It is struck rather hard with a hammer which sends the four points down into the surface of the wood. Work up to the pencil lines, being careful not to get outside the pattern outline. The correctness of the outline is very important. Work over the entire surface within the pattern outline

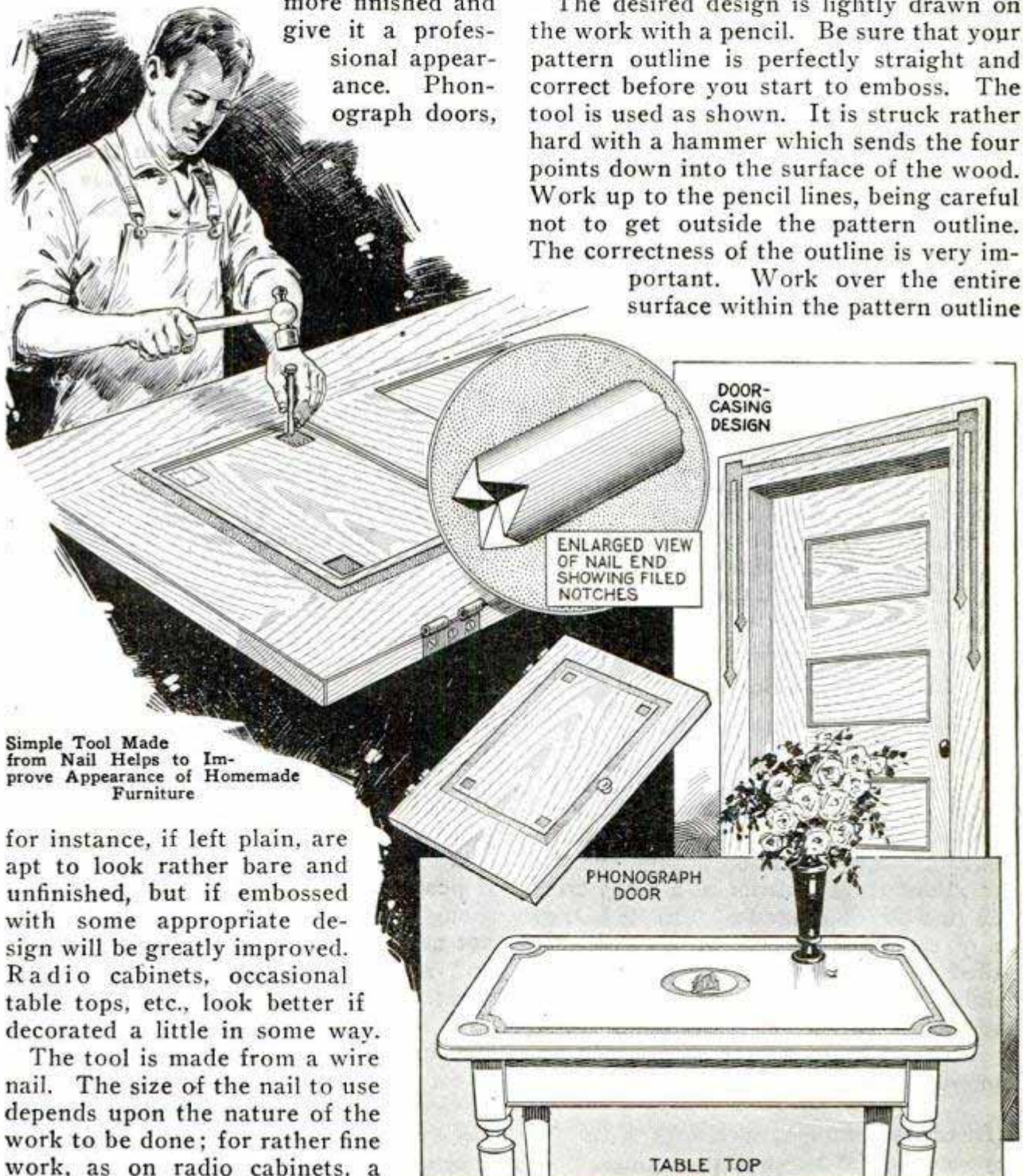

Simple Tool Made from Nail Helps to Improve Appearance of Homemade Furniture

for instance, if left plain, are apt to look rather bare and unfinished, but if embossed with some appropriate design will be greatly improved. Radio cabinets, occasional table tops, etc., look better if decorated a little in some way.

The tool is made from a wire nail. The size of the nail to use depends upon the nature of the work to be done; for rather fine work, as on radio cabinets, a

in this way. Then brush the work with a stiff brush to remove any loose pieces of wood that there may be.

The embossing should be done while the wood is in the white, before any stain or varnish has been applied. Due to its roughness, the embossed parts will finish a little darker than the rest of the surface, and this gives a good contrast. It is a good idea to practice on a piece of scrap board before you start on an important job. Like everything else, a little practice will teach a great deal more than a whole lot of printed instructions. The tool is really an adaptation of the "ground" tool used by wood carvers, but, while wood carving demands a lot of practice and skill, really good work can be done with this simple method without any previous experience.

Handy Milk-Bottle Carrier

A milk-bottle carrier for barn or emergency use can be made from a old barrel head and some tin cans. Cleat the barrel head so that it forms a solid disk. Then turn it over, with the cleats underneath, nail a barrel hoop around the rim and about three-fourths of a hoop from side to side for a handle. Cut in half as many tin cans as can be conveniently nailed to the surface of the tray to a height of about 3 in. They should be large enough to allow the milk bottles to fit inside of them. Such a tray will accommodate about ten bottles.

Ⓒ Discarded straight petcocks with the key removed make good pipe plugs.

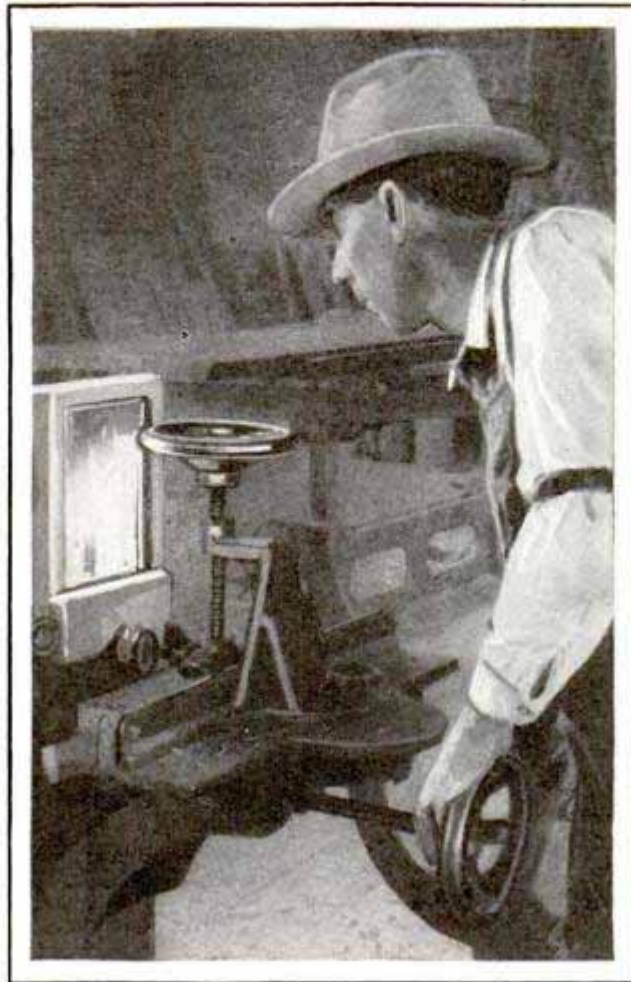

Shop Worker Reduces Fatigue and Saves Time by Using Mirror behind Dado Machine

Mirror Helps Do Dado Work

In a woodworking plant at Wahoo, Nebr., one of the workmen has installed a small mirror on the dado machine so that, by looking into the mirror, he can tell where to strike the wood with the power-driven bit. In the photo the workman is cutting mortise-and-tenon joints in the frame for a screendoor. He claims that the mirror not only saves one-third of the time but also prevents fatigue of the neck and shoulder muscles. The device has been in use for three years and all who have

worked with it have found it satisfactory. —Dale R. Van Horn, Walton, Nebr.

Extension Handle on Tap

After tapping a hole, it usually takes considerable time to screw the tap out, and the worker is likely to do this in haste and become more or less careless, which may result in a broken tap. To speed up the removal and at the same time lessen the danger of breaking off the tap, thread a 3-in. length of $\frac{1}{4}$ -in.

rod. Knurl it if possible although this is not necessary, and screw it into the tap, as shown. After the hole has been tapped,

unscrew the tap by rolling the extension handle between the palms.

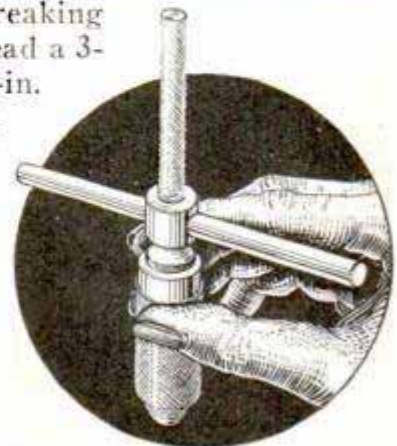

Brick Cleaner from Hacksaw Blades

For cleaning the face of brick or removing paint and plaster, an excellent tool can be made from a dozen or more old hacksaw blades, mounted so that they will be spaced about $\frac{1}{4}$ in. apart, and provided with handles, as shown in the drawing. To bind the blades together, washers are placed between the ends and long threaded rods, with a nut at each end, are used to form them into a solid bundle. The handles are made up of equal lengths of $\frac{1}{4}$ -in. rod, with the ends flattened, drilled and bent to the shape shown. Any brick can readily be cleaned on the face surface

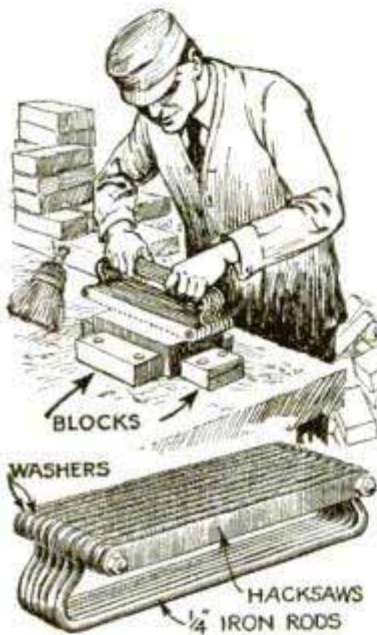

with this tool so that it has the appearance of being new when set into a finished wall. To hold the brick, four blocks of wood are nailed to a bench and spaced to accommodate the brick. The cleaner is rasped firmly across the face, making a clean job of resurfacing in a very few strokes.—G. A. Luers, Washington, D. C.

Rubbing Down Varnish

In doing some cabinetwork, I discovered a method of saving a lot of hard work and time when rubbing down the varnish with pumice stone. I have always had a great deal of trouble to get the finely powdered stone removed from the small interstices of the wood before applying the second coat and again later on. On the last job I did, that of making a library table of black walnut, I mixed a small amount of the powdered pumice with some walnut stain. The result was highly satisfactory. The object of mixing the pumice with the stain was to fix it so that if any small amount were left in the work it would be inconspicuous.—H. F. O'Neal, Noblesville, Ind.

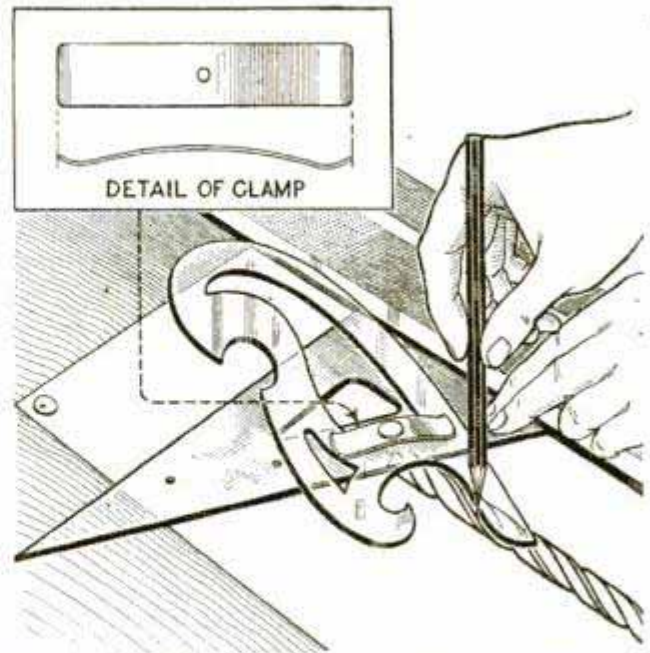

Clamping a French Curve to a Triangle Makes It Easy to Handle

Clamp on Triangle Holds French Curve

Many an exasperating job of irregular-curve drawing can be made just as easy as the use of a triangle. A small sheet-metal clamp grips and holds the curve securely in any position by means of a thumbscrew set in one of several threaded holes in a regular triangle, and permits it to be moved along in any direction, while it is kept in perfect alinement. The same curve section can be repeated any number of times at any desired intervals and with the assurance of getting it correctly located every time. A medium-size triangle will be found preferable to serve as a base for the clamp. No tap is necessary in making the holes, as a sharp screw will cut its own thread in celluloid. Care must be taken, however, not to make the blank holes too large. They should be slightly larger than the bottom diameter of the thread. The clamp is made of $\frac{1}{2}$ -in. spring brass or bronze, and should be slightly bent up at the ends and sprung up in the center, as indicated. All the corners should be rounded. The thumbscrew should not be too large and must have a small stem with a fine thread similar to screws in drawing instruments. In the illustration, the arrangement is shown in laying out the flutes of a twist drill, which can be accurately done in a short time, a guide line being drawn to one side of the triangle to preserve the vertical alinement.—H. Simon, Santa Ana, Calif.

This May Be Your Home

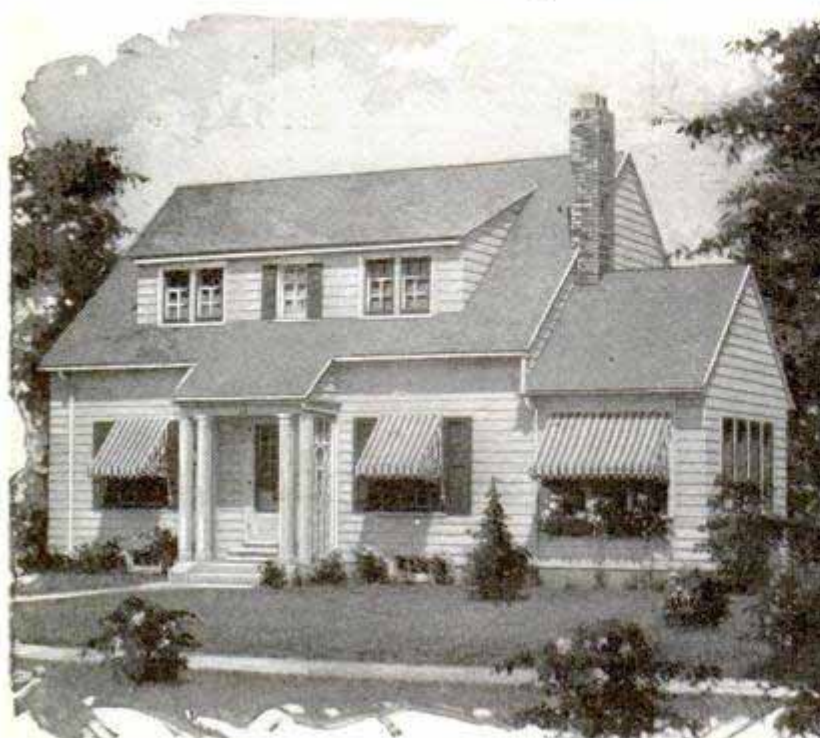

Copyright, Architects' Small House Service Bureau

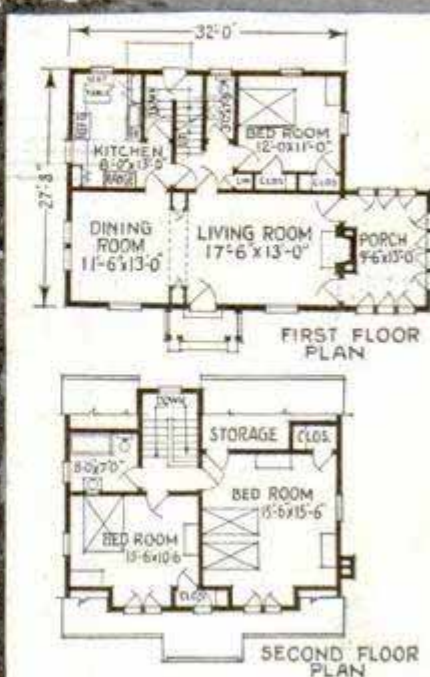

Plan No. 6A48

QUESTIONS regarding home building addressed to this magazine will be answered by The Architects' Small House Service Bureau of the United States, Inc., controlled by the American Institute of Architects and endorsed by the United States department of commerce. Inclose 10c and self-addressed envelope. Blueprints, specifications and material list for the house shown here may be obtained at nominal cost. Inclose self-addressed stamped envelope for reply. If further information is desired, send 5c and stamped envelope for a 24-page booklet explaining how the Small House Service Bureau functions and showing 12 sample plans. A new booklet, entitled "Fifty Ways to Lower Home Building Costs," illustrated by ten bureau houses actually lived in, and showing how as much as \$1,000 can be saved on a home, may be obtained for 20 cents.

THIS six-room Dutch colonial home, of frame construction, combines excellence of plan, economy of construction and beauty of design. It is suitable for almost every locality. It can be built on a fifty-foot lot, and by omitting the sun porch, a forty-foot lot will do.

The interior is a fine example of skillful planning. Very important are living and dining rooms of any home. These rooms concern the comfort of the entire family. In this home these are two fine, big rooms separated by an arched opening with bookcases at either side. This makes them practically one big room. The open fire is so placed that its cheerful blaze and warmth on a chill early autumn or spring day can be enjoyed by both rooms. A

French door at either side of the fireplace leads to the sunroom.

The first-floor bedroom and lavatory is a special feature. This room has two good clothes closets and there is a linen closet in the hall.

The position of the stairs gives them great privacy, which is most unusual in a small home.

On the second floor there are two bedrooms. One is fifteen feet six inches square and has wall space for twin beds. It also has a clothes closet and roomy storage space under the eaves large enough to contain several trunks.

In the kitchen there is a chance for a breakfast nook to be built into one corner, as shown on the first-floor plan.

IN accordance with the editorial policy of this magazine never to accept compensation in any form for what appears in our reading pages and also to avoid the appearance of doing so, we are obliged to omit the name of the maker or the seller of any article described. This information, however, is kept on file and will be furnished free, by addressing Bureau of Information, Popular Mechanics Magazine, Chicago.

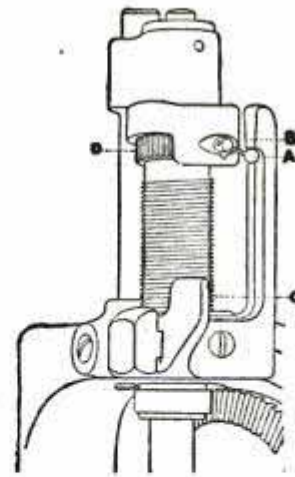
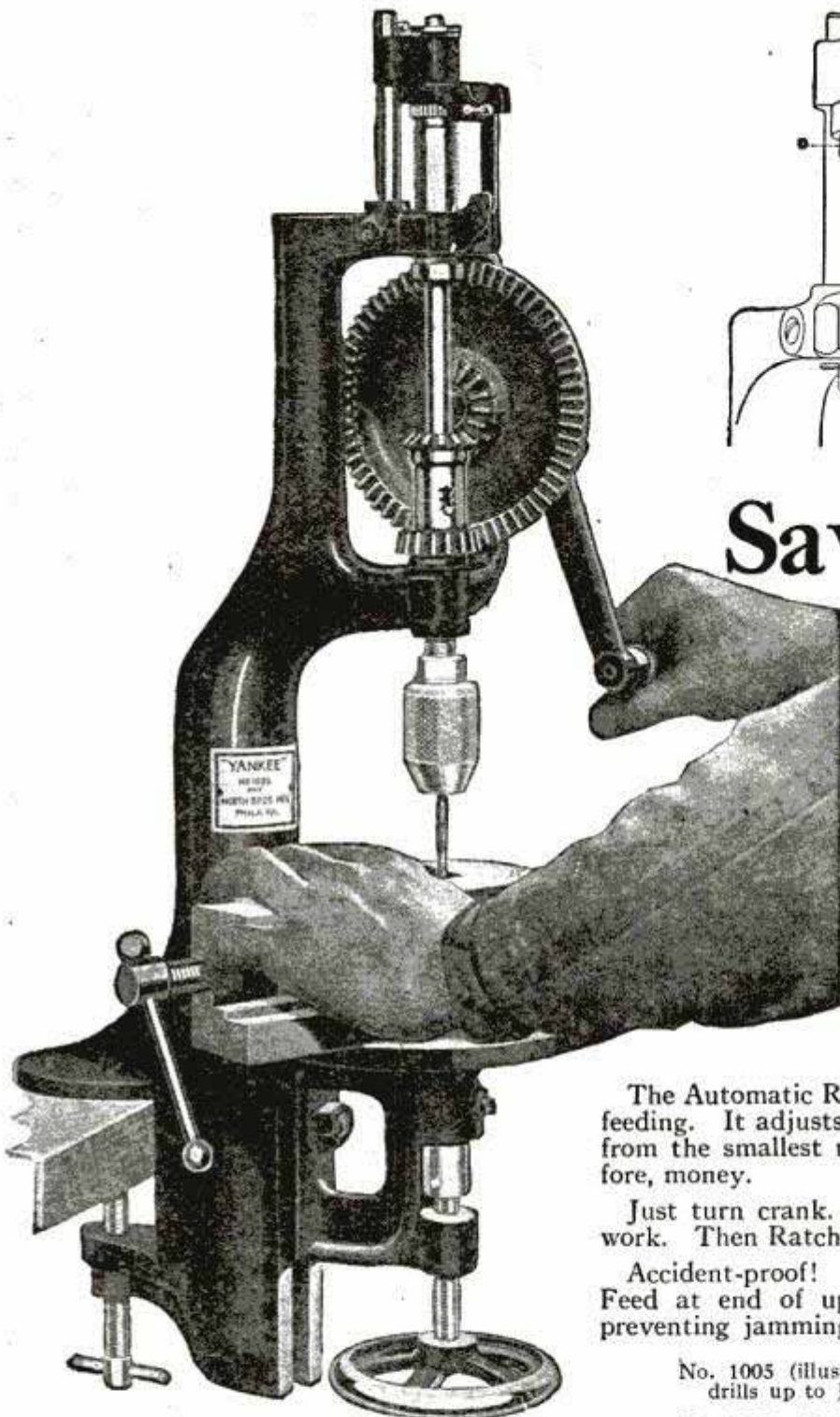

Enlargement of head of "Yankee" Automatic Bench Drill

D—Ratchet Teeth.
A—Ratchet Shifter in "knock-off" position at extreme of up movement.

B & C—Automatic "knock-offs" at top and bottom.

Ratchet Shifter (A) regulates Automatic Feed. Friction Feed quickly runs drill down to work. Then you move Ratchet Shifter to horizontal position, and Ratchet Feed takes hold. "Knock-offs" (B & C) throw off Shifter on down and up movements.

Saves Money by Saving Drills

No amount of experience could teach any mechanic to regulate the pressure on drills as evenly as this "Yankee" Automatic Feed Bench Drill does it for him.

The Automatic Ratchet Feed takes the place of hand feeding. It adjusts the pressure perfectly for all drills from the smallest up. This saves drills—and, therefore, money.

Just turn crank. Friction Feed runs drill down to work. Then Ratchet Feed operates.

Accident-proof! Automatically knocks off Ratchet Feed at end of upward and downward movement, preventing jamming, stripping, or broken gear teeth.

No. 1005 (illustrated). Two speeds; 3-jaw chuck holds drills up to 1/2 in. Entire length, 28 in.

No. 1003. Single speed; 3-jaw chuck holds drills up to 1/4 in. Entire length, 18 3/4 in.

Some other "Yankee" Tools

- Ratchet Breast and Hand Drills
- Ratchet Bit Braces
- Plain and Ratchet Screw-drivers
- Automatic Push Drills
- Ratchet Tap Wrenches
- Vises—Removable Base

"Yankee" on the tool you buy means the utmost in quality, efficiency and durability.

Dealers Everywhere Sell "Yankee" Tools

NORTH BROS. MFG. Co., Philadelphia, U. S. A.



FREE New "Yankee" Tool Book

This interesting little book is for all lovers of fine tools. It tells just what you want to know about all the famous "Yankee" Tools. Write for your copy today.

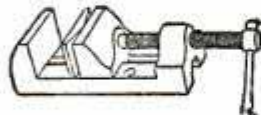

"Yankee" Vise No. 990

Designed for use on Bench Drills. Machined true on ends, bottom, and sides. Swivel jaw for taper work. Jaws open 3 in.

"YANKEE" TOOLS

Make Better mechanics



However storms may interfere with travel, telephone operators are at their posts

An Unfailing Service

AMERICANS rely upon quick communication and prove it by using the telephone seventy million times every twenty-four hours. In each case some one person of a hundred million has been called for by some other person and connected with him by means of telephone wires.

So commonly used is the telephone that it has come to be taken for granted. Like the air they breathe, people do not think of it except when in rare instances they feel the lack of it.

Imagine the seventeen million American telephones dumb, and the wires dead. Many of the every-day activities would be paralyzed. Mails,

telegraphs and every means of communication and transportation would be overburdened. The streets and elevators would be crowded with messengers. Newspaper men, doctors, policemen, firemen and business men would find themselves facing conditions more difficult than those of fifty years ago, before the telephone had been invented.

To prevent such a catastrophe is the daily work of three hundred thousand telephone men and women. To maintain an uninterrupted and dependable telephone service is the purpose of the Bell System, and to that purpose all its energy and resources are devoted.

AMERICAN TELEPHONE AND TELEGRAPH COMPANY
AND ASSOCIATED COMPANIES

BELL  **SYSTEM**

IN ITS SEMI-CENTENNIAL YEAR THE BELL SYSTEM LOOKS FORWARD
TO CONTINUED PROGRESS IN TELEPHONE COMMUNICATION

Thousands Can Now Enjoy Home Billiards

Brunswick Home Tables Moderately Priced—Sold on Easy Terms

Here's the opportunity of a lifetime to bring into your home the greatest sport of all—billiards. Show the family one of these attractive new Brunswick Home tables. Tell them of its modest price and the wonderful fun it provides—not for a short while but for years and years—and they'll be just as enthusiastic about it as *you* are.

Everybody loves billiards. There's a thrill to the game, a fascination—real competition. And besides the wonderful entertainment it affords, it provides mild, wholesome, health-building exercise.

You will get more real sport out of a billiard table in your home than anything you ever owned. Friends will flock to your house. It makes entertaining easy, for *everyone* plays or can learn to play quickly.

Read the description of the "Playmate" at the right. Note how little it costs to place it in your home. Then fill out and mail the coupon below for more complete information, pictures and prices on this and other Brunswick Home tables.

Don't miss this wonderful opportunity to interest the family in one of these tables. Write today.

The Brunswick-Balke-Collender Company

Established 1845. Branches in All Principal Cities of U. S. and Canada



The
"PLAYMATE"

A Genuine Slate Bed
Brunswick Home
Billiard Table

THIS newest Brunswick Home Table is a modified standard table—not a toy. It is substantially built and scientifically accurate. Cushions, playing angles and balls have been scientifically reduced to scale so that you have all the playing qualities of a standard size table. The slate bed assures an absolutely level playing surface. Folding legs enable you to set the Playmate up anywhere. It comes completely equipped ready for play—size 3½ x 7 ft.

Price \$26⁵⁰ down

Balance in small convenient
monthly payments

At a slight additional cost interchangeable cushions may be had, making the table suitable for either pocket or carom billiards. Smaller tables, in sizes 2¼ x 5 ft. and 3 x 6 ft., as pocket tables only, available at even lower prices.



**Play
Billiards**

The Brunswick-Balke-Collender Company
Dept. H-1143, 623 Wabash Avenue, Chicago, Ill.

Gentlemen: Without obligating me please send your Catalog, giving descriptions, sizes, prices, and also details of your easy payment plan on Brunswick Home Billiard Tables.

Name.....

Address.....



“Who’s seen the hammer and saw?”

WHY have to search kitchen and cellar before you can start a job? You can make yourself a tool chest. It provides the simple and right way to keep your tools safely. They’re always at hand when you want them.

Such protection justifies your purchase of good tools. And fine work requires fine tools. Most carpenters use Stanley Tools because of their superior material and design. The same characteristics make Stanley Tools the favorites in thousands of manual training classes.



A set of Stanley Tools provides all the tools you need to do the many repair jobs around the home—or to build a bookcase, a porch swing, a breakfast nook or other things you’d like to make.



*Buy separately
or in assortments*

You can buy Stanley Tools separately and so collect your own set. And for convenience in buying there are also a variety of sets. Assortments in strong cardboard boxes containing simple directions for making your own chest—ranging in price from \$5 to \$20. Or chests of tools from \$15 to \$95.



IMPORTANT: For only 10c (to cover cost of printing and mailing) we will gladly send you a plan sheet which gives full directions for making a Tool Chest like the one shown above. Ask for Plan No. 71—PM.

Ask your hardware dealer to show you the line of Stanley Tools. And send for our Catalogue No. 34-D which describes Stanley Tools both separately and in assortments. Address: The Stanley Works, New Britain, Conn.

The best tools are the cheapest to use
Ask your hardware dealer

STANLEY TOOLS

AERO COIL

SUPER-SENSITIVE

INDUCTANCE UNITS

The most important factors in perfect set performance:

Aero Coils are the *perfect* supersensitive inductance units! Due to their special patented construction, high frequency resistance is reduced to a minimum. Hence Aero Coils are capable of greater volume, and are sensitive to all the radio frequencies, thereby correcting the real cause of distortion, impossible to correct with other types of coils. But more! No dope is used. So if you are interested in better performance from any set, be sure to build with Aero Coils.

AERO TUNED RADIO FREQUENCY KIT

Price, \$12.00



The Aero Coil Tuned Radio Frequency Kit illustrated at the left will positively improve the performance of any receiver. Patented Aero Coil Construction eliminates radio frequency losses and brings tremendous improvement to volume, tone and selectivity.

Kit consists of three matched units. The antenna coupler has variable primary. Uses .00035 condenser. Eight-page color circuit, layout and instruction sheet for building the supersensitive 5 tube Aero-Dyne receiver packed with each kit. Extra copies, 75c each.

AERO INTERCHANGEABLE SHORT WAVE KIT

Completely interchangeable. Adopted by experts and amateurs. Range 15 to 130 meters. Includes three coils and base mounting, covering U. S. bands 20, 40 and 80 meters. You can increase the range of this short wave tuner by securing coils Nos. 4 and 5. Combined range of 25 to 150 meters. Both interchangeable coils fit same base supplied with short wave kit and use the same condensers. Coil No. 4 price \$4.00; Coil No. 5 price \$4.00.

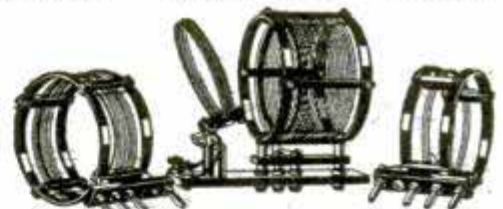

Price, \$12.50

AERO INTERCHANGEABLE COILS Nos. 4 and 5

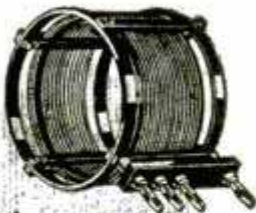

Increase range of your short wave tuner by securing Coil No. 4 and Coil No. 5, combined range 125 to 550 meters. Both interchangeable coils fit the same Aero base supplied with the short wave kit, and use the same condensers.

Coil No. 4—Range 125 to 250 meters.....\$4.00

Coil No. 5—Range 235 to 550 meters.....\$4.00



Other Supersensitive AERO Inductance Coils

There is an Aero Coil for every inductance requirement. In addition to those described above we make the following coils: Aero 3 Circuit Tuner, \$6.50. Aero Radio Frequency Regenerative Kit, \$10.00. Aero Low-Loss Antenna Coupler, \$4.50. Aero Oscillator (for Superheterodynes), \$5.50. Aero Wave Trap Unit, \$4.00.

You can get any or all of these coils from your nearest dealer. See him TODAY.

AERO PRODUCTS, Inc., Dept. 107, 1772 Wilson Ave., Chicago, Ill.

Pacific Coast Representatives: HENGER-SELTZER,

1111 Wall St., LOS ANGELES, CALIF.

377 Brannan St., SAN FRANCISCO, CALIF.

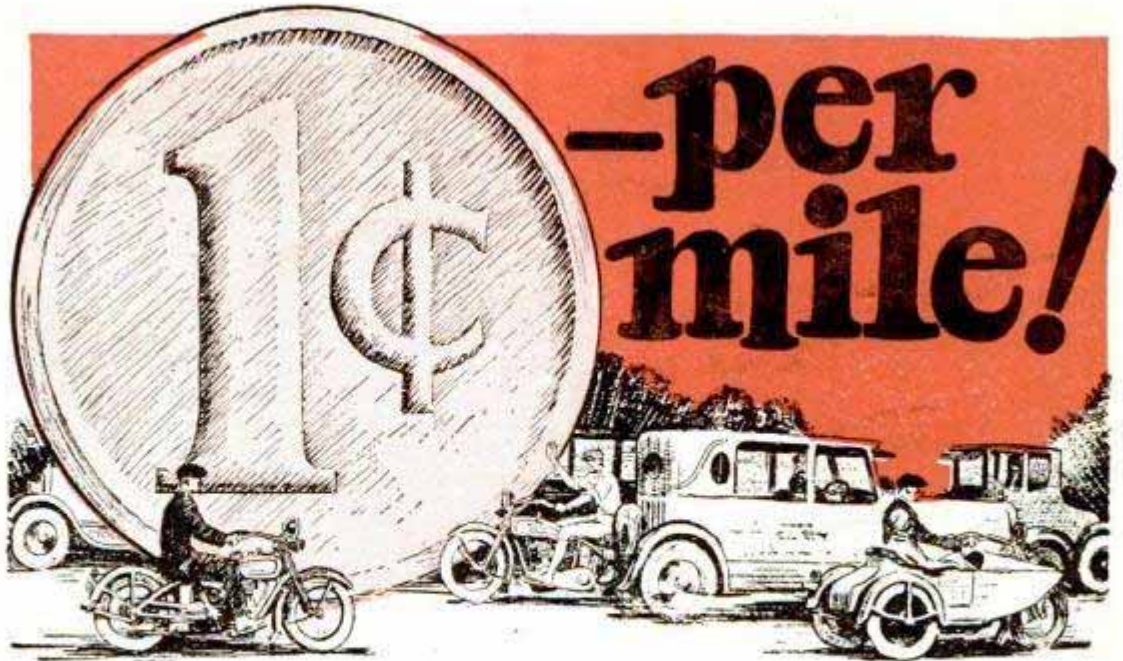

America's Lowest Cost Power Travel!

ONE-SEVENTH the cost of running a low priced automobile! Half the cost of street car travel!

Always ready for a comfortable ride. Convenient — dependable — safe — economical. Easier to ride and control than a bicycle — practically self-balancing. Ample power for all traffic and road conditions. First cost is also surprisingly low. Complete, with 3-speed \$235 transmission and full electric equipment, f.o.b. Milwaukee



HARLEY-DAVIDSON MOTOR CO.
Department P. Milwaukee, Wisconsin

The
HARLEY-DAVIDSON
[*New-Type*] *Single*
Motorcycle

Let your dealer explain his convenient *Pay-As-You-Ride* Plan. Send us the coupon for full details.

Safe

Easy to Ride

HARLEY-DAVIDSON MOTOR CO.,
Dept. P., Milwaukee, Wis.

- Interested in your Single; send catalog and my dealer's name.
 Interested in your dealer proposition. Is my territory open?

Name

Address

At last a STEEL TAPE *that*
is genuine STAINLESS STEEL



The measure of a good
mechanic—wherever good
tools are used



HERE, at last, is a steel tape that won't rust. Carpenters, builders, contractors, surveyors, mechanics — everybody who has used steel tapes knows how often they have to be scoured and what scouring does to a tape.

But this tape *can't* rust — it's made from genuine Stainless Steel. Use it in mud and water as much as you like — and then wind it up and forget it. It won't rust or stain, it will never need scouring or cleaning and the graduations will be as sharp and distinct after years of use as when the tape was new.

Made in 50, 75 and 100 ft. lengths of genuine Stainless Steel; graduated in feet, inches and eighths of an inch or in feet, tenths and hundredths of a foot. Quick reading figures—the foot mark is shown in a different size figure before each inch mark. Has leather case and push button handle. Ask your hardware dealer for Starrett Stainless Steel Tape No. 520.

You also get these same fine non-rusting qualities in Starrett Stainless Steel Rules, 6 and 12-inch lengths, hardened and tempered, and in 6-inch lengths flexible — graduated in 8ths and 16ths on one side and 32nds and 64ths on the other.

If you're interested in fine tools, write for a free copy of the 352 page Starrett Catalog, No. 23 "A.P."

THE L. S. STARRETT CO., ATHOL, MASS.

World's Greatest Tool Makers
Steel Tapes — Standard for Accuracy

Starrett Dealers are displaying Starrett Stainless Steel Tapes and Rules the week of Oct. 9th—look for "the measure of a good mechanic" in your dealer's window.



Starrett
STAINLESS STEEL
Tapes and Rules

Genuine Stainless Steel is manufactured only under the patents of the

AMERICAN STAINLESS STEEL COMPANY

Commonwealth Building, Pittsburgh, Penna.

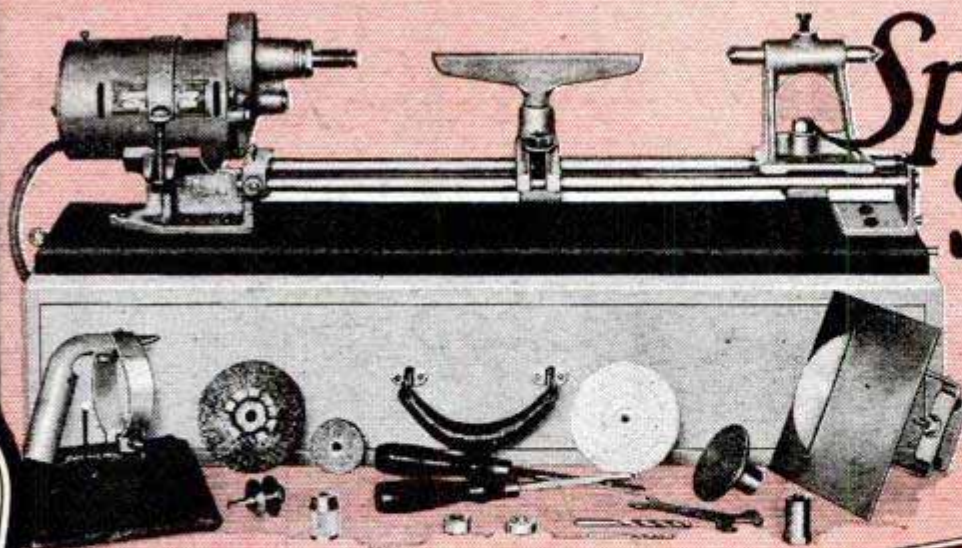

Speedway Shop

Make things
AT HOME

10 Days Free Trial

Act Quick!

Here is just what you have been waiting for! The big opportunity! The Speedway Shop is a compact and efficient electric workshop for you men who are "handy" with tools, mechanics, or experimenters!

The Speedway Shop is driven by the powerful back geared Speedway electric motor—famous the world over.

We are offering you the Shop on a 10 day free trial in your own home. Test it! Experiment with it! Use it as you would your own! You will find it the handiest, fastest metal and wood working outfit you have ever laid your eyes on. It is complete in every sense, and ready for operation.

In your own home—

Fascinating! Intriguing! Interesting! That's what users say about the work you perform in your own home with the Speedway Shop and Tools. You can make almost anything— attractive, odd furniture, toys, home and garden improvements, radio manufacturing, consoles, bric-a-brac, book shelves—countless useful articles. You can do buffing, polishing, grinding and drilling either at the bench or wherever you find a lamp socket and—all of this for only \$10.00 down—the balance on easy terms.

Free
blueprint
service

8 motor driven tools



Portable Saw Unit

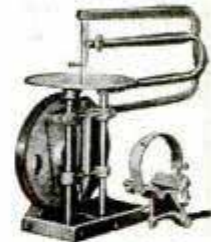

Jig-Saw Unit

A complete wood-turning lathe, bench saw, scroll or jig saw, a portable electric hand saw and all accessories for both portable and stationary power drilling, buffing, grinding and cleaning. Attaches to any light socket and converts a work bench into a complete private tool and machine shop. You can buy 2 or 3 units at first and add others as you need them.

A blueprint a month FREE

Each month for a year we will furnish you a blueprint of your own selection free to help you to get maximum service from the Speedway Shop and Tools. Write for a list of the interesting blueprints we have for you.

\$10.00 Down

Want a shop? It's easy to own one. We make it easy to pay while you enjoy a Speedway Shop right in your own home.

Write for full information

Don't hesitate. We want you to know more about the Speedway Shop and Tools. Every tool in the "Shop" is high-grade, built for regular work. A money maker for the small job man. A pleasure for the householder.

Get the full particulars. Send in the coupon today.

ELECTRO-MAGNETIC TOOL CO.

Dept. 211 — 1830 S. 52nd Ave.,
CICERO [adjoining Chicago], ILLINOIS

SEND COUPON NOW

- Electro Magnetic Tool Co., Dept. 211
- 1830 S. 52nd Ave., Cicero, Ill.
- Dear Sirs: Please send me full particulars about your 10 Day Free Trial, Free Blueprints and Your Easy \$10.00 Down Payment plan on the Speedway Shop.
- Name.....
- Address.....
- City.....State.....

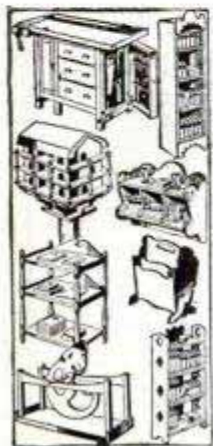

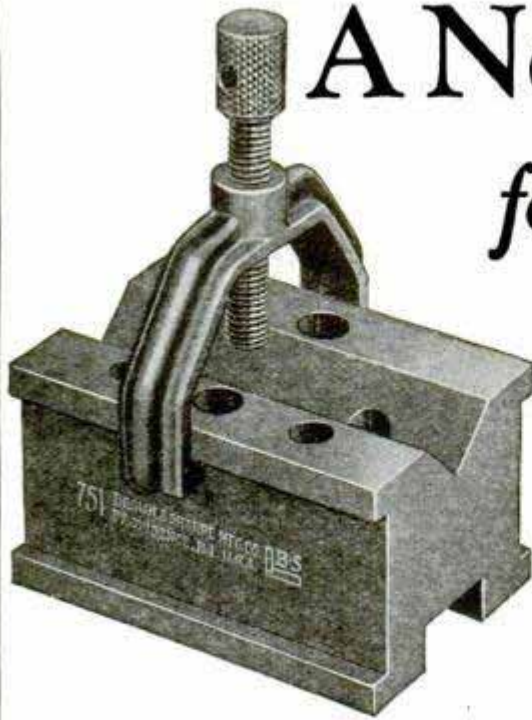

A New Handy Tool

for Home, Garage or Shop

Handy Block and Clamp No. 751

THIS Handy Block and Clamp No. 751 has hundreds of uses around the home, garage, or shop. You can use it as a V Block and Clamp for holding round work firmly for drilling, milling or grinding. You can use the Block as a vise for holding rectangular stock to be filed, countersunk or bent. The smooth flat surfaces may be used as anvils for riveting and similar operations. The holes in the block permit drifts and drills to project through the work being held.

The Handy Block and Clamp will be found the handiest tool for many an awkward job. You'll find new uses for it every day.

Ask your dealer for a free copy of Brown & Sharpe Small Tool Catalog No. 30. Keep it in your kit to use as a reference when buying tools. If your dealer cannot furnish a copy, write us direct.

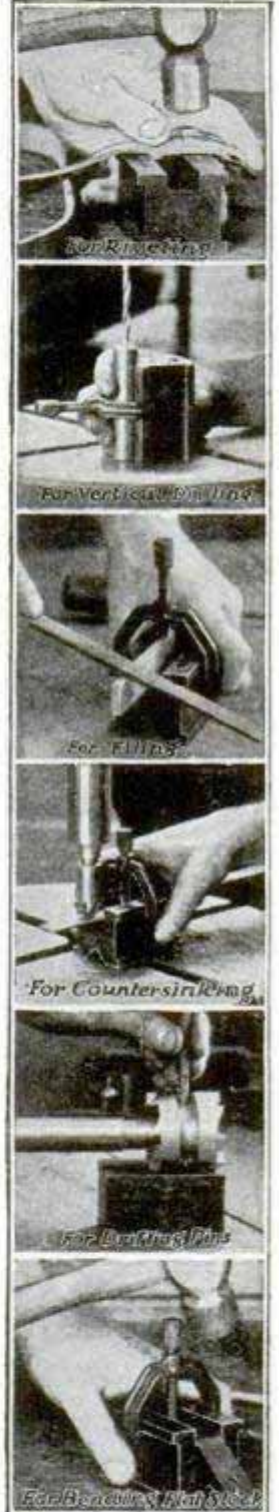

BROWN & SHARPE TOOLS

BROWN & SHARPE MFG. CO., Providence, R. I., U. S. A.



IT PAYS TO BUY A WITTE Engine FOR \$5 DOWN

and Balance on Your Own Terms

It Always Pays to Buy on Easy Terms PROVIDED You Buy
Something That EARNS You An Income—NOT OTHERWISE!

Buying "On Terms" depends on *what* you buy. There are three types of property which you may buy on terms. I call them: 1. Dead or semi-dead. 2. Stationary or problematical. 3. Money-making. For example, when you buy a valuable diamond on terms, you have simply converted your savings into a stone worth the same amount, which *earns* you nothing.

Take real estate: This also earns you little and may or may not increase in value. But take the WITTE Engine, buy it on terms and you are putting your money into something that *immediately* begins to *earn* you money! The WITTE Engine will save you the extra help you would otherwise need; in its portable form it can be used to do work for other farmers at a good profit to you, so that usually it has paid for itself completely before your payments are due and probably made you a profit besides, and will thereafter continue to be a money *earner*. It is best to buy on terms anything that *earns* you something.

It's So Easy Now to Buy WITTE ENGINES or anything you really need that will earn you something.

I found that out myself many years ago when I was fighting hard to make a bare living. A manufacturer of machinery induced me to buy several of his machines on time, paying a little down, and the balance in installments. With these new machines working, and earning money for me, I soon got ahead, the machines paid for themselves, and I bought a lot more in the same way. From this start the Witte Engine Works has grown to a point where I am known as the largest individual manufacturer of engines in the U. S.

Had I waited to earn and save the money to buy those first machines, I would not be in a position today to offer you this proposition, whereby you can have a WITTE Engine, or Saw Outfit, on easy payments that will pay for itself while you are using it, and keep on making money for you as long as you operate it.

The New Improved WITTE

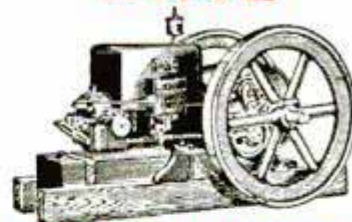

With Square PROTECTED
Tank, Removable, Die-Cast
Bearings, etc.
Sizes 1 1/2 to 30 H. P.

BUY ON YOUR OWN TERMS

No Interest Charged. You cannot afford to delay your engine order when you can buy on YOUR OWN TERMS. \$5.00 down will buy a WITTE *Stationary Engine*. The balance can be divided in any way to suit your income or convenience.

USE THE COUPON NOW!

WITTE ENGINE WORKS

1749 Witte Bldg., - - - KANSAS CITY, MO.
1749 Empire Bldg., - - - PITTSBURGH, PA.
1749 Witte Bldg., SAN FRANCISCO, CALIF.

ED. H. WITTE

1749 Witte Bldg., Kansas City, Mo.
1749 Empire Bldg., Pittsburgh, Pa.
1749 Witte Bldg., San Francisco, Calif.

I am interested in your engine and wish to use it for

Please send me, without obligation on my part, your big Free Catalog and information on your Easy Terms Proposition.

My Name is

My Mail Address is

Town..... State..... (2)

The new
Balkite "B" at \$27⁵⁰
 and the new

Balkite Charger *convert your radio set
 into a light socket receiver*

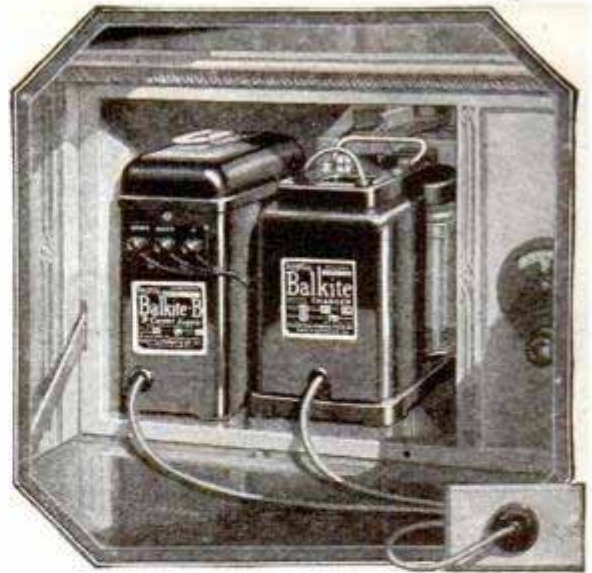

**Balkite Trickle
 Charger**

With 6-volt "A" batteries can be left on continuous or trickle charge thus automatically keeping the battery at full power. With 4-volt batteries can be used as an intermittent charger. Or as a trickle charger if a resistance is added. Charging rate about .5 ampere. Price \$10. West of Rockies \$10.50. (In Canada \$15.)



Balkite Combination

When connected to your "A" battery supplies automatic power to both "A" and "B" circuits. Controlled by the filament switch already on your set. Entirely automatic in operation. Serves any set using either 4 or 6-volt "A" batteries and requiring not more than 30 milliamperes at 135 volts of "B" current—practically all sets of up to 8 tubes. Price \$59.50. (In Canada \$63.)

To enjoy the convenience of a light socket set you need not discard your present receiver. Add the new Balkite "B" and the new Balkite Charger instead.

Balkite "B"—the proved "B" power supply—eliminates "B" batteries entirely and supplies "B" current from the light socket. The new Balkite "B"-W at \$27.50* serves any set of 5 tubes or less requiring 67 to 90 volts. Balkite "B"-X at \$42* serves sets of up to 135 volts and 8 tubes. Balkite "B"-Y at \$69* serves any standard set.

The new Balkite Charger at \$19.50,* with both high and low charging rates, is the most convenient of all methods of charging your "A" battery. At the low rate it can be left on continuous or trickle charge thus automatically keeping your battery at full power. In case excessive "A" current is required, a few hours' operation at the high rate quickly brings the battery to full charge.

Both the Balkite Charger and the Balkite "B" are entirely noiseless in operation, with nothing to wear out or replace. Other than a slight consumption of household current, their first cost is the last. Add these two Balkite Units to your receiver now. Then you will know the convenience of operating your radio set from the light socket. Ask your dealer.

*Balkite Charger \$20 West of Rockies. In Canada:
 Charger \$27.50; "B"-W \$39; "B"-X \$59.50; "B"-Y \$96

FANSTEEL PRODUCTS COMPANY, Inc., North Chicago, Ill.

(Listen to the Balkite Radio Symphony Concerts with Walter Damrosch and the New York Symphony, Saturday nights, 9 P. M., Eastern Standard Time, beginning October 23. Stations WEAf, WEEI, WGR, WFI, WCAE, WSAI, WTAM, WWJ, WGN, WCCO, KSD, WDAF.)

FANSTEEL
Balkite
Radio Power Units



Something NEW

These New
LePage's Books
 will show you
 how to make
better

CHRISTMAS GIFTS

NOW with the coming of the holiday, gift-making season, when the man who has a home workshop especially enjoys his hobby of making useful, practical gifts that can be used and appreciated by everyone in his home—come these two NEW LePage's Craft Books to show you how to make better Christmas Gifts and how to improve your craftsmanship. The titles of these two books are, "LePage's Practical Suggestions for the Home Workshop," and "LePage's Gesso-Craft Book."

Naturally when you tackle the making of an article like a breakfast nook, ship model or cedar chest, you want to come as near as possible to equalling the skill of the trained cabinet-maker. One of the things which he knows that you also must know is how to make strong joints—joints that combine strength with gracefulness and beauty. The only way to do this is with the use of glue, and this is exactly the information given you in these books. They tell you how to make strong joints with glue, and not only with glue, but with glue in its most convenient form—LePage's Liquid Glue.

Improve your craftsmanship

These books also show you how to cover up small defects in your craftsmanship. Now and then a tool will slip and an error is made. Or there are holes to be filled where nails or screws have been countersunk. Or the edges of a joint are not exactly even. A simple new way to repair these defects is with the use of LePage's Gesso instead of putty. LePage's Gesso will stick to any surface—wood, metal, glass, etc. It can be sandpapered, planed and painted or stained just like wood. We give you in the small panel below a simple formula for making LePage's Gesso, but of course we tell you more about it in the books themselves, together with practical information on decorating your finished articles with Gesso.

Send 10 Cents for These NEW LePage's Books

The practical and useful help of these two books is yours for only 10 cents. Just write your name and address on the coupon below, tear the coupon out and mail it to us today with 10 cents in coin or stamps, and we will at once send you a copy of these two LePage's Books, postage paid. Address LePage's Craft League, Dept. RR2, Gloucester, Mass. Tear out the coupon now so that you will not forget it.

Handiest tool in your workshop

Perhaps you have never thought of the special advantages of using LePage's Liquid Glue. It is always ready for immediate use. No weighing, soaking or heating is required. Its quality is always the same. It "sets" slowly enough so that you have plenty of time to place the joints together exactly as they should go. Slow setting also allows LePage's to penetrate the wood, increase the strength of the joint. LePage's Liquid Glue is equal in strength to any animal glue. Buy a can for your workshop. It is the easiest, quickest, handiest form of Glue. Insist on LePage's.

Recipe for Making LePage's Gesso

To make one cup of LePage's Gesso, you need 1 gill can of **LePage's Glue**, 1 1/4 cups whiting, 3 teaspoons linseed oil and 3 teaspoons varnish. Place whiting in mixing bowl and pour in slowly in this order, LePage's Glue, linseed oil and varnish. Mix until smooth. All ingredients obtainable at nearest hardware store.

**LEPAGE'S
 LIQUID
 GLUE**
Bottles, Tubes, Cans

**LEPAGE'S CRAFT LEAGUE,
 Dept. RR2, Gloucester, Mass.**

Gentlemen: Enclosed you will find 10 cents (coin or stamps) in payment for "LePage's Practical Suggestions for the Home Workshop," and "LePage's Gesso-Craft Book." Please send a copy of each to:

Name.....

Street.....

City..... State.....

New! the
**MULTICOLOR
 MECCANO**
 The last word
 in Construction Toys

Now you can build models in colors!

You've never seen anything like it, fellows! Look at the beautiful models on this page with their lustrous coloring—all made with the new Multicolor Meccano. Part after part gleams with brilliant colors, that's why the models are so realistic. And all the fine engineering quality for which Meccano has always been famous, is still there.

We wanted the best colors we could find so we selected Duco, the same genuine Duco that is used on the finest automobile bodies—you'll probably find it on Dad's new car. This gives a hard tile-like finish that does not crack or peel like ordinary paints. And Duco-finished parts *cannot* rust.

Get the newest thing in construction toys. Building with Meccano is as easy as building with blocks. Build your models in bright colors—flaming red for the Fire Engine, olive green for the Tank Car—only Multicolor Meccano gives you this, yet it costs no more.

You'll certainly give the gang a surprise when you display your up-to-the-minute Multicolor outfit. No more colorless, dull models for you—be a leader! This is the day of the new Multicolor Meccano.

There are sets from \$1.00 to \$45.00. Two dandy specials at \$5 and \$10 include motors. See them at your dealer's.

MECCANO COMPANY, Inc.

Div. H-2, ELIZABETH, N. J.

In Canada: Meccano, Ltd., 45 Colborne St., Toronto

Send for This FREE BOOK

It's an interesting story entitled, "How Jack Discovered the Perfect Toy." It will tell you all about the new Multicolor Meccano. Sent free for your name and address and those of three of your chums. Put No. H-2 after your own name for reference.

MECCANO COMPANY, Inc., Div. H-2, Elizabeth, N. J.
 In Canada: Meccano, Ltd., 45 Colborne St., Toronto



The Special \$5.00 Outfit

Contains the powerful Meccano electric motor and parts and full instructions for building more than 100 models. See it in full colors at your dealer's to fully appreciate its beauty. Sent prepaid upon receipt of price if not at your dealer's.

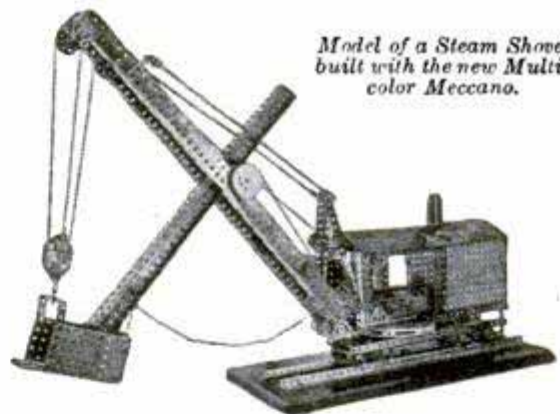

*Model of a Steam Shovel
 built with the new Multi-
 color Meccano.*

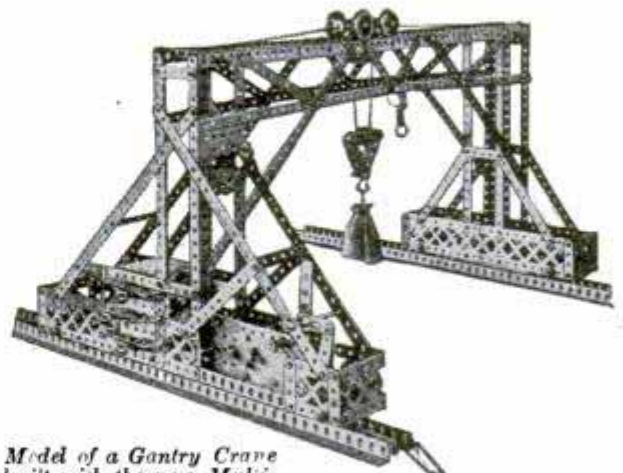

*Model of a Gantry Crane
 built with the new Multi-
 color Meccano.*

THE QUALITY TOY

30 Days Trial

Only **ONE** Dial to Tune



**1 Dial
5 Tube
\$57.00
RETAIL PRICE**

The Last Word in Radio —and the Biggest Values Ever Offered

Yes Sir!—you can put a NEW 1927 Model Westingale, 5-tube Radio in your own home and use it to your heart's content on 30 DAYS TRIAL. Entertain your family and friends. Listen to the music, concerts, sports, news, market reports from stations all over the country. Compare it with other sets for beautiful appearance—wonderful performance and low price—and if you are not convinced that Westingale gives you the greatest measure of Radio satisfaction and the best value for the money—YOU DON'T HAVE TO KEEP IT.

Powerful — Dependable **Westingale** 5-Tube — Coast to Coast

Don't buy any Radio until you send the coupon for our FREE Catalog which pictures and describes both the new 1-Dial and 2-Dial Models. Why pay more? Why not get the NEWEST Radio? Why take chances when all we ask is a 30-Day Trial at our risk to convince you that these NEW 1927 Westingale Models are years ahead in powerful reception—wonderful loud clear tone—handsome appearance—and EASY, simple control.

Look at these two distinctive Westingale Models—they're the last word in every way. Every late feature—every new worth while idea is embodied in their make up. Newest style period type cabinets. Two-tone, hand rubbed Walnut finish. The front panels enhanced with an artistic Spanish Galleon design embossed in dull gold, these new Westingale Models are unsurpassed in appearance—unbeatable in performance—and unbeatable in price.

Agents Wanted Everywhere—Buy at Cost

Right now we want to appoint an agent or dealer and place one demonstrating set in each locality because we know that each demonstration will sell more sets. This is your chance to get a Westingale Radio at a big discount and make it pay you big money. For a limited time we offer a big reduction, way below retail prices on the FIRST

Westingale outfit placed in each locality. Anyone can make quick sales and big profits in taking orders for Westingale sets. No radio experience necessary. We show you how. \$50 to \$100 a week—full or spare time. Our FREE book tells all about it.



**2 Dial
5 Tube
\$47.00
RETAIL PRICE**

Your Own Radio FREE!

Our FREE Catalog also explains a plan whereby you can put a Westingale Radio in your home on 30 Days Trial—demonstrate it to your neighbors and friends in your spare time, and get your own set without cost before the trial period is up. Mail the coupon or a post card for our FREE Radio Catalog today. Be first in your locality to get special discount prices and our FREE Radio offer.

Westingale Electric Co.
Dept. 21
1751 Belmont Ave., Chicago

Be First—Mail Now!

Westingale Electric Co.,
Dept. 21—1751 Belmont Ave.,
Chicago, Ill., U. S. A.

Please send your FREE Catalog on the New 1927 Westingale Radios. Also full particulars of your Special Discount on the first outfit placed in each locality and your FREE Radio Offer.

Name.....

Address.....

CROSLEY RADIO

All prices slightly higher west of Rocky Mts.

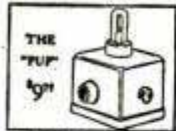

This little double-circuit 1-tube set has made long distance records.



4 tubes. Amazing efficiency. Crescendon equipped!

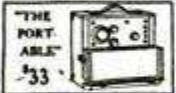

The 4-29 in portable form.



5 tubes, 1-dial control acuminators, Crescendon, power tube adaptability.



5 tubes. True-cascade amplification; non-oscillating and non-radiating.



In solid mahogany console. 5-tube \$50 instrument, Crosley Musicone speaker, ample compartment for batteries.



12-inch size, \$12.50. Super Musicone, \$14.75. Musicone Deluxe, \$23.50. Also beautiful Musicone console with room for batteries and accessories, as below.



CROSLEY

BETTER COSTS LESS

RADIO

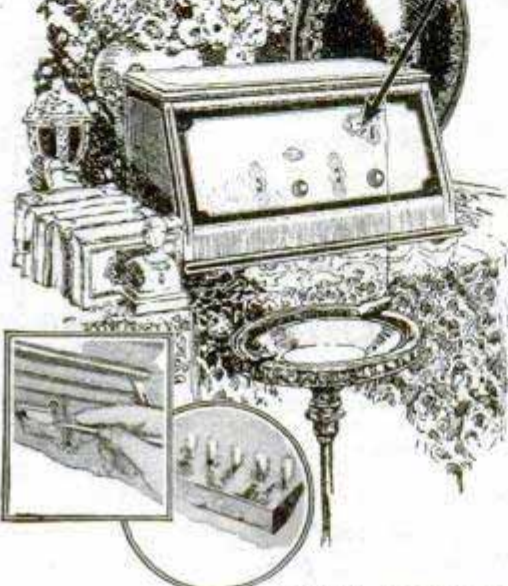

One-dial control. You find your station, then write its letters on the graphic dial, locating it once and for all, to turn to whenever your fancy dictates.

The new Crosley all-metal shielded chassis not only aids in producing astounding selectivity, but standardizes manufacture and helps make possible the price of \$50.

\$50

Slightly higher west of the Rockies. Never before, at anywhere near this price, has a radio set possessed all these advantages: 1. Single-dial control with graphic station selector. 2. Metal-shielded chassis, contributing to amazing selectivity and reducing cost. 3. Crescendon control, producing exquisite volume from distant stations. 4. Crosley Acuminators, which sharpen tuning and increase selectivity. 5. Power tube adaptability. 6. Beautiful, solid mahogany cabinet of distinguished design and exquisite two-tone finish.

One-Dial Control!

... in this amazing 5-tube set at \$50

Already the new 5-tube Crosley set, at \$50, has met such a tremendous demand as to confirm the prediction that it will replace thousands upon thousands of sets now in use.

Confronted by high prices, many people who desired to replace their old sets have hitherto hesitated to do so. Now . . . in the new Crosley "50" . . . they find the features and qualities they desire, formerly exclusive to very high priced sets . . . available at small investment.

The incomparable joys of Single-Dial Control! Uncanny selectivity, resulting from its metal-shielded chassis and the surpassing efficiency of the Crosley circuit's advanced design! Exquisite volume, thanks to the matchless Crescendon! Crosley Acuminators, power tube adaptability . . . all the attributes of radio at its best . . . for \$50!

In all the Crosley line no instrument represents a greater triumph than this wonderful 5-tube set. Examine the line in full, as illustrated in the marginal column at the left . . . each item a victory for mass production in reducing radio prices. Then see the Crosley line at Crosley dealers . . . including the new "50" . . . now on display!

See it . . . hear it. View the refreshing beauty of its solid mahogany cabinet. Operate it yourself. Watch the stations, written in on the graphic dial, parade before you and usher in their programs with unerring accuracy. Sharpen the selection with the Crosley Acuminators. Release inspiring volume by means of the Crescendon.

Know what heights . . . in tone, volume, selectivity and sensitivity . . . radio of moderate price has reached!

THE CROSLEY RADIO CORPORATION, CINCINNATI—POWEL CROSLEY, Jr., President

Crosley manufactures radio receiving sets, which are licensed under Armstrong U. S. Patent No. 1,113,149 or under patent applications of Radio Frequency Laboratories, Inc., and other patents issued and pending. Owning and operating station WLW, first remote control super-power station in America. All prices without accessories.



President
For Catalog write Dept. 15.

Crosley Features

"CRESCENDON"

When, on ordinary radios, ears must strain to catch station miles away, a turn of the Crescendon on Crosley radios instantly swells reception to room-fill-

ing volume. An exclusive Crosley feature. **ALL-METAL SHIELDED CHASSIS**

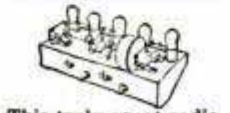

This truly great radio achievement, found in several Crosley sets,

furnishes a substantial frame for mounting elements, produces excellent alignment of condensers, shields the units from each other, prevents interstage, improves the stability of the circuit, increases selectivity and saves costs by standardizing this phase of manufacture.

THE SINGLE-DIAL STATION SELECTOR

Nothing in radio equals the joy or the convenience of single dial control. Crosley single drum control enables you to find the stations sought without log book or "tuning"

"THE ACUMINATORS"

Crosley Acuminators permit tuning in—loud and clear—weak stations passed over and entirely missed by ordinary single dial radios. In tuning high powered and local stations they are not used.

HEAD PHONES
\$3.00

QUALITY AND BEAUTY IN CABINETS AND CONSOLES

21 Jewel
Santa Fe Special
on credit

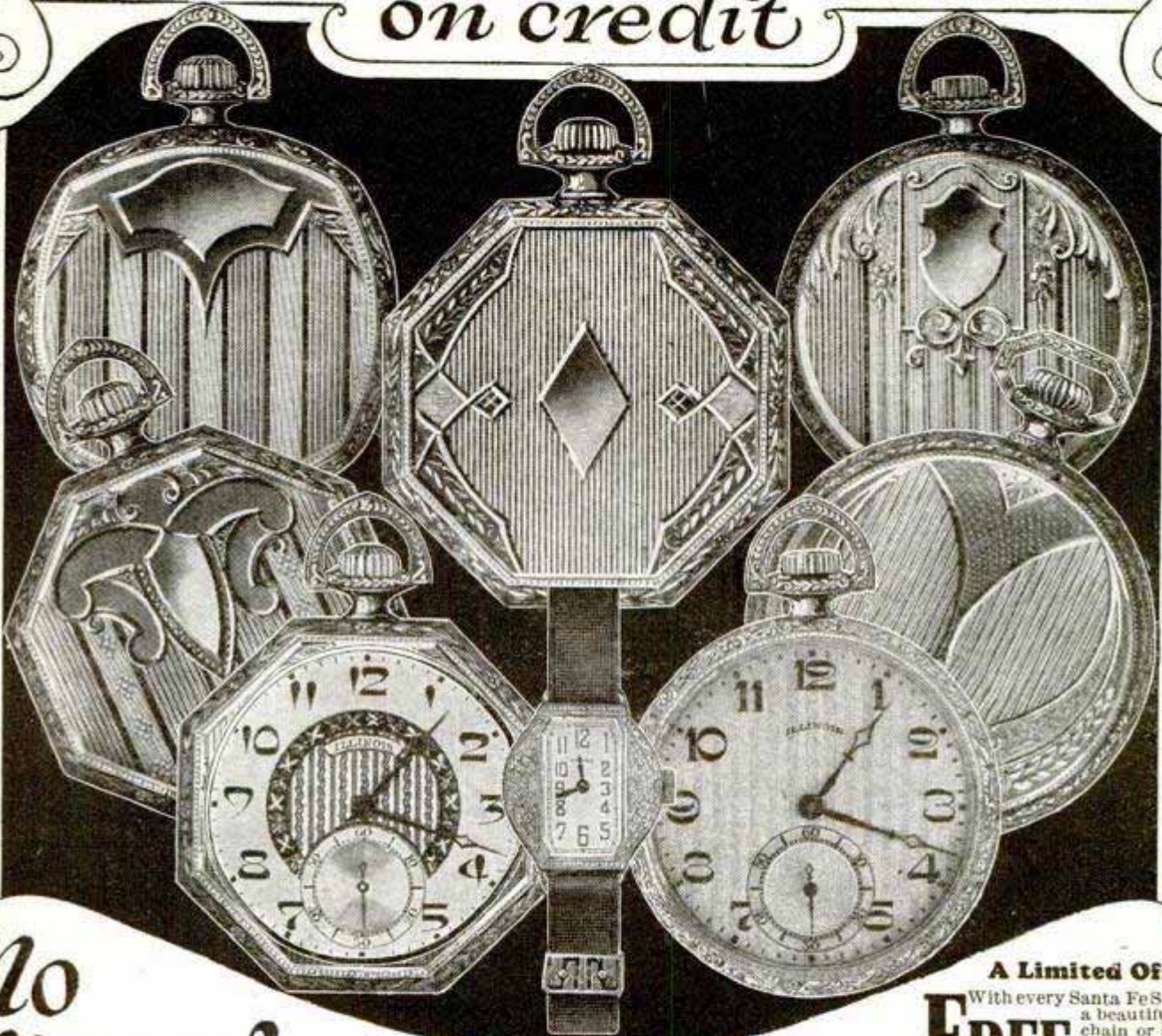

**No
 Money
 Down**

A Limited Offer!

FREE With every Santa Fe Special, a beautiful gold chain or strand of exquisite pearls. Write while offer lasts.

WE will send this famous watch direct to you, express prepaid, on **FREE** Approval. Examine watch and be convinced it's the best watch buy you ever saw. You save $\frac{1}{3}$ to $\frac{1}{2}$ your money by purchasing a Santa Fe Special Watch. We trust you—wear watch while paying for it.

Mail Coupon for FREE Watch Book →

Clip the coupon, fill out and receive the **FREE WATCH BOOK**. All the newest watch case designs in white or green gold, fancy shapes and thin models, are shown. Read our easy payment offer. Select the watch you would like to see; we will send it to you on approval, express prepaid. Wear the watch 30 days **FREE**. Return at our expense if not fully satisfied.

SANTA FE WATCH COMPANY

Dept. B 6 Thomas Building Topeka, Kansas
The Home of the Great Santa Fe Railway

SANTA FE WATCH CO.
 Dept. B 6, Thomas Building
 Topeka, Kansas

Please send prepaid and without obligation your Watch Book Free, explaining your "No Money Down" Offer on the Santa Fe Special Watch.

Name.....

Address.....

OXO-GAS OIL BURNERS

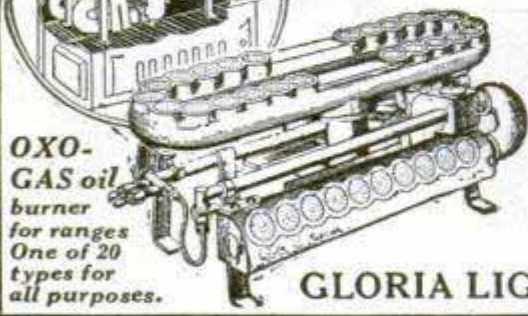

OXO-GAS oil burner for ranges One of 20 types for all purposes.

For Furnaces, Ranges, Heating Stoves, Etc.

OXO-GAS, the cheapest, cleanest, most efficient fuel known to science, is made from kerosene or distillate, and air, mostly air. Burns with a pure blue flame of high heating intensity, as silently as city gas. *Over a million in use.* Manufactured by the oldest (est. 1906), highest rated and most responsible corporation. *Ask any bank. Send for Catalog* illustrating and describing twenty different distinctive designs of oil burners for *Furnaces, Cook Stoves, Heating Stoves, Base Burners, Hot Water Heaters, etc.*

Agents Wanted Some choice territory for OXO-GAS agencies still open to thoroughly responsible parties. Your own locality may yet be unassigned.

GLORIA LIGHT COMPANY, 115-11 N. May St., Chicago, Ill.

NEW VEST POCKET ADDING MACHINE



ADDS, SUBTRACTS, MULTIPLIES, DIVIDES
Does work of \$300 machine. Guaranteed 5 years. **NOT A TOY.** Made of steel and indestructible. Million dollar capacity. Fits in pocket. Will not make mistakes. So simple child can operate it. Everybody should carry one for figuring.

FREE TRIAL \$2.50 Total Cost

SEND NO MONEY—Just name and address. We will ship Calculator immediately. On delivery pay postman \$2.50 (Plus few cents Postage). (If outside U. S. send cash). If not satisfied after 10 day trial you get your money back. **THOUSANDS OF SATISFIED USERS.** This is lowest priced practical calculator made. "Why pay more for inferior imitations?" Order from this ad.

Mail Coupon Today

BABY CALCULATOR SALES COMPANY
Dept. 41, P. O. Box 1118, CHICAGO, ILL., U. S. A.

- I am enclosing \$2.50—send adding machine prepaid.
- Send Adding Machine C. O. D. \$2.50 plus postage.

Name.....
Address.....
City..... State.....

AGENTS Write for big commission and territory proposition.

The man who studies gets ahead. Popular Mechanics Press will advise you what books to read to advance in your trade. 200 East Ontario Street, Chicago, Illinois.

Do Wonderful Chemical Tricks and Experiments with CHEMCRAFT Junior!



Make ink, dye cloth, test water and soil. Puzzle your friends with Magic Chemical Tricks; write secret letters with invisible ink, pour blue, brown and black liquid from a pitcher of water, make magic writing paper. It's all easy with this wonderful outfit. Always sold for 50c, but if you send us the names and addresses of five boys, we will send you

CHEMCRAFT JUNIOR for only 25c
BIG BOOK FREE!

Chemcraft Chemist Club Magazine: full of experiments, stories and chemical news. Just write for it—it's free.

The Porter Chemical Co.
113 Summit Ave. Hagerstown, Md.



\$7.65 IN 4 HOURS SPARE TIME



Hampton made \$7.65 in four hours spare time just wearing this Beautiful Hand-Tailored Cap, made to his Individual Measure, and you can do the same—you can easily earn \$50—\$75 a week in your spare time.

Get This Cap FREE

I want to give you this cap for taking a few orders—I know your friends will be delighted with its Class, Style and Fit and you will make a generous profit taking their orders. Choice of 5 styles and 25 fine fabrics. Send your name right away and I'll tell you how to make \$50 a week in your spare time. Write me at once. J. W. Taylor, Pres., Taylor Cap Manufacturers, Dept. P-3, Cincinnati, Ohio

PLUMBING - HEATING WATER SYSTEMS



SAVE UP TO 40%
Wonderful bargains—everything guaranteed. Full line of plumbing and heating supplies. Hot water, steam heating plants and fixtures and water systems at big savings.

Install Them Yourself
Finest materials all brand new and perfect. Tell us your wants and mail us a rough sketch of your rooms.

SEND FOR PRICE LIST
B. KAROL & SONS CO. 800 S. KEDZIE AVE. Dept. 20 CHICAGO

\$2000 in Three Months

Men and women let me tell you how I've sold, by mail, 2000 \$1 orders in three months. Mdse. cost 12c per order. **Send name.**
QUINCY CO., 357 Quincy Bldg., CHICAGO

Art Corner Your Pictures-Album
where you can keep them safe and enjoy them always.

Engel
5 Styles "Art Corners" Colors
are on sale at Photo Supply and Album counters everywhere. They are the only Quick, Easy, Artistic, No Paste, No Fold way to mount Kodak Prints. A dime brings 100 and 7 samples to try. Write
ENGEL MFG. CO.
10¢ Buys 100
Dept. 80L, 4711 M. Clark St., Chicago

Send for Book of 200 Home Plans FREE!

Swing a Hammer and Save \$500!

Hundreds of buyers find our plans so easy to follow and the material so accurately cut and marked that they put up their homes themselves. Studs, joists, rafters and sheathing cut at mill by power-driven saws. Saves 30% labor and 18% lumber waste. Permanent construction.

Highest Quality
All material guaranteed top quality. Everything furnished as specified. No extras. One guaranteed price covers all.



Gordon-Van Tine Home No. 911. Five rooms and bath. Materials—\$819

Buy Your Home Direct From Mill!

Over 200,000 customers help you save. Their volume enables us to operate on one small profit, and give you *wholesale prices*. Your savings run from \$200 to \$2,000. Homes planned for utmost in comfort and beauty. Many built-in features to lighten housework. Distinctive designs by skilled architects.

Gordon-Van Tine Co.

ESTABLISHED 1865

Satisfaction Guaranteed or Money Back
843 Case Street DAVENPORT, IOWA

Garages and Summer Cottages Build Yourself Save Money

Send us your bills to figure. Free estimates on any job.

Send For Book
200 plans, photos, color illustrations. Homes as low as \$649; Bungalows, Colonial, etc. Also ask for Building Material Catalog.

Gordon-Van Tine Co., 843 Case St., Davenport, Iowa

I expect to
 Build a.....
 Repair a.....
 Send me proper catalog.
 Name.....
 Address.....



\$100 a week Selling Shirts
Fred Frankel, Ill., writes: "I earned \$110 first week selling Carlton Shirts direct to consumer." You can too. No capital or experience required. We pay 25% cash commissions daily and big extra bonuses. **WRITE FOR FREE SAMPLES.**
 CARLTON MILLS, Inc., Shirt Mfgs., 114 Fifth Ave., Dept. 106-C, New York City

Mr. Brush Salesman Unusual opportunity is offered for aggressive, ambitious, hustling men to sell an old established high grade guaranteed, fastest selling line of Sanitary Twisted in Wire Brushes, sold direct to the home. We have openings for experienced brush men as managers in all territories. We want live wire, energetic Go-Getters. We pay larger commissions than any other Brush House in the Country. If you want to earn some real money, it will pay you to write us immediately for our proposition.
WIRE GRIP SANITARY BRUSH CORP., 15 Mercer St., New York City



MADE \$33

That's Segal's profit in one day. You get same chance. Just wear Hutchins tailored pants or knickers and take orders. Amazing values—best woolens, smartly tailored. Your profit \$1.00 a pair. Get samples free; no deposit. Write Hutchins Pants Co., Dept. P-19, 316 E. 5th St., Cincinnati, O. Agents: Big money. Learn about profit dividend plan. Get free line. Act quickie.

AGENTS

FREE 1000 Illustrations ELECTRIC FIXTURE CATALOG!

Write today for your copy. Save 50% direct from Manufacturer. No Middleman's Profit. **OUR SPECIAL: 8 Room Electric Set, ready to hang, \$24.50—Other bargains.**
UNITED LIGHTING FIXTURE CO. 83 Flatbush Ave. Dept. P, Brooklyn, N. Y.



You Can Play This Pan-American Saxophone!

Be talented! It's easy to learn to play America's most popular instrument—the SAXOPHONE!

Great artists, professional musicians, band and orchestra leaders will tell you that you can make no mistake in selecting a Pan-American Saxophone.

Pan-American's Remarkably Low-Priced

You'll be surprised at the remarkably low price—for this instrument of Pan-American quality.

Can be had in any model. Beautifully finished, completely equipped with latest key mechanism. *Factory guaranteed.*

Send coupon today for complete information and catalog of entire Pan-American line of band and orchestra instruments.

Send No Money MAIL COUPON

THE PAN-AMERICAN BAND INSTRUMENT & CASE CO. Dept. G-1, Elkhart, Indiana

YES—Send me complete information on other band instruments. I would like to learn to play.....(Instrument)

Name.....
 Address.....
 City..... State.....
 My local Music Dealer is.....

FREE TRIAL

Write today for free trial offer and easy payment plan on Pan-American band and orchestra instruments.



Garage men say there's nothing like it!



Convenient canvas roll case

THEY like the handy Prest-O-Lite 5-in-1 Outfit because it gets more work done, gets the work done better and saves time.

No matter what kind of a brazing, soldering, melting or fusing job is to be done, this outfit furnishes just the right heat instantly. And it can be carried easily to the work.

Four different sized torch heads come with the outfit, and there is also a convenient soldering iron that heats instantly and *stays hot*. The outfit also includes rubber hose and tank wrench.

Operates on Prest-O-Lite Gas in convenient tanks. Economical because empty tanks are exchanged for full ones at any one of the thousands of Prest-O-Lite Service Stations by paying a small amount for the gas only.

Ask about this money and time saving equipment at any Prest-O-Lite Service Station, or write direct for detailed information. The price is \$7.50 complete.

THE PREST-O-LITE CO., INC.

INDIANAPOLIS, IND. Dept. L-11

New York

San Francisco

In Canada: Prest-O-Lite Company of Canada, Ltd.
Toronto, Ontario

\$7.50



Prest-O-Lite Gas

"The gas of a thousand uses"



Now— a Crescent Tool for every hand's demand

The "Originators of the Crescent Wrench" now offer you a complete line of wrenches, pliers, hacksaws, screwdrivers, punches, cold chisels and similar tools. Get them from your hardware or accessory dealer.

CRESCENT TOOL CO.

210 Harrison St., Jamestown, N. Y.

CRESCENT Smith & Hemenway Mechanics' and Electricians' Tools

"Interlox"

MASTER SLIDE RULE

Takes accurate inside or outside measurements

MASTER RULE MFG. CO., 813 E. 136th St., NEW YORK

Dealers and Agents: request attractive proposition

Works fast. Slides in and out quickly. Durably made of brass trimmed boxwood. Any length 2 to 8 feet, 20 cents per lineal foot. If not at dealer's, sent postpaid.

Tight Handles—Send for booklet

"HOW to KEEP TOOL HANDLES TIGHT"

Fayette R. Plumb, Inc., 4857 James St., Philadelphia

SARGENT PLANES

See them at your hardware store.

Write for booklet.

SARGENT & CO., 49 Water Street, New Haven, Conn.

25¢

CLASS
FREE

Design shown made with any equal amount lettering, 2 colors enamel,

BASTIAN BROS. CO.



PINS
CATALOG

Silver Plate 25¢ ea; \$2.75 doz. Sterling silver 40¢ ea; \$4.00 doz.

728 Bastian Bldg. Rochester, N. Y.

Makes Old Ford a Tractor

We furnish everything for converting Ford Auto Chassis with Engine into a handy Farm Tractor. Just right for truck growers, small farms, nurseries, etc. Pulls 16" Plow, Discs, Seeds, Cultivates; Runs Belt Machinery. We also build Garden Tractors and Cutter Bar Mower Attachments.

Write for Free Particulars.

SHAW MFG. CO., Dept. F, Galesburg, Kan.

Handles Easily
Turns in 15' Circle



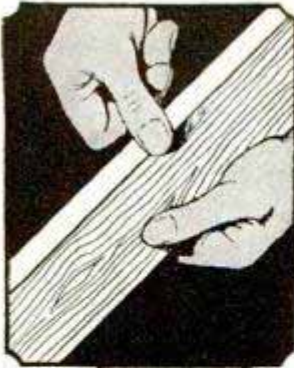

SIMONDS

NEW PLANER SAW

Leaves a Surface of Smoothness

Hundreds of plants are replacing their novelty saws with the new Simonds Planer Saws because the Planer Saw leaves a smooth cut at a faster hand feed than is obtainable with novelty saws.

The new Planer Saw can be used for soft or hard wood; for ripping, cutting off, or mitering. And it is made with the same precision and tempered steel that have distinguished Simonds cutting edges for nearly a century. Ask your dealer about the new Simonds Planer Saw. Or write direct for literature and full information.

SIMONDS SAW AND STEEL COMPANY

"The Saw Makers" FITCHBURG, MASS. Established 1832
Branches and Service Stations in Principal Cities



High Quality Long Life
Right Prices
These are found in all Gerstner
TOOL CASES AND CHESTS
for Machinists and Toolmakers.
A postal brings free catalog

Gerstner Sons

435 Columbia St., DAYTON, OHIO



Anybody
Can Use
It

KESTER READY TO USE METAL MENDER The Household Solder

Here's why thousands use Kester Metal Mender.
Simple—Requires Only Heat—Anyone can use it.
Safe—No messy pots or dangerous acids.
Sure—Genuine Solder makes firm metal joints.
Satisfactory—Works equally well on light or heavy, old or new work.
Economical—Saves many times its price.
Your Dealer Can Supply You

Soldering Booklet
"It's a Cinch to Solder"
Upon Request



CHICAGO SOLDER COMPANY
4201-336 Wrightwood Ave., Chicago, U. S. A.

Test these Tools at Our Risk!



Drive 3/4-in. chisel through 1 1/2-in. machinery steel. Lock our wrench with any other wrench and bring pressure until one breaks. Drive rivet punch through auto frame. Cut shavings off axle shaft with bearingscraper. If tools show slightest harm, return them.

CORNWELL Hand-Made Tools

Made of finest Swedish Charcoal Process Molybdenum Steel, from our famous Cornwell secret formula. Forged, heat treated and hardened and tempered in oil. Made by hand. NOT drop forged and case hardened.

Tools Like These Never Made Before

Mechanics amazed that such tools could be made. Place trial order at our risk. No other tools can stand these startling tests. Hundred thousand users.

Money-Back Guarantee

We replace any tool not standing astounding tests described in booklet. If you ever saw tools like these, return your order and get your money back.



Mail Coupon for Prices and Booklet

CORNWELL QUALITY TOOLS CO.,
Dept. F, Cuyahoga Falls, Ohio

Send me illustrated booklet with prices on full line of Cornwell Secret Formula Hand-Made Tools.

..... Occupation
Name.....
Address.....
City..... State.....

Fastest Cutting

Saws Fifteen Cords a Day!



**Men—
Let Me Send You My
Greatest LOG SAW Offer!**



It's easier now than ever before to own this fastest-cutting, easiest-moved, most powerful Log Saw. Now, you can make big money sawing firewood, stave-bolts, ice, shingle timber, etc. Write today for full details of this most wonderful offer. Know how easy it is to make big money sawing fifteen cords of wood a day with no hard work.

350 Saw Cuts a Minute—

nearly six each second. Just think of it—now you have a log—in a few seconds it's all sawed up into lengths you can use—without any hard work! The OTTAWA has balanced crank shaft, power force feed, friction clutch.

Make BIG MONEY—

Wood selling at \$3 a cord brings owner \$45 a day. Saw your own wood—go into the wood business. Don't let the lack of ready money stop you. Remember, we sell on very easy terms. More in use than all others combined.

**ONLY
\$39**

Puts the OTTAWA Working for YOU!

I average \$20 profit a day with my OTTAWA. — J. Schill, New York. "My OTTAWA has earned \$700 for me." — S. Graham, Wisconsin. "I can make more money with the OTTAWA than by farming." — D. Goff, Missouri.

OTTAWA 4.H.P. LOG SAW

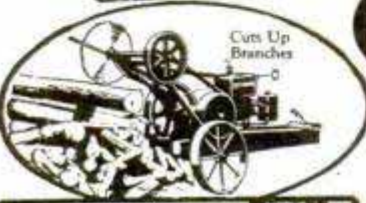

30 Days to Try—one whole month to use the OTTAWA at your own sawing. Shipped on trial only—backed by 10-year guarantee. Prove to yourself how easy you can saw 15 cords or more a day—at a cost of 1 1/2¢ a cord.

FREE Send me your name and address on postcard today, so I can send you my wonderful new edition of the "Wood Sawing Encyclopedia." Educational, instructive. Be sure to investigate—will help you to make big money.

HARRY OVERMAN, Pres. OTTAWA MFG. CO.
1742-P Wood St., Ottawa, Kans. Room 1742-P, Magee Bldg., Pittsburgh, Pa.

To Save You Freight—and get your machine to you a few days after you order, I ship from: Ottawa, Kan.; Pittsburgh, Pa.; St. Paul, Minn.; Albany, N. Y.; Memphis, Tenn.; Indianapolis, Ind.; Pueblo, Colo.; Ft. Worth, Texas; Portland, Ore.; San Francisco, Cal.



Easy to Solder This New Way

Pat. Applied For

Indispensable for all soldering work. Simple—Speedy—Economical.

3.75 Complete

Press-to-Feed Electric Soldering Iron

One hand does the work of two. Speeds up radio set construction. Simplifies all kinds of soldering work. Far better than a blow torch. Solder will not melt until it reaches Soldering Point. Porcelain insulation prevents heat from entering handle.

AGENTS—DEALERS—JOBBER

This newly invented electric soldering iron offers big money making opportunity. Order a sample today \$3.75. Discounts in quantities on request. Write to

ILLINOIS STAMPING & MFG. CO.
220 N. Jefferson St., Dept. 18, CHICAGO

\$25 to \$45

GET THE NEW IDEA BATES MOTOR SAW — 6 SAWS IN 1 —

Does the work of band-saw, rip-saw, cross-cut, miter, bevel and scroll-saw. A wonder worker for the home shop. Direct drive! Can't stick! Cuts 2" wood. Most amazing variety saw ever invented. Does more, costs less! Write for circular.

BATES MOTORCRAFT COMPANY
Dept. M 28 N. Clinton CHICAGO, ILL.

CALCULATIONS

in Office, School, Store and Shop can be instantly made with the Midget Slide Rule. It gives the answer to any problem involving fractions, mixed numbers, decimals, whole numbers, roots, powers, Log, and Trig. Functions. Thousands of these rules are used by Accountants, Engineers, Clerks, Students, etc. It is the most versatile calculator ever invented. If you have any figuring to do, order a Midget Slide Rule on trial. Made of aluminum with figures on white celluloid. Size 4". Price with Instruction Book \$1.50. Leather Case, 50¢ extra. Catalogue Free. Best C. O. D. if desired. Your money back if you are not satisfied.

GILSON SLIDE RULE CO., Niles, Mich.

BURN YOUR NAME ON TOOLS WITH THE ARKOGRAF

PROTECT YOUR TOOLS FROM THEFT
Write with electricity any name or design on the hardest and finest tools and instruments, or any metal, like writing on paper with pen or pencil. Complete Outfit \$3.50—Prepaid Anywhere. Interesting illustrated circular free. Write today. Agents wanted.
ARKOGRAF PEN CO., 1171 E. Stark St., Portland, Oregon

CRESCENT WOODWORKING MACHINERY

High in quality, moderate in price. Ask for circulars describing bench machines for the mail shop.

If you are interested in the larger machines we can supply you with Band Saws, Saw Tables, Self Feed Rip Saw, Shapers, Jointers, Variety Wood Workers, Planers, Planers and Matchers, Disk Grinders, Cut Off Table, Swing Cut Off Saws, Borers, Hollow Chisel Mortisers, Tenoner, Universal Wood Workers. Ask for circulars.

The Crescent Machine Co.,
93 Columbia St., Leontia, Ohio

FREE Kalamazoo Book of Factory Prices NOW READY

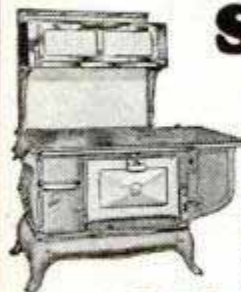

Ranges \$375 up

heating stoves. Cash or easy terms—as low as \$3 down, \$3 monthly. 24 hour shipments. 30 day free trial. 360 day approval test. Satisfaction guaranteed. 26 years in business, 600,000 customers. Write today for your copy of this FREE book.

KALAMAZOO STOVE CO., Mfrs.
391 Rochester Ave.
KALAMAZOO MICH.



Pipe or Pipeless
Furnaces
\$59.95 up

"A Kalamazoo Direct to You"
Trade Mark Registered

Beautiful HOUSES \$900 and BUNGALOWS

CAN BE BUILT FOR AND UP

This and many others in my new book, Building Plans for Modern Homes, will save you hundreds of dollars. One of the most complete and comprehensive books of plans ever published by any architect. New edition just off the press. Nearly 600 floor plans and photographs of Colonial houses, bungalows, etc., costing from \$200 up; gives sizes and cost to build. Sent postpaid for \$3.00.



**FREDERICK H. GOWING
ARCHITECT**
101 Tremont St., BOSTON, MASS.

Earn \$100 a Week Profits in Advance

Sell Gibson extra fine men's made-to-order all-wool suits at \$31.50, direct to wearer. Regular \$55 values. **Biggest commissions paid in advance.** We deliver and collect. 6 x 9 cloth samples (over 100 styles—all one price) and complete outfit in handsome carrying case, furnished to ambitious men who are willing to hustle and earn \$100 weekly. Write today.

W. Z. GIBSON, Inc., 161 W. Harrison St., Dept. Y-516, Chicago



TYPEWRITER PRICES REDUCED

FREE TRIAL

ON ALL
STANDARD MAKES

Big bargains, easy payments on late model Underwoods, Royals, L. C. Smiths, Remingtons, etc.—perfect machines expertly remanufactured by the "Young Process", guaranteed like new for five years. Shipped direct from our factory to you at big saving.

Our big illustrated catalog sent free and without obligation to buy. Write for yours today.

Young Typewriter Co., Dept. HO-3, 634 W. Randolph St., Chicago, Ill.



He Gets what he wants



He's the most popular fellow in town; a sheik in the parlor, a ring leader with the boys. Wherever he goes he gets what he wants with his

BUESCHER

True Tone Saxophone

Do you long for social popularity? The admiration of friends? A welcome hand at gay parties? Good times with those you like best? Do you want to be successful? A favorite with your "boss" and your fellow workers? All these things, and more, are yours if you will learn to play this most wonderful of all musical instruments.

You Can Do It, Easy

Within a week you can be playing tunes. 3 lessons, given on request with each new instrument, explain easy fingering and give you quick start. You might even be a wizard like Tom Brown, whose Buescher Saxophone has made him famous and rich.

Six Days' Trial -- Easy Terms

Try a Buescher, any Instrument you choose, in your own home for six days. This is a most liberal offer. If you like the instrument, pay a little each month. Play as you pay. Without obligation, mail coupon below for beautiful literature and details of trial plan. Get Started! Now.

BUESCHER BAND INSTRUMENT CO.
Everything in Band and Orchestra Instruments
1821 Buescher Block Elkhart, Indiana

Clip the Coupon NOW!

BUESCHER BAND INSTRUMENT CO., 1821 Buescher Block, Elkhart, Ind. 343

Gentlemen: Without obligating me in any way please send me your free literature. I am interested in the instrument checked below.

Saxophone Cornet Trumpet Trombone Tuba

Mention any other..... How old are you?.....

Do you play any instrument?..... What?.....

Write plainly Name, Address, Town, State in Margin Below

DIAMONDS

Genuine
Diamonds
Guaranteed

Cash
or
Credit



IDEAL
GIFTS

SPECIAL
VALUES

We import our Diamonds direct from Europe—finest quality, sparkling, blue white Gems of fiery radiance. All mountings of exceptional beauty—18-karat White Gold pierced and engraved. Our prices defy competition. Satisfaction guaranteed or money back.

New Christmas Catalog FREE!
Write Now! 132 pages of bargains in Diamonds, Watches, Silverware, Clocks, Ivory Goods and gift articles for all occasions.

Credit Terms: Pay one-tenth down; balance in weekly, semi-monthly, or monthly terms at your convenience. All goods delivered on first payment. Any article sent (no money down) for your free examination, if you prefer.



No. 855 Ladies' Wrist Watch
Solid 14-k white gold case, engraved, fancy wing ends, 15-jewel movement, guaranteed, \$30. \$3.00 a month \$3.00 down \$3.00 a month

17-Jewel ELGIN
No. 15

Green gold, Elgin Watch; 25-year quality case; 12 size; gilt dial; \$30. \$3 down. \$1.00 a week



Man's strap watch, nickel, cushion shape, 6-jewel, high-grade movement, fine leather strap \$9.95

Special Christmas Value

"Jocelyn" Diamond Dinner Ring. Beautiful solid 14-k white gold ring with 3 perfectly matched blue white Diamonds, \$75. \$1.75 a week



The Old Reliable Credit Jewelers

LOFTIS BROS. & CO.

Dept. F-894
108 N. State St. Chicago, Ill.

Our References: Any Bank or Banker in U. S. A.

\$351⁰⁰ CLEARED IN ONE DAY

So writes W. H. Adams of Ohio in August 1925. V. A. Marini of California reports \$11275 sales in three months. Jacob Gordon of New Jersey \$4000 profits in two months." Alexander of Pennsylvania "\$3000 profits in four months." Ira Shook \$365 sales in one day. Bram bought one outfit April 5 and 7 more by August 28. Iwata, bought one outfit and 10 more within a year. Mrs. Lane of Pittsburg says "sold 8000 packages in one day. J. R. Bert says "only thing I ever bought that equaled advertisement." John Culp says: "Everything going lively. Crispette wrappers scattered all over town. It's good old world after all." Kellogg, \$700 ahead end of second week.



WE START YOU IN BUSINESS

Furnish secret formulas, raw material, and equipment. Little capital required; no experience needed.

Build a Business of Your Own

No limit to the sale of Crispettes. Everybody likes them. It's a delicious food confection. Write for facts about a business that will make you independent. Start now, in your own town.

Profits \$1000 a Month Easily Possible

Send postal for illustrated book of facts. It contains enthusiastic letters from others—shows their places of business, tells how and when to start, and all information needed. Free. Write now!

LONG-EAKINS COMPANY

1128 High Street

Springfield, Ohio

Own a CORONA

The portable typewriter built like an office machine. Has four-row keyboard and big-machine features throughout. Write to

Corona Typewriter Co., Inc.,
108 Main Street, Groton, New York



M-m-m! TENDER STEAK

- Meat Tenderer
- Mince Knife
- Cleaver
- Ice Tool
- Food Chopper
- Fish Scaler
- Nut Crumbler

Ideal Fiber Cutter tenders meat to juicy tastiness. Housewives all say, "Just what I want." Tested and Approved by Good Housekeeping Institute. Two minute demonstration sells it.

AGENTS - Year 'Round Seller
This handy kitchen aid has no dull season. Needed every day. 100 per cent Profit. Agents make \$8 to \$20 a day. Boorem, Pa., writes. "Made \$25 clear profit today." You can do as well. Work spare or full time. Our time-tested sales plan shows you how. Write for details at once.

THE TYLER MFG. CO., Dept. M-6, Muncie, Ind.

"Independent" GOLD POINT \$2

Lever, Self-Filler Stylopen
"Makes Writing a Pleasure"

Jumbo, \$3.50; Red, \$3.00; Black

J. C. ULLRICH & CO., 161 Washington St., N. Y. Est. 1884 Agents Wanted

NEW! A BIG HIT!

The Little Checkwriter with the Big Protection



Salesmen!

At last! A checkwriter at everybody's price! Sells for \$12.50. Does more than larger machines costing hundreds! Our salesmen cleaning up!

The Arnold Features

1. Pocket size convenience.
2. Handsome nickel plated aluminum.
3. Light weight. Easy to operate.
4. Prints and cuts characters in acid proof ink.
5. Unlimited capacity. Low cost. Easy to ink.
6. Guaranteed for 5 years. Nothing to get out of order.

FREE SAMPLE OFFER! Salesmen! Here's the biggest selling proposition of the year for you. Wonderful opportunity with very liberal commissions to district managers and salesmen.

THE ARNOLD CHECKWRITER CO., Inc., Dept. 18
FLINT, MICHIGAN



Boy, Here's Real Music!

Where is there a red-blooded boy or girl who doesn't like music—and crave musical expression? And where is there a musical instrument that combines the natural appeal and national popularity of the harmonica?

The Hohner Harmonica is endorsed by amateur and professional musicians as the logical instrument for stimulating interest in good music among people of every age. It teaches accuracy, rhythm and expression, the basis of musical education.

With the aid of the Free Instruction Book, you can quickly learn to play a Hohner Harmonica. If your dealer cannot supply you write M. Hohner, Inc., Dept. 181, 114 E. 16th St., New York.

When you visit the Sesqui-Centennial Exposition at Philadelphia be sure and see the exhibit of



Be a
Taxidermy
Artist

Marvelous FREE Book Sent

You can now learn Taxidermy, the wonderful art of mounting birds, animals, tanning skins, etc. Learn at home, by mail. The free book tells how. Mount your own trophies. Decorate home and den. Hunters, trappers, nature lovers, you need taxidermy. Interesting, fascinating, big profits. Join our school. 100,000 students. Success guaranteed. Get our free book without delay. Send right now—today.

W. W. School of Taxidermy, 1778 Elwood Bldg., Omaha, Neb.

EASY
\$100
a
Week



FUGO
FIRE EXTINGUISHER

Unusual opening for live agents in every locality. Make \$5000 or more a year—easily. Fugo—the instantaneous automatic fire extinguisher—is needed and wanted in every home, store, theatre, garage, shop, school, automobile, etc. Cheapest fire protection available today. Within reach of all.

1 Qt. Size \$5.00 2 Qt. Size \$7.50

Recharged in 5 mins.

Amazing 30-second demonstration clinches sale—each one sold sells others. Territory going fast. Write at once for wonderful proposition that will **MAKE YOU BIG MONEY.**

THE NATIONAL FORMETAL CO.
6535 Metta Ave., N. E. Cleveland, Ohio

Double Keen Double Quick



Speed Up Your Morning Shave!

WE take the trouble to perfect a Gem Double Life Blade to save you trouble. That's why it's double-keen! That's why it gives a double-clean shave in half time! It gets the whiskers the first stroke!

This double-thick blade is double-durable! It's double-reinforced to go over your face with perfect smoothness. Double-protected, double-sealed. Sold everywhere.

P. S.—The Gem de Luxe Razor makes your money go double as far! It is scientifically designed, superbly made, and handsomely cased.

If your old Gem isn't 100% perfect, let our service department repair or replace it for you free. Send it to the

GEM SAFETY RAZOR CORPORATION
Brooklyn, N. Y.

GEM

Double Life BLADES



for **Rheumatic Pain**

At all druggists \$1.25

Break up Congestion

Apply Absorbine, Jr. when the first warning twinges come. It rouses the circulation, and brings quick relief to the congested area. Following the relaxed tension of the muscles, the pain and ache quickly disappear.

Absorbine, Jr. keeps muscles and joints limber and free from stiffness. Rub it in freely—it does not burn.

At all druggists', \$1.25, or postpaid
Send for free trial bottle

W. F. YOUNG, Inc. Springfield, Mass.

Absorbine Jr.

THE ANTISEPTIC LINIMENT



Big Money

Made by agents selling our wonderful Facial Soap, Perfumes, Toilet Articles, Spices, Extracts, etc. Free cake of soap and agents' terms mailed to any address.

LACASSIAN CO. Dept. 455 ST. LOUIS, MO.



New Plan!

makes it easy

\$50.00 to \$100.00 Weekly

Selling Shirts Direct to Wearer. No capital or experience needed. Spare or full time. Established 1885. Represent a real manufacturer.

WRITE FOR FREE SAMPLES

MADISON SHIRT MILLS, 562 BROADWAY, NEW YORK

AGENTS 500% PROFIT

GENUINE GOLD LEAF LETTERS

guaranteed to never tarnish. Anyone can put them on stores and office windows. Enormous demand, large profits. Paul Clark says: Smallest day \$28.70. R. L. Reel made \$920 in two months. Write today for free sample and liberal offer to general agents.

METALLIC LETTER CO., 433-B N. Clark St., CHICAGO

Have You These Symptoms of Nerve Exhaustion?

Do you get easily excited—easily fatigued? Do you suffer from constipation or stomach trouble? Do you sleep poorly—dream? Have you spells of irritability—depression? Have you heart palpitation, dizziness, ringing in the ears?



These are only a few of the signs of Nerve Exhaustion, that insidious trouble brought on by the strain and worry of present-day life. It steals unawares upon scores of apparently healthy men and women and, unless checked, slowly undermines their whole nervous system.

Richard Blackstone, famous nerve specialist, has written an amazing book, "New Nerves for Old," based on his many years of study and experience. In it he gives certain easy-to-follow rules that have already helped thousands to regain lost nerve power and bring back the glowing vigorous health of youth.

"New Nerves for Old" is invaluable to you, yet it costs only 25c in stamps or coins. Send for your copy TODAY. Address

RICHARD BLACKSTONE
4711 Flatiron Building, NEW YORK, N. Y.

Beautiful Complexion in 15 Days



Clear your complexion of pimples, blackheads, whiteheads, red spots, enlarged pores, oily skin and other blemishes. I can give you a complexion soft, rosy, clear, velvety beyond your fondest dream. *And I do it in a few days.* My method is different. No cosmetics, lotions, salves, soaps, ointments, plasters, bandages, masks, vapor sprays, massages, rollers, or other implements. No diet, no fasting. Nothing to take. Cannot injure the most delicate skin. **Send for my Free Booklet.** You are not obligated. **Send no money.** Just get the facts.

DOROTHY RAY, 646 N. Michigan Blvd., Suite 128, Chicago



BUILD SHIP MODELS!

Easy to build and sell. Plans and instructions: "Santa Maria" \$1.02—Viking Galley, 42c—Magellan's "Victoria" 77c—Hudson's "Half Moon," 92c—Clipper Ship, 82c—or all for \$3.75.

SEA ARTS GUILD, 405A Eleventh Ave., Milwaukee, Wis.

WHITE FLAME

BURNERS make your old kerosene lamps and lanterns give a brilliant white light better than electricity or gas. Doubles your light. Saves oil. **NO MANTLE TO BREAK.** Guaranteed Safe and Reliable. Delights every user. Send now for complete sample postpaid 50 cents, stamps or coin, 3 for \$1.25. **Money Back If Not Satisfactory.** Live Representatives Wanted. Exclusive Territory.

WHITE FLAME LIGHT CO., 68 Clark Bldg., Grand Rapids, Mich.



SAY! LISTEN!

A New Pair of Pants Matched to Your Coat and Vest

Just doubles the life of your suit. We can match almost any suit. 70,000 patterns. Sample is sent for your O. K. before making. All made to measure. Send piece of cloth or vest for matching.

ACME PANTS MATCHERS
Dept. A-12 20 W. Jackson CHICAGO

Enclose return postage if vent is sent



ALL FREE

10 year guar. Watch with chain and ring, large Eastman Roll Film Camera or 22 cal. Hamilton Rifle, yours for introducing finest assorted liquid perfume at 15c a bottle. Send for 20 bottles and choose gift as per offer in our catalog. We trust you—just write to **BELL PERFUME CO., Dep. A153, Chicago, Ill.**

22 CAL. RIFLE



Who will fly to the South Pole?

AIRPLANES are fast conquering the frozen wastes and desert plains; winning fame everywhere. They may even conquer the South Pole! Wouldn't you like to know how these marvelous machines are built, and how they fly?

BUILD A FLYING MODEL AIRPLANE

See how the body and wings are made and covered; how the different sections are joined together. Fly your Model under its own power and see how the big machines "take off" and land—you'll learn the principles of Aviation. It's an instructive and interesting science for every man and boy.

IDEAL Plans (Drawn-to-Scale) and Building-Flying Instructions show how to build and fly accurate 3 ft. Models of the following famous Airplanes. **Anybody can build one.** Send now for the set you want:

- JN Type—Curtiss Training Plane
- DH Type—DeHavilland World Flyer
- N C—4—Naval Seaplane (4½ ft. size)
- Bleriot, Nieuport or Taube Monoplane
- Cecil Peoli Racer

PLANS AND INSTRUCTIONS
25c per set postpaid
(7 sets—\$1.25)

This is the DE HAVILLAND Round-the-World Flyer

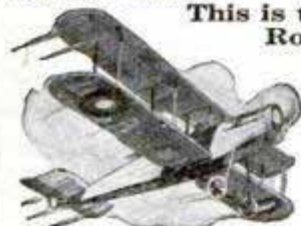

Complete Construction Outfit contains everything needed to build this wonderful 3 ft. Flying model: rubber tire disc wheels, carved propeller, formed ribs, etc., including full plans and instructions.

Complete Outfit **\$7.50** Postpaid

48 pp. Catalog of Model Airplanes, Parts and Supplies—8c postpaid

IDEAL AEROPLANE & SUPPLY COMPANY
408 West Broadway New York City



Any type of hair can be made to lie down

958 College Men tell how they keep their hair in place

If your hair is unruly you naturally wonder, "How do other fellows keep their hair in place?"

That is what we wanted to find out, too. So we went out and actually talked to 958 college men—to get the facts.

And here they are!—the hair dressing that college fellows overwhelmingly prefer to all others is—*Stacomb*.

Let us send you a generous sample of *Stacomb*, free—and after the first day you will know for yourself why so many fellows prefer this dressing.

Stacomb will keep your hair smoothly in place, all day long.

Yet *Stacomb* never leaves your hair greasy nor sticky. Nor dry and brittle, as water makes it. *Stacomb* helps to prevent dandruff.

And whether you prefer the combing cream (in jars and tubes) or the new Liquid *Stacomb*, you will find that both forms are equally pleasant to use and either one will really keep your hair in place. At all drug and department stores.

FREE OFFER — *Stacomb*

Standard Laboratories, Inc., Dept. BB-3, 113 West 18th St., New York

Send me free sample of *Stacomb* as checked:
Original, cream form New Liquid form

Name.....

Address.....



\$17 A WEEK IN SPARE TIME

That's what Dorothy Bagley of Ohio earned in spare time, the very first week she became an agent for our beautiful imported and domestic fabrics. You may do even better. No experience or capital needed. Write for big sample book. Address **THE NATIONAL IMPORTING CO., Dept. L-6, 573 Broadway, N. Y. C.**

Just Out!

World's Greatest Utility Light

300 CANDLE POWER—with new built-in Utility Pump. Handiest, most practical light invented. Storm-proof, rain-proof, bug-proof. Ideal for city, town, country—indoors, outdoors—anywhere. Bright, white light—20 times brighter than wick lanterns on half the cost. Burns 98 per cent air—4 per cent fuel, gasoline or kerosene. Lights with match. Clean, odorless, safe. Guaranteed.

AGENTS! Make \$60 to \$100 a week. No experience or capital required. Outfit Free to workers. Exclusive Territory. Write quick!

30 DAYS FREE TRIAL Try 30 days at our risk. Send for special money-saving offer and catalog giving all details FREE. Write now. **THE AKRON LAMP CO.** 111 Lamp Bldg., Akron, Ohio



To owners of factories and apartment houses, we say

BANISH SMOKE

Rid yourself of the smoke nuisance forever and save money on your fuel account.

CROWN SMOKE PREVENTORS

absolutely eliminate smoke—save fuel. A separate system for each type of boiler—built under the supervision of the country's foremost combustion experts. Write for folder S11.

CROWN FUEL SAVER CO. Richmond, Ind.

Distributors wanted—interesting proposition.



PA INVENTORS.

**JUST
ACROSS
STREET
FROM
U.S. PAT.
OFFICE.**

At the right is a view of my drafting and specification offices where a large staff of experienced experts are in my constant employ. All drawings and specifications are prepared under my personal supervision.



PROTECT YOUR IDEAS

Take the First Step Today

If you have a useful, practical, novel idea for any new article or for an improvement on an old one, you should communicate with a competent Registered Patent Attorney AT ONCE. Every year thousands of applications for patents are filed in the U. S. Patent Office. Frequently two or more applications are made for the same or substantially the same idea (even though the inventors may live in different sections of the country and be entirely unknown to one another). In such a case, the burden of proof rests upon the last application filed. Delays of even a few days in filing the application sometimes mean the loss of a patent. So lose no time. Get in touch with me at once by mailing the coupon on the opposite page.

Prompt, Careful, Efficient Service

This large, experienced organization devotes its entire time and attention to patent and trademark cases. Our offices are directly across the street from the U. S. Patent Office. We understand the technicalities of patent law. We know the rules and requirements of the Patent Office. We can proceed in the quickest, safest and best ways in preparing an application for a patent covering your idea. Our success has been built on the strength of careful, efficient, satisfactory service to inventors and trademark owners located in every state in the Union.

Clip this Coupon and Mail

TENTS

Write for these FREE BOOKS

NO CHARGE for Information On How to Proceed!

The booklet shown here contains valuable information relating to patent procedure that every inventor should have. And with it I will also send you my "Record of Invention" form on which you can sketch your idea and establish its date before a witness.

Such evidence may later prove valuable to you. Simply mail the coupon and I will send you the booklet, and the "Record of Invention" form, together with detailed information on how to proceed and the costs involved. Do this NOW. No need to lose a minute's time. The coupon will bring you complete information entirely without charge or obligation.



STRICT SECRECY PRESERVED

All communications, sketches, drawings, etc., are held in strictest confidence in strong, steel, fireproof files, which are accessible only to authorized members of my staff. Feel free to write me fully and frankly. Your case will have my personal attention. It is probable that I can help you. Highest references. But FIRST—clip the coupon and get my free book. Do THAT right now.

FREE COUPON

**CLARENCE
A. O'BRIEN**

*Registered
Patent Attorney*

70-P Security Savings and
Commercial Bank Bldg.,
Washington, D. C.

Clarence A. O'Brien

Registered Patent Attorney

Member of Bar of: Supreme Court of the United States; Court of Appeals, District of Columbia; Supreme Court, District of Columbia; United States Court of Claims

**Practice confined exclusively to Patents,
Trademarks and Copyrights**

Please send me your free book, "How to Obtain a Patent," and your "Record of Invention" form without any cost or obligation on my part.

Name.....

Address.....

It Now!

.....
(Important: Write or Print name clearly)

PATENTS TRADE-MARKS AND COPYRIGHTS

Have You An Idea?

Our Offer: FOR THE PROTECTION
OF YOUR INVENTION
YOUR FIRST STEP

Before disclosing an invention the inventor should write for our blank form

"RECORD OF INVENTION"

This should be signed and witnessed and returned to us together with model or sketch and description of the invention for **INSPECTION and INSTRUCTIONS**

No Charge for the Above Information

**Our Four Books Mailed
Free to Inventors**

Our Illustrated Guide BOOK

HowtoObtain a Patent

Contains full instructions regarding U. S. Patents. Our Methods, Terms, and 100 Mechanical Movements illustrated and described.

Our Trade Mark Book

Shows value and necessity of Trade Mark Protection. Information regarding *Trade Marks and unfair competition in trade.*

Our Foreign Book

We have Direct Agencies in Foreign Countries, and secure Foreign Patents in shortest time and lowest cost.

Progress of Invention

Description of World's Most Pressing Problems by Leading Scientists and Inventors.

We Regard a Satisfied Client as our best advertisement, and furnish anyone, upon request, lists of clients in any state for whom we have secured patents.

**Highest References—Prompt Attention
—Reasonable Terms**

VICTOR J. EVANS & CO.
PATENT ATTORNEYS

Main Offices: 956 9th St., N. W., Washington, D. C.

Opposite U. S. Patent Office

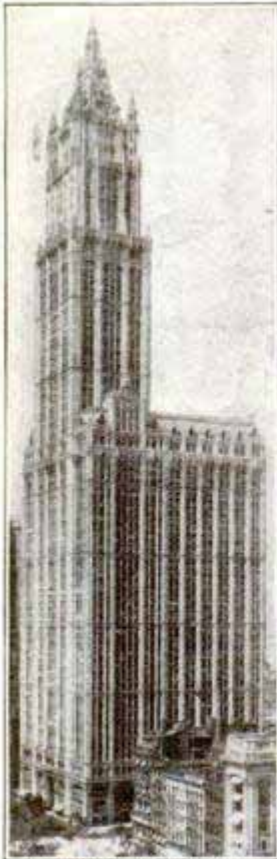

Our New York Office
Suite 1007 Woolworth Bldg.



Our Philadelphia Office
Suite 714-15 Liberty Bldg.



Our Washington Office
Victor Building



PATENTS TRADE-MARKS AND COPYRIGHTS

IMPORTANT

TO HAVE YOUR CASE MADE SPECIAL AND AVOID DELAY YOU SHOULD HAVE YOUR CASE MADE SPECIAL IN OUR OFFICE to secure protection, save correspondence and secure early filing date in Patent Office. To secure special preparation of your case send \$25.00 on account with model or sketch and description of invention.



MAIN OFFICE, VICTOR J. EVANS & CO.—VICTOR BUILDING, WASHINGTON, D. C.

Our Lawyers Practice in all U. S. Courts and defend Clients in Suits involving Patents, Trademarks and Copyrights

All Communications and Data Strictly Confidential. Interference and Infringement Suits Prosecuted

OUR ORGANIZATION OFFERS PERSONAL SERVICE By Experienced Patent Lawyers, Solicitors and Draftsmen

**FREE
COUPON**

**VICTOR J. EVANS & CO.
PATENT ATTORNEYS**

NEW YORK OFFICES
1007 Woolworth Bldg.

CHICAGO OFFICES
1114 Tacoma Bldg.

PHILADELPHIA OFFICES
714-715 Liberty Bldg.

PITTSBURGH OFFICES
514 Empire Bldg.

SAN FRANCISCO OFFICES
Hobart Bldg.

MAIN OFFICES: 956 9th Street, N. W., WASHINGTON, D. C.

Gentlemen: Please send me *Free of Charge* your books as described on preceding page.

Name

Address



Our Chicago Office
Suite 1114 Tacoma Building



Our Pittsburgh Office
Suite 514 Empire Building



Our San Francisco Office
Suite 1010 Hobart Building

PATENTS

TRADE MARKS • DESIGNS • FOREIGN PATENTS

MUNN & CO. PATENT ATTORNEYS

Associated since 1846 with the Scientific American

1572 SCIENTIFIC AMERICAN BLDG.
24 West 40th St., New York City

523 SCIENTIFIC AMERICAN BLDG.
Washington, D. C.

1312 TOWER BUILDING
Chicago, Ill.

665 HOBART BUILDING
San Francisco, Cal.

520 VAN NUYS BUILDING
Los Angeles, Cal.



Books and Information on Patents and Trade Marks by Request. Associates in All Foreign Countries.

INVENTORS

who derive largest profits know and heed certain simple but vital facts before applying for Patents. Our book *Patent-Sense* gives those facts; sent free. Write

LACEY & LACEY
Established 1869
704 F St., Washington, D. C.



PATENTS

Send us sketch or model for advice and exact cost of patent. Our book "**How to Obtain a Patent**" sent free. It tells how to apply for Patents, Trade Marks, Foreign Patents, Copyrights, etc.; gives information on Patent Procedure; tells what every inventor should know. Thousands of Inventors, who are our clients, are our reference.

CHANDLEE & CHANDLEE, 25 Years' Experience
473 7th St. Washington, D. C.

Have You An Invention?

If so the WORLD PROGRESS will send you upon request sample copy Free containing SUGGESTIONS TO INVENTORS as to Inventions Needed. We invite manufacturers to address us regarding inventions they want.

Subscription for one year 60 cents

WORLD PROGRESS PUB. CO., Inc.
Room 203 Victor Bldg. WASHINGTON, D. C.

PATENTS

Booklet Free Highest References
Promptness Assured Best Results

Send drawing or model for preliminary examination of Patent Office records.

ALL BUSINESS GIVEN PROMPT AND PROPER ATTENTION

Listed Patent Lawyer in the latest editions of the Rand-McNally Directory of Bankers and Attorneys, of Chicago, Ill.; The Baggott & Ryall Directory of Attorneys, New York City; The Lawyers Guaranteed Directory, Detroit, Michigan; The Lawyers and Bankers Quarterly, published by the Legal Directory Publishing Company of St. Louis, Mo.; the American Lawyers Annual, Cleveland, Ohio.

WATSON E. COLEMAN,
REGISTERED PATENT LAWYER

644 G Street, N. W., Opp. U. S. Pat. Office
WASHINGTON, D. C.

INVENTORS PROTECT YOUR IDEAS

Before disclosing your invention send for our Evidence of Invention Blank. This should be signed and witnessed and returned to us with a model or sketch and a description of your invention for our *Inspection and Instructions* which are free.

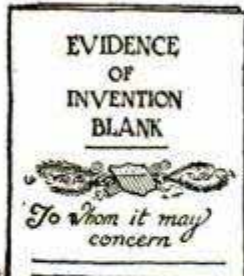

Also send for

Our guide book "**How to Get Your Patent**" which is sent free upon request. This book includes full instructions regarding U.S. Patents, Trade Marks, our Terms, Methods, etc.

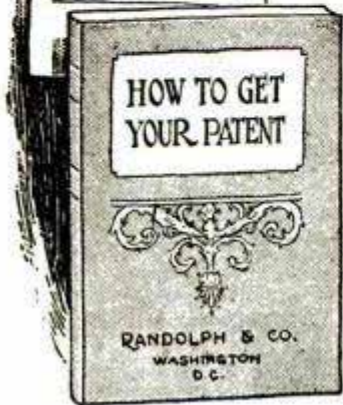

Terms Reasonable Best References

WRITE TODAY

RANDOLPH & COMPANY
300 Victor Bldg., Washington, D. C.
Please send me FREE OF CHARGE your Evidence of Invention blank and your guide, "How to Get Your Patent."

Name.....
Street.....
City..... State.....

RANDOLPH & CO.

300 Victor Bldg. Washington, D. C.

PATENTS

Trade Marks, Copyrights, Patent Litigation Handbook with illustrations, 100 mechanical movements. Sent free on request.

ALBERT E. DIETERICH
formerly member examining corps U. S. Patent Office
PATENT LAWYER and SOLICITOR

621-A, Ouray Bldg.
27 Years' Experience Washington, D. C.

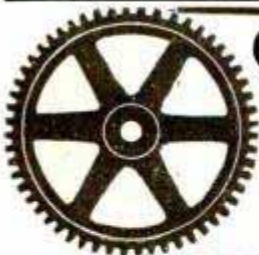

GEARS ALL KINDS SMALL

The most accurate made and prices reasonable. We carry a complete line of gears in stock for immediate shipment. Can also quote on special gears of all kinds. Send us your inquiries.

WRITE FOR CATALOGUE 10
CHICAGO STOCK GEAR WORKS
105-109 S. Jefferson St., CHICAGO

1000 NEEDED INVENTIONS!

Here is the most remarkable book ever offered to inventors. One Thousand needed inventions listed and described. Arranged as follows: General Problems; Automotive; Mechanical; Electrical; Chemical; Radio; Marine. Separate chapter on the Ten Most Needed Inventions. This book may give you one idea that will win you a fortune. Nothing else like it has ever been published. Compiled at enormous expense. Edited by Raymond Francis Yates, formerly Managing Editor of a leading scientific magazine. Over 100 pages, durably bound. Send no money. Pay postman only \$1.00 plus postage on arrival. Money back after 10 days' examination if desired. Limited edition. Write NOW.

BUREAU OF INVENTIVE SCIENCE
DEPT. 311 ROCHESTER, NEW YORK



United States Capitol

PATENTS

Don't Lose Your Rights To Patent Protection

Before disclosing your invention to anyone send for blank form "EVIDENCE OF CONCEPTION" to be signed and witnessed. As registered patent attorneys we represent hundreds of inventors all over the United States and Canada in the advancement of inventions. The form "Evidence of Conception," sample, instructions relating to obtaining of patents and schedule of fees sent upon request.

LANCASTER & ALLWINE
480 Ouray Bldg. WASHINGTON, D. C.
Originators of forms "Evidence of Conception."



Charge it!

Full Year to Pay
All transactions strictly confidential
10 Days Free Trial

Pin only \$1 to your order, and your choice comes to you parcel-post prepaid on 10 Days Free Trial. Then pay postman only \$1 more on delivery, and after free trial—pay balance in 12 equal monthly payments. Satisfaction guaranteed or money back.

FREE
"Royal Book of Gems"
Thousands of special values in genuine diamonds, watches and jewelry illustrated. Your copy sent immediately on request.
No Red Tape—No Delay

A FULL YEAR TO PAY

NO. MA1 672.50

Look Prosperous Wear Genuine Diamonds!



MA3— Lady's wrist watch latest style solid 14 K gold, highest grade 17 ruby and sapphire jewel movement, lifetime guarantee. Featured at **\$22**



MA2— Beautifully hand engraved wedding ring, 18 K white gold, with 5 genuine blue white diamonds—Featured at **\$29.50**

Royal Terms make buying easy



MA4— Fiery blue white diamond—best quality 18Kt. white gold—artistically carved, hand pierced, lady's mounting. Featured at **\$49.50**



MA5— Three perfectly matched blue white diamonds set in a beautifully hand pierced mounting—18Kt. white gold—latest creation. Featured at **\$36.75**



MA6— Something he will like and use. Famous Elgin strap watch, 20 year guaranteed green gold-filled case, radium dial—accurate time-keeper. Featured at **\$24.50**

Established 1895

ROYAL DIAMOND & WATCH CO.
Address Dept 1686 170 Broadway, N.Y.

PATENTS

To the Man with an Idea

I offer a comprehensive, experienced, efficient service for his prompt, legal protection and the development of his proposition.

Send sketch, or model and description, for advice as to cost, search through prior United States patents, etc. Preliminary advice gladly furnished without charge.

My experience and familiarity with various arts frequently enable me to accurately advise clients as to probable patentability before they go to any expense.

Booklet of valuable information and form for properly disclosing your idea free on request. Write today.

Richard B. Owen, Patent Lawyer
9-303 Owen Bldg., Washington, D.C.
41-E Park Row, New York City

TRADE-MARKS REGISTERED

BLUE BOOK ON PATENTS

AND PRIORITY RECORD BLANK GRATIS.

MONROE E. MILLER, PATENT LAWYER
411-2 Ouray Building, WASHINGTON, D. C.
ELECTRICAL AND MECHANICAL EXPERT



\$100 to \$125 PROFITS WEEKLY

New line of quality toilet goods sells like wildfire. No experience required. All you do is take orders from this beautiful sample case. Finest perfumes, soaps, facial creams, bath salts, face powders—wonderful products at prices that appeal to all women. Just send name and address for FREE CATALOG.

NATIONAL SOAP & PERFUME CO.
512 W. Huron St. Dept. A-11 CHICAGO



BOW LEGS?

OUR GARTER (Pat'd)

Makes Trousers Hang Straight

If Legs Bend In or Out. Self Adjustable.
Free Booklet—Plain Sealed Envelope

THE T. GARTER CO. Dept. 2, New London, New Hampshire

PIMPLES

Cleared up—often in 24 hours. To prove you can be rid of Pimples, Blackheads, Acne Eruptions on the face or body, Barber's Itch, Eczema, Enlarged Pores, Oily or Shiny Skin, simply send me your name and address today—no cost—no obligation. **CLEAR-TONE** tried and tested in over 100,000 cases—used like toilet water—is simply magical in prompt results. You can repay the favor by telling your friends; if not, the loss is mine. **WRITE TODAY.**
E. S. GIVENS, 429 Chemical Bldg., Kansas City, Mo.

When it's 23 Below Zero



The EVERBRITE Radiant Oil Heater

will keep you comfortable. Mrs. Senften, Nebr., writes: "Last Sunday it was 23 below zero but The Everbrite kept us warm and burned 25 hours on one filling."

Every home, store, church, can now have all the advantages of natural gas heat at a cost of 1 cent an hour.

Burns 8 to 10 hours on gallon of Coal Oil. Cheaper—cleaner—more comfortable than coal or wood fire. No wick—no smoke—no odor. Will heat the whole house in coldest weather. May be moved from room to room. Simple; turns up and down—off and on like city gas. Absolutely safe. Thousands in Happy Homes everywhere. Built of steel and nickel—weighs 44 lbs.—height 22 inches.

FREE Simply send name today for circular, full details how it works and amazing free home test offer.

EVERBRITE STOVE CO. 3212 Gateway Station, Kansas City, Mo.

Tires Hammered Full of NAILS LEAK NO AIR



MAKE YOUR TIRES PUNCTURE-PROOF In ONE Minute

Galacite The new scientific invention—has the marvelous property of sealing all punctures the moment they occur. ACTS INSTANTLY. You can pick up any number of nails WHILE RIDING without the loss of a pound of air. One application, made in a minute, without taking tire off wheel or rim, actually makes tire puncture-proof for life. Guaranteed not to injure tire, tube or valve. On the contrary Galacite preserves rubber, lengthening the life of both tube and tire,—

Often Increasing Tire Mileage from 10,000 to 12,000 Miles

MAKE THIS TEST Take a hammer and drive as many nails into a tire as you wish, 10, 50, 100, it makes no difference; all punctures are sealed instantly. Used in all kinds of tires including low pressure BALLOONS. Galacite is inexpensive and can be tried out at our risk. Warranted for one year but will last indefinitely.

GUARANTEED TO DO ALL WE CLAIM

Don't confuse Galacite with anything else ever intended for the same purpose; it is new and different—a revolutionary invention, the result of years of research and experiment. We are a long established highly rated concern. Galacite is backed by our Money Back Guarantee. It must make good—or we will. You take no risk.

AGENTS—Earn \$5,000 to \$10,000 a Year

TREMENDOUS PROFITS Galacite agents make almost unbelievable success. A NAIL DRIVING demonstration does the selling. No lengthy arguments. Demonstrate and sell to car owners, Garages, Filling Stations. Work all or spare time in your home town or travel. You can also manufacture and sell GALACITE PUNCTURE PROOF inner tubes. The market for Galacite is inexhaustible. EXCLUSIVE territory and splendid FREE ADVERTISING HELPS make your business permanent. RUSH your name to us for full particulars. TERRITORY IS GOING FAST. Delay may cost you the chance to make \$5,000 to \$10,000 a year. Send no money, just your name, but WRITE TODAY.

C. F. JOHNSON & CO. 19W. Jackson Blvd., Dept. 380 CHICAGO

*"GALACITE" Trade Mark Registered
Licensed under Folmir-Hewitt Process

DENINGER WILL TRUST YOU
SEND 10c INSTAMPS FOR CATALOGUES
BIG MONEY SAVING FOR YOU
Used and rebuilt motorcycles \$25 to \$100,
used bicycles \$9.50, tandems \$29.
All machines fully guaranteed.
New bicycles and motorcycles
at factory prices, save dealers'
profits. Motorcycle and auto-
mobile tires \$3. Complete lists
frames, engines, supplies.
DENINGER PRICE CUTTER, ROCHESTER, N. Y.

PAY AS YOU RIDE

MOTORCYCLES

RELIABLE STANDARD MAKES that you can **DEPEND ON**. Enjoy the glorious experience of going wherever you like—when-
ever you like. The price is within your means—
35% to 50% less than others. These machines
are althly used, thoroughly overhauled
or rebuilt. Send for catalogues.
MYEROW BROS.,
15 Berkeley St. Boston, Mass.

STOP FORD CRANKSHAFT END-PLAY!

C-A ADJUSTABLE BEARING corrects and prevents end-play without removing motor. Eliminates many troubles. Easy to install—simply drop pan. Only \$3.75. Ask your dealer or sent prepaid by **ADJUSTABLE BEARING CO., Dept. P, 405 Virginia Ave., Indianapolis, Ind.**

BIG BOOK OF AUTO SUPPLIES

Mailed Free—Postpaid
We want every car owner to have our Big New Complete Book of Auto Accessories. Write for a Free copy and see for yourself what you save.

NEW LOW TIRE PRICES
Every tire brand new stock and fully guaranteed. Prices also cut on Tubes, Batteries, Heaters, Winter Tops, Water Pumps, Radiators, Windshield Cleaners, Carburetors, Spotlights—all Repair Parts, Tools, etc. No matter what you need, this New Book will save you money. Send for it.

BROWN LYNCH SCOTT CO.
816 MAIN ST. MONMOUTH, ILL. [8]
WE SHIP IN 10 HOURS—BLS OR REFUND 5 PER CENT

MAKE YOUR Ford INTO THIS Sport Car—Save \$50 to \$150 with Red-i-Kut Life-Size Patterns \$5.00

Famous sure-fit **RED-I-KUT** life-size patterns and picture instructions show how you can easily convert your Ford into this **Fast, Saucy, Sport Car** as thousands have done, with easily obtained materials. No need to lay up the car. Rear seat fold, making 4-passenger car. Look at Wilfred Eno's. Eno says: "It took me 3 Sundays to build it and I sure am proud to hear them say, 'He built that snappy sport car.' I never cut any steel or did any wood-work before, but can't go wrong with Kuempel patterns." St. Louis, Mo.

The Lark life-size patterns for each part of the body so you can't go wrong, picture instructions and **CONICAL DISK WHEEL PATTERNS**. Only \$5.00 delivered. \$4 extra brings patterns for Jiffy Top and Gosum windshield. **RKO Steel for Lark \$10 complete**. Extreme West \$13. Order now while we can make good delivery, and really enjoy the wonderful spring days in your Lark. Keen, Classy, Up-to-the-minute. You can build it. Over 11,000 in use. Don't hesitate. "Swing Lo" Underswing Irons, no frame cutting kind, \$5.99. Only \$4.99 when ordered with Lark patterns. Send 10c coin for actual body photo and new manual of other distinctive sportbody patterns from \$5.50 up—"RKO" Steel "Swing-Lo" Irons, Tons and Windshields. **ORDER RIGHT NOW.** **KUEMPEL CO., 78 Kuempel Bldg., Guttenberg, Iowa**

Easy-to-Understand Instructions

The "Lark" Class—Snap

38-inch Easy Riding Seat

Season's Biggest Selling HIT

Every Car Owner and Garage Will Buy

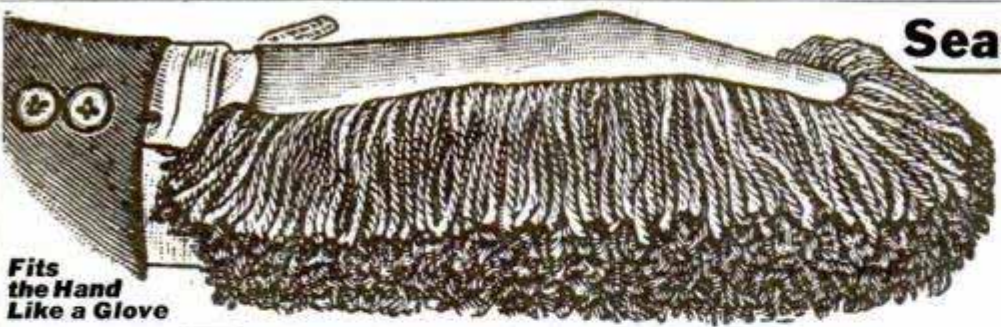

Fits the Hand Like a Glove

AUTO MITTEN DUSTERS

What It Will Do This large, Fluffy Chemically Treated Yarn Mitten Duster is by far the most practical and economical cleaning tool ever devised. It is made from a patented process, chemically treated soft yarn. Its ingenious construction exactly fits the hand like a glove; the surplus yarn material overflowing in palm of hand adapts itself to dusting and cleaning for every purpose.

chemical elements retained in the yarn by our patented process it cleans and polishes furniture and other woodwork around the house in one operation, leaving all cleaned surface with a lustre as beautiful as when new. It does not scatter dust from one place to another as common dusters do, but absorbs and retains it; and when soiled can readily be washed like any other garment, and when dry is as clean and large and as fluffy as ever.

Clean Your Own Car and Save Money

With the Aid of an Auto Mitten Duster a car owner can clean and polish his automobile in a few minutes, without soiling his hands or clothes; just once over and the car is spick and span. It makes frequent washings unnecessary, and as it takes time and money to have your car washed, the amount saved in one washing is enough to pay for several Mitten Dusters.

Cleans and Polishes in One Operation

With this Yarn Duster a housewife can do her house cleaning in less time and with less effort than is required with ordinary dusters. It does not only absorb and retain the dust as a magnet attracts steel, but with the

They Get the Money

Thos. Murphy, Lansing, Michigan, writes: I am now selling 5 Gross Auto Mittens a week with one Sub-agent helping me. My net profits are over \$100.00 per week.
 John Strom, Duluth, Minn., writes: Your Auto Mittens are real Winners. My average sales are about 1 Gross a day.
 Roy Wilson, Dallas, Texas, writes: Making more money selling your Auto Mitten Duster than I ever made before in my life. My profits are often over \$50.00 a day.
 Henry Mueller, Milwaukee, Wis., writes: Sold 60 Gross of your Auto Mittens at our State Fair last week. I made a real clean-up.
 H. C. Anderson, Valparaiso, Ind., writes: Made \$500.00 during last year's school vacation selling your Auto Mitten Duster, and expect to double that this year.

What You Can Earn

A three-minute demonstration on your car or your neighbor's car in any public place will bring you unlimited number of sales. Twenty million car owners and as many good homes give you virgin territory for every fresh day. Your earning capacity is only limited by the time and effort you devote to the work. A gross a day is not an unusual sales record; two and three at a clip, that's how they go. A mitten a minute should be your sales goal; it's been done; it's up to you. Mittens will cost you 25c each; they sell for 60c apiece and more; you make \$50.00 on every gross. Send us your name today and let us send you our FREE SAMPLE OFFER, and Selling Instructions, "HOW TO MAKE A CLEAN UP," with this magic Mitten Duster.

NATIONAL FIBRE BROOM CO., Dept. P.M., ST. LOUIS, MO.

Tire AGENTS WANTED

Use and introduce **MELLINGER CORD TIRES** **15,000 MILES GUARANTEED** Lowest Wholesale Prices in America. Shipped prepaid on approval. Make big money all or part time. No capital or experience. Sample sections furnished.
YOUR TIRES FREE! Simply send name today for valuable FREE BOOK; tells how thousands have gone into big business. **SPECIAL AGENTS' OFFER.** Wholesale Prices and FREE SAMPLE KIT. Write nearest address.
MELLINGER TIRE & RUBBER CO.
 Dept. 415, Kansas City, Mo. Dept. 415, Philadelphia, Pa.
 Dept. 415, Oakland, Calif. **WRITE NEAREST OFFICE**



You-and This New Machine Can Earn \$500 a Month

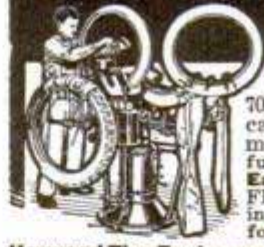

Operate a Tire Repair Shop
 70,000,000 Tires in use. America's greatest opportunity for men with small capital. We furnish everything—\$100 and up. **Easy payments.** We train you FREE right at home. Start making money at once. Write today for **Free Book of Opportunity.**
Haywood Tire Equipment Co. 1344 S. Oakley, Chicago

This Year—make it a Real Vacation!

Thrilling, foaming speed with the Super Elto outboard motor! Instantly attached to any rowboat. Easily portable. World famous for easy starting. Multiplies the pleasures of fishing, racing, vacationing. Write today for new catalog—beautifully illustrated—intensely interesting.



The Super Elto
 Elto Outboard Motor Co.
 Ole Evinrude, Pres.
 Dept. aa, Mfrs. Home Bldg.
 Milwaukee, Wis.
"Starts With a Quarter Turn"

VULCANIZES the—HEATLESS, CEMENTLESS WAY!
 —Sell "Seal-R-Tite" All Rubber Repair (the new Chemical Method of Vulcanizing) for Tubes, Casings, and All Rubber Goods. No cement, heat or gasoline used. **Instant and permanent repairs in less than two minutes.** Any size from a pinhead to a 17-inch blowout. Write today for sample and territory.
SEAL-R-TITE PATCH CO.
 Dept. 103 1354 S. Wabash Chicago

Sport Bodies for Fords AT FACTORY PRICES!

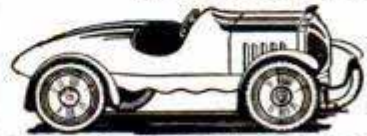

This Model in Grey Prime **\$39.50**
 Write for Booklet A-2 Showing Other Models.

SPORT FACTORIES, AURORA, ILL.

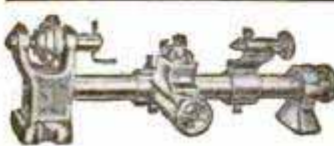

WADE BENCH LATHE
AMATEUR MECHANICS, REPAIR SHOPS, INVENTORS, STUDENTS
 A real machine tool for the home work bench—capacity 4" dia. x 12" length. For Metal—Wood—Composition Materials. Turning—Facing—Boring—Drilling—Winding—Thread Cutting. Accurate—Strong—Quiet—Compact. Slide-rest has travel entire length of bed. Leader-rod inside bed. No. 1 Lathe, plain headstock, \$28.00. No. 2 Lathe, back-gear headstock, \$58.00. Extra for lathes with 18 inches between centers, \$7.00. Complete line of accessories at equally low prices. Write for free catalog.
THE GEROLD CO., Dept. P- 28, 120 Liberty St., New York

EDWARDS WILL SAVE YOU MONEY ON METAL ROOFS

We own our own steel mills, roll our own sheets, make them into high-grade REO METAL SHINGLES, Sidings, Ceilings and Roofings of every type and style for every kind of building. We control every operation from the raw material to the finished roof and we sell direct from our factories to the user. Not a dollar to divide with anybody but the customer! You get better value for less money.

OUTLAST THREE ORDINARY ROOFS

EDWARDS METAL ROOFS are weather-proof, lightning-proof, fire-proof! The galvanizing bends with the metal. No tools required.



LOW-COST ALL-METAL GARAGES

Any size. Any style. Portable. Ready to erect. Complete with frames, doors, sash and hardware. Ornamental, durable, economical. Blue-prints and complete instructions FREE.

Write today. Get our low prices and Free Samples. Ask for Roofing Book No. 150 or for Garage Book No. 150

THE EDWARDS MFG. CO.
1100-1150 Butler St. Cincinnati, O.



Make Your Open Ford a Splendid Enclosed Sedan—Easy!



Strong! Light!
Handsome!
Reasonably Priced!
"ACME"
Sedan Tops

Make a well-built, distinguished-looking Sedan at a price within easy reach. Built to give permanent satisfaction! See your Local Dealer, or write direct for Descriptive Circular B-1 ACME BODY-TOP CO., Aurora, Ill.

MOTORCYCLES

LESS THAN HALF COST



Ace, Indian, Cleveland, Harley-Davidson, Henderson Motorcycles and Sidecars, new, used and rebuilt. Rider Agents Wanted. Write for FREE trial offer, agent's free outfit and big bargain bulletin. New American Bicycles in different styles and colors. Write for illustrated catalog giving our money saving prices.

AMERICAN MOTOR CYCLE CO.
2047 W. Chicago Ave., Dept. 1135 Chicago

SHAW MOTOR ATTACHMENT MAKES YOUR BIKE A MOTORCYCLE!

A high grade 2 1/2 H. P. motor attachment quickly clamped on any bike frame. Speed 4 to 40 miles an hour. 90 to 125 miles per gallon of gas. Special Low Price Now! Write today for Complete Description and Special Low Prices on SHAW Motor Attachments and the SHAW Complete Motorcycle. SHAW MANUFACTURING COMPANY
Dept. 37 Galesburg, Kansas



Make big money from repair work



Practically every householder spends at least \$10.00 to \$50.00 each year and many spend several times that much on simple repairs that can be made quickly, easily and well with

Smooth-On No. 1

With a can of Smooth-On, you can save this money in your own home—and by doing similar repair work for others, you can make money.

No skill is required to make repairs and the amount of Smooth-On used on any one job seldom costs more than a few cents.

Typical repairs that can be made perfectly with Smooth-On:—Stopping leaks in steam, water, gas, oil or stove pipes, mending cracks, breaks or leaks in furnaces and boilers, radiators, tanks, sinks,



Leak at radiator joint stopped with Smooth-On

pots and pails, making loose handles tight on umbrellas, knives, hammers, brushes, drawers, etc., tightening loose screws, hooks, locks, door knobs, etc.

On the Automobile:—Making bursted water jackets and pumps good as new, stopping leaks in radiator, hose connections, gas tank and gas, oil and exhaust lines, making a fume-proof joint between exhaust pipe and tonneau heater, tightening loose headlight posts, keeping grease cups, hub caps, and nuts from loosening and falling off, etc.

To get perfect results, write to us for and use the Smooth-On Repair Book. Free if you return the coupon.

Get Smooth-On No. 1 in 7-oz., 1-lb. or 5-lb. tins at any hardware store or if necessary direct from us.

SMOOTH-ON MFG. CO.
Dept. 37, 574 Communipaw Ave.
JERSEY CITY, N. J.



How to make
HOME-AUTOMOBILE
REPAIRS

Do it with
SMOOTH-ON

Write for FREE BOOK



Do it with SMOOTH-ON

SMOOTH-ON MFG. CO., Dept. 37,
574 Communipaw Ave., Jersey City, N. J.
Please send the free Smooth-On Repair Book.

Name.....
Address.....

COZY
Warmth
 for your home

at less expense for coal—and with less work tending the furnace.

CROWN FUEL SAVER

mixes RED HOT OXYGEN
 WITH GASES OVER FURNACE FIRE BED.
SAVES 20% of FUEL

Cold rooms—draughts—and wasted fuel are practically unknown in the homes where the Crown Fuel has been attached to the feed door of the heating plants. This marvelous device is a convenience that means better health, more comfort, more happiness for the members of the family who stay at home most of the long winter days.

Thousands of homes are more liveable because of the Crown.

During the last 11 years, thousands of foresighted men and women have taken advantage of the benefits rendered so inexpensively by the CROWN FUEL SAVER. They know the Crown assures cozy-warmth in every room—cuts down furnace drudgery by lessening the number of firings and the amount of ashes—does away with smoke and dangerous coal gases—and above all, saves enough coal to pay for itself many times over. (In fact, we guarantee the Crown to make at least a 20% coal-saving—or we will refund its purchase price, instantly and without argument.)

The Crown works automatically—requires no attention—never gets out of order—will last as long as your heating plant.

Investigate — then invest in a Crown.

As a straight money-saving proposition it is worth while investigating the Crown leaving out of consideration the dividends you'll draw in comfort and extra heat. Write today for full details and special low price of Crown with money-back guarantee.

CROWN FUEL SAVER CO.
 411 N. 10th St., Richmond, Ind.

DISTRIBUTORS WANTED—a real opportunity in the home heating and industrial power field, for in addition to the Crown Fuel Saver our exclusive franchise includes the Crown Smoke Preventor adapted to largest industrial heating plants. Write today for full details.



SHALER

5 MINUTE VULCANIZER

Clamp on a Patch and Light the Fuel!

Easiest Way to Fix Punctures

Fixing punctures is an easy, sure job with the handy little Shaler 5-Minute Vulcanizer. When the emergency comes, no matter where you are, simply clamp a Unit over the puncture with the Shaler Clamp, and light the solid fuel.

In five minutes unscrew the clamp, take off the Unit and throw it away. That's all. The repair is part of the tube—vulcanized (HEAT-WELDED).

That's why nearly five million motorists use it.

Get the complete outfit for your car today for only \$1.50 wherever auto supplies are sold. Slightly higher in Canada and far West.

C. A. SHALER CO.

2711 Fourth Street

WAUPUN, WIS.

SEND FOR THE INTERNATIONAL CATALOG



FOR FORD—Prices from \$27.85 up. Factory to consumer direct—Pay Only One Profit.

International Body Works, 914 W. Ohio Street, Dept. 7, Chicago, Illinois

30 Days' Free Trial on all MEAD Bicycles

New 1927 models now ready for delivery direct from our factory. Astonishing new prices and terms. Do not buy until you get them. Write today for beautiful 1927 catalog.

\$5 a MONTH —if desired. Earn the small payments with your bicycle.

Tires wheels, lamps, horns, equipment at half usual prices. Send No Money. Write for our marvelous prices and terms.

Mead CYCLE COMPANY DEPT. A-110, CHICAGO

Write us today for free catalog

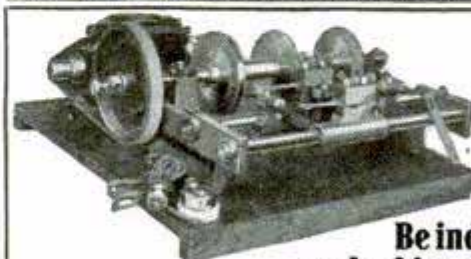

Don't Be a Slave

Be independent and make big profits with the

BEISSER KEY MACHINE

You can start a business of your own, no experience necessary. Only machine that will make first keys without taking lock apart. Makes a dozen duplicate keys per minute.

Write Today for Full Particulars

BEISSER KEY MACHINE CO.

407 Fort Street, East

Detroit, Michigan

I easily made



"I worked six days, six hours each day, and made \$123 quick, cash profit my first week. Have been going strong ever since — Stay-Prest is the best seller ever."

J. W. VARNER, Iowa

\$123
QUICK CASH
PROFIT FIRST
WEEK!

Startling New Invention

Stay Prest

TROUSER PRESSER

Brings Big, Quick, Cash Profits in Advance



Folds to 15 inches

FREE Selling Outfit

Hundreds of men and women are reaping a golden harvest of profit with this fastest selling, biggest repeating selling sensation! Your big cash profit in your pocket the minute order is taken—no waiting! Stay-Prest puts **New!** perfect crease in pants—takes out wrinkles and baggy knees—no steam—no heat—makes clothes last longer. Durably made—fully guaranteed. Every man a sure prospect—average sale **Big Profits!** men order 6 or more! Send today for **FREE Super-Selling Outfit**—learn how we guarantee your sales. Start now to make \$35 to \$50 a week spare time—**Sure Sale!** \$100 to \$150 a week full time.

THE GETGEY-JUNG COMPANY

S-121 G-J Building

Cincinnati, Ohio

Light Weight Marvel

Power $\frac{1}{2}$ to over 1 H. P.—Air cooled—Rated $\frac{3}{4}$ H. P. normal. Used for a multitude of power services for practical uses of individual or manufacturer in place of electric motor. Power from crankshaft at full speed—jack shaft at quarter speed. Spark speed control with simple make-and-break ignition or magneto.

WEIGHS ONLY 22 POUNDS

With carburetor, gas tank and base, complete, weighs 22 pounds. Furnish V or flat belt type pulley for crank or jack shaft. Power take-off pulley, 4 to 1 reduction. Ideal for applied power. Tell us your needs.

Write — **CUSHMAN MOTOR WORKS**

Builders of High-Grade, Light-Weight Engines

882 No. 21st Street,

LINCOLN, NEBRASKA



Pocket \$110 A Week With Amazing New Cap

New adjustable feature makes Fits-U Caps fit any head instantly. A perfect fit always. 36 snappy style-color combinations. Finest hand tailored workmanship. Amazingly low price. Every man and young man wants one of these new stylish caps. All you do is take orders. **No experience necessary. Big commissions daily in advance.**

Selling Outfit FREE

You, too, can make \$110 a week showing this wonderful Fits-U Adjustable Cap. We furnish complete selling outfit **FREE**. Write immediately for it—also for full details about the **FREE** cap we give you.

FITS-U CAP CO., Dept. N-72, Cincinnati, O.



Please Mention Popular Mechanics

No Wonder Some Folks Wear Beards!

They haven't heard about Barbasol. They don't know the modern way of shaving. Barbasol—no brush—no rub-in—no smart. Just you try it three times, according to directions. 35c and 65c tubes.

The Barbasol Co. Indianapolis Ind.

Enclose 10c. Please send trial tube.

Name

Address

.....

P-M-11-28

For Modern Shaving



75 MORE men who want \$100 a week AT ONCE!

Amazing preparation that does what motorists believed couldn't be done. RESTORES ORIGINAL LUSTRE TO DUCO, LACQUER, ENAMEL, Etc. Brilliant bone-dry beauty—rainproof, mudproof, sunproof. Trimmings sparkle. Single application lasts months—4 to 6 in can. Nothing ever before like it. Big demand wherever shown. Magically transforms shabby cars to newness. Unusual money-maker for hustlers, part or full. Send \$1 TODAY for 2 regular \$1.00 cans and complete details.

TARNOFF CHEMICAL CO., 1406 W. 26th, Cleveland, Ohio

"Red Devil" Glass Cutters

THE Glass Cutter every handy man should have — Red Devil No 48. Six hand honed wheels — a sharp one always ready. All Dealers.



LANDON P. SMITH, INC.
106 Coit St., Irvington, N. J.

"It's all in the Wheel"

This Most Modern LOG SAW Does the Work of 10 Men!



Saws Wood Fast

This one-profit WITTE Log Saw uses Kerosene, Gas-Oil, Distillate or Gasoline and will cut from 10 to 25 cords of wood a day. Easy to operate and move. New device makes easy starting in any temperature. Trouble-proof. Falls trees and saws them into blocks—runs other farm machinery. Fast money maker and big labor saver. Completely equipped with WICO Magneto, speed and power regulator, throttling governor and 2 fly wheels.

**Change to Tree Saw
in 3 Minutes** Ten seconds to clamp on tree. Saws them down level to the ground.



"Felled fifty 18-inch trees in less than 5 hours."
Earl McBurney,
Iowa.

Lifetime Guarantee

Sold direct from factory to you. An all-purpose outfit for any farm use. Engine can be attached to Pumps, grinders, etc.

**Buy On Your Own Terms
—No Interest Charges**

Free— Write today for new FREE Book and Low Easy Payment Prices. No obligation. Or if interested, ask about Engines, 3-in-1 Saw Rigs or Pump Outfits.

WITTE ENGINE WORKS

6746 Witte Bldg., KANSAS CITY, MO.
6746 Empire Bldg., PITTSBURGH, PA.
6746 Witte Bldg., SAN FRANCISCO, CAL.

Quick shipments also made from nearest of these warehouses: Minneapolis, Minn.; Atlanta, Ga.; Trenton, N. J.; Richmond, Va.; Tampa, Fla.; New Orleans, La.; Dallas, Tex.; Laredo, Tex.; Denver, Colo.; Billings, Mont.; New York, N. Y.; Albany, N. Y.; Bangor, Me.; Portland, Ore.; and Los Angeles, Calif.



GREATEST PACK OF TRICK CARDS

ever invented. Hundreds of the most astounding—perplexing, bewildering and mystifying tricks ever conceived, can be performed by anyone in a minute's time with this wonder pack. No skill—no sleight of hand—no practice required—**\$1.00** mystify your friends with the Master Pack. Complete with full secret instructions.

Wonder Magic Co., Suite 1104A, 25 W. 45 St., N. Y. C.



In almost every country
on the globe

Star Hack Saw Blades

are doing the hardest cutting jobs and are becoming internationally known as a solution to many cutting problems.

Write us of your requirements and let us send you sample blades that will do the job.

CLEMSON BROS., Inc., Middletown, N. Y.



**\$6
CASH
WITH
ORDER**

17" Over all, 4" Swing, 11" Centers. Shipping weight 13 lbs. Bed is machined and lathe well built. Also made in larger sizes.

SYPHER MFG. CO., Dept. L, Toledo, O.

GET YOUR SLICE OF BIG PROFITS

with this amazing new



DOUBLE EDGED RAZOR BLADE PARING KNIFE
The fastest selling home necessity ever offered. Sells for 25c. Your price \$1.50 dozen, prepaid. Guaranteed.

MORGAN MANUFACTURING CO., 440 S. Dearborn St., Dept. G, Chicago

JONES "QUICK-ON" RADIATOR SHUTTER

Makes You \$16 Daily Easily

Biggest seller ever invented. Nothing like it. Wind-proof, winter-proof, fool-proof. Good-bye hood covers, blankets, gunny sacks, robes, etc. Salesmen coin money from the very first day on. Ford Shutter can be attached in a jiffy. No bolts or tools necessary. Millions of Ford and Chevrolet cars a sure sale. Made for other makes of cars also. Retail \$1.50. Sample \$1.00 postpaid with the understanding if you are not satisfied may return and your money refunded. Don't miss out on this wonderful money-making proposition. Write today for full particulars. JONES SPECIALTY CO., Dept. G, 800 N. Clark St., Chicago, Ill.



SEND NO MONEY
ONE FULL YEAR TO PAY

DIAMONDS
Pick Yours Now!
We Deliver and Trust You

Again country's foremost diamond merchants lead in startling offers. Look over these bargains, at almost unbelievable low prices. Read descriptions. Your opportunity to secure the gem you longed for. **Easy Terms**—lower than cash prices.

Your Guarantee
We have faithfully served the public for nearly 100 years. Make your selections. Our money back guarantee fully protects you. Order from this ad. on 10 days' free trial.

Send No Money Now!
Keep your money in your pocket. Select the gem you want and wear it for 10 days. No. 1—Ladies' 18 kt. white gold ring, genuine blue white diamond, \$49.50—\$1 weekly. No. 2—Ladies' 18 kt. white gold ring, blue white diamond, blue sapphire at each side, \$69.50—\$1 weekly. No. 3—Ladies' friendship ring, 18 kt. solid white gold, 3 sapphires, genuine blue white diamonds, 4 blue sapphires, \$63.50—\$3.50 monthly. No. 4—Gents' 18 kt. solid white gold, genuine blue white diamond, \$69.75—\$4.65 monthly. No. 5—Ladies' 14 kt. solid white gold wrist watch, 15 jewels, 2 genuine diamonds, 4 blue sapphires, \$38.25—\$2.50 monthly.

Million Dollar Bargain Book—FREE
Contains up-to-the-minute gift suggestions at startling low prices and very liberal terms—write for a copy now!

FREE MILLION DOLLAR BARGAIN BOOK

J.M. LYON & CO., INC.
Dept. 1011 2 Maiden Lane
New York, N.Y.

OFFER NO. 1 \$49.50 \$1 Weekly OFFER NO. 2 \$59.50 \$1.00 weekly OFFER NO. 3 \$53.50 Monthly OFFER NO. 4 \$69.75 \$4.65 Monthly OFFER NO. 5 \$38.25 \$2.50 Monthly

"I Made \$3,000 in 3 Months from the New Food Sensation Greaseless Doughnuts"

That's what Thomas Minch did with Brown Bobby. You, too, can cash in big on this sensational new food product. Think of it! Actually a **Greaseless Doughnut!**

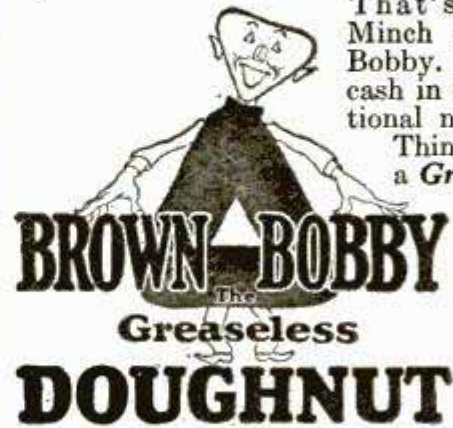

Mrs. Nelson, Rockford, Ill., makes Brown Bobbys at home. "Sold 90 doz. last week. Will sell 3 times that many this week. Wonderfully easy."

Fair Store, Chicago, says: "It's a great money-making device." "The demand for Brown Bobby is beyond my wildest expectations," writes Jas. O'Connor, Chicago. So it goes everywhere. Investigate!

Big Profits for YOU!

Millions of greasy doughnuts are sold daily, hard as they are to digest. What a mammoth market for Brown Bobby! Cooked without a trace of grease to a golden brown—crisped to a feathery lightness—Brown Bobby is positively the food sensation of the age. No one thought a doughnut could be made without grease. But WE did it. And YOU can get in on the first easy profits.

Simple, Easy and Sure

Get this! With one simple, inexpensive, electrically operated machine, you can turn out a full dozen Brown Bobbys every 3 minutes—cost, less than 1c each. No baking skill required. Just add water to our patented "Mix." No bother. No boiling grease. No odor. A child can do it. Big money for women making Brown Bobbys at home. Tremendous opportunities in every town for a thriving business on a surprisingly small investment. Wherever there are hungry people, Brown Bobby is a sure hit. In lunch rooms, drug stores, wherever food is sold Brown Bobby offers a chance for amazing profits. Special openings for Brown Bobby Specialty Doughnut Shops in every town.

Write Quick! Be the first in your locality to get the first easy profits. Whatever your present line-up, let us present you a plan that will be feasible and full of opportunity for a steady, paying business. Just mail the coupon! Get the facts now. Profits are waiting.

FOOD DISPLAY MACHINE CORP.
28 East Jackson Blvd., CHICAGO, ILL.

Food Display Machine Corp., Dept. 13-58
28 East Jackson Blvd., Chicago, Ill.

Gentlemen: Please send me the plan by which I can cash in on Brown Bobby, the Greaseless Doughnut. It is understood that this obligates me in no way whatever.

Name.....
Street.....
City.....State.....

Agents—Just Out!
NEW AMAZING INVENTION
One device makes window washing 75 percent easier. Washes, dries, polishes windows in a jiffy. Every housewife wants it. No more ladders to climb, no mussy rag or sponges to wring. Hands never touch water.

Make \$90.00 a Week Easily Quickly
Sells fast. Simply show it and take orders. Make 100 per cent profit. No experience needed. We show you how. Send for Catalog of this and 47 other Quality Rubber Products. Direct from Akron, the Rubber City. FREE outfit to hustlers. Write quick. **Kristee Mfg. Co., 411 Bar St., Akron, Ohio**



A practical lathe for shop or home. Cone or Back Geared Head; 6" swing, 12" or 18" between centers; speed 180 to 1750 R. P. M. Will do wood or metal turning. Low price, high quality. Send for complete information on Baby Grand Lathe, Drill, Grinder, etc. **The Watson Mfg. Co., 111 Watson Bldg., Toledo, O., U.S.A.**

Suppose You Were Offered Diamonds at 60% of Market Price



Suppose a reason you rarely think of makes possible here radically low prices, even for finest quality diamonds. Thousands of representative people, bankers, lawyers, merchants, others—continually reap this real advantage. Everything sent for Free Examination. This 3/4 century, oldest, largest diamond banking institution in the world, rated over \$1,000,000.00,—converts into cash the diamonds on which money was loaned and not repaid. Loan values, a fraction of market values, are the price basis. Diamonds too from big cash deals direct with European cutters. Must sell now

Why Pay Full Prices

When Much Less Buys the Same See this 3/4 less 1/16 ct., snappy solitaire for \$69.50. Try to match at \$115.00. Examine free any bargain at our risk. Startling, legitimate offers here of diamonds at 60% of market price. Send now for full details. Diamonds of unusual qualities (also watches) from unpaid loans, offered at radically low prices based on mere loan values. Then, too, we have hundreds of diamonds from big, cash, European deals with diamond cutters, who sacrificed these gems away under the market. Send now for our latest offers of this internationally known cash headquarters.



Unpaid Loan Listings Ready

As low as \$60 a Carat Radically different from a catalog. List accurately describes every diamond in full detail with guaranteed exact weight, color, quality, etc. Explains **Guaranteed Cash-like Insurance Policy Loan guarantee.** Also **Unlimited Exchange** privilege at price paid us. Gives full details of free examination offers. Don't wait, the very diamond you want may be in this very list at a price that will amaze you. Costs nothing to see. Write today. A postal **Mail Coupon NOW!** will do, or—



Command Recognition a DIAMOND Does It

JOS. DE ROY & SONS
Only Opposite Postoffice
1950 De Roy Bldg., Pittsburgh, Pa.

Without obligation to buy, send me free, in plain envelope, your Latest Bargain List of Diamonds, Watches, and other Jewels.

Name _____
Address _____
City _____ State _____

References by Permission:—Bank of Pittsburgh, N. A.; Marine National Bank; Union Trust Co., Pittsburgh, Pa. Your bank can look us up in the mercantile agencies.

MOTORCYCLES



Price \$10 and up purchased through our Co-Operative Plan for as low as \$1.00 down and \$1.00 per week

Indians Harley-Davidsons Ace Henderson and Cleverland

Motorcycles shipped to all parts of the world

WALKER-INDIAN CO., 188 Mass. Ave., BOSTON

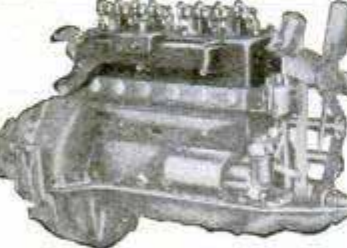

65 Mile Speed for FORDS!

LAUREL Overhead Valve System increases power 50 per cent. Saves Gas and Oil. Gives speed up to 65 m.p.h. to the motor. The "LAUREL" is the original overhead valve system for FORD, Overland and Dodge cars. Easily and quickly installed. Beware of imitations. Thousands of LAUREL Heads in use. Fits all FORDS, including new 1927 model. Also LAUREL Racing Heads, Water Pumps, etc. Low prices, easy terms.

LAUREL RADIO SET

Very Low-priced, 5 tubes, coast to coast reception. Embodies latest developments in radio engineering to bring clear, loud reception. Great selectivity. Beautifully finished. Write for literature. Big profits for dealers and agents selling LAUREL Specialties.

LAUREL MOTORS CORP., Dept. M, Anderson, Ind.

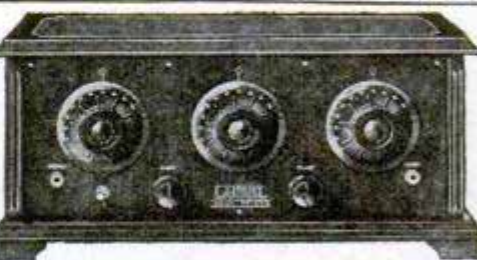

150 TO 300 MONTHLY FROM ONE DAY BATTERY CHARGING



Start a **Big Profit-Making Business** of your own—"One Day Battery Charging." Requires **small space** and **practically no investment.** Anyone can successfully operate. Charges batteries in 1/2 the usual time at 1/2 the cost. **Every car owner a customer.** The HB One Day Battery Charger will pay for itself on easy monthly payment plan with practically no expense to you—and bring you a handsome profit besides. Write for full particulars in Bulletin M. **NOW: HOBART BROS. CO. Box M-111 TROY, OHIO**



ONLY \$16 MONTHLY—MORE THAN PAID BY INCREASED PROFITS

30 DAYS FREE TRIAL ON ABSOLUTE MONEY BACK GUARANTEE

AMAZING NEW INVENTION



PUTS SPARKLING, DELICIOUS, INVIGORATING BEVERAGES IN EVERY HOME!

Instantly transforms grape juices, cider, aromatic drinks of all kinds into zestful, sparkling beverages for less than **three cents a quart!** Even costly, prohibitive "charged" bottle waters are now surpassed for fizz and sparkle by this new wonder-invention—the

BEACON SIPHON

Self-Charging

MAKES YOUR OWN SODAS, FRUIT DRINKS, etc.

Just think!—let your mouth water at the joy of champagne-like bubbles effervescing from a wishful, thirst-quenching, frosted tumbler of wine-grape juice or cider! Even drinking water can be quickly changed to a pure, healthful, sparkling drink compared only to the most expensive carbonated waters. The Beacon Self-Charging Siphon is easily and quickly charged by its companion, Beacon Bottled Power. Together, they comprise a truly marvelous invention, inexpensive, and now available for every home.



AGENTS WANTED Men to represent us in every community. Exclusive territory granted. Complete, handy, Sample Outfit furnished **FREE** to hustlers. Beacon is a big, quick, easy seller to good-fellows everywhere. Be first to use and introduce. Big demand. Huge profits. Wonderful repeat business. Write **QUICK** for all particulars. No obligation. Send **NOW.** **BEACON DEVICES, Inc., Dept. 81, North Tonawanda, N. Y.**

SOLDERALL

METAL IN PASTE FORM

The only convenient metal solder

Every Electrical Connection needs Solderall for perfect reception

25¢

The **SOLDERALL CO., NEWARK, N.J.**

BOYS Look, Movie Machines

for the family sell as low as **\$5.00**

We carry **WESTERN** and **COMEDY FILMS** only. Write now for free catalogue on machines and films.

GLOBE SUPPLY CO., P. O. Box 2722, Dept. P. M., Boston, Mass.

AGENTS MAKE BIG MONEY SELL FIBRE BROOMS

New Patent Fibre Brooms; Sweeps, Dusts, Mops. Big Demand, Quick Sales, Good Profits. Send for Free Sample Offer and Selling Instructions.

NATIONAL FIBRE BROOM CO., Dept. B & L, ST. LOUIS, MO.

"Old Hand Filers Are Taking Notice"

"I have turned out some beautiful work with your *Foley Automatic Saw Filer*. When I receive an old rusty broken tooth saw, I grind off the old teeth, polish the blade, handle and screws, *cut new teeth* and make it look like new."

ABRAHAM H. NACE,
132 Front St., Quakertown, Pa.

Make Big Money Filing Saws Automatically with **FOLEY AUTO Matic SAW FILER**

Model F-5
Motor Driven.

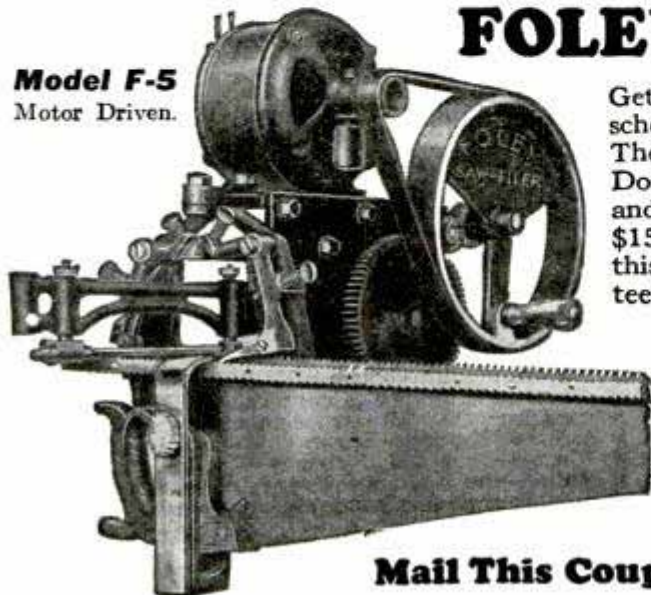

Get big business from carpenters, contractors, schools, machine shops and woodworking plants. The only machine that files ALL kinds of saws. Does better work than hand filers can turn out and in 1/6 the time. Some are making as high as \$15 to \$20 a day. A big money-maker for you this winter. Sold on a 30-day money-back guarantee. Mail this coupon now, for complete details.

Mail This Coupon

FOLEY SAW TOOL CO.
209 FOLEY BLDG. 914 EAST LAKE ST.
MINNEAPOLIS, MINNESOTA

Send me complete description and information about the Foley Saw Filer.

Name.....

Address.....



Lighting Fixtures
READY TO HANG
(Direct from the Manufacturer)
Completely wired, including glassware. Send for New Catalogue No. 27. Just reduced prices.
Special proposition to DEALERS.
ERIE FIXTURE SUPPLY CO.
STA. A ERIE, PA.

Year's Income in 1 Month

Agents Everywhere to Appoint Subagents and Handle Sale of
CHRISTMAS NOVELTY
which previous years prove will net large income during December. Every store and office a prospect. Sold day or evening. Easy method of display. Cash sales; no order taking. Active subagents make \$25 per day. Wire or write territory you can handle.
CONSOLIDATED CO., 67-V West Van Buren Street, CHICAGO

"Best Pen I Ever Had—and costs less!"

That's what users of the Postal say. New filling method—easiest ever devised. Holds 4 times usual amount of ink. Transparent (always know how much ink you've got!). Unbreakable. Only \$2.50! Sent C. O. D. Order now and try it! Money back if you don't like it.
Postal Pen Co., Inc., Dept. P. M. 11, 25 W. 43rd St., New York City

Can You Sell \$3.50 Ford Size Tires at

\$3.50
If so, write for our new plan on INSYDE TYRES. Written guarantee. Big money every day! **American Auto Accessories Co., Tire 431. Cincinnati, Ohio**

60 DAYS' TRIAL, MONEY BACK If Not Pleased. \$10 DAILY, EASILY MADE

New Unbreakable Fountain Pen

AGENTS' *Only* **67¢** Regular Retail Price \$1.25

Beautiful Red, Green, Black or Purple
Ladies' or Gents' Style

Guaranteed for Two Years

LATEST IMPROVED POINT



Writes Like a \$7 Pen

FREE

New and unusual Mail Order Distributing Plans and Large Wholesale Specialty Catalog showing best sellers from all parts of the world. **Money refunded if not pleased.**

MARK CHECK AND FILL OUT AT ONCE
F. SPORS & CO., 52 Main St., Lesueur Center, Minn.
() Send sample c. o. d. 67c, plus postage charges. () Send 12 trio pens, assorted colors, \$6.42 plus postage. () Send catalog, no obligations on my part.

Name.....

Address.....



American games, American ideals of sportsmanship follow the Y.M.C.A. wherever it goes. And American standards of foot-equipment, too. So, in Havana this brilliant Y team plays in Keds

This fast Cuban Team plays in Keds

It's no wonder so many stars play in Keds!

The Keds special basketball shoe grips the floor surely in the fastest play. Keds soles are light and springy. They cushion against shocks and jars. And Keds uppers are light, but strong to protect against sprains. There's a special Feltex innersole, too, to keep your feet comfortable. And only Keds are so long-lasting.

Ask for these championship shoes by name, but be sure the *name* Keds is on the shoe. They come in all popular styles, at prices from \$1.25 to \$4.50. They are made only by

United States Rubber Company

"METEOR"
Special Keds basketball shoe. It gives a sure grip on the floor. White or brown with black trim



They are not Keds unless
the name Keds is on the shoe

New and Used Auto Parts at 30 to 80% Saving

Our stock of new and used replacement parts is the largest in the world. No matter what you need, write to us for prices. You will save from 30 to 80% and parts can be obtained from us which it is impossible to get elsewhere.



Get Our Big Parts Book—FREE

Our Big 80-page Parts Catalog is the largest book of its kind ever issued. Everything for the automobile at cut prices—less than regular wholesale.

An enormous volume of business and quantity purchases make our low prices possible. Nationally advertised products. All new except where specified—Timken Axles and Bearings—Brown-Lipe Transmissions—Pistons—Rings—Hayes and Firestone Wheels—Rims—Tires—Tubes—also a complete line of Accessories. If it's for an auto, you will find it listed in our big parts Book.

Write Today for Your Copy—It's FREE

WARSHAWSKY & CO.

World's Largest Replacement Parts House
1915-35 So. State St., Dept. PM-11, CHICAGO, ILL.



DARCHE "CALL-ME" ELECTRIC ALARM AND LIGHT CLOCK

Will ring until you get up and STOP it. No home complete without one. Can be used as an "alarm clock" or "mantel clock." With a little effort on your part you can get one

FREE OUR OFFER TELLS YOU HOW

Agents, here is a big money-maker, no competition, sells on sight. A good punch board proposition. Write today for our descriptive literature. An ideal GIFT for any occasion. Mahogany finish. Size 10 1/2 x 8 1/2 x 4. This applies to U. S. only.

Darche Mfg. Co., 643 Washington Blvd., Chicago



WHAT EVERY MASON WANTS

We have Masonic books and lodge supplies for Blue Lodge, Chapter, Commandery, Scottish Rite, and Shrine.

Our Rituals Are Used the World Over

Send for free catalog of books and rituals for Masons, Odd Fellows, Knights of Pythias, Knights of Columbus, Elks, etc.

EZRA A. COOK, Publisher, Inc.
1350 N. Clark St., Dept. M, Chicago, Ill.

Kingsbury
Passenger Bus
"788"
16 in. long, \$3.



Your Bus Is About To Leave!

THIS Kingsbury 17-passenger bus is about to leave hundreds of toy stores, to go into eager children's homes. Bright enamel finish, balloon size tires vulcanized tight to the wheels. Powerful, long running spring motor. If your dealer doesn't carry Kingsbury Toys, write for Free Catalog. KINGSBURY MANUFACTURING CO., 83 Myrtle Street, Keene, New Hampshire.

KINGSBURY

▲ MOTOR DRIVEN TOYS ▲

A·B & C Radio Power from your light socket

SILITE

TRICKLE CHARGER

.6 ampere charging rate.
Absolutely noiseless—no
bulbs—makes a power unit
of your battery.

\$10.00

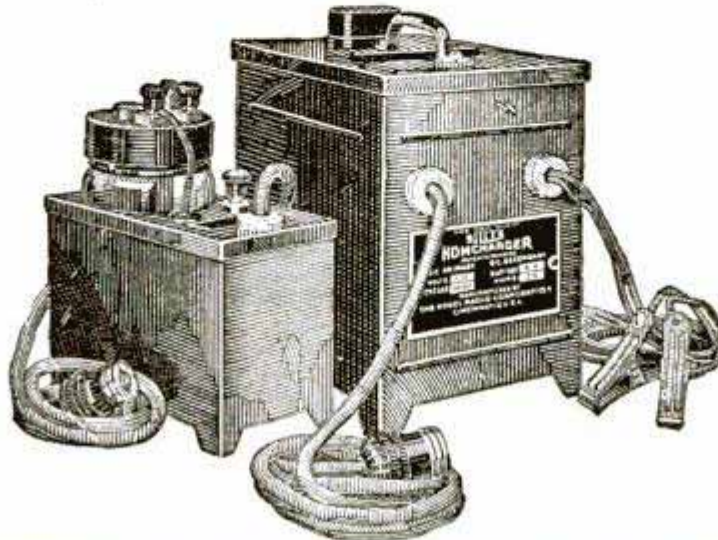

SILITE

HOMCHARGER

Charges at 2½-3 ampere.
Absolutely noiseless—no
bulbs—can be used while
set is operated.

\$19.50

Your battery troubles are over at last! Now ALL radio power is in your light socket, for ALL circuits, A, B, and C.

Silite, the marvelous new metallic glass rectifying element, provides perfect rectification of light socket current into "A" battery power. Leave the Silite Trickle Charger permanently connected to your storage

battery and on charge—then forget battery charging forever. Silite Trickle makes a power unit of your battery—insures constant, never-falling "A" current that operates your set at highest efficiency. For very large sets, where a higher charging rate is necessary, Silite Homcharger is recommended. Either model may be used while the set is operated.

Kodel A&B Transifiers

Kodel A and B Transifiers actually supply all A, B, and C current direct from the light socket—no batteries of any kind are needed. Just plug the Transifiers into the wall socket and turn on your receiver—smooth, uniform A, B, and C power operates your set as it has never operated before. Watch the new life, new pep it gives your set—the longer range, the much greater volume. Transifiers give quiet, noiseless reception that was never

before possible, even with fresh, new batteries.

Vastly different from and superior to the ordinary power units, Transifiers consume electric current only while you operate the set—maintenance cost is much less—it costs less than one-half cent for every hour the set is operated, for all A, B, and C power.

Ask any radio dealer to show you the Silite Chargers and Kodel Transifiers.

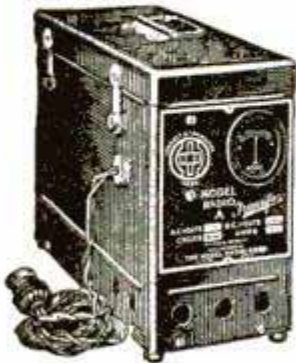

MODEL 10 "A" TRANSIFIER—Supplies 2, 4, or 6-volt "A" current direct from the light socket. For sets using up to 10 tubes **\$42.50**

MODEL 10 "B" TRANSIFIER—22½ to 150 volts "B" current; 4 to 10 volts "C" current for any size set. Operates power tubes **\$42.50**

MODEL 61 "B" TRANSIFIER—22½ to 90 volts noiseless "B" power for sets up to 6 tubes **\$28.50**
(Bulbs extra)

["Behind the Scenes in a Broadcasting Station" an interesting 24-page booklet, will be mailed free on request, together with literature describing Silite Chargers and Kodel Transifiers.]

THE KODEL RADIO CORPORATION

517 E. Pearl St. • Cincinnati, O.

Owners and Operators of Broadcasting Station WKRG



*Battery Chargers
Power Units*

KODEL

POWER SPECIALISTS SINCE 1912

*Radio Receivers
Loud Speakers*

SM PARTS THAT ARE BETTER



220 and 221

220 AND 221 AUDIO TRANSFORMERS

S-M 220—the big, husky audio transformer you hear in the finest sets—the only transformer with the *rising* low note characteristic that means real quality—not only on paper—but when you hear it. It is a power job—yet this finest of audio amplifying devices is sold, with a guarantee, for but \$6.00.

The S-M 221 is an output transformer that will bring out the low notes on your present set. Used between the last audio tube and the loud speaker—it eliminates blasting and will increase speaker capacity for handling strong signals without distortion. \$6.00.



Plug-In Coils

INTERCHANGEABLE COILS

Designed for extremely low losses and permanent uniformity. Space wound with enameled wire upon threaded moulded bakelite forms and sold under a guarantee of accuracy of less than one-half of one percent. Made in several models—for use wherever the best in coils is required—and in a variety of ranges from 18 to 1500 meters. Prices, \$2.50 to \$3.25 each, depending upon type. Universal 6 contact socket, \$1.00. Send for descriptive circulars.



210 and 211

210 AND 211 LONG WAVE TRANSFORMERS

Accurately measured and tested. Actual amplification to the fraction of one percent is predicted in the tests that these transformers have to pass. Type 210 is an untuned iron core transformer and the 211 a sharply tuned air core filter. Available peaking at any frequency between 40 and 65 K. C. for 199 or 201A tubes, price \$6.00 each.

631 STAGE SHIELD

An aluminum shield, $7\frac{1}{4}$ by 5 by $3\frac{1}{4}$ inches—for oscillator, detector, R. F. amplifier and other circuits. Pierced for a condenser, coil socket, tube socket, choke, bypass condensers and lead wires. It opens at the bottom allowing easy wiring and the top seals it tightly from outside interference. May be used in any standard circuit to improve results. \$2.00.

See them at your Dealer

All prices are 10% higher west of the Rockies.

SILVER-MARSHALL, INC.
840 West Jackson Blvd., Chicago, U. S. A.

FREE

NEW 1927 Radio Catalog

WRITE TODAY TO

Chicago Salvage Stock Stores
509 S. State St. Dept. PM Chicago, U. S. A.



MORE THAN a score of new hook-ups—all the latest and best—with specified parts to build them—at prices that mean big savings for you. And all the latest parts and accessories as advertised in current radio magazines. The largest, most complete and up-to-date radio stock in the world. Yours to choose from in this new catalog. Write for your copy.

Catch Fish!

Eels, Mink, Muskrats with our new folding galvanized **STEEL WIRE TRAP**. Write for our **FREE TRAP OFFER** and Bargain Catalog. \$1 Box of our famous Fish Bait FREE to introduce our traps. **WALTON SUPPLY CO., 3500 JUNIATA AVE., ST. LOUIS, MO.**

A&B Battery Charger ONLY \$2

Charges any type of storage A or B battery, using a few cents worth of ordinary house current. Cannot injure battery. Complete directions enclosed—anyone can operate. No expensive "Extras" to buy.

Satisfaction Guaranteed

Why pay \$10.00 to \$15.00 for a charger when you can get this splendid **GUARANTEED R. B. Charger** by mailing us two dollars (bills, money order, check or stamps). Enclose 10c in coin or stamps to cover mailing costs. Charger will be sent postpaid. If you are not satisfied, return within 5 days and we will refund your money.



Act at once. **TODAY**

R. B. Specialty Company

308 East Third Dept. A-54 Cincinnati, Ohio

RADIO DEALERS**SET BUILDERS!**

Get the new 1926-27
Van-Ashe Catalogue.

Van-Ashe has what you want—the new parts, circuits, and kits. All the hard-to-get items that set builders demand are shown—B-Eliminator kits; power-audio equipment; Sargent Infra-dyne intermediates; short-wave supplies. 12 hour-shipment; extra-good discounts. Write for catalogue today.

Dan-Ashe Radio Co.

206 North 10th St. ST. LOUIS, MO.

No^w Yale GROUND HOG
The Perfect Ground
DOUBLES POWER AND DISTANCE

Marvelous newly-invented ground gives 100% improved reception. Doubles power and distance. Stops leakage. Reduces static. Stops jangling even in mid-summer. Results never before equaled, users say. Satisfaction Guaranteed.

Proven absolutely essential to clear, powerful distance reception. Draws and holds moisture indefinitely. Highly sensitive to radio energy.

SEND NO MONEY—To introduce, we offer to those who act at once, regular \$5.00 size for only \$2.00. Send name today and pay \$2.00 plus 17c postage on delivery. Or send only \$2.00 with order and save postage.

FREE—Complete description of Ground Hog and full details of amazing special offer on request—Write today.

Yale Specialty Supply Co.

127 W. 4th St., KANSAS CITY, MO.



American Radio *Now—*
50% DISCOUNT ON RADIO!
BIG NEW 1927 CATALOG-FREE

Dealers, Agents, Set Builders—get our big 1927 Catalog—225 nationally advertised lines. Lowest prices in America! Largest, most complete stock. Radio's latest developments. It's FREE—send for your copy now. American Auto & Radio Mfg. Co., Inc. 1422 McGee St., Kansas City, Mo.

RADIO CATALOG

DEALERS!

Send for our big new live Catalog. Contains hundreds of standard nationally advertised sets, kits and parts.

Use your letterhead

Western Radio Co.
 136 W. Lake St. Chicago, Ill.

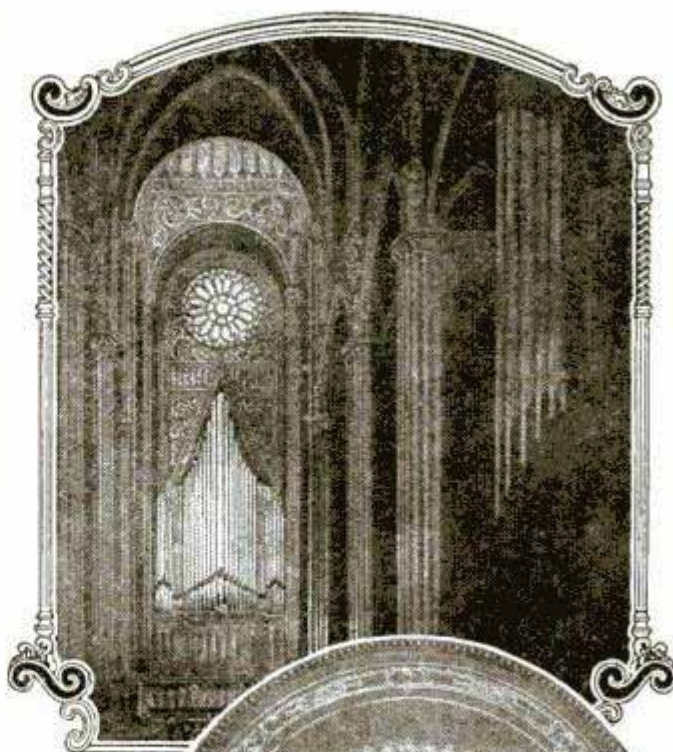

\$ 9.50

The Tower 
cone

RIVALING the grand cathedral organ in tone quality, range and volume, this handsome radio reproducer offers you—supreme enjoyment at minimum cost.

Ask your dealer to show you the exclusive Tower features.





The Crowning Adventure of Burgess Radio Batteries

They flew over the North Pole with Byrd

ON May 9, 1926, history was made . . . American history . . . World history . . . undying history.

Lieut. Commander Byrd in his fearless 1500-mile flight across the top of the world, adds another thrilling triumph to the long, proud list of American achievements.

Radio went along, for radio has become vital to the lives and success of explorers and adventurers. Burgess Batteries went along, sharing the fate—sharing the hardships and the glory of Commander Byrd, the Detroit Arctic Expedition, and Capt. Donald MacMillan.

It is eminently significant that in these glorious triumphs of American courage and American equipment where the test of men and their tools was the test of the survival of the fittest, that the standard products of the Burgess Battery Company were selected, used and "carried on" under extreme and unprecedented conditions.

BURGESS BATTERY COMPANY
GENERAL SALES OFFICE: CHICAGO

Canadian Factories and Offices:
Niagara Falls and Winnipeg



BURGESS RADIO BATTERIES

Please Mention Popular Mechanics

Save 20 to 50% FREE RADIO CATALOG

LATEST IN HOOK-UPS AND RADIO

NEW 1927 EDITION—FREE 164 PAGES

The Barawik Company, pioneers in radio, now offers you through its Radio Catalog and Guide, greater bargains than ever before in standard sets, parts, kits and supplies. No matter what parts you want, for whatever circuit or hook-up—you may prefer, we can supply them to you at big savings. Special prices on sets, tubes, batteries, cone speakers, cabinets, etc.

Write today for free 164-page Radio Catalog and Builders Guide, showing radio's newest creations. Also please include name of another radio fan when writing.

THE BARAWIK COMPANY

540-551 Monroe St. Chicago, Ill.

RADIO BOOK FREE

Tells how you can make big money in world's newest and greatest field. Presents lifetime opportunity in Radio. Right now we want live agents and dealers in every locality, \$60 to \$100 a week easy.

40% TO 60% PROFIT

FREE Simply send name for this big illustrated book explaining liberal profit proposition and how to get latest radio goods at wholesale. Also prices on parts, sets and accessories and amazing special offers—all free. Write today.

STANDARD RADIO CO. 1402 Walnut Street KANSAS CITY, MO.



MOVIES



We'll swap you your name and address for our catalogue on the greatest real home MOVIE-MACHINES in the world with dazzling models as low as \$3.75 postpaid. And say folks! We've also got the slickest regulation film at ridiculously low prices—and we don't have to tell you our films are the best.

Let's not miss this opportunity — Write TODAY—NOW
PARAMOUNT MFG. COMPANY
Dept. MC Boston, Mass., U. S. A.

Radio Blueprints

Blueprints for the most popular sets described in Popular Mechanics Magazine can be obtained for a charge just sufficient to cover the cost of production and mailing. The sets for which blueprints are available are:

Simple One-Tube Receiver	April 1926	15c
One-Tube Pocket Receiver	July 1925	10c
Two-Tube Loud Speaker Set	May 1925	10c
Three-Tube Cockaday Receiver	April 1925	10c
Three-Tube Low-Loss Short Wave Set	Oct. 1925	10c
Four-Tube Loop Set	Aug. 1925	10c
Four-Tube Portable Loop Set	Aug. 1926	15c
Five-Tube No-Battery Set	July 1925	10c
Five-Tube Browning-Drake Receiver	May 1926	15c
Six-Tube Self-contained Receiver	July 1925	10c
Six-Tube Perfect-Tone Receiver	Nov. 1925	10c
Six-Tube Counterphase Receiver	Feb. 1926	15c
Six-Tube Portable Loop Set	June 1926	15c
Eight-Tube Superheterodyne 1927 Model	Oct. 1926	75c
Set of blueprints including drilling templates		
B-Battery Eliminator	Mar. 1926	15c
Non-Radiating Unit	May 1926	15c
Simple Tube-Tester and Chart	July 1926	15c

Address the RADIO DEPT., Popular Mechanics Magazine 200 E. Ontario St., CHICAGO

Back numbers of the magazines describing the construction of the sets can be obtained from our Circulation Department, price 25 cents each.

PATENTED SUBANTENNA!

The Amazing, New
UNDERGROUND ANTENNA SYSTEM
Eliminates ALL Interference
Increases Distance — Kills Static

Science Now Offers a Positive Means to Enjoyable Long Distance Reception

How often, when perhaps for days you have anticipated listening to a certain program from some distant station your set has failed you—all because of the condition of the air. And too, how often "man-made" static, such as leaky power lines, a nearby electric motor or some other nuisance has spoiled your radio evening.

Indeed, there has been a dire need for some means of overcoming these obstacles. And now it has actually been accomplished, and not by muffling or killing the sensitivity of the set as some devices do, but by filtering out the unwanted impulses. SUB-ANTENNA is the answer, for it not only cleans up the reception before it reaches the set, but it actually gives greater distance, bigger volume to weak signals and finer selectivity. Send the coupon at once for full particulars and special Trial Offer.



Almost unbelievable, yet entirely true: SUBANTENNA positively makes every night a good radio night. For, no matter what the season, the condition, or the weather, you get clean, clear reception, free of the harsh, annoying crackles and crashes that make distant reception a miserable impossibility with a regular antenna.

Get Distant Music Clear as Local

No longer need static, air noises, arc lamps, leaky power lines, street car trolleys and other disturbances spoil your radio enjoyment. For now, you can bring in station after station with the clearness of a crisp, cold winter night. SUB-ANTENNA—the new underground pick-up system—gets nothing but the pure radio waves.

Use Filtered Ground Waves. Not Noisy Air Waves

Being buried in the ground and shielded, SUBANTENNA is sensitive only to the continuous broadcast wave. The intermittent impulses such as static, power line crashes, etc., are filtered out and grounded before they reach SUBANTENNA. Hence, you not only get clear reception from this new wonder system, but you get greater distance, because the radio signal is not held back by the interfering noise level.

Not Just a Wire. Nothing Else Like It

SUBANTENNA is not just a wire. It is a patented device consisting of a specially treated wire, uniquely insulated and sheathed in a lead jacket, and containing three specially constructed pick-up or building-up coils. Nothing else will do what SUBANTENNA does. And it's the only device of its kind in the world.

Make This Test

Select a night that is unusually bad for distant reception. First connect your set to your regular aerial. Then connect it to SUBANTENNA. If you do not get the results we promise, we agree to promptly refund your money.

Send Coupon for TRIAL OFFER

Right now—decide to tear down your aerial; that unsightly, inefficient combination of sticks and wire that is obsolete. Just send the coupon and we'll mail you full particulars of SUB-ANTENNA—the first and only really practical system of special reception. Mail the coupon NOW—for special trial offer. Clip at once!

Cloverleaf Mfg. Co. 2716 South Canal St., CHICAGO

CLIP AND MAIL NOW
CLOVERLEAF MANUFACTURING CO.,
2716 South Canal Street, Chicago
At once—send me full particulars of SUB-ANTENNA, also tell me about your special introductory TRIAL OFFER. This does not obligate me in any way.
Name.....
Address.....

RADIO AGENTS: NOTICE!
Just out—latest, greatest, 5 tube set made. Built-in speaker, front drop panel, piano hinged top. Temple speaker with finest unit, walnut finish two toned cabinet etched in gold 32x10x9 all complete with 5 matched tubes, and complete aerial outfit to retail at only \$59.50 less handsome commissions to you. Wire or write for details quick!
AERIAL ELECTRIC CO. LA SALLE and KINZIE. CHICAGO, ILL.

"B" BATTERY ELIMINATOR

Only \$7.95

Money-Back Guarantee

No more worry with "B" Batteries! Throw the worn-out old cells in the ash can! Hook up a Roll-O "B" Battery Eliminator and forget battery troubles forever. This wonderful new invention means better reception, sharper tuning. Gives you more real pleasure from your set.

Completely Equipped—No "Extras" to Buy

Operates perfectly on direct or alternating current, giving up to 90 volts current, and using the full wave of the power supply. Simple directions enclosed—anyone can plug it into any kind of set up to six tubes. Constant voltage gives set more power without danger of burning out tubes. Costs no more than set of good "B" Batteries. Solidly built in beautifully finished metal case, with genuine bakelite top.

Send \$1.00

SEND YOUR ORDER NOW

Don't blame your set because run down "B" Batteries won't let it work right. Order your Eliminator NOW. Former price \$12.95. Now cut to \$7.95. Write name and address on a piece of paper, pin a dollar bill to it and mail it TODAY. Pay postman balance \$6.95 plus a few cents postage when he delivers your Eliminator. Use it ten days. If not more than satisfied, return it and get your money back.

THE ROLL-O RADIO CO.

Dept. P-6, Third & Sycamore Sts., Cincinnati, O.

For You



THIS new, perfected saxophone offers you the final word in tone quality, beauty and durability. Its tone combines the resonant richness of the cello, with the brilliancy of brass. Its construction assures ease of execution. Musicians everywhere say it is truly a King. Every instrument is laboratory tested and guaranteed in writing.

It is easy to own a King. They are sent on ten days free trial and sold on convenient payment terms.

KING Band Instruments

Send for special catalog—on any instrument you are interested in—IT IS FREE

THE H. N. WHITE CO.

5211-81 Superior Ave., Cleveland, Ohio

Send me your catalog on

Instrument _____
Name _____
Street _____
City _____ State _____

THOUSANDS OF RADIO SET OWNERS

need these improvements

THE U. S. Navy the Signal Corps and 69 makers of leading standard sets use the variable resistance controls made by Central Radio Laboratories.

These improved controls should be used on your set if you want the last word in quality for fine reception. Yet, owing to our huge output the cost is no more than for many inferior devices.

Modernize Your Old Set with Centralab Modu-plug

Tone volume is, as you know, the one big improvement in this year's best sets. You can enjoy this improvement with your present receiver for only \$2.50. Modu-Plug is especially for that purpose. It provides full tone volume control from a whisper to maximum, simply by adjusting the small knob on the plug. Matches the speaker impedance to the set. Attaches instantly without tools.

Standard type Modu-Plug replaces present speaker plug. Cord type fits sets not equipped with jacks. Either \$2.50 type, at dealer's, or mailed direct.

Centralab Radiohm

With "A" Battery Switch

Here is the variable resistance guaranteed always smooth, noiseless and permanent in adjustment. Tapered to control oscillation and volume, it also has a positive, quick acting "A" battery switch. One knob replaces two. Turning knob to right lights tubes, then increases volume. To left decreases volume, then cuts off batteries. Resistance is 0 to 500,000 ohms. You cannot imagine the great improvement until you try it. Adapted to all circuits. \$2.30 At dealer's, or mail direct.

Centralab Rheostat S

Where your old design rheostat overloads, heats-up and quickly becomes noisy on new style tubes using increased current, Centralab Ribbon-type Rheostats will operate smoothly and permanently quiet. Insulated metal discs hold rigid a smooth flat resistance surface instead of wires, insuring even regulation and no dead spots. Every set using this rheostat is improved. 2 resistances for 5 to 10 tubes, at dealer's, or mail direct, \$1.25

SEND NO MONEY — If your dealer isn't supplied, order direct from us. Send no money. Simply pay postman on delivery, plus few cents postage. Install and test for 10 days. Then if you are not more than pleased and delighted with the wonderful results, return the goods to us and your money will be refunded. **10 DAYS' FREE TRIAL!**

CENTRAL RADIO LABORATORIES
30 Keefe Avenue Milwaukee, Wis.

Look! Magic—Tricks

MYSTIFY YOUR FRIENDS



MAGIC CARDS
Show card both front and back. Then simply passing hand over same, changes it to another card! Can again be exhibited both sides and changed back.

Startling, yet easy. Each..... **10c**

MATRIMONIAL THERMOMETER
No end of fun with this novelty. Length 5 1/4 inches. Hold the glass bulb in palm and send fluid up to different degrees marked. If fluid stops at "Jealous" or "In Love," etc., the fun starts. **3 for 50c** Each..... **20c**



THE SACRED RESURRECTION PLANT

Starts Growing in About Twenty Minutes



This rare and curious plant starts growing and stays green as soon as put into water. When taken out of water it dries, curls up, and goes to sleep. It will

keep thus for years and reawaken directly upon being put into water. Simply place the mummified plant in water; it will open up and start to grow in about 20 minutes; after that just keep the roots in water, changing water every four or five days. **3 for 25c.** Each..... **10c**



(Plant Closed)

MUSIC "RADIO" SEX INDICATOR

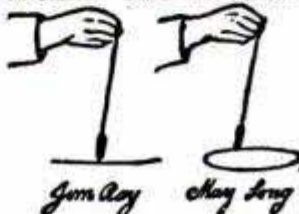

Hold it over a man's hand—Instantly it moves in a straight line, backward and forward. Hold over a woman's hand and it describes continuous circle. Same action can be obtained over letter written by a man or woman, etc. Fascinating; baffling. Results can be obtained with animals. Sold as a patented egg tester in Europe.

3 for 65c. Each..... **25c**

ALSO SEND 10c for wonder catalog of magic, puzzles, amazing novelties. Fascinating—mystifying. Send M. O., coin or check.

Dan Taylor & Company, Dept. 211, 1418 Vine St. CINCINNATI, OHIO

Real MOVIES

—Make them yourself with

VICAM Standard MOVIE CAMERA



Camera, Tripod, Projector and 2 Magazines Complete outfit for taking and showing standard size pictures. Equal to biggest cameras. Loads in daylight. Projects on wall or sheet.

\$37

Send 10c in Stamps for illustrated BOOKLET
VICAM PHOTO APPLIANCE CORPORATION
1224 Belmont Avenue, PHILADELPHIA

MAKE MONEY EVENINGS

Let me show you how 4364 men, without experience add \$25 to \$75 weekly to their income without giving up their present position.
A. T. FISCHER, 122 W. Austin Ave., Chicago, Ill.

\$75 A WEEK BUILDING RADIO SETS

—in your spare time

Join the Radio Association of America. Let it train you to build and repair sets, to be the "radio doctor" of your community. \$3 an hour easily made in spare time.

\$500 Earned in Spare Hours

Lyle Folliek, Lansing, Mich., writes: "Have already made over \$500 in spare time." He is just one of many. Our members are starting radio stores, securing better positions, passing radio operator examinations, qualifying as big-pay Radio Experts, as well as making money spare time.

Join the Association now!—By our Special Plan your membership need not cost you a cent. Number of these memberships limited. Write for details NOW!

RADIO ASSOCIATION OF AMERICA
Dept. A-11, 4513 Ravenswood Ave. CHICAGO, ILLINOIS

We make variable resistances for both the U.S. Navy and Signal Corps and for 69 makers of leading standard sets

Centralab



PLAY THIS HAUNTING "JAZZITHA" The one string Hawaiian Guitar

Have you seen the latest Jazz instrument? Everybody is talking about the curious, unusual "Jazzitha." If you hear it you will want to own one.

The simplest instrument in the world to play. Absolutely no instructions or lessons necessary. Music is written in numbers. The numbers on finger board correspond with Music numerals. "Boy"—what Music! In ten minutes you'll have everybody stepping. If you want your friends to sit up and take notice get yourself a "Jazzitha." Take it wherever you go. You're sure to have the time of your life. Be original—be the first one in your "crowd" to introduce this weird Jazzitha. Play all the latest song hits. Makes an ideal gift.

The Jazzitha is made of fine grained hard wood with specially designed metal sound box. Handsomely decorated and beautifully finished in lacquer—19 inches in length—comes with bar and pick.

\$1⁴⁷

Send No Money

Just your name and address when Jazzitha and sheet music arrive, pay postman only \$1.47—plus a few cents extra for postage. Outside of U.S. send check or money order in advance.

FREE—with every instrument we will include 3 extra Jazzitha strings worth 25c.

JUST OUT 5 Books of popular song hits—5 latest songs in each book written in numbers - - - 25 each

THE JAZZ STUDIOS

2512 41st Ave., Dept. 518, LONG ISLAND CITY, N. Y.



Efficiency Depends upon Feet

Was any man ever a success in business or craft—as executive, salesman, foreman or worker, who worked all day on painful, sensitive aching feet?

More nerves center in the feet than any other part of the body. And men who are on their feet all day depend more upon their feet than anything else for efficiency in their work.

The Foot Protection Bureau of the Herman Shoe Company, organized to study and recommend shoes for the PROTECTION of feet, recommends to you men who must have comfort, our famous Police Shoe No. 19.

Here is a shoe endorsed by foot specialists and doctors; made to the specifications of the N. Y. Police Department; good looking and dressy in every line. Genuine Munson Last, built-in leather arch support, water-proof storm welt—and solid comfort as well as long wear all the way through. Ask your Shoe Dealer for Herman's No. 19.

Write today for folder.

JOS. M. HERMAN SHOE COMPANY

Dept. 34 Millis, Mass.

Makers of more than 4,000,000 pairs of shoes for the Army and Navy. And of the famous Herman Official Boy Scout Shoes.



\$9 first day

Big Nimrod Line includes shirts of all kinds, overalls, coveralls, play suits, work pants, etc., etc.

—says J. S. Shirley of Iowa. "Did \$49.79 business in less than one day" — writes H. E. DesChamps of S. D. Men without experience make big money under our instructions.

FREE OUTFIT OFFER

Write for it—also The Book that makes up for the experience you might need. Gives you all information and instructions you need to start making big money.

THE NIMROD SHIRT CO.

Dept. 52, 4922-24-26-28 Lincoln Ave., CHICAGO



NIMROD

NOW ONLY \$4⁰⁰ DOWN

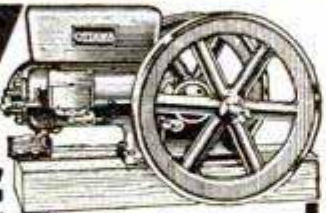

Put This MARVELOUS NEW ENGINE with Easy Starting Device To Work for You.

Increase Your Profits \$1000.00

Get my new FREE Book and ridiculously low prices —any size, 1½ H.P. up—Stationary, Saw Rig. Guaranteed to satisfy or your money returned. Built to stand hardest use, 30 days FREE trial. Send postcard for my new Free Book before you choose any engine. Write today, Harry Overman, Pres.

OTTAWA MFG. CO. 531E King St. Ottawa, Kansas. Desk 531E Magee Bldg. Pittsburgh, Pa.

Direct at Factory Prices

Sample \$1.18 3 for \$3.00 Postpaid

Hand Forged Razor Steel Blades

Send for our 100-page FREE List and "HOW TO USE A RAZOR."

Maher & Grosh Co.
106 A St., Toledo, Ohio



A Genuine \$2 Knife for \$1.18 Postpaid

Handy shaped Blade makes this knife best for mechanics, sportsmen and farmers; light but strong; re-sharpened easily. Stag handle. German silver finish; blades file tested, hand forged from razor steel and warranted.

No 57

500 Gallons Gasoline (Danger)

500 Gallons of Gasoline FREE!

to every purchaser of a *Blancke Thermostatic Carbureter Control*

We Guarantee It! And We Pay Many of Our Agents and Distributors from

\$250.00 to \$2500.00 a Month

for selecting the Ford Owners Who Receive This Astonishing Offer. It sounds impossible—too good to be true. But it is true.

Makes Fords Run On 94% Air

The *Blancke Thermostatic Carbureter Control* makes starting easy in coldest weather—eliminates carbon—prevents dilution of crank case oil—reduces repair bills. Makes motor run smoother. Overheating impossible. Faster acceleration. Installed in five minutes. Convincing demonstration. Sales fast and sure.

Blancke Plan Starts You Without Capital or Automotive Experience

Get in quickly on the Big Money being made. Our plan starts you immediately in a **business of your own** that makes you from \$250.00 to \$2500.00 a month profit. Use the Coupon now.

BLANCHE AUTO DEVICES CO.

157 E. Erie St. Dept. 815P Chicago

Cadillac now uses as Standard Equipment *Thermostatic Carbureter Control* under *Blancke* license.

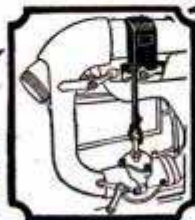

FILL IN AND MAIL TODAY

Blancke Auto Devices Co., Dept. 815P, 157 E. Erie St., Chicago

Gentlemen: Please mail me at once full particulars as to your wonderful money making plan for *Blancke* Distributors.

Name.....
 Address.....
 Town..... State.....

AGENTS! EXPERIENCE UNNECESSARY

AMAZING DISCOVERY ABOLISHES METAL POLISH

Imagine! Touch tarnished articles with *Lightning Polishing Floss* and you make them bright as new. Demonstrations positively astonishing! *Every one a sale!* Agents collect *real money* on *every call*.

Science has finally produced it. An instantaneous metal cleaner—neither sloppy liquid nor messy paste. Dry magic floss. Touch it to silver, nickel, copper or brass. The metal shines bright and clean instantly! No hard rubbing! Approved by Good Housekeeping Institute. Agents making up to \$30 a day! Makes a Sensational Demonstration

HOUSEWIVES, AUTOISTS AND STORES

Everybody Buys These Products. Housewives buy the *Lightning Polishing Cloths*. Autoists buy *Lightning Polishing Floss*. Sell both to stores and offices in big quantities. Nothing else like them. Sure big, quick **MONEY GETTERS**. **Sample Free!** Exclusive territory. Real cooperation. Triple profit. Answer this ad at once. Make big money. Easy! Quick! Don't delay. Write NOW! **FREE** test sample and proposition by return mail.

B. P. LIGHTNING PRODUCTS CORP., 1773 Greenleaf Ave., Chicago

FREE 25 Shells BETSY THE WORLD'S SMALLEST PISTOL

Shoots blanks as loud as 45. Harmless. Order today.

Send Only \$1.00

On arrival pay balance 98c, plus a few cents express charges. **25 BLANKS FREE.** Extra Shells \$1.00 per 100. Dealers write. Our proposition will interest you.

ARISTO CO., Dept. P. M., 408 Mallers Bldg., CHICAGO, ILL.

Agents! Money!

Big fast selling line of everyday necessities means more money for you. Free catalog. Credit. Write today.

JAMES C. BAILEY CO. DEPT. Y CHICAGO, ILL.

Earn a REAL Movie Machine FOR HOME USE

Write Today for Our Easy Plan

PILGRIM CO., 267 Spring St., Dept. P, Medford, Mass., U. S. A.

HOW A BOY BUILT UP A GREAT SQUAB FARM

Started small in backyard when at school with no money, now has \$30,000 plant, ships to New York 150 bbls. squabs yearly, receiving \$75 to \$100 a barrel. You can do the same. Send for this book. Price is fifty cents but we will mail it to you for the names and addresses of four of your friends and your own name and address. Write today to

Plymouth Rock Squab Co., 634 A St., Melrose High., Mass.

FREE Book HOW TO FEED AND CARE FOR CHICKS

Gives Money Making Secrets of Poultry Raising. Tells how to hatch, care for and feed chicks until fully grown. Gives plan of Poultry and Brooder Houses. Describes Miller's "IDEAL" INCUBATORS with Patented Egg Turning Trays. Oil and Coal Burning BROODERS. Eggs for hatching—Baby Chicks—BARGAIN PRICES. WRITE TODAY!

J. W. MILLER CO., Box 12, Rockford, Ill.

FOY'S BIG BOOK, in Colors

A complete guide to successful Poultry and Squab Raising. Low prices on CHICKS, Breeding Stock and PIGEONS. Write Today! **FREE!**

FRANK FOY, Box 18, Clinton, Iowa

RAISE BELGIAN HARES

NEW ZEALAND REDS—Chinchillas—Flemish Giants

MAKE BIG MONEY—We supply stock and pay you following prices for all you raise: Belgian Hares \$2 each—New Zealand \$3 each—Chinchillas \$4 each—Flemish Giants \$5 each. 32 page illustrated book, catalog and contract, also copy of *Fur Farming* magazine, tells how to raise skunk, mink, fox, etc., for big profits, all for 10c. Address

OUTDOOR ENTERPRISE CO., Box 25, Holmes Park, Mo.

BE PRESIDENT OF YOUR OWN COMPANY

CONCEIVE that of all methods present or past, the Nestler Rubber Fusing Process (U. S. Pat. No. 1,354,992) alone, produces a positive fusion or welding of new and old rubber!—The first and only practical and successful method of re-rubbing a tread worn tire, is here—a simple, quick, inexpensive process that makes tires new again and cuts tire costs in half!

Each year since 1917 thousands of tires have been successfully Nestlerized annually by ourselves and licensees. Due to increased demand and caused by high tire prices we have decided to issue a limited number of additional licenses. License rights will include protected territories, free instruction, and full cooperation. 17 million cars and 34 million tires replaced annually constitute a limitless opportunity for business and profit.

The demand for territories is great and prompt action is vital. A printed proposition with full facts and detailed information is now ready. Write for it TODAY.

NESTLER RUBBER FUSING CO., Inc.
DEPT. P11
245 W. 55th Street, New York City

NESTLER
RUBBER FUSING
STATION
TIRES



Send the Coupon
10-Day Tube Free



1000 men told

what they most wanted in a shaving cream

Then we made this unique creation to their order—as a courtesy to us, please accept a full 10-day tube to try

GENTLEMEN:—

We went great lengths to please you in a shaving cream. Then gained a great market as a result. From the beginning, men by the thousands flocked to its use.

We started by asking 1000 men their supreme desire in a shaving soap. They named four requirements. We met them one by one, then added a fifth they had forgotten.

We tried and discarded 130 formulas before we found the right one. It required all our expert knowledge as soapmakers—we're the makers of Palmolive Soap, as you know—to meet those requirements.

To add the final touch to shaving luxury, we have created Palmolive After Shaving Talc—especially for men. Doesn't show. Leaves the skin smooth and fresh, and gives that well-groomed look. Try the sample we are sending free with the tube of Shaving Cream. There are new delights here for every man who shaves. Please let us prove them to you. Clip coupon now.

Now men tell us we have a creation superior in 5 important ways to any other known. The coupon below brings you a 10-shave tube postpaid. Please use it; let us show you what we have done.

Five advantages

1. Multiplies itself in lather 250 times.
2. Softens the beard in one minute.
3. Maintains its creamy fullness for 10 minutes on the face.
4. Strong bubbles hold the hairs erect for cutting.
5. Fine after-effects due to palm and olive oil content.

Just send coupon

Your present method may suit you well. But still there may be a better one. This test may mean much to you in comfort. Send the coupon before you forget.

THE PALMOLIVE COMPANY (Del. Corp.)
CHICAGO, ILL.

10 SHAVES FREE and a can of Palmolive After Shaving Talc

Simply insert your name and address and mail to Dept. B-1262-The Palmolive Company (Del. Corp.), 3702 Iron Street, Chicago, Ill.
Residents of Wisconsin should address The Palmolive Company (Wis. Corp.), Milwaukee, Wis.

.....3391
(Please print your name and address)

\$5,000 A Year



Without previous experience selling Surety, the original powdered hand soap, direct to users and dealers. We assure your success. Everyone everywhere demands SURETY, the GENUINE product. Don't waste your time on something inferior but write today for FREE SAMPLE and exclusive territory.

SURETY MANUFACTURING CO.
26 W. Washington St., Dept. 12, CHICAGO

ONLY
\$1.00
DOWN

Brings This
SpeedWay 1/8 H. P.
Electric Drill

Act quick! This 1/4 inch SpeedWay Portable Electric Drill will drill holes in steel faster and cleaner than any drill you have ever used. A money maker and a time saver. Operates from any light socket. 7-foot cord. Trigger switch.

FREE—3 Drill Bits

Order from this advertisement. We will include free 3 drill bits—1/4 inch—3/8 inch—1/2 inch. No other extras to buy.

Send This Coupon and \$1.00

Pin \$1.00 to coupon today and we will ship. Pay balance to postman. Act at once! This low price offer is limited. Finest Portable Electric Drill on the market. Your money back if not satisfied.

ELECTRO MAGNETIC TOOL CO.
Dept. 1411, 1830 S. 52nd Ave., Cicero, Ill.

Electro Magnetic Tool Co.
Dept. 1411, 1830 S. 52nd Ave., Cicero, Ill.

Gentlemen: Here is my \$1.00 bill. Send me the SpeedWay Electric Drill. When delivered I will pay the postman \$18.75. Don't forget to include the 3 drill bits free.

Name.....
Address.....

Reduce This Fleshy Spot

DON'T weaken yourself with starvation diets—don't strain your heart with violent exercises. Here's a wonderful new invention which gives you an instant appearance of slimmness and quickly reduces the actual fat—without any danger, discomfort or disagreeable self-denial.

Take Off 2 to 6 Inches With New Self-Massaging Belt

The moment you put on this wonderful, new, self-massaging belt your waist is instantly reduced from 2 to 6 inches—but, better still, you should actually grow thinner day by day. At the same time all your stomach disorders, constipation, backaches and shortness of breath generally disappear as the sagging internal organs are put back in normal place. You are filled with a wonderful new energy and look and feel 10 to 15 years younger.

Like Having a Private Masseur

This new, wonderful Well Reducing Belt produces the same results as an expert masseur—only quicker and cheaper. It not only reduces your waistline when you put it on, but is so constructed that every movement you make, every breath you take, imparts a constant, gentle massage to every inch of your abdomen. In a few weeks inches and inches of fat should actually disappear.

The Well Belt is made of the same kind of scientifically treated rubber that is used by hundreds of professional athletes and jockeys and is highly endorsed for its healthful principles by physicians everywhere. Satisfaction guaranteed or your money instantly refunded without question. The Well Co., 911 Hill St., New Haven, Conn.

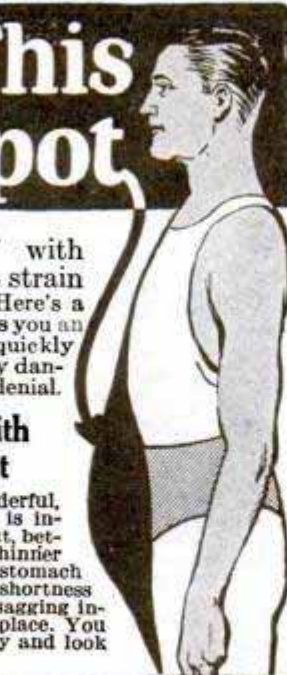

THE WEIL COMPANY

911 Hill St., New Haven, Conn.

Gentlemen: Please send me, without obligation, complete description of the Well Scientific Reducing Belt and also your special 10-day trial offer.

Name.....
 Address.....
 City.....State.....

The man who studies gets ahead. Popular Mechanics Press will advise you what books to read to advance in your trade, 200 East Ontario Street, Chicago, Illinois.

AGENTS Some Seller at \$1.75

Looks Like \$5.00 Worth Your Profit Over 100%

PERFUMES,
TOOTH PASTE,
FACE POWDER,
FACE CREAMS,
SOAPS, EXTRACTS, &c.

YOU should see this "Super 8" Package. Also our 11 piece Assortment selling at \$2.00 with 2 piece Carving Set FREE to each Customer. No fancy talk—Experience Unnecessary. Harris in W. Va. sold 800 in 6 weeks. Profit over \$100 a Week.



This is What Gets the Coin

MAKE BIG PROFITS right from the start. What more could you ask while introducing line of Soaps, Toilet Articles, Food Specialties, Polishes, Remedies, etc. at **ATTRACTIVE PRICES?** 100% Profit. 250 Products—All Repeaters. 30 years on Market. Write today for Illustrated Circulars and **UNIQUE SALES PLANS.** Act NOW.

E. M. DAVIS COMPANY, DEPT. 5647, CHICAGO, ILL.

Make 'Em Laff \$1.79

Protect yourself against hold-up, rowdies, etc., with this clever cigarette case of light weight metal. Looks exactly like the real thing! Pull the trigger, back flies the lid showing your cigarettes.



Lots of fun scaring your friends, and a great protector. Sold exclusively by us. **PAY POST-MAN \$1.79** on delivery plus postage. Money back if not satisfied. **CONSUMERS CO.** Dept. 4E, 34 W. 28th St., N. Y.

AGENTS

ADDING PENCIL

STARTLING INVENTION

ADDS CALCULATES COUNTS CHECKS

AGENTS

Simple Guaranteed Absolutely Accurate Size of Fountain Pen Money maker for agents. Everybody interested. Write today.

Add-O-Graph Co. Dept. 36 St. Louis, Mo.

WRITE!

A SCHOOLBOY CAN NOW "KEEP BOOKS"



Bookkeeping troubles made so easy with a So-Easy Loose Leaf Outfit. Binder, 200 sheets ruled to use in your business, A-Z index. Price \$3.00. **SPECIAL for 10 Days.** Send \$2.50 for book. I will include samples of 50 stock forms and "How to Find Errors in Trial Balances." **B. MOHLER, Box 453, CHICAGO, ILL.**

FORD OR CHEVROLET OWNERS

of Touring cars or Roadsters **MAKE MONEY. WHY CATCH COLD?** Enjoy real closed car protection. Price Low. Quality High. Write Factory Today. **KOUPET AUTO TOP CO., BELLEVILLE, ILLINOIS**



THE WONDERFUL "SAFETY FIRST" HEATER

The cheapest, cleanest, most efficient method of producing heat known to science! For heating garages, filling stations and small homes. Absolutely safe under all conditions, even in a room filled with gas. The **SAFETY FIRST HEATER** automatically makes and burns a blue flame gas of high heating efficiency from common kerosene (coal oil), costs less than dirty coal and is cheaper to install than an ordinary coal stove. An ornament wherever installed. Send for descriptive circular.

GLORIA LIGHT COMPANY 111-13 North May Street CHICAGO, ILL.



INCANDESCENT ROTATING FLAME

THE HI-LO OIL BURNER

in your heating plant (Hot Water, Steam or Hot Air) will automatically and economically maintain the desired temperature under all weather conditions. The simplest, most efficient yet lowest priced Oil Burner in the field.

Responsible Distributors Wanted.

"The LYON & HEALY is so popular because it's easier to play"—says Wm. Haines

NOW I know why the Lyon & Healy Saxophone is so popular with men in high school and college. *It's easier to play.* No long weeks trying to learn. Just a few short lessons on the Lyon & Healy Sax and you're ready for the orchestra."

Wm. Haines

Wm. Haines, popular Metro-Goldwyn-Mayer screen star, hero of "Brown of Harvard" and "Tell it to the Marines"—he knows what he is talking about. Why should you envy the other fellow his popularity, good times, leisure, extra spending money, *when you can enjoy the same things too?*



Easy to Learn Our Way

You can quickly learn to play a Lyon & Healy Saxophone because—with our sixty years musical experience to guide us—we have simplified the fingering, made it easy for you to play, easy to produce full, rich tones. The Lyon & Healy is the choice not only of noted amateurs like Wm. Haines, but of leading professional players as well, because of its extremely accurate adjustment, improvements in key action for hair-trigger finger work, perfection in pitch and resonant and mellow tones. Remember—it is made and guaranteed by *the most famous music house in the world!*

You Can Pay as You Play

Now you can own one of these wonderful instruments and pay in small installments, at the rate of only a few cents a day. Many earn enough playing for dances and parties to meet their payments. Mail the coupon today for full details. Don't delay!

Free Instructions!

Mail us the coupon below and we will include FREE with your Saxophone the same new and simple Course of Written Instruction, which Wm. Haines received, enabling you to learn quickly and easily. This amazing Course is exclusive with us. You cannot obtain it from any other music house. But it is yours, free, with a Lyon & Healy Saxophone.

Lyon & Healy

Everything Known in Music
246 South Wabash Avenue, Chicago



FREE! This fascinating illustrated book on saxophone playing.

Mail the Coupon!

LYON & HEALY, Inc., Factory Sales Division
246 S. Wabash Ave., Chicago

Please send me, FREE, full information regarding your Free Trial offer on the famous Lyon & Healy Saxophones, and your new book describing frankly the opportunities for pleasure and profit for Saxophone players.

Name.....
Street.....
City..... State.....

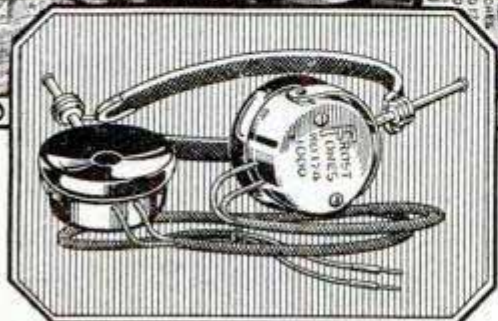
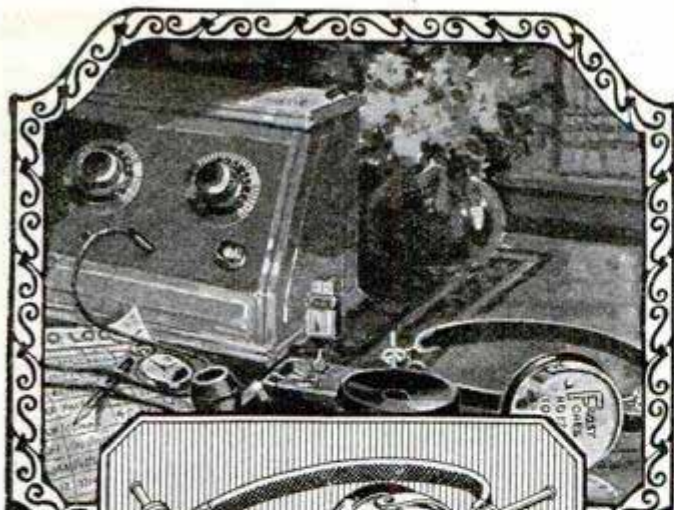

FROST-RADIO

Parts and Accessories



Type 700 and 800 Rheostats

These rheostats were first to meet the new high efficiency tube requirements. They give perfect control of both output (volume) and filament voltage without over-heating. Their smooth, noiseless operation causes no wear even after long use. Type 700 Metal Frame 50c, Type 800 Bakelite Frame 75c.

Type 880 and 890 Series Super Variable Resistances



They are non-inductive and give any degree of resistance from zero to maximum, smoothly, noiselessly and without wear. Type 880 has 2 terminals and Type 890 3 terminals. Both types \$1.25.



FROST-FONES for Quality and Distance
GEM-JAC



PAN-TAB

A small sturdy jack that projects only 1 inch behind panel. Strong springs permanently adjusted. Self-cleaning sterling silver contacts. Price 40c to 50c.

A De Luxe radio jack arranged for either panel or table mounting. Made of the finest materials. Price 65c to 90c.



HERBERT H. FROST, Inc.

160 N. LaSalle Street
New York CHICAGO Los Angeles

Big 3 ft. Telescope

Has unusually powerful lenses—magnifying over 8 times. Makes people and objects miles away seem close. Brings new pleasures to home, farm, camp, travel, sport. See moon and stars as never before. New Ferry "Wonder" telescope has 5 sections—opens out over 3 ft. long, measures 12 inches closed. Big, strong and powerful yet light, compact, easy to carry. Body and draws fully brass bound with knurled edges. Body covered with black leatherette, draws made of special, smooth finish fibre, easy to slide in and out. Brass safety caps at each end to keep out dust. Powerful lenses are special clear achromatic European optical glass.

Free

YES ABSOLUTELY FREE! Handsome leatherette covered Carrying Case light, strong, complete with strap. Case is 12 in. long, 2 1/2 in. in diameter. Protects from dust and damage. Handy for farmers, auto tourists and bikers.



3 ft. long open
12 in. long closed
FIVE SECTIONS
8-power Lenses

Read These Letters Thousands of Delighted Users

"I am delighted with the 'Wonder' telescope. Today I have been watching submarines 3 miles off the coast." —Phillip Brush
"I can see across the Mississippi 3 miles and see people fishing." —M. L. Thorn.
"I am nearly 80 years old and if I could not get another would not take \$10 00 for it." —A. R. Walker
"I can tell time on the church clock 5 miles away." —Edward Foster.
"Could tell color of aeroplane 4 miles away." —Mrs. L. M. Yarbrough.
"I saw a Light House 18 miles away." —Clyde Scribner.
"Can see men working 7 miles away." —S. M. Gearhart.
"I could see windmill more than 4 miles away." —Raymond Cosanova.

Send No Money

Sign and mail coupon below and Ferry Wonder 3 ft. Telescope with free Carrying Case will come by return mail. Pay postman special bargain price of \$1.85 plus few cents postage. Satisfaction guaranteed or your money back. Send coupon today!
FERRY & CO., Chicago, Ill.

**Ferry & Co., Dept. 1778
3224 N. Halsted St.,
Chicago, Ill.**

Send me 3 ft. Ferry Wonder Telescope and Free Carrying Case. I will pay postman \$1.85 plus postage on arrival. If I am not satisfied you will refund my money.

Name _____
Address _____
City _____ State _____
Catalog of Things You Want Sent Free

EVERYBODY'S HANDBOOK of Electrical Kinks

This is a brand new book similar to Popular Mechanics other "kink" books. It is made up of 214 ideas and short cuts for doing electrical work of all kinds. It is a book for amateurs as well as professional electricians. If you are interested in wiring, electric lighting, the making of electrical devices, experimenting, repair work, battery manufacture and repair, or telephones, you will find many helpful articles in this book. If you are interested in radio, you should have this book to learn some of the short cuts used by electricians in wiring and making apparatus.

THE BOOK CONTAINS

47 ideas on wiring	11 ideas on switches
45 ideas for making electrical devices	6 ideas on installation
19 ideas on electric light's	22 ideas on testing
5 ideas on transformers	12 ideas on repairing
5 ideas on motors	11 ideas on battery manufacture and repair
8 ideas on generators	5 ideas on telephones

There are 162 Pictures to make the ideas clear. Boys can follow the directions as well as men. If you understand the simple fundamental principles of electricity, this book will be a wonderful help to you.

Send No Money Just write your name and address on a postal card and say that you want the New book of Electrical Kinks. When the postman hands you the book, hand him \$1.50 and the few cents postage. If you live outside the U. S. or do not expect to be at home when the postman calls, send the \$1.50 with your order. Address

POPULAR MECHANICS PRESS Room 511 Popular Mechanics Bldg. 200 E. Ontario St., Chicago



BOW LEGS and KNOCK-KNEES UNSIGHTLY

Those afflicted with BOW LEGS should wear the "PERFECT LEG FORMS" and overcome this deformity. Trousers hang perfectly straight. Made of the highest grade Aluminum. Sanitary, Light and Durable. Easy to put on or off. Send for booklet showing photos of men with and without the "PERFECT LEG FORMS."

PERFECT SALES CO.
140 N. Mayfield Ave. Dept. 5 Chicago, Ill.

FORDS

no freezing no boiling!



Great Gas Saving

No need for winter fronts, summer pumps, or gas savers. The wonderful **Airlock does all three.** An absolutely genuine article which prevents freezing or boiling in any climate running or standing. It fuelizes and decarbonizes besides. Installed like a motometer. Makes an amazing demonstration. Sells like machine guns fire. Agents with Fords make \$50 daily. Free trial always. Address

AIRLOCK PRODUCTS
Box 588 Burnett, California

Send me Agents free trial offer of your sensational Airlock.

Name _____
(Print plainly)
Address _____

Chicago Man Discovers Gasoline Miracle!

Gives 333 Gals. at 1-1/2c a Gal Not a Mechanical Device

Here's strange news for motorists! Here's a new, amazing, necessary auto product that PROVES its wonderful merits at its OWN risk—not at YOURS. Nothing like it ever before. Not a mechanical device—not a carburetor contraption—not a dope to pour in gasoline. Absolutely new—different—GUARANTEED. The startling results shown below are backed by sworn proof. This marvelous discovery WILL BE SENT TO YOU FOR FREE TRIAL. WE TRUST YOU. Many so-called gasoline "savers" have been dumped on the market without results. But this is DIFFERENT! Here's a truly astonishing discovery that actually gives 333 gallons of gasoline at only 1 1/2c a gallon—doubles gasoline mileage—increases pep, power and speed—removes carbon—and lengthens the life of the motor.



You All Know Him

What IS It?

What is this new, marvelous, discovery all the newspapers are talking about? It is called—MOTOR-MYSTERY—discovered by the Chicago Scientist, L. Forgrave. Don't confuse it for a moment with any other product you have ever heard about. It is different. It is the proven solution of the gasoline problem—a problem that has long baffled motordom. It really is a miracle. Startling in action. Astounding in results. Car owners everywhere proclaim it the wonder of the age.

Stops Gas Waste

The amazing action of MOTOR-MYSTERY converts every particle of gasoline into pure, explosive, power-making vapor. Your gasoline wastage is now enormous. You are literally pouring dollars into your gas tank—from which you are not receiving full value. MOTOR-MYSTERY not only stops your gas waste, but cuts your repair bills—with a smoother running motor—increased pep—increased power—increased speed. Removes carbon in a jiffy. Old cars become like new—born again. Makes motoring a real pleasure. Worth many times its low cost. Pays for itself every few days. One of the biggest money-savers ever presented to motorists. Your car deserves MOTOR-MYSTERY.

Sworn Proof

Don't hesitate to send for Free Trial. We trust you. You risk nothing. MOTOR-MYSTERY is backed by sworn proof. We are a responsible firm. Ask any publisher, any express company. If MOTOR-MYSTERY were not a miracle, we would not be willing to send it on Free Trial. It is not an experiment, but a positive, proven success. We want you to enjoy the magic results of this wonder product—the year's biggest sensation. We don't ask you to take any risk WE TRUST YOU. You, and you alone, will be the judge.

Try It FREE

Send no money. We trust you. Just tear out and mail the coupon—NOW—for INTRODUCTORY FREE TRIAL and details of \$100.00 A WEEK INCOME PLAN FOR AGENTS. An amazing delightful surprise awaits you—you risk nothing—you gain much. This is a BIG proposition—introduced in a BIG way. Be the first to introduce this sensational product in your locality—full or part time. A product needed by every car, truck and tractor owner. A lightning seller, backed by a Refund Guarantee. Car owners are wild about it.

Drop dead slow-moving sales articles. Grab this new live rapid-fire seller. And make more money than you ever made before. Positively a sales "knock-out." Our big Sub-Agent Organizing Plan is a winner. Gets others working for you. Puts you into the big money class. Act quick. Don't delay. Cinch your territory. Mail the coupon—NOW—for Free Trial and sales plan.

M-M LABORATORIES, Inc.
6952-A N. Clark St., Chicago, Ill.

AGENTS \$100 A WEEK

MOTOR-MYSTERY is the sales sensation of the hour—one of the biggest money-makers you ever tackled. Sells at low cost under Money-Back Guarantee! We back you. Don't class this with ordinary agent jobs. We put you in the big money class on our capital. Over 20,000,000 car, truck and tractor owners need MOTOR-MYSTERY. Just what they have been waiting for. Your field is unlimited. No sales experience needed. Start in spare time. You will positively coin money. Big Sub-Agent Organizing Plan for full time men as our District Agents. Full co-operation. Never before have you been offered such an unusual opportunity to make from \$10,000 to \$25,000 a year. We back you with gigantic national advertising campaign.

Act Quick

Mail the coupon for Free Trial—NOW. Act quick. Territories are going fast. This is an unusual opportunity for sincere men who want to earn big money—who want to connect with a big, worthwhile proposition—a proposition that is unlimited. Grab this all-year-around fast seller. Prove MOTOR-MYSTERY at OUR risk. Start yourself on the road to big earnings. Lift yourself out of the rut.

What Users Say

"Your MOTOR-MYSTERY is all right. Does what you guarantee to do." WM. D. BENNETT, MICH.

"I must say that your MOTOR-MYSTERY does everything in the way of its guarantee. As a matter of fact you are undervaluing its value." W. C. BEEBE, CANADA.

"I want to say that I have tried MOTOR-MYSTERY and like it fine. I would like very much to take up the agency." C. E. BURLESON, MICH.

"I have used MOTOR-MYSTERY in a new Chevrolet car which has only been driven about two thousand miles and it has doubled the mileage." H. LARSON, TEXAS.

What Agents Say

"MOTOR-MYSTERY ordered last week received. It certainly surprised me and several others who saw the results. I will mail an order tomorrow. I have about made up my mind to take up your proposition devoting my entire time to it." F. B. CHAMBERS, N. Y.

"Enclosed find money order. Please send at once. I sent another order in the same mail. Send all together if possible. Please rush. Larger order next time." GEO. H. RICHARDSON, N. H.

"I used MOTOR-MYSTERY in my Dodge, which had a carbon knock. It removed the carbon knock and I noticed better performance of the motor. I am pleased with the results of my test." L. P. EASLEY, OKLA.

"The MOTOR-MYSTERY received. I am well pleased with the results. My motor is nicely cleared of carbon and runs as smoothly as a new sewing machine and my gas is cut in half." W. L. ALEXANDER, TEXAS.

"I wish to make arrangements at the earliest moment for having an ample stock of MOTOR-MYSTERY on hand, as there isn't any question that your goods will sell like hot cakes on a frosty morning." O. A. LEVERSON, WIS.

"Ship more MOTOR-MYSTERY, at once. It is all you claim." WM. YOUNG, ILL.

"Send more MOTOR-MYSTERY. After using it am convinced I can sell this wonder without trouble." CHAS. W. BATTLE, W. VA.

"Enclosed find check. Rush. Tried MOTOR-MYSTERY on my old Ford and doubled mileage." R. J. McMILLION, WIS.

"Send more MOTOR-MYSTERY as fast as God can let you." JOSEF SODERBERG, MICH.

"Ship more MOTOR-MYSTERY. Customers want it quick." C. A. BURCK, OHIO.

"Enclosed is check for more MOTOR-MYSTERY. Tried it on my car and it is a marvel and will sell like hotcakes." JAS. BRODIE COAL CO., MONT.

"Send more MOTOR-MYSTERY without fail." J. A. EARLY, IOWA.

Thousands More Like These

Rush for Free Trial

M-M LABORATORIES, Inc.
6952-A N. Clark St., Chicago, Ill.

I am interested in your FREE TRIAL of MOTOR-MYSTERY and your \$100.00 A WEEK INCOME PLAN FOR AGENTS. No obligation on my part.

Name.....

Street, R. F. D.....

City..... State.....

Great *New* Invention

for seekers of

Health Power Beauty



Elco Health Generators at last are ready for you! If you want more health—greater power to enjoy the pleasures and delights about you, or if more beauty is your desire—write! Ask for the book on these inventions which has just been prepared. It will be sent to you without cost. It tells you how Elco Health Generators aid you in leaving the lethargy and hopelessness of bad health and weakness behind forever. Re-vitalize yourself. Bring back energy. Be wholly alive. Write today!

10 Days Free Trial—Write for FREE BOOK



These great new inventions generate *High Frequency Violet Ray, Mechanical Vibration, Medical Electricity and Ozone.* Combined or separate.

They operate on the electric light in your home or on their own motive power at less than 50 cents per year. Elco Health Generators are positively the only instruments which can give you in one outfit Electricity, Violet Ray—Vibration and Ozone—the four greatest curative agents. Send coupon below. Get the Free Book NOW!



For All These:

- | | |
|-------------|-----------------|
| Rheumatism | Asthma |
| Gout | Hay Fever |
| Lumbago | Sore Throat |
| Neuralgia | Catarh |
| Sciatica | Deafness |
| Headache | Insomnia |
| Neuritis | Pain |
| Nervousness | Development |
| Circulation | Skin Disease |
| Weakness | Pimples |
| Paralysis | Scalp Disorders |
| Eye Trouble | Obesity |

MAIL the COUPON for FREE Book!

Do not put this paper down without sending the coupon. Don't go on as you are with pains and with almost no life and energy. You owe it to yourself to be a better man or woman. You were put here to enjoy life—not just to drag through it. So do not rest another day until you have put your name on the coupon here. That will bring the whole story of these great new inventions. Do it today—now.

Health Power Beauty

Lindstrom & Company

30 West Lake Street. Dept. 13-58, Chicago, Ill.
Please send me your free book, "Health—Power—Beauty" and full information on your 10-day Free Trial Offer.

Name.....

Address.....

12,000,000 FORD OWNERS
Need This
NEW Timer!

Earn \$100. Weekly Selling Them!

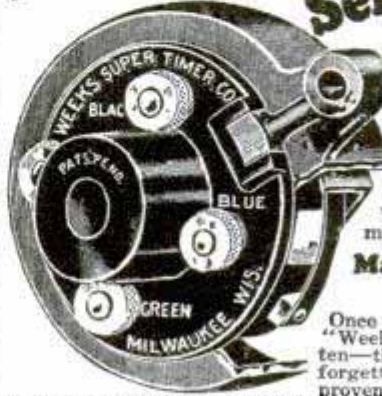

Makes Old Fords Run Like New

Once a Ford is equipped with the "Weeks", the Timer can be forgotten—the only thing that will prevent forgetting it will be the noticeable improvement in the running of the car. More power, more mileage, instant starting, amazing pickup, are a few of the features that will make any Ford owner a "Weeks" booster after he once uses this new Timer.

More power, more mileage, instant starting, amazing pickup, are a few of the features that will make any Ford owner a "Weeks" booster after he once uses this new Timer.

Get Territory Quick

FREE SAMPLE

To aid our agents we have arranged a plan that provides them with a Free Sample so they can equip their own car or carry it for demonstration purposes. The unique principles of this wonderful Timer will make themselves apparent to any Ford owner after a minute's examination. Send name and address for Free Sample Offer and particulars of our big money making proposition.

Our agents can easily make \$5,000, \$6,000, yes even \$10,000 a year. Spare time workers make \$20.00 and even \$30.00 a day. John Cable made \$200 in less than 10 days. Many others report tremendous profits. You too can get into the big money class the same as John Cable and others.

Weeks' Super Timer Co.
426-729 Elev. 11th St. Milwaukee, Wis.

Looks Like a Real

AUTOMATIC \$1.28

Protect yourself from toughs and hold-up men. Most amazing automatic, 4 1/2 in. long; gunmetal finish. Can't tell from real automatic until you pull the trigger, and presto! you have Opera Glass, Pocket Mirror, Magnifying Glass, Telescope, Mirror, Sun Dial, Compass, etc. Loads of fun; useful, instructive; a real protector.



Send No Money!

Just send name. On arrival of "Automatic" deposit with Postman \$1.48 plus a few pennies postage. Satisfaction guaranteed or deposit refunded. Supply limited. Order now. Big Bargain Catalog sent FREE. ORDER TODAY!

FERRY & CO., 3224 N. Halsted St., Dept. 9778, Chicago, Ill.

SELL THRU AGENTS

We supply Premium catalogs. You appoint boys, girls or women to sell groceries, candy, novelties, at low prices. Catalogs printed with your name. \$6.00 profit on every order. Information FREE. **BIG 4 CO. 553 Lake Street W. CHICAGO**

STOP CHASING RAINBOWS

Become a distributor of our World Famous Products. Goods used up between trips. Every item in daily demand. Repeat business assured. We back you with 50 years' experience and unlimited co-operation. Our products backed by \$10,000,000 Company are known and used everywhere.

A FEW DOLLARS WILL START YOU
All you need is a desire to work and make good. We show you how. Any average man, satisfied with \$35.00 to \$50.00 a week to start, can establish an income for life with us.

THE J. R. WATKINS CO., Dept. 251, Winona, Minn.

WRITE FOR INFORMATION TODAY

30 DAYS FREE IN YOUR HOME

Tested and approved by all of Radio's Highest Authorities



Send Coupon for Amazing Special Offer!

NOTE: This offer is made to prospective buyers by famous big Radio Corporation, one of America's oldest reliable manufacturers of fine sets—seventh successful year. Many satisfied users in every state.

BEAUTIFUL-BIG-POWERFUL Ultra Selective **MIRACO** Ultra 5

Retail LIST Price **\$49.75** **GET SPECIAL OFFER** now only **29.75** **One Year GUARANTEE**

AMAZING SPECIAL OFFER to User—Agents who will allow friends to see and hear their Miraco's.

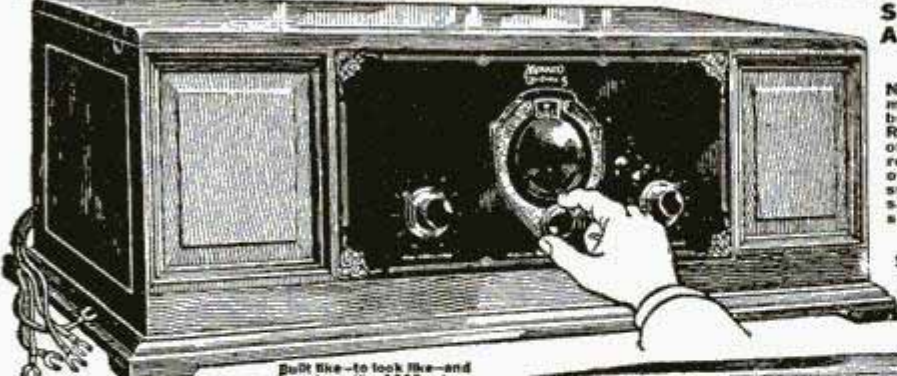

Built like—to look like—and perform like \$200 sets

Real Single Dial Control!

Magnificent Big Powerful Miraco "Unitune-5" Retail List price only \$87.50—get special offer The celebrated Miraco Ultra-5—U.S. Navy type circuit, has also been adapted to Single Dial Tuning—without sacrifice of selectivity, volume, clearness, power, tone, or distance getting qualities in the magnificent big Miraco Unitune-5, above shown, you turn one vernier knob for stations everywhere. Beautiful hand-rubbed, piano finished, solid walnut cabinet, 28 in. long, 15 in. deep, 19 in. high. Sloping Bakelite panel is walnut finished to match. Also offered on 30 days free trial!

Coast to Coast and Foreign Reception Certified

MIRACO RADIO GETS EM COAST TO COAST Reception Certified by Miraco users! Enormous sales of the celebrated Miraco 5-tube Receivers (resulting from delighted users so highly endorsing them to friends) again enable us to add hosts of costly new features, latest refinements and up-to-the-minute improvements such as you might expect to find only on much higher priced sets.

USER-AGENTS WANTED—WRITE! Reports from users everywhere leave little for us to add. Send coupon for plenty of additional proof and testimony of nearby users. **CUTS OUT LOCAL GETS PROGRAMS EVERYWHERE.** Meriden, Conn. Reports says the Miraco 5 is the best set they have heard. It gets stations all over the states, also Mexico, Cuba. Have a broadcast station next door but it doesn't matter with the Miraco 5, I get them all the same. H. B. Schreiber.

COAST TO COAST THRU LOCALS Omaha, Nebraska Miraco 5 was used for distance, volume, tone, volume. Where 5 local broadcast stations, here and she goes right thru and brings them from coast to coast. No trouble at all. H. N. Eller.

KEYS OTHERS FOR SELECTIVITY. Cleveland, O. Have been up against some pretty good radio sets with other sets and the Miraco 5 has them answering. In selectivity, volume and range it has outdone everything I have ever heard of. W. J. Farnham.

CRAGO LOCALS. Chicago, Ill. With 4 local stations broadcasting less than a mile away, one after another I have heard and kept as clear as high as 15 Chicago stations on your "Unitune-5". Even during the summer I frequently get stations clear, loud on speaker as far away as Colorado. New Jersey, New Orleans and many others. With the Miraco 5 I switch from one to another station in an instant. The selectivity is amazing, the set is beauty and the tone is perfect. W. J. Schaeffer.

FLORIDAGETS CAL FIRST NIGHT Fort Worth, Tex. Tuned in stations the first night racing throughout Florida, Cuba and as far as California with Miraco 5. Most Newark, Ohio hears them coast to coast. Westerville, O. We have no credit about 33 stations from CPUC Montreal, Canada, Wood Branch Columbia, Canada, WOODMOUTH South Florida stations in California a station at Seattle, Wash. We were more than pleased with the Miraco 5. Dan Brock.

HONOLULU TO LONDON FROM IOWA. Anthon, Iowa. Here are some of the stations we pick up on the Miraco 5 Sunday Jan. 24 between 10 and 11 P. M. 730. London, N.Y. 1040. St. Louis, Mo. 1040. San Juan, P.R. 1040. San Francisco, Cal. 1040. St. Paul, Minn. 1040. St. Louis, Mo. 1040. St. Paul, Minn. 1040. St. Paul, Minn. 1040.

NEW YORK LOCALS 153 STATIONS Buffalo, N.Y. I received 150 London, Ill. on Monday night but there was no such interference it was the very best. I also have heard 153 stations in U.S. and Canada. Asst. Sec. of State, Wm. C. Clegg, Wash. D.C. **MIRACOA HEARS PORTO RICO ON SPEAKER.** Spencer, Nabr. Using the Miraco 5 we have often heard Puerto Rico, Porto Rico, Miami, Florida, Ottawa, Canada and Vancouver, B.C., Canada and all along the Pacific coast. All the above heard thru the speaker. Have also heard Lima, Peru, South America, B. J. Schmidt. **WASH. GETS EM.** N. Y. CALIF. WASH., TEXAS. In less than a week after I installed the Miraco 5 (made in U.S.A.) I received 153 stations in New York City; Oakland, Calif.; Minneapolis, Minn.; Mexico City, several stations in Florida and many others. K. E. Sits.



Big Powerful New Unitune 5 MIRACO Ultra 5

Solid Walnut Cabinet 28 in. long 27 in. long **ULTRA-SELECTIVE LONG DISTANCE 5 TUBE SETS EASY ON BATTERIES**

SAVE or make a lot of money on sets and accessories by writing immediately for our Amazing Special Offer! It will astonish you. Unless 30 days' trial proves a Miraco the most selective, clearest toned and most powerful distance-getter among beautiful big 5-tube sets, don't buy it.

Send for Testimony of Users Everywhere First, reports of delighted users will assure you that the beautiful, big Miraco's actually are unsurpassed (even at much higher prices) for razor-edge selectivity combined with extreme long distance reception, clear natural tone and powerful loud speaker volume, plus economy in use of battery current. Second, it is our honest conviction—based on seven years' successful experience in building fine sets—that these latest Miraco's are the most marvelous values offered in high-grade receivers. Third, convince yourself by using a Miraco thirty days in your home before you decide to keep it.

Our Factory Prices Save You Up to 1/2! Facts About Makers of Miraco's:

To our many thousands of satisfied users throughout the world, we require no introduction. But those who have never enjoyed the pleasure and satisfaction of operating a Miraco Set, will undoubtedly wish to be assured that the makers of the Miraco are thoroughly reliable. We therefore present these facts about the Midwest Radio Corporation of Cincinnati, Ohio:

1. One of America's oldest, largest and most experienced builders of fine sets—seventh successful year.
2. Builds all sets complete in its own big factory and thoroughly tests them under actual broadcasting conditions before shipping.
3. Sells all sets on a Guarantee of Unconditional Satisfaction, allowing liberal trial privilege.
4. Deals direct by mail with its users, agents and dealers, thereby effecting great savings which are reflected in amazingly low prices.

You'll Be Proud of Your Miraco! Each Miraco comes completely assembled, rigidly tested, splendidly packed and factory guaranteed for one year. Easy to install and operate—full instructions supplied. A big, handsome, expensive-looking radio—one you'll be proud to have friends see and hear. Stylish, sloping front cabinet of solid walnut, handsomely gold illustrated genuine Bakelite front panel and genuine Bakelite knobs—finished in walnut. In construction, too, like high-priced sets. Finest parts obtainable—and many exclusive features. Literature describes them fully—send for it, testimony of nearby users and Special Offer!

Deal Direct with a Big, Reliable Firm! Thousands of satisfied customers can testify to the money they've made and saved by dealing direct with the great Midwest Radio Corporation. You are absolutely guaranteed and assured the same satisfaction. Clip coupon now and be convinced!



All the Proof you want is waiting for You! Coupon or postal bring reports from hosts of users in your vicinity and elsewhere proving that Miraco sets at rock-bottom money-saving factory prices, outperform sets costing up to four times as much. You can also buy speakers, tubes, batteries, etc., at big savings from us!

Get our proposition before spending money elsewhere. **MIDWEST RADIO CORPORATION** Pioneer Builders of Sets Cincinnati, O. **407-M Miraco Building** Without obligation, send free literature, testimony of users, AMAZING SPECIAL OFFER and full particulars of your big money-saving factory-price proposition on Guaranteed Miraco sets and all radio supplies. () Agent () User

AGENTS! DEALERS! Write for our latest Miraco proposition. Nation-wide popularity, superior performance of Miraco 5-tube sets, at amazingly lower prices, make them easy to sell. Send coupon today for proof

Send coupon for Amazing Special Offer

NAME _____ ADDRESS _____

Sensational Typewriter Offer



The World's Only Ball Bearing Typewriter

NEVER has there been such a typewriter bargain on as easy terms! A genuine Silent Ball Bearing L. C. Smith at a 40% savings!

Only the L. C. Smith has all these features:

Ball bearings (836 of them) at all points of wear. All the writing visible all the time. Non-shift carriage. 2-color ribbon. All the latest operating conveniences. Beautiful—renewed.

If you decide to keep it only **\$3⁰⁰** DOWN BALANCE EASY TERMS

Guaranteed 5 Years

Money cannot buy a better typewriter. U. S. Government bought 50,000. The choice of railroads, big corporations like the Standard Oil Co., etc., because of its exclusive ball bearing feature. Easiest running, longest wearing of typewriters.

Send No Money!

Just mail coupon. Without delay or red tape, typewriter will be shipped you. Use it 10 days. See how speedy and easy it runs—the perfect work it turns out. If not delighted, return at our expense. You'll want to keep it. You can, for \$3 down and \$5 monthly. Now is the time to buy. \$3 worth of extras free. Send coupon now before offer is withdrawn.

\$40 SAVED by Using this Coupon!

SMITH TYPEWRITER SALES CORP.
118-360 E. Grand Ave., Chicago

Ship me the L. C. Smith, F. O. B. Chicago. On arrival I'll deposit \$3 with express agent. If I keep machine, I'll send you \$5 a month until the \$66.70 balance of \$69.70 price is paid; the title to remain with you until then. I am to have 10 days to try the typewriter. If I decide not to keep it, I will repack and return to express agent, who will return my \$3. You are to give your standard 5-year guarantee.

Name.....

Address.....

City..... State.....

Employed by.....

Professional Movies with the Ease of "Still" Pictures

THE wonderful new DeVry motion picture camera for amateurs takes exactly the same kind of pictures as the professionals do. And yet, it is so simple of operation, so handy and so compact, that a child can take pictures with it. In every way it is just as easy to use as the "still" cameras. It holds 100 feet 35 m/m film.



DeVry Standard - Automatic MOVIE CAMERA

It remained for the famous DeVry corporation to produce this standard theatre size film, automatic professional movie camera, for amateurs at the amazing low price of \$150.00. Constructed of finest materials, it will last you a lifetime. At last amateurs can take actual motion pictures which can be shown in motion picture theatres, schools, churches—everywhere that real motion pictures are shown—and in the home as well.



NEW FREE BOOK

You should know more about the wonderful progress of motion picture photography by amateurs. We will gladly send you FREE and without obligation, our beautiful new book "New Facts on Amateur Motion Picture Photography." Write for it today. Learn how easily amateurs can master professional photography—how they, too, can take standard size motion pictures not only for their own pleasure but for immense extra earnings as well.

THE DeVRY CORPORATION

1111 Center Street Dept. 11-K Chicago, Illinois



THIS 68 PAGE RADIO CATALOG FREE

Contains 75 Radio "Hook Ups," 300 Illustrations, 650 articles, a page Log Book of all U. S. Broadcast Stations.

"Build your own with 'RASCO' Parts"
RADIO SPECIALTY CO., 98 E. Park Place, New York, N. Y.

Order Direct or from Your Dealer

UNION SERVICE COMPANY
Morris Heights
NEW YORK, NEW YORK

Operates from 110-120 volt A. C. Socket (any cycle) for less than five per year. Delivers a constant flow of unfading, clear, noiseless B power tubes with ease. No more recharging. No troublesome creepy acid cells. No more dead dry cells. Built-in handsome metal case.

LASTS INDEFINITELY giving maximum power at all times. Taps at 22½, 45 (90-100). Higher voltage can be obtained by connecting regular "B" battery in series with eliminator. Guaranteed to be equal or superior to any eliminator regardless of price. Use it for ten days to convince yourself, and if not found as claimed, return it and your money will be refunded. Trickle charger for A battery \$6.50.

\$10.98 Complete GUARANTEED

AUTOMATIC
TRAIN CONTROLNEW LIONEL
SWITCH TOWER

AS IF BY MAGIC!

—you can run your "Lionel Standard" Train at various speeds, stop it and reverse it by manipulating a small lever placed at any distance from the track. *As if by magic*—your Lionel Automatic Train Control will start and reverse your Lionel Train without being touched by hand, and *as if by magic*—you can switch your "Lionel Standard"

The New Lionel 100% Electrically Controlled Railroad

for "Lionel Standard" track.

Lionel makes the most complete and perfect line of model Passenger and Freight trains in the world,—both electrically-controlled and hand-controlled for "Lionel Standard" track; and hand controlled for "O-Gauge" Track. Lionel Trains are real in everything except size; every piece beau-

tiful in design, perfect in construction, and fully guaranteed. They contain hundreds of improvements and refinements not found in other lines. Yet Lionel Trains are the lowest in price consistent with supreme quality.

You can buy a Lionel "O-Gauge" Train for as low as \$5.75!

tiful in design, perfect in construction, and fully guaranteed. They contain hundreds of improvements and refinements not found in other lines. Yet Lionel Trains are the lowest in price consistent with supreme quality.

You can buy a Lionel "O-Gauge" Train for as low as \$5.75!

"STANDARD OF THE WORLD SINCE 1900"

LIONEL ELECTRIC TRAINS

MODEL RAILROAD
ACCESSORIES

"MULTIVOLT" TRANSFORMERS

Cross-section of
New Lionel Power
Station — showing
Lionel "Multivolt"
Transformer

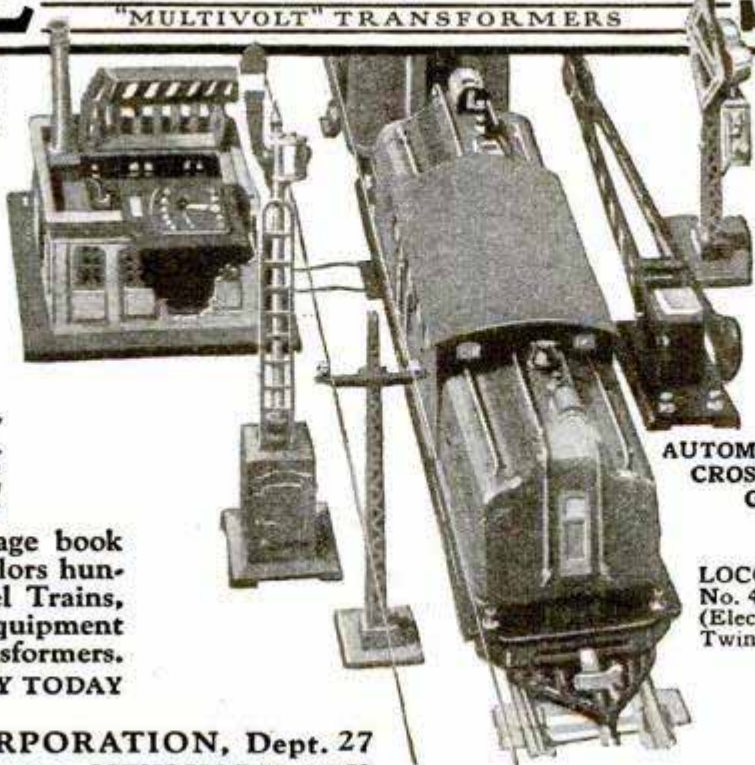
AUTOMATIC WARNING
SIGNAL No. 69AUTOMATIC
CROSSING
GATELOCOMOTIVE
No. 402 E
(Electrically Controlled
Twin-Motor, Reversible)

Send for the
NEW LIONEL
Model Railroading
Book—It's FREE!

This fascinating 48-page book illustrates in actual colors hundreds of Lionel Model Trains, Automatic Railroad Equipment and "Multivolt" Transformers. SEND FOR YOUR COPY TODAY

THE LIONEL CORPORATION, Dept. 27
15-17-19 East 26th Street • NEW YORK, N. Y.

Pay Nothing

Until December 15th
Then Only \$10 a month!

We will send you a Bulldog Pipeless Furnace for free inspection. If you want it, pay nothing until December 15th. Then pay only \$10 a month at our amazingly low price. Don't consider buying any furnace until you find out about the Bulldog. Write today.

Comes Completely Erected!

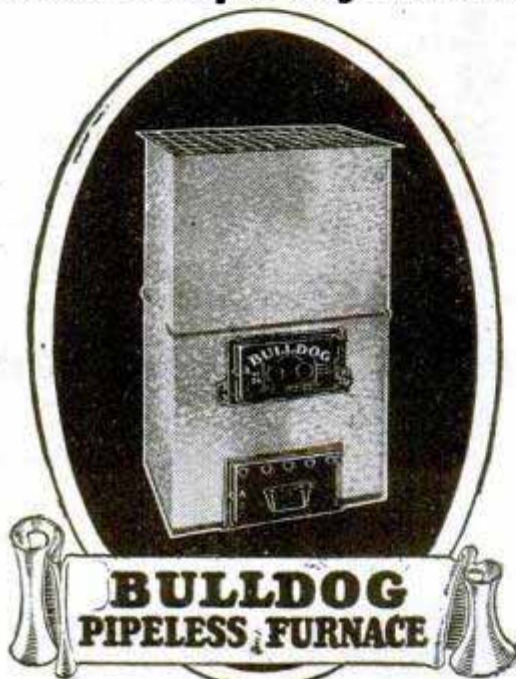

BULLDOG PIPELESS FURNACE

2½ Tons Heats 5 Rooms!

"There is no heater to compare with the Bulldog. I burned 2½ tons of coal last winter and heated 5 rooms and bath."

— Walter Geary, Gloucester, Mass.

That's what the Bulldog does with coal! Here's what it does with about the lowest grade of fuel you can think of!

"I can run my Bulldog Furnace steady for fourteen days in normal weather conditions at the actual cost of 50 cents." So writes F. R. Redetzke, of Cleveland, North Dakota, and he adds: "Hard to believe, is it? That's what some of my neighbors thought until I showed them! We have an unlimited amount of green screenings in this country. That's the fuel I am using."

Write! Send today for our free book and "Pay Nothing Now" offer — also get the wonderful record of Bulldog Success. **Factory connections in both East and West. We ship from nearest point. Get ready for winter NOW! Mail this coupon TODAY!**

Bulldog Furnace Co.

Babson Bros., Sole Distributors
19th and California Ave., Dept. 13-58 Chicago, Ill
Without obligating me in any way please send me your free catalog and special offer on the Bulldog Pipeless Furnace.
(Print name and address plainly.)

Name _____
Address _____

I'll Start You
in the
TIRE
Business
and Show
You How
To Make

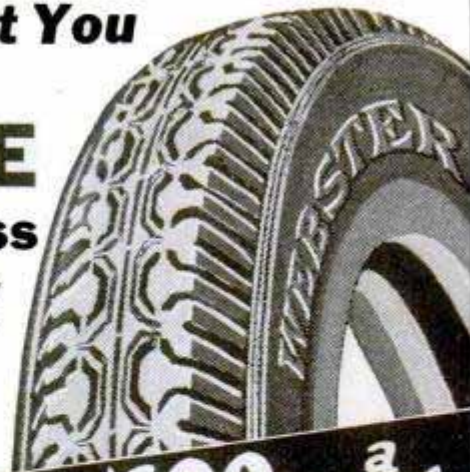

\$75 to \$100 a week
Be A WEBSTER DISTRIBUTOR

SELL DIRECT TO USER AT LOWEST PRICES — MAKE BIG MONEY—GET YOUR OWN TIRES FREE

I'll set you up in a Tire Business all your own—make you the exclusive Distributor for the well known WEBSTER Tires and Tubes—and show you how to make \$5,000 to \$10,000 a year clear profit without experience or capital.

By our plan you sell direct to the User for 25% to 40% less than retail prices—backed by a 15,000 mileage bond and an Ironclad Guarantee of satisfaction. Here's a big money-making OPPORTUNITY we are offering you.

FREE TIRE OFFER

Our men are coining money on this "Direct-to-User" scheme of selling. Everybody buys tires and tubes. Every car owner is a prospect. As a WEBSTER Distributor you will get the big end of this business in your locality because you can give better tires, better service for less money. If you want to make more money than you ever made before, write me today for all the facts and I will also send complete details of my FREE Tire offer which I make to all new Webster Distributors. Don't wait.

A. L. FREEMAN, Sales Manager

Webster Tire & Rubber Company
2009-27 Prospect Ave. Cleveland, Ohio

OIL BURNER BOILS 50 GALLONS IN LESS THAN AN HOUR
Use indoors or outdoors to suit convenience; burns with terrific, silent, blue flame; boils maple syrup, apple cider, fats, etc., in half the ordinary time.
BUY DIRECT AT FACTORY PRICES
No other compares with this wonderful Improved Kerosene Gas Burner. Indispensable for dairies, farms, homes, etc. Simplest scientific, popular priced burner ever constructed. No Soot, Smoke, Sulfur or Noise. Write for descriptive catalog.
HOME MFG. CO., Dept. B-13, 29 E. Kinzie St., Chicago, Ill.

350% Larger Market 50% Lower Price
MARVEL VACUUM CLEANER
(Non-Electric)
Can be sold to every home—350% larger market than can be sold by Electric cleaners! It's non-electric—no wires to tangle—no motor trouble—no operating costs—no service work. It's a fast seller with a wider market and less sales resistance—sells at 50% less than electric cleaners.
Fast Turnover—More Money
60,000 Marvels now in use. Agents are making upwards of \$300 monthly. You want fast sales—and that means BIG MONEY—HERE IT IS. Exclusive territories still open. Write TODAY.
MARVEL COMPANY
3450-S2 Archer Avenue
Dept. 805-P Chicago, Ill.

Weights 8¾ lbs.

66 MILES ON 1 GALLON

WILL YOUR FORD DO IT?

New Moisture Humidifier and Gas Saver

for all makes of Cars, Trucks and Tractors

Invented by Illinois Man

Walter Critchlow has perfected a wonderful NEW Vapor Humidifier and Gas Saver that beats anything ever gotten out. This amazing new invention is a Vapor Moisture device, which makes engines run all the time with the same wonderful efficiency they do on a cool night. It causes autos to give amazing mileage and automatically frees them from hard carbon, plug and valve troubles. Ford owners report 28 to 66 miles on one gallon. Some of the best records reported are:

	Miles		Miles		Miles
Buick	31 1/4	Hudson	29 1/2	Overland	43
Cadillac	27 1/2	Hupmobile	32 1/2	Packard	27 1/2
Chevrolet	42	Jewett	27 1/2	Paige	26 1/2
Chrysler	32 3/4	Marmon	24 1/4	Pierce Arrow	29
Dodge	33 1/2	Nash	31	Reo	30 1/4
Essex	34	Oakland	33	Star	41 3/4
Ford	66	Oldsmobile	34 1/2	Studebaker	31
				Willys-Knight	31

And Hundreds of Other Wonderful Records

Moisture in the Engine Gives Amazing Results

By using the VIX Vapor Humidifier and Gas Saver, a fog of vapor moisture passing through the engine supports the combustion, and enables the motor to run on a LEANER fuel mixture. With vapor moisture mixed into the fuel—you can drive with FASTER spark and LEANER gas mixture. The monoxide carbon gas in your engine (caused by unexploded and wasted gas and oil) crystallizes into and forms hard carbon. By this VIX process, MOISTURE is introduced into the engine in the CORRECT amount required; the oxygen from the water vapor is absorbed upon contact by the monoxide carbon gas (a natural chemical action)—both are MOIST and are then expelled through exhaust valves in the natural operation of the engine—BECAUSE both are MOIST and cannot crystallize or harden or become baked. You get ENORMOUS power, speed and mileage, no hard carbon, easy starting, faster pickup and a snappier, peppier motor.

VIX works wonderfully in Winter with all non-freeze and alcohol radiator solutions. It uses the alcohol vapor, and turns it into FUEL and POWER at a BIG SAVING and shows almost unbelievable results in easy starting, increased mileage and no hard carbon accumulation.

Men with Cars Make \$148.00 Weekly

VIX sells on DEMONSTRATION. It Makes a SENSATIONAL Demonstration.

With our FREE TESTER DEVICE—and your hood up to show VIX in operation—a few pulls of the Dash Control to show MAGNIFICENT BURST of ENGINE SPEED WHEN YOU OPEN IT UP—this Demonstration is STARTLING—ASTOUNDING—CONVINCING!

It means QUICK SALES—BIG PROFITS. Interested Car Owners are found everywhere—there are millions of them. No matter where you are, SALES can be made and PROFITS gathered in because auto owners are ALL desirous of using LESS gas and oil—and everyone is immediately interested when you start SHOWING and DEMONSTRATING.

1 VIX FREE OFFER

Mr. Critchlow, the Inventor and Manufacturer, offers 1 VIX FREE to introduce. Write him for one at once. MAIL THE COUPON TODAY.

Walter Critchlow Inventor and Manufacturer
805 S. Street Wheaton, Ill., U. S. A.

Big Cash Profits

\$4,939.66

in

3 3/4 MONTHS

This amazing new patent is a DEMONSTRATING device. To see it DEMONSTRATED is to buy one—car owners cannot resist its STRONG DEMONSTRATIVE appeal. Direct factory distributors and agents can easily earn BIG, QUICK PROFITS in spare or full time. One man actually made \$4939.66 in 3 3/4 months—another made

\$1,656.40 in 58 Days

Neither had any previous experience in this business. Read the monthly earnings reported by "spare time" distributors listed below:

Frank Hanfelder, \$107.00	H. B. Phelps, \$105.00
Wm. Fraser, \$189.00	H. C. Daniel, \$107.00
Louis A. Carlin, \$80.00	E. Schaefer, \$96.00
M. M. Werline, \$143.00	W. M. Hardy, \$132.00
P. R. Langel, \$117.00	W. R. Moser, \$81.00
R. Stefancky, \$189.00	James Paton, \$126.00

Do you want to do as well? Do you want to build a business of YOUR OWN? Do you want to do what others are doing—make money FASTER, take life EASIER, get more of the BETTER THINGS of life and GET AHEAD QUICKER?

APPRECIATES SALES HELP

OLDS SIX—I am getting good results with the VIX'S I have put on. I sold Mr. Plymton whose inquiry you forwarded me. Thank you very much for sending me those inquiries.—J. A. ROLES.

ALL CUSTOMERS BOOSTERS

(Mr. Lane has had 54 VIX'S since writing letter below) CHEVROLET—Have received the VIX—have tried it out—and it has them all shined. All auto owners I have sold are boosters.—J. R. LANE.

Every Auto Driver Knows This

HIS CAR RUNS BETTER ON A COOL, MOIST EVENING THAN ON A HOT DAY, and therein is our wonderful sales possibilities—and YOURS—if YOU become our distributor—to impart to every car owner—that wonderful night driving effect that we all recognize—with the added POWER—PEP—PICKUP—MILEAGE and SMOOTH RUNNING EFFECT.

MAIL THIS COUPON TODAY

GOOD 1 VIX VAPOR FOR 1 HUMIDIFIER FREE

Write Address Plain—Fill Out and Mail This Coupon, **WALTER CRITCHLOW**, Inventor and Manufacturer, 805 S. Street, Wheaton, Ill., U. S. A.

Please rush me full particulars free, to get 1 VIX Vapor Humidifier and Gas Saver FREE. Also how I can make \$500 to \$2500 a month as your County or State distributor if I decide to accept after making tests on my own car first.

Name.....
 Postoffice..... State.....
 R..... Box..... St. and No.....
 (Mark Plan wanted with X)
 1—Just a User: No Agency wanted.....
 2—Please reserve me this County, or several Counties, or Entire State. Name which.....



66 Miles on 1 Gallon
 Geo. B. Cousins, Ill.: "Last Sunday with the VIX on, we drove up to Nuttall, 33 miles, and back, a total of 66 miles, on a trifle over 1 gallon of gasoline."

58 Miles on 1 Gallon
 George H. Wheeler, Mich.: "I have the VIX on my Ford, which has been averaging me 58 miles to the gallon."

52 Miles on 1 Gallon
 Ambrose Dolney, Mich., FARMER: "I live 26 miles out of town. It used to take 2 1/2 gallons to go to town and back, but now with the VIX I do it easily on 1 gallon."

48 Miles per Gallon
 Chas. J. Jabossek, Texas (SWORN AFFIDAVIT): "The VIX on my Ford is great. Got 48 miles per gallon on 138-mile trip with 14 miles in black mud and chains on. Previously averaged 18 to 20 miles."

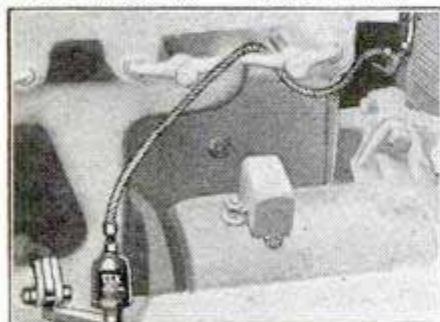

Model "A" Vix Vapor Humidifier and Gas Saver Attached on Ford

Model "A" is for FORD cars, delivery wagons and trucks—Model "B" (not shown here) is for all other makes of cars, trucks and tractors including Fords and Fordsons, too. (1927 Ford with new Holly Fuelizer requires Model "B.") Easily attached by anyone in a few minutes. No drilling or threading. Everything necessary furnished, including complete pictured instructions. Comes all complete, self adjusted. No attention required after installed. Is entirely automatic in operation. Pays for itself. Pays you a BIG PROFIT besides.

Here's an engine that's built for you to take apart and put together, over and over again — and it's the only engine you can do that to.

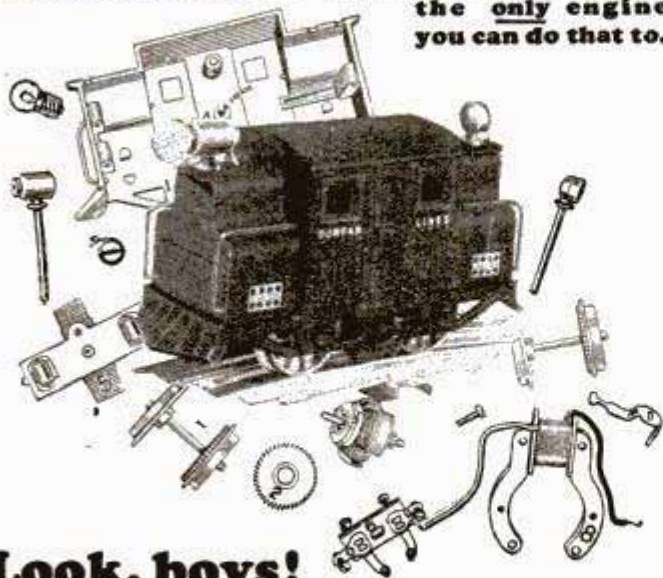

Look, boys!

A NEW KIND OF ELECTRIC ENGINE

LISTEN— You set your Dorfan Train on the track, turn on the electricity, and round and round, she flies. That's what any good electric train will do—only Dorfan runs so fast—and so smoothly!

BUT NOW LISTEN, BOYS— turn the "juice" off, uncouple the engine — and look at it. Those headlights pull out. The engine splits in two. A glance at the easy Dorfan Direction Sheet, and bit by bit you find yourself taking your engine to pieces—wheels, armature, "field," brush-holder, etc., etc.—all spread out in front of you.

THEN— the fun begins again—putting it together. So easy — yet so fascinating. With no tool but a screw-driver, you soon have it complete again and running. . . . Isn't that lots more exciting boys, than just sitting and watching your train go?

DORFAN LOCO-BUILDER ELECTRIC TRAINS

may be bought ready to run, complete with cars, track, etc.; or engines may be bought separately—in "Loco-Builder" form—all the separate parts in neat box. So, if you already own an electric train, you can bring it up-to-date by adding this take-apart engine. All your engine troubles will be over, for you can make all engine repairs yourself, and save time and money. And its motor is so strong and powerful that it will draw many, many cars.

You'll find Dorfan Engines and many different Dorfan train outfits, from \$6 up to \$36, in leading stores. But remember—only DORFAN has this "take-apart" engine.

----- ENTER OUR FREE PRIZE CONTEST -----
Show your toy dealer this ad and ask him for Free Entry Blank and Folder telling all about the Dorfan Prize Letter Contest. 100 big Prizes—Radio Sets, Bicycles, Canoes, Cameras, Watches, etc. Contest closes Jan. 15, 1927. If dealer hasn't an Entry Blank for you, send us his name and address and we'll see that you receive one.

THE DORFAN COMPANY, Dept. PM-11
137 Jackson Street Newark, N. J.

Dealers write for supply of Blanks. No boy can enter contest without one.

PARKS

WOODWORKING MACHINES

Cabinet
Shop
Special

\$290

with Motor

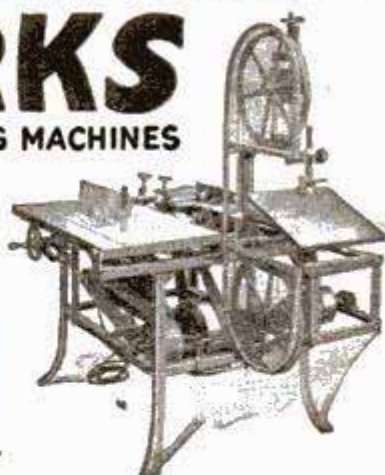

You ought to have this handy Parks in your shop. It is a compact, complete machine designed just like a big production outfit at one-fifth the cost. Includes 8-inch circular rip and cross cut saw with polished cast-steel saw table, 16-inch band saw with tilting table for bevel-sawing, 6-inch jointer, and motor operating from any light socket. Just plug in and go to work! Fits in a corner of your basement. Does any kind of cabinet and joinery work. Add lathe, shaper and other attachments any time at small cost. For the man who does "odd jobs" in his off time this Parks is a big money maker. Turn out as much as a four-man shop working by yourself.

Write for circular and Parks complete catalog of handy woodworking machinery.

The Parks Ball Bearing Machine Co.

1500-1540 Knowlton St.

Cincinnati, Ohio



The New Sypher No. 10

Biggest lathe value on the market. Length over all 30 in.; between centers 14 in. Swing over bed 7 1/2 in. Includes counter shaft. Bronze taper bearings. Weight 60 lbs. No. 11 Lathe, 40 in. over all; 24 in. centers, 7 1/2 in. swing. Price \$75.00. Time Payments if desired. Write today for circular.

\$60

The Sypher Mfg. Co. Dept. D Toledo, Ohio

FREE \$100 A WEEK ~ EASY

Haines of Carey, Ohio making \$1000 a month. Durr of Kansas City, Henry of N. C., Ridge of Ill., and many others are cleaning up. Experience not necessary. \$5.00 an hour easy for part time workers. Every car owner buys on sight the amazing new Hughes Valve Cap—makes pumping up tires unnecessary—keeps tires properly inflated—doubles tire mileage. Write quick for FREE sample and exclusive territory proposition.

AIRLOX RUBBER COMPANY
Dept. 805-L Chicago, Illinois

Why Not Solve Your Saw Problems With This Regular Tool

You will like its sturdy mechanical construction. It will saw wood, fibre, bakelite 1" and metal 1/4" thick. Sold also without motor. We carry a complete line of bench woodworking machinery. For details write to

DELTA SPECIALTY CO.
Dept. A-113 858 Third St. Milwaukee, Wis.

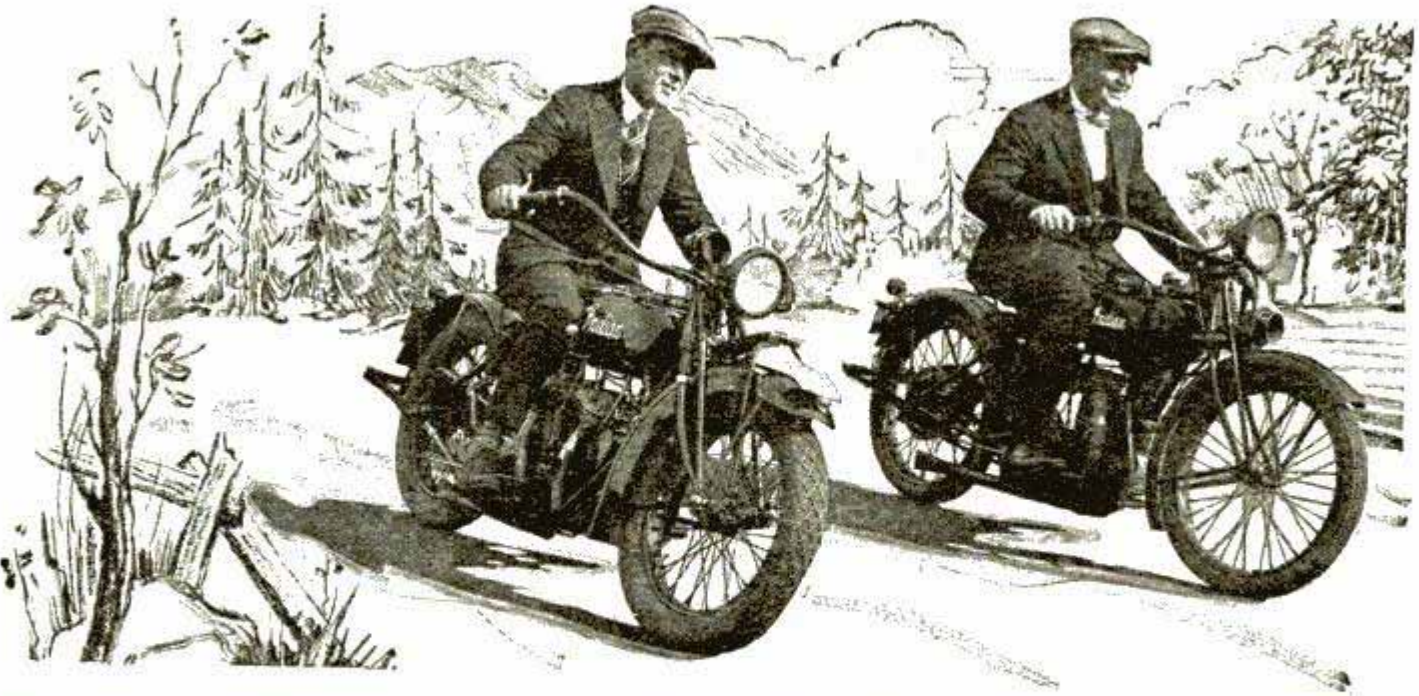

Two Famous "Pals" who cut the heart out of travel cost!

*I*F you want to travel for less than carfare—if you want the kind of convenience and dispatch which gets you there earlier and back sooner—if you like outdoor sport that packs a big "kick"—hop on one of these famous INDIAN "pals."

Know the real meaning of convenience and pleasure. Know motoring at its best—at a fraction of carfare cost, a cent a mile or less.

Lowest initial cost!
Lowest upkeep!
No garage bills!
No traffic delays!

Visit your nearest Indian Dealer. Let him demonstrate the Indian Prince and the Indian Scout—the two "pals" that cut the heart out of travel cost.

Easy to own—investigate
Let the Indian Dealer tell you about his pay-as-you-ride plan

that makes it easy to own an Indian. The coupon below brings you—free—our illustrated catalog. Mail it today for the complete, interesting story of these two famous models.

Indian Prince The Solo Single

Easier to handle than a bike. Learn to ride in 5 minutes. Climbs steepest hill on high. Speeds to 50 miles per hour. Low saddle. 3-speed transmission. Two-unit electrical system. Light in weight, yet sturdy in construction. 90 miles per gallon gas. Less than 1c per mile operating cost.

Price with complete electrical equipment \$225 F. O. B. Springfield, Mass.

Indian Scout The Solo Twin

Twin-cylinder smoothness, acceleration and power combined with light weight, low saddle, ease of handling and many other essentials for comfort and safety. 65 miles per gallon gas. 1c per mile operating cost. Highest used-value. Thousands of INDIAN SCOUTS delivered 6 and 7 years ago are in use today.

Price with complete electrical equipment \$285 F. O. B. Springfield, Mass.

Indian Motorcycle Co.

Dept. P-11, Springfield, Mass.

DEALERS!

A few good territories open. Our proposition is a winner for ambitious men. Write now!

INDIAN MOTORCYCLE CO., Dept. P-11
Springfield, Mass.

- Send me your illustrated Catalog describing the Prince and the Scout.
 Check this if you are interested in our money-making proposition to dealers.

Name.....

Address.....

City.....

State.....

The One BLOTORCH with a SAFETY VALVE

As in a steam boiler, there is pressure in the tank of a blotorch—and as in a steam boiler, that pressure should be safeguarded against dangerous explosiveness by a safety valve. In a blotorch, the pressure secured from the pump is often greatly increased by the heat reflected back from the work—often to the explosion point. That can't happen with a

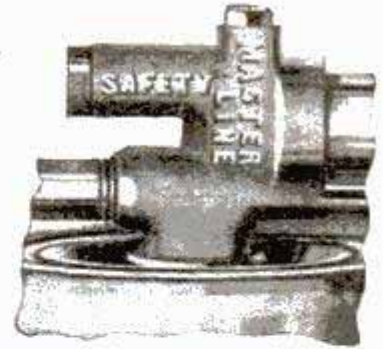

TURNER Master No. 45 Blotorch



because, like a steam boiler, it has a safety valve. Another feature that makes the Master No. 45 the safest torch is the one opening in the tank—above the fuel line.

And then, to cap it all, the Master No. 45 produces 400° greater heat, under all conditions—wind or intense cold—even with the poor grades of kerosene and gasoline obtainable today.

Greater Heat — Absolute Safety — Fearlessly Guaranteed

If your hardware man hasn't a
TURNER Master No. 45 Blotorch
mail your order direct to us.

\$7.75
POST-PAID

THE TURNER BRASS WORKS
Industry Ave., Sycamore, Ill.

Shoot the Best Gun

The NEW BENJAMIN is the finest air rifle ever made. Unlike all others. Has amazing accuracy—shoots hard and far. It's the original American genuine AIR operated rifle. One to six pump strokes compress air to any desired degree of power. Same force as in air drills and air hammers except you control the shooting force. Never loses force—no springs or levers to get out of order. Makes crack shots quickly, inexpensively. Gives years of delightful recreation with utmost safety. At your dealer's, or sent postpaid for \$5.00.

Shoot 5 Days FREE

We give you five days, ammunition supplied, to test the NEW BENJAMIN. If in this time you don't believe it to be the finest air rifle you've ever seen or used, and if you don't believe it is the one and only air rifle for you, return it, postpaid, and your money will be refunded at once.

The NEW BENJAMIN AIR RIFLE

America's Original Air Rifle

\$5 at your dealer's or sent postpaid direct from factory on FREE Trial as above if dealer does not handle it—write for our wonderful offer.

Get This Book and Details FREE

BENJAMIN AIR RIFLE & MFG. CO.
635 N. Broadway, St. Louis, Mo.

Please send your amazing offer and free copy of "The Shooter's Art," telling how to become a crack shot, how to hold, aim, and handle guns and guide others in use of guns.

Name _____

Address _____

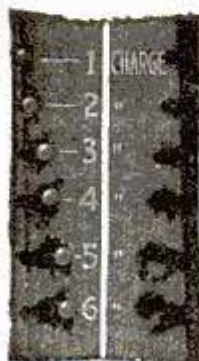

THE WOTEN GASOLINE ENGINE

Air-cooled—Water-cooled. One H. P. in 20 pounds. Handiest little engine ever made. Ideal wherever power is needed. Also the Metalum Model Airplane Engine, one-half H. P. in 3½ pounds. The market demands them in thousands. Generous agency propositions on request. Complete line of small gasoline and steam engines, battery chargers, etc. Catalogue Free.



DYNAMIC MANUFACTURING CO.
First Nat'l Bank Bldg., Dept. 7, CHICAGO

Chevrolet Coach FREE



Not a contest—but a bonafide opportunity to get a high-grade, gear-shift, closed car FREE, and also make \$50 weekly in spare time—\$100 in full time—selling my stylish new Cassimere Suits. My suits are amazing values at \$18.50. Sell like hotcakes. Preachers, teachers, office and factory workers, mechanics, etc., are making big money. No cash or experience needed. I furnish everything—tell you everything. Write quick for special offer!

C. E. Comer, Pres., THE COMER MFG. CO., Dept. W-5119, Dayton, Ohio

MEN \$75 Every Week



I Show You How Send For Samples

Yes, hundreds make more. But no wonder Fashion Wear Shirts take prospects "off their feet" when you tell them the amazing low prices for these fashionable, smart shirts. You can earn \$10 to \$15 every day just calling at factories, offices, garages, etc.

Every Man Wants 3 for \$4.95

Big profits for you. Satisfaction guaranteed or money back quick. You don't need experience. Samples sent absolutely free. Just send name on postcard. Make \$10 to \$15 the day samples arrive. But you must act quick on this unusual offer. Address **Charles Hope,**

FASHION WEAR SHIRT COMPANY
1200-20 Jackson Street, Dept. P-352, Cincinnati, Ohio

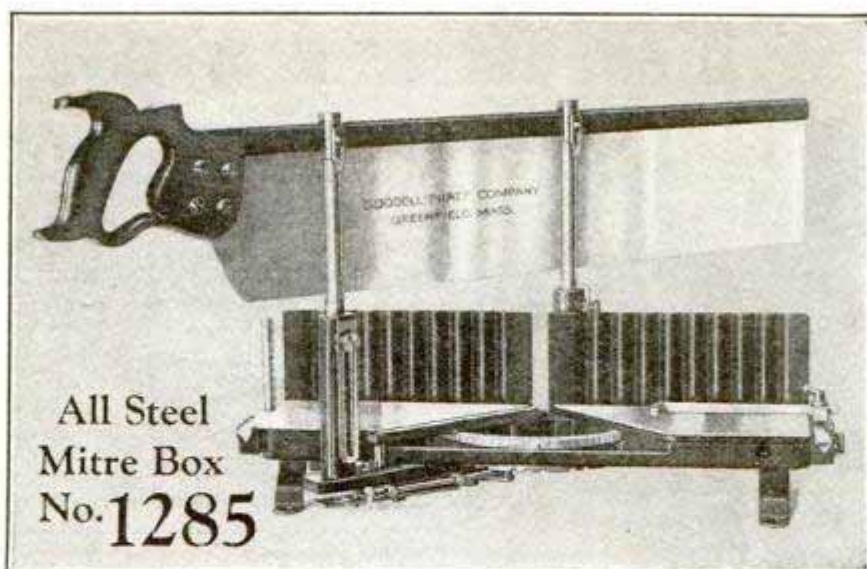

So Easy . . .

to figure any angle with this mitre box

THIS Goodell-Pratt Mitre Box figures your angles for you. Not merely 45 and 90°, but *any* angle you want.

If, for instance, you want to cut a beam or rafter to rise 4 inches to the foot, just set the indicator on the scale to 4—and you're all ready to saw.

Simple—quick—accurate. Saves you time and trouble and possible mistakes. No skill needed to use it.

No. 1285 is all-steel—the *only* all-steel mitre box made. It is trussed like a steel bridge. It won't bend or break.

The bottom plate is scored, so your wood won't slip while you're sawing. Both length and angle attachments provided. Fitted with first quality Back Saw.

You won't know how easy it is to cut *any* angle with absolute precision until you try this No. 1285 Goodell-Pratt all-steel Mitre Box. It is sold by good hardware stores. Its price, complete with 28x5 in. saw, is \$27.50.

*Write for this
FREE BOOK
of good tools*

Our Catalog No. 16 pictures and describes the Goodell-Pratt 1500 Good Tools. This book is valuable to the handy man and home mechanic. It's free. Write for it now.

GOODELL-PRATT COMPANY, GREENFIELD, MASS., U. S. A.

MAKERS OF *Toolsmiths* MR. PUNCH

GOODELL-PRATT

1500 GOOD TOOLS

Play a Tune

On Your Favorite Stringed Instrument



in 10 Minutes!

No Knowledge of Music Necessary
No Tiresome Practice

Now you can pick up your favorite stringed instrument and play a tune almost instantly, even if you don't know one note of music. These wonderful Ferry Player Instruments take all the work out of learning to play. No expensive lessons. No complicated musical signs and symbols. Play by numbers instead of notes (or by notes if you wish). Just press the numbered keys and you are playing tunes. Hundreds are playing Ferry Player Instruments who could never learn the old way.

Amazing New Invention

This is not merely a system of instruction—it is a new device invented by a musician that revolutionizes stringed instrument playing. Ferry Player Instruments give clearer, truer tones, are easier to finger and anybody can play.

Famous Vaudeville Star, Trisxie Friganza, writes: "I learned to play a tune in 3 minutes and had never touched a stringed instrument before." John Matise wrote: "Played tunes on Guitar the same day and am delighted. Anyone can play." Leonard Cleary: "In only a few days I have had my money's worth in fun. It certainly is one fine instrument."



Send for FREE Book Tells all about new Ferry Player Instruments and how you can play in 10 minutes. Also Free Catalog of special bargains in musical instruments. No obligation. Send for this Free Book now! Your friends will be astonished at your learning to play so quickly. You will be popular and always sure of a good time. Send coupon today.

Choose Your Instrument

What is your favorite stringed instrument? Send for this Free Book, and choose the one you would like to play. You can play it in 10 minutes! Send coupon now!

FERRY & Co. Dept. 8778, Chicago, Ill.

Send me Free Book on "Instant Playing" Instruments and tell me how I can play tunes in 10 minutes. No obligation.

Name

Address

City.....State.....

1200 LETTERS AN HOUR. Sealed and Stamped

With a So-Easy Moistener. Always ready, sanitary, saves licking your stamps, envelopes, gummed labels. Used by Sears-Roebuck and Montgomery Ward & Co. Thousands sold everywhere. Price \$1.25. SPECIAL—10 Days. Send \$1.00 bill for moistener, big office supply catalogue. "How to stamp and seal letters."

C. MOHLER, Box 453, CHICAGO, ILL.



\$5 FOR MEN EARN MONEY IN SPARE TIME

If you only have 2 or 3 hours a day spare time, especially evenings, you can turn them into CASH. Wonderful new article, sells itself to motor car owners. No experience necessary. \$1 to \$4 an hour earned in spare time. Every man, young or old, who needs money, send stamp for particulars.

Wonderlamp Company, 919 Fisk Building, Dept. A10, New York City

SAVE 1/2 ON PLUMBING & HEATING SUPPLIES

CATALOG FREE

90 pages. Beautifully Illustrated—Warranted high quality or money back. Get our Catalog before you buy. STANLEY PLUMBING SUPPLY CO., Inc. 1000 Spring Garden St. PHILA., PA.



PATENTED DRILL BLOCK

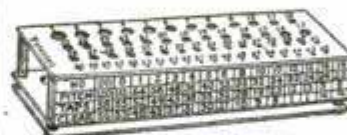

Light—compact—accurate—and practical. Non-corrosive metal, dull nickel finish. Thousands in use by mechanics. No. 1 holds drills 1 to 60. No. 2 holds drills 1-16 to 1/2 by 64ths. Sent post-paid anywhere in U. S. for \$1.25. Special literature sent on request.

GENERAL HARDWARE MFG. CO., 35 Warren St., New York

Big Xmas Sellers

Make \$1,000 between now and Xmas! Easy sales. Big list of holiday combination offers. Big season just ahead! Write today for list 18N.

C. I. TOGSTAD CO. 25 S. Clinton St. Chicago, Ill.



Papier Mache Deer Head Forms

Ready to attach horns, draw skin over face—have a perfect job. We make forms turned right, left sneaks to fit the north or south deer. Moose, elk, caribou, goat, open mouth rug heads.

New illustrated circular

Papier Mache Specialties Co. Reading, Michigan

RADIO TUBE SETS AND KITS FREE

New catalog of 5 and 7 Tube Sets and Kits The new and improved Hetro Magnetic Receiver—send for trial offer and proofs. \$35.00 UP

MERCURY ELECTRIC CORP., 2030 GRAND AVE., N.Y.C., N.Y.

Get into the MAIL ORDER Business

We supply you catalogs with your name printed on cover. BUY GOODS AS YOU NEED—good merchandise at low prices. Sample catalog and information free.

BIG 4 CO. 553 LAKE STREET A CHICAGO

REMINGTON PORTABLE TYPEWRITER Dealers and Branches Everywhere

861 IDEAS for Farmers

The experiences of 417 farmers and farmers' wives have been combined in "The Most Remarkable Book Ever Published for Farmers." There are 138 ideas for the farm shop, 35 on fencing, 98 on auto, truck and tractor, 61 on farm buildings, 36 on field machines, 48 on concrete work, 22 on orchard work, 23 on painting, 15 on live stock, 34 on poultry, 54 on garden work, 25 on electrical work, 22 on farm tools, 16 on hunting, fishing and trapping, 140 household helps, and many others.

SEND NO MONEY—Simply write a postal asking that Popular Mechanics Handbook for Farmers be mailed to you. When the postman delivers the book, simply hand him \$1 plus the few cents postage.

POPULAR MECHANICS PRESS Popular Mechanics Bldg. Room 611 Chicago, Illinois



Be my partner!

start *your own* TIRE BUSINESS

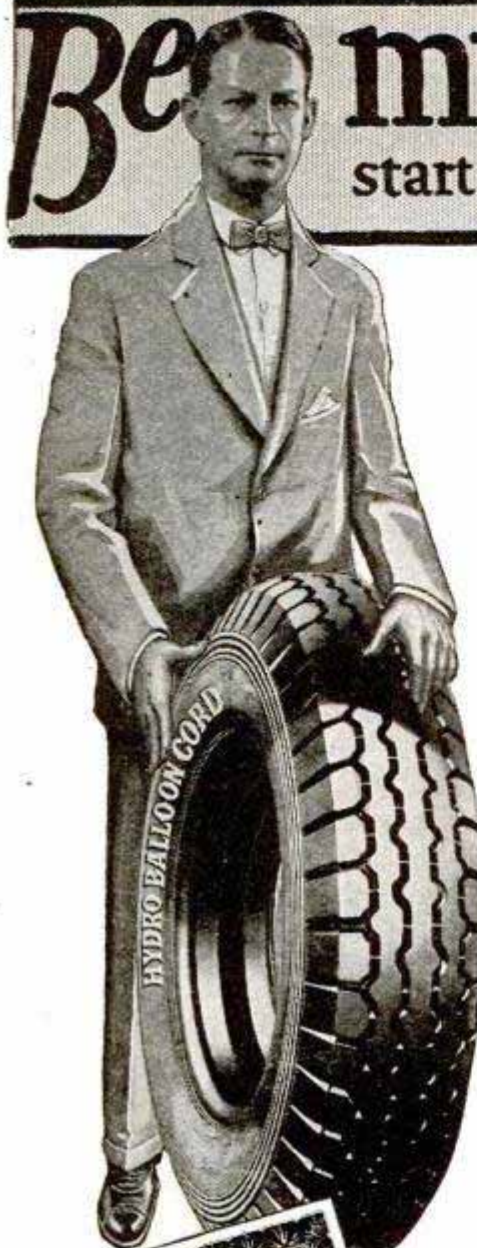

sell this marvelous tire
INSURED - for One Full Year **FREE!**

Make \$50-\$100 Weekly by Taking an Agency for Hydro 'Insured' Tires - Sold Only Through Authorized Salesmen-Agents

If you would break away from the monotonous routine of working long hours for a small salary—if you would want a snug bank account—if you want full or spare time occupation in dignified and fascinating work—**BE MY PARTNER!** Become an agent for **HYDRO 'Insured' TIRES** and with my assistance you will quickly establish a profitable tire business right in your own community. Every car owner wants Hydro Tires because they have *no competition in price — no rival in quality — no imitation in appearance — and no equal in the insured protection to the user*

No capital is required! The Hydro Plan is based on the fact that in every community there are worthy men who could easily become successful if they had the proper incentive. Many of these men are harder workers, better salesmen, and capable of making more money for themselves than the dealer who waits for business to come to his store. Perhaps **YOU** are the man we are looking for! If so, here is the chance of a lifetime to earn *real money*, because you sell a necessity that has *one of the greatest markets in the world*. Your prospects are limited only by the number of cars in your territory. Investigate!

The User's **FIRST** and **ONLY** Cost less than Dealer's Prices on other Uninsured Brands

Ours is the only tire factory in America selling its product only through authorized Salesmen-Agents. Eliminating the profits of jobbers, brokers and dealers enables us to offer car owners, real, outstanding Tire Values which mean quick sales

HYDRO

Insured **TIRES**
The Most Beautiful Tire in America

HYDRO TIRES — unsurpassed in quality and outstanding in performance, are definitely insured for **ONE FULL YEAR** against everything except theft! Each user is furnished with a **Tire Insurance Policy** that assures him a year's tire service regardless of wear or mileage. This is the sort of protection every car owner wants and Hydro is the first to offer it. It is the user's **Guarantee of Service**. Be the first in your community to sell tires that are completely **INSURED** for one year.

Act Now! Before Your Territory is Allotted

The man who succeeds and makes money is he who grasps an opportunity quickly. Hydro Agents are accepted on the exclusive territory basis. I want you to represent me in your territory, where there are thousands of dollars in profits waiting for some live hustler. I'll give you every cooperation. Just send us the coupon below and you can get started at once.

J. G. Faust
President.

SEND for Your SELLING KIT now!

This valuable **KIT**, complete for making demonstrations and easy sales, is supplied to Hydro Agents under our Agency plan.

THE BUSINESS OPPORTUNITY OF A LIFETIME!

Want to make extra money evenings and during spare time? Want to establish yourself in an enjoyable, profitable business of your own? Send now for complete details of the Hydro Exclusive Agency plan! Be a Partner in this \$1,500,000 company. Ambitious men are now making money by selling **HYDRO TIRES**. You can too!

Send us **Now!** Coupon



HYDRO-UNITED TIRE CORP. . . POTTSTOWN, PA.

HYDRO-UNITED TIRE CORPORATION, Pottstown, Pa.

Tell me how I can secure the Hydro Agency for my territory, and make from \$50. to \$100. a week as your representative. This does not obligate me in any way.

PM-11-20

Name _____

Address _____

City _____ State _____

Buy Army Aero Motors

129 miles per hour, 5 passengers, Ortonville, Minn.



Gnome 9 cylinder air cooled 165 H. P. as pictured, weight 292 lbs., complete for ice sleds, motor boats, snow sleds, 900 delivered.....	\$ 40.00
Gnome 50 H. P., 149 lbs., sport plane engine, 7 cylinders, complete.....	90.00
Le Rhone 120 H. P., 9 cyl., air cooled, 2 valves per cyl., complete.....	65.00
Le Rhone 80 H. P., 9 cyl., air cooled, 2 valves per cyl., complete.....	100.00
Curtiss 8 cyl., 90 H. P. OX5 water cooled motor boats, airplanes.....	250.00
Curtiss 8 cyl. 200 H. P. V23 water cooled motor boats, airplanes.....	200.00
Renault 8 cyl. 120 H. P. air cooled motor boats, airplanes.....	175.00
Liberty 12 cyl. 400 H. P. water cooled motor boats, airplanes.....	1500.00
Hispano Suiza 150 H. P., 180 H. P., 220 H. P., water cooled.....	\$275.00 up

All types surplus war aeroplanes, parts, wings, propellers, goggles. Makes Standard, Curtiss, Avro, Thomas Morse, Neuport. Fuselages \$50.00 up.

Write for Booklets. Enclose Postage

MARVIN A. NORTHROP

730 Washington Avenue, North, Minneapolis, Minnesota

Get Boice Prices Before You Buy!

As the world's largest builders of small bench machines, Boice offers greater values at lower prices with a positive money-back guarantee. Whatever you build, there's a Boice-Crane machine to do your work. Send 10c now for 64-page booklet containing helpful information and describing our circular saws, band saws, lathes, jointers, drills, mortisers, and other

Boice-Crane Bench Machines



Band Saw shown has 14" wheels, uses blades 3-16" to 1-2" wide. Saws 7" stock. Table 12x14" tilts 45 degrees. Has ball-bearing roller guides. Bronze bearings. **Bench Lathe** shown swings 8", C to C 19". Length 38 1-2". With attachments will do jig and circular sawing, grinding, sanding, drilling, furnished with metal-working model.

Handisaw model 3 shown, cuts 25-8" stock, Saw 8" diameter. Does ripping, grooving, moulding, mitering, rabbeting, sanding, grinding, etc. Dadoes 5-8" x 5-8".



All Boice machines are portable and driven by 1/4 to 1/2 h. p. motor attachable to light socket. Sold with or without motor. Send 10c for booklet today.—now!

W. B. & J. E. Boice, Dept. P. M. 11-B, Toledo, O.



NEW AUTOMATIC ADDER, \$3.50

Makes adding easy. It's accurate, quick, durable and easily operated. Capacity 8 columns. Saves time, brain work and errors. 75,000 pleased owners. Fully guaranteed. Price \$3.50 delivered. With metal operating bands, \$5.00 delivered. Agents wanted.

J. H. BASSETT & CO., Dept. 278, 1458 Hollywood Ave., Chicago, Ill.



Do Your PRINTING

Cards, stationery, circulars, tag, labels, paper. Complete outfits, \$8.85 up, Job Presses \$11 up, Rotary \$149. Card Cutters, \$3. Save money. Print for others, big profits. All easy rules sent. Write for catalog presses, type, paper cards, ink etc. **THE KELSEY CO., P-37, Meriden, Conn.**

MINNEAPOLIS LEGS ARMS



Largest Artificial Limb Center in the World

More limbs and braces shipped daily than from any other city. Write: **MPLS. ARTIFICIAL LIMB CO., 242 S. 4th St., MINNEAPOLIS, MINN.**

Free Treatment for Eye Troubles

Sufferers from dim or blurred vision, inflamed, weak and watery eyes; burning, smarting or granulated lids, and various other eye troubles, can now obtain a liberal test treatment of the famous Eye Ryne Drops absolutely free and postpaid by writing the Eye Ryne Laboratories, 210 West 8th St., Dept. 400-H, Kansas City, Mo. As this does not obligate you in any way, write today.

HOW TO MAKE DEVICES FOR OUTDOOR WINTER SPORTS

Motor-Driven Sleds and Ice Boats—Coasting Bobsleds and Toboggans—Skis—Gliders—Ice Yachts with Boat Book, 98c. Send No Money. Just write a postal.

Popular Mechanics Press, Room 611, 200 E. Ontario St., Chicago

AGENTS—\$60 A WEEK

We need men and women *now* to take orders for ZANOL Non-Alcoholic Food Flavors. Every variety. Put up in tubes instead of bottles. Six drops equal to teaspoonful of ordinary extract. Guaranteed under U. S. Laws. Preferred by housewives for convenience and economy. Used daily in every home. *Not sold in stores.* Fast repeaters. Steady, profitable, permanent business.

BIG PROFITS FROM 350 POPULAR ARTICLES

Any ambitious person taking orders for ZANOL Products, in spare or full time, can make \$35 to \$100 a week. Complete line of over 350 guaranteed Food Products, Toilet Articles and Household Necessities. *No experience required—we furnish complete equipment.* Just send your name and address and we'll forward FREE details of our money-making plan. Write **AT ONCE.**

THE AMERICAN PRODUCTS CO., 5648 American Bldg., Cincinnati, Ohio.



Only \$150

-and Easy Payments If Desired

With This Lathe You Can

- Machine Armatures
- Make Bushings
- Reface Valves
- Machine Pistons
- Undercut Mica
- Cut Threads
- Bore, File, Drill, Turn, Face, Grind, Polish, and do hundreds of other jobs.

Here is the greatest Lathe Value ever offered. A Universal Tool of highest quality and accuracy—one that will work metals of all kinds—cast iron, wrought iron, steel, aluminum, brass, bronze, copper, monometal—also fibre, hard rubber, and wood in pattern making. Note the many kinds of work it will do.

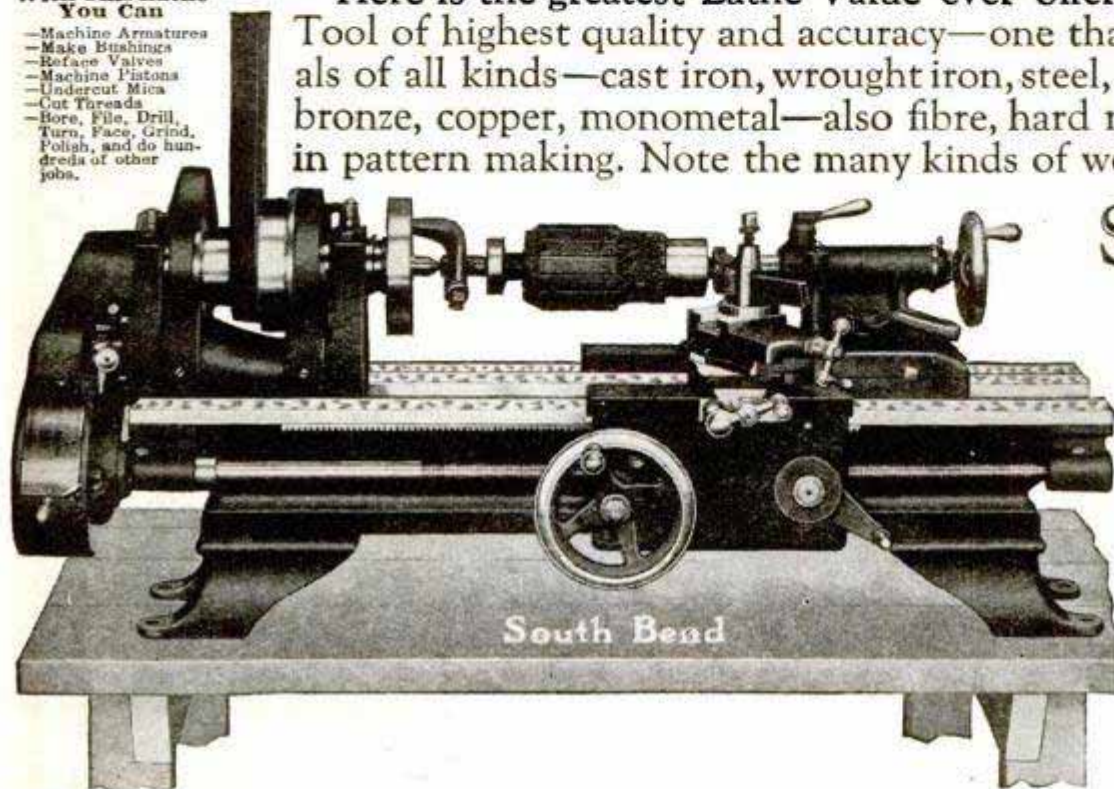

SOUTH BEND LATHE No. 22

Specifications:
 9 1/4" x 3' Back Geared Screw Cutting, swing over bed, 9 1/4"; distance between centers 16 1/2"; width of belt cone drive, 1"; length of bed, 3 ft. Power required, 1/4 H. P.; shipping weight, 350 lbs.

Complete Book of Instructions Sent Free with Each Lathe

It is as easy to learn how to run a Lathe as to learn to run a car. The operator soon becomes proficient, especially if mechanically inclined. With each South Bend Lathe, we send most complete book of instructions telling just how to do all kinds of work on the Lathe.



Easy Payments!

If you prefer, you can order any South Bend Lathe and pay for it out of income instead of capital. Write for Free Catalog and Bulletin No. 20-S, which tells all about this unusual South Bend Lathe now priced at only \$150. South Bend Lathes are also made in larger sizes from the 11" swing to the 24" swing.

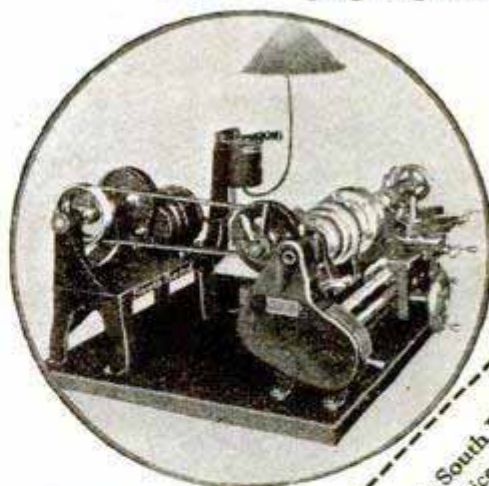

Illustration above shows South Bend Lathe No. 22 complete with Unit Drive very compact Bench Cutfit. Plugs in a light socket for power.

SOUTH BEND LATHE WORKS

815 E. Madison St.

South Bend, Ind.



Electrical Work



Piston Work



Cutting Threads

SOUTH BEND LATHE WORKS,
 815 E. Madison St., South Bend, Ind.
 Gentlemen: I would like your net factory price on a Screw Cutting Lathe, size _____ for (check kind of work)
 Manufacturing Machine Shop Carriage Work
 Please send Free Catalog.
 Name _____
 Address _____
 City _____
 State _____

Who's the Popular Boy?

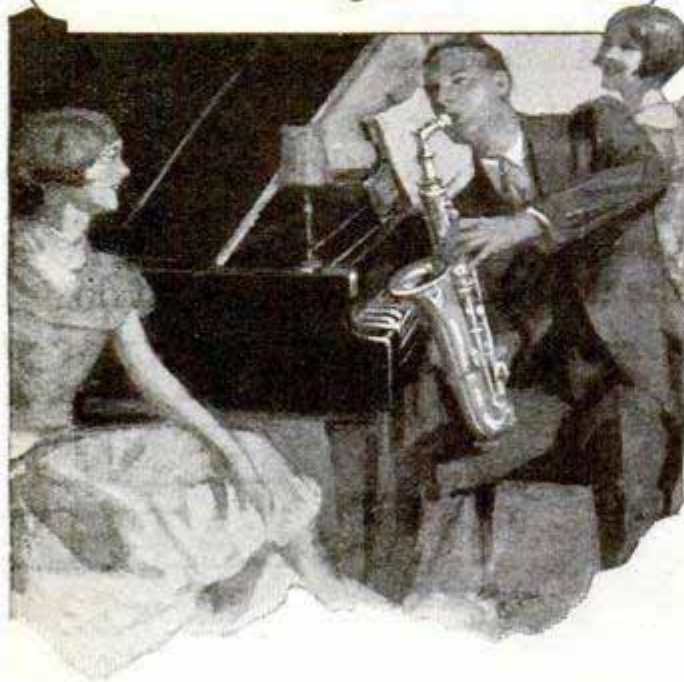

THE boy who plays a Conn is the most sought for fellow in his crowd. He's welcome everywhere, because he brings zestful, cheering music that everybody likes

With a Conn you can win this pleasure and profit quickly. Exclusive, easy-playing features speed your progress. Our simpler key system is easier to master; hydraulic expansion process makes easier blowing, more beautiful tone; perfect scale; drawn sockets with rolled edges and new foil pads eliminate trouble and improve tone.

Free Trial, Easy Payments on any Conn. Send the coupon or write now for free literature and details of trial offer.



CONN

BAND INSTRUMENTS
WORLD'S LARGEST MANUFACTURERS

C. G. CONN, LTD., 1131 Conn Bldg., Elkhart, Ind.
Please send free literature and details of free trial offer on

(Instrument)

Name _____
 St. or R. F. D. _____
 City _____
 State, County _____

Over 3,000,000 Users Endorse New Kerosene Light

Beats Gas or Electricity



MAKE your home bright and cheerful, saving one-half on oil. Scientific tests prove this wonderful new Aladdin 5 times as efficient as the best round wick open-flame lamps. 60 candle power pure white light for 50 hours on a gallon of common kerosene. No odor, smoke, noise or pumping up. Won't explode. **Guaranteed.**

10 Days' Free Trial

Prove to yourself by free trial that Aladdin has no equal as a white light. If not satisfied return at our expense. **Get Yours Free** We want one user in each locality to whom customers can be referred. In that way you may get your own without cost. Be the fortunate one to write first for ten day free trial and learn how to get one free.

AGENTS WANTED To demonstrate the Aladdin in territory where oil lamps are used. Experience or capital unnecessary. Many agents average five lamps a day and make \$500 a month. Write quick for territory and samples.

\$1000.00 Will be given to **REWARD** anyone showing us an oil lamp equal to this Aladdin in every way. (Full details of this offer given in circular.)

THE MANTLE LAMP COMPANY OF AMERICA
500 Aladdin Bldg., 609 W. Lake Street, Chicago, U. S. A.

MAN ALIVE!

This Amazing Device Adds
\$6750 A Week To Your Income



Ve Po Ad—the most sensational invention of the age! This remarkable little vest-pocket adding machine does the work of a \$300 machine. Adds up to a Million! Never gets out of order. Fully guaranteed. More than 100,000 in use!

Sells For \$2.95 — You Make \$1.35

Less than 10 sales a day brings you \$67.50 a week. **Ve Po Ad** astounds and fascinates. Positively accurate. Made of finest etched brass and handsomely cased in blue leatherette cover. Astonishing money saving value for \$2.95! Hundreds of prospects—merchants, grocers, butchers, farmers, garage men, salesmen—all need **Ve Po Ad** and buy like a flash on a minute's demonstration. You make 100% on each sale!

Get One FREE

No wonder salesmen are dropping everything to take up this record-smashing, fast-selling adding device. Shapiro out in California has made over \$475 a week selling **Ve Po Ads**. You can make money just as fast. No experience necessary. Write immediately for full details about **FREE Ve Po Ad** we will give you.

Reliable Typewriter & Adding Machine Corp.
180 West Washington St., Dept. 48, Chicago, Ill.



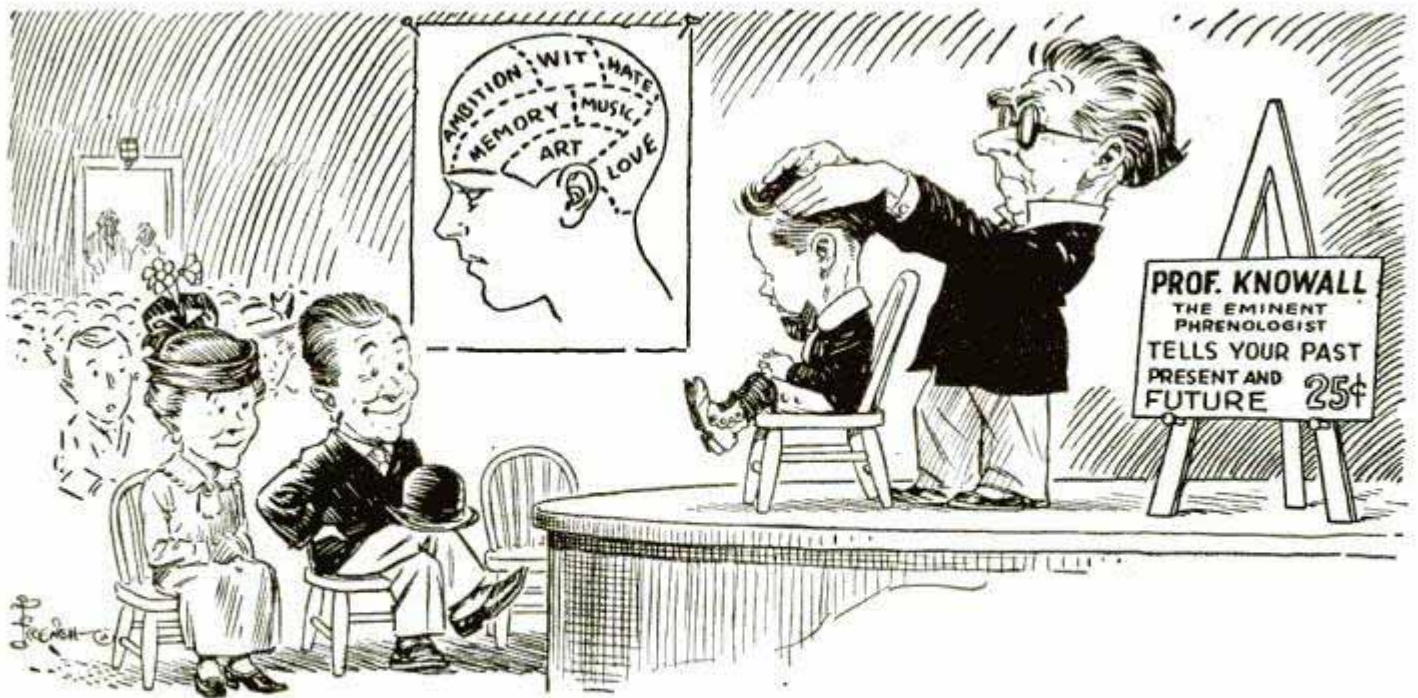

What Have the Bumps on Your Head Got to Do With Your Making Money?

By J. MATHESON BELL

WHEN I was a kid, it was a very popular thing to have your head examined by a phrenologist. He was supposed to tell fond parents what their beloved child would best be suited for.

By passing his hand over the bumps on your head he determined what you should be.

He made one big mistake, in my case, by feeling a certain bump and telling me I should be a preacher—I knew, what he didn't. I got that bump from falling out of a wagon.

More than that, I knew that if my father knew the truth, I'd get another bump, somewhere else, for having been in that wagon.

And so it goes, all through life. We never escape the bumps, of one kind or the other, and—they're not always the kind that hair grows on.

Some men seem to think that they have a monopoly on bumps—that they get them all, but the man never lived who didn't get his. The big difference in men lies in the fact that some men never talk about the bumps they get, while others do.

By their bumps ye shall know them. Every man gets bumps and lots of

them, big ones, little ones and occasionally a real whopper of a knockout.

It's the bumps of life that keep some men down and it's the bumps that make other men grit their teeth, swear a bit and become just that much more determined to win.

It's not how often that bump of hard luck hits you, but how you take it that counts.

Right now, you want more money. I'll bet you've tried hard, every way you can think of to get it—only to fall short—only another bump. Just when things were looking up and you thought you were about due to be on your feet, along comes sickness, out of work, or something else—just another bump.

It's bump, bump and nothing but bumps this whole life through.

Don't get the foolish idea that you can't whip every bump, because you can.

Maybe you wonder how I know.

Well, I'll tell you. I've had just as many bumps of hard luck as you ever did and maybe a few more. I know exactly how they feel and I know exactly how I licked 'em.

More than that, I've shown 4364 other men how to do likewise and I believe I can show you how to lick bumps. It may seem almost impossible to get to a point where they can't hurt you, but it's true nevertheless and if you don't

—it's the long sleep for you.

There's many a man who is so completely whipped by continued hard luck that he hasn't an ounce of comeback in him. It's all rot.

Don't tell me that you can't whip the world into giving you more money, a home of your own and a nest egg for a rainy day.

I'll prove it to you for a postage stamp. Just send for my 98-page book. It's a true story of life—of why some men fail while others succeed—of why some men slave their souls out working for others who enjoy themselves. If this book isn't worth the effort of a letter and the cost of a postage stamp, then you have my sympathy.

P.M.

Use
This
Coupon!

J. Matheson Bell,
President
OZARKA, INC.
124F W. Austin Avenue C
Chicago, Ill.

I am greatly interested in the FREE Book, Ozarka Plan No. 100, telling how I can establish myself in the radio business and add \$25.00 to \$50.00 to my weekly income in spare time.

Name.....

Address..... City.....

County..... State.....

OZARKA



INCORPORATED

124 F W. Austin Avenue C
Chicago, Illinois

124FW. Austin Ave. C
Chicago, Ill.



“Good Bye, Boys!”

“To-day I dropped in for a last word with the boys at the office. And as I saw Tom and Dave there at the same old desk it came to me suddenly that they had been there just so the day I came with the firm four years ago.

“When I started here I was put at a desk and given certain routine things to do. But after a few months I began to realize that I was nothing but a human machine and that I couldn't expect to advance that way.

“So I wrote to Scranton and arranged for a spare-time study course that would give me special training for our work. Why, do you know, it gave me a whole new interest in our business? In a few months I was given more responsibility and more money. Since then I've had three increases, six months ago I was put in charge of my department, and now my big chance has come—I'm to be manager of our Western branch at \$5000 a year! It just shows what spare-time training will do.”

If you want to make more money, show your employer you're trying to be worth more money. If you want a bigger job, show him you're willing to prepare for it.

There's a simple, easy way to do it. For 35 years the International Correspondence Schools have been training men and women right in their own homes whenever they had a little time to spare. Thousands of men and women have stepped up in just this way. More than 180,000 are studying now. Ten thousand are starting every month.

Can you afford to let another priceless hour pass without finding out what the I. C. S. can do for you? Here is all we ask—without cost, without obligation, mark and mail this coupon.

INTERNATIONAL CORRESPONDENCE SCHOOLS

Box 5612-E, Scranton, Penna.

Without cost or obligation, please tell me how I can qualify for the position or in the subject before which I have marked an X:

BUSINESS TRAINING COURSES

- | | |
|--|---|
| <input type="checkbox"/> Business Management | <input type="checkbox"/> Salesmanship |
| <input type="checkbox"/> Industrial Management | <input type="checkbox"/> Advertising |
| <input type="checkbox"/> Personnel Organization | <input type="checkbox"/> Better Letters |
| <input type="checkbox"/> Traffic Management | <input type="checkbox"/> Show Card Lettering |
| <input type="checkbox"/> Business Law | <input type="checkbox"/> Stenography and Typing |
| <input type="checkbox"/> Banking and Banking Law | <input type="checkbox"/> Business English |
| <input type="checkbox"/> Accountancy (including C.P.A.) | <input type="checkbox"/> Civil Service |
| <input type="checkbox"/> Nicholson Cost Accounting | <input type="checkbox"/> Railway Mail Clerk |
| <input type="checkbox"/> Bookkeeping | <input type="checkbox"/> Common School Subjects |
| <input type="checkbox"/> Private Secretary | <input type="checkbox"/> High School Subjects |
| <input type="checkbox"/> Spanish <input type="checkbox"/> French | <input type="checkbox"/> Illustrating <input type="checkbox"/> Cartooning |

TECHNICAL AND INDUSTRIAL COURSES

- | | |
|---|--|
| <input type="checkbox"/> Electrical Engineering | <input type="checkbox"/> Architect |
| <input type="checkbox"/> Electric Lighting | <input type="checkbox"/> Architects' Blueprints |
| <input type="checkbox"/> Mechanical Engineer | <input type="checkbox"/> Contractor and Builder |
| <input type="checkbox"/> Mechanical Draftsman | <input type="checkbox"/> Architectural Draftsman |
| <input type="checkbox"/> Machine Shop Practice | <input type="checkbox"/> Concrete Builder |
| <input type="checkbox"/> Railroad Positions | <input type="checkbox"/> Structural Engineer |
| <input type="checkbox"/> Gas Engine Operating | <input type="checkbox"/> Chemistry <input type="checkbox"/> Pharmacy |
| <input type="checkbox"/> Civil Engineer | <input type="checkbox"/> Automobile Work |
| <input type="checkbox"/> Surveying and Mapping | <input type="checkbox"/> Airplane Engines |
| <input type="checkbox"/> Metallurgy | <input type="checkbox"/> Navigation |
| <input type="checkbox"/> Steam Engineering | <input type="checkbox"/> Agriculture and Poultry |
| <input type="checkbox"/> Radio | <input type="checkbox"/> Mathematics |

Name.....

Street.....

Address.....

City..... State.....

Occupation.....

Persons residing in Canada should send this coupon to the International Correspondence Schools Canadian, Limited, Montreal, Canada.

Prepare NOW for Christmas

\$2

Brings Your Choice

Buy a Xmas gift on the same basis as 95% of the automobiles are bought. Pin \$2.00 to this "ad," indicate selection and mail today. Your choice will come for a 15-day trial. Try to duplicate elsewhere for less money. If satisfied, pay balance in 10 equal monthly payments. Otherwise, return and your \$2.00 will be refunded. No red tape—prompt delivery—dealings confidential.

\$10-\$45 Complete
See Description Below

\$10--14K white gold wrist watch; 4 blue-white diamonds; 4 blue sapphires. 15 jewel movement with expansion bracelet complete, in gift case \$45.00
\$4.30 a month.

\$12--Ladies 18K white gold ring. 2 diamonds in shank, large AAA blue-white diamond in center. \$39.50 - \$3.75 a month.

\$13--Ladies 18K white gold ring; AAA blue-white diamond \$50.00
\$4.80 a month.

\$14--18K white gold lace-work design, with 3 blue-white diamonds \$29.50 - \$2.75 a month.

\$15--Gents 18K white gold ring, extra heavy; blue sapphire in center; 2 blue-white diamonds \$57.50
\$5.55 a month

\$17--12 size, 7 jewel Elgin watch; 14K gold-filled case; with chain and 14K gold-filled fountain pen complete \$23.50
\$2.15 a month.

\$18--Famous BULOVA Gents Strap Watch 14K gold-filled case; 15 jewel movement. \$28.50 - \$2.65 a month. It's a Bulova \$18--\$28.50

\$12..\$39.50

\$13..\$50.

\$14..\$29.50

\$17 \$23.50

L.W. SWEET Inc.

DEPT. 66S 1660 BROADWAY NEW YORK

IT'S FREE!
Complete Booklet of appropriate Christmas Gifts, Diamonds, Watches and Jewelry.
Send for it TODAY.

\$25.00 a DAY-CLEAR

Write Quick for Details

SURFACING FLOORS

Scores of inexperienced men whom we started as American Universal Floor Surfacing Contractors are making up to \$10,000 a year in this wonderful, new, uncrowded field. Electrically driven American Universal Machines do 500% more work and 100% better work than most expert hand scraper, and earn six men's pay. Work is plentiful, fascinating, immensely profitable. Experience unnecessary. Small amount starts you. We furnish everything, teach you, help you succeed. Opportunity of lifetime to be your own boss and make big money.

AMERICAN FLOOR SURFACING MACHINE CO.
523 So. St. Clair St. TOLEDO, OHIO

Ives Electric Reversing Locomotive. The third successful year. Operated by Ives Push Button Control. Press the button to stop—again to reverse.

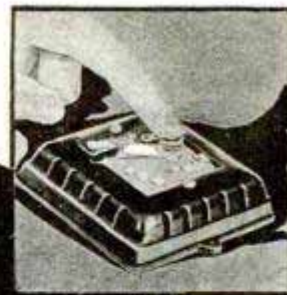
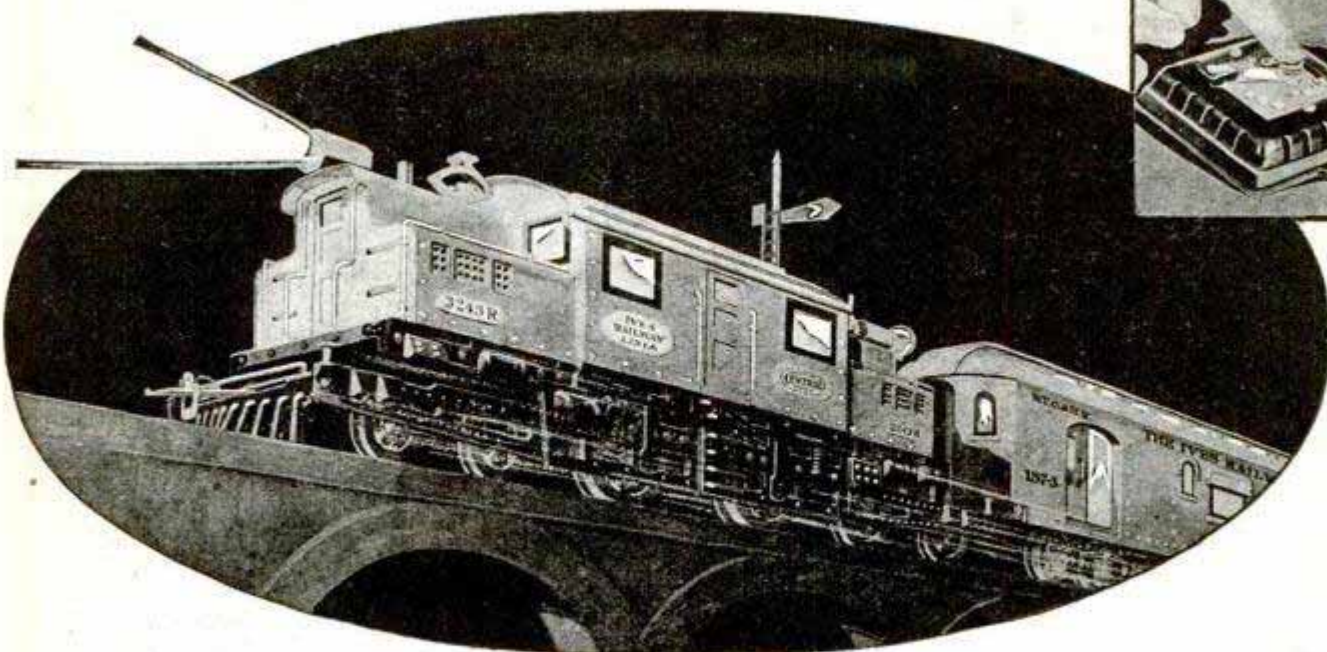

Just like sitting at the throttle of the *Twentieth Century Limited!*

WITH an Ives Electric Train you can do *everything* that the engineer of the famous Twentieth Century Limited can do!

Your Ives express speeds around the track. Automatic Signal 333 flashes out the warning at the highway crossings, keeping the track clear (*Safety First!*). Signal 331 flashes to the engineer danger or clear track, as the case may be.

When Signal 331 flashes the red, press the button and the train stops. Press it again, and it backs up to the point of safety. Now the light flashes green. Press the button twice, and proceed on your journey. How can you beat it for real good fun and realism!

Every up-to-date feature

IVES Trains have every device ever invented for making miniature trains just like their models, the famous transcontinental flyers. The only difference is in their size!

Ives locomotives have all kinds of

power for pulling long trains at express speed. All motors, even the smallest, are built with extreme care. Shining brass name and number plates make the cars and locomotives things of beauty.

You have a fascinating selection from the almost endless variety of passenger and freight cars, electric target signals and semaphore signals, tunnels, bridges, stations, etc. Prices range from the \$1.50 mechanical train to the big, complete \$50 electric outfit.

Toy, department, electrical, hardware and sporting goods stores sell Ives Trains.

Biggest, most interesting Train Book for boys ever issued—FREE

THE 1926 Book of Ives Trains is the largest, most colorful and fascinating book of miniature railways ever published. It has 44 pages, illustrated in full colors throughout, and tells you everything you want to know about electric and mechanical trains. Mail the coupon today.

[Safety First!]



Ives Automatic Two-Light Target Signal 331
(For any size track)



Ives Automatic Bell-Light Banjo Signal 333
(For any size track)

The Ives Manufacturing Corporation

Established 1868

Holland Avenue, Dept. D-6, Bridgeport, Conn.

IVES ELECTRIC AND MECHANICAL **TRAINS**

THE IVES MANUFACTURING CORPORATION
Dept. D-6, Holland Avenue, Bridgeport, Conn.

Please mail me your FREE 1926 Book of Ives Trains, containing 44 pages in full colors.

Name.....

Street.....

City..... State.....

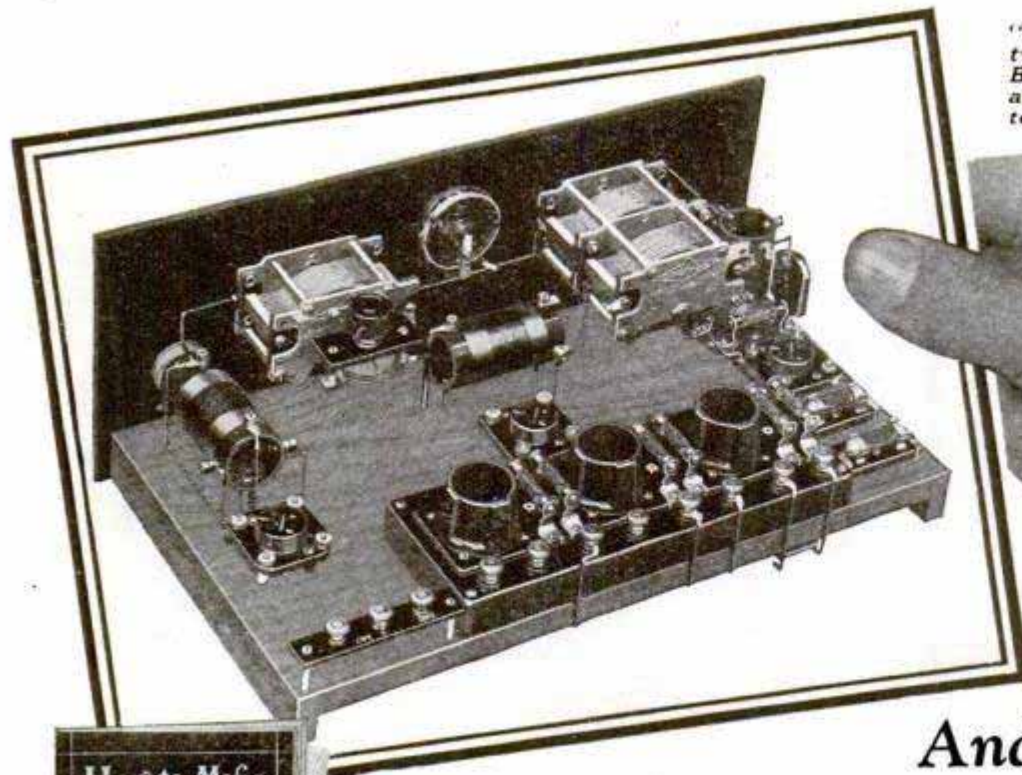

"Birds-eye" view of the new two-dial hook-up of the Daven Bass Note Circuit. Easy to assemble. The last word in tone quality.

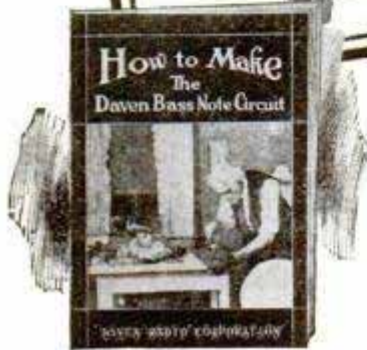

And Now— the Bass Note Circuit in a 2-dial hook-up

CLEARER than ever—even more selective—and always that crystal purity of tone—from highest soprano down to deepest, richest bass. The same astonishing Daven Bass-Note Circuit—with new refinements added.

For instance, two tuning dials only—instead of the usually accepted three. An R. F. choke coil that prevents the radio waves from entering the audio amplifier. A special compensating condenser that increases selectivity, especially in long-distance tuning. And a brand new layout, requiring less base space and a smaller, neater panel.

READ "HOW TO BUILD THE BASS-NOTE CIRCUIT"

A brand new booklet that tells you in the simplest, clearest way how to make yourself a Daven Bass Note Receiver. And a wiring diagram of an altogether new type—a boy can follow it clearly—shows you quickly how to assemble the parts. 25c per copy at any Daven Dealer's—or 30c by mail. And it's worth ten times as much in the new kind of radio reception it will help you obtain. Get your copy NOW—while the edition is plentiful—later on, you might have to wait for another printing.



DAVEN GLASTOR

the new Transparent Resistor. Enduring, noiseless. Changeless. Complete range of resistances.



DAVEN HI-DUTY GLASTOR

Specially designed for B-Eliminators. Will carry highest currents known to radio.

DAVEN

BASS NOTE CIRCUIT

for COMPLETE Radio Reception



NEW EDITION DAVEN MANUAL
This valuable Book explains Daven Amplification in full detail, and shows how to apply it to your set. 25c at dealers', 30c by mail. Complete Daven Catalog Free on Request.

"The Sine of Merit"
DAVEN RADIO CORPORATION
TRADE MARK "Resistor Specialists" REGISTERED
161 SUMMIT ST. NEWARK, N. J.



*Adjusted to Temperature
Adjusted to Isochronism
Adjusted to Positions
Adjusted to the Second
21 Ruby and Sapphire Jewels*



WONDERFUL QUALITY AND STYLE

Whether you want a lady's watch so small and dainty it becomes a piece of jewelry, or whether you want a watch made strong, sturdy and dust-proof for

all who need a watch for rough service, you will find it in the new Burlington catalogue—and at a remarkably low price, considering QUALITY.

21 JEWEL BURLINGTON

Yes, every Burlington watch for men has 21 jewels. The Burlington quality is exactly the same in the heavy service watch as it is in the very thin aristocratic model. Superior quality distinguishes the Burlington. We are proud of this distinction. Every owner is equally proud of it.

ROCK BOTTOM PRICES

This superb watch is sold on easy monthly payments at our rock bottom price. We send it on approval. Write today for the beautiful Burlington Book showing in colors the most complete assortment of watch styles and designs ever brought together under one cover.

Burlington Watch Co.

Dept. 13-58 19th St. and Marshall Blvd., Chicago
(Canadian Address: 118 Princess St., Winnipeg, Man.)

Please send me (without obligation and prepaid) your free book on watches, with full explanation of your liberal approval offer on the Burlington Watch.

Print name and address plainly.

Name

Address



**30
DAYS
FREE
TRIAL**

7 Tube Set Single Dial Radio

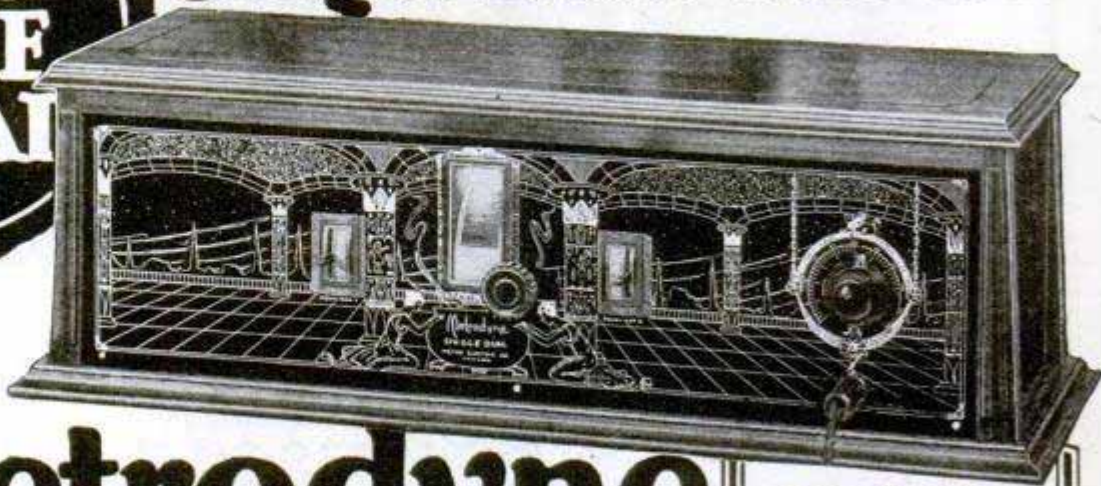

The Metrodyne

ONLY ONE DIAL TO TUNE

Retail Price
\$75

Completely Assembled
**BIG DISCOUNTS
TO AGENTS
AND DEALERS**

Wonderful offer direct from the factory! The world's greatest radio. A perfect working, single dial control, 7 tube receiver. And just to prove our claims, we will ship it to your home for 30 days' free trial. Test it under all conditions. Test it for distance, volume and tonal quality — and if you are not convinced that it is the best single dial set you ever heard, return it to the factory. We don't want your money unless you are completely satisfied.

BIG PROFITS TO AGENTS AND DEALERS

Our Agents and Dealers make big money selling Metrodyne Sets. You can work all or part time. Demonstrate the superiority of Metrodynes right in your home. Metrodyne Radios have no competition. Lowest wholesale prices. Demonstrating set on 30 days' free trial. Greatest money-making opportunity. Send coupon below—or a letter—for our agent's proposition.

Metrodyne Super-Seven Radio

A single dial control, 7 tube, tuned radio frequency set. Approved by America's leading radio engineers. Designed and built by radio experts. Only the highest quality low loss parts are used. Magnificent, two-tone walnut cabinet. Artistically gilded genuine Bakelite panel, nicked piano hinge and cover support. All exposed metal parts are beautifully finished in

24-k gold. Easiest set to operate. Only one small knob tunes in all stations. Dial is electrically lighted so that you can log stations in the dark. Volume control regulates reception from a faint whisper to thunderous volume, 1,000 to 3,000 miles on loud speaker! The Metrodyne Super-Seven is a beautiful and efficient receiver, and we are so sure that you will be delighted with it, that we make this liberal 30 days' free trial offer. You to be the judge.



**6
Tube Set**
\$48.50
RETAIL PRICE
Completely Assembled

METRODYNE SUPER SIX RADIO ON 30 DAYS' FREE TRIAL

Wonderful 6 tube, long distance radio set. Approved by America's leading Radio Engineers. Easy to operate. Dials log easily. Tune in your favorite stations instantly on the same dial numbers every time. No guessing. 30 days' free trial.

Mr. Howard of Chicago said, "With 5 Chicago Stations on the air I tuned in 17 out-of-town stations, including New York and San Francisco on loud speaker very loud and clear.

We are one of the pioneers of radio. The success of Metrodyne sets is due to our liberal 30 Days' Free Trial Offer, which gives you the opportunity of trying before buying.

MAIL THIS COUPON

or send a postal or letter. Get our proposition before buying a radio. Deal direct with manufacturer—**Save Money.**

Mail COUPON Below!

Let us send you proof of Metrodyne quality

C. J. Walker, Mariposa, Calif., writes: "Received my Metrodyne Single Dial set O. K. I believe that these one-dial sets are going to be excellent sellers. I had no trouble in tuning in stations enough to satisfy anyone, so you will please send me another set."

Roy Bloch, San Francisco, Calif., writes: "Very often we travel from New York to the Hawaiian Islands quickly—from station to station—by means of the little tuning-knob which operates the electrically-lighted dial. The Metrodyne Single Dial Set is much easier to operate than any radio set I've ever seen."

We will send you hundreds of similar letters from owners who acclaim the Metrodyne as the **greatest radio set in the world.** A postal, letter or the coupon brings complete information, testimonials, wholesale prices, and our liberal 30 days' free trial offer.

METRO ELECTRIC COMPANY
2161-71 N. California Ave., Dept. 148
Chicago, Illinois

Gentlemen:

Send me full particulars about Metrodyne 6 tube and 7 tube sets and your 30 days' free trial offer.

Name.....

Address.....

If you are interested in AGENT'S proposition, place an "X" in the square

METRO ELECTRIC COMPANY
2161-71 N. California Ave., Dept. 148, Chicago, Illinois

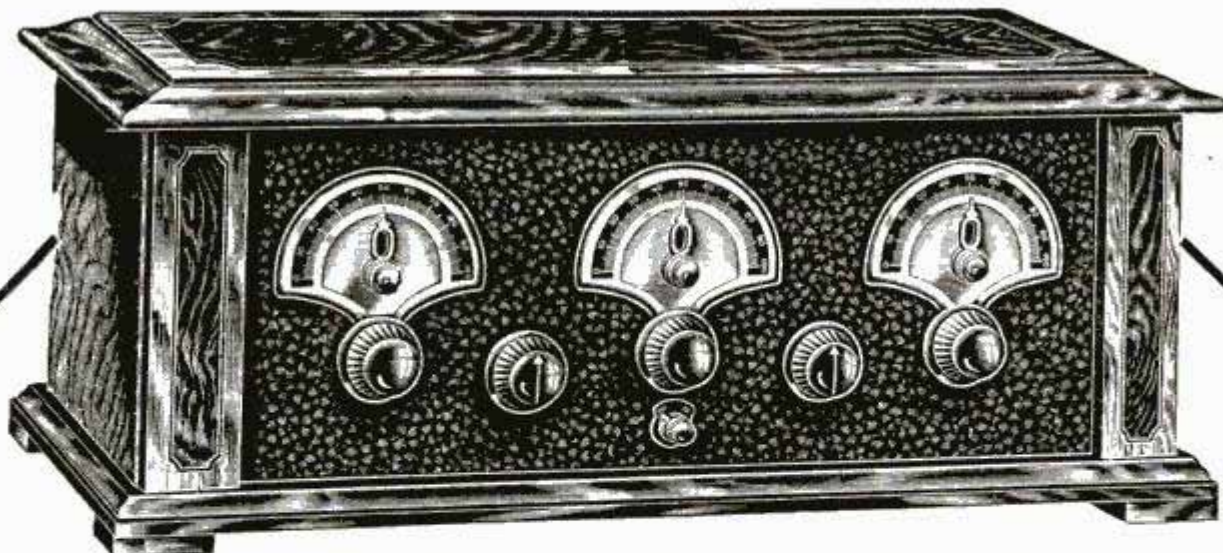

The Radio Set You Want at the Price You Want to Pay

A 5-Tube Set Superior to Most 6 and 7-Tube Sets in Tone Quality, Volume and Distance Getting

Nowhere will you find a value to compare with this remarkable new 1927 design 5-tube radio set. **DIRECT FROM FACTORY** to you at a tremendous saving. Embodies the newest forward steps in radio, such as U. S. Standard low loss coils, straight line frequency condensers, handy Vernier dials with etched metal plates. Gives you the best radio reception at low cost. A set you can buy complete cheaper than you can build. Direct from our own factory. The Barawik Company is one of the oldest radio specialty institutions in America, numbering 200,000 customers. Every item sold is of high standard. Buy from radio experts and save money. A remarkable 5-tube radio set—finer, better built and producing superior results. It is both rich and attractive looking, and for easy tuning, clear, sweet, natural tones, and distant reception. It is everything you will expect. Takes all tubes including the new power tubes.

Perfect Reproduction It stands alone in tone quality, as comparison with any set at any price will reveal. Is the choice of expert musicians who recognize finest distinctions of harmony and tone. Its beautiful, natural, well-rounded tones reproduce the human voice, whether in song or speech, as clear as a bell. Musical programs are reproduced in sweet, perfect tones, delightfully and harmoniously.

Artistic Cabinet Exceptionally fine hand-rubbed walnut finish cabinet. An ornament to any room. A truly distinctive, dignified cabinet in keeping with other Barawik qualities.

The Greatest Value Today—Look at These Prices! Quality considered, our prices are lowest. No where is there value to equal these prices.

\$24⁹⁵
 101Y5000—Set only, no accessories.....

Complete with All Accessories

For Storage Battery Operation Including: 5 201A type tubes, 2 45-Volt "B" Batteries, 1 Fine Loud Speaker, 1 6-Volt Storage Battery, 1 Complete Antenna Equipment, 1 "C" Battery, 1 Fine Head Set. Complete.

301Y5001—Shipping weight, 120 lbs..... **\$56.95**

301Y5002—For Dry Cell Operation Including: 5 199 type Tubes, 2 45-Volt "B" Batteries, 1 Fine Loud Speaker, 3 Dry Cell "A" Batteries, 1 "C" Battery, 1 Fine Head Set, Complete. Shipping Wt. 45 lbs..... **\$51.50**

Anyone can set up this outfit in an hour or so. Transportation charges extra.

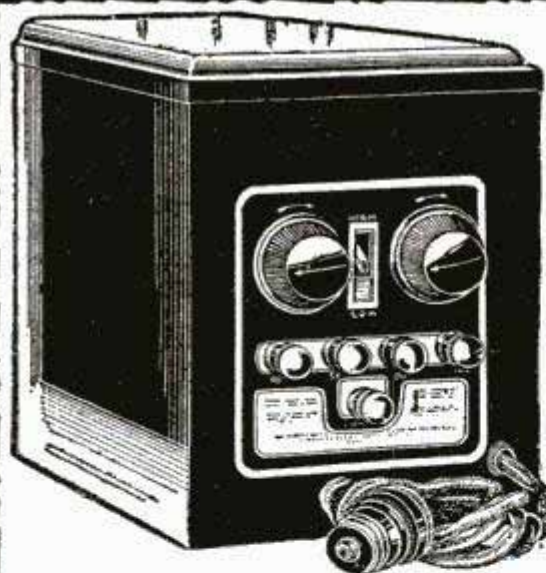

\$26⁹⁵

50 Milliampere Capacity at 150 Volts.

...
Delivers Up to 180 Volts.
 ...

For Sets Up to 10 Tubes

Genuine Raytheon "B" Eliminator

Made for us by America's leading manufacturer of "B" eliminators, of highest quality materials from expensive finish of real green Duco on case to genuine Raytheon tube. Filtering system of 1000 volt high-test condensers and extra capacity choke coils completely remove all hum out of alternating current.

Connect to your light socket, 110-volt, 60-cycle, A. C. current; uses few cents of current a week; pays for itself in replacing "B" batteries. Reception is clear, long distance easy to get due to constant output. Furnished completely assembled, ready to use, and fully guaranteed. Send your check or money order today. C. O. D. orders accepted with 25% deposit. Postage 30c extra. **\$26.95**

103Y575—Net price.....

The Barawik Co.

540-551A Monroe St., Chicago, Ill.

FREE RADIO GUIDE

Newest 1927 Edition

Shows the latest circuits, the newest developments in radio at startling low prices. Get the parts you want here and save money. The best in parts, kits, complete factory-built sets and supplies. Orders filled same day received. Write for free copy NOW; also please send names of one or more radio fans. Use coupon below.

BARAWIK CO., 540-551A Monroe St., Chicago



MAIL TODAY

BARAWIK CO., 540-551A Monroe Street, Chicago. Send me my copy of your new 164-page Radio Catalog and Builder's Guide for 1927.

Name.....
 Address.....
 Friend.....
 Address.....

We Guarantee to Improve Your Voice 100%



Read how to do it in "PHYSICAL VOICE CULTURE", the greatest book ever written on voice building. It will show you the one scientific, tested way to build a powerful singing or speaking voice. Send coupon below for—

Free Book!

Glad to Tell Everybody What Your Course Did

I shall certainly be delighted to tell anyone what your course did for me. In fact, I have been telling people for the last three years and started several people in the work in Japan.

When one lives in New York, as I do now, and sees the number of wholly unqualified people who are teaching singing, it seems as if there ought to be some test for teachers. I think that learning ten operatic roles, one after another, is a pretty good test of the condition of a person's throat, don't you? My voice doesn't seem to have suffered in the least from it. Florence Mendelson, New York City.

Wouldn't Part With Course for \$1,000.00

I have a great deal to say about this wonderful course, and want you to know that I am a happy man since taking it up. I needed your course badly, very badly. Being a teacher, I have to speak, at times, quite loud, and the strain on my throat was actually felt, and hoarseness followed. My voice is absolutely clear and resonant now. In fact, I have no words to thank you enough. I wouldn't part with my course for a thousand dollars.

Julio C. De Vosconcellos, New Bedford, Mass.

Lost Voice Restored—Sings Better Than Ever

I am very glad to be able to inform you that the study and practice of your exercises is making a great change in my voice.

You may appreciate what this means to me when I tell you that an illness while in France, weakened my throat to such an extent that I feared I would never sing again. However, after studying your lessons, I find that I can sing better than ever. In fact, I was told by a friend who had heard me sing at a reception that I had never been in better voice than I am now. J. Ralph Bartlett, Newton, N. H.

PERFECT VOICE INSTITUTE, Studio 93-58
1922 Sunnyside Ave., Chicago, Ill.

Gentlemen: Send at once, free and without obligation, your beautifully illustrated book "Physical Voice Culture" and full information regarding your home study method of voice building. It is understood that I do not have to pay a cent for this book, either now or later, and that I do not have to return it.

Name.....

Address.....

THE three letters on this page are from men and women who have learned that *Physical Voice-Culture* is the one, infallible, tested, scientific method of voice building. They are just a few of the thousands telling the same stories of success, in many cases, after all other methods of voice building had failed.

The new book, *Physical Voice-Culture* will show you how to build up a superb voice by the development of muscles whose existence you never suspected. No matter what condition your voice is in now, it will be improved at least 100% or every cent of tuition will be cheerfully refunded when you have finished the course.

Just a few years ago, Bert Langtre's voice was almost destroyed by catarrh and asthma. An impediment in his speech caused him untold embarrassment and suffering. Now he is singing in Grand Opera in California. "An unusual case," you say. Not at all. He merely took advantage of the opportunity you are given here.

Build up your voice the simple, easy, natural way by silent physical exercises in the privacy of your own home. The *Physical Voice-Culture* method is ideally adapted to home study. It is being taught as successfully by correspondence as by personal instruction. No one need know that you are studying until you have developed a strong, beautiful voice. When you are constantly urged to sing or speak at your church, at private receptions or public functions—when you are the most popular person in your circle of acquaintances, then you will know the rich rewards of *Physical Voice-Culture*.

Mail This Coupon!

Find out at once about the wonderful possibilities of your voice—possibilities that you have never realized! Simply send coupon for this book. Read the astounding *true stories* of what others have done. This may be the turning point in your life. Mail the coupon today.

Perfect Voice Institute
1922 Sunnyside Ave.
Studio 93-58 Chicago, Ill.



Now
Free

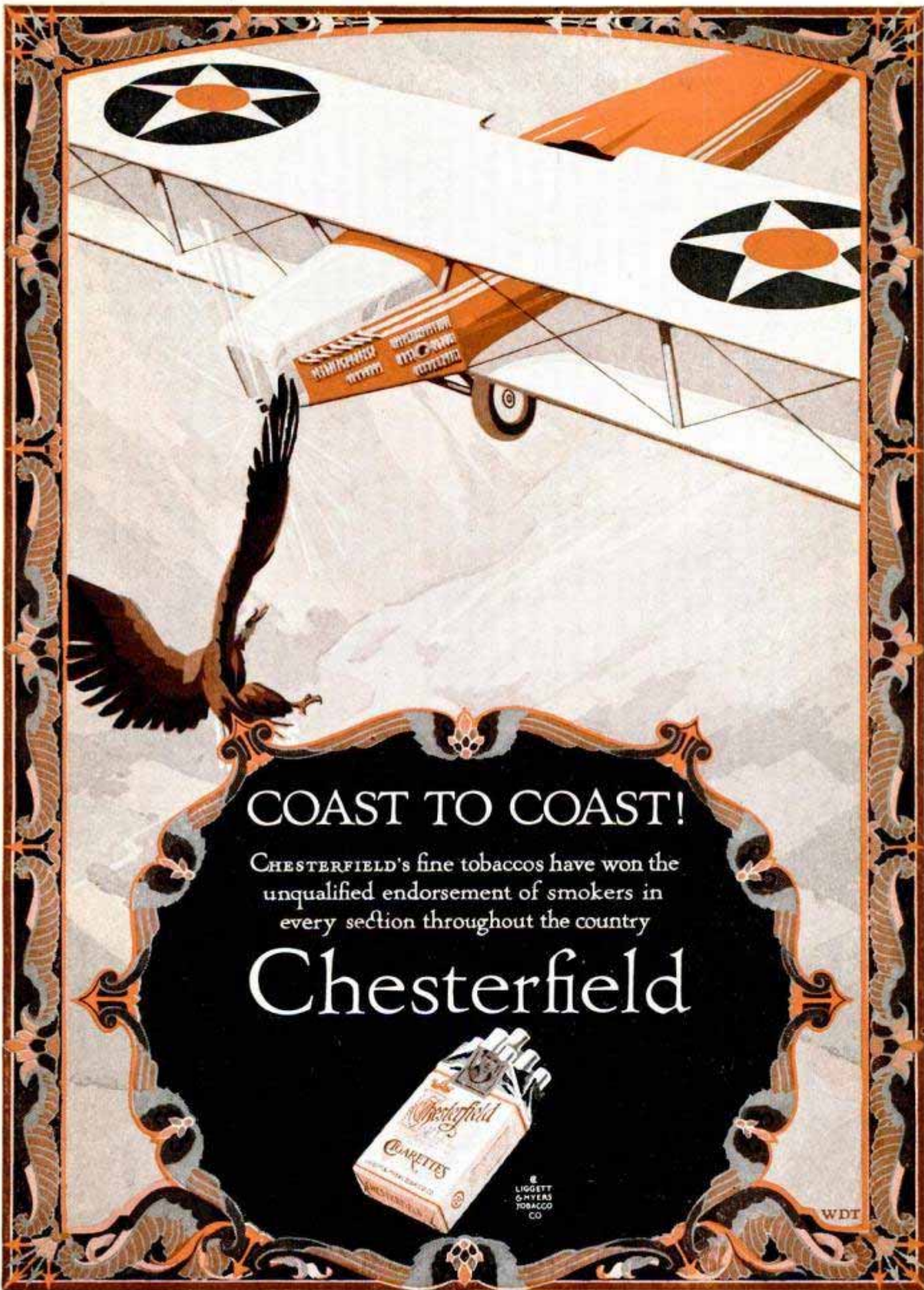

COAST TO COAST!

CHESTERFIELD'S fine tobaccos have won the
unqualified endorsement of smokers in
every section throughout the country

Chesterfield



LIGGETT
& MYERS
TOBACCO
CO.

W.D.T.

WURLITZER

TRADE MARK REGISTERED

THE WORLDS LARGEST MUSIC HOUSE



Try Any Wurlitzer Instrument in Your Own Home

EXAMINE it, show it to your friends, play it as much as you wish. An ample free trial—no obligation to buy. We make this liberal offer because we want you to see for yourself this superior quality of Wurlitzer instruments, the result of 200 years' experience. Noted musicians praise them for unusual tone quality, artistic workmanship and ease of playing. They are used in the finest bands and orchestras throughout the country.

Easy Payments

If you decide to buy, payments are arranged in small monthly sums. A few cents a day pays for your instrument. Special offers on complete musical outfits. Buy direct from Wurlitzer and save money.

SEND FOR New Catalog

The greatest musical catalog ever published! Over 3,000 articles—every known instrument described and illustrated; many of them shown in full colors. Gives you lowest prices and all details of Free Trial, Easy Payment plan. All sent FREE—no obligation. Just clip coupon and mail today.

Clip and Mail

THE RUDOLPH WURLITZER CO., Dept. 1778

117 E. 4th St., Cincinnati 120 W. 42nd St., New York
329 S. Wabash Ave., Chicago; 250 Stockton St., San Francisco

Send me, absolutely free, new illustrated catalog, with prices and details of Free Trial Easy Payment plan. No obligation.

Name _____

Address _____

City _____ State _____

Instrument _____
(State Instrument in which you are interested)