

POPULAR MECHANICS

MAGAZINE

WRITTEN SO YOU CAN UNDERSTAND IT

REG. D. TRADE MARK, GREAT BRITAIN, No. 410428

REG. U. S. PAT. OFF.

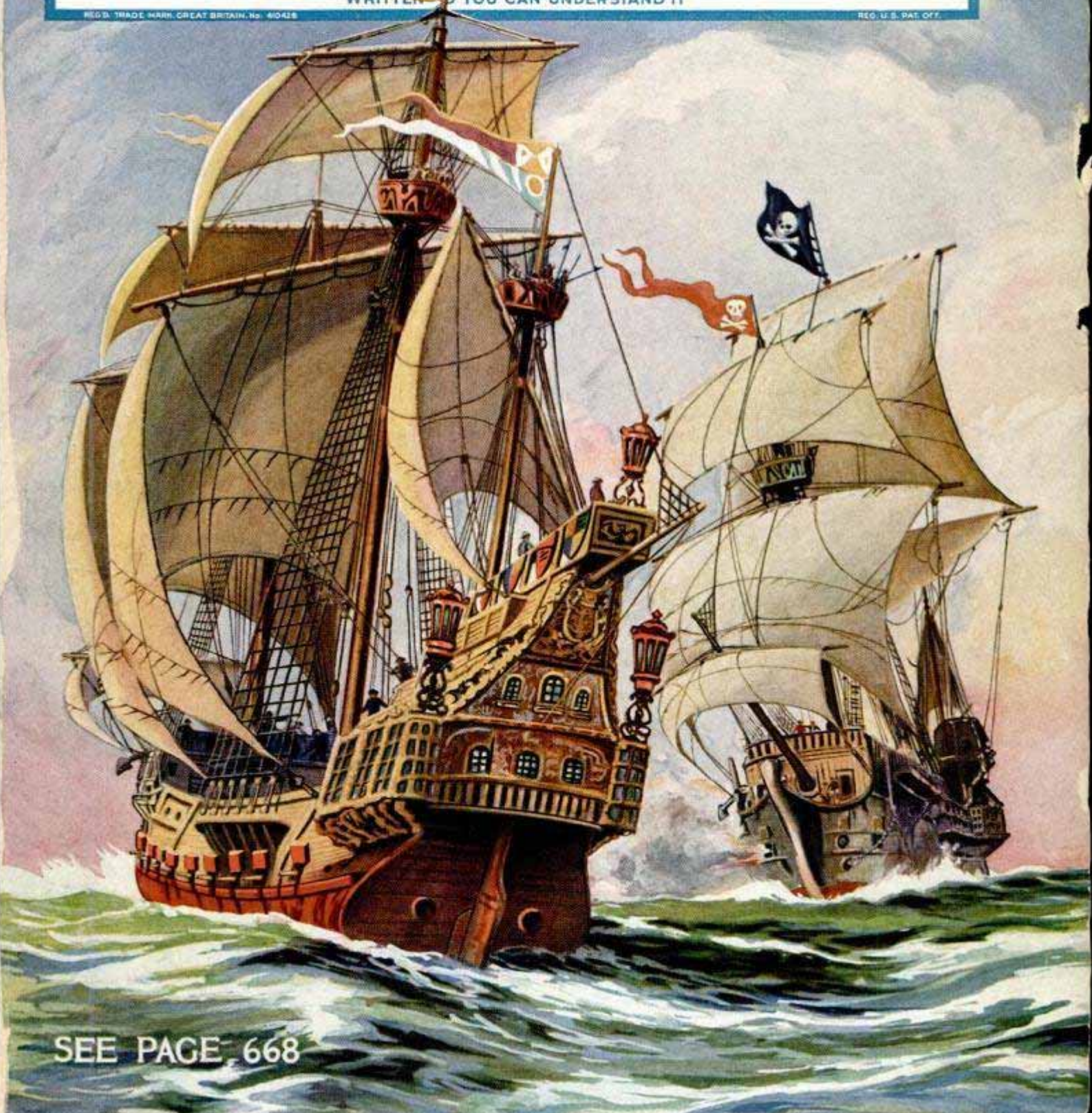

SEE PAGE 668

ATKINS

SILVER STEEL SAWS



Mr. Happy Man Says:

“ATKINS’ Means Saw Satisfaction”

Look for the ATKINS name on the blade when you buy a saw. It means greater value and satisfaction. “Silver Steel,” ATKINS’ exclusive formula, makes a saw that will outlast two or three of the ordinary kind. “Taper-Grinding” makes an ATKINS Saw cut faster, easier and cleaner.

Get your dealer to show you an ATKINS No. 400 Hand Saw—“Finest Saw on Earth.” It will give you a “lifetime” of satisfactory service—save you money and material every time you use it.

Ask or write for our interesting folder—“Saws in the Home.” It’s free.

E. C. ATKINS & CO.

Established 1857

Leading Manufacturers of Highest Grade
Saws for every Use; Saw Tools, Saw
Specialties, Plastering Trowels,
and Machine Knives.

INDIANAPOLIS, U.S.A.



**500
PUNCTURES
Yet Leaks
No Air**

**We
Want
Agents**

OVER 18,000,000 car owners are waiting for my amazing, long-life, no-trouble, air-filled, Milburn Puncture - Proof Inner Tube — the only tube to successfully withstand the 500-nail-hole-test without loss of air. Costs no more than the ordinary tube and is sold under a positive, money-back guarantee.

**Makes Motoring a Pleasure
Doubles Tire Mileage**

Users of Milburn Puncture-Proof Tubes everywhere are enjoying the easy riding performance of the air-filled tube without the annoyance of punctures and slow leaks. And a tire mileage increase from 12,000 to 15,000 miles. Many users report 30,000 miles (double mileage) without removing a tire from the wheel.

Test the Milburn at My Risk

You'll be delighted. And you'll realize how easily orders are secured. Sales experience is not necessary to coin money selling the Milburn. *Positively the biggest tube value obtainable.* Absolutely non-competitive. I control all basic patents. Car owners buy on demonstration. It makes no difference what tires they use or what car they drive.

\$5,000 to \$10,000

That's what the Milburn Agency will net you per year—and more. Stop working for others. Get into business for yourself selling Milburn Puncture-Proof Tubes. My *No-Capital-Direct-From-Factory-Sales-Plan* makes it easily possible. Line up your territory rights on this whirlwind seller—NOW—full or part time.

FREE TUBE OFFER

To every car owner answering this ad. Act quick. Clip and mail your FREE TUBE COUPON—NOW. References: Industrial State Bank, Chicago—Baker State Bank, Chicago.

**C. M. MILBURN, President
Milburn Puncture-Proof Tube
Company, Inc.
400-336 W. 47th St.
CHICAGO, ILLINOIS**

FREE TUBE COUPON—MAIL NOW
C. M. MILBURN, President
MILBURN PUNCTURE-PROOF TUBE CO., INC.,
400-336 W. 47th St., Chicago, Ill.
I am interested in receiving the facts
a share of the profits selling MILBURN PUNCTURE-
PROOF TUBES. Without obligation, send me infor-
mation about commission and Free Tube Offer
to car owners.



**Over
1,000,000
Sold**

**Money-Back
Guarantee**

We hereby agree to refund to any purchaser the full amount paid for any Milburn Puncture-Proof Tube that leaks air when punctured by anything not larger than a twenty-penny spike. We also guarantee that casings will last much longer and give much greater mileage where Milburn Puncture-Proof Tubes are used.

PROOF

J. D. Cooper—"I have made 30,000 miles with my Milburn Puncture-Proof Tubes and have not as yet removed a rim or casing and my casings are in excellent condition."

S. C. Winfrey—"I have driven 500 nails in one of my Milburn Puncture-Proof Tubes without loss of air."

J. S. MacElroy—"Received the shipment of 200 Milburn Puncture-Proof Tubes and find them as represented. Hope to send you another 200 tube order soon."

J. T. Berdahl—"Have been using Milburn Tubes since 1922, driving every day. Have pulled out any number of nails without loss of air."

I want to enjoy
MILBURN PUNCTURE-
PROOF TUBE Offer

Name.....
Address.....
City.....
State.....

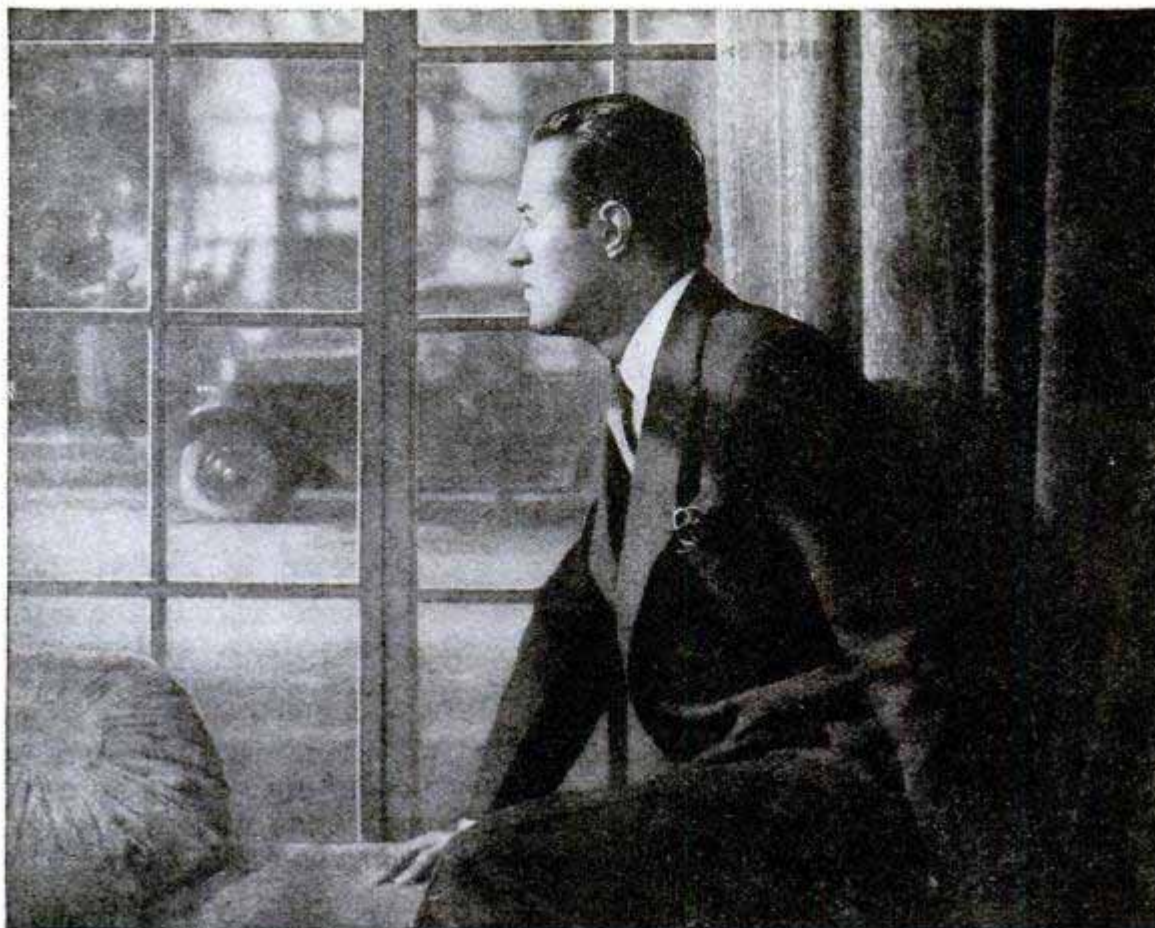

Friendly, But Friendless

—Perhaps It's comedones

SICK at heart he watched them go. Off for a good time! And he was not invited. Invitations for him were becoming fewer and fewer. He touched his face, gingerly, but never thought to blame it all on . . .

comedones.

* * *

A great many young men suffer from comedones . . . commonly called blackheads. Skin can't be clean-looking, fresh, wholesome, if these disfiguring formations are present. What's more, you may not even be conscious of comedones. But your friends notice them.



Pompeian Massage Cream helps you overcome comedones. It gives you a clean, clear, ruddy complexion. It gets into the pores where *comedones* form, rolls out all dirt and oily secretions, and stimulates a healthy circulation by keeping skin clean and pores open.

After you shave, spread Pompeian Massage Cream generously over your face—and *rub*. Continue to rub until the cream rolls out. Note how dark the cream looks. That's the dirt that was in your pores.

Don't have a dirty skin. Don't let *comedones* form. Use Pompeian Massage Cream every day. It means a healthy, wholesome skin. It means more joy in living.

Use Pompeian Massage Cream regularly at home—then you'll get the full benefit. At all druggists.

SPECIAL INTRODUCTORY OFFER

1/3 of a 60c jar—for 10c

For 10c we send a special Trial Jar containing one-third of regular 60c contents. Contains sufficient Pompeian Massage Cream to test thoroughly its wonderful benefits. Positively only one jar sent to a family on this exceptional offer.



THE POMPEIAN CO.,
Cleveland, Ohio, Dept. 83

Gentlemen: I enclose a dime (10c) for 1/3 of a 60c jar of Pompeian Massage Cream.

Name.....

Street.....

Address.....

City..... State.....

Popular Mechanics Magazine

200 E. Ontario Street, Chicago, U. S. A.

H. H. WINDSOR, Founder

H. H. WINDSOR, Jr., Editor and Publisher

London: Hachette & Cie.,
16-17 King William Street, Charing Cross, W. C. 2

Paris: Hachette & Cie.,
111 Rue Reaumur

Melbourne: Gordon & Gotch
509-513 Little Collins St.

ISSUED MONTHLY

SUBSCRIPTION:

SINGLE COPY, 25 CENTS

In United States and its possessions, also Canada, Cuba, and Mexico, per year, postpaid - \$2.50

To all other countries in the Postal Union - 3.00

All subscriptions are discontinued at expiration. Please examine the date printed on your wrapper.

Entered as Second Class Matter Sept. 15, 1903, at the Post Office at Chicago, Illinois, under Act of March 3rd, 1879.

Entered as Second Class Matter at the Post Office Department, Canada.

Published monthly by POPULAR MECHANICS CO.

Copyright, 1926, by Popular Mechanics Co.

Copyright in Australia. Copyright in France

Vol. 46

Contents for October, 1926

No. 4

Acrobat—dangerous act of balancing	542	Electric Fan—for closed cars	531
Advertising—bright wrappings sell goods	616	Electric Light—vacuum-base trouble light	636
Aerial Photography—views of Washington	609	Electric Lighting—lamp held by vacuum cups	577
Airplane		Electric Power—links U. S. from St. Louis to Boston	578
for twenty persons has three engines	599	Electric Wiring—holes for switch boxes <u>cut</u> in less than a minute	615
has sleeping cabin	578	Excavator—ditch digger as fire fighter	569
hunt bugs to curb plant disease	615	Filling Station—derrick at, represents oil well	608
monoplane that folds up	531	goldfish aid electric plant by devouring moss	607
to cross ocean in thirty-six hours	575	new way of freezing	534
Animals		Fishing	
behind scenes at the zoo	611	Atlantic New York's "fishin' hole"	593
big game increasing in national forests	572	transparent minnow trap	599
Archery—game on shipboard	607	Flag—mystery shrouds origin of U. S. flag	590
Asbestos—mines	579	Foot—pedaling player piano aids treatment of feet	562
Athletics—sprinter races billiard ball in speed contest	616	Football—how to be a star	554
Automobile—your next auto	602	Fountain Pen—filling device	574
Automobiles—Equipment and Supplies—fabric covers		Gambling—you can't win at	580
protect auto in repair	561	Garage—spiral floor in skyscraper	633
Automobiles—Lighting—shade for auto headlights	562	Garbage—burner for home	640
Automobiles—Lubrication		Garden—built-in terraces on hillside	563
springs operate oiler	626	Garden Tools and Appliances	
tester for crankcase oil	645	rake with long teeth	647
Automobiles—Motor—meter for auto compression	610	shears clip and hold flowers	578
Aviation		Glass—for lenses	646
floating hotels in ocean to serve air liners	601	Gold—old-time ruins of Timbuctoo, Calif.	641
one death in million miles of air traffic	594	Golf	
Barn—on wagon aids contractors	598	how the world's champion golfer drives	535
Basket—fireproof for waste	588	tees carried in hat	626
Bed—crib in railroad parlor car	537	tiny temple on course	635
Bees—swarm on car bumper	569	Grindstones—as stairway	574
Blowtorch—alcohol	574	Guns (Ordnance)—marine flirts with death testing machine guns	533
Boats and Boating		Hammer—has changeable tips	642
portable boat for bathing	534	Helmet	
stand by and come about	538	hinge on top of safety	563
Broom—on rubber tires	645	new style of steel helmet	635
Building Construction		Holder—for window cards	579
steel bridging for joists	607	Horse Racing—why gay colors are worn by jockeys	608
wheeled stand for painters	632	House	
Burbank, Luther—work continued by Leland Stanford University	632	a log cabin of today	595
Butterflies—fed on bottle at farm	625	built on high stilts	573
Cap—inflated swimming	537	summer home like barrel	552
Cap (Metal)—lever ring on bottle helps to remove	552	House Plan	704
Cards (Playing)—box for shuffling card deck	543	Household Devices	628
Cement—sprayer mends furnace	598	Iceberg—fighting icebergs	627
Check Protector—like pliers	625	Incas—ruins of palace show builders' skill	593
Chemistry—what it is doing for you	643	Inventions—patents sought in England by women	573
Churn—electric, fits on wall	609	Iron—reduce iron and steel waste by electric process	592
Ciphers—magic lure of	564	Ivory—carved tusk depicts biblical scene	600
Cleanliness—rubbish racks on lam's posts	624	Jack—auto in wheel socket serves as lock	624
Clock—to run for ten years on one battery	586	Lens—for big aerial camera	601
Clothing—animated faces on slickers	562	Microphone—monster "ear" to find planes	617
stainless stockings	562	Model	
Coal—dust for Diesel engine tested in Germany	601	how boys turn play into dollars	571
Coconut—bracelet of shell of	534	Independence hall modeled in sugar	545
Coils—winder for coiling springs	624	Monument	
Crime—electric protector on wrist disables bandits	553	marks landing place of U. S. troops in France	551
Deaf—flames help deaf children learn to talk	561	veiled sphinx at base of world war memorial	615
Disease		Motor Truck—for icing railroad cars	588
main cause of seasickness	553	Moving Pictures—riding log over deep chasm affords movie thrill	545
record of heartbeats made to help treat disease	599	Musical Instrument—ukulele with hinged neck	532
Dog—population of America	637	Name—Smith most common	637
Door—double dial in hotel room	594	Office Supplies—desk memorandum on roller	562
Education—geology school on wheels	570	Oysters—grown in trees	576
Eggs			
cleaned by sand blast	624		
woman risks life on cliffs for birds' eggs	572		

[Continued on Page 4]

Barrow for Truck and Tire 537 *Hub cutter for 615*

[Contents—Continued]

Paper—making machine model	646	Birds—winter house on porch	679
Parachute		Boats and Boating—cabin scow driven by auto engine	681
death dive hero tells his sensations	640	Cistern—self-cleaning device	679
flyers saved by	626	Dairy	
test strength of, with aid of elephant	594	barn-door fly chaser	667
Parasol—for bathers	543	spring hooks hold cows' tails	683
Pen—point cleaner	632	Electric Light—how to make a porch lamp	680
Pianos—playing twenty-four, tests outdoor theater	631	Ford Car—overcoming troubles in replacing windshield glass	679
Pipe—metal strip to hang pipe fits all sizes	616	Garden Tools and Appliances	
Poison—gun to kill weeds	636	rake cleans lawn thoroughly	684
Polo—bicycle game on beach	593	tight joints in rubber tubing	683
Postal Service—pony express to plane	589	Guns—cleaning shotgun barrels	684
Pump—foot, for auto tires	637	Harness—trace chain cover	678
Punch—vest pocket size hand	647	Holder—for medicine dropper	684
Radio		Ice—compressed air cleaning away mush ice	667
latest novelties	653	Knot—keeping shoes tied	673
our radio world of tomorrow	648	Latch—hand-wrought colonial	682
Radio Antenna—spring wire coil holder	654	Mending—tissue made from rubber tube cement	684
Radio Apparatus—rotary meter	664	Model—build your own ship models	668
Radio Application		Nails—method of starting	678
radio in test to find if continents move	598	Photography—imitation rock base for photos	673
to cash checks by radio	579	Pine—cone novelties	674
Radio Battery Charger—homemade	655	Razor—sharpening	667
Radio Condenser—what the new condenser ratings mean	654	Roof—smoke locates leaks in	684
Radio Dial—re-marking	657	Smoker's Accessories—stand that cannot upset	680
Radio Receiver—simplicity of latest superhet	658	Stovepipes—remedy for soot choked	678
Radio Transformer—primary for R.F. transformers	657	Tires—making bicycle tires unleakable	666
Radio Tubo—metal cap stabilizes	654	Toy—make a Teddy tumbler	665
Razor—safety, that folds up	616	Vacuum Cleaner—for dusting fruit	683
Refrigerator—in dairy truck	570		
Rubber			
drain Everglades for planting rubber	545		
vulcanizing to metal	592		
Safety Devices and Measures			
dummy of policeman	630		
safety sign for children warns against autos	637		
speeder trapped by whistle on auto exhaust	635		
Safety Movement—slogan-bearing street car aids safety campaign	617		
Salesmanship—push-button corner grocery	636		
Saws—saw with removable teeth	632		
Seals—trapping elephants of the sea	529		
Shaper-Jointer—swivel mounted, portable	600		
Shears—corrugated metal	647		
Ship			
powder puff for christening	610		
what is a ton?	646		
Shoe Polisher			
fits in pocket	551		
for hotels	631		
Skyscraper—eighty-one story building for Detroit	642		
Smokers' Accessories			
kit on auto door	586		
self-adjusting pipe reamer	640		
Sound—hinged "skirt" on street car deadens noise	610		
Stages—wheeled	635		
Stencil—pictures and writing copied from	586		
Street Traffic Regulations			
center line on auto road prolongs its life	550		
cost of traffic jams in New York	531		
Submarine—sub's wreckage	544		
Superstition—what is your pet superstition?	546		
Table—electric revolving	532		
Taxicab—with lottery wheel	553		
Temperature—moist air at sixty-four most comfortable	532		
Tennis—lever to tighten tennis net	589		
Time—telling time by stars with pocket dial	630		
Tires—drill regrooves truck tires	552		
Tractor—wheel without rim	633		
Travel			
around world in single day	588		
what is most interesting place in world	618		
Umbrella—to match raincoat	647		
Vikings—rock inscriptions show early visit to America	609		
Voice—electrical, given chorus girl	536		
Volcano—bore holes around to study eruptions	647		
Waste Products—chemists distill old shoes for medicine and paint	573		
Weather—observations made in seventeenth century	534		
Wheelbarrow—has adjustable balance	577		
Wind—resistance in motoring	551		
Wrench—for auto headlights	640		
X-Rays—old master restored by use of	587		

SHOP NOTES

Agriculture Implement—emergency grain drill tube	700
Alarm—electric, indicates unwound clock	694
Angles—method of measuring	701
Automobiles—Repairing—washing parts in gasoline	693
Bell—factory foreman's call	699
Blowtorch—made from gasoline lamp	685
Boilers—oil in may cause blistered tubes	703
Box—stock box with hinged end	703
Building Construction—kinks	692, 695
Centering—V-block device	696
Clamps	
for welding	702
holds pliers to bench	701
spring, for laying out blocks in pairs	690
Connecting Rod—fitting bearings	701
Drain Pit—sliding door on	697
Electric Battery—proof against corrosion of terminals	693
Fence Post—brace keeps heavy posts upright while tamping	687
Fire Protection—method for railroad ties	688
Ford Car	
assembling bendix drive on starter	686
device for changing spring shackles on	690
Funnel—radiator filling	698
Glazier Tool—grooved roller	687
Holes—cutting in thin sheet copper	687
Ladder—handy support	688
Lathe	
graduating a six-foot scale in a lathe	689
rigged up for use as rotary metal shears	698
Machine Shop—cutting a radius corner	694
Marking—quick acting blocks	702
Motor Truck—removable one-man body	689
Name Plates—making auto	700
Paint	
felt washer protects painted surfaces	690
homemade heat proof	699
when to paint vacuum equipment	696
Planing Machine—profile planing	698
Printing—emergency furniture	693
Road	
novel marking system	701
planks keep trench openings smooth	686
Safety Devices and Measures	
guard on power line poles	694
test for foul air in wells	698
Saws and Sawing Rigs	
how to braze band saws	687
sawbucks help raise log	702
to increase capacity of	699
Screwdriver—drill spindle	699
Seed—hulling and scarifying clover	696
Smokestacks—inside and outside coatings for	702
Surface Plate—glass for	693
Table—portable and collapsible for tools	691
Tags—waterproofing shipping	703
Trailer—carries concrete mixer	696
Wagon—set your own tires	690
Welding—V-blocks	691

AMATEUR MECHANICS

Automobile Driving—fence post pulls auto out of mud hole	667
Automobiles—Repairing—bellows blow carbon	683
Automobiles—Starting Devices—starting bank for auto	680

DRAKE'S PRACTICAL MECHANICAL BOOKS

THEY WILL RAISE YOUR PAY—

ORDER ON 5-DAY TRIAL

The books listed below will perfect you in your chosen trade—pave the way to the big positions. Written in non-technical language—easy to read and understand. *Every book covers its subject completely. An entire course of instruction condensed into one volume.* Your choice sent postpaid—you benefit 5 days—money refunded in full if not entirely satisfactory. Order direct from this page.

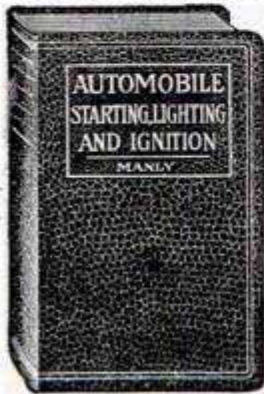

Automobile Books

- Automobile Starting, Lighting and Ignition, by Manly... 700 pp. \$3.00
 Brookes' Automobile Handbook. \$2.00
 Ford Motor Car, Truck and Tractor, by Manly... Cloth \$1.50
 Automobile Battery, Care and Repair, by Manly... Leatherette \$2.00
 Motorcycle Handbook, by Manly \$1.50

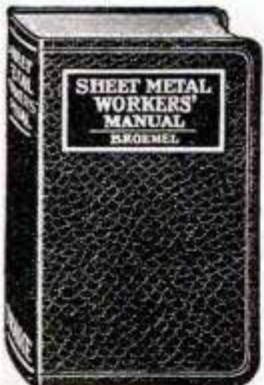

Shop Practice Books

- Sheet Metal Workers' Manual... \$2.00
 Oxy-Acetylene Welding and Cutting... Cloth \$1.25
 Slide Rule and Logarithmic Tables. \$2.00
 Handbook for Millwrights... Cloth \$2.00
 Machine Shop Practice... Cloth \$2.00
 Mechanical Drawing and Machine Design... Cloth \$2.00

ORDER DIRECT FROM THIS PAGE—ON OUR MONEY-BACK PLAN

The books listed above are only a few of the many in our catalogue, which you will receive promptly after filling out and mailing us the attached coupon. For quick action order direct from this page—cross name of each book wanted and send in with price quoted. We prepay postage and send the books on our money-back plan.

FREDERICK J. DRAKE & CO.
 PUBLISHERS

1008 Michigan Ave., Chicago
 Drake Books Are For Sale at All Book Stores

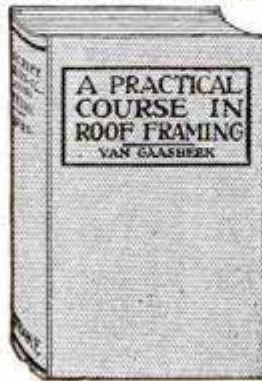

Carpentry Books

- Cloth Binding
 Modern Carpentry, 2 vols. \$3.00
 The Steel Square, 2 vols. \$3.00
 Modern Estimator... \$1.50
 Timber Framing... \$2.00
 Builder's Architectural Drawing... \$2.00
 Concretes... \$1.50
 Practical Bungalows... \$1.00
 Roof Framing, by Van Gasbeek... \$1.50

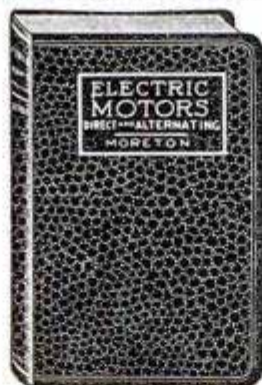

Electrical Books

- Telephony, Including Automatic Switching, by Smith, 450 pp. Leatherette \$2.50
 Practical Applied Electricity... \$2.00
 Wiring Diagrams and Descriptions. \$1.50
 Armature and Magnet Winding... \$1.50
 Electric Motors, D. & A. \$1.50



Painting and Decorating

- Ross Crane Book of Home Furnishing and Decoration... Cloth \$3.00
 House Painting Methods with the Brush and Spray Gun, by Vanderwalker. Cloth... \$2.00
 Interior Wall Decoration, by Vanderwalker... Leatherette \$4.00
 The Mixing of Colors and Paints, by Vanderwalker... Cloth \$2.00
 A Show at Sho' Cards... Cloth \$4.00
 Sign Painting, by Atkinson... Cloth \$4.00
 Strong's Book of Designs, Leatherette \$4.00
 Modern Painter's Cyclopaedia. Cloth \$2.00
 Automobile Painting... Cloth \$1.50
 New Hardwood Finishing... Cloth \$1.50
 Wood Finishing, Plain and Decorative... Cloth \$2.00
 Owen's Paint Guide... Cloth \$1.00

Steam Engineering

- Swingle's Handbook for Steam Engineers and Electricians. Leatherette.. \$4.00
 Examination Questions and Answers for Marine and Stationary Engineers. Leatherette... \$2.00
 Steam Boilers... Leatherette \$2.00
 Swingle's Catechism of Steam, Gas and Electrical Engineering. Leatherette \$1.50

Modern Languages

- By Prof. P. S. Allen, U. of Chicago
 French without a Teacher... Cloth \$1.25
 Spanish without a Teacher... Cloth \$1.25
 German without a Teacher... Cloth \$1.25
 Everyday French... \$1.25
 Everyday Spanish... \$1.25

Mail Coupon For Free Catalogue
 Your Guide to Home Study

FREDERICK J. DRAKE & CO.
 1008 Michigan Avenue
 Chicago, Ill.

GENTLEMEN:—Please send me free, postage paid, your illustrated catalogue which lists and describes 200 Practical Mechanical Books for Home Study.

My name is

and my address

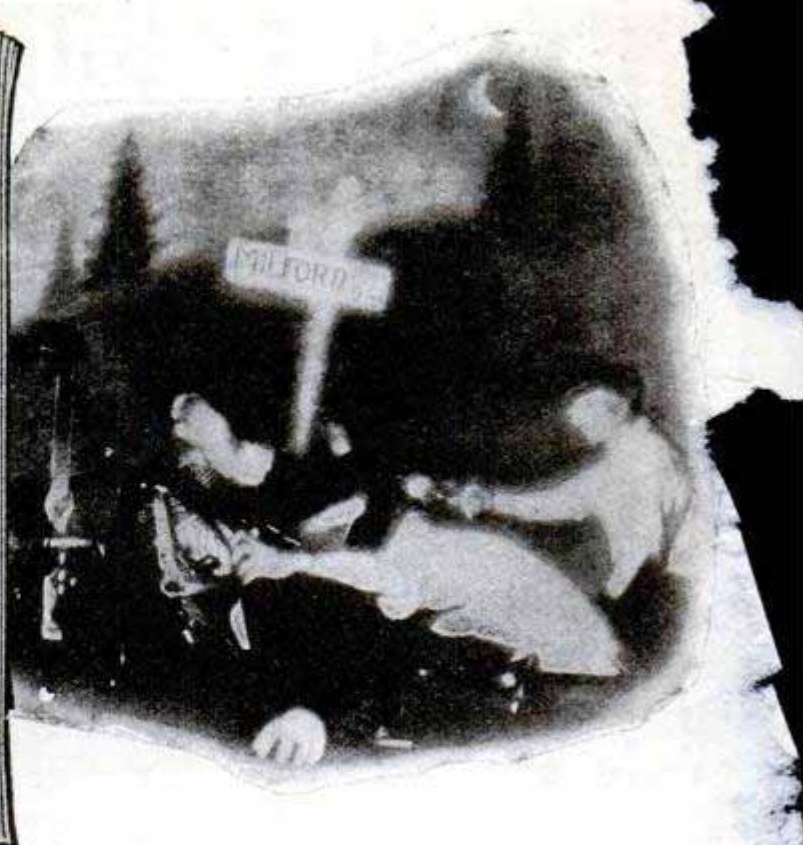

Send for this Free Book!

A FASCINATING BOOK of Detective stories that shows how ordinary boys and men have won nationwide fame, thousands of dollars in rewards, and important official positions by solving finger print mysteries!

"... Shortly before midnight a young couple slipped away from the dance. They sought out a long, low, rakish roadster. With powerful headlights picking out the path, it moved cautiously through the parking space and out onto the high road.

"Early next morning—a farm boy found the girl's dead body crumpled in the wayside ditch. Concealed in the bushes at the side of the road lay the boy's lifeless body, also shot from behind."

Who had committed the murder?

Read the rest of the story on page 15 of our new Finger Print book. Find out how the murderers were traced, tried and convicted, and how a certain finger print expert solved five murder mysteries and secured 97 convictions in less than a year.

Find out how you can become a Finger Print Expert.

Thirteen Thrilling Stories of Mystery and Achievement

Thirteen stories of crime, daring robberies, mysterious murders, thrilling escapes. You'll enjoy "Snowflakes," a great dope story—"The Invisible Finger Print," a blackmail mystery.

In "Foiled," a true account of a great political coup, you'll read of the astounding rise of a young country photographer who saved the Mayor of his city and was later appointed to the most important identification position in the state.

You'll read of men who achieved fame, big rewards and important positions in a short time through the study of finger prints.

Any man who can read and write can become a finger print expert.



PARTIAL LIST Graduates U. of A. S. Recently appointed Finger Print Experts of these States, Cities and Institutions.

State of Iowa
State of Idaho
State of Colorado
St. Paul, Minn.
Columbus, Ohio
Detroit, Mich.
Pittsburgh, Pa.
Great Falls, Mont.
Idaho Falls, Idaho
East Lansing, Mich.
Schenectady, N. Y.
Lorain County, Ohio
El Paso, Texas
Galveston, Texas
Houston, Texas
Lincoln, Nebr.
Everett, Wash.
Ogden, Utah
Butte, Mont.
Pueblo, Colo.
Albany County Penitentiary,
Albany, N. Y. [tiary
Wilkes Barre, Pa.
Livingston, Mont.
Alhambra, Calif.
Tulsa, Okla.
Havana, Cuba

Finger Print Experts Needed!

More and more the detection of crime resolves itself into a problem of identification. Trained men are needed every month to fill the new positions that are created. Records show that University of Applied Science graduates get first choice at the big positions. Listed below are some of the city and state bureaus to which U. of A. S. men have been appointed.

You can learn finger print identification in a few months in your spare time—at home.

Send the Coupon!

This book cannot be bought at any newsstand or bookstore—but it will be sent to you FREE if you write to us at once. Thirty-two pages, illustrated in color with weird crime pictures. This book explains your opportunities in the finger print world—shows how you can get your training in a few months—tells how you can get a professional finger print outfit free. Write for this book today.

University of Applied Science

1920 Sunnyside Ave., Dept. 13-57 Chicago, Ill.

University of Applied Science, Dept. 13-57
1920 Sunnyside Avenue, Chicago, Ill.

Please send me free your 32-page illustrated book "Finger Prints." I understand that there is absolutely no obligation. Also tell me how I can become a finger print expert by studying a few months in spare time—and how I can get a professional finger print outfit free.

Name.....

Address.....

City.....State.....

ELECTRICITY

Complete Study Course and Pocket Library \$10



SHIPPED FREE

A set of HAWKINS GUIDES is a true friend to the electrical worker. It tells you how to do any job the right way—without guessing or taking chances.

Hawkins Guides put all the facts about modern electrical engineering at your finger tips. Therefore your chances for advancement in the electrical field are unlimited.

HAWKINS GUIDES DOUBLE YOUR VALUE



Electricity is king! It is the ruling force of today—transportation, communication, light, heat, power—indeed every modern activity is dependent on electricity. Industry is crying for electrical men that know their jobs!

Hawkins Guides teach you all you need to know about electricity in easy, step-by-step lessons. Daily spare time reading of the Guides will greatly increase your value to yourself and your employer in a few weeks. Hundreds of our friends have written us and told us this!

READERS OF HAWKINS GUIDES KNOW HOW



"You can't stump him on an electrical job." "He certainly knows his business." "Certainly have to hand it to him for knowing how." —These are the things employers say about our friends who are readers of Hawkins Guides. No matter what question or problem comes up the Ready Reference Index enables you to give an expert answer at once.

HAWKINS STARTS YOU WHERE OTHERS LEFT OFF

Why should you work at low wages when easy reading of HAWKINS GUIDES will give you the money-making knowledge of the expert? Easy daily reading of the Guides will teach you in a few months what it has taken the expert a lifetime to learn!

With HAWKINS GUIDES in hand you have a running start to success in the electrical field. You will actually begin where others left off!

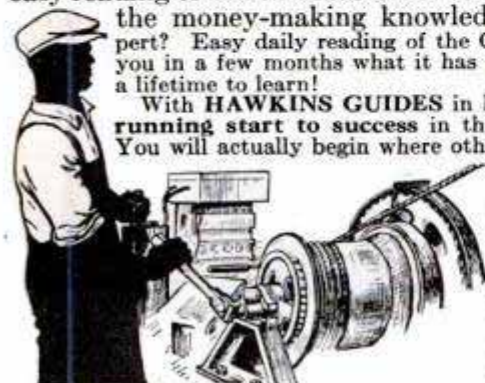

NOW!

This coupon is your golden opportunity. Tear it out—send it now!

FOR EXAMINATION!

REAL ELECTRICAL EDUCATORS

"Hawkins Guides at \$10 is the best investment I have ever made. Am able to take up almost any electrical job and have never gone to an electrical school."—B. Roesler, Oenaville, Texas.

AS EASY AS A. B. C.

"Everything in Hawkins Guides is very plain and anybody can read and understand them as easy as A. B. C."—J. Knight, Tobyhanna, Pa.

OTHER ENTHUSIASTIC READERS SAY

"Worth ten times their price." "Helped me to two raises in four months." "Better than a school of instruction." "Studied them when I was laid up and got further ahead than if I had been on the job."

Hawkins Guides Explain These Points So You Can Easily Understand:—

Magnetism—Induction—Experiments—Dynamos—Electric Machinery—Motors—Armatures—Armature Windings—Installing of Dynamos—Electrical Instrument Testing—Practical Management of Dynamos and Motors—Distribution Systems—Wiring—Wiring Diagrams—Sign Flashers—Storage Batteries—Principles of Alternating Currents and Alternators—Alternating Current Motors—Transformers—Converters—Rectifiers—Alternating Current Systems—Circuit Breakers—Measuring Instruments—Switch Boards—Wiring—Power Stations—Installing—Telephone—Telegraph—Wireless—Bells—Lighting—Railways. Also many Modern Practical Applications of Electricity and Ready Reference Index.

Hawkins Guides—10 POCKET SIZE NUMBERS

Each number easy to carry around and read in spare time. Big type and clear diagrams. Easy to study and learn. Durable, flexible binding—gold edges. 3,500 pages—4,700 illustrations. Shipped free for examination. Pay only \$1 a month if satisfied. Price of set, complete, \$10.

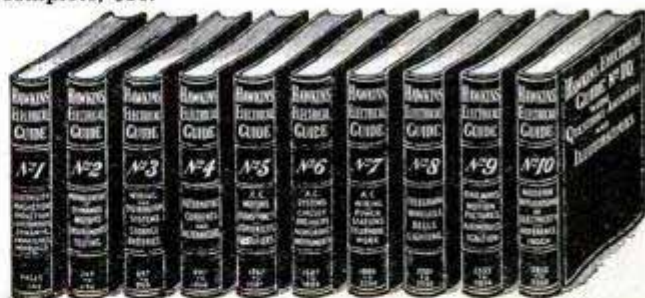

EXAMINE GUIDES FREE!

Let the Guides themselves demonstrate their practical value to you—as a study course, reference work and complete electrical library. You are the judge. Simply send this coupon. No obligation unless you are entirely satisfied. Tear out on dotted line—fill in—mail it NOW!

\$1 PER MO.

FREE EXAMINATION COUPON

Theo. Audel & Co., 65 W. 23rd St., New York City

Please send me (postpaid) for my approval Hawkins Electrical Guides, 10 numbers (price \$1 each). If satisfactory I will mail you \$1 in 7 days and further mail \$1 monthly until purchase price of \$10 is paid.

Name.....

Address.....

Occupation.....

Employed by..... 10T20



3 World-Famous
B.W. Cooke
"JOB-WAY"
**AUTO
LESSONS**

B.W. COOKE
Directing
Engineer
CHICAGO

GET THE FACTS!

About the Tremendous Money-Making Opportunities in the WORLD'S BIGGEST BUSINESS!

Find out how you can get into this gigantic Auto Business! Think of it—7 Thousand Million Dollars paid to Auto men every year *for upkeep alone!* See why there are so many Tremendous Opportunities for the trained Auto Man to get Big Raises in Pay QUICK!—opportunities waiting for YOU! My Free Book shows why. My Free Lessons show how you can take advantage of these wonderful Opportunities.

Be an Auto Expert

If you want to boost your pay quick, Mail the Coupon now. Be an Auto Expert. It's the one Business for the red-blooded, ambitious man who wants to make real money! I help you do it. Get all the particulars about my lifetime Employment Service and my lifetime Consultation Service—both of which I include Free of Extra Charge.

MAIL THIS COUPON NOW!
Send 3 AUTO Lessons and a BOOK FREE
B. W. COOKE DIRECTING ENGINEER Dept. 716
CHICAGO MOTOR TRAINING CORPORATION,
1916 Sunnyside Avenue, Chicago, Illinois

Dear Sir: Send me absolutely FREE and without any obligation on my part, 3 "Job-Way" Lessons and Jobs. Also your Auto Book FREE and full particulars of your 5 Outfits Offer.

Name.....

Address.....

Town.....

State.....



ACT QUICK!
My Big New Auto Book Also FREE!

Coupon brings this startling, revolutionary, new Auto Book, also absolutely Free! Shows how hundreds of men have reached Big Pay in amazingly QUICK Time! Shows what you can do!

Send for it Now!

Coupon Brings Full Details of my 5 OUTFITS OFFER

Includes Tools, Tool Bag, Electrical Test Bench and Radio Receiving Set—all Equipment. Also 303 Wiring Diagram Charts, also Socket Wrench and Ignition Wrench Sets.

NOW Absolutely FREE!

I'LL IMPROVE

That I Can Put YOU in Line for the BIG PAY JOBS—QUICK!

Clip coupon now! I'll send you absolutely FREE OF CHARGE—with positively no obligation on your part—3 "JOB-WAY" Auto Lessons and Jobs and my big, new Auto Book also! I want you to see for yourself—just why B. W. Cooke "JOB-WAY" Training is bringing so many men BIG Money in such remarkably quick time. I want you to see what it can do for you!

Find out how I train you **AT HOME!**

Don't sell your time for low pay! You don't need to! Get all the Facts! Find out how you can become a Big Pay Man in amazingly quick time! These 3 FREE Lessons show you why you can stay home; keep your present job! They prove that you don't have to leave your doorstep—that you can Master every branch of Auto work right in your own home. Send Coupon while I can still offer you these 3 Lessons absolutely FREE!

See How You Can Earn up to \$150 a Week

If you're earning a cent less than \$60 a week, clip coupon now! Get the proof. See for yourself how easily you can master Auto work right in your own home—and how quickly you can get in line for the big Auto Jobs that pay up to

\$10,000 a year and more—or in a Money-Making Auto Business of your own. Remember—these lessons and Jobs come to you absolutely FREE of charge and without any obligation on your part whatever.

Send Coupon at ONCE!

Learn how men without a day's previous auto experience, and only common schooling become Garage Owners, Superintendents, Managers and can earn up to \$150 a Week and more! See why hundreds of men have found "JOB-WAY" to be such interesting, practical Training!

I stand ready to give you absolute proof. Clip COUPON NOW and I'll rush your Lessons to you Absolutely Free!

B. W. Cooke
Directing Engineer
Chicago Motor Training Corporation
1916 Sunnyside Ave.
Dept. 716 CHICAGO

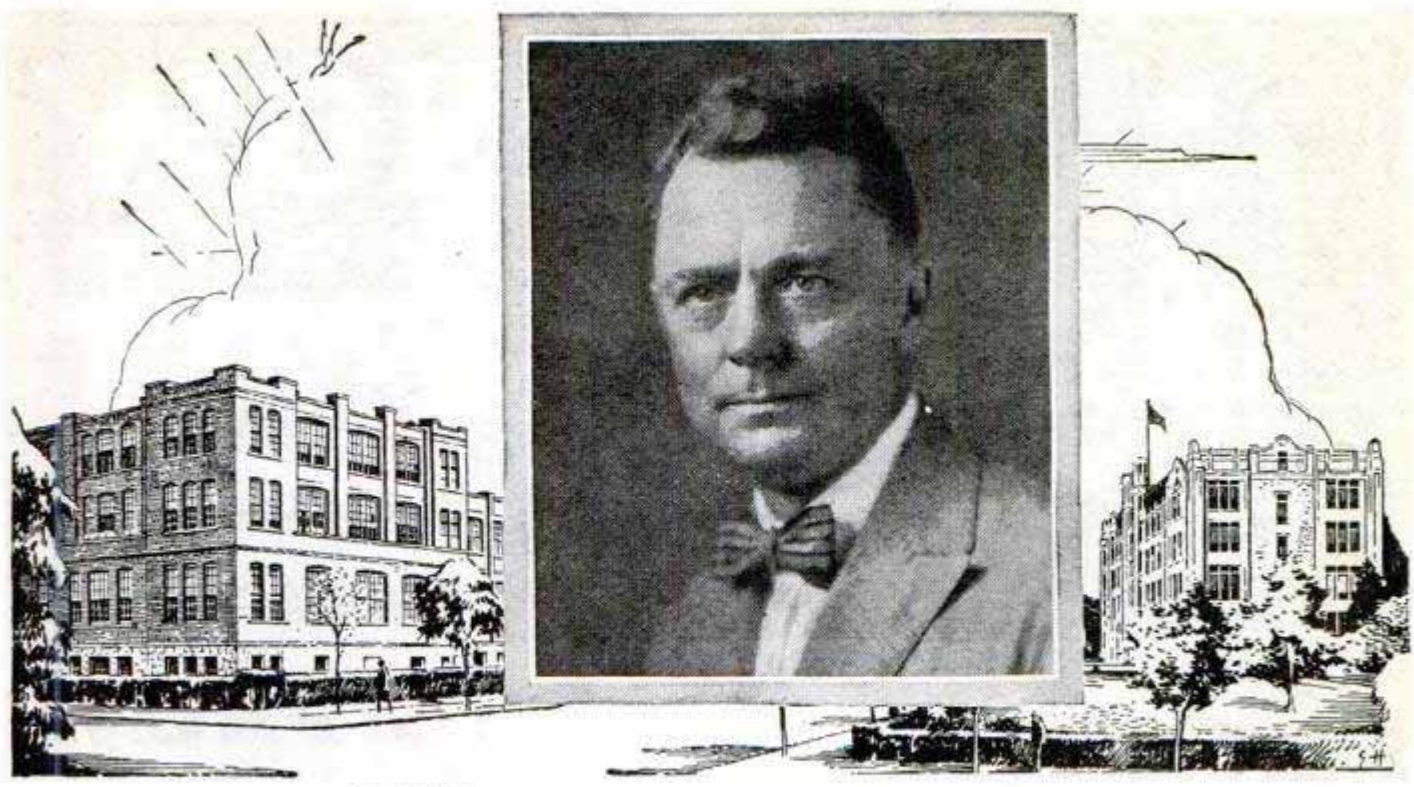

Fifteen years ago he was making only \$38 a month!

Success of W. H. Forse, Jr., an amazing tribute to the courage and ability of a man who refused to stay down

IF EVER a man had to fight for success it was W. H. Forse, Jr. He started as an office boy at \$5 a week and for eight long years after that tried vainly to find the work for which he was best suited.

He clerked in the credit department of the Ely & Walker Dry Goods Company, of St. Louis . . . he sold rope and woodenware . . . he even tried conducting a retail grocery store in a small town.

But it wasn't the work for him and he knew it. So, at the age of twenty-four, he decided to start over—to take up a course with the International Correspondence Schools and get into the one field that had always fascinated him . . . *accounting!*

As a result of this training, Mr. Forse secured a position as clerk with the Union Traction Company of Anderson, Indiana. He soon showed such mastery of his work that he was made chief bookkeeper, then acting auditor, auditor, assistant treasurer and then secretary-treasurer of the Union Traction Company and ten subsidiary corporations.

During this period, Mr. Forse was elected president of the American Railway Accountants Association and president of the Central Railway Accountants Association, became a Certified Public Accountant in Indiana, and wrote "Electric Railway Accounting and Auditing."

Today Mr. Forse is the president of the Forse Manufacturing Company, president of the Spinaway Manufacturing Company, treasurer of the Madison Loan Association and treasurer of the Woodlawn Heights Company—a brilliant example of the value of spare-time study.

Thousands of other prominent executives pay similar tribute to the high character of the training they received from the International Correspondence Schools.

Jesse G. Vincent, vice-president of the Packard Motor Car Company, is a former I. C. S. student. So is Walter C. Allen, president of the Yale & Towne Lock Co. So are Walter P. Chrysler, president of the Chrysler Corporation; J. R. Hall, vice-president of the Chandler Motor Car Company; E. V. Rickenbacker, vice-president and director of sales of the Rickenbacker Motor Company; and Aubrey B. Carter, secretary to the Comptroller of the Currency of the United States.

If the I. C. S. can help to smooth the path to success for men like this, it can help you. If it can help other men to

get out of the rut of routine jobs and go upward to the high-salary class, it can help you too.

At least find out how by marking and mailing the coupon printed below. It takes only a moment—it doesn't obligate you in any way—but it may be the means of changing your entire life. "Do it now!"

Mail Coupon for Free Booklet

INTERNATIONAL CORRESPONDENCE SCHOOLS
Box 5602-E, Scranton, Penna.

Without cost or obligation, please tell me how I can qualify for the position or in the subject *before* which I have marked an X:

- | BUSINESS TRAINING COURSES | |
|---|--|
| <input type="checkbox"/> Business Management | <input type="checkbox"/> Salesmanship |
| <input type="checkbox"/> Industrial Management | <input type="checkbox"/> Advertising |
| <input type="checkbox"/> Personnel Organization | <input type="checkbox"/> Better Letters |
| <input type="checkbox"/> Traffic Management | <input type="checkbox"/> Show Card Lettering |
| <input type="checkbox"/> Business Law | <input type="checkbox"/> Stenography and Typing |
| <input type="checkbox"/> Banking and Banking Law | <input type="checkbox"/> Business English |
| <input type="checkbox"/> Accountancy (Including C.P.A.) | <input type="checkbox"/> Civil Service |
| <input type="checkbox"/> Nicholson Cost Accounting | <input type="checkbox"/> Railway Mail Clerk |
| <input type="checkbox"/> Bookkeeping | <input type="checkbox"/> Common School Subjects |
| <input type="checkbox"/> Private Secretary | <input type="checkbox"/> High School Subjects |
| <input type="checkbox"/> Spanish | <input type="checkbox"/> Illustrating |
| <input type="checkbox"/> French | <input type="checkbox"/> Cartooning |
| TECHNICAL AND INDUSTRIAL COURSES | |
| <input type="checkbox"/> Electrical Engineering | <input type="checkbox"/> Architect |
| <input type="checkbox"/> Electric Lighting | <input type="checkbox"/> Architects' Blueprints |
| <input type="checkbox"/> Mechanical Engineer | <input type="checkbox"/> Contractor and Builder |
| <input type="checkbox"/> Mechanical Draftsman | <input type="checkbox"/> Architectural Draftsman |
| <input type="checkbox"/> Machine Shop Practice | <input type="checkbox"/> Concrete Builder |
| <input type="checkbox"/> Railroad Positions | <input type="checkbox"/> Structural Engineer |
| <input type="checkbox"/> Gas Engine Operating | <input type="checkbox"/> Chemistry |
| <input type="checkbox"/> Civil Engineer | <input type="checkbox"/> Pharmacy |
| <input type="checkbox"/> Surveying and Mapping | <input type="checkbox"/> Automobile Work |
| <input type="checkbox"/> Metallurgy | <input type="checkbox"/> Airplane Engines |
| <input type="checkbox"/> Steam Engineering | <input type="checkbox"/> Navigation |
| <input type="checkbox"/> Radio | <input type="checkbox"/> Agriculture and Poultry |
| | <input type="checkbox"/> Mathematics |

Name.....
 Street.....
 Address.....
 City..... State.....

Occupation.....
 Persons residing in Canada should send this coupon to the International Correspondence Schools Canadian, Limited, Montreal, Canada.

This One



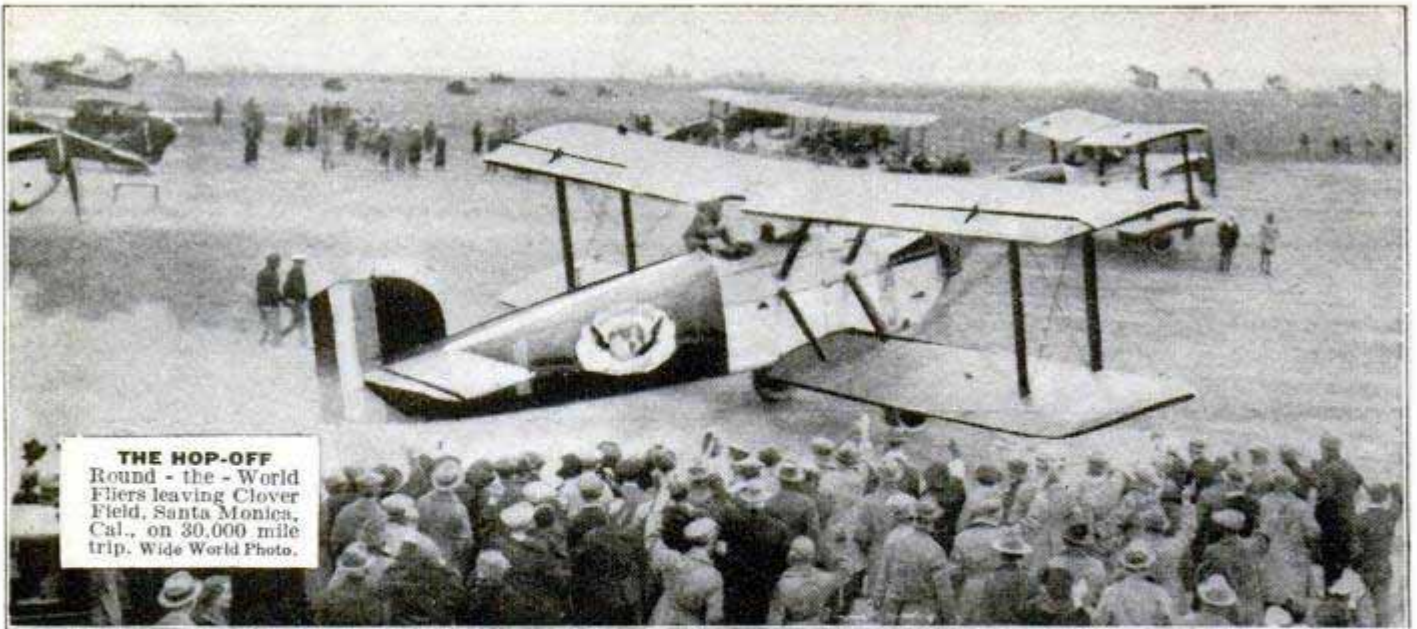

THE HOP-OFF
Round - the - World
Fliers leaving Clover
Field, Santa Monica,
Cal., on 30,000 mile
trip. Wide World Photo.

Daring Young Men Needed in Aviation

THERE is no field of work in the world today which offers such amazing opportunities to young men of daring and who love adventure as does Aviation. Although still in its infancy, there is a crying demand in Aviation for young men with courage, nerve and self-reliance. For those who can qualify there will be thousands of highly paid jobs which will lead quickly and surely to advancement and success.

Big Opportunities Await The Trained Man

Look over the fields of work which are open to the young man today. You will find that Aviation is the ONE FIELD that is not overcrowded—the ONE FIELD in which there is plenty of room at the top. Think of it. Only 21 years ago Orville and Wilbur Wright made the world's first airplane flight. Now airplanes fly around the world. Yes, Aviation offers the same wonderful opportunities today that the automobile and motion picture industries did 15 and 20 years ago. Men who got in on the ground floor of those industries made fortunes before others woke up. AVIATION IS NEW! It clamors for nervy young men—and the trained man has the world before him in Aviation.

Easy to Become an Aviation Expert — \$50 to \$100 a Week

You can qualify now quickly for one of these exciting highly paid jobs through a new, sure, easy method of training. The study of Aviation is almost as interesting as the work itself. Every lesson is fascinating and packed full of interest. That's why Aviation is so easy to learn—you don't have to force yourself

to study—once you start, you can't get enough of it. Only one hour of spare time a day will give you the basic training in an amazingly short time.

One student, S. F. McNaughton, Chicago, says: "Your lessons are like a romance, and what is more, after one reading, the student gets a thorough understanding. One never tires of reading them." James Powers, Pa., another student, says: "I am indeed surprised that such a valuable course can be had from such practical men for so little cost."

PREPARE For One of These POSITIONS

Aeronautical Instructor
\$60 to \$150 per week
Aeronautical Engineer
\$100 to \$300 per week
Aeronautical Contractor
Enormous Profits
Aeroplane Repairman
\$60 to \$75 per week
Aeroplane Mechanician
\$40 to \$60 per week
Aeroplane Inspector
\$50 to \$70 per week
Aeroplane Salesman
\$5,000 per year and up
Aeroplane Assembler
\$40 to \$65 per week
Aeroplane Builder
\$75 to \$200 per week

Personal Instruction by Experienced Men

Men who have had actual experience in Aviation give you personal attention and guide you carefully through your training. They select the lessons, lectures, blueprints and bulletins. They tell you the things that are essential to your success. Every lesson is easy to read and quickly understood.

Big Book on Aviation FREE

Send coupon below for New Free Book, just out, "Opportunities in the Airplane Industry." It is interesting and instructive and will show you many things about Aviation which you never knew before. Only a limited number offered—get yours before the edition is exhausted.



American School of Aviation
Dept. 1357, 3601 Michigan Ave., Chicago, Ill.

AMERICAN SCHOOL OF AVIATION,
3601 Michigan Ave., Dept. 1357, Chicago, Ill.

Without any obligation, send me your Free Book, "Opportunities in the Airplane Industry," also information about your Course in Practical Aeronautics.

Name.....
Street.....
City..... State.....

LEARN

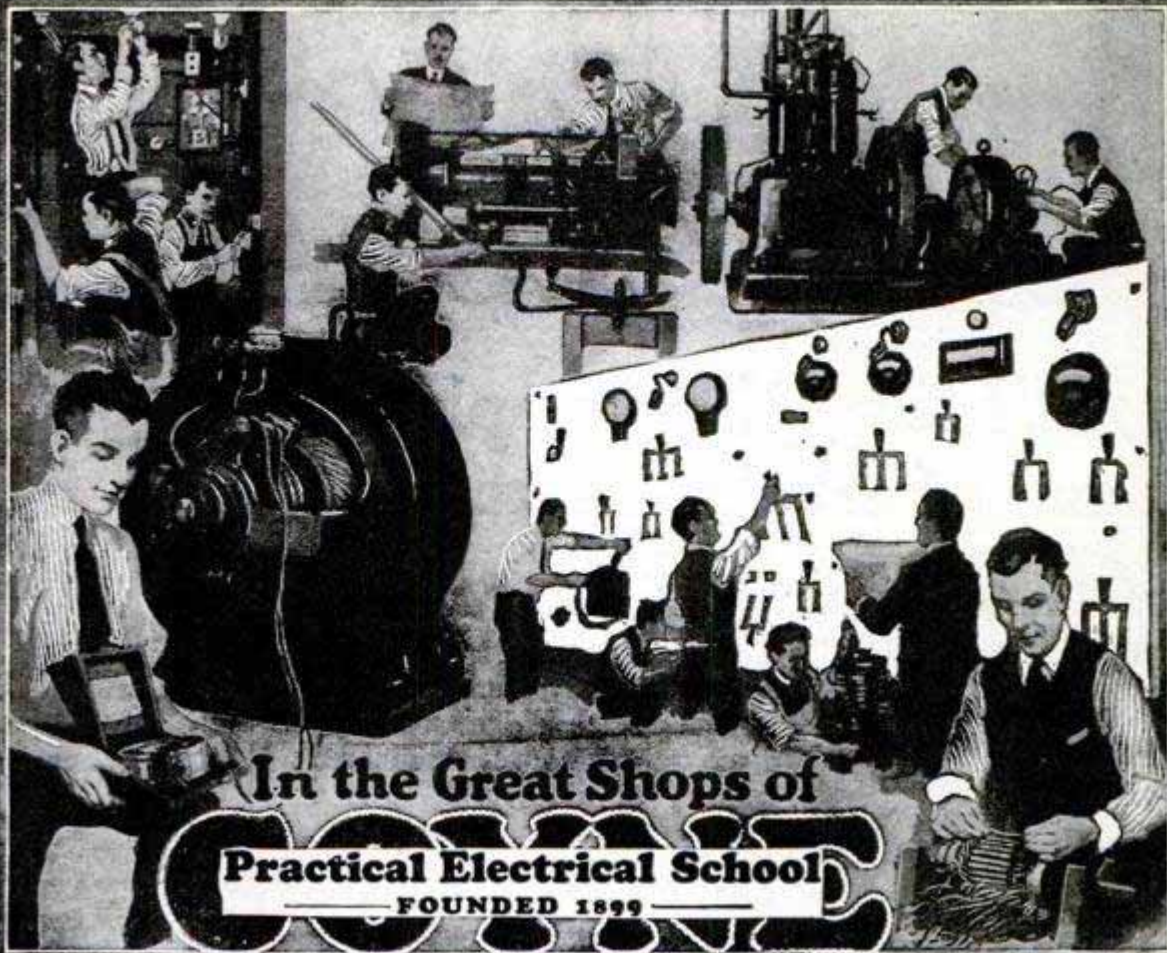

ELECTRICITY

In the Great Shops of
COYNE
 Practical Electrical School
 FOUNDED 1899

 MAKE
 \$200
 to
 \$800
 A MONTH

EARN BIG PAY!

Make \$200 to \$800 a Month

Why work for small pay. Why be satisfied to make \$25.00 or \$30.00 or even \$40.00 a week in a disagreeable job where you never know when you might get fired. Do pleasant work. Be an **ELECTRICAL EXPERT** and earn \$200.00 to \$800.00 a month or go in business for yourself and earn up to \$10,000 a year.

All Practical Work, No Books

I train you on actual Electrical Machinery. I don't teach you a lot of useless theory. My training gives you useable knowledge on the same kind of machinery you will find in Power Houses, Plants and industrial businesses.

Free Railroad Fare to Chicago

For a short time I'll pay your Railroad Fare to Chicago, and besides I'll include Free my two big Courses, Auto and Radio Electricity.

My Big Free Book Tells Complete Story

I haven't space here to tell you the advantages of my training but I'll send **ABSOLUTELY FREE** my big new book with over 150 actual photographs and success stories of my graduates. It tells you all about my employment service after graduation and how you can earn your expenses while attending my school. **FILL OUT THE COUPON NOW AND MAIL IT AT ONCE.** You owe it to yourself to get the facts.

COYNE Founded 1899 H. C. Lewis, Pres.
ELECTRICAL SCHOOL
 Dept. 76-72
 1300-1320 W. Harrison St. Chicago, Ill.

H. C. Lewis, Pres.
Coyne Electrical School
 1300-1320 W. Harrison St.
 Dept. 76-72 Chicago, Ill.

Dear H. C.—I sure want to get all the facts. Send me that big handsome 12x16 inch book. Of course I'm under no obligations and it doesn't cost me a cent.

Name.....

Address.....

Town.....

State.....

IN 3 MONTHS

NEW ENCYCLOPAEDIA

It's All Here—the Complete Record of World Progress! { THIRTEENTH EDITION }

GIANT presses speed forth the final pages. Fresh from the pens of the foremost living authorities, the new Britannica is here. This, the Thirteenth Edition, is as vast an achievement as any of the age's advancements which it records so brilliantly.

Sparkling, clear-cut reflection of all happenings of the breathless years just past is in these pages, and also the events about to be, those pending in laboratory and council chamber. Tomorrow's news is in the new Britannica.

World-Changing Progress

Inventors and business executives, scientists and leaders in today's advance, are eagerly awaiting this new Encyclopaedia Britannica. It affords the one up-to-date survey of all the stupendous world-changing progress of recent years. Here is news of telegraphic freshness from every frontier of civilization.

The Threshold of Tomorrow

The new Britannica is your 2,500 brain-power ally. Here are 45,000 separate articles from more than 2,500 authorities in every civilized country of the world. It is a wealth of facts, information, ideas, suggestions—all so accurately observed, so expertly written as to make the most secure foundation for any activity, of the present and immediate future.

To the Student and Scientist the new Britannica is a great international laboratory and lecture hall combined. To the manufacturer it is an up-to-date industrial plant which he may visit at will. To the Merchant it is a busy mart, a source of never-failing profit. To the Wage Earner it is the key to success, power and affluence. To the lover of the Great Outdoors it is the broad highway that leads to all the wonders of the world.

Discoveries are here that may

A Few of the Contributors and Their Subjects

Prof. ALBERT EINSTEIN
Time and Space

HENRY FORD
Mass Production

MME. CURIE
Radium

ANDREW W. MELLON
Finance

Gen. L. C. ANDREWS
Bootlegging

GEORGE
BERNARD SHAW
Socialism

RAMSAY MacDONALD
Labor Party

VISCOUNT ASTOR
Liquor Laws

Dr. GUSTAV
STRESEMANN
Conference of Locarno

MARSHAL FOCH
Morale in War

SIGMUND FREUD
Psycho-Analysis

HARRY HOUDINI
Conjuring

Mlle. SUZANNE
LENGLEN
Lawn Tennis

Major-General
LEONARD WOOD
Training Camps



Tear Out and Mail this Coupon TODAY

1926 BRITANNICA

{ DEDICATED, BY PERMISSION,
TO PRESIDENT COOLIDGE
AND TO KING GEORGE V. }

**More than 2,500
write 45,000
Articles**

OWEN D. YOUNG
*On Vice-President
Charles C. Dawes*

SEN. GUGLIELMO
MARCONI
Wireless

DR. ADOLF LORENZ
Bloodless Surgery

GEORGE EASTMAN
Photography

ELIHU ROOT
*Court of International
Justice*

ST. JOHN ERVINE
The Drama

LUIGI VILLARI
Italy and Mussolini

H. L. MENCKEN
Americanisms

ALONZO A. STAGG
Football

SIR JOSIAH STAMP
*Reparations and the
Dawes Plan*

DR. S. McC. LINDSAY
Prohibition

DANIEL STARCH
Advertising

FRANCIS WHITE
Tacna-Arica Dispute

L. TROTSKY
Biography of Lenin

further any man's present endeavors. Be among the first to know, and apply, this timely information.

Great Vital Value

In extent of information alone, the 33,000 pages of the Thirteenth Edition with 55,000,000 words equal more than 500 ordinary text books costing at least \$1,200. Yet you can have all this at a fraction of that cost, 32 volumes occupying less than 36 inches of shelf space. And easy terms of payment to meet any budgeting system are offered.

Prove It to Yourself

Human knowledge has opened out into new channels. For every ten opportunities of our fathers we have a hundred. By weighing present developments you assure yourself a full share of new opportunities.

To examine the possibilities costs you nothing.

The thrill of a most practical discovery is yours.

Through the medium of a most handsome and complete descriptive book of 80 pages you can examine the practical value of this new Thirteenth Edition of the world famed Encyclopaedia Britannica. This is sent you FREE. Here are reproduced specimen pages, many in color surpassing all similar work. In itself this is a treasure of information, a vast survey of progress in sciences and arts.

This 80-page Booklet

is here awaiting your name and address. Write for it now. Fill in the coupon below and drop it in the mail before the last collection tonight.



Use this Coupon for FREE Booklet

THE ENCYCLOPAEDIA BRITANNICA, Inc.

342 Madison Avenue, New York

PM-6A-1

Please send me, by return mail, without any obligation on my part, your free 80-page Specimen Book of the new 1926 ENCYCLOPAEDIA BRITANNICA (Thirteenth Edition.) Also full particulars of your easy terms of payment.

Name

Address

City..... State.....

NOTE: If you have a copy of the 11th or 12th Editions, please check here If you have never owned a copy of the ENCYCLOPAEDIA BRITANNICA please check here

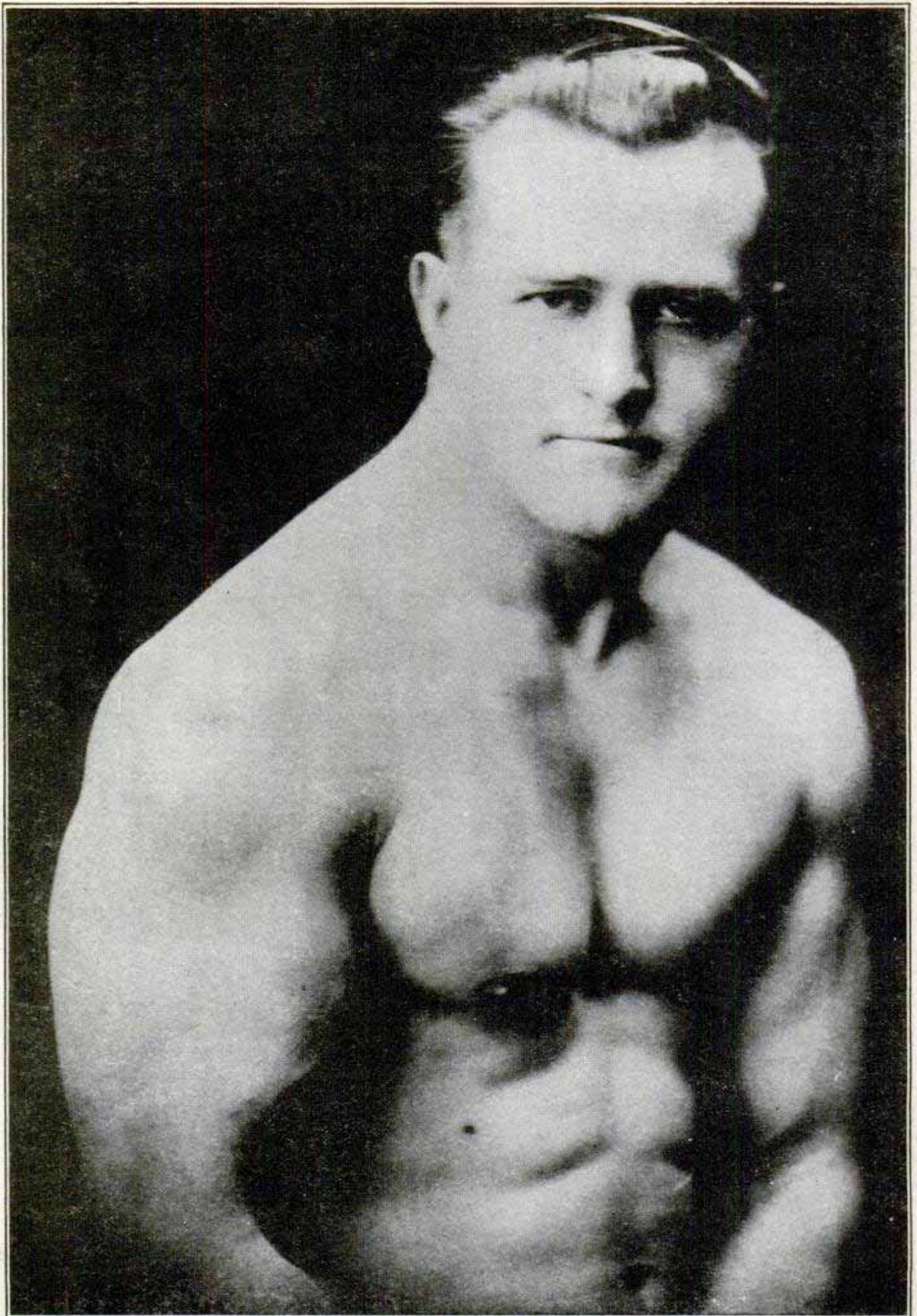

EARLE E. LIEDERMAN, *The Muscle Builder*

Author of "Science of Wrestling," "Muscle Building," "Secrets of Strength," "Here's Health," "Endurance," etc.

Will You Be No. 100,007?

A Dream That Came True 100,006 Times

By Earle E. Liederman

Years ago, I dreamed and hoped for the day when I would be able to help my fellow young men. I wished they could enjoy my robust health and muscle. I knew everyone admired muscles. I wanted a chance to show everyone how easy it is to have real muscular development. My dream has come true! Yes, fellows, 100,006 times I have taught that many men the secret of having steel muscles. As I write, my list is just over the hundred thousand mark. My muscle secrets must be told. I want to help every live wire realize his wildest dreams and ambitions when it comes to muscular development.

Now You'll Enjoy Life

I don't care who you are or what you look like—I'll guarantee to put muscles on you. I know. I was a weakling, too. I didn't only prove it to myself—I have proven to every last man who was game enough to go through with my system.

Here's How I Work

First of all—I make Aladdin look like a piker. I have no lamp, but the magic of what I do has developed over 100,000 healthy, muscular bodies. Yours ought to be one of them. As soon as you get on the job it will. I don't indulge in guess-work. My system rebuilds your body from head to foot. After a few days you will notice a feeling of new life—springy step, a snap and sureness that you knew nothing about.

I put you through a course you'll enjoy every minute—I enlarge your muscles, harden them; train them; I'm the muscle builder! You'll get real chest expansion. If you want big, show-off muscles, you can have them. If you want a beautifully formed symmetrical athletic body that will instantly respond to strength, speed and pep—that's the kind of body I'll build for you—yes, that's the kind of body I give all my happy boys.

Come Along On My Muscle Express

Remember, I can thank my muscles and my secret for my success. You have the same chance—if you will only grab it by signing the coupon below and rushing it to me. You want to act quick or your chance will peter out. Get aboard the Muscle Express. I send you at express speed on the way to health and strength.

My Guarantee

Remember, I don't just promise results—I guarantee them. Before thirty days roll by, I'll put one solid inch on your arm and two inches on your chest. This is just one of the surprises I have ready for you. I have a bag full of others and the beauty of it all is that it's so easy—never tiresome—and almost like playing.

Take My Tip

It's worth a ton of just talk or idle hope. Make up your mind now, this very second, that you are going to be strong, full of pep and ambition. Before long you will be surprising your friends by the change in your physique—your chest will stick out like a balloon. You'll have color in your cheeks—your arms will fill your coat sleeves—those legs of yours will hold you up like they never did before—you'll be real muscle all over—your walk will assure the world you are "there." You will have the same chance I had to make money out of your new strength, vitality and pep. Let me repeat—write now—this very second, because you might forget and miss out. I don't mean maybe or perhaps. If you are a "doubting Thomas" I dare you to call my bluff—make me prove it—it doesn't cost a cent to find out. Action is the only thing that counts in this "muscling" business—take my tip and rush the coupon for my big illustrated free book.

Send For My New
64 Page Book

"Muscular Development"

IT'S FREE

It contains forty-eight full-page photographs of myself and some of the many prize-winning pupils I have trained. Many of these are leaders in their business professions today. I have not only given them a body to be proud of, but made them better doctors, lawyers, merchants, etc. Some of these came to me as pitiful weaklings, imploring me to help them. Look them over now and you will marvel at their physiques. This book will prove an impetus and a real inspiration to you. It will thrill you through and through. The book is yours. I want you to have it with my compliments. Keep it. This will not obligate you at all, but for the sake of your future happiness and health, do not put it off. Send today—right now before you turn this page.

EARLE E. LIEDERMAN
Dept. 2010, 305 Broadway, New York City

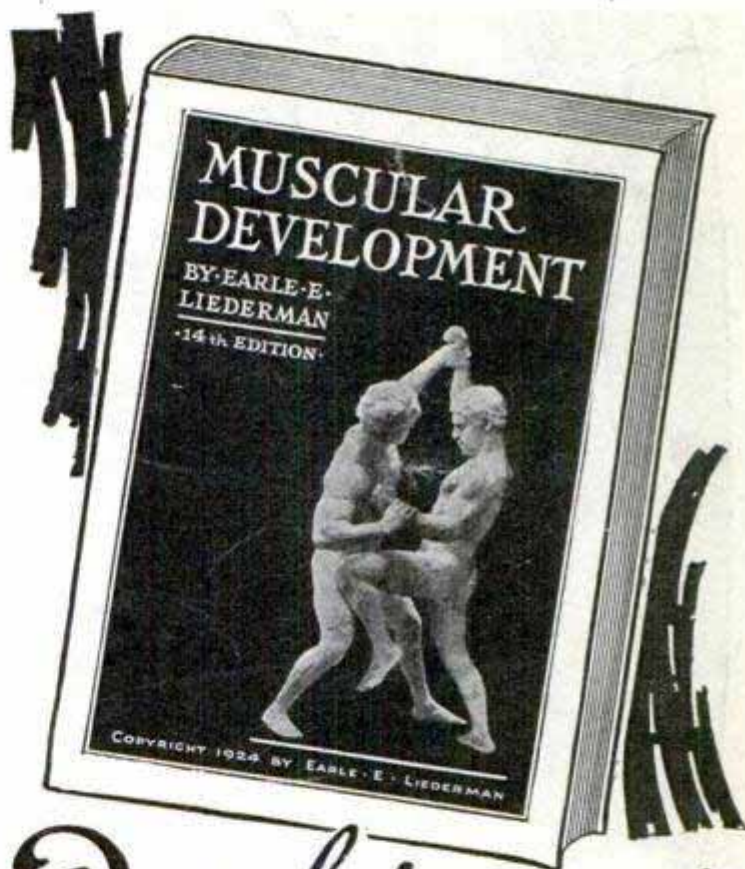

**It
Is
F
R
E
E**

DON'T
SEND ONE
PENNY

—

YOUR
NAME AND
ADDRESS
ON A
POSTAL
WILL DO

EARLE E. LIEDERMAN
Dept. 2010, 305 Broadway, New York City

Dear Sir:—Without any obligation on my part whatever please send me a copy of your latest book, "Muscular Development."

Name.....

Address.....

City..... State.....

(Please write or print plainly.)

FREE R. R. FARE To Chicago, Detroit, Cleveland, Boston, or Philadelphia

These Men Earn \$40 to \$125 a Week as Mechanical Dentists

These are actual pictures of dental laboratories owned by McCarrie graduates. This live, up-to-date profession offers any ambitious man the opportunity of a lifetime to become financially independent. Read the letters below. Many dental "labs" do a \$25,000 annual business. Mechanical Dentists earn \$40 to \$125 a week.

You Can Learn Mechanical Dentistry in a Few Months

Learn to make crowns, bridges, plates, etc., for dentists by our practical method of individual training. Many students complete the course in a few months. Day and evening instruction in all of our 5 big schools in Chicago, Detroit, Cleveland, Boston and Philadelphia. We help you secure spare time job while learning. No educational requirements for entering McCarrie School. No mechanical experience required.

No Classes — No Books Learn by Doing

Each student trained individually. You work with new set of tools and with precious metals. Training is practical, thorough and quick so that you can start your own laboratory after completion of course.



Read What Some McCarrie Graduates Write:

- A. K. writes: Am making good as manager of laboratory. Just turned down an offer of \$75 a week.
- C. M. writes: I am now doing laboratory work for D. D. N. M. at a salary of \$50 a week.
- S. K. H. writes: Some months I take in \$500. Last month I took in \$674.80.
- G. P. W. writes: Am making \$50 a week straight time turning out bridges, plates, etc.
- W. M. B. writes: I have an excellent business. I average \$75 to \$150 a week.
- R. W. B. writes: I secured one of the very best responsible positions immediately upon completion of my course.

These are specimens of hundreds of letters on file here from McCarrie graduates.

Facts About This Money Making Opportunity

There are 64,000 dentists in the U. S. Thousands of dental "labs" and expert mechanical Dentists are needed to handle the great volume of work required by dentists. Mail coupon for free book that gives all details of this great opportunity and **SPECIAL OFFER.**

McCarrie Schools of Mechanical Dentistry
1338 S. Michigan Ave. Dept. 33 CHICAGO, ILL.

FREE

R.R. FARE

to any McCarrie School.

Send coupon for details.

MAIL COUPON NOW

FREE BOOK

McCarrie Schools of Mechanical Dentistry
1338 S. Michigan Ave., Dept. 33, Chicago

Without cost or obligation, send me your illustrated book containing complete information as to my opportunities in the dental laboratory profession and details of your special offer.

Name

Address



**James Jacobsen,
Winchester, Ky.**

When I took up the N. S. T. A. course, I was selling shoes for \$35 a week. Now I am earning an average of \$135 a week. I attribute this remarkable progress to N. S. T. A. training.



**C. W. Birmingham,
Dayton, O.**

A few years ago I was working in a shop for \$15 a week. Immediately upon completion of my course I was offered a position through N. S. T. A. My earnings were from \$5,000 to \$6,500 per year. Today I am earning \$7,500 per year.



**F. B. Englehardt,
Chattanooga,
Tenn.**

Without this training I would still be working for the other fellow. This year I will make close to \$7,000 — some increase since my enrollment.



**Frank Walsh,
Springfield, Mass.**

I was clearing around \$1,000 a year when I was enrolled with N. S. T. A. I have increased my income to \$7,286. I now own my home, drive a nice car, and have a summer camp. My grateful thanks to N. S. T. A.

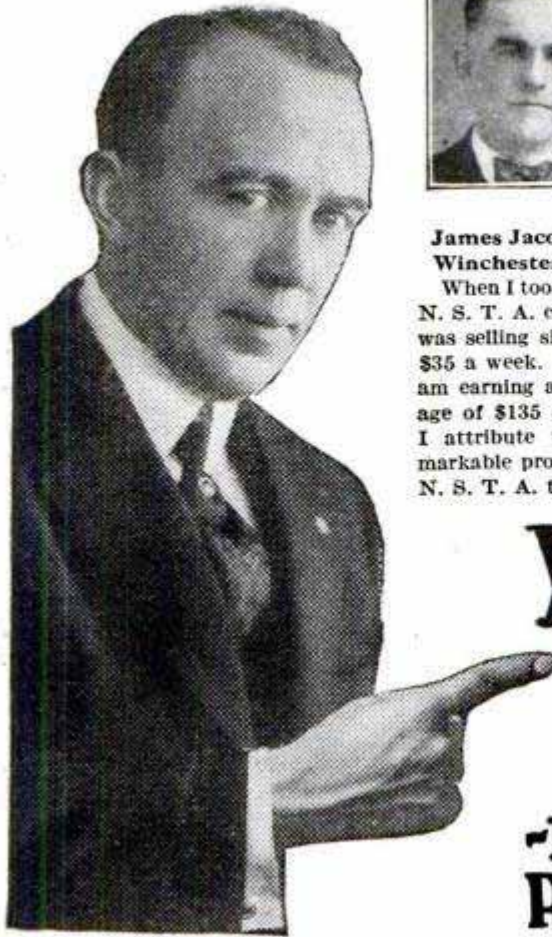

**J. E. GREENSLADE, President
National Salesmen's
Training Association**

You're Fooling Yourself

-if You Think These Big Pay Records Are Due to LUCK!

But don't take my word for it! When I tell you that you can quickly increase your earning power; I'LL PROVE IT! FREE! I'll show you hundreds of men like yourself who have done it. And I'll show you how you can do it, too.

I'LL come directly to the point. First you'll say, "I could never do it: These men were lucky." But remember the men whose pictures are shown above are only four out of thousands and if you think it's luck that has suddenly raised thousands of men into the big pay class you're fooling yourself!

Easy to Increase Pay

But let's get down to your own case. You want more money. You want the good things in life, a comfortable home of your own where you can entertain, a snappy car, membership in a good club, good clothes, advantages for your loved ones, travel and a place of importance in your community. All this can be yours. And I'll prove it to you, FREE.

First of all get this one thing right: such achievement is not luck—it's KNOWING HOW! And KNOWING HOW in a field in which your opportunities and rewards are ten times greater than in other work. In short, I'll prove that I can make you a Master Salesman—and you know the incomes good salesmen make.

Every one of the four men shown above was sure that he could never SELL! They thought Salesmen were "born" and not "made."

When I said, "Enter the Selling Field where chances in your favor are ten to one," they said it couldn't be done. But I proved to them that this Association could take any man of average intelligence—regardless of his lack of selling experience—and in a short time make a MASTER SALESMAN of him—make him capable of earning anywhere from \$5,000 to \$10,000 a year. And that's what I'm willing to prove to you, FREE.

Simple as A. B. C.

You may think my promise remarkable. Yet there is nothing remarkable about it. Salesmanship is governed by rules and laws. There are certain ways of saying and doing things, certain ways of approaching a prospect to get his undivided attention, certain ways to overcome objections, batter down prejudice and outwit competition.

Just as you learned the alphabet, so you can learn salesmanship. And through the NATIONAL DEMONSTRATION METHOD—an exclusive feature of the N. S. T. A. System of Salesmanship Training—you gain the equivalent of actual experience while studying.

The N. S. T. A. System of Salesmanship Training and Employment Service will enable you to quickly step into the ranks of successful salesmen—will give you a big advantage over those who lack

this training. It will enable you to jump from small pay to a real man's income.

Remarkable Book, "Modern Salesmanship," Sent Free

With my compliments I want to send you a most remarkable book, "Modern Salesmanship."

It will show you how you can easily become a Master Salesman—a big money-maker—how the N. S. T. A. System of Salesmanship Training will give you years of selling experience in a few weeks; how our FREE Employment Service will help select and secure a good selling position when you are qualified and ready. And it will give you success stories of former routine workers who are now earning amazing salaries as salesmen. Mail the attached coupon at once and you will have made the first long stride toward success.



N. S. T. A. Building, Dept. R-12 Chicago, Ill.

National Salesmen's Training Association, N. S. T. A. Building, Dept. R-12, Chicago, Ill.

Send me free your book, "Modern Salesmanship," and Proof that I can become a MASTER SALESMAN.

Name.....

Address.....

City.....State.....

Age.....Occupation.....



"Which Man Shall I Promote?"

WILL your employer think of you when the next good position is open? Will he say, "There's a man who is training himself to handle bigger work," or will he pass you by as just an ordinary routine worker?

Do not try to fool yourself. Your employer is watching you more closely than you may think. He's constantly checking up on your work, your abilities, your ideals, your aspirations. Stored away in the back of his mind or filed away in black and white, are his impressions of the kind of man you are and the kind of man you want to be.

He's willing and anxious to pay you more money the minute you prove that you are worth more money. But he can't take chances. When he promotes a man, he wants to be sure he will make good.

Decide now—today—that you are going to be ready when your chance comes. Choose the position you want in the work you like best—then train for it. You can do it in spare time in your own home through the International Correspondence Schools.

The
I. C. S.
is the oldest
and largest
correspondence
school in the
world

Mail the Coupon for Free Booklet

INTERNATIONAL CORRESPONDENCE SCHOOLS

Box 3607-E, Scranton, Penna.

Without cost or obligation, please tell me how I can qualify for the position or in the subject before which I have marked an X:

BUSINESS TRAINING COURSES

- | | |
|---|---|
| <input type="checkbox"/> Business Management | <input type="checkbox"/> Salesmanship |
| <input type="checkbox"/> Industrial Management | <input type="checkbox"/> Advertising |
| <input type="checkbox"/> Personnel Organization | <input type="checkbox"/> Better Letters |
| <input type="checkbox"/> Traffic Management | <input type="checkbox"/> Show Card Lettering |
| <input type="checkbox"/> Business Law | <input type="checkbox"/> Stenography and Typing |
| <input type="checkbox"/> Banking and Banking Law | <input type="checkbox"/> Business English |
| <input type="checkbox"/> Accountancy (including C.P.A.) | <input type="checkbox"/> Civil Service |
| <input type="checkbox"/> Nicholson Cost Accounting | <input type="checkbox"/> Railway Mail Clerk |
| <input type="checkbox"/> Bookkeeping | <input type="checkbox"/> Common School Subjects |
| <input type="checkbox"/> Private Secretary | <input type="checkbox"/> High School Subjects |
| <input type="checkbox"/> Spanish | <input type="checkbox"/> Illustrating |
| <input type="checkbox"/> French | <input type="checkbox"/> Cartooning |

TECHNICAL AND INDUSTRIAL COURSES

- | | |
|---|--|
| <input type="checkbox"/> Electrical Engineering | <input type="checkbox"/> Architect |
| <input type="checkbox"/> Electric Lighting | <input type="checkbox"/> Architects' Blueprints |
| <input type="checkbox"/> Mechanical Engineer | <input type="checkbox"/> Contractor and Builder |
| <input type="checkbox"/> Mechanical Draftsman | <input type="checkbox"/> Architectural Draftsman |
| <input type="checkbox"/> Machine Shop Practice | <input type="checkbox"/> Concrete Builder |
| <input type="checkbox"/> Railroad Positions | <input type="checkbox"/> Structural Engineer |
| <input type="checkbox"/> Gas Engine Operating | <input type="checkbox"/> Chemistry or Pharmacy |
| <input type="checkbox"/> Civil Engineer | <input type="checkbox"/> Automobile Work |
| <input type="checkbox"/> Surveying and Mapping | <input type="checkbox"/> Airplane Engines |
| <input type="checkbox"/> Metallurgy | <input type="checkbox"/> Navigation |
| <input type="checkbox"/> Steam Engineering | <input type="checkbox"/> Agriculture and Poultry |
| <input type="checkbox"/> Radio | <input type="checkbox"/> Mathematics |

Name

Street

Address

City State

Occupation

Persons residing in Canada should send this coupon to the International Correspondence Schools Canadian, Limited, Montreal, Canada.

Please Mention Popular Mechanics



Learn to Write

I Teach by Mail

I CAN make a good penman of you at your home during spare time, no matter where you live or how poorly you now write. My simplified system has shown thousands of others the way to good penmanship during the past twenty years — it can and will do the same for YOU!

Beautifully Illustrated Book

"How to Become a Good Penman"

It contains general information, with testimonials and beautiful specimens of penmanship showing what others have accomplished by the Tamblin System. **FREE!** (Your name elegantly written on a card if you enclose stamp for postage.) WRITE TODAY. Address

F. W. TAMBLIN

413 Ridge Bldg., Kansas City, Mo., U. S. A.



BE AN ARTIST

WE CAN TEACH YOU DRAWING in your own home during your spare time. Twenty-five years of successful teaching proves our ability. Artists receive large salaries. Write Today for Art Year Book

SCHOOL OF APPLIED ART
ROOM NO. 2 BATTLE CREEK MICH.



MUSIC LESSONS FREE



You can read music like this quickly

IN YOUR OWN HOME

Write today for our FREE booklet. It tells how to learn to play Piano, Organ, Violin, Mandolin, Guitar, Banjo, etc. Beginners or advanced players. Your only expense about 2c per day for music and postage used. American School of Music, 51 Lakeside Bldg., Chicago

LEARN WATCH REPAIRING

Be a watchmaker—you can learn this profitable trade by correspondence in a few weeks in your own home by the DeSelms Chart System. After you complete the course you will know a watch from A to Z. You will know just what the matter is and how to repair one. When you graduate you will be a practical watchmaker and repairer and competent to fill any position. Positions for our graduates. Ask for our Free Book. It explains our system and terms.

THE DeSELMS WATCH SCHOOL
LOGANSPORT, INDIANA



Delivered to You Free

for 30 days trial on approval. You can have your choice of 44 Styles, colors and sizes of the famous RANGER Bicycles. Express prepaid. Factory-to-Rider Prices save you \$10 to \$25 on your bicycle.

\$5 a Month if desired. Many boys and girls easily save the small monthly payments. Parents often advance first payment.

best quality, at factory prices, express prepaid. Tires, lamps, wheels and equipment, low prices. Send No Money, do business direct with makers.

Mead CYCLE COMPANY
DEPT. T-109 CHICAGO

Write today for free Ranger Catalog, factory prices and marvelous easy payment terms





STATION WOC
DAVENPORT

HERE'S WORK THAT IS
ALMOST ROMANCE!

Now Owns a Radio Store

"The Radio business is rushing just now. Building many Super Heterodynes, also doing installation and repairing. To your course I owe all my success in the Radio profession." A. J. Ommodi, Bowman, N. Dak.



Controls First Car by Radio

"I operate the portable broadcasting station in rear car, driving front car by Radio control. Will operate this car from New York to Frisco—12 months trip. Then we take the car around the world—a three years' tour. I use it all to you." Leo Paul, New York City.



You Can Do What These Men Did!

I Will Train You at Home to Fill a Big Pay Radio Job

Get into the great new Big-pay Industry—Radio. If you're earning a penny less than \$50 a week, clip coupon now. Send for AMAZING FREE BOOK, "Rich Rewards in Radio." Why go along at \$25 or \$35 or \$45 a week, when you could earn \$50 to \$250 in the same six days, as a Radio Expert? Hundreds of N. R. I. trained men are doing it—why can't you? I'll train you just as I trained them—just as I trained the men whose letters you see on this page. I'll teach you quickly at home in your spare time. Be a Radio Expert, and draw down big money for the easiest and most fascinating work in the world.

\$50 to \$250 a Week as a RADIO EXPERT

It's the trained man, the Radio Expert, who gets the big jobs of this profession—paying \$75, \$100, \$200 a week and up. Free book gives all the facts. Every day N. R. I. trained men are taking good places in the Radio field—men like you—men like those whose stories I show you here. You can prepare just as they did by new practical methods, learn right at home in your spare time. Lack of experience no drawback—common schooling all you need. Our tested clear methods make it easy for you. We guarantee to train you successfully. Big Free Book contains all the proof.

Clip Coupon Now for FREE BOOK

Most amazing book on Radio ever written—full of facts and pictures—tells all about the great Radio field, how we prepare you and help you start. You can do what others have done—GET THIS BOOK. Send coupon today—no obligation.
J. E. Smith, Pres.
NATIONAL RADIO INSTITUTE
Dept MT-7
Washington, D. C.



These Instruments Given FREE of Extra Cost

All instruments shown here and others sent to all my students free of extra cost under short time special offer. Clip coupon now—find out all about this big unequalled offer while you still have time to take advantage of it. This training is intensely practical—these instruments help you do the practical work.

My Radio Training is the "Famous Course That Pays for Itself"

Make more money quick when you take up this practical course.

I show you how to increase your earnings almost from the start of your course through practical pointers I give you.

Howard B. Luce of Friesens, Pa., made \$320 in 7 weeks during his spare time. D.H. Suitt of Newport, Ark. writes "While taking the course I earned in spare time work approximately \$900." Earl Wright of Omaha reports making \$400 in a short time while taking his course—working at Radio in his spare time only! Sylvester Senso, 207 Elm St. Kaukana, Wis., made \$500. These records not unusual—these men are a few of hundreds.

And when you graduate, my big Free Employment Department helps you get the job. You get just the same preparation and assistance toward success we gave E. W. Novy, Chief Operator of Station WRNY, Erle Chambers, Radio Engineer for Stewart-Warner, J. E. Fetzer, Chief Engineer of Station WEMC. The National Radio Institute, established 1914, today offers you the same opportunity these men had under a bond that guarantees you full satisfaction or money refunded. Mail coupon TODAY for my big Free Book and proof!

Originators of Radio Home-Study Training



\$70 in one Day for T. M. Wilcox

"I am in business for myself and recently made \$70 in one day. I was an electrician of rich experience and was occupying a splendid position as telephone superintendent when I enrolled with your course believing it would open up greater opportunities—have not been disappointed. Estimate that Radio will be worth tens of thousands of dollars to me in the next few years." T. M. Wilcox, Belle Island, Newfoundland.



Kimball With WMAQ Chicago

"Accepted a position with the Chicago Daily News Station WMAQ. My income practically doubled, thanks to your fine course. I handle all consultation also do operating." Keith Kimball, Station WMAQ, Chicago, Ill.



Promoted to Big Job

"Just been made Sales Manager of this Radio firm—received a very good increase in pay. Up to present have been getting salary which in 2 months enabled me to purchase a new car." R. Jones, Bay City Mich.

Read the true stories printed in this border-of men who got out of the rut



Chief Operator at Station WGR

"Am sending a photograph of station WGR where I am now Chief Operator. I am proud to say that your course is the reason for my success." Edward Stanko, Hotel Statler, Buffalo, N. Y.



Photo shows Graduate E. F. Spadoni in his own Radio store at Chicago, Ill. "Your course gets the credit," says Spadoni.



MAIL THIS NOW!

J. E. SMITH, President
NATIONAL RADIO INSTITUTE
Dept. MT-7 Washington, D. C.

Dear Mr. Smith: Without obligating me in any way, send me your free book "Rich Rewards in Radio" and all information about your practical, home-study Radio course.

Name.....Age.....
Street Address.....
Town.....State.....

SEND THIS COUPON



Quick Easy Way to Learn Drawing

How you can earn big money in Commercial Art, Illustrating, Designing or Cartooning, without being a "genius," and regardless of your present ability.

Never was there such a need for artists as today! Business revitalized needs scores. Illustrated catalogs, advertisements, posters, circulars, trade-mark designs—countless pieces of art work are needed by the busy business world. 20,000 periodicals are published in America—every one of them needs the services of artists for each issue. You can't begin to realize the gigantic amount of art work that must be done—and the demand is increasing daily. Big money is gladly paid—and big money is waiting for anyone with foresight enough to prepare for this pleasant profession. Through our quick, easy method of teaching, YOU can earn \$40 to \$100 a week as an artist, regardless of your present ability.

Learn in Spare Time

This simple method is like a fascinating game. No matter how little you may know about drawing, no matter whether people tell you, "you have no talent," no matter what your present ability may be—if you can write we can teach you to draw. This quick method simplifies everything—all the red-tape, "art for art's sake" teaching and superfluous theory is taken out and in its place is put definite, practical instruction so that you will make money in the art game. The course is the work of successful and experienced commercial art instructors. And all your instruction is under their personal supervision.

Write for Interesting Free Book

An interesting and handsomely illustrated booklet, "Quick Easy Way to Become An Artist," has been prepared and will be sent to you without cost if you mail the coupon below. Mail coupon NOW for this attractive free book and full details about our Special Offer to every new student. No obligation whatever. Address

Washington School of Art, Inc., Room 3010-D, 1115-15th St. N. W., Washington, D. C.

WASHINGTON SCHOOL OF ART, Inc.
Room 3010-D, 1115-15th St. N. W., Washington, D. C.

Please send me, without obligation, free book, "Quick Easy Way to Become An Artist," together with full particulars of Special Offer to every new student.

Name.....
(State whether Mr., Mrs. or Miss)

Address.....

City.....State.....



Young outdoor men wanted

Interesting, vigorous outdoor work in a growing organization where merit wins advancement. Good starting wages. Permanent positions and a real future for men who make good. Our present field force of Davey Tree Surgeons cannot meet the increasing demand. So we are selecting now, to enter our employ, a few sturdy, clean young men, thorough Americans, single, between 20 and 30 years old, free to travel, industrious, with good practical education, and able to give good references. Write for qualification blank to serve in place of personal interview.

The Davey Tree Expert Co., Inc.,
636 Federal Bldg., Kent, Ohio.

LEARN WATCH REPAIRING



You can learn by our modern and original system of instruction every part of the **Watch Repairing Trade** at home as good or better than at a shop. You can earn money while learning and secure a well paying position or start in business after completing our course of instruction. Good watch repairers are always in demand and earn from \$50 to \$75 per week. For particulars apply to the **Wisconsin School of Watch Repairing**
166 Mason St., MILWAUKEE, WIS.

Deagan Free trial! Xylorimba



Become a crack Xylorimba player right in your own home. Easy to play. Learn in a few hours with our 14 free complete lessons. Earn \$80.00 to \$200.00 a week!

FREE LESSONS—A YEAR TO PAY

Free trial, easy payment plan. Earn while you learn. Write for details special free trial offer.
J. C. DEAGAN, Inc., Dept. 1357
1770 Berceau Ave. Chicago, Ill.



Wonderful, new device, guides your hand; correct your writing in few days. Big improvement in three hours. No failures. **Complete outline FREE.** Write C. J. Ozment, D-34, St. Louis, Mo.

Learn to Mount Birds



Learn at home by mail, to mount birds, animals, game heads; tan furs, make rugs and robes. Complete lessons. Easily and quickly learned by men, boys and women.

FREE Write today for Free Taxidermy Book. Tells all about it. Every Sportsman, Hunter, Trapper and Nature lover should know this wonderful fascinating art. Save your trophies. Big profits. Success guaranteed. Our school is 20 years old—100,000 graduates. Investigate today. Write for Free Book.

Northwestern School of Taxidermy 9777 Elwood Bldg., Omaha, Neb.

AUDELS ENGINEERS & MECHANICS GUIDES

EXAMINE FREE!

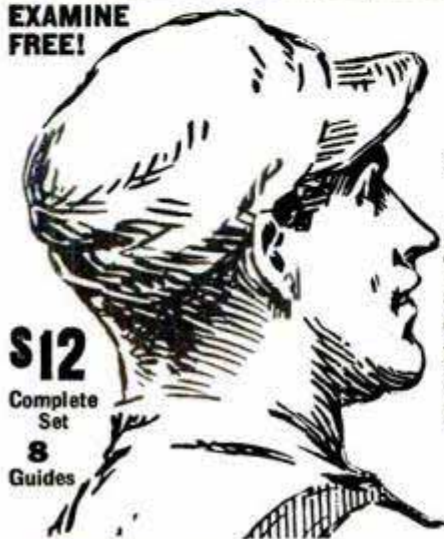

\$12
Complete Set
8
Guides

EASY TERMS

For Every

**Engineer
Mechanic**

**Machinist
Electrician**

**Fireman; Oiler
Engineer Student**

THIS Master Set is a gold mine of daily, practical helps for workers in every branch of engineering. A self-educating study course for the student; the standard reference work for the chief. Thousands of rules, tables, calculations and diagrams make it easy to read and learn. Latest inside information on theory and practice of modern engineering for reference study and review. Thousands of new short-cuts that make the job easier. Examine free! Pay \$1 a month (less than 4c a day) if satisfied that this set will help you to a better job—or make your present job easier.

AUDELS STANDARD LIBRARY

With Questions and Answers That Solve Your Problems

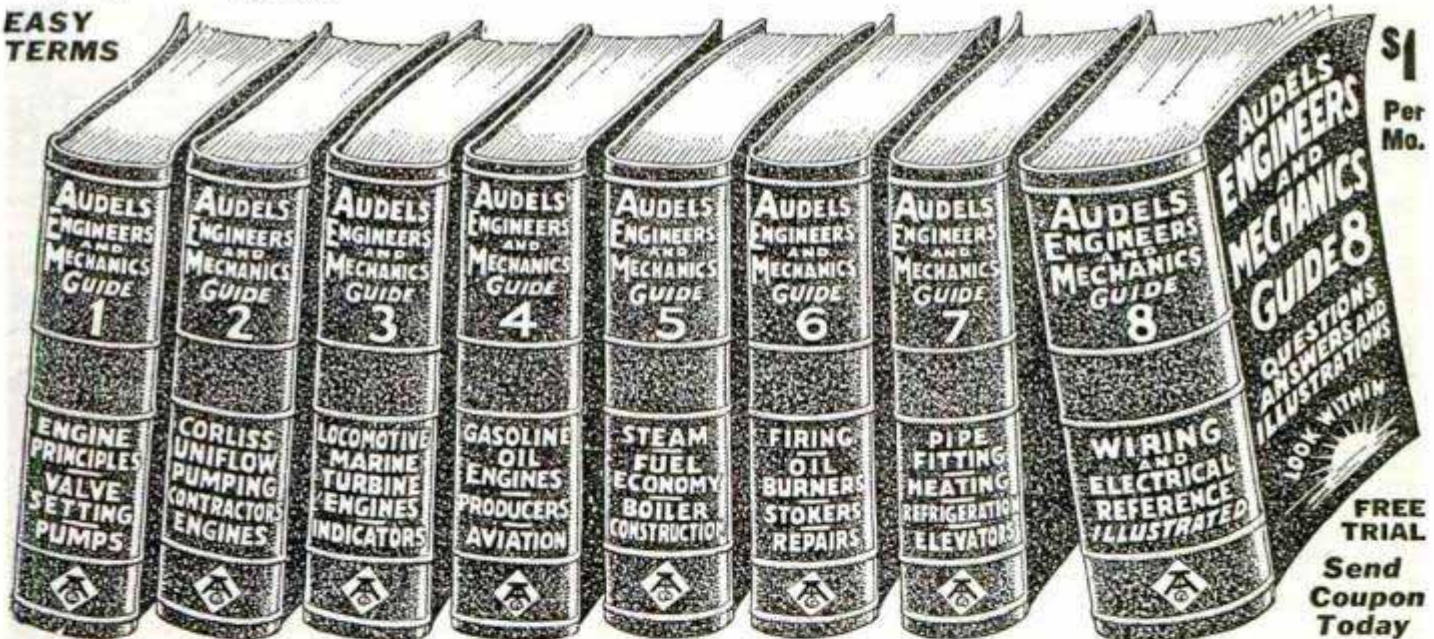

8 GUIDES—8754 PAGES—4750 ILLUSTRATIONS—POCKET SIZE

8 pocket numbers with Ready Reference Index. 8754 pages. 4750 illustrations. Easy to read. Highly endorsed. A good help in securing Engineer's License. Price \$12; terms, \$1 per month. Free Trial.

INFORMATION:—In A Handy Form. Answers to Your Questions and Problems. Here is a partial list of the subjects covered:—**Engine Principles, Valve Setting, Pumps, Corliss Engines, Uniflow Engines, Pumping Engines, Contractors Engines, Locomotives, Marine Engines, Turbine Engines, Gas Engines, Oil Engines, Indicators, Producers, Aviation, Steam, Fuel Economy, Boiler Construction, Firing, Oil Burners, Stokers, Boiler Repairs, Pipe Fitting, Heating, Refrigeration, Elevators, Dynamos, Motors, Lighting, Wiring, Electrical Diagrams, Radio, Electrical Reference and Calculations.**

FREE BOOK—FOR LIMITED TIME.



While the edition lasts, "Audel's Answers" will be included with each set of Audel's Guides. Contains special information for those who want to go before the board to get a license. Makes Engineers exams easy. Send this coupon at once.

THEO. AUDEL & CO., 65 West 23rd St., New York City.

Send me AUDELS ENGINEERS AND MECHANICS GUIDES, 8 numbers, \$12 and "Audel's Answers" for free examination. If satisfactory, I will send you \$1 in 7 days, then \$1 monthly until \$12 is paid.

Name

Address

Occupation

Employed by..... 10T30

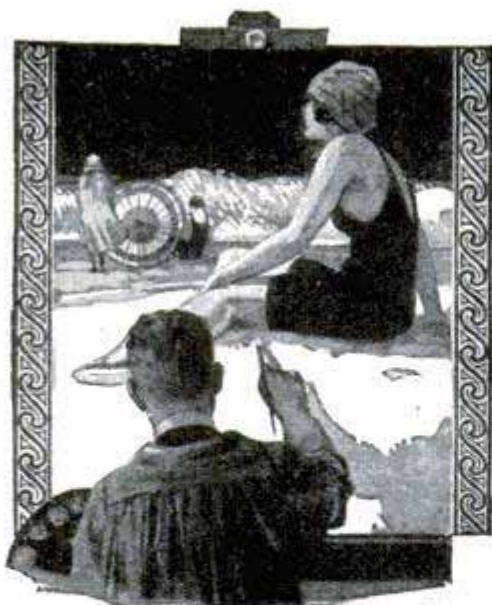

DRAWING is a way to FORTUNE

Ali Hafed, a Persian farmer, sold his acres to go out and seek his fortune. He who bought the farm found it contained a diamond mine which made him fabulously rich. Ali Hafed overlooked the great opportunity at his door to go far afield in search of wealth—which illustrates a great truth.

DO YOU LIKE TO DRAW?

If you do it is almost a certain indication that you have talent, a talent which few possess. Then don't follow Ali Hafed's example and look farther for fortune. Develop your talent—your fortune lies in your hand!

Earn \$200.00 to \$500.00 a Month and More

Present opportunities for both men and women to illustrate magazines, newspapers, etc., have never been excelled. Thousands of publishers buy millions of dollars' worth of illustrations every year. Illustrating is the highest type of art—pleasant work, yielding a large income.

THE FEDERAL COURSE IS A PROVEN RESULT GETTER

It is the only Home Study Course which has been built by over fifty nationally known artists—Sid Smith, Neysa McMein, Norman Rockwell, Clare Briggs, Charles Livingston Bull and Fontaine Fox among them.

FREE—"A ROAD TO BIGGER THINGS"

If you like to draw you should read this free book before deciding on your life's work. It tells about illustrating as a highly paid, fascinating profession and about the famous artists who have helped build the Federal Course. Just tear out this ad, write your name, age, occupation and address in the margin, mail it to us and we will send you your copy of the book and the sample lesson free. Do it right now while you are thinking about it.

Federal School of Illustrating

10136 Federal School Bldg.

Minneapolis, Minn.

Here's the Career for YOU



Get into Motion Picture Camera Work, Portrait and Commercial Photography. Learn at home. Big money while learning.

Earn up to \$250 a week

Hundreds of positions pay \$75 to \$250 a week. Or open your own studio. Easy, fascinating work.



CAMERA FREE

to students. Your choice of real Motion Picture Camera using professional film or 5 x 7 View Camera, anastigmat lens.

Write for big Free Book on Professional Photography. Explains amazing opportunities.

NEW YORK INSTITUTE OF PHOTOGRAPHY

12 W. 33d St., New York, N. Y., Dept. 49

Note: If you prefer to come to our studios for instruction, write for Catalog R-49 to nearest address: 10 W. 33d St., New York, or 630 So. Wabash Ave., Chicago.



ELECTRICAL

Course for men of ambition and limited time. Over 4000 men trained.

Condensed course in Theoretical and Practical Electrical

ENGINEERING

including the closely related subjects of Mathematics and Mechanical Drawing taught by experts. Students construct motors, install wiring, test electrical machinery. Complete course

IN ONE YEAR

Prepare for your profession in the most interesting city in the world. School established 1893. Send for catalog.

BLISS ELECTRICAL SCHOOL

428 Takoma Ave. WASHINGTON, D. C.



BIG MONEY IN POULTRY

Get into the poultry business NOW. This fall eggs and fowls will jump way up in price. Easy to make \$1,000 a year in spare time; or \$5,000 a year for full time. Free book tells all about our new, up-to-date, money-making poultry course and our remarkable plan of close, careful, individual assistance. Thousands use our methods.

Write for FREE copy today.

NATIONAL POULTRY INSTITUTE, Dept. 411, Washington, D. C.

Book on Law Free



Write today for this new book. It tells you how a law training will shorten your road to success. It also carries a vital and inspiring message to every ambitious man! Find out about the opportunities that await the law trained man. Find out how you can learn law right in your own home. No obligations. The book is absolutely FREE. Write Today, now while we are making a special reduced tuition offer.

American Correspondence School of Law
3601 Michigan Ave. Dept. 1357 Chicago, Illinois



Every Boy His Own Toymaker

Greatest boys' book ever written. Tells how to make a Steam Engine, Telephone, Magic Lantern, Boats, Kites, Balloons, electrical and mechanical toys, traps, fishing tackle, sleds, stilts, diving board, Bird Houses, etc. Fully illustrated 10c. 200 kinds. Iron, Wood and Wire Puzzles. Sample leader and Catalog 10c. WESTERN PUZZLE WORKS, SAINT PAUL, MINNESOTA.

Learn Watchwork, Jewelrywork and Engraving

A fine trade commanding a good salary, and your services always in demand. Address **Horological**, Dept. P, Bradley Institute, PEORIA, ILLINOIS, for our latest catalog.

WANT WORK AT HOME?

Earn \$18 to \$60 a week RETOUCHING photos. Men or women. No selling or canvassing. We teach you and furnish WORKING OUTFIT given with each enrollment. Limited offer. Write today. Artcraft Studios, Dept. 50, 3900 Sheridan Rd., Chicago

IF YOU STAMMER

Write for my free book "Millard's Advanced Natural Corrective Course" and a free copy of my speech magazine. 10,000 cases successfully treated. Est. 24 years. Largest school for stammerers in world. Millard Inst. of Normal Speech, 2317 Millard Bldg., Milwaukee, Wis.

Easy as A-B-C!

You Can Play Any Instrument In a Few Months This Delightful New Easy Way!

Quickest because natural and pleasant. Grateful students say they learn in a fraction of the time old dull methods required. You play direct from the notes. And the cost is only a few cents a lesson!

Learning music is no longer a difficult task. If you can read the alphabet, you can now quickly learn to play your favorite instrument! A delightful new method has made it positively easy to become a capable performer within just a few months. And the cost is only a *fraction* of what people used to spend on the old, slow methods!

You don't need a private teacher, this new way. You study entirely at home, in the privacy of your own room, with no one to interrupt or embarrass you. And, strange as it may seem, you'll enjoy every minute of it—because the new method is *agreeable* as well as *rapid*!

No Tricks or Stunts—You Learn from "Regular" Music

You don't have to know the first thing about music in order to begin. You learn to play from actual notes, just like the best musicians do. And almost before you realize your progress, you begin playing real tunes and melodies instead of just scales. There are no trick "numbers," no "memory stunts." When you finish the U. S. School of Music course, you can pick up any piece of regular printed music and understand it! You'll be able to read music, popular and classic, and play it from the notes. You'll acquire a life-long ability to please your friends, amuse yourself, and, if you like, make money (musicians are highly paid for their pleasant work).

Whether you like the piano, violin, 'cello, organ, saxophone, or any other instrument, you can now learn to play it in an amazingly short time. By means of this wonderful newly perfected method reading and playing music is made almost as simple as reading aloud from a book. You simply can't go wrong. First, you are told how a thing is done, then a picture shows you how, then you do it yourself and hear it. No private teacher could make it any clearer. The lessons come to you by mail at regular intervals. They consist of complete printed instructions, diagrams, all the music you need, and music paper for writing out test exercises. And if anything comes up which is not *entirely plain*, you can write to your instructor and get a full, prompt, personal reply!

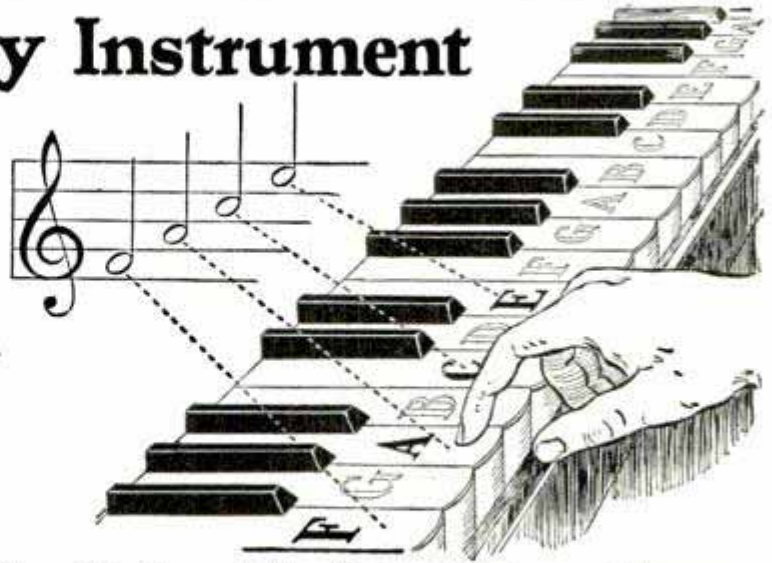

The Surest Way To Be Popular and Have a Good Time

Do you sit "on the sidelines" at a party? Are you out of it because you can't play? Many, many people are! It's the musician who claims attention. If you play, you are always in demand. Many invitations come to you. Amateur orchestras offer you wonderful afternoons and evenings. And you meet the kind of people you have always wanted to know. So don't miss this exceptional opportunity.

Learn to Play by Note

Piano	'Cello
Organ	Harmony and Composition
Violin	Sight Singing
Drums and Traps	Guitar
Banjo (Plectrum, 5-String, or Tenor)	Ukulele
Mandolin	Hawaiian Steel Guitar
Clarinet	Harp
Flute	Cornet
Saxophone	Piccolo
Voice and Speech Culture	Trombone
Automatic Finger Control	
Piano Accordion	

Free Book Explains All Get This Special Offer

The whole interesting story about the U. S. School course can not be told on this page. So a booklet has been printed—"Music Lessons in Your Own Home." You can have a copy absolutely free by mailing the coupon below. In the booklet you will find a special offer that makes the U. S. course available to you at a very low price—if you act promptly. With it will be sent a demonstration lesson which shows better than words how delightfully quick and easy this wonderful Method is. If you are really anxious to become a good player on your favorite instrument, mail the coupon now—today. Instruments supplied when needed, cash or credit. U. S. School of Music, 710 Brunswick Bldg., New York City.

U. S. School of Music,
710 Brunswick Bldg., New York City.

Please send me your free book, "Music Lessons in Your Own Home," with introduction by Dr. Frank Crane, Demonstration Lesson, and particulars of your Special Offer. I am interested in the following course:

(Name of Instrument or Course)

Name.....

Address.....

City..... State.....



High School Course in Two Years!

You Want to Earn Big Money!

And you will not be satisfied unless you earn steady promotion. But are you prepared for the job ahead of you? Do you measure up to the standard that insures success? For a more responsible position a fairly good education is necessary. To write a sensible business letter, to prepare estimates, to figure cost and to compute interest, you must have a certain amount of preparation. All this you must be able to do before you will earn promotion. Many business houses hire no men whose general knowledge is not equal to a high school course. Why? Because big business refuses to burden itself with men who are barred from promotion by the lack of elementary education.

Can You Qualify for a Better Position

We have a plan whereby you can. We can give you a complete but simplified high school course in two years, giving you all the essentials that form the foundation of practical business. It will prepare you to hold your own where competition is keen and exacting. Do not doubt your ability, but make up your mind to it and you will soon have the requirements that will bring you success and big money. **YOU CAN DO IT.**

Let us show you how to get on the road to success. It will not cost you a single working hour. Write today. It costs you nothing but a stamp.

American School

Dept. H774, Drexel Ave. and 58th St., Chicago

American School

Dept. H774, Drexel Ave. and 58th St., Chicago
Send me full information on the subject checked and how you will help me win success.

- | | |
|-----------------------------|---------------------------|
|Architect |Business Law |
|Building Contractor |Lawyer |
|Automobile Engineer |Machine Shop Practice |
|Automobile Repairman |Mechanical Engineer |
|Civil Engineer |Shop Superintendent |
|Structural Engineer |Employment Manager |
|Business Manager |Steam Engineer |
|Cert. Public Accountant |Foremanship |
|Accountant and Auditor |Sanitary Engineer |
|Bookkeeper |Surveyor (& Mapping) |
|Draftsman and Designer |Telephone Engineer |
|Electrical Engineer |Telegraph Engineer |
|Electric Light & Power |High School Graduate |
|General Education |Wireless Radio |
|Vocational Guidance |Undecided |

Name.....

Address.....

Wrestling Book 10c

Learn at Home



Men, Boys be perfect physically. Learn right in your own home from **WORLDS CHAMPIONS** how to be an expert **WRESTLER**. Learn secret trick holds, blocks, breaks and pinning holds. Learn how to defend yourself against bigger, stronger men. Learn Jiu-jitsu. Also most wonderful course in **PHYSICAL CULTURE** ever discovered. The world renowned **FARMER BURNS AND FRANK GOTCH** are authors of these splendid lessons. Learn to be a real athlete. You can if you'll try. Have a beautiful attractive body that all will admire. Surprise your friends, and the "bully" with your great ability. Learn to protect yourself, your mother, sister or sweetheart. Have perfect health, ability.

Only 10c

Send only 10c coin or stamps, for 32 page book, **ILLUSTRATED**, giving full particulars. Tells the secrets of the big Champions; gives many tricks, holds and other valuable information. A costly book which we send for only 10c—the cost of packing and postage. Don't miss it. Don't delay. **SEND TODAY—THIS MOMENT.**

Farmer Burns School, 1777 Railway Exchange Bldg., Omaha, Neb.

PIANO JAZZ

By Note or Ear. With or without music. Short Course. Adult beginners taught by mail. No teacher required. Self-instruction Course for Advanced Pianists. Learn 259 styles of Bass, 684 Syncopated Effects, Blue Harmony, Oriental, Chime, Movie and Café Jazz, Trick Endings, Clever Breaks, Space Fillers, Sax Slurs, Triple Bass, Wicked Harmony, Blue Obligato, and 247 other Subjects, including Ear Playing. 133 pages of **REAL JAZZ**, 25,000 words. A Postal brings our **FREE Special Offer.**

Waterman Piano School, 1826 W. Adams St. Los Angeles, Cal.

Anyone CAN LEARN

No talent or experience necessary. Fascinating work. Pays big money. Complete instruction book tells about: Alphabets, Colors, How to Mix Points, Show Cards, Window Board and Wall Signs, Ready made letters, Gliding, Tricks of the Trade, also gives 100 Alphabets and Designs. Book bound in flexible imt. leather-gold edges, and four ball bearing Show Card Pens. Sent postpaid \$3.00. (C.O.D.) 10c ex. Ogilvie Pub. Co., 57 Rose St. Dept. 50, N.Y. City

EARN MONEY IMMEDIATELY—
WE FURNISH EQUIPMENT TO START!!

LAW High-Grade Instruction

By Correspondence Prepares You for the Bar—Est. 1892
University Methods. Standard Text-Books. Approved by Bench and Bar. Graduates practicing in every state. Send today for Free Catalog and Rules for Admission to the Bar. **CHICAGO SCHOOL OF LAW, 802 Reaper Block, Chicago, Ill.**



TELEGRAPHY

(Morse and Wireless) and **RAILWAY ACCOUNTING** taught thoroughly. Big salaries; great opportunities. Oldest, largest school. Endorsed by Telegraph, Railway, Radio, and Government officials. Expenses low—opportunities to earn large portion. Catalog free. **DODGE'S INSTITUTE, Jones St., Valparaiso, Ind.**

Learn Photography at HOME

Earn \$3,000 to \$10,000 a year. Prepare quickly during spare time. Also earn while you learn. New easy method. Nothing else like it. Send at once for free book, "Opportunities in Modern Photography" and full particulars. Special offer open now. **International Studios, Inc., Dept. 1357, 3601 Michigan Ave., Chicago, U. S. A.**

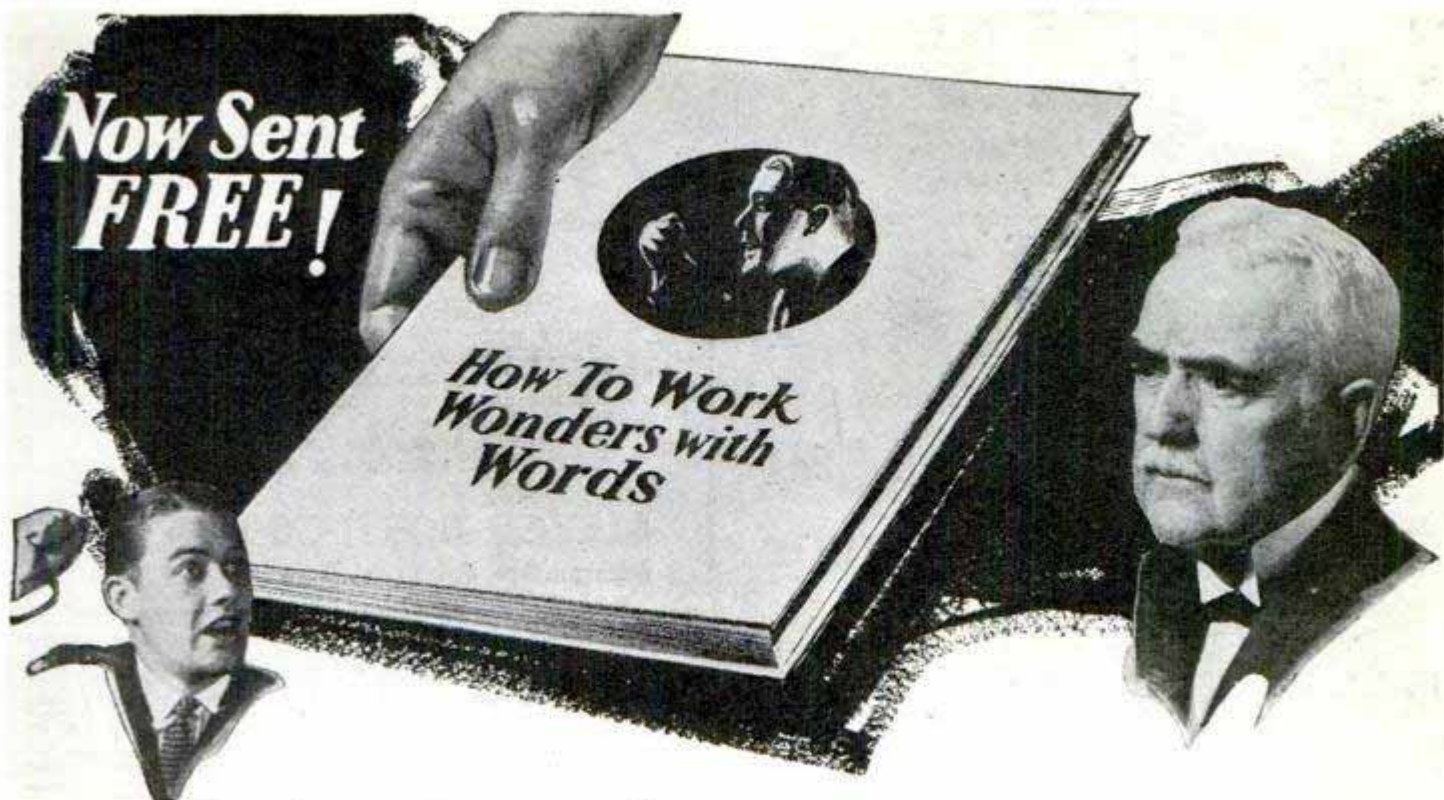

Not Only Men Who Have Made Millions Send for this Astonishing Book -but Thousands of Others!

Many successful business men have sent for this amazing book NOW MAILED FREE. Such men as Walter C. Ford, of the Ford Manufacturing Company; C. F. Bourgeois, President of Robischon and Peckham Company; H. B. McNeal, President of the Telephony Publishing Company, and many other prominent, prosperous business executives, are unstinting in their praise of it. But don't think it is only for big men. Thousands of young men have found in this book the key to advancement in salary and position, popularity, standing, power and real success.

Today business demands for the big, important, high-salaried jobs men who can dominate others. It is the power of forceful, convincing speech that causes one man to jump from obscurity to the presidency of a great corporation. Another from a small, unimportant territory to the sales-manager's desk. Another from the rank and file of political workers to a post of national prominence as a campaign speaker. A timid, self-conscious man to change almost overnight into a popular and much-applauded after-dinner speaker.

Either You Become a Powerful Speaker —or Your Training is Free

You are shown how to conquer stage fright, self-consciousness, timidity, bashfulness and fear—those things which keep you

silent while men of lesser ability get what they want by the sheer power of convincing speech. You are told how to bring out and develop your priceless "hidden knack"—which will win for you advancement in position and salary, popularity, standing, power and real success. This simple, easy, sure and quick training is guaranteed to do this—or it will not cost you a single penny.

Only 15 Minutes a Day Required

There is no mystery about the power to work wonders with words. It makes no difference how embarrassed or self-conscious you now are when called upon to speak. Certain

principles will show you how to rise head and shoulders above the mass and make yourself the dominating figure in any gathering. How to rise to any occasion and demand what you want with force, vigor and conviction. Give only fifteen minutes a day in the privacy of your own home and you can accomplish all this in a few short weeks.

Make This FREE Test

If you will fill in and mail the coupon at once you will receive this remarkable new book, "How to Work Wonders with Words," which gives you an amazing test by which you can determine for yourself in five minutes whether you are one of the seven men out of every nine who possess the "hidden knack" of powerful speech, but do not know it. Decide for yourself if you are going to allow fifteen minutes a day to stand between you and success. Thousands have found this to be the biggest forward step of their lives. If it has played such an important part in the lives of many big men, may it not in yours?

North American Institute

Dept. 1357, 3601 S. Michigan Ave.

Chicago, Ill.

North American Institute.

Dept. 1357, 3601 S. Michigan Ave., Chicago, Ill.

Please send me FREE and without obligation my copy of your famous book, "How to Work Wonders with Words."

Name.....

Address.....

City..... State.....

What 15 Minutes a Day Will Show You

- How to address business meetings.
- How to propose and respond to toasts.
- How to make a political speech.
- How to tell entertaining stories.
- How to write better letters.
- How to enlarge your vocabulary.
- How to develop self-confidence.
- How to acquire a winning personality.
- How to strengthen your will-power.
- How to be the master of any situation.



"They've tripled your salary, dear"

"I TELL you, Tom, it was a lucky day for both of us when you sent in that I. C. S. coupon. You'd never be where you are today if you hadn't decided to study in spare time just when you did."

Spare-time study with the I. C. S. is winning promotions for thousands of men and bringing happiness to thousands of homes all over the world. In offices, shops, stores, mines, mills and on railroads, I. C. S. trained men are stepping up to big jobs, over the heads of older men, past those whose only qualification is long service. There is a job ahead of YOU. Some man is going to be picked for it. The boss can't take chances. He is going to choose a trained man with sound, practical knowledge of the work.

Get busy right now and put yourself in line for that promotion. You can do it in spare time in your own home through the International Correspondence Schools, just as thousands of other men and women have done.



Mail the Coupon Today for Free Booklet!

INTERNATIONAL CORRESPONDENCE SCHOOLS
Box 5603-E, Scranton, Penna.

Without cost or obligation, please send me one of your booklets and tell me how I can qualify for the position or in the subject before which I have marked an X:

BUSINESS TRAINING COURSES

- | | |
|--|---|
| <input type="checkbox"/> Business Management | <input type="checkbox"/> Salesmanship |
| <input type="checkbox"/> Industrial Management | <input type="checkbox"/> Advertising |
| <input type="checkbox"/> Personnel Organization | <input type="checkbox"/> Better Letters |
| <input type="checkbox"/> Traffic Management | <input type="checkbox"/> Show Card Lettering |
| <input type="checkbox"/> Business Law | <input type="checkbox"/> Stenography and Typing |
| <input type="checkbox"/> Banking and Banking Law | <input type="checkbox"/> Business English |
| <input type="checkbox"/> Accountancy (Including C.P.A.) | <input type="checkbox"/> Civil Service |
| <input type="checkbox"/> Nicholson Cost Accounting | <input type="checkbox"/> Railway Mail Clerk |
| <input type="checkbox"/> Bookkeeping | <input type="checkbox"/> Common School Subjects |
| <input type="checkbox"/> Private Secretary | <input type="checkbox"/> High School Subjects |
| <input type="checkbox"/> Spanish <input type="checkbox"/> French | <input type="checkbox"/> Illustrating <input type="checkbox"/> Cartooning |

TECHNICAL AND INDUSTRIAL COURSES

- | | |
|---|--|
| <input type="checkbox"/> Electrical Engineering | <input type="checkbox"/> Architect |
| <input type="checkbox"/> Electric Lighting | <input type="checkbox"/> Architects' Blue Prints |
| <input type="checkbox"/> Mechanical Engineer | <input type="checkbox"/> Contractor and Builder |
| <input type="checkbox"/> Mechanical Draftsman | <input type="checkbox"/> Architectural Draftsman |
| <input type="checkbox"/> Machine Shop Practice | <input type="checkbox"/> Concrete Builder |
| <input type="checkbox"/> Railroad Positions | <input type="checkbox"/> Structural Engineer |
| <input type="checkbox"/> Gas Engine Operating | <input type="checkbox"/> Chemistry <input type="checkbox"/> Pharmacy |
| <input type="checkbox"/> Civil Engineer | <input type="checkbox"/> Automobile Work |
| <input type="checkbox"/> Surveying and Mapping | <input type="checkbox"/> Airplane Engines |
| <input type="checkbox"/> Metallurgy | <input type="checkbox"/> Navigation |
| <input type="checkbox"/> Steam Engineering | <input type="checkbox"/> Agriculture and Poultry |
| <input type="checkbox"/> Radio | <input type="checkbox"/> Mathematics |

Name.....
Street.....
Address..... 3-6-24
City..... State.....

Occupation.....

Persons residing in Canada should send this coupon to the International Correspondence Schools Canadian, Limited, Montreal, Canada.

PREPARE FOR AN ART CAREER

—thru the *only* school operated as a department of a large art organization. Commercial Artists trained the "Meyer Both Way" earn as high as \$10,000 per year. We today have hundreds of students who had previously studied in other art schools. Why? Because your instruction is based upon our everyday experience in meeting the art needs of leading advertisers. Home study instruction. Write for illustrated book telling of the success of our students.

MEYER BOTH COMPANY
Michigan Ave. at 20th St., Dept. 16, Chicago, Ill.

Music Lessons

WITH AN ACCREDITED SCHOOL

At Home

A Complete Conservatory Course By Mail

Wonderful home study music lessons under great American and European teachers. Endorsed by Paderewski. Master teachers guide and coach you. Lessons a marvel of simplicity and completeness.

Any Instrument Write telling us course you are interested in—Piano, Harmony, Voice, Public School Music, Violin, Cornet, Mandolin, Guitar, Banjo or Reed Organ—and we will send our FREE CATALOG with details of course you want. Send NOW.

University Extension Conservatory, 326 Siegel-Myers Bldg., Chicago, Ill.

LEARN WATCHMAKING

and become independent. We help you secure a position.

Easy to learn. Send for FREE CATALOG.
ST. LOUIS WATCHMAKING SCHOOL, Dept. 5, ST. LOUIS, MO.

Skin Troubles

Cleared up—often in 24 hours. To prove you can be rid of Pimples, Blackheads, Acne Eruptions on the face or body, Barbers' Itch, Eczema, Enlarged Pores, Oily or Shiny Skin, simply send me your name and address today—no cost—no obligation. **CLEAR-TONE** tried and tested in over 100,000 cases—used like toilet water—is simply magical in prompt results. You can repay the favor by telling your friends; if not, the loss is mine. **WRITE TODAY.** E. S. GIVENS, 428 Chemical Bldg., Kansas City, Mo.

Grow Taller

Science has found the way to add inches to your height. No need to envy and look up to the big fellows. No need to have the disadvantages of the little man. This course makes it possible for you to be on a level with your fellow men. Course is easy, inexpensive and results sure. Mail coupon for free information today!



L. GLOVER,
Room 37, 459 San Carlos Ave.,
Sausalito, Calif.

Without any obligation to me, send me full information on how to grow taller.

Name.....

Street..... City.....

DRAFTING PAYS from \$3,500 to \$10,000 a Year

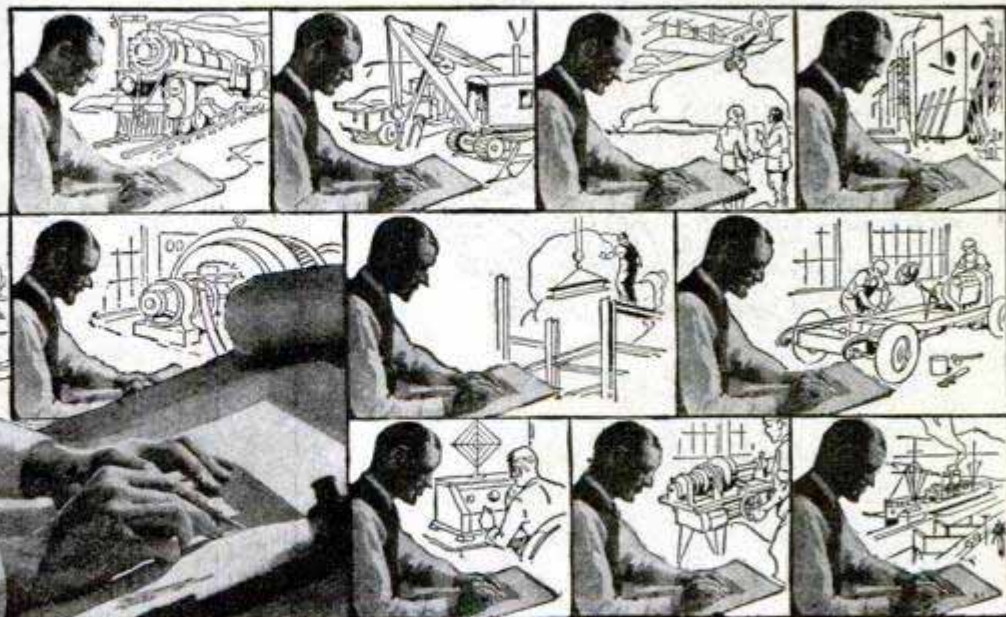
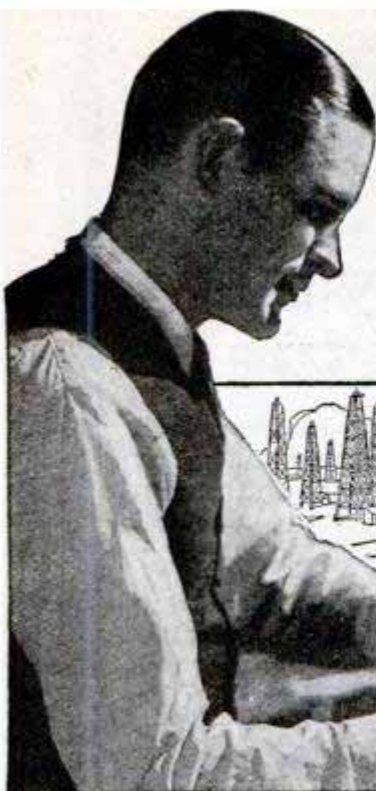

Well Paid Positions ~ \$75 a Week up

Machine Shop or Mill—Railroading or Radio—Electric Companies or Public Service Stations—Building, Engineering, or Mining—All of the World's Work Calls for Draftsmen—All Interesting and Easy for the Draftsman—The Field that Leads Them All Will Always Be Drafting

\$20 A DAY If a hundred dollars a week sounds big—yes, or \$150—you aren't in the right line of business! Get into a broader field—the broadest of all. That's drafting!

Drafting is the BIG field, men. Every industry you can name BEGINS with the draftsman. Without mechanical drawings—by the thousands—every shop in the land would be STOPPED.

In fact, it is the SERIOUS SHORTAGE of draftsmen that brings this offer: *I will furnish all instruments, supplies, even to the table, to those who start now!*

PAY AS YOU GO Don't give me the excuse that you have no ready money for this golden opportunity. I am not so interested in *cash*; I want your *application*. I want at least 200 men to start *right now*. I want them ready to recommend by Spring! We will get a flood of letters saying "send us draftsmen," from every sort of industrial and engineering concern, and we *must* make good.

The first week's pay envelope of many a Dobe-trained draftsman has held enough to cover the entire cost of the course! Most students learn evenings, keeping on with their old work until ready to step into somebody's drafting room. The first month equips you to take on simple drafting jobs on the side. It helps you learn; I gladly permit this.

Well-Paid Positions Every Way You Turn

A draftsman soon forgets the days when he used to wonder where to get a job. Instead, he asks "What line of work interests me most?" And "What part of the country suits me best?" Twenty of my graduates went to Florida this year; three are in Japan; last month one wrote me from Ceylon. And I wish we had the count of how many Dobe draftsmen have become chiefs!

Positions loom up almost as soon as you are enrolled in a Dobe class! We receive requests *daily* for men—for men only partly through our course. "We'll take a *beginner*," some concerns write us, "so long as he is a Dobe trained man and has begun *right!*"

IT'S EASY and interesting to learn drafting. For drafting isn't "drawing!" You don't need any "talent." A draftsman uses *tools* for every line and every curve. That's why drafting is so easily learned—and so interesting. *For you do everything by rule*. So, I guarantee if you can read and write, you can learn this line.

WARNING! The special offer of tools is for immediate action. Don't expect me to hold it open indefinitely. Clip the coupon *now* for free book:

Not a dollar's extra expense for tools, if you are prompt



"Have completed \$100,000 worth of work this year, thanks to Dobe instruction."—D. E. SANDERS (S. Car.)



"My new chief says, Dobe must teach right. I can handle everything so far. They pay me \$85 a week."—LEO NIECEBERGER (Pa.)



"Just been made chief and gets a good boost in pay. Your course has the goods."—WM. G. HAZLETT (Col.)

GOOD FOR TOOLS

Mail this IN TIME for my FREE TOOL offer and ENTIRE WORKING OUTFIT costs NOTHING extra, if you decide to ENROLL!

CHIEF DRAFTSMAN DOBE

1951 Lawrence Ave., Chicago, Dept. 13-57

Please send FREE and POSTPAID, without obligation, your new, fully illustrated book Successful Draftsmanship, complete information, terms, etc.



Name..... Age.....

P. O.

Play the HAWAIIAN GUITAR and be Popular!

Play all the latest hits just as the Hawaiians do. Be the most popular member of your set. Get in on all the good times. Entertain your friends—or play professionally. Be in demand everywhere. We will help you.



\$15
HAWAIIAN GUITAR
with Genuine Seal Grain
Fabrikoid Cover
FREE
when you enroll



This sweet-toned, mellow Hawaiian Guitar would cost you at least \$15 in any music store without the Genuine Seal Grain Fabrikoid Case. We can afford to give you the entire outfit free when you enroll, including picks, steel playing bar, etc., because we make them in huge quantities in our own factory. Nothing to buy—everything is furnished.

Learn in Spare Time at Home

You study in spare time—when you like—as long as you like. And even if you don't know one note from another, our method is so simple, plain and easy that you begin a piece your first lesson. In half an hour you can play it!

Famous Native Hawaiians Teach You

You receive expert instruction from such world famous players as Kolomoku, Kalaluki, Ferara and Seville. They quickly teach you the secrets of this fascinating instrument.

Complete Conservatory Course. You get 52 complete printed lessons. Nothing is omitted. Pictures explain every move. And no matter how little you know about music when you begin, no matter if you have never touched a musical instrument, you can positively learn to play by our plain, easy, picture method.

Only 4 Motions to Learn

Then you can play any music—popular songs, classical, old-time melodies, native Hawaiian airs—or real jazz—separately or with accompaniment. You'll never be lonesome after you learn to play on this beautiful Hawaiian Guitar.

Pay as You Play

We make it easy for you. You start any time—with a small first payment—then pay while learning. Write for liberal offer.

Our Written Guarantee

We guarantee in writing to teach you 45,000 successful students. And we coach and advise you after graduation—no extra cost.

Other Courses under famous teachers—Tenor Banjo, Violin, Mandolin, Banjo Ukulele and Ukulele.

FIRST HAWAIIAN CONSERVATORY OF MUSIC, INC.

9th Fl., Woolworth Bldg., Dept. 248, New York, N. Y.

Approved as a Correspondence School Under the Laws of the State of New York

ACT! Mail This Popularity Coupon NOW!

FIRST HAWAIIAN CONSERVATORY OF MUSIC, Inc.

9th Fl., Woolworth Bldg., Dept. 248, New York, N. Y.

Please mail full information about your 52-lesson Hawaiian Guitar Course. I am not obliged to enroll unless I want to.

Name _____

Address _____

City _____ State _____

Know
the
School



By
the
Emblem

Today's Big Opportunity

300 of America's leading schools of business are now opening their doors to young men and women who want to succeed in business—the greatest of all professions.

No prospective business student should select a school without having before him our free Booklet E, "The Sure Way To Success." It contains invaluable suggestions on choosing a career and a school. Send for it today. Don't let delay cheat you into failure!

National Association
Accredited Commercial Schools
1618 Mallers Building, Chicago

"STAMMERING Its Cause and Cure"

You can be quickly cured if you stammer. Send 10 cents, coin or stamps, for 288 page cloth bound book on Stammering and Stuttering. It tells how I cured myself after Stammering and Stuttering for 20 years. BENJAMIN N. BOGUE
6938 Bogue Building, 1147 N. Ill. St. Indianapolis

LEARN PIANO TUNING AT HOME

Send for FREE copy of the 28th ANNIVERSARY EDITION of our book "Winning Independence." Read how students master TUNING with our Tune-A-Phone, and WHY our graduates head the profession in all parts of the world. With Bryant's patented devices, tools, charts, and lessons, one learns quickly and easily. Low tuition, easy terms; Diploma granted. MONEY-BACK GUARANTY. \$10 to \$25 a day; exceptional opportunities, and an ideal profession await you.
BRYANT SCHOOL OF TUNING (71) Bryant Bldg., Augusta, Michigan



GOVT. POSITIONS

\$35 TO \$75 WEEKLY

- | | |
|------------------------|----------------------------------|
| () Railway Mail Clerk | () Meat Inspector |
| () P. O. Clerk | () Special Agent (investigator) |
| () Forest Ranger | () Stenographer-Typist |
| () File Clerk | () Immigrant Inspector |
| () Matron | () City Mail Carrier |
| () General Clerk | () U. S. Border Patrol |
| () Chauffeur-Carrier | () Typist |
| () Skilled Laborer | () Seamstress |
| () Watchman | () Steno-Secretary |
| () Postmaster | () Auditor |
| () RFD Carrier | |

Mr. Ozment, Dept. 111, St. Louis, Mo.

Send me particulars about positions marked "X"
—salaries, locations, opportunities, etc.

NAME _____

ADDRESS _____

BUILDERS TRADE GUIDES



AUDELS CARPENTERS AND BUILDERS GUIDES—4 VOLS. \$6

Inside Information for Carpenters, Builders, Joiners, Building Mechanics—all Woodworkers. **1600 pages; 3700 diagrams; flexible; pocket size.** Short-cut instructions, new methods, ideas, solutions, plans, systems—money saving suggestions. An easy progressive course for the apprentice. A practical daily helper and Quick Reference for the master worker. A Helping Hand to Easier and Better Work and Better Pay. To get this aid for yourself, simply fill in and mail the FREE COUPON below.

INSIDE TRADE INFORMATION ON:
 How to use steel square; How to file and set saws; How to build furniture; How to use mitre box; How to use chalk line; How to use rules; How to make joints; Carpenters' arithmetic; Mensuration problems; Estimating strength of timbers; How to set girders and sills; How to frame houses and roofs; How to estimate costs; How to build houses, barns, garages, bungalows, etc.; How to read and draw plans; Drawing up specifications; How to excavate; How to use settings 12, 13 and 17 on the steel square; How to build hoists and scaffolds—skylights; How to build stairs; How to put on interior trim; How to hang doors; How to lath—lay floors; How to paint.



AUDELS PLUMBERS AND STEAMFITTERS GUIDES—4 VOLS. \$6

A new set—just out! A practical, illustrated, Reference Library and Study-Course for Master Plumbers, Journeymen and Apprentice Steamfitters, Gas Fitters and Helpers, Sheet Metal Workers, Draughtsmen, Master Builders, Engineers and all Building Trade Students. **1670 pages; 3642 diagrams; flexible; pocket size.** Guides explain all the principles, advances and short cuts of the Plumbing and Heating trade. Contains instructions on how to figure and estimate jobs. Use FREE COUPON below to examine, without obligation, this valuable work.

INSIDE TRADE INFORMATION ON:
 Soldering, tinning. Joint wiping, bending, beating. Pipe—iron—steel, threading. Mathematics, tables, physics. Materials—iron, steel, copper, brass, lead, tin, antimony. Sheet metal—galvanization, syphonage, tanks. Drainage, sewage, purification. Fixtures—bath—kitchen. Pipe fittings, soil pipe, tools. Laying out work. Roughing. Screwed fittings, flanges, joints. Pipe bending, examples. Elbows. Heating, ventilation, refrigeration. Water supply, mains, wells, tanks. Gas-fittings. Underwriters. Sheet metal work, problems, methods, brazing, heating, lead burning. Welding, various welds, methods. Blacksmithing, forges, tools.

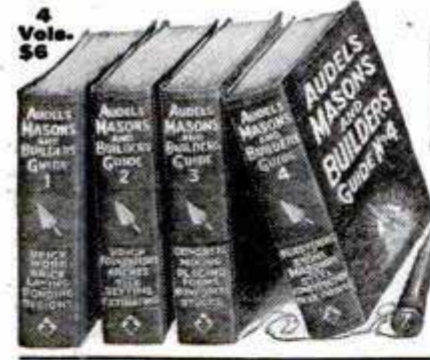

AUDELS MASONS AND BUILDERS GUIDES—4 VOLS. \$6

A new, complete, illustrated trade reference library, for Bricklayers, Cement Workers, Plasterers, Tile Setters and Stone Masons, including a practical outline of Steel Construction. **1100 pages; 2067 diagrams; flexible; pocket size.** A practical Trade Assistant explaining modern methods of masonry construction. Easy to understand and apply. A reliable and authentic reference work and study-course for Master Journeyman and Young Mechanic. Use FREE COUPON below and find out for yourself, without obligation, whether this set will benefit you.

INSIDE TRADE INFORMATION ON:
 Bricklaying, tools, materials; Brick designs, patterns, bonds; Setting frames and foundations; Mortars, scaffolds, estimating; Mortars and mortar mixing; Tile setting, mosaic, hollow tile; Straight edge test, troweling; How to figure brick work; Safe loads, piers, chimneys; Boiler settings, anchors, fire stops; Labor tables; Concrete, forms; How to figure concrete work; Stucco—on old and new buildings; Plastering—wood lath—metal; Plasterers agreement; Plastering on various surfaces; Stonemasonry; Cutting, finishing, estimating stone; Derricks, rigging; Steel construction; Fire proof; How to read blue prints.



PRACTICAL ELECTRICITY — 1 VOL. \$4

Audels Handy Book of Practical Electricity is a simplified Ready Reference and Study Course in one pocket size, leather bound volume—for Engineers, Professional Electricians and Students. **1040 pages; 2600 diagrams; flexible red leather bound.** A reliable authority and handy helper for every electrical worker. Contains important and valuable wiring diagrams, calculations, machine sketches, helps on maintenance and repair. Use this FREE COUPON today and find out, without obligation, how this handy book will help you in your daily work.



Complete in one handy, red leather bound volume
 1040 Pages
 2600 Diagrams
 WITH WIRING DIAGRAMS

INSIDE TRADE INFORMATION ON:
 Electro-Therapeutics, X-Rays, Shocks, Welding, Brazing, Radio Hook-ups, Motion Pictures, Telephone, Telegraph, Cranes, Bells, Elevators, Pumps, Tools, Ship Drive, Railways, Vehicles, Automobile Electric Systems, Ignition, Generation, Lighting, Plant Management, Power Plans, Armature Winding, Repairing, A. C. Motors and Apparatus, D. C. Motors and Apparatus, Alternator Construction, Dynamos, Wiring Diagrams, Sign Flashers, Cable Splicing, Power Wiring, Outside Wiring, Switches, Lighting, Rectifiers, Converters, Transformers, Fuses, Circuit Breakers, Rheostats, Electro Plating, Electrolysis, Storage Batteries, Magnetism, Electrical Energy, Conductors, Insulators, Static, Dynamic, Radio Electricity, Applications, Ready Reference and Index Covering the entire field of Modern Electricity.

Learn More and You Will Earn More!

Know your job and you'll never be without one. The skilled man is always in demand. Knowledge is power. Learn your trade thoroughly by easy reading. This coupon is your opportunity for advancement and better pay. You risk nothing in sending for Audels Guides for free examination. Send it NOW!

FREE EXAMINATION COUPON

THEO. AUDEL & CO.,
 65 W. 23 ST., NEW YORK CITY

Please mail me for free examination the books marked (x) below. If I find them satisfactory, I agree to mail \$1 in 7 days, on each set ordered, and to further mail \$1 monthly on each set until I have paid the purchase price.

4 CARPENTERS GUIDES \$6 4 PLUMBERS GUIDES \$6

4 MASONS GUIDES \$6 1 ELECTRICIANS HANDY BOOK \$4

NAME

ADDRESS

OCCUPATION

EMPLOYED BY..... 10T30



IN DRAWING CARTOONS

Why spend your time doing work that is drudgery, and get little money for it when you can enter this well paid profession? You can learn cartooning at home with this amazing easy method, which teaches you to draw cartoons that sell. You can also earn while you learn.

A steady income—\$3,000 to \$15,000 a year—your own boss—easy hours—no off seasons—that's the life of a good cartoonist. Right now you may be earning only a pitifully small salary—but with this training you can easily be on easy street—independent. There's always a demand for good cartoonists.

Easy to Learn Cartooning At Home in Spare Time

There is a knack about learning cartooning which you can master in your spare time with this simple home study method. It starts you at the very beginning—on simple fundamental principles—then takes you through every branch of humorous and serious cartooning. You will be surprised how quickly you can draw cartoons that will sell. Many earn even while learning.

Send for Free Book

Get this handsomely illustrated booklet which gives the details of this remarkable home study course in Cartooning. Gives thorough outline of the cartooning field and market for cartoons. Shows how to become a cartoonist. No obligation. Send for it today.

WASHINGTON SCHOOL OF CARTOONING

Room 3010-D 1113—15th St., N. W., Washington, D. C.

WASHINGTON SCHOOL OF CARTOONING

Room 3010-D, 1113—15th St., N. W., Washington, D. C.

Please send me without obligation, your Free Booklet on Cartooning, and full details of your home study method of teaching Cartooning.

Name.....
(Print Name Plainly)

Address.....

City..... State.....
(If under 16 please give age)



Will You Wear This Suit?

Show it to your friends and neighbors as a sample of our fine quality, hand-tailored **All-Wool Suits**, guaranteed \$40 values at amazing low price of \$23.50, take their orders, keep handsome profit for yourself and send orders to us.

Agents Making BIG MONEY

\$3.00 to \$5.00 an hour in spare time, \$75 to \$150 a week for full time. We supply handsome Swatch Line Outfit, large size samples and all latest styles in elegant Leather Case.

Positively finest selling outfit ever furnished salesmen. Write for yours at once, pick out your suit and get started making the Big Money right away. Address Dept. 767.

JAMES OLIVER, Inc., 848 W. Adams St., Chicago

Write name and address below and mail at once.

Name.....767

St. and No..... R. F. D..... Box.....

Town..... State.....

Learn Advertising at HOME

Some of the highest paid men in the world are advertising men. You can learn easily and quickly at home during your spare time. Bigger opportunities now in advertising than ever before. Tremendous demand for our graduates at big pay.

Send for **FREE Book**. Giving interesting information and vital facts—just what you want to know about advertising. Write today!

PAGE-DAVIS SCHOOL OF ADVERTISING

Dept. 1357 3601 Michigan Ave., Chicago, U. S. A.

Learn RADIO

\$3,000 to \$10,000 a Year. How to build, repair, install, sell radios now, quickly learned. Simple, easy home-study plan. 1000-mile set free with course. Low cost, easy terms. Send now for free big book on radio opportunities.

RADIO ASSOCIATION OF AMERICA
4513 Ravenswood Ave. Dept. A-10 Chicago, Ill.

NEW 1926 FREE OFFER

Bishop's ELECTRICAL DRAFTING and DESIGN
—Free With This Pay-Raising Set

For a short time only we will give every subscriber to Croft's LIBRARY OF PRACTICAL ELECTRICITY a copy of Bishop's ELECTRICAL DRAFTING AND DESIGN—absolutely FREE. This book tells you everything you want to know about reading and constructing all kinds of electrical drawings and diagrams. It comes to you FREE with

The Croft Library of Practical Electricity

A combined reference library and home study course 8 volumes, 3000 pages, 2100 illustrations, flexible binding \$1.50 in ten days and \$2.00 monthly for nine months—only 7 cents a day.

The man who gets anywhere in any line of endeavor is the man who KNOWS. And generally the more he knows the more he earns.

For the man who wants to know there is nothing better than these eight volumes packed to the covers with sound, helpful information on every phase of electricity from first principles to central station work.

SEE IT FREE— No obligation to Purchase

By just filling out and returning the coupon below you will have, at no cost to you whatsoever, a practical, useful set of books for 10 days' Free Examination. We take all the risk—pay all charges. You assume no obligation—you pay nothing unless you decide to keep the books. Send the coupon NOW and see the books for yourself. When your first payment of \$1.50 is received we will send you your free copy of Bishop's ELECTRICAL DRAFTING AND DESIGN.



FREE EXAMINATION COUPON

McGraw-Hill Book Co., Inc., 370 Seventh Ave., New York

Send me for 10 days' free examination the Croft Library of Practical Electricity. If satisfactory I will send you \$1.50 in 10 days and \$2.00 monthly until the special price of \$19.50 is paid. If not wanted, I will return the books at your expense. On receipt of my first payment of \$1.50, it is understood that I am to receive, free of charge, a copy of Bishop's ELECTRICAL DRAFTING AND DESIGN.

Signed.....

Address.....

City and State.....

Position.....

Employer..... P.M. 10-1-26

Strongfort—Man Builder tells you how to be powerful



STRONGFORT
Builder of Men

how you can make yourself over into a vigorous specimen of vital manhood. It will teach you how to fit yourself to be a credit to your social and business associates. Just mark the subjects on the free consultation coupon on which you want special confidential information and send to me. It's a man-builder and a lifesaver. Send for my **FREE BOOK**—Right Now. **TO-DAY!**

LIONEL STRONGFORT

Physical and Health Specialist for over 25 Years

STRONGFORT INSTITUTE

Dept. 236, NEWARK, NEW JERSEY, U. S. A.

YOU—like every other man worthy the name of "man"—have a burning desire to be strong—to be dynamic—to be vigorous—to be capable of defense—to be an outstanding figure—admired and respected by men and women. You know the penalty of weakness. You know that the skinny fellow with hollow chest and sallow face—like the flabby fellow with too much stomach and too little wind—is a ridiculous object, laughed at and despised—undesirable in company, unsought as a companion.

You don't have to be one of this kind. *You can be a real 100 per cent. man.* You can be just such a man as any one of the splendid fellows I have instructed. The world holds no parallel for the work I have accomplished in upbuilding weak men. And what I have done for others I can do for you through **STRONGFORTISM**—my world famed Course of health and strength building.

STRONGFORTISM

Will Do Wonders For You

I have made powerful men out of mere weaklings and many have become nationally famous. You may not seek tremendous strength. You may not want to become a professional strong man. But you do want good health and manly strength—*every man wants that!* You want energy and vitality. You want a clear, unflinching eye and a steady nerve. You want courage, "sand" and pep! And you can get all these by following in the paths in which I have directed thousands—you can be a *real man*. Above all, you can rid yourself of disheartening weaknesses and blighting ailments such as constipation, indigestion, rheumatism, high blood pressure, nervousness, lassitude, insomnia, catarrh, chronic colds, etc. if you are so afflicted.

Vibrant Life Awaits You

Many young men write me the most pathetic letters about their sorry plight and their hopeless state of mind. What I reveal to them, what I do for them, transforms their lives, makes them happy, joyous souls, with an entirely new outlook on life. My methods give to them speedily a bodily feeling so new, so different, so vigorous that they are like men reborn—vibrant with life, bubbling with energy, eager for contact with others, full of ambition and pep. Results are truly marvelous. Thousands testify to this fact. They tell a story of rejuvenation, restoration and rebuilding of the human body that is beyond dispute.

My Scientific Methods Are Beyond Physical Culture

Do not confuse the *Science of STRONGFORTISM* with gymnastic or ordinary physical culture courses. I am not merely a muscle developer. I am far more than that, for I have devised a system that restores sick, ailing, hopeless men to the **Glory of Powerful Manhood**—to the **Summit of Health, Strength, Happiness and Success**—without the use of dope and drugs, lifting and stretching-machines, unnatural deep breathing, starvation diets, nerve-racking routines or other foolish fads and fancies. What I have done for thousands of others I can do for you.

SEND FOR MY Free Book

The experience and research of a lifetime are contained in my wonderfully instructive book, "*Promotion and Conservation of Health, Strength and Mental Energy.*"

It will tell you frankly

— Clip and Send this Coupon —

FREE CONSULTATION

ABSOLUTELY CONFIDENTIAL

Mr. Lionel Strongfort, Strongfort Institute, Dept. 236, Newark, N. J.—Please send me absolutely free my copy of your book, "**PROMOTION AND CONSERVATION OF HEALTH, STRENGTH AND MENTAL ENERGY.**" I have marked (x) before the subjects in which I am most interested.

.. Colds	.. Weak Back	.. Weak Heart
.. Catarrh	.. Weak Eyes	.. Great Strength
.. Asthma	.. Flat Chest	.. Lung Troubles
.. Headache	.. Despondency	.. Poor Circulation
.. Rupture	.. Emaciation	.. Round Shoulders
.. Thinness	.. Rheumatism	.. Skin Troubles
.. Pimples	.. Nervousness	.. Stomach Disorders
.. Insomnia	.. Constipation	.. Increased Height
.. Overweight	.. Short Breath	.. Muscular Development

Name.....

Age.....Occupation.....

Street.....

City.....State.....



Learn to Play JAZZ by Ear in 90 Days

Be a master of jazz, syncopation, melody. It is easy to learn at home in your spare time. Wonderful Niagara Method shows you how.

By R. C. JAM-S

How I used to wish that I could sit down at the piano and pour out the golden syncopation of American melody, like the jazz piano players I had heard. How I used to wish that I could be the popular one in every crowd.

But I could not play a note. I did not know a thing about music.

Niagara Method Shows The Way

Then somewhere—just as you are reading this—I read of the Niagara Method which makes piano playing wonderfully simple. I sent for Director Wright's book "The Niagara Secret." I read the book, and I knew it was right.

I followed Director Wright's principles, and in no time I had caught on to his ideas.

Simple—Easy—Delightful

And the best part of it all is that there is nothing hard about the Niagara Method. In a short time, by following Director Wright's principles and by devoting a part of my spare time to the practical application of his course, I soon learned to play.

No tiresome scales—no arpeggios to learn—no weary hours of practice—no do-re-mi—no meaningless exercises. If you know the Niagara Method, you can sit down and reel off any popular song which the high-priced orchestra leaders play in the cabarets, clubs, hotels, dance halls, or theaters.

Decide to Begin Now

If you have never played a note, or if you do play—no matter how well—you too may become a master of jazz and melody by learning the simple, wonderful Niagara Method.

FREE BOOK



Don't wait another day. Send the coupon now for the "Niagara Secret." This book is yours absolutely FREE. If 10c (coin or stamps) is enclosed you also receive wonderful booklet "How to Entertain at Piano."

Ronald G. Wright, Director
Niagara School of Music,
Dept. 928 Niagara Falls, N. Y.

CLIP THIS COUPON NOW!

NIAGARA SCHOOL OF MUSIC, Dept. 928, Niagara Falls, N. Y.

Without obligation mail me your book "The Niagara Secret." I enclose 10c for book "How to Entertain at Piano"

Name _____

Street _____

City _____ State _____



... and, perhaps you, too, due to the lack of money, time and education necessary to master a trade, wonder what to get into *quickly* and make the most out of. Haven't you *overlooked* the very thing you are looking for? 60,000 Moler graduates *know* Modern Barbering is easy to learn, *quick* to earn, *clean* and *FASCINATING!* FIND OUT! Write for catalog "B-10."

Address the Branch
of the MOLER SYSTEM OF COLLEGES nearest you.
(Street address not needed)

Chicago, Ill.	Denver, Colo.	Dallas, Tex.
New York, N. Y.	New Orleans, La.	Houston, Tex.
St. Louis, Mo.	Omaha, Nebr.	San Antonio, Tex.
Kansas City, Mo.	Milwaukee, Wis.	Seattle, Wash.
Cincinnati, Ohio	Atlanta, Ga.	Tacoma, Wash.
Cleveland, Ohio	Fargo, N. D.	Toronto, Ont., Can.
Detroit, Mich.	Memphis, Tenn.	

FOREST RANGERS

Men wanting forest ranger, mail clerk, or other government positions, write for particulars.

MOKANE, 236, DENVER, COLO.



"BECOME A LIGHTNING TRICK CARTOONIST"

Send \$1.00 for Laugh Producing Program of 23 Trick Drawings with Instructions. Catalog of Chalk Talk Supplies Free. BALD AART SERVICE, Dept. 1, Oshkosh, Wis.

LAW THIS BOOK FREE!

Study at Home

Become a lawyer. Legally trained men win high positions and big success in business and public life. Greater opportunities now than ever before. Earn \$5,000 to \$10,000 Annually! We guide you step by step. Degree of LL.B. LaSalle law graduates practicing in every state. We furnish all text material, including 14-volume Law Library. Low cost. Easy terms. Valuable, interesting 96-page book free. Send for it NOW.

LaSalle Extension University, Dept. 1094-L, Chicago



If You Can Do This Step

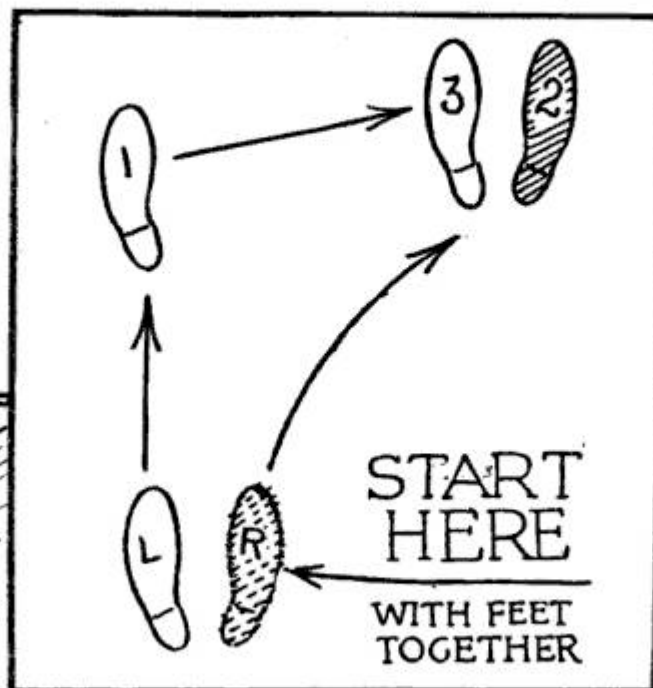

See how easy it
is to learn the
Arthur Murray
way!



I'll Make You A Finished Dancer in 10 Days

By **ARTHUR MURRAY**

World-Famous Dancing Authority

I DON'T care how poorly you dance now—I don't care if you've never been on a dance floor in your life—if you can do the simple step pictured above I'll guarantee to make you a finished dancer in ten days!

Just think! In ten days' time you will be able to do the Charleston, the French Tango, the Ritz Fox Trot, the Debutante Waltz, and all the other smart new steps—or I'll return every penny you have paid me!

That's a fair offer, isn't it? There's no excuse now for playing wallflower—no excuse now for passing up good times because you can't dance! My method of teaching dancing is so simple and easy to understand that you can learn any of the latest steps in one evening, right in your own room, without music or partner. And in ten days' time you will be ready to take your place as the best dancer in your set!

How to Be Popular

You'll never regret being an accomplished dancer! Think what it means to be popular, sought after, admired! The dances I teach you in my course are not only the standardized steps, but also the brand new ones—the peppy, zippy Charleston that has captivated society, the sensational, modern dances that have swept the world!

The sooner you learn to do the new dances, the sooner you start upon this sure path to popularity—the sooner you get some real fun out of life. You'll always be welcome everywhere. Better still, you'll

be in great demand—for everyone wants to dance with the good dancer, the one who knows all the latest steps!

And when you learn by my method—when you have the Murray foundation—it will be easy for you to learn *any* dance. Once you have my training you will be able to follow any music with ease and grace—you will be able to master quickly and easily any dance step after having seen it just once.

Five Lessons FREE

To prove that I can make you a finished dancer in ten days' time, I am willing to send you five lessons from my remarkable course—*absolutely free!* Just send the coupon (with 10c to cover cost of printing and mailing) and these valuable lessons will be forwarded at once. Also a free copy of my new book "The Short Cut to Popularity."

Don't wait—you owe it to yourself to clip and mail this coupon NOW. Arthur Murray, Studio 656, 7 East 43rd Street, N. Y. C.

**ARTHUR MURRAY, Studio 656,
7 East 43rd Street, New York City.**

To prove that I can learn to dance at home in ten days you may send the **FIVE FREE LESSONS**. I enclose 10c (stamps or coin) to pay for the postage, printing, etc. You are to include free "The Short Cut to Popularity."

Name

Address

City State

New Way to Learn

HERE'S BIG NEWS for men interested in Electricity, *men earning less than \$40 a week.* Here's the **QUICKEST** way to an Electrical **EXPERT'S** job at \$60 to \$125 a week. The first announcement of our new, rapid, simplified way to train you at Home in spare time, with **LESSONS, JOB-TICKETS** and **OUTFITS.** *Lessons* which take the mystery out of Electrical principles—*Job-Tickets* which apply what you learn in lessons, and give you step-by-step directions for doing actual Electrical Work. *Outfits* of standard tools and materials with which you **DO THE JOB.** Read this sensational announcement. It opens the way to a better job and bigger pay.

Chief Engineer
Dunlap

1 —with LESSONS!

The laws of Electricity **MADE EASY TO UNDERSTAND.** In simple language, written for the man with only common schooling. Starts you off with the simplest principles, then carries you by easy stages to the advanced work, the Engineering subjects absolutely necessary if you aim to fill one of the **BETTER-PAID** jobs in Electricity.

Seven (7) Electrical Outfits Given!

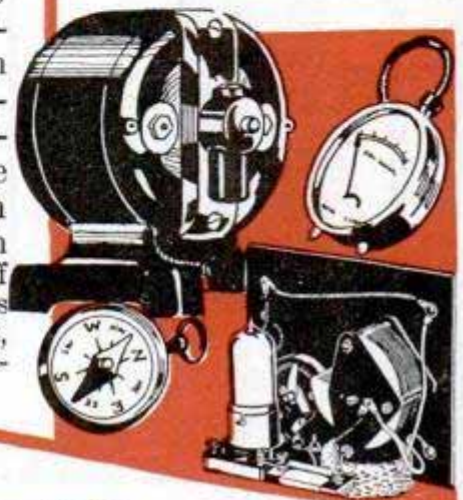

3 —with OUTFITS!

SEVEN (7) outfits of standard tools and materials now supplied without extra charge to every student. With lessons to explain *why* and job-tickets to tell you *how*, this you to get a practical slant on electricity—*quick!*

1. Soldering Kit and Furnace
2. Bell-wiring Equipment
3. Electric - light wiring equipment
4. Voltmeter and compass
5. Transformer
6. Radio Receiving Set
7. Power MOTOR

I send the motor to you "knock-down" with job-tickets for wiring the field and the armature. For changing the voltage. For converting it to a Generator. The same kind of work they pay experts big salaries to do.

**AMERICAN SCHOOL
CHICAGO**

2 —with JOB-TICKETS



A wonderful new system originated at the American School. After you have the **THEORY** from the **LESSONS**, we virtually send you "out on the job," with **job-tickets** and **outfits.** These job-tickets are illustrated, and give one-step-at-a-time directions for doing practical work. They show which materials and tools to use and tell you the **short-cuts** and **new ideas** used by Electrical **EXPERTS.**



ELECTRICITY!

BIG SALARIES waiting for you in Electricity!

Electricity is one of the greatest, FASTEST GROWING businesses you can get into. Leaders like EDISON, MARCONI and INSULL say it offers bigger opportunities today than ever before, that young men can make more money and climb higher here than in other fields. Even skilled Electricians earn bigger pay than mechanics in other lines. But with my training you can prepare for the BOSS-JOBS in Electricity, positions as Chief Electrician, Superintendent of Power Plant, Electrical Draftsman, Electrical Contractor, Superintendent of Electrical Construction, etc. Positions paying from \$250 to \$500 a month and more.

Thousands of Opportunities!

Our Employment Service reports a big demand for trained Electrical men by Electrical Power Plants, Electrical Manufacturing Companies, Telephone, Radio and Cable corporations, by Contractors, Builders and Steamship lines.

FREE JOB SERVICE!

We can frequently help our students find a **beginner's job** in Electricity within a few weeks after enrolling. And in addition, we accept your enrollment with the positive agreement to help you find a well-paid Electrical position within 60 days after completing this training, **or your tuition will be refunded.**

GUARANTEED TRAINING!

When we accept your enrollment for this wonderful home-instruction in Electricity we give you an agreement in writing, that it will lead to definite benefits in position and salary, *otherwise every penny you have paid will be refunded.* The American School believes home-training, like other things, should be *guaranteed* as proof of its value.

NEW WAY TO START!

Find out if you LIKE Electrical work—find out if our lessons and job-tickets are EASY

to master. Don't take our word for it—SEE for yourself before you decide. START with the COUPON, below. We'll send you 5 Job-tickets absolutely FREE—the same material sent to new students when they pay their money and enroll—to prove that you can learn at home in your spare time—to prove this training is honest, complete and SIMPLE. The most amazing offer in the history of home-training to enable you to get started IMMEDIATELY without risking a penny.

Start with the Coupon!

5 Job Tickets!
Absolutely **FREE!**

SEE!
before

you
decide

TRAINING built by 23 Noted Engineers

This is no one-man, one-idea school. Engineers from the leading Electrical corporations and Universities have helped me develop this complete home-instruction, men of such high standing, that they would not lend their names to any instructor or school which did not give honest service to every student. Lesson texts prepared by men from:

- | | |
|---------------------------------------|---|
| 1. General Electric Co. | 7. Western Electric Co. |
| 2. Commonwealth Edison Company | 8. Underwriters Laboratories, Inc. |
| 3. Crocker-Wheeler Co. | 9. Columbus University |
| 4. Cutler-Hammer Mfg. Company | 10. Dartmouth College |
| 5. American Telephone & Telegraph Co. | 11. Massachusetts Institute of Technology |
| 6. Westinghouse Electric & Mfg. Co. | 12. Lehigh University |
| | 13. University of Vermont |
- AND MANY OTHERS



THE AMERICAN SCHOOL

Now beginning its 30th year of service. Chartered as an EDUCATIONAL Institution. Not one dollar in profits has ever been paid out, every cent received for tuition has been returned to our students in instruction and service. Over 200 educators, executives and engineers have prepared the instruction we offer. Financial responsibility ONE MILLION DOLLARS.

CHIEF ENGINEER DUNLAP, Electrical Division

AMERICAN SCHOOL DREXEL AVENUE and 58th STREET
Dept. E-774, CHICAGO

Send no Money

Chief Engineer Dunlap, Electrical Division
AMERICAN SCHOOL

Dept. E-774, Drexel Avenue and 58th Street, CHICAGO

Send me please 5 Job-tickets, absolutely FREE and facts about the great Electrical business, without obligating me in the slightest degree.

Name.....

St. No.

City.....State.....

Say Good Bye to Poor Pay!



Several Hundred more trained men needed NOW.

Several thousand more will be needed soon.

Your ONE BEST Opportunity to rise above small pay.

AGE NO BARRIER!

VERY PROFITABLE TRADE NOW OPEN TO ALL

Those looking for a Real Opportunity—good salaries, steady work, dignified and pleasant—demand great now and always will be—a chance to establish a business of your own if desired—can count their search at an end when they merely send us their name to receive full information about

MECHANICAL DENTISTRY

This is not a *new* trade. Dentists today do not have the time to make plates, bridges, crowns, etc., so they employ a mechanical dentist or send this work away to a dental laboratory. There is thus a wonderful demand for Mechanical Dentists—and the demand is only beginning!

IN THREE MONTHS

Easily learned by actual practice—no classes whatever—no previous training required. Ages range from 16 to 50. Opportunity, good pay, and advancement for all! Bodee training is recognized as best by dentists everywhere owing to our 34 years' experience at this work. Bodee-trained men have the ability, skill and knowledge to enable them to easily lead the field.



\$3500 to \$5000

A YEAR

Compare also the very reasonable cost with the high charges of the newer and smaller schools which have sprung up!

JUST COMPARE

Compare this with what you are now doing or with the best you can find in any other line! Then compare the unrivalled training we have developed in 34 years' teaching experience—step by step—every point thoroughly covered—no time or effort wasted!

EARN WHILE YOU LEARN

For those who need financial assistance while in training we secure whole or part-time positions to meet their expenses.

OTHER ASSISTANCE

Besides providing the best of training at the lowest possible cost, securing jobs for students who need to earn while learning, giving free R. R. fare, etc., we help you secure good board at moderate price, conduct a Placement Bureau to select suitable positions for graduates and, should

FREE R. R. FARE

To make this exceptional opportunity equally available to all, we pay the student's railroad fare to our nearest school.

you desire to open a laboratory of your own, we assist you in securing a suitable location and equipping your laboratory.

Send AT ONCE for Bulletin 2 giving all details and interesting information

BODEE DENTAL INSTITUTE

NEW YORK PHILADELPHIA BUFFALO BROOKLYN
1755 Broadway 1305 N. Broad St. 501 Washington St. 85 Court St.

BE A PLUMBER and HEATING EXPERT

Here's the opportunity of a lifetime for men who want to learn a real trade. Thousands of trained plumbers making from \$75 to \$150 a week.

A few short week in our shops will fit you for any branch in the plumbing field. Here you learn lead wiping, building and construction work, jobbing, estimating, blue prints and specifications.

No books, all actual, practical work under the supervision of master plumbers.

Plumbers' opportunities are everywhere. In the cities, small towns and the country. Send for our free booklet on how you can earn your expenses while learning.

ILLINOIS PLUMBING WORKS SCHOOL
512-514 N. La Salle St. Dept. 5, Chicago, Ill.

ACCOUNTANCY

Training at Home WITH PERSONAL COACHING

Prepares you for the C.P.A. Certificate, or for the position as Chief Accountant, Cost Accountant, Auditor or Comptroller.

Write for our free interesting booklet which explains how you can secure this training in your spare time, and receive personal coaching by a professional accountant in your own community. Our guarantee protects you in case of inaptitude, sickness or straightened circumstances.

AMERICAN EXTENSION INSTITUTE
Dept. PM10 2005 Broadway, N. Y.



BART SUPPLIES

Quality art materials at lowest prices. Save on everything you need. Convince yourself—send today for catalog.

BART SUPPLIES, 419 Eustis Bldg., MINNEAPOLIS, MINN.

A Great Book Free

with this pay-raising library

For a short time only we will give every subscriber to the New Library of Machine Shop Practice a copy of French's Engineering Drawing—the greatest book on mechanical drawing ever written. This book makes drawing as plain as day—tells you all about instruments, plans and methods—and prepares you to handle any drawing job you will ever have to do. It comes to you absolutely free with

Machine Shop Practice

9 volumes — 3065 pages — 3608 illustrations
(A combined home study course and reference library)

The New Machine Shop Library is written for practical men. It gives you the best methods for every kind of machine shop work. It explains machine tools and their operation, drawing and design, tool work, gears and grinding, jigs and fixtures, automatic screw machines and their tools and all of the mathematics you will ever have to use. It is plainly written, completely illustrated—the very best kind of help to the machine shop man who wants to advance himself.

Sent

**F
R
E
E**

No money down—
only 7c
a day



FREE EXAMINATION COUPON

McGraw-Hill Book Co., Inc., 370 Seventh Ave., New York

Send me for 10 days' free examination the New Library of Machine Shop Practice. If satisfactory, I will send you \$1.50 in 10 days and \$2.00 monthly until the special price of \$19.50 is paid. If not wanted, I will return the books at your expense.

On receipt of my first payment of \$1.50 it is understood that I am to receive, free of charge, a copy of French's Engineering Drawing.

Signed.....

Address.....

City and State.....

Position.....

Employer..... P.M. 10-1-26

"I Wonder How He Knows So Much!"

How many men do you know who surprise you by the wealth of their general information and the breadth of their knowledge? If you were to inquire, you would find these men make a daily habit of consulting an up-to-date Encyclopaedia. Here they have the knowledge of the centuries—accessible, concisely and plainly stated, easy to grasp and to remember.

Get Your Facts From Nelson's

Every subject on which man would be informed is changing constantly. Nine times out of ten, the information you want is of current issue—a topic of to-day. All Encyclopaedias except Nelson's are deficient in this important and essential thing. The information which is obsolete is worse than none at all. You do not use a City Directory that is two years old. Why use an Encyclopaedia that is five or ten years old? NELSON'S TREATS UPWARDS OF 1,000,000 TOPICS, has 500 maps in color and black and white, and 7,000 illustrations to clarify the text, including text cuts, colored plates, photographs, charts, etc.

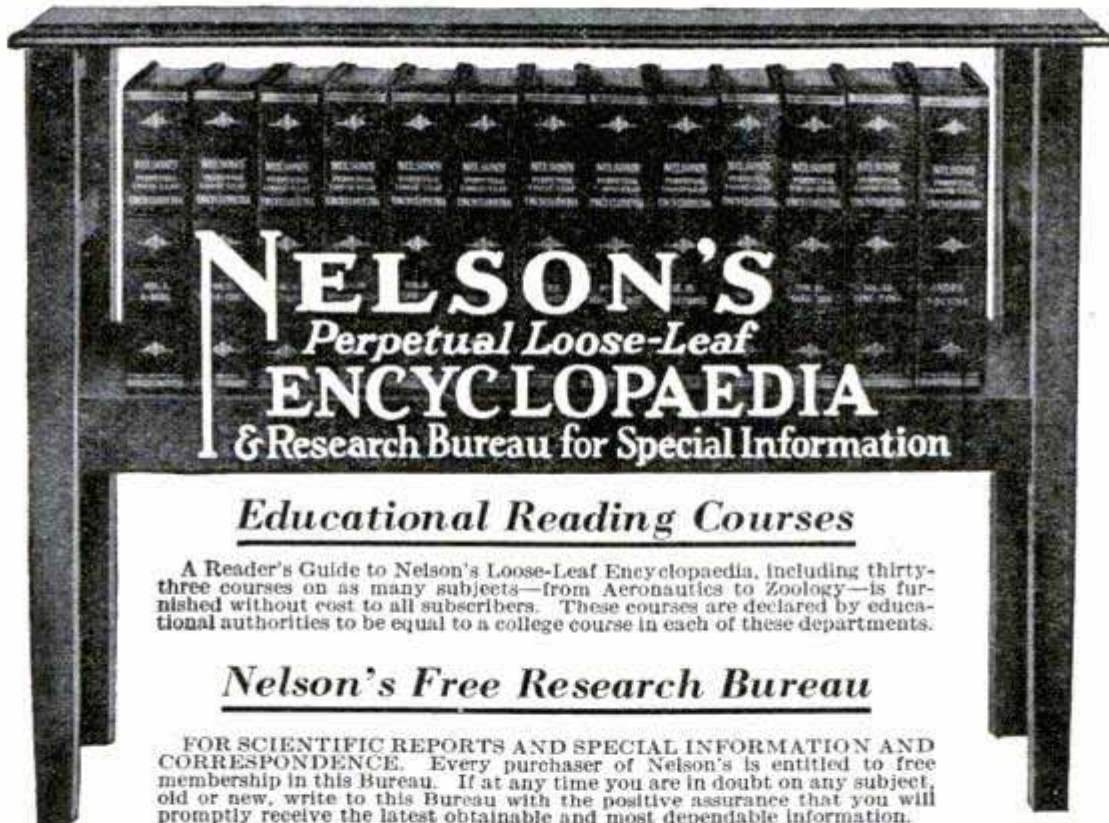

An International Editorial Staff

NELSON'S PERPETUAL LOOSE-LEAF ENCYCLOPAEDIA—the Great American Standard Reference Work—is complete in 12 handsome volumes and new Index Volume. Its staff of upwards of 1,000 contributors includes men and women foremost in scientific, professional and public life, who are practically eye witnesses of that which they write. The Index of 900 pages embraces more than 200,000 references, immensely increasing the value of the Encyclopaedia. It is the Key which unlocks thousands of hidden treasures in Nelson's.

THOMAS NELSON & SONS

Publishers for 127 Years

Originators of the Loose-Leaf Reference System

P. M. Oct. 381 Fourth Ave., New York City

Please send me your portfolio of sample pages, beautifully illustrated, containing color plates, maps and photographs, and full information how, by easy monthly payments, I can own Nelson's Perpetual Loose-Leaf Encyclopaedia and receive FREE membership in Nelson's Research Service Library Bureau for Special Information and Nelson's Readers' Guide FREE. This must incur no obligation whatever on my part.

Name.....

Address.....

City.....State.....

(Adv. Copyright, 1926, by Thomas Nelson & Sons)

Get Into This



Are you ambitious? Are you seeking a better job or a business of your own? If so, here's your chance—a chance to really cash in. There are more amazing money-making opportunities in the automobile business now than ever before. Follow the lead of the thousands of "Michigan State" graduates. They

have already proved what real training will do for an ambitious man. They are making big money. You can too!

This school has over 20,000 graduates. Come to Detroit, a fine city. Big business, pleasant climate all year around. Come now, and fit yourself for a better job or to run a garage business of your own. Thousands of battery shops, auto electrical shops, tire and welding shops are needed now. Only trained men can run them. Good work is what car owners want, and it takes a trained man to do it.

LEARN THE AUTO BUSINESS IN THE HEART OF THE INDUSTRY

Without any previous experience—just a liking for mechanics—you can learn the auto business from A to Z in a few weeks at the Michigan State Automobile School—the factory-endorsed school in Detroit—the heart of the industry. Then step out, equipped with knowledge and training, to a future of certain, big money making. You have great advantages, learning the business here. It's the fountain head of the

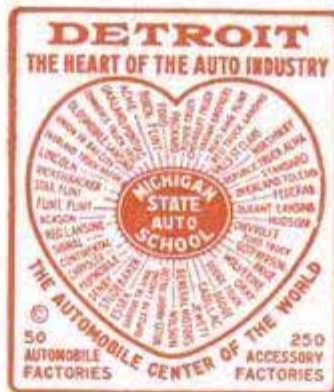

automotive industry. You are taught under factory-endorsed methods. You learn both theory and practice on latest equipment. Go through the great Ford plants. Visit the other auto factories. Learn their methods first hand—and it all means greater opportunities and more certain success. The Michigan State Automobile School, in Detroit, the automobile center, is the logical place to learn the auto business.

Detroit-Trained Auto Men Earn More Money

Detroit-trained men are preferred. Your diploma from the "Michigan State" is a valuable money-making asset. The Michigan State Automobile School is known the world over. Wherever autos are used—Detroit-trained men get the best jobs, highest pay. Auto, truck, tractor factories employ M. S. A. S. graduates. Leading factories, dealers, service stations, garages, shops and farms want men who have trained their heads as well as their hands—the M. S. A. S. Detroit-kind.

Start Now! A thorough training in Detroit, at the "Michigan State," fattens the pay envelope or starts you in business for yourself. You can take a full Automotive Course in 12 weeks. Or our great Master Course in 30 weeks. Or specialize in any of its money-making branches; be an Auto Electrician, Battery Service Man, Engine Man, Welder, Tire Expert, or Machinist. All courses include training in Business, Shop Management, Service, Selling, etc., by one of the big men from Detroit's auto plants. Classes always open. You can start at once.

Earn While You Learn If necessary we can assist students to secure part time work to earn a small amount each week. Or students who wish to take our evening course will be assisted to full time day jobs. Ask for details, and when writing, please explain your circumstances fully.

Life Scholarship Your enrollment entitles you to life membership, with privilege of our service any time you want it. Many students come back to

brush up on latest ideas and new equipment. It doesn't cost a penny extra. The position of the Michigan State (The Detroit Auto School) in the heart of this industry, assures most thorough, most practical, systematic training, at a cost so low and terms so easy that any man, anywhere, can afford it.

MICHIGAN STATE
310 Auto Building Detroit, Michigan

earn Autos Where Autos Are Made

BIG MONEY Business

Here Is A CHART OF FACTS

Authentic figures which point out the opportunities. Autos are increasing faster than repair shops or mechanics can keep up with them. Over 20 million are in use now. The auto industry leads all others in value of production. There are more autos than telephones. 269 cars to every service station. This shows as plain as A-B-C where the big chance is today.

Jerry De Nooyer, Battle Creek, Mich., writes:

"Am Service Manager of Cadillac and Olds service station at \$80 a week."
Ray Walker, Bethlehem, Pa., says:
"Had my pay raised three times this summer. When I went to M. S. A. S. I knew nothing about a car."

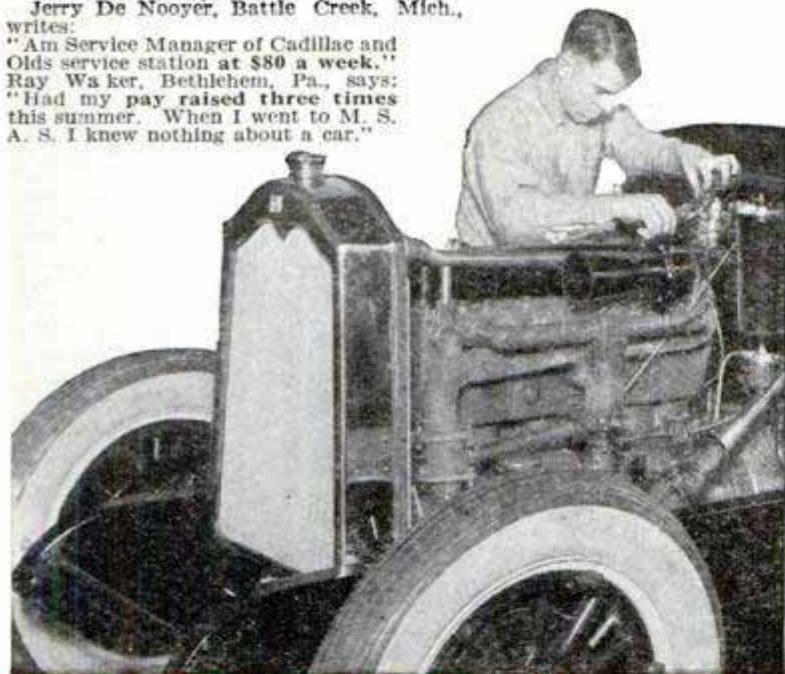

1926 Buick Master Six

Completely equipped chassis of the 1926 "Master Six" Buick, just furnished to us. The co-operation of the automobile manufacturers is one of the big advantages which you have in coming to the "Michigan State" in Detroit, the Auto Center. Many of the big companies assist us for your benefit, and furnish us their cars for you to work on. Here you work on up-to-date equipment, under the guidance of expert instructors. M. S. A. S. courses are long and thorough. Your M. S. A. S. diploma means much to you. It gives you the double prestige of being a "Michigan State" graduate, and of being a Detroit-trained man.

Mail the Coupon Send for big NEW Catalog. Get all the interesting facts. They will open the way to a bright future for you. Write a letter or a postcard or use this coupon. Do it now.

(Colored students not enrolled, except for our home study course)

AUTOMOBILE SCHOOL

3729 Woodward Avenue Detroit, Michigan

The Factory Endorsed School

20,200,000
Automobiles in U.S.
One Car to Every
6 People
269 Cars to Every
Repair Shop
Thousands more Trained
Men are Needed

FREE Home-Study Course

For students who cannot come to Detroit at once we have a fine Home Study Course. You can start to learn at home. Then come here later with no extra charge for the Home Study Course. It will help you to get a garage job right away. Write for full information about this and explain your circumstances.

Business Management Course

Business Course by former Packard service manager is free to all students. Teaches how to locate a garage, about equipment, systems, financing, selling, advertising. Worth \$100 alone. No extra charge.

Quality Training Only

The best training is the only kind you can afford to get. "Michigan State" graduates earn more money. Their Detroit training makes them wanted—your "Michigan State" diploma will be a valuable money-making asset. The Michigan State Automobile School is known the world over. Wherever autos are used, Detroit-trained men get the best jobs, highest pay. Leading factories, dealers, service stations, garages, shops and farms want men who have trained their heads as well as their hands—the M. S. A. S. Detroit-kind.

Mail Coupon To-day

Michigan State Automobile School 310 Auto Building
DETROIT, MICH.

Send me FREE and without obligation complete information about Detroit-training to make the most money.

Name.....

Street or R. F. D.....

City..... State.....

I am interested in [] 12 Weeks' Auto Course.
[] 30 Weeks' Master Course.
[] Home Study Course.

RUSSELL PATTERSON



Makes a
\$150
Drawing
in a
Few Hours!

—and now teaches you his original methods in a series of 20 snappy lessons—brimful with sparkling interest from the very start—a departure from the purely conventional. This training constitutes the last word in Humorous Illustration, teaching a New Art for a New Age—a pleasant relief from the old style, standardized instruction. Learn to draw the dashing, peppy types that are all the rage as exemplified by Mr. Patterson's numerous contributions to magazines. Let him teach you his clever technique. What profession could compare with this in its irresistible appeal or sheer earning power? Write now for full information.

Russell Patterson School of
Humorous Illustration
Michigan Ave. at 20th St., Dept. 12
CHICAGO - - - ILLINOIS

Learn Watchwork, Jewelrywork and Engraving

A fine trade commanding a good salary, and your services always in demand. Address **Horological**, Dept. P. Bradley Institute, PEORIA, ILLINOIS, for our latest catalog.

Work for "Uncle Sam"

RAILWAY POSTAL CLERKS
MAIL CARRIERS

\$1700 TO \$3000 YEAR

1VEL—See your country on government pay

1—BOYS—17 UP SHOULD MAIL COUPON IMMEDIATELY

York.

No Layoffs.

Paid Vacations.



Play Piano ^{BY} EAR -in 90 days!

YOU can play real tunes from the start. No notes to puzzle you—no tiresome scales to practice. You need not know a thing about music. Even if you have never touched a piano, if you can hum or whistle a tune, we can teach you to play all popular song hits *by ear* at a very small cost. No need now to spend years practicing under old time method. My new and original system teaches you easily and quickly. Write at once for

Free Booklet

to show you how easily it can be done.

This wonderful home course is offered at a ridiculously low cost. A little practice gives amazing results. You can sit down and play any Popular Jazz piece that you hum. Write us today.

ILLINOIS SCHOOL OF MUSIC
OF CHICAGO

652 Hearst Square Chicago

Send **NOW** for **FREE** Book



BE AN OFFICER in the U.S. Coast Guard \$1700 Up to \$7,500 Yearly

\$780 yearly at the U. S. Academy while training. You rank Ensign to Captain in service. Age requirements 18 to 24. Write Dept. A, for information.
COAST GUARD PREPARATORY SCHOOL
4000 Gz. Ave. N. W. Washington, D. C.

Welding

Become a Welding Expert! Then earn top wages or go into business for yourself. We train you at Home, in your Shop, or on the Job. "Kerr's Training Course for Welders" is a thorough course in practical experience, covering all metals. It trains you in **WHAT TO DO** and **HOW TO DO IT**. Write at once for terms and enrollment card. (State if you have the use of a welding outfit.)

KERR'S WELDING SCHOOL Dept. 2, 752 N. Broadway
LOS ANGELES, CALIF.

YOU CAN OIL PAINT

Amazing new method teaches men or women to earn after first lesson. OIL PAINT photos—portraits, landscapes or art subjects. Earn \$18 to \$50 and more a week. OIL PAINT OUTFIT GIVEN. Send now for free illustrated book. PICTORIAL ART STUDIOS, Inc., Dept. MP, 2731 No. Clark St., Chicago



FRANKLIN INSTITUTE,
Dept. B-177, Rochester, N. Y.

Sirs: Rush to me without charge: (1) Specimen Railway Postal Clerk Coaching Lessons; (2) FREE 32 page book describing U. S. Government positions open to men and boys, and full particulars telling how to get them.

Name.....

Address.....

Take this short cut to Success
In Electricity

Oscar Werwath Pres

\$50 VALUE
 Complete
 When You
 Enroll

Free

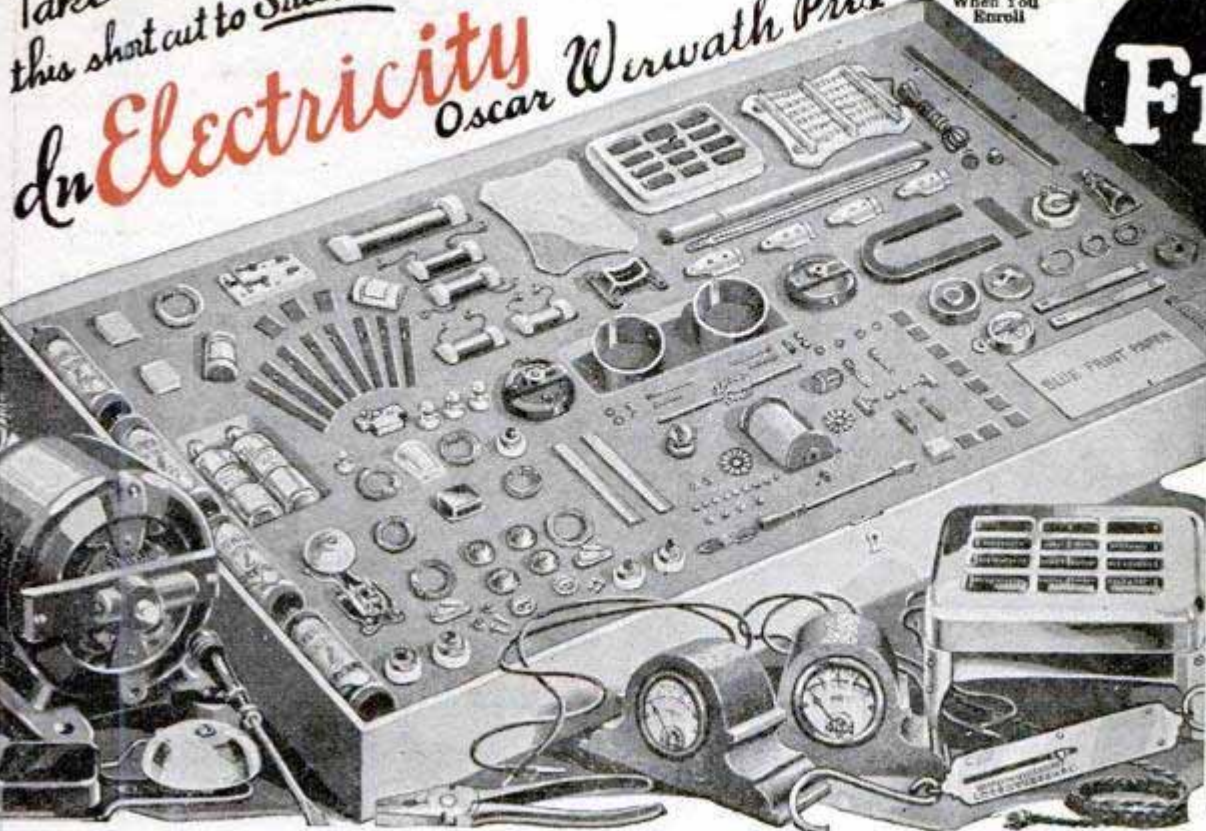

See What This Man Has Done



500% Increase in Salary
 Your course was the best investment I ever made. My earnings have increased 500% per month. With my increase in pay I could pay for the course every other month and not miss it.
HUGH M. FRIEL
 Wilmington, Dela.

I want to get together with YOU! Write me tonight. I will give you an Electrical Expert's Outfit FREE and train you at HOME in spare time. Even my beginners often get \$50 a week. ACT!!

HERE'S HOW S. OF E. MEN SUCCEED



EVEN UNCLE SAM asks for S. of E. men when he has a hard electrical job. Above is huge Nordberg engine for Panama Canal for which S. of E. men made the Acceptance test.

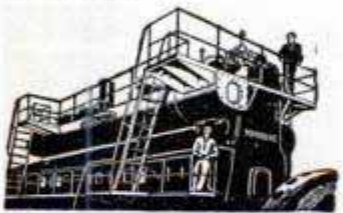

PRESIDENT of your concern is what many S. of E. men prefer. We help and advise you to start in business for yourself. New opportunities in every town.



30 DAYS FREE Resident training is my reward when you finish your course, if you wish to accept. Complete details when you send coupon.

I'M IN TOUCH with the electrical industry every day, men, and take my word for it, there's never been anything like the present. Concerns are asking for men every day. Our training satisfies you or MONEY-BACK. I help you get the job, too.

ELECTRICITY is booming! and the shortage of trained men is the only reason we're making this special offer. Every kind of concern you can think of depends on Electricity and new opportunities open every day—power plants, electric railroads, electric refrigeration, battery and central stations, etc.

CONCERNS are looking to me to supply them with men. No matter what you are doing now, or how much money you have, we can train you without disturbing your present work. We bring complete expert's equipment right to you and give you the training you need to get a real job. Even screw-driver electricians make record money now. But my men, with expert training get the call for really important jobs. Just a few fascinating hours a week right at home.

BE INDEPENDENT with an electrical training. In a few months you are a graduate **ELECTRO-TECHNICIAN** with signed diploma that opens the door for you anywhere in the electrical field. S. of E. men are everywhere succeeding. The big concerns like Harnischfeger Corp'n., Cutler-Hammer, Allis-Chalmers, Commonwealth-Edison all endorse our training and try first to get our men.

NO SPECIAL TALENT or training is required for success and big money in Electricity. There's a right way to do everything in electricity. We give the tools and equipment and show you the right way. When you get on the real job you're right home because it's no different. Many of our boys are in their teens—some are men past 50—but all multiply earnings with this easy training. Give me a chance to do it for you.

GIVE ME A CHANCE TO SHOW WHAT I CAN DO FOR YOU!

"I guarantee to stand behind you and make you a success in **ELECTRICITY**. For 22 years I've helped men get a start. Just give me a chance. Mail the coupon today—without fail."



OSCAR WERWATH, President.

SCHOOL of ENGINEERING of Milwaukee

SCHOOL OF ENGINEERING OF MILWAUKEE
 Dept. H376, Box 572, Milwaukee, Wis.

Send me FREE and postpaid without obligation your big 72-page book telling about S. of E. training and opportunities for me in electrical work. Also details of your employment service and money-back guaranty.

Name.....
 Address.....
 City..... State.....

DON'T FAIL TO MAIL ME!



"He Used to Belong to Our Crowd"

"He's the only one of the old gang who made good"

"THAT'S Bob Thompson, sales manager for Fink & Snyder. They say he makes \$15,000 a year.

"Yet it hasn't been long since he wasn't making more than \$35 a week. I know, because he used to belong to our crowd. There were six of us and there was hardly a night that we didn't bowl or shoot pool or play cards together.

"Lots of times we would sit down and talk about earning more money, but that's all it ever amounted to—talk! Bob was the only one who really did anything.

"I'm through wasting my spare time like this," he said one night. "I'm going to take up a course with the International Correspondence Schools and try to make something of myself before it is too late."

"We didn't see much of Bob after that—he'd always laugh and say he was 'too busy' when we'd ask him to join a party.

"Look at him now. A big man in a big job. Making five times as much as I'll ever make. Oh, what a fool I was not to send in that I. C. S. coupon when he did!"

How much longer are you going to wait before taking the step that you know will bring you advancement and more money? Aren't you tired working for a small salary?

It takes only a moment to mark and mail this salary-raising coupon and find out what the International Correspondence Schools can do for you. Surely it is better to send it in today than to wait a year or two years and then realize how much the delay has cost you. "Do it now!"

Mail the Coupon for Free Booklet

INTERNATIONAL CORRESPONDENCE SCHOOLS

Box 5605-E, Scranton, Penna.

Without cost or obligation, please tell me how I can qualify for the position or in the subject before which I have marked an X:

BUSINESS TRAINING COURSES

- | | |
|--|---|
| <input type="checkbox"/> Business Management | <input type="checkbox"/> Salesmanship |
| <input type="checkbox"/> Industrial Management | <input type="checkbox"/> Advertising |
| <input type="checkbox"/> Personnel Organization | <input type="checkbox"/> Better Letters |
| <input type="checkbox"/> Traffic Management | <input type="checkbox"/> Show Card Lettering |
| <input type="checkbox"/> Business Law | <input type="checkbox"/> Stenography and Typing |
| <input type="checkbox"/> Banking and Banking Law | <input type="checkbox"/> Business English |
| <input type="checkbox"/> Accountancy (Including C.P.A.) | <input type="checkbox"/> Civil Service |
| <input type="checkbox"/> Nicholson Cost Accounting | <input type="checkbox"/> Railway Mail Clerk |
| <input type="checkbox"/> Bookkeeping | <input type="checkbox"/> Common School Subjects |
| <input type="checkbox"/> Private Secretary | <input type="checkbox"/> High School Subjects |
| <input type="checkbox"/> Spanish <input type="checkbox"/> French | <input type="checkbox"/> Illustrating <input type="checkbox"/> Cartooning |

TECHNICAL AND INDUSTRIAL COURSES

- | | |
|---|--|
| <input type="checkbox"/> Electrical Engineering | <input type="checkbox"/> Architect |
| <input type="checkbox"/> Electric Lighting | <input type="checkbox"/> Architects' Blueprints |
| <input type="checkbox"/> Mechanical Engineer | <input type="checkbox"/> Contractor and Builder |
| <input type="checkbox"/> Mechanical Draftsman | <input type="checkbox"/> Architectural Draftsman |
| <input type="checkbox"/> Machine Shop Practice | <input type="checkbox"/> Concrete Builder |
| <input type="checkbox"/> Railroad Positions | <input type="checkbox"/> Structural Engineer |
| <input type="checkbox"/> Gas Engine Operating | <input type="checkbox"/> Chemistry <input type="checkbox"/> Pharmacy |
| <input type="checkbox"/> Civil Engineer | <input type="checkbox"/> Automobile Work |
| <input type="checkbox"/> Surveying and Mapping | <input type="checkbox"/> Airplane Engines |
| <input type="checkbox"/> Metallurgy | <input type="checkbox"/> Navigation |
| <input type="checkbox"/> Steam Engineering | <input type="checkbox"/> Agriculture and Poultry |
| <input type="checkbox"/> Radio | <input type="checkbox"/> Mathematics |

Name.....

Street.....

Address.....

City..... State.....

Persons residing in Canada should send this coupon to the International Correspondence Schools Canadian, Limited, Montreal, Canada.

LEARN WATCHMAKING BIG PAY! Big Demand for SKILLED WATCH REPAIRERS

Big pay envelopes are waiting, throughout America, for skilled watch workers, repair men on all makes of watches, and engravers. The demand far exceeds the supply and is greater now than at any time in history.

The Elgin Watchmakers College has graduated more certified watchmakers—with degrees conferred by Horological Institute at Washington—than any other school. The College was founded and financed by the Elgin National Watch Company, hence students have access to the world's greatest watch plant for practical observation and actual work-bench study.

If you are frittering away precious time in poorly paid work, resolve to learn this highly lucrative trade now. And don't delay—for the few available vacancies in the Elgin Watchmakers College Fall enrollment will be filled rapidly. Write for catalogue today.

Address Dept. 26, ELGIN WATCHMAKERS COLLEGE, Elgin, Illinois. An endowed college—not operated for profit.



\$100.00 EARNED BY YOUNG ARTIST IN 2 DAYS

Well-trained artists earn splendid incomes. The Federal home-study Course is a proven result-getter. If you like to draw, send 6c in stamps for 56-page book "Your Future."

State your age and present occupation.
FEDERAL SCHOOL OF COM'L DESIGNING
621 Federal Schools Building
Minneapolis, Minn.

LAW

IN YOUR SPARE TIME

Same course by correspondence as given for 15 years at classes of this college. LL. B. DEGREE CONFERRED.

3 year university course prepares for bar exam. Money back guarantee.

Low fee, easy terms, includes 1924 15 volume library, lectures, lessons, all expenses. Write for free book.
HAMILTON COLLEGE OF LAW, Dept. G-10, 1412 S. Mich. Av., Chicago

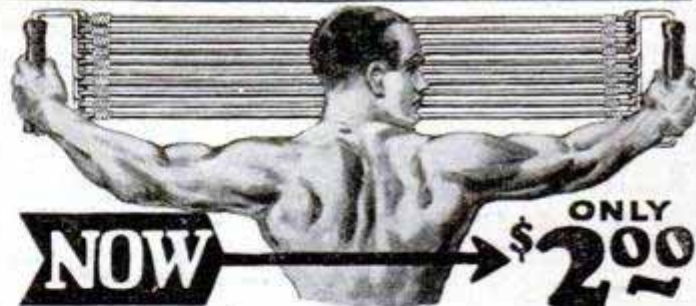

NOW

ONLY \$2.00

Giant Chest Expander

and Progressive Exerciser

Be a muscular Marvel. Have the muscles of a super-man. Become strong for your health's sake or to astound your friends with extraordinary feats which only men of giant strength can do.

Free instructions.

The Giant Chest Expander and Progressive Exerciser is made with new, live springy rubber so as to give it long wear and great resisting qualities. Sold with a guarantee to give entire satisfaction or money back. Made two ways, either

5 Cables or double strength 10 Cables

for **\$2** The double strength exerciser has resistance of over 200 lbs. for **\$4**

Order Today Send at once and get your Giant Exerciser at the present low introductory price. This price is made so low because we want everyone to enjoy muscles and strength at the lowest possible cost. Don't pay more—order from us—get the most for your money. Use coupon now.



PROGRESSIVE EXERCISER CO.,

4010 Langdon Bldg.,

Broadway and Duane Street, New York

Enclosed \$4 for your 10 cable Progressive

please find \$2 for your 5 cable Exerciser.

(Check the Exerciser you want.) It is understood that

if I am not satisfied with this Exerciser, I will return it

within 5 days and get my money back.

Name.....

Address.....

City..... State.....

NOW FREE



CLIP COUPON
5 BIG OUTFITS
Free OF EXTRA COST

B. W. COOKE
Directing Engineer

EARN UP TO \$150 a Week!

If you're earning a cent less than \$60 a week, clip coupon now. Get the proof that you can be on your way to BIG PAY as an Auto Expert QUICK! See for yourself how fascinating this training is—how easily you can master Auto Work right in your own home—and how quickly you can get in line for the big Auto Jobs that pay up to \$150 a week and more—or a Money-Making Auto Business of your own! Remember these Instruction Jobs come to you ABSOLUTELY FREE and without obligation. **CLIP COUPON NOW.**

To PROVE that "JOB-WAY" is "PAY-RAISE" Training

Clip coupon now. I'll send you absolutely FREE OF CHARGE—with positively no obligation on your part—6 "JOB-WAY" Instruction JOBS and my big book! I want you to SEE for yourself just why "JOB-WAY" Training is bringing so many men Big Money in such remarkably quick time. I want you to see how men without a day's previous auto experience—and only common schooling become Garage Owners, Superintendents, Managers, and earn up to \$150 a week and more! I want you to see why Hundreds of men have found "JOB-WAY" Training to be such interesting, most practical money-making training!

That's why I make you this unusual offer—with absolutely no strings on it and not a single penny's charge.

CLIP COUPON NOW and I'll rush your jobs to you absolutely Free!

I'll train you AT HOME Get these free Instruction Jobs now. See how thorough, how complete "JOB-WAY" Training is—includes all Electrical work—Ignition, Starting, Lighting—all Mechanical, also Welding, Brazing, Vulcanizing—also Business Course, Salesmanship, Advertising—How to Keep Simple Books—also Students' Magazine, also 5 Working Outfits. Nowhere else can you get this original genuine copyrighted B. W. COOKE "JOB-WAY" Training.

BE AN AUTO EXPERT

The World's Biggest Business Needs You

There are so many Tremendous Opportunities in this gigantic Auto industry that I want every ambitious man who really wants to make more money, TO HAVE these 6 instruction Jobs, just to see how easily and quickly I can put him in line for the big pay job. Just think! *Seven thousand Millions of Dollars*

are paid to Auto men every year for upkeep alone—*Nineteen Million Dollars a day!* Think what that MEANS TO YOU—the Big Pay Opportunities open to you as an auto expert! It's the ONE field for the man who wants a BIG pay check! **LEARN ALL ABOUT IT NOW!**

This Big Auto Book

Also Free! Coupon brings this startling, revolutionary Auto Book, too, absolutely Free! Shows how hundreds of men have reached Big Pay in amazingly quick time! Shows what you can do. Send for it now!



Act Quick! Don't delay a minute. Send coupon right now while I can still make you this special offer of 6 Auto Instruction Jobs absolutely free—as well as my Big Auto Book, free too! Act now!

Coupon Brings Full Details of My 5 OUTFITS OFFER
Includes Tools, Tool Bag, Electrical Test Bench and Radio Receiving Set—all Equipment Set—all 500 Wiring Diagrams, also Socket Wrench and Ignition Wrench sets.

B. W. COOKE DIRECTING ENGINEER
CHICAGO MOTOR TRAINING CORPORATION

1916 Sunnyside Ave., Dept. 716-A, Chicago

SEND ME LESSONS FREE and BOOK FREE

B. W. COOKE,
1916 Sunnyside Ave.,
Dept. 716-A, Chicago

Send me absolutely FREE and without any obligation on my part, 6 Auto Instruction Jobs. Also your Auto Book FREE and full particulars of your

5 Outfits Offer.

NAME.....

ADDRESS.....

TOWN..... STATE.....



From \$1,800 to \$10,000 in Four Years

Thanks to Higher Accountancy

"LaSalle training in Higher Accountancy has enabled me in four years to increase my business more than 500 per cent." So writes John H. Lansing, Public Accountant, Income Tax Specialist, and prominent citizen of Amsterdam, New York, who deliberately resigned as purchasing agent for a large carpet manufacturing company to start on his own as a Public Accountant.

Mr. Lansing was 43 when he enrolled with LaSalle, and at the time was earning from his newly adopted profession less than \$2,000 a year.

Today, the firm of which he is head is auditing the books of 100 business houses, including 20 corporations; and his Income Tax Department has more than 500 clients. Each year his business shows a healthy increase.

"When you consider that the average bookkeeper does not receive over \$40 a week," writes Mr. Lansing, "it is obvious that \$10,000 a year has advantages well worth the consideration of any ambitious man or woman. I shall always be grateful to LaSalle for the help it has given me in building a greater income."

Send for This Book—It's Free

Do you appreciate what Accountancy means in the business world? Do you realize that it constitutes the indispensable foundation for success in any business undertaking? Would you seriously fit yourself for positions paying \$3,000, \$5,000, \$10,000 a year and even better?

LaSalle has prepared a 64-page book entitled "Accountancy, the Profession that Pays." The information it contains is of very real and definite value. It will pay you well to read it. And—LaSalle will send it to you free.

Balance the two minutes that it takes to fill out the coupon against the rewards of a successful career—then clip and mail the coupon—NOW.

— — — Find Yourself Thru LaSalle! — — —

LASALLE EXTENSION UNIVERSITY
The World's Largest Business Training Institution
Dept. 1064-HR Chicago

I would welcome details of your salary-doubling plan, together with copy of "Accountancy, the Profession that Pays," also a copy of "Ten Years' Promotion in One," all without obligation.

Higher Accountancy

Training for positions as Auditor, Comptroller, Certified Public Accountant, Cost Accountant, etc.

Other LaSalle Opportunities

LaSalle opens the way to success in every important field of business. If more interested in one of the fields indicated below, check and mail now.

- | | |
|--|--|
| <input type="checkbox"/> Business Management | <input type="checkbox"/> Personnel and Employment Management |
| <input type="checkbox"/> Modern Salesmanship | <input type="checkbox"/> Banking and Finance |
| <input type="checkbox"/> Traffic Management | <input type="checkbox"/> Modern Business Correspondence and Practice |
| <input type="checkbox"/> Railway Station Management | <input type="checkbox"/> Expert Bookkeeping |
| <input type="checkbox"/> Law—Degree of LL.B. | <input type="checkbox"/> C. P. A. Coaching |
| <input type="checkbox"/> Commercial Law | <input type="checkbox"/> Business English |
| <input type="checkbox"/> Industrial Management | <input type="checkbox"/> Commercial Spanish |
| <input type="checkbox"/> Modern Foremanship and Production Methods | <input type="checkbox"/> Effective Speaking |

Name.....

Present Position.....

Address.....



\$25.00 DRAWING COURSE for \$2.98



Haven't you often wished that you could draw cartoons illustrate some idea, sketch some pretty face, etc. You can do all of these things. One of America's most famous Cartoonists and illustrators has developed a great, simple system for success in all branches of Commercial Art. This system has revolutionized the entire theory of drawing. It means that drawing can be as easy for you as writing—much simpler than learning shorthand, bookkeeping or typewriting. We are now placing this original system for learning Drawing, Art and Cartooning consisting of 34 lessons with over 500 illustrations within reach of every one. If you will devote a few hours each week to the Course WE ABSOLUTELY GUARANTEE that you will learn to draw and draw well before you have half finished the Course. If we fail to make this claim good, we will refund every cent paid us. By eliminating a large office force for answering correspondence, expensive catalogues, etc., we are enabled to make a price of \$2.98 the cheapest price ever known for a high-grade home study course. Many have sent us letters similar to that of Rob't P. Davis of Detroit, who wrote "I can't see how you ask so little, when others with inferior Courses get from \$20 to \$60 for theirs. It is more than I expected." Learn to draw. It is a big asset, no matter what field you are in.

Send No Money

Just order the course, and \$2.98 on arrival pay postman plus a few cents postage, payment in full for the entire Course and Free Drawing Outfit. If not entirely satisfied, return within five days and we will REFUND MONEY. Address:

FREE: If you order the course at once, we will include a drawing outfit, consisting of artist's pencils, pens, paper, erasers, thumb tacks, etc., enabling you to go to work without any additional cost.

LEDERER SCHOOL OF DRAWING, Dept. 1950-U, Chattanooga, Tenn. Orders from outside the U. S. A. are payable \$3.28 cash with order.

Study AT Home

Become More Efficient

Courses in *Mathematics, Chemistry, Psychology, Education, Business* and 40 other subjects command either High School or College credit. Start any time.

The University of Chicago
15 Ellis Hall CHICAGO, ILL.

Learn to **PAINT SIGNS and SHOW CARDS**

We quickly teach you by mail, or at school, in spare time. Enormous demand. Big future. Interesting work. Oldest, foremost school.

EARN \$50 TO \$200 WEEKLY

John Vassos, N. Y., gets \$25 for single show card. Crawford, B. C., says: "Earned \$200 while taking course". Send today for free information, samples and guarantee.

DETROIT SCHOOL OF LETTERING
154 Stimson Ave. Est. 1899 Detroit, Mich.



BUCHSTEIN'S FIBRE LIMB



is soothing to your stump—strong, cool, neat, light. Easy payments. Brace for all deformities.

D. BUCHSTEIN CO.
610 3rd Ave., So. MINNEAPOLIS, MINN.

Send for Catalog Today

Don't Envy The Plumber BE ONE!

\$11.00-\$16.00 PER DAY and work **EVERY** day, is the Plumber's wage.

Every skilled workman will tell you that Plumbers have the best of it. WINTER and SUMMER the Plumber is busy at top wages. No skilled Plumber is ever out of a job—compare his opportunities with any trade, plus the opportunities of having your own shop.

We teach you Plumbing with TOOLS (not books) under Licensed, Master PLUMBERS in one of the finest equipped schools in America. We make you a Plumber, every branch is taught thoroughly—Lead Work—Blue Print for plan reading—all other tricks.

LEARN IN 8 TO 12 WEEKS without previous experience. If you are making less than \$50.00 a week you owe it to yourself to investigate. Get FREE catalog that tells in pictures and words how we teach this trade. Special rates now.

KANSAS CITY SCHOOL OF PLUMBING
2030 Troost Ave. KANSAS CITY, MO.

Four Practical 90 Day Courses—COMMERCIAL ELECTRICAL ENGINEERING YEAR

Heat, Light, Power, A C and D C Armature Winding, Radio or Testing complete in 90 days B.S. Degree in Three Years. Send coupon for complete information.

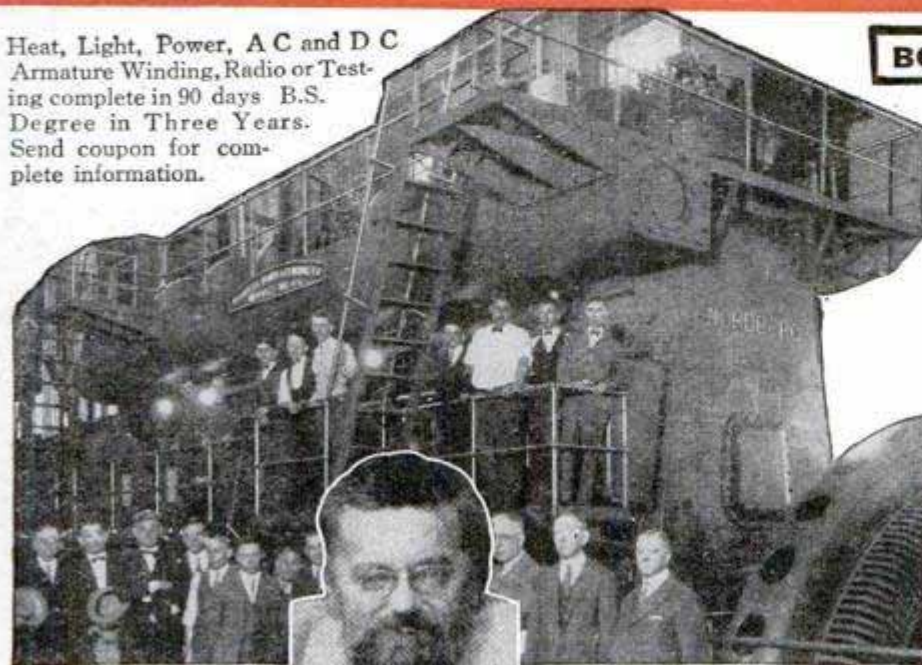

BOOK FREE—SEND COUPON

Even the United States Government endorses S. of E. training. At left is shown huge generating unit made by Harnischfeger Corporation for Panama Canal for which S. of E. students made the Acceptance Test by special request.

Get a better training in America's Electrical Center—Milwaukee. Concerns like Nordberg Mfg. Co., Harnischfeger Corp'n., etc., are the leaders.

22 YEARS TEACHING THE ONE RIGHT WAY



CHARLES P. STEINMETZ "electric wizard" of General Electric was for the last six years of his life on the Advisory Council of School of Engineering.

assistant to Dr. Steinmetz, the electric wizard.

THREE MONTHS FASCINATING

training fits you to enter the big job with one of these concerns or go into business for yourself. Thousands of opportunities exist in

every section for men with a little training to do house-wiring, operate battery service stations, to do automotive electrical work. In three months time S. of E. training gets you ready for the amazing opportunity of a lifetime.

S. of E. MEN GET PREFERENCE everywhere that men are hired for electrical work. For in nearly every electrical concern in America S. of E.

men will be found holding big jobs. They are on the lookout to help you succeed when you come in. In one of the 10 largest American cities the 3 biggest electrical jobs are all held by S. of E. men. To be an S. of E. man means prestige—preference!

ACT NOW BEFORE CLASSES FILL UP. Due to the enormous amount of personal attention given to each man, S. of E. classes fill up rapidly. Employers ask first for the S. of E. man. We suggest immediate action to avoid disappointment.

SPECIAL BOOK NOW FREE—Act! Clip and mail the coupon right away. A big 72 page book telling all phases of S. of E. training will be rushed to you. Get it by all means to help make up your mind. The most complete book on opportunities in electricity ever offered.

CLIP AND MAIL COUPON NOW! A PERSONAL CHALLENGE TO YOU

"Whatever your previous education our training will make you successful in Electricity! Put yourself in my hands for a few weeks and the big job is yours."

OSCAR WERWATH, Faculty President

DON'T WASTE another minute getting into the fascinating field of electricity. Never before has there been so many amazing opportunities. Electric refrigeration, radio battery work, central stations, power plants, are combing the country for men with electric training.

\$3200 AND UP with amazing opportunity for advancement awaits you in this most fascinating business of all. S. of E. training will prepare you in a few weeks time to step into a fine electrical job in a big corporation like General Electric, Western Electric, Commonwealth-Edison, Harnischfeger Corporation.

THE BIG CONCERNS are the ones who offer the big opportunities. And they prefer S. of E. men because 20 years experience has shown that they are the ones who succeed. The finest engineering talent available directs your work in classroom. They are big men like Prof. John D. Ball, for six years



You will find and enjoy a different spirit among S. of E. students than you find in the "trade schools." Good times mixed with work. Fraternities, daily broadcasting from Station WSOE. Above is photo of the student parade.

Men who make good are S. of E. Trained

"Thanks to the training you gave me I have never had difficulty in obtaining or holding very desirable positions. I am in the radio game and am bringing sound engineering principles to bear on the many problems that are usually solved by 'cut and dried' methods."—Waldorf A. Smith, Research Engineer, Carter Radio Co.



W. A. Smith



C. R. Lund

"The benefit of your training can best be attested by the product of the school. It is significant that the majority of S. of E. graduates obtain noteworthy and remunerative positions within a short space of time which is almost entirely due to the training received at their alma mater."—C. R. Lund, Electrical Engineer, Harnischfeger Corp.

SCHOOL of ENGINEERING of Milwaukee

Founded 1905, Dept. R376 415-17 Marshall St., Milwaukee, Wis.

SCHOOL OF ENGINEERING OF MILWAUKEE Dept. R376 415-17 Marshall St., Milwaukee, Wis.

Without obligating me in any way, please mail free 72-page illustrated book, "Electricity and the One Best Way to Learn It," and particulars regarding the course I have marked with an X.

Commercial Electrical Eng. ... Armature Winding
Elec. Eng. B.S. Deg. in 3 yrs. 1... Light, Heat, Power Wiring, Testing
Electrotechnics ...
Junior Electrical Eng. ... Practical Electricity
Automotive Electricity ... Home Laboratory Service
Radio Sales, Service and Broadcasting ... I am interested in your "Earn While You Learn" Plans

Name..... Age.....

Address..... Education.....

City..... State.....

Don't fail to mail me NOW!!

O. C. MILLER
 Director
 Extension
 Work
 American
 School



The American School

A million Dollar *No-Profit* Educational Institution, now offers men a *double* service—training for a specific job, then help in finding the job. For one small price, on terms of only \$5.00 a month, you are now assured of definite benefits, both in position and salary. Write for complete information—*today!*

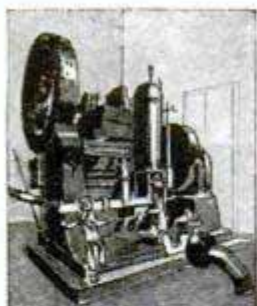

No machine can be built until the Draftsman first builds it on paper. My training prepares you for this work.



has the world seen any-
 like the building boom of
 This has created enormous
 demand for real Drafts-

**5
 BIG-PAY
 Branches**

The big money in Drafting goes to men who specialize in Machine Design, or Electrical Drafting, or Architectural Drafting, or Structural, or Automotive. It is not enough merely to know *general* Drafting practice. You must know how to calculate and design and plan original work. You need many Engineering subjects to fill the kind of a Drafting position that pays \$60 to \$125 a week. The American School *now* includes this *specialized* training in its *Drafting* course.

Costly Drafting Outfit Given!

Fine, imported instruments like these help you learn Drafting quickly and easily. These standard quality, full size instruments, board, table, triangles, T square, ink, protractor, etc., given to every student without extra cost.



O. C. Miller, Director Extension Work

AMERICAN SCHOOL

Dept. D-774
 Drexel Avenue and
 58th St., CHICAGO

3 Drafting

to prove you can

We have invented a new, simplified way to teach Drafting—the first real improvement in Drafting home instruction in history. We want you to see a few of these new Job-lessons, try them, test your own ability to master them—without one penny of cost or obligation. For instance you will see how we get away from the “copying” methods used in the past, so you develop into a DRAFTSMAN, instead of a “tracer.” See for yourself the ingenious new method which compels you to think, to solve problems, to do actual Drafting-room jobs from the very first lesson!

A New, Rapid, Simplified Training

Copying drafting lessons prepares you to be only a “tracer.” This new “Job-Method” gives you actual drafting-room jobs in a new one-step-at-a-time way. With pictures which you can understand almost without reading the “lessons.” And that is why the American School trained Draftsmen can qualify for a good job at big pay when they graduate.

Win Success Thru Drafting

Drafting is easy, fascinating work. Short hours. Big pay. And the Draftsman is always in line for promotion to executive positions. This training is *complete*. It includes high school subjects (if you need them) and all the Engineering and Mathematics. Drafting expert required.

**FREE
 Job Service**

The American School now offers its students and graduates, without cost, the service of an efficient employment department keeping in constant touch with employers of Draftsmen all over the U. S. We have placed hundreds of men in good, big-pay Drafting positions. We've made this training so complete, so practical, so easy to master, that our students are **bound to make good**. And so, because the demand for real Draftsmen continues to exceed the supply and because this training actually prepares men for good Drafting positions we back it with a **Free Employment Service**.

Lessons *Actually* FREE

Learn at home in spare time!

Draftsmen Wanted!

\$60 to \$125 a Week!

yourself. Plan your future in Drafting. Even if you have only common schooling, even if you know nothing of Drafting, we guarantee to make you a real Draftsman or to refund your money! Special surprise offer right now to the first 500 men who answer this ad—reduced price, easy terms. Coupon brings complete information.

70,000 fine jobs advertised last year. Get ready to fill one. Get out of the rut. Make something of

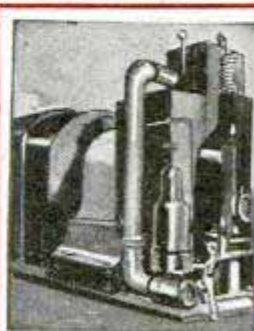

Electricity needs Draftsmen who know Electrical principles as well as general Drafting practice. I give you this training.



The demand for Draftsmen experienced in concrete and structural steel work is enormous. Many big-pay positions open.



Every great Auto factory employs Draftsmen who specialize in Automotive work—men who design bodies, plan engines, etc.

I Will Make This Contract With You



American School
—the Million Dollar
Educational Institution



4. or we'll refund every cent of your money.

- WHEN you enroll for our home-training in Drafting, we agree to give you:
1. Complete Drafting training, by the new Practice-Method.
 2. Professional Drafting Outfit, as illustrated.
 3. We will help you get a good Drafting position at a substantial increase in pay,

O. C. Miller

Coupon Brings 3 Lessons FREE!

Get them. Test your own ability to learn Drafting and get ready for a fine job and big pay.

Coupon also brings surprise offer, and complete information about your opportunities for success in Drafting. *Mail It Today!*

Read These Letters!

**City of Chicago
Department of Buildings**
Gentlemen: The same day I received my diploma I got word that I was one of the two candidates who had successfully passed the examination for Deputy Commissioner of Buildings of the City of Chicago, a position paying \$3600 per year.

There were eight applicants examined besides myself, all men well known to the architectural and engineering profession. Seven of these failed to obtain a passing grade of 70%. My grade was 84.69.

Inasmuch as I failed to pass this same examination three years before, my present success is mainly due to the knowledge gained through your School.

Yours very truly,
ROBERT KNIGHT

Got His Draftsman's Job

"I wanted to let you know how I came out in getting that job at the Brownell Co., Dayton, Ohio. I was to start and have a trial at Drawing, and I am still in the Drawing room. The engineer seems to like the work I make, and also the other draftsmen. I thank the School very much for getting me in at this place, because your letter of recommendation helped me a whole lot to get the job."

BERNARD WEBER,
730 St. Nicholas Ave., Dayton, O.

Liberty High School Bethlehem, Pa.

Dear Sirs:—This is to thank the American School for all that you have done for me since I signed up for the Drafting and Design Course.

In the eight years since then, I have gradually climbed from the position of tracer to that of Head of the Department of Machine Drawing and Design in our magnificent new \$2,900,000 High School here, at many times the salary which I received at that time.

The officials of the Pennsylvania State Department, and Dr. Wm. C. Ash of the University of Pennsylvania, all claim that our course in Drafting and Design is the best now being taught in this state. Every drafting graduate that we have turned out has proved successful, and one is now Chief Draftsman in a local steel concern. Yours sincerely,
J. S. LEAR

Has Charge of Large Jobs

"Even before I had finished my course, I was put in charge of large construction jobs in different cities. I have been doing that ever since, and the jobs are getting larger all the time. I owe my success to the American School because of the knowledge I gained in mathematics and calculations."

ELMER L. LAMB,
1306 Smith St., Peoria, Ill.

3 Drafting Lessons *Actually* FREE

**O. C. MILLER, Director Extension Work
AMERICAN SCHOOL**

Dept. D-774, Drexel Ave. and 58th St., Chicago

Rush 3 Free Drafting Lessons, Job and Raise Offer, complete information, money-back guarantee, etc., to prove I can become a real Draftsman at home in spare time.

Name.....
Street No.....
City..... State.....

Electrical Experts are in Big Demand!



It's a shame for you to earn \$15 or \$20 or \$30 a week, when in the same six days as an Electrical Expert you could make \$70 to \$200—and do it easier—not work half so hard. Why then remain in the small-pay game, in a line of work that offers no chance, no big promotion, no big income? Fit yourself for a real job in the great electrical industry. I'll show you how.

Be an Electrical Expert Earn \$3,500 to \$10,000 a Year

Today even the ordinary Electrician—the “screw driver” kind—is making money—big money. But it's the trained man—the man who knows the whys and wherefores of Electricity—the Electrical Expert—who is picked out to “boss” the ordinary Electricians—to boss the big jobs—the jobs that pay \$3,500 to \$10,000 a year. Get in line for one of these “Big Jobs.” Start by enrolling now for my easily learned, quickly grasped, right-up-to-the-minute, Spare-Time Home-Study Course in Practical Electricity.

Age or Lack of Experience No Drawback

You don't have to be a College Man; you don't have to be a High School Graduate. As Chief Engineer of the Chicago Engineering Works, I know exactly the kind of training you need, and I will give you that training. My Course in Electricity is simple, thorough and complete and offers every man, regardless of age, education, or previous experience, the chance to become, in a short time, an “Electrical Expert,” able to make from \$70 to \$200 a week.

Your Satisfaction Guaranteed

So sure am I that you can learn Electricity—so sure am I that after studying with me, you, too, can get into the “big money” class in electrical work, that I will guarantee under bond to return every single penny paid me in tuition, if, when you have finished my Course you are not satisfied it is the best investment you ever made. And back of me in my guarantee stands the Chicago Engineering Works, Inc., a two million dollar institution, thus assuring to every student enrolled, not only a wonderful training in Electricity, but an unsurpassed Student Service as well.

FREE Book on Electricity

I want to send you my Electrical Book and Proof Lessons, both Free. These cost you nothing and you'll enjoy them. Make the start today for a bright future in Electricity. Send in Coupon—Now!

L. L. COOKE, Chief Engineer
Chicago Engineering Works

2150 Lawrence Ave.
Dept. 17 Chicago

Get Started Now!
Mail Coupon

Name.....

Address.....

Occupation.....

I Will
Train You at
Home for a
Big Pay Job
L.L.C.

5 Big Fine
Outfits
to work with
No Extra Charge



With me, you do practical work—at home. You start right in after your first few lessons to work at your profession in the regular way and make extra money in your spare time. For this you need tools, and I give them to you—5 big complete working outfits, with tools, measuring instruments, and a real electric motor—5 outfits in all.

The “Cooke Trained Man is the “Big Pay” Man



\$20 a Day for Schreck

“The biggest thing I ever did was answer your advertisement. I am averaging \$500 a month from my own business now. I used to make \$18 a week.”
A. SCHRECK, Phoenix, Ariz.



\$700 in 24 Days

“Thanks to your Course, I made \$700 in 24 days in Radio. I run from \$10 to \$40 clear profit every day.”
FRED G. McNABB
7 W. 16th St.,
Atlanta, Ga.



GET
MY
FREE
BOOK!

L. L. COOKE, Chief Engineer,
Dept. 17, 2150 Lawrence Ave., Chicago, Ill.

Send me at once without obligation your big illustrated book and complete details of your Home Study Course in Electricity, including your outfit and employment service offers.

Classified Advertisements

WORLD'S BEST WANT AD MEDIUM

Advertisements in this section, 25 cents per word, each insertion, minimum 10 words, payable in advance. To be inserted under proper classification in November issue, copy should be in our office September 18th.

ADVERTISING AGENCIES

ADVERTISE in the classified section of newspapers and magazines, to secure help, money, or to sell. 24-word advertisement in nine big Metropolitan papers \$10.00. Nearly two million circulation. Many other bargain lists. Write for Free 58-page Directory No. 26. Brinckerhoff Advertising Agency, 37 W. VanBuren, Chicago.

A TEN Dollar Ad may put your proposition over. \$10 pays for a 4 line 24 word classified ad one Sunday in 10 of the largest newspapers. Reach over 7 million readers. Minneapolis Tribune, Buffalo Courier, St. Louis Post-Dispatch, Pittsburgh Press, Indianapolis Star, Atlanta Journal, Detroit Free Press, Birmingham News, Cincinnati Enquirer, Little Rock Gazette. Free catalogue showing other lists of newspapers and magazines sent on request. Ankrum Advertising Agency, 20 W. Jackson Blvd., Chicago. Largest classified advertising agency in the world.

ADVERTISE in 24 Big Sunday Newspapers, 24 words \$15.00. Excellent for securing Agents, Salesmen, and Business Opportunities. Catalog listing 1,000 leading Dailies, Weeklies, Mail Order Magazines, Everything. Free. Wade Advertising, Baltimore Bldg., Chicago.

ADVERTISE—Newspapers, Magazines, Country papers—classified (Want Ads)—display space. Free catalog. Martin, 37B West 39th, New York.

ADVERTISING in all magazines and newspapers at publisher's lowest rates. Book giving rates, closing dates, etc., 25c—refunded first order. Taylor's Advertising Service, 314-16 Brown Bldg., Rockford, Ill.

INCH Display 100 Monthly Magazines, \$4.00 Ad-Meyer, 4112M Hartford, St. Louis, Mo.

COUNTRY papers. All publications. European, Foreign. Lowest rates. Catalog. Owl Agency, Times Building, New York.

FOR ADVERTISERS

GUARANTEED Lists—agents, mail-order buyers, others, secured through our own advertising or copied from original letters; 500, \$2.25; 1,000, \$4.00. Price list free. Club mailing, Demuth Company, Englewood, N. J.

AMAZINGLY Resultful! Letters \$5.00; Circulars \$10.00; Folders \$15.00. Campaigns planned. Recognized authorities. Investigate! Finkel, Advertising, 15 Fairview, Jersey City, N. J.

RELIABLE Lists—Actual Buyers, Agents, Juveniles, Opportunity Seekers, \$4.00 thousand. Circulars mailed with ours, \$2.50 thousand. Field Co., 1145 East 99th St., Cleveland, Ohio.

YOUR 28-word ad 100 weeklies, monthlies, \$5.00; thrice \$10.00. Doisen, 36 Liberty, Brooklyn.

I WRITE letters, folders, booklets, complete followup for manufacturers, mail-order dealers. Long experience. Write for details. L. Taylor, 315 Brown Bldg., Rockford, Ill.

ADVERTISE in 300 country newspapers, 28 words, \$10.00. Keator, Hartford Bldg., Chicago.

25 WORDS 88 magazines; \$1.00. Thrice \$2.00. Smith's Service, 1194, Wenatchee, Wash.

GARAGES and Filling Station. Guaranteed lists copied from 1926 orders. 1,000—\$5.00; 500—\$2.75. William Johnson, Box 2013, Dallas, Texas.

25 HAND-COLORED ad-slides \$12.50, including lettering copy. Artercraft Photo, 394 Mass. Ave., Boston.

CUTS, Drawings \$1.50. Window Cartoons, 5, \$1.50. GPO, Bx171, New York.

SALES PROMOTION

CLINCH sales prospects by forceful letters, folders and booklets. Hewson, Advertising, Department 161, 121 North Broad Street, Philadelphia, Penna.

\$50 TO \$50,000 Daily Sales Developed During 28 years for clients by our direct mail plans, copy, campaigns. One product, 1923, an idea; this year \$100,000 orders booked. Fifty year old concern desired 50 national representatives in 1925; we produced 40 in three months. 700 dealers in 10 months at \$3 each, for another. Ten years Sales Promotion Manager Larkin Co. Submit sales problems for Free diagnosis. James C. Johnson, 118A Woodbridge Ave., Buffalo.

SALES creating letters written. G. W. Anderson, Box 1244, Phoenix, Ariz.

AUTOMOBILE SUPPLIES

MANUFACTURE Fibro-Seal, Guaranteed Puncture Plugger; Para-vulking, No-cement Instant Weld Patch; Super-Radiolyte, 20-Minute Battery-Charging Fluid. I'm headquarters for Guaranteed Formulas for High-class Automobile Specialties and all lines. Investment small—profits enormous. No Machinery necessary. Valuable Literature Free! Start a worth-while business with unlimited possibilities! Miller, Chemist, 1706-A Jetton, Tampa, Fla.

PAINT Remover; Remove the paint off your car for only a few cents. Formula one dollar. Diamond Specialty Co., Box 155, Fruitvale Station, Oakland, Calif.

GARAGEMEN, Look! Clean Ford Oil Line in 10 minutes. Sample 25c. Pat. 8-11-25. Metal Products Co., St. Cloud, Minn.

AUTO Emblems. Any Lodge. Write. North Central Distributors, Dept. J, Ashland, Ohio.

SELF steering Automobile Leaders. Write Britzius Mfg. Co., Dover, Minn.

VULCANIZING Auto Tires is a Paying Business. We have Plants near you from \$50 up. Catalog Free. Instruction Book \$1. Equipment Exchange, 108 East 11th, Los Angeles, Calif.

MAGNETOS, Starters, Generators, Ignition systems, spark plugs, part, timing chains, repairing. Melkert Magneto Co., 1759 E. 21st St., Cleveland, Ohio.

66 MILES on 1 Gallon—Amazing Gas Saver. All autos. 1 free. Critchlow, B-805, Wheaton, Ill.

BATTERY Tester and Inspector. Regular \$50.00 value; \$32.00. Battery Shop Equipment and Supplies at Wholesale. Adams-Barr, Columbus, Ohio.

VULCANIZING Auto Tires is a Paying Business on account of new tires advancing. We have Plants near you from \$100 up. We save you 50%. Catalog Free. Instruction Book \$1. Equipment Exchange, 108 East 11, Los Angeles, Calif.

BARGAINS on Radiators. All standard makes radiators furnished at bargain prices. State Make and model. We guarantee satisfaction. Independent Radiator Co., 1119 Wabash Ave., Chicago.

USED Auto Parts for Any Car. Allen's Parts Co., 2001 So. 9th, St. Louis, Mo.

AUTOMOBILES

PATENTS. Time counts in applying for patents. Don't risk delay in protecting your ideas. Send sketch or model for instruction or write for Free book "How to Obtain a Patent" and "Record of Invention" form. No charge for information on how to proceed. Communications strictly confidential. Prompt, careful, efficient service. Clarence A. O'Brien, Registered Patent Attorney, Security Bank Building (directly across street from Patent Office), Washington, D. C. See pages 140 and 141.

FOR FORD OWNERS

FORD Owners who dislike motor "bucking" in traffic, who wish to take long steep hills on high, who perhaps desire extreme speed, should use Avaco Valve Action which scientifically and simply increases valve capacity on a Ford. Durable, easily installed, inexpensive. Honest money-back guarantee. Write. Auxiliary Valve Action Company, Fitchburg, Mass.

DELIVERY bodies for Ford Model T. Chassis with inclosed Cab, suitable for Contractors, Grocersmen and farmers. Three styles. Price \$42.60. Write Daniel Zimmerman, Craigville, Ind.

FORDS: no freezing, no boiling, big gas saving. Airlock absolutely does it. Sells like machine guns fire. Free trial always. Airlock Products, Burnett, Calif.

PUT a "Bingo Timer" on your Ford. Guaranteed best made. Thousands in use. Requires no oil. No more trouble. All Dealers or direct with full particulars—\$1.50. Agents make big money. United Machinery Company, Cincinnati, U. S. A.

66 MILES on 1 Gallon—Amazing Gas Saver. All autos. 1 free. Critchlow, C-805, Wheaton, Ill.

DIRECT Engine Driven Tire Pumps for Ford Cars. Clagett Mfg. Co., Upper Marlboro, Md.

UNDERSLING with "RKO" Swing Lo Irons. See "Red-i-Kut" ad page 134.

MOTORCYCLES, BICYCLES AND SUPPLIES

EXCELSIOR and Henderson Parts all models, used, half price. Parts book 10 cents. Good used motorcycles, all makes, \$75.00 and up. John F. Ballak & Co., 100 N. 12th, St. Louis, Mo.

BICYCLES \$10 up. Racers \$15. Tandems \$25. Triplet Tricycles; Exercising Machines. Bicycle Spotlight, less batteries, \$3.50. McDougald, 175 W. Lake, Chicago.

TWINS \$25.00—\$75.00. Ace 4 \$75.00—\$125.00. Typewriters \$8.00—\$25.00. Send Cash. Knights, 1512 Locust, St. Louis, Mo.

1922 AND 23 Ele Harleys in good order to close. \$75.00. Motorcycle Ike, Chicago Heights, Ill.

GOOD Second Hand Parts for Indian, Harley, Henderson, Ace and Excelsior Motorcycles. No Junk. Ship C.O.D. No Lists. J. B. Dahl, 3661-63 Archer Ave., Chicago, Ill.

1923 HARLEY-DAVIDSONS, \$168; 1922, \$118; 1921, \$111; 1920, \$85; 1919, \$65; 1917, \$50; 1916, \$45; 1915, \$40; 1914, \$35. Guaranteed. Money refunded if not satisfied. Circular free. Wisconsin Cycle Sales Co., 726 National Ave., Milwaukee, Wis.

DON'T buy a Bicycle Motor Attachment until you get our prices. Shaw Mfg. Co., Dept. 27, Galesburg, Kans.

SEND for Bargain Bulletin. All makes of rebuilt motorcycles at lowest prices. Used parts half-price. Ash Motor Corporation, Rochester, N. Y.

OVERSTOCKED Used Motorcycles, 1923 Indian Chief \$95.00, 1923 Harley Davidson \$95.00, 1923 Henderson DeLuxe \$120.00. Two hundred others; write for free list. Myerow Brothers Co., 15 Berkeley St., Boston, Mass.

AVIATION

LEARN to Fly; \$100.00 including Solo. We guarantee to solo you regardless of the number of flying hours required. Our instructors are ex-army aviators and air-mail pilots with wide experience. Our training equipment is the best obtainable. Our course requires about two weeks, depending on the individual. No bond required, no charge for breakage. Eight years without an accident. 76 students graduated in 1925. Commercial aviation is a rapid growing industry. Don't delay! Enroll now in one of the oldest and best known flying schools in America. Robertson Aircraft Corporation, operators of the United States Air Mail, St. Louis-Chicago, Lambert-St. Louis Airport, Anglum, Mo.

TEN lessons in the air of twenty minutes each will make you a pilot by our advanced method of training. This, together with our five-weeks shop course at \$100.00, makes America's oldest aircraft factory the most popular flying school. Work after class hours guaranteed. Special evening course, including shop work, field and flying, \$190.00. Employment furnished during the day paying from \$20.00 to \$40.00 per week. Heath Airplane Company, Chicago, Ill.

AIRPLANES, motors and supplies; 80 H.P. LeRhone rotary motor \$125; 100 H.P. Gnome Rotary Motor \$100; Clerget Rotary Motor \$200; Lawrence 28 H.P. Motor \$125; Curtiss 90 H.P. \$500; slightly used \$350; tan leather helmets \$3.75 and \$5; nonshatterable goggles, 0-al. \$2.50; wide vision, \$4; temperature gauges with 12-ft. tubing \$7.50; leather breeches \$12; airplane cloth 65c yd.; dope \$2.50 gal.; compass \$10; aerial camera \$100. Logan Aircraft, 716 W. Superior Ave., Cleveland, Ohio.

SPECIAL Bargain; One Yackey sport, two place Tommy, with new OX5 motor, with special construction \$850.00. One JN, special built, wonderful performance, increased speed, brand new in every detail, new OX5, cheap for \$1,200.00. Both ships guaranteed in class A condition. Eagle Airport, Hinekey, Ill.

PATENTS. Time counts in applying for patents. Don't risk delay in protecting your ideas. Send sketch or model for instruction or write for Free book "How to Obtain a Patent" and "Record of Invention" form. No charge for information on how to proceed. Communications strictly confidential. Prompt, careful, efficient, service. Clarence A. O'Brien, Registered Patent Attorney, Security Bank Building (directly across street from Patent Office), Washington, D. C. See pages 140 and 141.

CURTIS Pultzer Racer Construction Set including Full Sized Plans and Genuine Curtiss Reed Propeller \$4.00 Postpaid. Special Offer: Wonderful Scientific Airglider with Ground Launching Device 50c Postpaid. Plans: Curtiss 35c; S. E. V. 75c; Loening 75c; "Bat" Catboat 17" Long. Construction Set, \$1.50; Plan 25c. Big Catalog Listing Latest Types of Model Airplanes, Boats and Supplies 5c. W. Phipps Company, 367 Wilson Avenue, Brooklyn, N. Y.

AEROPLANE Engines. New 165 H.P. Gnome. Biggest bargain war surplus cost \$3,000.00; sale price \$40.00 at Dayton storage. Write for complete booklet describing aeroplanes, motors, parts all types. Enclose postage. Resistal goggles with extra pair clear glass \$2.60. Build your own plane wings \$7.50 each. Marvin A. Northrop, 730 Washington Ave., North Minneapolis, Minn.

AIRPLANES. How to build them and be sure they will fly. Learn the two most powerful influences on the stability and operation of an airplane. Get our free information, blue prints and propeller literature. Crawford Airplane Mfg., 2325 American Ave. Long Beach, Calif.

COMPLETE Scale Plans with Building-Flying Instructions for following 3-foot Model Aeroplanes, 25c each postpaid; JN4D-2; DeHavilland; NC-4; Bleriot, Nieuport or Taube Monoplanes; Cecil Peoli Racer. Complete 48 pp. catalog 5c; listing hundreds of parts and supplies for experimenters. Ideal Aeroplane Co., 165 1/2 Spring Street, New York.

BUILD flying models of today's airplanes, ten different detailed drawings and instructions. \$1.00. Carl Roberts, Spring St. and River Road, Reading, Penna.

LEARN Airplane Construction! Prepare for factory employment or Assemble Your Own Plane in our shops. Ten weeks' comprehensive course, \$50. "Joystick" outfit for "Ground-flying." Saves "airtime" expense. Typewritten Instructions included. \$5. Three-seater Commercial plane, \$1,100. Allison Airplane Co., Lawrence, Kans.

AIRPLANES at prices within your reach. Airplane motors and supplies at prices that will interest you. Propeller circular 4c. Motorcycle biplane circular 4c. Heath Airplane Company, Chicago, Ill.

EARN \$3,500 to \$10,000 a year. Prepare for flying. Complete ground course in mechanics of aviation. Write for free catalog. Western Airplane Corporation, Desk K-10, Monadnock Block, Chicago.

FIVE place airplanes complete \$2,000. John H. Behmer, Lititz, Pa.

STURTEVANT Motor, 140 H.P., first class, \$275. H. Lesieur, 179 Eugenia, New Bedford, Mass.

MOTORS: Curtiss OXX-6 Class A (under Fifty Hours) for Plane, Sea-Sled, Motor boat, etc., \$275.00. All Motor and Plane Spares at Best Prices. Send for Catalogue. Monumental Aircraft Co., 339 N. St. Paul Place, Baltimore, Md.

THE American School of Aviation announces a new correspondence course in mechanics of Aviation. A thorough training in Practical Aeronautics. American School of Aviation, Dept. 1861, 3601 Michigan, Chicago, Ill.

MOTORS: Curtiss OXX-6 Class A (under Fifty Hours) for Plane, Sea-Sled, Motor boat, etc., \$275.00. All Motor and Plane Spares at Best Prices. Send for Catalogue. Monumental Aircraft Co., 339 N. St. Paul Place, Baltimore, Md.

THREE foot model aeroplane. Price \$1.00. Circulars free. Aero Shop, 3050 Hurlburt Ave., Detroit, Mich.

LEARN to Fly, \$100. Our instructors of long experience, our modern training airplanes, and the best equipped flying field in the middle west, make us the best equipped school in the country to teach you to fly. Write for booklet. Porterfield Flying School, 2514 East 59th Street, Kansas City, Mo.

AIRPLANE, Sled, Boat, Propellers \$5.75 upward. Leather Helmets, \$3. "Aerodrive" Boat, Sled Blueprints, \$1. Ostergaard Aircraft, 4269 No. Narragansett, Chicago.

NEW nine-cylinder Gnome aeroplane engine \$45. Albert Lathshaw, Clarion, Mich.

WELDING AND SOLDERING

ALUMINUM Solder—Applied with soldering iron same as soldering brass. Sample 35c. Large bar \$1.00. Modern Machine & Pattern Co., Terre Haute, Ind.

BOOKS AND PERIODICALS

SUCCESSBOOKS—Real Value "Master Key," "Business Power," "Creative Personality," "Culture of Courage," "Power of Will," over 400 pages each. \$2.75. All five books, \$12.50. Bargain lists 10c. Phipps Library, 1014 Belmont, Chicago.

BOOK marks, National Anthems, Old Oaken Bucket, Home Sweet Home. Each subject woven with the words, music bars and are artistically designed in beautiful colors with pure heavy silk. (3x12.) Price one dollar each. Maute Arterfast Specialties, 191 Bedford Ave., Brooklyn, N. Y.

CURIOUS Books, Unique Novelties, Stunning Pictures. Samples, 10 cents Prepaid. Linds, 214 W. 34th Street, New York.

PHILADELPHIA, The Sesqui-Centennial City. Beautiful Artistic Souvenir Book, 400 large pictures, Maps, etc. 35c includes postage. Cooper-Greene Co., Pub., 1116 Chestnut Street, Philadelphia, Pa.

WHERE'D Cain Get Wife? 15 pages, 20c. Jabe Studio, Kansas City, Mo.

HYPNOTISM easily learned. Guaranteed lessons, \$1.00. Wineholt Assn., Woodbine, 24, Penna.

BOOKS: Write for particulars of our sales and exchange plan. Kilburn, Spring Valley, Minn.

PITMANIC Light-Line Shorthand, Book, 25c. Marr, Teacher, Nashville, Tenn.

FREE—Send for my Newthought, Self-culture, Occult, Mystic and Scientific book literature. Martens Publisher, Burlington, Iowa.

INDUSTRIAL Alcohol. Wright's book. Full directions for making, fully illustrated. \$2.50. Spon & Chamberlain, 120 P. M. Liberty Street, New York, N. Y.

SCIENTIFIC Books. Send for descriptive circular. Levi Bryant, 543 East 47th St., Chicago, Ill.

MANUSCRIPTS Wanted—Meador Publishing Co., 27 Beach St., Boston, Mass.

PICTURES AND POSTCARDS

CEYLONESE Girl Models. Typical Island Beauties, 20 different, one Dollar bill. National Art Photo Galleries, 10, Temple Road, Colombo, Ceylon.

ART—photos 4 \$1.00. Cartoon lesson \$1.00. GPO, Bx471, New York.

TRUE-BLUE friends everywhere. Exchange postcards, stamps, etc. Fascinating—entertaining, instructive. Year, \$1; half, 50c; quarter, 25c. Hundreds listings, 10c. Ed Ericson, Elroy, Wis.

ART Pictures, Books and Novelties. Catalog 10c. Howard Sales Co., Dept. 15, 1188 Folsom St., San Francisco, Calif.

25 BEAUTIFUL Hand-Tinted Xmas Cards and envelopes, size 4x5, with your name printed raised gold letters. Post Paid \$1.85. Maguire's A1, Boulder, Mont.

EIGHTEEN Steel - Engraved Personal Everyday or Christmas Cards, \$1.50. Free Samples. Stanley, 41 Warren Avenue, Boston, Mass.

75 BEAUTIFUL Art Pictures and Bathing Beauties 25c (coin). Photo Sales Co., 3242 Riehton, Suite 400, Detroit, Mich.

JOIN Live Postcard Club; Membership lists including Catalog, 10c. Harvey Teeple, Decatur, Ind.

GAMES, ENTERTAINMENTS AND PLAYS

PLAYS, musical comedies and revues, minstrel music, blackface skits, vaudeville acts, monologs, dialogs, recitations, entertainments, musical readings, stage handbooks, make-up goods. Big catalog free. T. S. Denison & Co., 623 S. Wabash, Dept. 11, Chicago.

HALLOWE'EN Fun—Gypsy Fortune Telling Card Deck, with complete instructions, 25c. G. Elsea, Bowling Green, Ohio.

VENTRILOQUISM taught almost anyone at home. Small cost. Send 2c stamp today for particulars and proof. George W. Smith, Room S-123, 125 N. Jefferson Ave., Peoria, Ill.

100 LIGHTNING Chalk Talk Stunts \$2.00. Cartoonist, 2925 Euclid, Kansas City, Mo.

LEXINO Card Games, Fascinating—educating. 50c postpaid. Lexino, 1216 Colusa, Berkeley, Calif.

NOVELTIES, CURIOS, ETC.

POCKET Knife, two sharp steel blades, handle made of beautiful iridescent abalone pearl, nickel silver bolster ends. Prepaid \$1.75. Rutledge, Box 113, Costa Mesa, Calif.

CURIOS. Good Luck Smiling Buddha. An artistic Chinese curio for home or office. These wonderful Josses are hand carved solid black wood, beautifully polished, said by Chinese to bring good luck to owner. Attach \$5 bill, to your letter, send registered post. Model Chinese Junks finely carved, best workmanship \$5 upwards. Cheapest house in China for curios. All goods sent carriage paid and insured. S. Jobst, Ningpo, China.

MAGIC TRICKS, BOOKS AND JOKER NOVELTIES

MAGIC—Tricks, Books and Supplies. For Amateurs as well as the great professionals. Anyone can learn through our instructions. Feature Acts in Mind-Reading, Spiritualism, Rope Ties, etc. Large illustrated Professional Catalog, 20c. Chicago Magic Co., 140 S. Dearborn St. Dept. B, Chicago, Ill.

FOR something different, send 10c for "Fun-Magic-Mystery." New 80-page Book of 500 Tricks. Also contains Catalog largest line Magic Tricks and Supplies in South, at lowest prices. Send 10c today! Lyle Douglas, Station A, Dallas, Texas.

BOOKS, Magic, Mysteries, Magic Tricks, Novelties. Catalog Free. Singer, 555, Hancock, Wis.

FREE with \$25 order die box. Send 20c for our large catalogue of tricks, wigs, sensational escapes. Oaks Magical Co., Dept. 548 Oshkosh, Wis.

SEVEN Magical Delusions and Catalogs—25c. Gilmartin, Morgan Park, Ill.

FOUR Modern Miracles and Large Illustrated Catalogue 25c. One Dollar's Worth for 25c. Mysterious Chelsea, Station B, Box 24-M, New York.

FREE—our puzzle, trick, game, joke Novelty Catalog. Wright & Son, 601-G, Ind. Ave. Peoria, Ill.

CARD tricks, Coin tricks, Hypnotism, Ventriloquism. 64 page books. Complete guides, 10c each. Geo. Fenner, 2401 Jefferson, Louisville, Ky.

STAGE Money—Flash big roll, 200 bills, 50c; 1,000, \$2.25. Oaks Magical Co., Oshkosh, Wis.

WONDERFUL Bargain in Magic Tricks and Illusions. Famous Needle Trick only \$1.50, sample trick 20c. Get our free catalog F & R Co., Dept. F., Hoboken, N. J.

"JOKES on the Ford". Get this book. Make everybody laugh. 10c silver postpaid. Cooper's, Dept. 16, Fort Worth, Texas.

12 DIFFERENT Joke Cards, 10c. Nassstrom, 474 Midway, Pontiac, Mich.

STAMP COLLECTING

SEND for your copy now. 1927 Edition Scott's Postage Stamp Catalogue. Indispensable to the collector. 83d Edition. About 1,600 pages. No increase in price. Scott's Catalogue is the complete and authoritative handbook of Philately. It lists, describes, and illustrates every stamp ever issued by any government in the world up to the time of its going to press. Gives perforation, watermark, color, paper, and price at which each stamp may be purchased, used or unused from this company. Cloth bound \$2.00; with thumb index \$2.50. Shipping weight 3 lbs., postage extra. For sale at all dealers. When you buy your catalogue ask for our free price list of sets, Scott Seal packets, albums, catalogues, and accessories. Scott Stamp and Coin Company, 1 West 47th Street., New York, N. Y.

PARK Outfit!—10 fine articles—10c. Contains: airmail set; stamp from the smallest republic; stamp with picture of greatest rascal on earth; 2 triangle stamps; perforation gauge, millimetre scale, ruler; stamp from the most savage country on earth; set of beautiful Greece Red Cross (large stamps); scarce Hayti, catalogued (1923) at \$1.00; big Price List; packet from Dutch Indies, Argentine, Bosnia and Herzegovina, Algeria, British Guiana, Chad, Chile, Guatemala, Indo China, Luxemburg, Kouang-Tcheou, Newfoundland, Siam, Ubangi. This entire outfit for only 10 cents to applicants for Park Perfect Approvals. Order to-day! Park Stamp Co., 589 Beacon St., Boston, Mass.

ARABS! Bandits! Head-Hunters! Egypt (sphinx); Malay (tiger); Benadir (elephant); Tunis (arab); Turkey (sacred mosque); Belgium (showing battle between angel and "old horns"); Congo (head hunter)—All of these mysterious and remarkable stamps are contained in our Famous Phantom Packet—55 fine varieties (to approval applicants only) for 8 cents. Nothing like it; order at once! Pacific Stamp Co., Box 138, Helena, Mont. Extra! Send us, with your order for the Phantom Packet at 8c, the names of three of your friends who collect stamps; and we will give you, free of charge, a scarce set of 11 diff. Albania—bandit land!—cataloguing over \$1.50. Supply limited; write immediately!

MAGNIFICAROCIOUS 10c Snap, with Approvals. Over 111 diff. stamps, some from far off heathenish man eating lands, of guarded secret rites and fever jungles, where white men seldom tread. Also many issued during money panic. That scarce Liberia, Hidden Hyderabad, Remote Travancore, Quaint Cochin with bumber shoot watermark, Old Canada, Hong Kong (George), Bandit ridden Albania, Huge stamp from land of ginger and Capt. Kidd's travels, Ceylon (isle of rare spices), Malay (tiger), Nyassa (all rubberneck), Gabon (savage with snickersneezes), Congo (lady), Venezuela (large map stamp), Also Mammoth costly Catalogs. Fine approvals for adults furnishing references. Stamps Bought, Payn Stamp Co., 945 Grande Vista Drive, Los Angeles, Calif.

ANCHERS \$\$\$ Outfit—only 12c! Fine triangle stamp; set German stamps with (pre-war) value forty million dollars (interesting!); perforation gauge, mme. scale; small album; airmail set; scarce stamp from smallest republic on earth; newspaper set; packet good stamps from Travancore, Johore, Dutch Indies, etc. Entire outfit for 12c to approval applicants! (Nice pocket stock book, value 25c, with every order!) Ancher Stamp Co., 148½ Clerk St., Jersey City, N. J.

O-O-O-O-H. Boys! What a Thrill! The Fenway "Jungle" Packet!—Contains scarce stamps from jungle and cannibal-land! Included are: Abyssinia, Congo head hunters, Kenya and Uganda, Nyassa camels, Mozambique, Ivory Coast, Upper Volta, Togo, Ubangul, Tanganyika, Fiji Islands (cannibals!) and other savage lands. This wonderful packet from far-away countries to new approval applicants for only ten cents! Fenway Stamp Co., 161 Massachusetts Ave., Boston, Mass.

MYSTERY Packet—Stamps from Lands of Cannibals, sun-worshippers, wild savages, including Albania, Herzegovina, Antioquia, Chad, Congo, Cochin, Cape Good Hope, Guadelupe, Gold Coast, Kouang-Tcheou, Malay, Siam, Togo, Ubangi, Volta; (many unused) and other mysterious, far-off places, 105 stamps, all different, 5 cents to approval applicants! Big illustrated lists free with order. Write today! C. D. Reimers Co., Flatiron Bldg., Fort Worth, Tex.

\$1.00 FREE. Black U. S. Postage, Given Away with each order. Pioneer Stamp Album with 500 illustrations, 150 different stamps from 40 countries, Syria, Lebanon, Hejaz, Liberia, New French Colonies, British, Portuguese Colonies, South Africa, Australia, 500 hinges, 36 page illustrated catalogue, All for 15c. Big Commission to Agents for the Best approval sheets of stamps ever offered. Write for sample outfit. Hussman Stamp Co., Dept. M, 620 Olive St., St. Louis, Mo.

GUARANTEED the greatest bargains ever offered in our Mammoth Illustrated price list 2c or Free with Manor Packet of over 130 different stamps, mostly scarce and obsolete, such as Zanzibar, Victoria, Rouad, Sarawak, Cyprus, Malta, Kenya, Cayman, Turks, Wallis, Sierra Leone, Sudan, Johore, Syria, Palestine, Iraq, Belgian Congo, Nyassaland, Nigeria, So. Rhodesia, and 12 mint Azerbaijan, 25c to Approval Applicants Only. Pennsylvania Stamp, Co., Manor, Pa.

HOBBY News Magazine issued monthly for Stamp collectors, Coin collectors, Curio collectors, Firearm collectors, Stamp and Coin Exchangers, Post Card Exchangers, and for everyone interested with any hobby. Written by experts and an expert in charge of each department. Circulates throughout the world. \$1.00 per year; no sample copies, no back numbers. Hobby News, 224 East Forsyth, Jacksonville, Fla., U. S. A.

IDENTIFY water marks with Hussman Water Mark Detector. Lacquered tin box with directions and 1,000 stamp hinges. 15c. Bargain Packets, 100 British Colonies, 35c; 100 French Colonies, 30c; 100 Portuguese Colonies 40c; 100 New Europe 10c; 50 Asiatic, 15c; 50 African, 25c; 50 Australian, 25c; 50 So. & Cent. America, 25c; 500 all different 35c; 1,000 all different 95c. Hussman Stamp Co., Dept. PP, 620 Olive St., St. Louis, Mo.

100 DIFFERENT, Abyssinia, Azerbaijan, etc. 10c to Approval Applicants only. Floyd Marsh, 524 Hamilton Ave., Indianapolis, Ind.

PROCURE Russian stamps from Russia Philatelic International, I. Trerskaja, Jamskaja 3, Moscow, U. S. S. R. American branch P. O. Box 388, San Francisco, Calif.

FREE stamps to approval applicants. W. E. Harriott, 1420 Crawford, Boone, Iowa.

FREE—40 Czecho-Slovakia with approvals 3c (stamp) postage. Lightbowns, Osborne Rd., Southsea, England.

START a Stamp Collection—70 different stamps from 70 different foreign countries, including Africa, Asia, Australia, Europe, West Indies, etc. Our pamphlet which tells "How to make a collection properly," and price list of albums, packets and sets all for only 16 cents. Queen City Stamp Co., Room 36, 604 Race St., Cincinnati, Ohio.

STAMPS, 100 different 20c. Bargain packets and approvals. List free. Applicants with reference wanted. J. M. Ryan, Box 2004, Louisville, Ky.

100 FRENCH Colonials, 25 diff. Colonies, 20c; 50, 11c; 25, 7c. Lufbery, Port Orange, Fla.

100 STAMPS from 30 countries, 5c. Lufbery, Port Orange, Fla.

FINE Collection 300 different German stamps 68c. "Exchange," Cummington, Mass.

STAMPS—1,000, 25c; 500 different, 35c; 1,000, 90c; 2,000, \$3.75. Album holds 2,000 stamps, 60c. Micheal, 4444 Clifton, Chicago.

SOMETHING different. Revenues, telegraphs—locals. Side lines—No postage. Immense stock all countries. Stamps one cent upwards. Dandy premium to applicants. Reference required. Vanderhoof, 1114 Logan, Denver, Colo.

1,000 UNUSED Stamps 50 cents. Shacklett, 3915 Westminster, St. Louis, Mo.

25c EACH: 25 different Argentine, Chile, China, Colombia, Ecuador, Mexico, Persia, or Peru. Fred Onken, 630 79th Street, Brooklyn.

300—300—300—ALL different stamps. (\$6.00 catalogue); 300 hinges, 5 approval sheets; duplicate stamp album; perforation gauge, millimeter scale and ruler to approval applicants for only 20c. Edgewood Stamp Co., Milford, Conn.

FIRST Flight Airmail Covers 35c. Ralph Mack, Sr., Goshen, Ind.

100 DIFFERENT, Abyssinia, Azerbaijan, etc. 10c to Approval Applicants only. Floyd Marsh, 524 Hamilton Ave., Indianapolis, Ind.

FREE, 40 different Czecho-Slovakia with approvals. 2c stamp postage. Lightbowns, Osborne Road, Southsea, England.

100 DIFFERENT U. S. stamps 40c; no cut squares. Approvals all countries; send reference to M. L. Cook, 527 West 46th Street, Chicago, Ill.

CONFEDERATE prints, Airmails, 20 unused, Big Lists; 5c. Buckley, 1037 Philadelphia Drive, Dayton, Ohio.

FREE Hungary Charity No. 565 to 567 and a surprise packet given to those requesting for my 1, 2, and 3c approvals, and also my 50% discount. Chas. W. Schmidt, P. O. Box 4832, Frankford Station, Philadelphia, Pa.

TRINIDAD—Tobago. Two Complete Unused Sets, Trinidad Nos. 208-210, Trinidad and Tobago Nos. 101-105, 8 different scarce "Official" Stamps. Catalogue \$2.52 for 62c. G. S. Mollineux, Ridgefield, N. J.

FREE Packet. Containing stamps from Dutch Indies, Newfoundland, Canada, etc., to new applicants for our 50 and 60% sheets. Enclose postage, 2c. 1,000 best hinges, 10c. George Flagg, Box 2991, Boston, Mass.

FRENCH Colonies Free—Jungles, Tigers, Native Chief. 2c postage. Empire Stamp Co., Toronto, Canada.

FIFTY Different Fine Stamps from Angola, Azores, Cameroons, Congo, Gabon, Senegal, Madagascar, Sudan, Togo, Ubangi, etc., Only 7½ cents, to introduce approvals. Fennell Stamp Co., Dept. M, St. Louis, Mo.

100 FINE Stamps Free with Approvals. Reliant Stamps, 82 Nassau, New York.

100 DIFFERENT Foreign, 7c. 500 Different, 30c. 25 Japan, 5c. Bargain lists free. Stanton, Niantic, Conn.

DANZIG Stamps free. Interesting Packet from Danzig with big catalogues free for 2c. Midland Stamp Company, Toronto, Canada.

ILLUSTRATED Album, Packet Stamps, Hinges, etc. 10c to Approval Applicants. George Linn Company, Columbus, Ohio.

BEST one cent approvals in America. F. P. Hand, 1117 So. 60th St., Philadelphia, Pa.

1,000 ALL different stamps \$1.00. New price list of all United States stamps free. Voorhees, 7 South Dearborn St., Chicago.

50 DIFFERENT Finland only 30c. Gronberg, Box 5441, Philadelphia, Pa.

500 MIXED 15c. 100 Var. U. S. Precancels 20c. Charles Peugh, Elma, Wash.

200 DIFFERENT 8c. 100 U. S. 25c. United States Stamps; Packets, Lists Free. Midwest Stamp Co., Kemper Bldg., Kansas City, Mo.

500 MIXED U. S. and foreign stamps 15c. Glenwood Stamp Co., 30 Athol Street, Springfield, Mass.

EXCHANGE stamps, coins. Worldwide membership. Year \$1.00, Half 50c. Rabb, 2256 Maypole, Chicago.

500 DIFFERENT, 20c; 1,000, 35c; 2,000, \$1.27. Winholt Stamp Co., Woodbine, 26, Penna.

COUPON worth 50c, 7 British Colonies, catalog 20c, big packet stamps and Price Lists, 4c postage. 300 different 15. R. W. St. Benno, Glen Ellyn, Ill.

EXCHANGE stamps, etc. Club organized 1908. Interesting booklet, 10c. Ed Erickson, Elroy, Wis.

50% OFF. Thousand Books with stamps will mail on approval. Send us your address. Full satisfaction. K. Lissick Philately Co., 1476 Broadway, New York.

10 LATEST Mozambique Co. pictoriais 12c; 50 different Poiland 10c. Carlton Bain, 80 Magazine, Cambridge, Mass.

500, 42c, DIFFERENT; 1,000, 72c. Marko, 3027 Logan, Chicago, Ill.

SESQUICENTENNIAL Specialty! "Exhibition," "Charity," "Coat-of-Arms," "Pictorial," "Airmail," "War Sufferers," six wonderful sets; packet beautiful British, French, Portuguese Colonies; 100 different foreign. Big value, 15c, to approval applicants. Deering, 38 Fairmount, Marlborough, Mass.

STAMPS collected by missions. 1 lb. 35c; 5 lbs \$1.50. Robinson, 7144 Cornell, Chicago.

FINE Approval Selections at 50% discount. 100 stamps free for 3c postage. Write Now. Winholt Stamp Co., Woodbine, 26, Penna.

NEWFOUNDLAND Stamp on Approval. None better—none cheaper. Send want list and references. Try these—38 all different face. (Cat. about \$5) for \$1.00. Rev. Butler, St. Georges, Newfoundland.

200 STAMPS, Bargain List, Magazine, 15c. Harvey Teeple, Decatur, Ind.

STAMPS sent on approval at 70% discount. Reference required. Emory Renoll, Hanover, Pa.

APPROVAL Stamp Packet Sent Free. Cornish Co., Schenectady, N. Y.

STAMPS on approval ¼c up. Free premium. Herbert Kelgwin, Middletown, N. Y.

STAMPS, 100 all different. Postage 2c. Lists free. P. M. Quaker Stamp Co., Toledo, Ohio.

110 NEW Europe All Different, a wonderful collection cataloguing several dollars, free to collectors requesting our Net Approvals. Postage 2 cents. Badger Stamp Co., Milwaukee, Wis.

500 DIFFERENT only 25c (regular price 50c), many unused, from British, French, Italian and Portuguese Colonies, Chile, Fiume, Guatemala, Persia, Siam, etc., to all approval applicants. Big bargain lists free. Victoria Stamp Co., London, Can.

STAMPS, 100 varieties, Africa, Brazil, Peru, Cuba, Mexico, etc., 10c. 50 different U. S. 25c; 1,000 mixed, 40c; 1,000 hinges, 10c. List free. C. Stegman, 5941 Cote Brillante, St. Louis, Mo.

FREE! 25 different United States with 60% discount approvals to reliable parties. Seidenberg, Baroda, Mich.

UNITED STATES—Send on approval. Send me your want list. Ref. Please, M. Hanna, New Kensington, Pa.

SPECIAL 50 Varieties French Colonies, very fine, to Approval Applicants only. 10c. Richard Lamprecht, Vaiparaiso, Ind.

110 **DIFFERENT** Stamps, many unused, high values, free to collectors requesting our Net Approvals. Postage 2 cents. Christensen, Milwaukee, Wis.

24 **VARIETIES** Cuban stamps, 10 cents. List of 6,000 low-priced stamps free. Address Chambers Stamp Co., 111P, Nassau St., New York City, N. Y.

200 **DIFFERENT** stamps, Triangle, Pictorial, etc., 10c. R. H. Carlton, 380 W. So. Temple, Salt Lake, Utah.

COVERTCO Packet, 250 varieties unused and used stamps 15 cents. Covert Stamp, 39 State, Rochester, N. Y.

ZANZIBAR, Abyssinia, Travancore, Herzegovina, Quelimane, Mozambique, Stamps, Menagerie Collection, Album, 10c. Liberty, 3974 Arsenal, St. Louis, Mo.

PACKET of 23 stamps, no two countries alike. Packet hinges. Set of \$1 and \$2 U. S. Rev., all for 5c. P. M. Miami Stamp Co., Toledo, Ohio.

1,000 **DIFFERENT** stamps, only 60c. Guaranteed to please or money back. "Washington Stamp News" tells stamp collectors about new United States stamps that are to be issued. Sample copy, 2c. C. E. Nickles, 201 Seaton, N. E., Washington, D. C.

FREE! Loose Leaf Postage Stamp Album at rate of 8 pages each month given with subscription to monthly Journal. Send 2c stamp for prospectus. United Stamp Co., Marquette Bldg., Chicago, Ill.

20 **UNUSED** stamps free. All different. Postage, 2c. P. M. Fisk Stamp Co., Toledo, Ohio.

105 **CHINA**, etc., 2c. Album (500 illustrations) 3c. Bullard, Sta. A, Boston.

50 **VAR.** Scandinavians 10c. Gronberg, Box 5441, Philadelphia, Pa.

RARE COINS

YOUR Opportunity to Purchase Commemorative Coins at Bargain Prices. Columbian 69c. Lincoln \$1.25. Alabama \$1.13. Maine \$1.35. Pilgrim \$1.25. Missouri \$1.89. Grant \$1.23. Monroe \$1.17. Hu-guenot \$1.23. Lexington 99c. Stone Mountain \$1.23. California \$1.19. Vancouver \$1.23. Sesqui \$1.23. 3c Nickel and bargain price list 10c. Arey, Box 483, Muskogee, Okla.

RARE Coins Bought and Sold. Stocks, Bonds, Notes, 3 Curls, 2 Coins and Price List, 10c. Geo. Best, Cedar Rapids, Iowa.

100,000 **MARK** German Bill and special list 7c. Fred Greenclay, 1626 Washington, Denver, Colo.

CALIFORNIA gold Quarter 27c; Half 52c; 1820 cent 25c; 1825, 20c; Confederate \$100, 20c. A. Wylie, Wheaton, Ill.

OLD Money Wanted. Will pay Fifty Dollars for nickle of 1913 with Liberty head, (no Buffalo). We pay cash premiums for all rare coins. Send 4c for Large Coin Folder. May mean much profit to you. Numismatic Co., Dept. H, Fort Worth, Tex.

OLD Coins, Large Fall Selling. Catalogue quoting prices paid for coins, ten cents. William Hesselein, 101A Tremont Street, Boston, Mass.

TWENTY-ONE Different genuine German Reichsbanknotes 50c; 100 assorted \$1.00. We'ss, Box 3049, Memphis, Tenn.

BILLION Mark German Government Bond, \$1.00; ten Bonds, \$3.00. American Sales Co., Box 1278B, San Francisco.

CALIFORNIA gold, $\frac{3}{4}$ size, 27c; $\frac{3}{8}$ size, 53c; three-cent-piece and catalogue, 10c. Norman Shultz, Box 746, Salt Lake City, Utah.

TWO different Broken Bank Bills 25c. Durso, 25 Mulberry, New York City.

\$100 **C. S. A. MONEY** 10c; Roman coin 15c; 100 year old U. S. Cent 10c; U. S. Eagle Cent 2c or 3c, each 10c; U. S. \$1 gold \$2.65. Big retail list free; 32 pp. illustrated list and old coin, 6c. Elder Corp., 9 E. 35th St., New York.

40 **OLD** coins all different \$1.00. 25 different coins 50c. Monroe Half-Dollar Un-culated \$1.00. 15 different Confederate \$1.00. 500 different Germany City \$1.50. Claude Denney, Box 315, Dallas, Texas.

UNITED STATES and Foreign Money. Catalogue and Villa Bill 10 cents. Angelle, Colorado Springs, Colo.

GET Profit and Pleasure in collecting Old Coins. Send 10c for Sample Old Coin, together with my Large Illustrated Coin Catalogue. You'll be delighted with it. Send for it right now. B. Max Mehl, Professional Numismatist, Mehl Bldg., Dept. P., Fort Worth, Texas. Largest Rare Coin Firm in U. S.

STOCKS—Bonds, Domestic—Foreign, bought—sold. Dealers in all marketable securities. Frank O. Everett & Co., 20 Broad St., New York.

\$2 TO \$500 Each Paid for hundreds of Old or Odd Coins. Keep All Old Money, it may be very valuable. Send 10 cents for Illustrated Coin Value Book, 4x6. Get Posted. Guaranteed Prices. We Buy and Sell. Clarke Coin Office, LeRoy, N. Y.

UNITED STATES, Large Cent, two-cent bronze, three-cent nickel and Bargain List, 25c. Fifteen dates large cents, \$1.00. George Coffin, Greenwood Mountain, Me.

FOR BOYS

BOYS: Wind and assemble your own electric motor. Very interesting and educational. We furnish all parts and complete instructions for \$1.50. Write for circular. Hudson Valley Specialty Company, P. O. Box 642, Poughkeepsie, N. Y.

BOYS and Girls, Earn Xmas Money. Write for 50 sets St. Nicholas Christmas Seals. Sell for 10c a set. When sold send us \$3.00 and keep \$2.00. No Work—Just Fun. St. Nicholas Seal Co., Dept. 43PM, Brooklyn, N. Y.

EARN Spending Money. Sell 24 pkgs. postcards. You keep \$1.00. Wineholt Specialty Co., Woodbine, 28, Penna.

CAMERAS AND PHOTO SUPPLIES

PHOTOGRAPHIC equipment and accessories of every description are listed and illustrated in our 228-page catalogue. It will pay you to secure a copy which is issued free, as our prices are low. We also deal in used goods which are sold under the same guarantee as new goods. Ask for our Bargain Book. Central Camera Co., Dept. E110, 112 S. Wabash Ave., Chicago, Ill.

SEND 10c for the latest and greatest Bass Book of Cinema Apparatus; gives full description of all types of instruments as well as the price. Or, send \$3.00 for a 500-page Cinema Hand Book containing full instructions of the making and taking of films. Bass Camera Company, 105 N. Dearborn St., Chicago, Ill.

KODAK Film—Special Trial Offer—Your next roll developed 5c, prints 3c each. Beautiful 6x10 mounted Enlargement 40c. Sameday Service. Fleet Photo Service, 1210 G. N.W., Washington, D. C.

MODERN Photography in all its branches now taught by mail. New Successful Method. Students earning \$300.00 while learning. Big opportunity. Write for particulars and unusual offer open for short time. Dept. 3431, International Studios, Inc., 3601 Michigan Ave., Chicago.

FILMS Developed. Special Trial Offer. Any Size Kodak film developed 5c, prints 3c each. Trial 6x10 Enlargement in handsome folder 40c. Overnight Service. Roanoke Photo Finishing Co., 209 Bell Ave., Roanoke, Va.

UNEXCELLED Gloss Prints. Trial Offer. Your Kodak Film Developed and printed only 10c. F R B Photographers, Dept. "C," 1503 Lincoln Ave., Cincinnati, Ohio.

BIG Money Saved on Photographic Lenses and Apparatus—goods exchanged; repairing done. Ralph J. Goisen, 1128 Argyle St., Chicago, Dept. P.

CAMERAS, lenses, binoculars exchanged, firearms, microscopes wanted. National Camera Exchange, 5 South Fifth, Minneapolis, Minn.

SELL Your Pictures. Big market. Send dollar for list fifty buyers. Oakley, Box 331, Geneva, N. Y.

MAKE photos quickly, without camera or films. New discovery. Dime brings sample photos and Particulars. Koch's Studio, Collbran, Colo.

FREE—7x11 Enlargement of Any Kodak film with your roll developed and six prints; special trial offer—35c. Worlds Photo Supply, Box 66, Westerville, Ohio.

\$50.00 FOR Photographs—This price paid for photographs if they meet our requirements. Perhaps one of your pictures will bring this amount. For particulars, address Redkrafts, Dept. 11, Denver, Colorado.

25 **CENTS**—coin—6 exposure roll and 1 print each good negative. Photo Finishing Co., Waterloo, Iowa. Box 26.

HAVE You a Camera? Write for Free sample of our big magazine, showing how to make better pictures and earn money. American Photography, 116 Camera House, Boston, 17, Mass.

BARGAINS in Kodaks. Ray, 296 5th Ave., New York.

KODAK Films—Special trial offer; your next kodak film developed, 5c—prints, 2c each. Moser & Son, 1917 St. James Ave., Cincinnati.

MOTION PICTURES

SACRIFICING New \$150 Sept spring motor Movie Camera and leather case, \$37.50. Eastman negative Film $2\frac{1}{2}$ cents foot. Printer \$25. Movie Projector \$37.50. Motor driven suit case Projector \$85. Movie Films \$2 reel. Ray, 296 5th Ave., New York.

NEW and Rebuilt Machines for Big Theatres—Schools—Churches—Traveling Shows. Also Films—Supplies and Complete Theatre Equipments. Bargain List Free. Monarch Theatre Supply Co., Dept. P, Memphis, Tenn.

FILM—Million Feet for Sale. Cowboy—Drama—Comedy and Feature Specials. Mix—Hart—Chaplin and best Movie Stars. \$3.00 per reel up. Genuine List Free. We Supply the World. Dept. G, Monarch Films, Memphis, Tenn.

BIG Money Nightly—Complete Outfits, installment plan. Good Movie Camera, \$37.00. Ralph J. Goisen, Dept. M, 1128 Argyle St., Chicago.

PHOTOPLAYS wanted at once. Big money for good, original ideas. What have you? Write for folder M. Photoplays of America, Delta Bldg., Los Angeles, Calif.

FILMS—Features, Comedies, Weeklies, \$3.00 up. Exchange Privilege. Projectors, Supplies—Lowest Prices. Howard Leiber, 623 W. 170th St., New York.

HALF Price—Machines, Films, Stereopticons. National Equipment Co., Duluth, Minn.

MOVIE Machines, Safety Films and Steel Novelties, Catalogue Free. D. F. Elder & Company, Box 58, Chelsea, Mass.

\$\$\$ FOR Ideas. Photoplay Plots revised, criticized, copyrighted, marketed. Send for free booklet. Universal Scenario Company, 244 Security Bldg., Santa Monica and Western Ave., Hollywood, Calif.

MOVING-PICTURE Film For Sale Cheap. R. Kelly, Empress Theatre Building, St. Louis, Mo.

MOVIE films. Complete stories in two reels (2,000 Ft.) \$5 per subject. Remittance with order. Independent Films, 177 Golden Gate Ave., San Francisco, Calif.

SCENERY TO RENT

WORLD'S Most Beautiful Settings for operas, plays, minstrels. Amelia Grain, Philadelphia.

EDUCATIONAL AND INSTRUCTION

YOU can have a business profession of your own and earn big income in service fees. A new system of foot correction; readily learned by anyone at home in a few weeks. Easy terms for training; openings everywhere with all the trade you can attend to. No capital required or goods to buy, no agency or soliciting. Address Stephenson Laboratory, 1 Back Bay, Boston, Mass.

LEARN Watch, Clock and Jewelry repairing at home. My four book course complete \$3.00. James Koch, Watchmaker and Jeweler, 1015 Market St., Marcus Hook, Pa.

CONCRETE Inspectors, \$150.00 to \$200.00 per month light interesting work, easily learned at home. Write for free information. M. A. Wells Co., Raymond, Wash.

DRAFTING Taught—To limited number, reasonable rates, Edwards, Draftsman, 323 South Marsalis, Dallas, Texas.

SHORT Stories, Novels, articles, marketed for subscribers. No reading fees. Details on request. The Plotweaver, Dept. I, Hollywood, Calif.

FIREMEN, Brakemen, Baggage-men, (white or colored), sleeping car, train porters (colored), \$150—\$250 monthly. Experience unnecessary. 810 Railway Bureau, East St. Louis, Ill.

BARBERING. Learn Modern Barbering at Home. Practice on the Family. Practical, Scientific Instructions Complete for 50c. Send Money Order or Dimes. Foster, Expert Barber, Dept. A, 613 E. 60th St., Chicago, Ill.

EARN \$25 weekly, spare time, writing for newspapers, magazines. Experience unnecessary. Details Free. Press Syndicate, 981, St. Louis, Mo.

ARTIFICIAL Marble sanitary flooring instructions, ornamental casting, concrete, plaster, papier-mache decorations, garden furniture, statuary, Rubber-moulds, 17 years instructing the public; particulars and illustrations free. Chris. Mahler, Huntington, N. Y.

INSTRUCTIONS in Mail Order. Free. Popham, Box 431-D, Chicago.

MEN wanting forest ranger positions. \$1,500-\$2,400. Write for particulars and list Natl. forests. Mokane, A-21, Denver, Colo.

INSTRUCTION books, all kinds. Catalogue free. Wineholt Book Co., Box 4, Woodbine, Penna.

WORLD-ROMIC System. Masterkey 5,000 languages. Primers. \$1.98; Arabic, Chinese, French, German, Italian, Japanese, Russian, Spanish. Languages, 8 West 40th, New York.

ENGINEERING Courses Simplified. Lowest Prices. Descriptive Circular free. Lightning Method, Box 999, Long Beach, Calif.

MECHANICAL Engineering. Interesting. Highly Paid Work. Special Home Study Course. Write for Particulars and Free Copy of "Machine Designer's Manual." Harbor Technical College, 851 Pine Ave., Long Beach, Calif.

ALL men—women wanting Government Positions, \$140-\$225 monthly, should get our "Exam. Coaching" immediately. Write, Ozment, 101, St. Louis, Mo.

SONG Poem Writers—Send for proposition. Ray Hibbeler, D15X, 2104 N. Keystone Ave., Chicago.

ARE You interested in Writing short stories, poems, songs, photoplays. For Profit? Then send for our new edition of actual letters from prominent editors, who want your manuscripts. It's Free if you send for it Now. Address M. Mendelsohn, Editor, Dept. 102, Writer's Digest, 22 E. 12th St., Cincinnati, Ohio.

DOUBLE Entry Bookkeeping mastered in 60 hours with 8 keys; guaranteed; diplomas, International Bookkeeping Institute, Dept. 8, Springfield, Mo.

USED educational matter of all kinds. Sold on repurchase basis. Big savings. Money-back guarantee. List free. (Courses bought.) Lee Mountain, Pisgah, Ala.

USED educational matter. Lowest prices; terms. Catalog free. Mention Subject. Fred Goetz, 440-A Sansome, San Francisco.

\$115-\$400 MONTHLY paid—Ry. Station—office positions. Free passes, experience unnecessary. Write Baker, Supt., (ABT) Star Bldg., St. Louis, Mo.

USED Educational Matter bought, sold, exchanged. Bargain Catalogue Free. Handling, 799 Broadway, New York.

RADIO OUTFITS AND SUPPLIES

TROUBLE-SHOOTING—Do it yourself. Just off the press, valuable 24-page booklet tells how to locate and clear radio trouble; What to Do when Set Goes Wrong; How to Test; written by nationally known authorities, ask your radio dealer for, "Practical Guide for Every Radio Owner and Builder," or send 10c today to Universal Test Equipment Co., 2939 North Oakley Ave., Chicago, Ill.

HOMEPOT rectifier charges all batteries. Simplest design, common materials, easily built. Construction and operation blueprint fifty cents. C. C. Hubbell, 14B Cottage St., East Norwalk, Conn.

RADIO Tube 6 volt—Wonderful reception; fully guaranteed or money refunded, \$1.00. Barker, 620 West 125th St., New York.

TUNE in more stations easier with Andrews Radio Directory and Log Book. Get more out of your set. Every station listed three ways—wave length, call letters, and cities. Includes broadcast station map. Sent postpaid on receipt of 25c coin or stamps. Wayne Andrews Co., 1004 Andrews Bldg., Ft. Wayne, Ind.

AUDIO Transformers 70c up. 50H chokes unmounted \$2.00, for "B" eliminators, speaker bypass, etc., prepaid. Write for list. Radio Parts Sales Co., Box 24, Orange, N. J.

BUILD Super using Davisco Long Wave air core transformers and standard parts. Selectivity unparalleled, freedom from interference, tone unsurpassed, volume equal to power amplifier. Long range loop reception. Entirely new principle in Super-Het. Ask for literature, blue prints 50 cents. We can furnish parts to commercial set builders at special discount. Davisco, 30 Euclid Arcade, Cleveland, Ohio.

600 MILE Radio \$2.95 Postpaid. Needs no tubes nor batteries. Over 200,000 sold. Order direct from this ad. Crystal Radio Company, Wichita, Kans.

FIVE Tube Receivers. \$22.50 Delivered. Tubes 95c. Literature Free. Agents wanted. Seminole, 427 East 16th, New York.

MANUFACTURE Crystals—Big profits—particulars free. Box 313, Wichita, Kans.

TRADE AND TECHNICAL SCHOOLS

GET a Foreman's Job in any trade. Train yourself to earn more money. Become an expert Blue Print Reader. You can do it in spare time. My training will give you advancement in a few weeks. Write now—tell me what trade you want—I will send my plan at once. Carroll Rumsey, 165 Drexel Bldg., Philadelphia, Pa.

TELEGRAPHY—Both Morse and Wireless—taught thoroughly and quickly. Tremendous demand. Big salaries. Wonderful opportunities. Expenses low; chance to earn part. School established fifty years. Catalog free. Dodge's Institute, Fern St., Valparaiso, Ind.

LEARN Bricklaying at home or in school run by contractors. Catalog free. Associated Building Employers, D400, A. B. E. Building, Grand Rapids, Mich.

MAKE \$75 to \$250 weekly; Motion Picture, Portrait and Commercial Photography. Camera Free. For Special offer, write New York Institute of Photography, Dept. 49A, 10 W. 33rd St., New York.

SEE our display ad on page 89 this issue. Chicago Painting School, 150 W. Austin Ave., Chicago, Ill.

BUSINESS OPPORTUNITIES

QUIT Slaving for the other fellow and Hire Yourself as Boss! Manufacture These Biggest-Selling Specialties. 300 to 900% profit. Investment Small. No Machinery Necessary. I'll tell you how to make: Fibro-Seal, Guaranteed Puncture Plugger; Para-Vulkin. No - Cement - Instant - Weld Patch, Super-Radiolyte, 20-Minute Battery Charging Fluid; Guaranteed Metal Polishing Cloth; Non-Thermic Ice Saver Cloth; Tufalt—Prevents Runs in Silk Hosiery; Fly-Nox, Instant Fly-Killing Spray. Valuable Literature describing these, also sixty others. Free! Write today! Miller, Chemist, 1706-C Jetton, Tampa, Fla.

PATENTS. Time counts in applying for patents. Don't risk delay in protecting your ideas. Send sketch or model for instruction or write for Free book "How to Obtain a Patent" and "Record of Invention" form. No charge for information on how to proceed. Communications strictly confidential. Prompt, careful, efficient service. Clarence A. O'Brien, Registered Patent Attorney, Security Bank Building (directly across street from Patent Office), Washington, D. C. See pages 140 and 141.

100 QUICK Profit, Honest, Guaranteed Workable Mail Order Plans and complete instructions, including detailed working specifications of plans that have made fortunes. A high-class, complete publication, finished in 1926. Covers all departments of the mail-order business. Also teaches you clearly to originate plans of your own and put them into immediate operation. The only work of its kind ever published. Written by fully competent and reliable authority, under bond. Mail Order Service, Box 93, Omaha, Nebr.

COMPOSITION Floor Making earns industrious men \$12 and more daily if used as trade. Or make business of it with profits up to \$15,000 yearly. We teach everything, show opportunities, explain how to make good. Openings everywhere. Write Semi Tile, Dept. C, Hollis, N. Y.

START a business of your own. Nickel, silver, copper and gold plating. Large profits. Two dollars for full information or twenty cents for samples and particulars. Electro Platers Supply Co., 547 Considine Ave., Cincinnati, Ohio.

A SIMPLE visible Process for permanent preservation of all perishable bodies. Description and assurance, with most liberal terms, given. F. L. Jones, 669 G.P.O., New York.

ATTENTION! You can have a business of your own. Establish and operate New System Real Estate Business, brokerage and insurance agency in your community. Office at home. Earn \$5,000 year. Representatives wanted everywhere. Send stamp free booklet. Hayes Realty Association, Cincinnati, Ohio.

66 MILES on 1 Gallon—Amazing Gas Saver. All autos. 1 free. Critchlow, D-805, Wheaton, Ill.

MANUFACTURE New Fast Selling Novelties, toys, preparations. Mail Order. Agent's Goods. Free list reliable patterns, processes, commercial information. Manufacturer's Bureau, 3937A Tracy, Kansas City, Mo.

SELL, direct by mail. Use sales compelling letters, folders, booklets! Prepared by Hewson, Advertising, Department 162, 121 North Broad Street, Philadelphia, Pa.

MAKE More Money! Start a Mail Order business at home evenings. Write for free particulars. Conlon, 191 Park Place, Brooklyn, N. Y.

YOUR favorite products; manufacture them yourself. Guaranteed manufacturers' formulas supplied. All lines. Latest specialties. Romig, Box 103 M, Station W, New York.

YOUR own mail order or local business. Opportunities galore. Free particulars. Fayette Specialty Co., Connellsville, Penna.

MIRRORS Resilvered at Home. Costs Less 5 cents per square foot; you charge 75 cents. Immense profits plating like new brass worn-off auto parts, reflectors, tableware, stores, etc. Outfits furnished. Details Free. Sprinkle, Plater, 127 Marion, Ind.

SCHEMER, Alliance, Ohio, 36p monthly, prints mammoth \$-getters. Subscriber reports \$25,000 from three; another \$10,000 from one. Try your luck. Year, \$1.00; 3 months, 30c.

TATTOOING Supplies. Illustrated Book free. Manufacturer's Prices. "Waters," 965 W. Putnam, Detroit.

WRITE today for particulars of our free publishing proposition; let us show you how to give premiums in a mail-order business of your own; big opportunity. P. E. Junier Sales Service, 117 Pleasant St., Fairhaven, Mass.

I MADE \$30 a Week Home. French Breadmaking. 15 years' experience; Free Booklet tells. Ashbrook 67, Marengo, Ohio.

CHRISTMAS novelty sold merchants. Exclusive territory to financially responsible representatives. Big demand. Big money. Consolidated, 67 A, West Van Buren, Chicago.

SOURCE of supply for hundreds of imported and domestic mail order specialties, together with successful selling plan. All for 25 cents. Satisfaction Guaranteed. Methods, 1096 W. Main, Richmond, Va.

START magazine, 20 pages 6x9, \$2.50 hundred prepaid. Plan 10c. Dolsen 36 Liberty, Brooklyn.

MANUFACTURE and sell a new article, just out. Wm. Ortman Co., 277 23rd St., Milwaukee, Wis.

300% PROFIT making delicious Cream Candy Specialty. Expert instruction \$1.00. B. Sellger, 959 Frankford Ave., Philadelphia, Pa.

GET Quick Profit by mail. Easy when you know how. Free circular tells how. New Plan. Johnson, Box 253, Chesteron, Ind.

MONEY in Dry Cleaning; we furnish instructions and machinery; experience unnecessary. Potterf Manufacturing & Supply Co., 3850-52 Easton Ave., St. Louis, Mo., U. S. A.

LEARN to MANUFACTURE—It pays big profits. We teach you how. Start spare time. Few dollars. At home. We show you how to sell. Write for free circular. Heartinger System, 2002 Wyoming, St. Louis, Mo.

MAKE Sell Your Own Goods. Formulas, processes. All kinds. All lines. Catalog, circulars free. B. Thaxly Co., Washington, D. C.

DEALERS—big Battery Shop Equipment and Supplies at Wholesale. Get circular No. 131. Adams-Barr, Columbus, Ohio.

MAKE toys and novelties at home. Big profits. Instructions and illustrations, 25c. Astrolite Company, Sharpsburg, Pa.

VALUABLE Mail Order Information for Stamp. Wm. Bickley, Lockland, Ohio.

MARBLE mixing instructions, covering wood or cement flooring ½ inch thick, fire-proof, waterproof, low cost, sanitary, all colors. Particulars and illustrations free. Marble and flooring samples 12c. Chris. Mahler, Huntington, N. Y.

WANT More Money? Start Little Mail Order Business. Samples and Plan Free. Mailing Charges 10c. Suddam, 10748 112th St., Richmond, Hill, N. Y.

MAIL order Booklet, where to buy Books, Novelties, Specialties, 10c. Harvey Teeple, Decatur, Ind.

MAIL Order News contains latest money-making schemes, opportunities and suggestions showing big profits. Complete instructions how to start profitable Mail Order Business of your own. Everything explained. Sample copy of this big magazine 25c. None Free. Established 23 years. Mail Order News, 360 Bristol Bldg., New York.

CHEMIST furnishes reliable, guaranteed formulas for manufacturing your own household, toilet, laundry preparations, etc. Write for sample labels and details of the latest and best sellers. Scheid & Co., Box 1199, New Haven, Conn.

START Mail Order Business of your own at home. We supply catalogues with your address on. Wineholt Sales Co., Box 4, Woodbine, Penna.

MECHANICS, painters, carpenters, start furniture refinishing, painting, handyman shop on nearly nothing; winning plan brings customers quickly. John Braceland, 1139 So. Ninth, Philadelphia, Pa.

CHEMICAL Expert furnishes Manufacturing Formulas and Processes with complete working directions. Reliable individual service only. No lists. Charges reasonable. Correspondence invited. Dr. Arthur Van-Heeden, 508 South Oakley, Chicago.

\$750,000,000 MAIL-ORDER business in 1925. Many grow rich in this great trade. Sell merchandise, information, patented articles, various preparations. Breniser's Famous Mail-Order Handbooks tell how. Eleven brochures \$3. One book with complete catalog, 25c; none free. Breniser, (Established 1900) 335 Walnut, Philadelphia.

ENTER a new business. Earn \$3,000 to \$6,000 yearly in professional fees making and fitting a foot specialty, openings everywhere, with all the trade you can attend to; easily learned by anyone at home in a few weeks, at small expense; no further capital required, no goods to buy, job hunting, soliciting or agency. Address Stephenson Laboratories, (1) Back Bay, Boston, Mass.

DON'T gamble in mail order business. Be sure. Free circular puts you wise. MacRae, M40 Oregonian Building, Portland, Ore.

EARN \$10 daily silvering mirrors, plating and refinishing metalware, autos, chandeliers, bedsteads, headlights. Outfits furnished. E. Decie Laboratories, 1133 Broadway, New York.

LEARN the collection business. Good income, quick results. Interesting booklet, "Skillful Collecting" free. National Collectors Assn., Long St., Newark, Ohio.

\$3,000 TO \$5,000 Yearly. Want it? Others are making it. Send check or money order today for our invaluable books "How to Sell Real Estate," \$3.00—and "How to Conduct Real Estate and Insurance Business," \$1.50. Absolute satisfaction guaranteed. Free circulars. Realty Book Co., Dept. 52, Cleveland, Ohio.

PATENTS Procured; Trade Marks Registered—A Comprehensive, experienced, prompt service for the protection and development of your ideas. Preliminary advice gladly furnished without charge. Booklet of information and form for disclosing idea free on request. Richard B. Owen, 30-Owen Bldg., Washington, D. C., or 41-R Park Row, New York.

CHEMICAL Expert will furnish Formulas and Trade Secrets. All lines. Lists Free. W. L. Cummings, Ph. D., 228 Gordon Ave., Syracuse, N. Y.

RESPONSIBLE manufacturer wants competent men to manage office and salesmen. \$300 to \$1,500 necessary; will allow expenses to Trenton if you qualify. Address Manager, 536 Forst Richey Bldg., Trenton, N. J.

UNPATENTED Ideas Can Be Sold. I tell you how and help you make the sale. Free particulars (Copyrighted). Write W. T. Greene, 810 Jenifer Building, Washington, D. C.

WE Start You in Business, furnishing everything; men and women, \$30.00 to \$100.00 weekly operating our "New System Specialty Candy Factories" anywhere. Opportunity lifetime; booklet free. W. Hillyer Ragsdale, Drawer 4, East Orange, N. J.

SIGNS and Showcards Easily painted with Letter Patterns. Large variety of Styles and Sizes. Samples for stamp. John Rahn, #2120 Neva Ave., Chicago.

NOW that you have read all these offers, a 25c for Detailed Information (None "How" and "What" to Sell by Mail; Agents; or Direct! We want 100,000 customers! Opportunity is knocking—Surety Service, Dept. 10, 551 St., Rochester, N. Y.

TELEGRAPHY

TELEGRAPHY—Both Morse and Wireless—taught thoroughly and quickly. Tremendous demand. Big salaries. Wonderful opportunities. Expenses low; chance to earn part. School established fifty years. Catalog free. Dodge's Institute, H St., Valparaiso, Ind.

CHEMISTRY

FORMULA by Richards means the best. Your chemical problem solved and working process furnished \$5.00. Write me. W. Stedman Richards, Consulting Chemist, Box 2402, Boston, Mass.

FORMULAS AND TRADE SECRETS

MAKE-Sell Your Own Goods. Formulas, Processes. All kinds. All lines. Catalog, circulars free. B. Thaxly Co., Washington, D. C.

500 VALUABLE Formulas, 25c. Circular Free. Harvey Teeple, Decatur, Ind.

SPECIAL formulas for Manufacturing and Business purposes. Any one you want, including full manufacturing instructions and where to get all supplies, sent for \$5. Satisfaction guaranteed. Announcements of latest formulas for quick-selling seasonable products sent monthly without charge. Write today. National Information Bureau, 316E Shepard Building, Grand Rapids, Mich.

GUARANTEED formulas of the better grade supplied by chemist. Best sellers duplicated. Latest specialties. All lines. Romig, Box 193 N. Station W, New York.

FORMULAS—24 Ways to Make Money, 50 cents. The Gale Service, 3323 So. Ashland Ave., Chicago, Ill.

10c—ANY Formula 10c. "Hawkins," 215 Las Animas, Colorado Springs, Colo.

FORMULAS, Processes, Nonmedicinal. One Dollar Each. Hance, Chemist, 57 Saratoga, Yonkers, N. Y.

CONCRETE Waterproofing Processes, making Hard, Light Colored Dampproof concrete building blocks. Concrete Machine Co., 5 Main St., St. Louis, Mo.

FORMULAS, Guaranteed Best Chemical Science can devise. Stamp brings big bunch valuable literature describing Latest Reliable Processes for Manufacturing All Lines. Don't Buy till you've received these Profitable Propositions. No recipe-book Trash. 29 years giving satisfaction. Miller Chemist, 1706-U Jetton, Tampa, Fla.

EASY money maker, just like I use myself; why not you? Particulars for red stamp. W. P. Stump, Hemet, Calif.

500 FORMULAS including Luminous Paint—Renewing Dry Batteries—Resilvering Mirrors—Gas Tonic Puncture Plugger, 25c. Catalog Free. Ideal Book Shop, Park Ridge, Ill.

FORMULAS: New, different. Make beverages, extracts, syrups, flavors, etc. Home and manufacturing specialties. Valuable information free. Western Formula Co., 1613 Queen Anne Ave., Seattle, Wash.

AGENTS WANTED

NO Dull Times in the Food Business. Selling Federal Pure Food Products is the greatest, surest and safest business in the world today, and here is your opportunity to get into it. You can make \$3,000, \$5,000, \$10,000, or more per year—the only limit is your ability to take care of the business. You will need no experience or money to get into this business. We teach you everything you need to know. We furnish you with license. No Dull Times, for the People Must Eat, and our food products are the fastest selling, surest and quickest repeat order goods in the world. Sell on sight in every home where food is used—repeat orders immediately and every week thereafter. A real big business all your own. Every new customer adds a great deal to your weekly income. Your business once established, has a market value just like a store and can be easily sold. The greatest money-making opportunity of your lifetime because you risk absolutely nothing, as we guarantee your sales, and we will not let you fail. Remember! Guaranteed! Best products, biggest sellers, surest repeat orders. No capital or experience is required. We furnish capital and everything necessary for you to become a Federal Distributor. Exclusive territory will be given honest men or women who write at once. Federal Pure Food Company, 2309 Archer Avenue, Dept. A, Chicago, Ill. Largest packers of Pure Food specialties in the world. Reference, any bank, Dun or Bradstreet rating agency. Express or Railway Company in America.

\$8.50 to \$20.00 DAILY pay. Introducing New Insured Hosiery for men, women, children. 37 styles, 40 colors. Must wear or replaced free. Repeat orders sure. Nyland made 5393 in one month. Edwards, \$460.60. Mrs. Rome, \$445.25. Why not you? Even spare time should pay \$3 per hour. Your Pay Daily in advance. We deliver and collect. You simply write orders. No experience or capital needed. We furnish samples. All grades, colors, including silks. No matter what you are doing now, write for our offer. Macochee Textile Company, Card 25610, Cincinnati, Ohio.

STARTING with \$3.00 in September, 1925. Strong of Illinois built a business of \$15,000 yearly selling famous Wavex hair brushes which wave bobbed and long hair as they brush. Now sold direct only. This is your opportunity to be the first to show this amazing new invention to the women and girls of your community. Write today for free information. Wavex Company, Dept. 1008, 2214 So. Michigan Blvd., Chicago, Ill.

DON'T Wait! The market is hot for stylish shirts! \$100 weekly easy. New fall line of snappy Stylemer shirts. Complete free outfit with large swatches makes quick and easy profits. Write today if you want a business of your own. Experience or capital unnecessary. Just take the orders and get your profits—We deliver and collect balance. An exclusive territory full of profit is open to you! Write today for the big free outfit, and step out on easy street—your own boss. Stylemer, 81 W. Van Buren, Chicago, Dept. 101.

AGENTS, Salesmen, Crewmen, You'll Have the Devil's own time finding a better seller than "Zippo." Splendid profit on snappy 50c "Go-Getter" repeat article that sells on a ten-second demonstration. Works while you watch it! Demonstrates value while others waste time making claims. New development! Greatest scientific triumph of the age. It's the berries. Write immediately for complete proposition. Karam-Smith Company, 610 F St., Fort Wayne, Ind.

AGENTS—\$90 a Week—\$2 to \$5 an hour spare time. Make this with the celebrated line of Ho-Ro-Co Soaps, perfumes, toilet articles and specialties; over 200 items. Big profit makers. La-Em-Strait Hair Dressing selling like hot cakes. Write for Free Sample Case offer. Ho-Ro-Co Mfg. Co., 790 Ho-Ro-Co Bldg., St. Louis, Mo.

\$5,000—\$10,000 STEADY income, selling our products to homes, offices, factories. 25c for big tube wonderful Oolitic Skin Cleanser. Wholly free from soda, potash, grease, oil, and bottle Firestone Liquid Hand Cleanser, removing dirt, grime, instantly without water. Leaves hands astonishingly white, soft. Particulars mailed with these two products only. Oolitic Laboratory, 2132 Michigan Ave., Chicago.

IF I Send You a Suit made in latest style from finest goods, will you keep it, wear it, and show it to your friends as a sample of my sensational \$23.50 suits, guaranteed regular \$40.00 values? Could you use \$3.00 an hour for a little spare time? If so, write me at once for my wonderful new proposition. Just write your name and address on a card and mail to Dept. 426, Salesmanager, 133 So. Peoria, Chicago.

AGENTS—Steady income. Large manufacturer of handkerchiefs and dress goods, etc. wishes representative in each locality. Factory to consumer. Big profits, honest goods. Credit given. Send for particulars. Freeport Mfg. Co., 59 Main St., Brooklyn, N. Y.

SELL Christmas Cards. All Your Friends Use Them. Make your Christmas money. Engraved cards exclusively; best value in design, quality and price. Customer's name printed or engraved. Good commission. No money needed. Write for selling outfit and particulars at once. No replies considered after Nov. 20, or outside of U. S. Knight & Co., Box 176-M, Riverton, N. J.

AGENTS—Best seller; Jem Rubber Repair for tires and tubes; supersedes vulcanization at a saving of over 800 per cent; put it on cold, it vulcanizes itself in two minutes, and is guaranteed to last the life of the tire or tube; sells to every auto owner and accessory dealer. For particulars how to make big money and free sample, address Amazon Rubber Co., Philadelphia, Pa., Dept. 505.

66 MILES on 1 Gallon—Amazing Gas Saver. All autos. 1 free. Critchlow, G-805, Wheaton, Ill.

WONDERFUL Opportunity for you with "International," selling beautiful line of Dress Goods and Drapery Fabrics, ranging from Gingham to finest Silks. Home-town stores cannot compete in price, styles or variety. Complete sample outfit furnished. Our agents are doing tremendous Fall business. Write immediately and get your share. International Home Fabrics, 235 Fourth Avenue, New York.

\$18 To \$25 daily. Biggest selling line of 2-piece suits, \$9.95 and \$12.50; 3-piece wool suit, \$17.95 (regular \$28.00 value). All-wool overcoat, \$18.50. Splendid raincoats, slickers and boy's suits. Biggest commissions. Free outfit. "Jim" Foster, Inc., Dept. A-10, 2250 S. Spaulding Ave., Chicago, Ill.

ALL the Money You Want can be earned selling Perry photo medallions. Big demand. Ready sales. 400% to 600% profits. Photos perfectly reproduced, hand colored, on Medallions, Mirrors, Compacts, Jewelry. Write today. Perry Photo Novelty Corp., 1795 Jerome Ave., New York.

SALESMEN Selling to Men: We have logical side line for you that will sell along with any other line you may now be handling and probably make more money for you, provided you are now selling to men. Get full facts at once by addressing Salesmanager, 844 West Adams, Dept. 608, Chicago.

AGENTS: Signs embossed in colors are big sellers. Slogans for every kind of store. Samples, particulars, Free. Universal Company, 122-G Fifth Ave., New York.

GO into Business. Send for live propositions. Merry Specialty Co., Somerville, N. J.

AGENTS—Ford Engines Need Wizard-Twin Firing Tubes, Using Eight Spark Plugs. Superior Power Guaranteed. Retail \$5. Sample \$3. Wizard Products Co., 19 Pleasant Street, Dorchester, Mass.

AGENTS! \$1 an hour selling E. Z. Clean washing compound; sample and particulars free. Real Quality Products Co., Findlay, Ohio.

YOUR picture enlarged 6x8 (Ivorette Framed) \$1.50. Send photo. Jabe Studio, Kansas City, Mo.

MILLIONS of billfolds are sold every Nov. and Dec. for Xmas presents. Samples sent prepaid. 50c to \$3.00. Agents, ladies and gents. Buy from the maker. F. E. Williams, Hotel Roslyn, Los Angeles, Calif.

RADIO Accessory Agents:—We manufacture a first class quick selling Radio "B" device with two year guarantee. Thousands in use. Write. Kimley Electric Co., 2663 Main St., Buffalo, N. Y.

SELL Something Everybody Buys. Sure Repeater. Splendid Spare Time or Side-Line Proposition. Information Free. Box 29C, Station L, New York.

AGENTS, Peddlers, Streetmen; 10c seller, 8c profit. Sample for dime. O. Fling, 521 North Spring, St. Louis, Mo.

\$500 MONTHLY proposition. Particulars Free. B. Davis, 1726 Roosevelt Rd., Chicago.

AGENTS and salesmen wanted. Your commission 100%; make \$25.00 daily easily. Pocket chair, weight 1½ lbs. Indestructible. Quick Seller. Send for sample. Glasvin, 96 Fifth Ave., New York.

EVERY \$5.00 makes you at least \$3.50 selling nationally known grinding compounds to garages and farmers. Proco, 728 Filbert St., Pittsburgh, Pa.

SELL Christmas Cards, 40% Commission. Attractive box 24 engraved cards with lined envelopes. You deliver and collect first call. One dollar starts you. F. G. Post, 11 Markham, Buffalo, N. Y.

SELL the Dura-Flex Shoe. Absolutely no competition. Guaranteed. Sells at sight \$4.95 per pair. Big profit for you. Write Guaranteed Shoe Company, Auburn, Me.

THE Big Season is on; start now. Supreme Shirts give 100% satisfaction. Proposition and Kit Free. Supreme Shirt Co., 276-M Fifth Ave., New York.

McDONALD Polishing Cloth. Cleans gold, silver, nickel. Sample terms 15c silver. Daniel McDonald, 18 Agawam St., Lowell, Mass.

SAVE the manufacturer's profit. Manufacture your favorite products yourself. Guaranteed manufacturers formulas supplied. All lines. Latest specialties. Best sellers duplicated. Analytical work carefully performed. Romig, Box 103 N. Station W, New York.

AGENTS—Rubber specialties. House Dresses, Undergarments, combined for big earnings. This proposition satisfies. B. & G. Mfg. Co., Dept. 956, Pittsburgh, Pa.

AGENTS, Salesmen—Sell New Thermo-static Automatic Carburetor Control Attachment for Fords. Big profit, full or part time. Burns 95% air. Doubles Mileage. Attached in 2 minutes. No drilling. Does automatically exactly what Ford manual says do by hand. Cadillac now using Thermo-static Carburetor Control under Blanche license. Write today. Blanche Auto Devices Co., Dept. 805NX, 247 E. Illinois St., Chicago.

WHY not sell us your spare time? \$2.00 an hour, \$19.70 daily easy full time. Introducing latest guaranteed hose for men—women—children. 57 styles, 39 colors. Capital, experience unnecessary. We deliver and collect. Pay daily. We furnish samples. M. H. Mathews, Card 58610, Cincinnati, Ohio.

BIG Pay for Your Time supplying large demand for Sanitary Rubber Goods—Stepins, Shadow Skirts, Laundry Aprons, Household Comforts. Free Sample Offer. American Rubber Products Co., Dept. 908, Pittsburgh, Pa.

66 MILES on 1 Gallon—Amazing Gas Saver. All autos. 1 free. Critchlow, H-805, Wheaton, Ill.

AGENTS to make \$25.00 per day, selling Men's Silk Hose; cost you 9c pair, or \$13.00 per Gross Dozens. Send \$1.10 for sample dozen, Postpaid. Lewis Hosiery Company, 12 N. 3rd St., Philadelphia, Pa.

ALL-YEAR-ROUND profitable business selling wonderful new water softener and cleanser. Removes grease, oil, ink and dirt quickly. Every home and business place a live prospect. 100% profit. Big repeat orders. Exclusive territory. Write for free sample. Seacoast Laboratories, Sea Bright, N. J.

SELL Pocket Adding Machines. Sample \$1.40. Winchoit Distributing Co., 54, Woodbine, Penna.

EIGHT in Ten Need It. Wonderful profit producer and repeater. Sample and details fifty cents. Richont Researchery, 1702 Q, Washington, D. C.

WHAT is it that eliminates indigestion, retains health, returns ill health to normal, prolongs life, is not a medicine, and is a household necessity? Agents Wanted. Ask Dundee Mfg. Co., Inc., 157 Summer St., Boston, Mass.

2 WONDERFUL Inventions! Startling plan gives customer free gold plated device making old phonograph sound like Orthophonic Victrola. Other abolishes needles. Bradley sold 36 in 36 calls. Everplay, Desk B-10, McClurg Bldg., Chicago.

AGENTS—Send for Free Sample "Fret-not" Washday Wonder. Big Profit. You don't have to talk; if she doesn't buy at sight, leave sample. Exclusive territory. Credit given. Empire Specialties Co., 1549 N. Wells, Dept. 101, Chicago.

FREE Sample, "Rain Shield Wiper." Retail \$1.00—Cost (25 cents). Sold Clear and Rainy Days. No Cloth—No Paste—No Attachment. (1) Rub keeps windshield clear (48) hours. Experience Unnecessary. NuLife Corporation, Hartford, Conn.

CALIFORNIA Rosebuds selling like hot cakes. Agents coinng money; new stuff. Big profits. Catalog free. Mission Factory PM. 2328 West Pico, Los Angeles, Calif.

\$100.00 WEEKLY easy to agents to introduce new, sensational Motor-Mystery. Just what car owners have been waiting for. Nothing like it. Dodge Car, Local advertising to producers. Free offer starts you. M-M-Laboratories, 7034 No. Clark St., Chicago.

AGENTS—Stamping names on Pocket Key Protectors; sample Check with your name and address, 25c. Stamping Outfits, Emblem Checks, Check Fobs, Name Plates. Hart Mfg. Co., Desk 2, 303 Degraw St., Brooklyn, N. Y.

SELL personal Christmas greeting cards; names embossed in gold or black; \$1 dozen up; sample free. Dunbar Corporation, 249 W. 34th St., New York.

LIVE Agents Wanted to Sell No-Kik Starter Switch Control for Fords. Stops back-firing and prevents breaking Bendix A fast seller and a good money-maker for you. Send \$3.00 for sample. Warmac Manufacturing Co., 815 Webster Avenue, Scranton, Pa.

BE Independent. Make, Sell Your own specialties. Immense profits. Catalog dependable Formulas, special selected Agents' best sellers. Free. M. Lustrò, 832 East Pershing, Chicago.

AGENTS—Big steady income. New, exceptionally useful product. Nominal investment. No canvassing. Interstate Commercial Service, Elizabeth, N. J.

AGENTS: Either sex, a wonderful opportunity. Our new plan makes house-to-house work a real pleasure. Average earnings \$42.00 weekly. Hustlers send for free particulars, mention territory desired. The Crystal Clear Co. of America, 1001-3-5 Market St., Philadelphia, Pa.

SALESMEN: Write your name and address on a postal and mail to us. We'll show you sure earnings of \$20.00 a day. Will you risk one minute and a one-cent stamp against \$20.00? Mind you, we say we'll show you. Address Dept. 1029, William C. Bartlett, Inc., 850 W. Adams St., Chicago.

REAL Money for every man who wants to work. You can make \$10 every day selling McNeess Products. You can make Whatever you want to if you can qualify for Resident Manager. Write for the facts. Furst-McNeess Co., 506 Sunlight Bldg., Freeport, Ill.

TWO Dollars or More an Hour. Men, Women. Sell Home Necessities. Samples Free. Horner Manufacturing, 578, Pittsburgh, Pa.

AGENTS, both sexes, we manufacture and control new household article. Fast seller. Big profits. Exclusive territory. Write now. Connolly, 123 Liberty St., New York.

\$150 WEEKLY selling greatest invention for automobiles—one model fits all cars. Send for free introductory offer. Mae Auto Products Co., 6355 Broadway, Chicago.

WE have a line of goods for which every man in America is a prospect. It has everything any competing line has and something besides. It can be handled profitably by tailoring, shirt, hosiery, necktie, shoe, raincoat and other salesmen now selling to men. For full facts address Madison Bros., 135 So. Peoria, Dept. 74, Chicago.

AGENTS—Mesco Corn and Callous Remover will build you a steady repeat business. Send today for pocket-size trial outfit. The Moss Co., 299 Searle Bldg., Rochester, N. Y.

\$50,000. PICTURE Man Friedman made canvassing. Beginners can make \$100.00 weekly with my sales talk. Experienced men make more. Free book. "Profits in Portraits" explains. Samples Free. Picture Man Friedman, Dept. 8M, 541 W. Lake, Chicago.

AGENTS—Sensational money maker. Every woman buys dainty \$2 guaranteed wash dresses. We deliver. Free Selling Outfit. Write Maidrite, Dept. 211, Baltimore, Md.

AGENTS, \$72 a week—take orders for Novelty Guaranteed Cutlery. Knives, Razors, etc. Big commissions. Exclusive territory. Big money for spare time. Write for sample outfit. Novelty Cutlery Co., Dept. 431, Canton, Ohio.

MAKE—Sell Your Own Goods. Formulas, Processes. All kinds. All lines. Catalog, circulars free. B. Thaxly Co., Washington, D. C.

AGENTS, sell package candy to retail stores full or part time. Write Smaklets Co., 1822 Newport Ave., Chicago.

AGENTS—Send for new Fall Catalogue. Complete line Hosiery, Lingerie, Neckwear. Samples furnished. Wonderful opportunity. Full or part time. Monarch Company, 630 Market, Philadelphia, Pa.

AGENTS—Sell "No-Splash" 4 Strainer Water Filter. Big profits! Fast sales! Lowest prices. 6 dozen, \$1.80 postpaid. Jones Mfg. Co., 249 Franklin Street, Boston, Mass.

BOSTON Maid Frocks for Women and Children—nationally known—famously popular. From mill to wearers \$3.50 to \$20. Great income producers for men and women agents. Write for selling outfit. Bosworth Mills, B-14, Melrose, Mass.

OPEN Toilet Goods Shop or Sales Office Anywhere. We furnish everything at low prices. Liebig's, Beaver Dam, Wis.

STARTLING Selling Plan! \$1.25 premium free to every customer on \$2.00 sale of 8 ounce Vanilla, 6 ounce Shampoo and 4 ounce Lemon Lotion. Details and samples free. C. I. Togstad, Dept. 18P, 29 S. Clinton, Chicago, Ill.

MAKE \$100 a week and up, selling fine, made-to-measure, all-wool suits \$31.50. All one price, \$5 commission on each sale, in advance. Extra bonus for producers. 6x9 cloth samples furnished. Write today. W. Z. Gibson, Inc., 161 W. Harrison St., Dept. X517, Chicago.

PORTRAITS, photo pillow tops, frames, sheet pictures, medallions, merchants' signs, food products, photo jewelry, guaranteed hose, toilet requisites, luminous crucifixes. Catalog 50 specialties free. 30 days' credit. Jas. C. Bailey Co., Dept. C10, Chicago.

TAKE It Easy! You don't have to work your head off this Summer if you take orders for Carlton's ready to wear dresses. \$35 to \$75 commission easy in 5 half days! Every woman, every home, means a sale. 90% repeat orders. No selling experience needed by our plan. Sample line actually Free to First applicant in each town. Write quick! Carlton, Inc., 337 S. Franklin St., Dept. 753A, Chicago.

YOU Can Make Good Durable Paint and Varnish 40c per gallon. Write Dept. 2 Emmelmann Bros. Mfg. Co., Indianapolis, Ind.

PEARL Necklace, Genuine Jap Imitation, Graded, 24-inch, indestructible. Usually sells \$3.50. Sample \$1.00; four, \$2.00; dozen, \$1.00. Highest commissions popular line Toilet Preparations. Bluebell Products, 4339 Olive, St. Louis, Mo.

25 DAILY taking orders \$2.98 genuine colored slickers men, women, children. Outfit free. American Waterproof, 724 Roosevelt, Chicago.

REPRESENTATIVES wanted for easy selling wonderful line of Women's and Men's Fashion Shoes and Hosiery sold at wholesale price direct to the home. Big money for your spare or full time. We deliver and collect. Powerful selling outfit absolutely Free. Write Quick, Castle-Blair, Dept. C-410, 318 S. Michigan, Chicago.

WANT information on thousands fast-selling articles? Write Institute, G. P. O. B. 223, New York.

ONE Man made \$90 first Week selling concentrated flavors to housewives. Another, \$87. Goods absolutely guaranteed. Big repeat orders help you build up permanent business. Credit given. Express prepaid. Write quick for territory. Either Sex. Craig Bros., Niagara Falls, N. Y.

ACTIVE Agents—\$15 daily. Fastest selling complete line Neckwear. From manufacturer to wearer. Featuring "Colleejat," seasonal's latest. Sample dozen \$3.00. Particulars, swatches, Free. Continental Mercantile, 51-D Allen St., New York.

UNO—New fast selling household specialty for men and women agents. Big profits—exclusive territory. No sample outfit. Uno, H2125 South 43rd, Omaha, Nebr.

GET Free Selling Outfit! Earn \$3,000 to \$5,000 a year selling most complete line guaranteed Hosiery and Underwear in America. No experience needed. You can become District Manager and have others working for you—if you act quick! Write today. Malloch Knitting Mills, 5610 Grant St., Grand Rapids, Mich.

WRITE for details on high grade easy selling storm door proposition. S. J. Russell Co., Manufacturers, Peoria, Ill.

SHOVEY'S Profits \$75 Three Days after receiving sample Morey Auto Rim Tool. Big profits for live agents. M. Morey Rim Tool Co., Blissfield, Mich.

REAL Selling Sensation! Tremendous earnings whole or part time! Patented Hot Water Bottle Invention needed everywhere. Big commissions. Extra bonus. We deliver. Write quick, C1017, Lobl Corp., Middleboro, Mass.

AGENTS—\$25 to \$110 weekly, selling silk by yard. Commissions daily. Big repeat business. Beautiful outfit free; representing \$500,000 stock. New field. Full or Part time. No capital or experience required. Write Burton Silk Mills, Dept. J418, 250 West Lafayette, Detroit, Mich.

GENUINE Gold Leaf Letters anyone can put on Store windows. Guaranteed to never tarnish. Large Profits. Enormous Demand. Free Samples. Write today. Metallic Letter Co., 438-D North Clark, Chicago.

\$60-\$200 A WEEK. Genuine Gold Letters for store windows. Easily applied. Free samples. Liberal offer to general agents. Metallic Letter Co., 438-B North Clark, Chicago.

AGENTS—500% profit selling genuine gold window letters; Scripts. Experience unnecessary. Free Sample. Premier Letter Co., 121 N. Francisco, Chicago.

WE pay \$48 a week, furnish auto and expenses to introduce our Soap and Washing Powder. Buss-Beach Company, Dept. A42, Chionewa Falls, Wis.

KEEP all profits. Any formula, \$1.00, guaranteed. P. Laboratories, 233, Champaign, Ill.

START Making Money New invention used everywhere, write for exclusive territory. Hedge Company, Jackson, Mich.

THE Formulas Silvering Fluid, Brass Perfumes by return mail. Circuit Novelty Automatics, 2c. Receiving by Novelty Co., South Bend, Ind.

PRIVATE Brand Toilet Articles, Food Products, Household Specialties, Medicinal Preparations. We pack these goods for you under your private label. With your name on the goods you get all the repeat business. Appoint sub-agents to work with you. Highest Quality Merchandise. Over 200% profit. Write immediately for our attractive offer. Continental Chemical Company, 1900 West Broad, Richmond, Va.

SAF-TRAY. Newest Ash Receiver sells everywhere at \$2.00. Agents make 90% profit. Write for particulars. Manjeco, 25 East 26th Street, New York.

AGENTS, Dealers, Distributors wanted to sell Jiffy Showers. All metal. Retail \$3.90. Jiffy Shower Mfg. Co., Martin Bldg., Pittsburgh, Pa.

AMAZING Discovery of Brahma Diamond Astounds Jewelry World! Not Glass! Recognized by Science! Absolutely Guaranteed! Stands Tests! Sample Case Free! References required. Dept. 29, American Brahma Co., Flint, Mich.

ONE salesman each town, city. New plumbing tool. Box 71, York, Penna.

DIRECT factory representatives for changeable-letter window-display signs. Good income assured. Experience unnecessary. Samples free. Maze Manufacturing Co., Dent, Pa. Norwood Station, Chicago.

NEW Wonderful Seller, \$1.40 profit on every \$1.50 sale, monogramming autos; free samples. Monogram Co., B99, Worcester, Mass.

MEN and Women make \$10 to \$20 a day. Christmas Greeting Cards in Box Assortments are tremendous sellers. We publish a magnificent assortment of 21 Steel Engraved, Colored, Panelled, Bordered Cards and Folders with envelopes. Sells for \$1.00. Cost you 50 cents. A value never equalled. Start early. Write for particulars and free samples. Waltham Art Publishers, 7 Water St., Dept. 70, Boston, Mass.

DISTRIBUTORS, Salesmen, Energetic Men wanted every city to job Easy-Mend; new household product, thru agents and stores; can earn \$3,500—\$5,000 yearly; whirlwind seller; repeats 8 to 20 times yearly; successful campaign, sales talks, circulars free; few dollars capital starts you. Facts sent free. Thos. Barnett, Pres., 1811-B Mondamin, Des Moines, Iowa.

FIFTY weekly Circulating Magazine Clubs. Spencerkin Agencies, West Los Angeles, Calif.

\$15.00 DAILY in advance. No investment. Exclusive territory. Big season on Rhinestone Initial Buckles sell on sight. Chaton Novelty Co., 608 Blue Island, Chicago.

AMAZING 30-day Offer! To prove our Mexican Blue-Flash Gem really matches finest genuine Diamond Side-by-side, we'll mail perfect \$5.00 picked sample, alive with rainbow fire, for only \$1, with catalog, proof of our claims, and Free \$5 Jewel case proposition. Sells at sight; enormous profits! Write quick! Mexican Gem Co., Box P5C, Mesilla Park, N. Mex.

\$100 WEEKLY representing large Direct to Wearer Company; Complete shirt, necktie and work clothes line. Unbeatable combination means selling everyone. Advanced commission and bonus. Sales Compelling Outfit Free. Howard Shirts, 1213 VanBuren, Dept. M19, Chicago.

AGENTS—Sell Pure Linen Imported luncheon sets; big commission in advance. We deliver; a great new money maker for men or women agents. Belfast Linen Co., 6431 S. Dearborn, Chicago.

CAN you sell Ford size tires at \$3.50 each? Write for plan. Details free. American Accessories Co., Station 231, Cincinnati, Ohio.

AGENTS Wanted. Pocket Puzzles—200% Profit, Sample and Catalog Free to Agents. Western Puzzle Works, Saint Paul, Minn.

MARVELOUS New Invention, 400% Profit. Liquid Quick Mend for Hosiery and Fabrics. Tremendous Demand. Over 100 other fast sellers. Local and General Agents. J. E. Johnson Co., Dept. 446, 69 E. So. Water St., Chicago.

AGENTS \$60 a week and new automobile. Extra bonus besides. Introduce finest line guaranteed hosiery. Silk hose free for your own use. Samples furnished. Jennings Hosiery Co., Dept. 1631, Dayton, Ohio.

IT'S a winner. Combined cigarette and match case. Holds package of cigarettes and a box of matches in compact flexible container. Sells on sight for 75c. Costs \$3.60 dozen, \$36.00 gross. Write for particulars. All-In-One, Box 64, A-10, Minneapolis, Minn.

BECOME Your Home Town's Leading Business Man. You can make \$100.00 weekly selling our guaranteed food products, paints, oils, shirts, hosiery, etc., direct to consumer in towns and country. Every article a repeater. Your \$20 starting order of fastest sellers sent on trust. No experience necessary. Exclusive territory for men and women. Loverin & Browne Co., 1615 S. State St., Chicago.

SELLING Like Blazes! Eleven piece toilet goods assortment at \$2.00 with two piece carving set Free to your customers. 100% profit. Davis Products Co., Dept. 56, 1321 Carroll, Chicago.

\$75.00 TO \$150.00 Weekly to Introduce "Chieftain" 3 for \$1.95 Guaranteed Tailored Shirts. Samples and full working outfit Free. Your Pay Daily. Cincinnati Shirt Company, Secy. 15814, Cincinnati, Ohio.

NEW \$3.50 Automatic Adder. Fast seller—Big Profits. Exclusive territory for live-wire sellers. Bassett Company, 1458-C Hollywood Ave., Chicago.

JUST Out—Patented apron without strings, straps, hooks or buttons. On or off in a jiffy. Over 100% profit. Commissions paid daily. Write for free sample offer. Sta-Put Co., 2210C 11th St., St. Louis, Mo.

5-10-25 YEAR records of our representatives prove we have the proposition for you. New plan offer few additional people same clean cut \$25 to \$75 a week opportunity. No capital needed. Great Eastern Coffee & Tea Co., Dept. P-1010, St. Louis, Mo.

FORD Starter Switches, on spark, one dollar. Agents make two dollars profit. Baum's Metal Specialties, Kansas City.

AGENTS—Big Seller—\$20 a Day Easy selling Taylor Caps—made-to-measure—every man buys—some want 2 or 3 caps. Samples Free and Cap Free to good agents. Write quick for fast money making proposition. Address Taylor Cap Manufacturers, Dept. R-145, Cincinnati, Ohio.

EARN \$45 to \$85 extra a Week. Selling beautiful Shirts. Commission in advance. We deliver and collect. Write quick. Fashion Wear Shirts, Dept. M-942, Cincinnati.

EVERYBODY uses Toilet Preparations. Sell Dainty, Exquisite, Delicately scented Duo Compacts, Perfumes, Powders, Creams and Lotions. Flavoring Extracts and Specialties. Duo Co., TP-1, Attica, N. Y.

"MAGNAKLOTH" taking autoists by storm, one rub absorbs dust from the car or furniture, quick sale, big profits. National Service Co., Dept. "P," Pierre, S. Dak.

AGENTS \$200 weekly assured. Brand new proposition. No selling. Investigate today. Send 25c. I. Jankow, 574 E. 138th Bronx, New York.

MIRRORS Resilvered at Home. Costs Less 5 cents per square foot; you charge 75 cents. Immense profits, plating like new; brassy, worn-off autoparts, reflectors, tableware, stores, etc. Outfits furnished. Details Free. Sprinkle, Plater, 128, Marion, Ind.

AGENTS \$14 daily in advance. Bonus besides. Write orders for finest line guaranteed hosiery you ever saw. 126 styles, colors. We deliver or you deliver, suit yourself. Auto furnished. No experience needed. Spare time satisfactory. Credit given. Samples furnished. Wilkint Hosiery Co., Dept. 1031, Greenfield, Ohio.

AGENTS: Coin money selling new fabric table cover. Need no laundering. Housewives wild about them. Free offer. E. Condon, 120 High, Boston, Mass.

THANCO Vanilla—Bottle Yourself! Concentrated; add water; free labels. Crushes competition! 500% Profit! Immense seller, homes, bakeries, stores. Write Thomas Manufacturing Company, Indianapolis, Ind.

RAINCOATS—Full line, all prices. Also leather and sheep-lined coats. Big catalog Free. Commissions 25% with bonus. Hydro Raincoat Co., 718 Independence, Chicago.

66 MILES on 1 Gallon—Amazing Gas Saver. All autos. 1 free. Critchlow, E-805, Wheaton, Ill.

AGENTS—To sell Catholics—Wonderful Proposition. United Religious Goods Co., 201 United Bldg., Covington, Ky.

AGENTS—Demonstrators—To sell the Chrisman Ejector Fork—The latest in kitchen utensils—Sample 50c. The Chrisman Manufacturing Co., 301 Anthe Bldg., Covington, Ky.

SALESPERSON Wanted to Manage and Operate New System Fixtureless Chain Store in Your Community. Enclose stamp. Salesmanager, Box 74, Beaver Dam, Wis.

MANUFACTURE Very Latest, Biggest-selling Advertised Specialties yourself—No Machinery investment small—All lines. Stamp brings Valuable Interesting Literature explaining how others sell your products and big bunch lists Guaranteed Formulas. 300 to 1,200% profit to you. Reliable Information Only, No "Master Formula" trash. Miller, Chemist, 1706-V Jetton, Tampa, Fla.

NEW Inventions—First agent made \$185 first week. 500% profits. Free Sample Windshield Coating, also other real money makers. Safe-Vu Co., Dept. B, 707 Market, St. Louis, Mo.

AGENTS: \$15.00 daily easy with amazing fluid. Mends hosiery, dresses, and 1,000 other articles in few seconds. 50% to 200% profit. Free outfit. Nu-Way Laboratories, Desk 59, Mt. Healthy, Ohio.

AMAZING Large Cash Commissions Introducing Beautiful \$3.95 and \$4.95 Fit-to-Measure Guaranteed Shoes. Actual Samples Furnished. Write for Your Territory. Style Arch Shoe Co., Dept. 155-K, Cincinnati, Ohio.

"AMAZING New Cleaner." Cleans Everything. Sells like wildfire. Quick Repeater. 300% Profit. Miller, New York, made \$1,000 in 6 weeks. Beek, Illinois, \$98.00 in 2 days. Premium sales plan and Free Samples make selling easy. Work full or spare time. Write quick. Bestever Products Co., 1945E, Irving Park, Chicago.

PATENTS. Time counts in applying for patents. Don't risk delay in protecting your ideas. Send sketch or model for instruction or write for Free book "How to Obtain a Patent" and "Record of Invention" form. No charge for information on how to proceed. Communications strictly confidential. Prompt, careful, efficient service. Clarence A. O'Brien, Registered Patent Attorney, Security Bank Building (directly across street from Patent Office), Washington, D. C. See pages 140 and 141.

\$20 DAILY: Self threading needles; sell at sight. Sample, Self-Selling Plan stamp. Newmyr, Etners, Penna.

AGENTS wanted everywhere. Salesmen and House to House Canvassers. Men and Women to Sell the Frisco Can Opener. Every home, Restaurant, Hotel and Hardware store will buy. They sell themselves. You collect the money. Opens any can, square as easy as a round can. Send 50c today for sample and our special money-making offer. Chicago Tool & Engineering Co., 1034 W. Lake Street, Chicago, Ill.

DOUBLE your profits by manufacturing the products that you sell! Any formula you want \$5. Satisfaction guaranteed. Announcements of latest formulas for quick-selling seasonable products sent monthly without charge. Write today. National Information Bureau, 316T Shepard Building, Grand Rapids, Mich.

\$75 WEEKLY. Man or Woman Wanted with ambition and industry, to distribute Rawleigh's Household Products to steady users. Fine openings near you. We train and help you so you can make up to \$100 a week or more. No experience necessary. Pleasant, profitable, dignified work. Write to-day. W. T. Rawleigh Co., Dept. IL8253, Freeport, Ill.

WHOLESALE Guidebook—Where to buy thousands of fast-selling specialties wholesale—why pay more? Only 10c. F. Schultz, Noel, Mo.

WONDERFUL, Magical, Auto Cleaner Polish. One operation anything; guaranteed; registered; 12 oz. \$1.00 delivered. Agents Wanted. Fiant & Company, Westaco, Tex.

SELL Oriental Perfumes—Bridal Bouquet, Hindu Rose, Flor-Amour, Bokul—and make 100% profit. Romola Parfumerie, Inc., 111 Romola Bldg., 2934 Michigan Blvd., Chicago.

AGENTS: Milk Bottle Holders. Something New. Big Profits. E. A. Barr & Co., Shamokin, Pa.

AVERAGE \$300 monthly selling Patented Ovenette, hanger and other Novelties. Reliable Mfg., 3239 N. Central Park Ave., Chicago, Ill.

EARN \$100 weekly in advance! Sell our complete Guaranteed line direct to consumer. Big variety of shirts including silks, union-made work and flannel shirts, overalls, coveralls, work pants, play suits, leather coats and vests, flannel blouses and lumberjacks. Our booklet teaches how to make quick easy sales. Full cooperation. Complete selling outfit Free. The Nimrod Shirt Co., Dept. 8, 4923-28 Lincoln Ave., Chicago.

GOLD-LEAF Sign Letters; make and sell; 1,000% profit. Particulars, Johnston Co., Quincy, Ill.

AGENTS—Wonderful seller, new discovery. Auto Rubber Repair for tires and tubes. Superior to vulcanizing. Put on cold at very little cost. Outlasts tire or tube. Sells to every auto owner and accessory dealer. Agents if you want big profits, made quick, write for particulars and free sample to Waltham Rubber Co., 13 South St., Waltham, Mass.

THE best toothpaste for Pyorrhea is Zi-O-Dine. Every tube guaranteed. Taste and cleansing qualities wonderful. Fifty cent tubes. Agents wanted. Iodine Products Co., Laurel, Miss.

BIG Double Strength Extracts in immense demand. Build big permanent business. Also mighty attractive line toilet preparations, household specialties, etc. Duo Co., EX-1, Attica, N. Y.

AGENTS—Indian Medicines 500% profit. Samples \$1.00. Lincoln Supply, Box 33, New Rochelle, N. Y.

MAN in each town to plate auto parts, reflectors, bathroom fixtures, refinish beds, mirrors, chandeliers; by new method. No capital or experience required. Simple plan of manufacturing at home starts you in big money-making business. Outfit furnished. Free particulars and proofs. Gun Metal Co., Ave. H, Decatur, Ill.

WE Start You Without a Dollar. Soaps, Extracts, Perfumes, Toilet Goods. Experience unnecessary. Carnation Co., Dept. 2480, St. Louis.

GIVE Away finest laundry soap Free. You'll make \$10 daily easy by new selling plan. Big repeat business. Write quick. Wolverine Soap Co., 28 Wolverine Bldg., Grand Rapids, Mich.

AT Last! Diamond Rival Discovered! Amazing blue white Rajah Gem astounds jewelry world and deceives experts! Beautiful Sample case Free! \$100 weekly! Write Quick! Rajah Diamond Co., Dept. F-7, Salisbury, N. C.

SELL by mail! Big Profits! Books, Formulas, Novelties, Bargains, Particulars Free! Elfco, 523 South Dearborn Street, Chicago.

AGENTS — Clever Invention! Inkspoon makes every pen a fountain pen. Fast office seller; big profit, demand increasing everywhere. Exclusive territory offered. Sample free. H. Marul Company, Tribune Bldg., New York, N. Y.

AGENTS make \$100 week placing advertising Cigar Lighters with glass front. Every dealer wants one. Write for free plan. Drake Mfg. Co., Dept. M, Milwaukee, Wis.

AGENTS—Make a dollar an hour. Sell Mendets, a patent patch for instantly mending leaks in all utensils. Sample package free. Collette Mfg. Co., Dept. 404, Amsterdam, N. Y.

REMNANT Store, Bethel, Ohio. Greatest Dry Goods Bargains on Earth. Agents and Dealers.

A BUSINESS of Your Own—Making Sparkling Glass Name and Number Plates, Checkboards, Signs. Big Book and Sample Free. E. Palmer, 512 Wooster, Ohio.

AGENTS wanted — To sell Ray-O-Lite cigar and gas lighters. Big earnings. Sample 50c. Rapid Mfg. Co., 799-E Broadway, New York.

AUTOMOBILE Specialties. Guaranteed formulas for all latest money makers. Lowest prices. Write for free lists. Murphy, Chemist, Tujunga, Calif.

MAIL-ORDER Houses and Distributors; We pack French made beauty creams, face powders, perfumes, toilet preparations with your label. Chemist, A2700 Wabash Ave., Chicago.

BIG Money Selling New Household Cleaning Set. Washes and dries windows. Sweeps, scrubs, mops. All complete only \$2.95. Over half profit. Write Harper Brush Works, 132 3rd St., Fairfield, Iowa.

ONLY 1 Sale Daily Means \$135 per Month Profit! Full or spare time. New \$5,000 Accident and Sickness Policy, \$25 Weekly Benefit. Premium \$10 yearly. Tremendous demand—amazing profits. \$100,000 guaranteed with State. Write quick for territory and special contract. Underwriters, Dent. 702, Bonnell Bldg., Newark, N. J.

WANTED: Local and State Representatives for famous ready made Artistic Signs, price tickets, etc. No competition. Full protection. Large profits. For particulars write Artistic Signs, 790R Broadway, New York.

FREE Sample—Just invented, Never Loose Comb, for ladies, gents. Spors Co., Lesueur Center, Minn.

KLEENZIT Kleening Pencil—New, different, instant appeal to housewives and tailors. Sell like hot cakes. Removes spots from clothes without leaving marks or rings. 50c seller—big profit. Agent's sample 25c. Write quick. Exclusive territory. Argyle Specialty Co., Dept. P, Argyle, Wis.

FREE. Large wholesale specialty catalog, showing best sellers, from all parts of the world. Spors Co., Lesueur Center, Minn.

AGENTS or distributors for perfumed candy product, 5 and 10c seller; big profits; good repeater. Restricted territory. Mirador, 114 East 28th st., New York.

NECKWEAR — Wonderful proposition. Get details. Astor, 318-M Broadway, New York.

AGENTS—\$11.25 starts 15 stores working for you, bringing \$47.25 week steady; no selling; Samples displayed in stores work for you. Write "Master," 816½ Chestnut, St. Louis.

\$31.00 PROFIT—with \$1.50 Outfit—Big Money—Easy Work. Selling Gold Monograms for Automobiles, Luggage, Windows, Wagons. No Experience. No License. "Samples Free." NuLife Monograms, Hartford, Conn.

MOCCASIN Manufacturer Wants Agents Everywhere to sell a complete line of moccasins to wearers. Entire new line. No competition, repeat orders. Get details. Daley Moccasin Co., Fort Covington, N. Y.

AGENTS—Biggest money makers ever offered. Sell offices, homes Bestufone, which makes both hands free while telephoning; Midget Collapsible Garment Hangers which everybody wants; and Everin Keypurse to hold change and keys. G. Kalina Company, 1308 Avenue N, Brooklyn, N. Y.

FORDS; no freezing, no boiling, big gas saving. Airlock absolutely does it. Sells like machine guns fire. Free trial always. Airlock Products, Burnett, California.

"LIQUID-LEATHER" Fills Holes in Shoes, Rubbers, Tires. Dries Instantly. Pliable, Waterproof. Just Imported from France. Tube Retail 75c—Cost 35c. Sells Housewives, Sub-Agents. NuLife Leather, Hartford, Conn.

AGENTS—New Plan, makes it easy to earn \$50.00 to \$100.00 weekly, selling shirts direct to wearer. No capital or experience needed. Represent a real manufacturer. Write now for Free Samples. Madison Company, 566 Broadway, New York.

AGENTS wanted to sell Men's Hats direct from Factory. Send for Catalogue. Model Hat Mfg. Co., Dept. 5, East Orange, N. J.

GOLD Initials, easily applied on Automobiles. Biggest moneymaker today. Cost 5c, you get \$1.50. No experience needed. Free samples. "Ralco," Monograms, 1043 Washington, Boston, Mass.

PERFUMED Beads from California. Fast Sellers. No Competition. License unnecessary. Big margin. Hire subs. Clean up. Mission, 519PM, 2328w. Pico, Los Angeles, Calif.

WE Pay \$50 a Week and Expenses and give auto to men and women introducing our goods. Mariax Co., D-20, 4520 Magnolia, Chicago.

GOLD Sign Letters. \$9.75 for Thousand. Non-Tarnishable. Free Sample. Catalogue. Foil Sign Works, 438 Broadway, Denver, Colo.

BIG Money and Fast Sales. Every owner buys Gold Initials for his auto. You charge \$1.50; make \$1.35. Ten orders a day easy. Write for particulars and free samples. American Monogram Co., Dept. 40, East Orange, N. J.

FIBRE Brooms—detachable handles, fine finish. Good profits, repeat sales. The Fibre Broom People, 147 New Jersey Ave., Brooklyn, N. Y.

AUTO owner tire agent wanted each locality to use and take orders for hand-made Mellinger cord and balloon tires; guarantee bond 15,000 miles; shipped prepaid on approval; get your tires free; no capital or experience required; make \$100 to \$300 weekly. Write for wholesale prices and sample kit. Address Mellinger Tire Co., Dept. 400, Kansas City, Mo., or Dept. 400, Philadelphia, Pa., or Dept. 400, Oakland, Calif.

GOLD Leaf Window Letters and Script Signs. No experience; 500% profit. Samples free. Consolidated, 69U—West Van Buren, Chicago.

AGENTS make 500% profit handling auto initials, sign letters, novelty signs, etc. Catalog free. Hinton Co., 4317 Homerlee Ave., East Chicago, Ind.

EASY to Earn \$10 Daily selling our Seven-in-One Vest Pocket Wonder Tool for Radio, Automobile, Electrical or Home use and other Live, popular priced specialties. All 100% profit items—and Ready Sellers. Write Today for particulars. G. M. Z. Co., 309 Sixth Avenue, New York.

\$1 PER Nour selling Dirt-Solvo Washing Powder. Big repeater; exclusive territory. Premiums for customers. Sample free. Goodspeed Products Co., Rutland, Vt.

OUR Luminous Crucifix Shines in the Dark. Every one amazed at the wonderful effect. Easily demonstrated. Easily sold. W. G. Hannan Co., Dept. B, 2539 So. State St., Chicago.

FORMULAS—All Kinds. Catalog Free. Clover Laboratories, Park Ridge, Ill.

AGENTS—Here's a New One. "Best-ever Powdered Hand Soap." Sells like wildfire. Marvelous Discovery. Removes grease, paint, ink, oil, in fact anything from the hands. Cannot harm skin. 150% Profit. Great Repeater. Agents simply coin money. "Free Samples Get the Business." Write immediately. Bestever Products Co., 1937 E. Irving Park, Chicago.

DO you want good live agents—fellows who can get the business? Ask me how others are doing it. I'll gladly render the necessary assistance without cost to you. Address, M. L. Rund, Mgr. Classified Advertising, Popular Mechanics Magazine, Chicago.

YOU can be your own boss with our Key-Check outfit. Good for \$5 a day stamping names on pocket key checks, fobs, etc. Sample check with your name and address, 20 cents. Pease Die Works, Dept. M, Winchester, N. H.

MANUFACTURER lamb wool polishers, dusters. Newhall, 358 Broad St., Lynn, Mass.

MILLIONS stolen. Remarkable new \$5.00 Check Protector stops forgery. Inks, protects two colors. Sensational sales, profits. Write. Safety Devices Corp., Grand Rapids, Mich.

AGENTS—N-R-G Laundry Tablets. The old reliable moneymaker for live agents. Millions sold—200% profit—sales waiting for you. Clothes washed spotlessly clean in 10 minutes without rubbing. Free samples. N-R-G Company, 230 W. Superior, Chicago.

AGENTS: 500% profit. "Happy Home Make Shampoo" builds your own big business. Martin of Indiana made \$75.00 in one day. Missouri man made \$750.00 one month. Exclusive territory. Geo. A. Schmidt & Co., Dept P, 236 W. North Ave., Chicago.

AGENTS \$1. Retail \$3. Your Profit \$2. Wonderful pocket Adding Machine with Magic Writing Pad. Particulars Free. Typewriter Supply, 905 Hersh Bldg., Pittsburgh, Pa.

WILLIAMS' No-Water Hand Soap. In tubes, has taken Auto owners by storm; washes dirtiest hands perfectly clean without water; easy demonstration makes quick sale. 150% profit. Williams Co., Dept. 265, Montclair, N. J.

GET Our Free Sample Case—Toilet articles, perfumes and specialties. Wonderfully profitable. La Derma Co., Dept. A, St. Louis, Mo.

AGENTS make \$3.00 an hour taking orders for our 40 Fascinating Kitchen Specialties. No competition. Write quick. General Products Co., Dept. 7K, Newark, N. J.

POLMET—The Wonderful Polishing Cloth that cleans all metals without liquid, paste or powder. Approved by "Good Housekeeping" and "Modern Priscilla"—sells fast at 25c. Sample free. Gale & Co., Inc., 15 Edinboro St., Boston.

EARN \$10 daily silvering mirrors, plating and refinishing metalware, autos, chandeliers, bedsteads, headlights. Outfits furnished. E. Decle Laboratories, 1133 Broadway, New York.

AGENTS: Big Money Monogramming by Transfer Method. Catalog Showing Over 50 Styles and Particulars Free. Motorists' Accessories Co., Mansfield, Ohio.

AGENTS: Our gold-eyed Needle Cases are wonderful sellers; immense profits: \$50 to \$300 weekly; proof and particulars free; sample outfit 15c; factory prices. Paty Needle Co., 231 Davis Square, Somerville, Mass.

SOMETHING New—"Handy Packet." An attractively put up package of useful household necessities. Positively a sale in every home; fine side line; big profits. Send for sample. Prentice-Lee, 145 East 23rd St., New York.

INSTANT Weld. Repairs largest punctures without cement or heat. Lenn's profit one day. \$56. Write quick. Free sample; territory going fast. Tourists' Pride Mfg. Co., Desk T, Minneapolis, Minn.

OVER 100% Profit. Self Lighting Gas and Cigar Lighters; Everybody interested, repeat business. Sell individuals, dealers, ubagents. Particulars Free. P. Bernhardt, 127 West 30th St., New York.

AGENTS—Sell 5c fast selling candy specialties to stores. Big profits. Lorrac Products Co., Albany, N. Y.

BIG Proposition. "Lanowa" Polishing Cloth-Mitten Duster Combination selling like wildfire. 200% profit. Exclusive territory. Write for sample. Fraser, 305-J 43rd, Kansas City, Mo.

BIG Money Monogramming automobiles. \$1.35 profit on \$1.50 sale. Particulars and samples free. Evans Products Company, Midian Avenue, Windsor, Conn.

HIGH-GRADE SALESMEN WANTED

BIG Money for Men. Let Fairbanks—with 40 years' success—put you into business introducing—taking orders—full or spare time—for America's greatest made to measure suit and overcoat values—all wool and all one price—\$23.75. Just show the big 9x13" samples—130 new stylish fabrics—in 30 fashion styles. Get orders on the spot. Pays you \$4 profit on every sale—cash in advance. We ship and collect—guarantee perfect fit, style, workmanship, and satisfaction. No investment—no deposit—no capital needed. Big complete outfit given free. Sales course, just what to do and say, accompanies outfit—all free. Write quick for exclusive territory and all particulars. Tell us if you have had previous selling experience. Fairbanks Tailoring Company, Dept. 880, Oakley Blvd., at Wabansia Ave., Chicago, Ill.

HERE IT IS! The new and snappy fall line of Stylemor shirts. Big market. Exclusive territory full of profit means \$100.00 to \$125.00 weekly—Easy! Complete free outfit with large swatches makes quick and easy profits. Experience or capital unnecessary, for a business of your own. Take the orders, collect your commissions, and we deliver and collect the balance. Low prices, fast service make repeat orders a cinch. Write today for the big free outfit and then ride on easy street. Stylemor, 81 W. Van Buren, Chicago, Dept. 102.

SPLENDID earnings and Continuous success are yours as a Davis Salesman. Fourteen years' superior value—giving have earned national fame for "Square Deal" Clothes \$29.50, \$34.75, \$42.50. Orders come easy for these hand tailored, guaranteed fitting garments that save \$10 to \$20. Satisfaction or money refunded. New tailoring plant assures prompt delivery. Free advertising helps, liberal commissions; extra bonus! Outfits limited—write quickly. Davis Tailoring Co., 2077 Iowa Ave., Dept. A-10, Cincinnati, Ohio.

AUTO Specialty Salesmen with Car—How would you like to be in business for yourself and net \$25.00 and up per day? We start you in business. Sell Likum Alarm Ignition Locks, a wonderful new invention which gives car owners real protection against theft and saves the battery from running down. Easily installed on any make of car. Exclusive territory allotted to Agents. Write for details and enclose \$2.50 for sample on approval for your car. Leomis-Knight-Miller, Inc., Springfield, Mass.

TAILORING Salesmen! Don't waste your good time trying to sell "ready mades." Leave them to the local dealer. Don't try to sell at more than \$23.75. It can't be done! Investigate the new Hudson line for Fall. One price, \$23.75. Made to Measure Only. All wool. Over 100 swatches in the line, all beauties. Outfit Free. Write quick, stating experience, territory and references. Hudson Tailoring Co., Dept. 107, 901 W. Adams St., Chicago.

LET us help you make \$200 to \$400 a month. Wanted—Ambitious men to run a business on our capital. Over 500 every-day necessities, known everywhere—used by millions for 43 years. Recognized the best. In big demand—easy to sell—good repeaters—we guarantee satisfaction. Double your profits under our new selling plan. Experience not necessary. Write Dept. 34, John Sexton & Co., Box H. H., Chicago.

WANTED—Salesmen to sell salesbooks, credit registers, autographic registers and register rolls on commission. Part or full time. Syracuse Salesbook Company, 406 Chamber of Commerce Bldg., Syracuse, N. Y.

AN Unusual Opportunity to Build Up a Life Income with Markwell Automatic Tacking Machine. Here is a chance to connect with the world's leading distributor of Automatic Tacking Machines and other labor-saving devices for commercial use. We are going to place several salesmen, district representatives and distributors in all territories. Repeat orders for tacks for Markwell Automatic Tacker, which are distributed by us exclusively, assure you of a life income. Write stating qualifications, references, territory desired, etc. Markwell Corp., 99 Hudson St., New York.

MAKE \$100 Weekly in spare time. Sell what the public wants—long distance radio receiving sets. Two sales weekly pays \$100 profit. No big investment, no canvassing. Sharpe of Colorado made \$955 in one month. Representatives wanted at once. This plan is sweeping the country—write today before your county is gone. Ozarka, Inc., 431 N. LaSalle Ave. M Chicago

MAGIC Moving Window Salesman. It's Real changeable letter system has actually boosted users' sales 200% to 400%. None but dead dealers indifferent. If you can spot a winner, get the facts and begin pocketing \$100 weekly. Display Products Company, P. O. Box A5123, Gateway Station, Kansas City, Mo.

WONDERFUL New Invention—The Jacob-Ness hoof trimmer and deborner, so simple horses' and cows' hoofs trimmed without raising their feet from floor. Salesmen now working making from \$15 to \$25 daily. Sold direct with the understanding if not satisfied, return clipper in ten days and money will be refunded. Write for complete sales proposition. Jacob-Ness Clipper Co., Fergus Falls, Minn.

WANTED: Manufacturer has position vacant for traveling salesman, straight salary \$50.00 per week, car furnished. Applicants must have good personality, possess a fair education, ability to furnish references. For further information write, giving age, nationality, married or single, education with three references as to character and ability. All applications considered confidential. Haley Supply Company, Pittsfield, Mass.

CIGAR and Candy Salesmen! Write for most attractive sideline on market. Electric Humidifier, sells for \$12.50. Commission \$5.00. Lincoln Products Co., 2657 North Kildare Ave., Chicago, Ill.

SALESMEN—Manufacturer of new type work garments wants district representatives to call on garages, filling stations, etc., earnings will average approximately \$450 a month; experience unnecessary. Write in detail. Work Wear, Hammond, Ind.

SERVE Humanity. Our representatives make \$4,000 yearly, up. No other proposition just like ours. System Bible Co., Dept. 600, 209 S. State, Chicago.

GREAT neckwear line now free! Features finest quality neckwear at factory prices. Collect big commissions daily. Write for Free tie offer and Free outfit. Newco Neckwear, Desk 10-B, Covington, Ky.

BECOME Your Home Town's Leading Business Man. You can make \$100.00 weekly selling our guaranteed food products, paints, oils, shirts, hosiery, etc., direct to consumer in towns and country. Every article a repeater. Your \$20 starting order of fastest sellers sent on trust. No experience necessary. Exclusive territory for men and women. Loverin & Browne Co., 1600 S. State St., Chicago.

HERE'S Your Chance—Something New just out, nothing on market like it; big money maker; good men averaging \$400 a month; send 40c for sample. Money back guarantee. The G. & G. Co., Dallas, Texas.

\$60-\$200 A WEEK. Genuine Gold Letters for store windows. Easily applied. Free samples. Liberal offer to general agents. Metallic Letter Co., 438-A North Clark, Chicago.

SALESMEN—Sideline—Pick up big commission selling plain advertising Toy Balloons for World's Largest Balloon Factory. Pioneer Rubber Company, Willard, Ohio.

SALESMEN or Distributors. Sell Auto Accessories under a new plan direct from Factory proposition; own your own business. Good repeater all year round. Territory going fast. Write for particulars. Jiffy Manufacturing Company, Inc., Huron, S. Dak.

ADVERTISING Salesmen wanted to take orders for Auto Key Purse; new invention; sells to advertisers by thousand; commission 20%; sample by mail 25c. Novelty Cutlery Company, 231 McGregor Ave., Canton, Ohio.

SALESMEN Selling to Men: We have logical side line for you that will sell along with any other line you may now be handling and probably make more money for you, provided you are now selling to men. Get full facts at once by addressing Salesmanager, 844 West Adams, Dept. 609, Chicago.

SALESMEN: Write your name and address on a postal and mail to us. We'll show you sure earnings of \$20.00 a day. Will you risk one minute and a one-cent stamp against \$20.00? Mind you, we say we'll show you. Address Dept. 1028, William C. Bartlett, Inc., 850 W. Adams St., Chicago.

COLLECTS Money from the Dead-Beats. Retail \$5.00—Cost \$1.00—Profit \$4.00. "New Method." Every Storekeeper, Doctor buys quickly. Wonderful Money Getter, Federal Association, Hartford, Conn.

SALESMEN Wanted: Work from Leads Resulting from our circularization and national advertising. Beverage line. High-class men only. No down-and-outers need apply. Sales Manager, 2714 Locust, St. Louis, Mo.

WITH Ford or Chevrolet Roadster or Touring cars to Make Money and enjoy closed-car comfort. Protect your Health. Complete Koupet California Tops. Quality High. Price Low. Write Factory Today. Koupet Auto Top Company, Belleville, Ill.

100% PROFITS, liberal bonus, transportation free goods, selling repeating super-quality perfumes and toiletries. LeMaire Perfume Co., 3330 Carroll Ave., Chicago, Dept. 69.

SALESMEN, sell signs, house numbers, show cards. Write for particulars. Lynch and Gross, Bausman, Pa.

BIG commissions paid daily. Sell dependable line popular priced shirts, maker to wearer. Values unbeatable. Experience unnecessary. Pocket-Kit free to workers. Merit Shirt Co., 640-P, Broadway, New York.

GIVEN Away, in ten states, one year each, exclusive right to sell auto headlight-glare eliminators. Sample free. Contract \$5. Patent No. 1,593,849. Reynolds Glare Eliminator, Madison, S. Dak.

SALESMAN—Side or full time, fast sellers, wonderful repeaters, enormous profits. Merchant pays \$2.00, retails for \$3.50, salesman makes one dollar. Box 32, Mansfield, Ohio.

SELL Mitchell's Super Razor Blades to the dealer. Liberal Commissions. Write for pocket outfit, and begin at once. G. C. Mitchell Co., Inc., Aurora, Ill.

SALESMEN to manage cigar business. High quality line. Liberal commissions. Permanent. Responsible party financed. Popular prices. Advertising furnished. Shelby Cigar Co., Shelby, N. C.

YOU Want Livewire Salesmen: Get your names from a list that's under constant revision. Names arranged alphabetically by states. \$3.00 a thousand. Dr. Hazelton, Box 571, Gulfport, Miss.

SALESMEN—Salary and expenses guaranteed against commissions while you learn to sell our specialty. A business of your own. Box 221, Iowa City, Iowa.

SALESMEN—Sell Ideal Specialty; Every Businessman a prospect; excellent full time or side line; we deliver and collect; you collect commission with order. Stewart Henry Co., Box 983, Pittsburgh, Pa.

NEWEST Invention! Abolishes kinks, snarls and automatically coils telephone, electric iron and lamp cords. Housewives, business men, companies actually buying 5 to 50. Free sample to workers. Neverknot, Dept. B-10, McClurg Bldg., Chicago.

We have a line of goods for which every man in America is a prospect. It has everything any competing line has and something besides. It can be handled profitably by tailoring, shirt, hosiery, necktie, shoe, raincoat and other salesmen now selling to men. For full facts address Madison Bros., 135 So. Peoria St., Dept. 75, Chicago.

CALENDAR salesmen: Our line is the only one that covers entire field. Calendars—Fans—Signs—Pencils—Blotters—Aluminum—Wood—Celluloid. Remembrance advertising for every merchant. Full or part time. Dept. 226, Model Calendar Co., South Bend, Ind.

SALESMEN: Want \$6,000 this year? Write us today. Strong retail line, nationally advertised. Company established 26 years. Liberal advances to producer. Continental Co., 1300 Liberty Bldg., Cleveland, Ohio.

MINUTES Pay Dollars demonstrating wonderful three pound Calculator. Retail \$15.00. Work equals \$300 machines. Adds, subtracts, multiplies, divides automatically. Five year guarantee. Big demand; large profits, experience unnecessary. Write quick for liberal trial offer and protected territory. Lightning Calculator Co., Dept. F, Grand Rapids, Mich.

TAILORING Salesman, \$100-\$150 Week selling union hand tailored made-to-measure suits. \$23.50-\$29.50. Liberal commissions advanced. Wood & Co., 651 S. Wells, Chicago.

SALESMEN—Become Independent. Own Your business, experience unnecessary selling our \$7,500.00 Accidental Death; \$50 Accident; \$25 Sick Weekly Benefits—\$12.50 Yearly. Other Amounts proportionate. Guaranteed steady income from renewals. \$250,000 Deposited Insurance Department. Universal Policy, Dept. A, 30 Clinton St., Newark, N. J.

FOUR \$7.50 sales to merchants net you \$20.00 daily. Sayers Systems, 2803 Sheffield Ave., Chicago, Ill.

CALIFORNIA Rosebuds selling like hot cakes. Agents coining money. Absolutely new. Big profits. Catalog free. Mission Factory SP, 2328 West Pico, Los Angeles, Calif.

SALESPEOPLE: Make bigger, easier, quicker profits selling the amazing 26 ounce All-Purpose Waterproof Featherweight Coat. Men's coat \$8.50, ladies' \$5.95. Remarkable value, up-to-the-minute style. Write now for full details of selling plan. Featherweight Coat Co., 5719 Euclid Avenue, Cleveland, Ohio.

WANTED—Tailoring Salesmen, make \$60 to \$125 per week. Biggest merchants in many towns have started with our line. We are the largest made-to-measure tailoring house in the country, furnishing elaborate sample equipments, including 500 all-wool fabrics. You make your own profits from \$8.00 to \$15.00 on each order. Guaranteed absolute satisfaction, perfect fit, best workmanship, or no sale. Write for our line and all accessories to be sent free. Tell us all about yourself. Address N. O. Perry, Sales Manager, Box 483, Chicago, Ill.

ANY Salesmen Can Sell Them! Merchants everywhere use punchboards. Someone sells them, why not you? Collect big commissions daily. Newest, largest, elaborate catalog sent upon request. Lincoln Sales Co., 9 So. Clinton, Chicago, Dept. D.

GOLD Leaf Window Letters and Script Signs. No experience; 500% profit. Samples free. Consolidated, 69V—West Van Buren, Chicago.

SELL Men's Shoes direct. \$50 to \$100 weekly. Every man a prospect. Easy sales. Low priced. Real comfort, long wear. You take orders, keep big deposit. We deliver and collect. Full or part time. We help you succeed. Easywear Shoe Company, Dept. 229, Indianapolis.

YOU Can Make \$50.00 to \$200.00 a week traveling and appointing agents for us. Write immediately for particulars. J. M. Pitkin & Co., 100 Pitkin Bldg., Newark, New York.

\$100—\$200 WEEKLY. Retailers' live-wire specialty. \$10 weekly guaranteed against com. Reliable house. Guarantee dealers turnover or money back. Pay you to investigate. Appleton Specialty Co., Cedar Rapids, Iowa.

SALESMEN, profitable sideline selling useful advertising specialty. Jotsworth, 544 W. Lake St., Chicago, Ill.

SELLS for \$9.75. Prints ad on wrapping paper, envelopes, etc. \$4.00 commission. Send 10c for sample work. Automatic Ad-Stamp, Joplin, Mo.

TAKE orders for coffee, sugar, flour, meats, canned goods, staple groceries also paints, radio sets, tires, auto and tractor oils. No capital or bond required. We deliver and collect. Permanent business. Big pay. Write at once. Hitchcock-Hill Co., Dept. 50, Chicago.

SELL Printing. Low prices. High quality. \$1.00 per thousand commission. Send 10c for outfit. Ozark Press, Joplin, Mo.

HELP WANTED

BOYS—Men 16 Up Wanted. Learn Auto Repairing. \$25.00 to \$75.00 week. Learn at home while earning. Illustrated book with sample lessons free. Write immediately. Franklin Institute, Dept. B100, Rochester, N. Y.

MEN, 18 up, wanting to qualify for U. S. Mail Service positions, \$142 to \$225 monthly. Write immediately for free particulars. P. Bradford, 112 Bergen Ave., Jersey City, N. J.

TREMENDOUS shortage of Auto and Tractor Mechanics everywhere right now for jobs paying \$60.00 to \$100.00 weekly. No strikes or layoffs. Very little schooling required. I teach you thoroughly in eight weeks and pay your board and railroad fare. Money back if not satisfied. Special reduced tuition offer to those who write quick for particulars and Free book. Address, McSweeney Auto Shops, Dept. J Z14, McSweeney Bldg., Cincinnati, Ohio, or 1815 East 24th St., Cleveland, Ohio.

WOULD you risk a 1c postal against the chance to make \$5 to \$15 daily during the next four months introducing an absolutely new line of Insured Hosiery—guaranteed 12 months. Your Pay Daily. Monthly bonus extra. Magnificent sample outfit furnished. If so send name and address to Macochee Textile Company, Card 26010, Cincinnati, Ohio.

MR. BRUSH Salesmen—Old Established New York Brush Manufacturers require services of men in all territories to sell their extensive line of Sanitary Twisted in Wire Brushes. We pay larger commission than any other Brush House in the country. Write immediately for our proposition. Wire Grip Sanitary Brush Corporation, 15 Mercer Street, New York.

\$95.00 TO \$225.00 Month, Men—Women 18 up. Get U. S. Government Jobs. Railway Postal Clerks—Mail Carriers—Postoffice Clerks and Clerical Positions. Steady. Paid vacation. Experience unnecessary. Common education sufficient. 32 page book with sample examination coaching and full particulars free. Write today sure. Franklin Institute, Dept. B3, Rochester, N. Y.

BECOME a Landscape Architect. Uncrowded profession of wonderful opportunity for money-making. Easily mastered by mail. Earn while you learn. Write for book. American Landscape School, 56-E, Newark, N. Y.

MEN 18 Up. Be Railway Mail Clerks. Commence \$1,900 year. Sample coaching free. Franklin Institute, Dept. B-16, Rochester, N. Y.

MIDDLE-AGED Man: It will not injure your health. Pocket Book or Reputation. Stamp for Particulars. N. E. Badgley, 1063 W. Madison, Chicago, Ill.

MEN wanting to prepare for forest ranger or railway mail clerk examinations Write Mokane, A-23, Denver, Colo.

MEN, 18 Up. Be Railway Mail Clerks, Carriers—Postoffice Clerks. \$1,700-\$2,700.00 year. Steady. Sample examination coaching free. Write today. Franklin Institute, Dept. B16, Rochester, N. Y.

WE Start You in Business, furnishing everything. Men and women, opportunity to earn \$35 to \$100 weekly operating Ragsdale's original "New System Specialty Candy Factories" anywhere; wholesale or retail. Big commercial candy book free. W. Hillier Ragsdale, Drawer 350, East Orange, N. J.

MEN—Be Railway Mail Clerks. Commence \$1,900 year. Sample coaching free. Franklin Institute, Dept. B16, Rochester, N. Y.

DON'T prepare for any Civil Service Examination without seeing our catalogue. Free. Columbian Correspondence College, Washington, D. C.

EARN \$10 daily silvering mirrors, plating and refinishing metalware, auto, chandeliers, bedsteads, headlights. Outfits furnished. E. DeCle Laboratories, 1133 Broadway, New York.

SILVERING Mirrors, French plate. Easily learned; immense profits. Plans free. Address, Wear Mirror Works, Dept. 34, Excelsior Springs, Mo.

U. S. GOVERNMENT wants men. \$1,700—\$1,900 and up at start. Railway Mail clerk examination coming. Let our expert (former Government examiner) prepare you for this and also Rural Carrier, Post Office, Customs, Internal Revenue, and other branches. Write today for free booklet, Dept. 8, Patterson Civil Service School, Rochester, N. Y.

BUSINESS SERVICE

BUSINESS Problems Solved—all kinds—where to buy, how to sell, increasing business, advertising, getting agents, special formulas for all kinds of products, etc. Complete solution of problem \$5, particulars free. Satisfaction guaranteed. All confidential. Write today. National Information Bureau, 316F Shepard Building, Grand Rapids, Mich.

IF You Are Thinking of Canada, our Farm and Business listings extend from coast to coast. Wilson Agency, St. James Chambers, Toronto, Canada.

BUSINESS problems analyzed. Manufacturers and Mail order dealers. Advertising, merchandising ideas. Complete service, any subject. **Arvor Business Service**, 245 West 112th Place, Chicago.

MECHANICAL drawing, detailing and tracing executed by capable draftsmen; checked by experienced engineers. Write us your needs. **Triangle Drafting Service**, 5124 Sheridan Road, Chicago.

REPRESENTATION in Washington, D. C. Mail address, information. Anything. Anytime. Service, 223 Victor Bldg.

DELAWARE Incorporator. Charters: Fees Small; forms. Chas. G. Guyer, 901 Orange St., Wilmington, Del.

INFORMATION

FOREIGN Service—With mining, oil, electric, railway, fruit, sugar and other companies in Latin America. Send ten cents for further particulars. **Foreign Service**, Box 69, Station D, New York City.

LETTER SPECIALISTS

LETTERS, circulars, booklets. Results sure. **Greenwalde**, 5560 Bartlett, Pittsburgh, Pa.

TYPEWRITERS AND SUPPLIES

TYPEWRITERS, all standard makes, thoroughly re-manufactured by the famous "Young Process" and shipped direct from factory to you on 10 days' trial. Guaranteed 5 years. Easy monthly payments. Write today for free catalog. **Young Typewriter Company**, Dept. 575A, 654 W. Randolph St., Chicago.

ALL makes, lowest prices, 5-year guarantee. Several specials. Free illustrated catalogue. **Henry Typewriter Co.**, 217 West 125th St., New York, N. Y.

UNDERWOOD Typewriters—only \$3.00 down. Easy monthly payments. Low prices at less than manufacturers. 10 days' free trial. Rebuilt, all worn parts replaced. Just like a new machine. 5-year guarantee. Write for a big free catalogue B-151. **Shipman-Ward Mfg. Co.**, 1517 Shipman Bldg., Chicago, Ill.

TYPEWRITERS, all standard makes. \$10 up. Fully guaranteed. Free trial. Write for complete illustrated lists. **Northwestern Typewriter Exchange**, 121 N. Francisco Ave., Chicago.

100 **TYPEWRITERS** Free. Overstocked. Rent rebuilt Underwood or Remington \$3.00 month. If you pay its value in rental, we give machine free. Particulars free. **Pittsburgh Typewriter Exchange**, 945 Hersch Bldg., Pittsburgh, Pa.

PRINTING, ENGRAVING AND MULTIGRAPHING

\$3.00 **DELIVERED**. 500 Watermarked Bond Letterheads, 8½x11, and 250 envelopes, money with order. **Job Printing Specialty**, National Printing Company, Goshen, Ind.

5,000 **LOTS** 5½x8½ Circulars, \$10.00; Ad. Slips, \$5.00; 3½x6 Four-page Folders, \$13.75. All Printing Lowest Prices. Elegant Samples Free. **Good's Printery**, Harrisonburg, Va.

PRINTING—Get our samples and reduced prices on all kinds high-class work on **Hammermill Bond**. **Hall Printing House**, Meadville, Pa.

ENVELOPES printed, 5,000, \$8.80; 1,000, \$2.50; 24 pound, 6%. **A. Kuhlman**, 1806 Sycamore, Cincinnati, Ohio.

"**NEARGRAVURE**" Process—Get samples—See the Difference. **Soliday's**, Knox, Ind.

SELL Printing 40% commission. Samples free. **Pitts, Amana**, Iowa.

STATIONERY Embossers are fine Christmas Gifts. Circular Free. **Midwest**, Box 47, Springfield, Ill.

ARTISTIC Printing; low prices. Samples free. **Acorn Press**, Sidney, Iowa.

BUSINESS and Personal Cards at special prices. Samples for Stamp. **Business Card Specialty Shop**, P-5-2, Jackson, Mich.

PRINTING—Quality work. Fair Prices. Folders, circulars, Catalogs. **Garrison Press**, Harrisonburg, Va.

1,000 **LETTERHEADS** on Envelopes, printed, postpaid \$2.95. 4605 Wells Street, Milwaukee.

PRINTING—250 Bond Letterheads or Envelopes \$1.25. **Classic Service**, Warren, Pa.

BETTER Printing Personal Stationery, 100 Envelopes, 200 sheets, \$1.00 Prepaid. Get Prices on business letterheads, Envelopes, Cards, Tags, Statements, etc. **Vidette**, Columbus Grove, Ohio.

250 **WATERMARKED** Bond Letter Heads or envelopes, \$1.50; 500, \$2.25. **Pfager Bros.**, Hackensack, N. J.

500 **FINE** Business cards 95c postpaid. "Volume does it." Satisfaction or your money back. Samples stamp. **Norman Company, Inc.**, 562 Williams Ave., Portland, Ore.

HAMMERMILL Bond letterheads or envelopes 200—\$1.00, 1,000—\$3.50. Free samples. **Zippo**, 3597 East 118, Cleveland, Ohio.

GOOD Printing for everybody. 24-page list free. **Economy Press**, Mountville, Pa.

225 **BOND** letterheads, envelopes, billheads, cards, \$1.25 each. **Combination**, \$4.00. **Economic Press**, Leonia, N. J.

250 **EACH** Hammermill Bond Letterheads. Envelopes, \$3.00. Samples. **Midland Press**, 543 West Hickory, Kankakee, Ill.

COMMERCIAL Printing. Prices Right. Samples Free. **The Fox Press**, Frankfort, N. Y.

QUALITY Printing! Reasonable Prices! Send for Free Standardized samples and prices. Folders, Circulars, Catalogs our specialty. **Ernest Fantus**, 525 South Dearborn, Chicago.

250 **LETTERHEADS**, 250 white envelopes printed and mailed \$3.00. Samples printing free. **Sunco**, Mohawk, N. Y.

GUMMED Labels, 500 name and address, 2 lines 35c. 3 lines 55c. Catalogue. **Eastern Label Co.**, B. Clintonville, Conn.

200 **BUSINESS** cards, \$1.00; 1,000, \$2.75. Delivered. 250 Bond Letterheads or Envelopes, \$1.50. Samples. **Acorn Press**, Box 273, Newport, Ky.

PICTURES Make Printing Powerful. Cut catalog 10c. **Superior**, 2602 Brooklyn, Detroit.

MULTIGRAPH typewriting business correspondence, two dollars thousand. **Hammermill Bond Letterheads**, four dollars. **Mayera Corporation**, Monmouth, Ill.

WE print Stationery, Booklets, Catalogs, Circulars. Samples. **Commercial Press**, Batavia, Ohio.

PRINTING OUTFITS AND SUPPLIES

COMPLETE printing outfits, presses, type, ink, paper, supplies. Write for Catalog. **Kelsey Company**, G-11, Meriden, Conn.

PRE-USED Printing Presses, Type supplies. List for 2c stamp. **Popular Bargains**, Richland, Pa.

PRINTING Outfits—Presses, type supplies, type novelties. Send stamp for catalogue. **Model Press**, York, Penna.

DPLICATORS AND DEVICES

YOU can make 50 to 100 copies of a letter, notice, etc., at a cost of three cents on a **Heyer Quality Duplicator**. Write for free trial offer. **The Heyer Duplicator Co.**, 14 S. Wells St., Chicago, Ill.

ADDING MACHINES

FREE Trial. Marvelous new Adding Machine. Adds, Subtracts, Multiplies, Divides, automatically. Work equals \$350.00 machine. Price only \$15.00. Speedy, durable, handsome. Five-year guarantee. Used by largest corporations. Write today for catalog and free trial offer. **Lightning Calculator Co.**, Dept. E, Grand Rapids, Mich.

NEW \$3.50 Automatic Adding Machine. Adds, Subtracts, Multiplies. Absolutely accurate. Capacity \$999,999.99. Fully guaranteed. 75,000 pleased users. Makes adding easy, positive, quick. Eliminates Mistakes. Saves Time. Postpaid \$3.50. **Bassett Co.**, 1458 B Hollywood Ave., Chicago.

WORLD'S Finest pocket adding machine. Steel construction. Adds, divides, multiplies, subtracts; million-dollar capacity. Does work like a \$300 machine. \$3.00 postpaid. **Scientific Instrument Co.**, Box 1328, Chicago.

RUBBER STAMPS

RUBBER stamps and stamp supplies. Mail orders filled promptly. **F. D. Hale**, Manufacturer, 64 Tonnele Ave., Jersey City, N. J.

MUSIC stamps, Sign markers, rubber type catalogue 25c. **W. Karstaedt**, Dayton, Ohio.

RUBBER Stamps, Stencils. **Adamec**, 180 Harman St., Brooklyn, N. Y.

MAILING LISTS

99% **GUARANTEED** Mailing Lists. Accurate, Reliable, Guaranteed. The kind that produces business; compiled for every possible business or individual. Lists of every kind of any business or individuals compiled for your individual needs anywhere. Catalogue and information on request. **National List**, 847 Broad, Newark, N. J.

350 **FRESH** country names \$1.00. **Seminole**, 427 East 16th, New York.

1,000 **NAMES**, \$1.00. Mention Classification. **Wincholt Sales Co.**, 4, Woodbine, Pa.

LIST of names \$2.00 per hundred. Owners of farms for sale. **Mailing List Service**, Wabasha, Minn.

FOR SMOKERS

HAV-A-TAMPA, **Admiration**, **El** Product, **Garcia Grande**, and 15 other leading brands of Cigars sold direct to consumer. All leading brands of Cigarettes handled. Bulletin 44 free upon request. Trade supplied. **Richard Lavery**, Asbury Park, N. J.

HOMESPUN Tobacco Guaranteed—Chewing, five pounds, \$1.50; ten, \$2.50. Smoking, ten, \$1.50. Pipe free; pay when received. **United Farmers**, Bardwell, Ky.

NATURAL Leaf Smoking Tobacco. Aged in bulk, two years old, mellow and sweet; 5 lbs. \$1.00; 10, \$1.75. Satisfaction guaranteed. **Farmers' Union**, Mayfield, Ky.

SEND 10c, Silver or Stamps, for sample package 20 fine cigarettes. Large pocket tin Special Blend smoking tobacco also sent for 10c. Direct-to-smoker. **French Tobacco Company**, Dept. 14, Statesville, N. C.

BOATS AND LAUNCHES

HUBBELL Marine Coolers convert Ford engines into marine motors. Booklet free. Ford speedboat, easily built, blueprint and directions, sixty cents. **C. C. Hubbell**, 14B Cottage St., East Norwalk, Conn.

MAKING Boat Models? Use **Stanzall** Waterproof Glue for permanence. Send 30c for ¼ lb. trial size. **L. W. Ferdinand & Co.**, 152 Kneeland St., Boston, Mass.

REVERSE gears, pumps, universal joints, etc. bought, sold, exchanged. **Wm. H. Baker**, Pond St., Quincy, Mass.

BOAT Building Plans for amateurs. Rowing, sailing, speed, cruising. Free catalog. **The Rudder**, 9 Murray Street, New York.

MAKE 16' Rowboat; blueprint 30c. **Weesho-Uco**, 31st Office, Detroit.

RAZORS AND BLADES

RENEW your old safety razor blades quickly and easily. Make new blades better. Apply **Nura** to your strop or strop-er, and see the difference. **Nura** makes blades last indefinitely. Straight razors seldom, if ever, need honing. Stop buying blades. Will not injure Strop. Guaranteed. Send 50 cents, no stamps. **Nura Co.**, Box 342, Rochester, N. Y.

GILLETTE Style Blades. Dozen 45 cents; 3 dozen \$1.25. **Wallace Kutz**, 132 Chambers, Phillipsburg, N. J.

SWEDISH razors (Eskilstuna) \$2.50. **John Hanson**, Skepparegatan 23, Stockholm, Sweden.

FOR THE HOME

GRANDFATHER'S Clock Works, \$5.00. Build your own case; Instructions free; make good profits selling your friends. Clock works with chimes for old or new cases. Write for full particulars. **Clock Co.**, Ruffner St., Philadelphia.

HOUSE-KEEPERS' Delight. 500 helps for house and home. This valuable book, \$1.00. **S. H. Austin**, 2061 Harrison St., Chicago.

VALUABLE Information for housewives sent free. Enclose stamp. Address **B. Tupper**, Box 181, Los Gatos, Calif.

GUNS, SPORTING GOODS, ETC.

SEND for our free illustrated, descriptive bargain price list for all your Fall and Winter Sport and Outing Supplies. **Byrnor Supply Co.**, Dept. P, St. Louis, Mo.

DIAMONDS, WATCHES AND JEWELRY

WATCHES cheap. Reliable makes. Trial. **Ralph Pile**, Somerset, Penna.

WATCH REPAIRING

WATCHES: all makes repaired by experts. Write International, Box 5P, Fordham Station, New York.

WATCHES carefully repaired. Cleaning \$1.00; Mainsprings \$1.00. **Ralph Pile**, Somerset, Penna.

ANTIQUES, WAR RELICS AND INDIAN GOODS

EGYPTIAN Antique Jewelry, Tutankhamen Souvenirs, silver shawls, scarabs, postcards, price list free. **Pharaoh's Store**, Fouad Stefan, Luxor, Egypt.

FOR Dens. Relics from Europe's battlefields; also medals. Illustrated catalogue 25c. with Sample War Photos. **Welsh**, 1889 Albany Ave., Brooklyn, N. Y.

SEND 5c for fine, new list Indian relics, antique firearms. **F. E. Ellis**, Webster Groves, Mo.

PHONOGRAPHS AND SUPPLIES

SCIENCE'S Masterpiece! World's smallest portable phonograph. (Camera Size.) Plays every size record. (Not a toy.) Wonderful tone qualities, like a \$300.00 machine. \$8.00 postpaid. Scientific Instrument Co., Box 1328, Chicago.

BUILD your own phonographs. We can supply you with motors, tone arms and all accessories at wholesale prices. Write for catalogue AX. Pleasing Sound Phonograph Co., 204 East 113th St., New York, N. Y.

BUILD your own Phonograph. We furnish everything. Catalog sent free. American Phonograph Co., 3752 Belmont, Chicago.

MUSIC AND MUSICAL INSTRUMENTS

SAXOPHONES, all other Band and Orchestra Instruments, best makes, new and used, on easy terms. Also buy, exchange, repair. Write today for free catalogs, bargain bulletin and "Musical Booster" magazine, all free. Get acquainted with the big Professional Supply House. Crawford-Rutan, 1010 McGee, Kansas City, Mo.

ARTISTIC, National Anthem, woven words, music bars, U. S. colors, flag and gold star scrolled in gold with heavy silk, 3x12. Price one dollar. Maute Artcraft Specialties, 191 Bedford Ave., Brooklyn.

OWN a High-class Violin. We show you how. Ye Olden Violin, Benton Harbor, Box 179, Mich.

SONG poem writers! Address Monarch, 1472 Broadway, Dept. 104, New York.

FREE: "Song Writers' Guide." B1-1239 Elm, Green Bay, Wis.

REAL Jazz Piano Lessons. Latest Hits, taught quickly at home. Booklet and Sample Lesson Free. Address Studio, 7 United Schools of Popular Music, P. O. Box 1959, Boston, Mass.

SONG Poem Writers—Send for proposition. Ray Hibbeler, D1, 2104 N. Keystone Ave., Chicago.

CORNETISTS—Trombonists—Saxophonists—Clarinetists. Get "Free Pointers." Name instrument. Virtuosi School, Buffalo, N. Y.

SHARPS and Flats—Free. Very interesting. Send for it Today. Harry L. Alford, 192 No. State St., Chicago, Ill.

WRITE Songs. Big money and reputation. Write for information. J. Gordon Pub. Co., 201 N. Hoyne Ave., Chicago.

VIOLINS, Deep, Mellow, Soulful—on credit. Easy terms for wonderful instrument. Get details today. Gustav F. Henning, 2424 Gaylord St., Denver, Colo.

I WANT Song Poems. Casper Nathan, 3544 N. Racine, Chicago.

"**MUSIC** Composed" to words. Bauer Bros., (formerly of Sousa's Band), Oshkosh, Wis.

PATENT ATTORNEYS

PATENTS. Time counts in applying for patents. Don't risk delay in protecting your ideas. Send sketch or model for instruction or write for Free book "How to Obtain a Patent" and "Record of Invention" form. No charge for information on how to proceed. Communications strictly confidential. Prompt, careful, efficient service. Clarence A. O'Brien, Registered Patent Attorney, Security Bank Building (directly across street from Patent Office), Washington, D. C. See pages 140 and 141.

INVENTORS: Send sketch or model for advice and exact cost of patent. Ask for our Free book: "How to Obtain a Patent." Tells what every inventor should know. Established twenty-eight years. Highest references. Prompt service. Reasonable charges. Chandler & Chandler, 474 Seventh, Washington, D. C.

LACEY'S Patent Sense. Valuable book free. See ad page 144.

PATENTS—Send for form "Evidence of Conception" to be signed and witnessed. Form, fee schedule, information free. Lancaster and Allwine, Registered Patent Attorneys in United States and Canada, 221-Ouray Bldg., Washington, D. C.

INVENTORS having ideas to patent: Write for Booklet explaining Co-operative Plan for handling your applications. Tells how to sell and safeguard your inventions at lowest cost. Ralph Burch, Patent Lawyer Jenifer Bldg., Washington, D. C.

PATENTS, Trade-Marks, Designs. This firm has 27 years' experience and gives expert personal service at reasonable rates. We properly protect your invention. Write for free information and exact cost of procuring patent before proceeding. John B. Thomas & Co., 902 F St., N. W., Washington, D. C.

EDWARD C. SASNETT, Formerly a Principal Examiner United States Patent Office. Strictly Personal Service. McGill Building, Washington, D. C.

SUCCESSFUL patent selling through co-operation. Booklet free. Chartered Association American Inventors, Barrister Building, Washington, D. C.

PATENTS Procured. Prompt Service. Personal, careful and efficient service. Highest references. Moderate fees. Send sketch or model for actual search and advice. George P. Kimmel, Master of Patent Law, 55 M. Legal Bldg., Washington, D. C.

RICHARD E. BABCOCK, Patent Lawyer, Washington Loan & Trust Bldg., Washington, D. C. Booklet.

MONROE E. MILLER, Ouray Bldg., Washington, D. C. Patent Lawyer; Mechanical, Electrical Expert. Booklet and Priority Record blank gratis.

MILLIONS spent annually for ideas! Hundreds now wanted! Patent yours and profit! Write today for free book—tells how to protect yourself, how to invent, ideas wanted, how we help you sell, etc. American Industries, Inc., 500-Victor Bldg., Washington, D. C.

ESTABLISHED 1864. Milo D. Stevens Company. Free Booklet, Patents, Trade-Marks, Copyrights. Offices, Monadnock Block, Chicago; Barrister Building, Washington, D. C.

PATENTS, Trade-Marks, Copyrights, and Patent Litigation. Write for advice and instructions how to proceed, costs, etc. Hand Book with illustrations of 100 Mechanical Movements sent free on request. Albert E. Dieterich, Patent Lawyer and Solicitor, 621-B Ouray Bldg., Washington, D. C.

INVENTIONS patented; Trade-Marks Registered; Reasonable charges; prompt service; plain advice; request particulars. Jaynes & Jaynes, 700 Kellogg, Washington, D. C.

PATENTS—Trademarks obtained. Information free. O. A. Michel, Registered Attorney, Box 624-B, St. Louis, Mo.

PATENTS, Booklet free. Highest references. Best results. Promptness assured. Send model or drawing for preliminary examination. Watson E. Coleman, Patent Lawyer, 644 G. Street, Washington, D. C.

PATENTS—Write for our Guide Books and "Record of Invention Blank" before disclosing inventions. Send model or sketch of your invention for Free Inspection and Instructions. Terms Reasonable. See advertisement on pages 142 and 143. Victor J. Evans & Co., 934 Ninth, Washington, D. C.

UNPATENTED Ideas Can Be Sold. I tell you how and help you make the sale. Free particulars (Copyrighted). Write W. T. Greene, 807 Jenifer Building, Washington, D. C.

U. S. AND foreign patents, trademarks; moderate rates. 22 years' experience. George C. Heinicke, 32 Union Square, New York; registered in U. S. and Canada.

PATENTS Procured: Trade Mark Registered—A comprehensive, experienced, prompt service for the protection and development of your ideas. Preliminary advice gladly furnished without charge. Booklet of information and form for disclosing idea free on request. Richard B. Owen, 30-Owen Bldg., Washington, D. C., or 41-R Park Row, New York.

"**INVENTOR'S** Advisor," the valuable Patent book with 139 mechanical movements and illustrations, sent free upon request. M. M. Labiner, Patent Attorney, 3 Parkrow, New York.

INVENTORS—Write for our Guide Book, "How to Get Your Patent" and Evidence of Invention Blank. Send model or sketch of your invention for our prompt examination and instructions free. Randolph & Co., Dept. 436, Washington, D. C.

PERCY S. WEBSTER, 203 Saving and Loan Building, Stockton, California. Long established organization. Patent booklet free.

"**INVENTORS'** Guide" sent free on request; this book contains illustrations of patented inventions and gives valuable information and advice for all who have original ideas or improvements. Frank Ledermann, Registered Attorney and Engineer, Woolworth Bldg., 1712, New York.

PATENTS, Trade marks, copyrights. Prompt, personal, reliable service. Over 36 years' active practice. Write for terms. Book free. Address E. G. Siggers, N. U. Bldg., 918 F Street, Washington, D. C.

FOR INVENTORS

PATENTS. If you have an invention which you wish to patent you can write fully and freely to Munn & Co., for advice in regard to the best way of obtaining protection. Please send sketches, or a model of your invention and a description of the device, explaining its operation. All communications are strictly confidential. Our Handbook on Patents is sent free on request. This explains our methods, terms, etc., in regard to Patents, Trade Marks, Foreign Patents, etc. "Scientific American" contains Patent Office Notes, Decisions of interest to inventors and particulars of recently patented inventions. Munn & Company, Solicitors of Patents, 1523 Scientific American Building, New York; 524 Scientific American Bldg., Washington, D. C.; 1313 Tower Bldg., Chicago, Ill.; 666 Hobart Bldg., 582 Market St., San Francisco, Calif.; 521 Van Nuys Building, Los Angeles, Calif.

A NEW Book Just Out. 1,000 Needed Inventions! Arranged as follows: General Problems; Automotive, Mechanical, Electrical; Chemical; Radio; Marine. Separate chapter on the ten Most Needed Inventions. Nothing else like it has ever been published. Edited by Raymond Francis Yates, formerly Managing Editor of a leading scientific magazine. Over 100 pages, durably bound. Price only \$1.00. Money back after 10 days' examination if desired. Bureau of Inventive Science, Dept. 310, Rochester, N. Y.

WE Finance your application and assist selling the patent. Patents Bureau, Times Bldg., St. Louis, Mo.

A LARGE manufacturer of commercial refrigerating machines desires successful design gas fired household machine. Address Box MLR, Popular Mechanics, Chicago.

SAVE wasteful patent expense; patented or unpatented inventions. Write us. Central Sales Agency, Independence, Mo.

PATENTS wanted cash or royalty basis; send description. Box 126, Dowagiac, Mich.

LACEY'S Patent Sense. Valuable book free. See ad page 144.

WANTED—A good article to sell agents. H. J. Bibler, Florence, Kans.

EDWARD C. SASNETT, Formerly a Principal Examiner United States Patent Office. Strictly Personal Service. McGill Building, Washington, D. C.

WANT Patent, outright. Box 265, Station C, Los Angeles, Calif.

INVENTORS Universal Educator—contains 900 mechanical movements; 50 perpetual motions. Tells how to obtain and sell patents. Suggests new ideas. Explains how to select your attorney and avoid patent sharks. Price (revised edition) \$1.50 postpaid. Albert E. Dieterich, 621-Ouray Bldg., Washington, D. C.

SUCCESSFUL patent selling through co-operation. Booklet free. Chartered Association American Inventors, Barrister Building, Washington, D. C.

UNPATENTED Ideas Can Be Sold. I tell you how and help you make the sale. Free particulars (Copyrighted). Write W. T. Greene, 807 Jenifer Building, Washington, D. C.

PROTECT your patents, trademarks in case of infringement. Guaranteed by strongest bonding company, surplus \$4,000,000. Patent & Trademark Protection Co., Drawer 1345B, St. Louis, Mo.

I AM in touch with hundreds of moneyed men and manufacturers who wish to buy good inventions. Write Hartley, 38 Court St., Bangor, Me.

WILL buy improved invention. Write W. L. Kendig, 416 N. Duke Street, Lancaster, Pa.

PATENTS Wanted—We buy and sell practical patents. Big opportunity, undeveloped field. Describe briefly. M. Okamura, Box 1290, Honolulu, Hawaii.

INVENTORS—Write for our Guide Books and "Record of Invention Blank" before disclosing inventions. Send model or sketch of your inventions for our free inspection and instructions. Terms reasonable. See advertisement on pages 142 and 143. Victor J. Evans & Co., 157 Ninth, Washington, D. C.

HAVE You an Invention? If so, write for our free book, "How to Get Your Patent," tells our terms and methods. Send model or sketch for our free examination and instructions. Randolph & Co., Dept. 144, Washington, D. C.

GET your own patents. Legal blanks, complete instructions \$1. Cutting Sons, Campbell, Calif.

PATENTS. Time counts in applying for patents. Don't risk delay in protecting your ideas. Send sketch or model for instructions or write for Free book "How to Obtain a Patent" and "Record of Invention" form. No charge for information on how to proceed. Communications strictly confidential. Prompt, careful, efficient service. Clarence A. O'Brien, Registered Patent Attorney, Security Bank Building (directly across street from Patent Office), Washington, D. C. See pages 140 and 141.

I SELL Patents. Established in 1900. The only man in America who has spent the past 25 years exclusively at this work. An experience highly valuable to you, if you have a good patent to sell. Charles A. Scott, 773PM Garson Avenue, Rochester, N. Y.

PATENTS Procured: Trade Marks Registered—A comprehensive, experienced, prompt service for the protection and development of your ideas. Preliminary advice gladly furnished without charge. Booklet of information and form for disclosing idea free on request. Richard B. Owen, 30-Owen Bldg., Washington, D. C., or 41-B Park Row, New York.

PATENTS FOR SALE

FOR Sale Outright or Royalty Patented household window cleaner's seat. L. Loepfe, 3309 Chippewa, St. Louis, Mo.

ROYALTY Basis—Newly Patented Tractor Drive Wheel. Prevents Side-Slip of Tractor When Operating on a Hill-Side. Eliminates Packing of Soil between Cleats or Grousers. An All-Purpose Wheel for Maximum Traction Level Land or Hill-Side. P. F. Leverenz, Box 76, Paso Robles, Calif.

SHOE Duster, 1,587,024. Triple combination; immense open field. Murphy, 730 Eddy, San Francisco, Calif.

FREE. Cobuilders of motors may have use of patent No. 1,527,861, free, five years on one type of motor built, applying first with this ad. C. L. Ginty, R. 1, Lockport, N. Y.

OUTRIGHT—patented Convertible Non-Skid Auto-Sleigh attachment for Ford cars. A. H. Normandin, 24 Williams Ave., Brockton, Mass.

FOR Sale—Patent No. 1,592,627. A real trouble-saving necessity when changing hands on Fords. Charlie Egleston, Coalmont, Ind.

AIR compressor automatically provides tires with air while wheel is running. Wm. Pearson, Estacion de Correos, Luyano, Havana, Cuba.

PATENT for sale, reasonable. Novelty comb secretes hair tonic, etc., each hair receives its share when combing. Address Mrs. B. Abbate, 1448 Richardson St., Locust Point, Baltimore, Md.

VALUABLE invention; Patented, will sell outright, might take stock in new or established company. P. O. Box, 212, Enid, Okla.

PATENT on Plaskul: New Family Game. Children say its lots of fun, others say its educational. Sample 80c. Anna Johnson, Marietta, Minn.

OUTRIGHT—Variable Slicing Device for slicing butter in individual slices the desired thickness. A labor-saving device for restaurants and eating houses. Patent allowed in June, 1926. Perry R. Tally, Prescott, Oreg.

FOR Sale—Patent on Tractor Planters, U. S. and Canadian. This is a very useful and practical device, and will undoubtedly find a ready market when placed on sale. Will sell patents outright or place on royalty. Address Alvin Brown, R. R. No. 2, Box 36, Plainfield, Ill.

I AM offering 75% of Exclusive Patent Rights of Safety Aeroplane. Patent No. 1,228,729 to anyone that will furnish me with present type machine so I can improve safety. W. F. Williams, Box 396, Orange, Texas.

FOR Sale—Patent on Windmill. Is possible to lift from 15 to 20 gallons of water per stroke. Has 24-inch stroke. Will place patent on royalty basis with reliable concern. For full particulars address James F. Struble, 225 E. B St., Hutchinson, Kans.

OUTRIGHT or Royalty—Anti-Sagging Trouser Grip Patented—Cheap to Make—Spot Weld or Rivet to Any Belt Buckle. Ed. W. Hirschman, 7 Hyatt Block, Findlay, Ohio.

FOR sale—outright or royalty. All Metal Bobsled. Patented in United States and Canada. Morten Mortenson, South Range, Wis.

PATENT Swing Jaw Wrench for sale or place on royalty. Josiah Cookerley, So. Milford, Lagrange Co., Ind.

OUTRIGHT or Royalty—Smokers' metal novelty, 1,594,311. Ludasy, Box 5, Lansing, Mich.

PATENTED invention revolutionizing spraying douche nozzle used by every woman at present. It's Big Money Maker. Cash or Royalty basis. Box 32, Dayton, Ohio.

FOR Sale, outright or royalty, patent on Ring Puzzle—very interesting. The only puzzle of its kind out. A. Sendek, Jr., Box 416, Jerome, Pa.

PATENT No. 1,569,757; Watering device for grindstones; simple, thoroughly practical; no opposition; cheaply manufactured; outright cash sale. Copies of patent on request. Address, Joseph H. King, Box 777, San Diego, Calif.

FOR Sale—Copyright 896,851. New Game. Address Box 266, Fostoria, Ohio.

MILK Closure Fastener for milk cows. Interested parties please communicate with T. B. Smith, Pocatello Idaho, P. O. Box 940.

ADJUSTABLE parcel carrier, can make of paper or leather. W. James, 292 10th Street, Milwaukee, Wis.

OUTRIGHT, newly patented stop device for phonographs. S. W. Eichelberger, Box 306, Goose Creek, Texas.

OUTRIGHT, U. S. rights for adjustable jar and bottle opener. L. H. Morris, 418 Palmetto St., Jacksonville, Fla. Invite Offers.

OUTRIGHT or royalty, U. S. patent, masonry spacing and facing elements. M. Green, 545 5th Ave., Homestead, Pa.

FOR Sale—New Invention. Combination Bottle Opener and Can Opener. Ser. No. 128,821. Filed Aug. 12, 1926. Inquire Fred Kohler, 1334 Monadnock Block, Chicago, Ill.

THREE Patents and One Trade Mark outright. All on market. Gypsy Queen Folding Cooking Stand, Wash Basin Holder, Folding Ironing-Board. Curious not wanted. Gypsy Queen Co., Pawnee, Ill.

WHY let your patent lie idle? Tell our two million five hundred thousand readers about it! The majority of our readers are especially interested in new ideas and inventions. Ask me to tell you how other inventors successfully sold their patents. M. L. Rund, Mgr., Classified Advertising, Popular Mechanics Magazine, Chicago.

SURVEYING INSTRUMENTS

LARGEST stock of new and used surveying instruments in the country direct from factory. Satisfaction guaranteed or money refunded. Wissler, 619 N. Broadway, St. Louis.

MODELS AND MODEL SUPPLIES

PATENTS. Time counts in applying for patents. Don't risk delay in protecting your ideas. Send sketch or model for instruction or write for Free book "How to Obtain a Patent" and "Record of Invention" form. No charge for information on how to proceed. Communications strictly confidential. Prompt, careful, efficient service. Clarence A. O'Brien, Registered Patent Attorney, Security Bank Building (directly across street from Patent Office), Washington, D. C. See pages 140 and 141.

HULIT & Co., General Model Makers, 625 W. Jackson, Chicago, Ill. Specializing in high-grade model work on inventions of merit. Complete Equipment, Experienced Workmen.

MODELS, Patterns, Special Machinery Building. Expert. Vandermark, 511 Walnut, Cincinnati, Ohio.

QUALITY Models. Reasonable Prices. Rennie Nortwed, Ethan, S. Dak.

LET our experience be your guide. Models that are models; Tools and equipment for economic manufacturing. Patterns of all types; manufacturing in all branches. Satisfaction guaranteed. United Machinery Company, Cincinnati, U. S. A.

THE Modelmaker, a magazine for all interested in making working models. Sample 10 cents. Modelmaker, 122 Liberty St., New York.

WE make working models for inventors and do experimental work and carry a complete stock of brass gears and model supplies. Send for catalogue. The Pierce Model Works, Tinley Park, Ill.

MODEL steam engines and boilers. Boat and boiler fittings. Send 10c stamp for catalog. Refunded with first order. Model Machine Shop, P. O. Box 5, Station Y, New York City.

MODELS, Tools and Dies, and General Manufacturing, new invention, our specialty. Logan Machine & Manufacturing Co., 126 S. Clinton St., Chicago, Ill.

SPECIAL machine builders, tool and die makers, inventor's models, production work of all kinds. Dept. L, Quality Hardware & Machine Co., Ravenswood and Thorndale Avenues, Chicago, Ill.

MANUFACTURING

METAL-CRAFT — Eventually — Metal-Craft. Competent Engineers, Designers and Producing Organization await your commands on dies, stampings, die-casting, deep pressing, screw-machine and wire products. Plating. Enameling. Burnishing. Assembling. Wrapping and Packing to your specifications. Large completely equipped plant which guarantees prompt, efficient service. It is not the quality of raw materials alone, nor the precision in manufacture, and not just the service rendered that has given Metal-Craft the good reputation they bear—but all of these, as a constant certainty, in Combination. Estimates promptly furnished. Metal-Craft Manufacturing Company, Chicago, Box 259-W.

A CAPABLE American Inventor—Improving, Designing, Inventing of Ideas, Inventions and Patents. Address H I P, 722 Mace St., Greensburg, Pa.

PATTERNS, wood and metal. Models, tools and dies. Brass, bronze, aluminum and iron castings. Screw machine work, production work of all kinds. Write Modern Machine & Pattern Co., Terre Haute, Ind.

FREE List describes latest Novelties, Toys, Preparations, agents' goods, you can manufacture. We furnish plans, patterns, ideas. A. Barter, 3937 Tracy, Kansas City, Mo.

SPECIAL Machinery builders, tool and die makers, forgings. Patents developed. C. M. Bindner, Sec'y, Market at Prospect, St. Louis, Mo.

MANUFACTURING screws, nuts, bolts, automobile parts, and parts for any other kind of Machines in Iron, Brass and Steel. William Grieshaber, 624 Manor Street, York, Pa.

WANTED, concern to manufacture and market Safety Lock for automobile cushions. E. E. Davidson, 610 S. P. Bldg., Houston, Texas.

MANUFACTURING Models, Dies, Stampings, Brass Work, one or thousands. Baum's Metal Specialties, Kansas City, Mo.

WOOD articles manufacture. Model supplies; patterns, lumber, mouldings, tools. The Woodcraft, 105 West, 100 Street, New York.

OUR factory will make your models, manufacture your articles as well as build your tools, dies and fixtures. Standard Die & Specialty Co., 1932 Austin Ave., Chicago, Ill.

WIRE goods made to order. Cooley Mfg. Co., 530 N. Western Ave., Chicago.

MACHINE work of any kind wanted by well equipped shop. The Greaves-Klusman Tool Co., Cincinnati, Ohio.

MACHINERY, TOOLS AND SUPPLIES

SURPLUS Machinery from our plant at extremely low prices. Lathes. Drill presses. Shapers. Milling machines. Hack saws and small tools. Ask for list. Electro Platers Supply Co., 547 Considine Ave., Cincinnati, Ohio.

16" SMITH and Mills Crank shaper, \$500.00; 20"x10" Bradford engine lathe, \$375.00; 10" Drill press with chuck, new, \$19.25; No. 60 Heald auto cylinder grinder, \$750.00; Geared chain hoists, one ton, \$27.50; 1/4 H.P. New motors \$15. Write for complete machinery and supply catalog. Cincinnati Machinery Supply Co., 218 E. Pearl St., Cincinnati, Ohio.

BOLTS, nuts, rivets, etc. O. L. Dickey, Bayonne, N. J.

FOR Sale—No. 2 Brown & Sharpe Miller, \$250.00. Photo. Lucas & Son, Bridgeport, Conn.

GOODELL Bench Lathe, every extra, perfect, half price; particulars. Route 2, Box 86, Lankershim, Calif.

WATCHMAKER'S Lathe, with complete screw cutting attachment at a bargain. R. Jaegermann, 5815 Easton Ave., St. Louis, Mo.

CONCRETE Building Block Machines and Molds. Catalogue free. Concrete Machine Co., 5 N. Main St., St. Louis, Mo.

ELECTRICAL

MOTORS—1/4 and 1/2 hp., split phase and repulsion induction. Electrical books, Toy Motors. Catalog. Manhattan Co., 333b W. Manhattan Blvd., Toledo, Ohio.

ENGINES, MOTORS AND DYNAMOS

ALTERNATING current motor bargains, single and three phase. All sizes, all kinds, both new and rebuilt. Send for new price list. Guaranteed makes only. General Electric, Wagner, Westinghouse, Century. Motors bought, repaired, exchanged. Hyre Electric Co., 615 HF So. Dearborn St., Chicago.

ALTERNATING Current, One Phase Motors, Repulsion Type, New. One Horse Power \$39; 1/2 HP \$29. Rebuilt 1/4 HP \$6. Steege Co., 25-27 South Clinton, Chicago, Ill.

MOTORS—New GE 110 or 220 volt 60 cycle Single Phase 1/4 HP \$11.90; 1/2 HP \$28.53; 1 HP \$38.50. Mail \$3 check or money order. We will ship COD anywhere. Motor Specialties Co., Crafton, Penna.

GOVERNORS for Auto Engines. Let us show you how to make a power plant for the shop or farm. A. C. S. Governor Co., 214 No. Los Angeles St., Los Angeles.

HERE is your opportunity to obtain grinders and buffers, brand new, they are full 1/4 H.P., 110 volt, AC, 60 cycle, with cord and plug, with 6" emery wheel on one side and 6" buffer on the other, enclosed dust proof motor. We only have a limited number left at \$15.75 each. Cash with order. Brand new 1/4 H.P., 110 volt, AC, 60 cycle, motors with pulley at \$10.00 each. Immediate shipment. General Distributing Co., Security Storage & Van Co., Duluth, Minn.

MOTORS: Alternating Current 1/4 Horse, 110 V., 1750, \$6.50. New Direct Current 1/4 Horse, 110 V., 3300 speed, \$3.75. Special lot 32 V., 25 Amp., new farm lighting plants with engine, \$35.00. Also other bargains. Queen City Electric Co., 1736 Grand Ave., Chicago, Ill.

DO you want an electric lighting plant on your farm, with your gasoline engine and one of our 1,000 Watt, 32 volt, Westinghouse generators. You can have electric lights in your house, barns, etc., at a very low cost. Run your washing machine, cream separators, etc. The cost of the above generators are \$48.00 each. Write for bargain catalog on engine driven lighting plants. General Distributing Co., Security Storage Bldg., Duluth, Minn.

OTHERS have successfully sold their machinery through our columns—so can you. Ask me for proof. M. L. Rund, Manager, Classified Advertising, Popular Mechanics Magazine, Chicago.

BENDING MACHINES

THE famous Hossfeld Wrenchless Universal Bender is the last word in bending machines; bends metal, cold or hot, into most any conceivable shape, including Eye-bolts and Automobile Spring Eyes. Bends up to 1" bars or 1 1/4" Pipe cold. Used by the largest corporations, yet so inexpensive that even a farm shop need not be without one. Send for Circular. Hossfeld Mfg. Co., Box 344, Winona, Minn.

BLACKSMITHS

BLACKSMITHS, Make More Money in Job Shop or Factory Doing Hard Jobs Easy. Be a Master Machine and Plow Blacksmith and Expert Tool Dresser and Tempering to a Standard with Collard Tempering Charts. All for One Dollar. Samples Free. W. M. Toz, Sidney, Ohio.

FOR SALE—MISCELLANEOUS

2-15 DROP Annunciators—150 Push Buttons. Lind, 3238 Encinal Ave., Alameda, Calif.

ADDRESSOGRAPHS, Letter Folders, Multigraphs, Envelope Sealers, Duplicators, less than half price. Guaranteed. Pruitt Co., 117 No. Market, Chicago.

EXCHANGE Colorado land, 10 acres. Want telescope, 3 1/2 objective lens. F. H. Freeland, Hot Springs, S. Dak.

BUY—Exchange—Sell! Many of our readers have for sale or exchange the article you are looking for—and lots of them are looking for the very items you want to turn into cash. Get together! Let our two million five hundred thousand readers know your wishes—they'll help you! Send your ad today to M. L. Rund, Manager Classified Advertising, Popular Mechanics Magazine, Chicago.

WANTED MISCELLANEOUS

MAIL us your discarded Jewelry, Gold, Crowns and Bridges, Watches, Diamonds, Silver, Platinum, and old False Teeth. Money promptly mailed. Goods returned if offer refused. United States Smelting Works, (The Old Reliable), Dept. 71, Chicago.

REAL ESTATE, FARM AND ORCHARD LAND

ATTENTION—"Get acquainted." Cash for your property. Farm, Hotel or Retail Store, no matter where located; confidential service. Hayes' Business Agency, Cincinnati, Ohio.

CASH for Your Property or We'll Trade Little or Big—Anything for Anything Here, There and Everywhere. More than a Million in Income Properties for your consideration. Carver-Morris Realty Service, 104 East 14th, Kansas City, Mo.

COME to Virginia where seasons are right. Buy farm direct from owner. J. S. Wrenn, Emporia, Va.

FINE Home and 180 Acres. Furniture and Equip.—All \$1,850. Bldgs. insured \$2,000 with splendid 7-room house, convenient hustling town; Widow's low price \$1,850, half cash. Details pg. 8 free illus. Catalog. Strout Agency, 255-P, 4th Ave., New York City.

HERE'S your land, \$10 down and \$10 a month buys twenty acres of my best land near lakes and towns in central Michigan for \$400, or ten acres for \$250. Write at once for free picture book. G. W. Swigart, P-1276 First Natl. Bank Bldg., Chicago.

ILLINOIS Farm—240 acres, no waste, good, fertile land, 6 Room house, Large Barn, and other outbuildings—2 miles from Town—\$60.00 per acre. Good terms for the right man. C. C. Beacham, Centralia, Ill.

120-ACRE Southern Wisconsin dairy farm, good soil and buildings, \$135.00 per acre, \$2,500.00 down. O. Coburn, Whitewater, Wis.

\$10.00 DOWN, \$3.00 monthly, buys 5 acre Cadillac, Michigan, Fruit or Poultry farm land, Camp Site or Summer Home. Near fine lakes and streams. \$200.00. Best hunting, fishing, bathing, swimming. Good auto roads. Get booklet and map. O. Hermann, 140 So. Dearborn St., Chicago.

OZARK land; ten acres near White River and proposed Dixie Dam, \$100; \$5 monthly. Alvin Zimmermann, 1800 N. Fifth, Kansas City, Kan.

PECAN-Orange-Fig Groves "On the Gulf" Monthly payments. Guaranteed care. Big, quick returns. Suburban Orchards, Dent, M. Biloxi, Miss.

SELL your property quickly for cash, no matter where located. Don't pay big commission. Particulars free. Real Estate Salesmen Co., Desk B, Lincoln, Nebr.

DOGS AND PETS

COONHOUNDS and Combination Hunters, trained in swamps and hills of Tennessee and Alabama. Free trial before you buy. Write Southern Farm Coonhound Kennels, Selmer, Tenn.

TRAINED duck dogs. Rexford McNutt, Hortonville, Wis.

PEDIGREED Pups High Class, Police, Alredales, Collies, Chows, Danes, Wire Hair, Manlewood Kennels, Medway, 3, Mass.

BEAUTIFUL registered Bull Pups, \$15. Bulldogs, 501 Rockwood, Dallas, Texas.

BEAGLE pups—Males \$8.50. Females \$7.50. Floyd Boyd, Millersburg, Ohio.

GREAT Dane Harlequin Puppies registerable, sired by Oberon Imported Harlequin, K. F. Hogrefe, Battle Creek, Nebr.

RABBIT Sale—Pedigreed, \$2.00 up. Illustrated book, 10c. Maikranz Rabbitry, New Bethlehem, Pa.

FOXES, raccoons, muskrats, skunk, ferrets, rabbits, squirrels, mink, opossums. B. Tippman, Caledonia, Minn.

PERSONAL

WONDERFUL health book for only 10c (publisher's price \$1.00). Appreciated by every reader, sick or well. Teaches health the natural way, also suggests reliable self treatment of disease. Address, Author, Box 437, Seattle, Wash.

UNUSUAL Horoscope Consisting of Extensive four page Special Horoscope, and Astro Analysis. Send 50c and birthdate. Money returned if dissatisfied. Prof. Bolles, Box 125, Cranford, N. J.

SEND 25c coin and your date of birth for forecast of your vibrations for 1927. Aryel Synclare, Numerologist, Box 25, Patton, Calif.

STOP stammering, increase salary. Descriptive booklet Free. Samuel A. Robbins, 399 Boylston, Boston, Mass.

ASTROLOGY—Stars Tell Life's Story! Send birthdate and dime for character reading. M. Kleman, 90 Adelaide St., Winnipeg, Man.

QUESTIONS answered—Science, History, Love. Any sensible question, one 50c—three \$1. Lincoln Syndicate, 1573 17th Street, Milwaukee, Wis.

FASCINATING, entertaining, instructive. Exchange postcards, stamps, etc. Interesting booklet, 10c. Edd Ericson, Elroy, Wis.

ASTROLOGER will read your life. Test predictions for one year, 20c, dimes or stamps. Send year and birthdate. Money back, if dissatisfied. G. Niemeyer, 621 McConnell Terrace, Atlantic City, N. J.

TOBACCO or Snuff Habit Cured or no pay. \$1.50 if cured. Remedy sent on trial. Superba Co., N3, Baltimore, Md.

MISCELLANEOUS

MEXICAN made pistol holders, cartridge belts; horse hair goods, lariats, sombreros. List free. Ingersoll Leather Co., 307 Fannin, Houston, Texas.

ARTIFICIAL Eyes. Booklet free. Denver Optic, 559 Barclay, Denver, Colo.

BIG Discount on fruit, shade, ornamental trees, shrubbery, etc. Send list of what you need. Desk M. Baldwin Nursery, Centralia, Ill.

YOURSELF. Learn to hire yourself at your own price. Particulars free. Femco, Alton, New Hampshire.

BIG Red Fountain Pen, regular \$4.50 seller, only \$1.55 while they last. Guaranteed satisfactory. Order now. Southern Sales Co., Waco, Texas.

FUNNY White Mule—America's greatest magazine, including snappy pocket novelty 10c. White Mule Beaver Dam, Wis.

SAFE-OPENING taught by mail; only expert methods used. C. I. Mitchell, Temple, Tex.

MIRRORS Resilvered at Home. Costs Less 5 cents per square foot; you charge 75 cents. Immense profits, plating autotaps, reflectors, tableware, stoves. Refinishing metalware, etc. Outfits furnished. Write for information. Sprinkle, Plater, 288, Marion, Ind.

ALASKA Indian had made beaded Hair Seal Moccasins, very comfortable and durable; average price for average size \$2.25 per pair Post Paid. Perry M. Hern, Skagway, Alaska.

TATTOOING—learn tattooing, with my outfits. Send for circulars; they explain everything. Sergt. Bonzey, 367 South Main, Providence, R. I.

HARRIS Tweed, cream of Scotch Home-spuns direct from Makers. Suit-lengths by Post, \$2.00 per yd. Samples free on stating shades desired. Newall, 270, Stornoway, Scotland.

HOMEOPATHIC and Biochemic preparations sent postpaid to all parts of the world. Manual and booklets free. Halsey Bros. Co., 645 St. Clair St., Chicago, Ill. Established 1855.

BUILD yourself an electric clock! Instructions and blueprints of a novel model everyone can make. \$1. Particulars free. Albert Delbig, Electrical Engineer, 1690 Park Ave., New York.

SEND us your key and 25c. We will duplicate and return same day. Tuerk Mfg. Co., 32 No. Jefferson St., Chicago.

CAN You Draw? Make money at home. Something new. No canvassing. Sample and particulars 10c. "Straley," 1017 W. Mulberry, Springfield, Ohio.

WEEDS—Cut them with cutter bar on Shaw Garden Tractor. Also plows, cultivators and runs belt machinery. Low prices. Immediate delivery. Shaw Manufacturing Company, Department C, Galesburg, Kans.

CUTS anybody can make. Simple, cheap process. \$1. Specimens, particulars, 2c stamp. M. Day, Windfall, Ind.

AMATEUR Cartoonist's money making plan \$1.00. Particulars free. Smith's Service, Wenatchee, Wash.

I CATCH from 45 to 50 foxes in from 4 to 5 weeks' time. Can teach any reader of this magazine how to get them. Write for particulars. W. A. Hadley, Stanstead, Quebec.

YOU need a better grip on mathematics? Tell us to send you a copy of "Mathematics for the Practical Man," only \$1.50. By common sense methods it removes the mystery and difficulties so algebra and even calculus are made simple. Assuming your knowledge is limited to arithmetic you quickly and easily gain a working knowledge of Algebra, Geometry, Trigonometry and Calculus. Simply pay postman when he hands you the package. Address Popular Mechanics Press, Room 810, 200 E. Ontario St., Chicago.

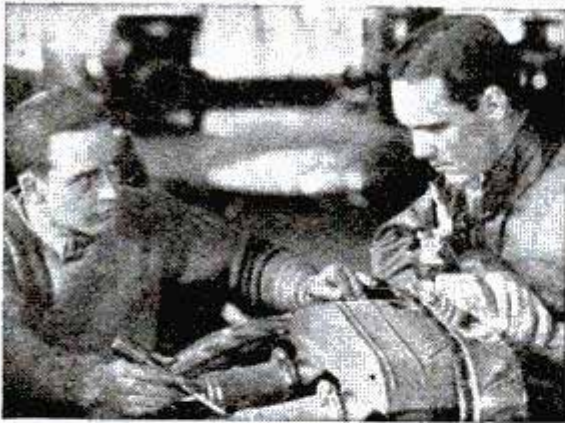

Automobile Experts in Demand

*Study with the same school that helped
to train many leading men in the
automobile industry*

THE best proof of the value of the home-study courses of the International Correspondence Schools is the success of I. C. S. students. This success is especially apparent in the automobile industry.

Jesse G. Vincent, Vice-president of the Packard Motor Car Co., is a former I. C. S. student. So is Walter P. Chrysler, President of the Chrysler Corporation. E. V. ("Eddie") Rickenbacker, Vice-president and Director of Sales of the Rickenbacker Motor Car Co.; Hiram Walker, Chief Engineer of the Chandler Motor Car Co., and John Moore, designer of the famous Ansted Motor, are also former I. C. S. students.

The first step they took was to mark and mail an I. C. S. coupon similar to the one printed below. Make your start the same way and make it right now. We'll gladly send you complete information about the I. C. S. Automobile Courses or any other course in which you are interested.

INTERNATIONAL CORRESPONDENCE SCHOOLS
Box 5604-E, Scranton, Penna.

Oldest and largest correspondence schools in the world

Without cost or obligation on my part, please tell me how I can qualify for the position or in the subject before which I have marked an X:

- | | |
|---|--|
| <input type="checkbox"/> Complete Automobile Course | <input type="checkbox"/> Gas Engine Operating Course |
| <input type="checkbox"/> Automobile Electric Equipment | <input type="checkbox"/> Complete Gas Engine Course |
| <input type="checkbox"/> Electrical Engineering | <input type="checkbox"/> Architect |
| <input type="checkbox"/> Electric Lighting | <input type="checkbox"/> Architects' Blueprints |
| <input type="checkbox"/> Mechanical Engineer | <input type="checkbox"/> Contractor and Builder |
| <input type="checkbox"/> Mechanical Draftsman | <input type="checkbox"/> Architectural Draftsman |
| <input type="checkbox"/> Machine Shop Practices | <input type="checkbox"/> Concrete Builder |
| <input type="checkbox"/> Railroad Positions | <input type="checkbox"/> Structural Engineer |
| <input type="checkbox"/> Civil Engineer | <input type="checkbox"/> Chemistry <input type="checkbox"/> Pharmacy |
| <input type="checkbox"/> Surveying and Mapping | <input type="checkbox"/> Airplane Engines |
| <input type="checkbox"/> Metallurgy <input type="checkbox"/> Mining | <input type="checkbox"/> Agriculture and Poultry |
| <input type="checkbox"/> Steam Engineering <input type="checkbox"/> Radio | <input type="checkbox"/> Mathematics |

BUSINESS TRAINING COURSES

- | | |
|--|---|
| <input type="checkbox"/> Business Management | <input type="checkbox"/> Salesmanship |
| <input type="checkbox"/> Industrial Management | <input type="checkbox"/> Advertising |
| <input type="checkbox"/> Personnel Organization | <input type="checkbox"/> Better Letters |
| <input type="checkbox"/> Traffic Management | <input type="checkbox"/> Show Card Lettering |
| <input type="checkbox"/> Business Law | <input type="checkbox"/> Stenography and Typing |
| <input type="checkbox"/> Banking and Banking Law | <input type="checkbox"/> Business English |
| <input type="checkbox"/> Accountancy (including C.P.A.) | <input type="checkbox"/> Civil Service |
| <input type="checkbox"/> Nicholson Cost Accounting | <input type="checkbox"/> Railway Mail Clerk |
| <input type="checkbox"/> Bookkeeping | <input type="checkbox"/> Common School Subjects |
| <input type="checkbox"/> Private Secretary | <input type="checkbox"/> High School Subjects |
| <input type="checkbox"/> Spanish <input type="checkbox"/> French | <input type="checkbox"/> Illustrating |

Name.....

Street
Address.....

City..... State.....

Occupation.....

If you reside in Canada, send this coupon to the International Correspondence Schools Canadian, Limited, Montreal

You-and This Machine Can Earn \$300 a Month

Start a **Big Profit Making Business** of your own—"One Day Battery Charging." Requires **small space and practically no investment.** Anyone can successfully operate. Charges batteries in $\frac{1}{4}$ the usual time at $\frac{1}{4}$ the cost. **Every car owner a customer.**

Try it out for thirty days at our risk, under absolute **money back guarantee.** The HB One Day Battery Charger will pay for itself on easy monthly payment plan with practically no expense to you—and bring you a handsome profit besides. Built by Successful Manufacturers Since 1893.

Write for full particulars in Bulletin M—NOW!

HOBART BROS. CO., Box M10, Troy, Ohio

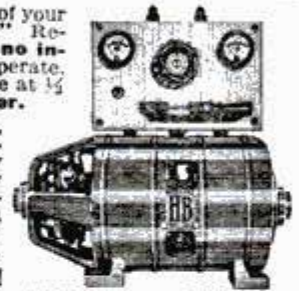

Music Instructor

These books are illustrated and gotten up to make the method of self-teaching so simple that any one without any knowledge of music could learn to play any of the following:

SAXOPHONE	30c	MANDOLIN	30c
ACCORDION	30c	PIANO	30c
BANJO	30c	UKULELE	30c
GUITAR	30c	VIOLIN	30c

The above prices are postpaid. Any above 4 titles, \$1.00 postpaid.
J. C. DORN, 725 S. Dearborn St., Dept. 17, CHICAGO

LEARN WATCHMAKING AND ENGRAVING



BY OUR PROFIT-SHARING PLAN OUR GRADUATES SUCCEED

One of our Iowa students started in a very small way—now doing over \$30,000 a year. Another in Wisconsin, over \$10,000 the first year. Day or night classes. Call or write for FREE BOOK

Chicago School of Watchmaking, Dept. 2101, 4844 Lincoln Avenue, CHICAGO

Become an OIL PAINTER

EARN WHILE YOU LEARN Our NEW method trains you in three months to paint on Canvas beautiful Saleable Pictures. Your Big Chance to become a Modern Artist. Individual Training at Home. Write for full plan.

HOME ART STUDIOS, 5220 Lakewood Ave., CHICAGO



BIG PAYING HOTEL JOBS OPEN

to trained men and women; we train you by mail; get 20 years' hotel experience in few months; earn \$3,000 to \$10,000 a year; fine living; work is fascinatingly interesting; quick advancement. Send for FREE BOOK today!
LEWIS HOTEL TRAINING SCHOOLS, Room C-329, Washington, D. C.

Health Food Directory —

How to select the proper foods for gaining weight; reducing; building vitality; disease resistance; constipation; building muscle, etc. Rates and tabulates standard branded foods. No other book like it. 150 pages of valuable information. Special price 25c, postpaid. Limited edition.

Macfadden Publications, Inc., Dept. P.M.10, 1926 B'way, N. Y. City

Be a High-Salaried GARMENT DESIGNER

Join this wonderful profession with its amazing opportunities for both sexes. Clean, dignified work.

**MEN AND WOMEN
EARN \$75 TO \$500 EVERY WEEK**

PARRY PRACTICAL TRAINING qualifies you in a few weeks to hold BIG-PAY positions in America's largest fashion salons and clothing and fur industries. No experience needed. This long-established school is the only one officially recommended and endorsed by Chicago Designers' Association of Women's Apparel. Write for full particulars of special offer.
PARRY GARMENT DESIGNING INSTITUTE
Dept. 107, 19 S. Wells St. Chicago, Ill.

Mail This Coupon Now

R. H. Parry, Director, PARRY GARMENT DESIGNING INSTITUTE

Dept. 107, 19 South Wells Street, Chicago, Illinois

You may send FREE particulars of Designing Course checked.

MEN'S GARMENTS

WOMEN'S GARMENTS

FURS

Name.....

Address.....

FREE This New Book

Tells how, with \$5 to start, I made more than \$100,000, as a Real Estate Specialist. Tells how I help other ambitious men and women make big money my way. Tells how you, *yourself*, can learn the secrets of my success—use my money-making system—build up a big-profit business of your own—right at home—in your spare time. Send at once for this intensely interesting book of fascinating facts and positive proof of amazing success.



WHEN I say that this new book tells you about a way to make *big* money—that's just what I mean—**BIG MONEY!** D. H. Garrett made \$630 his first week. F. W. Hovey made \$1,500 in one deal. H. G. Stewart made \$14,400 in less than a year. L. C. Clarke cleaned up \$4,500 in one transaction. And other wide-awake men and women are making more money in the Real Estate business than they ever dreamed possible.

But don't take my word for it—don't take *anybody's* word. Get the free book of *facts* and *proof*. It doesn't cost a penny. Yet it can be worth more to you than any other book you ever owned.

You will find this book one of the most amazing books of business opportunity you ever read. It tells just how you can get into Real Estate—the business of a million opportunities—where

Proof!

"It may astound some to know that I have made between \$8,000 and \$10,000 in three months, which may be directly attributed to your splendid Real Estate System."—A. W. Fosgreen, New York.

"I have been helped a great deal by your system. I have a new car, two typewriters, stenographer and dandy office, and money in the bank, all through my own efforts without any capital to start."—Alice Moore, Conn.

"I was a Ford salesman earning \$300 a month. Your System increased my earnings 200%. I now own a Chrysler Sedan, up-to-date office equipment and have increased my bank account."—Alfred J. Bennett, Mich.

"Your System is wonderful. Without giving up my job as stationary engineer I made \$900 in three months in my spare time."—Matthew J. Stokes, Penna.

"Connected with a firm that employs one hundred men. Have earned over \$2,300 this month."—E. M. Coffey, New Jersey.

trained men often make as much in *one deal* as the average man makes in *a whole year of hard work*.

Why be satisfied with small pay? Why be content with \$20, \$30, \$40 a week? Why struggle along, year after year, on an in-

come too small to meet your needs? Why keep plodding along in a business that is limited in its opportunities—a business that offers you no attractive future—no chance to make really big money?

There is no room here to tell of the money-making opportunities that Real Estate holds for you. So, get my free book—and *get it now*. It contains facts you can't afford to miss—positive proof of what I have done—what others are doing—and what you, yourself, can do.

Fill out the coupon at the foot of this page. Tear it out and mail it. Then you will receive—without charge—your copy of this book of business opportunity, which points a straight, sure path to a better business life and a bigger bank account.

Don't wait. Don't delay. Don't cheat yourself out of this big chance to make big money. Get the facts—the brass-tack facts—before it is too late. American Business Builders, Dept. 44-J, 18 East 18 Street, New York.

Free Employment Service

Real estate corporations, subdivision operators, auctioneers, realty bond houses, building and loan associations, insurance companies and others requiring trained representatives (men or women) should register at once for our free employment service. Address—Business Development, Dept. 44-J, 18 East 18 St., New York.

This Book Shows How

American Business Builders, Inc.
(Authorized Capital \$500,000)
Dept. 44-J, 18 East 18 St., New York



Send me your free book, "How to Become a Real Estate Specialist," containing facts and proofs of how I can make big money in Real Estate.

NAME.....

ADDRESS.....

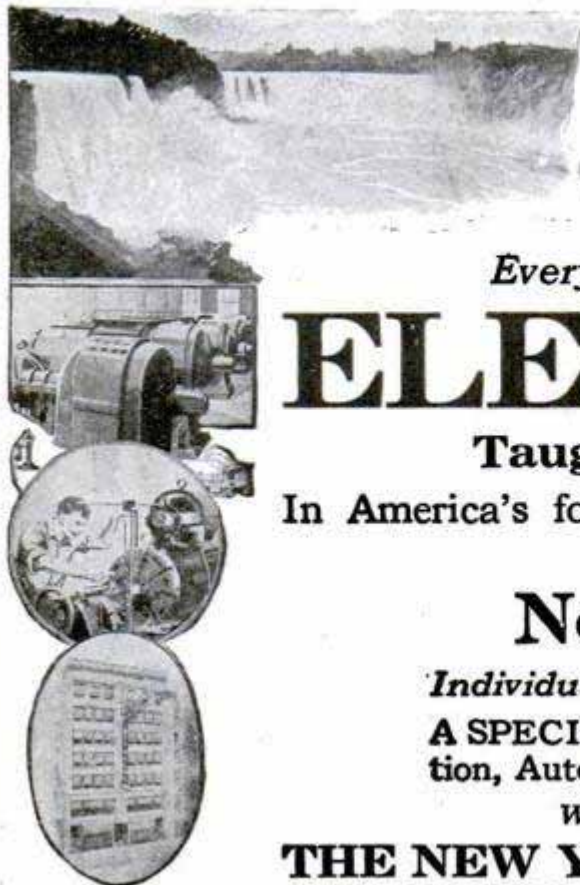

Learn By Doing!

Every phase of all branches of

ELECTRICITY

Taught By Actual Practice

In America's foremost institution for trade training.

Established 1902

No Books Used

Individual Instruction. Start Any Day.

A SPECIAL and SEPARATE Course in Ignition, Auto Lighting and STARTER Systems.

Write for FREE 64-Page Catalog

THE NEW YORK ELECTRICAL SCHOOL
44 West 17th Street NEW YORK CITY



DO YOU LIKE TO DRAW?

It's Easy To Learn When Shown In The Right Way

Some of the cleverest cartoonists and comic artists in America today learned how to draw quickly—by following **CARTOONIST EVANS' SIMPLE AND EASY METHOD**. This school is recommended by foremost cartoonists because they know the students are handled right. If you like to draw, send 6¢ in stamps for **portfolio of cartoons and full details**. The course is **NOT EXPENSIVE**.

The W. L. Evans School of Cartooning 821 Leader Building
CLEVELAND, OHIO

"THERE'S MONEY IN IT"

AT HOME

LEARN TELEGRAPHY

AT HOME

MORSE AND WIRELESS



TEACH YOURSELF

in half usual time, at trifling cost, with the wonderful Automatic Transmitter, **THE OMNIGRAPH**. Sends unlimited Morse or Continental messages, at any speed, just as an expert operator would. Adopted by U. S. Government, and leading Universities, Colleges and Telegraph Schools. 3 Styles. Catalog free. **OMNIGRAPH MFG. CO., 13-19 Hudson St., NEW YORK**

If you own a Radio Phone Set—and don't know the code—you are missing most of the fun.

TRAVEL—for 'UNCLE SAM'

RAILWAY MAIL CLERKS
MAIL CARRIERS—POSTOFFICE CLERKS
\$1700 to \$2700 a Year for Life

No "lay-offs" because of strikes, poor business, etc.—sure pay—rapid advancement. City and country residents stand same chance. Common sense education sufficient—no political influence.

STEADY WORK

Cut coupon and mail it before turning the page.

MEN—BOYS
18 to 45

Use Coupon Before You Lose It

COUPON

FRANKLIN INSTITUTE, Dept. B-174, Rochester, N. Y. Rush to me, entirely free of charge, (1) A full description of the position checked below; (2) 32-page book, "How to Get a Government Job"; (3) Free Sample coaching lessons.

Railway Mail Clerk (\$1900 to \$2700) Customs Positions (\$1140 to \$1860)
 Postoffice Clerk (\$1700 to \$2300) Internal Revenue (\$1140 to \$1860)
 City Mail Carrier (\$1700 to \$2100) Rural Mail Carrier (\$2100 to \$3300)

Name

Address

PLAY A SAW!

I'll Teach You in 24 Hours!

Be Popular! Amaze Everybody— Play for Fun or Money

Wonderful music from a saw—sweet and mellow like a rare old violin. Tone effects that are positively startling—all so unexpected that nothing compares with it in winning instant popularity in your social group or as a salaried entertainer. *And it's so easy!*

Just to prove how quickly you can learn, I'll send you a genuine "Musical Saw" (special temper, process patented) for **FIVE DAYS' TRIAL**. I guarantee that in 24 hours you can play tunes like "Old Black Joe" and "Home, Sweet Home." Then the latest jazz and song hits, operatic and classical music. Amazingly simple—no notes to read, no dreary practice.

Thousands Successful by My Method

Just three short, simple lessons reveal every secret of my 12 years' success as a professional saw musician—secrets with which I have taught thousands. Many of my pupils are on the vaudeville stage, playing in dance orchestras, making big money as entertainers. Let me prove that you, too, can quickly play like a professional—amaze your friends and always be in demand at parties and entertainments.

PHONOGRAPH RECORD of Saw Solo and Duet **FREE!**

Two beautiful selections, amazing to anyone who has never heard the Musical Saw's sweet tone. Send 10c to cover handling and postage. Or if you do not want the record, ask only for my big **FREE Trial Offer** with which all my pupils have made their start to fame and money.



Robert S. Alter, broadcasting celebrity, has delighted audiences of six leading stations, including an appearance from WSN "Steamship LEVIATHAN."



"Bud" Gamble is paying his way around the world with the Musical Saw. Is now in Europe.



Charles Guglielmi booked to play saw solos in Broadway (New York) motion picture theatre.

Mail Coupon

C. J. MUSSEHL
Pioneer Artist on the Musical Saw, has taught thousands to become Experts, Vaudeville Stars and High-Priced Entertainers.



I'll Loan You The Saw 5 Days Free!



C. J. Mussehl, Pres.
Mussehl & Westphal
257 W. Water St.
FORT ATKINSON, WIS.

- Without obligation to me, send me, postpaid:
- Full particulars about **FREE Trial Offer**.
 - Phonograph Record. (Send 10c, stamps or coin, to cover handling and postage if you want record.)

Name.....

Address.....

Town and State.....

Mussehl & Westphal
Fort Atkinson, Wis.

Pain and Disease

Quickly Conquered by

VIOLET RAY



Let us tell you how thousands of men and women suffering from rheumatism, neuritis, paralysis, nervousness, skin diseases, headaches, constipation, sprains, prostate trouble, goitre and many other ailments, even hay fever and asthma, have found quick relief—new health and vitality with this marvelous, scientific invention. Pains vanish almost instantly.

Violetta

Ten Days FREE Trial

For Health—Beauty—Vigor

Endorsed and used by hospitals, sanitariums and physicians. Every home can now have one. Saves hours, days, months of suffering. No medicine. Painless, pleasant treatment. Only the violet ray can penetrate to every nerve affected. Simple, safe, painless—anyone can use VIOLETTA. Why suffer pain and poor health when you can try VIOLETTA 10 days FREE.

This Book FREE

Tells all about violet rays—how this marvelous discovery by Nikola Tesla, the electrical wizard, now brings this mysterious curative power to all. Contains many astounding testimonials from our thousands of satisfied users. Send for the facts and our liberal trial offer today. Mail the coupon now.



VI-REX CO., Dept. 210
2304 Warren Avenue, Chicago

VI-REX CO., 2304 Warren Ave., Dept. 210 Chicago
Please send me your free book on Violet Rays and details of your 10 days' free trial offer.

Name.....

Address.....

City..... State.....

Ailment.....

BIG DEMAND—BIG PAY for Mechanical Dentists

Lots of Jobs **WE TRAIN YOU QUICK TO FILL THEM**



This Stivison trained expert can earn more in one day than some mechanics in other trades make in a week. He got his training by the tool-using, actual doing method taught each student personally by a graduate Dentist. No books—no tiresome lectures. You do work that is actually worn away by patients who come to my clinic for dental work. Only a dentist knows what dentists need. I teach every branch of Laboratory Dentistry. Thousands of dentists do laboratory work because of shortage of mechanical dentists.

Dentists Want My Graduates

The average student is ready to go out and take a job after six months, but you can stay until you are satisfied that you have mastered mechanical dentistry. Anyone interested in a mechanical profession should consider it his first duty to find out what mechanical dentistry offers and why it is such a paying profession. If you would get in the big pay class you should get my latest book, "A Short Cut to Success," which explains the possibilities, my method of teaching and my amazing offers in regard to Real Dentists' Tools and R. R. fare to Kansas City. This book is sent without charge to anyone interested in a mechanical future that offers big pay opportunities. If you have a common school education, good eyes and hands you, can learn Mechanical Dentistry.

Write Today

STIVISON DENTAL INSTITUTE
503 McMillen Bldg. KANSAS CITY, MO.

Brain-Feast

Solvents, grapefruit, berries, tomatoes, UNDER PROPER CONDITIONS:—dissolve tumors, blood clots, lime in joints (enabling use of limbs), eliminate catarrhal matter from nose, ears, tonsils, bronchials, etc. PYORRHOEA. See reprint "Dental Digest". PREGNANCY. Delivery painless. Eat nerve or muscle food TO SUIT OCCUPATION prevent undue retention of WASTE in blood (basis of all disease).

Educational Booklet 10c. BRINKLER SCHOOL OF EATING, Dept. 42-K, 131 West 72nd St., New York

PIANO JAZZ BY "PIANO BILL"

Teaches: Player Piano Effects, Ear Piano Playing, Negro Harmony, Chimes, Blues, Sweet Harmony Snappy Chord Combinations, Etc. 15 Easy lessons. Write for circulars. Kindly state if you already play and how you do it. Write "PIANO BILL", Dept. 7, Toronto 3, Canada.

BECOME A RAILWAY POSTAL CLERK

Pay has been raised from \$1900 to \$2700 a year. Steady job. Pleasant work. Common education sufficient. No "pull" necessary. Mail coupon for FREE Catalog.

Patterson Civil Service School
Dept. 810 ROCHESTER, N. Y.
Sirs: Send me without charge your Catalog, describing this and other U. S. Government positions.

Name.....

Address.....

Patterson Civil Service School
Dept. 810 Rochester, N. Y.

How to Get that RAISE in PAY

Come on up to Chicago for 12 weeks or less. I'll start you into Big Pay in fascinating Electrical Job.

Now — no more need for long years of flunky work. You can step into a Big Money job quick, this way. Actual experience here—with expert supervisors. No previous experience or higher education needed.

FIT YOURSELF FOR ONE OF THESE POSITIONS

- Electrical Contractor Up to \$25,000 per year
- Electrical Estimator Up to \$15,000 per year
- Maintenance Engineer \$3,000 to \$5,000 per year
- House Wireman \$1.00 to \$2.00 per hour
- General Electrical Repairman \$1.00 to \$1.75 per hour
- Motor and Generator Expert \$1.00 to \$1.50 per hour
- Armature and Stator Winder \$1.00 to \$1.50 per hour
- Telephone Expert \$40 to \$75 per week
- Trouble Shooter \$40 to \$60 per week
- Radio Engineer Unlimited
- Sub-Station Engr., Installer or Operator \$150 to \$250 per month
- Boss of your own shop Unlimited

More Electrical Men Needed

Now is the time to start into this fascinating field. The demand for electrical men is growing faster and faster. More and more power companies are extending their operations. More and more railroads are being electrified. Large electric companies now have actually started the tremendous task of electrifying the farms. One of the first in this field was the Milwaukee Power Company, which this year has installed electricity on about 100 farms per month. Think what all these electrical developments mean to you! With this practical training you can quickly become a valuable man—and just at a time when trained men are most needed. Don't wait. Send the coupon below now for full details.

GREER COLLEGE OF ELECTRICAL ENGINEERING
 Dept. 1001 2024 S. Wabash Ave., CHICAGO

Free Electrical Book

Send the coupon now for this interesting book. All about electrical opportunities and how to make your start.

ERWIN GREER, President, Greer College
 Dept. 1001, 2024 S. Wabash Ave., CHICAGO.

Please send me your FREE BOOK and offer for Electrical Automative course
 It is understood I am not obligated in any way

Name

Address



Scene in radio department. Here you can fit yourself for commercial operator's license if you wish. We teach code as well as theory. Thoroughly practical from start to finish—as is the entire Greer training.

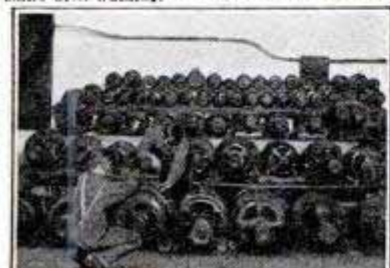

This view shows some of our spare motors, ranging from 1-6 to 25 H.P. These are of all types and makes—for you to disassemble, strip, rewind and experiment with all you wish. They are here for your use and for no other purpose.



View of part of the interior of the hangar for practicing house wiring—right in the Greer Shops. You learn here by real experience—with an expert always at hand to show you how.



Learning about parallel and series circuits in the Greer Shops. Individual instruction throughout this training. You go ahead as fast as you are able. No one is held back because someone else is slow.



Investigating the mysteries of an automatic telephone. This telephone system is rapidly replacing the old style in many cities. It takes an army of men to install the new mechanism and keep it in repair.

FREE
 Until further notice, all men taking electrical training in our shops are offered the AUTOMOTIVE COURSE with no added charge. This gives you two wonderful courses for THE PRICE OF ONE. A very valuable combination.

Learn to Boss the Job

Your training in the Greer shops is by actual experience. That is why our men are able to pick off the good jobs so soon after finishing here. That is why they are able to boss the work of less experienced men or to go into business for themselves.

Regarding Our Equipment

On our floors are over 200 motors, of practically every kind, type and make. Complete armature and stator department, with latest equipment for winding, etc. Rotary converters, alternating current generator, high tension line, automatic telephone panel—all right here in our shops for you to use. We have found that men in our shops learn easier, better and quicker, when allowed to take apart and reassemble any equipment they wish. Instead of forbidding this, we now find it wise to encourage it—along with our regular methods of instruction. None of our apparatus is enclosed in glass show cases nor by railings with "hands off" signs. It is real working equipment and serves its purpose only when you learn something valuable from it.

Free Employment Service

Our employment department is ready to help you—while in training and for life. Day and evening classes. The coupon below will bring you our big illustrated Electrical book free by return mail. Be sure and send the coupon now while you have it in your hands. Don't wait. Do it now.

FREE RAILROAD FARE TO CHICAGO IF YOU ACT PROMPTLY

PICK THE JOB YOU WANT

There's a way to get it



Men don't just fall into easy jobs or big pay positions—they prepare for the big chance before it comes.

Make up your mind today what you want to be, then take the first step at once. You don't have to go to college to get ahead. Other men have gone there for you and have put the things they learned there and through years of practical experience into easily understood books which give you a short cut to a better and a bigger job.

We have picked 13 of the best paying professions and have published for your benefit new editions of the most practical, the most valuable books we have ever printed on the subjects covered.

JIFFY INDEX

Our new Jiffy Index makes each book a quick reference work—no time need be wasted in search or study—put your finger on the facts you want instantly.

PAY-RAISING BOOKS

Automobile Engineering, 5 volumes, over 2,000 pages	\$24.80
Civil Engineering, 9 volumes, 3,900 pages, 8,000 pictures	29.80
Business Management, 8 volumes, 2,500 pages, well illustrated	29.80
Fire Prevention and Insurance, 4 volumes, 1,500 pages, 600 pictures	14.80
Electrical Engineering, 4 volumes, complete in every way	19.80
Modern Shop Practice, 6 volumes, 2,300 pages, 2,500 pictures	24.80
Steam and Gas Engineering, 7 volumes, 3,300 pages, 2,500 pictures	24.80
Law and Practice (with reading course), 13 volumes, 6,000 pages, illustrated	49.80
Telephony and Telegraphy, 4 volumes, 1,728 pages, 2,000 pictures	14.80
Sanitation, Heating and Ventilating, 4 volumes, 1,454 pages, 1,400 pictures	14.80
Drawing, 4 volumes, 1,578 pages, 1,000 pictures, blue prints, etc.	14.80
Employment Management and Safety Engineering, 7 volumes, 1,800 pages, 540 illustrations, charts and diagrams	24.80
Architecture, Carpentry and Building, 5 volumes, includes 58 beautiful architectural plates free	24.80

SHIPPED FREE

Words alone cannot describe the full value these books may be to you, so we ship Free for Examination. Pick the set you want, the price is plainly shown, but **Send No Money**; just your name and address, and the books will be sent promptly.

Take ten full days to read, test and examine them. You'll realize at once what a tremendous force for your future they can be.

After ten days you send only \$2.00; then \$3.00 per month until the balance is paid. **There Are No Interest Charges of Any Kind**; the price shown is the total.

EMPLOYMENT SERVICE

For the benefit of red-blooded men who look forward to bigger earnings and greater responsibilities—which we give through these books—we conduct a complete employment department and include this service without cost. We are in close touch with a great many employers whose needs you might never hear of except through us.

AMERICAN TECHNICAL SOCIETY,
Dept. X-719, Chicago, U. S. A.

Please send me set of

for 10 DAYS' examination. I will examine the books thoroughly and if satisfied, will send \$2.00 within 10 days and \$3.00 each month until I have paid the special price of \$..... If I decide not to keep the books I will return them at your expense at end of 10 days.

Name.....

Address.....

Reference.....

ELECTRICITY

Practical-Technical TRAINING

Great demand for practical-technical electricians and engineers. Fascinating work. Rapid advancement. Thousands of positions open. Finlay trained men earn \$10 to \$25 a day and more. Send today for latest catalog, beautifully illustrated, explaining One and Two year courses in Electrical Engineering. Also 12 weeks course in Practical Electricity. Degrees and certificates of efficiency awarded.

Courses to suit your needs

Finlay condensed method now in 24th successful year trains head and hand. Completely equipped shops and laboratories. Faculty of trained experts. Students assisted to positions.



EARN \$10 to \$25 A DAY

FINLAY ENGINEERING COLLEGE
112 Finlay Bldg. Kansas City, Mo.

Learn to Make SHOW CARDS

— Quick Easy Way!

Every Store Needs Clever Show Cards

Earn \$50 to \$75 a week. Business of your own. Marvelous method makes it amazingly easy to learn at home. Write now for Special Offer and illustrated book to Washington Show Card School, Dept. 3010-D, 1117-15th St., N.W., Washington, D.C.



SAXOPHONE MUSIC Catalog

Just out—complete catalog of latest jazz hits, also standard saxophone solos, duets, trios, quartets—2,000 selections. Largest general dealers of saxophone music and supplies in the world. *Expert repairing.* Send for free catalog today.

FINDER & URBANEK Inc., Dept. 1957, 1322 West Congress St., Chicago

DRAW CARTONS

Turn Your Talent Into Money

Cartoonists earn from \$50 to \$300 per week—some even more. Remarkable new Circle System of Drawing teaches you in half the usual time. Send for **booklet** and sample **lesson plate** explaining full details of the Course.

THE NATIONAL SCHOOL OF CARTOONING
623 Penton Building Cleveland, Ohio



Joy-STOMACH for SUFFERERS

For 27 years I have been telling stomach sufferers how to get well. Testimonials from all over the world tell of wonderful results. This information is sent without cost or obligation. Write for it today to

BYRON TYLER, Dietician. Estab. 1899
172 Gibraltar Bldg. Kansas City, Mo.

These Real Blue Prints and two Books Sent **FREE**



**Just
mail the
coupon below!
Send no money!**

Every builder can get these real blue print plans and our book "How To Read Blue Prints" without sending us a penny. Just send the coupon. Lots of valuable and interesting information—all free. Yes, and we'll send along another book on building; it tells why "the big money goes to the man who *knows*." It explains the practical Chicago Tech. easy method of home-training for men in the building trades. Learn how to get the jobs that pay most money or how to get into your own business as a building contractor.

Plan Reading—Estimating—Superintending, etc.

Train at Home to **MAKE MORE MONEY** **No Schooling Necessary**

Learn how to read plans, lay out work and run jobs. Your spare time is enough. Wherever you may be—whatever your job—we can help you quickly to fill a higher place and have a bigger income. Age does not matter. Previous school training is not needed. This is a practical course for practical men, prepared by practical instructors who have been through every branch of the building game themselves. You owe it to yourself to find out how to make more money.

To Builders Living in or Near Chicago

Visit our Day or Evening School for builders and see with your own eyes the work we do. 1000 builders attend each year. You can get the same training *at home*. Same lessons—same blue prints—same practical instructors—same successful results.

Get the Facts Find out how little time it takes to make more money—much more money—in building. Write today. The coupon brings all *Free*.

**Chicago Technical
SCHOOL for BUILDERS**

Dept. 1055, 118 East 26th St., Chicago, Ill.

Mail the Coupon—NOW

**Chicago Technical
SCHOOL for BUILDERS**

Dept. 1055, 118 East 26th St., Chicago, Ill.

Please send me without obligation, Free and Postpaid, your two Books and Blue Prints for Builders. It is understood that no salesman will call on me.

(Please Write or Print Name Plainly)

Name.....

Address.....

City..... State.....

Age..... Occupation.....



Chosen Out of 100 Applicants

The Way to Bigger Income

"To LaSalle goes the credit for training me so that I was able to turn a refusal into an acceptance in preference to over one hundred other applicants," writes E. W. DeMotte, a New York man. "I cannot give too much credit to LaSalle and its Placement Department for the success of my application for this very fine position." LaSalle trained him. LaSalle got him the job.

"My investment in LaSalle training," writes J. B. Lewels, "has already paid me, during two months alone, an actual cash profit of 300 per cent."

Send for Salary-Doubling Plan

Such records as those just cited are within the reach of any man who will set his goal toward real success. During only six months' time as many as 1,248 LaSalle members reported definite salary-increases totalling \$1,399,507, an average increase per man of 89 per cent.

If you are in earnest when you say that you want to get ahead, you will not be satisfied until you have put this kind of training to the test—exchanged it, just as thousands have done, for a bigger income.

The details of the LaSalle Problem Method—often spoken of as the *salary-doubling plan*—will be sent you for the asking. Whether you adopt the plan or not, the basic information it will place in your hands, without cost, is of very real and definite value. And it's FREE.

Balance the two minutes that it takes to fill out the coupon against the rewards of a successful career—then clip and mail the coupon NOW.

LA SALLE EXTENSION UNIVERSITY

The World's Largest Business Training Institution

Dept. 1064-R Chicago

Tell me about your *salary-doubling plan* as applied to my advancement in the business field checked below. Send also copy of "Ten Years' Promotion in One," all without obligation.

- Business Management
- Modern Salesmanship
- Higher Accountancy
- Traffic Management
- Railway Station Management
- Law—Degree of LL.B.
- Commercial Law
- Industrial Management
- Modern Foremanship and Production Methods
- Personnel and Employment Management

- Banking and Finance
- Modern Business Correspondence and Practice
- Expert Bookkeeping
- C. P. A. Coaching
- Business English
- Commercial Spanish
- Effective Speaking



Name

Present Position

Address

Make Art Objects Like These Yourself

Do This Profitable New Work At Home
You can easily make extra money at home in spare hours, decorating candlesticks, lamp shades, toys and novelty furniture. Many do it solely for artistic pleasure; thousands make fine incomes supplying enormous demand.

Send for Free Book
Tells how you can become a member of Fireside Industries, national organization of co-operative home-workers. Outfit furnished without extra cost. Send 2c for postage on beautiful book giving full details.

FIRESIDE INDUSTRIES
Dept. 66-P Adrian, Michigan

MEN WANTED

TO LEARN

Motion Picture Projection

\$2,000 to \$4,000 a Year

Quickly learned. Short hours, big pay. Best equipped school in Michigan. Projectionists for Movie Houses and Road Shows.

MOVIE OPERATORS SCHOOL

61 Sproat Street,

DETROIT, MICHIGAN

LEARN MECHANICAL DENTISTRY

IN THREE MONTHS
and qualify to earn \$2,000 to \$5,000 a year.

FREE employment service enables you to **EARN WHILE LEARNING** this NEW money-making Profession. Age no barrier and no previous training required. The only school in New York where students learn by doing actual work in gold before graduation. Individual instruction. Day or night sessions. Write NOW for free catalog P and SPECIAL TOOL OFFER

N. Y. SCHOOL OF MECHANICAL DENTISTRY
Penn Arcade, 147 W. 33rd Street New York
FREE RAILROAD FARE

How to Straighten Bow and Knock-kneed Legs!

Improve your personal appearance by using the new patent "Lim-Straitner," Model 18. Corrects bow and knock-kneed legs safely, quickly and permanently at home. No costly operation or discomfort. Is worn at night. Easy to adjust; its result will save you soon from further humiliation and will improve your personal appearance 100 per cent. Write today for copyrighted Physiological and Anatomical book and experience of others without obligation. Enclose a dime for postage.

M. TRILETY, Specialist Dept. 1421L
BINGHAMTON, N. Y.

"I would not part with it for \$10,000"

So writes an enthusiastic, grateful customer. In like manner testify over 100,000 people who have worn it.

The Natural Body Brace

Comfortable and Easy to Wear

Overcomes Weakness and Organic Ailments of women and men. Develops erect, graceful figure, brings restful relief, comfort, health and strength.

Not Sold in Stores—

Made to Measure—Makes work easy and walking a pleasure; replaces and supports misplaced internal organs; reduces enlarged abdomen; straightens and strengthens the back; corrects stooping shoulders; develops lungs, chest and bust; relieves backache, curvatures, nervousness, ruptures, constipation.

Get Well—Stay Well Write today for illustrated booklet, measurement blank, etc., and read our very liberal proposition.

HOWARD C. RASH, Pres., Natural Body Brace Co.
223 Rash Building • • SALINA, KANSAS



**30
Days
Free
Trial**

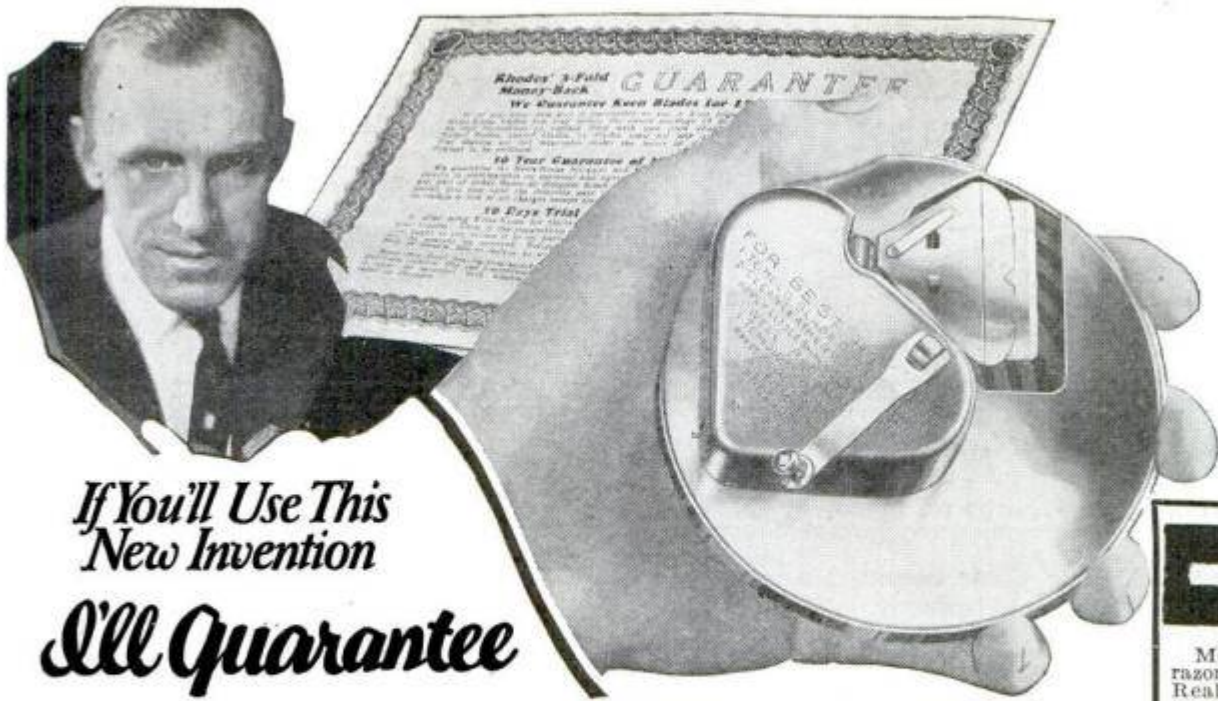

**Mystery
Razor
FREE!**

*If You'll Use This
New Invention*

I'll Guarantee

To Keep You in Razor Blades for Life!

KRISS-KROSS marks such a radical advance in new shaving comfort and economy that it deserves to be classed as much more than a stropper. It's a **super-stropper**—a blade **rejuvenator!** Almost literally it makes a new blade out of an old one every day—makes hundreds of keen, quick shaves blossom where only one grew before.

KRISS-KROSS strops your blade on the diagonal just like a master barber. Pressure decreases automatically. Nickel jig flies up to notify you when your blade is ready with the **keenest cutting-edge steel can take!**

No wonder that this super-stropper prolongs the life of any make blade, single or double edge, for weeks, months and years! No more bother about remembering to buy new blades! No more "raking" with dull ones! KRISS-KROSS solves your blade problem for all time.

Sensational Offer

And now for my smashing offer! To introduce KRISS-KROSS stropper during the next 30 days I am giving with it, free, a new kind of razor. This unique razor, with 5 special process blades, completes the outfit with which I guarantee to keep you in razor blades for life!

**Rhodes' KRISS KROSS
STROPPER**

Rhodes Mfg. Co., Inc., 1418 Pendleton Ave., Dept. P-370 St. Louis, Mo.



Most astonishing razor you ever saw. Really 3 razors in one. Adjustable to any shaving position. Flip of finger makes it straight or T-shape in a jiffy. Nothing like it ever on the market before. I'll send you one FREE to introduce KRISS-KROSS super-stropper. Limited offer. Find out about it today!

Use the blades and keep renewing them with KRISS-KROSS super-stropper. If one of them goes back on you I'll recondition or replace them with new ones free. No strings. No red tape. I give my amazing guarantee in **writing**. It is an ironclad agreement to **KEEP YOU IN RAZOR BLADES FOR LIFE!**

Send for Full Details

This astonishing offer is limited. Send for information on amazing KRISS-KROSS inventions today. They are never sold in stores—and are even more remarkable than I can tell you here. Clip the coupon to-day! No obligation!

AGENTS: \$30—\$66 A Day!

Make big money with KRISS-KROSS! Free razor boosts sales amazingly. H. King made \$66 one day. C. E. Conklin made \$22 in 2 hours. Others average \$175-\$400 a month. Every man buys on sight. Unique sales plan brings big extra profits. Wonderful free illustrated salesmanship manual, too. Get details at once.
Sold only through Authorized Representatives

Rhodes Mfg. Co., Inc.,
1418 Pendleton Ave., Dept. P-370
St. Louis, Mo.

Without obligation, please send me full details of your special introductory offer to keep me in Razor Blades for LIFE. Also send me full description of KRISS-KROSS stropper and FREE adjustable razor.

Name.....

Address.....

City..... State.....

() Check this space if you are interested in becoming an authorized KRISS-KROSS representative.



YOUNG MAN—BE UP AND DOING

RAILWAY MAIL CLERKS

\$1900 to \$2700 a Year

Mail Coupon Before You Lose It

Steady Work—No Layoffs—Paid Vacations—Travel—See Your Country—Common Education Sufficient
MEN—BOYS, 18 UP—RUSH COUPON

FRANKLIN INSTITUTE, Dept. B-176, Rochester, N. Y.
 Sirs: Rush to me without charge: (1) Sample Railway Postal Clerk and Mail Carrier Examination questions; (2) tell me how to get a U. S. Government job; (3) send sample coaching lessons.

Name

Address

Whatever Your Question;—be it the pronunciation of Fascista, the spelling of a puzzling word, the location of Esthonia the meaning of soviet, realtor, vitamin, etc., this Supreme Authority—

WEBSTER'S NEW INTERNATIONAL DICTIONARY

contains an accurate, final answer. 407,000 Words. 2700 Pages. 6000 Illustrations.
 Regular and India-Paper Editions. G. & C. MERRIAM CO., Springfield, Mass.
 Write for specimen pages, prices, etc., and FREE Pocket Maps, per Popular Mechanics.



LEARN CARTOONING



The Landon PICTURE CHART method of teaching makes ORIGINAL drawing easy to learn. Hundreds of sketches like the above explain every step in creating ORIGINAL heads, figures, animals, etc.

Successful Cartoonists Earn Big Salaries

The cartoonists who draw "Freckles and His Friends," "Winnie Winkle," "Regular Fellers," "Cicero Sapp," "Guss and Gussie," "Mom 'n Pop" and hundreds of other artists, including Dorman Smith, Ethel Hays and Edwina, credit their start to the Landon Course of Cartooning. They learned to draw through the Picture Chart Method in their spare time, at home, and are now earning from \$75.00 to \$300.00 and more per week. Send 6c in stamps today for sample Picture Chart and full explanation of this wonderful course and information showing possibilities for you. Please state your age.

The Landon School
 138 National Bldg., CLEVELAND, OHIO

NOW—Boys^{earn} Men's Wages

\$75⁰⁰ to \$125⁰⁰ Weekly, Paid to

AUTO MECHANICS

Why go on begging for a raise? Why growl and complain because you don't get it? Why, when every city, town and farming community is pleading for more auto and tractor mechanics—trained as McSweeney students are trained, to know cars of every make and to know them "inside out"?

Every month my men are taking fine jobs formerly filled by half-trained students or half-baked, self-trained mechanical tinkerers.

I Train You in 8 Weeks

Think of it! Working with real tools on real equipment you become in only EIGHT WEEKS a better auto mechanic than men who have "fiddled" around an ordinary garage for years trying to learn. Let me send you the proof, letters from former McSweeney students now earning up to \$10,000 a year. "Mac's SHOP WAY Means Bigger Pay."

Your Money Back Guaranteed

If, when you have finished your training, you are not perfectly satisfied; if you are not qualified to fill a big pay job, I will re-

fund every cent of your tuition. There is a reason for my making such a convincing offer. Ask yourself why. Then write quick for my remarkable SPECIAL TUITION OFFER. Save one-third now. See what you get:

FREE Your Board for 8 Weeks and Your Railroad Fare

For a limited time only I will pay your railroad fare to Cincinnati or Cleveland and give you your board free for 8 weeks. Send the coupon NOW—before it is too late—for my big illustrated book and full particulars of this amazing offer. Don't delay.

McSWEENEY Auto, Tractor and Dept. JO-14 Electrical SCHOOLS
 Cleveland, Ohio
 Cincinnati, Ohio

Please send your Special Offer and Big Illustrated Book.

Name

Address

City..... State.....



10 Thousand OIL BURNERS At Half Price

Amazing Advertising Offer To Introduce Improved Burner

Now, if you will act promptly you can own a new, improved oil burner at a cost so marvelously low it will astound you. No strings to the offer. No if's or but's. For 10,000 of the new improved Oliver Burners for ranges and heating stoves are going to be placed in representative homes at half price—as part of a gigantic advertising campaign.

NEVER before in oil burner history has such a sensational bargain been offered! And it is made now only because we want people to actually see how many advantages this improved device has over old, crude burners.

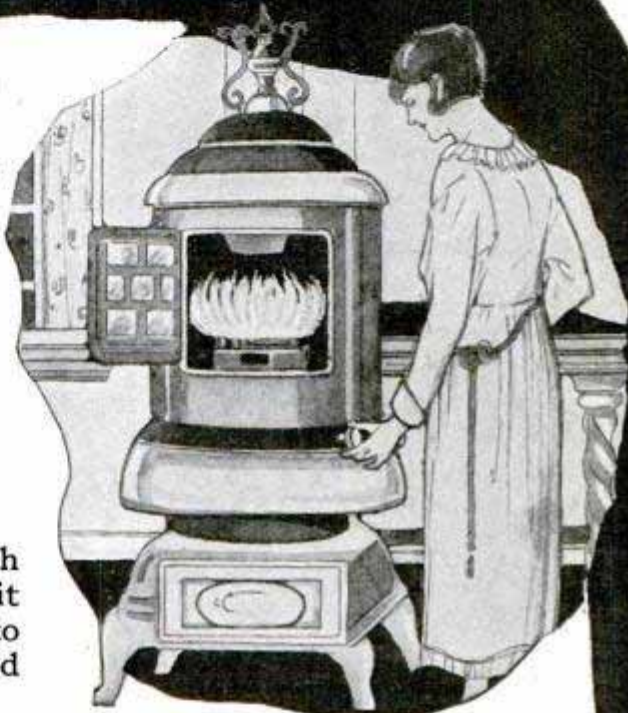

FOR EVERY STOVE AND RANGE

There is an Oliver burner model to fit every stove and range. Absolutely safe. Odorless, wickless. Installed in fifteen minutes. No holes to drill. No changes whatever to make. Lasts a lifetime. And complete heating satisfaction is guaranteed.

Now you must act at once to take advantage of this lifetime opportunity. 10,000 stove burners may seem like a great many. But remember, over 275,000 Oliver Burners have already been sold. They will go fast at this sensational price. Get rid of the dirt and drudgery of coal and wood forever. Have clean, quick, odorless oil heat for cooking or heating. Send no money. But get the full details, and register yourself for the opportunity to get a modern Oliver Stove Burner for only a few dollars, by sending in the coupon—right now. Don't miss your chance. **ACT!**



**AGENTS
WANTED**
Write for confidential Sales Plan

OLIVER OIL GAS BURNER

OLIVER OIL BURNER CORPORATION
M-131 OLIVER BLDG. ST. LOUIS, MO.

SPECIAL COUPON OFFER

Oliver Oil Burner Corporation,
M-131 Oliver Bldg., St. Louis, Mo.

I understand this coupon entitles me to half price on your improved range or heating stove burners. Send me details. This does not obligate me in any way whatever.

I am interested in a burner for my
.....heating stoverange

Name.....

Address..... County.....

Town..... State.....

SPECIAL COUPON OFFER

Aviators Preparatory Institute INCORPORATED 475 Fifth Avenue - - NEW YORK



WALTER HINTON

Walter Hinton, President of the Institute, former United States Navy Aviator, piloted the famous NC-4 in the first flight across the Atlantic Ocean, in May, 1919. He flew the first plane between New York and Rio de Janeiro in 1922-23. In March, 1924 Mr. Hinton returned to Brazil as a member of the Alexander Hamilton Rice Expedition where he explored and mapped by air thousands of square miles of unknown jungle territory.

YOUNG MEN

PREPARE NOW

The Age of Flight is Here

A great industrial development in air transport has begun in the United States. The good places will go to young men with the necessary knowledge and training. These young men will be the aircraft engineers and executives, the operating officers and pilots who, during the next few years, will contribute to America's Air Supremacy.

You cannot learn to fly by home study, but the first step toward learning to fly or proficiency in any other branch of aeronautics is

A THOROUGH KNOWLEDGE OF PLANES, AIRCRAFT ENGINES, CONSTRUCTION, INSTRUMENTS, AND WHY AN AIRPLANE FLIES.

This knowledge is now available in easily understood form in the Thorough and Comprehensive

Spare Time Study Course of the AVIATORS PREPARATORY INSTITUTE Under Mr. Hinton's Personal Direction

Mail the Coupon for Complete Information and Synopsis of the Course

AVIATORS PREPARATORY INSTITUTE, INC.
475 FIFTH AVE., NEW YORK.

Without obligation, please send me full details of Walter Hinton's aeronautical study course.

STOP USING A TRUSS

Do Away With Steel And Rubber Bands

FREE TRIAL

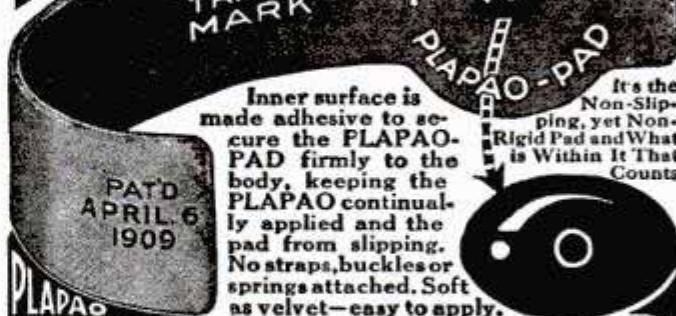

Inner surface is made adhesive to secure the PLAPAO-PAD firmly to the body, keeping the PLAPAO continually applied and the pad from slipping. No straps, buckles or springs attached. Soft as velvet—easy to apply.

FREE to 5,000 Truss Sufferers

To the extent of 5,000 sufferers who may apply I will send, ABSOLUTELY FREE, a sufficient quantity of the Plapao to positively convince them that this is the only logical, common-sense way of treating rupture. Plapao is a highly astringent medication placed within the Plapao-Pad and being absorbed through the skin, creates a wonderful feeling of relief and at the same time tends to strengthen the weakened muscles and thus permanently close the rupture opening. The process of recovery is natural, so you'll have no use for a truss—you can throw it away forever! Old and young have testified under oath that the Plapao-Pads cured their rupture—many of them long-standing, aggravated cases—without delay from work. Patent allowed in U. S. and foreign countries. Awarded Gold Medal at Rome and Grand Prix at Paris.

Send No Money—for a sufficient quantity of the Plapao is sent without charge to enable you to give it a thorough test; you pay nothing for this trial now or ever. Write for it and full information today. Address Plapao Laboratories, Block 1427 St. Louis, Mo.



"Been on a vacation Bill?"

"No, Jim — I've stopped smoking. Gained six pounds in a week. You know how I used to smoke—a package of cigarettes and a cigar or two a day—it sure had some hold on me. But I'm cured—



took a scientific home tobacco treatment—fixed me up in two weeks.

"Wasn't hard on me at all—noticed improvement the first day—I feel like a new man. It didn't interfere with my work—didn't leave any druggish after-effects—the money I saved in the last two weeks has paid for the treatment alone.

"Why don't you take it! It has cured men like you and me for over forty years—it is a doctor's individual prescription that sure fixes you up. Just send the coupon for full information NOW. No obligation. All correspondence is strictly confidential."

The Keeley Institute, Dwight, Ill.
Please send me, without any obligation on my part, your free booklet which will tell me how to rid myself of the tobacco habit.

Name.....
Town.....
Street..... State..... PM-10

Can you fix it

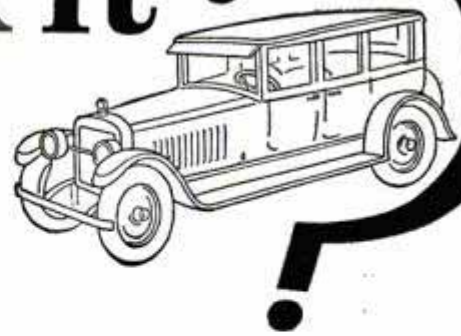
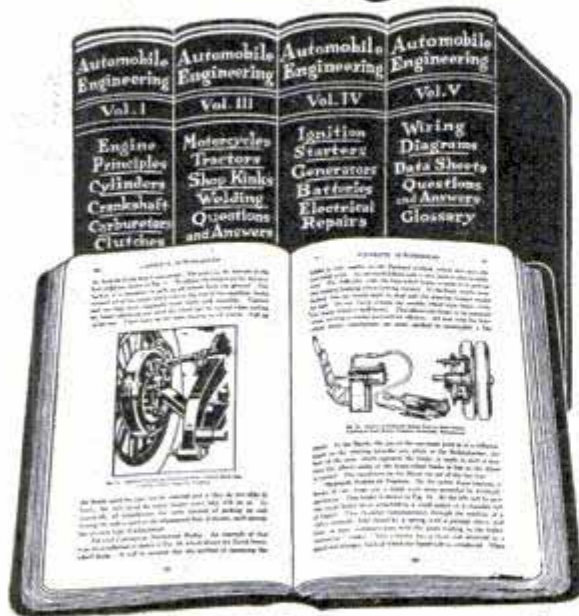

New books have "jiffy index," making all facts instantly available. You find anything you want to know in a moment in this *brand new 1926 edition.*

These books tell how

HERE are the most interesting, the most practical books we have ever published on automobile construction, operation and repairs. Brimful of facts, photographs and explanations so easy to understand that anyone can learn how in almost no time.

Over 2000 pages, with diagrams, blueprints and everything else needed to make anyone an authority on automobiles.

Whether you want to qualify as garage owner, auto repair expert or merely wish to know how to keep your own car 100% efficient, you will welcome these books, especially on our

No Money Offer

This plan brings this valuable information within the reach of everyone. You don't send us a single penny. You don't have to pay us anything—just send your name and address and we'll send you the complete set of 5 volumes, specially bound in Flexo covers.

Read them carefully; keep them 10 days; find out anything you want to know, and then if you want to keep them, send only \$2.00 then and \$3.00 per month until the special low price of \$24.80 is paid. There is no further obligation.

American Technical Society Membership Free

This is a great organization for the publishing and spreading of specialized knowledge—we have over a million dollars of resources, enabling us to get the cooperation of the largest automobile manufacturers and dealers, who have furnished us plans and photographs. If you send NOW for this new edition of Automobile Engineering, we will include a Consultation Membership in this great organization.

Eighteen automobile experts will be ready to help you at all times. You can write or wire any time for special information. Answers will be sent to you promptly—without cost.

Don't Hesitate

There are no strings to this offer—it means just what it says. Send name and address on the coupon and *ALL* of the five books—the complete set—will be sent to you for examination.

Remember one fact only which you can find in these books may save you an expensive repair or help you to a better job.

Learn All About Autos

Get these five big books on this liberal offer and learn all the things you want to know about autos. Carburetors, engines, springs and spring suspension, brakes, 4-wheel drives, lubrication systems—all are fully covered.

These complete and comprehensive auto books are yours if you want them on this easy plan. Send for a set NOW; there's nothing to pay.

Jiffy



Index

You don't have to read the books through; the index enables you to put your finger on the information wanted in a jiffy.

For Free Offer, Use Coupon

American Technical Society,
Spec. Dept. A-719, Chicago, Ill.

I would like to look at the 5 Auto Books described above. Send them on your FREE offer. I will examine them carefully and return them in 10 days unless I like them; in which case I will send you \$2.00 then and \$3.00 per month until the total price of only \$24.80 is paid. I am entitled to the services of your employment department without charge. You are to also send me Free Consulting Membership Certificate in the American Technical Society.

Name.....

Street.....

City..... State.....

Reference.....

EMPLOYMENT SERVICE FREE

In addition to all this, those who send now will be entitled to the service of our EMPLOYMENT DEPARTMENT without charge. We are in daily contact with firms all over the country who need good men and are willing to pay big. This service costs you nothing. Don't miss this special offer. Send now.

BOYS

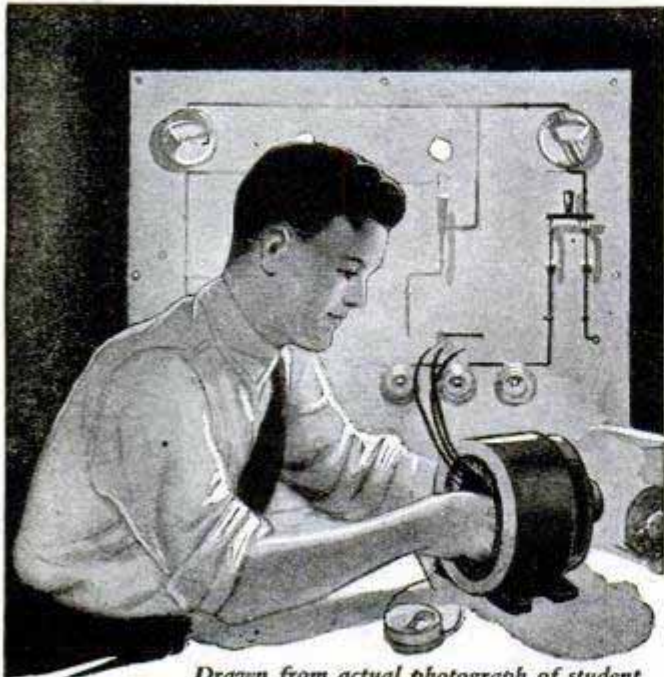

Drawn from actual photograph of student doing spare time electrical work

Learn Electricity Make Big Money

How would you like to earn two or three dollars every evening after school and prepare yourself for a fine big job at the same time? Here's the opportunity of a lifetime for you fellows who like Electricity. Begin right now to prepare yourself for a regular man's size job in this fascinating field. Your chances for a big success are simply wonderful—the pay is big (thousands of men earn \$70 to \$200 a week) and advancement comes swift and sure.

I Will Train You at Home

With my easily earned, spare time Electrical Course I will train you at home like I have trained hundreds of other boys who are now big successful men. It will not interfere with your school work and you can earn more than the small cost of the course doing odd electrical jobs in your spare time. The Course pays for itself. I will show you how to get this work and how to do it. Some of my boy students make \$10 to \$15 a week this way.

Tools, Apparatus and Radio Course —Given Without Extra Charge

Send me the coupon below and I will tell you all about the big outfit of tools, apparatus and instruments and a new Radio Course that I am giving to my students for a limited time. I will send you my big interesting Electrical Book and a sample lesson, too—all Free. You will be tickled with the things I will send you Free. Mail the coupon right now.

L. L. COOKE, Chief Engineer
Chicago Engineering Works
Dept. O17 CHICAGO

Look What This Boy Is Doing

"Although the School term is coming to a close, and I am pretty busy with my examinations, I manage to keep up with my electrical studies and work."

"I guess I forgot to tell you I am now in business for myself. Am doing fine, but owe it all to you. If it had not been for your Course, I, being under age, could not have secured my license in this town. But I got it, and now have all the work I can do, averaging \$20 to \$30 a week, thru spare time work."

"I went out on a job tonight after school, on which I made \$3 and brought home another on which I made \$2.50—\$5.50, for 4 hours' work and no material furnished by me."

ROGERS SMITH,
1215 Chestnut St.,
Greenville, N. C.

Use This "FREE BOOK" Coupon

L. L. COOKE, Chief Engineer,
Chicago Engineering Works,
Dept. O17 2150 Lawrence Avenue, Chicago

Send me your Big Outfit Offer, your big Electrical Book, Sample Lesson and particulars of your Electrical Course and Extra Radio Course. This will not obligate me in any way.

Name.....

Address.....

This Coupon only for use of boys 15 years old or more.



Drum Lessons With the Outfit

With each genuine Ludwig Trap Drum Outfit we furnish an instruction method. Ludwig drum sets from \$32.50 up. Call on your music dealer or write us for full particulars. Send for free catalog.

World's Largest Makers of Drums and Banjos

LUDWIG & LUDWIG
1611 N. Lincoln St. Chicago, Ill.

High School Training at Home This New Easy Way

Why be handicapped by lack of education? Through a wonderful Question-and-Answer-Method you can now acquire the essentials of a high school training right in your own home in your spare time. No correspondence, no home work. This method is now being used by teachers and students in thousands of high schools. The subjects covered are Algebra, Biology, Physics, Economics, Literature, Latin, Spanish, English, French, Ancient and American History.

The cost is amazingly low—only a few cents a day. Mail post card for additional information.

HIGH SCHOOL HOME STUDY BUREAU, Dept. 410, 31 Union Square, New York City

Learn to **PAINT SIGNS and SHOW CARDS**
We quickly teach you by mail, or at school, in spare time. Enormous demand. Big future. Interesting work. Oldest, foremost school.
EARN \$50 TO \$200 WEEKLY
John Vasson, N.Y., gets \$25 for single show card. Crawford, B.C., says: "Earned \$200 while taking course." Send today for free information, samples and guarantee.
DETROIT SCHOOL OF LETTERING
150 Stinson Ave. Est. 1899 Detroit, Mich.



BE A RAILWAY TRAFFIC INSPECTOR

PAYS UP TO \$250 per Month
Expenses Included



NO Hunting for a Position After Completing Your Training



Read what Dan'l. M. Mack says: "I received my diploma on April 15, was on my way to take a position on the evening of April 16, and started to work on April 17. If this is not quick work, I don't know what it is. I found the school very thorough."

Our students never worry about a position. You start at \$120.00 per mo. or more, expenses paid. Our guarantee explains how you take no risk.

Railway Traffic Inspection is a delightful, uncrowded profession with unlimited advancement opportunities. Regular hours, outdoor work, travel, reporting to high railway officials.

Hundreds of Satisfied Graduates
Send coupon for details and guarantee agreeing to refund your money if position is not secured upon graduation.

STANDARD BUSINESS TRAINING INST.
Buffalo, N. Y.

Send me, entirely free, Booklet No. D-302, giving full particulars about course in Railway Traffic Inspection.

Name.....

Street.....

City.....

Discovered!

The Secret of Caruso's Amazing Vocal Power



"The Songbird of the Ages," Enrico Caruso. The richness, the fullness, the beauty and the astounding power of his voice was due to the exceptional development of his Hyo-Glossus muscles.



Eugene Feuchtinger, musician-scientist, who discovered the function of Hyo-Glossus in voice production, and whose famous "Physical-Voice-Culture" system has developed thousands of voices.

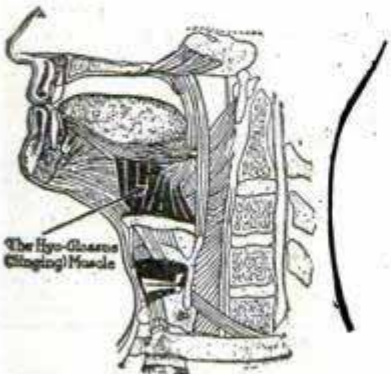

Diagram of the Normal Throat showing the Complete Vocal Mechanism. Your throat looks like this. So did the throat of the great Caruso. The Physical-Voice-Culture system of silent, scientific exercises will develop your vocal organ to its full strength.

THIS IS AN AGE OF MARVELS. Wonderful scientific discoveries have changed our mode of living and our mode of thinking.

One discovery of tremendous benefit to all humanity is the discovery of the principle of voice control by Eugene Feuchtinger, A. M.

His resulting system of voice development revolutionizes old methods, and changes voice development from a little understood art to an exact science.

More than that, it brings a Perfect Voice within the reach of every man and every woman who desires a stronger, richer voice for either singing or speaking.

Prof. Feuchtinger's method is founded on the discovery that the Hyo-Glossus muscle controls the voice; that a strong, beautiful voice, with great range, is due to a well developed Hyo-Glossus—while a weak or a rasping voice is due to under-development of this vital vocal muscle. A post-mortem examination of Caruso's throat showed a superb development of Hyo-Glossus muscles. But it required years of training under the old method to produce this development.

You can develop your Hyo-Glossus in a much shorter time by Prof. Feuchtinger's wonderful scientific method. You can take this training under the direction of the Professor himself, wherever you may live. And the cost is so low that it is within the reach of every ambitious man or woman.

100% Improvement in Your Voice—Guaranteed

Professor Feuchtinger's method is far simpler, far more rapid, far more certain in results than the tedious, haphazard methods of ordinary vocal instructors.

Under his direction, your voice will be made rich, full and vibrant. Its overtones will be greatly multiplied. You will add many notes to its range and have them clear, limpid and alluring.

We **ABSOLUTELY GUARANTEE** an improvement of 100 per cent. If you are not absolutely satisfied that your voice is doubled in volume and quality, your money will be refunded. You alone, are to be the judge.

You Do Not Know Your Real Voice

Until you have tried this system, you cannot know the possibilities of your vocal gifts. Physical-Voice-Culture **PRODUCES** as well as **DEVELOPS** the true voice. It corrects all strain and falsetto and makes clear the wonderful fact that any normal person can develop a fine voice if correctly trained. Thousands of delighted graduates

testify to this. Many of them grand opera stars, concert singers, speakers, preachers, actors and educators.

FREE!

The Wonderful New Book—
"Physical-Voice-Culture"

Send the coupon below and we will send you **FREE** this valuable work on voice culture. Do not hesitate to ask. Professor Feuchtinger is glad to have us give you this book. It's free and need not be returned. You will do yourself a great and lasting good by studying this book. It may be the first step in your career. Do not delay. Send the coupon **TODAY!**

Perfect Voice Institute
Studio 13-57

1922 Sunnyside Ave., Chicago, Ill.

Please send me copy of your new free book "Physical-Voice-Culture". I understand that this is free and there is no obligation on my part. I am interested in

Singing Speaking Stammering Weak Voice

Name

Address



What Are YOUR Mistakes in English?

They may offend others as much as these offend you
Thousands of persons make little mistakes in their everyday English and don't know it. In a five-minute conversation or in an average letter, from five to fifty errors will appear. It is surprising how many people fall in spelling such common words as "business," "abbreviate," etc. It is astonishing how many men say "between you and I" instead of "between you and me," and use "who" for "whom," and mispronounce the simplest words. Few know whether to use one or two "c's" or "m's" or "r's," whether to spell words with "ie" or "ei," and how to punctuate in order to make their meaning absolutely clear.

A REMARKABLE INVENTION

Sherwin Cody, perhaps the country's foremost teacher of practical English, has for the past twenty years applied scientific principles to teaching the correct use of our language. He made tens of thousands of tests and found that the trouble with old methods is that points learned do not stick in the mind. In school you were asked to remember rules, and if you forgot the rules you never could tell what was right and what was wrong. Mr. Cody has solved the problem by creating instinctive habits of using good English through the use of his

SELF-CORRECTING METHOD

A patent was granted to Mr. Cody on his unique device, and now he places it at your disposal. This invention is simple, fascinating, time-saving, and incomparably efficient. You do the lesson given on any page, then you see exactly how Mr. Cody himself would correct it. You mark your errors and check them in the first blank column. Next week you try that page again, correct your errors, and check them in the second column. You see at a glance what you have learned and what you have failed to remember, until you have reached the 100% point in spelling, punctuation, grammar, and expression.

ONLY 15 MINUTES A DAY

A remarkable advantage of Mr. Cody's course is the speed with which these habit-forming practice drills can be carried out. You can write the answers to fifty questions in 15 minutes and correct your work in five minutes more. You waste no time in going over the things you already know. Your efforts are automatically concentrated on the mistakes you are in the habit of making, and, through constantly being shown the right way, you soon acquire the correct habit in place of the incorrect habit. There is no tedious copyintg. There is no heart-breaking drudgery.

FREE—NEW BOOK ON ENGLISH

A command of polished and effective language denotes education and shows your culture. It wins friends and favorably impresses those with whom you come in contact. In business and in social life correct English gives you added advantages and better opportunities, while poor English handicaps you more than you will ever realize. And now, in only 15 minutes a day—in your own home—you can actually see yourself improve by using the 100% self-correcting method. Write today for our new free book, "How to Speak and Write Masterly English." Merely mail the coupon or a postal card.

SHERWIN CODY SCHOOL OF ENGLISH
510 Searle Building, Rochester, N. Y.

SHERWIN CODY SCHOOL OF ENGLISH
510 Searle Building, Rochester, N. Y.
Please send me your Free Book, "How to Speak and Write Masterly English."

Name.....
Address.....
City..... State.....

Learn How to BOX

JIMMY DeFOREST BOXING COURSE

Teaches by mail the same System he taught Champion JACK DEMPSEY



In 20 weeks, under the System of Jimmy DeForest, World's Greatest Trainer and Maker of Champions, you will master the priceless knowledge that made Jack Dempsey his millions, and fortunes for a host of other Jimmy DeForest-trained ring stars. Every 6 months 30 are selected from all classes and recommended to leading promoters for boxing engagements. That's how pupils are brought to the front at once. Boys who were once rank amateurs are today earning big money; weaklings have been made strong, courageous; men have learned the art of self-defense. Send today for the now famous book, "The Golden Age of Boxing," greatest book of its kind ever written; full of valuable information, photos of great fighters and pupils who became successes over night. Enclose 10c to cover cost of mailing, etc. Write now.

JIMMY DeFOREST BOXING COURSE 347 Madison Ave., Box 610, NEW YORK CITY

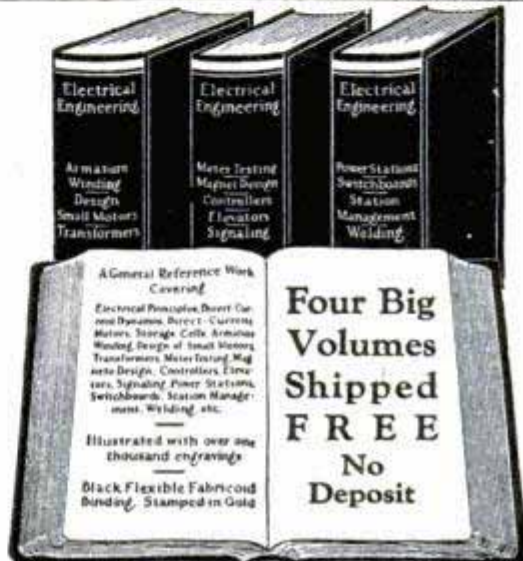

Four Big Volumes Shipped FREE No Deposit

ELECTRICITY and How to Make It Pay BIG! FOUR BIG BOOKS TELLING HOW

Your future lies before you. Between the covers of these four big books, filled with money-making facts, you may find the answer to all your problems. You will find them a veritable gold mine of facts on electricity, facts which RAISE MEN'S PAY. No need to spend long hours in grinding study if you know where to find the things you want to know when you need them.

SHORT ROAD TO SUCCESS

There is a shorter road than years of study and experience. Learn in an hour what someone else experimented on for a year. Let him tell you how he did it, look at the drawings others have made and learn from them. It's easy if you have these special volumes arranged for ready reference. These books were published for busy men, men who want to get ahead with the least waste of time. You'll find them a big help no matter what your present job or station in life.

COMPLETE IN EVERY WAY

This is the most complete 4-volume set of Electrical Engineering we have ever published. No such value has ever been offered here. Brimful of interesting and instructive electrical subjects, hundreds of drawings, blue prints and photographs. A marvelous array of pay-building material, but so simply told and so easily understood that anyone will enjoy them. Over 2000 pages bound in flexo covers.

EMPLOYMENT SERVICE FREE

To aid ambitious men to get ahead—to help them get better jobs when needed—we have established a big employment department. We are constantly in touch with large and small employers and frequently know of opportunities you would never hear of. This service is FREE with these books.

SHIPPED FREE

Our plan brings these four splendid volumes within the reach of every one. You don't send us a single penny—you don't make any deposit with us—just send your name and address and we'll send the complete set bound in special "flexo" covers. Read them carefully. Keep them 10 days, then send only \$2.00. After that, \$3.00 per month until the special low price of only \$19.80 is paid. There is nothing else to pay us.

AMERICAN TECHNICAL SOCIETY Electrical Division E-719, Chicago, Ill.

You may send me your complete Electrical Engineering library, 4 big volumes bound in flexo covers, with the understanding that I am to have 10 days to decide if I want to keep them. I will either return them then or send you \$2.00 then and \$3.00 per month until the special low price of \$19.80 is paid. Your employment service is to be free if I want it.

Name.....
Address.....
City..... State.....
Reference.....

Are You Well Bred—But Still an Outsider?

Then You
Need This
FREE Booklet

The Development of Culture

"THE proudest gates fly open at the approach of courage and culture," said Emerson. "With culture you can make of yourself what you please," Lord Chesterfield claimed.

How about you? Have you culture? If so, are you employing it to the best advantage? The people who succeed most easily in this world are the cultured people. They make friends easily. They are liked wherever they go. People are always glad to help them.

Many people have culture but few show it. Not because they are afraid to show it but simply because they don't know how. Over and over they continue to do the very things that show lack of refinement. Day after day they continue the little habits—the little mannerisms that lower them in people's eyes. Why do they do these things? Simply because nobody ever told them. Nobody ever corrected them.

Do You Ever Feel Lack of Culture?

Do you ever feel that people are slighting you? Do you ever feel that you are not receiving the attention and respect you deserve?

No doubt you are well bred. But have you ever felt ill at ease in a gathering of cultivated people? Do cultured people take to you as much as you would like? They are polite, of course. And yet you feel a certain formality—a certain coldness in their manner.

Many people are confronted with this problem. Some of them realize the reason

Get This Free Book

If you are interested in learning

How to make an impression on people
How to develop social charm
How to gain poise
How to be at ease in any situation
How to gain true culture
How to apply culture to business
How to show culture in speech
How to show culture in dress
How to compel attention
How to overcome timidity
How to overcome self-consciousness
How to strengthen your personality
How to attract valuable friends
How to gain the social success you deserve

—lack of culture. But very few discover the cure.

Good Manners Are Not Enough

A man or woman may be a master of etiquette and still be uncultured. Perfect etiquette does not insure culture. It is merely an outward indication. In fact, people sometimes concentrate on etiquette in order to hide their *lack of culture*. These people are always found out. There are innumerable little "give aways"—little casual remarks—little unconscious actions which show with startling clearness your culture—or *your lack*.

Don't Obey Rules of Etiquette Blindly

Uncultured people or people who are only half-cultured oftentimes obey rules of etiquette blindly. They do not discriminate—or interpret these rules. They obey the letter of the law rather than the spirit of it. Thus, unconsciously they make mistakes that a cultured person *could not possibly make*.

It does not matter whether your lack of culture is apparent or real. You can quickly overcome it. You can quickly gain poise—refinement—self-confidence. It is the simplest thing in the world to correct the little mannerisms, the little "give aways" that are holding you back.

Culture teaches you the *spirit* of etiquette. The cultured man knows *instinctively* just what to do and say at all times. He who understands culture—he who knows the principles—the "reason why" of etiquette, is never at a loss in *any situation*.

Get This New Booklet

We have just published a new booklet—"The Development of Culture." We will gladly send you a copy upon request. The booklet is beautifully printed and filled with interesting illustrations.

If you had to quit work for a month in order to read this booklet, it would probably be one of the most profitable months you ever spent. But you don't have to do that. It takes but an instant to sign the coupon. You get the booklet for nothing.



It tells about the most practical, common sense method of developing culture that was ever devised. It offers you the secrets of poise, refinement and self-improvement, both moral and physical as well as mental.

It shows you how to recognize true culture instantly—how faulty culture leads to failure—how true culture insures success.

It opens the gates of education, refinement, enlightenment and gives you a sure and satisfactory guarantee of social and business success. Send for "The Development of Culture" now. Do not delay.

NELSON DOUBLEDAY, Inc.,

Dept. C-2310, Garden City, Long Island

MAIL THE COUPON NOW!

NELSON DOUBLEDAY, Inc.
Dept. C-2310, Garden City, Long Island

Without obligating me in the least, please send me at once your beautifully illustrated booklet which describes the "Science of Culture" and tells me how I can obtain this on seven days' free trial.

Name.....

Address.....

City.....State.....

Hawaiian Guitar FREE

Worth
\$18

When You Enroll

This Hawaiian Guitar expert and professor wants the opportunity to welcome you as a student so you will quickly learn how to play a Hawaiian Guitar—yes, you will be able to play just like the native Hawaiians. To get you started and help your musical success, which will bring you popularity, you will receive a beautiful Hawaiian Guitar, the same as the one pictured, free when you enroll. Our short cut method of instruction will enable you to play a piece almost from the first lesson. Rush coupon for full particulars today and we will reserve a gift Hawaiian Guitar for you.



Play Quickly

With our short cut method of instruction you will quickly learn how to play Hawaiian Guitar, which will bring you popularity and social success. You learn to play from notes. If you never had any musical training, you will quickly get on, because our nine experts have perfected a course of home instruction which is as simple as learning A, B, C's.

Picture and Phonograph Record Method Easy

We don't depend upon printed lessons only for your success, but we also furnish pictures of our professors playing, diagrams, charts and phonograph records for each lesson. This practically brings our professors from our studio to your own home and enables you to listen to their playing just as if they were actually in front of you. To prove this is easy, we will send you your first lesson free. Rush coupon now.

HAWAIIAN STUDIO No. 5210
of New York Academy of Music
100 Fifth Avenue, New York, N. Y.

Please rush your Free book, "How to Learn Hawaiian Guitar," and my first free lesson. Also reserve a gift Hawaiian Guitar for me. This obligates me in no way whatever.

Name.....
Address.....
City..... State.....

Make Furniture At Home

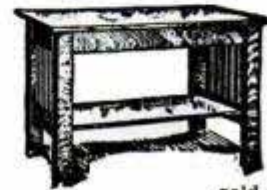

—either for your own pleasure or to sell. It is easy when you have the instructions supplied in Popular Mechanics Home Furniture Making Library. This library consists of the

following cloth-bound, profusely illustrated books of which many thousands have been sold to satisfied customers everywhere:
1. Mission Furniture—Part 1
2. Mission Furniture—Part 2
These two practical, money-saving books contain full directions and drawings for the making of all sorts of furniture, including tables, chairs, stools, davenports, electric table lamps, and many other useful and beautiful articles of furniture. Crystal clear instructions in 2 handy books; 240 pages—123 illustrations. Just follow directions and you'll be amazed at your good results. Use the furniture in your own home or sell it. One man writes he

sold over \$1,000 worth of furniture made from these books. You can do the same.

Send No Money! Just write a postal asking that Popular Mechanics Home Furniture Making Library be sent you C. O. D. When the postman delivers the books, simply hand him \$1.98 plus the few cents postage. Money refunded if not delighted.

POPULAR MECHANICS PRESS
Popular Mechanics Bldg., Room 710, Chicago, Ill.



be an airplane expert!

Aviation is new! It is the field of wonderful opportunities today! It is not crowded. It offers every man of average ability a chance to become an Airplane Expert. I am looking for ambitious, daring, red-blooded fellows who want to make Big Pay in a clean, fascinating field. Airplane Experts can find steady employment—anywhere, any time.

PAYS BIG MONEY—QUICK!

It's a well-known fact that Aviation is one of the best paying lines of industry. I can cite you instance after instance where Airplane Experts are getting anywhere from \$2,000 to \$10,000 per year. A few happy hours—at home in your spare time—with my thorough aviation course, will fit you to step into the big pay class! A working outfit

OUTFIT FREE! **WHEN YOU ENROLL** such as pictured to the left is yours—free—the minute you enroll. **WRITE TODAY!** My attractive and complete catalog is yours for the asking—absolutely free! Also—for a limited time I am including with each enrollment a special offer on free airplane parts. Don't hesitate. Write today.

Leslie Coombs, "The Chief," Chief Engineer
WESTERN AIRPLANE CORPORATION
Aeronautical Training Division Dept. M-10
Suite 402-3-4-5 Monadnock Block Chicago, Ill.

Leslie Coombs, Chief Engineer, WESTERN AIRPLANE CORPORATION, Dept. M-10, Monadnock Block, Chicago, Ill.

Dear "Chief":—I am an ambitious, red-blooded fellow and want to get into the new Big-Pay field—aviation! Please send me one of the free copies of your book on how to become an airplane expert. Also tell me about your special offer of free airplane parts.

Name.....
Address.....
City..... State.....

It takes *only* 8 weeks to get a big job

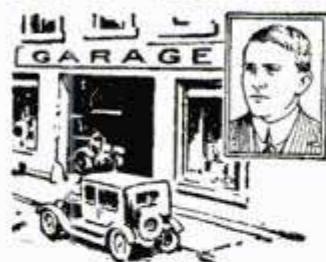

Geo. Smith owns an agency and repair shop in West Alexandria, Ohio. He makes \$200 a week.



D. M. Collins, Williams-ville, West Virginia, writes, "After finishing McSweeney training, I started in as manager of a garage at \$300 per month."

In the Auto, Tractor and Electrical Business

Read what these men are doing—here is your big chance to get "on easy street." Come to these great shops on the biggest SPECIAL offer ever made.

Big firms need trained men. The Auto and Tractor Business is on the boom. Thousands of trained men will be needed during the next few months. I get calls every day from Garages, Battery Stations, Auto Repair, and other successful concerns for McSweeney men. When the big fellows need high grade men they know where to come for them. They want McSweeney trained men.

My training is unusual. Scientific tool training—that's the secret. You do things here according to the latest engineering standards. Thousands of dollars have been spent in modern tools and equipment. You'll know a motor like a brother. That's why my men are at home with the biggest shops in the country. If you want to succeed the way Smith, Collins and the rest have—qualify by the same method.

I'LL PAY YOUR RAILROAD FARE AND BOARD YOU!

In order to fill the openings that now exist, I am making an offer no one has ever made before—FREE RAILROAD FARE, FREE BOARD. But even that is not all. I'll tell you about the rest in my letter.



C. E. Gillespie has charge of a fleet of trucks and tractors with the State Highway Commission, due to McSweeney training.

Send for FREE BOOK

My big illustrated training book tells how others are succeeding. It tells many things you ought to know about Autos and Tractors. Write for it and my short time offer NOW. It soon expires.

MC SWEENEY

AUTO, TRACTOR and ELECTRICAL SCHOOLS

9th and Walnut Sts., Dept. JP-15, Cincinnati, Ohio
1815 East 24th Street, Dept. JP-15, Cleveland, Ohio



McSweeney Auto, Tractor and Electrical Training Shops, Dept. JP-15, (Address shops nearest you) Cincinnati, O., or Cleveland, O.

Without any obligation send me your big free book on Autos. Also information regarding special temporary offer.

Name.....

Street.....

City.....State.....

Helpful IDEAS for Home Owners

In these two practical books, you will get 502 ideas that will be helpful in making your home a better place to live in—a home to be proud of. The ideas are for the making, improving and repairing of the devices needed about and in the home. The books are:

1. Home Mechanic's Handbook No. 1
2. Concrete Handbook No. 1

These books tell how to make most everything, from door stops to a refrigerator, and from a concrete sidewalk to a lawn fountain.

Send No Money Simply write a postal and ask that Popular Mechanics two Homeowner's books be sent C.O.D. When the postman delivers the books to you, hand him \$1.00 plus the few cents postage.

POPULAR MECHANICS PRESS

Popular Mechanics Bldg. Room 710 Chicago, Ill.

\$1
TWO BOOKS FOR

Books on all subjects are sold by Popular Mechanics Press, 200 East Ontario Street, Chicago, Illinois.

861 IDEAS for Farmers

The experiences of 417 farmers and farmers' wives have been combined in "The Most Remarkable Book Ever Published for Farmers." There are 138 ideas for the farm shop, 35 on fencing, 98 on auto, truck and tractor, 61 on farm buildings, 36 on field machines, 48 on concrete work, 22 on orchard work, 23 on painting, 15 on live stock, 34 on poultry, 54 on garden work, 25 on electrical work, 22 on farm tools, 16 on hunting, fishing and trapping, 140 household helps, and many others.

SEND NO MONEY—Simply write a postal asking that Popular Mechanics Handbook for Farmers be mailed to you. When the postman delivers the book, simply hand him \$1 plus the few cents postage.

POPULAR MECHANICS PRESS

Popular Mechanics Bldg. Room 710 Chicago, Illinois

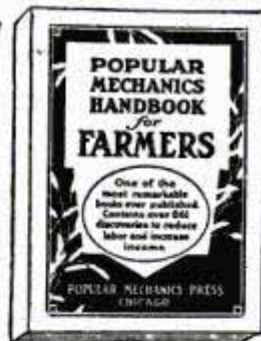

Books on all subjects are sold by Popular Mechanics Press, 200 East Ontario Street, Chicago, Illinois.

Get on "Uncle Sam's" Payroll

Railway Postal Clerks, City Mail Carriers, Rural Carriers,
City Postal Clerks, Clerks at Washington, D. C.

\$1140 to \$3300 a Year

Steady, Short Hours—Long Vacations With Pay MEN—BOYS 18 OR OVER

Mail coupon immediately—today sure. Don't delay.

Franklin Institute, Dept. B180, Rochester, N. Y.

Gentlemen: Rush to me, entirely without charge, 32 rare book with list of U. S. Government big paid positions obtainable. Advise me also regarding the salaries, hours, work, vacation and send free sample coaching lessons.

Name.....

Address.....

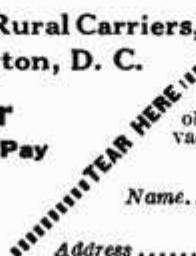



His Salary Was Raised

while others were reduced

"Up to the time I enrolled for a course with the International Correspondence Schools, I had only a grade-school education. Since enrolling, I have advanced to a much better position, where my salary is nearly four times as much as I was making previously. I would not be able to hold my present position had I not taken your Course. Recently I received a nice increase in salary, while other men were being reduced."

Read that last sentence again—"Recently I received a nice increase in salary, while other men were being reduced."

There could be no better proof of the value of an I. C. S. course than that. It shows that the trained man is given preference over all others and paid more money, even in slack times, if his work deserves it. It shows that there are always bigger, better jobs open for men who have the foresight to prepare for them in spare time.

Why don't you study and get ready too? We'll be glad to help you if you will only make the start.

Choose the work you like best in the coupon below; then mark and mail it to the I. C. S. today. This doesn't obligate you in the least, but it will bring you information that will start you on a successful career. This is your opportunity.

The I. C. S. is the oldest and largest correspondence school in the world

Mail the Coupon for Free Booklet

INTERNATIONAL CORRESPONDENCE SCHOOLS

Box 5606-E, Scranton, Penna.

Without cost or obligation, please tell me how I can qualify for the position or in the subject before which I have marked an X:

BUSINESS TRAINING COURSES

- | | |
|---|---|
| <input type="checkbox"/> Business Management | <input type="checkbox"/> Salesmanship |
| <input type="checkbox"/> Industrial Management | <input type="checkbox"/> Advertising |
| <input type="checkbox"/> Personnel Organization | <input type="checkbox"/> Better Letters |
| <input type="checkbox"/> Traffic Management | <input type="checkbox"/> Show Card Lettering |
| <input type="checkbox"/> Business Law | <input type="checkbox"/> Stenography and Typing |
| <input type="checkbox"/> Banking and Banking Law | <input type="checkbox"/> Business English |
| <input type="checkbox"/> Accountancy (Including C.P.A.) | <input type="checkbox"/> Civil Service |
| <input type="checkbox"/> Nicholson Cost Accounting | <input type="checkbox"/> Railway Mail Clerk |
| <input type="checkbox"/> Bookkeeping | <input type="checkbox"/> Common School Subjects |
| <input type="checkbox"/> Private Secretary | <input type="checkbox"/> High School Subjects |
| <input type="checkbox"/> Spanish | <input type="checkbox"/> Illustrating |
| | <input type="checkbox"/> Cartooning |

TECHNICAL AND INDUSTRIAL COURSES

- | | |
|---|--|
| <input type="checkbox"/> Electrical Engineering | <input type="checkbox"/> Architect |
| <input type="checkbox"/> Electric Lighting | <input type="checkbox"/> Architects' Blueprints |
| <input type="checkbox"/> Mechanical Engineer | <input type="checkbox"/> Contractor and Builder |
| <input type="checkbox"/> Mechanical Draftsman | <input type="checkbox"/> Architectural Draftsman |
| <input type="checkbox"/> Machine Shop Practice | <input type="checkbox"/> Concrete Builder |
| <input type="checkbox"/> Railroad Positions | <input type="checkbox"/> Structural Engineer |
| <input type="checkbox"/> Gas Engine Operating | <input type="checkbox"/> Chemistry <input type="checkbox"/> Pharmacy |
| <input type="checkbox"/> Civil Engineer | <input type="checkbox"/> Automobile Work |
| <input type="checkbox"/> Surveying and Mapping | <input type="checkbox"/> Airplane Engines |
| <input type="checkbox"/> Metallurgy | <input type="checkbox"/> Navigation |
| <input type="checkbox"/> Steam Engineering | <input type="checkbox"/> Agriculture and Poultry |
| <input type="checkbox"/> Radio | <input type="checkbox"/> Mathematics |

Name.....
 Street.....
 Address.....
 City..... State.....

Occupation.....
 Persons residing in Canada should send this coupon to the International Correspondence Schools Canadian, Limited, Montreal, Canada.

Books on 76 Subjects

No doubt you have wondered where you could get books on subjects not to be found in book stores. Popular Mechanics Press has specialized in supplying books on any subject. Look over this list. You will find books here that you have long wondered where you could secure. Check the books you want, and mail this advertisement as your order blank.

- ACCOUNTING**
Accounting Practice... \$7.00
- ACTOR**
Training for the Stage... \$1.75
- ADVERTISING EXPERT**
Principles of Advertising \$5.00
- AIRPLANE**
Practical Aviation... \$3.00
- ARCHITECT**
Easy Steps in Architecture... \$1.50
- ARTIST**
Rosenberg's Practical Art... \$5.00
- ARTS CRAFTS**
Arts Crafts Lamps... \$1.00
- AUTHOR**
The Way Into Print... \$1.00
- AUTOMOBILE**
Dyke's Encyclopedia... \$6.00
- AUTO-SUGGESTION**
Auto-Suggestion... \$3.50
- BANKING**
American Banking Practice... \$4.00
- BARBER**
The Barber's Manual... \$5.00
- BASKETRY**
Raffia Basketry as an Art... \$2.50
- BLACKSMITH**
Modern Blacksmithing... \$1.25
- BLUE PRINTER**
Blue Printing... \$2.00
- BLUE PRINT READING**
Blue Print Reading... \$2.00
- BOAT BUILDER**
Boat Book... \$0.50
- BOOKKEEPING**
Single and Double Entry \$6.00
- BIRD HOUSES**
Boys' Bird Houses... \$1.00
- BRICKLAYER**
Plain and Fancy Brickwork... \$1.50
- CABINET MAKER**
Modern Cabinet Work \$10.00
- CARPENTER**
Modern Carpentry... \$3.00
- CHALK TALKER**
Tarbell's Chalk Talk... \$1.50
- CHARACTER BUILDING**
Character Building... \$1.25
- CHARACTER READING**
Text Book of Humanology... \$2.00
- CHEMISTRY**
General Chemistry... \$3.75
- CHIROPRACTOR**
Practice of Chiropractic \$11.00
- CIRCUS**
Amateur Circus... \$1.75
- CIVIL ENGINEER**
Civil Engineering... \$5.50
- CIVIL SERVICE**
Course in Civil Service... \$1.50
- CONCRETE**
Concrete Products... \$3.00
- CONTRACTOR**
Builders' Handbook... \$6.00
- DEBATER**
Elements of Debating... \$1.50
- DENTIST**
Operative Dentistry... \$6.50
- DENTIST, MECHANICAL**
Full Denture Prosthesis \$8.00
- DETECTIVE**
Instruction for Detectives... \$1.00
- DICTIONARIES**
Universal Dictionary... \$1.25
- DIESEL ENGINES**
Diesel and Oil Engineering... \$5.15
- DOG RAISER**
Complete Book of the Dog... \$3.00
- DRILL OPERATOR**
Modern Drilling Practice \$3.00
- DRY CLEANER**
Practical Dry Cleaner... \$3.25
- ELECTRICITY**
Practical Electricity... \$3.25
- ELECTROPLATER**
The Modern Electroplater... \$3.00
- ENGRAVING**
The Art of Engraving... \$4.50
- ENGLISH**
Self Improvement in English... \$2.50
- ESCAPE ACT**
33 Rope Ties... \$1.00
- FARMER**
Cyclopedia of Agriculture... \$4.50
- FINANCIER**
Law of Financial Success \$1.00
- FINGER PRINT EXPERT**
Finger Print Instructor \$3.15
- FORMULAS**
Henley's Formulas... \$4.00
- FORTUNE TELLER**
Language of the Hand... \$0.75
- FOUNDRYMAN**
Foundry Work... \$2.25
- FURNITURE MAKING**
Mission Furniture (3 vols.)... \$3.00
- GEAR CUTTER**
Gear Cutting Processes \$3.00
- HOBBIES**
Hobbies... \$1.50
- HOME MECHANICS**
Tinkering with Tools... \$2.00
- HUNTER**
The Still Hunter... \$2.00
- ICE BOATING**
Ice Boating... \$1.00
- INSPIRATIONAL BOOKS**
You Can... \$1.00
- JOURNALISM**
Training for the Newspaper... \$1.75
- LATHE OPERATOR**
Lathe Work for Beginners... \$2.50
- LOCKSMITHING**
Locksmithing... \$1.50
- LOOM FIXER**
Practical Loom Fixing... \$1.50
- MAGIC**
Modern Magic... \$2.00
- MAIL ORDER BUSINESS**
Selling by Mail... \$4.00
- MILLING MACHINE**
Production Milling... \$3.00
- MINING**
Elements of Mining... \$6.00
- MODEL MAKING**
Model Sailing Boats... \$2.00
- OCCULTISM**
Occultism Simplified... \$1.00
- PAINTER**
Expert Wood Finisher... \$3.50
- POLICEMAN**
The Policeman's Art... \$1.50
- POULTRY RAISER**
\$4,223 from a Town Lot \$1.00
- PSYCHO-ANALYSIS**
Outwitting Our Nerves... \$2.50
- PUBLIC SPEAKER**
Art of Public Speaking... \$2.25
- RABBIT RAISING**
Practical Rabbit Keeping... \$1.50
- RADIO**
Lefax Radio Handbook \$3.50

Send No Money

Just check the books you want, write your name and address below, and mail the whole advertisement. It is your order blank. When postman hands you books, pay him the price and the postal charges. If you prefer to send cash, postage will be prepaid. We have many other books on these subjects and on 2,000 other subjects. Catalog free.

CHECK THE BOOKS YOU WANT AND MAIL TODAY

Name.....
 City..... State.....
 Address.....

Mail to Popular Mechanics Press,
 Room 710, 200 East Ontario St., Chicago, Ill.

Don't Throw Money Away

Here's your chance to save \$20.50! Here is the biggest bargain in body building apparatus ever offered in the world!

Read This List—

- Complete scientific course of instruction in **BODY BUILDING** Worth \$10.00
 - Champion Progressive Muscle Building Exerciser** Worth 10.00
 - Victor Master Grip (Patented in all countries)** Worth 5.00
- \$25.00**

\$4⁵⁰

Complete Outfit

outfit at any price! This is the Champion Muscle Builder of the World! It is made with steel reinforced handles—the strongest made. It is progressive and can be used with any number of cables from one to ten. Everlasting quality throughout! When used with my Scientific Course of Instruction you almost will be able to see your muscles grow. Your chest expansion will increase, your heart and lungs will have more room. Every muscle and organ in your body will feel like new.

VICTOR MASTER GRIP

This machine will increase your forearm and wrist muscles to an unbelievable development. It is progressive and can be used with one, two or three springs. It is also a grip tester. Professional strong men and athletes everywhere praise the Victor Master Grip. Alone with instructions \$3.00.
High Tension 10-Cable Exerciser, alone with instructions \$5.00.

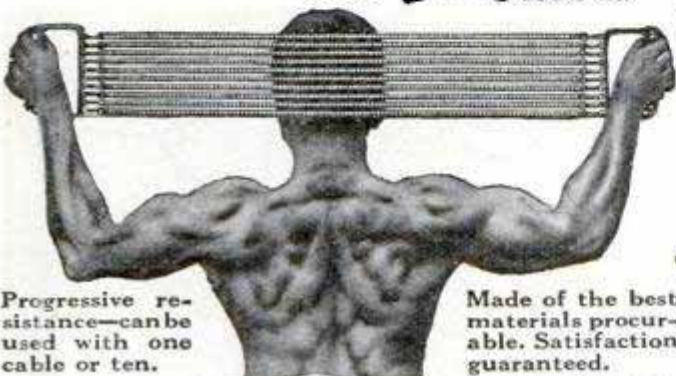

Progressive resistance—can be used with one cable or ten.

Made of the best materials procurable. Satisfaction guaranteed.

HIGH TENSION 10-CABLE EXERCISER

That's a bargain in *Health*.—a bargain in *Strength*.—a bargain in *New Life* for YOU. You could pay up to \$50 or \$60 for a similar apparatus and instruction elsewhere, but you couldn't get a better

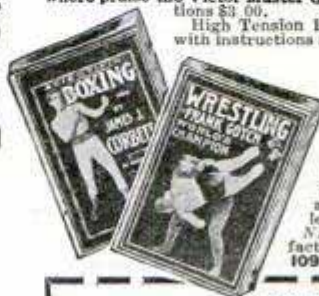

These Two Big Books FREE with Each Outfit

"Boxing" an illustrated book by James J. Corbett and "Wrestling" by Frank Gotch will be sent with your apparatus FREE, if you hurry. Both books are filled with inside dope on boxing and wrestling. I have only a few copies of each left. Get yours by mailing the coupon now. **TONIGHT**—before you go to bed. Absolute satisfaction guaranteed. **HENRY VICTOR, Dept. W-102, 109 East 13th Street., New York City.**

HENRY VICTOR, Dept. W-102, 109 East 13th Street, New York City

Gentlemen: Send me your complete outfit and the two books FREE. I enclose the bargain price of only \$4.50. If I am not satisfied my money will be refunded in full.

Name.....

Address.....

City.....State.....

FREE Book on Deafness

Write today for 168 page FREE book giving full particulars and testimonials from hundreds of grateful users whose hearing has been restored by use of our "little wireless phones for the ears."

Wilson Common-Sense Ear Drums require no medicine but effectively replace what is lacking or defective in the natural ear drums. They are simple devices, which the wearer easily fits into the ears where they are invisible. Soft, safe and comfortable.

WILSON EAR DRUM CO., Incorporated
111 Todd Building LOUISVILLE, KY.

Free Treatment for Eye Troubles

Sufferers from dim or blurred vision, inflamed, weak and watery eyes; burning, smarting or granulated lids, and various other eye troubles, can now obtain a liberal test treatment of the famous Eye Ryne Drops absolutely free and postpaid by writing the Eye Ryne Laboratories, 210 West 8th St., Dept. 400 F, Kansas City, Mo. As this does not obligate you in any way, write today.

Fibre-Lite Limbs
BRACES AND TRUSSES
DO NATURE'S WORK. GREAT INVENTION. EASY TERMS. AGENTS WANTED
WRITE FOR FREE FIBRE SAMPLE. **WORMAN CO.** 252-P HENNEPIN AVE. MINNEAPOLIS, MINN.

HAIR GROWS!

when our Vacuum Cap is used a few minutes daily. Sent on 60 days' FREE trial at our expense. No drugs or electricity. Stops falling hair, cures dandruff. A postal brings illustrated booklet.
MODERN VACUUM CAP CO.
558 Barclay Denver, Colorado



Big Money for You as an Automobile Mechanic

These four practical books, written by five well known teachers of automobile practice, will teach you right in your own home during your leisure time just what you need to know about automobile troubles and repair. They will teach you automobile construction, maintenance and repair as experts know them and will help you to earn an expert's pay.

Practical Automobile Library: Four Books—\$1.50 in 10 days and \$2 monthly for 6 months—only \$13.50 in all!

Hundreds of question-answering diagrams—hundreds of clearly-marked illustrations—make the books plain and readily understandable. All the explanations and descriptions are clear, simple, direct. Every chapter is packed with definite, step-by-step, how-to-do-it information. Here is your opportunity to enter a big-pay field.

Sent FREE

Send No Money Mail the Coupon



FREE EXAMINATION COUPON

McGRAW-HILL BOOK CO., Inc., 370 Seventh Ave., New York

Send me for 10 days' free examination the New Practical Automobile Library. If satisfactory I will send you \$1.50 in 10 days and \$2.00 monthly until the special price of \$13.50 is paid. If not wanted, I will return the Books at your expense.

Signed.....

Address.....

City and State.....

Position.....

Employer..... P. M. 10-1-28

The First
Twenty
WORDS

Creating
Wants

Making
Prospects
Want to
Be Shown

Talking
About
TIME

Creating
Confidence

Dont Tell
ALL
You Know

Here's **SUCCESS** in **SELLING** for YOU!

If you **KNOW** and **USE** the principles of **SELLING** which are so clearly illustrated in these twelve little books, *you are a successful Salesman.*

If you don't know and use them, you will have to do so before you can hope to be a successful Salesman.

There are **TWO** ways to learn them, however;—you can plug along, maybe for a dozen years or more, until they are pounded into you by experience; or you can read these twelve little books **NOW** and start twelve years ahead of the game!

Endorsed and used in their own sales-promotion work by hundreds of great companies, including:

The Hudson Motor Car Co.	Calumet Baking Powder Co.
E. C. Atkins & Co.	Phoenix Chair Co.
Congoleum-Nairn, Inc.	Ajax Rope Co.
Ely & Walker Dry Goods Co.	Lennox Oil & Paint Co.
G. I. Sellers & Sons Co.	U. S. Slicing Machine Co., etc

THE COMPLETE SET of twelve books will come to you pre-paid by mail in return for **ONE DOLLAR BILL.**
(SEE ADDRESS BELOW)

How We
Think

**ALL
Twelve
Books**

**For
ONE
Dollar**

"I SEE
What You
Mean!"

Meeting
Objections

Closing
IS Sales-
manship

The
Think-it-over
Callback

The
Talk-it-over
Callback

MACKINTOSH SERVICE: 844 Rush St. CHICAGO



Learn Electricity

IN LOS ANGELES



You train on modern electrical equipment.



There are hundreds of **BIG-PAY** electrical jobs open right now—and we can't turn out Trained Electrical Men fast enough to supply the demand. Employers are offering \$60 to \$200 a week to National graduates. But only **trained** men are wanted—men who have completed National's practical shop trained course and **mastered** all branches of electricity.

Learn Electricity Thoroughly at One of America's Oldest and Most Completely Equipped Electrical Schools

National has a world-wide reputation for producing thoroughly trained Electrical Men. 16,000 graduates praise our "Personal Instruction" method. Endorsed by leading educators, electrical associations and big employers. You train on \$1,000,000.00 worth of new electrical equipment and learn everything!

FREE Employment Service! FREE Electrical Catalog!

Special low tuition offer to men who can come to Los Angeles now and enter fall classes. We help you get the job you want. Send for big 64-page catalog describing National training methods. It shows you the way to big pay.

NATIONAL ELECTRICAL SCHOOL



NATIONAL ELECTRICAL SCHOOL, Dept. 663,
4004 So. Figueroa St., Los Angeles, Calif.

Send me your big Electrical catalog free and special low tuition offer.

Name.....

Address.....

For 2 Cents BUICK Himself Will Show You How to Earn MORE MONEY



Will you spend a postage stamp to prove that you CAN tear away from small pay? That you can earn just as big money as the man who has everything he wants? Stop working for nothing right now! In an amazing short time you can be master of a real trade—earning real money. The great Detroit School of Trades—supervised by the Michigan State Board for Vocational Education—has retained D. D. Buick, pioneer of the Valve-in-The-Head Motor and one of the organizers of the Buick Motor Car Company, as chief engineer. Already Mr. Buick has graduated hundreds of men into big pay jobs. Send the coupon to him — he'll show you how you, too, can smash into the big pay class quick—and at amazing low cost.



D. D. Buick, pioneer automobile manufacturer, once was a tradesman himself, then a great manufacturer. He knows exactly what you need to fit you quick for one of the big money trades. He supervises your training personally.

Mr. Buick knows exactly what you need to fit yourself for the big jobs. Some of the biggest industries in the world cooperate with us.

This Beautiful FREE Book Shows You How

Our FREE employment placement department places hundreds of men every year in big pay work.

We have day and night classes—you can work and go to school too. Detroit is a magic city—a mammoth city of industry. What better place could you want to be trained right.

What place can offer you bigger opportunities. Right now you can forget small pay, break free from shackles. Send for this beautifully illustrated FREE book and learn exactly how quick you can be earning big wages—and how easy you can step into a real job. Send the coupon this minute.

NOW!
Step Into Steady WAGES



D. D. Buick, Chief Engineer

Detroit School of Trades
Dept. 1026, Detroit, Michigan

CHOOSE!

In This Great School We Teach These Big-Pay Trades

- Bricklaying—\$1.50 to \$1.65 per hour
- Plastering—\$1.50 per hour
- Plumbing—\$1.25 to \$1.75 per hour
- Carpentry—\$60.00 to \$125.00 per week
- Electrical—\$10.00 to \$14.00 per day
- Sign Painting—\$1.00 to \$2.00 per hour
- Paper Hanging—\$10.00 and up per day
- Interior Decorating—\$10.00 to \$14.00 per day
- Plan Reading and Estimating—\$70.00 to as high as \$250.00 a week
- Auto Mechanics—\$1.00 to \$2.00 per hour
- Auto Painting—\$9.00 to \$12.00 per day
- Auto Trimming—\$9.00 to \$14.00 per day
- Metal Finishing—\$10.00 per day
- Acetylene Welding—\$1.00 to \$2.00 per hour
- Toil Making—\$70.00 to \$200.00 per week

The nation sends out a steady cry for more and more skilled tradesmen. But they must be trained—and trained right. Thousands of Detroit School of Trades graduates step at once into big money—or their own business. Joe Hansen was making 65 cents an hour and the very day our experts graduated him our employment dept. put him right out on the job at \$1.65 an hour. Now he's going to be a contractor for himself. Brooks was a low pay bank clerk — He came to this school and in an amazing short time stepped into \$1.25 an hour. Gerald Waiet, George Wells, hundreds of others have done it too. And so can you. We train by actual work—NO BOOKS.



In his great college of trades each department is a big school in itself.

Mail This COUPON—Your First Step to Big Money

D. D. Buick, Chief Engineer
Detroit School of Trades
Dept. 1026, Detroit, Michigan

Send me at once your big illustrated catalogue. I want to earn big money.

I am interested in the trade of.....

Name.....

Address.....

City.....State.....

Make That Dream Come True!

Haven't you often pictured yourself playing the Hawaiian Guitar, a happy crowd around you, everybody enjoying and admiring your playing? Now you can reach your goal—and play all the latest hits just as the Hawaiians do!



You can play the **HAWAIIAN GUITAR** just like the Hawaiians!

\$15
HAWAIIAN GUITAR
 with Genuine Seal Grain
 Fabrikoid Cover
FREE
 when you enroll

Complete Conservatory Course

52 complete lessons. Pictures explain every move. Our method is simple, practical and interesting—only 4 motions to learn. No tiresome scales and exercises—you play a real piece your very first lesson.

Expert Instruction by Native Hawaiians

Get the advantage of expert instruction by Kolomoku, Kalaluki, Ferera and Seville—every one famous as both player and teacher. Even if you never touched a musical instrument in your life, under their direction you make rapid headway—you will be astonished when you see how easy it is!

This Sweet Toned Hawaiian Guitar

In genuine Fabrikoid Case—and complete playing outfit including picks, steel playing bar, etc. sent you free when you enroll. Retailers ask \$15 or more for a similar outfit without the case. Remember, there are no extras—we furnish everything with the course.

Learn in Spare Time

Pick up your guitar at any time and play. Your lessons are always handy—you can always refer to them. You are never hurried or forced. And no waiting for a class to form—start now—go ahead as fast as you like.

Pay as You Play

Small first payment starts you. And the entire 52-lesson course comes to just a few cents a lesson! Begin now.

We Guarantee

in writing to teach you. And after graduation we coach and advise you without charge. Over 45,000 successful graduates.

Tenor Banjo and other courses—Violin, Mandolin, Banjo Ukulele, Ukulele—under well-known instructors. Write for information.

FIRST HAWAIIAN CONSERVATORY OF MUSIC, INC.
 9th Fl., Woolworth Bldg., Dept. 348, New York, N. Y.

Approved as a Correspondence School Under the Laws of the State of New York

SEND THIS COUPON FOR LIBERAL OFFER!

First Hawaiian Conservatory of Music, Inc.
 9th Fl., Woolworth Bldg., Dept. 348, New York, N. Y.

Please mail full information about your 52-lesson Hawaiian Guitar Course. I am not obliged to enroll unless I want to.

Name _____
 Address _____
 City _____ State _____

Build Your Own Airplane

Blue Prints and Material Now Ready for Builders

EASY TO BUY

EASY TO FLY

The Lincoln Sport Plane



100 Miles per Hour with 30 H. P. Engine. Special Sale on Complete Set of Parts. Complete set constructional details of Sport Plane 50c. Send Today.

The Lincoln Monoplane



Real performance in a light Monoplane. Blue Prints are life size. A Motorcycle engine will give this plane real performance.

OUR NEW AIRCRAFT INSTRUCTION BOOK—FLIGHT—has over 100 illustrated photos of American and foreign planes. A complete history of Aviation. It sells for \$1.00 postpaid.

Blue Prints of both planes on special sale NOW! Send 25c for illustrated catalog. Write today.

Lincoln Standard Aircraft Company
 Dept. D-M, LINCOLN, NEBRASKA

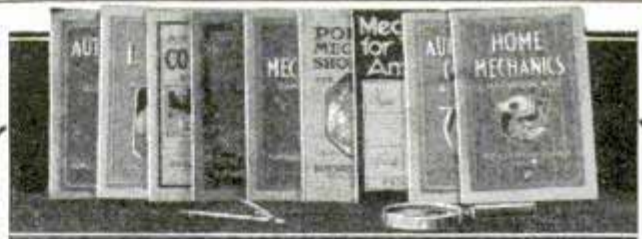

Popular Mechanics New Handbooks

If you could thumb through these new books, you would want them all. They are literally jammed with practical ideas. Each one is written so clearly that a boy can understand the directions. Each is the experience of a practical man or woman. Most articles are illustrated with photographs or drawings. The practical nature of the subjects has made a wide sale for them already although they have been on the market only a few weeks. Here are the titles of those now available:

- Popular Mechanics Lathe Handbook No. 1
- Home Mechanics Handbook No. 1
- Handbook for Women
- Popular Mechanics Concrete Handbook No. 1

Any 2 for
\$1

- Popular Mechanics Boat Book
- Automobile Owner's Handbook
- Auto Tourist's Handbook
- Auto Repairman's Handbook No. 1
- Drilling and Thread Cutting

Order Several at One Time

So low is the price that it is certainly wise to order as many of these at one time as you can use. You may have any two for \$1. These books make good presents. They are splendid for boys taking manual training courses.

Free Magazine, Personal Advancement with each order.

POPULAR MECHANICS PRESS
 Popular Mechanics Bldg., Room 704, Chicago, Ill.

Be an EXPERT DECORATOR In a few weeks



HARRY GLICK,
Principal,
Chicago Painting School

**I Specialize
in PAINTING
—have for 25 years**

That's all I know—that's why I can train you to be an expert in a few weeks in the Painting Trades — A regular honest to Goodness TRADE.

**I Have Earned Over
\$50.00 IN ONE DAY**

When prices were less than one-half of what they are today and work was not nearly as plentiful as it is now—jobs were hard to get but I always had all I could do, and with the great shortage of men at the present time

**YOU CAN EARN MORE
JUST THINK OF IT!** *I Am Giving You Facts*

You will be a full fledged
Sign Painter — Decorator — Paper Hanger
Auto Painter — Show Card Writer
or a Pictorial Painter in

6 TO 12 WEEKS

—not just an ordinary one but better than many who have been at the game for years.

straight from the shoulder when I tell you there is a big shortage of men in these trades. That's why I consider them **THE BEST OF ALL** for any man to learn—You will have a Trade that will

PAY YOU BIG MONEY

and make you satisfied and happy the rest of your life. No Talent or Education necessary.

I Know I Can Put You in the Big Money Class

I am so sure of this that to induce you to send at once for my big free catalog so that you will understand more clearly what my courses are,

I WILL PAY RAILROAD FARE TO CHICAGO

to all who enroll at once. *Get Busy Today—Clip the Coupon Below—Be on Your Way to SUCCESS.*

Chicago Painting School
147 W. Austin Ave.
DEPT. 12 CHICAGO ILL.

SEND THIS TODAY!

MR. HARRY GLICK, Principal
CHICAGO PAINTING SCHOOL
147 W. Austin Ave., Dept. 12

Dear Sir: Send me your free Catalog, describing your courses, and special offer with no obligation on my part.

Name

Street

City..... State.....

Learn a GOOD Trade LOOK ABOUT YOU



Pilot \$5.00 an hour



*Airplane Mechanic
\$85.00 to \$125.00 a week*

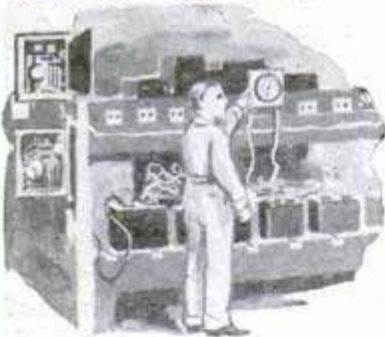

*Batteries
\$300.00 a month*

From ground to sky there's ACTION. Young men mechanically inclined have taken our old civilization and turned it upside down. THE BEST TRADES are mechanical. Over 20,000,000 cars and trucks running. All accessory trades such as welding, vulcanizing, auto painting, developing by leaps and bounds. In the air HUNDREDS of daring men are making fortunes flying. On the field it takes five mechanics to keep one flyer in the air—and what with aircraft manufacture, repair and general ground work, every month opportunities are doubling for the man who knows his trade. If you want to be independent—prosperous—see the world—do the work you like—own your own business, BE A LEADER in our mechanical civilization—HERE'S YOUR CHANCE. MY BIG FREE BOOK IS THE KEY to ten thousand opportunities. Write for it today. It will open your eyes; it will change your whole future.

Sweeney Flying School

Here's the great business of the future. The Sweeney School teaches flying with skilled instructors, fine planes, a great flying field, all equipment. All the time in the air necessary to make you a skilled pilot. If you want to be a pilot, fit yourself for government mail or commercial service, exhibit at fairs, etc., here's your chance.

Easy Now to Learn Expert Flying

At the completely equipped Sweeney airport in North Kansas City—a few minutes from the post office—you are taught in latest model planes, Swallows and others, with dual controls until you are a master aviator. Some learn flying for pleasure; many learn to become mail or commercial pilots—crop dusters—aerial advertising—photo work—taxi service, etc. These jobs pay \$125 to \$225 a week.

Ground School Trains Mechanics

SWEENEY GROUND SCHOOL is a thorough course in practical airplane mechanics. You don't have to take flying unless you want to. Airplane mechanics are in great demand. Five men on the ground needed to keep one man in the air. Learn by doing. Construction and repair of planes—all about motors—re-covering wings, etc. Mechanics and engineers earn from \$50 to \$125 a week. Riggers earn \$50 to \$75. You work on latest type equipment and become a skilled man in a great new business. Mechanics and ground men always assured of interesting, profitable steady work.

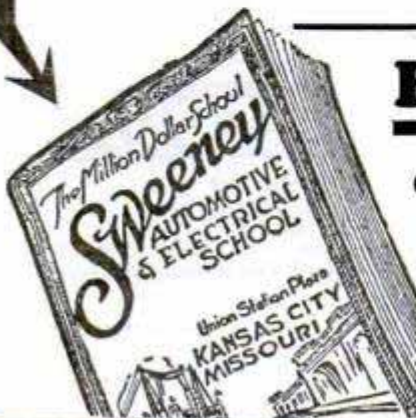

FREE

65-Page
Book
Get
It
Now!

Sweeney

Aviation—Automotive
3031 SWEENEY BLDG.

-the sky's the Limit!

THE MILLION DOLLAR SWEENEY SCHOOL

with over 65,000 graduates, trains you in a good trade. What appeals to you? Auto repairing—bus line driving—garage—repair shop—tire shop—welding—radio broadcasting—auto painting, or does opportunity call you FROM THE AIR? Do you want to be a pilot—or airplane mechanic? Write me today—GET THE FACTS—about wages—profits—opportunities and HOW THE SWEENEY SYSTEM is equipped to give you successful training.



Garage Owner \$3000⁰⁰ Up

Auto Mechanics Wanted

Auto Mechanics make \$50 to \$100 a week. Learning is easy by the Sweeney System of Practical Training. Use tools not books. Be an auto mechanic—driver—truck driver—repair man—tire man—demonstrator. Own your garage or repair shop. Run a welding and vulcanizing shop. You can learn these trades separately or in a combined course.

Sweeney System "LEARN BY DOING"

If you are mechanically inclined, if you like to work with tools, you will learn under the "SWEENEY SYSTEM" by actually doing the work on the most complete gas engine and electrical equipment. Over \$200,000 invested. \$50,000 Radio Station WHB. You'll get dirty and greasy, but you'll learn through the SWEENEY SYSTEM OF PRACTICAL TRAINING that fits you for the big pay jobs waiting for Sweeney Trained Men.

Send for This Big FREE Book

That's the first step. It obligates you to nothing but gives all the facts. Tells all about different mechanical trades. Shows how men LEARN BY DOING. How we teach with TOOLS—not books. Tells all about wages and opportunities. Fully illustrated; pictures of men at work. Takes you through the million dollar school—one of the sights of Kansas City—on Union Station Plaza—right by the great Liberty Memorial. Men come from all over the world to this school. Read letters from happy graduates, making good. Special section devoted to flying—pictures of planes and hangars and Sweeney Students at work. Clip coupon—or postcard will do—but DON'T PUT IT OFF. This book costs me a dollar but I send it absolutely free. No colored students accepted.



Vulcanizing \$5⁰⁰ a day



Welding \$12⁰⁰ a day



Tractor Road Work \$10⁰⁰ a day

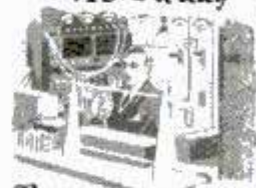

Radio Station Opr \$350⁰⁰ a month

mey
—Electrical School
KANSAS CITY, MO.

EMORY J. SWEENEY, President
3031 Sweeney Bldg., Kansas City, Mo.

Please send me your FREE 64-page catalog and full details of your courses leading to BIG PAY JOBS. I am interested in

- () Flying
- () Airplane Mechanics
- () Auto Mechanics
- () Welding and other trades
- () Batteries
- () Vulcanizing

Please mark X opposite subject in your mind.

Name..... Age.....

Address.....

Town..... State.....

MARK X IN SUBJECT THAT INTERESTS YOU

10 DAYS' TRIAL
SEND NO
MONEY



NO
NEED
FOR A
NEW
PHONOGRAPH

New PHONIC Reproducer

makes an up-
to-the-minute
Phonograph out
of your old one!

\$3.85

Direct
from
Factory

Now at last you can say goodbye to the squeaky, nasal, rasping, metallic tone of your phonograph. Now you can have the beautiful, natural, full-rounded tone of the expensive new machines which are startling the world. Yet you need not buy a new phonograph if you have an old one. The reproducer is the HEART of any phonograph—and the New PHONIC reproducer makes your old phonograph like an entirely new one. Based on the new PHONIC principle. Makes you think the orchestra or artist is in the same room.

Gives the New Tone and Volume of Latest New Phonographs

Tones never before heard are clearly distinguished when the new PHONIC reproducer is used. Test it on an old record. Hear the difference yourself. Listen to the deep low notes and the delicate high notes. Hear how plainly and clearly the voice sounds. Note the natural tone of the violin and the piano, and the absence of "tinny" music. You will be amazed. The new PHONIC reproducer is ideal for dancing or for home entertainments. Its volume is almost double that of the ordinary reproducer.

10 Days' Trial—Send No Money

You cannot realize how wonderful the New PHONIC is until you hear it. That is why we want to send it to you on 10 days' trial. Send no money now—just the coupon. Pay the postman only \$3.85 plus a few pennies postage when the New PHONIC arrives. Then if you are not delighted, send it back within 10 days and your money will be refunded. If sold in stores the price would be at least \$7.50. Our price only \$3.85. Over 350,000 people have dealt with us by mail. You take no risk. Mail the coupon now for 10 days' trial. BE SURE TO STATE THE NAME OF PHONOGRAPH YOU OWN.

NATIONAL MUSIC LOVERS, Inc., Dept. 5810
327 West 36th Street, New York

Please send me a New PHONIC reproducer for.....

I will pay the postman \$3.85 plus few cents postage. If I am not satisfied after trial, I will return your reproducer within 10 days and you guarantee to refund my money.

Name.....

Address.....

City..... State.....

ANY BOOK IN PRINT

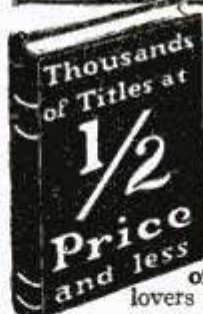

Delivered at your door. We pay the postage. Standard authors, fine editions, new books, all at biggest savings. Be sure to send postal for Clarkson's catalog. **FREE** Write for our great book catalog. This catalog is a short course in literature and is so used by some of America's leading universities; 300,000 book lovers buy from it. Free if you write now.

DAVID B. CLARKSON THE BOOK BROKER
1021 CLARKSON BUILDING, CHICAGO, ILLINOIS

DON'T STAMMER

Quick, easy, complete cure guaranteed. Information, diagnosis, phonograph record and catalog free. America's foremost school. Est. 1894. Act before it is too late.
153 Stimson The LEWIS INSTITUTE Detroit, Mich.



Want
to
make
more
money



Be a
Civil
Engi-
neer

Here is an easy way to learn. You hold your future in your own hands. If you have a grammar school education, and want the advantages of knowledge usually gained in college, you will welcome this new system of reading at home. No long hours of grinding study; just the meat of every subject told in such a simple way that anybody can understand.

If you want to get ahead—now is your chance We Ship Nine Books FREE

This is a "straight-from-the-shoulder" offer to men who want a big future. If you could hear half the stories of success we receive, you would not hesitate a minute. Send for the books now; just your name and address; and we'll ship the entire set of nine volumes. Keep them ten days, then if you realize how valuable they are to you, send only \$2.00, and after that only \$3.00 per month until the small total of only \$29.80 is paid. A free membership in the American Technical Society will be included if you send NOW. This entitles you to full consultation privileges with 18 engineering experts.

The special jiffy index puts facts at your finger tips

AMERICAN TECHNICAL SOCIETY, Dept. C-719, Chicago
You may send me, for Free examination, your nine new books on Civil Engineering. Unless I return them in ten days I will send you \$2.00 as first payment, then \$3.00 per month until the special price of only \$29.80 is paid.

Name.....
Address.....
City..... State.....
Reference.....

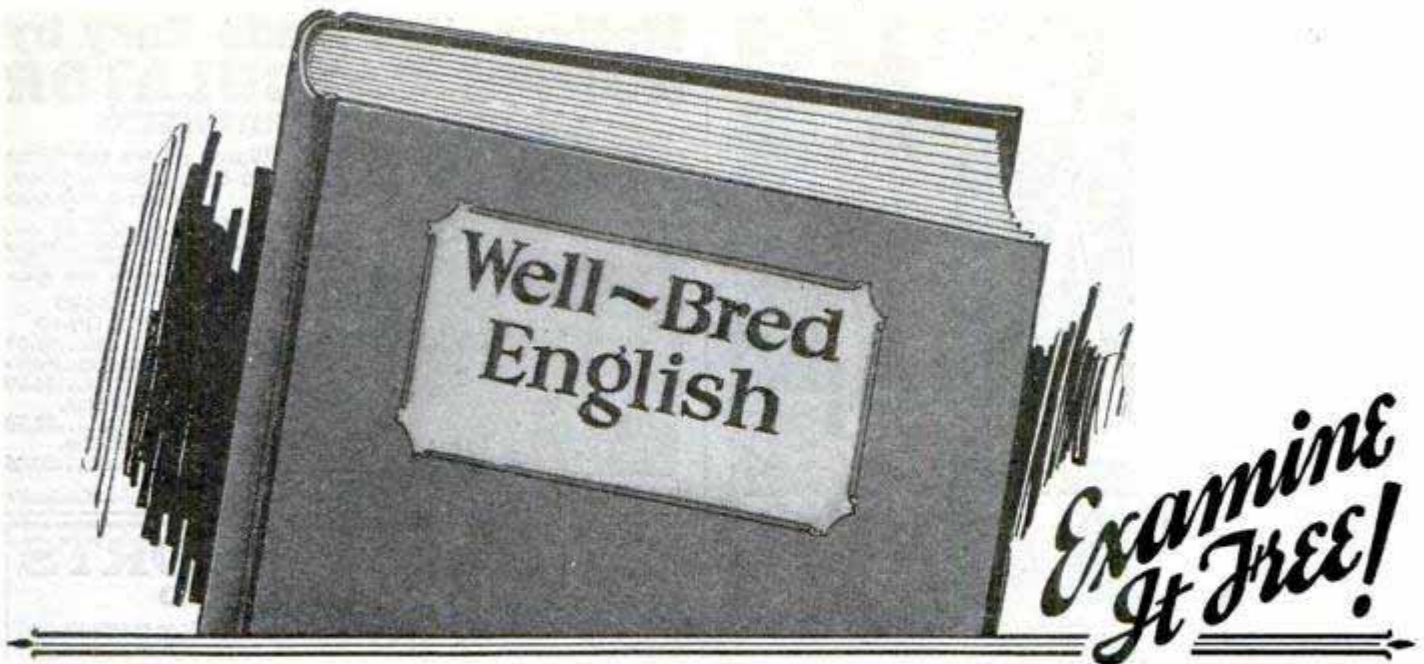

Do You Make These Tell-Tale Mistakes in English?

Are you always SURE of yourself in conversation—or do you often unconsciously make mistakes that cause others to judge you unfavorably? For example—how would you pronounce “abdomen,” “demonstrate,” “ennui”? Can you discriminate between “emigrant” and “immigrant,” between “disinterested” and “uninterested,” “further” and “farther”? Would you say “Whom shall I call” or “Who shall I call”? Don’t let your English handicap you—learn now the simple secrets of making it well-bred.

THE English you use is the surest index to your education and culture. No matter how particular you may be about your appearance, clothes and grooming—the moment you begin to talk you tell the world *what you are*. And the impression you create depends entirely on *how you say* what you have to say.

If you unknowingly mispronounce words, if you make grammatical errors, if you have to search frantically for the right words to express your idea, you make an unfavorable impression. Your listeners naturally assume that you are lacking in culture and education.

Make This Interesting Test

How would you pronounce “epoch,” “era,” “data”? How would you pronounce “finance,” “advertisement,” “evening,” “column,” “coupon,” “incomparable,” “ascertain,” “appendicitis”? Are you *sure* that you pronounce them correctly?

Do you ever say “efflusive” for “effusive,” “affect” for “effect,” “irrevel-

lant” for “irrelevant”? Do you ever say “can” for “may,” “shall” for “will,” “sure” for “surely”? Should you say “between you and me” or “between you and I”? Should you say “He is apt to do this” or “He is likely to do this”?

A perfect command of your English enables you to express yourself clearly, correctly and well on all occasions. It not only marks you as a man or woman of education and breeding, but it also helps you to win the things you want most in life—a better position, bigger pay, prestige and popularity.

“Well-Bred English”

An Authoritative New Book About Voice, Speech and Conversation

“Well-Bred English” is an extraordinary new book that is not only a pronouncing dictionary, not only a very useful source of information on the choice and use of words, the building of a vocabulary, the construction of sentences, the wording of thought—but also *the only book ever written that gives examples of actual conversations between cultured men and women in ball-*

room, at fashionable dinners and teas, at country clubs, in business. These conversations are given word for word, written phonetically so that they reveal not only valuable secrets of speech and conversation but the pronunciation of familiar words.

“Well-Bred English” tells you what to talk about in different environments—how to be an interesting conversationalist. It tells you how to make your voice rich and vibrant, how to increase your vocabulary, how to choose words, how to pronounce words correctly, how to overcome lisping, stammering, stuttering. It gives the pronunciation and meaning of foreign words in frequent usage, and even tells how to overcome a foreign accent. It is complete, useful—unlike any book of the sort ever attempted.

5 Days’ FREE Examination

Send no money. Just mail the coupon and we will gladly send you without obligation a copy of “Well-Bred English” for 5 days’ FREE examination. After the five days you have the privilege of returning it or sending only \$3 in full payment and keeping the valuable book as your own. Mail the coupon NOW. Nelson Doubleday, Inc., Dept. E-2310, Garden City, New York.

Nelson Doubleday, Inc., Dept. E-2310
Garden City, New York

Send me “Well-Bred English” free for 5 days’ examination. Within that time I agree to return it without obligation if I am not delighted, or keep it and send only \$3 in full payment. I am to be sole judge.

Name

Address

City.....State.....

How Do You Pronounce

“acclimated”
“débutanté”
“orchestra”
“theatre”
“leisure”

Do You Say

“go slow” or “go slowly”
“I feel badly” or “I feel bad”
“the best of the two” or
“the better of the two”

Do You Know

how to make your voice rich and vibrant
how to discriminate in the use of words
how to overcome a foreign accent
how to “make” conversation



**DR. HARLAN TARBELL
MASTER OF MAGIC**

*I'll Teach
YOU
Real Professional
MAGIC*

at Home ~ By MAIL



**Big Stage Illusions
Secrets of the Orient**

Master Illusions from Europe, India, China, Japan. Guarded secrets of the Orient—over 150 tricks from small effects to Big Stage Illusions, with nearly 1500 illustrations, *that and more* is what you get in the Tarbell Course in Magic!

Read This Great Endorsement

Dr. A. M. Wilson, Editor of the Sphinx, Official Organ of The Society of American Magicians, pays the Tarbell Course this tribute:

"The greatest work on Magic ever attempted and will mark an epoch in Magic greater than the revelations of Robert Houdini, Father of Modern Magic, 60 years ago."

**Money-Back Guarantee
Protects YOU**

The Tarbell course in Magic protects you with an Iron Clad Guarantee to refund your money if you are not satisfied. You can't lose. You have everything to gain.

**Get Started on the
Road to Big Money**

You need not give up your job. You don't have to be a "professional" to make big money. You can make nice money entertaining on-the-side as a semi-professional, or if you want to, you can become a big Magician, make big money and enjoy fame and glory. Learn all the great limitless opportunities that are in store for you. Mail coupon NOW!

The first
and only
Course in
Magic

ever offered to the
public teaching
real professional
Magic!

Mail This Coupon NOW!

Tarbell System, Inc.
1926 Sunnyside Ave., Studio 13-57 Chicago

Tell me about Dr. Tarbell's new and simple system by which I can learn the secrets of MAGIC. Also tell me about your Special Price and Easy Terms Offer. No obligation on my part.

Name.....

Address.....

Age.....

**Mathematics Made Easy by
ROPP'S CALCULATOR
AND SHORT-CUT ARITHMETIC**

Shows the Answer as Quickly as a Watch shows the Time to all Problems likely to occur in the Office, Store, Shop, Bank, Farm, or Factory. **Over 2,000,000 Sold**

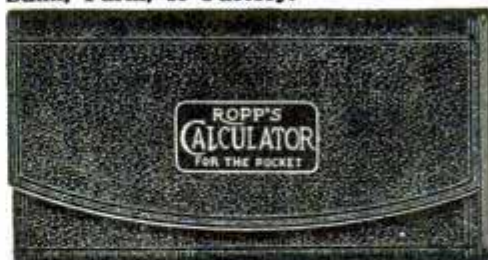

Explains and simplifies every principle in Arithmetic, Mechanics, and Mensuration.

PRICES POSTPAID
Desk Size...\$1.50
Leatherette, Pocket Size...\$1.00
Pocket Size, Cloth...\$0.50
Pocket Size, Paper...\$0.35

Popular Mechanics Press, Room 210, 200 E. Ontario St., Chicago

**OUTDOOR SPORTS
THE YEAR 'ROUND**

Popular Mechanics New Useful Book—Outdoor sports appeal to us all. But the fun is double when you make your own devices. There are 226 clearly written and concise articles telling how to make equipment for new and popular sports of many kinds in the new Outdoor Sports book. There are clever devices for such sports as:

- | | | | |
|------------------|--------------|----------------------|--------------|
| Swimming | Trapping | Photography | Kite flying |
| Camping | Tobogganing | Tennis | Summer games |
| Football | Baseball | Outdoor winter games | Nutting |
| Swinging | Fishing | Skating | Pushmobiling |
| Trolley coasting | Golf | Boating | Racing |
| Roller skating | Boat sailing | Toy making | Skiing |

It is easy to make the devices described because there are 317 helpful illustrations. The articles are clear enough for boys, yet interesting enough for any man.

Send No Money Just write your name and address on a postal card and say that you want Outdoor Sports the Year 'Round. When the postman hands you the book, give him \$1.50 plus the few cents postage. That is all. If you live outside the U. S. or if you are not at home when the postman delivers the mail, then send \$1.50 with your order. Address your postal to

POPULAR MECHANICS PRESS Room 710, Popular Mechanics Bldg. 200 E. Ontario St., Chicago

Build a Boat Popular Mechanics Boat Book tells how to make 21 kinds of boats and canoes. Fully illustrated. You can build a boat any time of the year. Many do the building in winter. Price 50 cents. **POPULAR MECHANICS PRESS, Popular Mechanics Bldg., Rm. 710, Chicago, Ill.**

2¢
BRINGS
YOUR
COPY



OF
THIS
GREAT
BOOK

Do you know how to figure interest, obtain a divorce, measure potatoes, make a will, endorse checks, write letters, conduct meetings? This book answers these and 10,000 other questions. A complete library of facts in one volume.

544 Pages

More than 500 subjects, fully illustrated with forms, charts and tables. Gives commercial laws, legal forms, interest tables, all forms of measurement. How to advertise, make investments, draw contracts, measure grain, lumber, wall paper, etc. Concrete advice on all daily problems.

Used Everywhere

Millions own "The Business Guide" — merchants, lawyers, farmers, teachers, mechanics, clerks. Many write they would not part with it at any price. Should be in every home.

Special Offer! Always sold for \$5.00, but special publishing arrangements furnish complete volume in heavy Law Buckram binding at greatly reduced price.

SEND NO MONEY — Fill out coupon and mail. When book arrives pay postman \$2.97 plus postage. Keep the book a week and if not more than satisfactory, send it back. (If remittance with coupon, \$2.85.)

J. L. NICHOLS & CO., Dept. 1, Naperville, Ill.
Send my copy of the Business Guide as per your special offer.

Name.....

Address.....



J. A. Rosenkranz
President

This Remarkable New... AUTO BOOK FREE

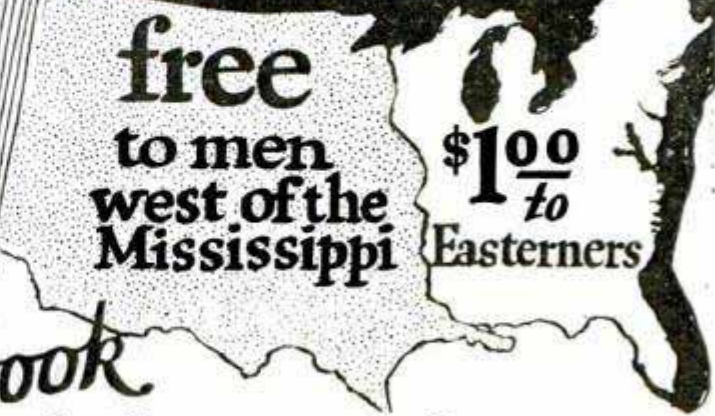

**We have
Auto JOBS
WAITING
here for you now!**

Our Free Employment Service has hundreds of jobs for National students. You can work at part time jobs to earn board and room while training. When you graduate we help you get the job you want—in a garage—a service station—or help you start in business for yourself. Even years after you leave, this free service will help find jobs for you. This 21-year old school has 16,000 graduates, many of them heads of big businesses. They want other National-trained men to help them. The leading auto manufacturers and associations endorse National training methods and give preference to National students.



Special Reduced Tuition NOW!

To get good men quick I am cutting the price of my training 30%. This offer can't last. Ambitious men will mail this coupon right now and in a few months they will be on the way to become high-paid Auto Experts holding good, steady jobs. Sign below for bigger pay!

this book

is only for men who can Come to California to Learn Autos!

I need men **right now** to learn the auto business and go right to work. The best service shops in Los Angeles are paying National-trained men \$60 to \$100 a week. They need more **thoroughly** trained auto repair men—quick!—so I can make you a special offer if you can come to California NOW!

I'll Help You Make More Money—Quick!

It costs me a dollar to send you my 84-page book that tells you the **Truth** about your opportunity to make money in Autos. It gives plain facts—shows just how 16,000 other men have succeeded through my training—and proves that I have the equipment, the instructors and the location to fit you to become a real Auto Expert. I don't rush you through half-trained. I guarantee to employers that my graduates know their stuff. That's why National graduates make good everywhere. It pays to come to Los Angeles and get **quality** training. I have no "free offers"—no free railroad fare—but I do guarantee to give you the most thorough, practical training. And my catalog proves it! Before you pay any money for automotive training—read my book and judge for yourself where you'll get the best, most thorough training.

NOW! Are you ready for My Special Offer ?

If you live west of the Mississippi River and are ready to go to work right away—I'll send you my \$1.00 catalog **absolutely free**. It explains everything. If you live in the East, send me \$1.00 and I'll mail you the catalog. Then, when you enroll, I'll credit you with a dollar, so you won't be out any money.

J. A. Rosenkranz, President
National Automotive
Dept. 452, 4004 So. Figueroa St.
Los Angeles, Calif.
I live west of the Mississippi—so send me your \$1.00 Auto Book Free.
(If you live elsewhere—enclose \$1.00 and it will be deposited to your credit at 5% interest.)

National Automotive

& Electrical Schools Established 1905

Dept. 452, 4004 So. Figueroa St., Los Angeles, Cal.

Name.....
Address.....
City..... State.....



Learn to Write For Newspapers This New, Easy Way

New "Copy Desk" Method Enables You to Prepare Quickly for Success—Right at Home—In Spare Time!

If you have ever dreamed of a career as a writer, here is your opportunity to prepare for success in a fascinating, money-making profession, and at the same time acquire a broad background of knowledge and experience that may lead to distinction, even fame, in the field of literature.

As a newspaper writer, you have the opportunity to see more of life—its adventures, romance and mystery—than would be possible in almost any other vocation. Probably no other line of endeavor affords the opportunity of seeing so much of life.

Well Paid and Full of Opportunities

Salaries for newspaper writers, both men and women, compare most favorably with those in other important professions. Furthermore, those who develop real ability stand out so prominently in the spot light of publicity, that they are singled out for big money offers, not only from competitive publishers but from important corporations in other lines of business.

A Remarkable Method of Training

Our remarkable course of instruction—called the Copy Desk Method—is especially arranged for home instruction, and is conducted by practical newspaper men—men who know from personal experience the things they teach you to do.

Through this Copy Desk Method which actually reproduces the conditions under which the staff writers of big newspapers work, you receive a thorough, practical, training in every branch of this fascinating subject. You learn newspaper writing as it is actually done in the big newspaper offices. Your training is carried on exactly as though you were at the copy desk of a New York Newspaper.

Every phase of newspaper work, every kind of writing, is covered so thoroughly that you will be amazed at how rapidly you progress. Yet the price of the course is very moderate.

Illustrated Booklet—FREE!

Our FREE 32-Page Booklet, "Writing for Profit," describes the course in detail. The coupon below will bring your copy to you, without any obligation whatever. If you are ambitious for a career as a writer, fill in and mail the coupon now! **Newspaper Institute of America, Dept. 710, 25 West 45th St., New York City.**

Newspaper Institute of America, Dept. 710—25 West 45th Street, New York City

Please send me your 32-page illustrated booklet, "Writing for Profit," describing your course in Writing by the Newspaper Copy Desk Method.

Name.....
 (State whether Mr., Mrs. or Miss)
 Address.....
 City.....State.....

It's Fun to Make Things



Let the other boys wonder how you can make so many interesting things. Make your own motor sled. Make your own radio. Make your own skis and snowshoes. You can learn how to make almost anything that any boy could want by following the pictures and the simple directions in

The Boy Mechanic Library

And just think of it, there are nearly 4,000 separate articles in the four beautiful volumes! Some of the most fascinating subjects are listed below.

How to Make Things

- | | |
|-------------------|-----------------------|
| Boats | China painting |
| Winter sports | Decorative metal work |
| Camping | Furniture making |
| Ice boats | Farming |
| Water sports | Poultry |
| Toboggans | Models |
| Tents | Laboratory helps |
| Indian snowshoes | Household helps |
| Skating | Wood working |
| Gymnasium | Electrical devices |
| Wind wagons | Photography |
| Motor sleds | Music |
| Radio | Outdoor games |
| Magic | Stoves |
| Trapping | Furnaces |
| Pets | Wireless |
| Leather work | Tricks |
| Carpentry | Puzzles |
| Painting | Bicycle |
| Toys | Flowers |
| Fishing | Hunting |
| Fruit growing | Kites |
| Entertainments | Metal working tools |
| Automobile | Secret locks |
| House decorations | Swings |
| Drafting | Sleds |
| | Power devices |

Learn how to make things to sell. Learn how to make things to enjoy yourself. Buy the complete library, including Book 1, Book 2, Book 3 and Book 4.

Send No Money

Simply sign your name and address on the attached coupon and mail it at once. When the postman delivers the books to your door, pay him the price of the books and the few cents postage. That is all.

POPULAR MECHANICS PRESS
 Popular Mechanics Building
 Room 1710 CHICAGO, ILL.

Mail the Coupon Today!

POPULAR MECHANICS PRESS
 Popular Mechanics Building
 Room 1710, Chicago, Ill.

Please send me at once C. O. D. The Boy Mechanic Library comprising Book 1, Book 2, Book 3, and Book 4. I will pay postman \$7 and the few cents postage.

Name.....
 City.....
 State.....
 St. No. or R. F. D.....

If you want individual books at \$2 each, check the numbers of the books you want: 1 2 3 4

Own a Typewriter!

A Bargain You Can't Ignore! Try It Free, and See!

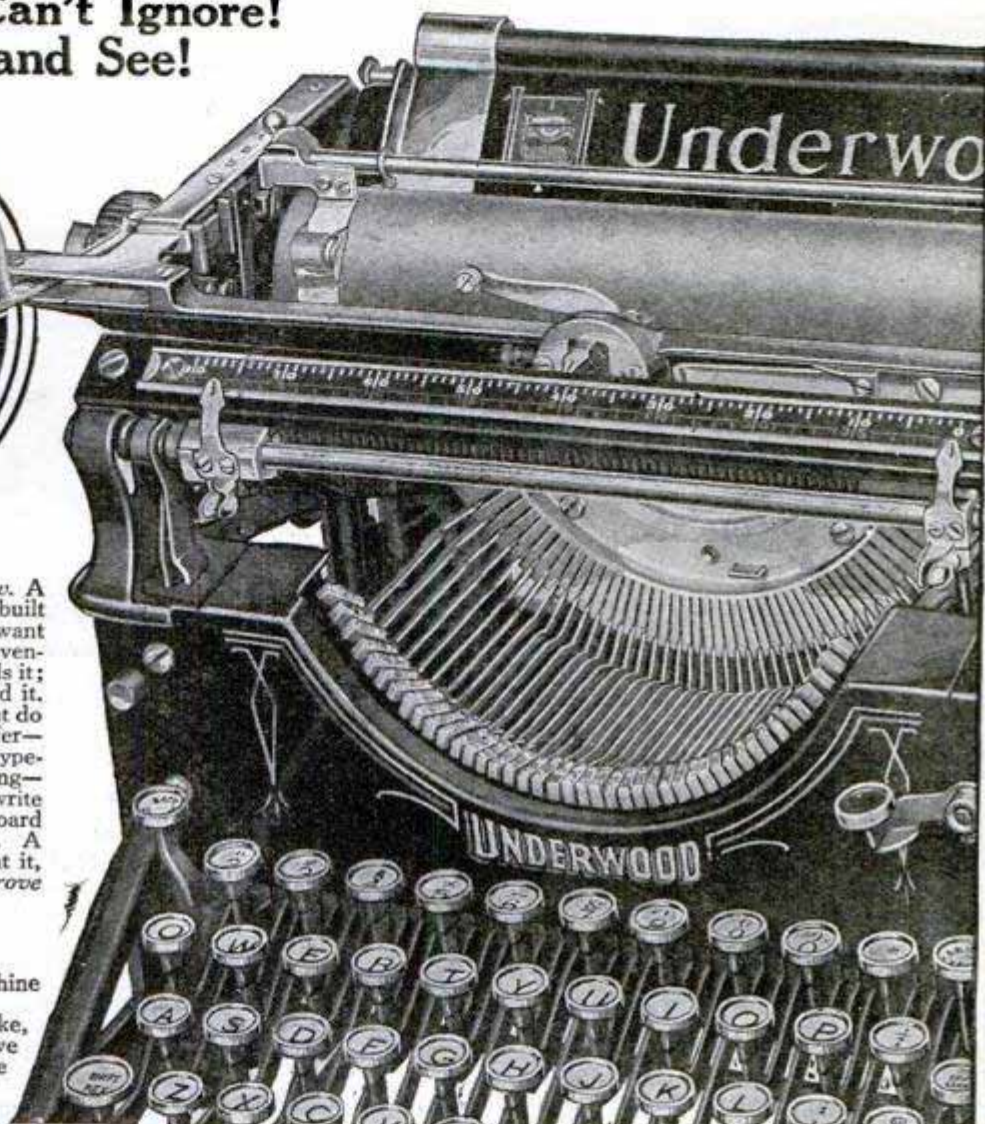

GET YOUR typewriter now. A genuine Shipman-Ward rebuilt Underwood is the one you want—"the machine you will eventually buy!" Everyone needs it; now anyone can afford it. Don't send a cent—but do get our big special offer—our valuable book on typewriters and typewriting—free. You can learn to write on this standard-keyboard machine in one day. A week after the expressman has brought it, you'd feel *lost* without it. A trial will prove it—and doesn't cost you a penny!

A New Plan

Our rebuilt plan gives you the *best* machine and saves you a *lot* of money.

The Underwood is so famous a make, and No. 5 so popular a model, you'll have to speak up if you want one of the lot we are just completing now!

We rebuild from top to bottom; replace every single worn part; each machine is in *sparkling* condition. New typewriters are commonly guaranteed for a year; we guarantee these completely rebuilt Underwoods *five* years! That's our Better-Than-New Guarantee! And we guarantee a big saving in money!

We don't ask for a cent now. Nor any money at all, unless you are completely won by the wonderful writing machine we ship you for an unrestricted 10-day free trial. When you do buy, take advantage of our very liberal scale of monthly payments. A host of our patrons have paid for their typewriters out of money made typing for others. (One woman made a *thousand* dollars at home last year with her Underwood.)

Free Trial Offer

If you know typewriters, you know the perfect work and the ease and speed of an Underwood. If you have never owned a typewriter, start with the finest! You can try this one at our risk. But, the time to act is NOW. Don't miss out on this present bargain offer. Don't



This is a Genuine UNDERWOOD
*
The ace of All Writing Machines!

* **Act NOW If • Ever!** *

do longer without the convenience of a typewriter. **FREE!**

Our plan gives you the opportunity of a *thorough trial* before you buy. You run no risk whatever. You start to pay for your typewriter *after* you have found it the one and only machine for you! Put get the facts before this lot of machines is all in use. Clip the information coupon before you turn the page. It will pay you! Note the very useful book you will receive free! Write for full particulars at once.

Get our catalog that tells how we rebuild these wonderful Underwood typewriters in the largest factory of its kind in the world, and lowest prices and terms in existence. We will also include free, the new Type Writing Manual—it gives many examples of uses for your typewriter; in business accounts, social correspondence, recipes, shopping lists, household accounts, etc.; school work, literary work, etc. Clip coupon now!



Mail to SHIPMAN-WARD MFG. CO.
2127 Shipman Building, Chicago
Please send me full offer, with Type Writing Manual FREE, prices, terms, etc., and full information about your FREE course in Touch Typewriting. All without obligation; this is NOT an order!

Name.....
Street.....
P. O.....



Tobacco Is Hurting You

Look at the facts square in the face, Mr. Tobacco User. You may think tobacco is not hurting you.

That is because you haven't as yet, perhaps, felt the effects of the nicotine poison in YOUR system. For you know that nicotine, as absorbed into the system through smoking and chewing tobacco, is a slow working poison. Slow, yes—but sure.

Tobacco is lowering your efficiency. It slows a man down. Makes it harder for you to concentrate your mind on your work. You haven't near the amount of "pep" and energy you would have if you stopped using it. There's many a man twice as old as you in years who's twice as young in energy, simply because he lets tobacco alone.

Some day you will realize to what an alarming extent tobacco has undermined your system.

When your hands begin to tremble—
and your appetite begins to fail—
and your heart seems to "skip a beat" now and then—
and slight exertion makes you short of breath—
then you have a right to suspect that
TOBACCO is getting the upper hand.

Any well-informed doctor will tell you that these are only a few of many symptoms of tobacco poisoning.

And YOU know that the use of tobacco in any form is an expensive, utterly useless habit. You know you ought to quit.

Tobacco Habit Banished Let Us Help You

It doesn't make a particle of difference whether you've been a user of tobacco for a single month or 50 years, or how much you use, or in what form you use it—whether you smoke cigars, cigarettes, pipe, chew plug or fine cut or use snuff—**Tobacco Redeemer** will positively remove all craving for tobacco in any form in a very few days. Not the slightest shock to the nervous system. Your tobacco craving will usually begin to decrease after the very first dose—there's no long waiting for results.

Tobacco Redeemer contains no habit-forming drugs of any kind and is marvelously quick, scientific and thoroughly reliable.

It is in no sense a substitute for tobacco. After finishing the treatment you have absolutely no desire to use tobacco again or to continue the use of the remedy. It helps to quiet the nerves and make you feel better in every way.

Results Guaranteed

A single trial will convince you. Our legal-binding, money-back guarantee goes with each full treatment. We will refund every cent you pay for the treatment if after taking it according to the easy-to-follow directions, it should fail to banish the tobacco habit completely.

SEND Coupon for Free Proof

Let us send you our free booklet on the deadly effects of tobacco, together with testimonial letters from men all over the country telling how they have been absolutely freed from the tobacco habit by this simple home treatment. You could not ask for stronger proof that **Tobacco Redeemer** will free you from the habit than the evidence we will gladly send on request. Just mail the coupon—or a postal will do.

NEWELL PHARMACAL CO.

Dept. 300 Clayton Station St. Louis, Mo.



Free Book Coupon

NEWELL PHARMACAL CO.

Dept. 300 Clayton Station St. Louis, Mo

Please send, without obligating me in any way, your free booklet regarding the tobacco habit and proof that **Tobacco Redeemer** will positively free me from the tobacco habit or my money will be refunded.

Name

Street and No.

Town..... State.....

Sensational Sample Offer

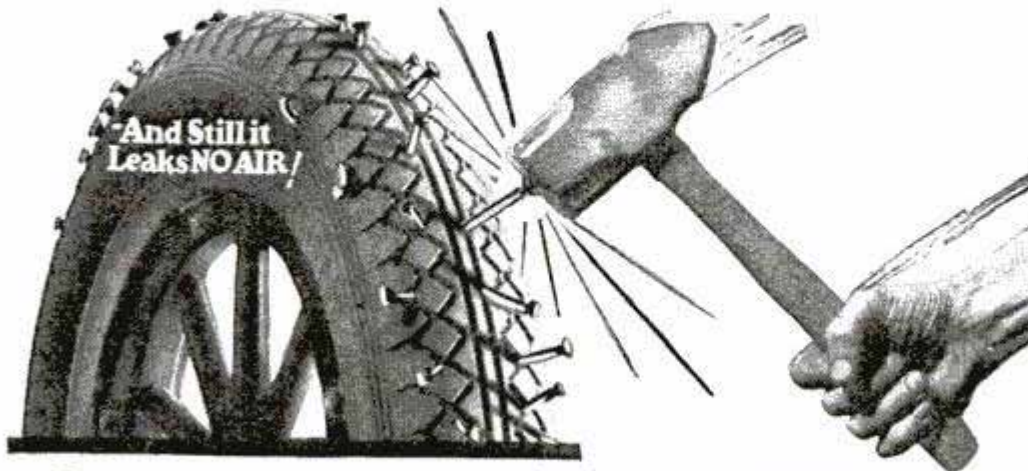

Amazing Tire Fluid Seals Punctures!

Startling Discovery Makes Old and New Tires Puncture Proof. Increases Mileage Tremendously. Seals Slow Leaks, Valve Leaks and Porous Tubes. Prevents Rim Cuts and Broken Side Walls. Read Inventor's Free Trial Offer Below!

HERE is a wonderful new scientific discovery called Aer-Pruf, which seals punctures instantly while you are driving. You never even know you have a puncture. It doubles tire mileage because it prevents driving with partly flat tires—the biggest cause of tire trouble.

No injurious effects on casing or tubes. Will last the lifetime of the tube. Applied in a minute. Aer-Pruf does away entirely with changing tires and patching tubes on hot, dusty roads—in blazing sun or in freezing snow storms.

Tests on this boon to autoists have been astounding! Steve H. Temple drove a tire that had been punctured 50 times over 3,000 miles and it did not leak a pound of air! An old tire, after being treated with Aer-Pruf, was punctured with 857 nails without a single leak. Another tire was punctured 1,100 times!

Sensational Money Maker

So startling is this invention, so marvelously successful that our representatives are piling up big profits for just a few hours' work. Every auto owner, whether he drives a Ford or a Cadillac, is eager to buy—he detests the fuss and bother of changing tires on the road and mending tubes. Absolutely no sales talk is necessary—a deaf and dumb man can sell Aer-Pruf. If you have a car you can equip one of the wheels with an old tube to use for demonstration. But you don't need a car—an old discarded casing and rim will be sufficient to bring in \$15 to \$25 every day.

Sample Offer Free

Right now we are making a big, special offer to send you sample sets of Aer-Pruf at the inventor's risk. And also, we agree to actually pay you for testing Aer-Pruf if you are not amazed and delighted with it. Send the coupon for full details—and generous money-making proposition. Mail it today.

AER-PRUF MFG. CO.

P-2212 Logan Bldg., Mitchell, S. Dakota

**\$75 to \$150
a Week to Agents!**

Aer-Pruf is the most remarkable selling proposition ever seen. And the biggest quick-money discovery of all time! Read what these full-time and spare-time demonstrators say:

\$57 One Evening!

"Demonstrating on Main Street Saturday evening have made as high as \$57 for one evening's work."—FRANK RYMAN.

\$9 in 5 Minutes!

"Aer-Pruf is everything you claim. On first demonstration I made \$9 in about 5 minutes—with plenty of prospects left to call on."—HENRY DUBOIS.

You Can Do As Well!

AER-PRUF MFG. CO.
P-2212 Logan Bldg., Mitchell, S. Dak.

Please send me full details of your Free Sample Offer and your offer to pay me for my time in testing these samples if I am not amazed and delighted with them.

Name

Address

City.....State.....

Don't miss it

This Tenor Banjo

WORTH \$18

FREE

When You Enroll



This handsome full size, professional tenor banjo is yours when you enroll. We want to make one thousand new friends this month. We want to present one of these wonderful, delightful instruments as a gift to each of one thousand readers of this magazine—and here's why. Before becoming a professor, and a lover of music, particularly the tenor banjo, Prof. Six yearned and yearned for the possession of a genuine, professional instrument, the same kind used by the big, successful professionals of the world. Now we want you to succeed. We want to help every music-lover that we can, attain success, and this gift offer is made to pave the way for you, and no previous musical knowledge is necessary.

We have another surprise for you! Not only do we start you on the way to popularity, success and fame by supplying you with an instrument that you can compare to any used or displayed in your town, but under personal supervision you will be given, by mail, the benefit of Professor Harry S. Six's twenty-two years' experience as director of Glee and Instrumental clubs of New York University. We don't just send you a lot of printed words and instructions and trust to luck that you will catch on. Our method is different and has proven to be the simplest devised by man—that is why we claim you'll be able to play in thirty minutes. Put us to the test.

Learn in 30 Minutes With My Picture Method

Arthur Brisbane, the highest paid journalist in the world, once said that "a single picture is worth a thousand words." He was right, for it stands to reason, when you take your instrument in hand along with the actual photographs of our professor in action as your guide, it is easy to imitate and do the right thing. But that is not all. We also furnish as an additional guide, phonographic records of our professor playing the piece you are learning, along with our thorough, printed and illustrated, easy-to-read course.



Doesn't that sound easy? It is easy. If you could sit at our desk and see the letters and telegrams from our pupils you would be convinced that we have perfected the simplest, yet most highly efficient course to insure your mastery of the tenor banjo.

Don't Send a Single Cent

Investigate offer today. Don't put off until tomorrow, because you might forget and miss this wonderful opportunity. It might be the turning point in your career. Don't send a single cent. Just drop a line—use coupon or postal card will do—telling you are interested in receiving full particulars about course and to reserve one regular eighteen dollar, full size professional tenor banjo for you, which is offered as a gift. Act quickly, because there may not be enough gift banjos to go around for the million or more readers of Popular Mechanics. This does not obligate you in any way. Therefore, do not hesitate—put in your reservation now, this very minute. You will soon join our happy army of enthusiastic finished tenor banjo musicians.

EARN BIG MONEY—

FREE BANJO COUPON

New York Academy of Music
Studio 110-100 Fifth Ave., New York

Please rush all free information relative to your Tenor Banjo Course and reserve a gift banjo for me. This obligates me in no way whatever.

Name.....

Address.....

City.....State.....

Practical Aviation

\$75.00 to \$200.00 weekly. Get into it NOW

LEARN PRACTICAL AVIATION AT HOME—AND GET BIG PAY
—YES!, \$75.00 to \$200.00 WEEKLY!

Aviation is the booming industry—growing by leaps and bounds. **Men needed in every arm of the service.** Five times as many men needed today in Practical Aviation, in servicing and building, as for piloting.

We teach you Practical Aviation at home.
LEARN WHILE YOU EARN

Our course is one of the most complete and thorough ever published; **directed by aviators who have flown hundreds of thousands of miles.** They write in a way that you will understand, and you will grasp the full meaning of everything about an airplane; how it flies; construction; airplane engineering; maintenance; etc.

Our course is the foundation work for everyone who aspires to get into aviation.

Lessons—drawings—questions easily mastered by anyone who can read and write.

Our easy payment plan aids you. We help you get a position.

MONEY BACK GUARANTEE if not satisfied. Red-blooded men of action are getting into Aviation and making money.

WRITE for FREE illustrated folder telling about the United States School of Aeronautics and how they can help you get into aviation.

Write to Dept. A

UNITED STATES SCHOOL OF AERONAUTICS

MAYWOOD, ILLINOIS

[Near the Chicago Air Mail Terminal Field—

Handbook for Farmers

861 discoveries by practical farmers, telling how to make, repair or improve the various devices and machines used about a farm or garden. 683 illustrations. "The Most Remarkable Book Ever Published for Farmers," says one authority. **Send No Money.** When the postman delivers the book to you, hand him \$1 plus the few cents postage.

POPULAR MECHANICS PRESS
Popular Mechanics Building, Room 710, Chicago, Ill.

Make Arts-Crafts Lamps



Some make them for pleasure, and some make them for sale.

For either purpose, these cloth-covered, illustrated books will be a wonderful aid. They tell just how to make 33 kinds of lamps for table and wall. The directions are so clear that even boys can make the lamps with these books.

Arts-Crafts Lamps, How to make them Lamps and Shades in Metal and Art Glass
The two Arts-Crafts Lamp Books . . \$2

Either book alone, \$1

Send No Money—just write a postal

Popular Mechanics Press
Popular Mechanics Building
Room 710, Chicago, Ill.



Join The Gasoline War!

Cut Your Gasoline Cost to 9¢ Per Gallon

\$51
an Hour

The Stransky Vaporizer is one of the biggest sales propositions of the century—you can make big money quick. But don't take our word for it. Read what these men say. J.W. Cronk made \$51 in one hour. He says: "The results of one hour's work—17 men gave me orders for the vaporizers."

\$120 in One Day!

I have found out that the Stransky will do what you said it would. I took forty orders in one day and wasn't out long. My Ford runs better than it ever did. I can save half the gas and it pulls better.—J. M. James.

\$48 in 3 Hours

My gas bill has been cut nearly in half. I have removed every particle of carbon from my engine. Since I installed it my engine runs as good as new, starts easier and quicker. I went out Saturday about three hours and secured 16 orders.—J. A. Williams.

ONE MILLION Satisfied Users

Ford Runs 60 Miles on a Gallon

I made approximately 60 miles on a gallon of gas in a Ford sedan, and I made 15 miles on one quart of gas.—O. C. Zeigler, Pa.

32 Miles with Buick

Vaporizers installed on both Buick and Ford are doing wonderful work; getting 32 miles on Buick and 51 miles with Ford.—Harvey C. Hipple.

Say good-bye to the high cost of gasoline! For now an amazing new invention—a ridiculously simple little device—makes practically any car give twice its regular mileage to the gallon! Already it is being used by over a million satisfied car owners—on all makes and models of cars. And now the inventor will send you a sample at his own risk! Read his offer below.

\$250 to \$500 a Month

WITH this wonderful new invention, auto owners in all parts of the country have chalked up records of from 37 to 57 miles and even up to 61 miles on a gallon of gasoline.

And now this amazing new invention is making big money for agents and distributors. Now you, too, can make good money—just telling your friends about it. You can easily earn astonishingly big profits in full or spare time—many are earning \$250 to \$500 a month.

Fits Any Make or Model Car

Here's how this wonderful little device works—how it adds more power and mileage to any make or model car. Every carburetor is adjusted to make starting easy—it gives a rich mixture to start a cold engine. But once the engine gets heated up the mixture is far too rich, resulting in faulty explosion.

Half the gasoline is drawn into the cylinders in a raw state and instead of exploding, it burns. This causes a heavy deposit of carbon.

But with this startling little device in a car all this is changed. As soon as the engine warms up, this device automatically begins to admit a much larger volume of air, thoroughly vaporizing all the gasoline, giving it fully 50% more power—breaking it up so that it explodes instead of burning.

Introductory Sample Offer

To introduce this new invention Mr. Stransky, the inventor, will send a sample at his own risk. Not only that, but he will actually pay you for testing his Vaporizer if you are not delighted with it. Write at once for his proposition.

The demand for the Stransky Vaporizer is enormous. Agents handling this device are simply coining money. Splendid for spare time work.

Be the man to cash in big in your community.

MAIL THIS COUPON TODAY

J. A. STRANSKY MFG. CO.,
M-10 Stransky Bldg.,
Pukwana, South Dakota.

Tell me how I can get sample of the Stransky Vaporizer at your risk. Also tell me how I can make from \$34 to \$69 a day as your distributor. This does not obligate me in any way.

Name.....

Street or R. F. D.....

City.....State.....

J. A. Stransky Manufacturing Company

M-10 Stransky Building
PUKWANA, S. DAK.



Everyone Can Write Shorthand This New Way

Used by
 Executives
 Sales-managers
 Salesmen
 Reporters
 Engineers
 Physicians
 Writers
 Clergymen
 Teachers
 Students
 Stenographers
 Clerks

At last—a really scientific way to write shorthand! No drudgery! No tedious memory work! No unfamiliar signs and symbols! Just your ABCs, written with pencil or on the typewriter. After your first hour's study you can begin to use this system. The most accurate and rapid shorthand ever known.

Only 3 Weeks Required to Complete the Course

Contrast this short time (three to eight weeks) with the months of study and years of practice necessary to attain proficiency in the use

of any other system. (Government statistics show that 88% of those who study other systems fail to make use of them!)

Amazing Speed Quickly Developed

No one ever fails to master this new, easy method. Students and graduates make speed records never attained before. Notes made by one person can be transcribed by another.

Speedwriting

The NATURAL SHORTHAND

—was originated by Miss Emma B. Dearborn, a nationally recognized authority, who for eighteen years trained teachers, students and speed contestants, in practically every kind of conventional shorthand, in such notable educational institutions as Columbia University, University of California, Rochester Business Institute and Simmons College, Boston. Throughout the United States and in foreign lands Speedwriting has been welcomed enthusiastically by business and the public. It is used in the U. S. Army and Navy. Everywhere this new, natural shorthand is hailed as the perfect system that will eventually supplant all others.

Mail Coupon for FREE Book

Let this inspiring, illustrated book tell you what Speedwriting is like, how it will save your time, money and strength and make you more valuable in your work, whether you are an executive, professional or business man or woman, experienced stenographer or beginner.

Mail the Coupon NOW!

Brief English Systems, Inc., Dept. 7210, 200 Madison Avenue, New York City

Without cost or obligation on my part, please send me your new illustrated booklet on Speedwriting, the natural shorthand.

Name.....

Address.....

City..... State.....

Wanta Play Banjo?

C. McNeil—Earn money thru famous McNeil Banjo Course. Easy as A B C with CHORD-CHART SYSTEM and phonograph record by Chas. McNeil, 6 years with Brunswick. Easy payments. Write for Free Book and Banjo offer! CHICAGO TENOR BANJO INSTITUTE Dept. 1357 1621 N. Lincoln St., Chicago

TELEGRAPH-RADIO

\$18 to \$35 a week while training for Radio and Telegraph Operator jobs at \$150 to \$300 per month. Write for particulars.

CHICAGO TELEGRAPH INSTITUTE Dept. 1-10-6 1338 S. Michigan Avenue, CHICAGO

LEARN BEEKEEPING

and become independent. We help you secure a position. Easy to learn by doing. Instruction FREE for help in apiaries located in resort section. LATSHAW SCHOOL OF AGRICULTURE, PETOSKEY, MICHIGAN

Let us recommend the best books to study on any subject. Popular Mechanics Press, Chicago, Illinois.

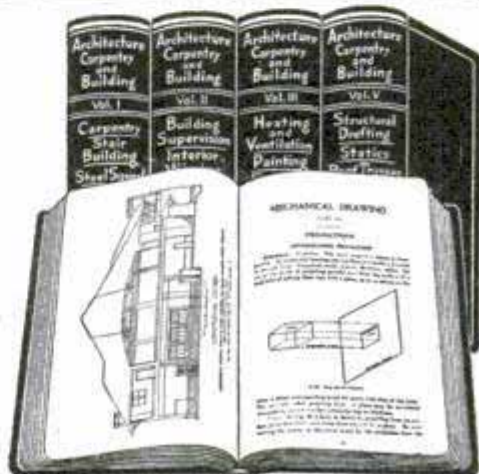

Brain Tools

For Architects, Draftsmen, Carpenters, Contractors, Builders and all who expect to build

Men who work with their hands know that headwork gets them more money.

Brain tools make the tools in your tool box at least twice as effective, and the best brain tools you can get are good books—not just any books, but books which tell you the things you want to know, and do it instantly. Carpenters make themselves contractors by learning how to estimate correctly. Contractors are able to handle bigger and more profitable jobs by learning how the big fellows do it, and architects and those who want to enter this highly paid profession earn more money by having facts and figures at their finger tips.

This brand new set of five handsomely bound books covering all phases of architecture, carpentry and building, enables you to get authoritative, specialized information in a moment. No tedious long hours of reading—no hard grinding study, but instant reference to the vital facts. You don't waste a minute—the new jiffy index puts before your eyes, without wasted time, the things you want to know.

The most complete work of its kind we have ever published; nothing has been overlooked. Use of tools—building construction, heating, lighting, plumbing, architectural drawing, blueprint reading; in short, the most comprehensive and easily understood work of its kind.

These Books Sent FREE

Yes, this is true. We ship them to you without a penny of down payment. When you get them, look them over carefully—note how easy it is to find what you want to know—test the index in any way you want to and then, if after 10 days you agree that you have at hand a veritable mine of invaluable information, send only \$2.00 and keep the books. After that send us only \$3.00 per month until the small total of only \$24.80 is paid. For a short time we will include with each set a complete portfolio of the five basic orders of Architecture. These 58 beautifully illustrated plates are drawn to scale and carefully figured. Size of each 11x15 inches. You'll thank the day you sent for your set.

Learning Means Earning

and here you have at hand information gathered from hundreds of experts, all for so small a sum you'll never miss the money. Use these books as others have done and you'll get many times their price in a few months. One job alone may repay you several fold. Send for your set today.

FREE EXAMINATION COUPON

AMERICAN TECHNICAL SOCIETY Dept. G-719, Chicago, Ill. You may send me, entirely without obligation, this handsome set of 5 volumes—Architecture, Carpentry and Building. I am to have full ten days in which to look them over and decide if I want to keep them. After which I will either send them back or send \$2.00 down and \$3.00 per month until the special price of only \$24.80 has been paid. Please include FREE the portfolio of 58 handsome plates.

Name.....

City..... State.....

Reference.....

Free Membership
 Send now and we will include with these money-making books a membership in the American Technical Society which entitles you to free consultation privileges with twenty highly paid experts. This alone is invaluable.



*"They last twice as long as
the smaller batteries
of equal voltage"*

"THAT'S a pretty broad statement, Tom. Won't you have to make it conditional on the number of tubes in the set or the use of the new power tubes?"

"No, sir! Under the same operating conditions—whether you use four, five tubes or more, whether you use a power tube that uses up to 135 volts, the Eveready Heavy-Duty No. 770 or the even longer-lived Eveready Layerbilt No. 486 will last twice as long as the smaller sized 45-volt batteries."

"Well, they ought to, they cost more."

"Yes, about a third more—but lasting twice as long as the smaller batteries, they cost much less."

"Your arithmetic is good, Tom, but if that's so, when I bought my set why did the dealer equip it with the smaller Eveready 772? Why didn't he put in the Eveready Heavy-Duty Batteries?"

"He probably thought he was doing you a favor—making your first investment cost you a little less. That little difference looks like a lot to a good many folks who are buying their first set, equipped with tubes, loud speaker, 'A' and 'B' batteries and everything."

Heavy-Duty batteries last twice as long as the smaller

batteries of equal voltage. Eveready Heavy-Duty Batteries are the great contribution that the world's foremost electro-chemical laboratory has made in "B" battery economy, dependability and satisfaction, and the satisfactory reception of radio programs.

Dry "B" batteries give a noiseless current, pure D. C. (direct current), the kind that is essential if you prize pure tone.

Send for booklet, "Choosing and Using the Right Radio Batteries," which we will be glad to send you upon request. This booklet also tells about the proper battery

equipment for use with the new power tubes. There's an Eveready dealer nearby.

NOTE: A "C" battery gives a quality of reception unobtainable without it and greatly increases the life of your "B" batteries.

Manufactured and guaranteed by
NATIONAL CARBON Co., Inc.
New York San Francisco
Canadian National Carbon Co.,
Limited, Toronto Ontario

Tuesday night means Eveready Hour
—9 P. M., Eastern Standard Time,
through stations:

WEAF—New York	WSAI—Cincinnati
WJAR—Providence	WTAM—Cleveland
WEEL—Boston	WWJ—Detroit
WTAG—Worcester	WGN—Chicago
WFI—Philadelphia	WOC—Davenport
WGR—Buffalo	WCCO—Minneapolis
WCAE—Pittsburgh	WCCO—St. Paul
	KSD—St. Louis

LEFT - Eveready Layerbilt No. 486.

RIGHT - Eveready Dry Cell Radio "A" Battery. 1½ volts.

EVEREADY
Radio Batteries
—they last longer

T.



© The Sphere

Where Smoke and Dust Are Unknown; Passengers Dining in Comfort on Flying Journey from England to France; Artist's Sketch of Interior of Big Airplane Cabin at Meal Time

Drawn by W. Bryce Hamilton
Sphere artist

June 19,
1926.

Popular Mechanics Magazine

REGISTERED IN U. S. PATENT OFFICE

WRITTEN SO YOU CAN UNDERSTAND IT

Vol. 46

168

OCTOBER, 1926

No. 4

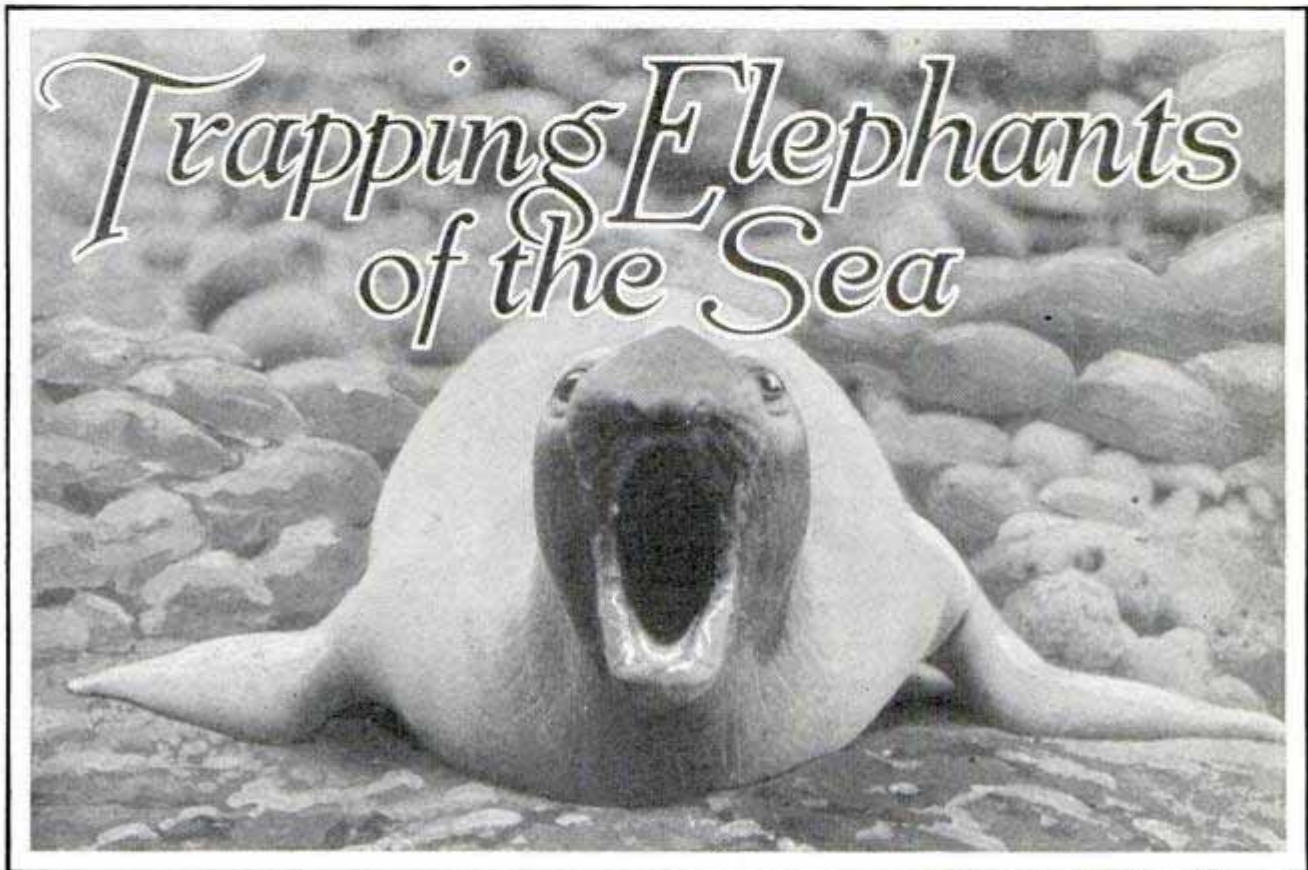

By ANDREW R. BOONE *931 Fifth Ave. Los Angeles, Calif.*

THE Marines have landed and have the elephants well in hand."

In these words might that famous message from the United States marines be paraphrased, and no levity intended. Uncle Sam's soldiers of the sea recently boarded the U.S.S. "Eagle No. 34" at San Diego, Calif., proceeded 240 miles south and west to Guadalupe island, 135 miles off shore from Lower California, and brought back three members of the only known herd of northern elephant seals.

They braved the perils of a Pacific storm and a rocky landing on the wind-swept island. A quarter of a mile from shore, where the little navy craft remained, the ocean was 10,000 feet deep, and thus anchorage was practically impossible. Crates in which the sea elephants were transported upset; their man-powered

whaling boat that they rowed from ship to island and back again, capsized; they worked in chilling water for hours and defended themselves against the sharp teeth of 6,000-pound seals—and returned with the last trophies the Mexican government will ever permit to be taken from the shores of Guadalupe.

As the first step in capturing sea elephants for the San Diego Zoological society, the marines made fast to the motor dory three crates, made of heavy wire screening and wood. After a battle with the waves, the crates were landed and then came the task of inducing the animals to enter captivity.

Lieut. E. W. Dort, U. S. N. reserve, in charge of the expedition, had the men spread out wire wings toward the elephant which was driven into the cage

After much prodding. The same procedure was followed with two others. Then, by man power, the crew dragged each crate to the edge of the water. At that point barrels were lashed to each side to float the captives to the boat where they were slung aboard easily by means of a crane.

Difficulties greater than any physical dangers of catching and transporting the sea elephants were found in their feeding, members of the party reported. The seals eat live fish only, when in their wild state, and when, on a previous expedition, one was being taken from Guadelupe to the United States, it soon died because keepers did not know how to feed it.

Zoologists had attempted to learn, by examining the stomachs of those found dead on the beach, what they ate, but nothing other than black, volcanic sand was ever discovered. Apparently they frequently fasted for considerable periods. Lieut. Dort, by virtue of a former experience of the kind, was prepared to force-feed these three prizes, and soon after they were deposited aboard "No. 34," all were eating and looking for more dead fish. At San Diego the animals were hoisted again and again let down, this time on a motor truck, which bore them safely to an artificial pool of salt water where they will spend the rest of their lives.

Guadelupe island, named for the patron

saint of Mexico, is of volcanic origin and lies far away from the lanes of travel. The first inroads there took place in the late eighteenth century when fur seals were discovered. Until 1830 they were subjected to annual raids by sealers who built stone houses on the island and completely depleted the fur-seal herds.

Next came whalers, presumably only to fill their waterbags.

After the whalers came hunters of elephant seals. During the early days of California, the demand for whale oil for lighting purposes soon exceeded the supply. Whales became scarcer and were found only in more distant regions. It was about this time that some ingenious follower of the sea found that the blubber of the elephant seal contained a large quantity of oil.

The natural sluggishness of these animals, sunning themselves on the beach, made them easy prey for the killers, and they were slaughtered by the thousands, to become victims of the try pot. As a result, the herd at Guadelupe is the only one remaining today.

The elephant seal is a true seal, differing from the more commonly know varieties by its great size and by the presence on the adult males of a short trunk, from which they derive their name. Unfortunately, little is known of their habits.



Trying to Isolate a Prize Specimen from the Herd; Using Barriers of Wood and Wire to Surround Elephant Seal and Direct It toward the Cage

Pilot - B. H. DeFord



Folding Monoplane with One Side of Wing Laid Back against the Fuselage

MONOPLANE THAT FOLDS UP FITS INSIDE GARAGE

Successful test flights with a folding monoplane are reported from Roosevelt field, Long Island. The wing can be bent back flat against each side, reducing the width from forty-four feet to twelve and one-half so that the plane can be housed in an ordinary garage. An additional feature is an air brake on the wing, which makes it possible to reduce the speed considerably in landing and thus to stop the plane in a shorter distance.

TRAFFIC JAMS COST NEW YORK MILLION DOLLARS DAILY

In New York city, loss by traffic congestion costs its citizens \$1,000,000 a day, according to estimates, and \$600,000 every twenty-four hours in Chicago. The problem has a direct relation to the high cost of living, for the expense of delivering products affects the price to the consumer. In one center, it is said to cost as much to distribute potatoes from the freight station among the buyers as it does to haul them 1,000 miles by rail. Six cents a minute is the approximate expense of keeping a motor truck of average size on the streets, whether running or not, according to careful figuring. A small car will consume one gallon of gasoline in forty minutes of idling. A large taxicab company states that it would save \$100,000 a year in gasoline if it could save only two minutes on each trip. Public-transport

concerns must provide a large number of units to offset delays caused by traffic congestion. Lack of parking space is an additional costly result of clogged streets to the other inconveniences and expenses which must be borne by the ultimate consumer. It is evident, therefore, that the traffic problem affects all citizens.

ELECTRIC FAN FOR CLOSED CARS 201 RUNS ON SIX VOLTS

Among recent accessories for the comfort of the autoist, is a six-volt electric fan that may be attached to the interior of the car. It affords healthful ventilation and a cooling current when the auto is stopped in congested streets on warm days.

List price - \$10.00



Electric Fan Installed in Auto; It Operates Efficiently on Only Six Volts

*Knapp Electric Corp.
 160 W. 42nd St
 New York City*

*Kansas City Times
 7/20/26*

45 W. 17th St.

New York

Kansas City Mo 7/10/26

UKULELE WITH HINGED NECK
FOLDS INTO HANDBAG
(also inventors)



Ukulele in Use Resembles Ordinary Instrument with Round Head; Inset Shows How Neck Folds

Measuring but nine inches long when folded, a patented collapsible banjo-ukulele can be carried in a handbag, where it is less bother and not so likely to be damaged on outings. The neck is on a hinge, is quickly opened for playing and the folding feature is said not to detract from the tone quality. An attractive design is painted on the instrument.

BALANCE OF HEAT
AND HUMIDITY
FOR COMFORT

Tests at the bureau of mines in Pittsburgh, Pa., have established what experts declare to be the proper balance of heat and humidity favorable to the greatest human comfort. In perfectly

still, saturated air, a temperature of sixty-four degrees is the most satisfactory to the average person of European race, the measurements indicated. Two degrees more are necessary for complete comfort if the air is only eighty-per-cent saturated, and if the moisture is reduced to fifty per cent, sixty-nine and one-half degrees are needed. Such conditions were held comparable to those of an ideal day in May or June. With a relative humidity of twenty per cent, the comfort line lies slightly over seventy-two degrees. The "still" tests represented only half of the problem, for when the air is moving, a higher temperature is necessary since the skin is cooled by convection induced by air movements. The experiments showed that a temperature of seventy-six degrees with a relative humidity of forty-five per cent, when the air was drifting 340 feet a minute, was just as comfortable as a temperature of seventy degrees in perfectly still air of the same degree of humidity. At eighty degrees and a relative humidity of fifty per cent, the air had to be circulated several times as fast as in the preceding test, to give equal comfort. The amount of clothing and the activity of the person, change these "comfort levels."

ELECTRIC REVOLVING TABLE
HELPS GATHER REPORTS

An electrically driven revolving table is being used in the department of agriculture at Washington to facilitate the collection of separate sheets of reports into complete



Revolving Table Used in Government Department to Enable Old Employees to Do Work of Gathering Pages of Reports While Seated

W. Arentstein & Sons, Inc.
45 W. 17th St.
New York

W. Arentstein & Sons, Inc.
45 W. 17th St.
New York

groups. Formerly the stacks of sheets, as they came from the printers, were laid out in rows on long tables and the workers walked down the row, taking a sheet from each pile. The process involved much loss of time and required strong employes to stand the continuous walking. The

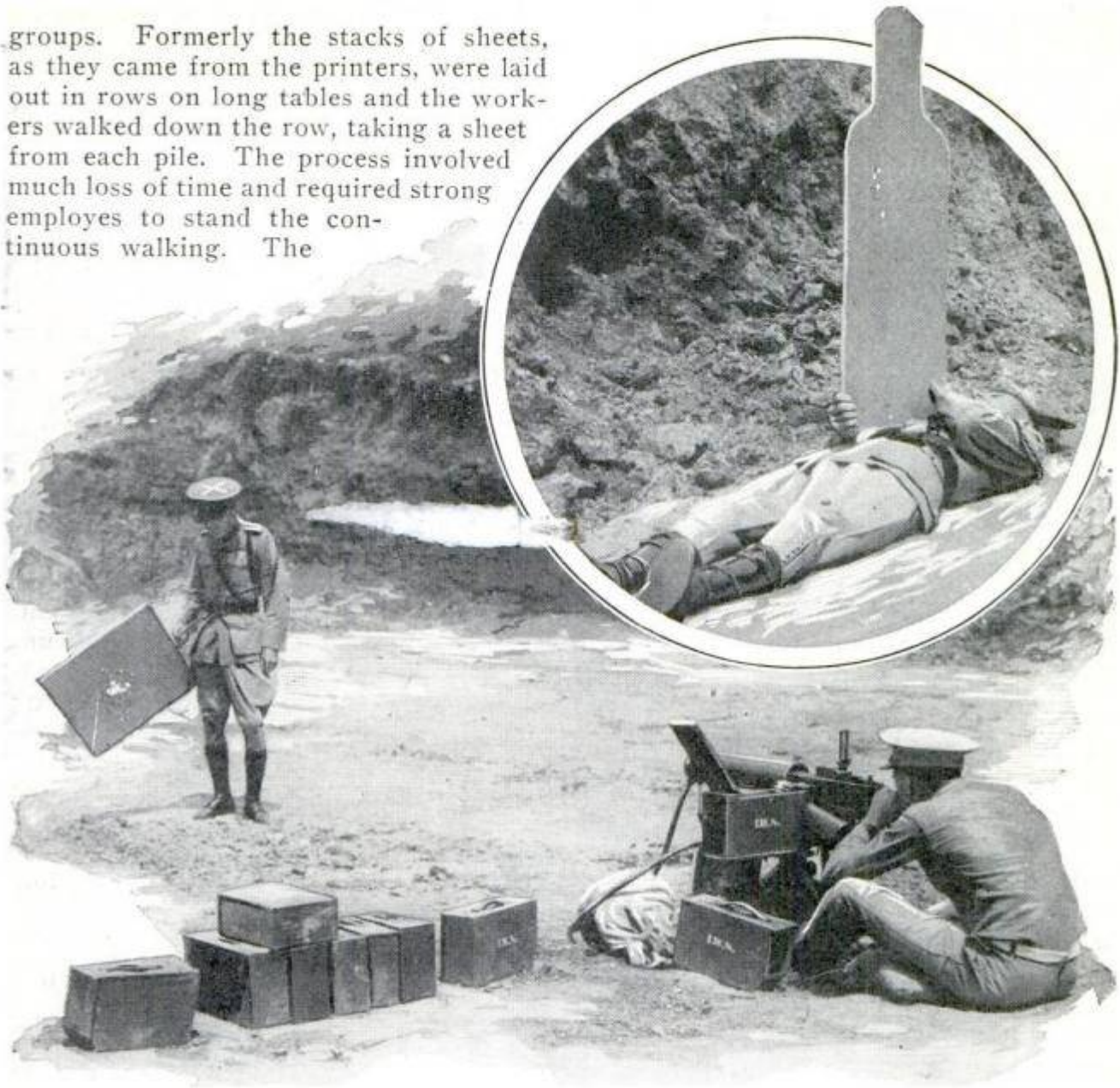

Capt. Bleasdale and Machine Gunner Demonstrating Accurate Fire; Holding Target, the Captain Advances toward the Gun While Bullets Whiz Close By; Inset, Supporting a Dummy Figure in Accuracy Test

revolving table now in use brings the sheets to the workers, and enables the employment of aged and crippled government servants, who otherwise would have to be pensioned. At the end of the revolution a complete copy is gathered.

BIG STEAMER WITH NINE DECKS LAUNCHED IN FRANCE 182.

One of the largest vessels afloat is the "Ile de France," a 40,000-ton ship with nine decks. The hull has the approximate height of a twelve-story building. The steamer is considered an innovation in French maritime enterprises as, heretofore, emphasis has been on elegance and comfort rather than size.

MARINE FLIRTS WITH DEATH TESTING MACHINE GUNS 110.

Walking down a ten-inch lane between machine guns spitting lead, Capt. Victor Bleasdale, of the Marine corps, seemingly invites certain death in his daily work at Quantico, Va. He does it to show that the bullets do not vary in direction after discharge, and to convince recruits that they could walk safely close to a protecting machine gun barrage in making attacks on an enemy. The secret of the test is to walk straight. In another demonstration, he holds a man-size target while bullets shoot over the head of the dummy, showing that fire directed close above advancing soldiers would not harm them.

St. Joseph News Press
7/23/26

175 PATRON WATCHES HIS HAIRCUT
IN DOUBLE BARBER MIRROR

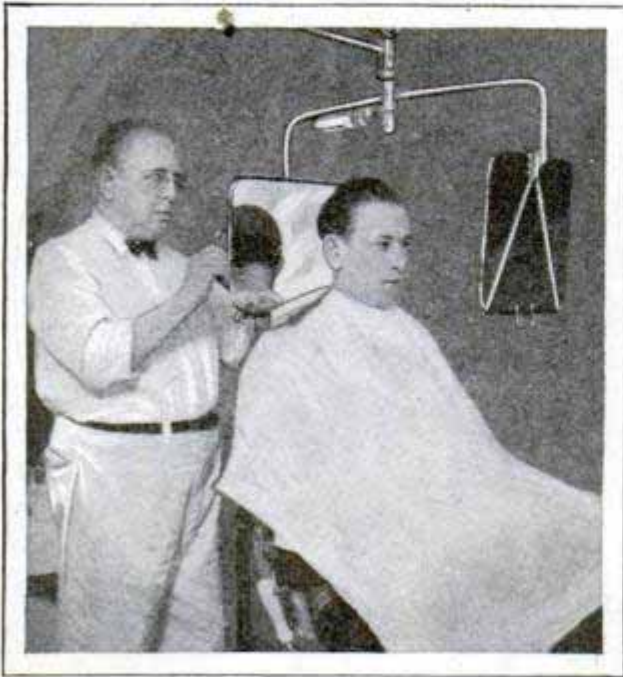

Double Mirror in Use; It Affords Both Front and Rear View, and Is Easily Turned Out of Way

Raised or lowered by a pulley, a special mirror arrangement over the barber chair affords the customer a view of the entire haircutting process. The glasses are quickly swung out of the way and do not interfere with the barber's movements.

PORTABLE BOAT FOR BATHING
FOLDS INTO SMALL BAG

A sailboat that can be folded into a small case for carrying is one of the latest accessories for the bathing beach. It is brilliantly colored, weighs but twenty-five pounds and contains balsa wood, the light tropical product more buoyant than cork. It is said that the craft is constructed to serve as a life preserver for four persons, should such use be necessary. Besides the sail, which can be erected in three minutes, a wooden paddle is furnished. The boat folds up on brass hinges and is

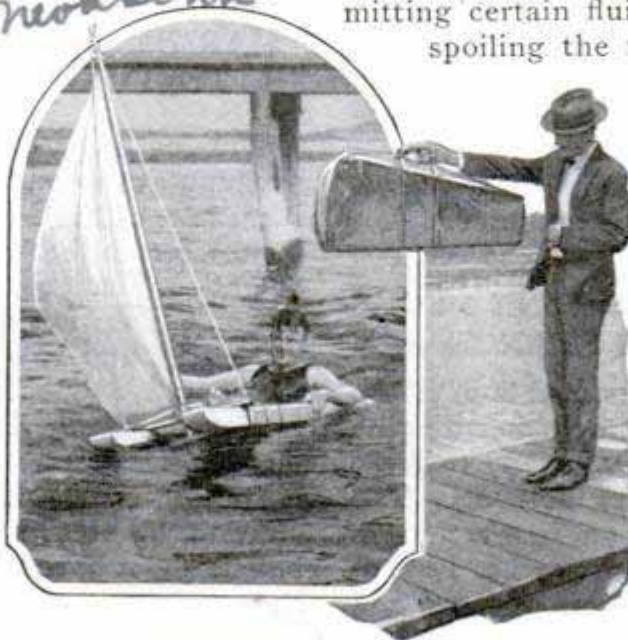

Swimmer with Boat and Craft in Bag

only three feet in length when closed, so that it can be carried in a car without projecting.

184 BRACELET OF COCONUT SHELL
LATEST FAD IN EUROPE

Coconut-shell bracelets, studded with precious stones and ornamented with gold or platinum, have become popular in European fashion centers. Those from the South Sea islands are considered the best as they are less likely to break. To make the bracelets, the nuts are gathered about a month later than usual, the inside is scooped out and the shells buried in clay soil for six months to improve the grain. From fifteen to twenty bracelets of different sizes can be cut from some of the larger nuts. They are finished in various patterns, and the more elaborate ones are priced at several thousand dollars, depending largely upon the value of the stones with which they are decorated.

215 NEW WAY OF FREEZING FISH
PRESERVES THEIR FLAVOR

By immersing fish in brine baths then freezing them quickly at low temperature, chemists are reported to have discovered a way of preserving them without any loss of flavor. Laboratory tests indicated that fish so treated would keep in good condition for two years. Under old methods, large crystals, formed during the freezing, puncture the delicate tissues, permitting certain fluids to escape and thus spoiling the flavor. Persons blind-

folded and asked to taste, alternately, fresh fish and those prepared by the improved process, are said to be unable to detect any difference. After the fish are frozen, they are wrapped in parchment paper. No metal except aluminum is allowed to touch them. Cross-country shipping of fish thus is thought possible.

Test made
at Columbia

Esaco Corporation
19 W. 44th Street
New York

Chicago
New York
New York
New York

HERE'S HOW WORLD'S CHAMPION GOLFER DRIVES

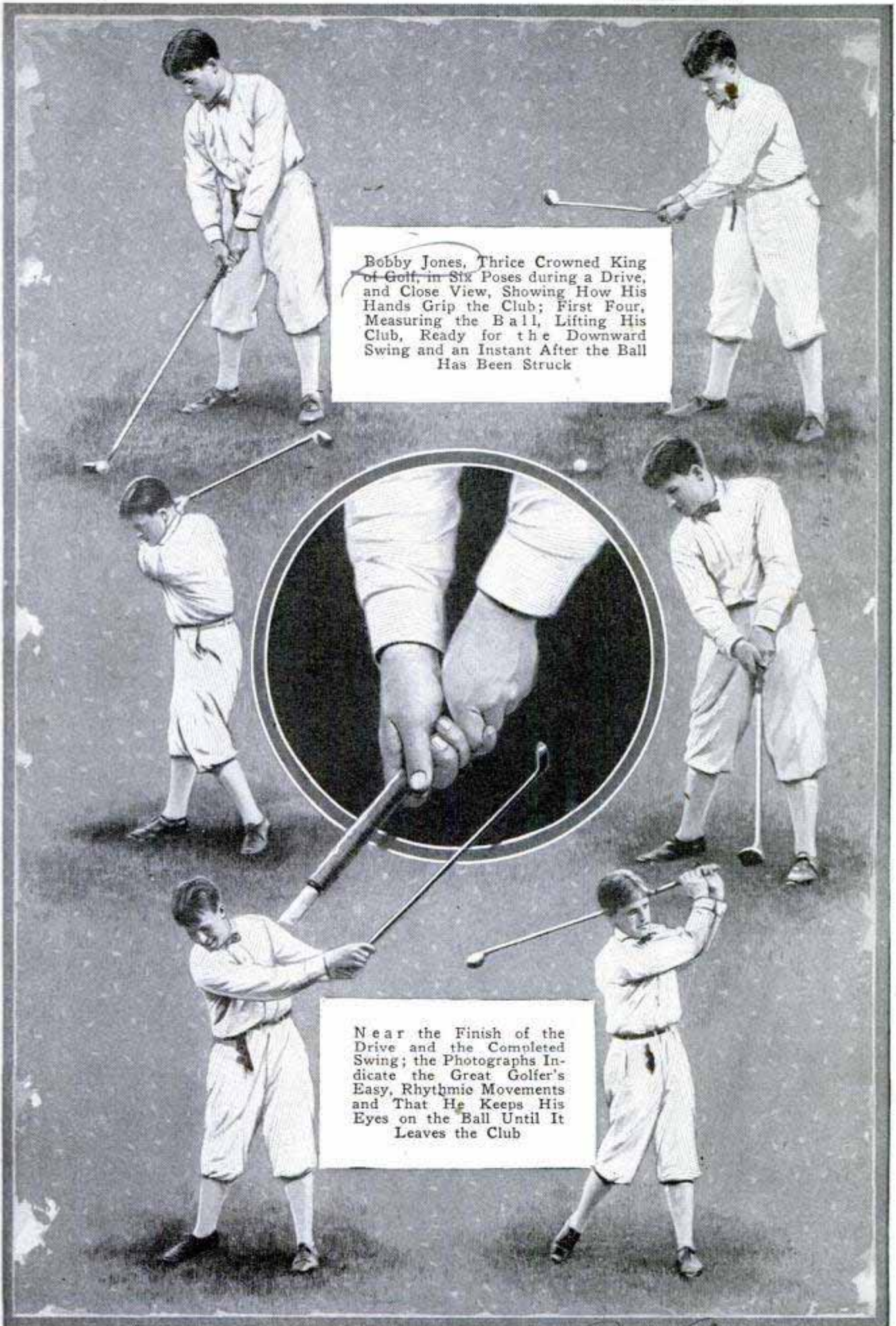

Bobby Jones, Thrice Crowned King of Golf, in Six Poses during a Drive, and Close View, Showing How His Hands Grip the Club; First Four, Measuring the Ball, Lifting His Club, Ready for the Downward Swing and an Instant After the Ball Has Been Struck

Near the Finish of the Drive and the Completed Swing; the Photographs Indicate the Great Golfer's Easy, Rhythmic Movements and That He Keeps His Eyes on the Ball Until It Leaves the Club

B.A.

*Anderson, N.Y.
Crotch. m.
LeCarbura,
Ond. Austin C.*

ELECTRICAL VOICE IS GIVEN THE CHORUS GIRL

Apparatus Installed in Orchestra Pit, as for Reproducing Voices of a Musical Chorus Number, and Examining Details of the Recorder

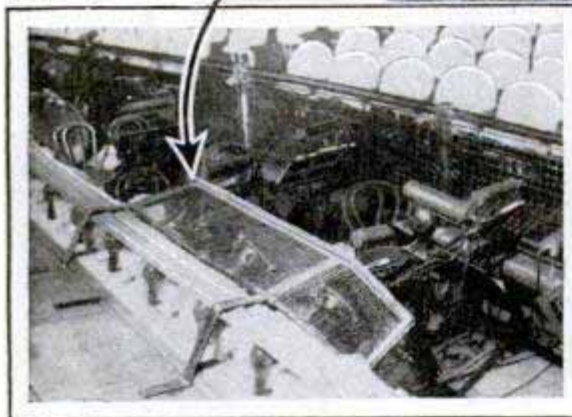
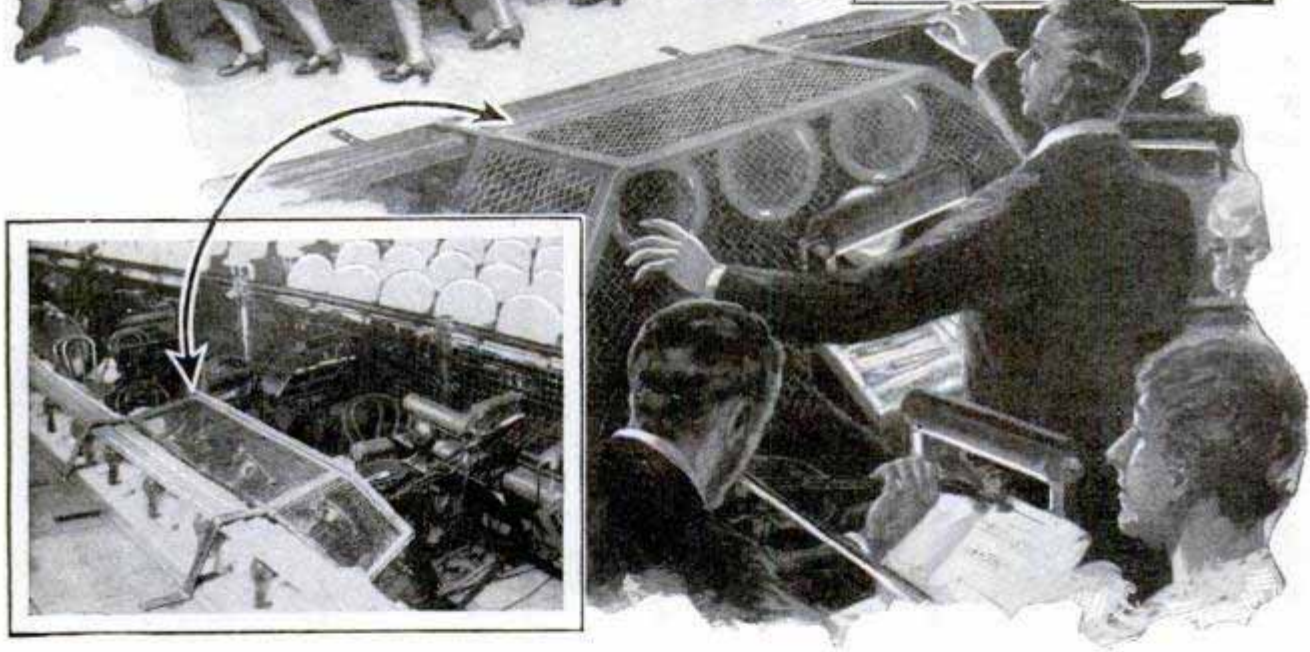
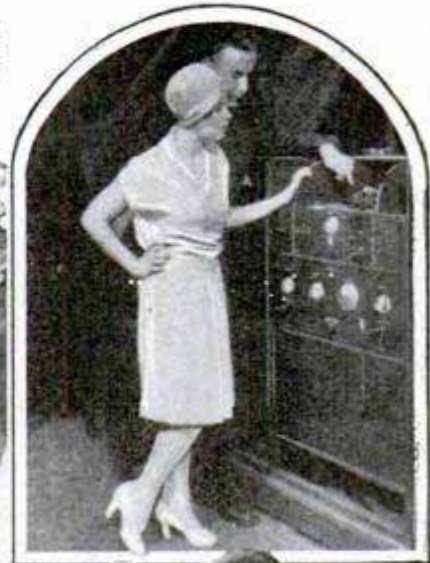

THAT nature does not put all her eggs in one basket is again instanced in the assembling and training of a chorus for a musical revue. Some girls are good-looking, some are graceful, some are excellent dancers, and some can sing; but to seek a combination of all these attainments in one chorus girl is to ask for the impossible. So a well-known producer of musical comedies decided some time ago to raise the vocal side of his presentations to the same high standing as the other features. Realizing that even if a chorus girl could sing, the physical effort might be too much in addition to dancing and acting, he sought the aid of scientists in evolving some means of supplying the desired vocal effect. The electrical reproducing device now available for home use

caught the fancy of the producer, and he immediately set to work on a plan for utilizing this general idea on the vast scale necessary for theatrical purposes. First, to meet the requirements of ample volume, to overcome the sound absorption of scenery, upholstery, draperies and closely packed audience of the theater, the power of the electrical voice, for such it is in truth, was increased tenfold. Even so, the volume was insufficient, especially as a complementary chorus to accompany the supporting orchestra, to be clearly heard. Then a hundredfold increase was tried and proved more than ample. Indeed, on the outdoor tests the electrical voice was heard at a distance of seven miles. Meanwhile, the producer commissioned the recording studios to attend to the vocal

numbers. The best vocal talent was secured, trained in the quiet and orderly studio, and the polished performance recorded by the light-ray method, which assures a faithful record of exact rendition. It might be added that the light-ray apparatus consists of a minute mirror which vibrates with the impact of the sound waves striking a minute aluminum cone, thus sweeping a group of light beams more or less into the slots of a photoelectric cell. The latter has the property of varying its electrical conductivity according to the light which reaches it. Thus the sound values are translated into electrical values and delivered to an electromagnetic cutting tool, which, vibrating accordingly, engraves the soft-wax master record with a corresponding wavy groove. In due course, therefore, the producer obtains the necessary records for his vocal numbers. Perfectly synchronized, perfectly matched in pitch, the electrical voice has blended with the usual chorus and the supporting orchestra so perfectly that even the critics attending the first-night performance were unaware, at first, that the vocal effect of the chorus was assisted by mechanical means. The voice starts with a disk record which, in outward characteristics, seems much like the usual home-phonograph record. It is placed on a motor-driven turntable. An electromagnetic pick-up or reproducer translates the wiggles of the needle into corresponding electrical wiggles or variations, which in turn are amplified. The final stage of amplification makes use of a 250-watt tube—power comparable to that of many first-class broadcasting stations. The amplifier output is sent to cone reproducers in the theater. The entire equipment is in duplicate, to guard against possible breakdown. An operator stands by the mechanism, which is placed beneath the stage or in some other place, invisible to the audience.



More Comfort for the Baby and Mother While Traveling; Crib at End of Parlor Car

**CRIB IN RAILROAD PARLOR CAR
LATEST TRAVEL CONVENIENCE**

Spacious cribs attached to the wall at one end of parlor cars in service on a southern railroad have proved of great aid to mothers caring for babies while traveling. They have railings to keep the infant from falling out, are comfortable and sufficiently roomy to provide the child with ample playing space.

Southern Pacific

**INFLATED CAP HELPS
SWIMMING**



Buoyant rubber caps for bathing keep the head up so that the beginner is encouraged to be less timid and the experienced swimmer can float more easily. The cap is helmet-shaped, fitting well over the ears to keep out the water; the air-inflated double walls are soft and comfortable, and the protector is slipped on or off easily.

Cap, Inflated, Is Easily Slipped On or Off and Is Securely Held by Chin Strap

140
1.59 each
\$12.00 per doz
Surg Cap Co., 934 N. Lancaster Ave. Lancaster, Pa.

38.2

Stand By to Come About!

With Spinnaker Set and Wind on Quarter
the Yacht Heads for the Finish

By J. EARLE MILLER

“OUT spinnaker and ease the sheets!”

The skipper, from his post at the wheel, barks the best command the racing crew of a fore-and-after ever hears. The starboard watch is on, but the port watch comes tumbling up from below to lend a hand, for luck has changed, after four days and five nights of waiting, and now, almost in sight of the finishing line of the world's longest fresh-water yacht race, we've got a freshening breeze on the quarter to blow us into port, all our light racing canvas drawing. Not all, rather, but most of it, for last night, to climax one of the slowest, most exasperating races ever run in the nineteen years of Chicago-to-Mackinac island duels—the classic of the Great Lakes—a three-minute squall popped up out of the southeast, snapped our fore topmast off three feet below the peak and sent our giant reacher and

Nova Scotian Fishermen
Are Stanchly Built to
Weather the Rough Sea
of the Grand Banks, and
Carry Enormous Sail
Spreads; This Is "Blue-
nose," the Canadian Fish-
ing-Cup Defender

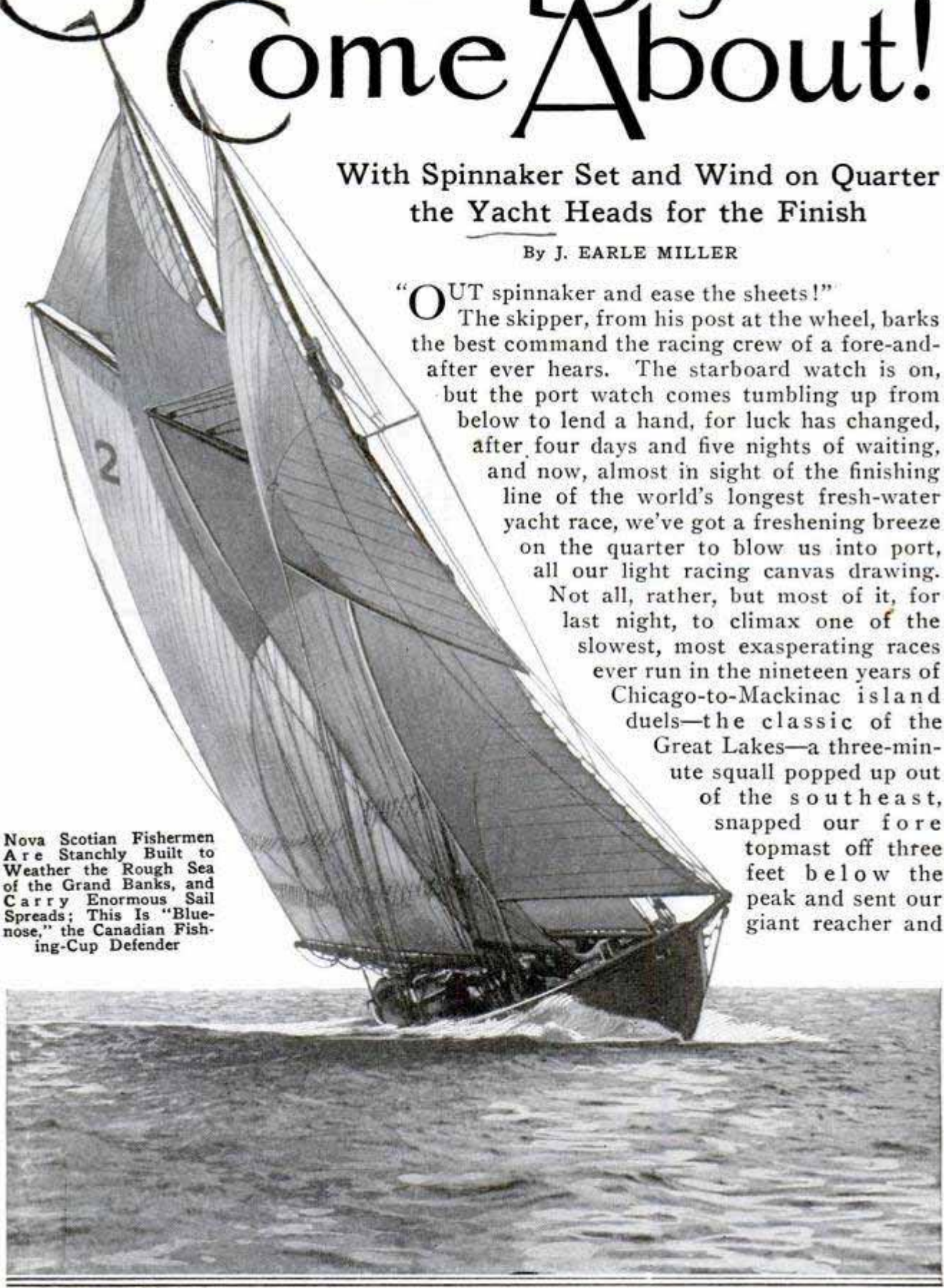

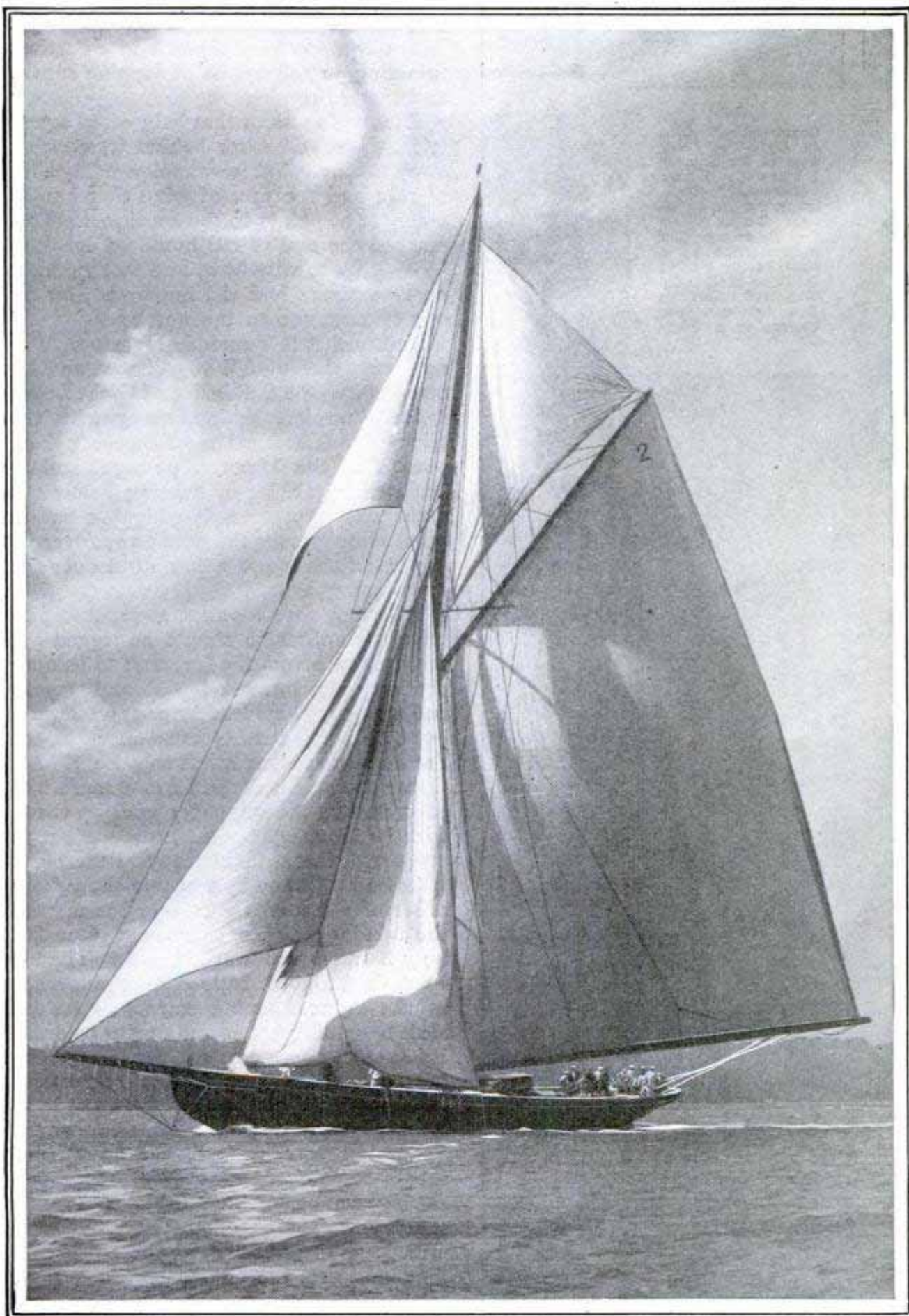

Slipping Along in a Light Breeze, with More Sail Being Set, a Cutter Presents a Beautiful Sight; This Is the Favorite Rig for Large Racing Yachts Abroad; It Points in the Wind as Well as a Sloop and Has a Big Canvas Spread Approaching That of a Schooner

38-23

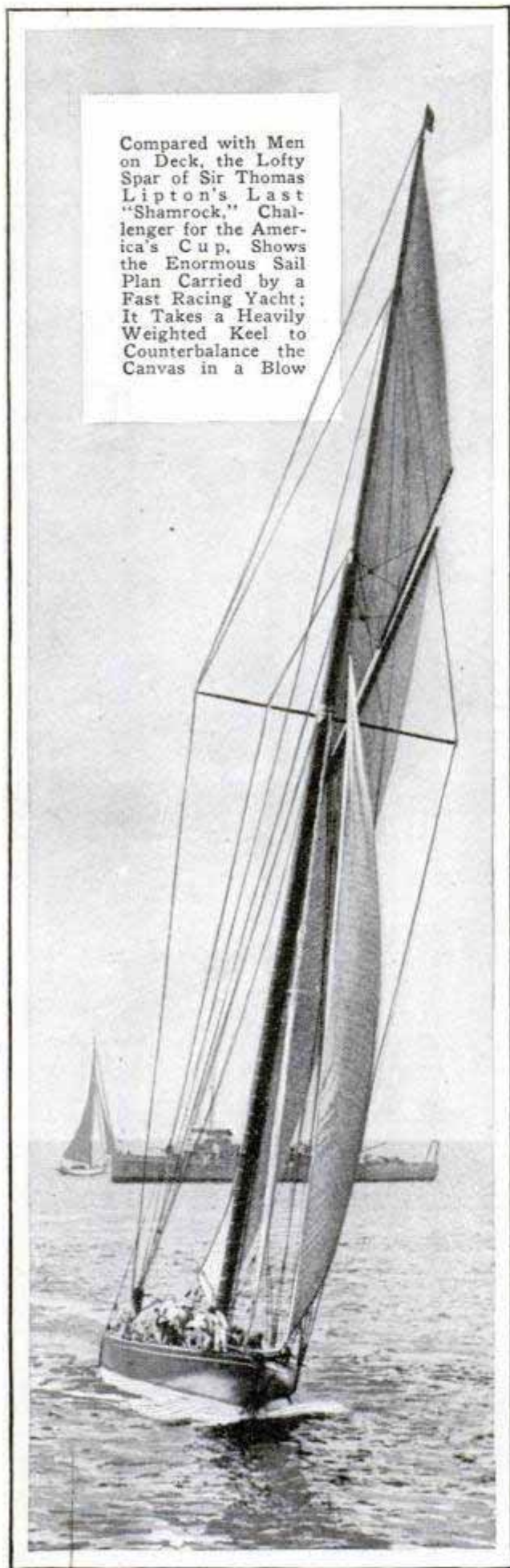

Compared with Men on Deck, the Lofty Spar of Sir Thomas Lipton's Last "Shamrock," Challenger for the America's Cup, Shows the Enormous Sail Plan Carried by a Fast Racing Yacht; It Takes a Heavily Weighted Keel to Counterbalance the Canvas in a Blow

one of the biggest fishermen the Great Lakes ever saw over the side in a slatting, tumbling, jumbled mass of flapping canvas and snarled rigging.

The single puff of that baby-sized squall left two hours' work behind it, clearing away the mess, but it was followed by a bit of rain and a capful of wind that hauled a couple of points to the southeast. This marked the end of 105 hours of constant beating up to windward and tacking back on long slants into the northwest, far off our true course to the northeast.

And now it is Thursday morning. The reefs and shoals of Waugoshance and Ile aux Galets—the Skilligalee of Great Lakes sailors—are left behind, along with the tricky winds and calms of Sleeping Bear point and the Manitou passage, and at last the telltale bit of bunting below the main mast crosstrees is whipping out to point directly over the port bow, advertising to all the world a fair wind over the starboard quarter.

With our fore topmast gone, the spinnaker boom, which should be rigged out to windward from the foremast to balance the main and foresail, the jib and staysail and the jury-rigged fishermen to leeward, can't be hoisted in its usual position, for there are no halyards left to raise it.

But the mainmast still has a spare halyard, and so the spinnaker goes up there, with its long, light pole, thrust far out to starboard, the outhaul ready in the block at its end. "Stand by to come about," the order of a few moments ago, has marked the turning point of the race. Our last long hitch to windward is over. The big spinnaker, a giant balloon of a sail, made of the lightest racing canvas, is hauled aloft by willing hands and begins to draw. Inboard, its peak spills the freshening breeze into the belly of the jury-rigged fisherman—one advantage of having it on the mainmast—and we are on our way.

A sailor speeds aft to the fantail and squats down over the recorder of the patent log, calling off the mileage to another standing by the chronometer. Five minutes pass, and the man at the clock calls time, and gets the figures back. A hasty calculation—the difference between two readings, multiplied by twelve—shows eight miles an hour, and the wind is freshening a bit as it hauls farther to the south.

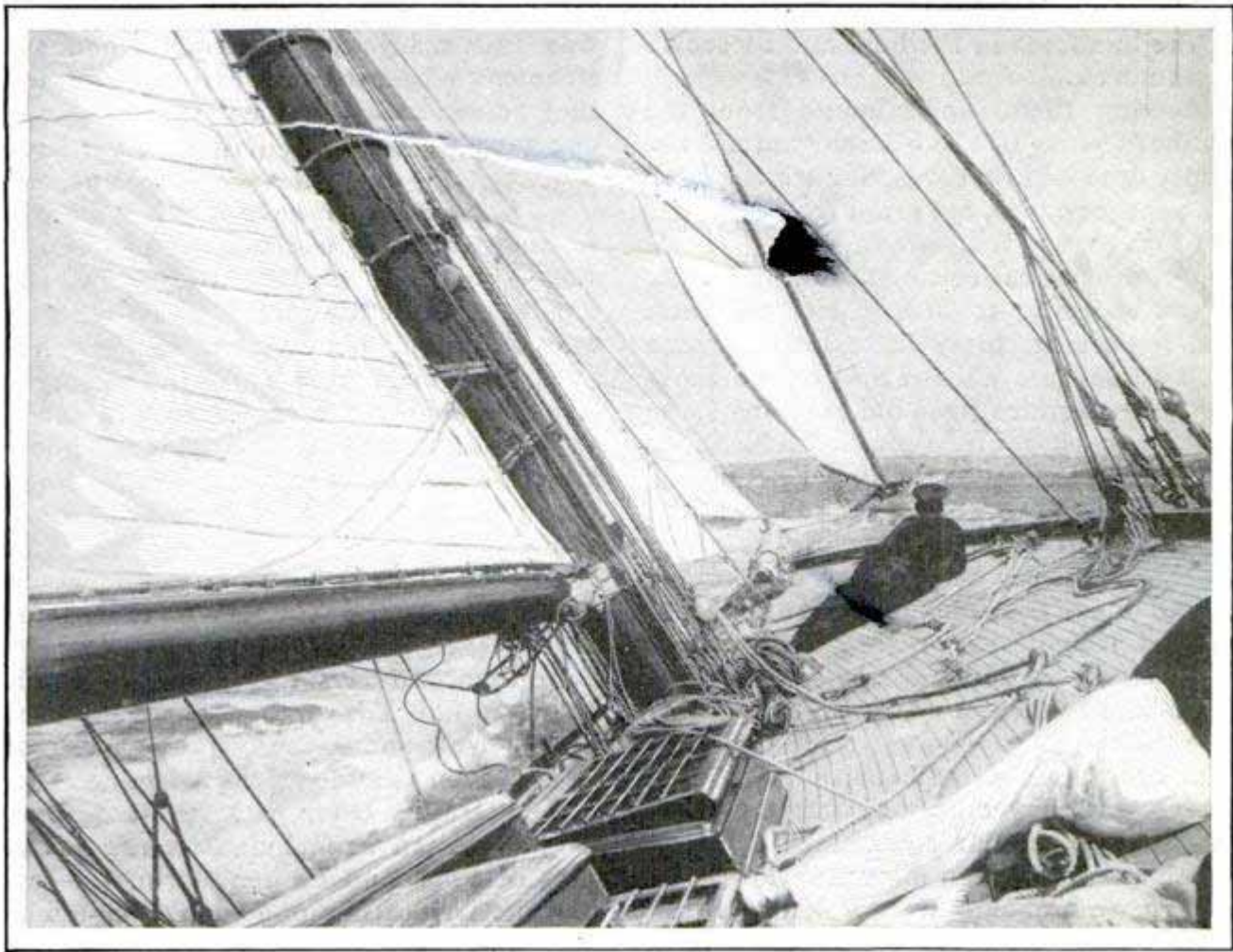

"White Heather" Chasing "Lulworth" Home in a Stiff Breeze at Plymouth, England; with Everything Drawing and Decks Heeled Over, the Low Freeboard of the Yachts Is under Water to Lee

The next five minutes we foot along at nine miles, just about the best we have done since last Saturday night, when, eight hours out from the starting line, we rode out a four-hour squall with lee rail under, water swishing around the cabin trunk, and the bow bringing up tons and tons of green seas as it dipped into each choppy roller. We rode it out with our heavy canvas on, even up to a jib topsail, and logged better than twelve miles an hour—while it lasted—and that's not bad for the "Rainbow," our ex-Nova Scotian fishing schooner, built to battle heavy seas off the Grand Banks, but not for piling up the miles in fair-weather racing.

The main and foresail, eased far off to port to balance the hefty spinnaker, are drawing perfectly now, and the little four-bladed "spinner," trailing 125 feet astern at the end of the log line, turns over and over as it is dragged through the water, transmitting, through the twisting line, steadily mounting figures to our patent log—the speedometer of a ship.

We've left St. Helena, a pretty little island, astern, and off the port bow, five miles away, the lookout sights the bobbing iron-work tower of the Graham shoals gas buoy, the turning point where we will enter the Straits of Mackinac, better known as the Great Lakes' counterpart of the corner of Forty-Second and Broadway.

Down the straits, from the opening of navigation in the spring to the coming of the ice in the winter, there rolls a constant procession of huge lake-type freighters, 600-foot steel giants, loaded with their 12,000 tons of iron ore, bound for the blast furnaces of South Chicago and Gary. They come out of the northwest—downbound from Lake Superior ports—pass Mackinac island under the whitewashed walls of the old fort, where the flags of France and later of England once flew, swing into the straits and join the parade from the lower lakes. There are big coal carriers from Ohio ports, bound for the Wisconsin shore, and equally big ones out

of Detroit, with new automobiles stowed by the hundreds in the hold and by scores on the deck.

Meeting them, north-bound from the southern ports of Lake Michigan, are the empty ore and coal carriers, hurrying back for another cargo, big grain freighters out of Chicago, and through and through these trucks of the seas scurry passenger liners, speeding to keep their schedules, and important, fussy little ferries, some with passengers aboard and others moving railroad trains from old Mackinaw, the northernmost point in lower Michigan, to St. Ignace, the tip of the upper peninsula.

From our position, we see them all and are glad the breeze is bowling us along at a good speed, with plenty of steerage way to dodge the lumbering red and black-painted freighters, for they are slow to give way for anything as small as our fifty-three-foot schooner. Last night, just before the moon popped up to lift the darkness around White shoals, a 500-footer, loaded with flivvers, came charging down, way off the regular steamer course, and for an anxious fifteen minutes it looked as though we and they were going to run a dead heat for an unmarked watery spot in the lake. Flashlights, played on our white canvas to supplement the usual running lights, had no apparent effect, and a

red Coston light, with cap snatched off, was just ready to be struck when the steamer's wheelsman came up a point and they passed us 200 feet astern. That was one race we won, even though we have lost—as we know we have—this one.

By how much we have lost it we begin to suspect when the glasses pick up a sloop scudding southward down the straits, eight or nine miles away, with all canvas furled, her engine sending her along at a good clip. By hull and rigging it is unmistakably the schooner "Gaviota," one of our worst enemies. Headed home under power means that she finished some time yesterday, while we are still bowling along under sail, with the regatta committee seals on our auxiliary motor intact.

The homebound "Gaviota" is the first of the fleet of fourteen we have seen for more than two days. Tuesday, while still trying to find a favorable breeze far over on the west shore, many miles south of Washington Island and the Porte de Mort—the "Death's Door passage" that some long forgotten Frenchman named in the days of Joliet and Father Marquette—we saw the last of our opponents. She was the yawl "Jeanette," sighted some miles ahead and several to windward, close inshore and still beating northward, when we caught a favorable wind to blow us

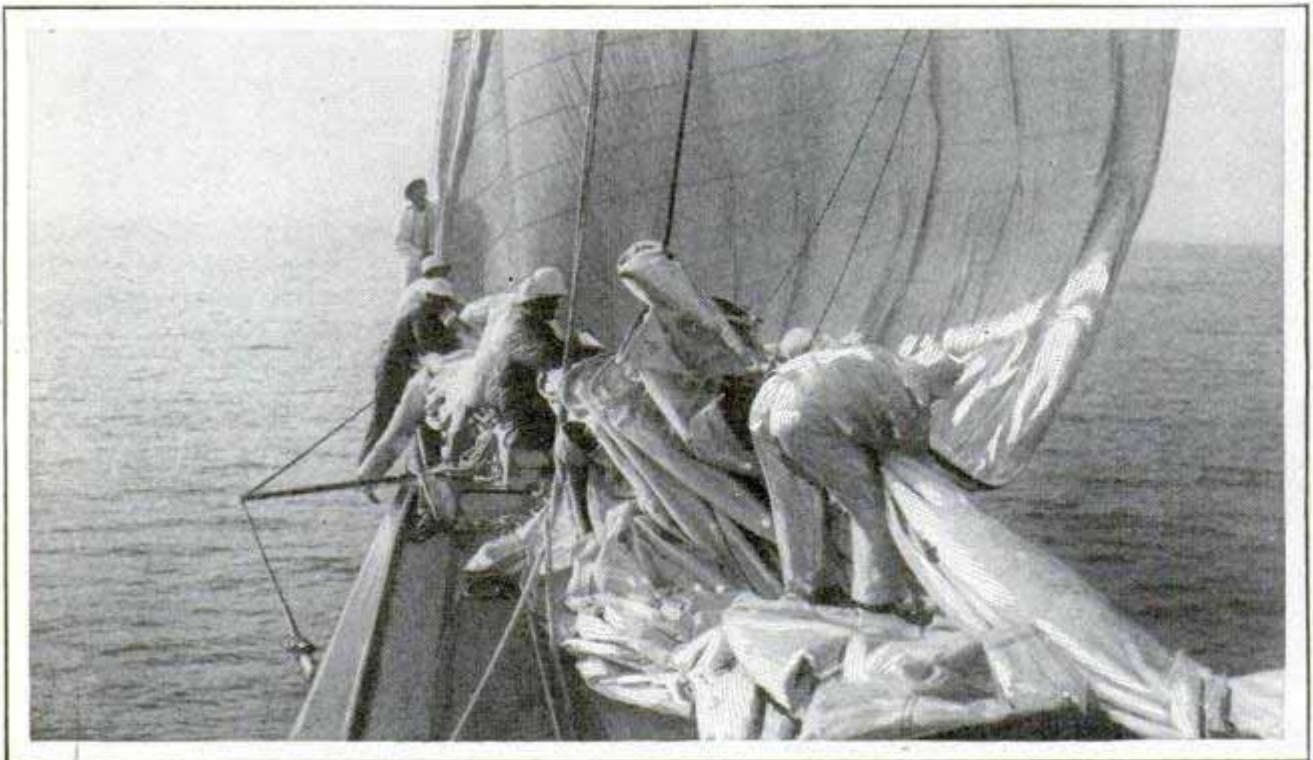

Getting In the Spinnaker Is a Job for Many Hands; as the Halyards Are Slacked Away, the Great Folds of Fluttering Canvas Must Be Subdued and Brought Down to Deck

*Co., 485 21st Ave
New York.*

across the lake to the usual Mackinac course, around Point Betsy and the Manitou islands.

We learned later she kept on north clear to the Whiskey Islands, and then bore east to beat us across the finish line by less than two hours.

While we watch "Gaviota" chugging southward, "Rainbow" breasts the gas buoy off Graham shoals, the helmsman spins the wheel hard over and we trim sail and point up for the finish line, in plain sight seven miles ahead. A long string of signal flags, whipping in the breeze from the tall wireless mast atop the highest hill above Mackinac fort, spell out a welcome in international code.

Beneath the fort on the narrow strip of beach nestles the town, and at the water's edge the glasses pick out the tent of the regatta committee, pitched beside a flagpole from which flies the burgee of the yacht club. A lone committeeman, lounging on watch in the shade, comes to life, and through the binoculars we watch him slip a shell into the signal gun and stand by, lanyard in hand, ready to give us the finish signal.

The skipper, at the wheel, orders the crew to stations ready to take in the spinnaker as soon as we get the gun. A puff of smoke leaps from the signal gun and on its heels we get the report. Down spinnaker and stand by to take in the fisherman, foresail and the main topsail. A sailor at the chronometer calls the time, 12:43 o'clock. We made it in four days, twenty hours and forty-three minutes.

Under main sail, jib and staysail we glide up the harbor, passing across the bows of the sloop "Intrepid." No need to ask the name of the winner—from the tip of her lofty Marconi spar she flaunts a broom, and one of her crew calls across the news that she won that more than 300-mile race by ten seconds!

That's yachting on fresh water.



Umbrella Bag Open, in Carrying Position and Loaded with Articles for the Beach; It Is Light and Waterproof



*94
36 A. State, Chicago*



Courtesy American Exporter

FANCY PARASOL FOR BATHERS ALSO SERVES AS BAG

Besides keeping the sun from the bather while on the sands, a brightly colored rubberized parasol may be used as a bag for taking articles to or from the beach. A wet bathing suit, for instance, can be tucked inside and will not drip, and other things may be carried. A string connects all the ribs of the parasol, to bind them together when it is used as a carrier.

BOX FOR SHUFFLING CARD DECK REQUIRES NO SKILL

2098



Cards are mechanically shuffled in a box containing compartments which mix them thoroughly as the holder is moved up and down. A small door which

closes tightly prevents the cards from falling out. The device insures a good shuffle and eliminates possibility of stacking deck.

*U. J. Cuzelman
Arkens, Kans.*

SUB'S WRECKAGE TELLS MUTE STORY OF TRAGEDY

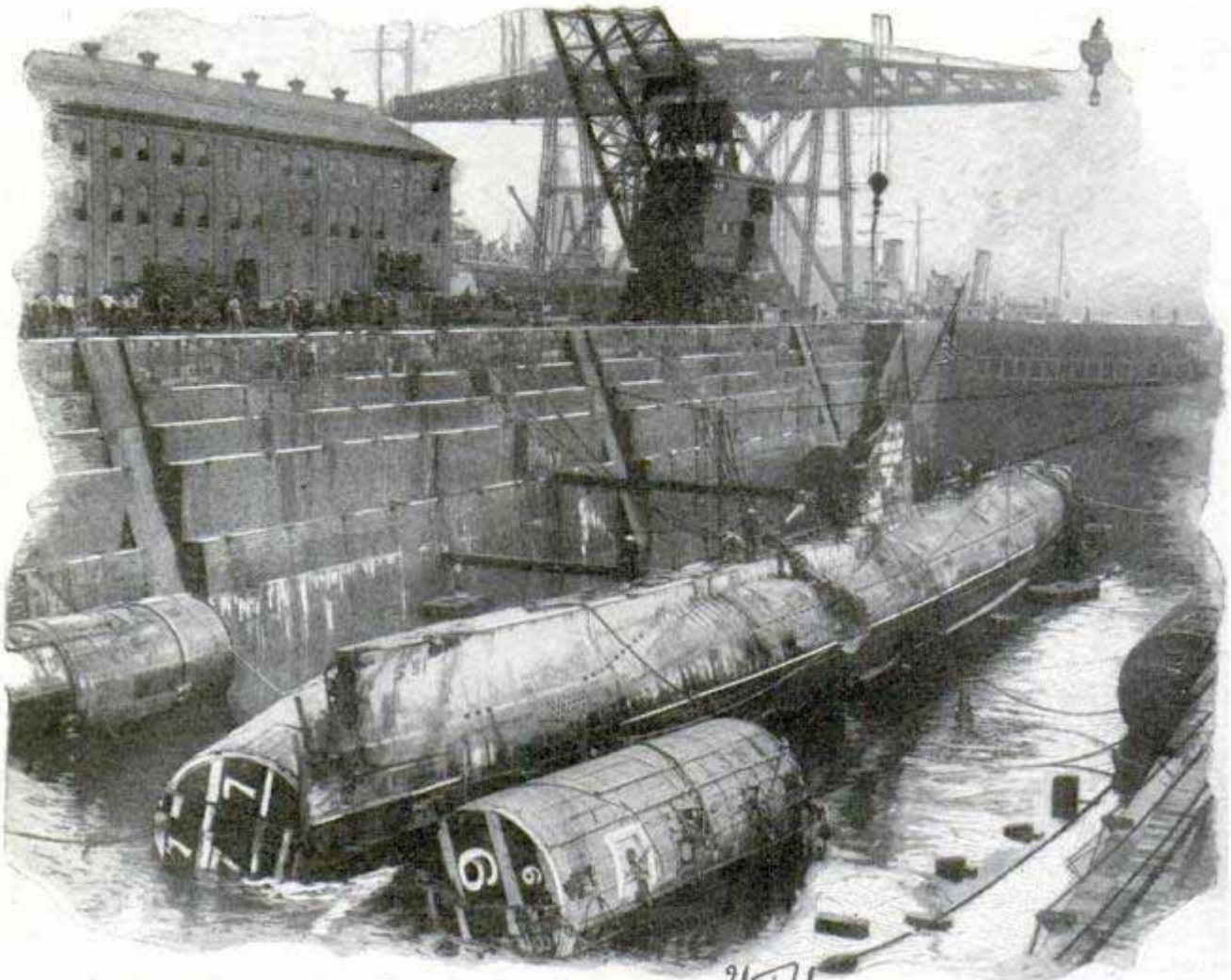

Secure at Last in Drydock at New York, the "S-51" with Two of the Pontoons That Helped Lift It from the Ocean Floor; the Gash Cut by the "City of Rome" Is Visible in Front of Conning Tower

Examination of the "S-51" has shown the crew's efforts to prevent sinking when the submarine was rammed by the "City of Rome," Sept. 25, 1925. According to testimony before the naval board of inquiry, the engine telegraph in the control rooms registered "ahead, both engines." Evidently, this was the last order from the commanding officer to the engine room. But the clutch to the starboard engine had been thrown three-quarters out and that of the port engine entirely out. The throttle was in "stop" position and the air throttle "cracked," or barely open, as if one of the engine room squad had tried to shut off the air when he was caught by the water. All this is held to indicate that the crew tried to avert disaster without waiting for orders from the bridge. The rudder was turned hard to right, showing that an attempt had been made to swing away from the "City of

Rome." Watertight doors separate the five compartments of the submarine but, apparently, the water rushed in so fast that the men did not have time to close them. Bodies were found in all compartments. That the crew died at their posts of duty was also indicated. The body of Lieut F. D. Foster was found in the engine room with his hand extended toward one of the control valves. James Marlow Schofield, the radio operator, died with his earphones on his head and his hands on his instruments. The disaster claimed the lives of thirty-three of the crew of thirty-six. Seventeen bodies were found in the hull when it was taken to the drydock in the New York navy yard. Raising the submarine was one of the most difficult tasks ever attempted by the navy.

¶Thirty years will be required for the restoration of Rheims cathedral.

DRAIN EVERGLADES FOR PLANTING RUBBER?

Can Florida's millions of Everglade acres be dried up and planted to rubber trees and garden crops? The problem is said to be under consideration by federal reclamation experts, and a survey to determine the engineering requirements of such an undertaking has been authorized, it is reported. The first step necessary would be to lower the waters of Lake Okeechobee to a level where they would not overflow the southern banks and flood the territory. The second would be to drain off the heavy rainfall on the Everglades themselves. Canals already have lowered the lake about five feet. To lead off the rain, which averages from fifty-five to sixty-five inches a year and often falls in torrential downpours, would require large canals. One already dug is twenty-five miles long, 200 feet wide and varies in depth from fourteen to thirty feet. Much of the land in the Everglades is exceedingly rich, so that some of the experts believe that it would produce sufficient return in garden crops to pay for much of the reclamation work in a year or two.

INDEPENDENCE HALL MODELED IN SUGAR

Fashioned entirely of sugar and without molds or reinforcement, a replica of Independence Hall has been prepared from an old woodcut of 1781, for exhibition at the sesqui-centennial exposition in Philadelphia. The artist is said to have completed it in the short time of twenty hours.

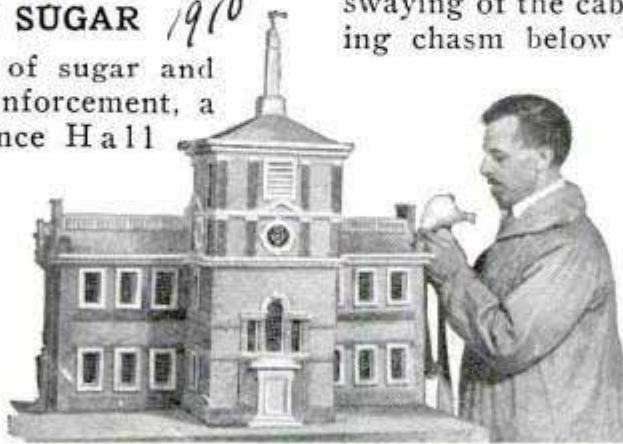

Putting Finishing Touches on Sugar Model of Independence Hall; It Was Copied from Old Woodcut

John M. Schorpp, Easton, Pa.

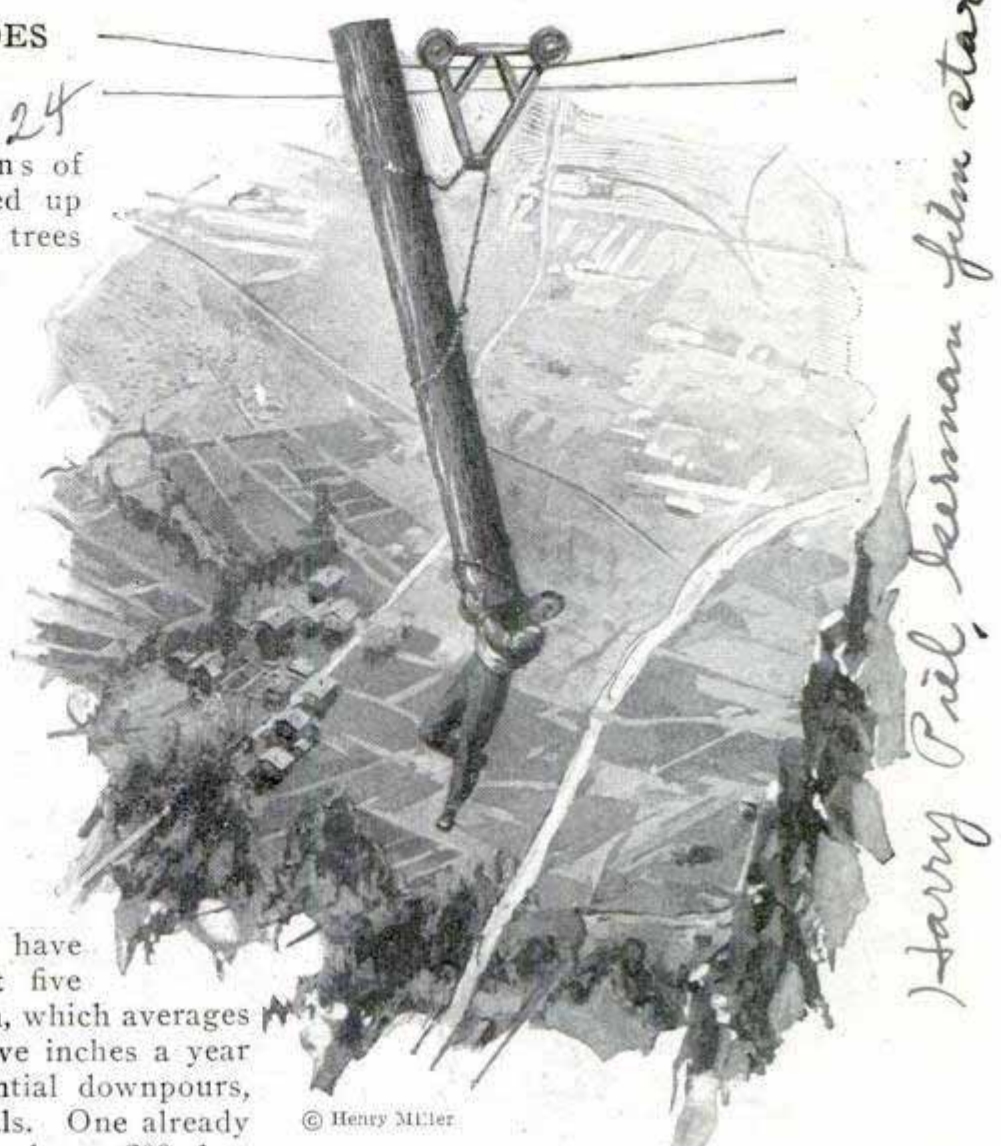

© Henry Miller

Riding Swaying Log in Scene from Motion Picture; Actor Supported Most of His Weight with Hands

RIDING LOG OVER DEEP CHASM AFFORDS MOVIE THRILL

One of the high lights in a sensational scene from a German motion picture was gained by having the hero, while clinging to a log, ride across a deep canyon. The swaying of the cable above and the yawning chasm below made the feat appear sufficiently risky to give the audience the thrill desired by the producers.

(Salts contained in the ocean, if removed and spread over the United States, would make a layer more than a mile and a half deep, it is estimated.

Harry Piel, German film star

24

2312

Chicago...

2253

Jacoma Park, Washington, U. S.

What is Your Pet

IF you got up on the morning of Friday the thirteenth, broke the mirror while dressing, spilled the salt at breakfast, opened your umbrella in the house and walked under the painter's ladder when going to work, would you have an unlucky day? Probably.

And not because any of those things in themselves are harmful. But anyone who performed that particular combination, or any part of it, hardly would be in proper mental and physical condition to have a very successful day. Breaking the mirror and spilling the salt are apt to be indications of bad nerves, which aren't conducive to a lucky day. Absent-mindedly opening an umbrella in the house where it may swipe the bric-a-brac off the tables and knock the pictures off the walls, or walking under the painter's ladder at the risk of being crowned by a carelessly dropped bucket, both indicate that you may, in equal absent-mindedness, walk in front of a street car or automobile or perform some such other unlucky stunt later in the day.

So you see there really is something to your superstitions, after all.

Many of the commonest superstitions are well grounded in fact, even though the fact is not apparent on the surface. Children who disturb grouchy elders by singing early in the morning are told that one who sings before breakfast will cry before night. As there usually is a certain amount of singing and a certain amount of crying in a child's day, it is pretty safe to say that, if the day starts with one, the other will come along in due course. And if a particularly grouchy person is awakened by early-morning song, the crying is apt to come before breakfast too!

The superstition often impressed on children that whistling or singing at the table is unlucky has the same well-founded basis in fact, as children often learn when they persist in the practice.

Gamblers believe that the person who lends money, during play, to a fellow player, will be unlucky, and the borrower will be lucky. Inasmuch as the lender has decreased his available capital, and therefore limited his chances, and the borrower is playing on borrowed money, with consequent increase of his chances, the belief seems quite well grounded.

The reason for many commonly held ideas, however, is not so easily found. Some of them go back thousands of years into prehistoric times, coming down to us, often in corrupted forms, as the remnants of ancient and forgotten religions. The black-cat superstition is a direct descendant of the days when the cat was worshiped in Egypt.



Mask and Costume Used in Tibetan Mystery Play from Collection of Field Museum

Superstition?

Some years ago the swastika swept the country as a lucky emblem. As a basic form of design, it was known in the Orient thousands of years ago, and recent excavations have disclosed that it was similarly used as a religious ornament by the Mayas and the Incas of Central and South America hundreds of years before Columbus discovered America. As a lucky emblem, it was based on Oriental legends where it has played a part in religious worship for centuries.

The swastika and the black-cat pin, and scores of other lucky emblems, went their way in due course, and along came the "Good Fairy." Rotary clubs and business organizations helped distribute the charming little statuette and advised their members to keep

one on the desk to bring good luck. Quite probably many of them did, for just to look at the graceful child figure was enough to put one in a good mood, which is the first essential toward a good day.

The superstitions attached to numbers are not so easily explained. Seven has been a lucky number from remotest times, just as thirteen has had a reputation for being unlucky. The favor shown seven is easily traced to its Biblical connections, the world, according to Genesis, having been made in seven days, while the number reappears repeatedly in the visions John saw on the isle of Patmos. The bad luck attached to thirteen may possibly date from the Last Supper, when Christ and the twelve disciples formed thirteen at the table.

Why Friday should be an unlucky day on which to start a journey is hard to see



Good-Luck Rings from Many Lands; for Centuries, the Finger Ornament Has Been Associated with a Wide Range of Mystic Influences

in these days of modern transportation, but in olden days when stagecoaches did not run on Sunday it quite possibly meant that many Friday journeys were broken by the week-end halt away from home.

A horseshoe nailed over the door certainly isn't unlucky, so long as it remains in place, and might bring decided ill luck if it fell while someone was passing beneath, but it is probable that the horseshoe myth has a very simple explanation. An old shoe, studded with rusty nails, and left lying on the ground, might be very unlucky for one stepping on it, whereas if everyone was convinced that to nail it up brought luck, the danger of lockjaw from a nail puncture would be definitely removed.

But can anyone explain why the wishbone of a fowl should be a harbinger of luck, or why a wish made while breaking a wishbone would be granted the holder

20
 Dr. J. Sully, Home, England.



Auto-Radiator Cap Combining Several Luck Symbols, Horseshoe, Four-Leaf Clover, Swastika, Wishbone and Black Cat; Examining the 183-Carat Sultana Diamond, Which Is Reputed to Carry Misfortune to Anyone Who Owns It; an East Indian Charm with Movable Features; If Both Eyes and Tongue Protrude When the Owner Grasps the Piece in the Morning It Is Considered a Good Omen



sands of miles from home, but the names that have been attached to some of them in their wanderings form a surprising commentary on the reluctance of even the world's most brilliant people to risk a possible run of bad luck.

Sailors probably hold more than their share of superstitions, some inexplicable to a landsman, and others easily traced to their source. One of the oldest and most general is that it is very, very unlucky to whistle on shipboard—in fact, in the navy, it is forbidden. Since no crusty old merchant captain or salty admiral of the line likes to have his nap spoiled by unseemly sounds from the crew, it is quite easy to see how the myth of bad luck attached itself to whistling.

A few years ago a navy officer, detailed as governor of a Pacific island possession, decided that, since the navy ruled the land, ship rules should apply, and he forbade whistling at any place in his island domain. As a sequel

two whistling marines deserted and sailed for Japan in a native boat and nearly died before they were rescued at sea. The story leaked out, a court of inquiry was ordered and the officer killed himself to escape court martial. That is the only case on

of the larger piece? The luck supposedly attached to four-leaf clovers is an equal mystery, probably going back to a religious symbolism that may be as old as the swastika story or the cats of the Nile.

One of the most modern luck systems, which sprang into prominence during the war, is the chain letter, supposed to go three times around the world, in some versions, and in others to be duplicated and sent to nine or ten friends, who in turn send copies to as many more, until, if all carried out the behest, the postage bill would pay off all the world's debts. The chain letter probably started as a diversion to interest the soldiers thou-





Kissing the Blarney Stone for Success in Marriage and the Gift of Eloquence; Irene Bordoni Throws a Pinch of Salt over Her Left Shoulder, a Rite Supposed to Ward Off Ill Fortune When the Cellar is Tipped Over; at Left, Shoes on the Newly-Weds' Auto for Good Luck



Starting a Journey on Friday Means a Disastrous Ending, So Some Believe; Seeking Beauty by Bathing Hands in Dew at Sunrise

record where not whistling was unlucky.

The practice of christening ships by breaking a bottle of champagne (before prohibition) or something else over the prow as the boat starts down the ways dates back to the days when libations to the gods of Tyre, Sidon, Carthage, and, later, Rome were poured over a newly built vessel. Sailors believe that if the sponsor is inept and fails to break the bottle the ship will be pursued by bad luck.

The belief that a person falling from a great height died a merciful death by losing consciousness because of the rapidity of his fall persisted for centuries until, only a year or so ago, airmen finally exploded it by deliberately falling 1,500 feet and more before opening their parachutes—and retained consciousness all the way. An equally old belief, with no more basis in fact, is that a person drowning or fall-

ing sees his whole past life sweep before him in a mental picture. As a matter of fact, some persons who have gone down two or three times in the water and then been fished out and revived, report they did review their past, while others insist they were busy thinking about the possibility of a future.

148
**CENTER LINE ON AUTO ROAD
PROLONGS ITS LIFE**

Paved auto roads with a line painted down the center last longer than those not so marked, according to George F. Schlesinger, Ohio highway director. He explains that motorists do not go too close to the edge of the macadam or other paving when the line is present, as they feel safer in driving near the mark. This reduces the breakage on the sides.

*Automotive industries
7/18/26*

© Keystone View Co.



Will Opening the Umbrella in the House Bring Misfortune? Alice Brady Defies the Old Superstition



Even Skeptics Admit Horseshoe over Door Is Harmless if Securely Fastened; Broken Mirror, to Others, Spells Bad Luck

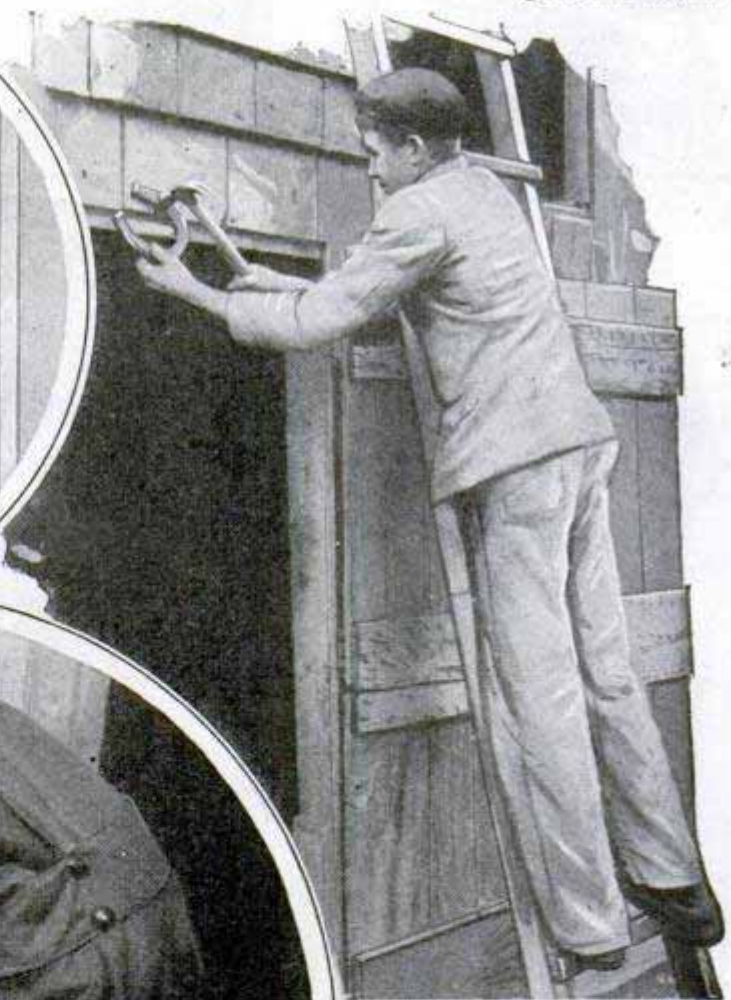

37

**WIND RESISTANCE
IN MOTORING** 86

That the velocity of the wind makes a material difference in the speed of his car is realized by every motorist, but just what the resistance amounts to is not a matter of common knowledge. The increase in resistance is not in direct proportion to the increase in the velocity of the wind. For example, a wind of fifty miles an hour exerts a pressure of ten pounds against each square foot of surface directly in its path, while if the wind velocity doubles or the body moves through the air at a speed of 100 miles an hour, it meets with a resistance of forty pounds per square foot. To travel at fifty miles an hour against a head wind of equal velocity, sets up a total resistance to the movement of the car of about 1,000 pounds.

At this speed, the total pressure exerted against a man of ordinary size would be equal to a 200-pound weight distributed over the upper half of the body, and it may be conceived that breathing under such conditions is rather difficult.

1725

**SHOE POLISHER FITS IN POCKET
AND CARRIES CLOTHES BRUSH**

Shoe polisher and clothes brush have been combined in a compact outfit that can be folded up and carried in the pocket. The shining material is wool sheepskin on a leather back and the brush slips into a small open bracket attached to the polisher.



Philip Horowitz
13 E 26th St
New York.

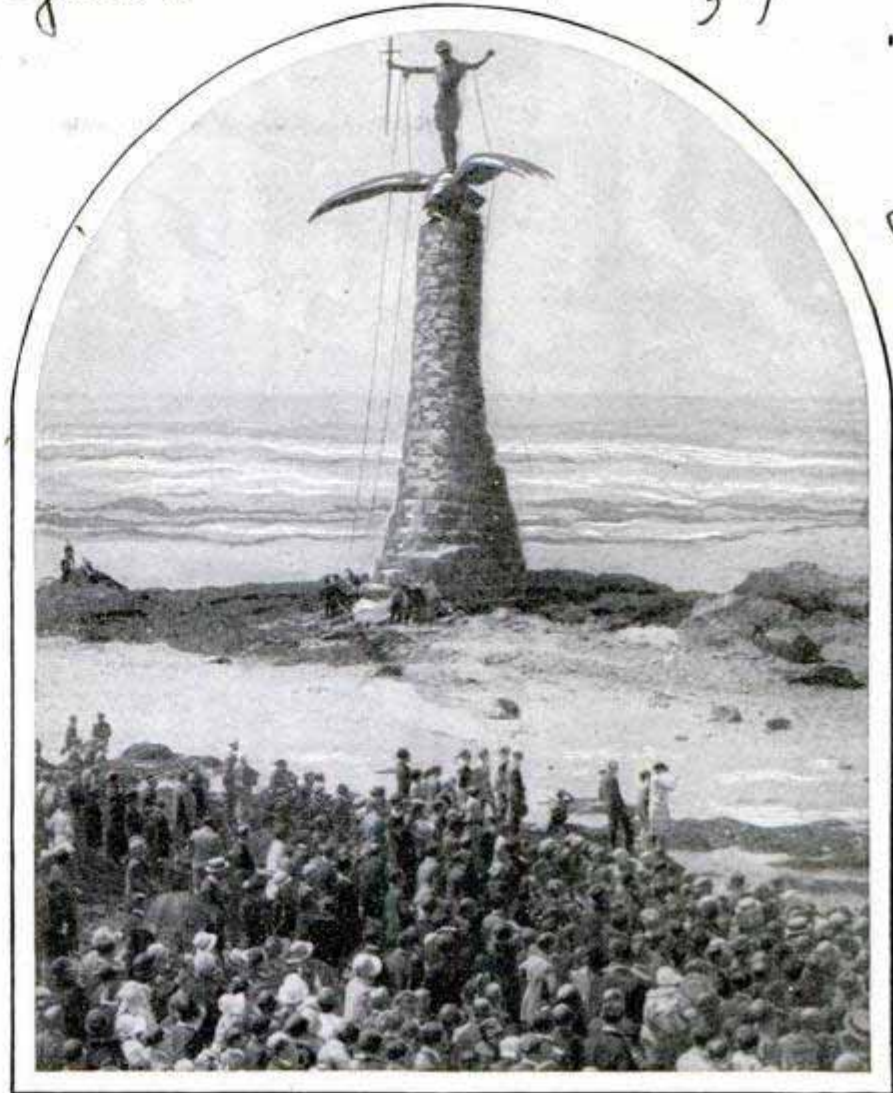

The Monument at St. Nazaire, France, Marking the Landing Place of the First American Units during the World War

**LANDING PLACE OF U. S. TROOPS
MARKED BY MONUMENT**

To commemorate the landing of the first American soldiers at St. Nazaire, France, June 26, 1917, a bronze monument, costing \$100,000, has been erected on the shore of the bay. It is the work of Mrs. Harry Payne Whitney. Funds for the memorial were raised by subscription.

**PLANE BEATS CARRIER PIGEONS
IN FIFTY-MILE RACE** 27

Bird wings were beaten by the man-made variety in a race between three carrier pigeons and an airplane from Hammondsport to Auburn, N. Y. The plane won by three minutes and had about sixteen miles farther to go than did the pigeons. The fastest bird covered the distance, fifty miles, in fifty-one minutes.

N.Y. Herald
7/1/20

under auspices of the St. Nazaire Association

203/4



Located on Lake Sable, near Grand Marais, Mich.

Where a Cartoon Inspired an Architect; Unique Barrel Home Built for William Donahey, the Artist; It Has Accommodations for a Whole Family and Is Decorated with Tiny Human Figures

SUMMER HOME LIKE BARREL HOLDS SIX PERSONS

Adopting an idea from William Donahey's cartoons, officials of a cooperage company constructed a unique vacation home in the shape of a barrel for the artist. Measured in liquid capacity, it would hold 21,000 gallons, but was built as a comfortable house to live in with a main room twelve feet in diameter on the first "floor" and sleeping quarters, reached by a spiral stairway, above. A pantry is also provided, and another barrel serves as a kitchen. Children dressed to represent dwarf characters created by Mr. Donahey helped make the presentation.

that it always cuts to the same depth. Two sizes of blades are furnished, one for a one-half inch slot and the other for three-quarters of an inch.

SMALL LEVER RING ON BOTTLE HELPS REMOVE CAP



Removing the cap is simplified in a bottle that has a ring attachment at the side. Pressing on it pries the top off quickly and with little exertion. To the cap is con-

DRILL REGROOVES TRUCK TIRES TO PROLONG THEIR LIFE

When the tread on solid truck tires has worn down, new grooves are quickly made with a portable cutter operated by a motor-driven drill. The knife is V-shaped, giving the desired form of groove and is so guided



nected a small tin fork, useful for the camper or picnicker.

POCKET CAMERAS FOR POLICE TO AID WAR ON CRIME

So that photographic evidence of crime and accidents may more easily be obtained, policemen in Cincinnati have been equipped with pocket cameras. They are instructed to take snapshots at the scene, and the films are developed by a special photographer at headquarters.

Pioneer Cooperage Co. 446 N. Hoy St. Chicago

Black & Decker Mfg Co Towson, Md.

Dr. Ernest S. Benson, 574 E. Seneca Syracuse, N.Y.

July 1926 American City

549 W. Washington Chicago

Announced by City manager C. E. Sherrill

**MAIN CAUSE OF SEASICKNESS
LIES IN INNER EAR 46**

Physicians no longer regard seasickness as a mystery and, besides discovering its chief causes, have found ways to relieve it. The trouble, in most cases, has its origin in the well-developed, delicate inner ear, near the seat of the body's balancing apparatus. Infants and deaf persons do not suffer seasickness, indicating that the ear theory is correct. The rolling and tipping of the vessel cause an overstimulation of the nerves in the balancing area and this disturbance in time is communicated to the nerves that lead to the stomach, heart and other organs with the consequent illness. Dr. P. H. Desnoes, a port medical officer, recommends that persons contemplating an ocean voyage observe a few simple rules of hygiene and diet for a week or so before going aboard to avoid serious seasickness. Abundant sleep, horseback riding and swimming are favored and foods with an acid reaction should be avoided, he says. On board, little liquid should be taken at meals but plenty between, only the foods that appeal to the appetite should be eaten, and the mind should be pleasantly occupied.

**TAXICAB WITH LOTTERY WHEEL
GIVES PATRONS FREE RIDE 11**

Taking advantage of the public's love of gambling, owners of a taxicab company in Montevideo, Uruguay, have painted the left rear disk wheel of their vehicles with numerals from 1 to 20 and fitted a pointer in vertical position to the axle. When a patron hires a cab, he and the driver note the number at which the hand points when the trip is started. If it indicates the same numeral when the destination is reached, there is no charge for the ride. This concern is now said to have a larger patronage than any of its competitors.

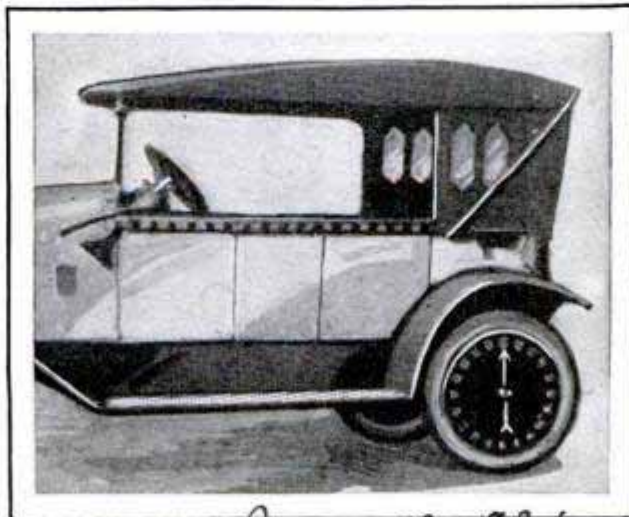

Courtesy L'Illustration *June 19, 1926.*
Taxicab with Numbered Rear Wheel and Pointer; Passengers Have a Chance of Enjoying Free Rides



Amil Bruno

Battery and Shocker Exposed on Wearer's Wrist; It Is Intended to Stun an Assailant with Electric Charge

**ELECTRIC PROTECTOR ON WRIST
DISABLES BANDITS**

Worn like an arm band and connected to a battery concealed in the clothing, an electric apparatus devised by a German inventor is intended to protect the wearer from an assailant by temporarily stunning him with a discharge of 10,000 volts. The current is turned on when the guard comes in contact with the attacker.

**HOT DOG AND BUN ARE BAKED
AS ONE IN COOKER 26**

Both the roll and the frankfurter are cooked at the same time in an electric unit designed for installation at lunch counters and soda fountains. The dough is poured into molds, a sausage placed in each and, in about four minutes, both have been baked sufficiently for consumption. Another attachment provides an injector by means of which a dose of mustard may be applied to the sausage.

*Singular machine
Patent mfg. Co. 1213 Chestnut St.
St. Louis, Mo.*

How To Be A



by Knute Rockne

University of Notre Dame

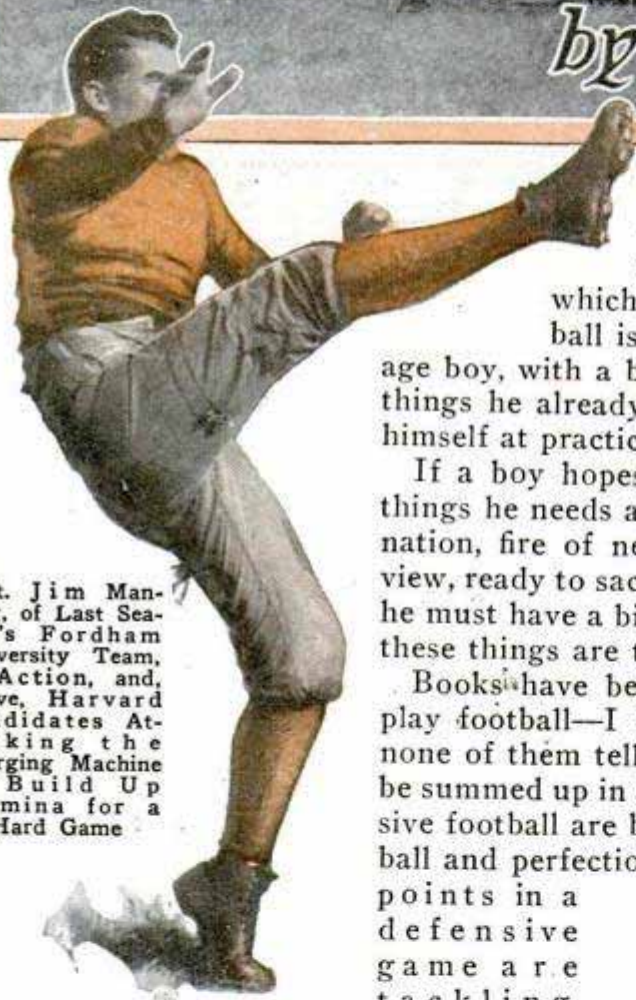

Capt. Jim Manning, of Last Season's Fordham University Team, in Action, and, Above, Harvard Candidates Attacking the Charging Machine to Build Up Stamina for a Hard Game

IT doesn't take an expensive supply of purchased equipment to outfit a boy for high-school or neighborhood football, which is one of the important reasons why football is such a popular game. In fact, the average boy, with a bit of ingenuity and the odds and ends of things he already has, can assemble a complete outfit for himself at practically no expense.

If a boy hopes to be a good football player the main things he needs are brains, courage, self-restraint, co-ordination, fire of nervous energy and an unselfish point of view, ready to sacrifice for the team as a whole. Of course, he must have a bit of speed and a bit of physique, but then these things are taken for granted.

Books have been written by many coaches on how to play football—I have written some of them myself—and none of them tell all the story. Yet, the basic things can be summed up in a very few words. The essentials of offensive football are blocking, interfering, ability to handle the ball and perfection in the execution of details. The main

points in a defensive game are tackling,

ability to knock down forward passes and to ward off would-be interferers by use of hands and nimbleness of foot. Get eleven boys together who have all or most of these abilities and, with plenty of hard practice and drill, you can whip them into a team that moves like one boy.

The one point where the average high-school or neighborhood team is weak,

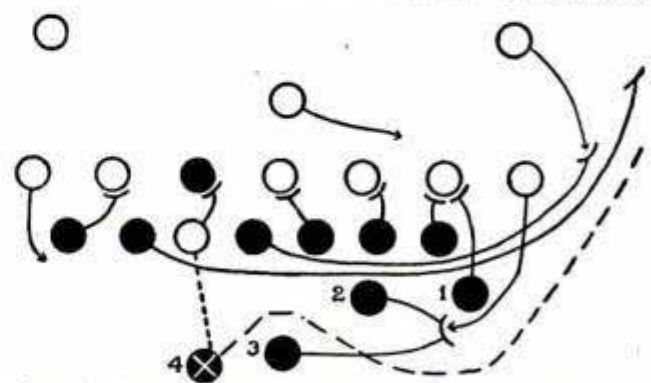

One of Rockne's End Runs; the Attacking Team Is Shown in Black, with Center in White, and Defenders in White with Black Center

Football Star

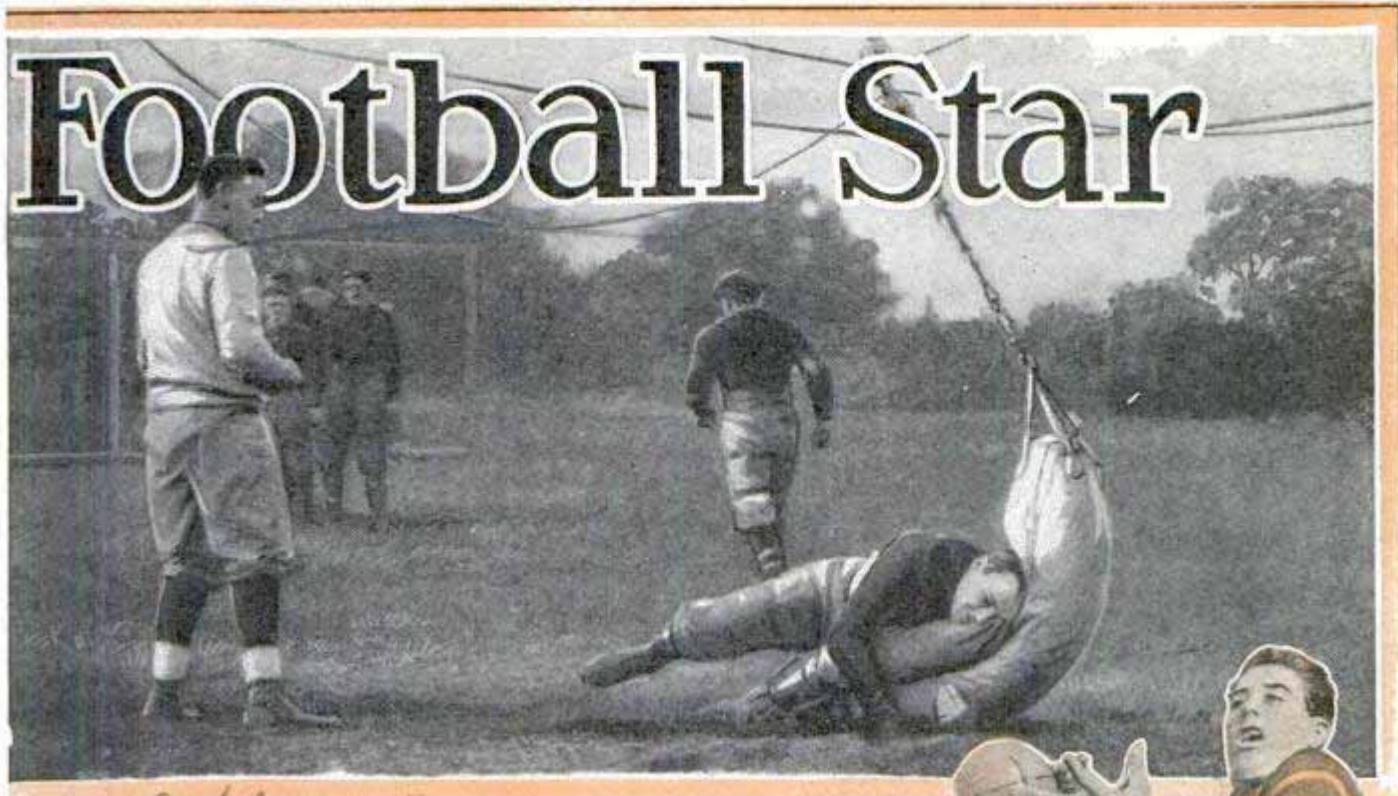

Athletic Association Notre Dame

however, is in appreciation of the necessity of hard work and constant drill. It is so much pleasanter to go out and play a game than to spend hours working over tackling, running, signals and other drill points. Without the training, however, there can't be much success in the playing. It isn't enough to master the mechanical details of the game, learn signals and complicated plays. The good team is the one that is able to study the other fellow and beat him by quicker wits. You not only have to know when to do a thing, but when not to do it. Take forward passing, for example. The good quarter back—and the quarter back must run his team—needs to know when to try a forward pass, but more important still, he must know when not to try it.

A good team will not try to forward pass against a strong wind; it will not forward pass while deep in its own territory, unless it is behind or near the end of the game; it will not forward pass near the opponent's goal line except on fourth down; it will not forward pass when the opposing team is plainly expecting one; nor will it forward pass when it is ahead in the score. In other words, the good quarter back gambles only when he has nothing to lose and everything to gain. When he has everything to gain, as for example when his team is behind, then he resorts to the pass.

A book of advice for the quarter back alone could easily be written, without telling everything he ought to know. He must have confidence in himself, and have control over his team, so that when he stakes everything on a play there will be no questioning of his judgment. He must bark out his numbers clearly, distinctly and loudly. When in doubt, he must remember that it is always the safest thing to punt.

© U. & U.
Capt. McGrath, of Last Year's Georgetown Team, Catching a High One, and Army Players Tackling the Dummy, Above

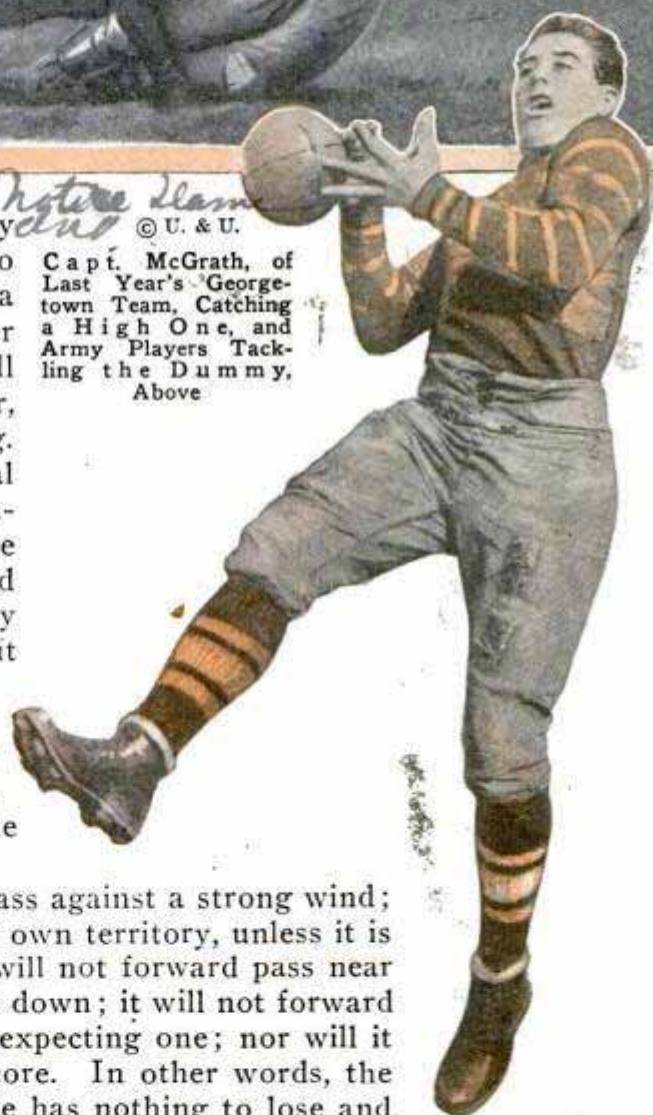



Knute Rockne, the Coach Who Developed the Famous
Four Horsemen of Notre Dame

Plays do not mean as much on offense as the average boy would think. One team will put on some plays that work wonderfully well, and another team will try the same plays and they look terrible. It is all a matter of execution. The quarterback should keep track of the plays that have worked and those that have failed, then drop the latter and push the former. That is one of the big things emphasized in any book on football tactics and strategy.

Getting back to homemade equipment, though, how many boys know that they don't need a special pair of football shoes, special football pants, shoulder guards or a helmet? You can make a very serviceable pair of football shoes out of any old pair of everyday ones by simply nailing on a set of fiber cleats, which can be obtained cheaply from a sporting-goods dealer or the maker. A pair of swimming trunks seems a queer thing to include in a football outfit, but if you sew a pair of fiber thigh guards to them, don the trunks and put on an old pair of khaki trousers over them you have all the leg protection you need, as shin guards are no longer in fashion. Cheap cotton hose and jerseys don't cost much, and on the shoulders of the jersey you can sew in some horsehair padding, such as you will find in an old buggy or automobile seat, and have good shoulder protection. You may be surprised to know that a headgear is not necessary, and that quite a few college players have never worn one, yet have never received a head injury. The headgear serves chiefly to protect the ears, and if you feel that you must have one, buy the cheapest you can get. Nose guards, like shin guards, are obsolete.

I haven't much to say on what a boy should eat, as the old-fashioned ideas on strict training are also becoming passe. Of course, a boy should absolutely abstain from stimulants (even coffee must be taboo) smoking and poisons, such as alcohol, but if he eats at home the fine home cooking which his mother prepares is good food for any football player. There are just a few things he ought to stay away from. They are chocolate, cocoa, chocolate candy, greasy fried potatoes, pork and bananas. These things are all hard to digest and the average boy will



Batteries of Powerful Lights Strung above Carson Field, Cincinnati, Enable the University Team to Meet Opponents after Dark; 32,000 Watts Make the Field Nearly as Bright as Day; Below, Chester Bowman, Olympic Star Runner, Is Shown Bucking the Shoulder Straps in Practice for the Syracuse Team



George Wilson, Captain and Star Half Back of Last Season's West Coast Champions, the University of Washington, Shown Carrying the Ball

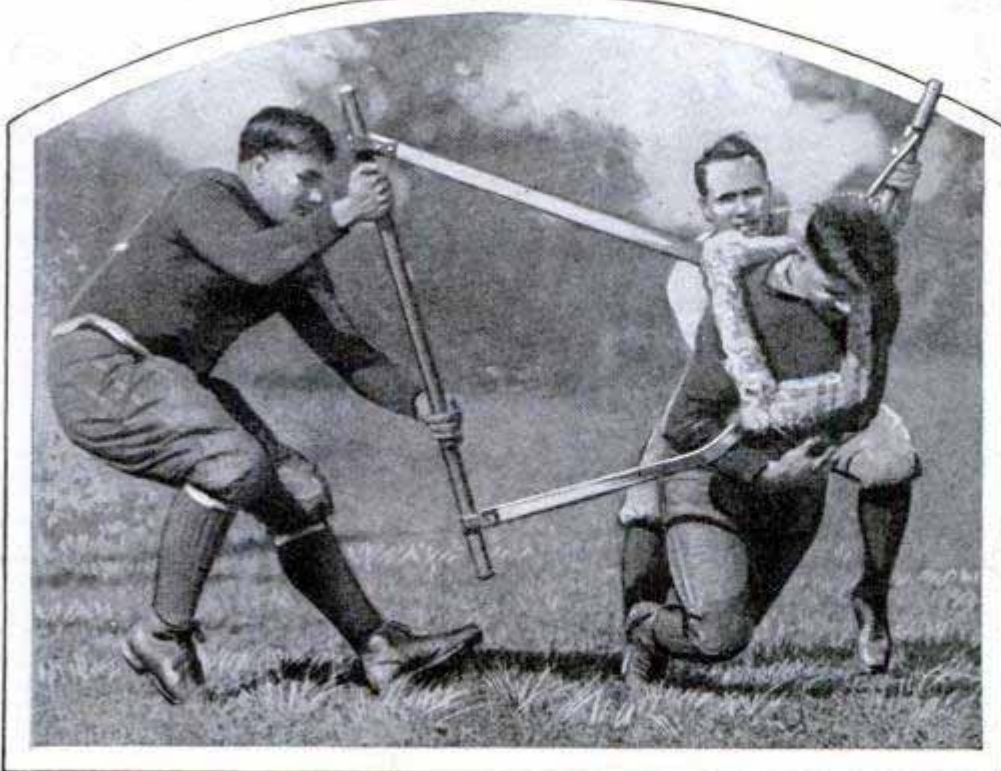

find that they do not agree with him when he is playing football. Boys should eat regularly, three times a day, and must not eat between meals. The meal before a

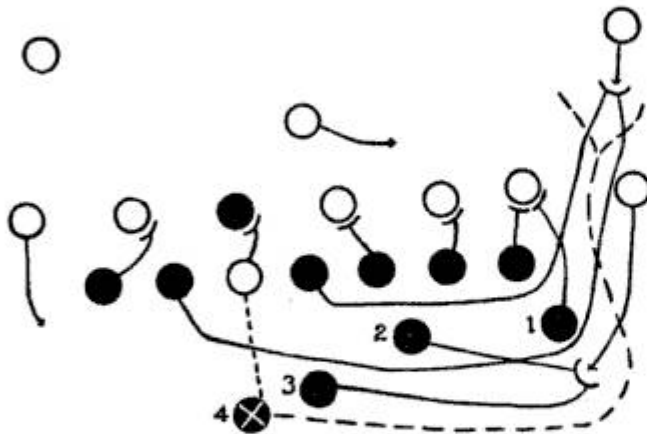

An Off Tackle Play Designed by Rockne; Note the Back Four, with the Ball, Has Two Routes Open

game, however, must be very light. This is important. The boys should not eat when they are tired. They should not drink ice water before a meal. If a boy bears these few things in mind, he will find that, as far as the stomach is concerned, he will feel fit for the game. Boys should go to bed every night around ten o'clock and should get at least nine hours' sleep. They should not take the game too seriously but should try to get as much fun out of it as possible. Do not try to play, if you are hurt, and be sure to have all injuries treated by a competent physician. Towels applied as hot as you can stand them will be found a great relief to most bumps and bruises. However, don't be a mollycoddle—remember that football is supposed to bring out the Spartan in the young boy, which means to make as little out of an injury as possible, not losing, however, the common-sense point of view.

The proper way to tackle a man is to

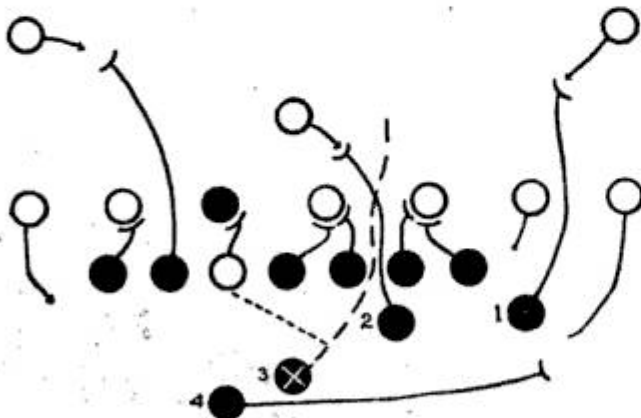

A Plunge in Which Back Four Fakes as Though He Had Ball, While Two Clears Way for Three

crouch down low with the weight well forward, head back and eyes open and knees well bent. Keep your eyes on the man you are tackling, particularly his hips, drive at him with all the power of your legs and hit him squarely with the shoulders and the instant the shoulder lands, wrap your arms around him and pull the arms toward you as hard as you can, still shoving through with the shoulders, and take one or two short, digging steps. This will throw the ball carrier back in the direction from which he came. It stands to reason that if you knock him off his feet he cannot go any farther. The high spots of tackling, however, are lots of leg drive, eyes open, and using good judgment in timing and distance. Sometimes, when the ball carrier is far to one side, the tackler will have to leave his feet and throw his body in front of the ball carrier, wrapping his arms around him as he does so. This will cause the ball carrier to fall over

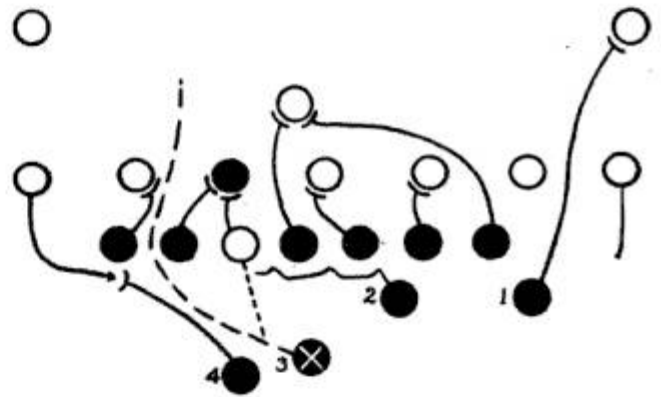

A Weak Side Play in Which a Hole Is Opened through Which Back Three Plunges with the Ball

the body of the tackler, as he is obstructed by his body and cannot get away, having the tackler's both arms wrapped about him.

Blocking is the means used by an offensive player to keep a defensive player from the ball carrier. Interference is collective blocking. In the line, there are two methods of blocking generally used. If the opening of a hole is intended, the offensive lineman charges into his opponent, hitting him a little bit above the knee, using short, digging steps, with lots of leg drive. The legs should be well straddled, tail low, head back and eyes open and you should stick to your man as long as you can. If, however, you are merely blocking him to prevent him from getting through to hurry the passer or to hurry the kicker and it is not necessary to make a hole,

then the offensive lineman merely slaps his hip in the opponent, getting the head and arms beyond him and using all the length of his body as a blocking surface. Do not go so low that the defensive man can jump over you. These two types of blocking, of course, are used against stationary players. Out in the open, the block to use against a running opponent is what is known as the cartwheel. This means to throw your body horizontally at your opponent very much the same as the diving tackle, only you do not use your arms. You hit him with your hips or side and keep on rolling. Get plenty of leg drive and be sure to dive through the man, not merely in front of him.

The points to remember on defense are that the guards, tackles and ends must charge through their own territory as if expecting the play to come over their hole. The defensive center is allowed certain liberties and may be in the line charging. He may drop back three yards or he may be in the line non-committal, ready to charge or pull out, depending on what kind of play comes along. If the other team has first down ten, the defensive center will be in the line but ready to pull out to help tackle on the flanks. If it is second or third down, small yardage to gain, the center will line up on the line

and charge through. If it is second or third down, many yards to gain, the defensive center can drop back several yards to a position where he can best defend against that which under the conditions he has every right to expect—a forward pass or a trick play. If the opponents have a formation where the quarter back receives the ball from the center, the defensive center will be in the line charging. If the other team, however, is using the direct pass to the ball carrier, then the defensive center can be in the line ready to pull out or he can drop back several yards. The man backing up the line is responsible for line plunges and end runs. When the other team has second or third down, many yards to gain, he should be more alert for forward passes and may drop back several yards. The half backs are responsible mostly for forward passes. The man playing safety on defense will have to be a good punt catcher and can also help defend against long forward passes. On defense, every boy should take it upon himself to do everything in his power to stop the play that the opponents put on, but above all, he must use his hands, be shifty on his feet and use his eyes. See everything.

Harvard Tries Out a New Device for the Perfection of the Forward Pass, a Sheet of Canvas with Holes, through Which Ball Is Tossed

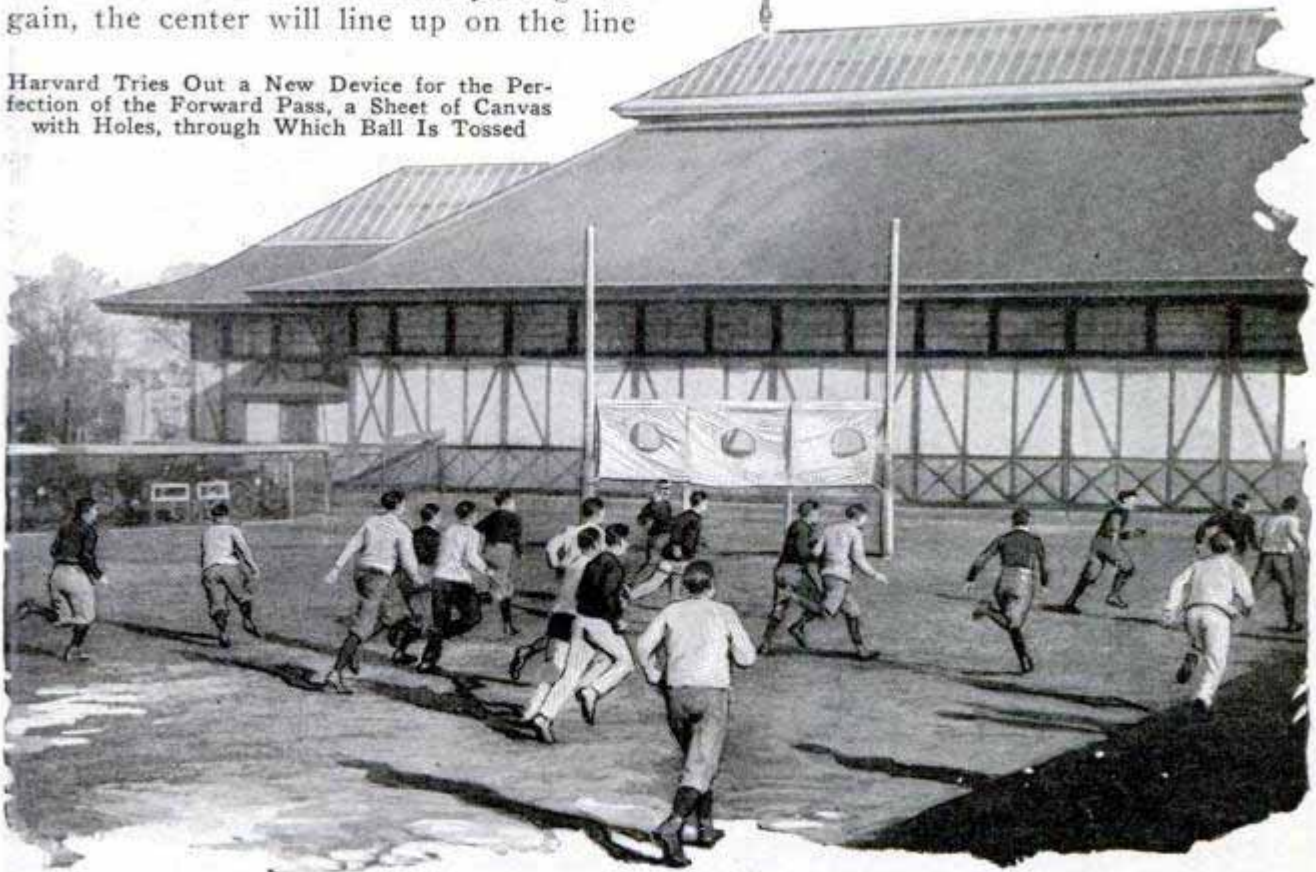

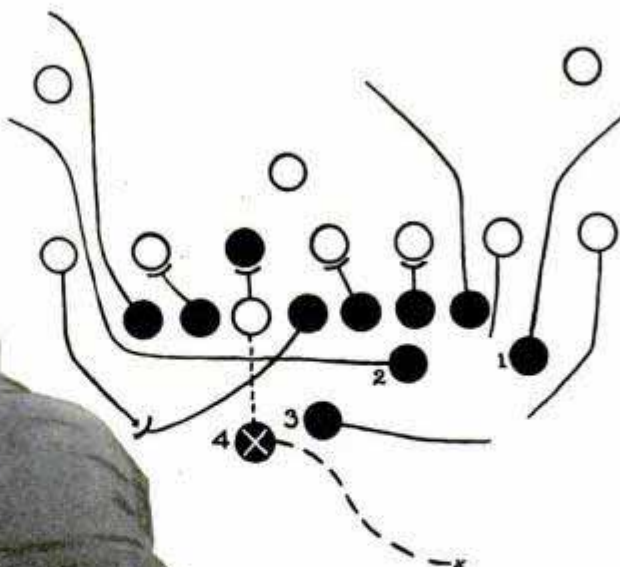

One of Rockne's Many Forward Passes, Used by the Famous Four Horsemen

One of the things the quarter back must learn is that, if a punt looks as though it would roll for touch back, he should not try to catch it. Close to his own goal line, he should kick on first down unless he intends to play for position. When

near the sides lines, it is always best to run a play for position. The quarter back should keep his eyes open and watch for weak spots in the opposing team, and when he finds one not forget it. Against a strong defensive team, kick, kick and keep on kicking. On a wet and muddy field, kick and let the other fellows take the chances of fumbling the ball. Always be sure that every man on the team is ready before you call a play. Usually you will find it best to charge on the next number after the signal, instead of on the signal itself. That gives the boys a second to get set for their specific job. Maneuver to keep away from the side lines and near the center of the field as much as possible. Watch who makes a tackle and it may suggest a play to you. Use punt formations deep in your own territory and save your close attack until after you get past the middle of the field. Stall when you are playing against the wind, and speed up the game when you have the wind behind you. Likewise stall when you are ahead or when your team is tired, and speed up when you are behind or when the eleven are hitting on all cylinders. Save your best forward-pass plays for the second half. If you have a weak kicker you can try a long forward pass in your own territory. Against a team which has a powerful offense, hold the ball as long as you can.

Don't try to handle a kicked punt which is rolling uncertainly, and when you are

Red Grange, the Wheaton Iceman and Greatest Player of Recent Years, Who Made a Fortune in a Few Weeks

catching a punt and you see the opponents have their ends right on top of you, signal for a fair catch. Be sure that you are able to tackle in the open, but, if you can maneuver a ball carrier toward the side lines, do it.

In offensive territory, use your best play on first down. By best play I mean the one that has proved the biggest ground gainer. Try a trick play or a long ground gainer whenever you have recovered a fumble, as you will then catch the defensive team up in the air. When the defensive line tightens, use end runs, and when they spread out, use line plunges.

FLAMES HELP DEAF CHILDREN LEARN HOW TO TALK 91

Sensitive gas flames that dip and sway when vibrations of the voice come in contact with them are used by an English instructor to help teach deaf children speech. The little tongues of flame shoot up through hollow tubes and can be regulated as desired. They give the child a visual picture of his voice as a substitute for the sound impression received by the person of normal hearing. For example, certain vowel sounds cause the flame to dip sharply such as the "ar" in carpenter and the "a" in table. By stationing the child farther away from the flames, he learns to speak louder and develop his voice.



© Photopress
Deaf Children Learning to Talk with the Aid of Sensitive Gas Flames Which Move with the Voice Vibrations

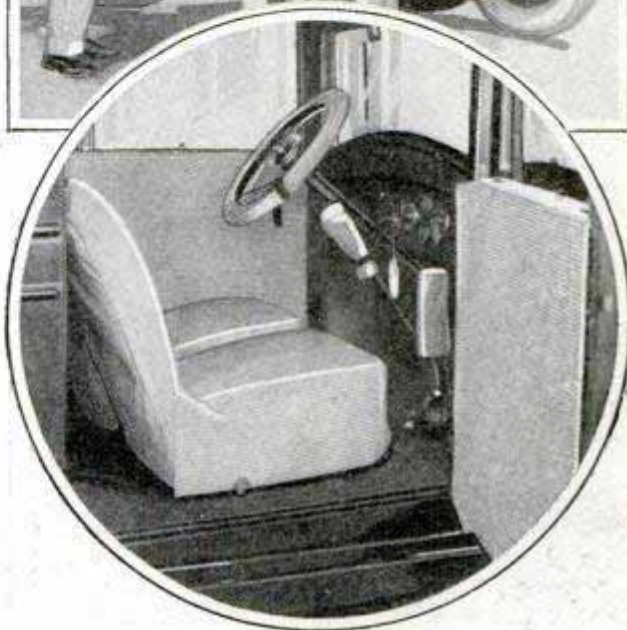

Covers on Seats, Door, Wheel and Clutch, and Above, over Fenders, Cowl and Hood

FABRIC COVERS PROTECT AUTO WHILE BEING REPAIRED

Stains are kept from the auto upholstery, and fenders, cowl and hood are protected against scratches while the car is being repaired, by fabric covers quickly slipped over the parts most likely to be damaged. It is said that the entire set can be adjusted in less than three minutes. The durable fabric can be washed without shrinking and the shields are made in various sizes to fit almost all makes and models of cars. Covers for the seats are intended to be left in place, if desired. They fit snugly and are attractive.

☐ In the language of the sea, a ship's carpenter is commonly known as "Chips."

13

Riverside Manufacturing Co.

*Miss Olga Thompson, at
Huggs Toy & Stationery Dept + Slumb
E.C. Inc*

52 W 17th St New York



Comic Face on "Slicker"; It Changes Expression as Garment Wrinkles and Has Movable Eyes

ANIMATED FACES ON "SLICKERS" LATEST FASHION NOVELTY

With almost every movement of the wearer, faces painted on slickers with waterproof paints, change expression, for the eyes, lashes and lips are inclosed in celluloid compartments and are movable. Animal designs are also devised in the same way, and for those who desire something distinctive, a skull pattern is provided.

DESK MEMORANDUM ON ROLLER ECONOMIZES PAPER



Paper is supplied as needed for making notes from a roller pad placed on the desk. A strip, four and one-half inches wide, is carried on a pivoted reel on top of the holder and is unwound by turning a

Can be ordered from Hardware

milled-head screw. At the upper end of the pad is a metal straightedge for tearing off pieces to be filed away.

PEDALING PLAYER PIANO AIDS TREATMENT OF FEET

Operating a mechanical piano in stockinged or bare feet is recommended by an eastern physician to help strengthen the foot muscles and to relieve arch troubles and other ailments. Besides the exercise of pumping the pedals, the music takes the patient's mind from his pain, the doctor asserts, and he believes the response of the muscles to the vibrations of the instrument exerts a beneficial effect. The player-piano method is superior to dancing or operating a bicycle, the physician declares. The importance of proper care of the feet is now widely recognized, and most doctors agree that many ailments can be traced to their abuse. It is said that ninety per cent of all foot afflictions are caused by improperly fitted shoes.

SHADE FOR AUTO HEADLIGHTS 1995 KEEPS RAYS ON ROAD

The principle of the eyeshade has been adapted to automobile headlights in a metal shield that fits over the bulb and can be adjusted to keep the rays of the lamps on the road instead of shining into the eyes of approaching drivers. The deflector is made to fit on any standard light and is quickly put on underneath the outer rim of the lamp. It may be bent or turned to any desired angle.



63 STAINLESS STOCKINGS

Waterproof imitation-silk stockings that are not stained by mud splashes have appeared and are available in any shade desired. A method has also been devised for giving the material the dull sheen characteristic of genuine silk instead of the bright luster of the artificial product.

Answers 9/2/26 maker unknown

Mark Nor. Am. 326 Highland
Sum Seattle, Wash.
Srin, Seattle, Wash.

The Cooper Hardware
Mr. J. M. Chang
Chicago
S. Dearborn
Patent Products
Patent Corp.

Owner - application for a road between Los Angeles and the ocean

COSTLY GARDEN BUILT IN TERRACES ON HILLSIDE

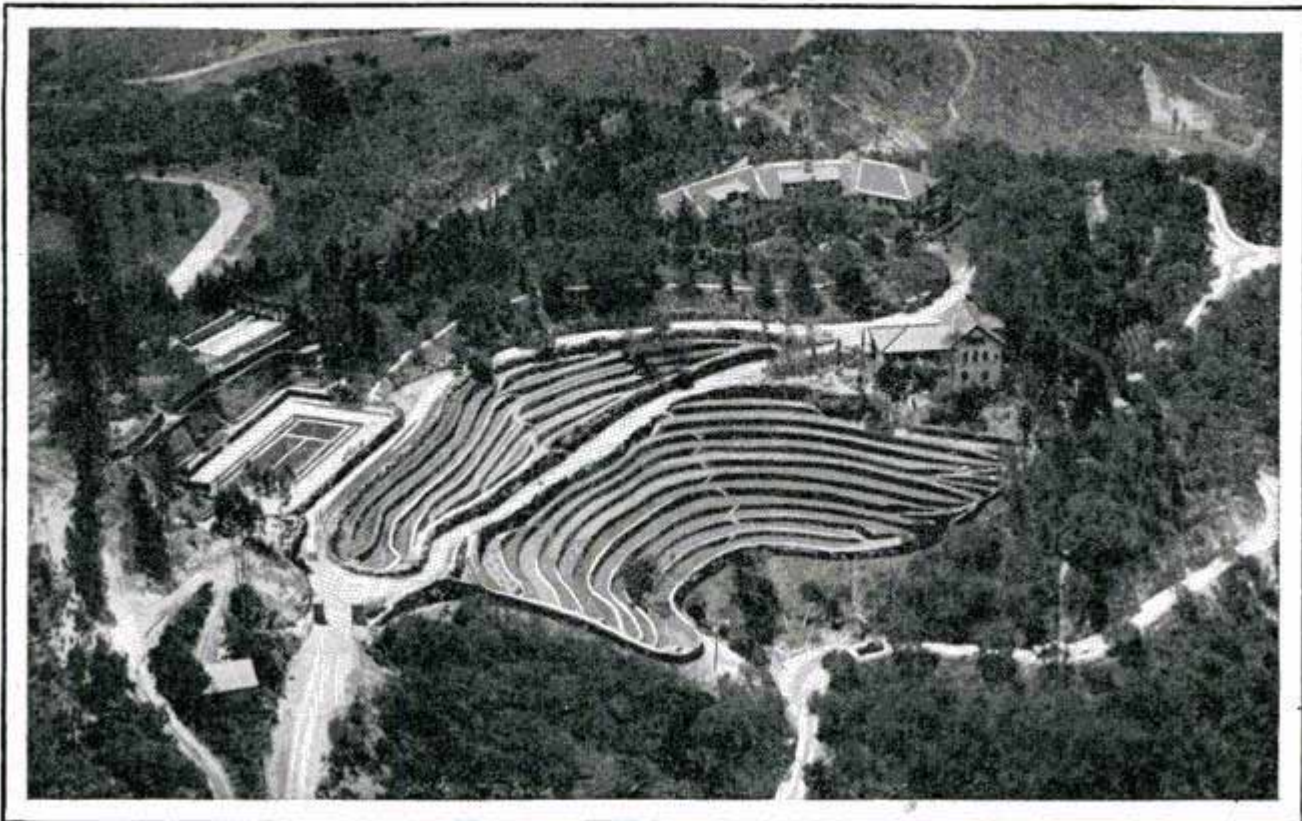

Terraced Garden on the Grounds of a Private Estate in California; Tinted Sandstone Walls to Support the Steps Produce Pleasing Color Combinations, and the Different Levels Are Connected by Stairways

What is believed to be the world's costliest private vegetable garden is being completed in southern California. It is of the "hanging" or terraced type, comprises one acre of level land, and represents an expenditure of \$75,000. The owner's estate is on the high hills, and the only spot available was an amphitheater-like slope, which has been converted into an extraordinary garden. Employing a beautifully tinted sandstone, a series of gracefully curved walls, aggregating more than a mile and a quarter in length, was built to form the terraces. Embodied therein are numerous boulders, weighing up to a ton and a half each and requiring hand hoists for placing. The average height of these supports is four and a quarter feet, though some rise eighteen or twenty. The soil surface on the terraces is from six to ten feet wide and averages eight. All are connected by three-foot

stone stairways, each of the lower tiers having four, and these steps zigzag and fit in so admirably that they are not readily detected at first glance. In the middle section, they assume the character of stone ladders. The terraces have an easy grade from north to south and are watered by a gravity irrigation system.

HINGE TOP ON SAFETY HELMET ADDS TO WEARER'S COMFORT

Provided with a front section that tips up over the head on hinges, a safety helmet for workers does not have to be removed, when not in use as a protector, and can be closed quickly in case of an emergency. When raised, the movable part stays up out of the way of its own accord and fits snugly, yet not uncomfortably, well down on the neck and chest, when lowered.



Helmet Closed, Showing Window, and Top Tipped Back; a Soft Headpiece Protects the Scalp

Madison Chicago

326 W.

Willson Hoggles & Co. Pasadena Ca

The Magic Lure of Ciphers

Secret Writing Has Saved Scholars' Necks and Won Wars;
How Mystery Messages Are Formed and Solved

By PAUL PADDOCK

IF you should lose your pocketbook while traveling abroad, the single word "sooty," cabled home, would tell the folks that you were in need of funds. And if you received the word "stall" in reply, you would have a right to feel disappointed, for it would mean, "no more money will be sent." If the business man wants to be kept posted on affairs while in foreign countries, the brief message "otter" will order his firm to "keep me well informed as to business. If anything important occurs, do not fail to wire me."

The foregoing expressions are taken from a travelers' code system of some 2,000 terms, each of which stands for a whole message. Many firms and individuals have their own systems of secret communication by telegraph, cable and radio, and at Washington, a number of experts in the department of justice and in the signal corps of the army are constantly at work, revising and translating codes and ciphers that carry important state and military secrets in peace times as well as in war. The dot-and-dash signals that sometimes interrupt your radio programs, crossword puzzles, writing for the blind and shorthand are also forms of this art of cryptography, or secret writ-

ing, one of the oldest and most difficult sciences known to man.

Discussing this science, Edgar Allen Poe once declared, "it may roundly be asserted that human ingenuity cannot concoct a cipher which human ingenuity cannot solve." He partly substantiated his position by deciphering scores of complex codes sent to him for tests. But it is not necessary to go back to the author of "The Gold Bug" for proof of the statement. The Riverbank laboratories, near Geneva, Ill., for more than thirty years, have been demonstrating that Poe was entirely right.

Calling on Col. George Fabyan, founder of the institution, for a glimpse into this fascinating world of hidden meanings, you step into one of the most remarkable libraries in the world. Here, among first editions of Shakespeare and hundreds of other rare old volumes, are some 39,000 different ciphers. Years ago, Col. Fabyan became interested in the subject of cryptograms while seeking a secret code for use in his business. To satisfy his curiosity, he scoured the world for books relating to ciphers.

After a few moments' talk with Col. Fabyan you learn that cryptography probably originated several centuries before Christ, very likely under the direction of the famed Assyrian queen, Semiramis. At any rate, one of the earliest examples of cryptography is found on her tomb. Some 700 years after it was inscribed there, an expert laboriously deciphered it, and this was the reward for his labor: "O poor miserable slave of deciphering that thou art, from this time on, occupy thyself with more

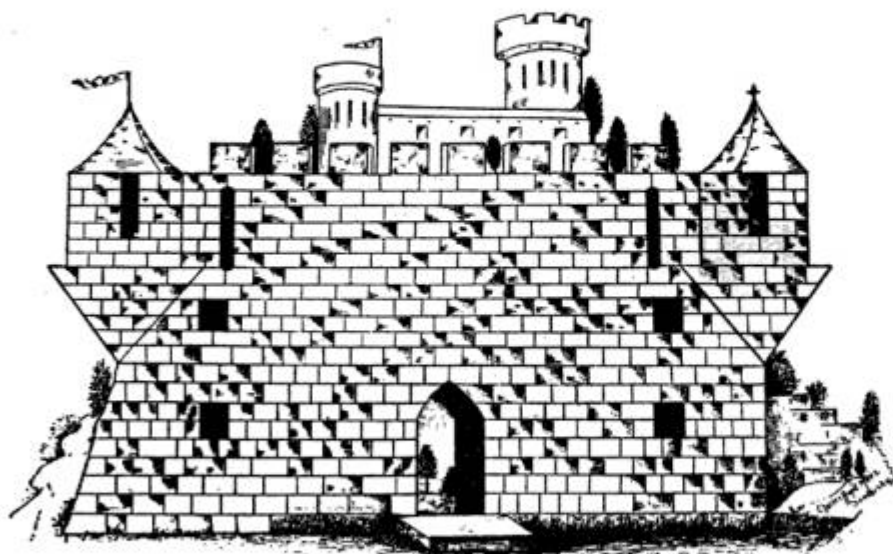

Even a Brick Wall May Tell a Story in Cipher; White and Shaded Blocks Here Are Arranged to Spell a Short Poem

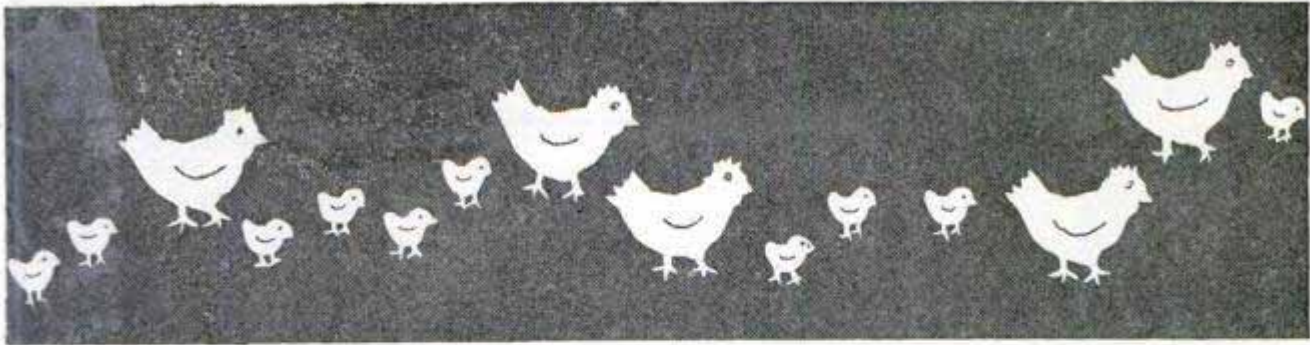

Another Illustration of the Almost Limitless Possibilities in Cipher Picture Writing; Here, the Hens Represent One Part of the Cipher and the Chicks Another; the Word Is "Egg"

fruitful things than to spend time thus uselessly!"

The Spartan soldiers employed an ingenious cipher system, using strips of parchment wound in a special way around a wooden cylinder. The writing was inscribed longitudinally, the parchment removed and dispatched. The officer who was to receive it had a cylinder exactly like the one on which the strip first had been wound. He wrapped the parchment on his cylinder making the original message clear.

Bacon and other scientists in the time of Queen Elizabeth wrote profusely in cipher for self-protection and secrecy because, at that time, anyone who had scientific knowledge was likely to be suspected of being in league with the devil and to be beheaded.

A method of inserting ciphers in books was worked out by using different forms of type, and as the printing was absolutely controlled by the government and all typefounders and printers licensed, heavy penalties were imposed on persons who used printing presses without government permission. Thus it was possible for those having control of printing to insert ciphers in the books for the purpose of recording any information they chose with the idea of having it available for others of the time or for posterity.

"The use of ciphers," Col. Fabyan declares, "seems to go by cycles. About every 300 years, they reach a high point. We have just passed through one such

period in the World war. All true ciphers can be grouped into two great classes, transposition and substitution ciphers. Frequently, an expert can tell almost at a glance to which class a particular cipher belongs. In the first class, the letters have been rearranged to conform to some plan; in the substitution cipher, numbers, designs or what not are substituted for the real characters. Suppose you let Miss Cora Jensen here, one of my assistants, show you how a real cipher is tackled."

Miss Jensen led the way to her office, where more bookcases filled with works on ciphers lined the walls. She produced a long sheet of paper, ruled in tiny squares. This jumble of letters, grouped in units of five, was written in pencil:

LXFZI QCTAM PCSPT RFZIQ SPLOL
 RFZIQ GFASP TGTCP OFCTR FZIQS
 PLBTH TVSPX LAMTR MTGRP FOAFZ
 RMLGN ETCLX FZIQC TAMPC SPTMT
 BSPPG AMTGT HLNMA MTYPS PPGSV
 OTCOF CTMLN MAMTY PSPPG MTBGP
 YPCPS PGSZA TMTBX TBFGR PTGTC P

"This is what is known as the reversed single-alphabet cipher," Miss Jensen said. "It looks hard but it really isn't. One of the first steps in solving a cipher of this kind is to count the number of times each letter has been used. This is important, for we have discovered, after counting the characters from thousands of pages of many kinds of manuscript and printed text, that, in English, the letters are used in the following order of frequency, e, t, a, o, n, i, s, h, r, d, l, c, u, f, m, p, w, g, y, b, v, k, x, q, j, z. In other words, the vowels



Illustrations of Early Egyptian Picture Writing, Possibly the Beginnings of the Alphabet as We Know It Today; Designs Similar to These Are Sometimes Made into Ciphers for Modern Usage

occur about forty per cent of the time, the consonants l, n, r, s, t, about thirty-five per cent and j, k, q, x, z, less than two per cent. The order varies somewhat in other languages, but the e is always first."

Miss Jensen rapidly wrote the alphabet in a column down the side of a sheet of paper and then put a check after each letter as it occurred in the cipher. Before she had gone very far, it was apparent that the t's, p's and f's were leading, while the a had been used but five times and the e, the most frequently used letter in the alphabet, not at all. Evidently, then p or t, stood for e. To illustrate, Miss Jensen made the substitution, putting down p as the cipher equivalent for e, t for a and other letters as they evidently fitted the frequency guide.

The cipher, with the translation written above it, then looked like this:

SUBSTITUTION CIPHER

1	2	5	6	2	5	5	6	1	3	1	5	1	2	1
1	2	6	1	3	5	3	6	1	2	4	5	1	5	5
6	3	1	5	1	2	6	2	3	3	5	5	4	4	4

—KEY—

1	2	3	4	5	6	1	2	3	4	5	6
N	O	P	Q	R	S	A	B	C	D	E	F
G	H	I	K	L	M	T	U	W	X	Y	Z
J						V					

The Message in Cipher Above Is "The Surest Way Not to Fail Is to Determine to Succeed." A Glance at the Key Explains the Secret; the Letter Equivalent for Each Number Is Found in the Key Corner That Corresponds to the Arrangement of the Lines Appearing with Each Number

IWOUL DRATH ERBEA COULD BEIFI
 LXFZI QCTAM PCSPT RFZIQ SPLOL
 COULD NOTBE ANARE FORAC OULDB
 RFZIQ GFASP TGTCP OFCTR FZIQS
 EISAM AYBEW ITHAC HANCE OFTOU
 PLBTH TVSPX LAMTR MTGRP FOAFZ
 CHING PARIW OULDR ATHER BEAHA
 RMLGN ETCLX FZIQC TAMPC SPTMT
 SBEEN THANA MIGHT HAVEB EENBY
 BSPPG AMTGT HLNMA MTYPS PPGSV
 FARFO RAMIG HTHAV EBEEN HASNE
 OTCOF CTMLN MAMTY PSPPG MTBGP
 VERBE ENBUT AHASW ASONC
 YPCSP PGSZA TMTBX TBFGR
 EANAR E
 PTGTC P

The top line of letters is easily identified as a sequence of properly spelled words with the letters chopped up into groups of five. The translation forms this poem:

I would rather be a could-be,
 If I could not be an are,
 For a could-be is a may-be
 With a chance of touching par.

I would rather be a has-been
 Than a might-have-been by far,
 For a might-have-been has
 never been
 But a has was once an are.

The key to this reversed alphabet is as follows. Plain text, a, b, c, d, e, f, g, h, i, j, k, l, m, n, o, p, q, r, s, t, u, v, w, x, y, z; cipher, t, s, r, q, p, o, n, m, l, k, j, i, h, g, f, e, d, c, b, a, z, y, x, w, v, u.

One way to tell the difference



Miss Jensen at One of the Multiple-Alphabet Tables; Different Combinations of Letters Produced on Strips under the Glass

between a transposition cipher and a substitution cipher is to count the occurrence of the vowels. If they constitute forty per cent or so of the text, the decipherer can be fairly sure that the cryptogram is of the transposition class. An aid in working the ciphers is what is known as the polyalphabet, a curious arrangement of little pasteboard strips between plates of glass. Each strip is printed with the alphabet and can be moved up and down to form combinations of letters crosswise to help reveal what characters have been substituted for the real ones.

The use of numbers instead of letters is a common way of writing in ciphers. Another sheet of lined paper was produced with a sequence of numbers. A glance at the key explains it.

The cipher: 11,21,25,12,
14 31,12,24,22,24 31,31,45,
34,11 35,11,24,14,11 25,14,
24,35,15 12,25,35,11,43 13,
14,41,44,45 13,35,12,45,11
31,11,14,35,13 25,11,43,13,14 41,41,13,25,35
15,12,25,25,12 41,26,26.

The key: 1 2 3 4 5 6
1 a e i j n r w
2 b f k o s x
3 c g l p t y
4 d h m q u v z

Solution: "Absence of occupation is not rest; a mind quite vacant is a mind distressed."



By Rotating the Different-Lettered Disks in This Device, Cipher Combinations Are Produced



A German Love Message in Flower Cipher; It Reads, "I Will Remain True to You Until Death"

The alternate vertical-transposition cipher is another simple form. As may be seen, it is made by putting the letters down vertically instead of horizontally, in the manner indicated in the key.

The cipher: TEA00 OTNAH ETB-
HD EEEGF IISRX ASTFR STOIM
PSWWT GEOAL EGNCR.

The key: THEFIRSTGR
EATGIFTWEC
ANBESTOWON
OTHERSISAG
OODEXAMPLE

The message is: "The first great gift we can bestow on others is a good example."

While the use of ciphers probably helped some of the writers of old keep out

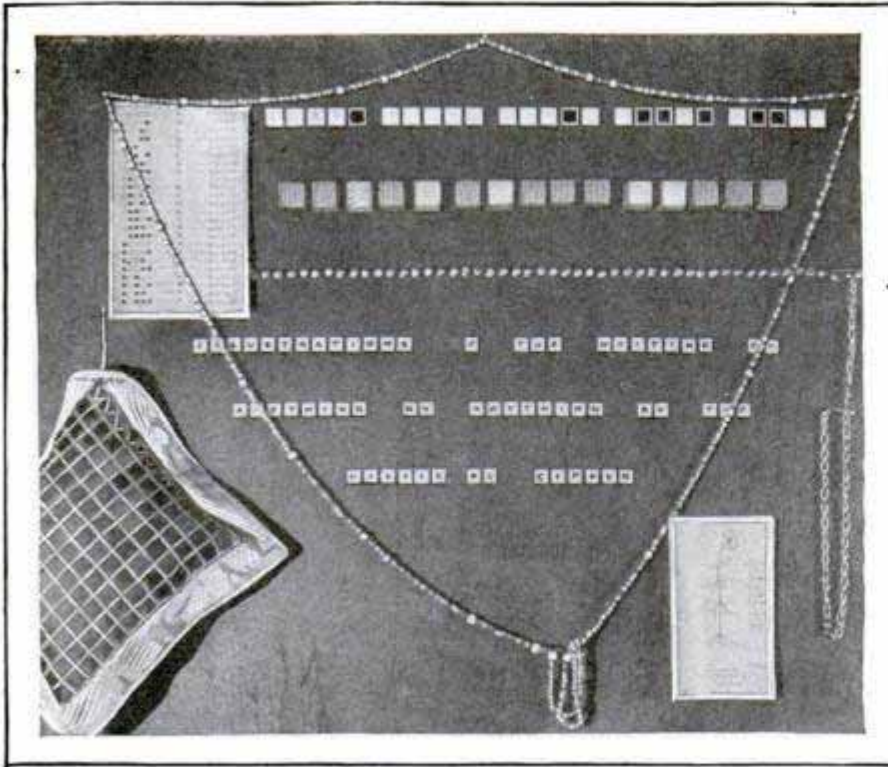

Blocks, Beads, Chain Links and a Pillow-Top Design Arranged in Cipher, Showing That Common Objects May Represent Secrets

of prison, the cryptogram was also an aid in other ways. For instance, when the seventeenth-century lover wanted to "say it with flowers," he sometimes did so literally. The blossoms, prepared as a wreath, apparently were first laid in a row on a table, the different kinds occupying their proper places, either singly or in duplicate. The stems were then tied together with strings and then rolled up, making a circular bouquet, or wreath, like the one illustrated herewith, which is taken from Johannes Balthasar Frederici's "Cryptographia," published in Hamburg in 1685. The design is to be read in clockwise direction beginning at exactly twelve o'clock. The end of a word is indicated by a spray of lilies of the valley. The message reads, "Ich bleibe dir getreu, bis in den tod," which, translated, is, "I will remain true to you until death."

Volumes in Col. Fabyan's library show that many of our modern forms of secret writing are not new at all, but merely modifications of ciphers originated centuries ago. In 1588, for instance, Timothy Bright, "doctor of Phisike," printed one of the first known works on shorthand, and in 1669, Jeremiah Rich published the entire Book of Psalms in shorthand that closely resembles the characters used today. It is a tiny volume, little more than

two inches long, half an inch wide and less than that in thickness. Other books show that cipher principles were used in devising one of the first combination locks, similar to those we use today, and in one of the works of Trithemius, sometimes called the "Father of Ciphers," appear illustrations of various forms of the wheel cipher. On the spokes were different arrangements of the alphabet. A revolving guide attached to the center was also printed with the alphabet in normal order. By swinging it around, until the characters on it are opposite to those on the spokes, various

equivalents for the letters of the alphabet are obtained.

"Solving ciphers is a process of fitting and trying," said Col. Fabyan. "We worked eight months on one here before we finally got it. There can be only one correct solution so that this really helps matters, although the key is often hard to find. But the cipher expert learns how to find clues and recognize them when he does find them. For instance, the kind of words used give us help. If two or three stories were submitted to us from each of two authors and then another story, written by one of them, were sent in unsigned, we would be able to plot a curve, based on the vocabulary used, so that we could tell which of the two writers was the author of the unsigned manuscript."

"During the war, we had considerable trouble with messages not written in cipher at all, but just jumbles of letters or symbols. But some of the most perplexing cryptograms are simple after all. One that gave us considerable worry proved to be in route cipher. It may be formed in this way: Rule your paper in five columns and put a word in each column, as you write line by line. To make the cipher, simply take the words by columns instead of by lines. Telegrams are frequently sent in this manner."

59

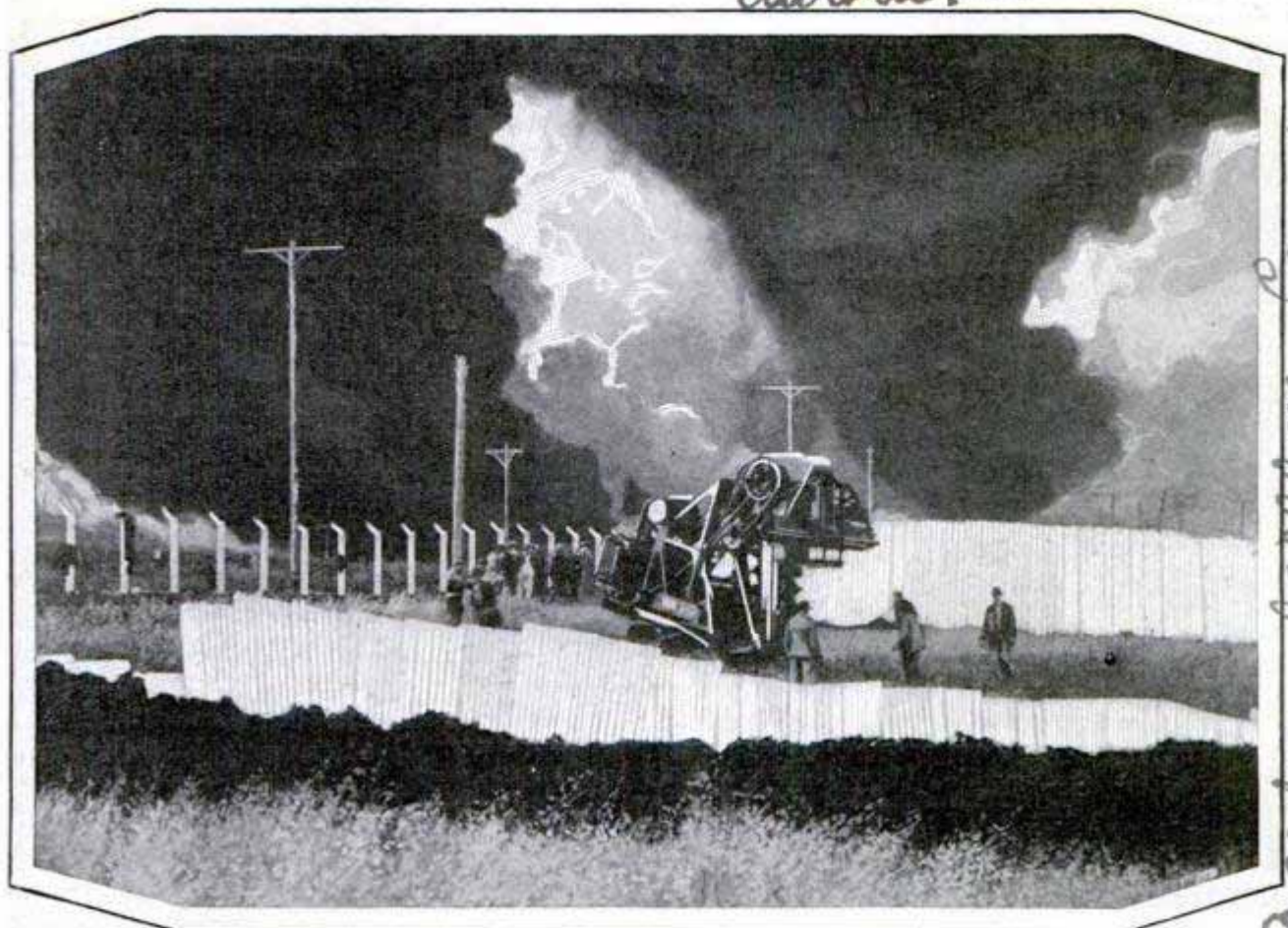

*Barber - Corne W. Park Ave
Aurora, Ill.
630*

View of Oil Fire and Barricades Erected to Keep It from Spreading; the Ditch Digger Is Seen in the Center; When Flames Became Too Hot, Operator Jumped Off, Allowing Ditcher to Run near Blaze

DITCH DIGGER AS FIRE FIGHTER HALTS OIL BLAZE 59

Operating close to the intense heat of a large oil fire in California, a motor-driven ditch digger did the work of scores of men in forming a trench barricade to halt the progress of the flames. It maintained a rate of 300 feet an hour, scooping out a ditch two and one-half feet deep and eighteen inches wide. Sheets of corrugated iron set on end and lapped over each other were placed in the trench and dirt thrown against them to hold them in place. At times, the flames came so close to the digger that the operator had to abandon the machine. He left

it in gear, and it kept an approximately straight line without guidance until he went back to it when the wind shifted and blew the heat the other way.

BEES SWARM ON CAR BUMPER AS SUBSTITUTE FOR TREE 58

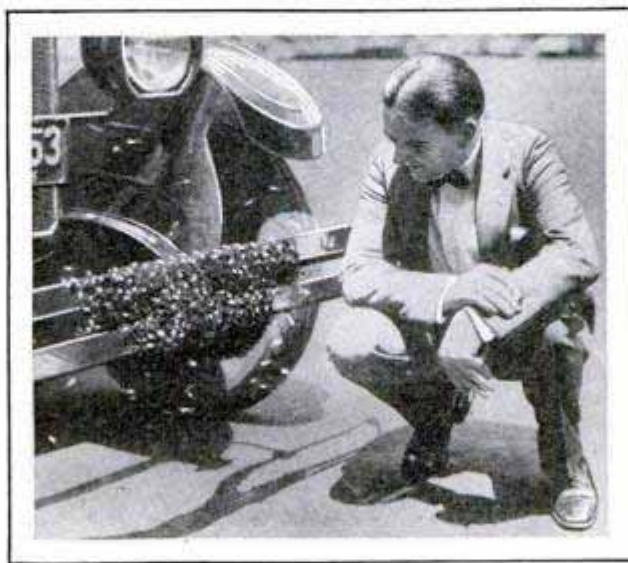

Bumper That Proved Popular with Bees; Swarm Collected While Owner of Car Examines His Visitors

Following their queen, a swarm of some 12,000 bees alighted on the bumper of an automobile parked in a busy Ohio city street. Under similar circumstances, colonies have been known to collect on living persons and on other objects instead of a tree, for the members of the swarm always try to keep close to their queen.

*J. J. Murphy
Cincinnati*

2256

Chicago Daily News 7/12/26

Submarine
**CABLE REPAIRS
SIMPLIFIED
BY CHARTS**

When a break occurs in an ocean cable, it is possible by electrical measurements and calculations from the shore to tell how far from either end the trouble lies. A ship is guided to the spot with the aid of charts on which are marked the position of the line, when it was laid, and any repairs that have been made since. An anchored buoy is set to indicate the point of departure, then the ship steams back and forth across the line, dragging a grapnel resembling a five-pronged

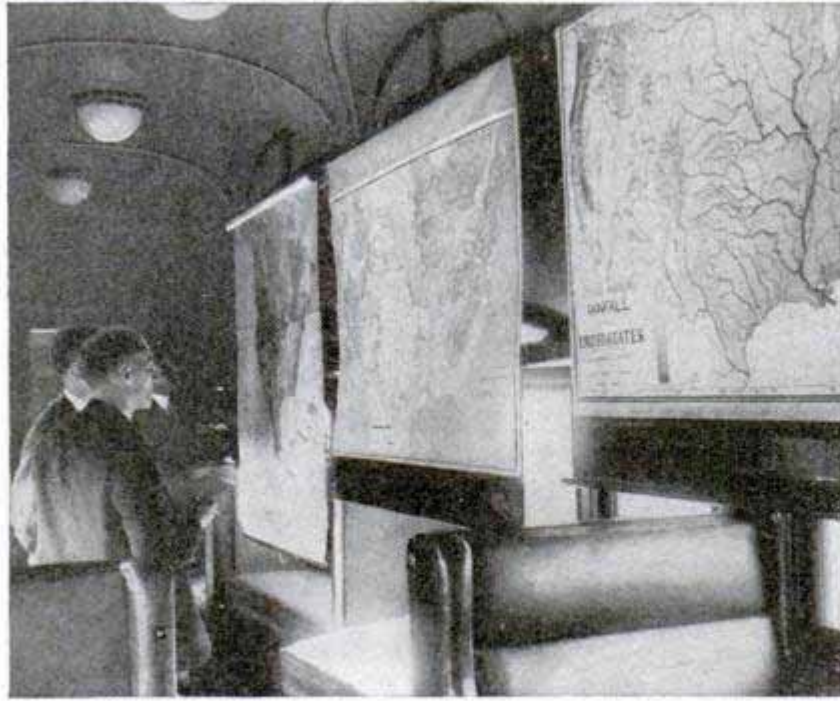

Interior of the "Geology Special," Railroad Car Fitted as Classroom with Maps and Other Equipment

**GEOLOGY SCHOOL ON WHEELS
IN-CROSS-COUNTRY TOUR**

To study geology and natural resources first hand, a group of teachers and students from Princeton university toured the country in a specially equipped railroad car. It was fitted with rolling wall maps and other classroom and library apparatus. The trip was arranged as part of a course and was featured by lectures.

**REFRIGERATOR IN DAIRY TRUCK
KEEPS MILK FRESH**

Refrigerating plants on wheels have been introduced on a western dairy farm to keep milk and cream from spoiling during deliveries. They are auto trucks equipped with a brine tank from which circulation is afforded through a series of pipes by means of a pump. Each truck has a capacity of forty-six cases of milk and cream, besides a special can compartment for the larger quantities purchased by restaurants.



Big Brine Tank in This Motor Truck Keeps Milk Fresh on Long Hauls from Dairy Farm

anchor over the sea floor. For depths of over a mile, a special form of gripper is used. When it hooks the cable, it cuts it in two and holds one of the severed ends tightly. It is thus easy to lift the line, splice on a new section and connect it to the other end which is raised in similar fashion. Most breaks occur near the shores. The cable has a host of enemies. One of the worst is the teredo or sea worm that bores into ship bottoms and wharves. To protect the wires against these creatures, the shore ends are wound with a layer of brass tape between the insulation and the sheathing wires. In northern waters, icebergs occasionally grind the cables flat, exposing the conductors and sometimes cutting them off.

Once a shark bit into the line and its tooth was found in the covering. Another cable was tangled into loops and finally broken by a whale that died in trying to free itself. It was hauled up by the repair ship. The first international cable from Dover to Calais was picked up by a fisherman who thought it was a new kind of eel.

*Chassis Esrahm Bros., Eureka, Calif.
Designer - Don Hollingsworth, Ventura, Calif.*

*Built by H.Y. Wheeler,
2814 S. Grand Ave.,
Los Angeles, Calif.*

HOW BOYS TURN PLAY INTO DOLLARS

*Robert and
Wallace
Esmond
Pasadena,
Calif.*



Tiny Steam Engine of Scrap Parts and Student Builder; Upper Right, Boys Who Make Several Thousand Dollars Yearly Modeling Sea-Going Vessels

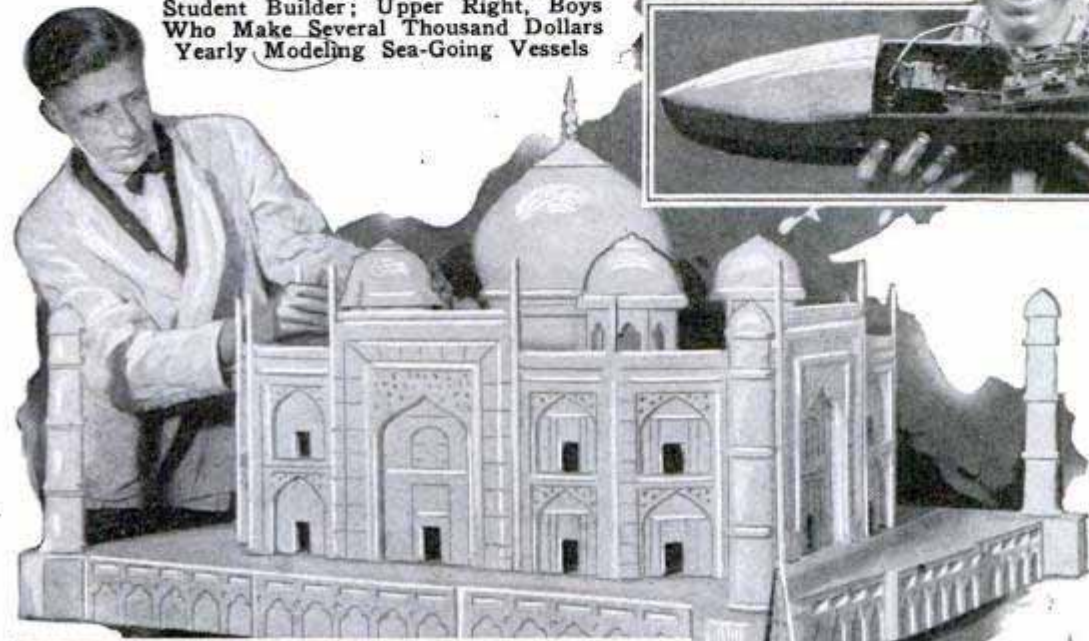

Robert Taylor, Thirteen Years Old, of Los Angeles, Holding Electrically Propelled Toy Motor Boat He Built and, at Left, Model of Famous Taj Mahal Fashioned by Morris Shamrock, Seventeen Years Old

*Junior
High*

*Levon H. High
Ceramio Clais
Los Angeles
Calif*



Joseph H. Moore, a Pasadena High-School Senior, with Hydroplane He Constructed during Spare Hours, and, at Right, Model of Gothic Cathedral Designed by First-Year High-School Art Students of Topeka, Kansas; Windows Are of Painted Isinglass, Giving Effect of Stained Glass Units; Church Is Four Feet Long and Nearly as High

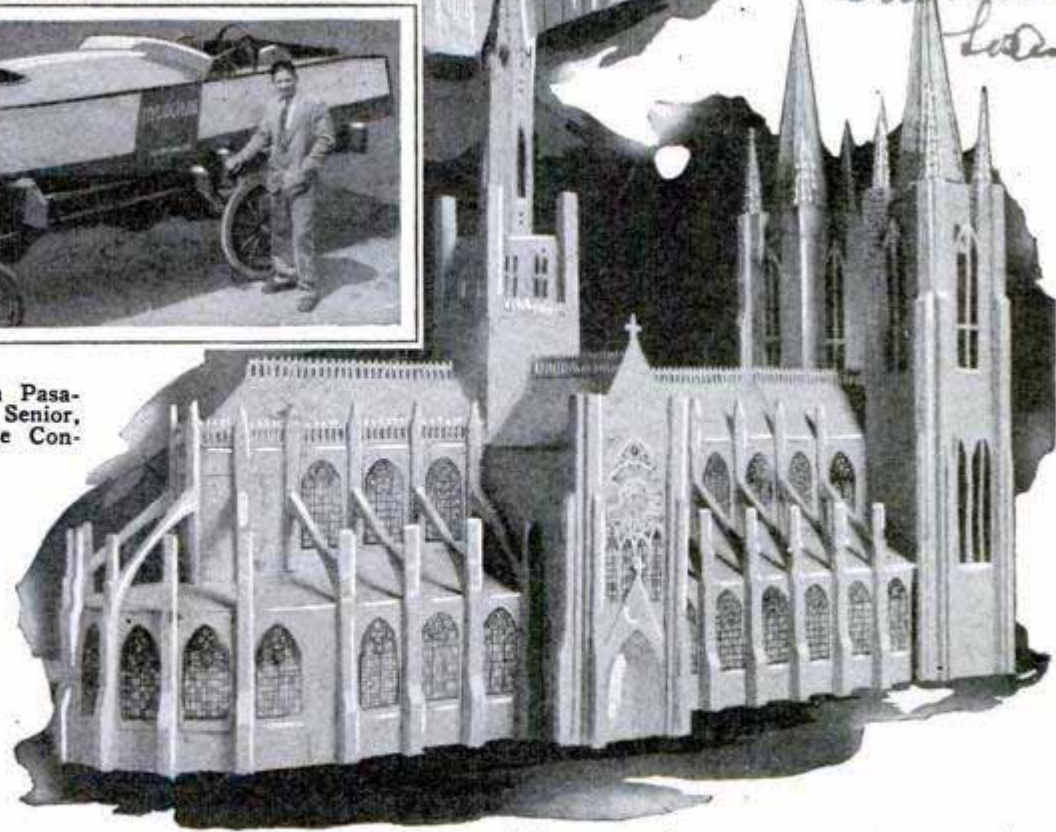

WOMAN RISKS LIFE ON CLIFFS FOR BIRDS' EGGS

Mrs Kathleen Ordway
 and Samuel Long

82

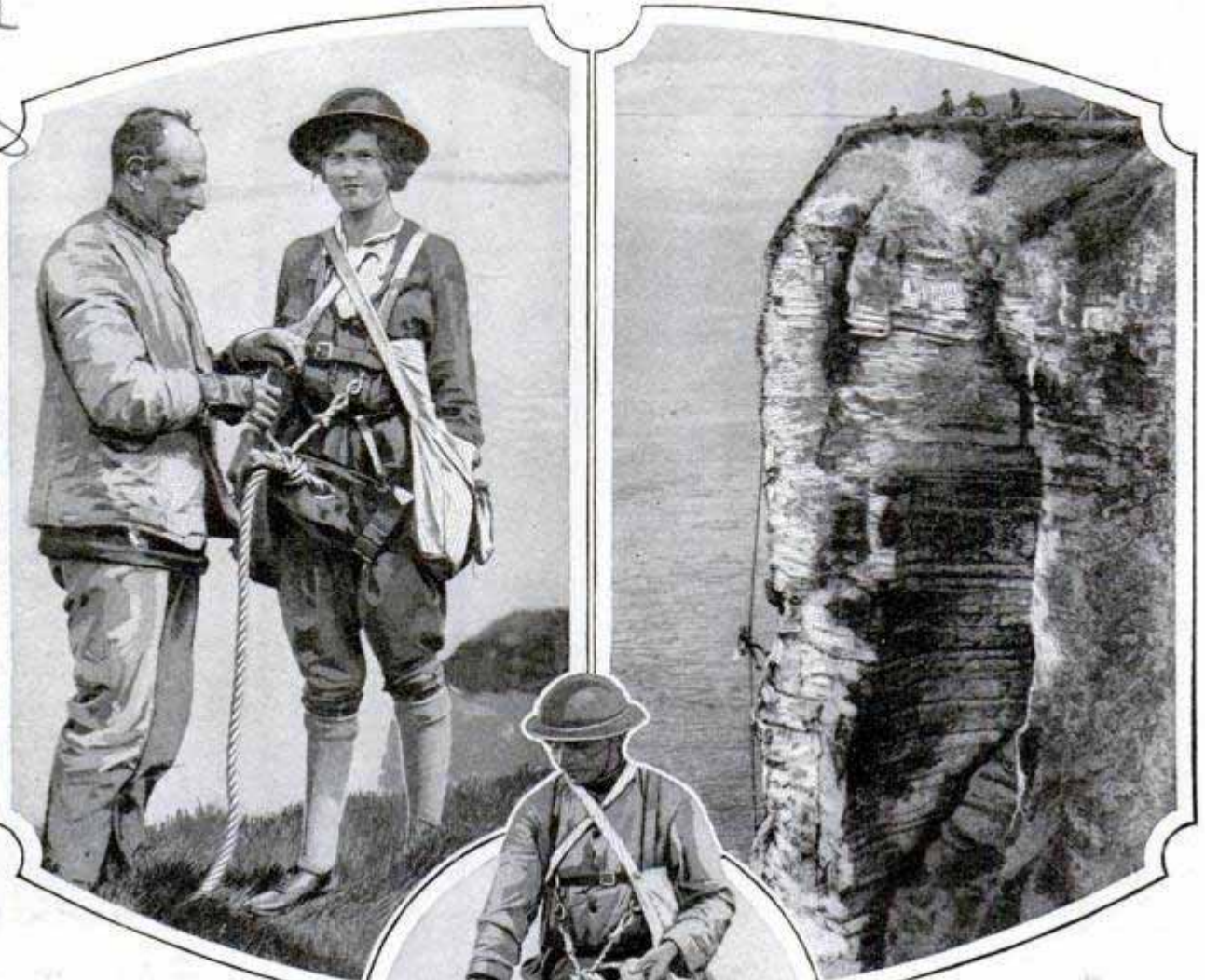

Young Woman in Working Costume, Being Lowered over Cliff, and Helper Sorting Eggs

Suspended from a rope sling lowered over the top of a high cliff near a village in Yorkshire, England, a young woman works at the hazardous task of gathering the eggs of sea birds that nest among the rocks. To protect her head from falling stones, she wears a tin hat. Most of the eggs are sold for food and some to collectors.

the federal forest service. While showing no increase, mountain goats and mountain sheep are reported to be "holding their own," despite prevalent belief that these animals were threatened with extinction. In 1925, the big

game census, taken by nearly 1,000 forest rangers, also included estimates as to the number of beaver. The tabulation showed that some 114,000 of these animals live in the national forests exclusive of Alaska. A bureau of the department of agriculture states that there are some 30,000 antelope in the United States, of which 7,500 roam the federal forest areas. This is an increase over previous years, partly due to migration from lower open ranges. Public sentiment favors the preservation of

BIG-GAME ANIMALS INCREASING IN NATIONAL FORESTS

100

Largely due to the protection they are afforded, big-game animals, deer, bear, antelope and elk are increasing in numbers on the 158,000,000 acres of national forests, according to Will C. Barnes of

Assistant Forester

the black and brown bear so that these animals can now be hunted only during a limited season when their fur is of the best quality for the market. The 1925 census showed an increase of 2,000 bear in the national forests, although this larger number was believed partly due to the closer count made by the census takers. The grizzly still is scarce. In New Mexico there are said to be but twenty-two members of this species. In spite of the 22,000 deer lost by killing during the hoof-and-mouth epidemic in California, these animals showed a greater increase in that state than in any other. In the east, their numbers are growing also, more than 70,000 being found in the White Mountain national forest. Enforcement of game laws and the destruction of predatory animals have favored the deer.

CHEMIST DISTILLS OLD SHOES FOR MEDICINE AND PAINT

1804

Valuable products have been obtained from old shoe leather by a graduate chemistry student of an eastern college. He is reported to have derived various medicinal substances, perfume, paint, ammonia, gelatin and narcotics after "distilling" worn-out shoes.



Substances from Old Shoes and Refining Apparatus

Joseph Michelman
Roxbury, Mass.



How Steel Is Aiding the Home Builder; Stilts under House on Bank of Hudson River

HOUSE BUILT ON HIGH STILTS HAS GARAGE IN BASEMENT

Chiefly because of high land values in New York city, lots that otherwise would not be utilized, have been adapted for dwellings so that houses on stilts and in holes along raised streets are not uncommon. An example is an artist's home overlooking the Hudson river. In this case, the lot was thirty to sixty feet below the level of the pavement, but a steel framework was constructed as a foundation and the cellar made into a roomy garage reached by a short ramp from the street. The house is heated with gas and has many other modern conveniences.

PATENTS SOUGHT IN ENGLAND BY SIX HUNDRED WOMEN

Among the 33,033 applications for patents filed during 1925 in Great Britain, 608 were from women. The total represented an increase of 1,633 over 1924. Receipts from patent fees were \$1,958,385 and total receipts, including those from designs and trade-marks, were \$2,380,220.

34
 Mrs. C. C. Placard
 28 W. George St
 New York
 Mrs. C. C. Placard
 28 W. George St
 New York

7/10/26

Springfield Mass.

TRAPPERS ARE SAVED BY RADIO WHEN MAROONED IN ARCTIC

75

Radio messages sent from station WBZ saved hunters and trappers isolated in a lonely trading post at the extreme northern end of Hudson bay from starvation and possible death last winter. A supply ship with the season's provisions was crushed in the ice and a relief vessel was unable to penetrate to the post during the short Arctic summer. The trading company finally asked the station to broadcast word for a special courier to rush two sled loads of provisions to the isolated men. The call was picked up on a receiving set at Chesterfield inlet and the supplies sent as requested. Weeks later, the radio station received a telegram stating that its appeal for aid had been heard and the distressed hunters relieved.



Old Grindstones Form Serviceable Stairway as Their Thickness Is Right for an Easy Step

OLD GRINDSTONES AS STAIRWAY STILL SHARPEN KNIVES

One answer to the question what becomes of old grindstones is found in an eastern park where eighty discarded sharpeners have been converted into a stairway up a steep embankment. They have not lost their whetting powers and still will put a keen edge on a pocketknife.

ALCOHOL BLOWTORCH WORKS WITHOUT AIR PUMP

2274

Burning alcohol as a fuel, a small pocket-size blowtorch employs the heat-generator system to furnish gas under pressure, doing away with the necessity of a pump. The torch consists of two small nickelplated tubes, one containing a large wick in the upper end, and the other provided with a needle-valve outlet curved over just above the wick. The valve is unscrewed and the tube filled with alcohol and enough alcohol poured in the other tube to thoroughly saturate the wick, which is then lighted, and the valve swung back in place above it. The heat from the lighted wick warms the valve and pipe, expanding the alcohol vapor and forcing it out through the tiny valve opening as a stream under pressure, the stream being ignited by the fire from the wick.



FOUNTAIN-PEN FILLING DEVICE REDUCES LOSS OF INK

1618

Fitting in any ordinary ink bottle a bulb and cup attachment affords fountain-pen users a measured supply, prevents soiling the point and barrel, and reduces loss of ink by spilling or evaporation. Pressure on a small plunger fills the cup with sufficient ink for the



pen, and if any is left over, it is automatically drawn back into the bottle when the plunger is released.

Our Bureau of Information will answer all questions regarding articles appearing in this magazine.

Sanford Mfg Co. Congress and Peoria

The Lenk Mfg Co, 34 Portland

Stones discarded by Barney and Berry Skate Works

53

AIRPLANE TO CROSS OCEAN IN THIRTY-SIX HOURS?

Germany

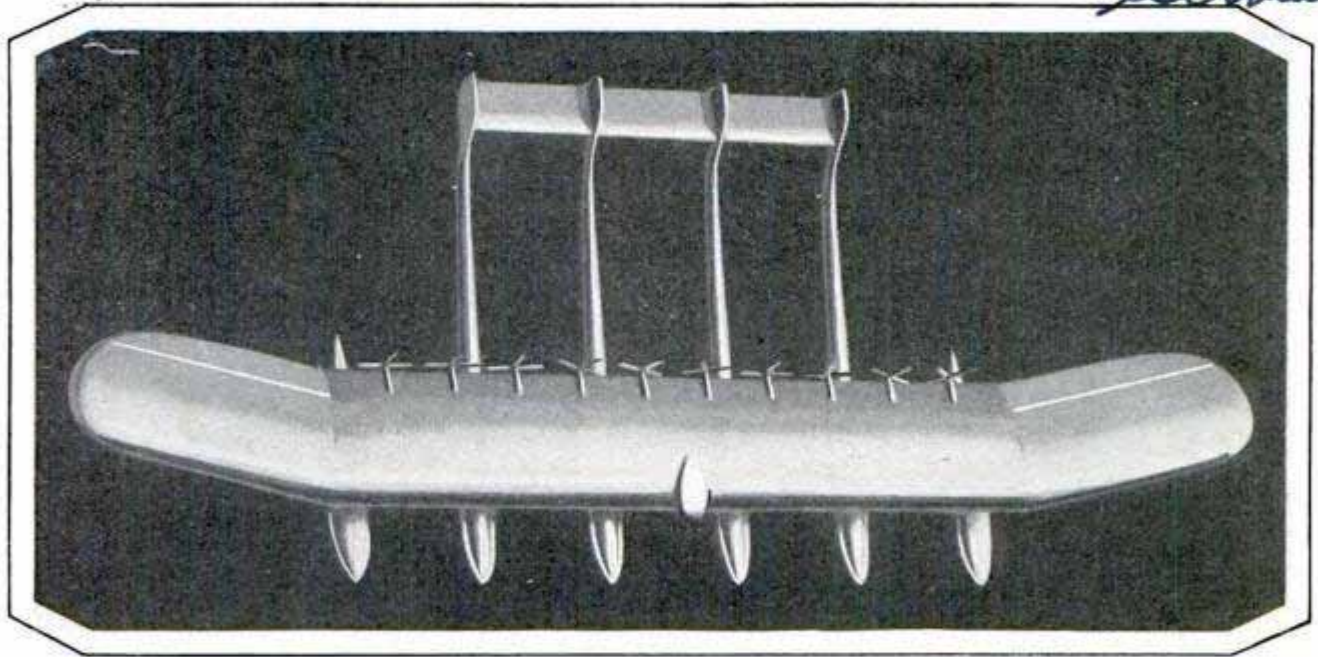

Upper View of Model of Huge Airplane Showing Arrangement of Propellers, the Floats and Four Tail Ends, like a Series of Planes "Welded" into One

One of the obstacles to adapting the airplane to transatlantic traffic has been the difficulty of constructing a craft capable of carrying heavy loads without bending or collapsing in the center. This problem is believed to have been solved in an "unlimited-span plane," designed by a German expert. Essentially, the craft is a system of several individual planes beside one another and comprising six floats, four of which are full seaplane hulls. Ten 1,000-horsepower motors drive the ten propellers, which are expected to send the plane at full speed from the Azores to New York in about fifteen and one-half hours, and from Hamburg, Germany, in thirty-six. Even if several engines on one

side should break down, horizontal rudders are so adjusted as to warrant a possibility of a straight flight. Other parts of the ship are furnished in multiple for added safety. The interior arrangements include separate compartments for passengers, dining and smoking rooms, and quarters for officers, pilots and other members of the crew. The plane will carry 136 persons besides luggage and freight.

One of the features of the plan is a wide corridor at right angles to the direction of flight and between the passengers' quarters and the rest of the ship, to shut off the noise of the motors. A company has been started to construct the plane, patents on which have been obtained.

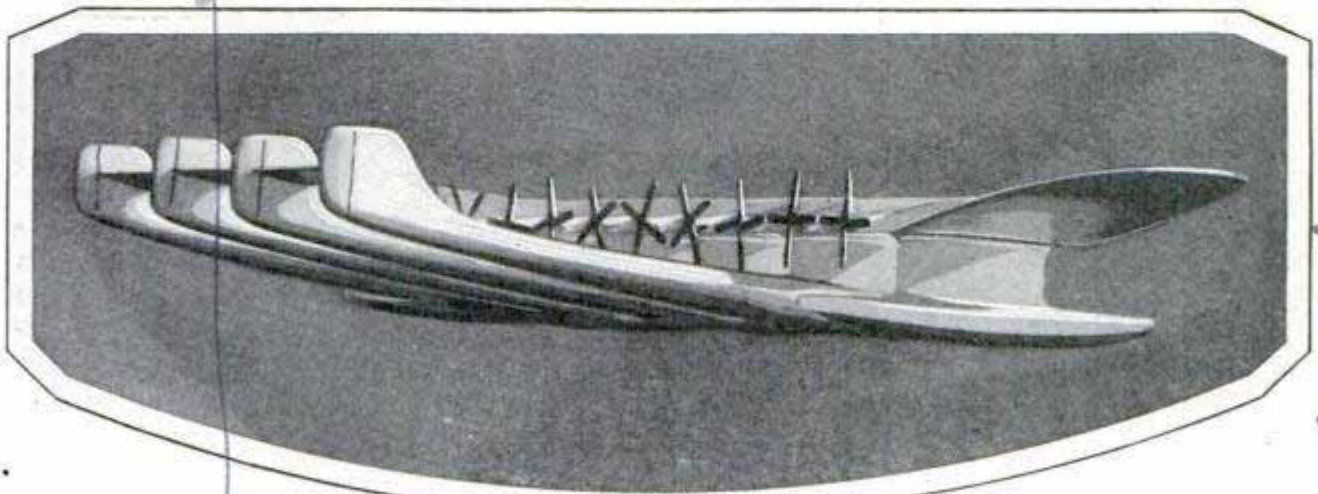

Side View of Model; the Craft Is to Be Constructed along Lines That Will Reduce Wind Resistance to a Minimum and Support Heavy Loads without Bending in Center

Dr. E. Cumpster before
the Aerodynamical
Research

Baltimore, Md.

OYSTERS ARE GROWN IN TREES TO PREVENT LOSS

2313

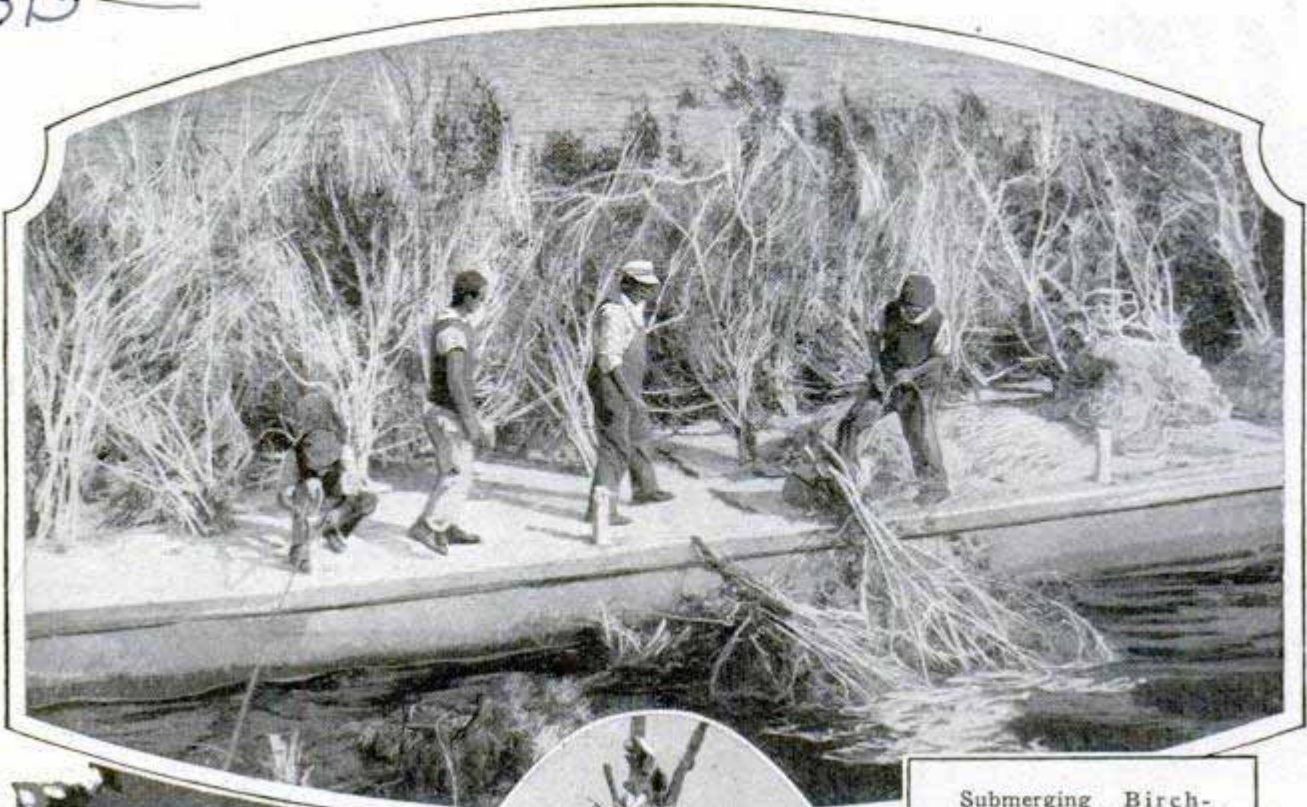

Submerging Birch-
Tree Brush in Oyster
Bed to Furnish Young
Bivalves a Lodging
Place

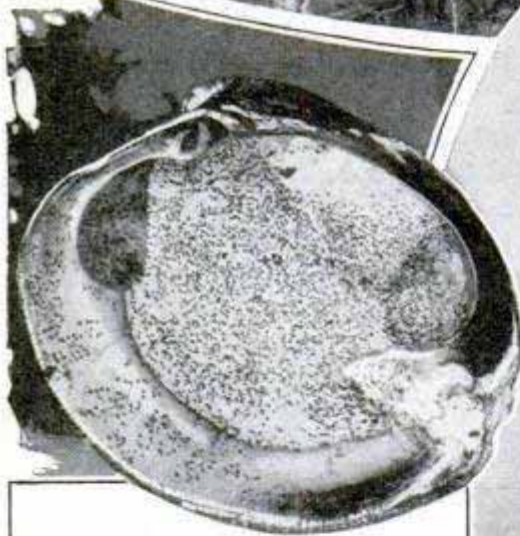

Tiny Oysters Crowded upon
Shell, Too Thick for Full Develop-
ment; Right, a Typical "Tree"
with Its Growth of Small Oys-
ters; These Are Scraped Off and
Replaced for Final Growth



Young Oysters Enlarged;
Thousands Can Lodge on
a Single Tree "Parking
Place"

Oyster trees have assumed an important place in conserving the diminishing supply of bivalves along the coast line of the United States. In extensive tests, the attempt has been to supply the newly born mollusks with the type of artificial home best suited to their growth. Under natural conditions the baby oyster moves around about two weeks and then takes up its

permanent abode. Its life ambition is to attach itself to a smooth, clean surface from which it does not have to move. The surface may be that of a submerged rock, an empty shell, or even a glass bottle discarded by the outer world. The supply of new-born is more abundant than the "parking" facilities. With a hundred or more of the creatures attached to a single

893 Putnam Ave
577
Brooklyn, N.Y.

2261

Your le
tion
wh
ic

shell, there is overcrowding with a resultant continual struggle for existence, in the course of which a large majority of the oysters are killed. To avoid this loss, the oyster tree has been developed as an ideal anchorage for the baby oyster. The tree is birch, submerged in the form of brush placed in tidal flats and sunk by means of weights. The numerous twigs and branches provide generous space. A single tree will accommodate a colony of thousands of tiny oysters. The tree-grown oysters are transplanted with little difficulty when they develop.

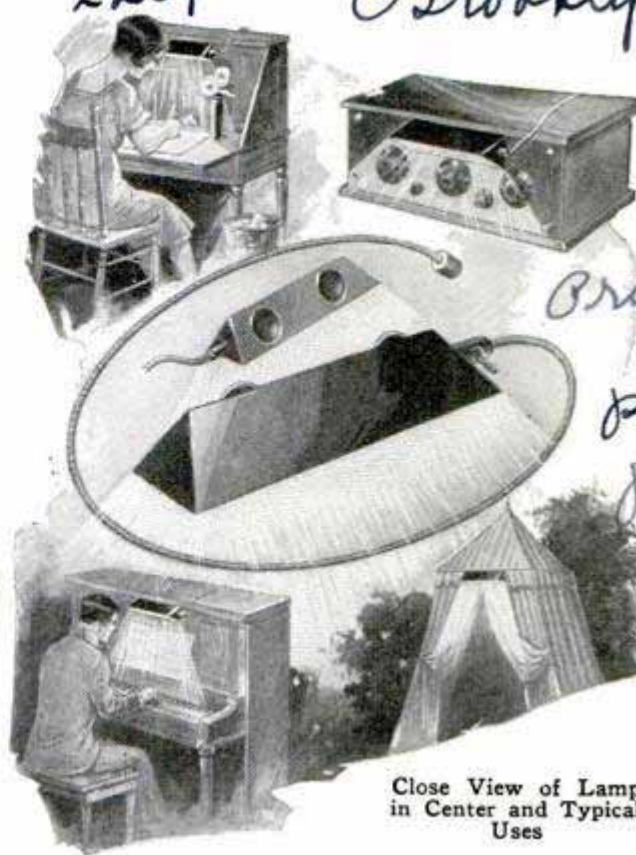

Price 3.50
Patent
Pending

Close View of Lamp in Center and Typical Uses

LAMP HELD BY VACUUM CUPS HAS MANY USES

Fastened to almost any non-porous surface by two vacuum cups, a shaded electric lamp can be used on the piano, for the radio set, the cash register and in many other places. It saves boring holes and making other alterations not always justified in installing a lamp temporarily. A clip is provided for attaching the light to cardboard or other materials to which the cups will not cling.

TESTS FOR MOLDING SAND TO AID FOUNDRY WORK

Through tests whereby foundrymen can tell whether they are using the right kind of molding sand in making castings, better products are anticipated as well as considerable saving in the industry. The material is examined with the aid of special apparatus to determine if it has sufficient strength, permeability and the right texture to prevent flaws and other imperfections in the castings. Costly mistakes can thus be avoided, and it is expected that foundrymen will be able to effect economies in the purchase of sand, an item that now calls for an expenditure of about \$8,000,000 a year.

Robert E. Kennedy
909 W. California St.
Urbana, Ill.
and National Research Council
Research Committee
American Foundrymen's

HALIBUT CHANGES SKIN COLOR TO MATCH LODGING PLACE

Besides its shifty eye and turnable spine, the halibut is distinctive because it can change color to match its surroundings. This mysterious power is apparently connected in some way with the eyesight, for when the optic nerve is severed, the change does not occur. Fishermen prevent this color change by laying the fish with its eyes down.

BARROW FOR BRICK AND TILE HAS ADJUSTABLE BALANCE

Constructed of electrically welded steel, a special wheelbarrow for brick and tile has an arrangement at the side whereby the balance can be adjusted for different loads, saving the user strain and preventing upsets. Besides this feature, the barrow has springs to ease the jars, and holes are punched in the bed and dash to permit riveting on old belting or wooden strips to prevent chipping.



Barrow Loaded and Accurately Balanced for Easy Pushing; the Springs Ease Jolts

Brick - \$23.50
Tile - \$25.00
Cmco.

H. D. Conkey & Co.
Mendota, Ill.

Chicago

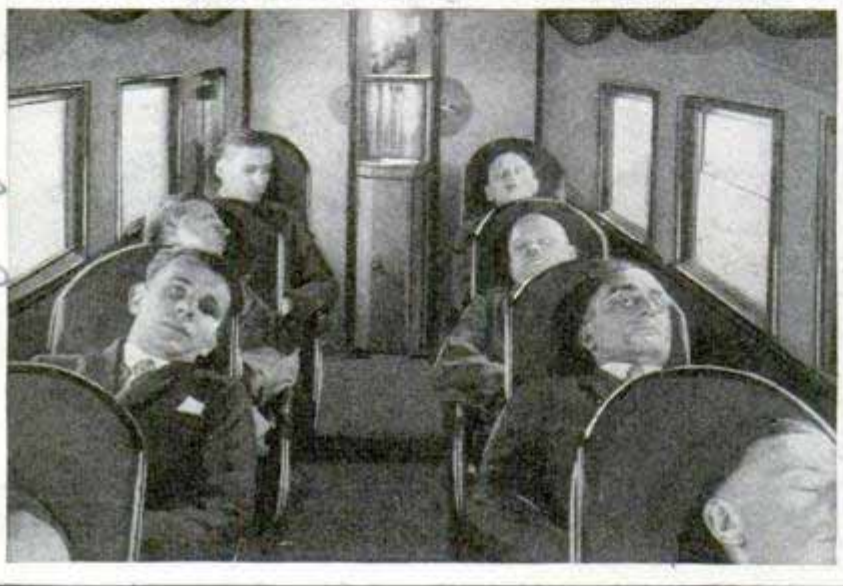

Exterior View of Airplane Sleeper and Interior of Cabin with Its Reclining Chairs Tipped Back for Daytime Naps

AIRPLANE HAS SLEEPING CABIN FOR TRIPS BY NIGHT

The aerial sleeping car has appeared in Europe in a plane equipped with cabin seats that may be converted into berths for night travel. They tip back at a comfortable angle and may be used for resting during the day. The ship has two motors and is otherwise fitted for luxury and safety.

SUPER-POWER LINES LINK U. S. FROM ST. LOUIS TO BOSTON

Practically all of the northeastern section of the United States is now linked together by a system of high-tension electric-transmission lines. The last gap was closed when a twelve-mile stretch in Pennsylvania was completed. Improved service, greater savings and decrease of interruptions are seen as the outstanding ad-

vantages of this system. The Mississippi valley to Boston line, according to the Pennsylvania public-service information committee, will have a total power reserve of 1,200,000 horsepower. It does not permit the transmission of power generated in Missouri to New England, but enables neighboring electric concerns to shift their power loads.

GARDEN SHEARS CLIP AND HOLD FLOWERS

Designed to hold the fruit, vegetable or flower after it is clipped, a new type of garden shears, recently invented, enables the user to reach objects beyond arm's length, using but one hand. When clipping fruit from a tree, or grapes from a vine, particularly if working from a ladder, the novel feature is expected to prove

very useful. One side of the blade has an upturned ridge, a quarter of an inch high, and the other side a steel spring lever. As

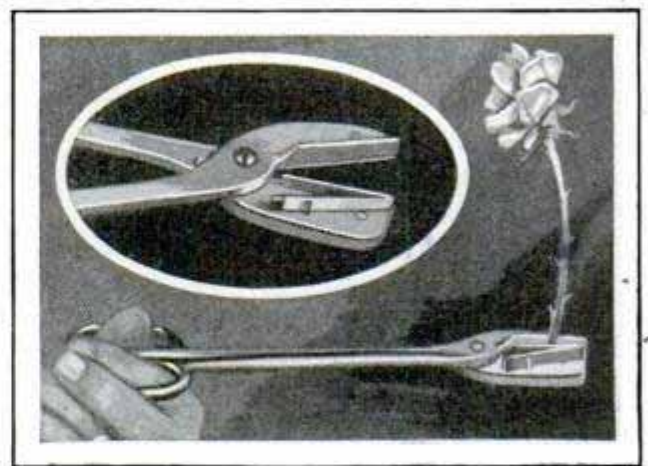

Flower Clutched in Cutter and Inset Showing Ridge on Blade of Shears That Grips Stem

the fruit or flower is clipped, the stem is held firmly between the two, but the pressure adjusts itself so that even the stem of a delicate flower will not be injured.

Print at Johanna's Press

News Bulletin 7/19/26

Pennsylvania Pub. Service Information Commission

J. J. Smith, 1807 Warren St. Chicago

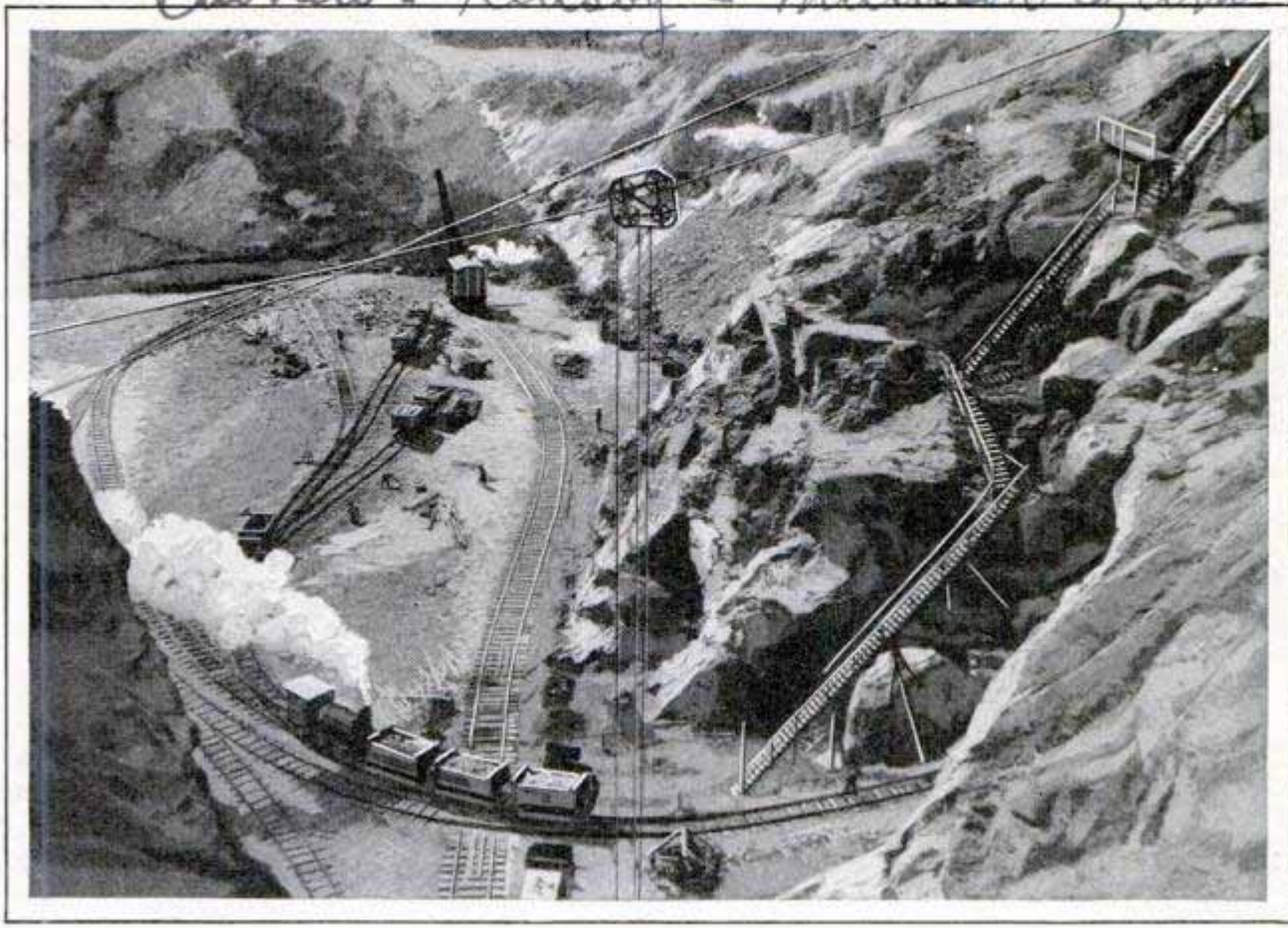

Scene at a Busy Canadian Asbestos Mine, Where Nature's Own Fire-Resisting Material Is Dug and Shipped to All Parts of the World; the Entire Plant Covers More Than 100 Acres

1269 W. North Ave. Chicago

DIGGING MINES TO FIGHT FIRES
THE STORY OF ASBESTOS 54

Asbestos for fire protection, insulation, shingles, clothing, and any other purposes, is commonly seen but few persons stop to think that the material is of mineral nature and is mined out of the ground. One of the largest deposits and one that has supplied much of the asbestos used in the last twenty-five years is in the province of Quebec in Canada. The entire plant covers some 120 acres and the product is taken out with electrically and steam-operated apparatus. Several grades of the material are in commercial use, determining qualities being length and fineness of fiber, flexibility, strength and degree of heat resistance.

PLAN TO CASH CHECKS BY RADIO
AS AID TO TOURISTS 124.

Promising great aid to travelers, a development of the radio-picture transmission process makes it possible for tourists to cash checks on their banks thousands

of miles away and to have the money in their pockets half an hour or so after signing them. A wireless photograph of the check is sent to the bank, which sends back the order for payment by radio. Likelihood of fraud is reduced by this method and persons are spared the inconvenience of carrying large sums with them.

HOLDER FOR WINDOW CARDS
 1886 SAVES USING PINS

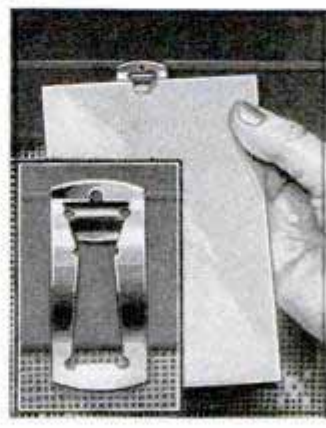

Milk, ice and other cards, as well as window decorations, are displayed without the use of nails, tacks or pins, with the aid of a holder that can be slipped over the bottom of the shade and has a spring clasp to keep the card in place. It may also be suspended from the top of the lower shade.

*Sparks Ryan & Co.,
 Akron, Ohio.*

Chicago Tribune 7/18/26

2004



House Profits Are Doubled by Making One Roulette Wheel Serve Two Board Layouts, Giving Twice as Many People the Chance to Risk Their Money on Systems That Look Good but Aren't

Here's How the Gambler Hides His Percentage So That, No Matter What the Result of the Game, the Winners Lose in the End

THERE is an old saying around the race tracks that you can beat a race, but you can't beat the races. The gambler who first made that discovery didn't add anything to the sum of human knowledge, for expert mathematicians had settled the question long before horse racing became a business, and settled it not only as regards the race-track gambler, but every other form of risking money.

There are runs of good luck and runs of bad luck, but the mathematical laws of chance demonstrate conclusively that, in the long run, the best the bettor can do is break about even—provided the odds are right and the game on the square. No commercial gambling proposition, however, from the nickel slot machine to a roulette wheel, gives the bettor an even break—bookmakers and slot machine and gambling-house owners insist on the "house percentage" to make sure that they will make money. Against such odds you can't win.

How many millions are bet—and lost—on horse races at American tracks in a year's time is a matter of conjecture, but more than a million and a half is regularly bet, at the track, on a single race, the Kentucky Derby. Bets made at the track, however, are only a small percentage of the bets made on any race. A crowd of 50,000 or 60,000 is a big turnout for any



Even an Honest Pair of Dice Doesn't Give the Crap Shooter a Fair Run for His Money, for the Odds Are Wrong

CAN'T WIN

race track, but in New York city alone it is estimated that more than 300,000 people regularly play the handbooks, while the total of handbook devotees in the country probably exceeds five millions.

If you add up the odds offered by the bookmaker on any given race, you can determine approximately how much he expects to take away from his customers or, as they are called by the "talent," the "suckers." Say there are nine horses entered in the race. Reduce the odds offered to fractions, add up, and the result, if it was an honest book, at fair odds (which no book can be, if the bookmaker is to earn his living) should total one. If the total is more than one, as it invariably is, the bookmaker is going to win, while, if it should be less than one, which it never is, the bookie would be in for a loss.

The shaving of the odds is only one small angle in the despoiling of the suckers who bet on races. Every bookmaker, tout and racing sheet frankly admits that the game is fixed; in fact, the more crooked they can make it appear, the more suckers they can get, through the curious twist of human nature which makes millions seek to profit through "inside knowledge" of the crookedness. The green-goods salesman, who takes a thousand or so for a lot of newspaper clippings supposed to contain many thousands in bills, has been profiting on this quirk of human nature for generations.

Every turf-tip sheet contains frequent reference to "sleepers," horses which are

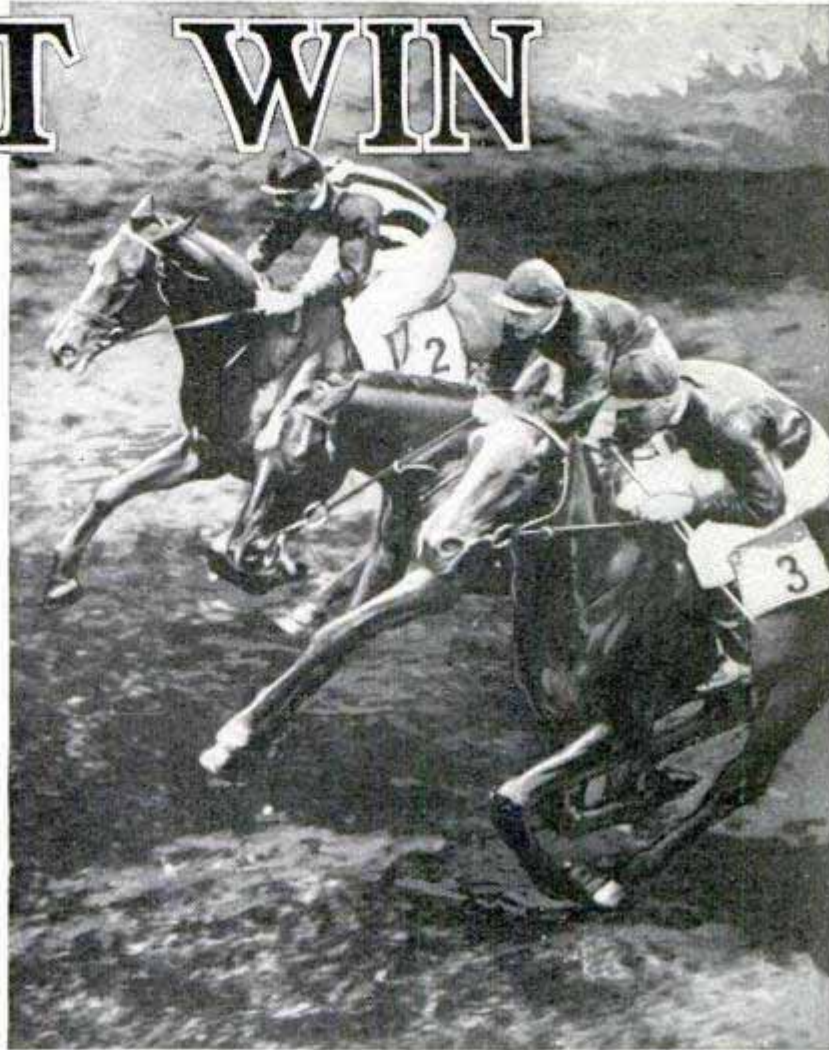

The Sport of Kings Is America's Best Money Maker for Professional Gamblers, Because of the Ease with Which Odds May Be Shaved

"ripe for a killing," yet the bettors who accept the tip and bet on the horse ignore the fact that, if the tip is true, then the owner, trainer and jockey have been in a conspiracy to mulct the public. A sleeper is a horse that has been deliberately held back to make a poor showing in several races, so that eventually long odds will be quoted against it. When the time comes for the killing, the horse is entered in a race where it is pretty sure to win, and the owner's money is sent to other cities to be bet away from the track in small sums, so the bets will not pull down the odds. The process of having the horse lose repeatedly is called "qualifying" the animal, though really it is the betting public that is getting qualified.

One of the racing handbooks a couple of years ago, announcing a marvelous new way to beat the races by parlaying bets, attacked all other forms of gambling by

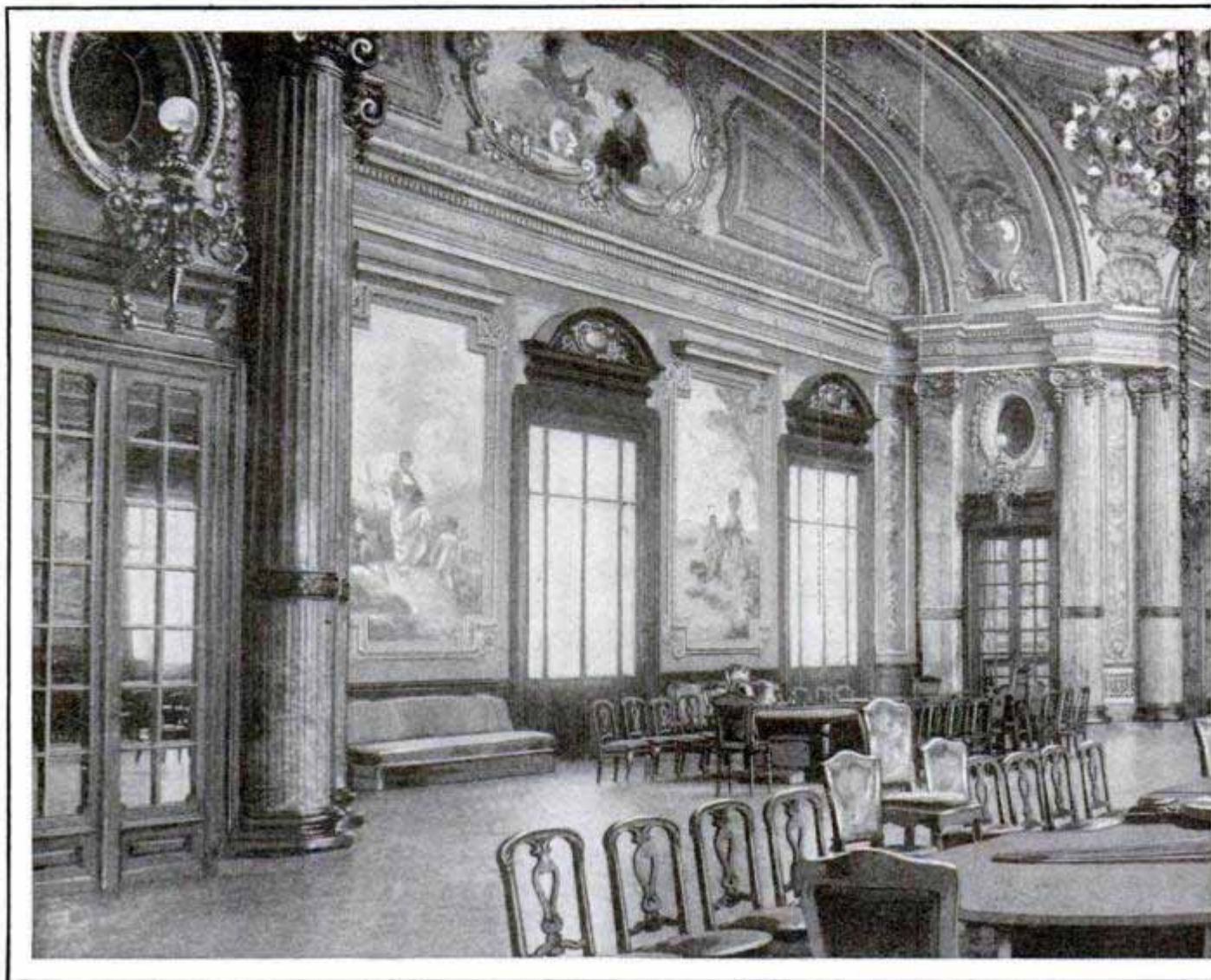

One of the Gorgeously Decorated Gambling Rooms in the World-Famous Casino at Monte Carlo, Where the House Percentage Pays All the Cost of Government for the Entire Principality

quoting the odds against the player. The figures in some cases were understated rather than overstated, but they included odds of five and a half to nineteen that the roulette player would lose; nearly two per cent against the man "fading" another in a crap game; more than two per cent against a faro player; "considerably" against the guesser in a coin-tossing match, and gave the added information that poker "eventually will break the player in a game where the house takes out a percentage."

Poker, as a matter of fact, can break a player in more ways than one, and in "friendly" games where there is no house deduction. The gambling-house practice, however, of deducting a certain sum from card games to pay expenses makes the result, so far as the players are concerned, no different from a group of friends who pool their money, draw to see who wins,

and let a stranger take out part of the pile for supervising the job.

There are probably more poker players in the United States than players of any other single card game, but out of the millions, comparatively few amateurs have any correct conception of the chances of filling any given hand. With a deck of fifty-two cards it is possible to form 2,598,960 different five-card hands, but 1,302,540 of these will have no poker value, that is, they will not even have as much as one small pair.

Most poker players know it is safer to draw to a straight open at both ends than to one open only at one end, or in the middle, and they likewise have observed that there are fewer "openers" out in a three or four-handed game than in a larger one, but have never stopped to apply the knowledge to their playing. As a matter of cold mathematics, if a big pair

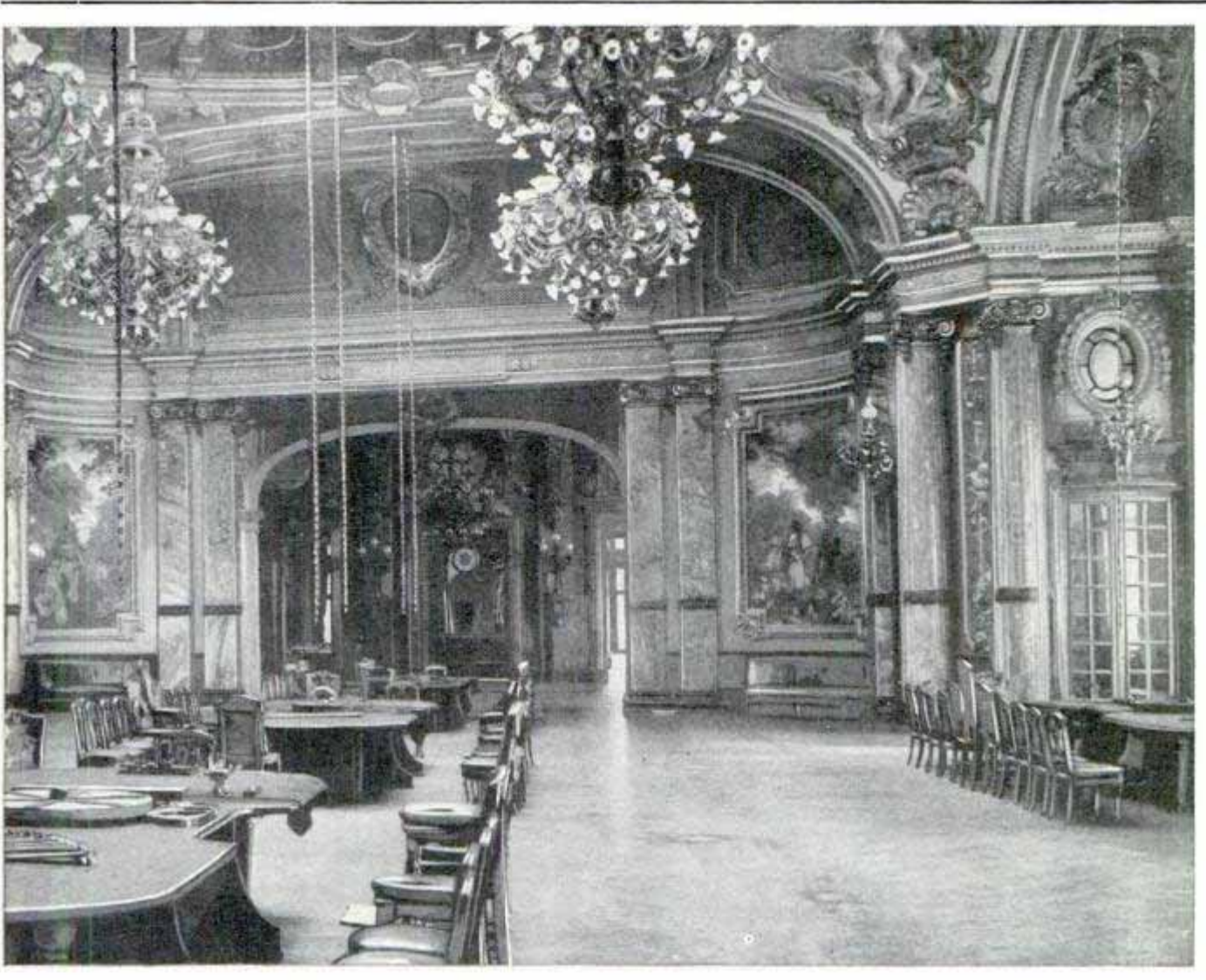

The Rulers of Monte Carlo Abolished Taxes Because of the Vast Gambling Profits, and Likewise Barred Their Own Subjects from the Casino, Where Only Foreigners Are Permitted to Lose Money

is a good hand in a game of three persons, then small threes is the lowest hand on which it is safe to stay in a game of four or five, and big threes, or even better, in a game of six or seven players.

Out of the 2,598,960 five-card hands which can be formed from a poker deck, there are only forty possible straight flushes, four of which, of course, are the royal flushes. It is possible, however, to form 624 different sets of fours, and 3,744 full houses. Next there are 5,108 ways in which flushes can be made; 10,200 straights; 54,912 sets of threes; 123,552 hands which would contain two pairs, and, finally, 1,098,240 hands containing single pairs. There is no absolutely unbeatable hand in poker as now played, for the holder of a royal flush might possibly, though it is highly improbable, meet a similar hand, and halve the pot. In former days, however, before flushes were recognized,

there was one unbeatable hand—four aces—for the man who had them knew to a certainty that no one else could hold that same hand.

It is curious to note that more than one-half of all the five-card hands which can be formed from a poker deck do not even contain a small pair. Except for the general rule requiring a pair of jacks or better on which to open a pot, an ace-high hand would be a good one on which to stay, in the long run, for it would give an actual percentage in favor of the player.

Going back to horse racing, it is equally interesting that ten horses in a single race can finish in 3,628,800 different ways. An amusing story is told of a gambler in Australia who thought this curious piece of information offered an easy way to make money, so he began wagering on the question, but, unfortunately for him, met a man who was a bit smarter, and who

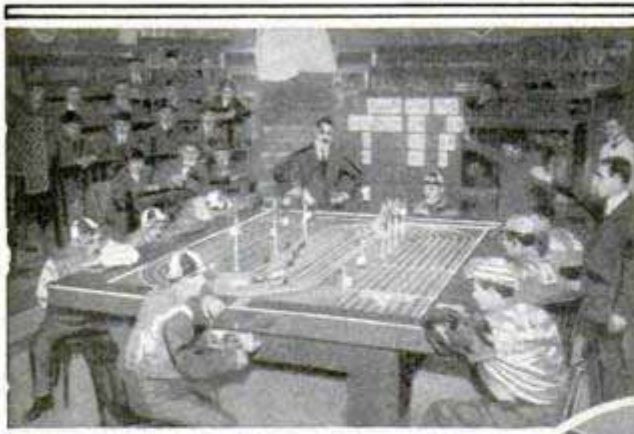

Berlin's Latest Gambling Game Is a Mechanical Race Track with Real Jockeys for "Atmosphere"; in the Center Is a Betting Machine in a London Club, and Below, Chicago Officials Are Wrecking Slot Machines

phrased the question, "In how many ways can ten horses be placed?" instead of in how many ways can they finish. Only three horses can be placed in a race, first, second and third, so there are only 720 combinations, there being 120 actual sets of threes in a ten-horse race, but each set can finish in six different ways.

Next to betting on horse-race tips, there probably has never been any gambling scheme which brought out as many "sure-thing" systems as roulette. The practice of doubling after each loss until the player wins is impractical for two reasons: the limits of the player's pocketbook and the limit fixed by the house, which commonly ranges from fifty cents or a dollar to \$100 to \$500. Even if the limit of an individual bet were removed, the player who had a run of bad luck would find the arithmetical progression affecting his purse. Say, the player sits down at the table with \$1,030 and starts wagering \$1, but meets a run of bad guesses. The first loss would be \$1, doubling the bet he would lose \$2 the next time, then \$4, \$8, \$16, and so on. If he loses his tenth bet of \$512, he will have paid out \$1,023 and, with only \$7 left, must

stop playing. It is probable that more people have spent more time trying to figure out a way to break the bank at roulette than have tried systems in any other one game. Roulette lends itself to system playing more than a card game, because the layout is so simple, and the whole thing is visible on the board, whereas the mathematical laws governing cards are more or less of a mystery.

Most of the roulette systems are attempts to get away from the huge losses attendant to attempting to double bets after each loss until one wins. Such systems, called martingales, can actually be worked, but have the drawback that they limit winnings to a very small sum, and even then aren't always proof against misfortune. Most of the systems are based on some one of the possible variations of divided plays. The player decides on an amount to be risked in each play, say \$6, and then divides it in three or four parts, such as one, two, two, and one dollar, setting the figures down in a row on a sheet of paper. He starts out by betting the first dollar, continuing until he succeeds in losing it,





The Mecca of Society Gambling, Until Recent Years, Has Been Monte Carlo, Perched on the Hillside above One of the Most Beautiful Bays on the Mediterranean; the Casino Is in the Center

and pocketing any winnings in the meantime. As soon as he loses a bet, he puts the amount down at the bottom of the column and then bets the sum of the top and bottom numbers, in this case \$2. If he wins, the two numbers are crossed out and the next top and bottom sum bet, while, if he loses, the \$2 loss is set down and the new sum, now \$3, is wagered. The play keeps on until all the figures in the column have been crossed off—and the player has won \$6. No matter what sum he fixes as the basis of play, the winnings in any one cycle of plays will be that amount, provided a long string of losses doesn't run him above the table limit before the cycle is completed.

Starting on a \$6 basis, twenty bad guesses would entail a loss of \$210, though the twentieth bet would be but \$20, so the system would be fairly successful in avoiding the table-limit rule, but after it is all played out, the final winning is but \$6.

The gambling house, of course, does not depend on the individual player's luck, or rather bad luck, to make its profit. That is all nicely taken care of by the zero, or, on many roulette wheels, the double zero, on which the house wins. With thirty-six numbers on the wheel, one or two for the house do not appear to be such a great percentage, particularly when the house explains that it is merely an exchange for the favor extended the player of varying his bets at will. Yet, as a matter of mathematics, it gives a very decided advantage to the house.

Any form of gambling game ever invented can be reduced, for examination of its mathematical chances, to the simplest of all gambles—tossing a coin. Over a long period of tossings it is practically certain that approximately one-half the results will be heads and the other half tails, so it is a fair fifty-fifty bet which will lead at the end, say, of one hundred tossings. But, after a run of ten or twenty consecutive heads or tails, it is still a fifty-fifty bet that the next toss will be either the one or the other, and you can take your choice. The fact that for ten or twenty consecutive times the toss has given the same result has not altered the mathematical fact that the next toss is still an even bet.

The failure to make allowance for that fact is one of the chief handicaps of an inexperienced bettor. When a player has had an unusual lucky run at craps there are always more people ready to bet against him, figuring his luck must change, and when one has had an unusually unlucky run, he is often prone to overplay to recoup, figuring again that luck must change. Over a long series of plays, running into the hundreds or thousands, there is justification for the idea of changing luck, since eventually the winnings and losses will average, more or less, provided the game is fair. But in the immediate game an unusual run of good luck or bad luck does not alter the fact that the next play still is one with equal chances of continuing or changing the run.

16-22 Hudson St.

new York.

1912.



Duplicator in Service; It Is Rocked Back and Forth like a Desk Blotter

PICTURES AND WRITING EASILY COPIED FROM STENCILS

Letters, drawings and similar subjects are quickly reproduced in a hand-operated duplicator which carries the stencil on a curved ink pad, rocked back and forth to make the impression. A feature of the outfit is an automatic alinement apparatus which insures straight margins and registration of all the copy.

CLOCK TO RUN FOR TEN YEARS ON SINGLE BATTERY

Requiring no winding, wiring or connections, electromagnetic clocks introduced by a French firm are intended to run for ten years on one battery. The actual consumption of electrical energy, according to careful tests, is but 1.2 watts per year and approximately seven-eighths of this is regenerated by the clock's mechanism, functioning as a dynamo. These time-

pieces are said to require no cleaning or lubricating, are precise, regardless of tem-

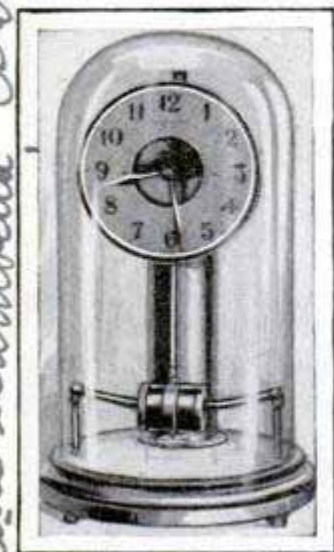

perature conditions, and are easily regulated. If stopped, they start going of their own accord.

LEGEND OF FRANKLIN AND KITE DOUBTED BY HISTORIAN

Benjamin Franklin may not have performed the experiment with the kite and the key, as popular biographies narrate, and he probably was not the first to test the principle of lightning rods, but these doubts in no way detract from his greatness as a scientist, according to Prof. Marcus W. Jernegan, of the University of Chicago. Franklin is believed to have first suggested determining the identity of lightning by means of a rod, but French investigators are thought to have made the proof. Pictures of Franklin flying a kite, while his small son stands by, are misleading. Prof. Jernegan holds, for at the time of the experiment, if made at all, the son was twenty-three years old. The historian deplors the fact that a suitable monument has not been erected in Franklin's memory.

121

2215

SMOKER'S KIT ON AUTO DOOR SAVES ROOM ON DASH

Holding cigars, matches and a receptacle for ashes, a smoker's kit is fastened to the automobile door with rubber-covered supports. It is in an accessible position, does not interfere with opening or closing the door and has proved popular with many drivers who find the dashboard sufficiently filled with instruments without adding another.



ELECTRIC OIL BATH FOR EGGS HALTS SPOILING

Eggs are sealed from air to aid their preservation by passing them through an oil bath heated by electricity to 235 degrees Fahrenheit. The liquid fills the pores so that decomposition is delayed.

Mfr. Horo Electric Apparatus Co. 119 Ave. Lambetta. Bologno. Sw. Switz. 1912.

no Chicago agent

Cooper Arm Thermometer Co. Cooper Peppabuck, Conn.

General Electric Co. Schenectady N.Y.

Hawkeye Utilities, d. av. 7.4

Price \$1.25

Price \$1.25

OLD MASTER IS RESTORED BY THE USE OF X-RAYS

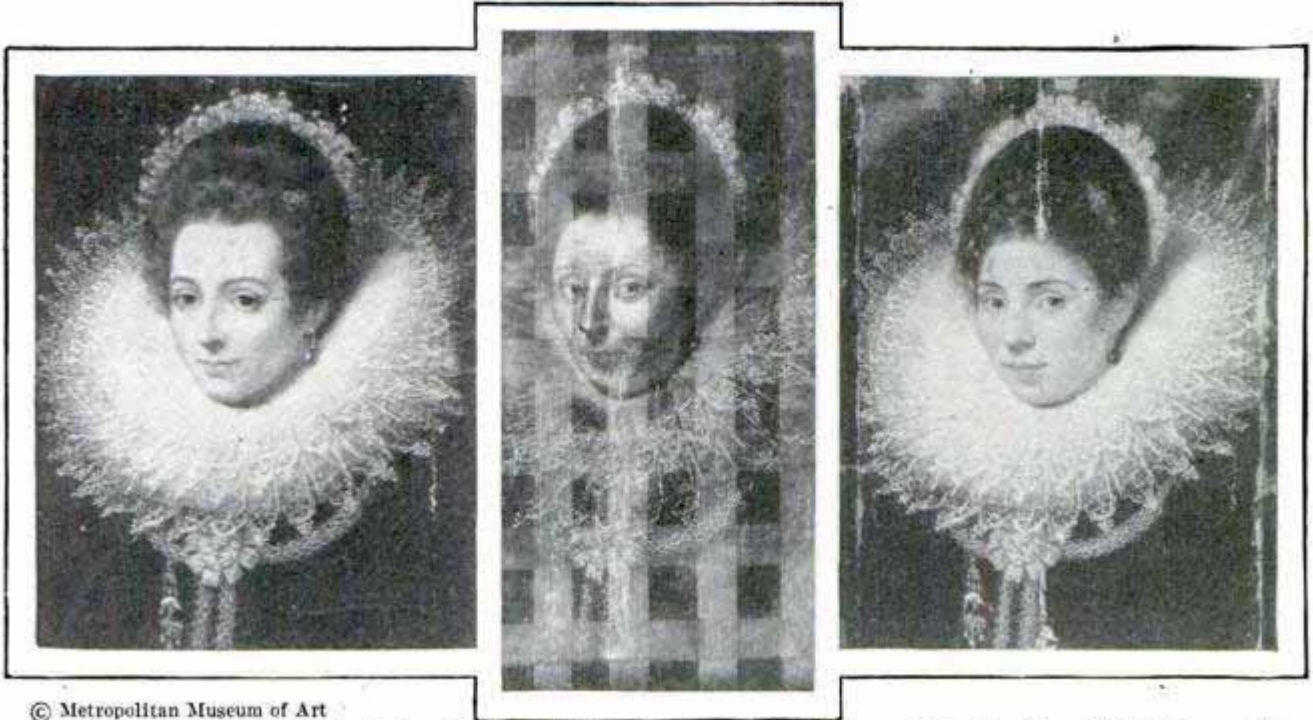

© Metropolitan Museum of Art

Portrait before Cleaning, the X-Ray Photograph Showing Overlying Colors and the Cradling Which Braces the Panel at the Back, and the Restored Painting; Note Larger Nose, Fuller Lips and Other Changes

How science can be combined with art and successfully applied in solving a difficult problem, where the identity of a painting by a master is at stake, is revealed in the restoration of a "Portrait of a Lady," by Frans Pourbus, which is now in the Metropolitan Museum of Art. Through the process of a thorough X-ray treatment, this picture has finally been identified as a genuine example of the master.

It appears that the woman's face had been overpainted with newer pigments and, to all appearances, was an old portrait with a new face. Experts examined the painting and discussed the problem, wondering whether an old face would be found underneath or whether the original had been lost beyond recall. According to Alan Burroughs, who conducted the experiments, the X-rays, broadly speaking, distinguish between old and new paint. The densities of the several pigments employed appear upon the X-ray film as well defined shadows, and from these the trained eye is able to determine facts not evident from examination of the surface.

The Metropolitan museum has reproduced three illustrations showing the different states of the painting before cleaning, a typical X-ray film taken from the portrait, and the portrait after it had

been cleaned and restored. The X-ray recorded a woman's face differing in several respects from that on the surface of the painting. Her nose was larger, her lips fuller, her eyes more slanting and her face more pointed. Whereas the face seen by the naked eye had the prettiness of an "ideal portrait" of recent times, the face revealed by the shadowgraph is that of a real person. Closer examination of the X-ray pictures showed that the painted surface beneath the repaint extended intact over the middle portion of the panel, the only damage being a chip out of the forehead and a crack running through the left side of the face. The crossbars over the entire panel are a shadow record of the cradling which braces the panel at the back. The cradling and repaints on the front hid from the eye the fact that the original panel had been inlaid in a panel larger by about one and one-half inches on each side, but the X-rays revealed the fact as can be observed in the darker band at the top and bottom of the shadowgraph. On the evidence of the X-ray, the museum had the panel cleaned of its overlying colors, with the result shown in the third reproduction.

(Nearly all snowflakes are shaped in some variation of a six-pointed star.

under supervision of Edward M. ...

FIREPROOF BASKET FOR WASTE
IS FIXED TO OFFICE DESK

73



Desk Waste Basket in Use

Attached to the desk where it is reached easily, a waste-paper basket consists of two metal sections. One is the container proper and tips outward when material is to be placed inside, or is easily taken out by a single upward and outward movement of emptying. It falls back inside the outer shell when released, preventing exposure of the contents. The basket is finished in a variety of colors to harmonize with the rest of the office equipment.

AROUND WORLD IN SINGLE DAY
FEAT OF FUTURE?

105

When Linton Wells and Edward S. Evans lopped nearly a week from the previous world's record for circling the globe, conjectures began as to how long their time of twenty-eight days, fourteen hours and thirty-six minutes would stand. Evans predicts that in a few years, their record will be as humorous as Nelly Bly's, several hours more than seventy-two days. In fact, he points out, there are airplanes today fast enough to fly around in less than twenty-four hours, starting and returning to Point Barrow, Alaska, as the distance there is but 6,000 miles. The chief doubtful factor is that the craft are not yet equipped for a dependable flight of such long duration. Evans and Wells

covered more than 20,000 miles, using seven modes of travel which involved seventeen airplanes, three special trains, two liners, many small boats and autos, a jinrikisha and their feet. Two thirds of their plans went wrong but their own resourcefulness and the co-operation of others helped overcome these difficulties. The roughest flying encountered was between Pasco, Wash., and Boise, Idaho, where the air was so "bumpy" that sharp dips caused the carburetor to choke at times. The part of the journey covered by airplane totaled 8,500 miles.

AUTO TRUCK FOR ICING CARS
CUTS SWITCHING COST

2206

Switching refrigerator cars to the icing racks was found so expensive in a western city that an auto truck with elevator, raised by jacks, was devised to take the ice to the car. It carries sufficient ice for a whole car and the screws which lift the load are actuated by gears operated by the truck's motor.

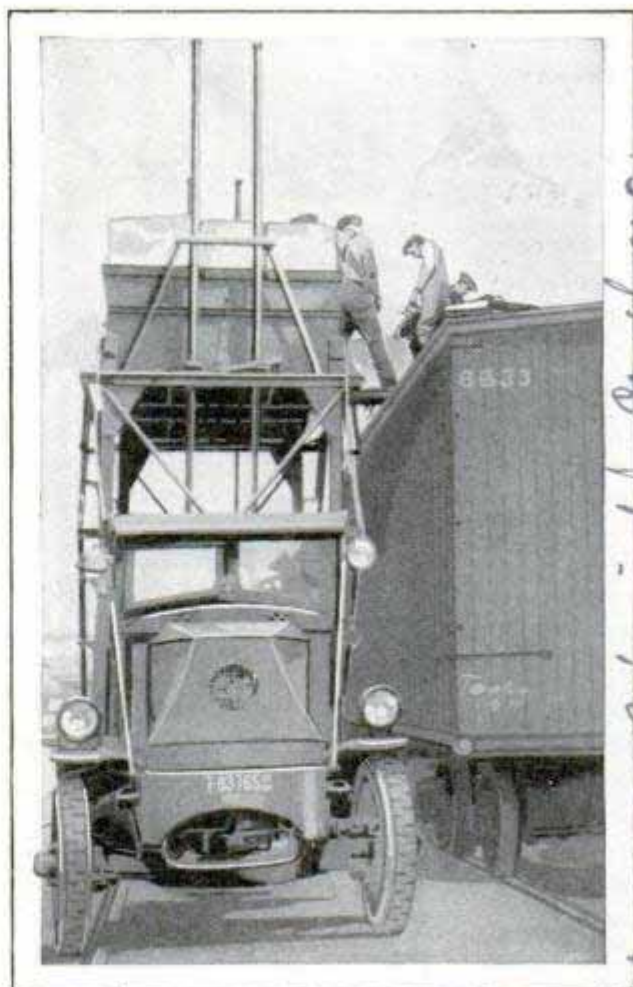

Icing Freight Car from Truck; Cakes Are Hoisted on Elevator Run by the Motor

C. L. Thornberry 1010 N. 22nd St. Lincoln, Neb.
Chicago Daily News 7/15/26
Thomas Wright Cold Storage 245 Northmouth Jersey City, N.J.

PONY EXPRESS TO PLANE TALE OF TRANSPORTATION 99.

Inauguration of mail and passenger service between Philadelphia and Washington by air recently recalled the rapid

trained treasure hunter with his portable testing outfits, automobiles and even airplanes. But gold mining has slumped. The world's annual production is some \$80,000,000 below what it was previous to the war. And digging for the precious



Three Stages in Transportation Illustrated at Sesquicentennial Exposition; the Horse Typifies Days of the Pony Express; Next, the Motor Car and Finally, the Speedy Airplane

transportation developments in this country. Three important stages in this growth were illustrated in a tableau at the Sesquicentennial exposition. It included a saddle horse, signifying the times of the pony express, an automobile and the first airplane for the new mail-carrying route between the two cities.

FINDING OF NEW GOLD FIELDS REVIVES MINING INDUSTRY 133

Recent discoveries of gold in northern Ontario, southern California and the republic of Panama, promise enrichment of the world's supply and stimulation of that branch of the mining industry, which suffered heavily during the war. Whether these finds will prove abundant, remains to be seen, but the general activity is welcomed as improved transportation facilities, opening of new districts to agriculture and other pursuits and the establishment of permanent commercial centers often follow in the wake of a gold rush. The old-time prospector with his crude equipment is disappearing before the technically

metal is not always a "gold mine" financially. In 1925, only seven companies in the United States paid dividends. Their total was about \$3,000,000. Exhaustion of deposits, high labor and equipment costs and the expense of opening new fields are some of the contributory causes to this condition. A bonus for new gold was sought in congress, although some operators were not in favor of the movement. But the bills failed to pass principally because of the sudden decline in prices due to deflation in 1920. Africa leads the world in gold production.

LEVER TO TIGHTEN TENNIS NET 103 **AIDS ACCURATE GAME**

Playing with the net too high or too low is a common fault in tennis, for accurate adjustment is bothersome and often difficult with the usual string fastenings. This detail is simplified by means of a lever attached to one of the posts. Raised or pressed down, as needed, to keep the net at the proper height, it remains in that position until released. The adjustment is quickly done.



Pressing the Lever Raises the Tennis Net to the Correct Height and Keeps It There

New York Times 7/15/26

M. O. Lane & Sons Ardmore, Pa.

M. O. Lane & Sons, Pa.

2200
 514 Woodward Bldg
 Washington, D.C.

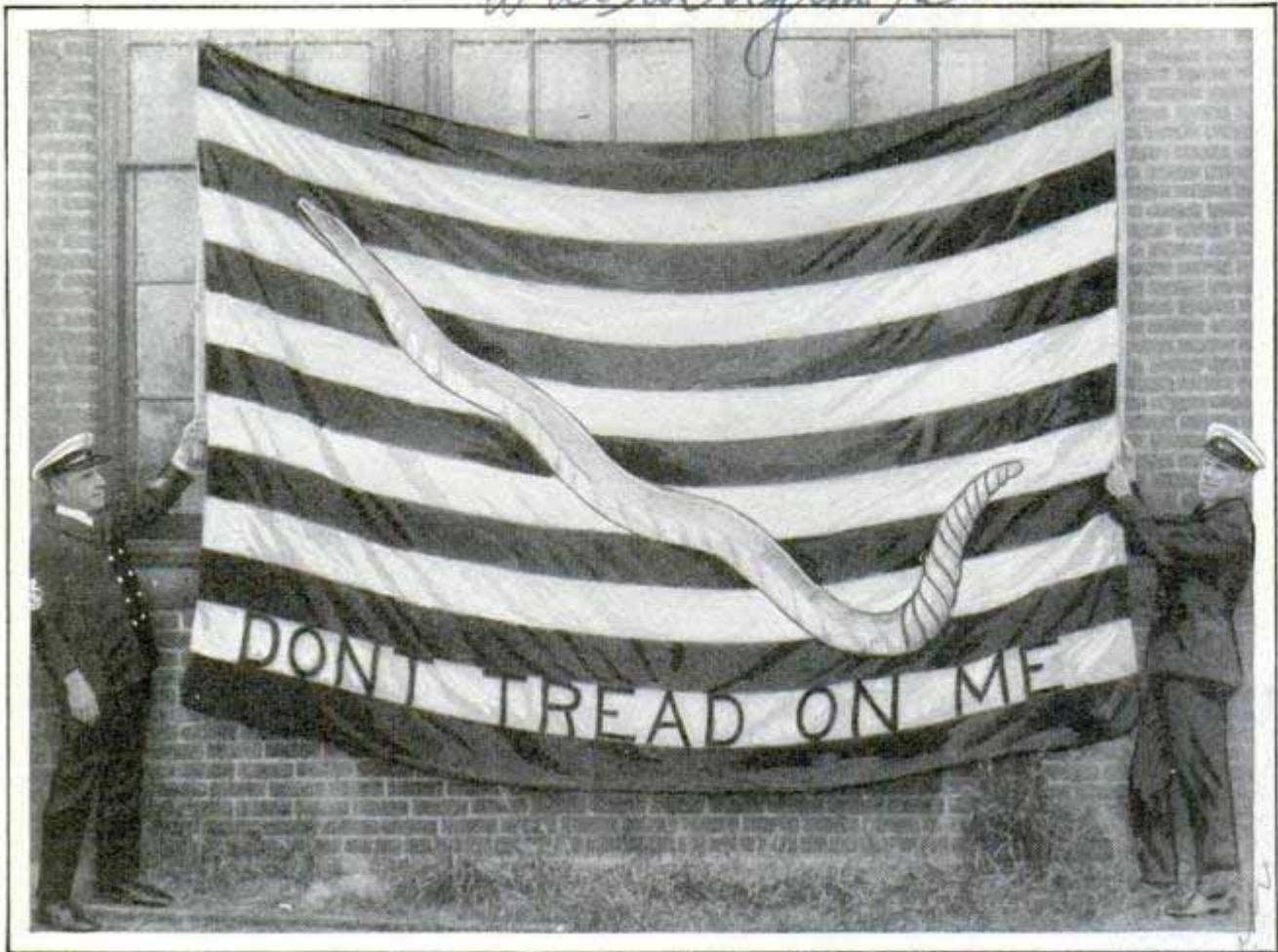

The Famous Rattlesnake Flag of 1775-76 with Red and White Stripes; Variations of This, with Different-Colored Stripes, Were Flown Aboard on Private and State Ships

Mystery Shrouds Origin of Our Flag

All Nations to Honor Stars and Stripes Which Has Remained Unchanged Longer than Banner of Any Other Nation

WHO suggested the idea of incorporating a stripe and a star for each of the thirteen colonies in the first American flag remains a mystery on the eve of the 150th birthday of Old Glory, which will be celebrated June 14, next year.

The commonly accepted story that Betsy Ross, a Philadelphia flag maker, was the author of the idea, is discounted by evidence displayed this year by the navy department at the Philadelphia exposition, though it is quite probable that she was the maker of the first American flag, as her shop was only a few doors from the meeting place of the Continental Congress when the design was authorized.

The navy exhibit, however, shows that flags with thirteen stripes had been used on land and sea by the colonists more than a year and a half earlier, and that a flag

with thirteen stars in the union had been hoisted two years earlier by the schooner "Lee" and the Rhode Island colonial troops. The "Lee" flag, with its five-pointed stars grouped on a blue union, bore an anchor surmounted by the word "Hope." It marked the first known use of stars in an American flag, and was unfurled soon after the battle of Concord, in 1775.

On December 3 of the same year the newly formed American navy gathered off Philadelphia and raised a flag with thirteen red and white stripes, but retaining the union of the British jack. On Jan. 1, 1776, six months before the Declaration of Independence, the same flag was unfurled over the Continental army at Cambridge. A year and a half later the main features of the two flags were combined

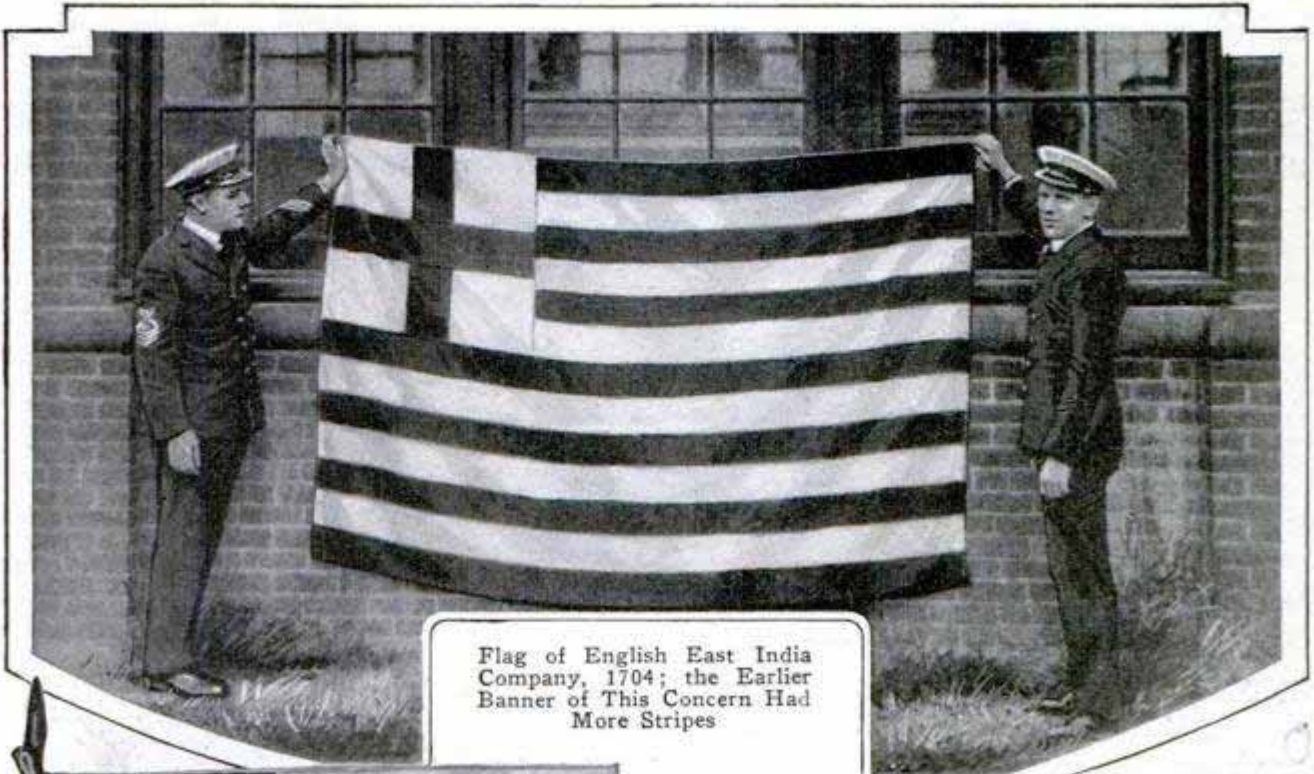

Flag of English East India Company, 1704; the Earlier Banner of This Concern Had More Stripes

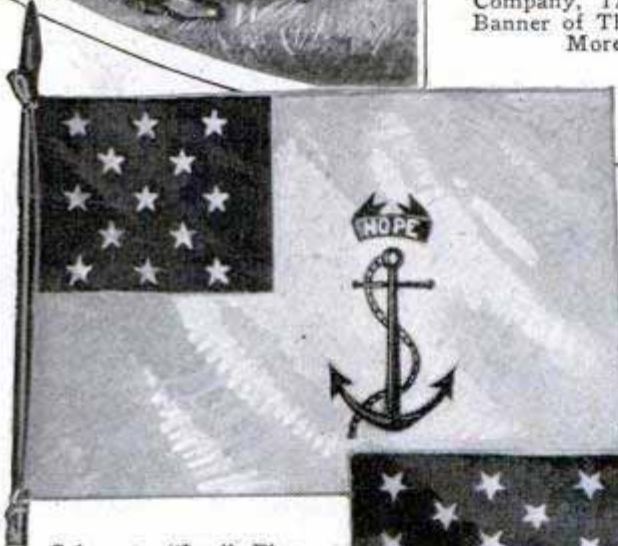

Schooner "Lee" Flag of 1775; First Appearance of Stars; Note They Are Five-Pointed and Arranged in Parallel Rows

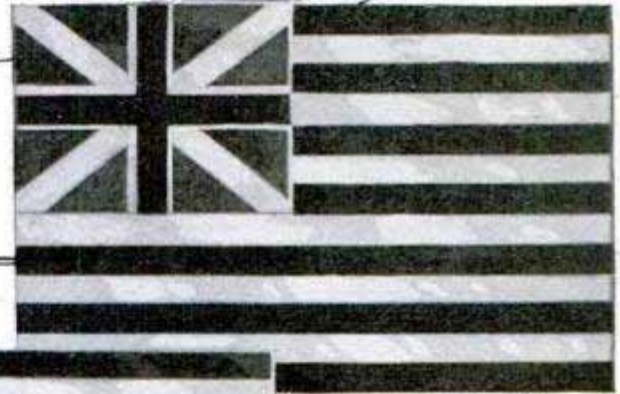

Grand Union Flag. Hoisted Dec. 3, 1775, over Newly Founded American Navy and Jan. 1, 1776, over Continental Army

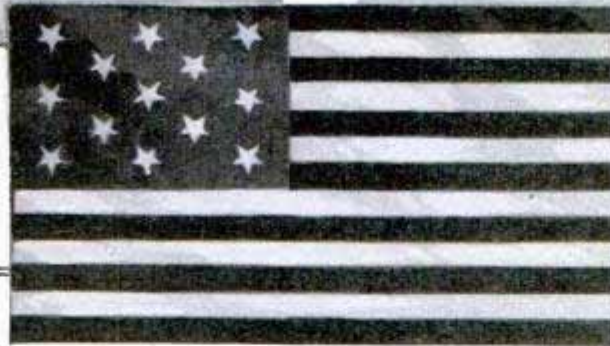

Fifteen Stars and Fifteen Stripes; It Was This Style, the "Star Spangled Banner," That Inspired Francis Scott Key's Poem

Adopted June 14, 1777; Starry Union Borrowed from Schooner "Lee" Flag

Designed by Capt. S. C. Reid of U. S. Navy, the Flag of 1818; It Is Still in Use Though with More Stars



in the original Stars and Stripes—the union of the “Lee” flag replacing the British union.

The original idea of using stripes possibly goes back to the familiarity of the colonists with several flags employing the same device. The British East India company’s flag of 1704 had thirteen red and white stripes, and was a common sight in the ports of the colonies, while the colonists who came over from Holland were accustomed to the flag of the United States of Netherlands, with its stripes of red, white and blue. In fact, the flag of New Netherlands, as New York was known while still a Dutch possession, had the same stripes and colors.

During 1775-1776, while the navy flew the grand union flag, with its thirteen stripes and the British union, at the stern, the ships also displayed a jack in the bows which featured thirteen red and white stripes crossed by an uncoiled rattlesnake, and, in the bottom white stripe, the legend, “Don’t Tread on Me.”

From May 1, 1795, until 1818 the Stars and Stripes had fifteen stars and fifteen stripes, two having been added for new states. In 1818, the law establishing the present flag, designed by Captain S. C. Reid, U.S.N., was passed, providing that thereafter the stripes should be limited to thirteen for the original colonies and one star added for each new state.

REDUCE IRON AND STEEL WASTE BY ELECTRIC PROCESS

Nearly 20,000,000 tons of iron and steel, approximately twenty-five per cent of the yearly output, are now wasted annually in castaway articles, according to a British expert. In the opinion of an eastern engineer, much of this could be saved for re-use by electrolysis. He suggests the erection of large tanks, conveniently placed and containing an iron solvent, in which cans, old automobile bodies and other articles that now disfigure the countryside could be dumped and the iron reclaimed. Existing power plants could supply electricity for this purpose during hours of low consumption through the regular channels, he believes, and he further holds that electrolytic iron might be manufactured directly from the ore at plants near waterfalls where there are large deposits. An interesting phase of this problem is that uncontrolled electrolysis now causes corrosion and disintegration of piping and struc-

tural framework, but improved methods of construction and insulation will reduce losses from this cause to a great extent, the engineer believes.

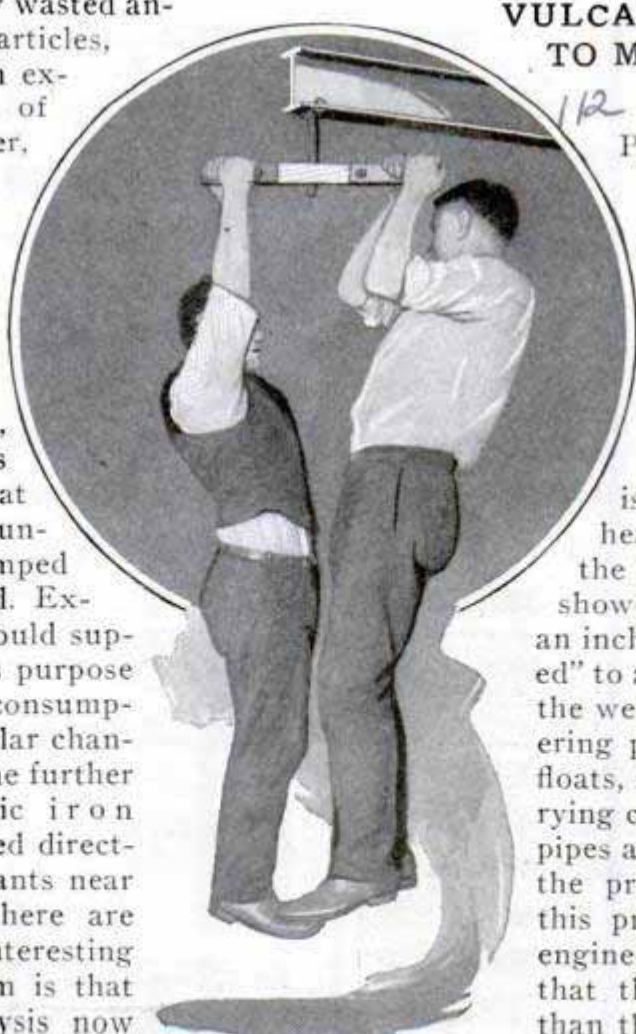

Demonstrating the Strength of Rubber “Weld” on Steel: Strip Supporting Men Is Inch Square

VULCANIZING RUBBER TO METAL PREVENTS CORROSION

Promising great service to industry, a process for locking rubber to wood or metal has been developed by chemists. A specially compounded cementlike product is applied to the surface, then the rubber is vulcanized either by heat or air, the latter in the case of wood. Tests showed that a rubber strip, an inch square, and so “welded” to a steel beam, supported the weight of two men. Covering pontoons and seaplane floats, steel-tank cars for carrying corrosive acids, interior pipes and fittings are a few of the practical uses to which this process can be applied, engineers say. It is reported that the method is cheaper than the old way of first anchoring hard rubber layers to a corrugated metal surface.

Charles Page Perin, Metallurgical Engineer, 40 W. 40 St. New York

1925 Michigan Ave Chicago

Vulcalok - O. Woodrich Co. Akron, Ohio.

**RUINS OF INCA PALACE SHOW
ANCIENT BUILDERS' SKILL**

Little is known of the purpose for which the vast structures erected by the Incas were intended, but the ruins tell that these ancient builders were craftsmen of

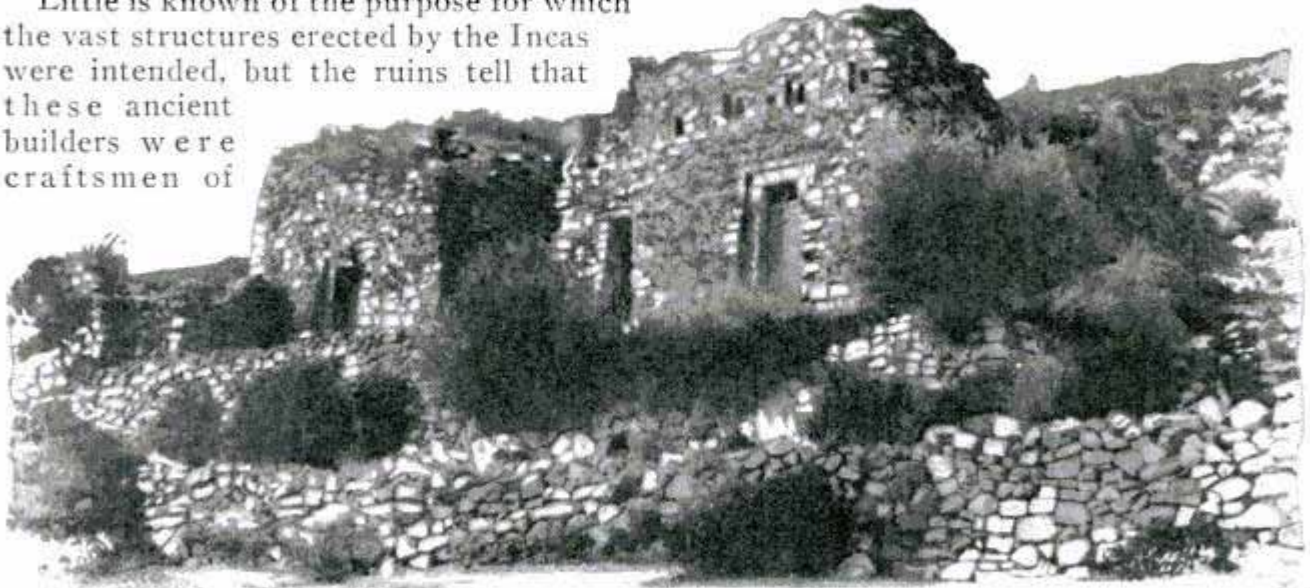

Ruins of Inca Palace on Lake Titicaca Island; the Huge Structure Apparently Was Erected for Religious Purposes; Workmanship of a High Order Is Revealed in the Masonry

the highest order. An illustration of their work is found in an old sun palace on an island in Lake Titicaca, between Peru and Bolivia, 12,000 feet above sea level, the highest lake in the world to be traversed by steamers. The stones were so carefully cut and fitted that most of the walls withstood the hands of the invaders and have resisted the ravages of more than 400 years. Fragmentary evidence indicates that the "people of the sun" were also skilled as metal and pottery workers, good road builders, spoke at least two languages and had a highly developed labor and colonization system. They are believed to have settled near Lake Titicaca about 300 years before Pizarro arrived near the Peruvian coast in 1527.

**ATLANTIC NEW YORK'S
"FISHIN' HOLE"**

More than 1,000,000 men enjoyed the sport of deep-sea fishing near New York city last season, according to reports. Special boats carry large groups of anglers to chartered locations. The craft, as a rule, are in charge of veteran fishermen experienced with tides, winds and weather.

and expert at taking their patrons to places where the principal catches, bass and blackfish, are likely to be found. Up-

holstered chairs, dining and lounging rooms are provided on many of the boats and some have complete tackle outfits for sale as well as bait of all kinds. They leave at intervals from midnight until late afternoon and, at weekends, are usually crowded to capacity.

**BICYCLE POLO GAME ON BEACH
LATEST OUTDOOR SPORT**

Bicycle polo proved a popular novelty at a California beach this summer. Special sticks of short length enabled players to strike the ball at close quarters and the hard sand made a good surface for the maneuvering of their "ponies."



Bicycle - Polo Enthusiasts, Enjoying a Game on Sandy Beach; Skill and Alertness Are Demanded and Beneficial Exercise Is Afforded Arms and Legs

Chicago Daily News

Malcolm Wright and Chamberlain

and Russell Pryor

POPULAR MECHANICS

594

378 Third St

DOUBLE DIAL IN HOTEL DOORS
INSURES GUEST PRIVACY

Dayton, Ohio

inventors E. J. Morrison
and Russell Pryor
makers Morrison & Pryor
378 Third



Hotel Guest Setting the Dial from Inside Room and Maid Reading the Indicator

Set in the hotel-room door and regulated from the inside, a little dial indicator shows the hour at which the occupant intends to leave. Besides preventing disturbance, the arrangement helps attendants in their work as they are informed when they may visit each room and delays are thus avoided.

WOMEN THE FASTER WORKERS
EXPERIMENTS SHOW

122

Laboratory tests held at Johns Hopkins university show that women can do more work in a given time than men, but men display superior judgment. The tests involved substituting letters for symbols and were given to 542 women and as many men, college students in various part of the country and ranging in age from nineteen to thirty-nine. Judgment of the subjects was measured by requiring each to estimate, in advance, how much work could be

Scene Service

done in the time given, one minute and fifteen seconds for the first test, and one minute for the second. There was little difference in attention to directions and correctness of substitutions. The women worked faster, but were less accurate in estimating how much work they could do.

ONE DEATH IN MILLION MILES
RECORD OF AIR TRAFFIC

149

In the forty-seven months preceding June 1, army flyers covered more than 1,000,000 miles with the loss of but one life. During that period, 1,197 passengers and 61,412 pounds of express were carried a total distance of 1,098,373 miles in 14,644 flying hours. Flights started totaled 691, of which 662 were completed. There were twenty-six crashes with but two accidents to personnel. These figures were compiled at the United States airway control office at Fairfield, Ohio, and refer to operations of government planes, which are now extensively used for carrying officers, messages and parcels of importance.

Chicago Daily News 7/21/26

TEST STRENGTH OF PARACHUTE
WITH AID OF ELEPHANT

Motion-picture wind machines and an elephant play important parts in testing parachutes at an open-air laboratory near Los Angeles. The chute, attached to a harness worn by the elephant is opened and kept distended by the artificial gale from the big motor-driven propellers. The big four-footed helper is a substantial anchor and the blast is increased to measure the strength of fabric and cords.

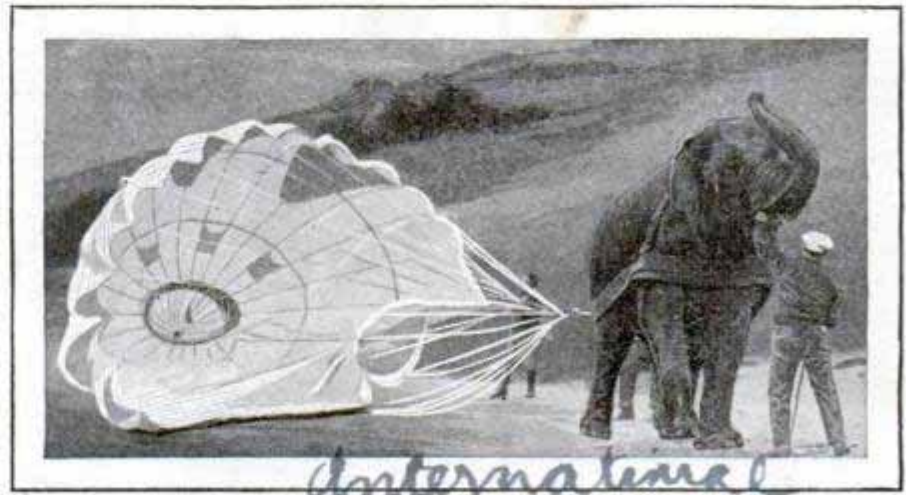

Elephant Aiding Parachute Test; Canopy Is Pulled against Blast of Air from Wind Machine to Measure Strength

International

2190
Cmr. 18. H. ...
4639 Montgomery Ave.
Bethesda, Md.

A Log Cabin Home of Today



LOG-CABIN days are being revived and revised, near Washington, D. C., where a trio of homes built of Canadian cedar and spruce logs are now occupied by contented owners who have used original plans, modern conveniences and forestry products of the pioneering era in the construction of the most unusual mansions built during recent years.

If ever you have lived for a few weeks or a month in one of those charming cedar cabins of northern Maine or southern Canada resorts, you will understand why Dr. S. S. Jaffee and Maj. C. G. Mettler happened to build permanent houses of logs close to the national capital. Both were delighted with the cabins in which they lived during winter and summer vacations spent in the woods. They tested out the timberland cottages during days when the thermometer recorded forty-five degrees below zero and when the mercury soared to peak of summer temperatures. They found neither flaws nor faults in the construction, durability or livability of the log houses.

Hence, for their own homes, one chose cedar and the other spruce in rough log form. In both instances, the amateur builders sought to purchase the raw logs of local dealers. The prices which the middlemen asked were prohibitive. The retail lumbermen wanted from \$8 to \$10

a piece for logs forty feet long and eight inches in diameter. So Dr. Jaffee arranged to buy his supply on the stump. The logs cost thirty cents each as growing trees, while cutting, skidding to the river, and formation into rafts cost fifty cents more. Rafting to the railroad and freight to Washington brought the total cost up to \$2 a log. Had they been dressed into lumber, there would have been an import duty to pay, but there is no charge on logs in the rough. With logs costing \$2 each and each log eight inches in diameter, a forty-foot wall, eight feet high, takes but \$24 worth of material, making an unusually cheap form of construction.

Nowadays, it is extremely difficult to find an American carpenter who is experienced in log-house construction. The Washingtonians solved the dilemma by importing workmen from northern Maine. These homespun carpenters charged only from \$4 to \$5 a piece daily and board. The cabin owners were their own architects and designers. The Mettler home more closely resembles those spacious, inviting and comfortable cottages of Maine and the New England woods and mountains. The Jaffee home is a real mansion made of Canadian cedar, most unusual in layout, arrangement and finish.

Most of the rooms in this picturesque

*Lodges and Clubhouses
Bushman - \$2.50.
Camps. Log Cabins.*

For information - Write Mr. S. S. Jaffee, 1314 - 18th St N.W.

ten-room house are informal and so comfortable and inviting that your tendency is to tarry. To balance these, there are several formal rooms which lend dignity to the attractive home which is illuminated by electricity, heated by an oil-burning furnace, provided with every modern comfort and furnished luxuriously. The logs look as they did in the forest. The bark has not been removed. Cedar bark, unless diseased, remains in position indefinitely. The cracks between the logs were plugged with metal lath, cut to fit and nailed into place. Cement plaster, colored with burnt umber to resemble the cedar bark, was worked into position over the lath to fill all the chinks and crevices.

The house is roofed with cedar shingles which were milled expressly for that purpose. A thick layer of fireproofing and insulating material was laid as a protective blanket between the roof boards and the shingles. The tiny cracks around the

doors and windows were plugged with 300 pounds of oakum sealed into permanent position. Dr. Jaffee says the log mansion is so wind-tight and weather-worthy that during the normal Washington winter, windows have to be left open during ordinary weather for ventilation purposes and to moderate the natural temperature.

The mansion has really been built in the style of a house within a house, for the structure was originally built in two sections which, when completed, were combined. A commodious, high-ceiling living room, eighteen by thirty feet in floor dimensions, is the outstanding feature. All the other rooms are lathed and plastered as in the ordinary residence, but the ceiling of this lounge room and library shows the natural logs with roof boards and supports stained a natural cedar-bark color. A large stone-faced fireplace, which accommodates five-foot lengths of cordwood,

Individual Rustic Porches Open from Each Bedroom, Overlooking a Formal Garden, Above, While Below Are Two Views of the Six-Room Cottage, with a Garage on the Basement Floor.

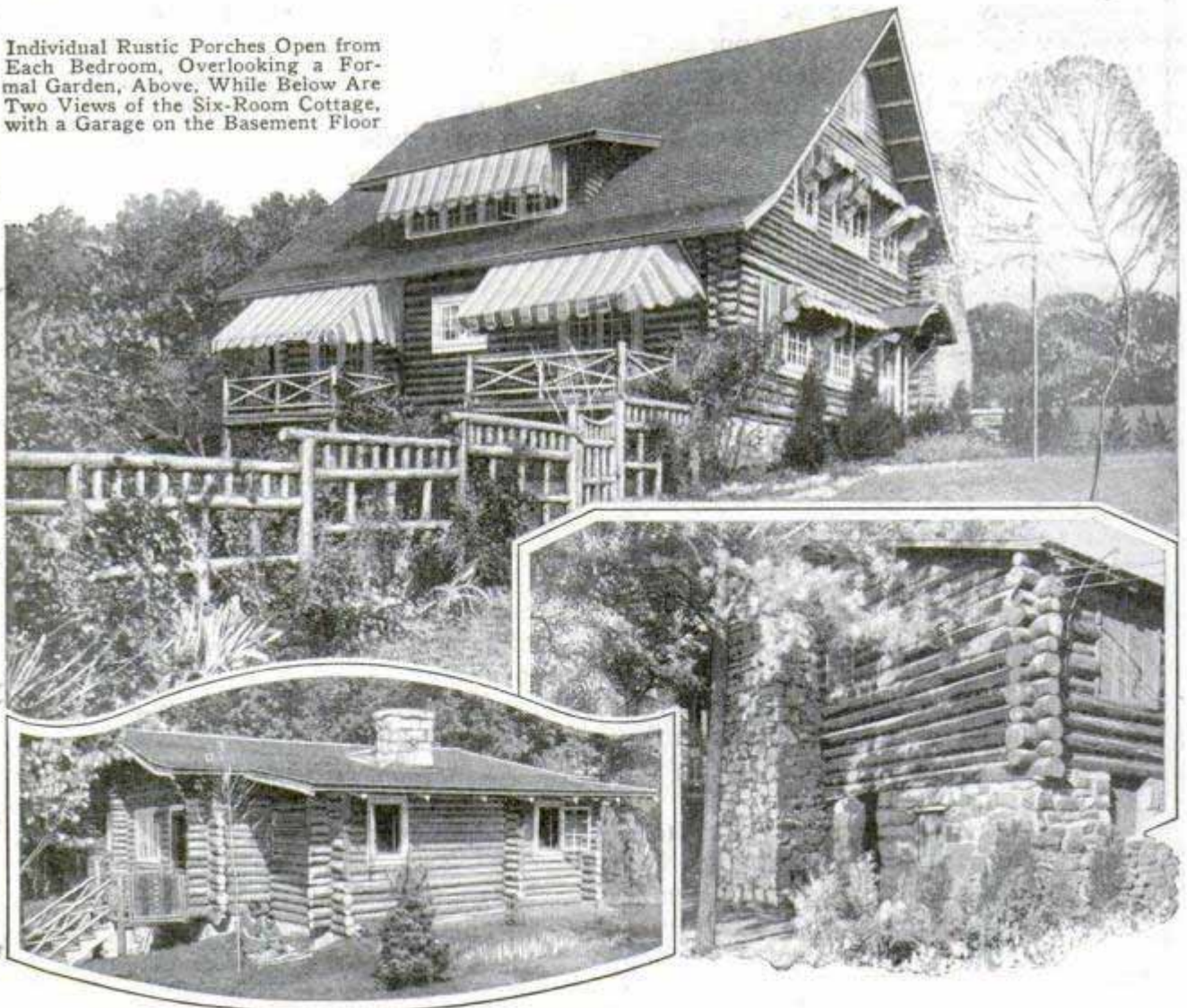



Even the Small Cottage over the Garage Has a Big Living Room, Featuring a Massive Stone Fireplace, While All the Doors, Like Those of the Main House, Were Handmade in Ancient Style

and a music alcove, in balcony form, on the level of the second floor with a rustic log railing are other features.

The main section of the house is sixty-five by thirty-four feet with six rooms on the ground floor and four upstairs. Instead of having a formal dining room, the Jaffees have provided a cozy dining alcove. Whenever they entertain guests, the table is laid in the large living room and library. An interesting feature of the first floor is a suite of rooms which is linked by a corridor with the rest of the house, but which can be shut apart as though entirely isolated. This suite consists of two bed-chambers and a connecting bath. Each chamber has a small private rustic porch which overlooks a charming garden.

The house is built on a strong and serviceable foundation of concrete and stone. It is important in such construction to protect the base logs against extreme weathering and fairly rapid deterioration. This is done by building a durable foundation of brick, masonry, tile, concrete or cement blocks. Dr. Jaffee imported only

two carloads of cedar logs to build his commodious home. He utilized the surplus material in building rustic fences and porches. His ornamental garden is most attractive as a result of the rustic fence which surrounds it. His cedar mansion is also unique in that the front and rear exposures are interchangeable by a few modifications. The residence was built at the center of a four-acre tract. It lies between two paved avenues. The front of the house is on one avenue grade, while the rear is attractively terraced and beautified, the street being about one story below the ground-floor elevation.

There were enough logs left over after the main house was completed to build a snug and slightly six-room cottage. Originally, its owner planned using the cabin for servants' quarters. People who passed that way, however, were so insistent that the cottage be rented that Dr. Jaffee finally assented.

The Mettler home is built of spruce logs which were "barked" before they were skidded and used for the house.

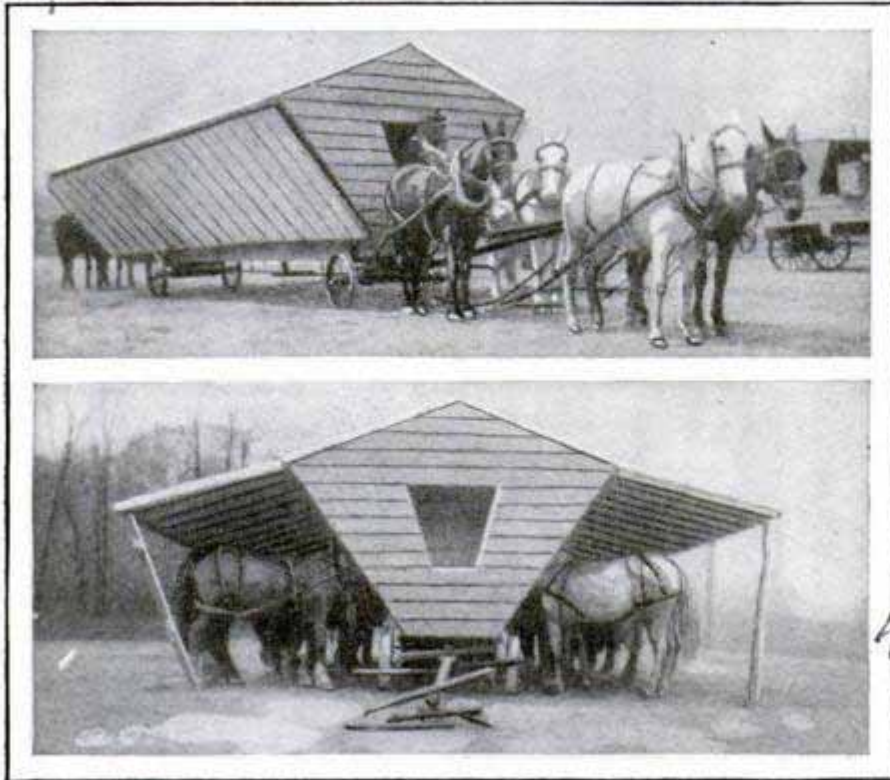

Barn Closed for Travel and Open; Sides Form Protecting Roofs for the Horses, Which Are Fed from Central Mangers

HORSE BARN ON FARM WAGON AIDS CONTRACTORS

Easily moved from job to job, a portable shelter barn that will accommodate eighteen horses and can be used for hauling hay and grain, has been devised for the special use of contractors who find caring for the teams an expensive and bothersome item. The structure is thirty-six feet long and twelve feet wide when closed. Hinged sections on the sides open out to form the shelters and double the width of the barn. Feed racks and end walls are securely built in.

RADIO IN WORLD TEST TO FIND IF CONTINENTS MOVE

134 Are the continents moving? Observers in more than twenty countries have united in a world-wide survey to find the answer to this question, which is regarded as having important connection with the origin of the great land areas and the changes that have taken place on the earth's surface. Solution of the riddle is being sought by making careful longitude calculations from appointed stations. This involves accurate time measurements. Radio signals sent from powerful broad-

H. U. Jones 7/18/26

casting centers will be recorded at the instant of reception at each observation point, and the measurements made in this survey will be compared with similar observations in 1931, it is planned. If evidence is found to support the theory that the continents move, the measurements and comparisons will be continued.

CEMENT SPRAYER MENDS FURNACE

40 Brick and tile-furnace settings are quickly coated for further use with a special cement which is applied by a small nozzle sprayer operated under 100 pounds of air or steam pressure. The distributor is controlled by a single valve, is light and compact and easily operated by one man. Carborundum is an essential part of the cement mixture, its heat-resisting qualities affording a durable surfacing. It may be applied to hot or cold settings.

Spraying Cement on Furnace Brick; Flow Is Controlled by Hand Nozzle

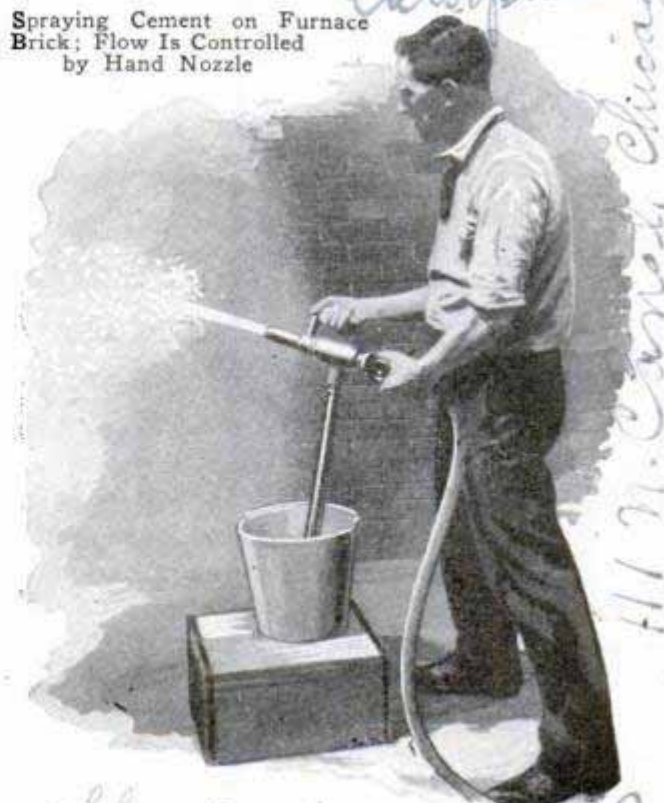

Carborundum Co., Chicago
411 N. Canal, Chicago
Est. 1888

52. maker. *Whitworth Aircraft. Ltd.*
Parkside, Coventry, England.

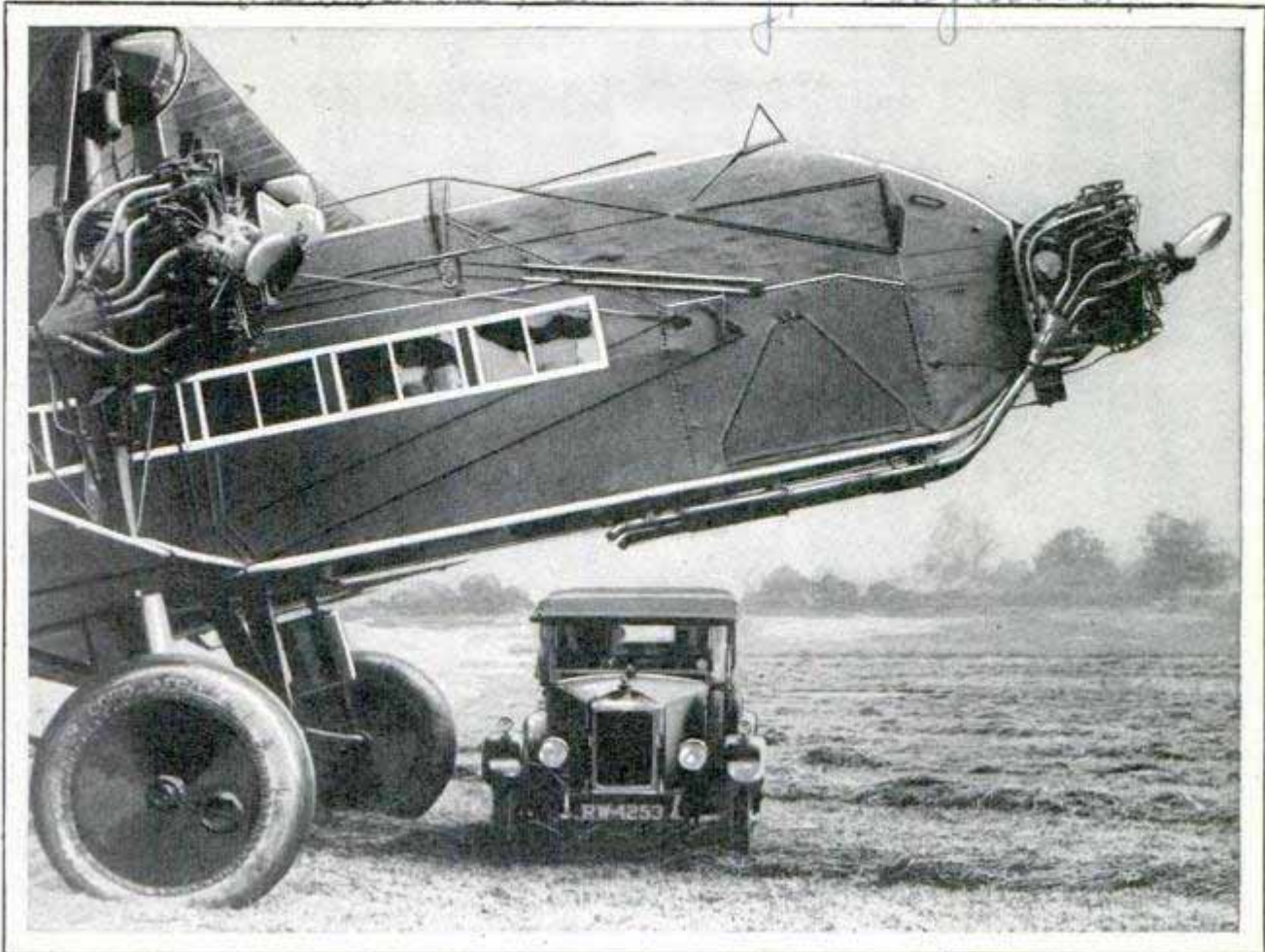

Motor Car under Giant Plane Emphasizes the Huge Size of One of the Latest Sky Craft; Motors on Sides and at Front, Three in All, and Accommodations for Twenty Passengers Are Features

Foreign
PLANE FOR TWENTY PERSONS HAS THREE ENGINES

Accommodations for twenty passengers and their luggage are provided in a monster airplane launched in England. To reduce the hazards of journeys, it has three engines, to eliminate, as nearly as possible, the need of forced landings. Besides the passengers, a crew of several men is carried.

Medical School
RECORD OF HEARTBEATS MADE TO HELP TREAT DISEASE *36*

Diagnosis of heart and lung diseases will be simplified and made more accurate, it is expected, through an instrument developed at the university of Pennsylvania. It combines some of the principles of the telephone, the phonograph and sound-amplifying apparatus that was used during the war to detect the presence of undersea craft. With it, records of murmurs in the chest, heartbeats and other sounds are made and these noises are reproduced so loudly that a whole classroom can hear

them, it is said. Should comparison be desired in a doubtful case, a record of a diseased condition could be played, showing what noises attend the malady, giving the examiners an accurate guide without the necessity of searching for another patient with such an affliction. The instrument eliminates most of the likelihood of error arising from the human element in using the stethoscope. It is planned to produce the equipment for physicians' as well as classroom and laboratory use.

1928
TRANSPARENT MINNOW TRAP IS EASILY SET

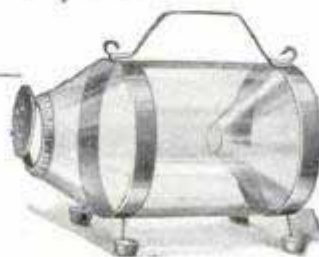

Transparent pyralin forms the sides of a minnow trap now on the market. It is reinforced with galvanized-iron bars and heavy wire,

easily carried and set, and is said to have proved practical and efficient.

Dr. nos. Dr. Richard C. Cabot, Boston, Mass

S. C. du Pont de Nemours & Co. Inc.

*Co. a. l. Santa
Mara. Calif*

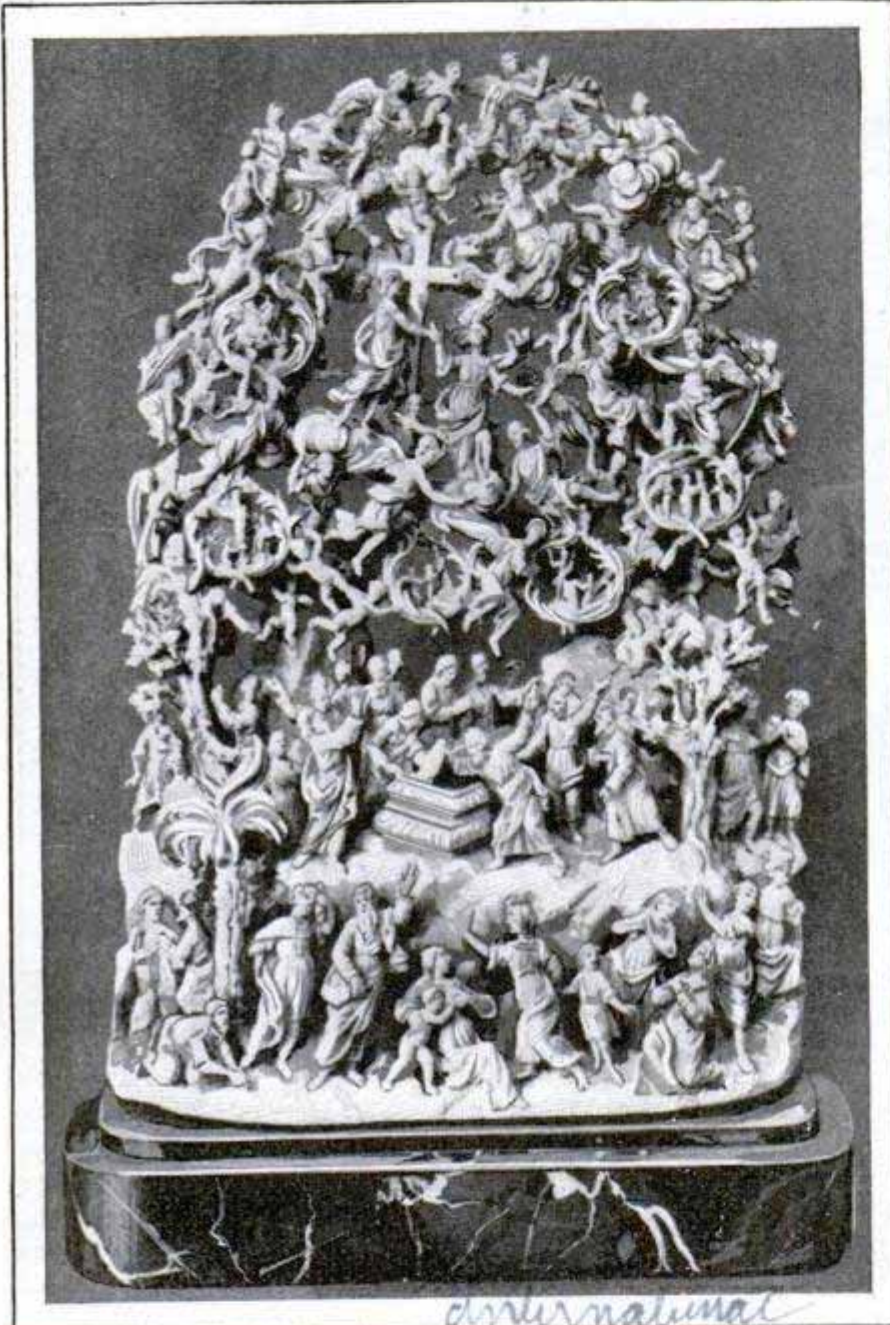

Elaborate Carving from Split Ivory Tusk; Figures in Full Relief Emphasize Realistic Appearance

SCORES OF FIGURES CONTAINED IN CARVED IVORY TUSK

One of the latest additions to the Victoria and Albert museum in London is an intricate carving from a single ivory tusk, split down the middle. It contains scores of tiny figures, grouped in a tableau to represent the "Assumption of the Virgin." The lifelike appearance of the forms is increased by the fact that they are cut in such full relief as to give the impression of almost complete detachment. It is believed probable that the work was executed by a Spanish or Italian craftsman of the eighteenth century.

BALTIC SHALE RICH IN OIL

Tests of oil-bearing rock found in the Baltic regions have shown that it contains seventy-five gallons to the ton, of which eighty to ninety per cent can be extracted. This is said to be about twice the possible recovery from American shale. Improved processes of separating the oil at a California plant have enabled the product to be marketed in competition with the well oil. It is being used as fuel for locomotives and for an ore extraction plant. After the shale is mined, it is crushed, heated in large steel retorts and the distilled oil drawn off in storage tanks. Gases are cleansed and cooled and more oil taken from them. The spent shale is made into fire and insulating brick.

SWIVEL-MOUNTED SHAPER-JOINTER WORKS WELL

Operated from a lighting socket, the one-quarter horsepower motor in a combination shaper and jointer is attached to the table by swivels so that the cutters can be set at any angle desired relative to the work. Smaller cutters can thus be used with a consequent saving in power and added safety. The outfit is portable and runs at high speed. It is said to perform well and to produce a high quality of work. It weighs less than nineteen pounds, including the motor.



12/18

Handwritten notes and scribbles on the right margin.

Handwritten text at the bottom right corner.

FLOATING HOTELS IN OCEAN TO SERVE AIR LINERS

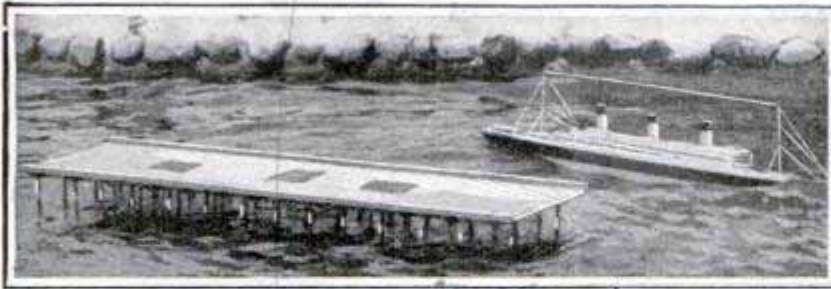

Model Landing Platform, Ship in Pool and View of Anchors on Float

Hotels and landing fields on floats anchored in the Atlantic ocean have been suggested for stations along a proposed air line between Atlantic City, N. J., and Plymouth, England. To demonstrate the steadiness of the floats, a six-foot model and one of a steamer were placed in a pool. It was seen that the platform rocked but slightly while the ship tossed and rolled with the waves. The stations would be some 1,200 feet long, 600 feet wide and seventy feet above the surface of the water. Powerful searchlights would help guide the planes, which each would carry twenty-five passengers besides baggage.

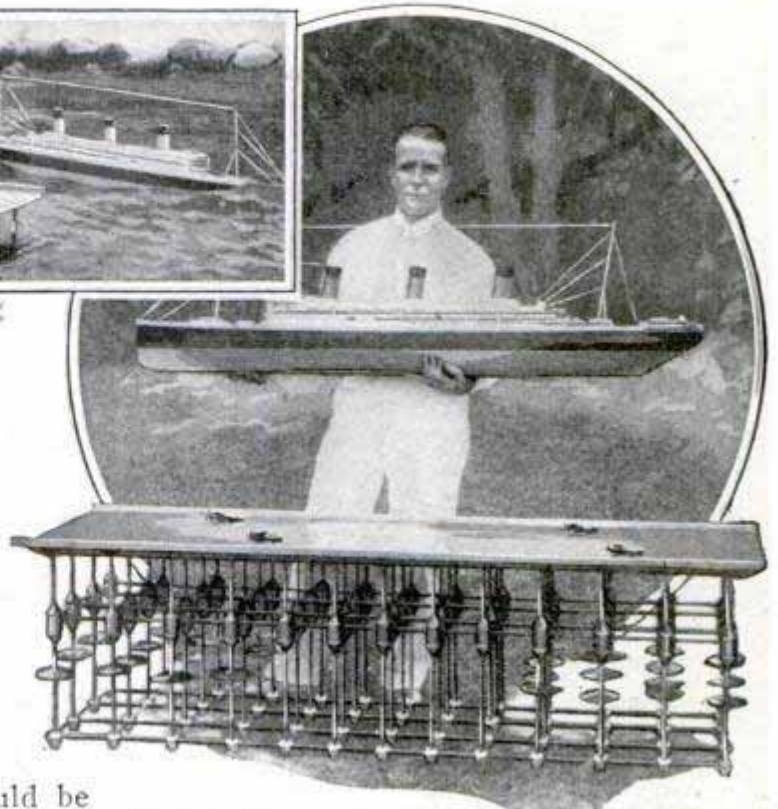

fuel, but was unsuccessful, as he found it impossible to accomplish complete combustion of the coal in the short time available. In spite of the encouraging results of these last tests, engineers declare that coal will not be practical until a motor is designed that will take any kind rather than the prepared fuel used in these experiments.

COAL DUST FOR DIESEL ENGINE TESTED IN GERMANY

Successful experiments at running a Diesel engine on powdered coal are reported from Germany. One unit was operated several thousand hours under test. Coke slag and ash formations in the cylinders were removed by combustion gases and the problem of introducing the coal dust into the cylinders against high pressure was also solved. Special construction kept the powder from getting into the lubricating oil. Rudolf Diesel, the inventor of this type of engine, is said to have expected to use powdered coal as well as oil and other liquids for

LENS FOR BIG AERIAL CAMERA WEIGHS FORTY-FIVE POUNDS

American lens makers demonstrated their skill in preparing the huge "eye" for a camera constructed for the U. S. air service. It weighs forty-five pounds and is said to be the largest camera lens ever ground in this country. With the mounting, it measures nine by nine inches and has a focal length of thirty-six inches. It will take pictures of entire cities at one exposure.

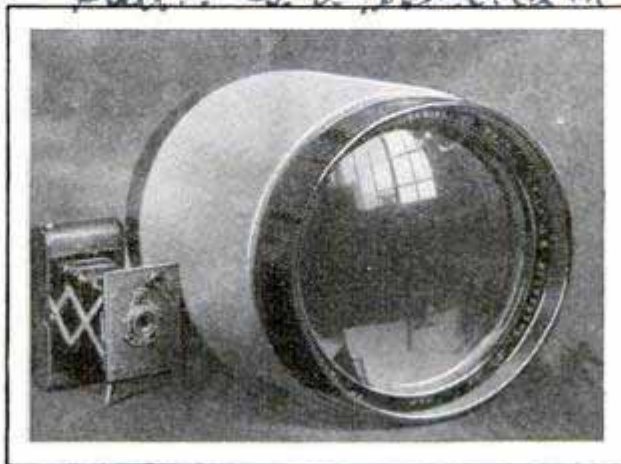

Lens of Huge Camera Compared with Small Pocket Kodak to Illustrate Size

Marie Journal 7/18/26

Miss G. H. ...

Owner - John Wyath

Elmwood



One of the First Automobiles Ever Made in the United States, a Steam Carriage That Is Still in Use in Sayler Park, Ohio

Your

By HAROLD

with corresponding improvement in fuel, oil and tire economy.

The trend toward smaller cars began several years ago in Europe. Over there a 2,500-pounder is now popularly considered a large car, and it is, compared with the average European automobile, for many foreign cars weigh only 1,000 to 1,500 pounds and some

weigh as little as 600 pounds, while the smallest closed bodies weigh as little as 120 pounds. As a rule, four-cylinder engines are used with piston displacements ranging from forty to about 100 cubic inches, whereas, in comparison, the Ford is a monster with a displacement of 176 cubic inches. Maximum speeds of these cars range from forty to eighty miles an hour, fuel economy from thirty to sixty miles per gallon, and passenger capacity

UNQUESTIONABLY the most interesting thing about the automobile is its ever-changing features. It is never quite the same two years in succession. It is continually exhibiting something new to interest motor-car owners.

In just the past two or three years such important improvements as four-wheel brakes, balloon tires, air cleaners, oil filters, lacquer finish and all-steel bodies have been added. What next?

The answer to this question is likely to disclose the most radical development since the automobile was first conceived, and the answer is this: Smaller and lighter cars are going to be manufactured. These cars will give thirty to fifty miles on a gallon of gasoline and will be capable of doing almost anything larger cars can do. Already one American manufacturer has announced such an automobile, and it is understood that between now and the first of the year there will be several others.

This statement alone is of interest, but in addition there are indications that this small-car development will eventually influence big-car construction with the result that the automobile of the future will be smaller and more economical, yet just as comfortable and capable as the common run of cars built today. In short, it appears that automobiles of all capacities will be scaled down in size and weight,

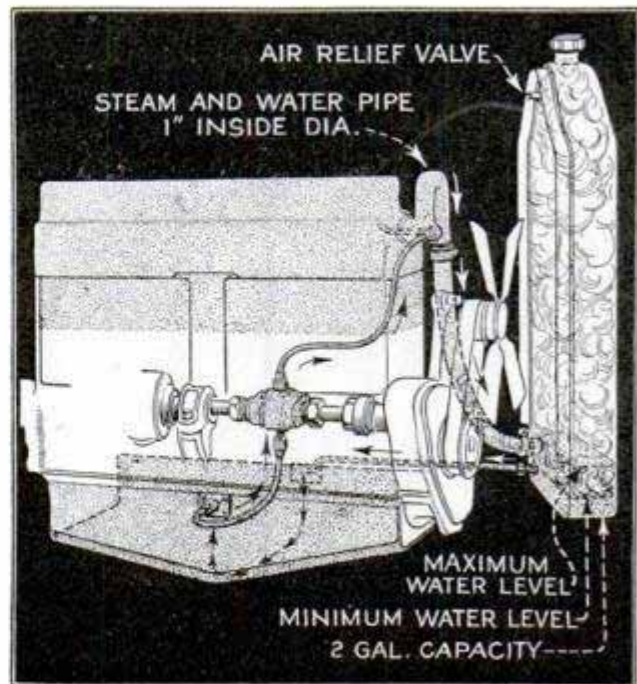

Steam-Cooling System That Gives Greater Efficiency and Reduces Size of Radiators

W. S. ...
Overland Co.
Toledo, Ohio

1209 Island St.
Alameda, Calif

4 cyl. v. m. cooled motor
3 speed
3 1/2 in. wheelbase.
Weight 560 lbs.

Next Auto?

F. BLANCHARD

varies from two to five persons.

The development of attractive, roomy, well-built, powerful, high-efficiency

One of the Smallest Cars Ever Made; It Weighs Only Six Hundred Pounds and Has an Air-Cooled Motor

airplane tires
3 1/2 in. rear clearance
speed - 65 m.p.h.

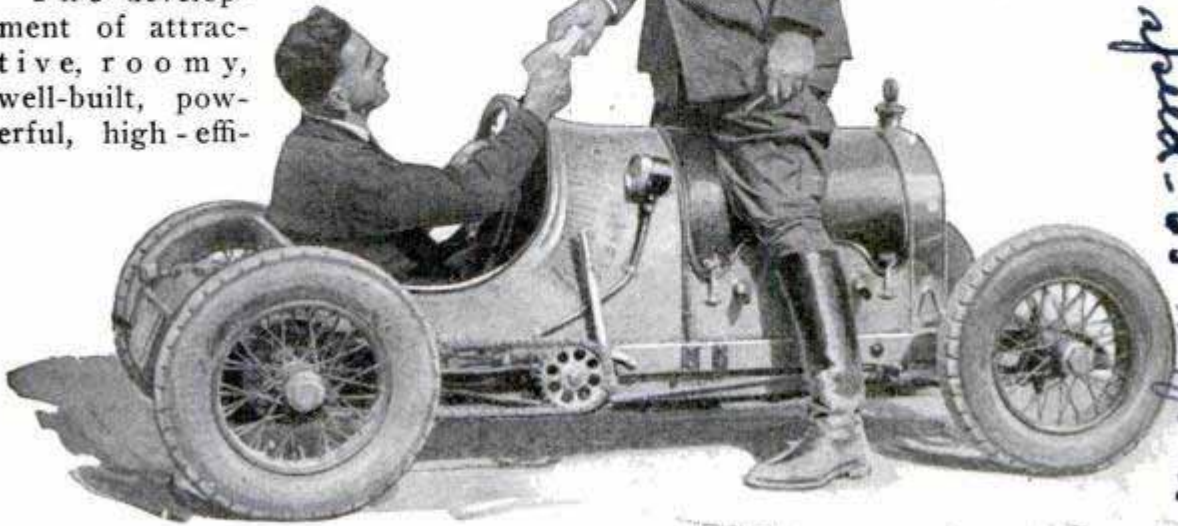

ciency automobiles in the 100-inch wheel-base class is rather certain to influence the construction of cars of every size and price. And, in passing, it should be pointed out that there seems to be little connection between size and performance. A small car can be built to ride almost as well as a large car, and its top speed, its road-holding ability, and other features, may come close to equaling those of the large car. In fact, the very large ones seem to have as many disadvantages as very small cars. The big car is, of course, difficult to handle in traffic and it also may be clumsy on the road. Usually it does not act as well on turns as smaller cars. A rough proof of this is that racing cars are usually built with wheelbases of about 100 inches.

All of which leads up to the view that there is no particular sense in building automobiles bigger than they need be. This view was recently expressed by no less an authority than Thomas J. Litle, president of the Society of Automotive Engineers, who said that there was no good reason for building a two or three-ton car to carry two passengers or more; that present designs were crude and

should be discarded; that because a car was high-priced was no reason why it should be overweight.

In order to give a more detailed picture of what Mr. Litle was driving at, as well as to give an idea of what the future may bring forth, it is necessary to look at the modern racing car. The speedway has always been a testing laboratory for the refinement of features which eventually were placed on stock passenger cars. Racing construction in the past has always been several years ahead of passenger-car construction, and if this has held true in the past, there is some reason for believing it will be true for the future also, and that racing-car features of today should be the passenger-car features of tomorrow.

It is significant that the size of racing-car engines has grown steadily smaller. In the early years, racing engines had piston displacements of 1,200 cubic inches or more and developed about 200 horsepower. For the past three years the displacement has been 122 cubic inches, while, this year, the limit was cut to ninety-one cubic inches. Yet racing-car speeds have gone steadily upward, although weight has been reduced but slightly. Time was when a



American Light-Car Engine of Only 131 Inches' Displacement, Which Gives Speeds of over Sixty Miles

1,200-inch engine gave 200 horsepower. Last year racing engines of one-tenth this were yielding the same horsepower, while this year the ninety-one-cubic-inch engines are delivering 150 horsepower.

How did this happen? How is it possible for horsepower to go up as engine size goes down? The answer is better engine design. As engine size has gone down engine speed has gone up. The big engines of bygone days had a maxi-

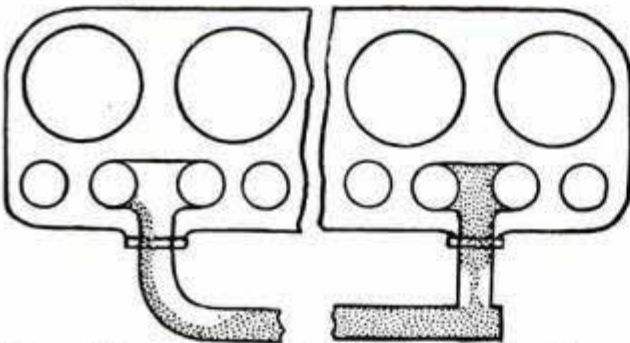

How a Better Mixture Is Obtained by Using Square instead of Rounded Gas Passages

mum speed of about 1,200 revolutions per minute whereas the racing engines in use today run at 7,000 revolutions. To run even a small engine at such enormous speed means that pistons, cylinders, connecting rods, crankshaft and all other parts must be carefully made of the very finest material. It means also that they must be most precisely balanced, bearings nicely calculated to stand the strain and lubrication must be unflinching.



Illustrating Combustion in Cylinders, from Left to Right, Too Lean, Correct Mixture and Too Rich

Probably the greatest problem in the modern racing engine is the valves. At 7,000 revolutions, each valve opens and closes fifty-eight times per second. The wonder is that they stand up at all at such terrific speed, and it is difficult in a long race. Each cylinder also has to receive fifty-eight charges of fuel each second. Experience has shown that the suction of the piston in itself is insufficient to adequately fill the cylinders in the fraction of time available. For such speedy work it is necessary to assist piston suction by adding a supercharger, which is nothing more nor less than a pump in the intake manifold that helps force in more mixture than the pistons can draw in.

Because of valve breakages at these excessive speeds several racing-car engine builders are experimenting with the two-cycle system. One car with such an engine was started in the last Indianapolis race. While it did not have the speed of the more highly developed four-cycle cars it gave promise of interesting results when the design has been more completely developed. For those who are not familiar with the two-cycle engine it may be well to explain the difference between the two-stroke cycle and the four-stroke cycle. In the latter, the piston makes four strokes for each explosion, two up and two down, namely, suction, compression, explosion, exhaust. In the two-stroke, the piston makes two strokes, one up and one down, for each explosion. The suction and exhaust strokes are eliminated. In its simplest form, the engine has no valves but the piston uncovers two ports or openings in the cylinder walls at the bottom of its stroke. One is the intake port and the other is the exhaust port. When the exhaust port is uncovered, some of the exhaust shoots into



Rubber Block Which Replaces Spring Shackles and Bolts, Needs No Oiling

it. An instant later the intake port is uncovered, and the mixture is forced into the cylinder, the incoming charge helping to force out the remaining exhaust gas.

Not only is the two-cycle engine appealing for racing because of the elimination of poppet valves, but also because it gives twice as many power strokes as the four-

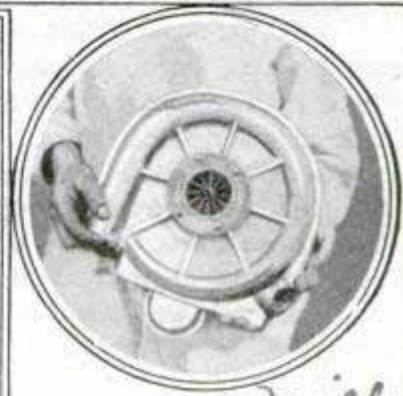
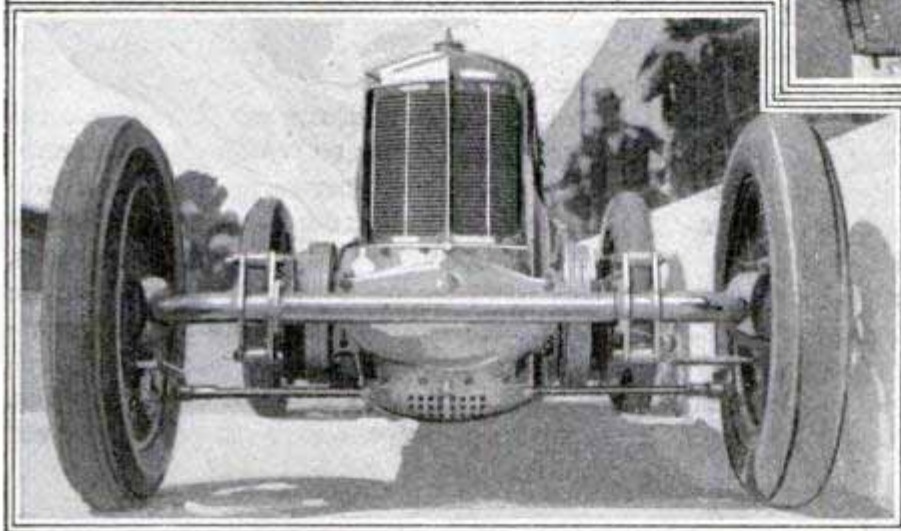
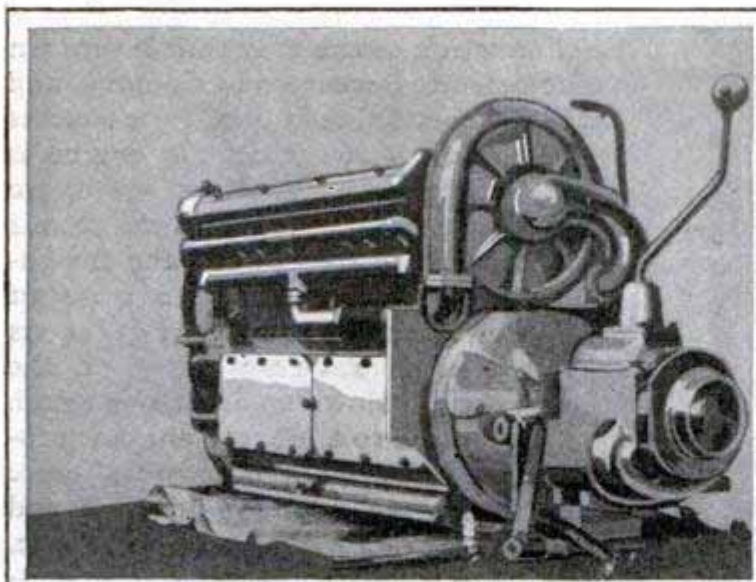

Courtesy of Motor Age

One of the Pigmy Front-Wheel-Drive Racers, Capable of Speeds of More Than One Hundred Miles an Hour; the "Blower" or Supercharger Is Shown at the Lower Right and the Motor Block Above

cycle engine, a feature that becomes increasingly important as engine size decreases. It is therefore of especial interest to learn that a well-known Italian automobile manufacturer has already built a two-cycle ninety-one-cubic-inch engine which has developed a speed of 11,000 revolutions, and yet even this does not seem to be the limit of engine speed.

In view of this, it would not be surprising if the ninety-one-cubic-inch four-cycle engines of the future developed double the speed and double the power of present engines, or 300 horsepower instead of 150. Then, if two-cycle engines are brought to the same standard of efficiency, this power will be doubled again, which means that 600 horsepower will be obtained from a ninety-one-inch engine.

If this happens, how large an engine would be required to develop thirty horse-

power? Such an engine would be one-twentieth the ninety-one-cubic-inch engine or four and a half cubic inches—about as big as a wine glass. This possibility is far in the future. It may never happen, yet the thought is interesting.

But what of the immediate future? Since a ninety-one-cubic-inch engine will yield 150 horsepower, is it not an interesting possibility for a high-grade, low-weight passenger car?

And if such an engine is suitable for a high-priced small car, why would not a little smaller, slightly slower-speed engine of similar design be ideal for a slightly smaller medium-priced car?

With such small engines, it would be quite feasible to build cars with bodies amply roomy for five passengers and still not have a wheelbase in excess of 120 inches. Weight, of course, would be

...and a market.

Dr. M. Constantine

M. Constantine at Paris

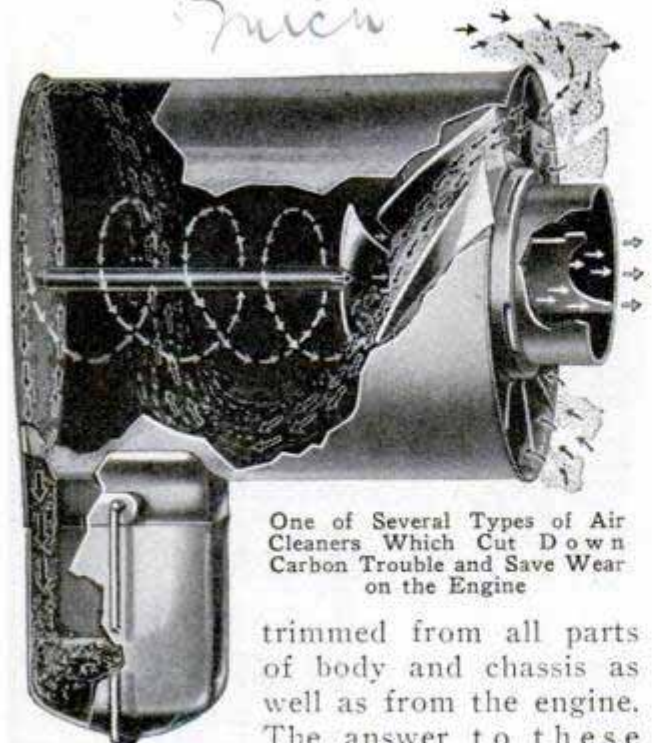

One of Several Types of Air Cleaners Which Cut Down Carbon Trouble and Save Wear on the Engine

trimmed from all parts of body and chassis as well as from the engine.

The answer to these questions, perhaps, has already been furnished by Europe. Over there are found stock cars with ninety-one-cubic-inch engines with top speeds of eighty miles.

There is some evidence that lighter cars along these lines will be developed in all price classes here in America and that these cars will be vastly more economical of fuel, oil and tires and will have even more ability than present cars.

Another important step in the offing is the elimination of the gear shift lever. An engine recently developed in England, and now in production, does this. The shaft is always engaged, but when the engine is idling, turning over at slow speed, no power is transmitted, and the car stands still. Step on the accelerator, and the engine speeds up and begins to transmit power, slowly at first, so that the car starts without a jerk. Take your foot off the gas, and the car slows up and stops again. When you come to a hill, the engine automatically speeds up and delivers more power, and when you top the rise and start down the incline it slows down again.

An equally important trend in this country is the movement toward better and more lasting bodies. Many closed car bodies wear out long before the engine, has outlived its usefulness. The reason is the constant strain to which they are subjected. One engineer has proposed a pivoted type of construction that will eliminate the body strains. Adjustable seats, back rests that slide up and down with the movement of the passenger's body, easier-operating clutches, and possibly compressed-air or other form of power brakes, all promise more comfort to the driver and passengers.

Morris Motors, Ltd. of Ford Ltd. Cowley, Oxford

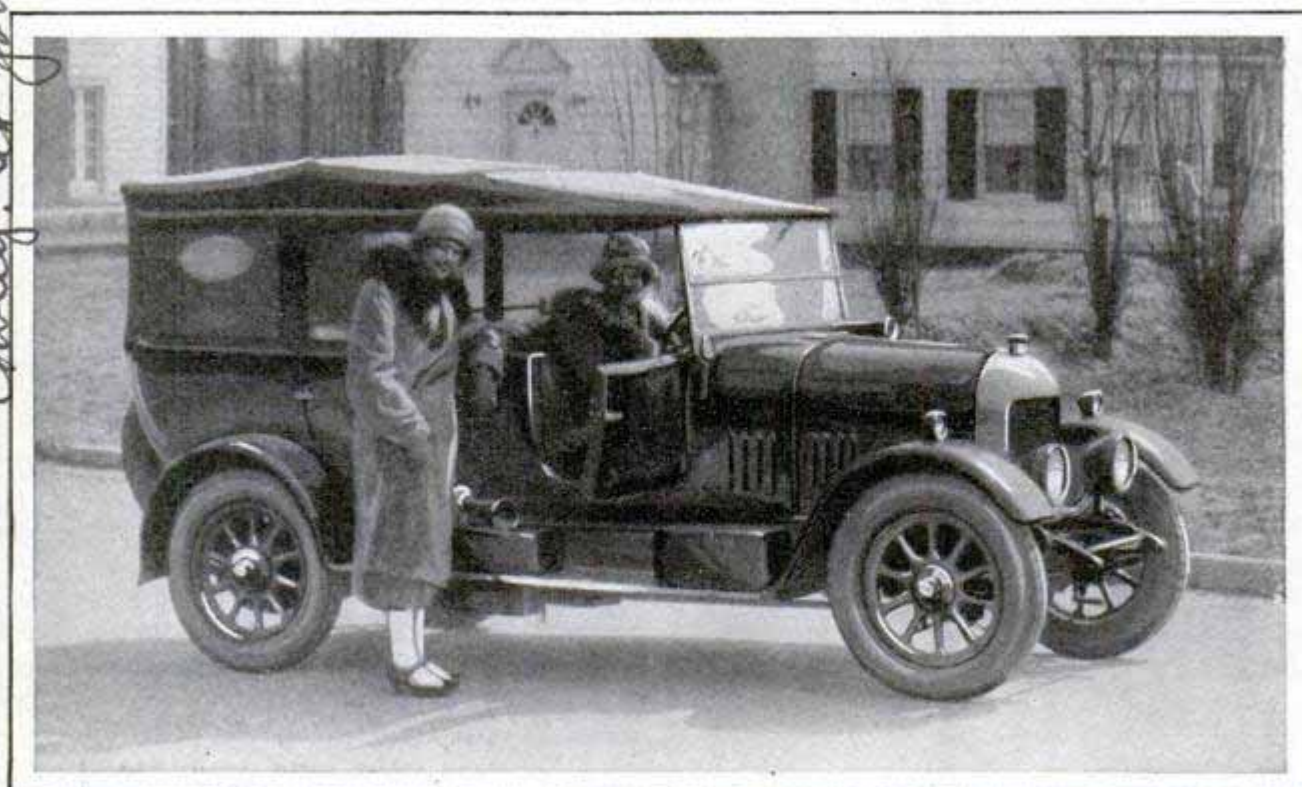

An English Light Car Capable of High Sustained Speed with a Small Motor, Which Is Notable for Its Great Economy of Operation

THE MYSTERY OF LOST COMETS

2526
 93
 Ensor's comet, discovered in 1925 and slated to return in the northern heavens early this year, disappointed the astronomers. It failed to appear, so the observers added it to the list of fiery travelers, that, like some ships of the sea, have been mysteriously swallowed up and never seen again. Biela's comet, found in 1826, kept a regular schedule for several years, then suddenly broke in two. The parts were last observed in 1852, but twenty years later, when the earth was crossing the path of the comet, a remarkable shower of shooting stars came from that part of the heavens which would have been occupied by the comet had it been visible. After Lexell's comet was discovered, in 1770, predictions were made that it would return every five years, but it was never seen again. It was the same with the comet found by Peters, in 1846, Stephens' comet in 1867, and DeVico's, which should have been visible in 1921 after an absence of seventy-five years, but could not be found. Two main reasons are given for these disappearances. The comets literally waste away or are thrown out of their normal course when they pass too near some great planet.

GOLDFISH AID ELECTRIC PLANT BY DEVOURING MOSS

1326
 Now the goldfish enters the ranks of man's dumb servants. Spray ponds where water is cooled at small transforming stations along electric transmission lines, are being kept free from clogging moss by stocking them with the sparkling fish. An interesting balance in numbers and food was maintained at one pond. When the moss was exhausted, some of the goldfish turned cannibals and devoured the others. The survivors kept the vegetable growth from accumulating around the nozzles.

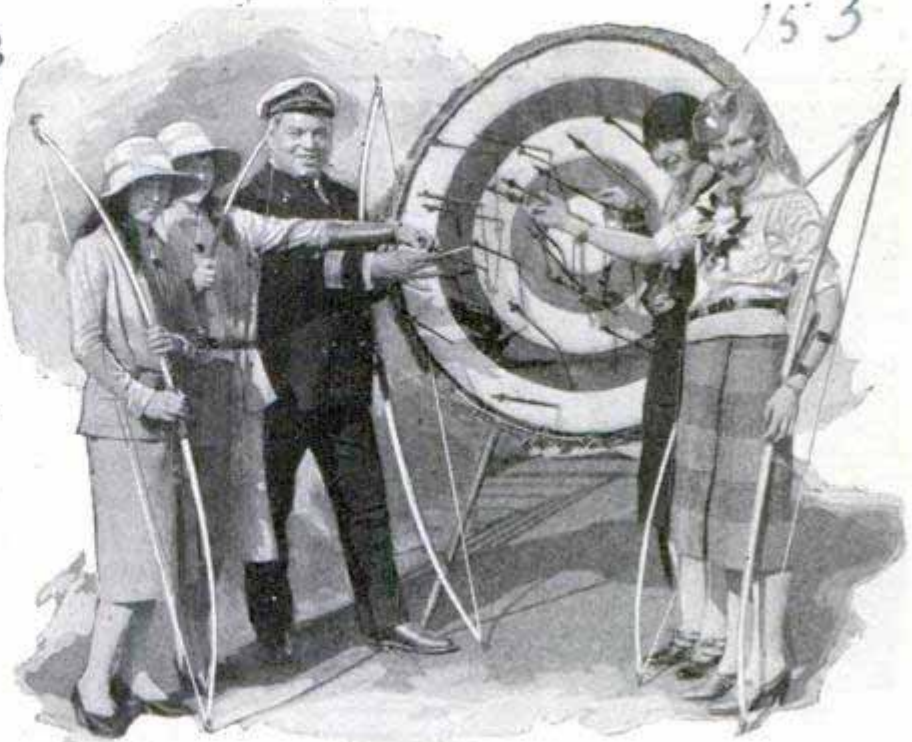

Instructing a Group of Happy Players in the Latest Ship Sport, Deck Archery; It Is Recommended as Means of Avoiding Seasickness

ARCHERY GAME ON SHIPBOARD LATEST DECK SPORT

Keeping the mind pleasantly occupied is recommended as a means of warding off seasickness, and one of the sports offered for this purpose is deck archery. The equipment is essentially like that used on land. A canvas backstop catches stray arrows. The sport is not an easy one even on land, and the movements of the ship afford additional opportunity for the archers to show their skill.

STEEL BRIDGING FOR JOISTS SAVES TIME IN BUILDING

292
 In place of wooden units, steel bridging between joists is said to save time in building, requires about half the

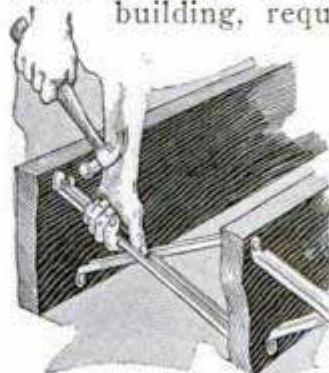

nailing and cannot split or crack. Furthermore, better floors are assured as the steel will not warp, and additional safety is secured as the bridging is fire-proof. The members are ready for installation, saving the time and expense of cutting and fitting.

270. Warrenton
 Chicago

General Products

**MICE DANCE IN MODEL "HOTEL"
TO AMUSE SPECTATORS**



Glass-Walled Model Hotel in Which Dancing Mice Caper for the Entertainment of Shoppers

To exhibit a collection of fifty Chinese dancing mice, a San Francisco man constructed a model hotel with a glass front and glass partitions between the rooms. Holes were cut through these walls. At intervals, the mice dash in circles in and out of the openings, causing great amusement.

**WHY GAY COLORS ARE
WORN BY JOCKEYS**

Few frequenters of the race tracks, watching the winning of a Derby, know that the brightly colored silk shirts and caps that the jockeys wear probably had their origin nearly 400 years ago and that the use of different colors is the result of a close race run in 1727 which the judges had difficulty in deciding as all three jockeys "rid in yaller." In 1530, King Henry VIII of England listed expenses of making doublets "for the running boys of the stabul," and for "ryding cappes of blac satin," an item paid to the "mylanner" (mil-

liner). From this record, it appears that the king was the first to dress his jockeys in colors. In 1762, thirty-five years after the confusing race in which the three yellow-clad riders participated, the Jockey club passed a resolution compelling owners to adopt jackets and caps of a particular color for their separate use. The custom has persisted since that date. The duke of Devonshire's straw-colored jacket and cap, selected then and still in use, have figured as winners in many a race up to the present time. Nowadays, if an owner runs a horse under colors other than those registered in his name, he must make a declaration of his plan to the clerk of the course before the race starts, otherwise he is subjected to a heavy fine.

**DERRICK AT FILLING STATION
REPRESENTS OIL WELL**

Patrons of a gasoline-filling station in an Ohio town may form the impression that the fuel is being pumped directly from the ground when they stop for a supply.

The illusion is effected by means of a replica of an oil-well derrick and walking-beam pump. This goes up and down as the gasoline is being forced from the storage tank into the glass dispensers in front of the station. The office is also built to represent a shack such as are commonly seen in the oil fields.

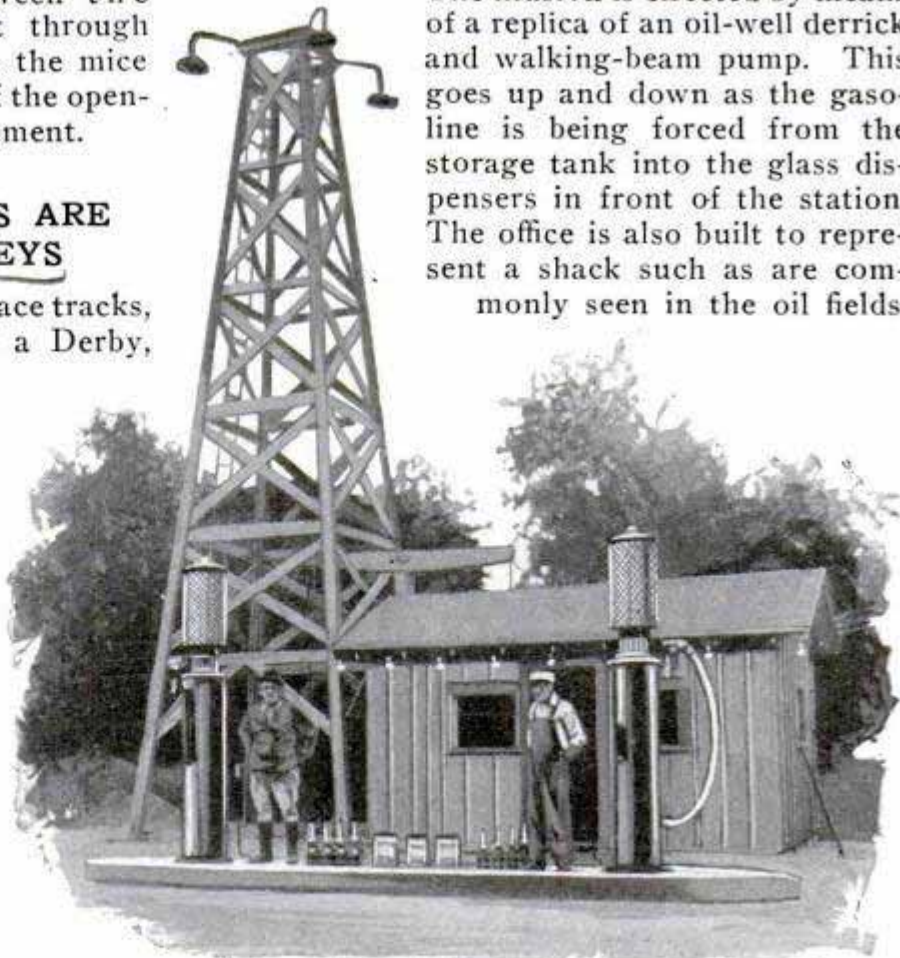

An Innovation in Filling-Station Architecture; the Derrick's Beam Pump Actually Runs When Cars Are Filled

Emb. Mrs. A. La. Coleman - Union City, N.J. 8315 Montgallent.

*South by L. B. ...
New ...*

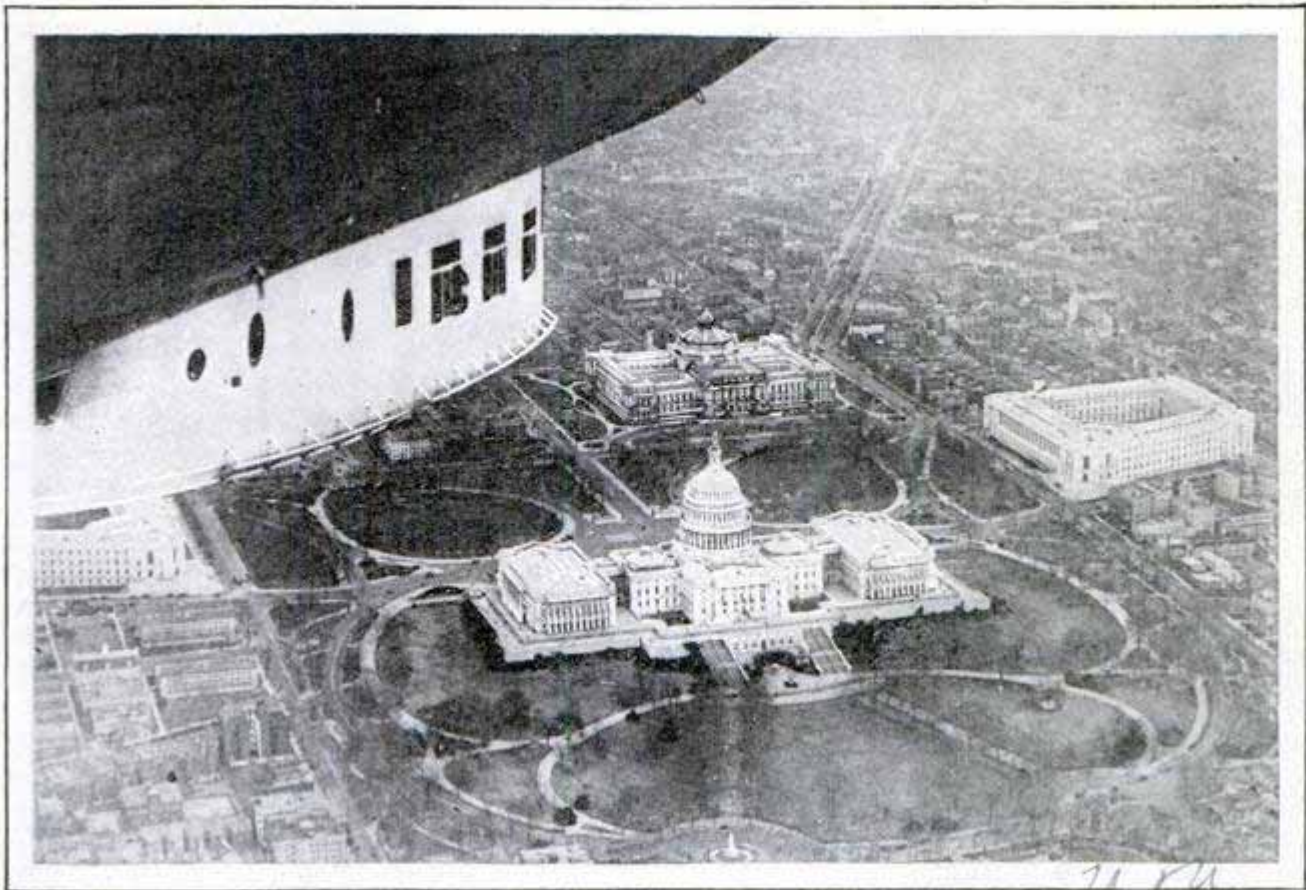

Looking Down on the Political Heart of America from the Dirigible "Los Angeles," Part of the Ship Showing in the Upper Left Corner; Low Altitude and Slow Speed Aided the Photographer

AERIAL VIEWS OF WASHINGTON SHOW CAPITOL'S POSITION

Keeping in mind the relative location of important government buildings in Washington has been simplified for the visitor by means of aerial photographs. Several taken by the navy department recently from the dirigible "Los Angeles" are considered especially informative, as the craft was not at a great altitude, and consequently details and landmarks in the pictures are more easily identified.

VIKINGS VISITED THE FAR WEST ROCK INSCRIPTIONS SHOW 32

That the Norsemen had been in America long before Columbus is further indicated by a story of a battle between Vikings and Indians, inscribed on a boulder near Spokane, Wash. The inscriptions were believed to have been the work of Indians, but recently, Prof. Oluf Opsjon, an authority on Norse history, translated them and declared them to be records in runic characters of a fierce struggle in which a party of twelve Norsemen had escaped from the red men after an equal number

of Viking warriors had been killed and six of the seven women captured. The survivors returned later and wrote the story. Many of the characters were covered with moss, and its removal is expected to reveal further inscriptions. The scientist places the incident at about 1010 A.D.

ELECTRIC CHURN FITS ON WALL PUMPS WATER AND TIRES 1599



Operated by electricity from a lighting socket, a churn that fits against the wall is out of the way when not in use, and is said to consume about one-tenth of the current used by an electric iron.

It may also be used for pumping water, for inflating tires, turning an ice-cream freezer, and for various other similar purposes.

The length of the stroke may be easily regulated without moving the churn.

Chicago Daily News

7/6/26

*W. J. Wick,
El Paso, Ark.*

Yvette J. ... Yacht Club ... breaks, kills ... Science Island ... NY



Launched with a Pat from a Monster Powder Puff; Scene at a Yacht Christening

POWDER PUFF FOR CHRISTENING REPLACES CHAMPAGNE

Boat-christening procedure was varied somewhat at an eastern launching, when the young woman sponsor patted a huge powder puff against the nose of a trim little yacht instead of breaking the formerly customary bottle of champagne. The novel departure was considered appropriate in preparation for a journey and several members of the boat club had voted against using wine.

HINGED "SKIRT" ON STREET CAR DEADENS NOISE

Constructed of light-gauge metal and lined with an insulating lumber, a twelve-inch "skirt" around the substructure of a street car in use in a Michigan city, is said to absorb much of the noise and also improves the appearance of the car, as it hides most of the trucks and wheels. It is on hinges so that it can be raised for

inspections. Besides this feature, the car has an insulated and rubber-covered floor and in the wheels are rubber pads which help deaden the noise.

METER FOR AUTO COMPRESSION 2202 SHOWS CAUSE OF LOSS

Loss of compression and the cause, whether due to cylinder trouble or valve leakage, are determined with a simple meter without dismantling the motor. The results are obtained by passing compressed air through the instrument and then on into the cylinder being tested and out through any leaks that may exist. The percentage of such loss is accurately registered on a gauge, enabling the tester to determine the size of the leak and to identify a scored, warped or otherwise faulty cylinder. To make examination for valve leakage, the procedure is practically the same, except that the top of the piston is sealed with heavy cylinder oil. Subtracting the amount of valve loss, if such is shown, from the total loss revealed by the first test, leaves the amount of piston leakage. The meter is simple to use, is easily attached to the cylinders after the spark plugs have been removed and has a signal whistle to indicate when the piston is beginning its compression stroke, the proper position for making the test.



Meter in Position for Use and View of Top of Instrument Showing the Registering Dials

Carroll by - St. Louis Car Co. 800 Broadway, N.Y. 110

W. J. ... P. and ...

Price \$50.00 ... Micrometry ... 1068



Behind the Scenes at the Zoo

Chimpanzee Rates Highest in Intelligence, While Elephant and Domestic Horse Are Tied for Second Place, with Lion Third

By FLOYD TAYLOR

IN one of the thick albums of Edwin R. Sanborn, official photographer, there is a fine picture of the deadliest snake in the New York Zoological society's collection, the jararaca-cu.

To get this photograph Mr. Sanborn spent an hour alone with the infuriated snake. The jararaca-cu is not accustomed to photography, and it is worth any man's life to go near it carelessly. It can strike two-thirds of its own length and its victims have only from ten minutes to half an hour to live unless anti-venom serum can be secured. Twice Mr. Sanborn was within range of the snake, within about three feet of it, when it hurled itself toward him and buried its fangs in the camera cloth as he stepped aside. Mr. Sanborn paid little attention to the snake's hisses. For twenty-five years he has been photographing everything from elephants to little ground hogs, and he has taken about 5,000 pictures of birds, animals and

reptiles, including those of the most deadly snakes and the most ferocious beasts.

An hour passed while the jararaca-cu rippled on the floor. Occasionally Mr. Sanborn clicked the shutter of the camera and then changed the plates. Finally he was satisfied, and the snake was put back in its cage while the photographer developed his pictures.

John Toomey, head keeper, says that the only safe assignment in the zoo is caring for the lions, tigers and other jungle cats. The cages of these are divided in two parts and, while a keeper works in one, the cat is in the other.

"There are marks on several of our keepers," he said, "which prove their work is dangerous, with more risk in it than might be supposed. Animals that have been quiet for years will make a sudden attack and the keeper is unprepared.

"In certain months the animals are more dangerous than in others. Elks are likely

to be troublesome from August to February, their mating season, when their antlers are tough and pointed, and they resent the intrusion of the keepers. I have seen an elk plunge against the gates with enough force to knock them from their hinges. The buffaloes must be watched carefully. Their method of attack is peculiar. With their great power and surprising speed, they roll men along the ground with their heads, bucking viciously. I recall at least two instances of

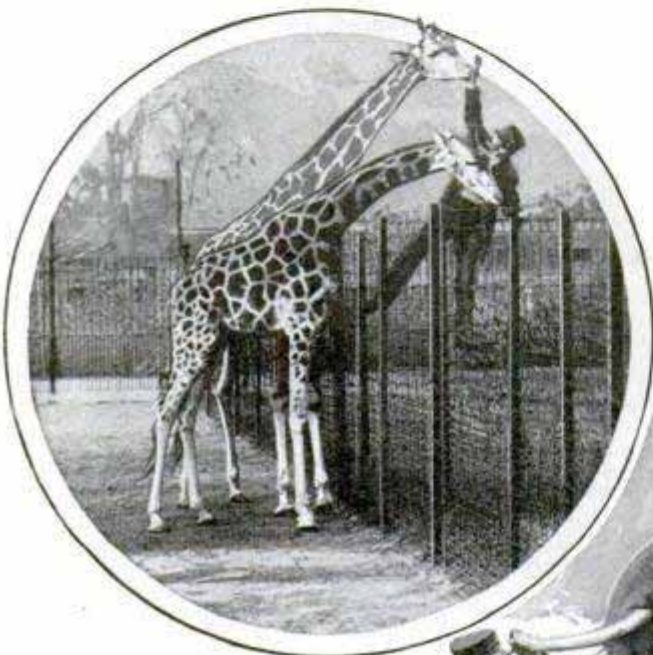

The Keeper Has to Climb High to Get the Giraffe to Hold Up Its Head While the Photographer, in the Paddock, Snaps the Picture; at Right, Two Tons of Elephant Is Being Posed

keepers who have been savagely mauled by buffaloes. To do any work in a bear's cage, it is necessary to drive the bear up on the rocks in the back of the cage. One of our men, while in a cage, turned to find a gigantic brown bear leaping on him. He threw up his hands and attempted to dodge past the bear. He got by, but his hand was badly cut. Gangrene set in, and it had to be amputated.

"After the animals have been in the zoo for a time, they are less dangerous than when they first arrive. When they become used to their surroundings and find the keepers have no intention of harming them, they can be approached in comparative safety."

The biggest eater in the zoo is the African elephant, "Khartoun." It weighs 10,000 pounds and every day consumes 125 to 150 pounds of hay, thirty pounds of carrots or beets, fifteen loaves of bread, and drinks ten to fifteen gallons of water. "Alice," its companion and rival for eating honors, drinks water directly from the hose and thus conceals her gallon capacity. The hippopotamus manages to live and prosper on a ration of 100 pounds of hay, ten loaves of bread and ten heads of cabbage or a similar quantity of beets.

The menu for the zoo includes 120 varieties of food, and there are consumed during the year 100,000 pounds of meat, 75,000 pounds of bread, 35,000 pounds of fish, 2,000 dozen eggs, 3,000 quarts of fresh milk, 1,500 quarts of condensed milk, 15,000 bunches of bananas and seventy cases of oranges. The monkeys start the day with oranges, bananas and apples and, for dinner, drink a punch of milk and eggs. The eagle and the vulture get a pound of

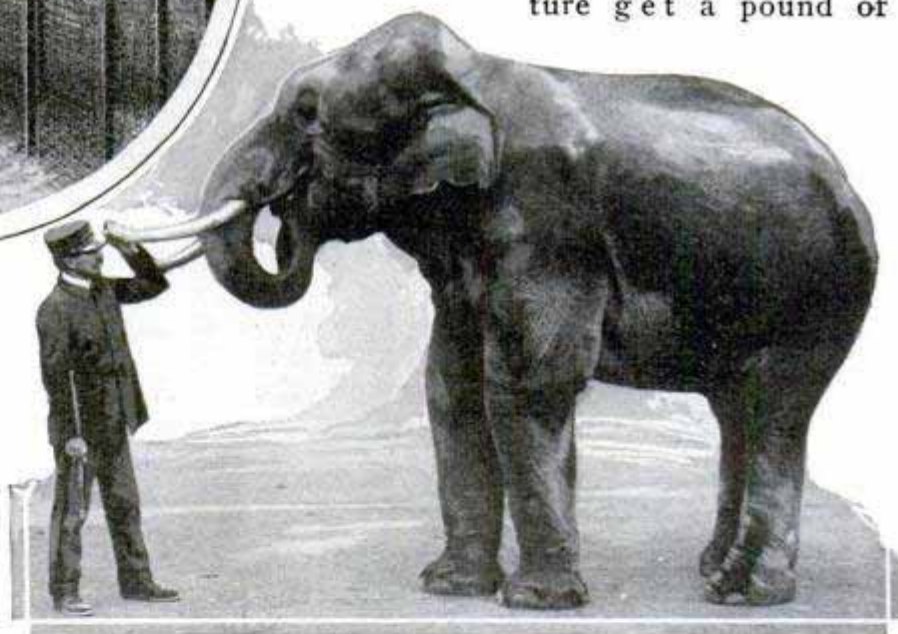

meat a day a piece, and the ostrich has half a peck of lettuce or crushed oats.

The python, which is twenty-two feet six inches long, supports its length on a dinner once a month of thirty to fifty pounds of mice, rats, chicken and guinea pig. A meal for it costs \$8. The sea lion thrives on seven pounds of fish a day.

Pythons are cheap; they can be obtained for from \$300 to \$400 a piece. Macaws bring from \$300 to \$1,200. "Khartoun," who was bought for \$1,200 when it was very young, is worth \$25,000 now

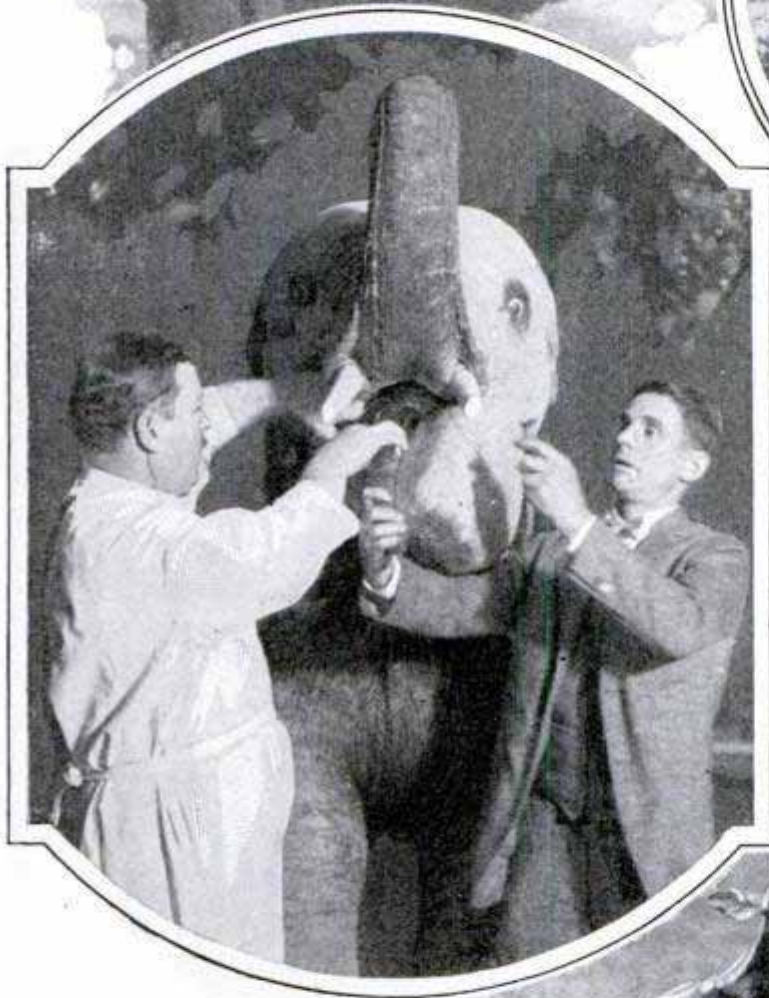

Asking a Ton of Hippo to Open Its Mouth, So the Photographer Can Get a Nice Picture of Its Teeth, Is Only One of the Jobs a Keeper around the Zoo Is Called On to Perform; in the Circle, a Russian Brown Bear Is Being Persuaded to Stand Up Nicely on Its Hind Legs and Act Friendly While the Cameraman Clicks the Shutter; from Constant Handling Many of the Wild Animals Become Quite Tame



The Dentist Who Undertakes to Cure an Elephant's Toothache, Acquired from Eating Too Much Candy and Peanuts, Literally Has His Hands Full While He Fills a Pachyderm-Size Tooth; Above Is a Mule-Deer Fawn Being Raised on a Bottle at the Bronx Zoo in New York; Keepers Must Know Many Things, Including How to Be a Mother to Young Animals

that it is full-grown. Ostriches cost from \$25 to \$500 a pair, eagles and vultures from \$10 to \$200 a piece; birds of paradise from \$200 to \$1,000, an Indian rhinoceros \$8,000, and pygmy hippopotamuses about \$5,000.

Dr. William T. Hornaday, former director and general curator of the zoo, says the chimpanzee is the most intelligent animal in his care. In the scale of intelligence, he gave the chimpanzee 925 points, the Indian elephant 850, the domestic horse 850, the lion 725 and the rhinoceros 175. The zoo's smallest mammal is from Egypt. It is the jumping rat, or jerboa, which looks like a miniature kangaroo. The smallest bird is the strawberry finch and the rarest mammal the giant tapir, which is only a third grown and weighs 800 pounds. It was captured in Panama.

One of the most difficult tasks in the zoo is that of Dr. W. Reid Blair, who cares for sick and injured animals. He often has to treat monkeys for tuberculosis and sea lions, which were brought to the zoo from the frigid waters of the Pacific, for pneumonia. The tiger sometimes gets a toothache and the elephant develops enor-

mous corns, which must be trimmed. The delicate bones of the deer and antelope are snapped as they race in their fields and must be set as carefully as the fracture of a man's leg.

The more hardy animals at the zoo live in the open all the year round, and herds, like those of the buffalo and wild horse, have large pastures. In the winter, the tropical birds live in a steam-heated house.

Mr. Hornaday says most of the animals are as happy as a man, who had struggled for years to make both ends meet, would be if he was suddenly installed in a fine hotel where someone else paid his bills.

"Care given to the animals," he said, "extends the life of many of them far beyond what they would expect in the merciless jungle. One of the leopards lived to the ripe old age of twenty-one. It had not a tooth in its head at the last, to be sure, but it was kept alive all the same with plenty of chopped beef.

"Then there is our polar bear, 'Silver King,' now twenty-three years old. It is hardly conceivable that it could have lived so long had it been left to face its enemies and the rigor of the Arctic winters."

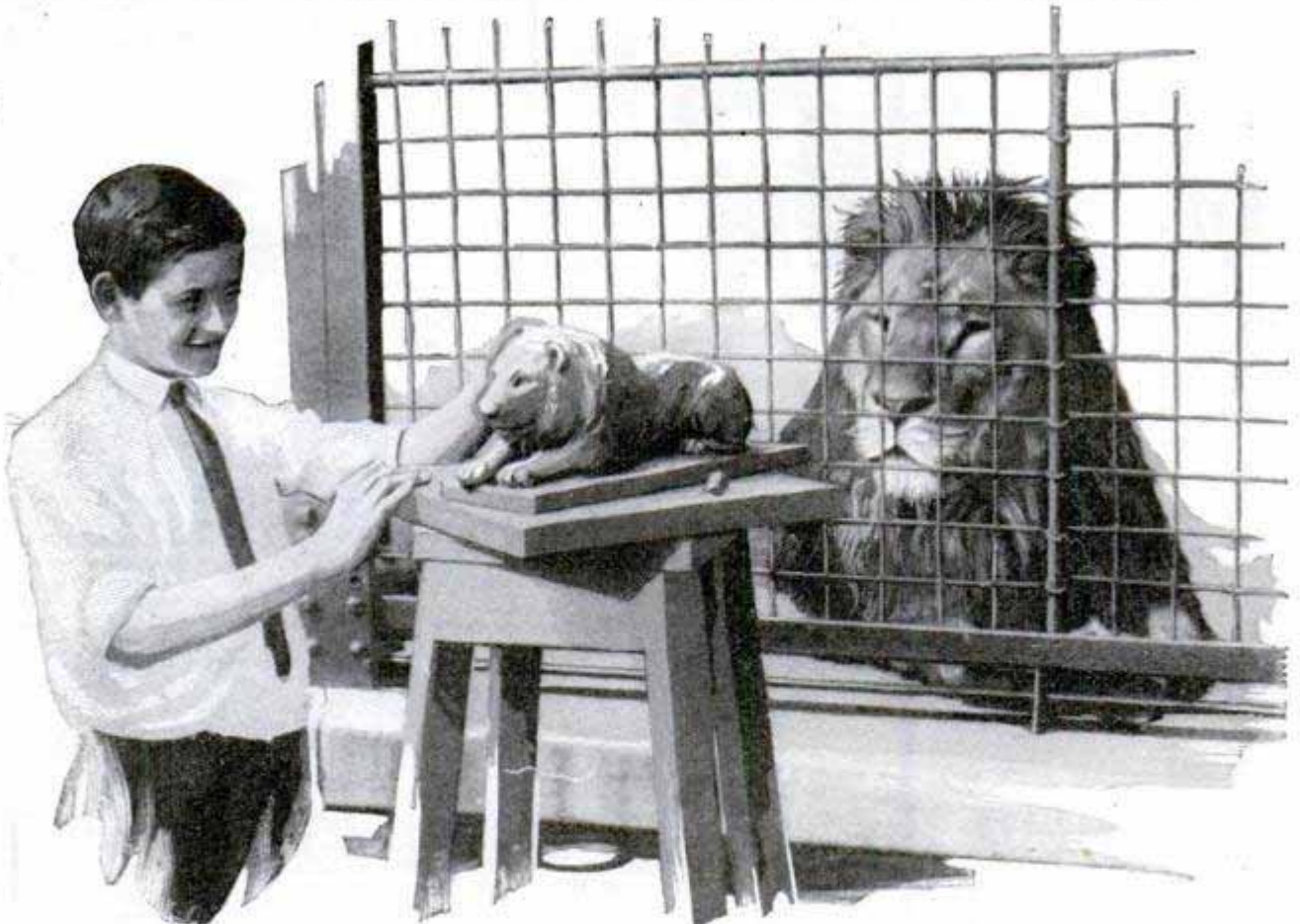

An African Lion, as Much Interested in the Work as the Young Sculptor, Who Is Trying to Perpetuate Him in a Plaster Model, from Which Bronze Ornaments May Later Be Cast

Capt. Herbert Beardley, Fairchild Ave.
 Newark, N.J.

PLANES HUNT BUGS TO CURB PLANT DISEASE

25

Bug hunting by airplane, to help rid the country of plant pests, such as rust, enemy of wheat crops, and other diseases is proving effective. On a wing of the plane is a little box containing glass slides covered with vaseline. As the ship rushes by, dust particles are collected on the surfaces and after landing, the hunters, who are trained scientists, seek through the "catch" for the little spores, the parasites that lodge upon wheat stalks and take the moisture and soil food that the grain needs. One of the objects of the hunting is to find out how far the spores travel and where they start. Planes are up on suitable days all the way from Texas to Minnesota. Already the hunters have found that the barberry bush is a prolific breeding place for rust. It is said that one bush in Indiana cost the farmers within a radius of fifteen miles a loss in crops of \$12,500 a year. The spores are only one five-thousandth of an inch in diameter, travel at high altitudes and with the speed of the wind. This season, the aerial bug seekers were anxious to find out if the rust which had appeared in Mexico and in Texas had traveled as far north as Minnesota.

Article by Lorena A. Nichols, Minneapolis Sunday Tribune 7/4/26

The Popular Mechanics' Bureau of Information offers its free service to all readers of our magazine. Names and addresses of manufacturers and dealers in articles described, and any other details in our possession will be promptly furnished.

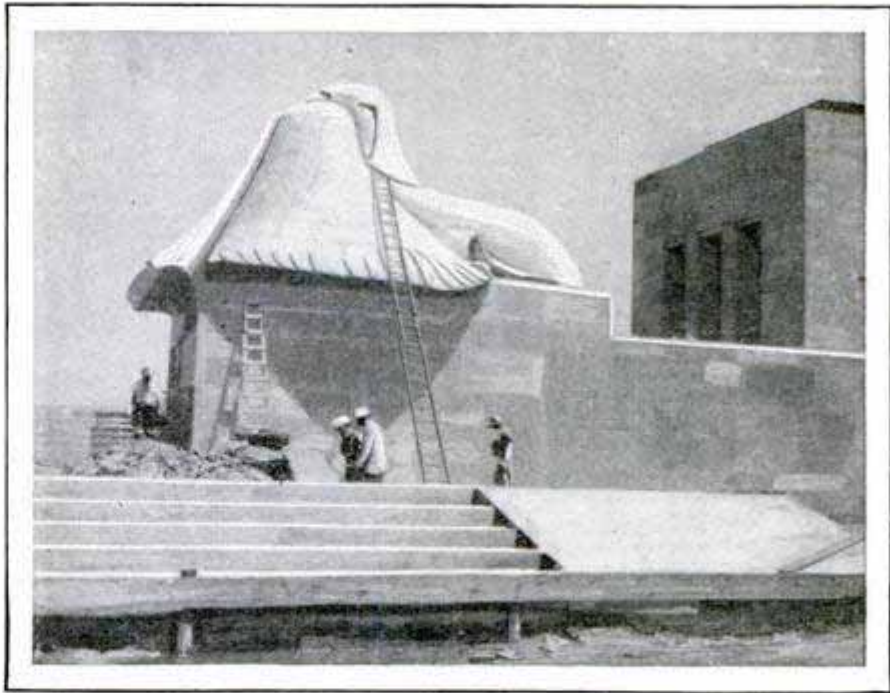

Adaptation of an Ancient Egyptian Figure to a Modern Monument; Veiled Sphinx at Base of World War Memorial in Kansas City, Missouri

SPHINX UNDER VEIL OF GRIEF GUARDS WAR MEMORIAL

Veiled under a shroud of stone as though in perpetual grief, the figure of a sphinx has been carved at the base of the memorial to soldiers of the World war in Kansas City, Mo. The emblem was chosen as expressive of eternity and mourning.

HOLES FOR SWITCH BOXES CUT IN LESS THAN A MINUTE

2269

Driven by an electric drill or a hand brace, a cutter for making wiring outlets in plaster or wood, is said to finish a hole for a switch box in less than a minute when the drill is used and in about three minutes with the brace. The operation is performed by four saws placed in such a way that each one cuts one side of the opening. The tool is attached to the wall at the place where the hole is wanted with screws and then the drill or brace connected.



Cutter Used with Hand Brace, and Opening Made in Wall for Electric Switch

Handwritten notes: "quadro ngle Corp. 114 Maiden St. New York"

BRIGHT WRAPPING SELLS GOODS

64

Exporters have found that the color of the labels on their merchandise is an important factor among peoples of several foreign countries. In West Africa, wrappings with gaudy pictures of birds, beasts and fish help sell cloth. The Hovas of Madagascar prefer guns with highly ornamented stocks and bicycles painted with bright aluminum. South American natives are also fond of gold and silver paint. Chinese are particular in regard to colors. Green and white to them are indicative of mourning and must be avoided on packages, but red, yellow and gilt papers are popular, as they are also in India. Chinese buyers are especially concerned about tinned goods and will reject a whole shipment if a label is blemished, it is said.



Borah and Hagenlacher at the Starting Line; the Billiard Ball Led at First, but Was Beaten at the Finish

SPRINTER RACES BILLIARD BALL IN NOVEL SPEED CONTEST

Can a sprinter run faster than a billiard ball rolls from the stroke of a champion player? To answer the question, Charles Borah, freshman at the university of southern California, pitted his speed against that of a ball driven by Eric Hagenlacher, balkline-billiard champion. The distance was seventy-five yards. For three-quarters of the way, the ball was in the lead and then friction got the best of its momentum, allowing Borah to finish ahead.

METAL STRIP TO HANG PIPE OF ALL SIZES

For hanging lengths of pipe from ceilings, steel tape, in handy reels of 40 or 100 feet, can be adjusted to fit conduit of any diameter, eliminates waste and requires no bolts. It is looped around the pipe, bent so that the end can be drawn through a narrow slit in the strap and secured by means of a cotter pin inserted through the two holes along the edges of the tape.

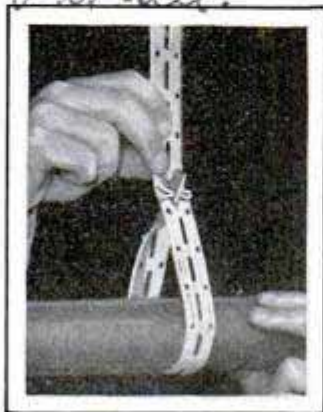

SAFETY RAZOR THAT FOLDS UP FITS VEST POCKET

17/0

With finger grips instead of an ordinary handle, a safety razor that can be slipped into a small leather case and carried in the vest pocket is a convenience while traveling. The grips fold flat when not in use, and are placed close to the cutting edge to steady the razor while shaving.



WHAT BECOMES OF OLD TIRES YOU THROW AWAY

57

Thousands of discarded automobile tires are purchased from garages and shops and sold to vulcanizers or rebuilders at prices ranging from fifty cents to \$5 each. Boots are made from old casings and some revenue is obtained from tire fabric of suit-

*Consolidated Steel Strapping Co.
2600 N. Western Ave.
Chicago*

*7:30 pm
newly
72 machine
Empire Station Co.*

*Chicago
7:17/26*

Chicago What is the Most

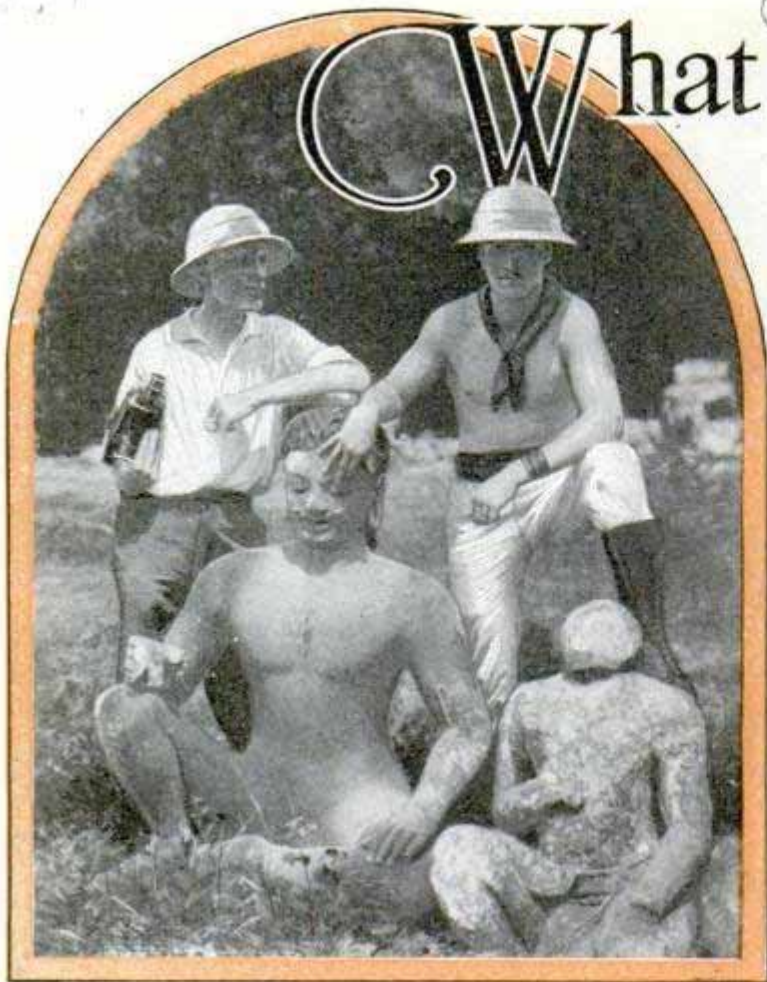

Statue of a Leper King. Seated, the Only Life-Size Human Figure Found among the Ruins of Pnom-Pher, One of Asia's Mysteries

AT Angkor, in Cambodia, a province of French Indo-China, are the ruins of the Khmers—a vast, lost city which once held more than a million people, who disappeared, where and when no man knows, and left not the slightest trace of their destination behind.

That, says Burton Holmes, the great travel lecturer, is the greatest sight on earth today, and so he puts it at the head of his list of the seven most marvelous things he has seen.

Yet six times as many people crowded in to hear Burton Holmes tell about Switzerland and show pictures of the same scenes they had read about and seen pictured for years as came to hear him tell about the lost city of Angkor.

The reason, says Mr. Holmes, is that people prefer to hear and see the things they have always heard and seen, since it is to the places already known that most of us dream of going. Nobody, virtually, knew anything about the ruined city of the Khmers, and when the lecturer came back from a trip into the jungles of Cambodia with reels of movies and a vast store of fascinating information, he discovered

that not many people cared to know about it.

Burton Holmes has spent most of every year since 1892—when he was twenty-two years old—traveling around the world as deputy eye for the folks at home, and in his thirty-four years of travels he has covered more than three million miles outside of the United States, in addition to a vast mileage piled up at home during his winter lecture tours. He has seen every civilized country and practically every uncivilized one, and probably knows every nook and corner of the globe better than any living man, or any man that ever did live, since his occupation is, or at least once was, virtually unique.

Out of his thirty-four years' experience he compiled for Popular Mechanics readers a list of the seven greatest sights he has ever seen. One of the seven is in the United States—the Grand Canyon of the Colorado—and he puts it fourth on this catalog of wonders.

First of all come the ruins of Angkor—a vast city of magnificent stone buildings that have stood empty and alone in the midst of the jungles since their inhabitants, for some unknown reason, went away some eight centuries ago, never to return.

Second he puts the pyramids of Egypt, probably the most familiar man-made monuments in the world, and follows



Chinese Boatman Sculling His Craft through the Rapids Just Below Gorge of the Yangtze-Kiang

Interesting Place in the World?

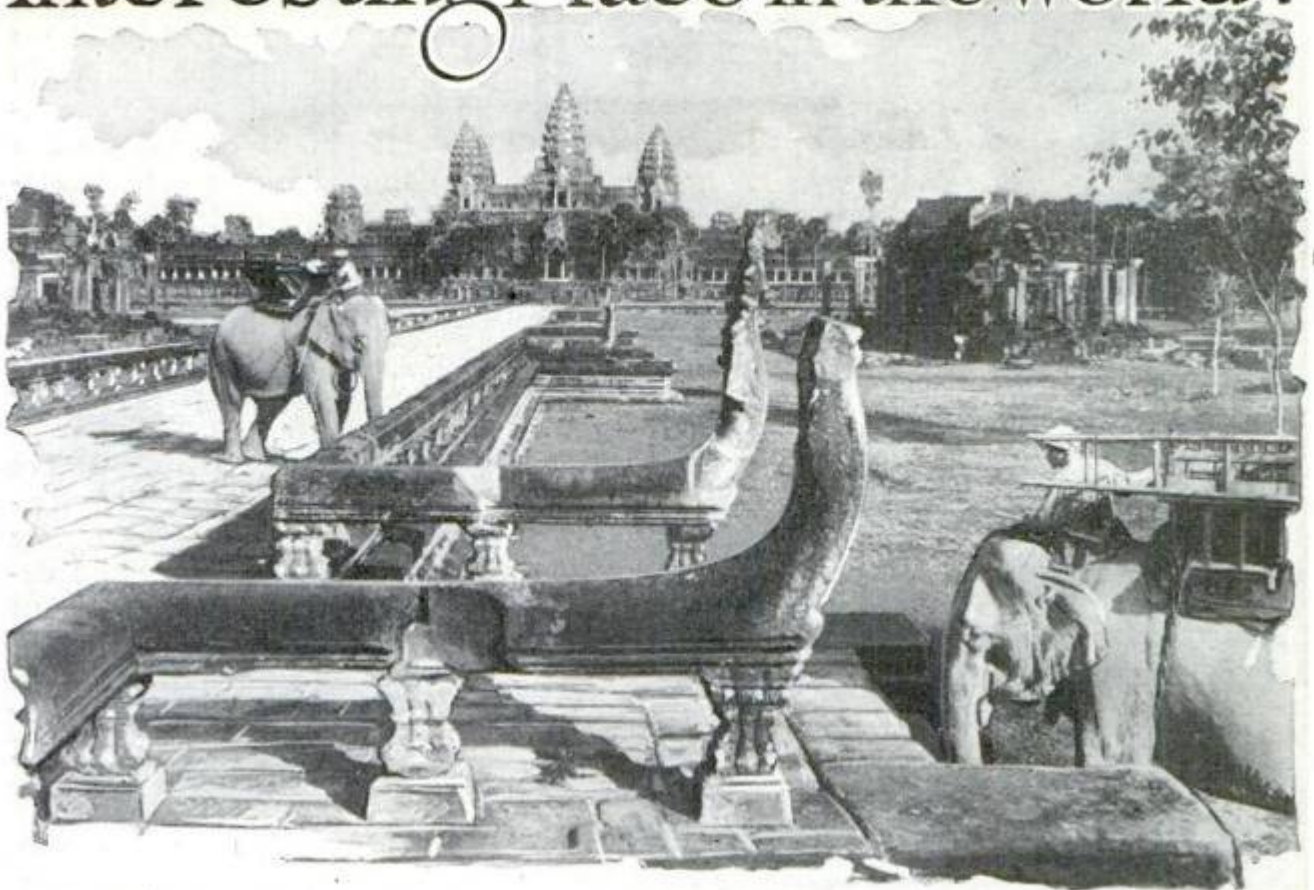

Ruined Palace and Gardens of the Khmers at Angkor, Cambodia, Who Disappeared, with a Million People, When and Where No Man Knows, Leaving the World's Greatest Sight Behind in the Jungle

them with the Taj Mahal, acclaimed by artists and architects as the most perfect building ever erected.

Fourth is our own Grand Canyon, and fifth the little known Meteora monasteries, parked atop the granite cliffs overlooking some of the deepest gorges in all Thessaly. Sixth, he selects the shrines of Nikko, Japan, with their incomparable gateways—architecture well-nigh as perfect as the Taj Mahal, which also is a shrine, built by an Indian prince in memory of his queen.

Last come the gorges of the Yangtze-kiang, China's most famous river.

Of his seven greatest sights, one, the great pyramid of Cheops, is the only survivor of the famed seven wonders of the ancient world. The biggest and costliest tomb ever built, taking the work of 100,000 men for twenty years, it remains today a marvel to engineers because of its mathematical perfection. Standing originally 481 feet high, with a base measuring 755 feet on each side, engineers have been able to find an error of only sixty-five hundredths of an inch in the base and one three-hundredths of a degree in the angles of the corners.

The Nikko shrines of Japan, covering a vast forest tract, with one of the world's most beautiful roads leading for twenty miles to the incomparable temple gates, are a memorial to two great warriors, Iyeyasu and Iyemitsu, once masters of Japan, but now gods. The two are the Caesar and Napoleon of Japan and in the three centuries or more that have passed since the great collection of shrines were laid out the setting has become one of the most beautiful in the world. The Yomeimon, or "Gate of Beauty," a thing of indescribable grandeur, commonly called by the Japanese the "sunrise to sunset" gate, because, they say, it would take fully that long to examine all of its marvelous carvings, is the gem of the shrines. Beneath the spreading eaves of a tiled roof, hundreds of furious beasts, dragons, lions, doglike creatures, "a sculptured nightmare," as Holmes describes it, is heavily overlaid with gold and lacquer, the inch or more of gold at places giving the effect of solid metal. Side by side with the grotesque creatures are beautiful gate panels that seem to actually bloom with gorgeous chrysanthemums and a maze of

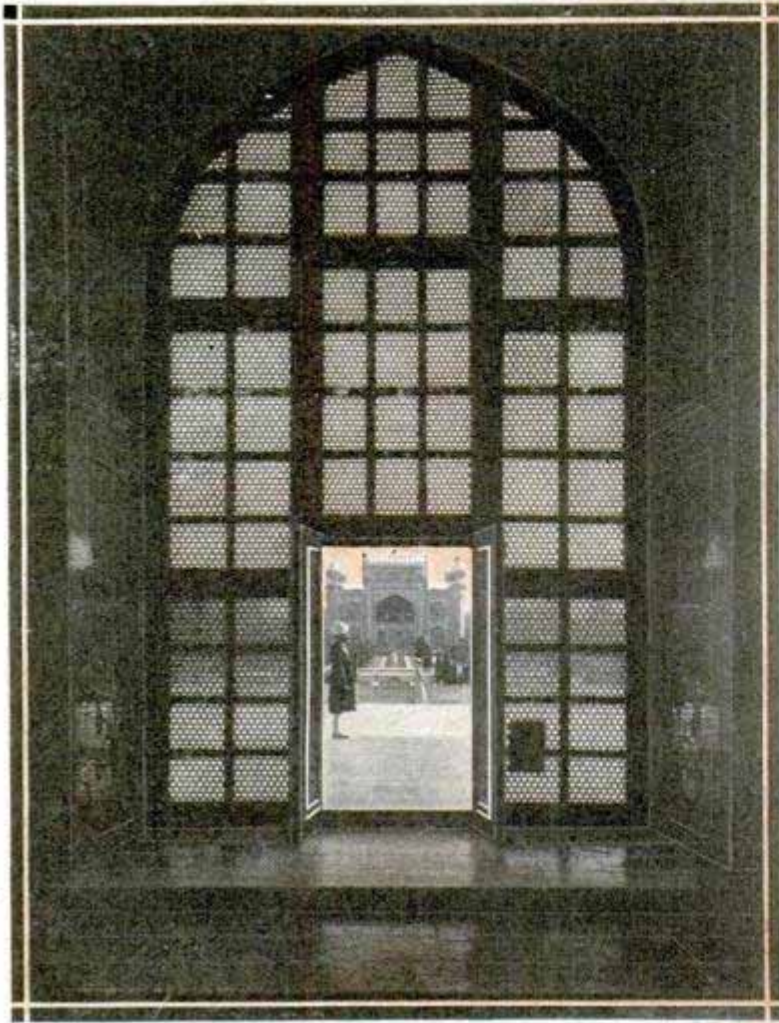

© Publishers' Photo Service

Looking Out through the Marvelous Carved Marble Door Screen of the Taj Mahal, at Agra, India, Above, and the Taj Itself, at the Right, Famed as the World's Most Beautiful Building

delicate tracery. The workmanship is so perfect that no hidden defect has ever been found, but on one pillar the artists deliberately inverted a design and carved it upside down, stopping short of perfection out of deference to Heaven, and to avoid the jealousy of the gods who might be aroused by such a perfect piece of art from the hands of men.

Like the ruins of Angkor and the Japanese shrines, the monasteries of Thessaly are little known in this country. Perched on jutting crags, high above deep and dark valleys, they are one of the last surviving relics of an age when safety lay only in seclusion. To reach many of the group of buildings it is necessary to be tied up in a net and hauled aloft on a

rope lowered by the monks above. The principal buildings stand, apparently, on islands in mid-air, while all along the canyon sides, high out of reach, are the deserted caves and bird-nest-like dwellings once peopled by the hermits of the Middle Ages, when hermit hunting was a fashionable sport among the Turks and no one was safe if his home could be reached by anybody else.

Lecturing every winter before thousands of his fellow Americans, Mr. Holmes has accurately indexed their interests and desires. First, he says, they want to know about the countries of Europe, especially those they have visited or hope some day to see. To see, in the travel

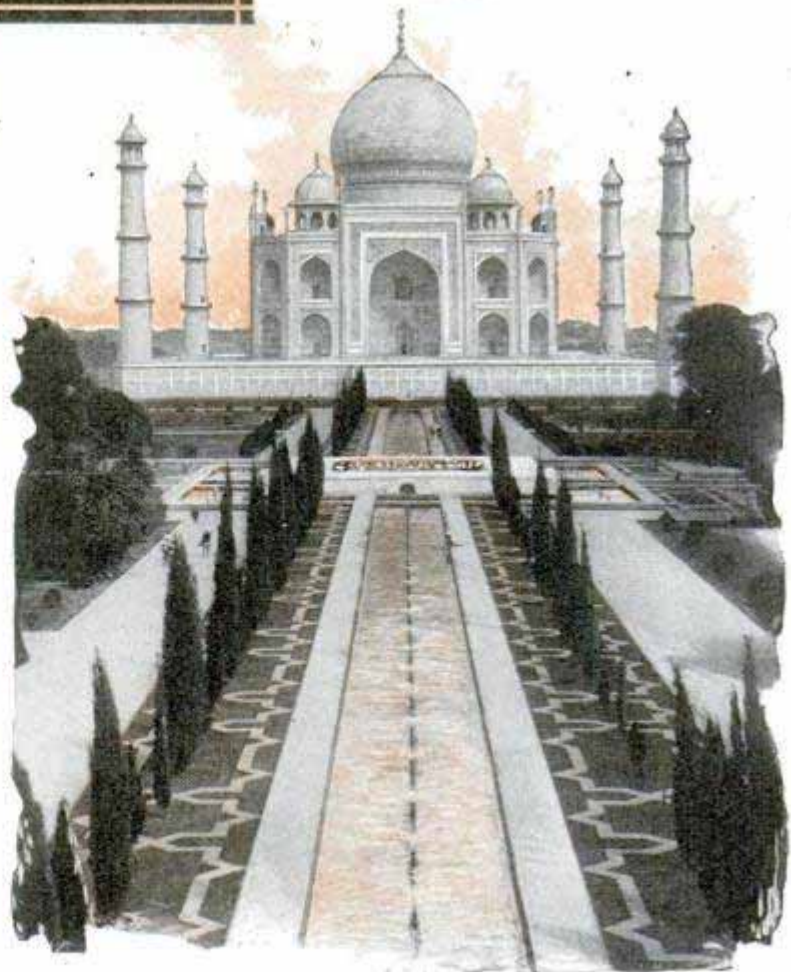

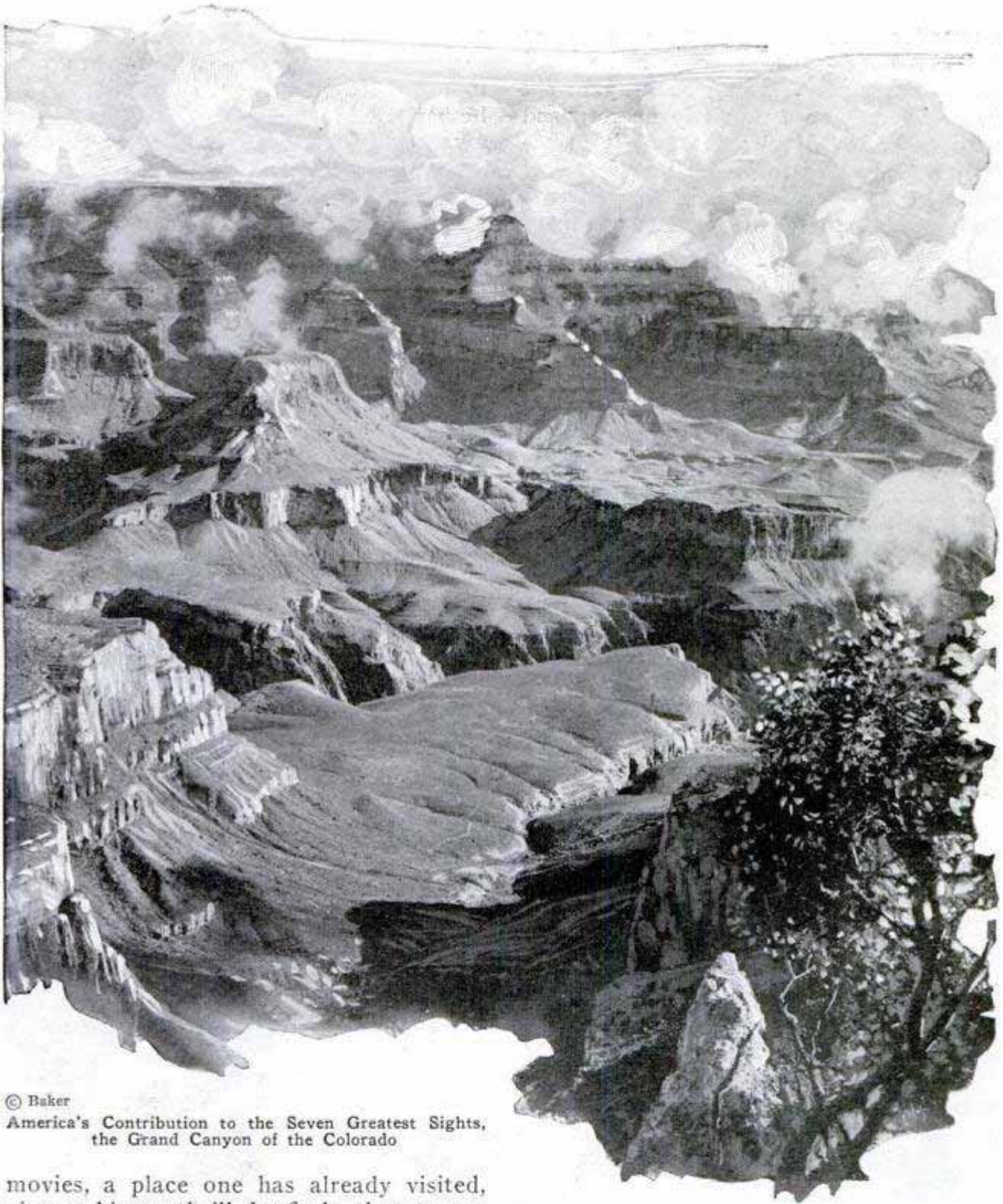

© Baker
America's Contribution to the Seven Greatest Sights,
the Grand Canyon of the Colorado

movies, a place one has already visited, gives a bigger thrill, he finds, than to see the film of some country one never expects to visit.

His own choice, after trying them all, is Japan in the Orient and Italy in the Occident. Climate, customs and a wealth of beauty spots dictate his selection. He likes Japan, the Japanese and their habits so well that he has adopted Japanese dress—kimono and sandals—for his private life and only turns to European clothes when appearing in public. His studio in New

York, where he makes his home for the few days or weeks he can spare each winter from his lecture tours, is filled with works of art from all over the world, but Japanese treasures predominate.

He picked the pleasant occupation of wandering around the world looking at things for other people more or less by accident. "I wanted to lead the carefree life of a millionaire," says Holmes, "but I lacked the wherewithal, and so I became

13 41
 a traveler and have been at it ever since." Born in Chicago in 1870, he had visited Europe at sixteen, going back again six years later. From that trip he returned with a wealth of pictures and information, and decided to give a lecture about what he had seen. It paid so well that he collected enough to go back again.

"It is ever fascinating to me," he says. "Japan always gives me pleasure, because, while it is now civilized and clean, yet it is totally different from anywhere else in the world. When I go to a foreign land I practice the Pierre Loti fashion of expatriating myself, living the lives of the natives better to understand the country. Above all places I think I should choose Italy and Japan in which to live, dividing my time between them. They are so good to look at and always refreshing and beautiful. Here in America we spend millions of dollars for carefully designed facades, and even then do not overcome ugliness in the skyline. There are more natural pictures for the eye in Italy than perhaps anywhere else in the world."

In his more than a third of a century of wandering he has been in more out-of-the-way places than a school geography de-

scribes, yet he claims never to have had any particularly thrilling adventures, and to prove his claim points out that, while he has lived on railroad trains for several months of the year, he has never been in a wreck, and that twice when ships on which he was to have sailed were lost at sea, something had come up to prevent his being aboard.

Yet in 1901 he crossed Siberia in forty-two days, before the railroad had been built. It took twenty-seven days to make 1,300 miles on river steamers, and thirty-six times when the boat stuck on sand bars, the passengers had to get out and help push it off, while, in between, they slept on crowded decks and lived mainly on quantities of tea.

As a war correspondent he was caught in the Italian front lines by an Austrian barrage, and escaped uninjured, only to find, when he returned to his car, that it had been blown to pieces by a shell landing far behind the lines. A few months ago, touring the battle fronts in Morocco, he heard bullets whiz by, but the guide explained there was no particular danger since it was only natives taking pot shots at the party because they were Christians.



Only One of the Seven Wonders of the Ancients Still Survives, the Great Pyramid of Cheops, in the Center, Which Holmes Places Second on His List of Wondrous Sightings

1547



© Newman

Above is the Yomiemon, or Gate of Beauty, of the Japanese Shrines of Nikko, a marvelous piece of gold-lacquer work, called by the natives the "Sunrise to Dark Gate" because it takes all day to admire it; below is one of the monasteries on the rock islands of Thessaly.

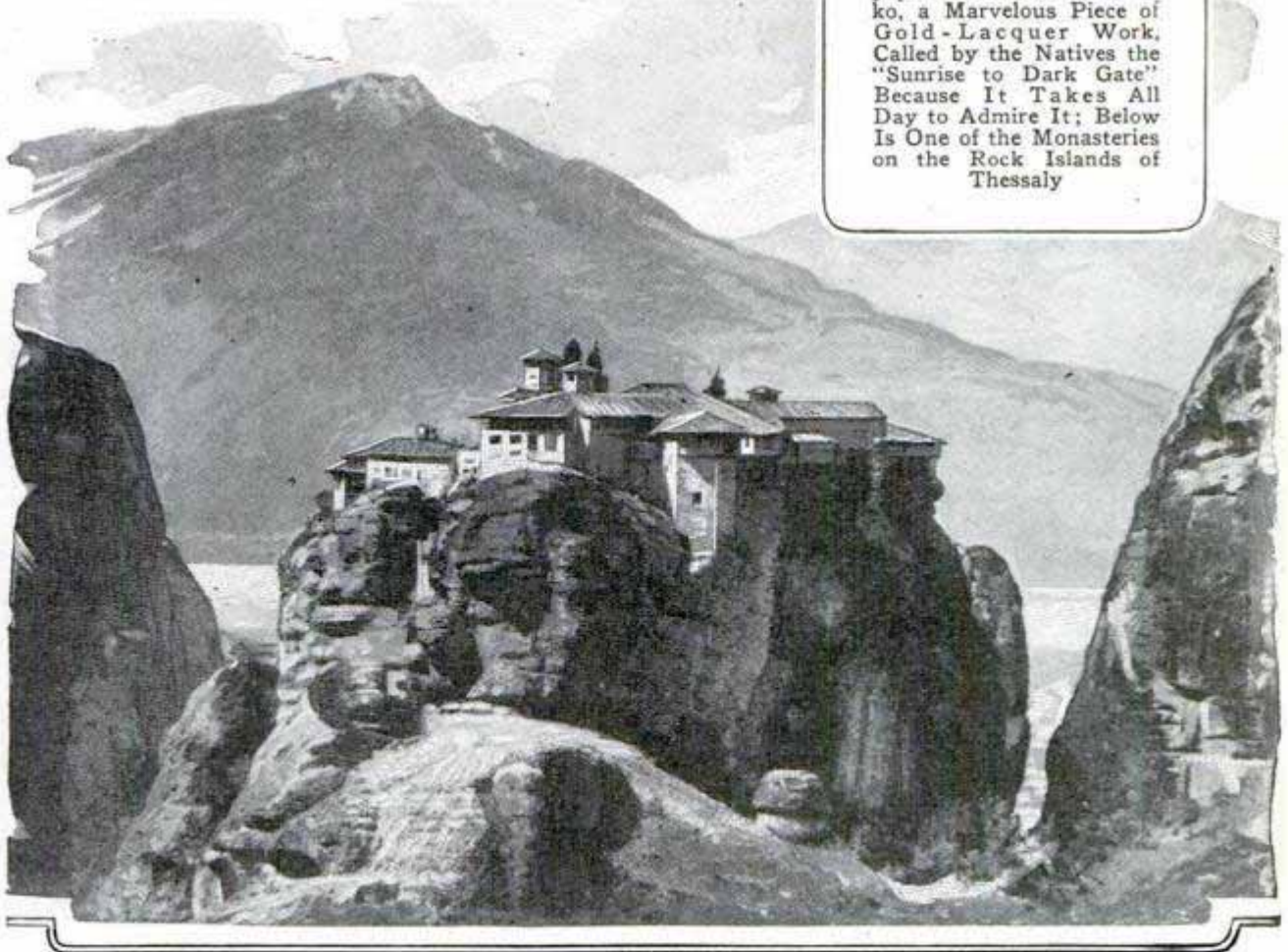

Berkeley Calif

3



Within Easy Reach of Passers-By; Wire Basket for Rubbish on Street-Light Pole in Munich

RUBBISH RACKS ON LAMP POLES HELP KEEP CITY CLEAN

Receptacles for rubbish are conveniently placed within easy reach on the poles along the streets of Munich. They are easily kept clean, save the trouble of raising the cover on the old type of cans at the curb and the content is quickly removed for disposal.

WINDER FOR COILING SPRINGS MAKES DIFFERENT SIZES

Needing coil springs of various sizes for replacing broken ones in operations on the oil fields, an Ohio man devised a winder with which he could make his own.



It consists chiefly of a hand-power reel in which mandrels of different sizes can be used and the pitch or lead of the spring determined by the position of a little cam set in various

*Reps. series 3, 4, 5 h. 1000
Guaranteed year*

positions. Springs of a wide variety of length, and either right or left-hand, can be quickly coiled on this winder with as good results as on a lathe, it is claimed. The device is being put on the market by an eastern manufacturer.

user - Washington Co-operative

EGGS CLEANED BY SAND BLAST TO PREVENT DAMAGE

To eliminate the drudgery involved in cleaning eggs and the harmful effects in washing the shells with various compounds, a combination sand-blasting and grading apparatus has been put into use by western producers. It has a capacity of 300 cases or 9,000 dozen a day. A fine grade of white sand is used for the cleansing and is driven against the eggs, three dozen at a time, by a current of air. After the scouring, the sand is blown out by a small fan. From the cleaning compartment, the eggs pass over a battery of powerful electric lights, and an attendant candles them as they move along to the packers, who put them in crates ready for marketing. Because of their excellent condition after this treatment, the product is said to bring from one to four cents more per dozen than eggs that have been cleaned in the ordinary way.

Egg and Poultry Association Seattle Wash.

AUTO JACK IN WHEEL SOCKET ALSO SERVES AS LOCK

Eliminating the use of a crank, lever or other means of lifting, an auto jack is slipped into a permanent socket on the back of the wheel. The car is then moved slowly until the base of the jack is fully on the ground. This raises the car sufficiently to give the tire on that corner a clearance of six inches. The jack may be used also as a mud hook and as a lock, a hole being provided for adjusting a padlock.



Earthquakes that occur under the ocean are said to have much greater severity than those experienced on land.

*Marine Sea Corp
1819 Broadway
New York*

Hoskins & New Co. Astoria, O. 1910

BUTTERFLIES FED ON BOTTLE AT UNIQUE FARM

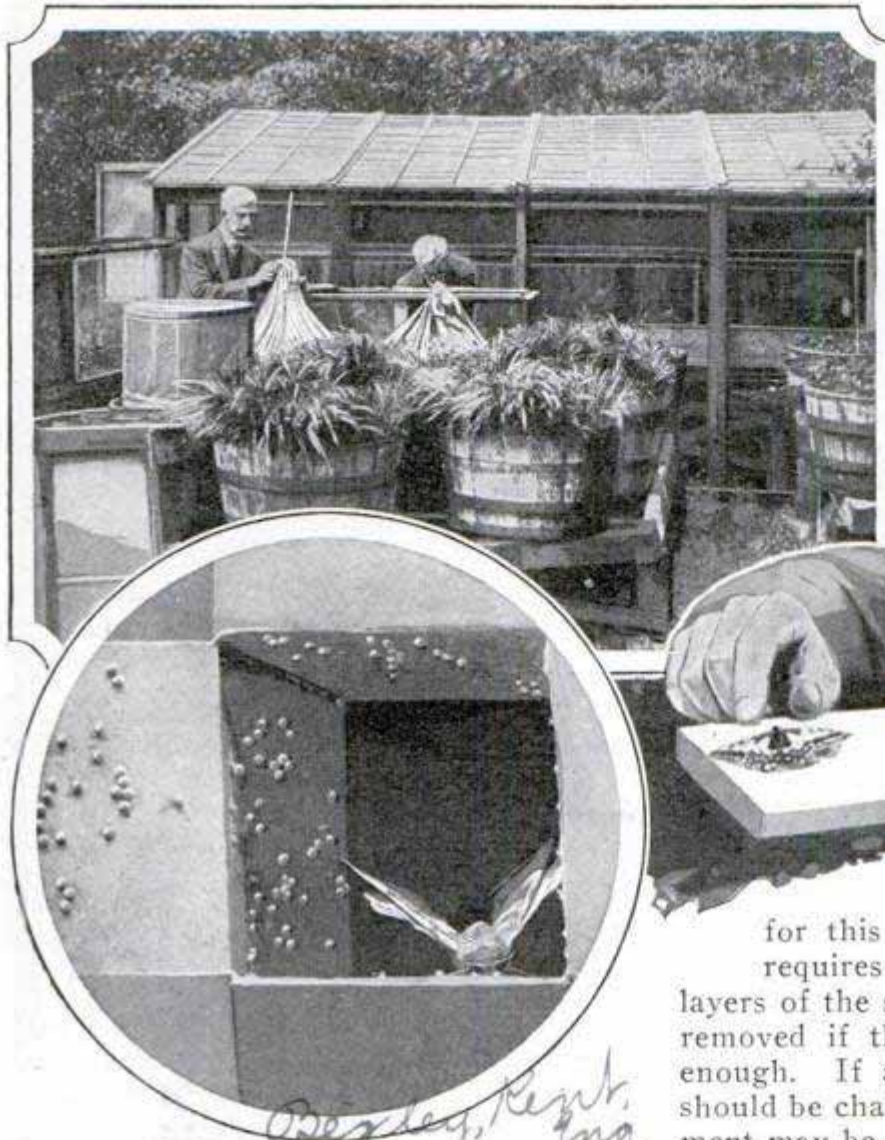

L. W. Newman and Scenes at His Butterfly Farm; Thousands of Specimens Are Raised for Collectors

Bottle-fed butterflies may be seen in great numbers on the farm of an English naturalist who raises the insects for zoos, museums and schools. His charges number as high as 50,000 at one time, some of them being nourished by sugar and water which they sip from cotton stuffed into the neck of a bottle. During the egg-laying period, the moths and butterflies are confined in specially constructed cardboard boxes for better protection.

HARM OF TOUCHING POISON IVY REDUCED BY WASHING ⁵⁶

Several thorough washings with hot running water and ordinary alkaline kitchen soap, as soon as possible after contact with poison ivy, will greatly reduce the harmful effects from the plant, the de-

partment of agriculture states. The reason for this is that the poison usually requires some time to penetrate the layers of the skin so that it can be partly removed if the scrubbing is done soon enough. If a basin is used, the water should be changed frequently. The treatment may be continued with good results even after inflammation has developed. Applications of solution of cooking soda, Epsom salts or fluid extract of grindelia, diluted with four to eight parts of water, are beneficial, but if the poisoning is severe, a physician should be consulted. Washing is also recommended after contact with sumach or poison oak.

CHECK PROTECTOR LIKE PLIERS WORKED BY HAND



Checks are quickly and permanently safeguarded against forgery and raising by a hand protector operated like a pair of pliers. A dial on one side is turned to make an impression from number stamps, according to the amount of the check.

*Arnold Check Writer Co.,
837 Pleasant St.*

2095
626

Chicago

Res. Tee Co. 5012 N. Lincoln



Wearing Golf Cap with "Magazine" of Tees, and Close View of Band, Showing How They Are Inserted

GOLF TEES ARE CARRIED IN HAT TO PREVENT LOSS

Space for several golf tees is provided in the outside band of a cap with a wide visor to shade the player's eyes. The tees are held securely and are always accessible, sparing the golfer the inconvenience of searching through his pockets or club bag.

TWENTY-EIGHT FLYERS SAVED BY ARMY PARACHUTES

Fibers spun by the caterpillar are flimsy and brittle, but woven into silk cloth for army parachutes, they have been instrumental in saving at least twenty-eight persons from death in airplane accidents. All these are enrolled in what is known as the "Caterpillar club." The dependability of the army parachute has been demonstrated repeatedly. Aug. 24, 1920, flyer O'Connor, a civilian, staged a leap at Mc-

Cook field expecting to try a "pet brand" of parachute. It failed to open, but his life was saved in the folds of an army chute which he had been persuaded to take along. The longest leap on the club's records was made from an altitude of 10,000 feet by Lieut. J. T. Johnson of Selfridge field, near Eaglesmere, Pa. Lieut. John A. Macready, noted altitude flyer, made a successful jump by night over Dayton. He guided his crippled plane away from the city where it would not be likely to do damage on falling, and jumped. Later, walking into a circle of excited persons who had gathered about his blazing plane, he gave them a startled moment, for they believed that he had been crushed under the ship. Aug. 29, 1924, Lieut. L. L. Kontz and Private W. E. Goggin of Bolling field both jumped from the same plane and landed safely.

AUTO SPRINGS OPERATE OILER TO LUBRICATE CHASSIS

2238

When the auto bounces, the chassis is given an oiling. This is the feature of an automatic lubricator which utilizes the action of the springs to keep the chassis greased. An oil reservoir and plunger pump are so adjusted that, when driving over uneven roads, the deflection of the springs will actuate the pump, forcing a small amount of lubricant into the parts when it is most needed. Ordinarily, the reservoir needs filling about twice yearly.

min. 1.476

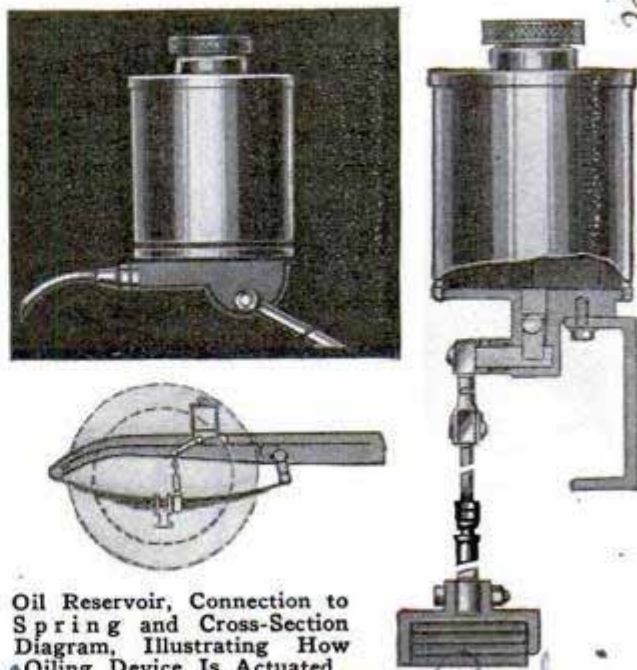

Oil Reservoir, Connection to Spring and Cross-Section Diagram, Illustrating How Oiling Device Is Actuated

L. W. George, Research Engineer

Chicago Daily News 7/12/26

FIGHTING ICEBERGS

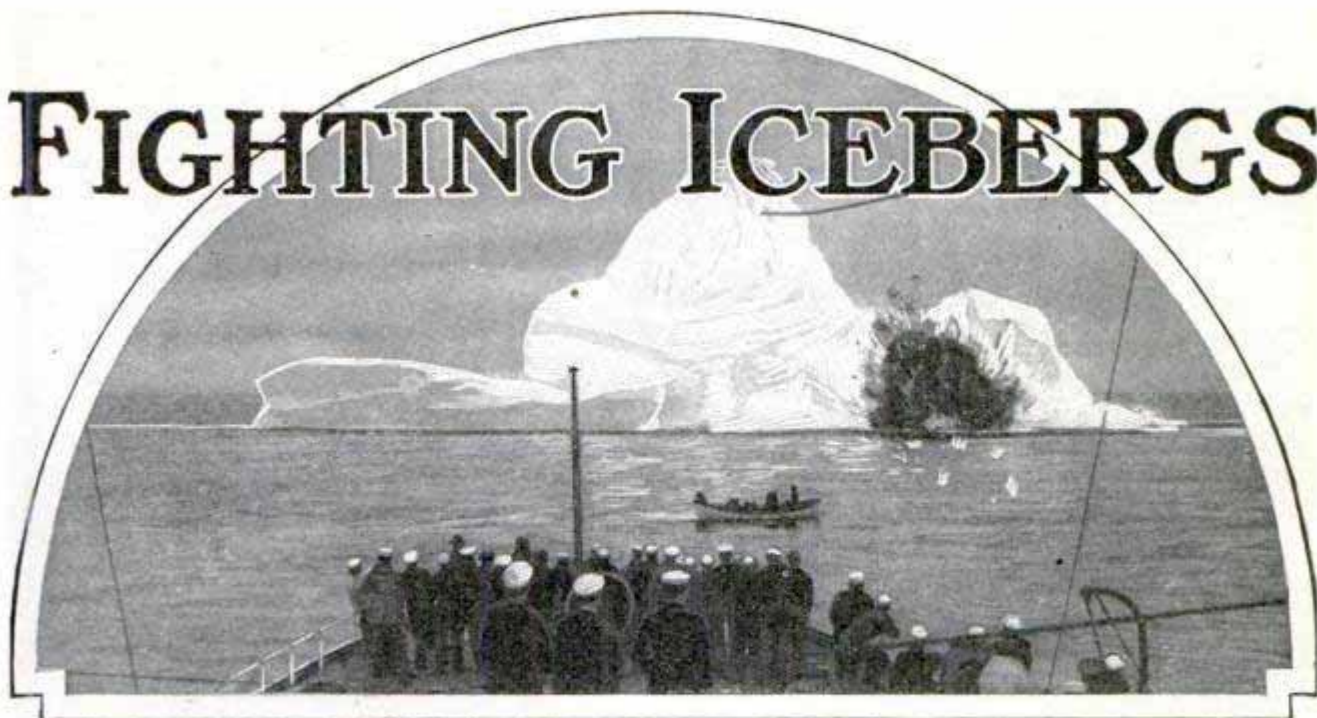

Shattered Ice, Powder-Blackened, Is Hurlled High in the Air as U. S. Coast Guardsmen Explode a T.N.T. Bomb in an Effort to Destroy an Iceberg Floating in the Steamer Lane

American Coast Guardsmen on the International Ice Patrol Ride Herd on Drifting Mountains and Try to Destroy Them

By F. A. ZEUSLER

Lieutenant Commander, U. S. Coast Guard

U. S. Modoc, Halifax, Nova Scotia

IT is midnight in the open North Atlantic off the Grand Banks of Newfoundland, and the U. S. coast guard cutter "Modoc" is rolling in the heavy swell. On the high bridge seamen stand at the searchlights, playing their beams over a mountain of ice. All around us is the hurrying traffic of the busiest ocean boulevard in the world—the North Atlantic steamship lane. Warned by the lights focused on the million and a half tons of iceberg, the ships veer to the south and dash past at twenty knots.

Fourteen years ago, in these same waters, the giant "Titanic," making her maiden trip, plowed into an underwater off-shoot of one of these giant bergs and went down with more than 1,500 souls. The next year the International Ice Patrol, paid for by all the big maritime powers, but performed by two American coast guard cutters, came into being, and since that time not a ship has been lost.

In the radio room of the "Modoc," or her sister cutter, the "Tampa," when they exchange places, as they do each fifteen days, operators stand by every hour from

March 1 to the middle of July, copying and transmitting a steady stream of messages. Last year the ships of fourteen nations—more than 500 of them in all—were guided through the danger zone by the radio reports from the ice patrol.

Greenland's icy mountains, made famous by a song, furnish all the bergs that menace the Atlantic shipping lanes. Each spring they break loose from the glaciers and start on their 1,800-mile journey south to eventual disintegration in the warm Gulf stream. On March 1, the ice-patrol ships put to sea, one from Boston, bound direct for the danger zone, and the other from Wilmington, N. C., en route to Halifax, N. S., the base of operations, where they refuel, take on provisions and give the crews shore leave between patrols.

One man of the two crews, the oceanographer, remains on duty on the Banks throughout the season, transferring to the relieving boat each time. His duty is to keep track of every berg, plot its position and course, and furnish the radio bulletins of information and warning to shipping. As the first cutter puts to sea, a

radio message is broadcast to all ships and land stations that the ice patrol is on the job, followed by a request that all shipping approaching the Banks send position, course and temperature of the sea at four-hour intervals. The last is the important thing. The bergs, sweeping south in the Labrador current, meet the Gulf stream near the Grand Banks, and rapidly disappear in its warm water. The Labrador current, however, is not a year-around stream, but a river of cold water that starts flowing south in the spring, continues for a few months, and then, after losing an unequal battle with the Gulf stream, disappears until the next year.

Early in the spring the two meet down below the southern end of the banks, the cold stream gradually increasing in power until it is whirling the icebergs southward as fast as two miles an hour. Then it begins to fall off, as the warm Gulf stream swings farther northward, and finally, about July 1, disappears for the season.

The line of their meeting is not an imaginary one, but a well-marked spot, with olive-green water north of it and the indigo blue of the Gulf stream on the south side. The cold wall is also the usual border line of the fogs that cling for fully half the time over the banks.

The four-hour temperature readings pour in from a multitude of ships. By the end of the first fifteen-day tour, we have hundreds, perhaps a thousand or more, such readings, all set down on a

chart, and thereby the outline of the danger zone. We can tell then whether it will be a bad ice year, as 1926 was, with bergs far south of their usual range, or whether it will be a mild one.

All the time the patrol is locating bergs, sweeping north far up toward Greenland to inspect the south-bound squadrons, and then back down to the danger line to ride herd on them as they arrive. Each morning and evening at the same hour the report of every berg in the steamer lane is broadcast. The broadcast message gives the position of each berg, its size, drift and speed. During the day, as each new berg is sighted, a special broadcast announces the fact, and every hour calls from many ships are answered giving special information.

Each berg as it is sighted is photographed, sketched and studied, its course and speed calculated, and finally it receives a number by which it will thenceforth be known until the Gulf stream melts the last of it. Each one has distinguishing marks and peculiarities that are soon recognized for future identification.

Contrary to an accepted belief, icebergs do not turn turtle often, nor usually until near the end of their days. When the patrol first meets them in March, they often are more than 500 feet long, longer than a city block, and the visible portion—which is only one-eighth of their mass—will tower 250 feet or more into the air. Bergs of 1,300-foot length have been seen. The patrol crews divide them into two main

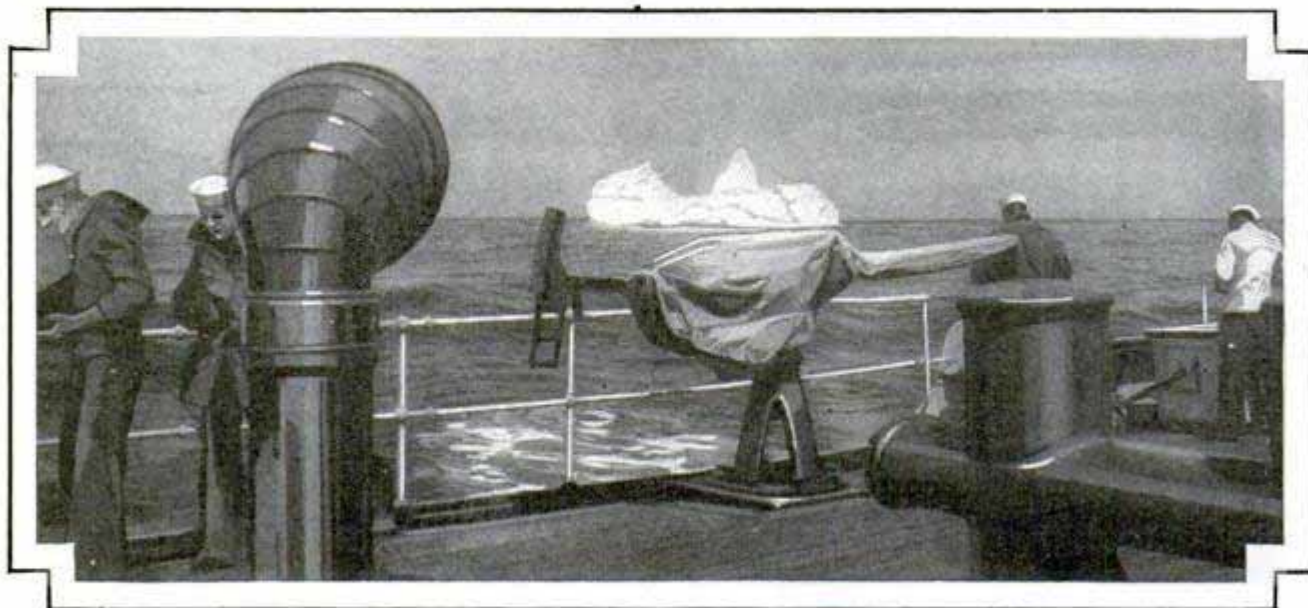

Only One-Eighth of a Floating Berg Is Above the Water, Though the Visible Portion Often Is 200 Feet or More in Height and Longer Than an Average City Block

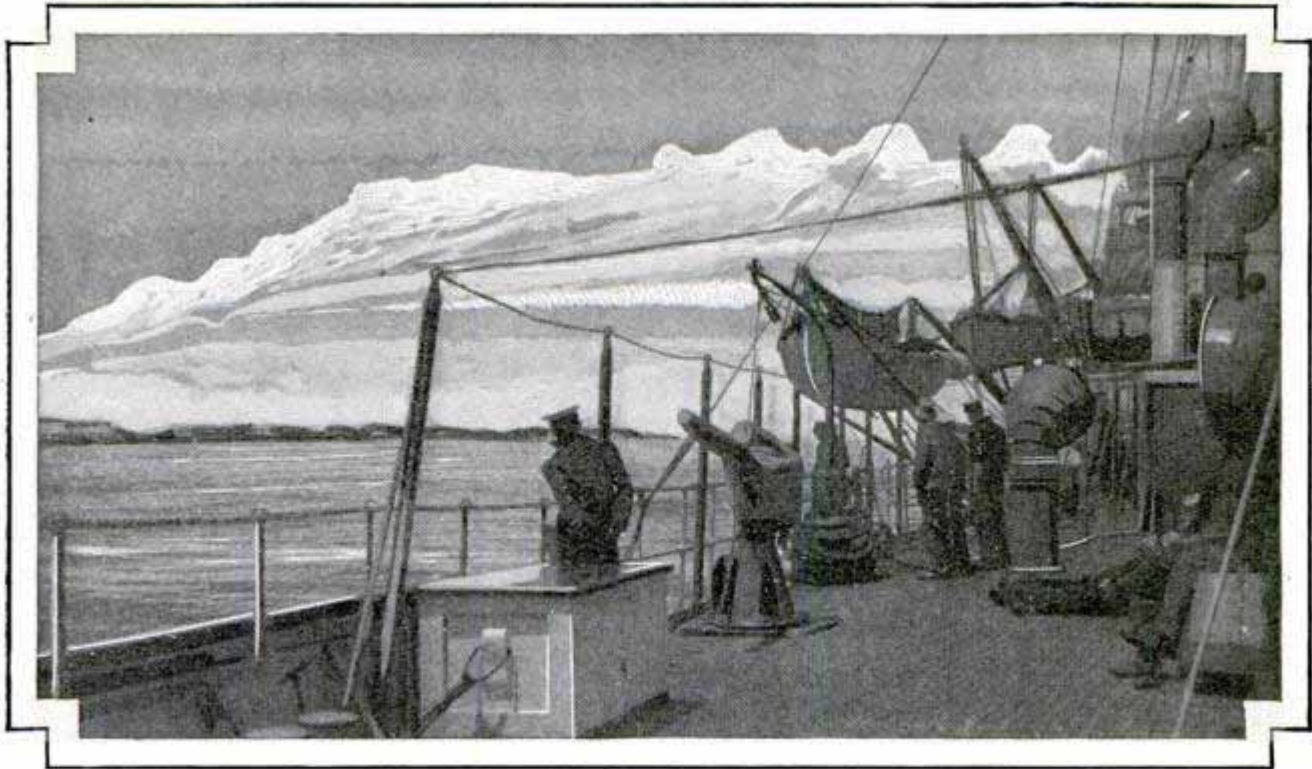

Cruising Close Alongside, the U.S.S. "Modoc" Rides Herd on a Wandering Berg as It Drifts Southward into the Transatlantic Steamer Lane near the Spot Where the "Titanic" Was Sunk

classes, solid bergs and "drydocks." The latter is simply a berg with a deep saddle depression through its middle, leaving two peaks standing at either end, and bearing a marked likeness to a floating drydock.

So far no great success has been awarded attempts of removing the menace. Last year, the coast guard began experimenting with bombs and mines. In previous years shell fire had failed utterly. A six-pound projectile, fired point blank at 150-yard range, will not penetrate more than half its length. The mines were not much more successful, though, toward the end of a berg's days, they will hasten disintegration by opening up new cracks.

Each year since the patrol was established, in 1913, the anniversary of the "Titanic's" loss, on April 14, has been observed by the crew. At 3:00 p.m., in response to a radio appeal, all ships in the North Atlantic shut down their radio sets for five minutes while the coast guardsmen gather on the after deck of the cutter. The church pennant is hoisted above the American flag at the stern, the ship's surgeon, doubling as chaplain, delivers a suitable memorial address, and three rifle volleys are fired across the waters where the great liner went down.

The ice patrol is carried on in the midst of one of the greatest fishing zones in the

world. All around on the Grand Banks, the North American fishermen are working away through almost constant fog, while farther to the east and north is a vast fleet of barks, barkentines and great square-riggers which come out each year from France. To the fishing boats the presence of the patrol cutters prove a godsend. The coast guardsmen trade tobacco and vegetables to the fishermen for fresh fish; the surgeon visits them to set broken arms and legs and treat various diseases, and the cutter's mechanics are always ready to make repairs on a broken fog gun or other gear.

Coming out freshly provisioned each two weeks, the patrol ships find the icebergs have their uses, for a boat can always be lowered to chop off a supply of ice for the ship's refrigerators. The bergs, breaking away from the snow and ice cap of Greenland, which in places is as much as a mile thick, are composed largely of snow, compressed into ice, which accounts for their generally white color, shot through with greens and blues. When a boat draws alongside, where small particles are dropping into the water, the newcomer is surprised to hear the ice effervesce as it strikes the sea, like so much soda water. The reason probably lies in the presence of air in the compressed snow.

237
630

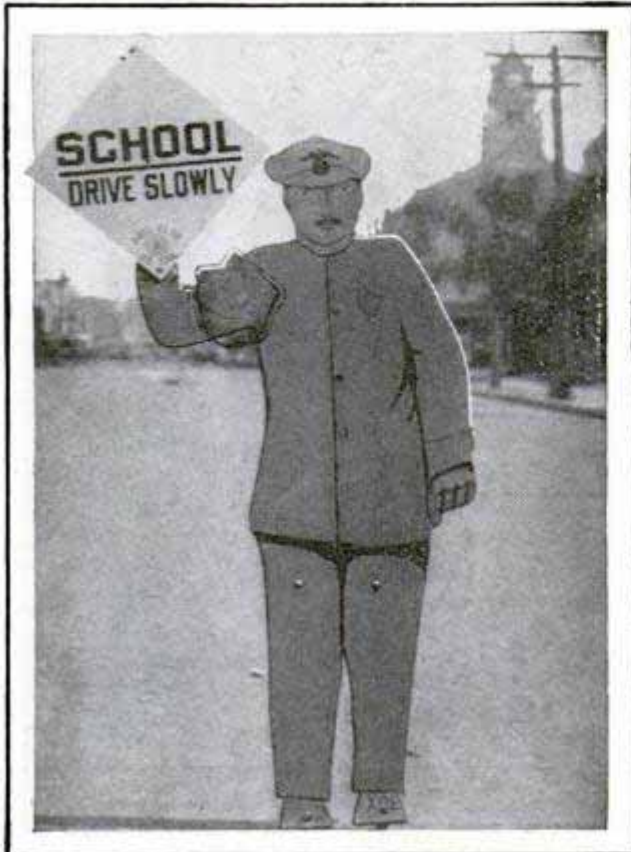

Always on Duty and Visible to All Motorists, This Dummy Policeman Guards School Crossing

BOYS' DUMMY OF POLICEMAN GUARDS STREET CROSSING

Boys in the woodworking class of a California high school have constructed a dummy traffic policeman to maintain constant guard at an intersection near the building. It is firmly attached to the pavement in the middle of the street and bears aloft a warning sign that is visible at some distance to motorists approaching in either direction.

PROOF OF WEIRD FISH TALES FOUND IN COLLECTION

Specimens that furnish a basis for some of the wild stories told about inhabitants of the deep seas have been gathered during a 20,000-mile cruise of the schooner "Blossom." One of the most interesting species captured was a Portuguese man of war, a fish having tentacles speckled with microscopic bombs which explode when they strike a victim and minute harpoons that inject an acid poison into the flesh. Another, known as the "sea devil," closely resembling the stingaree, is said to be able to pull the weight of a vessel after running afoul of the anchor chain, and a

blow from its wings will stave in a small boat. The golden dolphin was also captured. These fish are reputed to be the swiftest inhabitants of the ocean.

TELLING TIME BY STARS EASY WITH AID OF POCKET DIAL

65 For thousands of years, man has checked the passage of time by the position of the stars, but for the most part, this task has been left to the astronomers and their great telescopes. Now, with the aid of a little pocket dial, almost anyone who can read can learn the hour of night by consulting the stars. The instrument consists of an aluminum disk with a hole in the middle and two movable arms which rotate about the center. The circumference of the disk is marked out into the quarter hours of a twenty-four-hour day and an inner circle is graduated into the months and days of the year. The observer first sets the date arm and, with it pointing downward, sights the north star through the hole in the disk. Then he moves the time arm around until it is lined up with the two edge stars in the bowl of the Great Dipper. At that position, the arm will indicate the correct time. The instrument, which simply translates the movements of the "heavenly clock," the circuit of the Great Dipper about the Pole Star, into hours, may also be used for estimating latitude and longitude. With its carrying case and instruction book, it

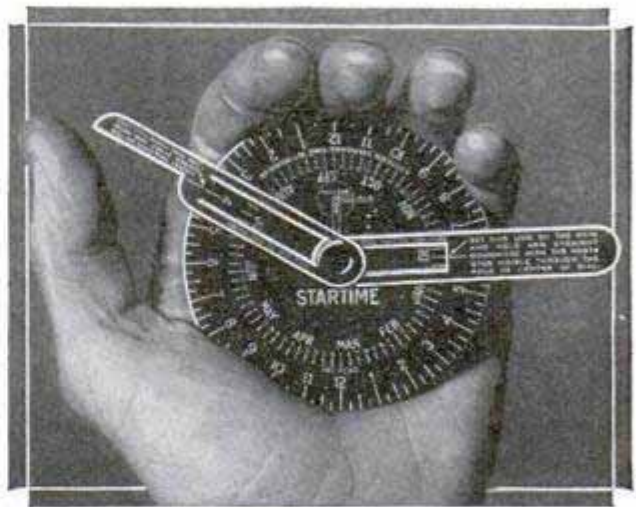

Dial for Telling Time by Stars, Showing Date and Time Arm and the Graduated Center

weighs less than an ounce, fits flat in the pocket and is serviceable to campers.

San Diego

In Cleveland Museum
directed by Capt. George

Starline Mfg. Co.
222 Eden City

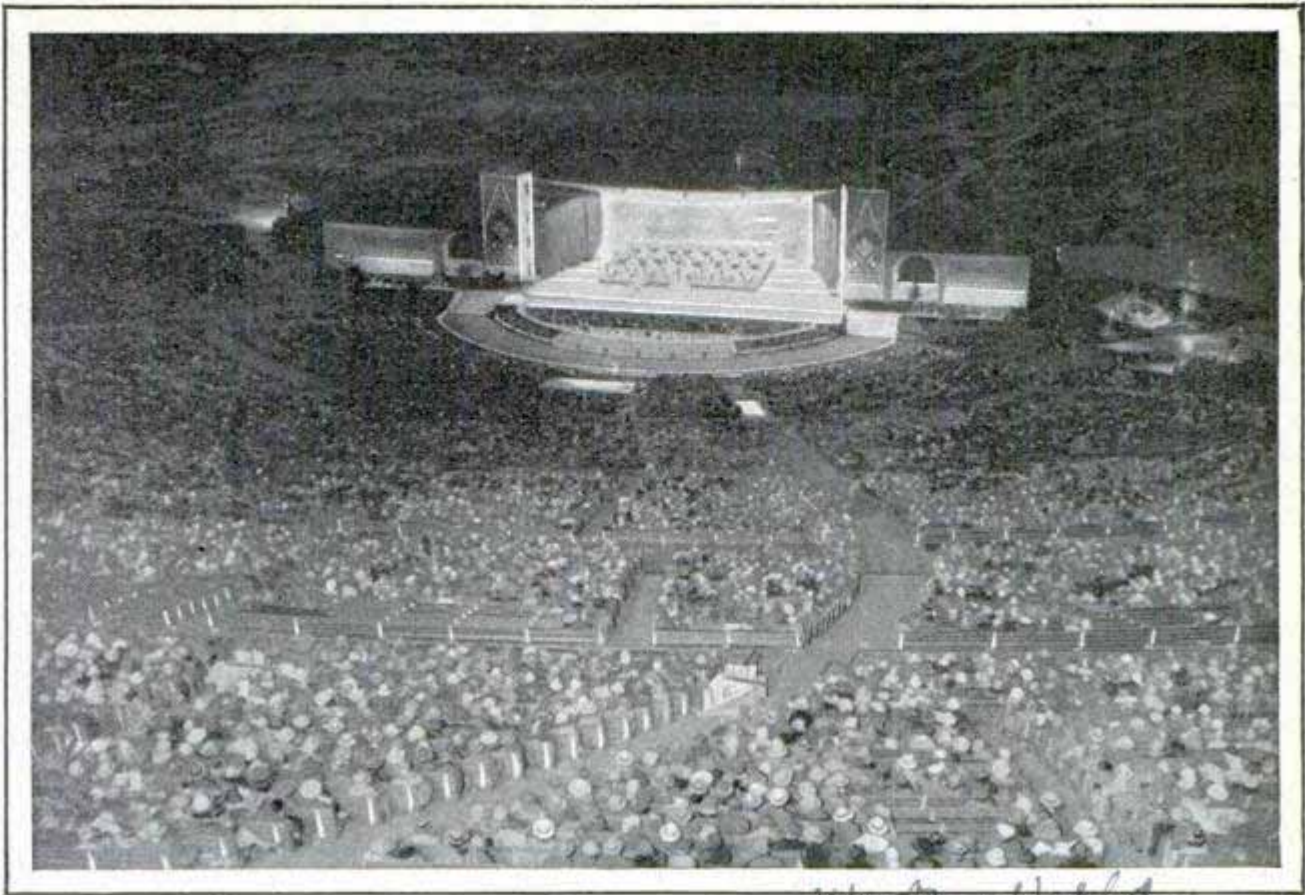

Remarkable Night Photograph of Hollywood Bowl Where Twenty-Four Pianos Were Played in Ensemble to Test Acoustics of This Natural Outdoor Theater; It Has Seats for 30,000 Persons

PLAYING TWENTY-FOUR PIANOS TESTS OUTDOOR THEATER

Music from twenty-four pianos, played in ensemble, was one of the features of the dedicatory program in the newly constructed Hollywood bowl, near Los Angeles. This outdoor theater has remarkable acoustics, tests having shown that sounds can be more clearly heard in it than in many interiors. There are seats for about 30,000 persons, and the bowl is one of the first units in a proposed \$1,000,000 public center in the Hollywood hills.

MYSTERY IN FLOATING ISLAND THAT RISES AND SINKS

Rising to the surface about the middle of August each year and sinking in February, a floating island on a small lake in Michigan has been a riddle to investigators. Efforts have been made to keep it submerged under tons of rocks but it bobs up again in spite of the burden. Another floating island on Henry's lake in the Rocky mountains is said to sail at the rate of five miles a day, and unsuspecting travelers who land on it quickly become con-

fused and often lost. Some of these wandering isles are accumulations of brush and driftwood and their alternating rise and fall has been attributed to the growth and decay of perennial plant roots.

SHOE POLISHER FOR HOTELS TO SAVE FURNITURE

Consisting of two rollers, a block and a shining cloth, a shoe-polishing stand



intended for hotel rooms is expected to prevent needless marring of chairs and other articles of furniture. The cloth is adjusted in such a way that all parts of the shoe can be reached and, when not in use, the lid of the stand is lowered so that it may be

used for other purposes. A similar polisher is being made for home use.

Esrit 7/18/26

*H. A. Schwardlager
741 Clinton St.*

WHEELED STAND FOR PAINTERS
ADJUSTED WITH CRANK

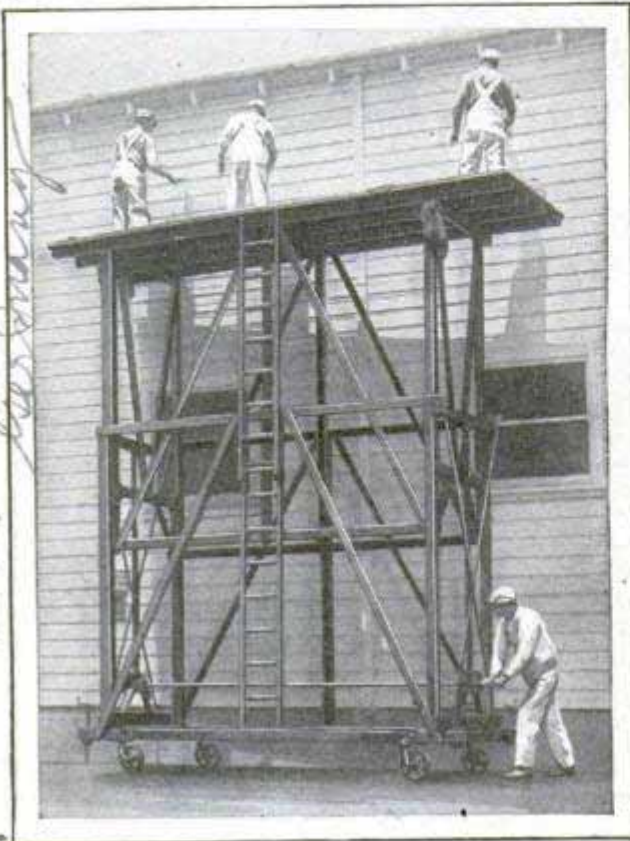

Portable Staging on Painting Job; Workman at Right Is Elevating the Platform with Crank

As a substitute for ladders or suspended scaffolds, an elevating platform on wheels enables painters or other workmen to keep a convenient operating position with little time required for shifting from place to place. The platform is raised or lowered by means of a hand crank and is geared for easy manipulation. Little danger attends the use of this equipment and it saves scratching the sides of walls.

SAW WITH REMOVABLE TEETH
CUTS ACCURATE GROOVES



For grooving, molding and other special operations, a saw with removable teeth of high-speed tool steel, is said to insure accurate work and to save time in sharpening. Wear on

the teeth is compensated for by moving them outward, as needed, a rack fitting a special lock providing exact adjustment

with little trouble. New cutters or those of a different pattern may be inserted without taking the saw from the mandrel.

BURBANK'S WORK IS CONTINUED
THROUGH UNIVERSITY

Although Luther Burbank is dead, his experiments are being carried on under a foundation controlled by Leland Stanford university. The plant wizard made the arrangements not long before his death, as he preferred to have his work continued rather than accept large sums which were offered him for his thirteen-acre farm. Thousands of the plantings are yet in the developing stage and will require years of research before final results are known. In all, there are 53,874 plants, trees, shrubs, bushes and vegetables in the picturesque and extensive gardens.

PEN POINTS QUICKLY CLEANED
WHILE STILL IN HOLDER

Without removing them from the holder, pen points are thoroughly cleaned with a pincer-shaped, padded accessory. A German inventor has devised for the writing set. The soft lining prevents injury to the point, absorbs clotted ink and also keeps stains from the fingers.



The cleaner is finished in different styles to harmonize with the other writing equipment in a special set.

GOLD BURIED DURING CIVIL WAR
SCRATCHED UP BY HEN

Scratching in a Kentucky garden, a hen uncovered a mystery of sixty-two years' standing. She dislodged a gold piece that was part of a \$1,600 treasure pot buried by a man as he entered the Civil war in 1864. He died a prisoner without revealing to members of his family where the gold was hidden. It was all recovered after the first piece was found.

*Richard by
L.O.B. Mayer in
Philadelphia, Pa.
Denny Wigston
Jacony.*

*Owned by Mrs
Rebecca Edington
H. D. ...
Burdorff, Ziller
St. 22/11, Leirmoen.*

*Owned by Mrs
Rebecca Edington
H. D. ...*

and consulting

Chicago
Jackson Blvd. Chicago
Launceston

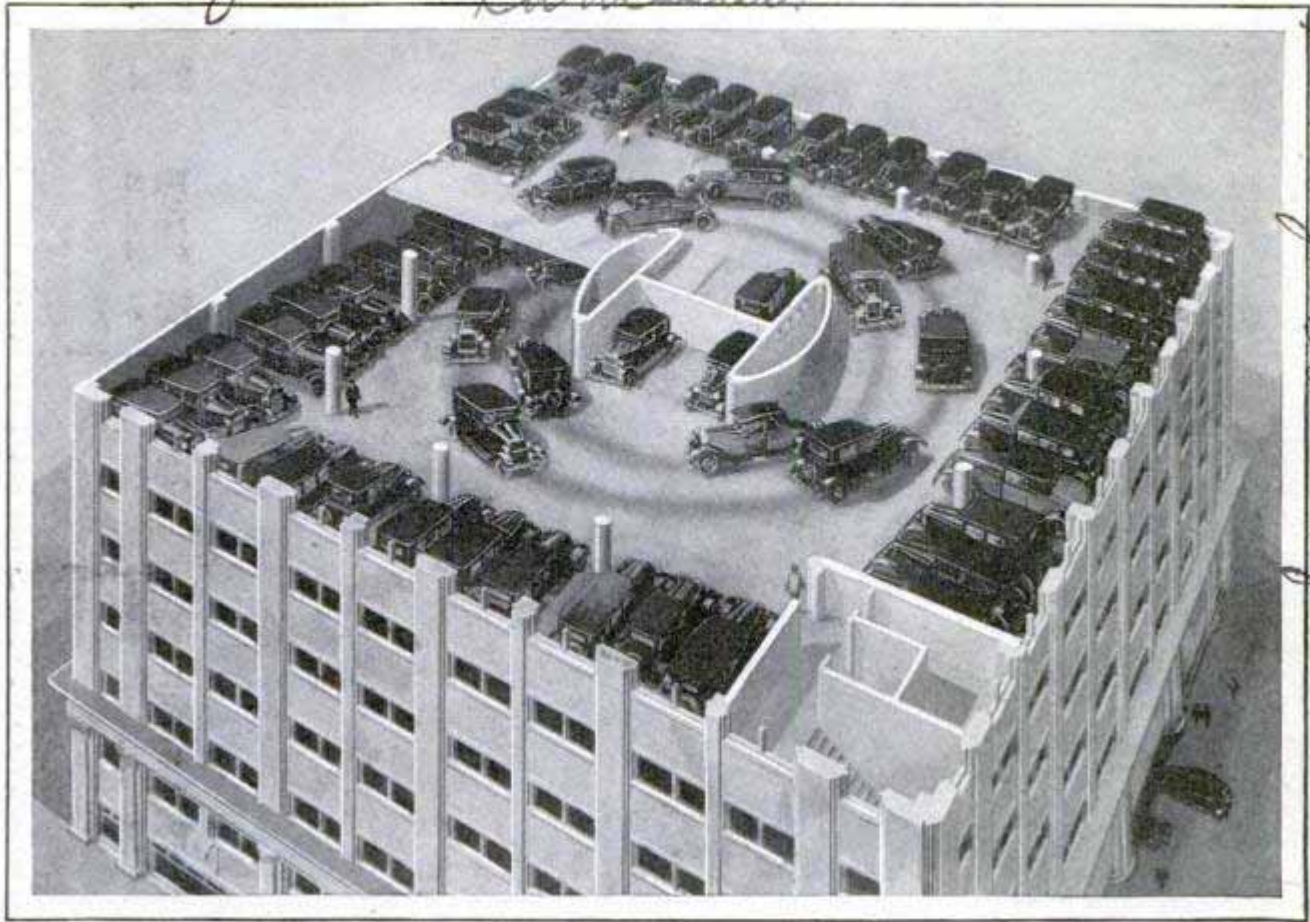

Courtesy Condron & Post

Model of the Spiral-Floor Garage; Cars Are Seen Winding About as Though Entering and Leaving, and Storage Spaces Are Indicated; Roomy Center Area Easily Affords Two-Way Traffic

Samuel C. Lancaster
Denver, Colorado, Fremont

SPIRAL FLOOR IN HIGH GARAGE REPLACES RAMPS AND LIFTS

Automobiles ascend under their own power, without the need of elevators or ramps, in a patented skyscraper garage devised as a solution of the parking problem. It is estimated that a building of this type, holding 500 cars, could be emptied or filled in thirty-three minutes. The floors are arranged in spiral fashion, furnishing a continuous driveway at gentle slope from the top to the bottom. Drivers can handle their own cars without the assistance of attendants and, when they reach their floor, they may walk down steps or ride in passenger elevators. The spiral plan may be adapted entirely to shop purposes, allowing a promenade

in the center of the structure with abundant show-window space on the inside. In the garage plan, the central spiral is wide enough for two lanes of travel, one ascending and the other descending.

TRACTOR WHEEL WITHOUT RIM REDUCES POWER LOSS

Self-cleaning and of simple, rigid design, a rimless tractor wheel devised by a western inventor is said to eliminate one of the chief causes of loss of power in such units, that is, the tendency of the soil to become packed on the wheel, thus decreasing traction. A firm grip on the roadway is obtained by means of separate treads spaced sufficiently far apart to permit loose soil or mud to slip through.

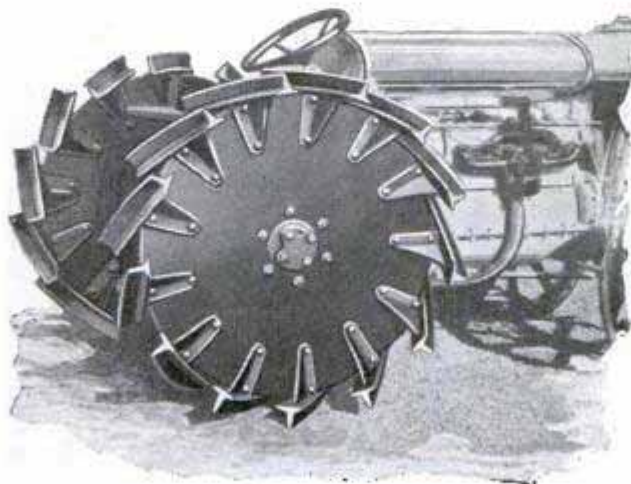

Tractor Wheel with Separate Treads Instead of Usual Corrugated Rim; Space Is Left for Dirt to Fall

with a. Harry
Medford Ore.

Constructed by B. O. Van Cannon Elevators, Inc.
235 First St. San Francisco, Calif.

335 Oriental Theatre Chicago

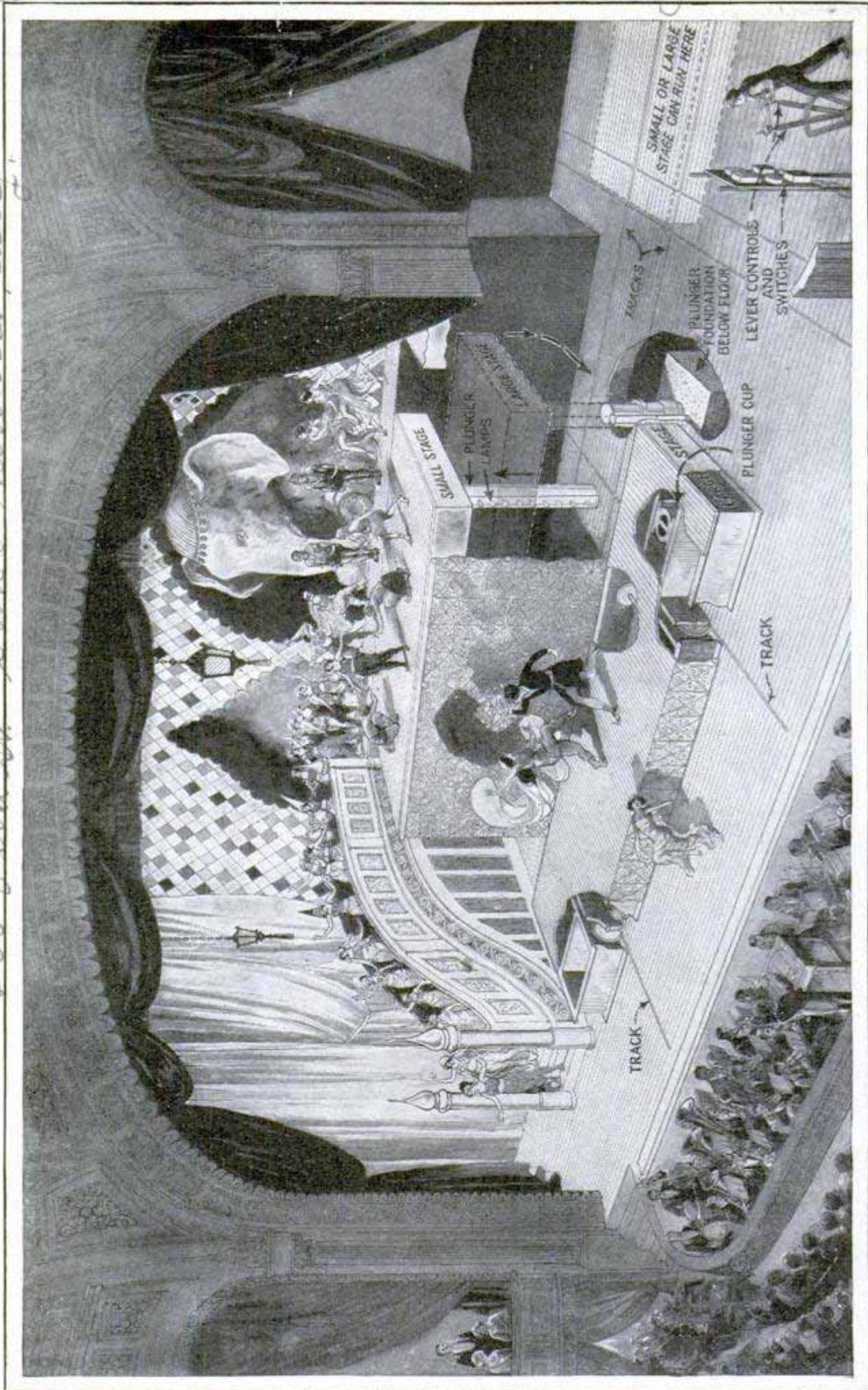

Artist's Drawing of the "Flying" Stages Arranged for an Oriental Ballet; Platforms Can Be Elevated Nine Feet and Run Outward to the Footlights, Back Stage or to Either Side; They Are Controlled by Levers at Right; a Curtain Drop Unwinds and Conceals Lifts as Platform Rises

**WHEELED STAGES
GIVE NOVEL
EFFECTS** *2335*

Saving time in shifting scenes and affording opportunity for settings that would be impossible or constructed only at great expense on an ordinary platform, lift stages on wheels have been added to the theater's equipment. They are propelled by electric motors and lifted by hydraulic pressure. They may be rolled sideways, backward or forward on small steel tracks set in the stage proper and, if desired, can be pushed entirely out of the way when not in use. Two

of these stage cars were installed recently in a new Chicago theater. The larger, nine feet wide and thirty-two feet long, weighs about 5,000 pounds. While an act is in progress on it, a second may be staged on a smaller car, which rolls under the larger or may be used alone. Lifts raise the cars to a height of nine feet above the main stage. To shift gears, so that the car may move from a forward to a sideways direction, or vice versa, a lever is turned at the back of the car.

**NEW STYLE OF STEEL HELMET
GIVES MORE PROTECTION** *2204*

More of the face is shielded by a new style of steel helmet submitted to the ordnance department, and its higher crown is also regarded as a factor in its favor. It has a steeper slope than the old style so that, it is expected, missiles will be likely to glance off and do less damage.



© Henry Miller
Brig. Gen. C. C. Williams, Chief of Ordnance, Examining New and Old Styles in Tin Hats

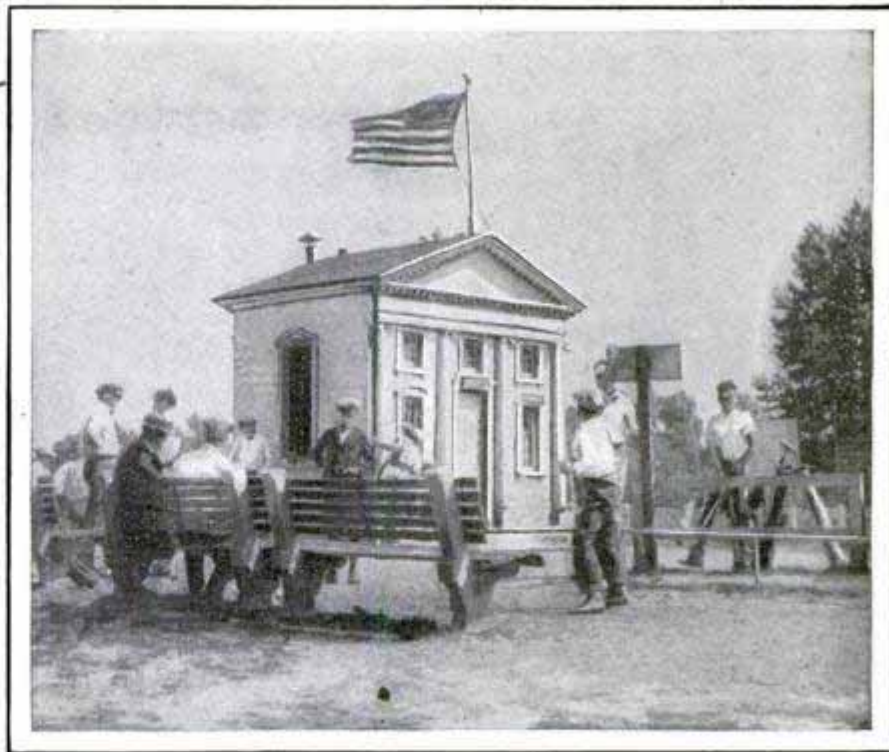

Where Golfers on a St. Louis Course Start Their Games; Ticket Booth in Form of Little Temple

**TINY TEMPLE ON GOLF COURSE
USED AS TICKET BOOTH** *Forest Park*

One of the smallest municipal structures in St. Louis, Mo., is a ticket booth built to resemble a miniature temple on one of the city golf courses. It adds greatly to the appearance of the links.

**SPEEDER TRAPPED BY WHISTLE
ON AUTO EXHAUST** *29*

By means of an automatic whistle a Frenchman has devised, speeding autoists are made to advertise the fact that they are exceeding the legal limits and thus work their own undoing. The attachment fits on a by-pass leading out of the exhaust pipe. As long as the car proceeds at a normal rate, it makes no sound, but at high speed, the increased force of gases produces a screaming noise that can be heard at a great distance, it is said.

in Paris.

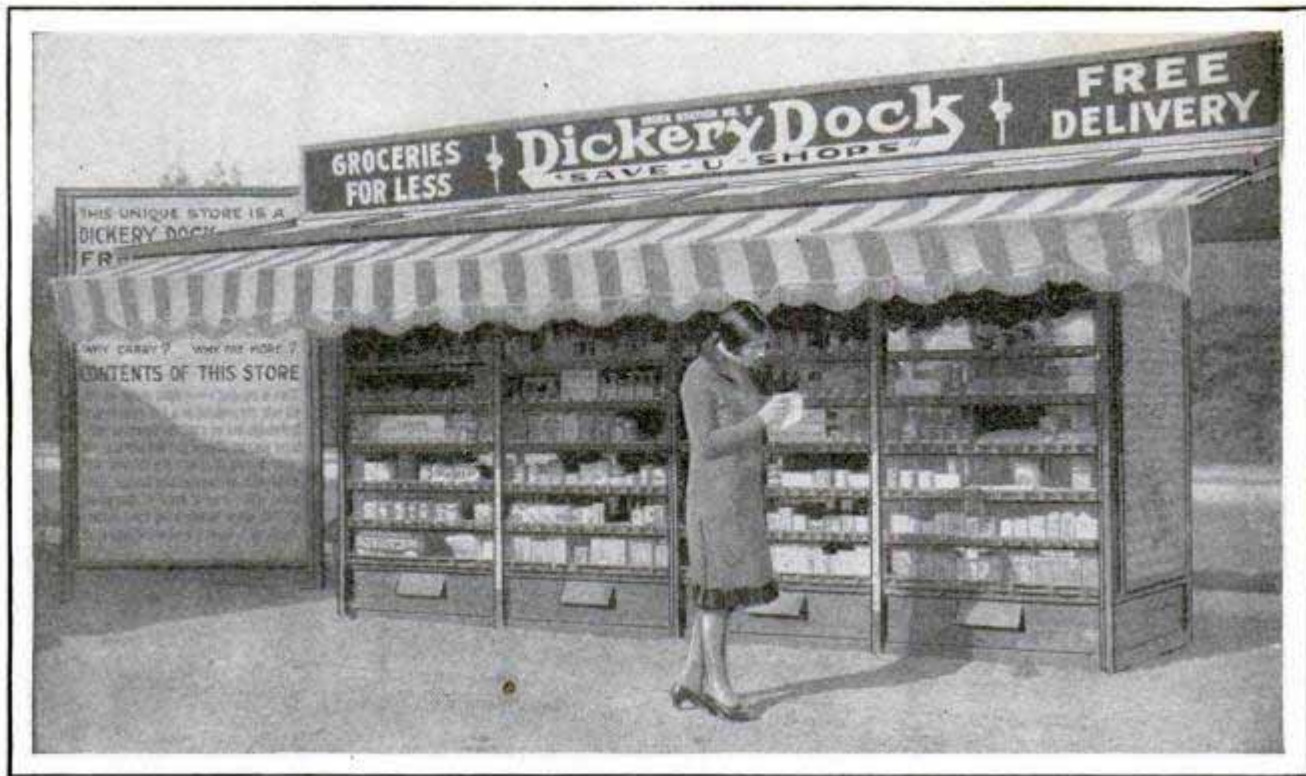

Patronizing the Clerkless Grocery; It Is a Big Display Counter at Handy Street Intersection; Customers Prepare Their Orders on Card Which Is Later Collected and Goods Delivered

PUSH-BUTTON CORNER GROCERY SAVES PHONING FOR ORDERS

Customers can see the goods before ordering and are spared the trouble of telephoning by means of a street-corner grocery-display shop in a California city. It is essentially a permanent showcase with a set of push buttons for registering on a card what articles are wanted. The slip is signed with the person's name and address, dropped in a slot and collected later for delivering the order.

VACUUM-BASE TROUBLE LIGHT HOLDS TO ANY PART OF CAR

Plugged into the dash-bulb socket or headlamp, an auto trouble light has a

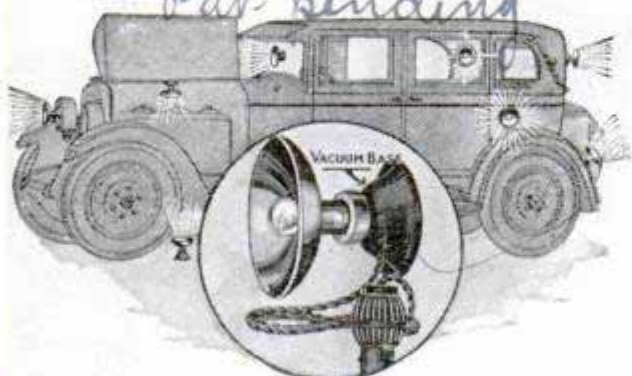

Lamp with Vacuum-Socket Base, and Drawing That Shows Installation at Several Points in Car

suction-cup base of live rubber so that it can be attached to practically any surface of the car. It is said not to injure polished metal or enamel, holds firmly and the flat bottom permits setting the light upright on the ground or beside the auto.

POISON GUN TO KILL WEEDS ELIMINATES PULLING

Rooting dandelions or other weeds from the lawn is an unpleasant task and often



To Kill Weeds; the Poison "Needle" Injects Chemicals into Roots of Troublesome Plants

injures the sod. These disadvantages are said to be overcome by a poison gun with which a quantity of liquid is injected into the heart of the weed, resulting in its withering and death in a few hours. The implement is a tubular-shaped barrel holding gasoline or chemicals, and has a sharp point which is thrust into the weed. Pulling a trigger injects the liquid.

Rats can adapt themselves to almost any climate from that of the arctic regions to the tropics.

singlewood

2239

Pat. pending

*Johnson, Wm. Chicago
946 W. Huron*

*Vaculite Co, Box 1308,
Santa Monica, Calif.*

*Alvin Johnson
946 W. Huron
Chicago*

2024

New Ways to Avoid Home



Strongly Propped Ironing Board Fitted into Door Panel Is Always Ready for Use, Saves Space, as It Folds Flat When Not Needed, and Eliminates Lifting and Storing



To Protect Watch from Pickpockets; If It Is Jerked Suddenly, Little Prongs Spring Out of Acorn Attachment and Hold It to Cloth

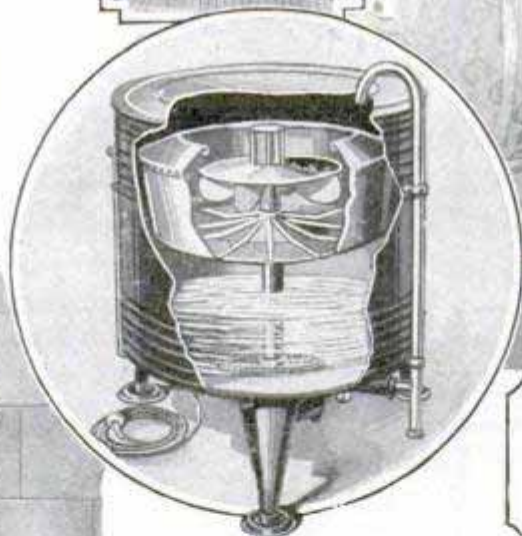
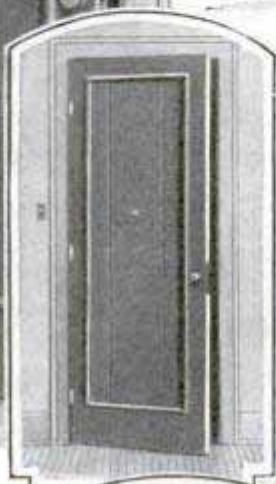

Whirling Electric Washer Empties Itself Automatically by Means of Small Pump, Thus Saving Much Heavy Lifting

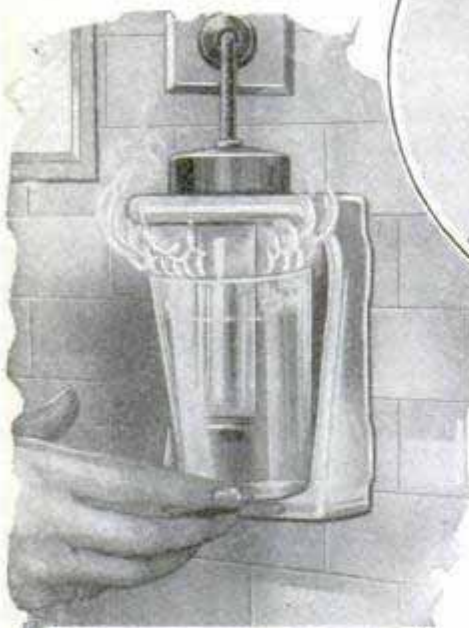

Hot Water in Small Quantities Quickly Furnished from This Tiny Electric Heater Attached to Wall Socket



Adjustable Spoon Bowl Gives Service as an Egg Beater and Is Also Useful for Basting

Drudgery

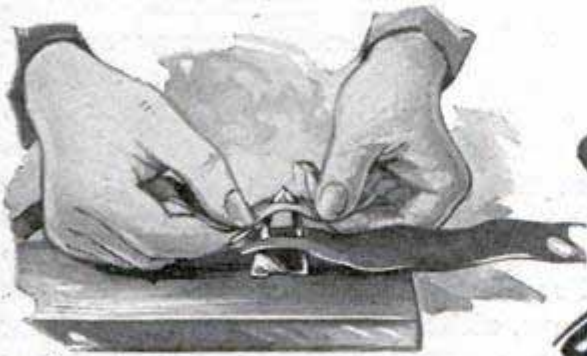

To Save Sewing, This Splicer Firmly Joins Rags for Rugs and Other Purposes



Can Opener Operated like Pair of Shears Has Slightly Curved Blades Which Leave Clean, Smooth Cut



Light Frame Bracket and Screen for Shower Bath Completely Shields Walls and Prevents Wetting of the Floor



Artistic Wire Clock Frame for Covering with Decorative Fabric or Parchment



Twisted Clothesline Eliminates Use of Pins; Articles Are Fastened between the Strands



Spoon with Square Edge and Perforations Permits Tasting Liquids and Solids

2823

*No Change agent
Techs. Service*

Pouring Rubbish from Metal Basket into the Incinerator, Which Destroys the Material without Any Odor



**GARBAGE BURNER FOR HOME
ELIMINATES ODORS**

Garbage and other refuse are said to be destroyed economically and without odors in a gas-burning incinerator, intended to be placed in the basement and close to a chimney where a good draft will be available. It has a capacity of about four bushels, a week's deposit for the average family, but occupies only two square feet of space and is said to use but little gas. It is filled from an enameled basket, which is to be kept in the kitchen, and is easily put into operation. An automatic shut-off for the gas may also be obtained.

**SELF-ADJUSTING PIPE REAMER
FITS ANY SIZE BOWL**

Pipe bowls are quickly and easily cleaned with a reamer that fits snugly against the sides of the bowl and is worked to the bottom simply by turning it around. Carbon and other waste matter are scraped away. The cleaner is self-adjusting so that it fits all

sizes of pipes, large or small, without injuring the wood.



**HERO OF DEATH DIVES TELLS
OF HIS SENSATIONS**

Besides performing a great service to aviators in testing equipment, parachute jumpers have exploded some of the myths about falling from high places. It was once a common belief that if a person fell from a very tall building, he would be unconscious before reaching the ground because of his rush through the air. Capt. H. Spencer, an English parachutist who has made more than 180 head-first leaps from airplanes, testifies that he is clear-headed even after a drop of nearly 1,000 feet before pulling the cord. There is no feeling of mental confusion or dizziness, he says, although the sensation of falling is present. Estimating the distance dropped, enables him to pull the cord at the right time. This calculation is not always easy, as no objects go flashing past to help judge the speed, and the jumper is alone in the empty air, often looking upward to see how the rigging functions. Some parachutes are made in three units, a pilot bag which comes out first, dragging a larger or shock support, followed by the third or main umbrella, large enough to check the descent sufficiently to prevent a violent fall to the ground.

**WRENCH FOR AUTO HEADLIGHTS
WILL NOT MAR METAL**

Headlight rims are quickly and easily removed without scratching the finish by means of an adjustable wrench consisting of a strip of strong fabric and a lever with protruding points on one side. The strip is formed as a loop about the rim, passed through a link at the head of the lever, where the points come in contact with the wrench to help tighten it. It fits different sizes of lamps and can also be adapted to turning other objects.



*Co
Band. B. Specialty
920 S. Michigan Ave. 1938
Chicago*

*The Eggert Mfg Co
1307 Buena Vista Ave*

WHERE BEARDED MINERS TRADED "DUST" FOR FOOD

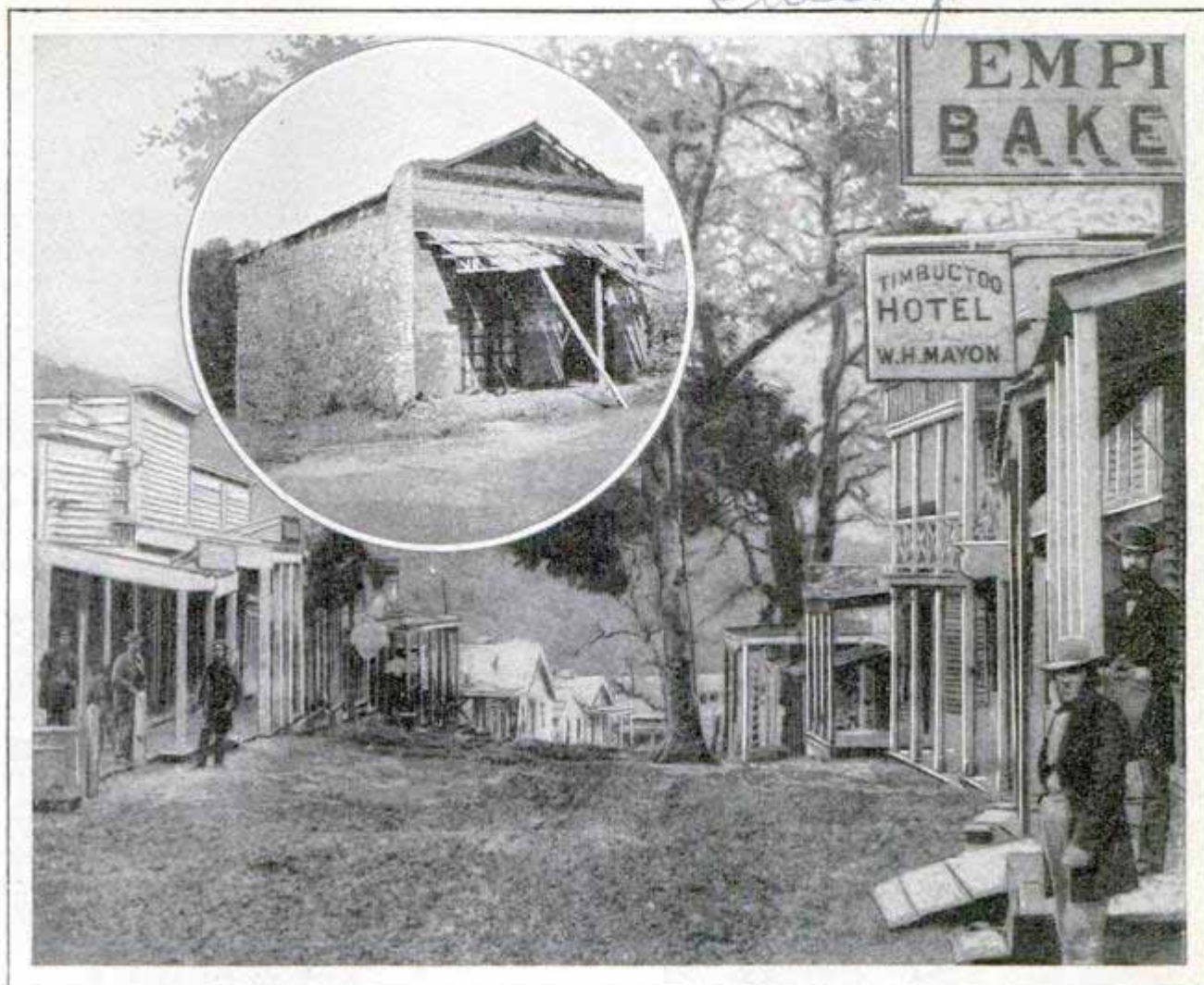

A Glimpse of Timbuctoo, Calif., as It Looked in the Days of the Forty-Niners; Inset Shows the Ruins of the Town's Commercial Center Where Gold Dust Was Bought

Only time-worn ruins of the town of Timbuctoo remain in the northern mine country of California. History says that a group of "State of Mainer" set that thousand-year-old desert name down in the foothills, when they came with pan, pick and shovel to do the first placer mining in 1849. Timbuctoo itself, once gay with work and play, is now but a memory and a name—a mere dot of a cabin perched on the point of a hill to the right; a barn, a well—once the village pump—and a tree-shaded home on the left, and the sturdy ruins of the building which once centered the commercial life of the town. Of brick and native stones, its iron doors still on guard, it has held its own. Painted on the space between the doors with pigment to which time and weather alike have been as nothing, is a sign that still announces to a curious world: "Gold

Dust Bought." A copy of an old picture shows that once oak trees grew undisturbed in the street of the town, shading and guarding the old bank. To Timbuctoo, as to many other camps in the days of '49, came first the placer miners. They worked the surface. Next, because this method was too slow and the results too small, ingenuity worked out the hydraulic process which tore down whole hillsides into the sluice boxes where the crosswise riffles caught the gold from the rushing water. Then the white miners left and the Chinese came, content to work slowly where others had rushed. At one time there were more than 500 of them, it is said, patiently working the old tailings over and over again until, the profits becoming too scanty, they, too, moved on, and Timbuctoo went quietly down the years, remembered only by a name.

Models of Atomic Structure, Which Indicate to the Synthetic Chemist What He Must Do to Accomplish His End; Roughly, They Represent in Tangible Symbols, How Atoms Combine with Each Other to Form Different Substances



What Chemistry Is Doing for You

Modern Wonder Workers Turn Milk into Umbrella Handles and Oat Hulls into Radio Dials

IT has been many years since the alchemists of old sought in vain the secret of changing base metal into gold.

Since that time chemists have learned to make artificial silk, rubber, dyes and have created any number of things that never existed before. In many cases they have not only succeeded in duplicating the product of nature's laboratory—they have actually made stronger, purer and more lasting things than nature.

Just a few of the many miracles of chemistry are the making of buttons from corncobs, umbrella handles from milk, poker chips from cheese, radio dials from oat hulls, meringue from beef blood and furniture from carbolic acid. Not only are handsome pens and pencils products of milk, but so are the "pearl" buttons on a shirt, buckles on milady's shoe or the back of your waistcoat, cigaret holders, ladies' beads, toilet articles, umbrella handles, electric switch plates, mah-jong counters and lots of other things of everyday use-

fulness. The hard buttons on your overcoat, the handle of your penknife, billiard and pool balls, even the radiator cap and timer of your car—very possibly your pipe, too; anyway, a host of other things in ordinary use are apt now to be made from the hulls left when your breakfast cereal is milled.

Even the rich yellow of the lemon is merely a matter of chemical artifice. The fruit of the lemon tree contains more citric acid—which is what the housekeeper buys it for—just before rather than after it is fully ripe, hence it comes from its native habitat a brilliant green which the sun has had no chance to turn yellow. You would not recognize it as a lemon, nor would you buy it. So the "true lemon color" you do know is obtained by its later exposure to ethylene gas.

The meringue on your favorite lemon pie is quite likely not white of egg at all, but beef blood from a slaughterhouse. Then there is a glass which will bounce

like a rubber ball when dropped on the floor; artificial fabrics which include not only the "silk" with which we are becoming familiar, but artificial cotton as well, and even wool; enduring "paints" which are not paints at all in the old sense and synthetic colors with which nature has had nothing to do; sirups which never crystallize (turn to sugar) so that candies made of them remain fresh indefinitely, and their heavy cream centers may actually be turned to liquid after the chocolate exterior has set.

Twentieth century chemistry is modern magic. The American chemist of 1926 is a wonder worker beside whom magicians and alchemists of the past simply fade out of the picture. In laboratories far from the rush and bustle of life, a thousand and one chemists dig deep into nature's secrets, and humanity is forever being made more comfortable, given greater conveniences and made more efficient through practical application of what they learn. Always, too, some waste product or by-product, hitherto discarded, is being put to splendid, practical uses. However startling the statement may seem, it is a fact that there has been more progress in chemistry in the last ten years than in a thousand years before.

"Nor is it fair to deprecate chemical products as substitutes," says Dr. John E. Teeple, treasurer of the American Chemi-

cal society. "If a genius creates something which has the exact properties required, and is possibly better suited to its purpose than any natural product, he has given the world that for which he should receive high praise.

"To illustrate," he goes on, "take dye-stuffs. Valuable land can now be devoted to the raising of food which formerly was given over to indigo, madder and other vegetable dyes, for we now replace those with synthetic dye materials which are better in many ways."

Fountain pens, buttons and poker chips from cheese! That's karolith—triumph of American chemistry—made of casein. Chemists worked it out after five years' trying. Casein is one of the products of milk, and skim milk, from which the butter fats have been removed, is largely casein and water. The farmer feeds skim milk to hogs and throws out barrels of it. Chemists coagulate casein by adding the same rennet used in cheesemaking and get a rubbery mass. A chemical then turns this product into a tough, hornlike material with astonishing strength.

These technicalities may sound dry, but we are about to connect up your coat buttons and the oat hulls and corncobs. Enormous quantities of oat hulls come from breakfast-cereal manufacture, a half million pounds or more a day, with little value as fuel and not much more as cattle feed. But the chemist found quantities of furfural in oat hulls while trying to make them more palatable for the cow that gives the casein.

Important - developed by H. S. Parie, U.S. Bureau of Chemistry

Probably not commercialized

for U.S. Mexico and Canada

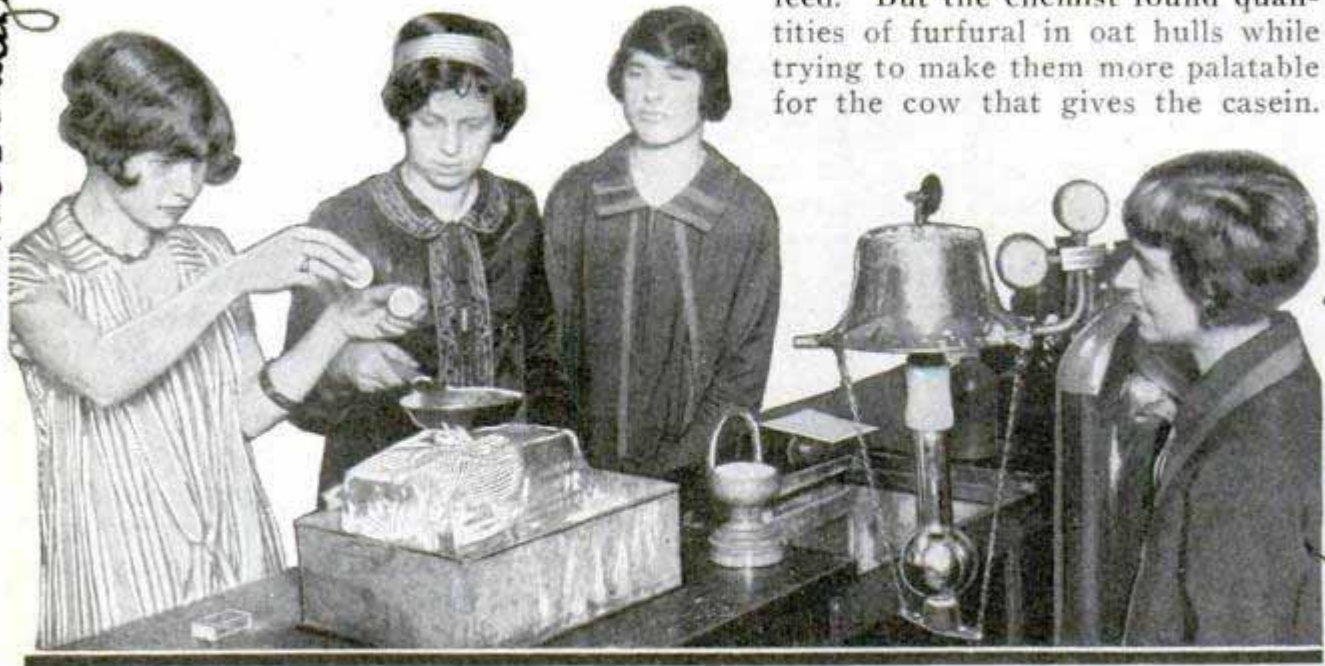

Cooking an Egg over Liquid Oxygen, Prepared in Apparatus at Right, at 300 Degrees below Zero, and Contained in a Hole Chopped in Block of Ice

Heylandt Sales Co., 140 S. Dearborn.

Meantime government chemists were learning the trick of getting furfural in paying quantities from corncobs, too.

Furfural has many uses. It is an excellent germicide and disinfectant, a superior base for certain dyes, and an admirable solvent for use with paint which is sprayed on instead of being brushed. Such paints dry by evaporation, leaving a permanent coating that practically unites with the original material.

Then there is bakelite made from carbo-lic acid. It is named for Dr. L. H. Baekeland, of Columbia university, who invented it. Besides coming in solid form it can be used as a liquid in varnish, enamel, lacquer, and so on. More fascinating is the likelihood that we shall make furniture of bakelite and similar substances, which can be cast or machined in almost any form, are proof against acids and, what is more momentous, against scratches, take a high polish and can be produced in every conceivable color. Chemists making furniture for us from carbo-lic acid! It has already been done and will be done commercially soon.

Soon, too, some names must be found for artificial wool and artificial cotton, which are coming fast, as yet largely as a by-product of the vegetable silk industry. Think of wood being transformed into a soft, fleecy "lamb's wool"! As for artificial cotton, much of the absorbent we now use is actually made from wood fiber. The ever-present chemist again.

America needs much more white of egg than the American hen produces—though she does very well of yolks—and has imported annually tons and tons of albumin from China, which the Chinese gather from sea birds' eggs and dry. Now come the chemists who get excellent and wholesome "white of egg" from the blood of the Texas steer.

But for the chemists, who have given us the tungsten filament and the gas-filled electric lamp, Americans would annually pay a billion dollars more than they do now for the electric light we use; that is, if we were restricted to the old carbon filament lamp of past years.



Inspecting a Sample of Oil, and Drawing Off a Portion from the Crankcase for Test

TESTER FOR CRANKCASE OIL PREVENTS MOTOR ILLS

If the crankcase oil needs renewal, the fact is quickly learned with a tester designed to show if the lubricant is too thin, worn out or otherwise likely to cause the ills that attend old oil. A small sample, drained into the tester, is sufficient, and the result is quickly obtained.

BIG BROOM ON RUBBER TIRES SAVES WORK IN SWEEPING

Mounted on a two-wheeled, rubber-tired carriage, a big broom for sweeping walks or floors need not be lifted after each stroke and is easily pushed. A rearward pull of the handle is all that is necessary to raise the bristles, and a forward shove lowers them to working position. The broom is reversible and adjustable for wear on the fiber. At least fifty per cent more surface can be swept by one person with this arrangement, the manufacturers claim.

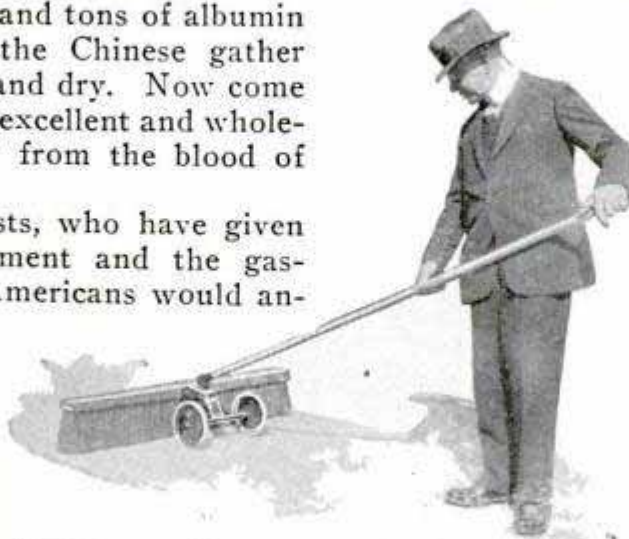

Wide Broom with Its Rubber-Tired Carriage Is Easily Pushed and Cleans a Large Area

2140
Chicago agent
Hutchins Oil Tester Co. 1325 Burns Ave. St. Paul, Minn.
1936
W. W. Vestor, 60 Market St., San Francisco



Fine Lenses in the Rough; Glass Nuggets Being Broken Up into Pieces Suited for Grinding

NUGGETS OF GLASS BROKEN UP TO FIND PERFECT LENSES

Fine optical glass for canera and microscopic lenses is now being produced in quantities in the United States as one of the results of the World war. Formerly the best lenses were imported from Germany, where lens making had been developed to a fine art, but when the war cut off the supply and vast quantities of binoculars and other optical devices were needed for the American army, an industry that now rivals the best German factories sprang up almost overnight. At a recent meeting of the Royal Society in London, tribute was paid to the remarkable way in which American glass makers had overcome all the difficulties of producing fine optical glass. In the rough, the glass emerges from the furnace as huge nug-

gets, crisscrossed by the fissures and lines resulting from the internal stresses of cooling. Such a nugget must be broken and rebroken until from its heart the lens maker extracts pieces of perfect glass suitable for his work.

23 WHAT IS A TON?

Tonnage of a ship refers not to its weight, as is often supposed, but to its carrying capacity. The term originated in the time of King Henry VII of England who introduced one of the first navigation acts of its kind in which the importation of Bordeaux wine in any vessels except those owned by his lieges was forbidden. The liquor was carried in huge barrels called tuns and, since then, the cargo capacity of a ship has been measured by tunnage or tonnage, the modern term. In connection with war vessels, however, the word refers to the weight of the water they displace, or their displacement tonnage, the common way of describing the weight of other ships.

Answers 4/18/26
2299 PAPER-MAKING MACHINE MODEL FORMS FOUR-INCH STRIP

Many models of industrial apparatus merely illustrate the movements of the larger units, but a tiny paper-making machine, constructed by French experts, actually makes paper. It yields a sheet four inches wide and the entire mill is but two feet wide, two feet high and nine and one-half feet long. It took builders some twelve years of labor before the model was completed.

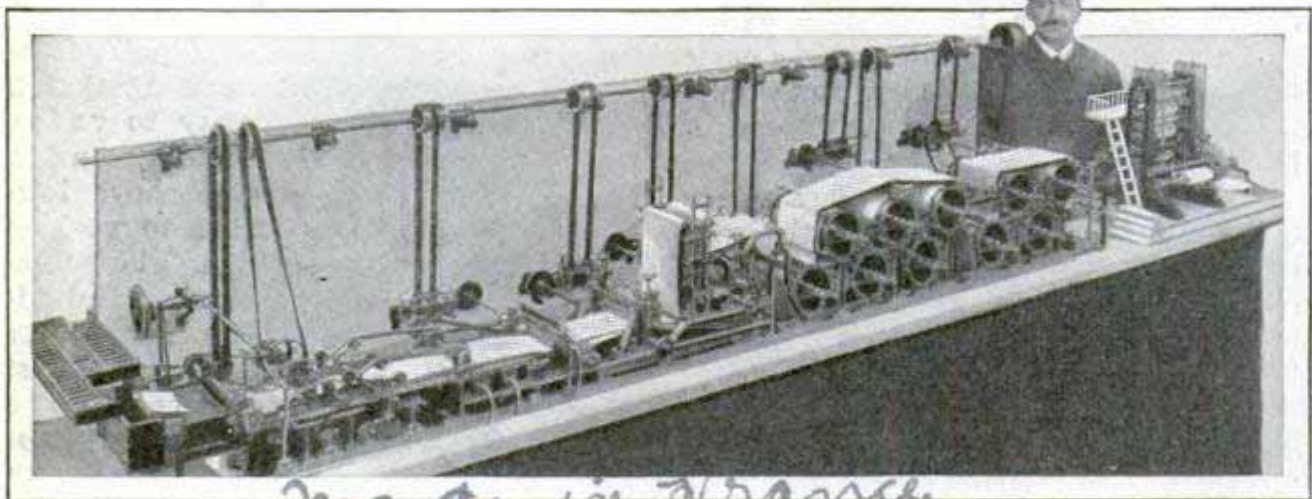

Model Paper Mill in Action; It Duplicates the Larger Units in Practically Every Detail, Making a Strip of Real Paper Four Inches Wide; the Machine Is Less Than Ten Feet Long

Made in France
H. H. Wood & Co., 308 Chestnut St.
Penna

*Optical Works
Jena Germany 2/19*
Karl Guss

Aurora, Ill.
647
2003 Price - \$1.25

**BORE HOLES AROUND VOLCANO
TO STUDY ERUPTIONS** 17

In the belief that changes in temperature will be more easily determined and thus the likelihood of eruptions foretold, scientists, under the direction of Dr. Thomas A. Jaggar, have bored a number of holes ten feet deep around the crater of the Kilauea volcano on the island of Hawaii. The openings are cased around the top and capped so that temperature tests may be taken at any time. It is thought that a rise in the mercury would presage an eruption and thus a "log" of the life of the volcano would be afforded. The holes are 1,000 feet apart and were dug with compressed-air drills.



Illustrating the Way Rake Is Used, and Close View of Teeth Reaching between Shrubby

**VEST-POCKET SIZE HAND PUNCH
IS USEFUL IN HOME** 1796

For the mechanic and home worker, a small punch now on the market is said to penetrate readily sheet material up to about three-thirty-seconds of an inch in thickness with a minimum of effort. The punch itself is contained in the end of a threaded screw which has a small lever handle for power. The die into which the metal is forced, is in the base of the frame. A gauge prevents forcing in sheets too thick

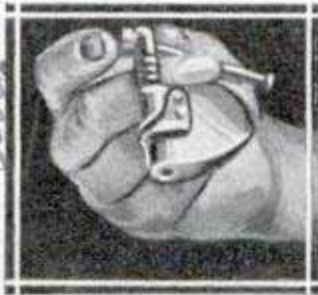

to be penetrated, and the entire punch is so small that it may be carried conveniently in the vest pocket.

**UMBRELLA TO MATCH RAINCOAT
CONTAINS RUBBER FABRIC** 20.

In the wake of the brilliant-hued raincoat has come the umbrella to match, a rubberized article that is said to weigh no more than the ordinary kind and has a soft, velvety finish, without the glaze sometimes considered an objection in material of this kind. The frame is strongly constructed with ten ribs, and the umbrella is furnished in a wide variety of shades ranging from blue, green, red and other plain colors to plaid.

**LAWN RAKE WITH LONG TEETH
USED LIKE BROOM**

Equipped with long, steel tines that reach in between the shrubbery and do not tear up the sod, a special rake for lawns is wielded with an easy sweeping motion, does not become clogged readily and stirs the soil without injury. The tines are fitted securely into a steel yoke.

**CORRUGATED-METAL SHEARS
CUT WITHOUT DISTORTION**

In cutting sheets of corrugated metal, the edges are usually bent out of shape and have to be straightened. This is said to be unnecessary with a lightweight pair of shears, nearly small enough to be slipped into the pocket, which cut straight, on curves or obliquely across the sheet without distorting the corrugations. It has two rotary, double-edged cutters, knurled on the shearing edges, and is held to the metal by means of a screw cap, which may be quickly loosened when the operator desires to withdraw the shears.



*Woodell. Pratt & Greenfield
Mass.
No. 286 1/8 pound die
with stripper*

34 N. Dearborn Chicago

*Diegel, Katschuld
& Co. Baltimore*

*Joseph T. Dyerson
518 N. 16 St.
Burlington Chicago*

Our RADIO WORLD

Dr. Lee De Forest Forecasts Future Developments in Wireless

By J. OLIN HOWE

WHAT is on the radio horizon? And beyond it? What lies over the hill?

"Radio will be as much a commonplace with the next generation as the telephone with this, lifting civilization to new levels," answers Dr. Lee De Forest, inventor of the "talking lamp," the radio tube known as the audion.

Although more than 3,000,000 radio sets were placed in American homes last year, the tube is only twenty years old. Without it we should be unable to telephone across the continent, and multiplex telegraphy and telephony both—by either of which numerous messages may go over the same wire circuit at the same time—would be only a dream.

The tube makes possible the sending of pictures and writing by wire or by wireless, it gives us the talking movie, it has revolutionized the art of recording and reproducing sound by the phonograph, and it will give us television, and much besides.

Yet the real birth of radio as we know it today occurred twenty-six years ago when De Forest, sitting in his \$2-a-week hall bedroom in Chicago on a warm September evening, first observed the "Welsbach effect" which led to the invention of the talking lamp later on.

"I went crazy mad over that," Dr. De Forest said recently, "because the fluttering of the flame in the Welsbach burner gave me the idea that heated gas around an incandescent mantle might be sensitive to wireless waves. Later I substituted the filament in the electric lamp."

De Forest was hardly more than a year beyond his graduation from Yale at the time, but had been out in the workaday world long enough to find that his degree got him very little there. An electrical company was willing to pay him \$8 a week and he eked out this income by translating French articles for a technical publication and by teaching nights. It was the same company that later paid him

of TOMORROW

something like 50,000 times the amount of this his weekly salary for the right to use his tube in the telephone business. Not at once, however, did De Forest perfect his invention and certainly not for many a year did recognition come to him. Men of science and captains of industry scoffed at the "useless toy."

As recently as the summer of 1912, De Forest, having already lost two fortunes in ex-

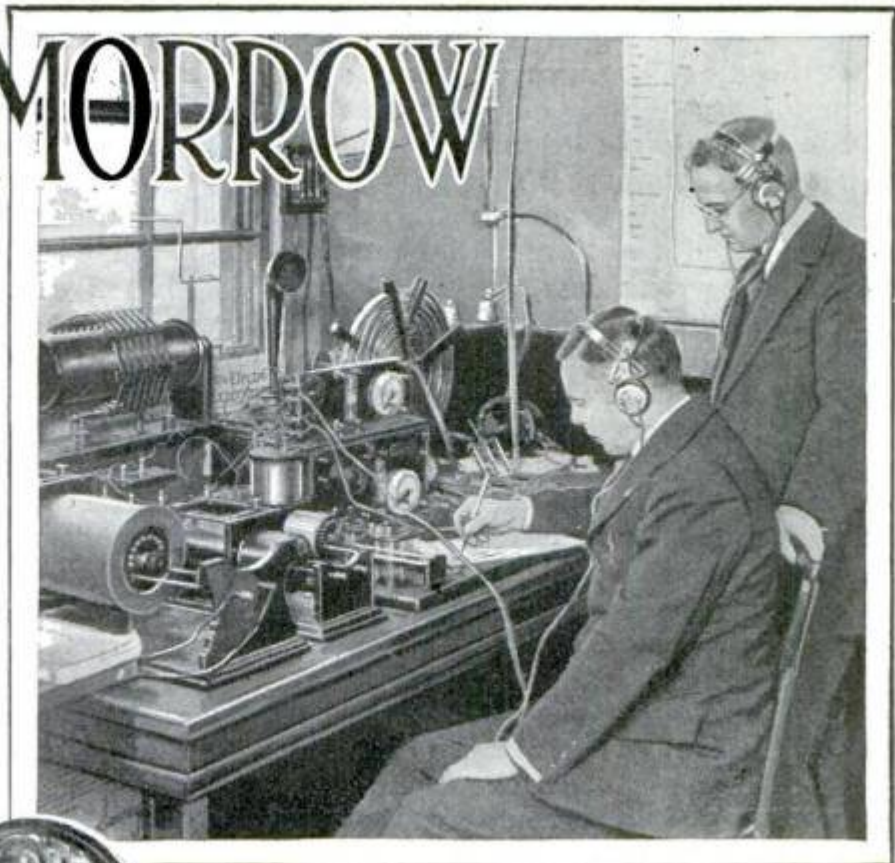

Old-Time Receiver and Dr. De Forest at a Modern Set; Swift Radio Changes of Recent Years

perimental work, was employed as a research engineer of a California company at a small salary. He needed \$125 to save his French patents and went to the president of the company he worked for to borrow this sum. In return, De Forest offered a half interest in his French rights. The president thought it too much of a gamble and, to the despair of the inventor, his French patents reverted to the government. Two years later came the war and the magic tube took its place as the very heart of military communication. Countless bulbs were supplied the allied armies.

De Forest sighs in recalling this. "One million dollars is a conservative estimate of the royalties which would have been paid during the war years, if I had been able to hold on to those French patents," he says. "Unfortunately my friends believed I was only dreaming."

An eminent professor of electrical engineering had thought even less of the ideas of the student, De Forest, years before. The latter graduated from Sheffield scientific school in '96



and spent the next three years in post-graduate work for a doctor's degree. Little heed was given to De Forest's fantastic research.

One night, while he was working in a basement laboratory, the lights suddenly went out in this professor's classroom. He suspected De Forest of having removed the wrong fuse, but could never prove it. Shortly after, however, he found that De Forest had nailed his apparatus to a laboratory table. This was too much. "A student who will spoil a table like that," said the professor, "will never amount to anything."

Much time elapsed between the observing of the Welsbach effect and the actual production of the vacuum tube in 1906. This tube, about the size of an Edison lamp, contained a filament, a grid and a plate and De Forest coined a name for it from "audio," to hear, and "ion," meaning one or more electrons. The three-electrode tube thus became the "audion."

In 1912, the telephone company, seeking to extend its long-distance service, purchased the audion patent rights for \$140,000. In less than two years, they were able to open service across the American continent. Later the same company paid \$250,000 more, for the little lamp had grown from a mere child of imagination to a full-sized servant of mankind. It relayed wireless dots and dashes across the sea and it carried the human voice on telephone wires over the land.

"Now we have all there is under the audion patents," said a leading telephone attorney to a friend of De Forest.

"But not the exclusive right to sell radio sets to the public. De Forest retains that."

"What does that amount to?" cried the other in derision.

True, what did it amount to nine years ago? Broadcasting, actually first done publicly when, on July 15, 1907, the races of the Inter-Lake Yacht association at Put-In-Bay on Lake Erie were reported by radio, was a joke in 1917. Even three years later, on Nov. 2, 1920, when KDKA of East Pittsburgh went on the air as the first regularly established broadcasting station, radio was still something of a joke. The owners of the station had decided there was a future in radio, and had made up fifty sets, and induced fifty wealthy men to spend \$100 each, though the purchasers believed they were throwing their money away.

And of broadcasting, 'way back in 1907, De Forest had said: "Church music, sermons and lectures can be spread abroad by the radio telephone. In the rural districts scores of individual radio-telephone services can be maintained between widely separated farms, ranches, crossroad stores, etc. For the distribution of music, the radio telephone means an enormous increase of patronage among music lovers."

But De Forest visions still greater developments in the next few years.

"Amazing improvement in the quality of reception is a matter of the near future, and it must come," he says. "Instead of many tubes, we may substitute one big tube which will do its work much better. The photo-electric cell may give us television.

"Broadcasting will take on entirely new phases and conceivably the national government may take over all broadcasting of a general or public nature. We shall have radio schools—a whole system of education in which all instruction is given over the radio, and

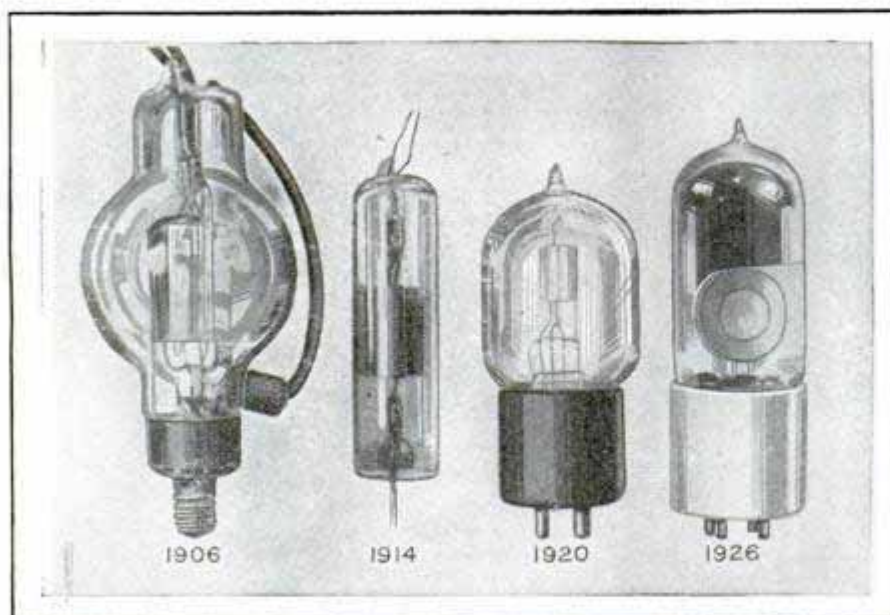

Another Illustration of Radio's Rapid Development; Changes in Tubes, the "Talking and Listening Lamps," since 1906



Two Pioneer Sets of Apparatus, Yet Each Is But a Few Years Old; at the Left, Dr. De Forest at His Wireless Telephone of 1919 and, at Right, an Audion Hook-Up of Yesterday

we shall have radio newspapers and magazines, and perhaps a radio church.

"Radio telephony and wire telephony will be linked up to a degree which will make it possible for us to listen to broadcasting over our telephone wire, and doubtless plug in a loud speaker on a telephone circuit.

"While it has already made itself indispensable in our daily lives, it is a fact that radio is yet in its merest infancy. The task directly ahead is to improve the speaking and singing voice of radio.

"There is no set today which, with its loud speaker, gives perfect reproduction of music. Every set, and many loud speakers, distort the sound in some way. Designers have been too economical, have sought to make one tube do the work of

two, have tolerated back-feeding—have failed sufficiently to shield the various elements. We must remember this, though, that in radio the extreme sensitiveness essential to true reproduction calls imperatively for good broadcast reception. The loud speaker cannot make up for deficiencies in the receiving set. Here we come to the limitations on the number of tubes which can be used to advantage, and we run into difficulties in the multiplication of tubes which seem likely to be overcome by the use of one large audion equivalent to several smaller ones, with diverse steps of radio-frequency amplification in the same tube.

"Now something about static? Unfortunately man doesn't subdue the forces of nature which he learns to utilize. At least, not in his present stage of development. He doesn't even adapt them; he adapts himself to them.

"Can we conquer static? Probably not, put as baldly as that. At least, not for a very long time. But we can learn its diagnosis, as we have that of lightning, and how to insulate ourselves from it and, somewhat, to keep out of its way.

"To me the delightful thing about radio is that it enters so indispensably into

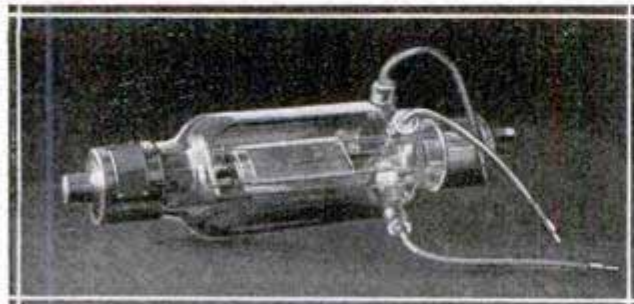

Early Vacuum Tube Dr. De Forest Developed for Sending Messages; He Called It the Oscillation

modern life. It extends the hearing power of the human ear around the earth, or will do so, to enable anyone to listen to audible sounds anywhere else. Some day in the future man may even go out from his own planet and beyond his own atmosphere and if other planets are inhabited by sentient beings, he and they may find it possible to communicate. But not by radio as we know it today.

"There are far more interesting radio possibilities—and not only possibilities, but certainties—much nearer at hand. For one thing, the range of the human ear is already increased astonishingly by it and will be more so. We hear overtones and undertones we didn't know existed.

"In New York we hear heartbeats in Chicago and the footsteps of a Washington fly walking across a sheet of paper. Radio has long since passed the amusement phase and will go down in history as one of the few revolutionary devices in human progress. Think of listening in on a tiger hunt in India, or an elephant hunt in Africa—on war and all that goes with it—on parliamentary debates and world events of any important kind. All this will come.

"Television we have now, in a way. At

all events, by using the photo-electric cell and boosting its frequency many times higher with the audion tube we can transmit pictures and writing, either by wire or by air. This will become a commonplace in its turn and checks drawn in London or Paris and transmitted by radio will be cashed in New York or San Francisco.

"It is even said that a coronation in the first-named city may be pictured in New York theaters the same evening. Before such a feat is possible, however, coronations may have gone out of fashion. Yet the transmission of still photographs is already by way of being standardized and sending motion pictures is but a matter of working out technical details.

"But is this true television? By that term we really mean the ability ourselves to see over long distances. Not to be shown pictures taken far away, but to actually view the scene itself in Los Angeles while we are in New York.

"Can we ever do so fantastic a thing? Theoretically, it is possible. Commercially and financially, it is impractical. Even so, I can say that there are undreamed of possibilities in radio—possibilities perhaps limitless from any standpoint of human limitations!"



Wrapping and Packing Radio Tubes for Shipment; These Magic Little Units Are Handled Carefully as Belongs Parts That Have Played So Important a Role in Radio's Progress

Here Are Radio's Latest Novelties

*Pilot - Billy Brock
Radio operator - Norm Souler*

98P-R



Air-Mail Pilots Equipped to Receive Radio Weather Reports; Right, Attractive Pedestal Speaker

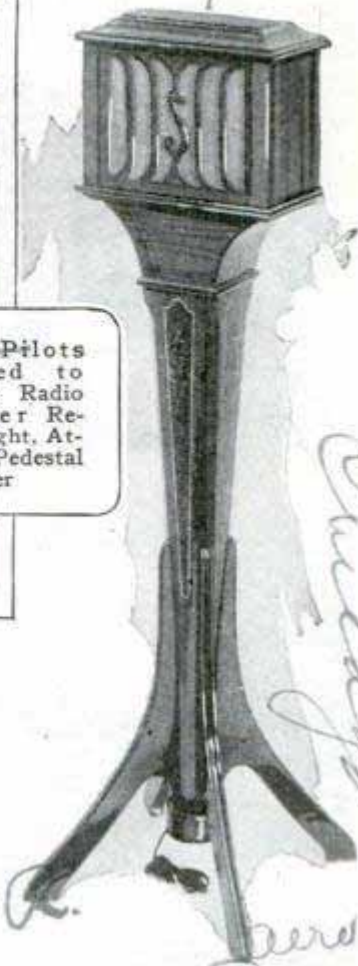

*H. L. S. & Co. Inc.
1500 Montrose Ave.
Chicago*



Left, Double-Coil Radio Beacon That Guides Aircraft over Its Route; Center, Parasol Aerial Looks like a Rosette of Giant Hairpins; It is Claimed to Be More Efficient Than the Usual Aerial, with the Added Advantage of Portability

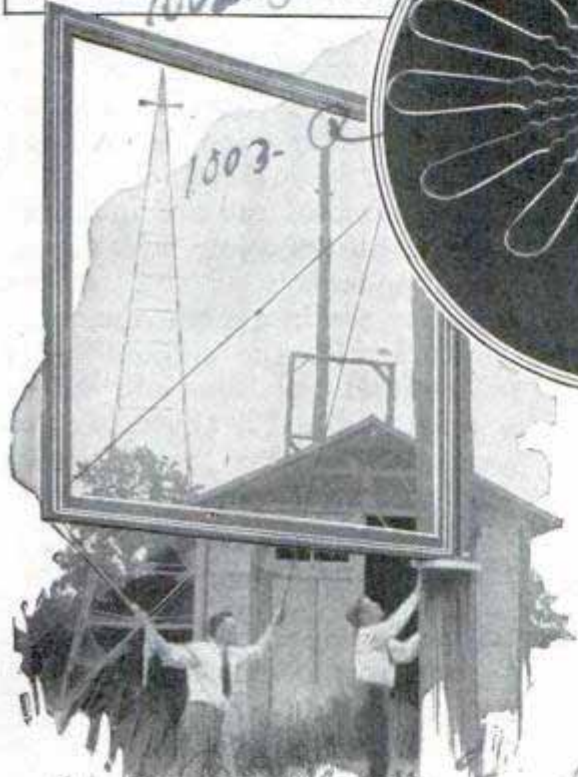

*972
2.*

Below, Arctic Radio Equipment with Battery Supply Designed for the Detroit Arctic Expedition; It Represents the Latest Type of Low-Power Low-Wave Apparatus



Above, James Cruze, Directing Naval Battle Scene for Big Picture by Radio; This Method of Supervision Enables the Director to Keep in Constant Touch with All the Various Units of Elaborate Productions Employing Hundreds of People Spread over a Large Area

*Burgess Battery Co.
Madison*

*Old & Rome Co.
Catalina Island*

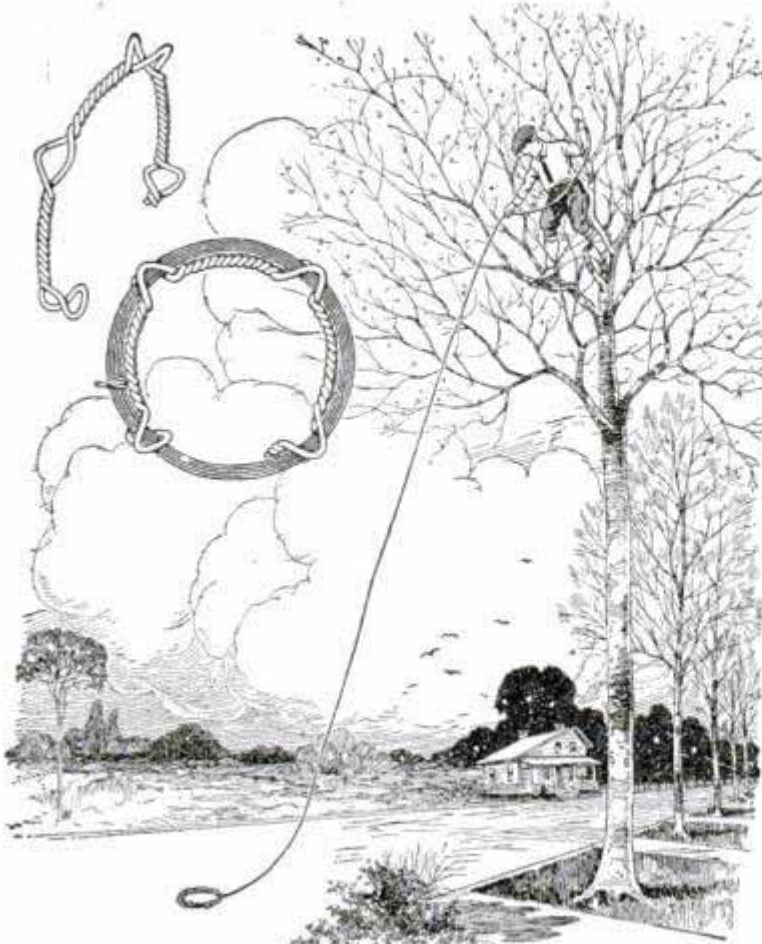

Spring-Wire Coil Holder Prevents Tangling of Aerial Wire during Installation

Spring-Wire Coil Holder Prevents Tangling of Aerial

A wire coil holder that saves winding the wire on a spool and prevents tangling is shown in the illustration. If you have ever climbed to the top of a 60-ft. tree with a tangle of aerial wire hung to every limb and the wind blowing a gale, you will appreciate the usefulness of such a coil holder. The device is simple and easy to make, the construction being indicated in the diagram. It consists of a length of steel wire twisted, as shown, with the idea of making a holder of variable size, so that it will fit coils of different diameters. The wire used should be springy, and as it does not form a complete circle, it will adapt itself to the coil and hold it firmly.—Watson Brown, Iuka, Miss.

What the New Condenser Ratings Mean

A simpler method of giving the rated capacity of condensers is now in general use and marks a third step in the interest of simplicity and efficiency since the old days when manufacturers marked their condenser capacities in relation to the number of plates used. Several years ago a 23-plate variable condenser was understood to be of .0005-mfd. capacity, etc.; then this crude rating gave way to the more exact method of stating the measured capacity regardless of the number of plates. A farad is the unit of capacity, or the ability to store up electrical energy; but it is so large that radio condensers are measured in millionths of it, called a microfarad and indicated by the abbreviation mfd. Now that condensers of still smaller capacity are in general use, such as .0001 mfd., the millionth of a microfarad has been adopted as

the commercial unit and is abbreviated to mmf. Thus .0001 mfd. is equal to 100 mmf.; .00004 mfd. to 40 mmf., and so forth.

Metal Cap Stabilizes Tube

A metal cap, designed to fit over the standard tube, changes the oscillation period to a point where the tube is not affected by vibrations from the set or loud speaker. The method of using the cap is clearly shown in the illustration, and is quite different from the usual devices for eliminating tube vibration.

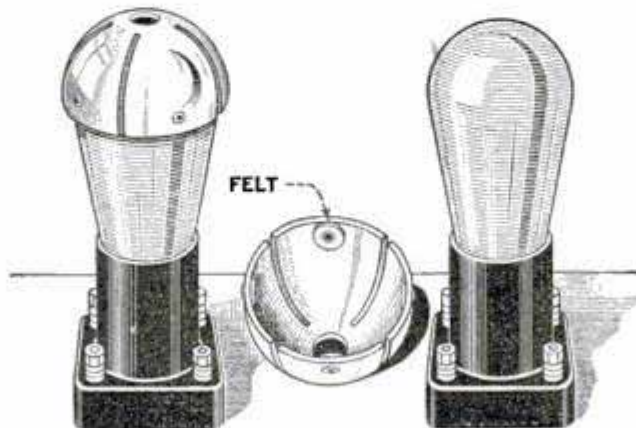

Left, Tube with Cap in Position; Right, Cap Removed, Showing Felt Pads That Separate Metal and Tube

Spring-suspended and rubber-cushioned sockets often eliminate or minimize vibrations, but there are cases where heavy vibrations from machinery and traffic render all efforts useless. For these the metal cap has been designed.

*Colin B. Kennedy Co.
6400 Plymouth Ave
Chicago, Ill.*

Cheap Homemade Battery Charger

By JOSEPH PAULY

THIS simple battery charger or "booster," made from odds and ends about the average home, costs but \$2.50, is extremely simple to build, and saves many trips to the battery station. It is not intended for large sets that place a heavy drain on the A-battery, as the charging rate is low, but is especially adapted for sets with not more than 5 tubes of the A-type on a 6-volt battery or those employing 199 or similar tubes on a 4-volt storage battery. It is used in the same manner as the well-known trickle chargers now on the market, and can be left connected for long periods without overheating or even getting warm. After having the battery fully charged, the author connected the little charger, placing the battery on

charge when the set was not in use. The materials required are a small glass jar of the type used for preserving, a bell-ringing transformer of the tapped type, an aluminum pie plate, a strip of lead, two binding posts, a $\frac{1}{4}$ -lb. box of borax and a board, $\frac{1}{2}$ by 6 by 10-in., for the base. The bell-ringing transformer is of the common step-down type tapped for various voltages, usually 6, 12 and 18 volts, and may be obtained from any dealer in electrical supplies. The aluminum and lead plates are $1\frac{1}{2}$ by 7 in. and are bent in the manner shown in the diagram so as to fit over the top of the jar. The former is cut from the pie plate with a pair of tin snips, and the lead plate from a $\frac{1}{16}$ -in. sheet which can be obtained at a plumbing shop. Holes



Materials Required to Build the Battery Charger; at Right, Details of Plate

for the binding posts are drilled in the end of each strip. The step-down transformer is screwed to one end of the base-board and the glass jar is placed at the other, as shown. The jar is held in position by the top of a tin can, to prevent it from shifting about. Dissolve $\frac{1}{4}$ lb. of borax in about 1 pt. of distilled water and let it set. It will be found that a portion of the borax will not dissolve but will remain at the bottom. The clear solution should be poured off, being careful not to disturb the sediment. The sediment is then washed out of the container and the clear solution poured into it until the jar is three-fourths full. Now hang the plates in the jar, in the position shown, and connect the rectifier jar across the transformer to form the cell, using either 12 or 14 volts. The transformer is then plugged into the 110-volt line, the cell-forming process taking about 12 hours.

This forming process is necessary since, up to this point, it will not rectify alter-

nating current; the process converts the cell, which would previously pass current in either direction, into one that will pass current in one direction only. As the cell forms, the aluminum plate will turn light gray where it is exposed to the action of the solution. This coating is an aluminum oxide, insulating the lead from the aluminum plate, when current attempts to pass from the aluminum to the lead plate, but acting as a conductor when the current passes in the reverse direction.

If, after five or six hours of forming, the aluminum plate has not turned to a light gray, but has a dark-slate appearance, the cell has refused to form. There may be one or more reasons for this; first in importance, that the water used for the solution is not properly distilled, second, that the aluminum is not pure, and third, that the plates are not clean. Remove the plates, dry and rub them down with emery cloth to remove any grease or foreign matter; make sure the aluminum, and dis-

Completed Unit Connected to Storage Battery Ready for Charging

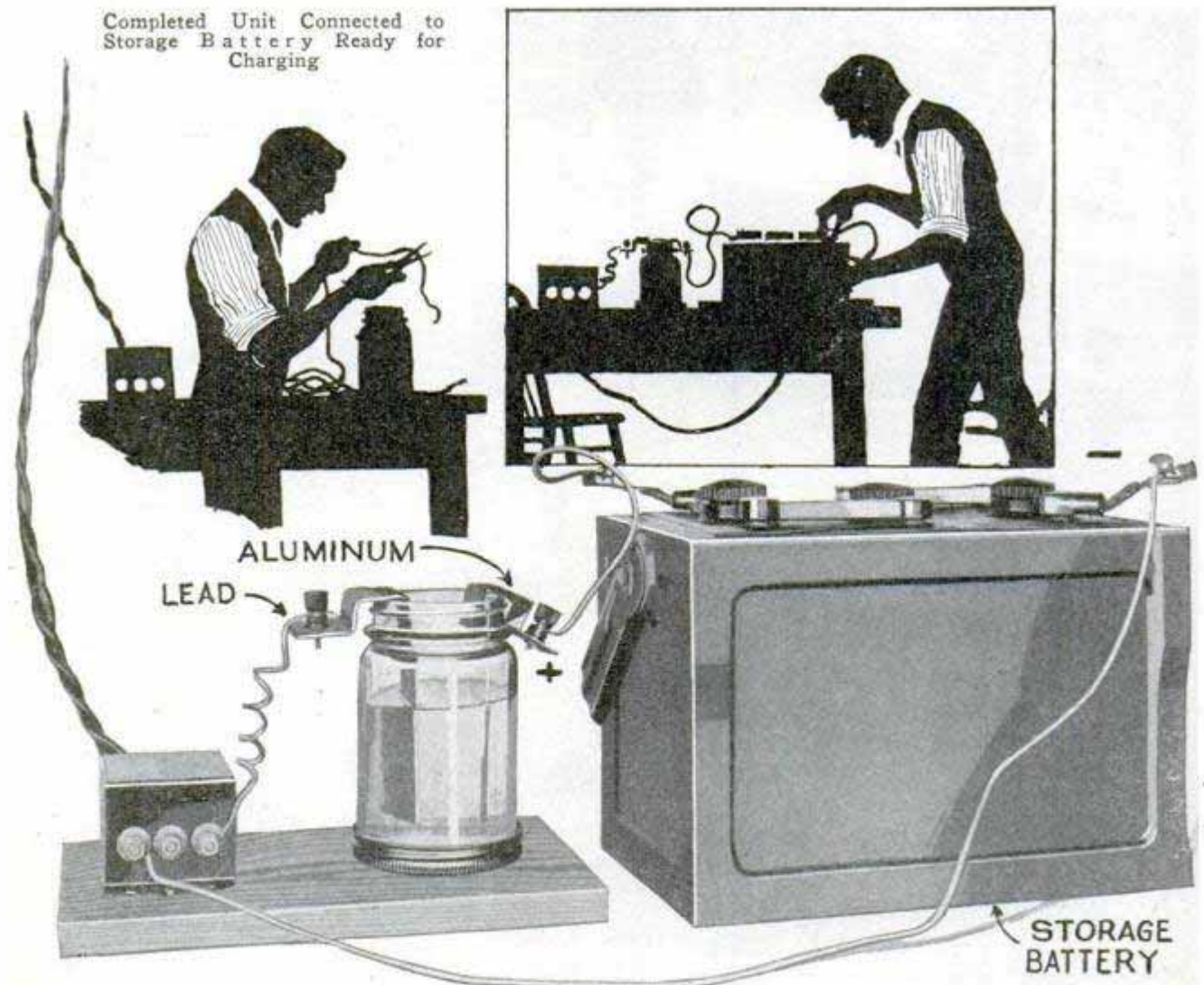

filled water used are pure. After the plate is formed, the charger is connected to the storage battery, as shown in the photo. The aluminum plate is always positive and goes to the positive of the storage battery; the negative terminal of the storage battery is taken to the transformer, the other side of the transformer being connected to the lead plate. A little oil on top of the solution will prevent creeping and evaporation,



How Cell Is Connected across the Transformer for the Cell-Forming Process

but the cell requires no further attention. The charger can be left connected to the battery for long periods without heating, and draw practically nothing from the lighting circuit; the charger is for 100-volt, 60-cycle alternating current only, so it is well to see what type of current is available before building the unit. Besides the material already mentioned the only supplies needed are two binding posts, and 5 ft. of ordinary lampcord, with plug.

Re-Marking Radio Dials

Radio dials and lettered binding posts often become darkened and worn, due to constant handling, but they can be made like new with little effort and expense. Obtain a small tube of Chinese white at a painters' supply store. Remove the old white filler from the dial or binding post with a sharp tool, a large darning needle being ideal for this purpose. It is important that the engraving be cleaned out thoroughly before refilling, or the new paint will not stick. Put in the new filler of Chinese white and allow it to set for three minutes. Now hold a piece of cloth flat on a table and rub the post or dial on the cloth to remove the excess filler.—John C. Heberger, Rochester, N. Y.

Efficient Primary for R. F. Transformers

The idea of winding the primary of a r.f. transformer in a slot or groove is not a new one, but it has the advantage of reducing the capacity coupling between the primary and the secondary. The sketch illustrates an easily made winding form for such a primary. Three round disks of $\frac{1}{16}$ -in. bakelite are held together with

two ordinary shoe eyelets. Two of the disks are of the same size, the third and smaller one being placed between the other two. The three are clamped together and drilled for the eyelets, and the latter inserted and clinched over the terminals. The primary, consisting of 15 to 20 turns of No. 32 d.s.c. wire, is wound in the slot; the ends are soldered to the terminals, and the finished coil slipped inside the secondary, whereupon the terminals are connected to the B+ and plate as in-

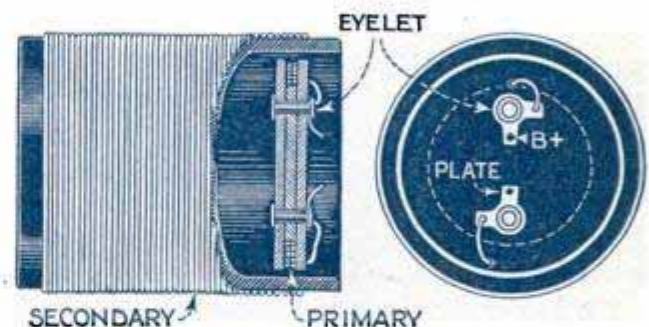

Cut-Away Section Shows Primary Coil in Position; Right, End View with Primary Terminals

dicated. The eyelets which are used to hold the plates together should be obtainable at any shoe store. If $\frac{1}{16}$ -in. bakelite is not available, cardboard will serve the purpose practically as well.—Hugh G. Bersie, Chicago, Ill.

EXCEPTIONAL SIMPLICITY is Feature of LATEST SUPERHET

by Frank L. Brittin

AS easy to build as the average 5-tube set, this latest product of Popular Mechanics radio laboratory introduces an entirely new note in modern superheterodyne design. The superiority of this well-known circuit is undisputed; when correctly built, it has invariably proved its right to the title "Rolls-Royce" of radio receivers. Up to the present time, however, it has been necessary for the average superheterodyne builder to follow several hard and fast rules to obtain the remarkable selectivity, tone and range for which the circuit is noted. Without facilities for carefully matching tubes, checking i.f. transformers and proper shielding, no two sets worked exactly alike; some were good and others no better than the average tuned r.f. sets, depending on the skill of the builder and the quality of the materials available.

All hit-and-miss methods are eliminated in this powerful and selective receiver, which employs a specially designed three-stage resistance-coupled unit, making possible the use of any intermediate-frequency best suited for the needs of the individual builder. In the early days of superheterodyne development, resistance-coupled i.f. amplifica-

tion was used with excellent results. This method, however, was used by only a few experts, who, after many experiments, occasionally found just how much drawing ink and graphite from lead-pencil shavings would turn the trick. Today we have highly developed permanent resistor units available for all, and it is no longer necessary to depend on specially peaked and matched transformers nor upon arbitrary frequencies that must be carefully filtered out to obtain maximum results.

For the model described, which, of course, is used in the Chicago territory, a tuned filter peaking at 46 kilocycles was used, as this was found to keep at a minimum the interference due to harmonics from powerful stations in this region. While this frequency may be used in any other territory, it may be found advisable to select a tuned filter peaking at a frequency either above or below 46 kilocycles, depending on the wavelengths of the local stations. This is an easy matter, since the filters are available for any frequency, from 40 to 50 kilocycles. This makes the receiver extremely flexible, and results in greater selectivity, without sacrificing tone quality, and, at the same time, greatly increases range and volume. Perfect inter-

stage amplification, due to the resistance-coupled unit and the use of extra-heavy a.f. transformers, capable of handling both the higher and lower frequencies, makes possible the true reproduction of the living voice. With a suitable

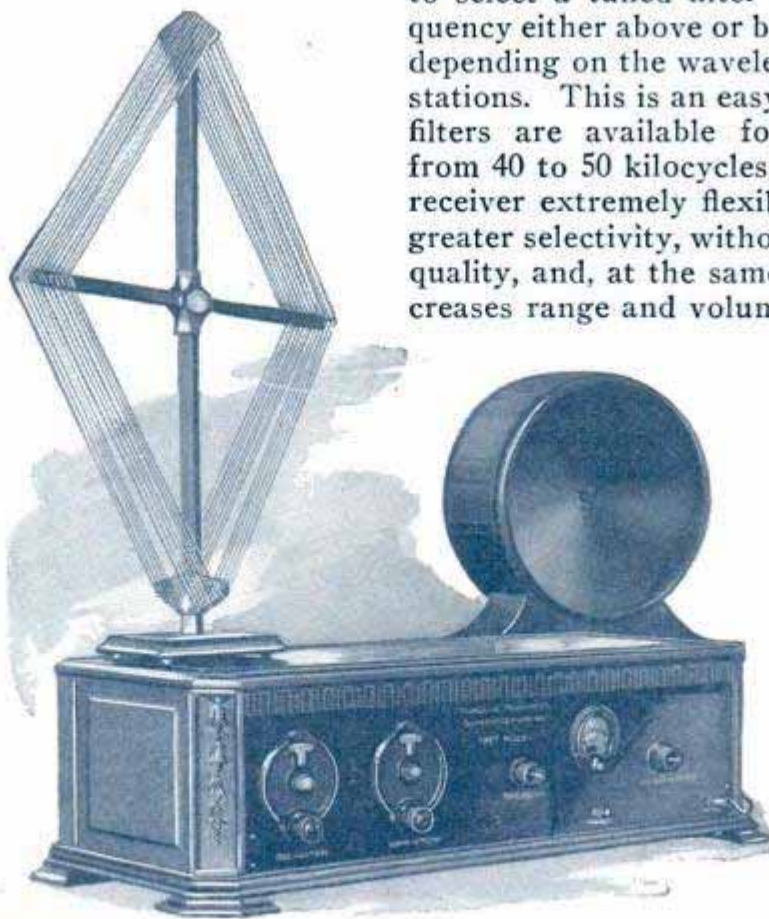



speaker or combination of horn and cone speaker in series, capable of truly reproducing the output of the receiver, each instrument in the orchestra can be heard; the low notes of the bass and kettledrums as well as the high-pitched clarinet and piccolo notes are given their true tonal values. A third transformer of the output type is used between the loud speaker and the output of the power tube; this transformer is designed to keep the direct plate-current of the power tube out of the loud speaker, thus increasing the handling power of the latter several times.

Distance tests during the summer months, usually not considered good for radio reception, resulted in a log of some sixty stations scattered over the east coast, Canada, and southern states. Most of

these stations were logged during severe static disturbances

and many through a barrage of local high-powered stations.

No lengthy construction data are required to build this set as each step is carefully covered in the photos and diagrams. The front-panel template should be carefully laid out on a sheet of bristol board if blueprint templates are not used; the layout of the subpanel is shown below and the holes for the instrument mounting screws indicated. Details of the subpanel mounting brackets are shown below the subpanel layout; it will be noted that strips of bakelite are used to drop the subpanel $\frac{3}{16}$ in. below the top of the outside brackets to make room for the aluminum "can" or shield above the subpanel.

The oscillator unit is completely isolated

**POPULAR MECHANICS
SUPERHETERODYNE
1927 MODEL**

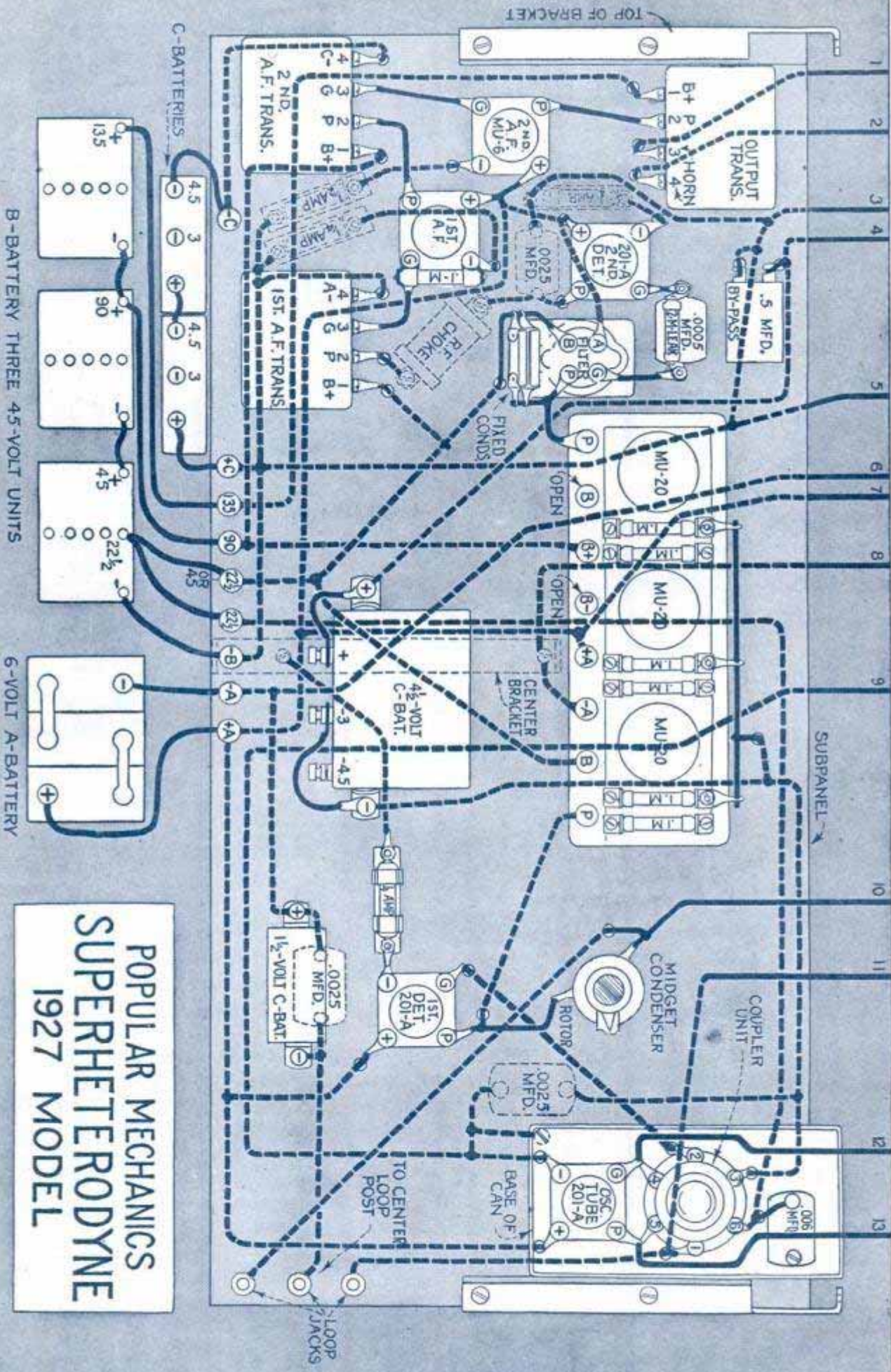

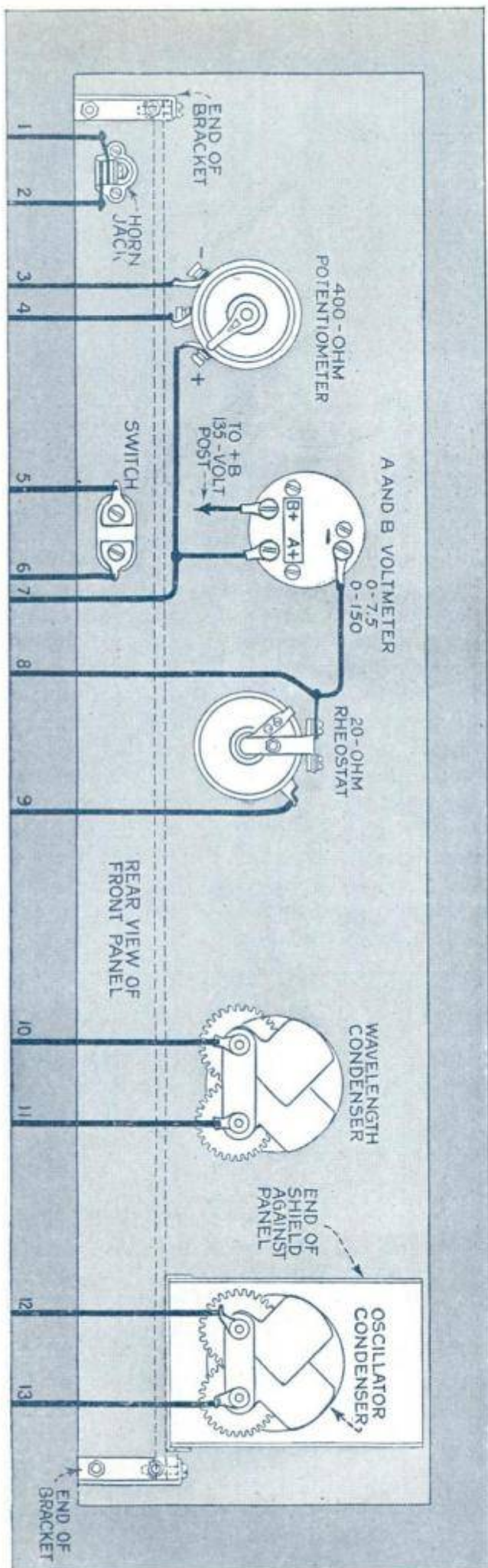

in this aluminum can, shown in the photo at the right. This can may be obtained with most of the holes drilled and ready for use; the top and bottom are removable, the base of the can is screwed to the subpanel and the tube socket and universal socket for the plug-in coupler unit mounted in the position shown. Three short lengths of brass tubing furnished with the unit are used to elevate the coupler socket about $\frac{1}{2}$ in. above the base of the can. The tube socket is mounted directly on the can base or can be slightly raised on bakelite strips if desired. The .006-mfd. fixed condenser is mounted on the base of the can directly in front of the coupler unit under the oscillator condenser, one side screwed to the can for the A-negative connection and spaced by an extra brass nut, as shown in the detailed diagram. The other side of this fixed condenser does not touch the can and is provided with a soldering lug and connected to the No. 6 post on the coupler-unit socket. Holes are drilled in the can base and subpanel near each terminal of the tube socket and coupler-unit socket, all leads to these terminals being taken below the subpanel and insulated from the can with short lengths of good black spaghetti tubing.

Next assemble all instruments on the front panel except the oscillator condenser and screw the front panel temporarily in place on the outside subpanel brackets. When assembled, the front edge of the can base should be against the front panel. Place the sides of the can in position in the base and line up the condenser mounting holes on the front of the can. After drilling the holes in the can, enlarge the hole for the condenser shaft so no metal will come in contact with the shaft when the condenser is in position. When completely assembled and the lid in position, this aluminum can effectually shields this usually "touchy" part of the circuit. The oscillator condenser, top and sides of the can are then left off the assembly until all the wiring is completed, the last two wires from the oscillator condenser to the coupler terminals 4 and 5 being added after the can is finally assembled. The subpanel layout shows each instrument above the subpanel in its proper position; the only instruments below the subpanel being the r.f. choke coil, by-pass condensers and filament control ballasts shown in the large wiring diagram and indicated by

dotted lines. The ballasts are all below except the one for the first detector tube; a single brass machine screw holds each ballast mounting in position on the subpanel, and the choke coil is held in position with a short brass machine screw at each end, as indicated. These ballasts are $\frac{1}{4}$ amp. each, except the one for the power tube MU-6 in the last a.f. tube socket; this ballast must be of the $\frac{1}{2}$ -amp. type. The MU-6 tube used has a 6-volt filament, and, while the ballast indicated is not necessary for this tube, it is installed so that other types of tubes may be substituted, if desired, in the second a.f. stage. Three MU-20 tubes must be used in the resistance-coupled unit; therefore the 6-volt filament supply line is taken directly to this unit.

There are a few slight changes necessary in the resistance-coupled unit to facilitate wiring under the subpanel, and these changes must be made before this unit is mounted in its position. Six small C-battery posts will be noted on the upper front edge of the unit; these posts are connected together on the underside of the unit with short metal strips. Remove these strips and replace the nuts as you found them; soldering lugs are then placed under the three binding posts located on the top of the unit at the end of each resistor marked 1.M and connected

together with a short length of busbar wire as shown in the wiring diagram. The remaining three C-battery posts nearest each tube have no external connection on this side of the unit.

Referring to the subpanel layout, note the holes drilled in the subpanel and marked respectively P, B, A-negative, A-positive and B-positive; these holes are directly below the corresponding posts of the unit when it is in position. Carefully remove the corresponding binding posts on the unit and replace them with five $1\frac{1}{2}$ -in. brass machine screws; leaving the connecting strips on the underside of the unit just as they were and screwing up hexagon brass nuts to hold the strips firmly in place. Posts B-negative and "output" B are not disturbed, and no external connection is taken to them; these posts are marked "open" in the wiring diagram. The "output" P-post is not disturbed and carries the only external connection on this side of the unit, namely the output of the unit to the P-post of the filter. The unit is now ready for mounting on the subpanel and before mounting it see that all terminals are tight; the long screws at the four corners hold the unit in position. Additional brass nuts are placed on the long screws that replaced the binding posts and are now protruding through to the underside of the subpanel; soldering lugs

MATERIAL LIST

- | | |
|--|---|
| 1 front panel, 3-16 by 7 by 30 in. | 3 $4\frac{1}{2}$ -volt C-batteries, large, tapped type. |
| 1 subpanel, 3-16 by 10 by 29 in. | 1 $1\frac{1}{2}$ -volt single cell, C-battery, large type. |
| 2 strips bakelite, 3-16 by $\frac{1}{2}$ by 5 in. | 3 45-volt B-battery units, heavy-duty type. |
| 1 strip bakelite, 3-16 by $\frac{1}{2}$ by 2 in. | 1 gridleak, 2 meg. |
| 1 Daven 3-stage super-amplifier unit, type 3-R. | 1 gridleak, .1 meg., with mounting clips. |
| 3 Daven $\frac{1}{4}$ -amp. ballasts, complete with No. 50 mountings. | 1 400-ohm potentiometer, Frost, Yaxley, Centralab, or similar type. |
| 1 Daven $\frac{1}{2}$ -amp. ballast, with No. 50 mounting. | 1 20-ohm rheostat. |
| 3 Daven MU-20 tubes. | 1 jack, open-circuit type. |
| 1 Daven MU-6 power tube. | 1 push-pull filament switch. |
| 4 201-A tubes. | 11 binding posts, with engraved tops. |
| 1 S-M plug-in-coupler unit, type 110-A. | 3 Sangamo fixed condensers, .0025 mfd. |
| 1 S-M universal socket, type 515. | 1 Sangamo fixed condenser, .0005 mfd., with grid-leak clips. |
| 1 S-M tuned air-core filter, type 211 (available for any frequency between 40 and 50 kilocycles) any of which may be used. | 1 Sangamo fixed condenser, .006 mfd. |
| 2 S-M a.f. transformers, type 220. | 1 by-pass condenser, $\frac{1}{2}$ mfd., Sangamo, Dubilier or Tobe-Deutschmann. |
| 1 S-M output transformer, type 221. | 8 doz. soldering lugs, long, round-hole type. |
| 1 S-M aluminum shield, type 631, for oscillator unit. | 10 2-ft. lengths, round, tinned-copper busbar wire. |
| 2 Remler capacity units, .0005 mfd., type 631. | 4 lengths black spaghetti tubing. |
| 1 Jewell or Hoyt A and B voltmeter, double range, 0-7.5 and 0-150 volts. | 2 ft. stranded, flexible, rubber-covered fixture wire. |
| 5 standard spring-suspended sockets, Benjamin or similar type. | 12 6-32 brass machine screws, $1\frac{1}{2}$ in. long, round head. |
| 3 cord-tip plugs and jacks. | 18 6-32 brass machine screws, 1 in. long, round head. |
| 2 Benjamin subpanel brackets. | 30 6-32 brass machine screws, $\frac{1}{2}$ in. long, round head. |
| 1 Samson r.f. choke coil. | 7 6-32 brass machine screws, $\frac{1}{2}$ in. long, round head, nickelplated. |
| 2 National velvet-vernier dials, type B, dual range. | 20-in. strip brass, 1-16 by $\frac{1}{2}$ in., for brackets. |
| 1 midget condenser, Chelton or S-M, low-loss type. | |
| 1 three-tap, loop aerial, box type preferred. | |

and place the rotor of the coupler at an angle of about 45° , replacing the lid of the can firmly so that it will not vibrate; plug in the loud speaker and turn on the filament switch. Turn the rheostat well over to the right, and keep the potentiometer as far to the left as possible for the first test. Slight changes in the rheostat and potentiometer settings will be required but the approximate positions are as given. To pick up a station, slowly rotate the dials in step, never tuning them independently when locating a station. When the signal is heard at good volume, leave the oscillator dial as it is and readjust the wavelength dial a few points on either side of the oscillator setting to bring the signal in at maximum strength. Now adjust the midget condenser to the point that gives the loudest and clearest signals. Once found, this adjustment need not be changed.

For these first tests, which should be made when local stations are on the air, it is well to keep the B-battery voltage to the plates of the oscillator and detector tubes on both $22\frac{1}{2}$ -volt posts, and the resistance-coupled unit on 90 volts just as shown on the large wiring diagram. Later, as you become more familiar with the instrument, raise both $22\frac{1}{2}$ -volt B-battery connections to 45 volts and the 90-volt connection to $112\frac{1}{2}$ volts. This B-battery arrangement will necessitate a more critical rheostat adjustment on the oscillator tube, but will bring out the full possibilities of the instrument. The arrangement of the tubes should not be changed except that the new 200-A or 300-A detector tubes may be used if desired. The first a.f. amplifier tube may be either a 201-A or a power type, but if a power tube is used, the ballast and negative grid bias must be changed to suit the tube specifications. Ample volume is obtained with the 201-A tube; therefore, it is recommended for the first a.f. stage. The .1-M resistor, clipped across the filament and grid posts of this socket is necessary

regardless of the type of tube to be used.

Popular Mechanics radio laboratory has made every effort to make this set as simple to build as possible; all details have been carefully checked, and a set of enlarged blueprints of the wiring diagram, schematic diagram, full-size drilling templates, as well as additional photos of the subpanel layout and under-subpanel wiring have been prepared. The complete set may be obtained from Popular Mechanics Radio department, 200 E. Ontario st., Chicago, Ill., for 75 cents. Specify blueprint No. 114.

Rotary Radio Meter Has Five Ranges

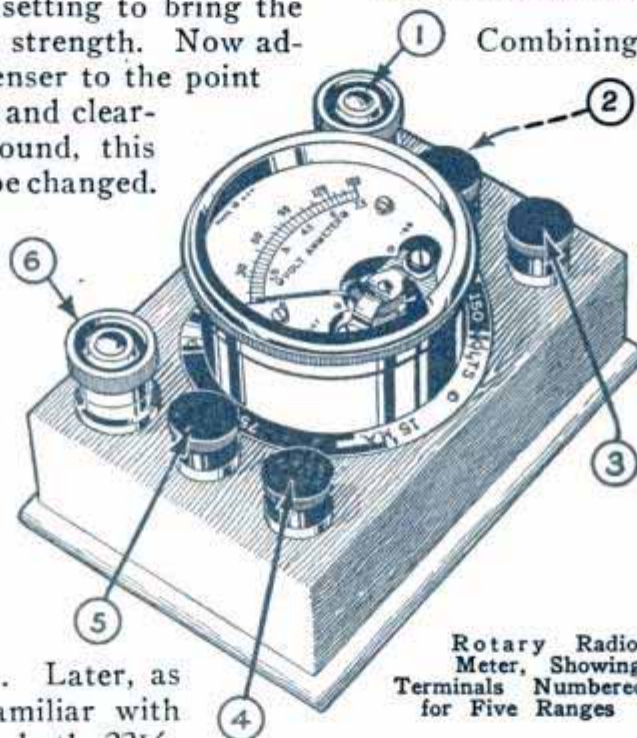

Rotary Radio Meter, Showing Terminals Numbered for Five Ranges

Combining five ranges, a new radio meter of rotary design has appeared on the market. It can be used for all testing on receivers, tubes, batteries, battery chargers and battery eliminators. The meter is mounted on a mahogany block, and is turned by a knurled rim to the five different positions, registering with each of the binding posts through a series of segments within the base block. The No. 1 post is the positive

terminal used for all measurements; No. 2 is the 7.5-volt scale, for testing tubes, filament voltages, and A-battery voltages; No. 3 is the 150-volt scale, for measuring plate voltages on tubes, and of B-batteries and B-eliminators; No. 4 is the 15 milamp. scale, for obtaining the plate current on single to three-tube sets, and for testing tubes; No. 5 is for the 75-milamp. scale for testing the plate current of large sets of four or more tubes or power amplifiers, and outputs of B-eliminators. The No. 6 post is for the 7.5-amp. scale for measuring the current taken by tube filaments, singly or in sets, and for charging A-batteries. Wiring diagrams are supplied with the meter for checking battery eliminators, coils and transformers.

High Electrical Measurement Work



Making a "Tumbling Teddy"

By E. R. HAAN

THE toy described in this article is very simple to make, but will provide endless amusement for the youngsters. No special tools, other than those to be found around the average home, are needed for its construction; a scroll or coping saw is useful for cutting out the figure of "Teddy" himself, but, in the absence of this tool, the figure can quite easily be cut with a knife, if a little care is used in the operation.

The ladder is the first thing to make. This is formed from two lengths of $\frac{3}{8}$ by $\frac{3}{8}$ -in. wood, 24 in. long, with eight rungs of $\frac{1}{8}$ by $1\frac{1}{32}$ -in. stuff, each $2\frac{3}{4}$ in. long, spaced exactly $2\frac{7}{8}$ in. apart. The rungs are fastened to the sides of the ladder with common pins and glue, leaving one off at one end temporarily. On each end of the ladder is fastened a base, consisting of a block of wood, 4 in. square and 1 in. thick. As will be noted, the end of the ladder sides are set in inclined slots cut in the base blocks, glued, and fastened with round-headed brass screws. When joined to the bases, the ladder is not exactly vertical, but inclines 1 in. for every 10 in. of its length. The ladder can be made in any length desired; there is no need to stick to the 24-in. size of the original, but, in case it is made longer, the bases must be made longer also, so as to keep the toy stable. For a very long ladder, it would be best to fit one base and leave the upper end of the ladder open, but this means that the figure must be lifted from the bottom to the top every time

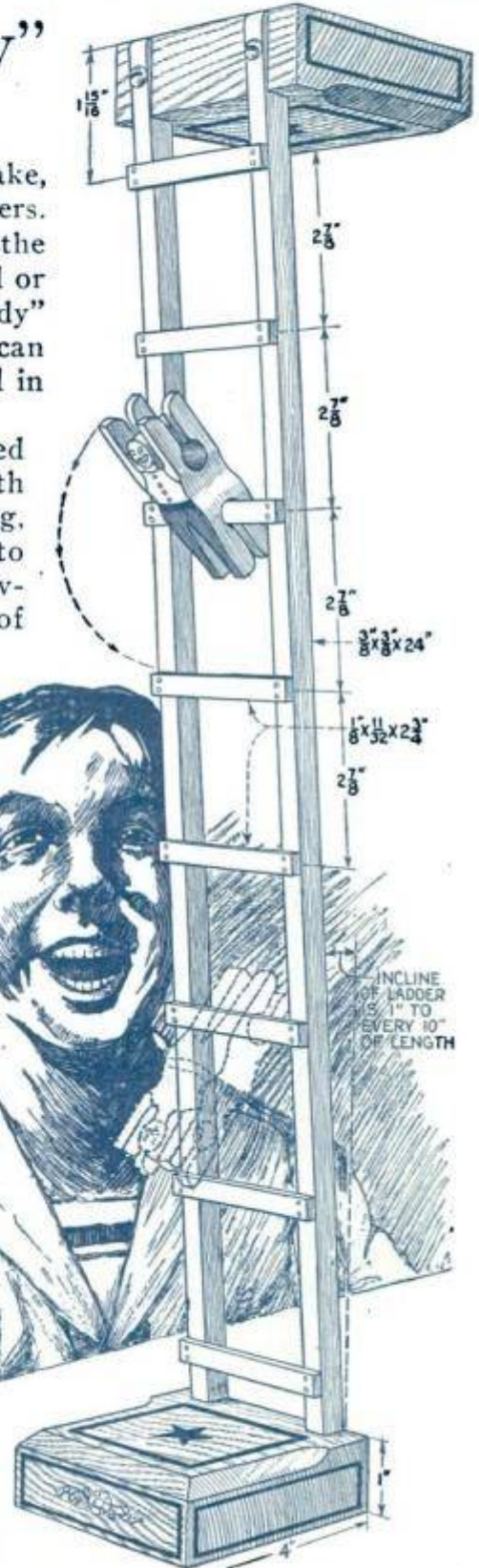

Here Is "Tumbling Teddy," an Acrobatic Clown That Will Amuse the Youngsters for Hours at a Time

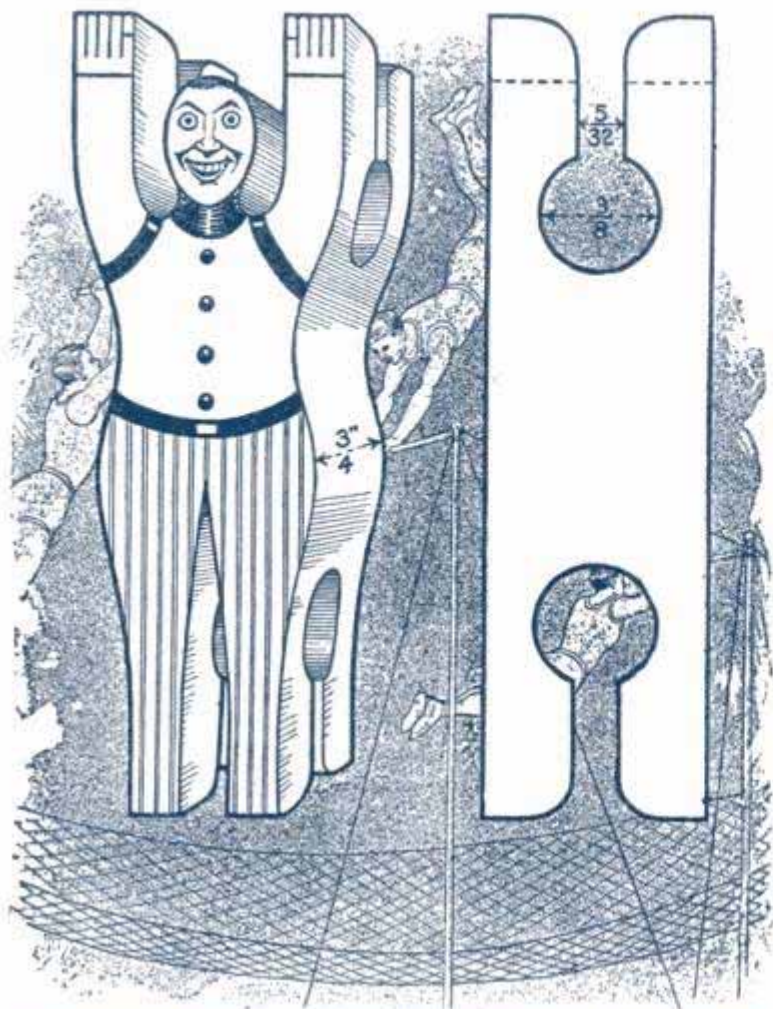

Details of the Figure of Teddy; the Holes and the Slots Must Be Exactly in the Center of the Clown

it tumbles down, while with a base at each end the whole ladder is simply reversed, and Teddy then tumbles to the other end of the ladder.

The figure of Teddy is $3\frac{1}{8}$ in. long, from the tip of the upraised hands to the bottom of the "feet." The figure is cut out of $\frac{3}{4}$ in. stock, preferably with a scrollsaw, as mentioned previously. The exact width of the figure is not so important, but in the original the width at the widest part, on a line across the shoulders, is 1 in., at the waist $\frac{5}{8}$ in. and the hips $\frac{7}{8}$ in. Exactly in the center of the thickness of the figure, and $\frac{3}{4}$ in. from the ends, two $\frac{3}{8}$ -in. holes are drilled through, and $\frac{5}{32}$ -in. slots cut from these to the ends. It is important that the holes and slots be exactly in the center of the figure, else Teddy will not perform properly. The inner edges of the slots are rounded off as indicated in the detail drawing. When finished, the figure is placed on the ladder at the place where the rung was left off, and this rung then pinned and glued in.

Now, if the ladder is placed upright, with the figure at the top, Teddy will gracefully tumble down the ladder to the bottom, when the whole toy is reversed and the operation repeated. It may sometimes be found necessary to trim a little from the sides of the slots so that the figure can swing freely, and tumble down without a stop from top to bottom, but a little experiment will soon put it in first-class shape. The toy, of course, may be decorated in any manner desired.

Making Bicycle Tires Unleakable

Any bicycle tire that has a few small holes in it and is not worn down much, can be repaired easily so that it can be used until the rubber wears through. The tire is taken from the wheel and a small slit, about 6 or 8 in. long, is cut in it in the inside edge, as indicated. Next a supply of corks, a little smaller than the diameter of the tire, is procured. Corks cost almost nothing, so enough of

them can be bought for a few cents. The slit is pulled open and the corks are inserted into the tire, care being taken to keep them straight. They can be pushed entirely around the tire with a piece of rubber hose so as to make them fit tight. After the tire is completely filled with corks, the section of the tire where the slit was cut can be tightly taped to keep the tire intact. The tire is then replaced and glued with rubber cement. This repair will be found very good.—Wilson G. Walters, Rochester, N. Y.



Compressed Air Cleaning Away Mush Ice

The successful winter operation of a hydroelectric plant was menaced by the entrance of mush ice into the penstock. This plant incurred considerable expense by the building of a series of screens designed to keep the ice out. But the ice continued to form and choked the screens. These were discarded in favor of a steam line to melt the ice before it could enter. This method also proved unsatisfactory. A visitor at the plant suggested the use of compressed air. A very small compressor was installed and the air piped to a point below the intake where, when released, the air would bubble up to the surface of the water. The thousands of little bubbles kept the entering water in such turmoil that ice could not form over it.—Sherwood J. Gee, Montpelier, Idaho.

Sharpening the Razor

Take a clean, bright piece of $\frac{1}{2}$ -in. lead pipe and rub it over the razor strop a few times. Then strop your razor, and you will find how quickly it will be sharpened. I have been doing this for 15 years and have never found it necessary to hone my razor.—H. A. Barwick, Montreal, Can.

Fence Post Pulls Auto Out of Mud Hole

Due to the differential action of the rear wheels of an automobile it is often a difficult job to get out of a mud hole, as most drivers have experienced. However, by fastening a fence post, or any post of suitable size, to the rear wheels, as illustrated, it is a comparatively easy job to get out of the mud. The post should be tied to the wheels under the driveshaft and removed when it reaches the back of the fenders.—Art. Hellberg, McGregor, Iowa.

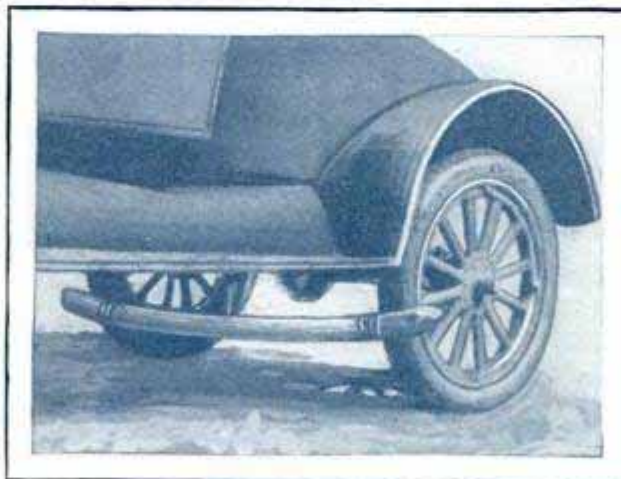

Get Your Car Out of a Mud Hole with the Aid of a Fence Post

Cords Hanging in Barn Doorway Remove Flies from Cattle as They Enter

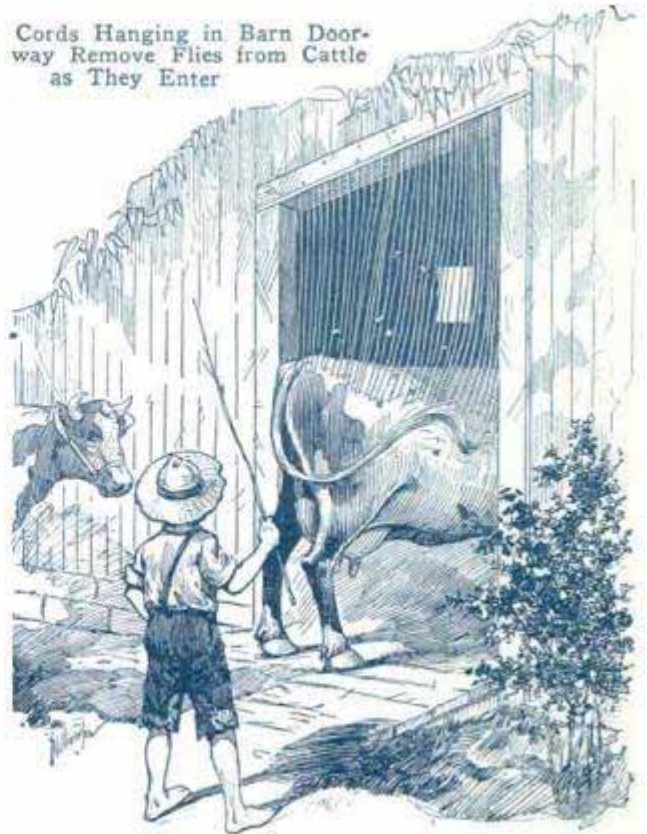

Barn-Door Fly Chaser

Observing that most of the flies that troubled his cows at milking time were carried into the barn from the pastures by the animals themselves, a Wisconsin farmer made the fly chaser shown in the illustration, and reduced the annoyance to a great extent. Across the door from the yard to the barn a bar was placed at a height of 7 ft. and from this was suspended a curtain of twine strands, which hung to within $2\frac{1}{2}$ ft. of the ground. As the cows entered the barn through this door, in single file, the curtain brushed across their backs and sides and dislodged the flies, allowing the animals to enter the barn practically free from them. By keeping the interior of the barn darkened the milking then could proceed without much trouble.

☛ Mirrors and picture glasses should be cleaned with a pad of tissue paper sprinkled with methylated spirits.

Build Your Own Ship Model

By J. EARLE MILLER

BUILDING one of the ship models which have attained such favor for interior decoration is a simple task, once the secret of the carving of the hull has been mastered. This job has scared many prospective model builders, but by the "bread and butter" method used by professional model makers the hull is, in fact, the easiest and simplest part to make.

This is the story of the building of a model of Hendrick Hudson's "Half Moon," one of four model ships recently constructed in the Popular Mechanics experimental shop. While no authentic plans of the actual "Half Moon" exist, this model represents what the ship must have been like, according to contemporary accounts and plans.

To start with, the builder will need four 2 ft.

lengths of $\frac{7}{16}$ -in. net white pine, 10 in. wide and free from knots; a cigar box or two for thinner wood; a dozen lengths of



round dowel stock, equally divided between the $\frac{3}{16}$, $\frac{1}{4}$, $\frac{5}{16}$ and $\frac{7}{16}$ -in. sizes, to make the masts, yards, bowsprit and flag-pole. The dowel stock can be obtained from a hardware store and the white pine, which should be well seasoned and dried, from a lumber dealer.

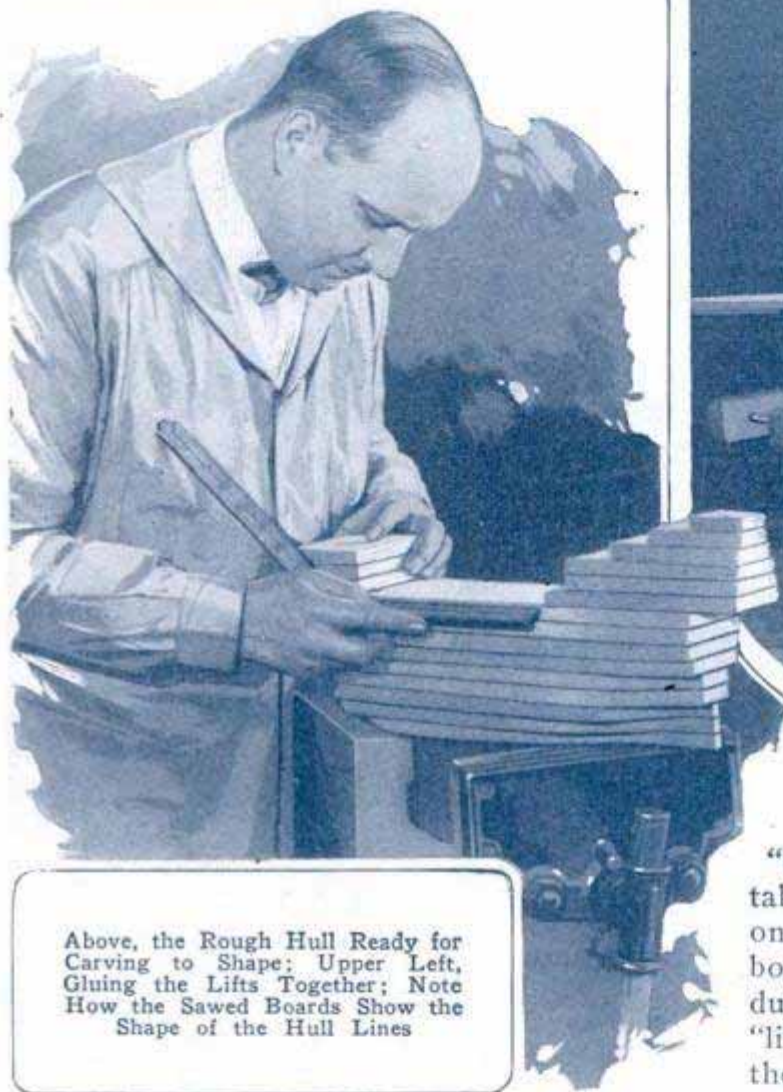

Above, the Rough Hull Ready for Carving to Shape; Upper Left, Gluing the Lifts Together; Note How the Sawed Boards Show the Shape of the Hull Lines

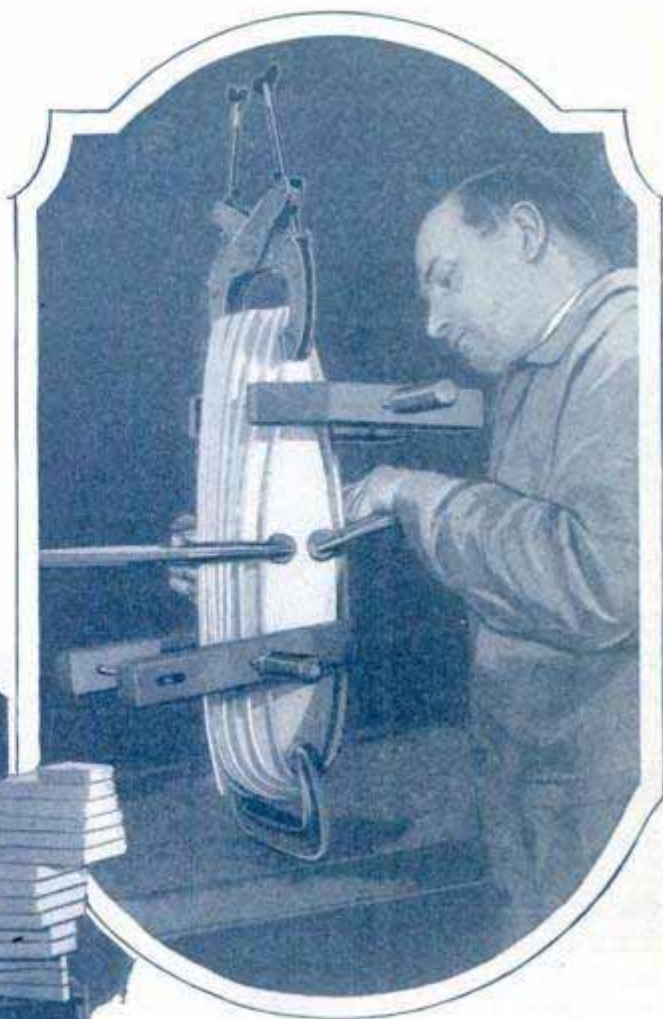

The templates represent the "bread and butter" method lines as taken from the blueprints, and are one-quarter the size of the actual boards. In this system, the hull is reduced to a series of flat boards or "lifts," which are glued together and then carved down with draw and spokeshaves, chisels and files. As the

inner edge, where each two lifts meet, represents the hull line at that point, it is only necessary to carve off the projecting corners. The carving of this hull was completed in less than an hour.

The hull templates, as given, were laid out for lifts $\frac{7}{16}$ in. thick, which happened to be the size on hand. Take a large sheet of drawing or heavy wrapping paper and lay it out in 1-in. squares. Using one of the horizontal lines as a center, lay off the full-size half-template according to the squares given for line No. 1. Then fold the paper along the center line and cut both thicknesses at the same time. Unfold, and you have the full template for the first plank below the finished deck. Follow

The tools needed include a coping saw, a drawshave and spokeshave, flat chisels and gouges, several flat, half-round and round files, a wood-carver's knife, or, in its stead, a strong, sharp jackknife, a gluepot and supply of a good grade of glue, two or three large clamps and a half dozen of the small metal clamps sold in the dime stores.

Blueprints for this, and a wide range of other ships, are sold at prices ranging from \$2.50 to \$10 a set, depending upon their completeness. A full set of five prints purchased from a model designer for this ship costs \$10, but the ship can be built without the use of prints by laying out the hull from the templates given.

the same process for the other eight lifts in the hull, and for the shorter pieces of the poop and forecastle (fo'c'sle). The rounded ends of the templates are the bow ends. The templates are then laid on the pine boards, marked, and are then ready for sawing. The bow or stern ends of each piece should be indicated, and the center marks at bow and stern transferred from the templates to the wood. The lifts are then sawed out with the coping saw, and are ready for gluing, after the center lines have been marked down one face and both ends.

Start with lift No. 1, coat it with glue on the side bearing the center mark, and coat the unmarked side of lift No. 2; place the two glued surfaces together and line them up by the center marks. As No. 1 is the first lift under the deck line, you are building the hull from the deck down to the keel, so that the center lines will be face up, and as the lifts get smaller toward the keel, each succeeding one can be lined up by the end marks. At the stern the templates have all been

continued to the same length, and the ends are lined up vertically as the gluing proceeds, while the bow ends get progressively shorter, simplifying the later carving of the stem. When plank 9 has been

glued in place, clamp the entire hull tight and set it aside for twenty-four hours. While it is setting, the laminations of the poop and quarterdeck and the forecastle can be glued together in the same way and placed in clamps or a vise.

After the glue has set, the forecastle and stern superstructures are glued to the main hull and held in place with the large clamps. Like the hull parts, the pieces of the poop and

quarterdeck are cut to line up at the stern, and, in gluing, they are centered in the same way as the hull parts. In assembling the stern superstructure to the hull the upper works project over the stern $1\frac{1}{8}$ in. to take care of the extreme rake of the stern, which is sawed out later. After the stern sections are glued and clamped in place a line is drawn across the deck $8\frac{1}{2}$ in. forward from the front end of the lower

lamination of the quarterdeck, and the forecastle glued on, with its rear edge on this line. The completely assembled hull and superstructure, ready to start carving, is shown in the photograph on page 669. The first step is to saw

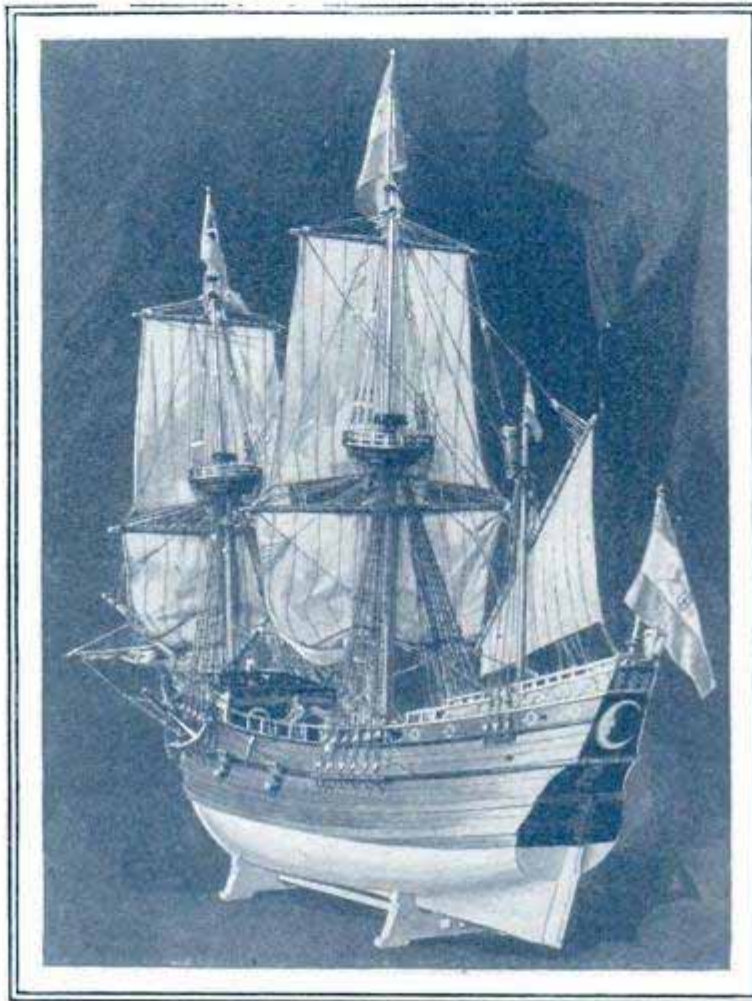

View of the Completed "Half Moon" Model, Fitted with Sails

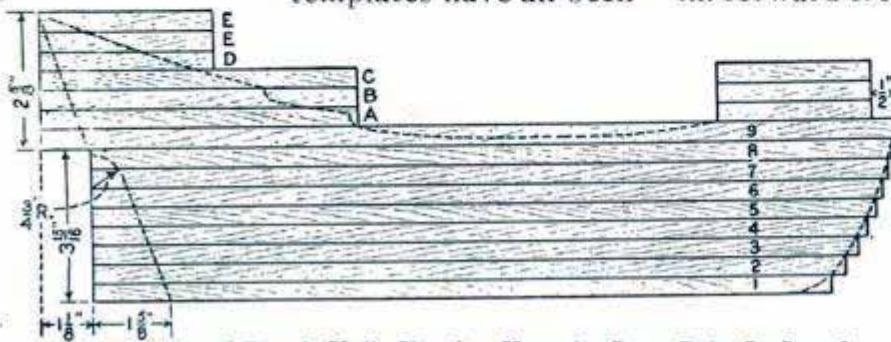

Side Elevation of Rough Hull, Showing How the Stern Rake Is Sawed

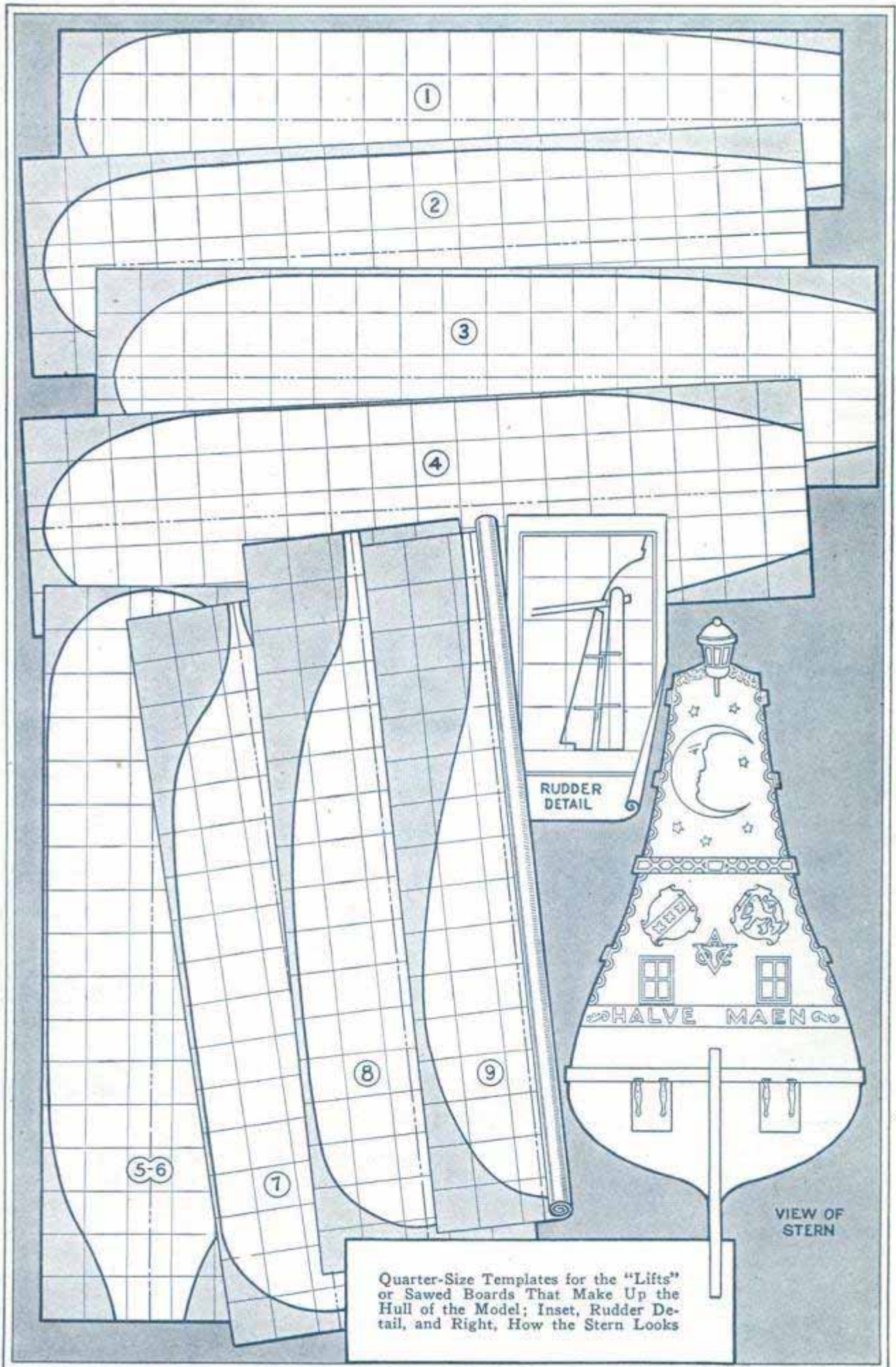

Quarter-Size Templates for the "Lifts" or Sawed Boards That Make Up the Hull of the Model; Inset, Rudder Detail, and Right, How the Stern Looks

FO'C'SLE TEMPLATES

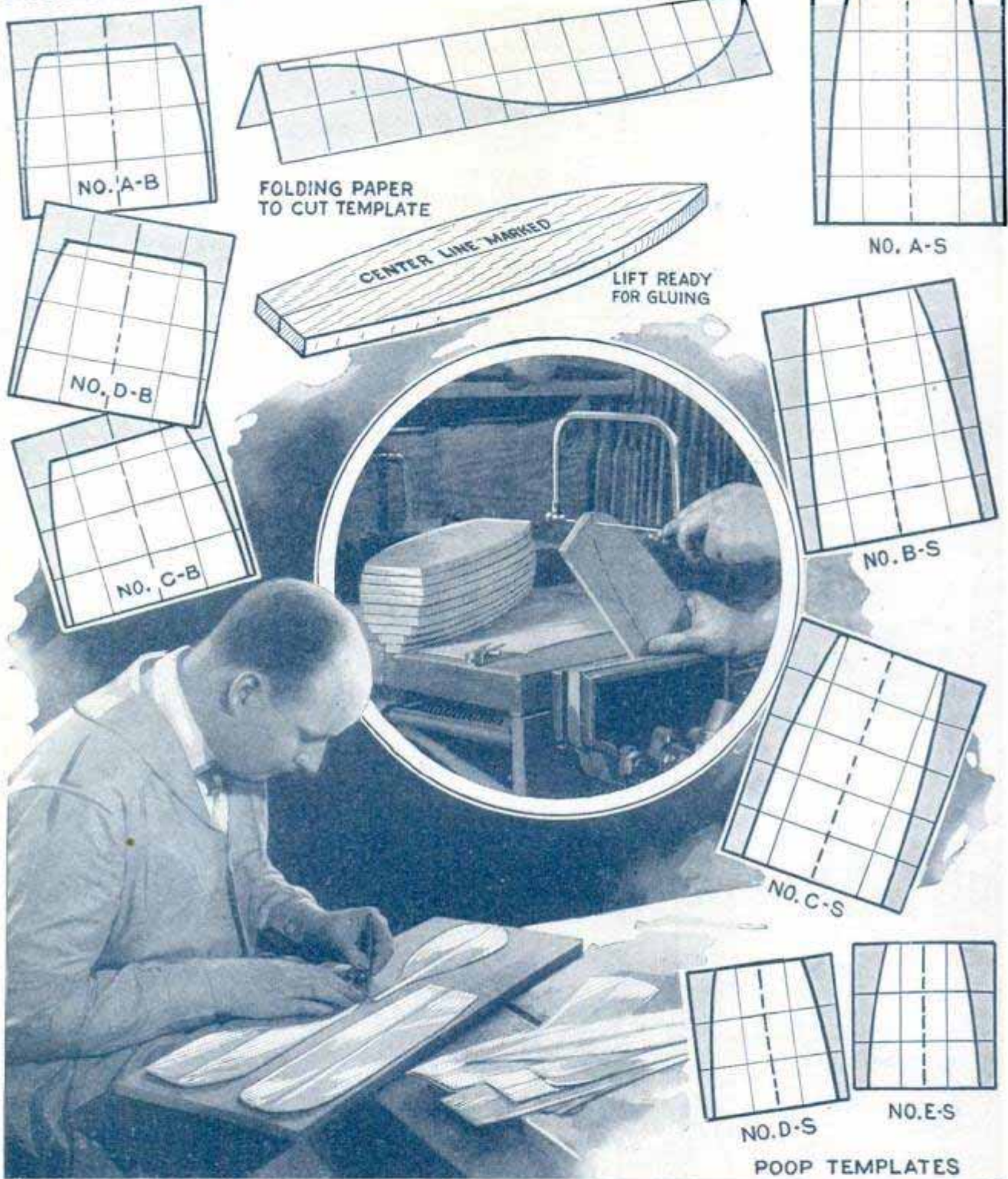

Details of Making and Using Templates, Marking Out Lifts from Templates, and Sawing Them Out

the rake of the stern. Draw a line down the side from the extreme rear of the top-most plank in the poopdeck, to the point where the superstructure meets the main hull. Next mark a point $1\frac{7}{8}$ in. from the stern end on the keel plank, and a second point $3\frac{1}{8}$ in. up from the bottom of the keel plank and $\frac{3}{4}$ in. in from the stern, and connect this point with the one on the keel

plank. From the upper point draw a $\frac{3}{4}$ -in. arc, and then, with hand and coping saws, saw out the stern rake. Next shave off the last inch or two of the hull down to the stern lines. With that much completed, it is easy to shave off the projecting edges of the remainder of the hull until the rounded lines are completed.

(To Be Continued)

Mounted Photographs Set on Imitation Rock Base

Anyone who has tried to cut out and mount enlarged snapshots on wood has made the discovery that, unless both feet are together and in the same plane, one leg will be shorter than the other and none of the usual methods of attaching them to the base can be applied. The difficulty can be overcome by carving an imitation boulder from a block of soft pine, with a ledge on which the rear foot rests, so that the figure appears to be stepping down from the rock. First cut out the base, which may be square or round, about $\frac{5}{8}$ or $\frac{3}{4}$ in. in thickness. If a lathe is available, an attractive base can be turned in a few moments. Lay a piece of 1-in. soft pine on the base, with its front edge $\frac{3}{4}$ in. back from the edge of the base block, and, with a pencil, lay out an irregular-shaped piece, slightly smaller than the base block and forming about three-fourths of a circle. Cut it out with a coping saw, and then, holding the mounted photo against the straight surface at the front of the block, mark the outlines of the feet. With a small gouge or knife cut recesses for the feet to a depth of about $\frac{1}{4}$ in., sloping them slightly back at the top so that when the figure is glued in place, it will lean backward about five degrees. Take a piece of wood about 1 in. wide, nail the block to it and clamp in a vise. This holds the block firmly and leaves it free for carving. Use small chisels or gouges to cut away the material, sloping the imitation rock down to the edges, and leaving as many gouge marks as possible, as the rougher the rock is, the better it will appear when finished. Nail or glue the completed carving to the base, and glue the figure in place. A good finish can be obtained by lacquering the edges of the base black and giving the rock and visible portions of the top surface of the base a heavy coat of bronze. After the bronze dries, paint it over with a green vernis-martin lacquer, and before



Imitation Rock Base for Mounted Photos Solves the Problem of Mounting Them

this has quite set, wipe off most of the green with a rag, leaving it showing in the cracks and recesses. The back and edges of the board on which the photo is mounted can be bronzed and treated in the same way.—J. Earle Miller, Chicago, Ill.

Keeping Shoes Tied

Children often run around with loose shoe strings, which looks untidy and is also a source of danger. A good method of making the knot stay tied is shown in the photo. Both ends are run through the same top eye and the lace is then tied in the usual way. It will be found that this knot will not loosen. Of course, the string should not be so long that the loose ends will reach the ground.



You Can Make These Pine-Cone Novelties

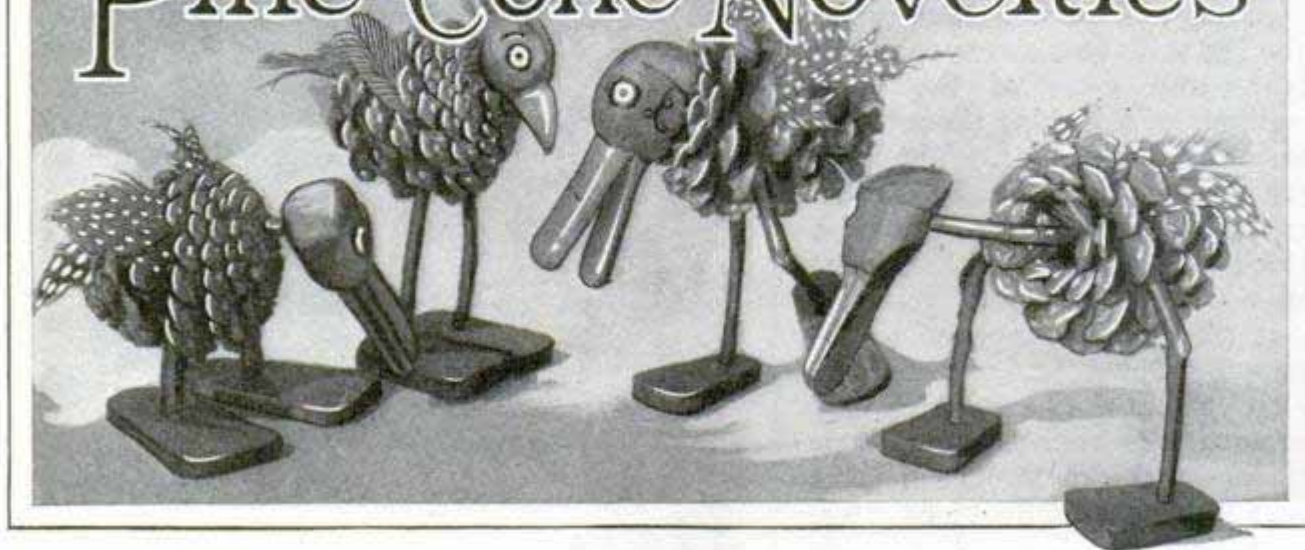

By F. W. WEST

ATTRACTIVE or grotesque birds and other novelties can easily be made from pine cones by anyone possessing a little skill and ingenuity. Besides the cones, all the material needed is some sticks, twigs, feathers and paint. No particular sizes are given, as they must depend on the size of the cones and upon the effect one wishes to obtain.

A general idea of the birds may be obtained from the headpiece, and Figs. 5, 6, 7, 8, 9 and 10, which show the details. The heads are most easily made from small forked pieces, which should be at least 1 in. in diameter after the bark is removed. The painting may be done with oil paint, water colors or lacquer. The latter is easily applied and dries quickly. Two brushes are needed, one a No. 1 camel's-hair brush for the eyes and for striping, and a No. 3 brush for the other work. The eyes should be painted first, preferably black. Fill in with green around them, as indicated in Fig. 8. Next paint the top of the head, using red. The light part of the beak is yellow. Then, with the small brush, make a black stripe down the sides of the beak to divide the lower and upper part. The appearance can be improved by separating each color with a stripe of black. White pine or other soft wood is most suitable for the legs and feet.

To assemble the birds, attach the legs to the cone first. Take two small twigs of any length and size desired, shave one end of each down thin (Fig. 9) and apply a little glue. Then insert the legs between the scales near the stem end and, after the glue has set, trim the legs to the desired length, shaving off the lower end to fit in holes drilled in the feet, which should be about $\frac{1}{4}$ in. thick, and attach with glue. To fasten the head, drill a small hole in the stem end of the cone, shave the end of the neck to fit and attach it with glue. Finally glue a small feather to each side of the cone to represent wings, and one or two feathers in the end for a tail, and the bird is complete.

The turtle (Figs. 1 to 4) should be made from a well-formed cone with the scales at the stem end intact. This end is cut off and forms the back shell. Drill a small hole through the center where the stem was removed. The under shell, Fig. 3, is cut from $\frac{1}{4}$ -in. wood, just large enough so that the back covers it. The hole in the center is the same size as the hole in the back. Paint the beak and the eyes olive and black, respectively, and the other parts of the head and neck to match the natural color of the shell. The assembling is easy. The legs and tail are scales taken from another cone and are attached with

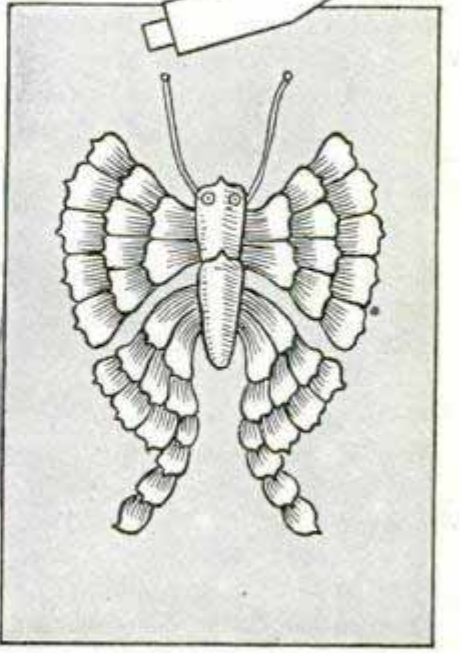
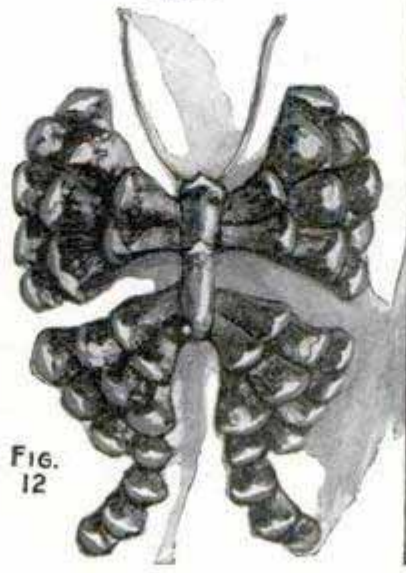
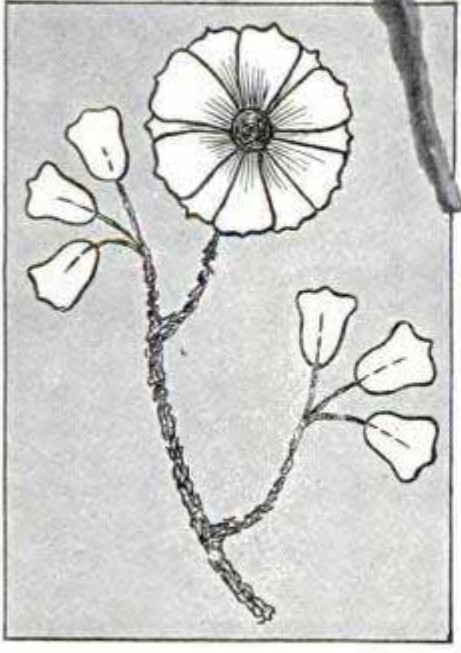
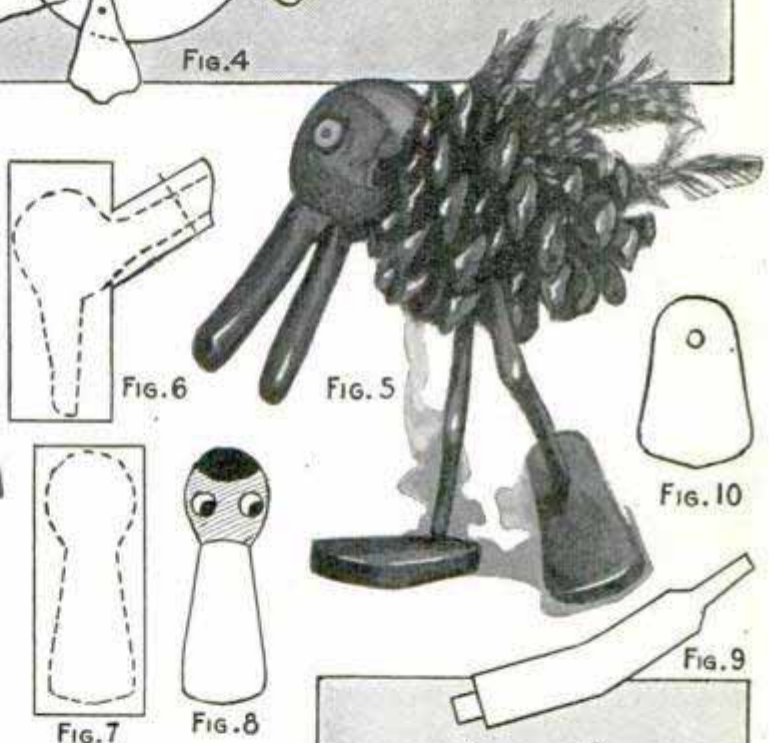
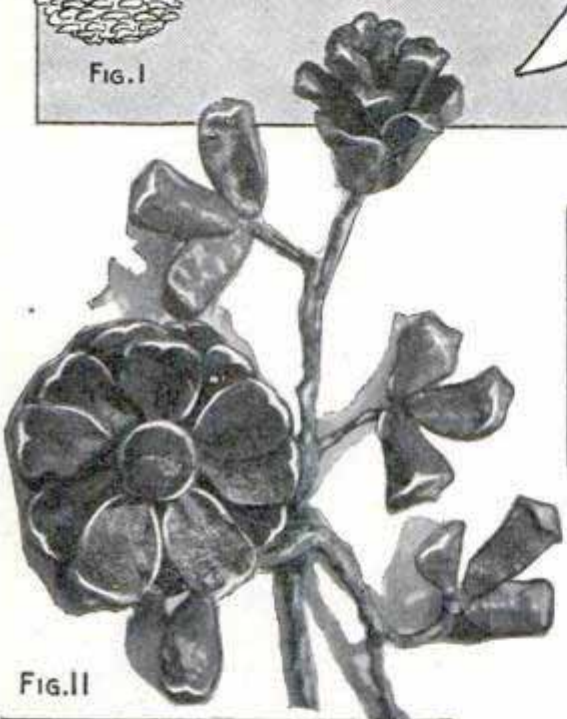
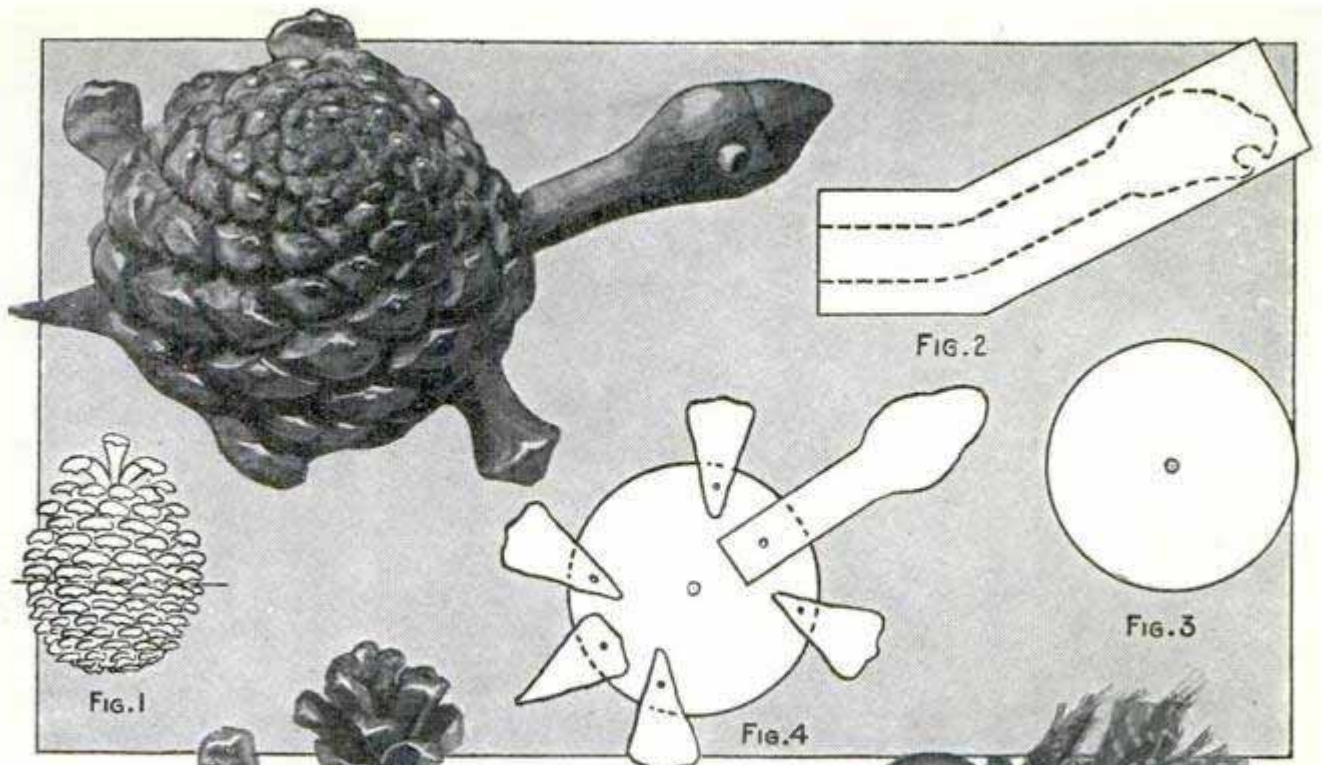

glue and a small brad or pin, as indicated. The head is fastened in the same way. To joint the back and bottom shell, use a small wooden dowel or pin, fitting tightly in the holes in these parts. Fasten with glue, squeezing or clamping them until the glue has set. Then trim the dowel flush with the bottom and back, and paint the ends the same color as the head. This completes the turtle.

Artificial flowers made from cone parts are shown in Fig. 11. To make them, cut the cones in two pieces of about equal length. For larger flowers remove a few of the foremost scales, leaving bare a portion of the core of the cone. Shape this to resemble

the center of a flower, and drill a small hole to attach the stem. Smaller flowers are made similarly from the bare end of the core, drilled for the stem, which is made from small wire, preferably pipe-stem cleaners. The leaves are made of detached scales and are glued on.

For the butterfly (Fig. 12), trace the design on durable paper, attach with glue two or more scales for the body, and make the wings with scales overlapping like shingles on a roof, as indicated. Paint to suit yourself, and after the paint is dry, tear or cut away the surplus paper. The underside of the wings should be covered with silk or crepe paper, attached with glue that will not stain the material. The tendrils and legs are made of pipe-stem cleaners. Flowers and butterflies may be painted to suit your own fancy.

The cat (Figs. 13 to 20) requires two well-formed cones with all the scales intact. The cones should be equal in diameter, but one slightly longer than the

other. The former makes the forepart of the cat's body. Cut both cones as shown in Fig. 13, and drill holes through the parts in the center to receive a piece of insulated wire with the webbing removed. To join the parts of the body, bend the wire as required to give the humped effect, apply glue to this and to the cut-off

ends of the cones, run the wire through the cones and hold them together with a rubber band or piece of twine until the glue has set. If you want a longer body, two more cones may be cut off in the same way as the turtle shell and attached one to each end of the body, gluing in additional scales where needed. For the head, select

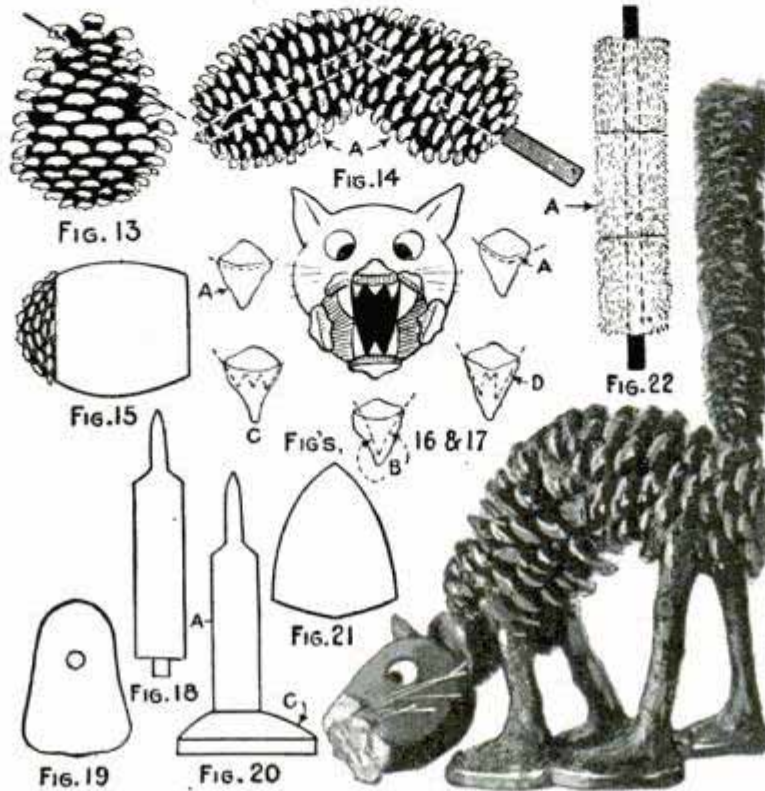

a small cone, cut off the three or four foremost scales and drill a hole in the stem end to receive the protruding end of the wire. Fill and cover the entire open part of the cone with plaster of paris (preferred), furnace cement or putty, and form a flat surface for the mouth on the small end (Fig. 15). Smooth and shape the plastered surface with a putty knife or wooden paddle. If furnace cement is used, dip the putty knife or paddle frequently in cold water. Putty works very nicely if it is warmed before being applied. The head may also be made of wood if desired. The teeth and lips are made of scales, as indicated. The legs (Fig. 18) are formed from sticks and may be straight or slightly crooked, the hind legs a little longer than the fore legs. Match and trim to the length required. Shave the top end to fit between the scales on the body and cut a small, round tenon on the bottom end (Fig. 18) to fit the hole in the foot (Fig. 19). Use $\frac{1}{4}$ -in. wood for the feet.

Build them up with plaster of paris, as at C. For the tail (Fig. 22) use the large ends of three or more cones with the scales cut down so that only a small portion remains to give a bristly effect.

Glue the ears and teeth in place. For the neck, use a short section of cone with the scales left on, but if any of them interfere with getting the legs in place, these may be split or removed. To attach the tail, cut the insulated wire flush with the top end, apply glue to the protruding wire on the other end and insert the tail as shown. The best way to paint the cat is to dip it or pour the paint over it, black being the most suitable color. After this is dry, paint the teeth white, the lips and mouth red, the eyes black and white, and the nose white. A scale or a small round-headed peg will serve for the latter. To attach the whiskers, made of bristles, drill holes with a needle, apply glue to the ends and insert them.

The parrot with its perch (Figs. 23 to 28) is a little more elaborate than the other birds, but after trying your hand on those, you will have small difficulty in making it and need but little description to guide you.

The feet and legs are made of pipe cleaners, four pieces being twisted together for the legs (Fig. 25) and the ends left loose to form the toes, cut as indicated by the dotted lines to make a pair. The base is cut from a 1/2-in. board about 4 in. in diameter. The upright is a 3/16-in. metal rod, 24 to 30 in. long, and bent to the shape shown. The ring should be at least 3 1/2 in. in diameter. The link supporting the ring may be a piece of small chain, or a ribbon may be used. The wings and tail should be made of scales and are dipped in red enamel or lacquer. The assembly is readily understood from the drawings.

The savage (Figs. 29 to 37) is also a good figure to make. The eyes are painted

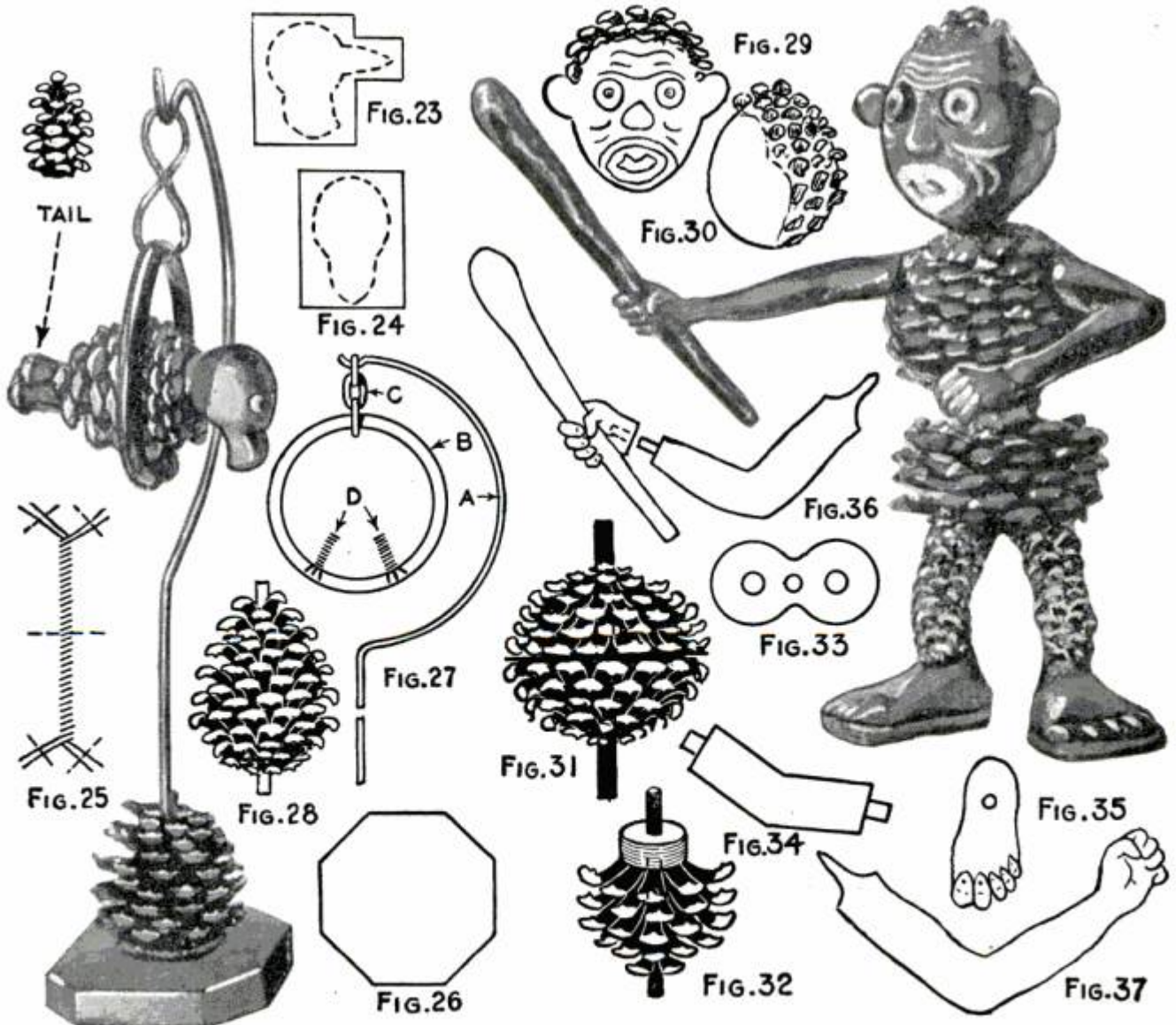

on, or tacks having large, flat heads may be used instead. The facial wrinkles may be cut or painted in. The upper part of the body is made from the stem ends of two cones, cut off and joined with wire or with a small, round stick. To make the lower part of the body, cut the small end out of a cone, and remove all but four tiers of the mid-section scales (Fig. 32). Drill a hole through the center to receive the long end of the wire protruding from the upper part of the body. The piece in Fig. 33, used to attach the legs to the body, is cut from thin wood and small enough to be entirely covered by the lower part of

the body. The center hole in this piece receives the wire protruding from the lower part of the body, and the outer ones the legs. The latter (Fig. 34) have small tenons to fit in these holes and in holes in the feet, to which small scales are attached for toes. The arms and hands are whittled from small, crooked limbs. The club and the hand holding it are made in one piece. Each arm is made separately with a small tenon on the end to attach it to the hand. Assemble the parts with glue and paint them black, the eyes white, and black, the lips and teeth white, and the inner part of the mouth red.

Trace-Chain Cover Prevents Chafing



To guard against chafing of the horses' flanks, a western farmer took old bicycle tires, cut them in two and slipped the trace chain inside of them as

shown in the drawing. This not only prevents pain, but hushes the noise of the chain as well.—Dale R. Van Horn, Walton, Nebr.

Remedy for Soot-Choked Stovepipes

Where there are several lengths of stovepipe extending from the stove to the chimney there is a tendency for the stove to choke up and allow the smoke to enter the room. This is especially true of stoves burning soft coal. It is not always convenient to remove the pipes, but the trouble must be remedied at once for it is dangerous to let the coal gas escape. A quick remedy that will work at least until it is possible to clean the pipes thoroughly, is to start the fire going at a good rate and, when it is burning brightly, throw in a handful of powdered sulphur. Allow this to burn for a few moments and then throw in a cupful of water which will cause considerable steam. Then close all

the dampers; this will force the soot out of the pipe. Another method is to use paraffin or tallow candles on the coals instead of the sulphur, throwing the water on the coals after the wax has melted.

Method of Starting Nails

When a nail is to be driven at some point so high that it cannot be held conveniently for starting, one of the two methods illustrated may be used successfully. Either the nail is wedged between the claws of the hammer with the head resting firmly against the latter, as shown in the upper figure, or it can be held between the fingers, letting the head rest against the hammer handle as shown in the lower figure.—W. C. Ratcliffe, Tannersville, Va.

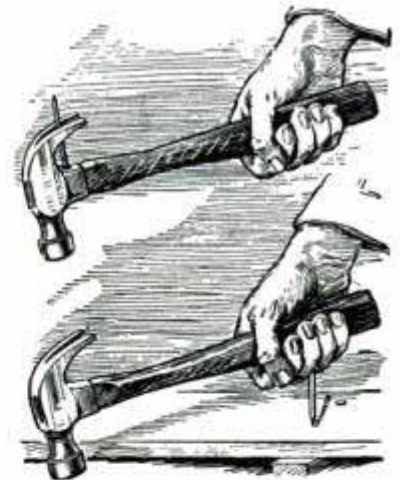

Connecting Auto Stop Light

If the switch controlling the auto stop light sticks, the battery will run down in a short time. To avoid this, I connected mine to the ignition switch instead of to the ammeter. Thus it will not light except when the motor is running.—Preston J. Cheu, Millville, N. J.

Overcoming Troubles in Replacing Windshield Glass

Trouble is often experienced when replacing the lower glass in two-piece double ventilating windshields, which are used on many Ford cars. Glass of standard size is found too wide, and is so high, when in the frame, that the rubber weather strip cannot be used between the pieces of glass. The trouble usually originates from rain causing rust under the brass channel that holds the glass. The rust can be dug out with a sharp screwdriver after pulling out the brass channel. This must be done carefully, however, as the brass is easily bent out of shape. It can be removed by grasping the roll edge with a pair of pliers and pulling up. If the channel is sprung together so that the glass cannot enter, it can be straightened with a flat stick of wood of the same thickness as the glass, the end of which is pressed into the groove and pushed along in it. Another place for rust is in the groove on the underside of the frame, which fits over a strip on the dash. Rust here will hold up the whole windshield frame, but it can be easily scraped out.—E. T. Gunderson, Humboldt, Iowa.

Self-Cleaning Device for Cistern

To make a cistern self-cleaning, provide a length of conductor pipe and an elbow and connect them to the overflow pipe as shown in the drawing, taking care to cement the joint so that there will be no leak. When the water rises above the level of the overflow pipe it will be drained off, but, instead of the surface water running off, the water on the floor will be forced out and with it the dirt that has settled at the bottom. It takes only an hour to install the pipe, and it will keep the cistern water clean, provided, of course, there is enough rainfall to cause the cistern to overflow.—Joe Lauth, Pontiac, Ill.

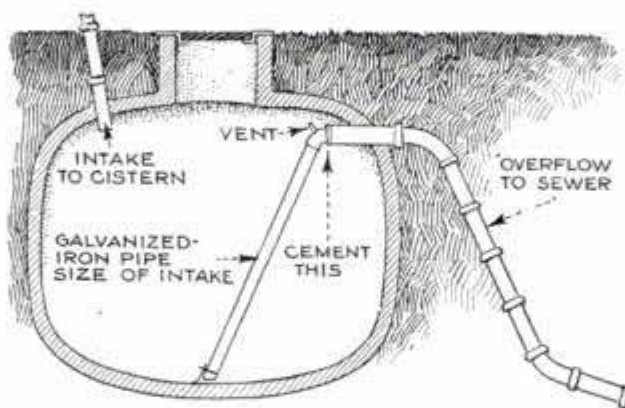

How to Keep Your Cistern Clean Automatically with a Length of Conductor Pipe

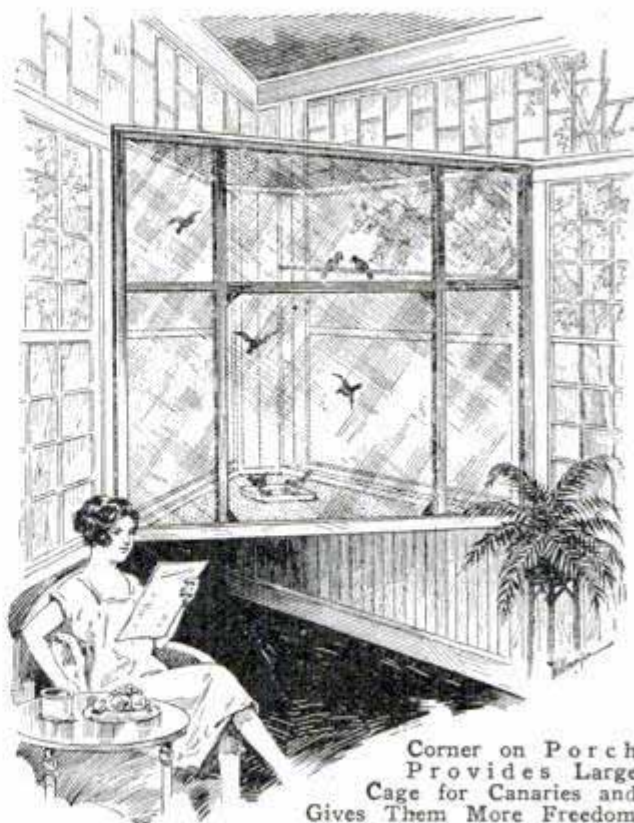

Corner on Porch Provides Large Cage for Canaries and Gives Them More Freedom

Winter Bird House on Porch

Birds flying through the trees are one of the greatest delights of my garden and the one which I missed most keenly during the winter months. The sun porch was resortlike even in January with blossoming cyclamen, gorgeous cactus and ferns, and I determined to provide a winter resort for my canaries. I screened in the corner of the porch, provided swinging perches and a tin tray full of sand for a floor. The birds were then turned loose in it and showed their appreciation of their spacious home with warbles, chirps and trills. They require no more care than one bird. The front section of the screen can be raised like a window sash so that the sand may be changed and water and food provided. During the winter the radiator keeps the porch warm, and with all the windows open in the summer the canaries seem to almost believe they are outdoors.—Mrs. Ruth Laughlin Barker, Santa Fe, New Mex.

How to Make a Porch Lamp



Attractive Hand-Wrought Porch Light That Can Readily Be Made by the Home Mechanic

Novelty and usefulness are the features of the sheet-metal porch lamp shown in the illustration, which anyone handy with tools can easily make at a cost of less than \$1.50. The glass shade consists of a colored bottle cut to form a cylinder. Use a file to nick the side of the bottle. Sheet copper will be found most convenient to work with. It is soft, so that it is easily bent or hammered to any shape. It is bent upward at one end to form the base for the shade holder, which is riveted on. A disk at each end of the shade, to close it, and lengths of copper rod or tubing, to connect the disks, form the shade holder. To make the upper disk convex use a ball-peen hammer on a concave wooden anvil. If desired, the whole surface can be hammered to give it a hand-wrought appearance, and this finish can be preserved by applying some transparent lacquer over it when completed. It should

be noted that while the rods that hold the lower lamp disk and ring to the base are riveted, the rods connecting the upper and lower rings are simply inserted in holes so that they can be removed for cleaning the glass or renewal of the lamp.—G. A. Luers, Washington, D. C.

Starting Kink for Auto

In some of the earlier ignition systems, the starting current is so great that the coil cannot draw its full share. Also, when a modern engine is stiff or the battery is weak, a full voltage is not available for the coil. In nearly all of these systems there is a small resistance coil in series with the spark coil, the function of which is to heat up and cut down the current if the motor is stopped with the switch on. Shorting out part of the resistance coil will send a greater current through the coil. Connect the center of the resistance to either end through a convenient horn button. Solder should be used in tapping the coil. Use heavy, twisted lampcord, and a horn button with good contact points. Press the button only while the starter is operating.

Ash Stand That Cannot Upset

A smokers' ash tray, which can be tilted to any angle without upsetting, is shown in the illustration. The base consists of a 4-in. copper ball, which is half filled with lead. A slight depression is made in the bottom to make it stand steady. The column is a piece of $\frac{3}{4}$ -in. brass tubing soldered to the ball and of any convenient length. To the top of the tube a medium-sized ash receiver is soldered. The entire stand can be nickel-plated or enameled and decorated with Egyptian characters.—L. C. Ferguson, Ontario, Calif.

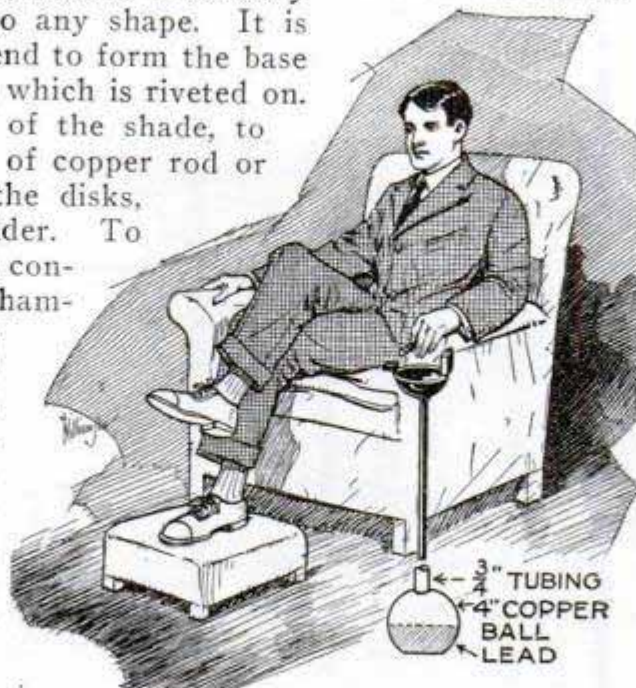

Ash Stand, with Heavy Ball Base Containing Lead, Will Not Upset

A Cabin Scow Driven by Auto Engine

THE conversion of automobile engines into power plants for marine purposes has always been a moot question. In this

tact but the transmission was changed. This originally had a four-to-one reverse ratio and this was too slow. The reverse idler was removed; the gears within the transmission were removed and a combination was selected which gave the reverse a two-to-one ratio. The gear selected for this position was mounted on the transmission jack shaft, which is the lower one. Only one of the sliding gears was used on the

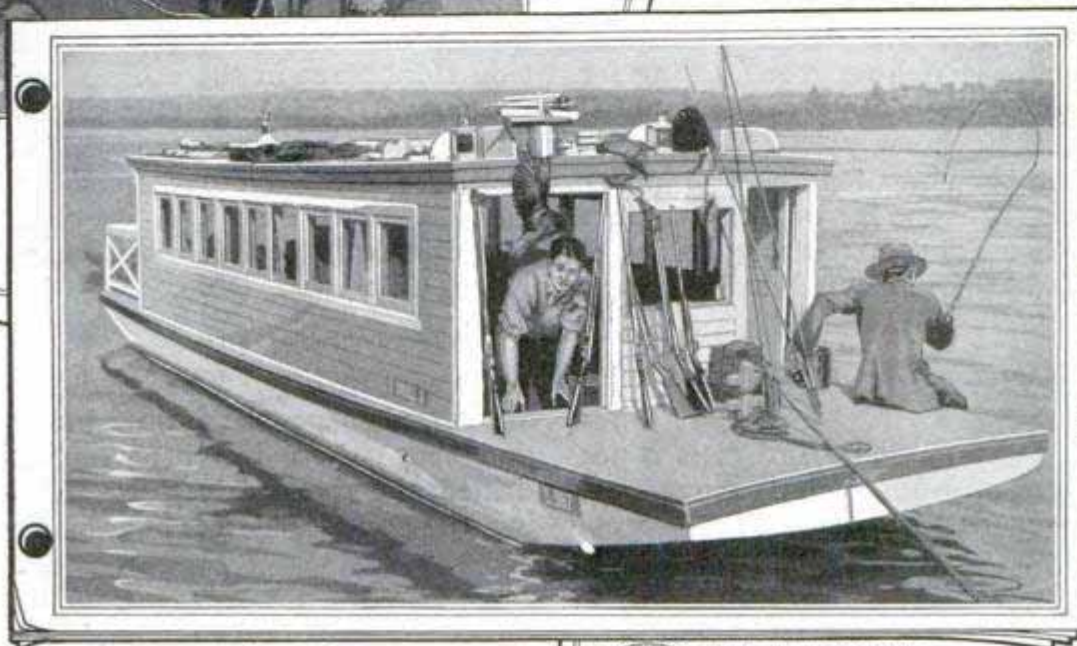
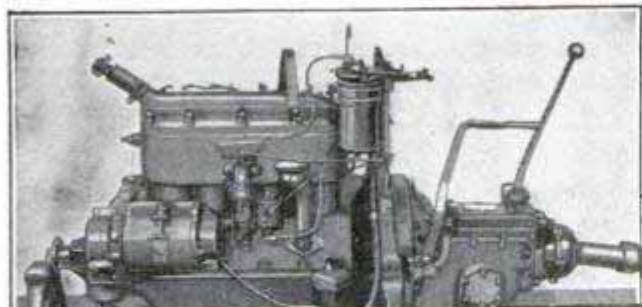

Old Auto Engine Installed on Large Cabin Scow Furnishes Its Power and Gives a Speed of Eight Miles

instance, such an installation was found entirely satisfactory. The engine first was overhauled and new bearings and piston rings were provided throughout.

For the cooling system, the old centrifugal pump was discarded and a $\frac{1}{2}$ -in. gear pump took its place. This had a two-way valve arrangement so that the bilge water could be pumped out. A small metal dash was built and mounted at the transmission to engine joint. On this dash the vacuum tank, oil gauge, ammeter, trouble light, ignition switch and controls were mounted. The starting switch with the automatic cut-out was mounted on the crankcase, where it is convenient to the foot. A length of $1\frac{1}{2}$ -in. iron pipe was used for the legs, and the mounting of the engine in the hull was thus greatly facilitated. The clutch and transmission assembly was used, the clutch being left in-

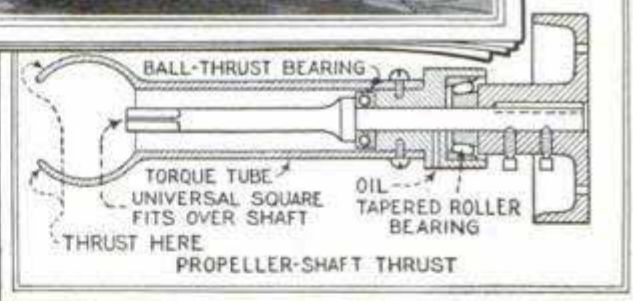

transmission shaft and this was arranged to be shifted into mesh with the little reverse gear. This gear with its mounting had to be provided with a new mounting on the side of the transmission case and this meant raising it and bringing it out a little to accommodate the gears it meshed with. A cast-iron block between the mounting and the case did the trick. Instead of four gears or speed changes in the transmission, there were now but two, direct forward and two-to-one in reverse.

The clutch is shifted by means of the brake lever, which was bent and mounted so as to throw the clutch out when the operator lifts on the bent portion of the

same material as the lift. The thumb lift is of $\frac{3}{16}$ -in. plate and should be made long enough to pass through the gate and provide at least $\frac{1}{2}$ -in. engagement with the latch. The latch plate must, of course, be slotted to clear the movement of the thumb lift.—G. A. Luers, Washington, D. C.

Vacuum Cleaner for Dusting Fruit

Last summer at picking time we had many dust storms, which coated our fruit with dust, detracting considerably from its appearance when packed for the market. To overcome this trouble we tried blowing the dust off with a vacuum cleaner and found this method very effective.—Mrs. M. W. Annis, Shafter, Calif.

Tight Joints in Rubber Tubing

In joining two lengths of rubber hose, it is not good practice to stretch them over a piece of brass tubing that is slightly larger in the inside diameter than the hose, as the joint will leak after the rubber stretches. Get a short length of brass tubing the same diameter as the inside

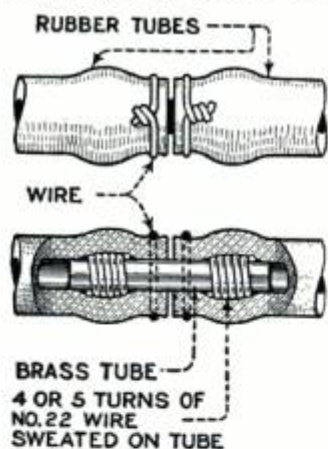

diameter of the rubber and wind four or five turns of No. 22 copper wire around each end, sweating it in place. This can be done by means of a small alcohol lamp, which can be obtained at almost any hardware store. This collar of wire should be about $\frac{1}{4}$ in. from the end of the tube so that the rubber tubing can be slipped on more easily. After the rubber tubing is forced over the collar, twist a wire around the end, as indicated in the illustration. You will then have a good coupling, which will not leak and, if used to convey air, will easily stand a pressure of 80 lb. per sq. in.

☐ A fountain for the lawn can be provided by inverting a flowerpot and pushing the hose nozzle up through the hole. This fountain can be moved about by yanking the hose and without wetting the feet.

Spring Hooks Hold Cows' Tails

A Wisconsin dairyman, whose barn is equipped with the most modern conveniences in every respect, conceived the idea of providing, at each stanchion, the chain-suspended spring hooks shown in the drawing, to prevent the cows from switching their tails



about while being milked. The chains are attached to the left side of each stanchion and can be easily and quickly attached or detached by the dairyman.

Bellows Blow Carbon from Cylinders

Garages equipped with a compressed-air outfit can easily dispose of carbon dust when grinding valves by blowing the dust out. Where compressed air is not available, the mechanic usually blows it out with the mouth, getting his face full of carbon and his lungs choked as a result. The illustration shows how a local repair



man, doing a one-man business, makes use of a pair of old-fashioned bellows for this purpose. He keeps them in the tool kit at all times, and when scraping carbon or doing any job that collects dirt and dust on the work, he blows everything clean with a stroke or two of the bellows.—L. B. Robbins, Harwich, Mass.

Rake Cleans Lawn Thoroughly



My father had me rake up a dirty lawn. When I got through I had only gathered up half the stuff. I had a rubber band in my pocket and by slipping it on the coarse-toothed garden rake, the small bits that would otherwise slip through were caught easily. The band is slipped over and under the teeth a short distance above the edges as shown.—Walter Brown, West Brattleboro, Vt.

Holder for Medicine Dropper

When medicine is to be measured carefully, it is annoying to find the dropper has been mislaid or broken among other bottles or containers in the medicine chest. To make it convenient and safe from breakage, a Wisconsin doctor places a label of double thickness on the bottle, attaching it so as to form a pocket, as shown in the illustration. The double label makes the pocket strong enough to prevent tearing and the dropper is always convenient for use.



Smoke Locates Leaks in a Roof

Instead of waiting through several rainstorms to locate all the leaks that may be suspected in a roof, they can be determined all at once in this manner: Close all windows and doors and plug up any opening that can be seen in the top of the building. Make a fire in a large kettle or iron washtub and place it on the attic floor under the roof. A good fire for this

purpose must be a sort of smudge, which will give off plenty of smoke. It may be of punky, wet wood, or pieces of cedar bark twisted together, dampened and then laid over a small, hot fire in the center of the receptacle. Where plenty of straw is available, throw some wet straw on the fire. When the smoke is thick, go up on the roof and you will see small spirals issuing from every leaky place in the roof. Chalk such spots and then mend the roof before the next rainstorm, and it is safe to assume that you will have a tight roof. The smudge will also help to eliminate all kinds of insect pests.—L. B. Robbins, Harwich, Mass.

Mending Tissue Made from Rubber-Tube Cement

Mending tissue used for holding together small breaks or tears in clothing can be easily made from ordinary rubber-tire cement. All that is necessary is to flow the cement upon a waxed or oily paper. It can be made as heavy as desired, and, when dry, can readily be peeled off the paper. In use, it is placed on the underside of the cloth and a hot iron is applied, with a piece of clean cloth between the iron and the rubber to act as a protection and to hold the edges of the break together.—B. Murray, Sturgis, Mich.

Cleaning Shotgun Barrels

Being at a loss to find a suitable rod and brush to clean the barrel of a rusty shotgun, I procured a length of No. 10 gauge wire, which I doubled and bent as shown in the drawing. By placing a small quantity of steel wool in the open fork of the rod and latching the ends together by

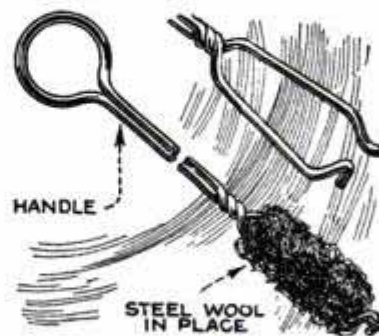

means of the hook provided, I made a cleaning rod that did the work in a most practical manner. The construction of a rod of this

kind also has the advantage that the worn wool can be removed instantly, and new wool substituted as quickly.—G. E. Hendrickson, Argyle, Wis.

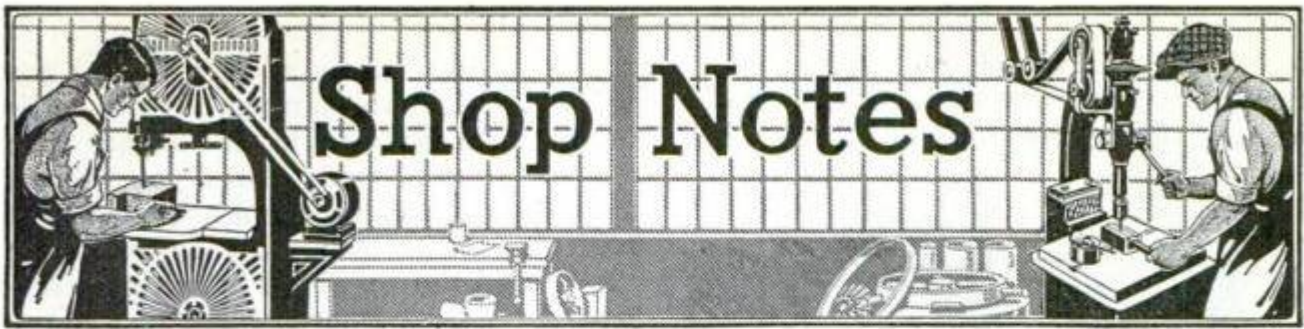

All Shop Notes published in 1925, in book form—Fifty Cents—from our Book Department

Blowtorch Made from Gasoline Lamp

By L. B. ROBBINS

MANY modern gasoline and kerosene lamps operate on the principle of the plumber's blowtorch, the gasoline in the fount being projected into the burner in the form of vapor, where it is ignited and consumed in flame. A lamp of this type can be converted into a useful soldering outfit as shown in the illustrations. As the fount holds 1½ qt. of gasoline and

the burner is small, one filling of fuel will last a long time.

First remove the air chamber at the top of the lamp, the mantles and the generator. Leave the vertical air-intake tube standing. Saw off the generator about 3 in. above the locknut and force the shredded asbestos out of the tube. Then replace it and attach a length of thick-walled rub-

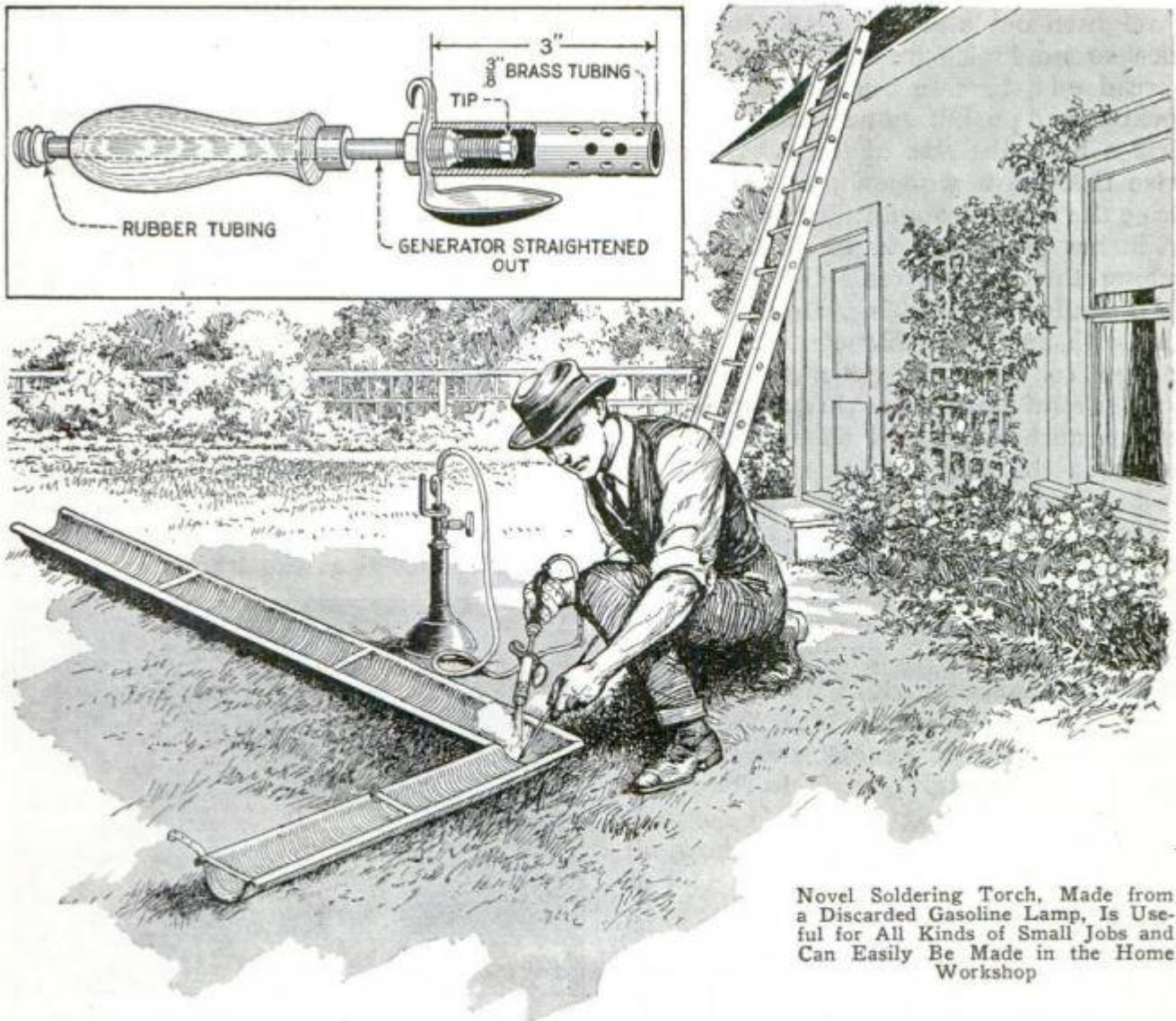
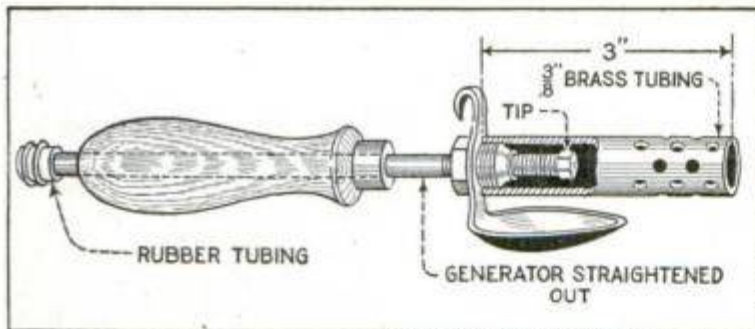

Novel Soldering Torch, Made from a Discarded Gasoline Lamp, Is Useful for All Kinds of Small Jobs and Can Easily Be Made in the Home Workshop

ber tubing, wiring this on. A few turns of stiff wire near the metal tube will prevent the tubing from kinking at this point.

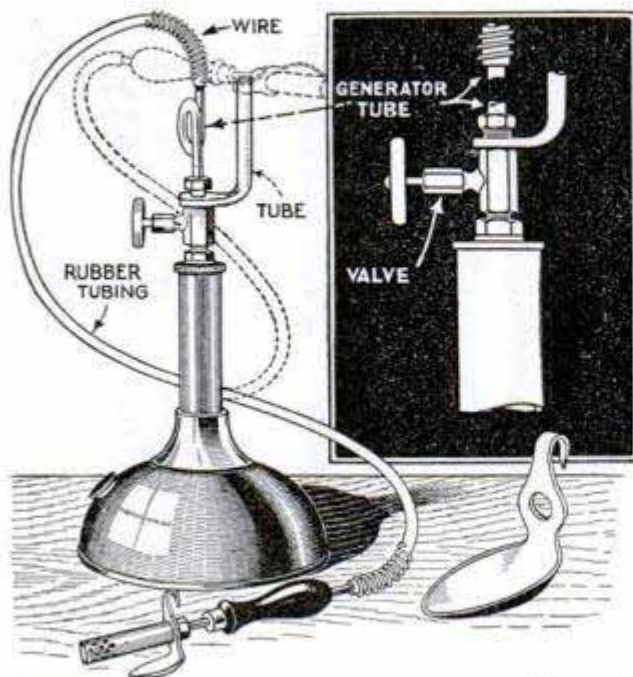

Construction Details and Assembly of the Blowtorch

Straighten out a second generator in the vise so no kinks are left. Saw off the spread end, reverse the direction of the locknut and push it up near the tip. Then drill a hole, the size of the tube, lengthwise through a wooden tool handle and drive the tube through it, leaving a couple of inches projecting to which the rubber tubing should be wired. Get a piece of thick-walled brass tubing, about 3 in. long and with an inside diameter that can be tapped to take the generator locknut. Drill several small holes through this tube in the unthreaded end as indicated. A heavy spoon, with a wide shank, should be fashioned as shown and a hole drilled in the handle of such size that the generator tube will be a force fit in it, while leaving sufficient material outside to cover the end of the large tube completely. Now assemble the parts. The generator tip should rest about a third way down the length of the perforated tube, the spoon shank should bear against the threaded end of the tube, and the locknut should be screwed up tightly against it. If the generator tends to slip or air spaces show, fill these with hard solder. The top end of the spoon shank is bent to form a hook so that the burner can be hung up.

To start the outfit, pump air into the lamp fount, burn a little gasoline in the

spoon to heat the tube, turn on the gas valve and light the burner. If the tip is in the right position in the burner tube and the holes properly placed you will get a nice blue flame, hot enough for any light soldering. Experimenting in enlarging the hole in the tip and in varying its distance from the burner end will get you the best results. When found, a drop of solder will hold it permanently in position.

Assembling Bendix Drive on Ford Starter

When assembling the bendix drive on a Ford starting motor, take care to see that the stop nut or bearing, which enters the mounting bracket on the starting motor, is not too tight, and that the bearing is in proper alinement with the bracket. The bearing should be oiled and then fitted so that it can be readily turned with the fingers. If the bearing is too tight, dress it down with an oilstone, as too tight a fit will cause the bearing to freeze to the bracket, which will result in serious damage to the starter.

Planks Keep Trench Openings Smooth

Keeping pavements smooth at trench openings, where the pavement cannot be relaid until the back filling has settled properly, and where the tires of passing vehicles keep pulling out the backfill, has been solved in one city by placing planks in the trench. Two or more 3-in. planks, wide enough to fit the opening in the pavement and cut to the proper length, are placed in the opening, the backfill being graded so that the plank surfaces are flush with the top of the pavement. The planks are lifted out at intervals and more backfill is added as the trench settles.

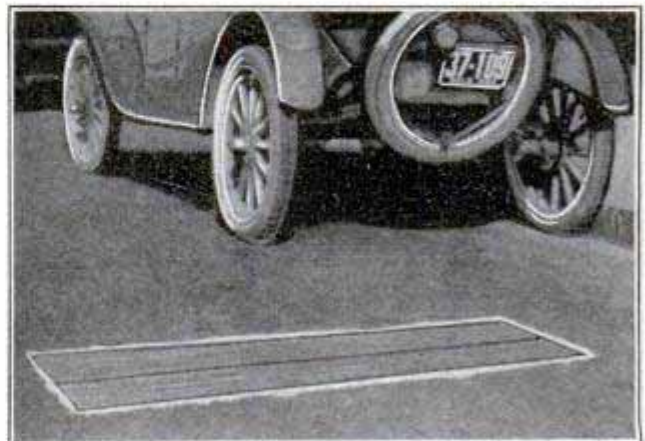

Planks Used to Cover Trench Openings in Pavements

How to Braze Band Saws

The proper way to braze band saws is to make a lap joint by beveling the ends for a distance equal to about two teeth. The blade is clamped so that the ends overlap in the center of the clamp. After applying a little powdered borax in the lap, a small piece of silver solder, about the size of the braze, is inserted. Heat the brazing tongs to a red heat and press them against the joint firmly, holding them there until the tongs cool to a dull red. The tongs are then slid back and forth along the blade a few times to insure a uniform braze. Then the cooled joint is carefully filed down to a uniform thickness.—William C. Thomas, Chicago, Ill.

Brace Keeps Heavy Posts Upright While Tamping



When he had to set a number of heavy fence posts in concrete, a mid-west farmer found the task seemingly impossible without the aid of an assistant to hold each post perpendicular while the concrete was poured and tamped into the hole around the post. As help was not available, he devised the simple brace shown in the drawing. A length of $\frac{1}{2}$ -in. round iron was bent to the shape of a horsehoe with loops at each end and one at the center. To each of these loops a pointed standard of the same material was attached, the points being bent slightly inward. To support a post set in the hole the brace is placed as indicated and the hook points of the three standards are forced into the sides. The post is safely and securely held in this position and the operator is free to tamp the cement and gravel around it. If made in a larger size, the same kind of support could be used to brace telephone poles as very little support is necessary to hold a pole in position when it is once erect.

Grooved Roller for Glaziers

To simplify the application of putty to window sash, a Wisconsin glazier devised the illustrated grooved roller. The putty is placed on the mixing board and rolled out to the desired thickness, after which it is cut into V-shaped strips with the roller. A strip, 8 or 10 in. in length, is used each time and can then be smoothed on more readily

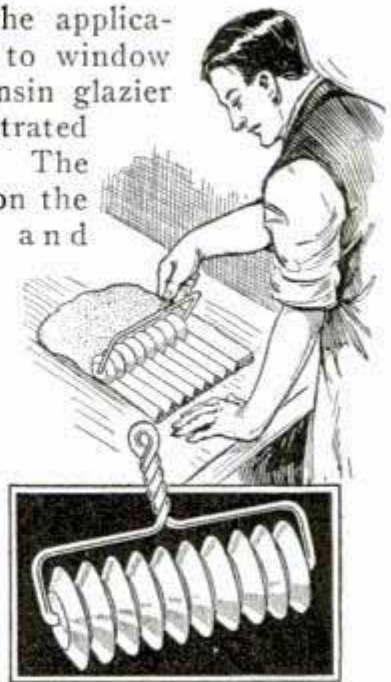

than when applied with a putty knife.—G. E. Hendrickson, Argyle, Wis.

Cutting Holes in Thin Sheet Copper

Having occasion to cut a large circular hole in a tank of thin copper and having no tool on hand for this purpose, the one shown in the illustration was improvised in a few minutes and found entirely satisfactory. All that is needed is a drill and bit, a machinists' C-clamp, two short pieces of wood and an old hacksaw blade. These parts are assembled as shown in the illustration, the center hole first being drilled so that the drill fits in it and serves as a center. A cut is made in the end of one of the blocks of wood to hold the saw blade securely. The teeth prevent it from sliding up in use when the pressure of the clamp is applied and the grooves on the drill keep it from turning in the blocks when the device is used. The jaws of the C-clamp must be placed between the drill and the saw blade.—W. N. Lurcott, Weehawken, N. J.



Letter returned

Lathe Rigged Up for Use as Rotary Metal Shears

Nearly every day the average small machine shop that depends on rapid production for work and profits has need for a device that will cut a piece of sheet

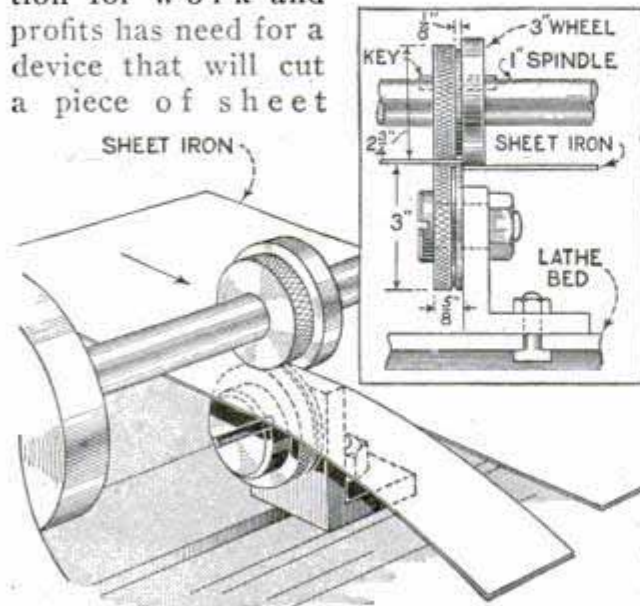

Rotary Shears Run by Lathe or Milling Machine Are Useful for Small Shops

metal of medium gauge. We were recently called upon to make four ventilators using about 20-gauge sheet iron. As we had no tools except ordinary hand snips, and I knew that the job would be a tiresome one, I did some figuring, which resulted in the rotary shears shown in the drawing.

The outfit consists of two circular cutters, each of which is mounted on a suitable shaft and is partly knurled to grip the metal while cutting it. The device is set up in a lathe or milling machine and one man can easily operate it. The upper cutter is made of tool steel, turned down to 3 in. in diameter, and has a 1-in. hole to fit on an arbor to which the cutter is keyed. The smooth part is $3\frac{1}{4}$ in. in diameter. I did not grind the cutter, as we were in a hurry, but it was hardened in oil. Do not forget to undercut it as shown, or you will be unable to sharpen it. The lower cutter is turned to 3 in. in diameter, but only three-fourths of the face is knurled. It is held in place and rotates on a stud driven into an angle-iron bracket, which in turn is clamped down securely. When assembling the device, care should be taken to bring the rolls together firmly but not tight in a horizontal direction. One-half the thickness to be cut is

the proper space between the knurled parts of the cutters. The lower cutter should, of course, be lined directly under the upper cutter. In using the shears no pressure is required to follow the line. It took about three hours to make them, and they saved considerable time.—Omar Fluharty, Sciotoville, Ohio.

Simple Method of Protecting Railroad Ties against Fire

One of the hazards troubling the railroads is firing of ties, piled along the tracks, by sparks from passing locomotives. Those made from fat pine, which are desirable for their lasting qualities, or those treated with creosote to prolong their life, are very easily ignited. A roadway supervisor has adopted a successful plan of preventing these fires by covering the piles with a 4-in. layer of earth which is jammed down tightly, so that no cracks are left between the ties. Any projecting ends of ties at the sides of the piles are similarly protected, a shovelful or so of earth on each piece being sufficient to give ample security against fire.—L. M. Jordan, Newton, Ala.

Handy Ladder Support

Getting the ladder out of the shop or putting it back is much simplified by using the device shown in the drawing.



A wire is stretched from one end of the shop to the other and a pulley is placed on the wire with a hook heavy enough to hold the pulley vertically. When the ladder is withdrawn the pulley and hook will be at the entrance

of the building where the ladder may be hung on and pushed back in place readily.—F. E. Poister, Morrill, Kans.

Removable One-Man Truck Body

A wrecking company in San Francisco has equipped one of their lumber trucks with a removable body for hauling bricks

bent to form hooks. These catch the rear roller, holding the body in the position shown. When this has been done the driver slowly backs up until the empty body stands vertically on end and the



Special Body Built by a Wrecking Company for Hauling Brick; It Can Instantly Be Removed or Attached to Truck by One Man

because the limited extent of their trade in this commodity did not warrant the expense of a special truck for this purpose. There are two rollers provided on the bed of the truck to facilitate moving the body. To remove the body from the truck, the rear roller is turned by means of a bar until the body is moved to the position shown in photo No. 1. The rear end is lowered to the ground, as shown in photo No. 2, but the body is kept from slipping off the truck by means of two steel straps

truck is ready to be used for hauling lumber. In placing the body on the truck again, the driver backs the truck up to the body, which is standing vertically, pushes the body over, until it strikes the roller on the rear of the truck, then drives forward until the roller on the rear engages with the two steel straps. Now he can easily lift the rear end of the body and push it forward on the rollers. All the operations are easily and quickly performed by one man.—C. W. Geiger, San Francisco, Calif.

Graduating a Six-Foot Scale in the Lathe

A small jobbing shop had only a lathe, drill press and shaper. A tailor brought in a piece of brass, 7 ft. long, 2 in. wide and $\frac{1}{8}$ in. thick. He wanted a 6-ft. length of this marked in $\frac{1}{8}$ -in. graduations to be used for measuring cloth. We first fastened the brass with screws to a piece of machine steel, $7\frac{1}{2}$ ft. long and $1\frac{1}{2}$ in. square. This was placed in the lathe, as shown, and an indicator was used

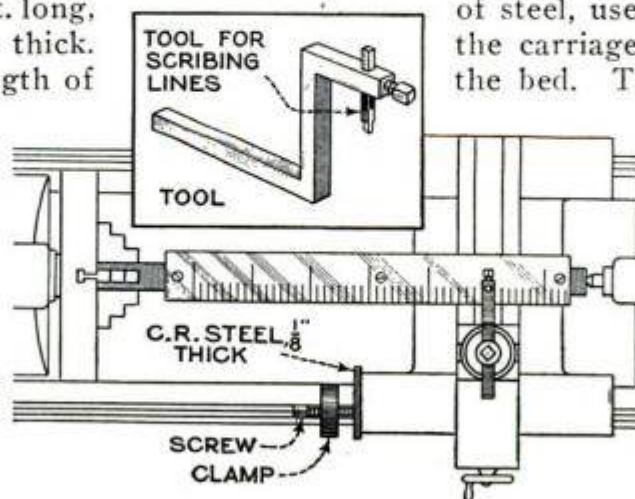

Graduating a 6-ft. Metal Scale in the Lathe for Use as Tailor's Measure

to line it up on the top and side. The 1-ft. graduations were measured off with an ordinary scale, and the 1-in. and the $\frac{1}{8}$ -in. graduations with a 1-in. and $\frac{1}{8}$ -in. length of steel, used between the edge of the carriage and a clamp stop on the bed. The cross slide and the scribing tool shown in the upper detail were used to do the marking. This method, of course, will not make a precision scale but the job was quite sufficiently accurate to serve the tailor's requirements. — C. Moran, Philadelphia, Pa.

Spring Clamp Facilitates Laying Out of Blocks in Pairs

In cases where it is necessary to mark off a large number of blocks in pairs, the

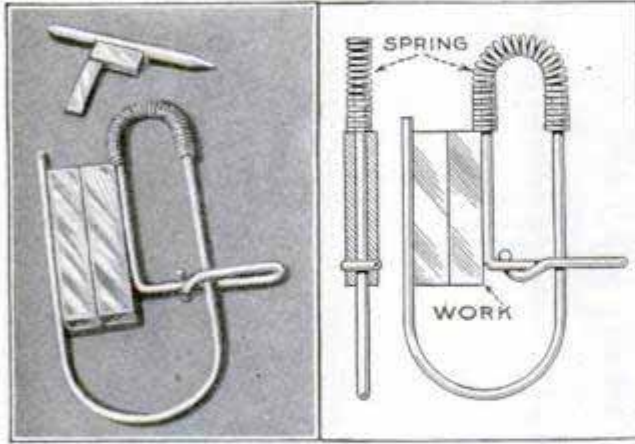

Spring Clamp Facilitates Marking Off Blocks by Handling Two at a Time

spring clamp shown in the illustration has been found to be of considerable assistance. The clamp is made of two pieces of $\frac{3}{16}$ -in. wire held together by a coil spring as shown. The tendency of the spring to straighten out holds the clamp tightly against the work. One wire is bent at right angles and looped around to inclose the other, in order to keep both in line opposite each other.—Harry Moore, Montreal, Can.

Felt Washer Protects Painted Surface

When drilling through a painted or highly polished surface such as the dash or

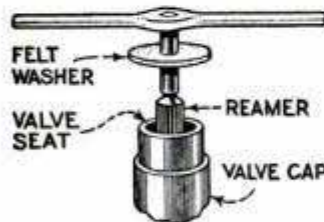
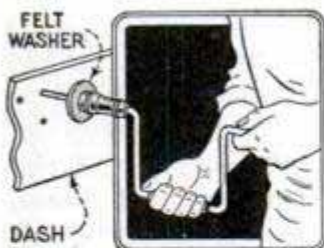

will go through the work suddenly and the handle will strike the work. On gears, valve cages or wristpin bushings, where the teeth may be marred, the valve seat

fender of an automobile, the drill frequently breaks through and the chuck mars the finish. A piece of leather or felt put over the bit and against the chuck as shown in the illustration will prevent this trouble. Similarly when using a tap or reamer the tool

bruised or the face of the piston scratched, such a leather or felt washer put between the tool and the work will prevent this objectionable bruising.—G. A. Luers, Washington, D. C.

Set Your Own Wagon Tires

Wooden carriage and wagon wheels often lose so much of the natural moisture in spokes, hubs and especially the felloes that the steel tires become loose, and the wheel is soon ruined if used in that condition. Instead of taking it to the blacksmith, soak the wood parts in water until the tire is tight and the wheel, when tapped, gives the sound of solidity. Now, the important thing is to make this setting last at least one season, and this is done with oil or paint as follows: As soon as the wheels are surface-dry, give the wood a coat of kerosene, and again let it, too, become surface-dry. This allows the oil or paint to penetrate deeply enough to hold, as keeping moisture in the wood depends on a cover of paint or oil. Now apply a good wagon paint, or linseed oil of which one-third is drier.—Louis Murback, Poultney, Vt.

Device for Changing Spring Shackles on Ford Cars

When fitting new spring shackles and bushings on a Ford, either on account of

wear or failure altogether, do not jack up the body to take the weight off the springs. They can easily be changed by using a C-clamp of suitable size and a strip of hardwood, say, 1 by 2 by 8 in. in dimensions, and clamping it in position, as shown, recessing it to fit over the oiler in the spring perch to avoid damage to the oiler. Screwing up on the clamp will cause the shackle bolts to slip out. With the usual type of coil-spring shock absorbers, a clamp can be used without a wooden strip.—C. S. Bartless, Dallas, Tex.

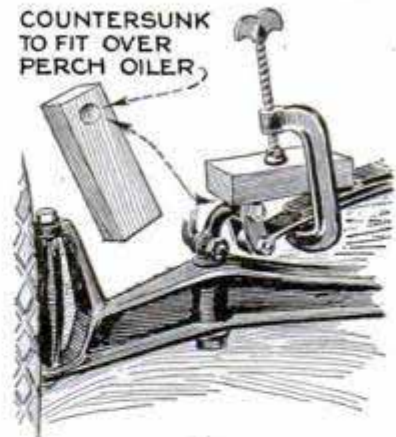

Portable and Collapsible Tool Table

Mechanics often carry their tools along to a job and when they get there they may have to work for long periods on their knees or standing on a stepladder. Where several tools are used, convenience and a considerable saving of time can be accomplished by having the tools at all times readily accessible on a small portable and collapsible tool table of the kind shown. It is adjustable to any range of height up to the worker's head, and the top revolves, so that any tool can be brought within easy reach. The

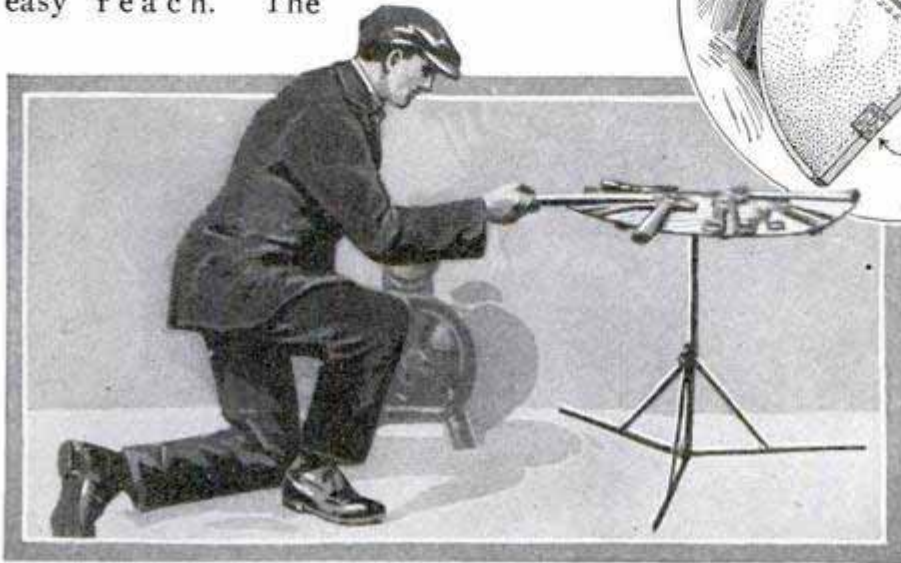

Collapsible Workbench, Which Is Light in Weight and Can Readily Be Carried in the Tool Chest, Facilitates Work of a Mechanic

table is durable and exceedingly light, and can be carried in a tool box, when collapsed. It is made from an ordinary metal

music stand, which can be obtained for a few dollars. With the iron rod deep in the stem and

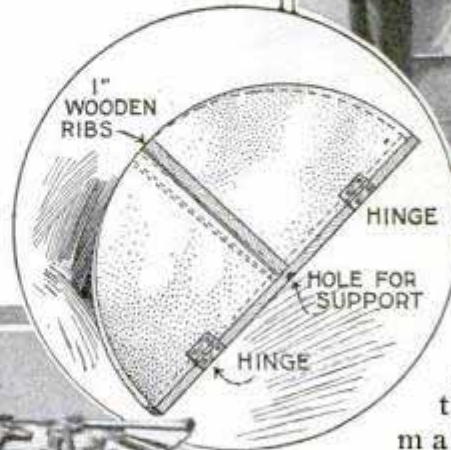
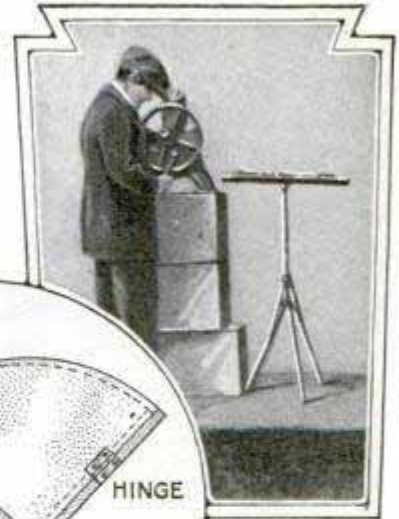

the legs folded upward against the stem, it makes a neat bundle, about 2 ft. in length, weighing less than 4 lb. The flat top consists of two semi-circular pieces of heavy sheet metal, hinged together and reinforced underneath by light wooden ribs, as shown. A hole in the center of these ribs fits over the upper end of the stand.

The table can be adjusted to any height from 18 to 60 inches.—P. C. Grose, McComb, Ohio.

Welders' V-Blocks

Most welding shops possess some kind of V-block arrangement for lining up broken shafts, rods, etc., or butt-welding pipes and tubes, but the one shown in the drawing has a few advantages not commonly known. In the first place the lining-up member is well away from the heat of the torch, and is not underneath the work as in ordinary extension V-blocks, where it soon becomes scaled and difficult to move. Secondly, there is no limit to the length



to which the vees can be extended. As no machinery is required to make a pair of these blocks, smaller repair shops can adopt them profitably. Take a piece of $\frac{1}{4}$ or $\frac{3}{8}$ -in. flat stock, bend it to the double V-shape shown and then cut the piece in half. In use, the work to be welded is laid in the vees on one side and any suitable piece of round stock is laid in the others to line them up. The alining rod should be placed in the vees first and these slid in or out until the two portions of the pieces to be welded are balanced.

☞ A good auto-top dressing consists of 2 lb. lampblack in oil, 1 gal. pure boiled linseed oil and 1 pt. pure turpentine, with a small amount of drier.

KINKS THAT HELP THE BUILDER



Tools for Applying
Pebble Dash to Stucco

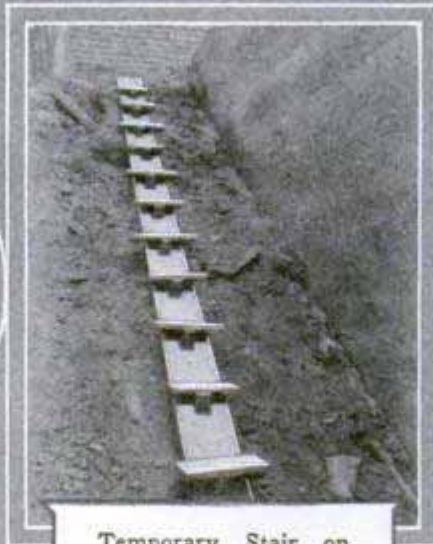

Temporary Stair on
Loose Dirt

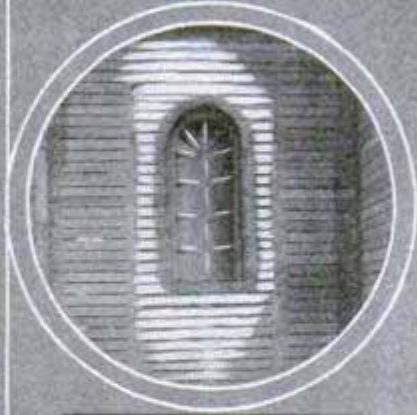

Framing for Niche in
Living-Room Wall

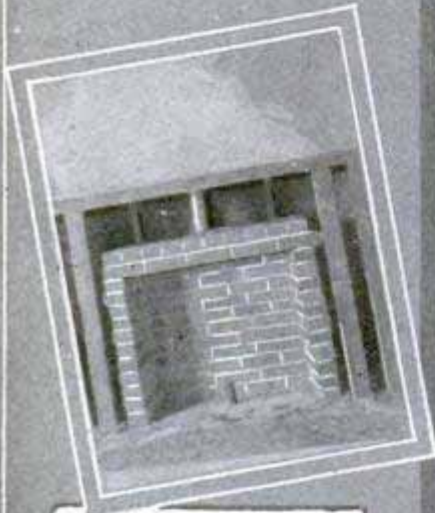

Fireplace for Gas
Log with Air Vent



Scaffold for Street Does
Not Block Traffic

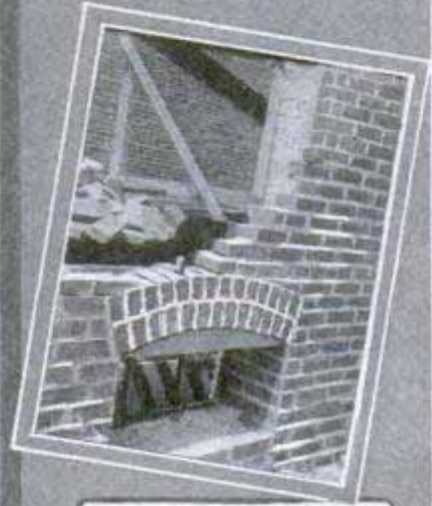

Wedging Bricks,
Makes Good Arch



Roofers' Nails Hold
Stucco to Old Wall

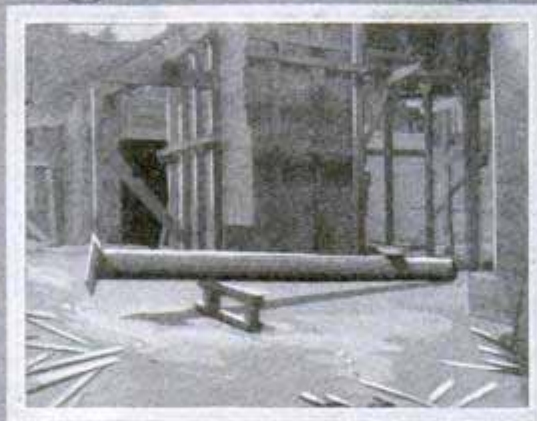

Support for Column
Facilitates Handling It



Holding Stone Veneer
to a Brick Wall

Glass for a Surface Plate

The other day I needed a surface plate; something that would be fairly accurate. I looked over the workshop but could find nothing that would answer the purpose. Precision surface plates are expensive and for the little use we have for them yearly, it really does not pay a farmer to buy one. I needed the surface plate badly and had about given up when I happened to think of a broken windshield which we had left from an auto accident. We never dreamed that it would be of any use whatever, but, while it was not perfect, it served as a dandy surface plate and will answer for pretty fine jobs in any farm or other workshop. In going over the matter with a mechanic recently, he decided to get one for himself after he had examined it.—H. W. Swope, Danville, Pa.

Protection against Corrosion of Battery Terminals

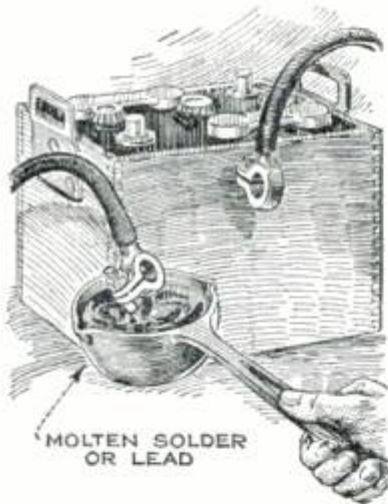

On automobiles where battery terminals are subject to considerable corrosion, it is a good idea to tin the terminals. This can be done best by dipping them in melted solder or lead up to

the insulation on the cables. The clamp screws and nuts should also be tinned. A method of doing this, which has been found practical and satisfactory, is to melt the solder or tin in a ladle and then dip the terminal in it, as shown.

Belt-Saving Trick

A great saving can be made in a shop where there are many belts, if the following method is used: When the belts are to be laced, punch out holes large enough to insert eyelets in the holes. It will be found that the holes, especially in rubber belting, will not become worn so quickly.

Washing Parts in Gasoline

In the garage or machine shop, when engine or machine parts are placed in a pan of gasoline to be cleaned, the liquid often becomes so dirty that it is difficult to locate the pieces when wanted. To overcome this, one mechanic employs the novel drain table shown in the illustration. A disk, somewhat smaller than the diameter of the pan top, is cut from a piece of

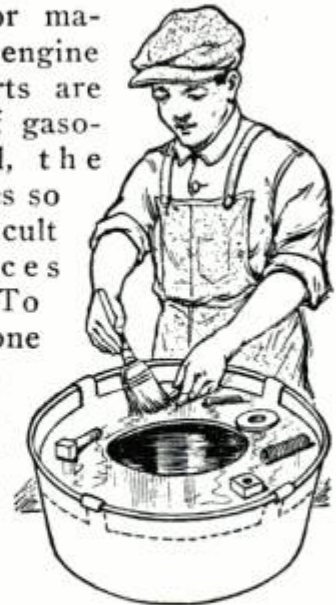

heavy tin, leaving projections or ears at four points. A circular hole is cut out of the center of the disk and the ears are bent over the edge of the pan to hold it. Parts are placed upon this drain table where they may be readily brushed and cleaned with gasoline and left there until the surplus gasoline has drained off.—G. E. Hendrickson, Argyle, Wis.

Printers' Emergency Furniture

It sometimes happens in printing offices that there is no metal furniture of the required size. This makes it necessary to resort to numerous emergency methods, the most usual of which consists in filling up the space with lead slugs. The drawing shows a convenient and simple method of filling large spaces by making furniture of the proper size from pieces of rule or slugs. Pieces of the proper length to fill the space are cut and notched on a saw trimmer, which is found in nearly every plant. These notched pieces are put together and then placed in the space to be filled, as shown in the illustration.—A. C. Cole, Chicago, Ill.

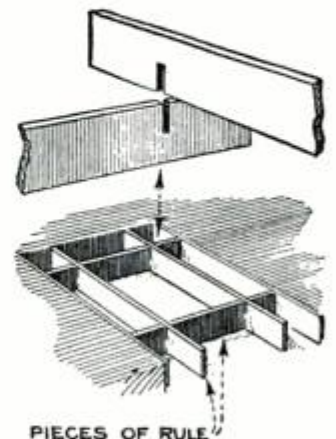

Safety Guard on Power-Line Poles

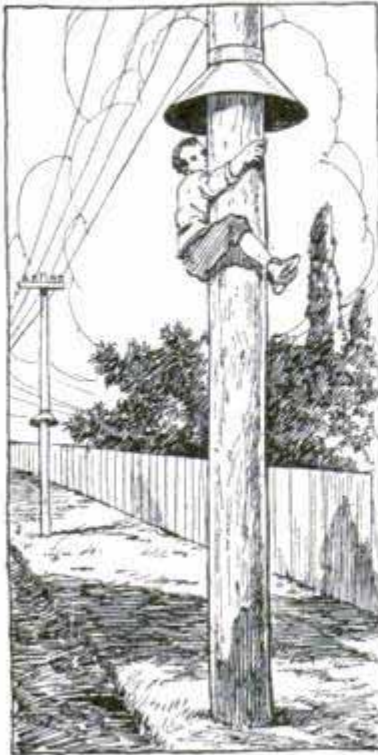

Children frequently climb telephone and power-line poles and serious accidents have often resulted from contact with live wires. To prevent this, the Louisville Gas and Electric company provided guards made of sheet metal and attached these to the poles, as shown in the illustration. This was found to discourage the children from using the poles for climbing.

Cutting a Radius Corner

Cutting a corner on a given radius is something many machinists consider impossible without the liberal use of a file, and this is more or less difficult where a high degree of accuracy is involved. A good method of accomplishing this job with ease is shown in the drawing. The edge of the cutter is first ground to produce a radius about one-tenth smaller than the finished radius of the piece. This will make the actual radius

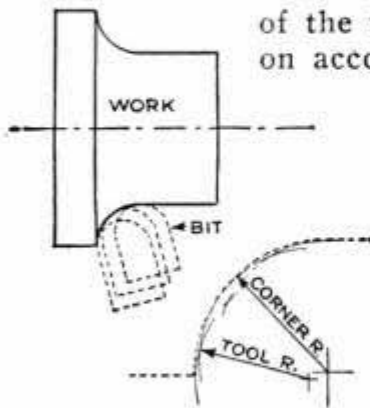

of the tool even smaller on account of the angle at which the upper surface of the tool is tipped. With the shape of the corner roughed out with other tools, begin to use the special cutter on one side, then on the opposite side, and then at the center, shifting the tool as soon as more than one-third to one-half of its lip starts to cut. This work is done best with the

Children frequently climb telephone and power-line poles and serious accidents have often resulted from contact with live wires. To prevent this, the Louisville Gas and Electric company provided guards made of sheet metal and attached these to the poles, as shown in the

power shut off and the belt operated by hand. The result of cutting in this manner is to remove a fine chip of metal at each cut, which eliminates chattering as the tool never gets a grip on much metal. A series of small shallow ridges will be left, but these are so slight that they disappear after a few light strokes with a fine file. The completed job will be well finished and accurate. It is also possible, with this method, to merge the arc of the corner exactly with adjoining surfaces.

Electric Alarm Indicates Unwound Clock

One of the janitor's duties in a large manufacturing plant is to see that the master clock is kept wound and running on time each day. After several lapses of memory, when he allowed the clock to run down, he devised the following simple method of warning when the spring was nearing the end of its operating power. He drilled two holes in the side of the case, one near the bottom and the other directly opposite

the side of the spring. An insulated electric wire was run through the lower hole and bolted to the metal frame of the clockwork. The top hole was reamed out just large enough so that a spark-plug porcelain could be forced tightly through it. This porcelain was connected to a second wire and the wires were connected to a battery and doorbell in series. The contact point in the porcelain was adjusted a certain distance from the spring so that, when it was nearly uncoiled, it would touch the point and close the circuit, ringing the bell.

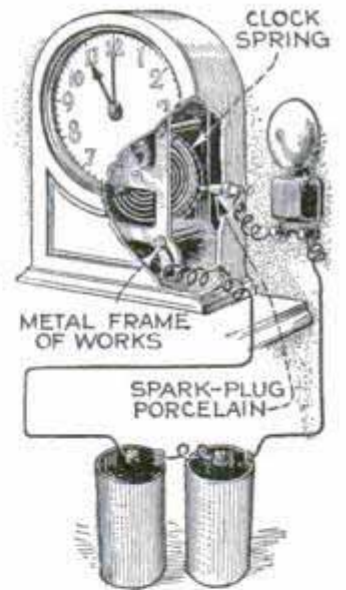

To make a battery box acid-proof, melt 8 parts of wood tar and 14 parts rosin in an iron kettle, then stir in 10 parts fine brick dust; apply solution warm after the box has been cleaned and sandpapered.

KINKS THAT HELP THE BUILDER



Hood over Pulley Protects It from Debris



Hot-Air Vent Held Securely by Ears

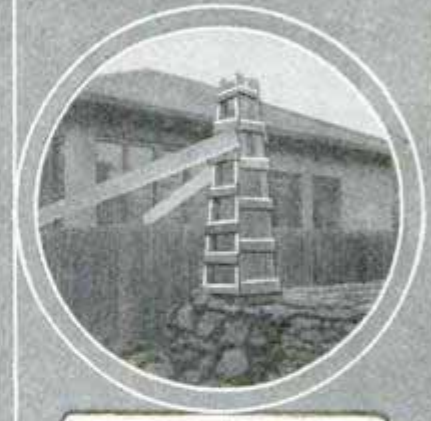

Framework and Bracing for a Rubble Pier

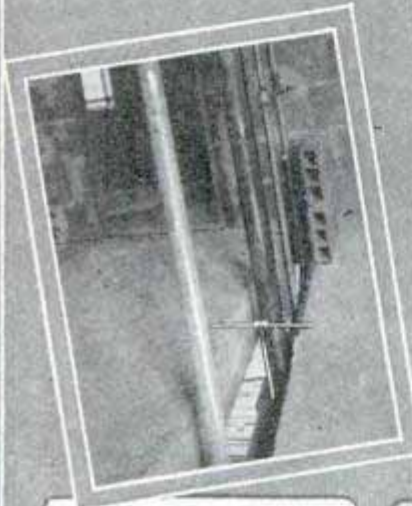

Sturdy Hanger for Heavy Soil Pipes



Stone-Filled Barrels for Temporary-Line Poles



Pipes Held on Floor to Prevent Moving



Strap Irons on Plank Ends Prevent Splitting



Quickly Erected or Dismantled Wooden Derrick



Convenient Platforms for Cornice Builders

V-Block Centering Device

One of the quickest methods of marking the center of short lengths of round work is to use the handy V-block attachment

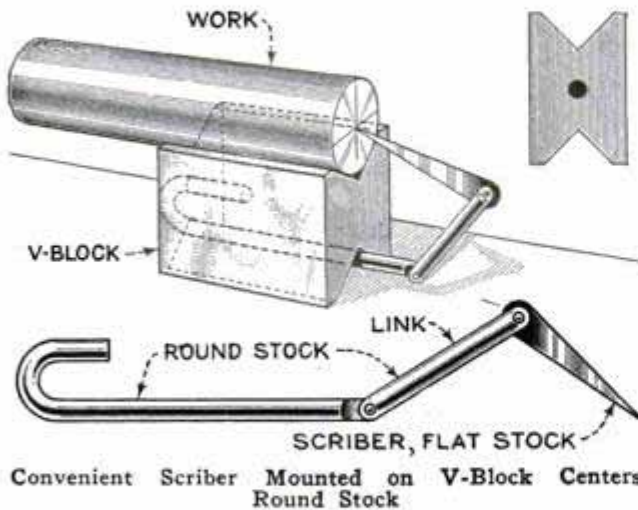

shown in the drawing. It consists of three pieces: a block having a "V" cut on two opposite sides; a length of rod fitting in the bottom "V" and bent over so that when put in place the end slips into a hole drilled in one end of the block; a length of the same-size rod pivoted to the end of the first piece, and a scriber, made of flat stock, pivoted on the end of the link. Any size of work can be marked off and a further advantage is that the work need not be square on the end, as the scriber readily accommodates itself to irregular surfaces. In use, the scriber is moved downward and the shaft turned and marked in two or more places, the point of intersection being the center.—Harry Moore, Montreal, Can.

Hulling and Scarifying Clover Seed

We have grown our own sweet-clover seed for several years and thresh it with our grain thresher. It does not hull the seed, but this work and the scarifying are done in one operation in the following way: A quantity of coarse, sharp sand or gravel is obtained; this is dried, and then run through a fanning mill so that all sand particles smaller than a clover seed are screened out. A bushful of the coarse gravel, which passes through the fanning mill, is placed in a barrel-type concrete mixer and a bushful of the unhulled clover seed is put in with it. The two are tumbled together for about 15

minutes. Both are passed through the fanning mill with a screen that will allow the clover seed to screen from the gravel. The wind blast removes the loosened hulls and the seed is clean and well scarified by the scratching the sharp gravel gives it.—Wendell N. Mitchell, Rogers, Nebr.

When to Paint Vacuum Equipment

New pipes or cylinders in which a vacuum is to be maintained should not be painted until after the plant is set in operation and a vacuum is being maintained within the parts. The reason is that all metal is more or less porous, and when it is new, it allows leakage. If painted before using, the thin coating on the outside soon gives way. It should be painted while in use with a thin-mixed paint as this allows the pores to become filled, and the result will be a very noticeable increase in the vacuum.

Trailer Carries Concrete Mixer

Having a number of widely scattered jobs to do, a western construction company built a heavy trailer for one of its trucks to carry a big concrete mixer, in order to transport it faster than it could travel on its own power. Four wheels with solid rubber tires were used. They were put on axles fastened to a triangular framework of iron beams, a small beam being placed at the front end to keep the mixer from running onto the wheels at this end, which were very close together. Iron plates were used as a runway, and the mixer

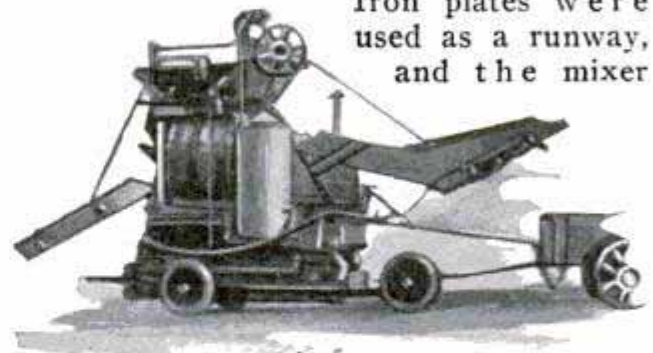

Large Concrete Mixer Transported from Place to Place on Heavy Trailer

run up on the low framework under its own power.—A. Flinner, Wichita, Kans.

Paraffin rubbed on woodwork with a soft cloth will remove all dust and dirt.

Novel Sliding Door on Drain Pit

By DALE R. VAN HORN

ONE of the objections to the open drain pit usually found at gas-filling stations is that there is no convenient method of keeping out the rain and snow. The accompanying illustration shows an installation which embodies this desirable feature in a practical, efficient

is set into the side of the pipe and a cable runs over the pulley. The end inside of the pipe is connected to an iron weight

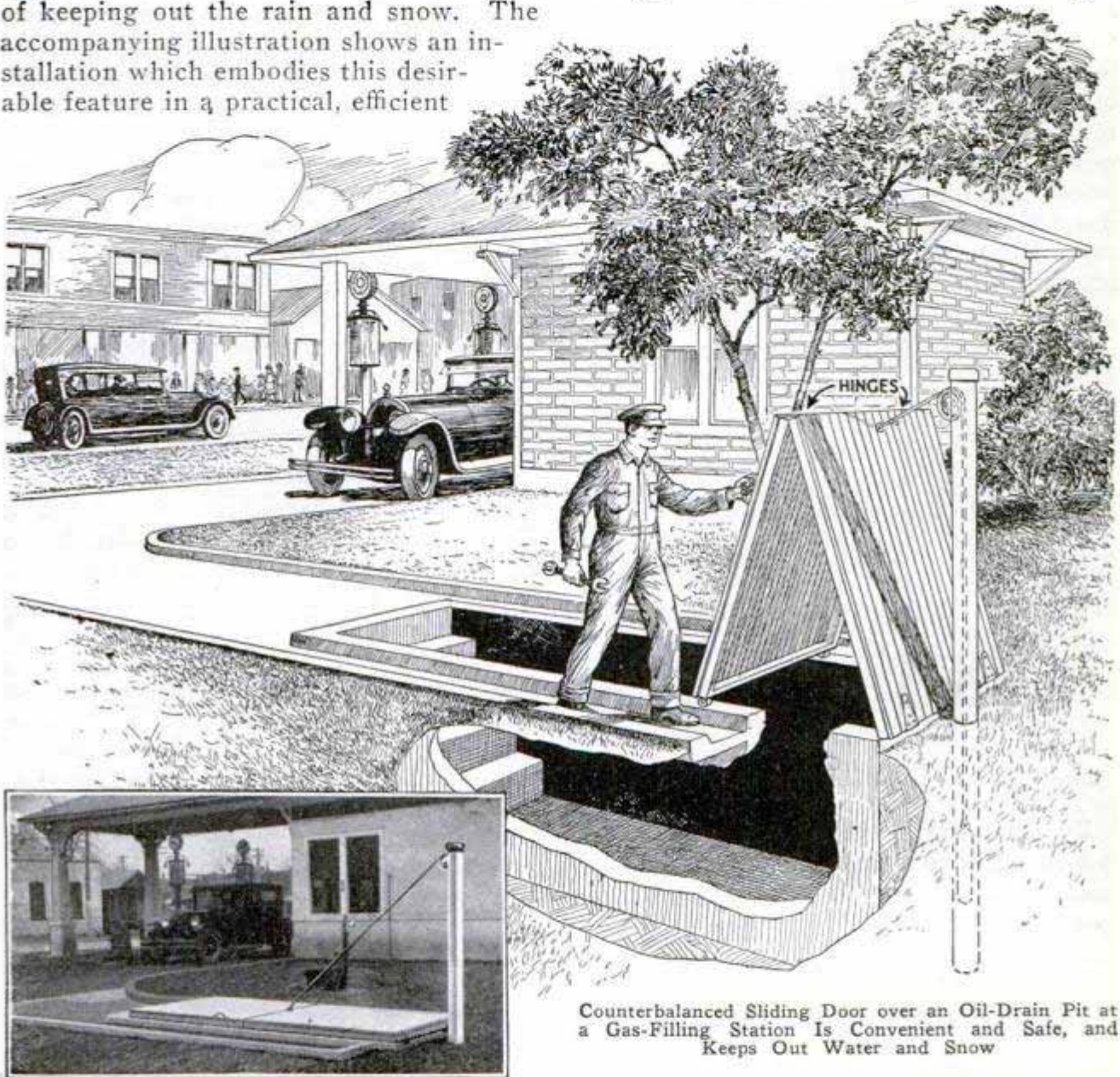

Counterbalanced Sliding Door over an Oil-Drain Pit at a Gas-Filling Station Is Convenient and Safe, and Keeps Out Water and Snow

way. With this sliding door, the pit is kept closed at all times except when a car is to be drained. It is a matter of a few seconds for the operator to raise it to an upright position and attend to the car in the usual way. Since the door is counterbalanced with a weight inside of a vertical pipe (indicated by the dotted lines) only a little effort is required to open or close it. The pipe should be about 4 in. in diameter and extend 5 ft. above the ground, its total length being sufficient to allow it to be solidly set and give the weight freedom to run the necessary distance. A pulley

which pulls up and down freely, thus counterbalancing the weight of the door. A cap is screwed on top to exclude moisture. The door itself is made in two sections. Each section is of the same length and slightly wider than the pit. One section is hinged to a piece of 2 by 4-in. wood, which is mounted on the end of the pit by means of bolts whose heads are imbedded in the concrete. The other section of the door is hinged to the first section by means of ordinary hinges. Both sections are covered with matched lumber, with cleats on the inside, and the edges are trimmed with material, 1 in. thick and 3 in. wide.

When the door is down these hinges fit along the edge of the concrete pit. A handle is provided on one section of the door. To facilitate opening and closing the door it will pay to attach small casters to this half of the door so that they will ride on the concrete edge, which is built in the usual way. Steps lead down to the bottom of the pit for the worker. No dimensions are given as these are hardly necessary because each filling station proprietor has his own ideas about a pit. The installation shown is used in a number of cases in and around Kansas City and is proving entirely satisfactory.

Handy Radiator-Filling Funnel

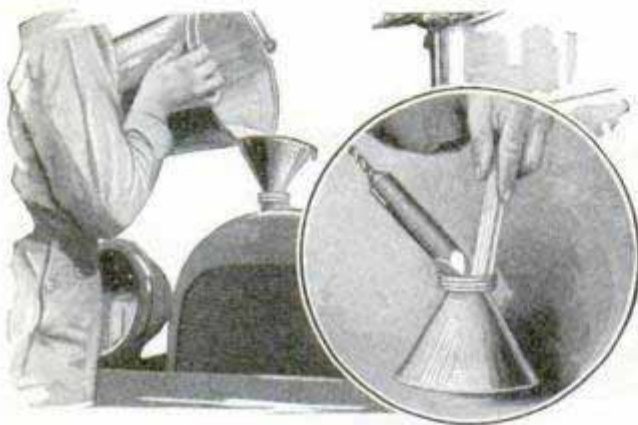

Simple Funnel Facilitates Filling Auto Radiators

By soldering a tin funnel, which had lost its neck, to a cap of a glass jar it was made into a very satisfactory radiator filler. A hole, a little larger than the small opening of the funnel, was cut in the cap and the latter was soldered in place, as shown in the right-hand figure.

Test for Foul Air in Wells

Inexperienced well workers often lose their lives by going into wells without first testing them for foul air. This can be done by lowering an ordinary lantern into the well, as far as possible. If there is any foul air the flame will get dim and if there is much of it the light will go out entirely. The foul air can be removed in the following way: Lower to the bottom of the well an old pail filled with burning charcoal, holes being punched through the bottom of the pail to permit sufficient draft. As the foul air is heated it rises out of the well and fresh air enters to take its place.

After the fire has burned for about 10 or 15 minutes it can be removed, and the workers can go down safely. Even if the well is very dirty, carbonic-acid gas or foul air will not collect again for a considerable time, at least not for several days. A pail, a sufficient length of wire attached to the handle, and a long cord or rope, can nearly always be obtained, but a blower and a length of hose are not always procurable. Furthermore, the blower method is not quite reliable. Fresh air can be forced down into the well but a layer of gas may still remain at the bottom. One breath, enough to fill the lungs, may cause almost instant death. The easiest and surest method is the use of a charcoal fire as described.—James E. Noble, Toronto, Canada.

Profile Planing

In machining large, cast-iron forming dies of the kind shown in the detail, the method indicated in the illustration was found especially convenient. We made a template out of $\frac{1}{2}$ -in. machine steel and clamped this on the planer table. It was a duplicate of the dies, but about 1 ft. longer because the stroke of the planer must be greater than the length of the job being planed. The roller and the arm, which holds it, are screwed to the planer head and the latter is kept against the template with a rope and weight, the rope being fastened to the planer head and sliding over a pin, as shown. The depth of the cut is regulated by moving the clapper box. It is evident that the tool will move in a path that exactly duplicates the template. The operator feeds the tool by hand.—Charles Kugler, Philadelphia, Pa.

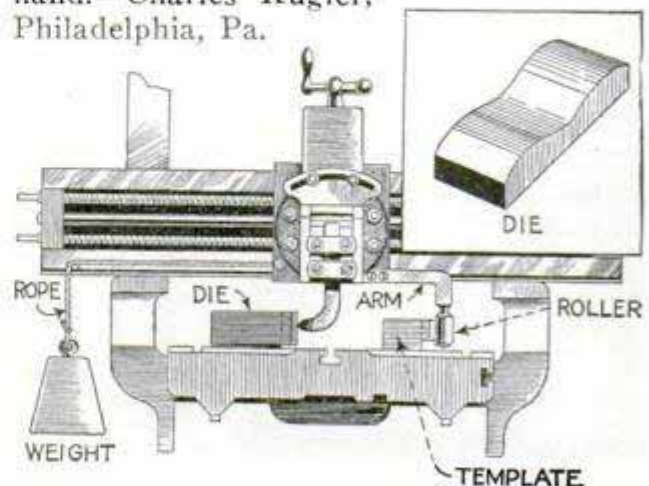

Profile Planing on Large Dies Was Done in Record Time by Using Template

Drill-Spindle Screwdriver

When a large number of long screws have to be driven, a fixture permitting the driver to be used in a drill press will be found a timesaver. By running the press at a reasonable speed, the work can be done much more quickly than by any hand method. The device consists of two round stock bearings, a length of steel tubing, a slotted screw and the special driver. The driver head is finished with a tongue in the center to fit the slot in the screw. These two parts are finished first, then, with a washer behind the head of the screw, the two bearings in which they turn are driven tightly into the ends of the tube. Another washer is placed on top of the bearing containing the driver screw, and two locknuts on top of this. These nuts are adjusted so that the screw will drive the screws into the work but will itself turn when the head touches. This forms a friction-slip drive and can be adjusted nicely with just enough tension to drive the screws. The tool is gripped in the drill-press chuck and the work, with the screws started a thread or two by hand, placed on the table. The screw to be driven is brought beneath the tool and the spindle fed down until the slot and tongue engage. The screws are then driven into the work by operating the drill press. The connection is maintained until the screw is finally driven, when the driver screw turns or rather ceases to turn with the machine.

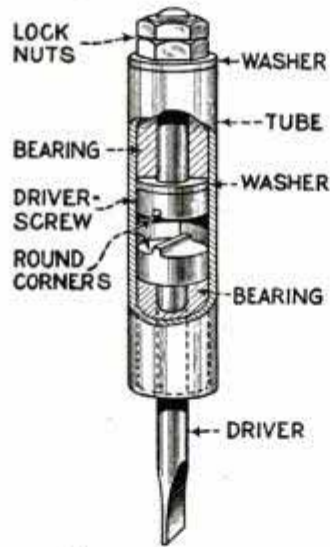

Homemade Heat-Proof Paint

Where a heat-proof black paint is required, the following easily prepared mixture will be found practical. It consists of graphite, 2 parts; Fuller's earth, 10 parts; sodium silicate, 11 parts; glucose, 1 part and enough water to make the mixture applicable with a brush.

To Increase Capacity of Saw

When it was necessary to cut a large quantity of 5-in. pipe, the handsaw was found just a little too small, both in stroke and depth of cut, making it necessary to turn the pipe three times. To hasten the work and make smoother cuts, a piece of $\frac{3}{8}$ -in. rod was bent as shown in the illustration, and a pin to hold the blade was set in the flattened lowered end. By using a longer blade, the pipe could be cut through with one setting. The attachment has been left on the saw permanently, as it does other work just as well as before the alteration.—Harold E. Benson, Boulder, Colo.

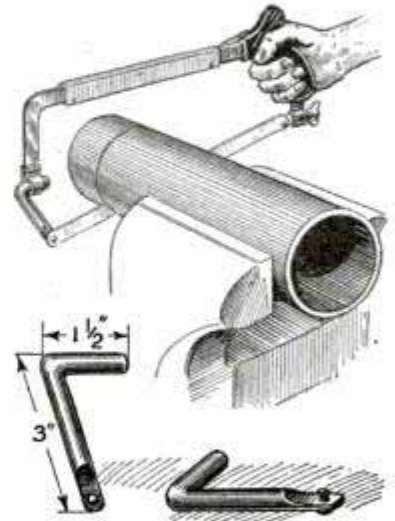

Factory Foreman's Call Bell

When there is need in the shop or factory for a loud gong, such as is used to call the foreman to the office or announce the starting and quitting time, the installation shown in the drawing will be found useful. Remove the small bell and substitute a brake drum taken from an old auto wheel. Fasten this on with a large screwhook or a bolt bent to L-shape. There should be about $\frac{1}{4}$ in. clearance between the clapper and the gong shell. Drive three nails into the wall round the edge of the drum, to make it stand out from the wall as indicated. This will prevent muffling of the sound and the bell will give a clear signal.—Earl E. Moffat, Pasadena, California.

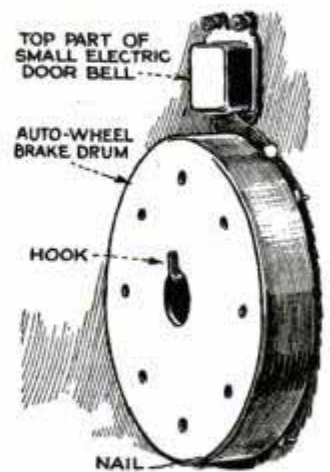



Quantity Production of Automobile Name Plates of Type Metal Is Easy Work for Anyone and Only a Few Tools Are Required to Do It

Profit from Making Auto Name Plates

By BRONALDO MURRAY

MAKING automobile name plates for autoists is a profitable spare-time business. Anyone can make a mold, pour the metal, and finish a large number in a short time. The only equipment necessary for this work is a gas plate, or other heating device, a small melting pot, a ladle and a polishing wheel upon which a wire brush and a cloth buffer are mounted.

The material used to make the name plates is ordinary type metal such as printers use in their linotype machines. A little metal antimony is added for hardening. The melting pot should be of iron and the type metal can readily be melted over an ordinary gas flame, or if this is not available, over a gasoline or kerosene-stove flame. A blowtorch can also be used for this purpose. After the metal has been melted, it is poured into a plate-steel mold with a ladle, as shown in the accompanying illustration. The mold is made from two steel plates riveted together. The lettering is cut in one plate with a metal-cutting scrollsaw, which plate is

then riveted to the second. After the metal has been poured and hardened, it is dipped in water to cool it. Shrinkage of the metal then takes place, which makes it comparatively easy to remove the name plate. This is done by laying the mold, with the name plate in it, face down on the bench top, and tapping the back side with a light hammer to loosen the plate. The work is finished nicely on a buffer, and dipped in a transparent varnish.

To facilitate fastening of the name plate to the radiator it is advisable to drill two or three small holes through the letters at different points. Bolts, a little longer than the thickness of the radiator, are pushed through the holes and washers and nuts on the other end hold it in place securely.

Emergency Grain-Drill Tube

While using the wheat drill this spring one of the rubber tubes dropped down and wound around one of the wheels, which ruined it. A length of old bicycle

tire was found, and a length of strap iron was placed in it to hold the section straight. This was attached in place of the damaged tube and answered as well for completing the spring seeding as a regular tube.—Geo. G. McVicker, North Bend, Nebr.

Novel Road-Marking System

Road commissioners in St. Joseph county, Mich., have found that they can save labor and material in dividing county highways into two lanes of travel by using white-painted squares every 10 ft. apart instead of applying a solid white band the whole length of the highway. The new method has proved entirely satisfactory.

Method of Measuring Angles

When no protractor head is available, an angle can be accurately measured by the method shown in the illustration. The dimension B is always the same and the distance C is read directly from the scale. First see that the surface plate is level,

TANGENT ANGLE $A = \frac{2\frac{1}{8}}{4} = .531$
 TANGENT $.531 = 28^\circ$
 OR $A = 28^\circ$

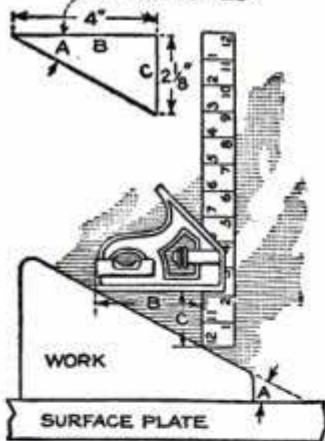

then mount the square on the work as shown and move the scale up or down until the bubble in the level is in the center. Now two sides of a right-angle triangle are known, and the angle A can be calculated by dividing the length of side C (2 1/8 in.) by the length of side B (4 in.), the result in this case being .531, which is the tangent of the angle A. A table of natural functions will show the corresponding angle to be 28°. The application of this method is unlimited, and if a micrometer depth gauge is used to get the exact measurements of B and C very accurate results can be obtained.

☞ A good method of curing egg-eating hens is to punch tiny holes in each end of an egg, blow the inside out and then fill the shell with mustard.

Clamp Holds Pliers to Bench

Considering the facility with which parts are held in the jaws of large pliers and tongs for such work as splicing and fitting timbles to wire cables, holding bar stock and electric conduit, the bench fixture shown in the illustration should appeal to all mechanics having such work to do. It is made of fairly thick flat iron or steel, and its construction and use are shown with sufficient clearness in the illustration to make any more detailed description unnecessary.—G. A. Luers, Washington, District of Columbia.

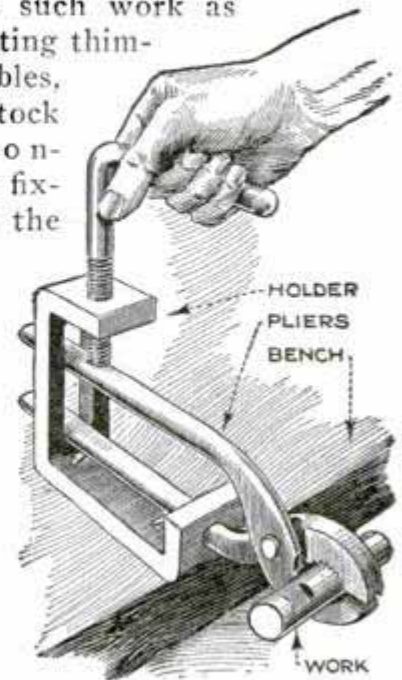

Fitting Connecting-Rod Bearings

Frequently, upon examining connecting rod bearings, it is found that the bearing shells are floating loose in the connecting rod and in the cap, even though they had originally been riveted in place. After re-riveting the bearing shells it may happen that their edges are lower than the surfaces of the rod and cap. To remedy this by filing is difficult and tedious work, necessitating repeated checking on a surface plate if an accurate job is to be done. An easier way is to make a number of shims, with the inner edge folded over, so as to press directly upon the bearing shells. If the number of shims and their thickness are correct, the bearing shells will be held permanently in place.—Richard P. Cole, Paterson, N. J.

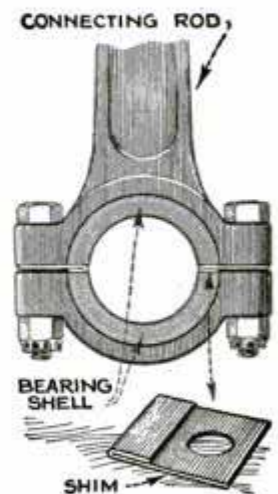

Sawbuck Helps Raise Log

Sometimes it is troublesome to lift a large log up on a sawbuck, but with the

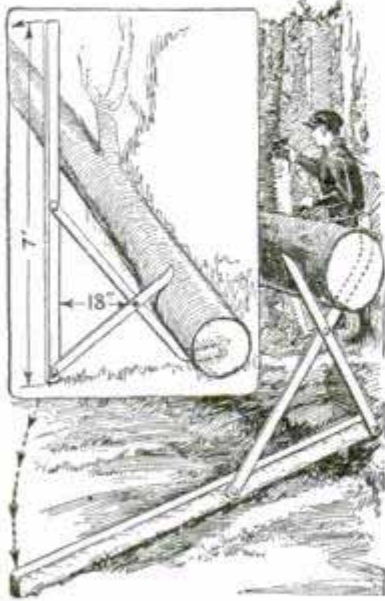

buck shown in the drawing the task will always be easy. It has a 7-ft. base made of 2 by 4-in. stock, and the other members are 1 by 4-in. In use the device is placed so as to straddle one end of the log and by pulling the base down, as

indicated by the arrows, the log is raised with little effort.—Luther Strosnider, Onago, Kans.

Clamps for Welding

It is often difficult to get a clamp to suit a specific welding need; sometimes the right size is not available, or else the clamp is not sturdy enough to withstand the strain. The clamp shown in the accompanying illustration is strong enough to stand any strains to which it may be put, and is adjustable. In making it, a ring, 1 in. wide and cut from 2-in. boiler tubing, is flattened on the sides to an oval shape. A reinforcement made from a section of a similar ring is fitted snugly around one end of the oval, and the ends of this strip welded to the sides. A $\frac{5}{16}$ -in.

hole is drilled through the top of this reinforced section and the top of the ring, and then tapped for a setscrew. The shoe of the clamp is a piece of ring, 1 in. wide, and is also cut from boiler tubing, bent to fit. A spot countersink is made in the top of this shoe to receive the point of the setscrew. Because of its adjustable feature, this easily constructed



clamp comes in handy for many special purposes about the shop or plant.—A. G. Wikoff, New York City.

Inside and Outside Coatings for Smokestacks

There is no oil-mixed paint that gives good service when applied to the inner surface of a smokestack or breechings. The best covering is three or four coats of cement mixed in small quantities at a time to the consistency of thick paint and applied with a brush. A wire brush should be used to remove all soot and rust from the crevices before the cement is applied. For the outside, asphalt paint is best and this, also, should be applied only after a thorough wire brushing of the surface.

Quick-Acting Marking-Off Blocks

For holding medium-length round pieces when marking off positions on opposite sides or at right angles, the device shown in the illustration will be found to be a great convenience. Once it is made, the center is known, and, unlike V-blocks, where the height center varies with the diameter of the work, it remains the same for all sizes within its capacity.

To make it, two square blocks are cupped out on one side, clamped together, drilled and reamed at opposite corners to take two guide bars. The bars are a tight fit in one block and a sliding fit in the other. The latter is drilled through cornerwise to receive a tightening bar, which consists of a piece of cold-rolled stock drilled and countersunk in the center and sawed in two. A special screw with a tapered point, entering a tapped hole in the block, expands the two halves of the tightening bar against the guide bars. With this device the blocks can be adjusted very quickly

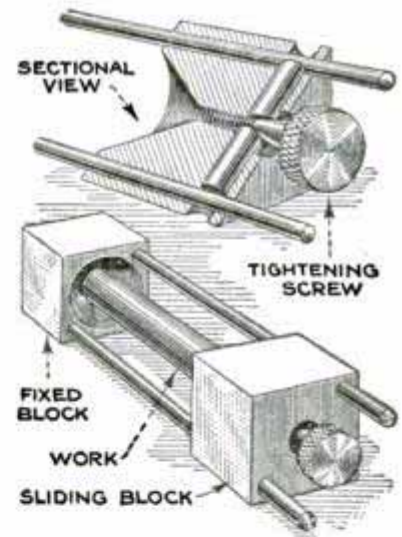

to hold the work. The piece is inserted in the cupped end of the fixed block, and the sliding block pushed up against the other end. One turn of the screw then tightens it in place.

Oil in Boilers May Cause Blistered Tubes

The practice of using oil in boilers to loosen scale and prevent them from rusting, when allowed to cool off or for other purposes, is not good unless care is taken to remove all particles of it with some grease dissolvent afterward. If this is not done, the oil adheres to the tubes or plates and prevents water from coming in contact with the metal. Thus the heat is not carried away from this point and the tube or part may become so hot as to blister and weaken.—Geo. G. McVicker, North Bend, Nebr.

Waterproofing Shipping Tags

Shipping tags bearing order numbers, addresses and other essential information can be waterproofed to prevent the writing from "running" by the simple method indicated in the drawing. Get an open glass jar, about 8 or 10 in. in height and large enough to allow your hand to enter freely. Suspend a 60-watt lamp in the jar as shown. Turn the current on and shave enough paraffin so that, when melted, it will come up to the top of the lamp. It is then an easy matter to dip the tags in the melted paraffin, and this will effectively waterproof them. After use, the lamp is turned off and the paraffin is allowed to harden around it. When ready to use it again, just turn on the lamp and in a few minutes the paraffin will be melted so that tags can be dipped in it. The tags also will be strengthened by the treatment.—E. V. Wills, Chicago.

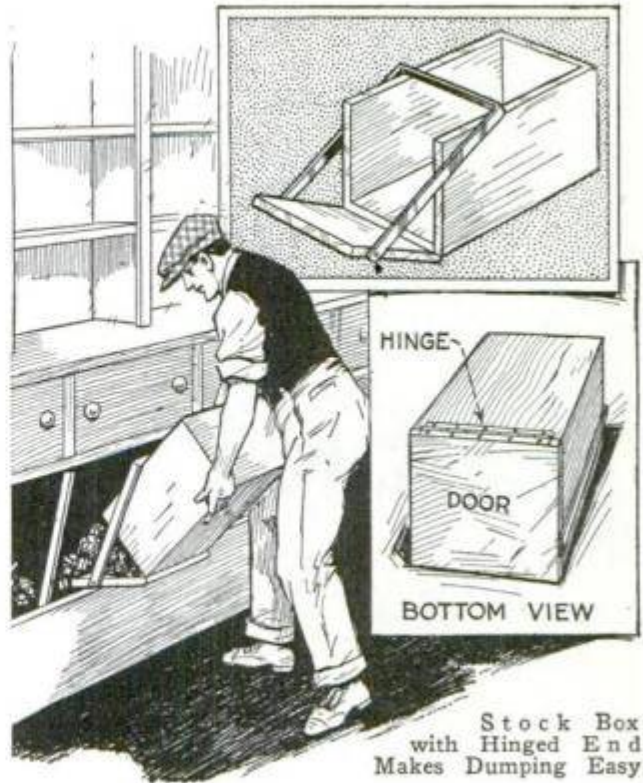

Stock Box with Hinged End Saves Time in Store

A useful box to have around a store-room, where small parts are kept in bins, is one with a hinged end like that shown in the drawing. For dumping a boxful of parts into a bin without loss of time nothing could be handier. With ordinary boxes the user must tip them up to empty the contents, with the not uncommon result that some of the pieces are scattered on the floor. The other way is to ladle the contents out by handfuls, which, of course, is slow. We took an ordinary wooden box and knocked out one end of it, then made a new endpiece, the full over-all width of the box, and hinged it at the bottom. Next we bent an iron strap, to fit close over the box lengthways, and attached the ends to the hinged lid with a screw on either side. It is quite easy to unload this box into a bin even at shoulder height from the floor. It is lifted up and the hinged end is pushed a little way into the bin. The strap is then raised and pushed forward to open the lid. Tilt the box slightly, shake it, and the contents will slide out.—H. Moore, Montreal, Can.

ⓘ Taps should never be screwed down hard; if this is done, their washers wear out quickly, and the taps begin to leak.

This May Be Your Home



Copyright, Architects' Small House Service Bureau



Plan No. 5D33

QUESTIONS regarding home building addressed to this magazine will be answered by The Architects' Small House Service Bureau of the United States, Inc., controlled by the American Institute of Architects and endorsed by the United States department of commerce. Inclose 10c and self-addressed envelope. Blueprints, specifications and material list for the house shown here may be obtained at nominal cost. Inclose self-addressed stamped envelope for reply. If further information is desired, send 5c and stamped envelope for a 24-page booklet explaining how the Small House Service Bureau functions and showing 12 sample plans. A new booklet, entitled "Fifty Ways to Lower Home Building Costs," illustrated by ten bureau houses actually lived in, and showing how as much as \$1,000 can be saved on a home, may be obtained for 20 cents.

THE plan presented here was awarded an honorable mention by the jury in a recent competition for a five-room bungalow. The charm and simplicity of the exterior of this small bungalow are easily seen.

The rectangular shape of the floor plan permits a simple and direct roof treatment, without hips and valley, resulting in economy of construction and a low skyline. This low skyline aids materially in creating the satisfying impression of hominess and intimacy between the house and its setting.

The living room is of good size and proportion. If a fireplace is desired in this room, it could be provided at the end adjacent to the furnace flue, without much difficulty or additional expense. The dining room is conveniently located, with a deep bay window to make it sunny and

cheerful. The two bedrooms occupy corner positions and thereby are able to have cross ventilation. Each has a large clothes closet.

The kitchen is in the front of the house and is lighted and aired from two sides. The entrance to both kitchen and basement is protected by a trellis, so that the coming and going of the butcher, baker and candlestick maker will be unnoticed.

Materials used: Frame construction with wide wood siding or heavy shingles for exterior finish.

Width: Twenty-four feet. Depth: Thirty-eight feet.

Approximate size of lot: Thirty-five feet.

Facing: The house should be faced so as to take advantage of prevailing winds, sunny exposure and local views. The plan shown here can be reversed, if desired.

IN accordance with the editorial policy of this magazine never to accept compensation in any form for what appears in our reading pages, and also to avoid the appearance of doing so, we are obliged to omit the name of the maker or the seller of any article described. This information, however, is kept on file and will be furnished free, by addressing Bureau of Information, Popular Mechanics Magazine, Chicago.

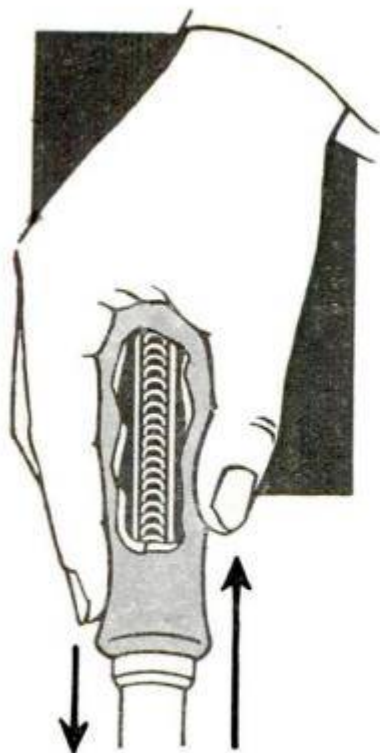

The spring puts *magic* into "YANKEE" No. 130-A

JUST PUSH! The spring in handle and "Yankee" Spiral do the work for you—and save your time.

Without loss of a second, the spring brings handle back ready for the next push.

And the tension keeps blade in screw-slot, leaving one hand free to hold work.

One handed, you can quickly drive (or draw) screws in the most difficult places with this "Yankee" Quick-Return Spiral Ratchet Screw-driver No. 130-A.

Right-hand Ratchet, Left-hand Ratchet and Rigid. Three sizes of bits.

No. 130-A. Standard size

No. 131-A. Heavy pattern

No. 135. Light pattern

"Yankee" Spiral Ratchet Screw-drivers, without the Quick-Return feature, No. 30-A, No. 31-A, No. 35.

Some other "YANKEE" TOOLS

Ratchet Bit Braces	Automatic Push Drills
Ratchet Breast and Hand Drills	Plain Screw-drivers
Automatic Feed Bench Drills	Ratchet Tap Wrenches
Vises—removable base	

"Yankee" on the tool you buy means the utmost in quality, efficiency and durability



Dealers Everywhere
Sell "Yankee"
Tools



FREE

New "Yankee" Tool
Book

This interesting little book is for all lovers of fine tools. It tells just what you want to know about all the famous "Yankee" Tools. Write for your copy today.

NORTH BROS. MFG. Co., Philadelphia, U. S. A.

"YANKEE" TOOLS

Make Better mechanics

Telephoning over a ray of light*Building on the Telephone Principle*

FIFTY years ago Alexander Graham Bell discovered the principle of the telephone. His first telephone employed wire as the connecting path over which words passed. Four years later he used a beam of light instead of wire to carry speech between telephone instruments.

Today, both wire and wireless telephony are employed on every hand in the service of the nation. Wire telephony, with its thousands of central offices, its complex switchboards and millions of miles of wire, envelops the country, carrying for the American people 70,000,000 conversations every day. Wireless telephony is broadcasting

entertainment and carrying important information to the remotest regions.

But new applications of the telephone principle are still being found. In the loud speaker, in the deaf set, the electrical stethoscope, the improved phonograph, the telephone principle has been adapted by the Bell Telephone Laboratories to the uses of the physician, the public speaker and the musician. The scientific research and engineering skill, which enable America to lead the world in telephone service, are also bringing forth from the telephone principle other devices of great usefulness.

**AMERICAN TELEPHONE AND TELEGRAPH COMPANY
AND ASSOCIATED COMPANIES**

BELL  **SYSTEM**

**IN ITS SEMI-CENTENNIAL YEAR THE BELL SYSTEM LOOKS FORWARD
TO CONTINUED PROGRESS IN TELEPHONE COMMUNICATION**

When you grip it you'll know . . .

YOU'LL realize that here is no ordinary hammer: but a tool built after careful study of what a hammer should be . . . and what it should do.

Feel the balance, with the weight where it should be to give driving force with an easy swing.

See that large face that lets every blow strike true; the knife-like claws with the Plumb "curve" that draw any nail with ease.

And the Take-Up Wedge—that Plumb invention which permanently solves the loose handle problem.

Balance! Power! Head always tight! These features are built into the Plumb Hammer for a lifetime of service.

In your hardware store—try a Plumb. Then use your own judgment.

FAYETTE R. PLUMB, Inc., Phila., U. S. A.



**Plumb Take-Up Wedge
Keeps Handle Tight**

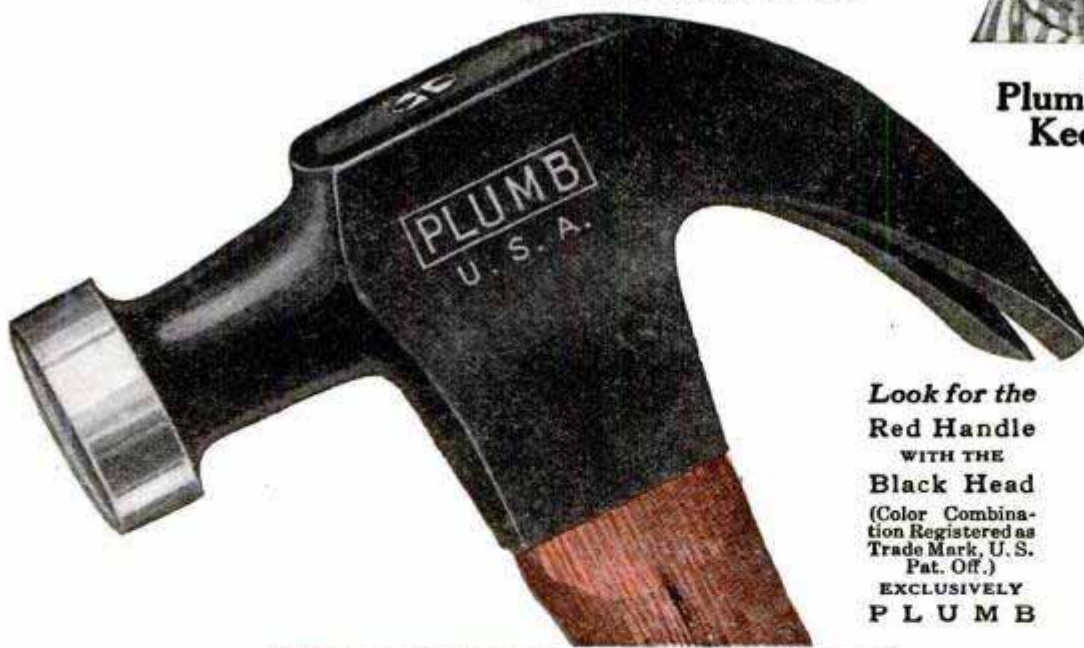

**Look for the
Red Handle
WITH THE
Black Head**
(Color Combination Registered as Trade Mark, U. S. Pat. Off.)
**EXCLUSIVELY
P L U M B**



Here is the wedge, invented and used only by Plumb that keeps handles always tight. When this wedge is inserted into the tapered hole, its V shape expands the wood against all sides of the eye, all the way in the hammer head.



When the handle works loose (and all handles do, because wood will shrink) you give the wedge a turn and the handle is solid and firm again for a long period of satisfactory service.





*Buy separately
or in assortments*

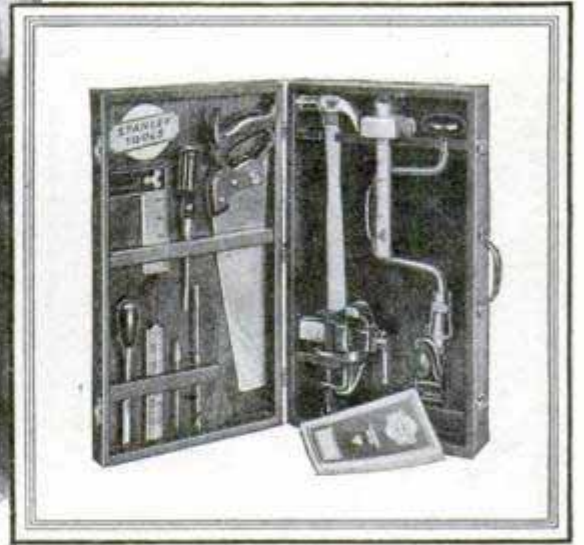

She will approve a hanging bookrack

AN open bookrack that hangs on the wall is fashionable just now. Why not make one yourself? There's real satisfaction in making something with your own hands. Relaxation, too. With a set of Stanley Tools you are able to attend to odd repair jobs and make many of the things you want around your home.

Good tools are necessary to do really good work. Every Stanley Tool is as efficient as expert craftsmanship can make it. That's why nearly every carpenter uses Stanley Tools. And that is why they are the first choice in thousands of manual training classes.

You can buy Stanley Tools separately and gradually accumulate your own set. And there are sets of Stanley Tools in a wide range from

which to choose—from No. 904 containing 12 tools in a sturdy oak chest at \$15, to No. 850 containing 49 tools in a beautiful cabinet at \$95.

There are also assortments of the same Stanley Tools in strong cardboard boxes with careful directions in each from which you can make your own chest. Prices \$5 to \$20.

IMPORTANT: For only 10c (to cover cost of printing and mailing) we will gladly send you a plan sheet which gives full directions for making a bookrack like the one shown above. Ask for Plan No. 1—PM.

Send for our Catalogue No. 34 which describes Stanley Tools both separately and in assortments. Address: The Stanley Works, New Britain, Conn.

The best tools are the cheapest to use. Ask your hardware dealer

STANLEY TOOLS

new! Valspar Brushing Lacquer *Dries in Minutes!*

VALSPAR Brushing Lacquer is the last word in Lacquer finishes. It is not only good for indoor use but is especially recommended for outdoors—on front doors, porch furniture and boats, canoes etc. It is waterproof, heat-proof and weatherproof and flows from the brush like a good enamel. Anyone can apply it.

No more excuse for shabby-looking furniture, woodwork and old unmatched pieces around the house. No more need to wait hours and hours for paint to dry. The new Valspar Brushing Lacquer, not only dries in minutes but dries with a satiny finish that looks well and wears well.

You'll enjoy using Valspar Brushing Lacquer—it's so easy! It's a joy

to see old furniture and woodwork transformed into new beauty with this wonderful lacquer.

Look around now and see if you haven't one or several articles that you'd like to dress up with a coat of this Marvelous New Finish.

It comes in the following colors:

<i>Cardinal Red</i>	<i>Nile Green</i>
<i>Jonquil Yellow</i>	<i>Persian Lilac</i>
<i>Palm Green</i>	<i>French Gray</i>
<i>Java Brown</i>	<i>Italian Blue</i>
<i>India Ivory</i>	<i>Holland Blue</i>
<i>Oriental Green</i>	<i>Peacock Blue</i>
<i>Coral Sand</i>	<i>Argentine Orange</i>
<i>Chinese Red</i>	<i>Black and White</i>



If you want any other color you can easily mix two or more of the above colors to produce an endless variety of shades. Fill in the coupon below for trial samples.

This Coupon is worth 20 to 60 cents

VALSPAR BRUSHING LACQUER

VALENTINE & COMPANY, 460 Fourth Avenue, New York

I enclose dealer's name and stamps—20c for each 40c sample can of colors specified at right. (Only three samples of Valspar Brushing Lacquer supplied per person at this special price.)
Print full mail address plainly.

Send me these
Valspar Lacquer Colors

1.....
2.....
3.....

Send Free Book

Dealer's Name..... P. M. 10-26

Address.....

Your Name.....

Address..... City.....

3000 Miles in 24 Hours

and Good Tools make it possible to Maintain this Schedule

THE giant mail plane, bearing your letter, roars across the field and leaves the earth on the first stage of a 3000 mile journey. You marvel at the ingenuity of the men who conceived this great machine droning its way toward the horizon with dizzying swiftness.

But mere genius, unaided, could never have built the airplane whose motor deafens your ears with its terrific roar. Tools are needed to build airplanes and they must be *good* tools. That's why you'll find Brown & Sharpe Tools in every shop where airplanes are made or repaired. Their high quality is known throughout the world.

Brown & Sharpe Tools are *the* tools for every mechanic's kit. Remember, you can't beat a Brown & Sharpe Tool for accuracy.

Ask your dealer for a free copy of Brown & Sharpe Small Tool Catalog No. 30. Keep it in your kit to use as a reference when buying tools. If your dealer cannot furnish a copy, write us direct.

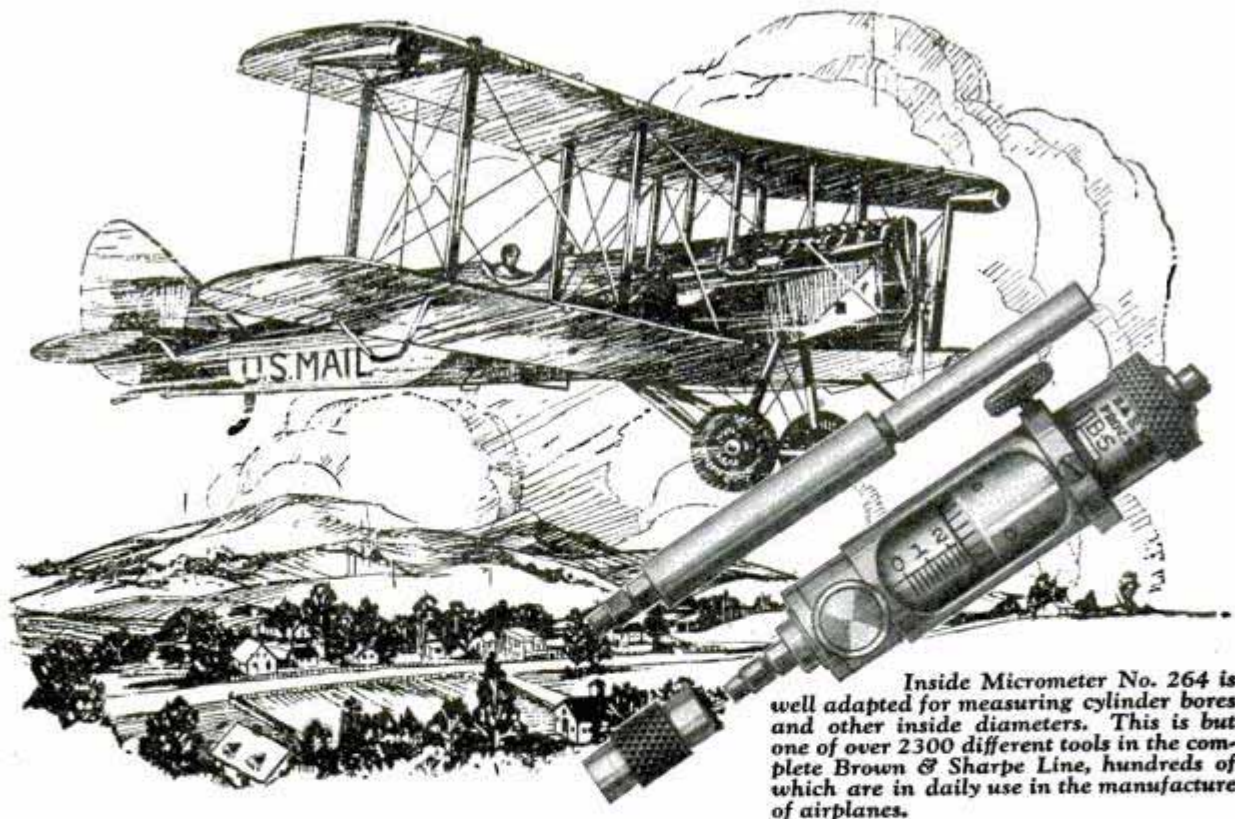

Inside Micrometer No. 264 is well adapted for measuring cylinder bores and other inside diameters. This is but one of over 2300 different tools in the complete Brown & Sharpe Line, hundreds of which are in daily use in the manufacture of airplanes.

BROWN & SHARPE TOOLS

BROWN & SHARPE MFG. CO., Providence, R. I., U. S. A.

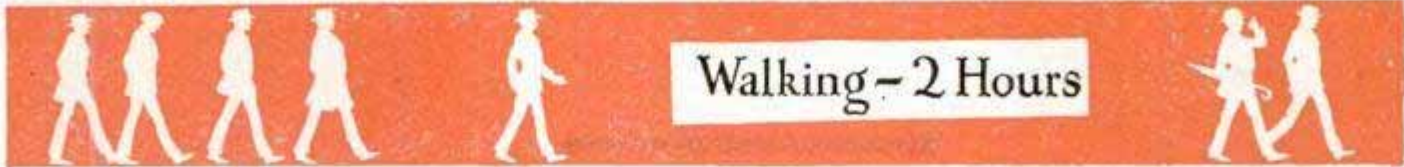

Walking - 2 Hours



Street Car - 1 Hour



Single
20 Min.

Pays for Itself - in Time Saved!

RIDING a Harley-Davidson Single is the new-day means of rapid travel at lowest cost. Direct — safe — convenient — comfortable! Ride it to work — and save an hour. Ride it on errands — and park it in any 2 x 8 ft. space. Ride it into the country — and enjoy traveling as you never have before. All at a cost of only *one cent per mile!*

Easier to ride and control than a bicycle — safe. Sturdy 4-cycle motor and 3-speed transmission.

Easy to buy. Your dealer offers a convenient Pay-As-You-Ride Plan. See him today.

The price of the Single, complete with built-in electric equipment, f. o. b. Milwaukee **\$235**



HARLEY-DAVIDSON MOTOR CO.
Department P. Milwaukee, Wisconsin

The **HARLEY-DAVIDSON**
[*New-Type Motorcycle*] **Single**



Mail the
Coupon



HARLEY-DAVIDSON MOTOR COMPANY
Dept. P., Milwaukee, Wis.

Interested in your Single; send catalog and Dealer's name.
 Interested in your Dealer proposition. Is my territory open?

Name

Address

Operate your radio set from the light socket

*Either with the new Balkite Combination
or with Balkite "B"
and a Balkite Charger*



**The New
Balkite Charger**

MODEL J. Has two charging rates. A low trickle charge rate and a high rate for rapid charging. Can thus be used either as a trickle or as a high rate charger. Noiseless. Large water capacity. Rates: with 6-volt battery, 2.5 and .5 amperes; with 4-volt battery, .8 and .2 amperes. Special model for 25-40 cycles. Price \$19.50. West of Rockies \$20.



**Balkite
Trickle Charger**

MODEL K. With 6-volt "A" batteries can be left on continuous or trickle charge thus automatically keeping the battery at full power. Converts your "A" battery into a light socket "A" power supply. With 4-volt batteries can be used as an intermittent charger. Or as a trickle charger if a resistance is added. Charging rate about .5 amperes. Over 200,000 in use. Price \$10. West of Rockies \$10.50.

All Balkite Radio Power Units operate from 110-120 volt AC current with models for both 60 and 50 cycles. Prices are higher in Canada.

The most convenient way of operating your radio set is from the light socket. Now you can do it merely by adding the new Balkite Combination or Balkite "B" and a Balkite Charger. Either way will give you full silent power for both circuits from the light socket.

All Balkite Radio Power Units are permanent pieces of equipment. They use no tubes. They have nothing to wear out or require replacement. They are noiseless. They do not hum. They always give just the power needed by the set because they do not run down or run low. Other than a slight consumption of household current their first cost is their last. With sets of high current requirements they effect a decided saving.

Operate your set with Balkite Light Socket Power. Over 600,000 receivers—one of every ten—are already Balkite equipped. Equip yours with Balkite and convert it into a light socket set. Know the pleasure and satisfaction of owning a set always ready to operate at its best.

FANSTEEL PRODUCTS COMPANY, Inc.,
North Chicago, Illinois

FANSTEEL
Balkite
Radio Power Units



**A New Balkite "B"
at \$27.50**

Balkite "B" eliminates "B" batteries and supplies "B" current from the light socket. Noiseless. Permanent. Employs no tubes and requires no replacements. Three new models. Balkite "B"-W at \$27.50 for sets of 5 tubes or less requiring 67 to 90 volts. Balkite "B"-X, for sets of 8 tubes or less; capacity 30 milliamperes at 135 volts—\$42. Balkite "B"-Y, for any radio set; capacity 40 milliamperes at 150 volts—\$69.



Balkite Combination

When connected to your "A" battery supplies automatic power to both "A" and "B" circuits. Controlled by the filament switch on your set—entirely automatic in operation. Can be put either near the set or in a remote location. Will serve any set now using either 4 or 6-volt "A" batteries and requiring not more than 30 milliamperes at 135 volts of "B" current—practically all sets of up to 8 tubes. Price \$59.50.

TRADE MARK **WURLITZER** REG.
 SUPREMACY IN MUSICAL INSTRUMENTS



Learn to Play

You are always popular and sure of a good time if you can play some musical instrument. By yourself, with your friends around the piano, in orchestras or bands,—there is no end to the pleasure music will give you. And there is no easier way to earn money in your spare time. Choose your instrument now and let Wurlitzer help you buy it and learn to play it.

Try Any Instrument in Your Own Home At Our Expense

You may now have any known musical instrument for an ample free trial in your own home. There is no obligation to buy—no expense for the trial. You may return the instrument to us if you decide not to keep it.

Monthly Payments

The Wurlitzer plan makes it easy for you to own the instrument you want. Payments are conveniently arranged in small monthly sums—a few cents a day will pay.

Wurlitzer instruments are known everywhere for their unusual tone quality and excellence of workmanship. They are used by the greatest

professional musicians, bands and orchestras. Harry L. Jacobs of Sousa's Band, Brooke's Marine Band, and Chicago Grand Opera says: "I am proud to be the owner of one of your new cornets. It is positively superior to anything I have had in all my years of cornet playing."

Easy to Buy

Thousands of amateur musicians are playing on Wurlitzer instruments. Many of them could not have bought except through the Wurlitzer selling plan. Wurlitzer is the world's greatest music house, with stores and dealers in all parts of the country. But no matter where you live you will receive the same service by mail as though you lived next door to the factory. Send the coupon today.

Send for Free Catalog

The greatest musical catalog ever published. Over 3,000 articles—every known instrument described and illustrated—many of them shown in full color. Gives you all details of the Wurlitzer plan. Send coupon now.

The Rudolph Wurlitzer Co., Dept. 1777
 117 E. 4th St., Cincinnati 329 S. Wabash Ave., Chicago
 120 W. 42nd St., N. Y. 250 Stockton St., San Francisco

Send me absolutely free, your new illustrated catalog of musical instruments. Also tell me how I may try any instrument in my own home at your expense and how the Wurlitzer plan makes it easy for me to buy. No obligation.

Name _____
 Address _____
 City _____ State _____
 Instrument _____
 (State instrument in which you are interested.)



If a Stranger walked into YOUR home—?

"JUST now I am listening to the '_____ Hour,' and if a stranger should walk into my house, not knowing I had a radio, he would believe the musicians were actually hidden in another room. I recommend Daven Resistance Coupled Amplification to anyone!"
J..H., Philadelphia, Pa.

NEVER has any radio hookup caused the sensation that the Daven Bass Note Circuit is causing. It does the thing that radio hook-ups of the past have never been able to accomplish—brings out all the **deep bass tones** as clearly and perfectly as the middle and higher registers.

In addition to this new quality of tone, it gives ample volume, perfectly controllable from whisper to roar; sensitivity, selectivity and ease of tuning. Simple to build, because constructed in straight line, economical of space.

Build yourself a Daven Bass Note set. The parts listed below may be secured from any authorized Daven service dealer with full instructions for assembling. We will gladly send you catalog, full information about the Daven Bass Note Circuit and address of nearby Daven dealer.

DAVEN BASS NOTE CIRCUIT

Made Up of These Daven Standard Parts

- 1 Set D. R. F. Coils
- 1 Daven Super-Amplifier with the new Glastors
- 3 Daven MU-20 Tubes



The New Daven Glastor. A resistor that is absolutely changeless and noiseless, because built on an entirely new principle—Daven Processed Glass.

- 1 Daven MU-6 Power Tube
- 1 Daven Leakandenser No. 22
- 1 Daven 1/4 Ampere Ballast

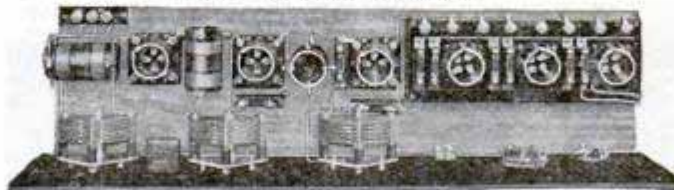

Birdseye view of an economically assembled Daven Bass Note Circuit.

- 1 Daven 1/2 Ampere Ballast
- 1 Daven Type "A" Condenser



Hi-Duty Glastor. Glastor's "big brother." For use in B-Eliminators. Ample heat-radiating surface.



This valuable book (25c at the dealer's, 30c by mail) explains Daven Amplification. Daven Catalog Free on request.

"The Sine of Merit"
DAVEN RADIO CORPORATION
TRADE MARK "Resistor Specialists" REGISTERED
160 SUMMIT ST. NEWARK, N. J.

The Dealer on whose window you see this sign will demonstrate Daven Amplification for you.



10 Days Free Trial

The Speed Way Shop
(Model 260)

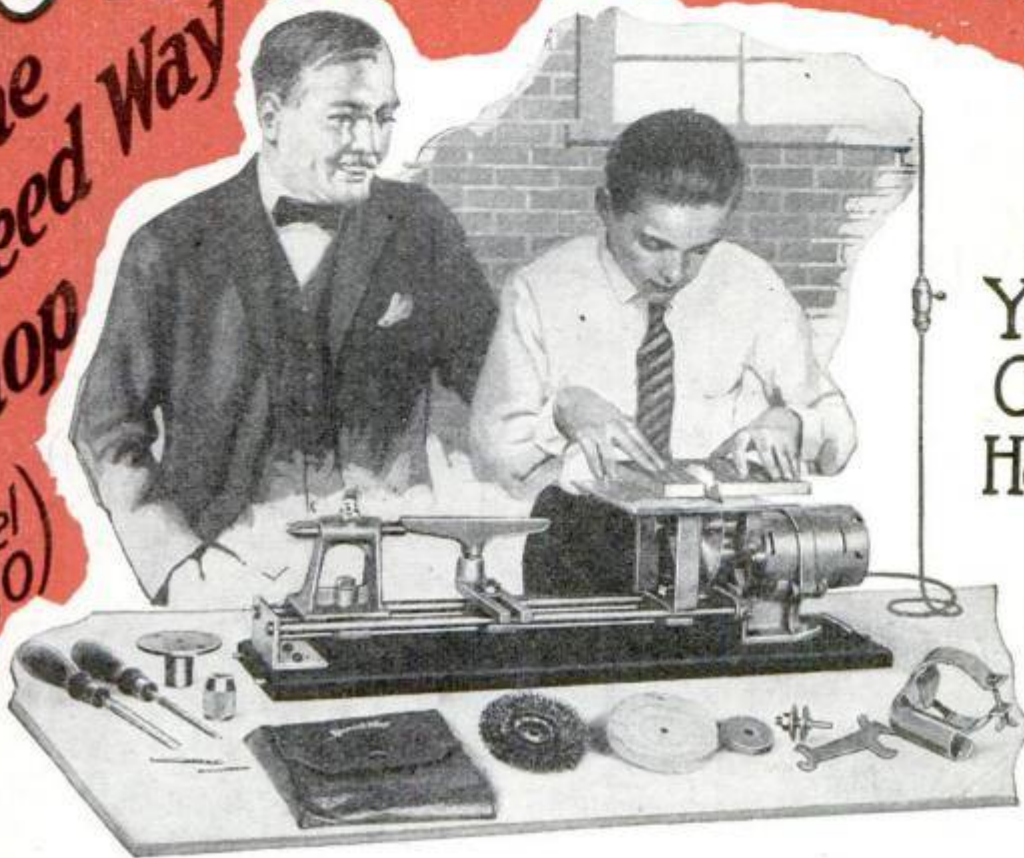

In Your Own Home

Eight Complete Motor Driven Tools

The SpeedWay Shop and Tools is a compact metal and woodworking outfit for mechanics, experimenters, householders, farmers and shop men. The power unit is our powerful back-geared SpeedWay electric motor.

Only \$10 Down



Portable Saw Unit

We make it easy to pay while you enjoy these sturdy tools in your own home. You can do Wood Turning, Bench Sawing, Scroll Sawing, Portable Sawing. You can do buffing, polishing, grinding and drilling either at the bench or anywhere there is a lamp socket.

Bench Saw, Lathe, Jig-Saw, Grinder, Buffer, Portable Saw, Cleaner, Drill

Attach to any lamp socket and convert your bench to a complete private workshop. Have the chips flying in five minutes after receipt.

10 Days' FREE Trial



Jig-Saw Unit

Test the SpeedWay Shop for 10 days in your own home. If it does less than we claim, return it.

Free Blueprint Service

Each month for a year we furnish a free blueprint of your selection and help you in other ways to get maximum service from the SpeedWay Shop and Tools. Write for list of blueprints and interesting things that users (Judges, Lawyers and Doctors), are using these tools for.

SEND COUPON TODAY

Make Things at Home

We furnish free, Blueprints explaining just how to make Furniture, Birdhouse, Toys, Trellis, etc. You can do Ratlio jobs; polish auto and golf clubs; and endless other things.



We want you to read what others say about SpeedWay Shop and Tools. We want to show you how it will profit you. Send the coupon TODAY. Every tool in the "Shop" is high grade, for regular work. A money maker for the small job man. Get full particulars. Send coupon TODAY.

ELECTRO-MAGNETIC TOOL COMPANY

Dept. 210

1830 So. 52nd Ave., CICERO, ILL. [Adjoining Chicago]

Electro Magnetic Tool Co.,
Dept. 210,
1830 South 52nd Ave., Cicero, Ill.

Dear Sirs: Please send me full particulars about 10-day free trial, free blueprints and \$10 down payment on SpeedWay Shop.

Name.....

Address.....

City..... State.....

5 tube SINGLE DRUM



STATION
SELECTOR

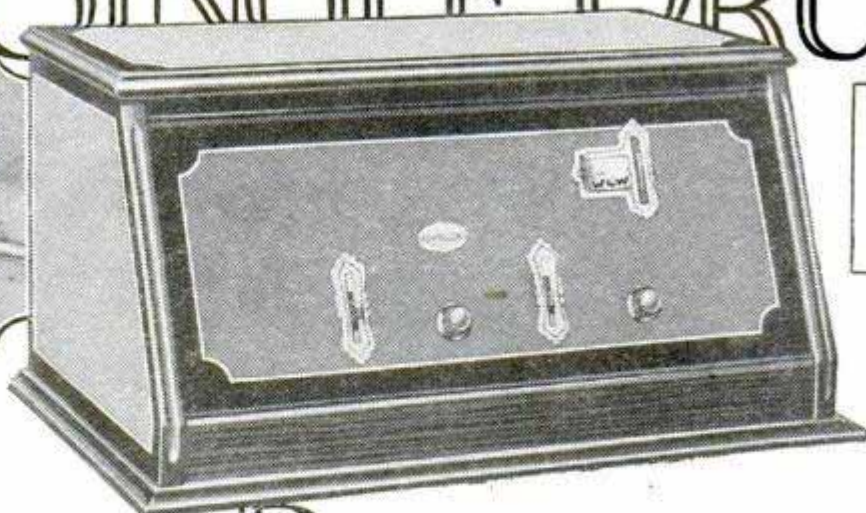

RADIO RECEIVER

6 Other Crosley Radio Achievements

The Crosley 1-tube "Pup"—\$9.75—a double-circuit set, with which laymen have heard radio signals probably the greatest distances.

The 4-tube 4-29—\$29—a 4-tube receiver of amazing efficiency. Already proven its right to a permanent position in the Crosley line. CRESCENDON equipped!

The 5-tube 5-38—\$38. The 5-tube tuned radio frequency set incorporating the CRESCENDON—a spectacularly popular model.

The 5-tube RFL 75—\$65—true cascade amplification; non-oscillating—non-radiating, regardless of how it may be mishandled.

The 5-tube 5-75—\$75—embodying the 5-tube single control, with drum station selector, as offered in a table model at \$50. SOLID MAHOGANY cabinet. Musicone built-in—41 inches high.

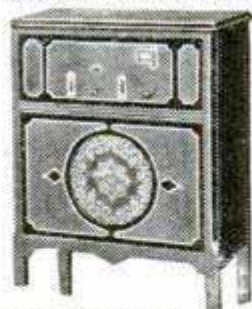

The 5-tube RFL 90—\$90—introducing the double drum station selector! Solid mahogany cabinet. Musicone built-in—ample room for batteries and all accessories. 41 inches high, 30 1/2 inches wide. Prices slightly higher West of the Rockies.

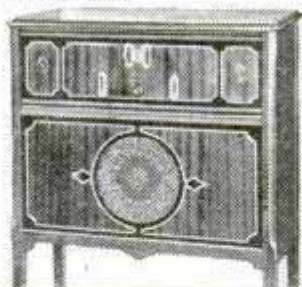

Crosley manufactures radio receiving sets which are licensed under Armstrong U. S. Patent No. 1,113,149 or, under patent applications of Radio Frequency Laboratories, Inc., and other patents issued and pending.

The CROSLY MUSICONES



The announcement of the new Super-Musicone is predicated on the success of the Regular (12-inch cone) Crosley Musicone in replacing hundreds of thousands of old type loud speakers. Musicone Regular 12-inch cone \$12.50. Super-Musicone, 16-inch cone, \$14.75. Musicone-sole with built in Musicone, \$32.00.



With the Graphic Station Selector, Stations from one end of the wave band to the other, are easily brought in at all times—**IN THE SAME PLACE.**

\$50.

Contrast the surpassing performance of this new type of Crosley Radio with what has hitherto been considered radio perfection.

The cabinet is solid mahogany, beautifully finished in two-tone and striped in gold. Metal fittings are rose gold finish.

The metal shielded chassis is divided into three compartments. The units shielded from each other, prevent interstage as well as external coupling. This improves stability of circuit and increases selectivity. This has never before been offered in sets of moderate price.

Crescendone Control affords unusual volume from distant stations.

Heretofore single dial control sacrificed selectivity. By means of the Acuminators, very sharp tuning is accomplished where the reception from local stations spreads broadly over the dial. Under average conditions, when once adjusted, these acuminators do not have to be touched again.

Crosley Musicones are manufactured under basic patents issued and pending, controlled by Crosley.

CROSLY · RADIO

BETTER
COSTS
LESS

Write Dept. 15, CROSLY RADIO CORPORATION, CINCINNATI, O.

How to make better Christmas Gifts

Wonderful New Way to Improve
Your Craftsmanship

LEPAGE'S NEW BOOKS
WILL SHOW YOU HOW

NOW with the coming of the holiday, gift-making season, when the man who has a home workshop especially enjoys his hobby of making useful, practical gifts that can be used and appreciated by everyone in his home—come these two NEW LePage's Craft Books to show you how to make better Christmas Gifts and how to improve your craftsmanship. The titles of these two books are, "LePage's Practical Suggestions for the Home Workshop," and "LePage's Gesso-Craft Book."

Naturally when you tackle the making of an article like a breakfast nook, ship model or cedar chest, you want to come as near as possible to equalling the skill of the trained cabinet-maker. One of the things which he knows that you also must know is how to make strong joints—joints that combine strength with gracefulness and beauty. The only way to do this is with the use of glue, and this is exactly the information given you in these books. They tell you how to make strong joints with glue, and not only with glue, but with glue in its most convenient form—LePage's Liquid Glue.

Improve your craftsmanship

These books also show you how to cover up small defects in your craftsmanship. Now and then a tool will slip and an error is made. Or there are holes to be filled where nails or screws have been countersunk. Or the edges of a joint are not exactly even. A simple new way to repair these defects is with the use of LePage's Gesso instead of putty. LePage's Gesso will stick to any surface—wood, metal, glass, etc. It can be sandpapered, planed and painted or stained just like wood. We give you in the small panel below a simple formula for making LePage's Gesso, but of course we tell you more about it in the books themselves, together with practical information on decorating your finished articles with Gesso.

Send 10 cents for these NEW LePage's Books

The practical and useful help of these two books is yours for only 10 cents. Just write your name and address on the coupon below, tear the coupon out and mail it to us today with 10 cents in coin or stamps, and we will at once send you a copy of these two LePage's Books, postage paid. Address, LePage's Craft League, Dept. RR1, Gloucester, Mass. Tear out the coupon now so that you will not forget it.



Handiest tool in your workshop

Perhaps you have never thought of the special advantages of using LePage's Liquid Glue. It is always ready for immediate use. No weighing, soaking or heating is required. Its quality is always the same. It "sets" slowly enough so that you have plenty of time to place the joints together exactly as they should go. Slow setting also allows LePage's to penetrate the wood, increasing the strength of the joint. LePage's Liquid Glue is equal in strength to any animal glue. Buy a can for your workshop. It is the easiest, quickest, handiest form of Glue. Insist on LePage's.

Recipe for making LePage's GESSO

To make one cup of LePage's Gesso, you need 1 gill can of LePage's Glue, 1 1/4 cups whiting, 3 teaspoons linseed oil and 3 teaspoons varnish. Place whiting in mixing bowl and pour in slowly in this order, LePage's Glue, linseed oil and varnish. Mix until smooth. All ingredients obtainable at nearest hardware store.

LE PAGE'S LIQUID GLUE

Bottles, Tubes, Cans

LePage's Craft League,
Dept. RR1, Gloucester, Mass.

Gentlemen: Enclosed you will find 10 cents (coin or stamps) in payment for LePage's Practical Suggestions for the Home Workshop, and LePage's Gesso-Craft Book. Please send a copy of each to:

Name.....
Street.....
City..... State.....

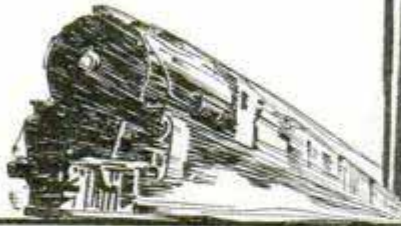

Remington
Portable *for*
maximum speed
and portability



Weights $8\frac{1}{2}$ pounds net
Carrying case
only 4 inches high

THE Remington Portable is faster than human fingers. It is ready to work anywhere — everywhere. It is a born traveler. Small, light, unobtrusive, it is today a necessary part of the equipment of those who travel — for business or pleasure.

Take the Remington Portable with you wherever you go. It is the smallest and lightest portable typewriter with four-row standard keyboard. It has the greatest capacity for work. It is incomparable for strength and durability. It



is the recognized leader—in sales and popularity.

Send for our booklet, "For You—For Everybody." Please address your letter to Department 12.

Remington Portable can be purchased on terms as low as \$5 monthly.

Remington Typewriter Company
374 Broadway New York

Branches and Dealers Everywhere

Remington Typewriter Company
of Canada, Ltd.
68 King Street, West, Toronto

Remington TYPEWRITERS

A Machine for Every Purpose

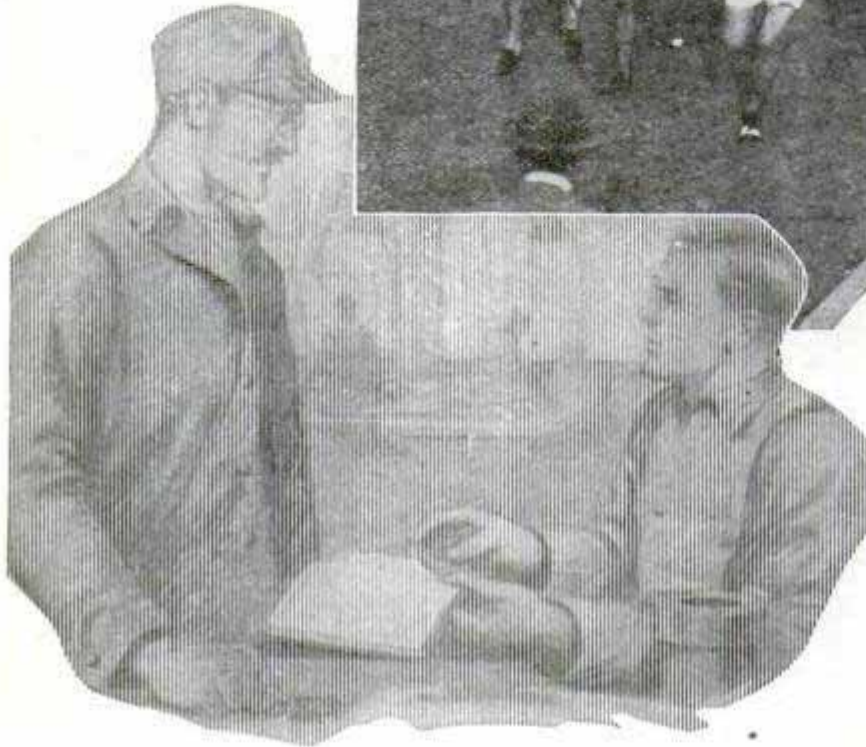

Remington-Made Paragon
Ribbons and Red Seal
Carbon Papers always
make good impressions

CREDIT
INTERNATIONAL
NEWSREEL

Off to a good start

Getting off on the right foot—

—starting with good tools—is just as important in work as in sport.



A really good man—in sport or work—can sometimes come out from behind and win, but any disadvantage in those first few strides makes a heavy handicap for the best of them.

If you've a young fellow—a son, a friend, or an employee—who is just beginning to use tools, start him right. Give him a Starrett Apprentice Set, No. 901. Accuracy in the tools he works with is pretty sure to teach him accuracy in the work he does.

The No. 901 Set, in a handsome wooden case, contains a 6 in. Combination Square, 6 in. Flexible Steel Rule, Center Punch, Center Gage, 5 in. Divider, 6 in. Outside and 6 in. Inside Calipers and the Starrett Book for Machinists' Apprentices—184 pages on how to use tools and how to do good work.

Ask your dealer. Also write us for a free copy of the 352 page Starrett Catalog No. 23 "AP".

THE L. S. STARRETT CO.

World's Greatest Toolmakers
Manufacturers of Hacksaws Unexcelled
Steel Tapes—Standard for Accuracy

ATHOL, MASS.

Use Starrett Tools





Knowing tomorrow's weather today is possible with a ~
Tycos Stormoguide
If your Dealer cannot supply You, write
Taylor Instrument Companies
 ROCHESTER N.Y.
 Canadian Plant, Tycos Bldg. Toronto
 There's a Tycos or Taylor Thermometer for Every Purpose

Sittin' Pretty!

I'll say



Envy him? Don't! He did it in just a few weeks. Taught himself, secretly, at home. A little practice—now he's sittin' pretty, with his

BUESCHER

True Tone Saxophone

Do you long for attention? the admiration of friends? gay parties? good times with those you like best? All these things, and more, are yours if you will earn your welcome -- learn to play this most wonderful of all musical instruments.

You'll Walk Away With It

Within a week you can be playing tunes. 3 lessons, given on request with each new instrument, explain easy fingering and give you quick start. You might even be a wizard like Tom Brown, whose Buescher Saxophone has made him famous and rich.

Take One Home on Trial. Easy Terms

Try a Buescher, any Instrument you choose, in your own home for six days. This is a most liberal offer. If you like the instrument, pay a little each month. Play as you pay. Without obligation, mail coupon below for beautiful literature on any instrument, and details of trial plan. Get Started! Now!

BUESCHER BAND INSTRUMENT CO.
 Everything in Band and Orchestra Instruments
 1390 Buescher Block Elkhart, Indiana

Clip the Coupon NOW!

BUESCHER BAND INSTRUMENT CO. 321
 1390 Buescher Block, Elkhart, Indiana

Gentlemen: Without obligating me in any way please send me your free literature. I am interested in the instrument checked below.

Saxophone Cornet Trumpet Trombone Tuba

Mention any other.....

Name.....

Address.....

Own a CORONA

The portable typewriter built like an office machine. Has four-row keyboard and big-machine features throughout. Write to

Corona Typewriter Co., Inc.,
 108 Main Street, Groton, New York



Beautiful HOUSES \$900 and BUNGALOWS

CAN BE BUILT FOR AND UP
 This and many others in my new book, Building Plans for Modern Homes, will save you hundreds of dollars. One of the most complete and comprehensive books of plans ever published by any architect. New edition just off the press. Nearly 600 floor plans and photographs of Colonial houses, bungalows, etc., costing from \$200 up; gives sizes and cost to build. Sent postpaid for \$3.00.



FREDERICK H. GOWING
 ARCHITECT
 101 Tremont St., BOSTON, MASS.

EARN \$1300 in SPARE TIME



Mrs. Limeberry of Indiana is a busy woman, yet she found time last year to earn \$1300 as agent for our beautiful line of imported and domestic fabrics. We offer you the same opportunity she had. No capital or experience needed. We supply you with full details and an exquisite sample book. Write for wonderful proposition to agents.
THE NATIONAL IMPORTING COMPANY, Dept. K-6, 573 Broadway, New York City

This Year~
make it a Real Vacation!



Thrilling, foaming speed with the Super Elto outboard motor! Instantly attached to any rowboat. Easily portable. World famous for easy starting. Multiplies the pleasures of fishing, racing, vacationing. Write today for new catalog—beautifully illustrated—intensely interesting.

The Super Elto
 Elto Outboard Motor Co.
 Ole Evinrude, Pres.
 Dept. 24, Mfrs. Home Bldg.
 Milwaukee, Wis.



"Starts With a Quarter Turn"

**Double Pleasure
Double Measure**



**100% Perfect
Blades to the Package**

WE don't do things by halves! We're not satisfied just to make Gem Double Life Blades double-keen! We make them double-thick to hold their keenness! We double-reinforce them so they're double-rigid! Then we double-seal and double-protect them so they're double-perfect when you get them!

Begin to enjoy double-pleasure shaves tomorrow. Sold everywhere.

P.S. You'll get double-satisfaction with a Gem de Luxe Razor. It's the finest razor money can buy. If your old Gem isn't right up to perfection, our service department will be glad to replace it! Send it to the

GEM SAFETY RAZOR CORPORATION
Brooklyn, N. Y.

GEM
Double Life
BLADES

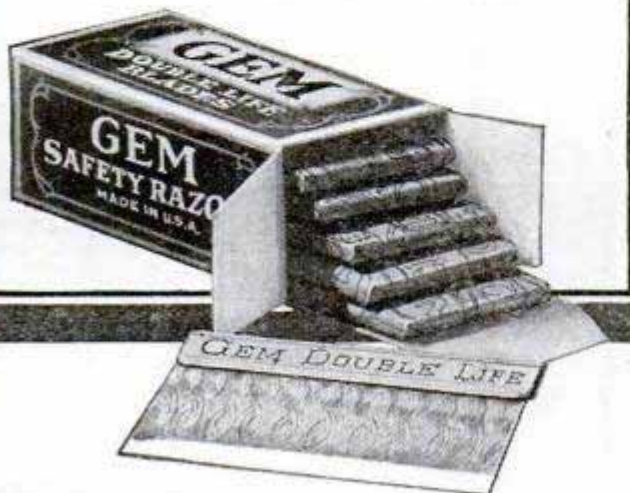

Please Mention Popular Mechanics

**Pocket \$110 A Week
With Amazing New Cap**

New adjustable feature makes Fits-U Caps fit any head instantly. A perfect fit always. 36 snappy style-color combinations. Finest hand tailored workmanship. Amazingly low price. Every man and young man wants one of these new stylish caps. All you do is take orders. *No experience necessary. Big commissions daily in advance.*

Selling Outfit FREE

You, too, can make \$110 a week showing this wonderful Fits-U Adjustable Cap. We furnish complete selling outfit FREE. Write immediately for it—also for full details about the FREE cap we give you.

FITS-U CAP CO., Dept. A-10, Cincinnati, O.



AGENTS 500% PROFIT
GENUINE GOLD LEAF LETTERS



guaranteed to never tarnish. Anyone can put them on stores and office windows. Enormous demand, large profits. Paul Clark says: Smallest day \$28.70. R. L. Reel made \$920 in two months. Write today for free sample and liberal offer to general agents.

METALLIC LETTER CO., 433-B N. Clark St., CHICAGO



New Plan!
makes it easy

\$50.00 to \$100.00 Weekly

Selling Shirts Direct to Wearer.
No capital or experience needed. Spare or full time. Established 1885. Represent a real manufacturer.

WRITE FOR FREE SAMPLES
MADISON SHIRT MILLS, 562 BROADWAY, NEW YORK

Just Out!
World's Greatest Utility Light

300 CANDLE POWER—with new built-in Utility Pump. Handiest, most practical light invented. Storm-proof, rain-proof, bug-proof. Ideal for farmers, campers, tourist, sportsmen.

Bright, white light—20 times brighter than vick lanterns on half the cost. Burns 96 per cent air—4 per cent fuel, gasoline or kerosene. Lights with match. Clean, odorless, safe, Guaranteed.

AGENTS!

Make \$60 to \$100 a week. No experience or capital required. Outfit Free to workers. Exclusive Territory. Write quick!

FREE TRIAL

Try 30 days at our risk. Send for special money-saving offer and catalog giving all details FREE. Write now.

THE AKRON LAMP CO.

110 Lamp Bldg., Akron, Ohio



Earn \$100 a Week
Profits in Advance

Sell Gibson extra fine men's made-to-order all-wool suits at \$31.50, direct to wearer. Regular \$55 values. **Biggest commissions paid in advance.** We deliver and collect. 6 x 9 cloth samples (over 100 styles—all one price) and complete outfit in handsome carrying case, furnished to ambitious men who are willing to hustle and earn \$100 weekly. Write today.

W. Z. GIBSON, Inc., 161 W. Harrison St., Dept. X-516, Chicago



\$351⁰⁰ CLEARED ~ IN ONE DAY

So writes W. H. Adams of Ohio in August 1925. V. A. Marini of California reports \$11275 sales in three months. Jacob Gordon of New Jersey \$4000 profits in two months." Alexander of Pennsylvania "\$3000 profits in four months." Ira Shook \$365 sales in one day. Bram bought one outfit April 5 and 7 more by August 28. Iwata, bought one outfit and 10 more within a year. Mrs. Lane of Pittsburg says "sold 8000 packages in one day. J. R. Bert says "only thing I ever bought that equaled advertisement." John Culp says:

"Everything going lively. Crispette wrappers scattered all over town. It's good old world after all." Kellog, \$700 ahead end of second week.



WE START YOU IN BUSINESS

Furnish secret formulas, raw material, and equipment. Little capital required; no experience needed.

Build a Business of Your Own

No limit to the sale of Crispettes. Everybody likes them. It's a delicious food confection. Write for facts about a business that will make you independent. Start now, in your own town.

Profits \$1000 a Month Easily Possible

Send postal for illustrated book of facts. It contains enthusiastic letters from others—shows their places of business, tells how and when to start, and all information needed. Free. Write now!

LONG-EAKINS COMPANY

1028 High Street

Springfield, Ohio

RAISE BELGIAN HARES

NEW ZEALAND REDS—Chinchillas—Flemish Giants
MAKE BIG MONEY—We supply stock and pay you following prices for all you raise: Belgian Hares \$2 each—New Zealands \$3 each—Chinchillas \$4 each—Flemish Giants \$5 each. 32-page illustrated book, catalog and contract, also copy of *Fur Farming* magazine, tells how to raise skunk, mink, fox, etc., for big profits, all for 10c. Address

OUTDOOR ENTERPRISE CO., Box 25, Holmes Park, Mo.

When it's 23 Below Zero



The EVERBRITE Radiant Oil Heater

will keep you comfortable. Mrs. Senften, Nebr., writes: "Last Sunday it was 23 below zero but The Everbrite kept us warm and burned 25 hours on one filling."

Every home, store, church, can now have all the advantages of natural gas heat at a cost of 1 cent an hour.

Burns 8 to 10 hours on gallon of Coal Oil. Cheaper—cleaner—more comfortable than coal or wood fire. No wick—no smoke—no odor. Will heat the whole house in coldest

weather. May be moved from room to room. Simple; turns up and down—off and on like city gas. Absolutely safe. Thousands in Happy Homes everywhere. Built of steel and nickel—weighs 44 lbs.—height 22 inches.

FREE Simply send name today for circular, full details how it works and amazing free home test offer.

EVERBRITE STOVE CO. 2212 Gateway Station, Kansas City, Mo.

STOP THAT LEAK WITH SMOOTH-ON No. 1

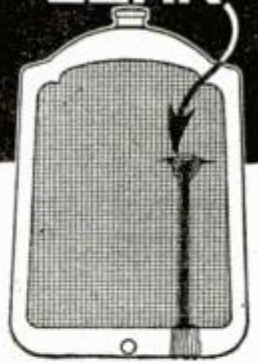

YOU can apply Smooth-On with radiator full or empty, hot or cold, without removal from the car and without putting inside anything that clogs the circulation.

Merely roll the Smooth-On into a stiff putty, press it against and into the leak with your thumb or pack it into the defect with a knife blade or screw-driver, and scrape off the excess. The leak will stop instantly, and the repair is permanent. For a few cents and in a few minutes you will have avoided all the delays and expense of a professional repair job that couldn't be any better.

Burst Water Jackets. Water jackets of automobile, stationary or marine gas engines which have developed long or short cracks or have even had pieces broken entirely out from freezing can be made thoroughly and lastingly serviceable by similar repair, or by applying Smooth-On under straps or a plate.

Smooth-On No. 1 can be used in a hundred ways in the household, and it often saves from \$50.00 to \$100.00 on the first job.

Keep a can of Smooth-On No. 1 with your tool kit and some day when caught with a repair job you will thank yourself for your forethought.

Get Smooth-On No. 1 in 7-oz., 1-lb. or 5-lb. tins at any hardware store or if necessary direct from us.



Write for
FREE BOOK

FREE

This booklet tells how to stop not only water leaks in radiators, bursted water jackets, and at loose hose connections, but also how to stop gas leaks from the tank, gasoline lines and exhaust system, and oil leaks at gaskets and at cracks in crank or gear case. It also tells how to make headlight posts, nuts, hub caps and bolts and grease cups stay tight, and shows dozens of simple money saving Smooth-On repair jobs.

Sent free if you return the coupon

SMOOTH-ON MFG. CO.
Dept. 37, 574 Communipaw Ave.
JERSEY CITY, N. J.



Do it with SMOOTH-ON

SMOOTH-ON MFG. CO., Dept. 37,
574 Communipaw Ave., Jersey City, N. J.

Please send the free Smooth-On Repair Book.

Name.....

Address.....

P.M.

PREST-O-LITE COMBINATION
5 IN 1 OUTFIT

Convenient Canvas Roll Case

\$7.50



Repairing
a radiator



Heating and
bending rod

Intense heat that is portable

NO MATTER where there's a job that requires heat, you can carry the handy Prest-O-Lite 5-in-1 Outfit right to your work.

Its intense heat is ready instantly to help you make a quicker, better job of any brazing, soldering, melting or fusing work. Always ready; intense heat instantly.

The outfit is complete with four different size torch heads—the proper flame for every need. The outfit also includes a convenient soldering iron, rubber hose and tank wrench.

This equipment operates on Prest-O-Lite Gas in convenient tanks—the same gas used everywhere for truck lighting. Empty tanks are exchanged for full ones at any one of the thousands of Prest-O-Lite Service Stations. You pay a small amount for the gas only.

Ask about this money and time saving equipment at any Prest-O-Lite Service Station, or write us. The price is only \$7.50 complete.

THE PREST-O-LITE CO., INC.
INDIANAPOLIS, IND. Dept. L-10
New York San Francisco
In Canada: Prest-O-Lite Company of Canada, Ltd.
Toronto, Ontario

Prest-O-Lite Gas
"The gas of a thousand uses"

Please Mention Popular Mechanics

FREE New Book FACTORY PRICES

Save $\frac{1}{3}$ to $\frac{1}{2}$

New FREE book quotes **Reduced Factory Prices**. Introduces sensational **5-Year Guarantee Bond** on Stoves, Ranges, Furnaces. 200 styles and sizes. Beautiful porcelain enamel ranges and combination gas and coal ranges in soft grey and delft blue.

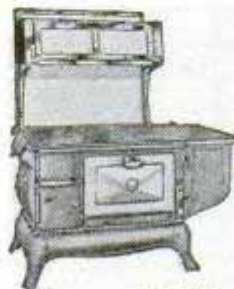

Ranges \$37⁷⁵ up

KALAMAZOO

MICH.



Heating \$27²⁰ up
Stoves

Mahogany porcelain enamel heating stoves. Cash or easy terms—as low as \$3 down, \$3 monthly. 24 hr. shipments. 30 day free trial.

360 day approval test. Satisfaction guaranteed. 26 years in business, 600,000 customers. Write today for your copy of this FREE book.

KALAMAZOO STOVE CO., Mfrs.
391 Rochester Ave.

"A Kalamazoo Direct to You"
Trade Mark Registered



\$100 a week
Selling Shirts

Fred Frankel, Ills., writes: "Learned \$110 first week selling Carlton Shirts direct to consumer." You can too. No capital or experience required. We pay 25 per cent. cash commissions daily and big extra bonuses.

WRITE FOR FREE SAMPLES
CARLTON MILLS, Inc., Shirt Mfrs.
114 Fifth Ave., Dept. 106-B, New York



DENINGER WILL TRUST YOU

SEND 10c INSTAMPS FOR CATALOGUES

BIG MONEY SAVING FOR YOU

Used and rebuilt motorcycles \$25 to \$100,

used bicycles \$9.50, tandems \$23.

All machines fully guaranteed.

New bicycles and motorcycles

at factory prices, save dealers'

profits. Motorcycle and auto-

mobile tires \$3. Complete line

frames, engines, supplies, etc.

DENINGER PRICE CUTTER, ROCHESTER, N. Y.

PAY AS YOU RIDE

HOW A BOY BUILT UP A GREAT SQUAB FARM



Started small in backyard when at school with no money, now has \$30,000 plant, ships to New York 150 bbls. squabs yearly, receiving \$75 to \$100 a barrel. You can do the same. Send for this book. Price is fifty cents but we will mail it to you for the names and addresses of four of your friends and your own name and address. Write today to

Plymouth Rock Squab Co., 634 A St., Melrose High., Mass.

You and This New Machine
Can Earn
\$500 a Month



Operate a Tire Repair Shop

70,000,000 Tires in use. America's greatest opportunity for men with small capital. We furnish everything—\$100 and up. Easy payments. We train you FREE right at home. Start making money at once. Write today for Free Book of Opportunity.

Haywood Tire Equipment Co. 1344 S. Oakley, Chicago

EDWARDS WILL SAVE YOU MONEY ON METAL ROOFS

We own our own steel mills, roll our own sheets, make them into high-grade REO METAL SHINGLES, Sidings, Ceilings and Roofings of every type and style for every kind of building. We control every operation from the raw material to the finished roof and we sell direct from our factories to the user. Not a dollar to divide with anybody but the customer! You get better value for less money.

OUTLAST THREE ORDINARY ROOFS

EDWARDS METAL ROOFS are weather-proof, lighting-proof, fire-proof! The galvanizing bends with the metal. No tools required.



LOW-COST ALL-METAL GARAGES

Any size. Any style. Portable. Ready to erect. Complete with frames, doors, sash and hardware. Ornamental, durable, economical. Blue-prints and complete instructions FREE.

Write today. Get our low prices and Free Samples. Ask for Roofing Book No. 150 or for Garage Book No. 150

THE EDWARDS MFG. CO.
1000-1050 Butler St. Cincinnati, O.



SHAW MOTOR ATTACHMENT MAKES YOUR BIKE A MOTORCYCLE!

A high grade 2 1/2 H. P. motor attachment quickly clamped on any bike frame. Speed 4 to 40 miles an hour. 90 to 125 miles per gallon of gas.

Special Low Price Now! Write today for Complete Description and Special Low Prices on SHAW Motor Attachment and the SHAW Complete Motorbicycle. **SHAW MANUFACTURING COMPANY**
Dept. 37 Galesburg, Kansas



SEND FOR THE INTERNATIONAL CATALOG



Our net price list. Full line of auto bodies and accessories for Fords at Wholesale Prices. Save big money on bodies by buying Direct from Factory.

FOR FORD—Prices from \$27.85 up. Factory to consumer direct—Pay Only One Profit.

International Body Works, 914 W. Ohio Street, Dept. 7, Chicago, Illinois

Can You Sell \$3.50 Ford Size Tires at

If so, write for our new plan on **INSYDE TYRES**. Written guarantee. Big money every day! **American Auto Accessories Co., Tire 231.** Cincinnati, Ohio

MOTORCYCLES

LESS THAN HALF COST



Ace, Indian, Cleveland, Harley-Davidson, Henderson Motorcycles and Sidecars, new, used and rebuilt. **Rider Agents Wanted.** Write for FREE trial offer, agent's free outfit and big bargain bulletin. **New American Bicycles** in different styles and colors. Write for illustrated catalog giving our money saving prices.



AMERICAN MOTOR CYCLE CO.
2047 W. Chicago Ave., Dept. 1035, Chicago

BURGESS FLASHLIGHTS & BATTERIES

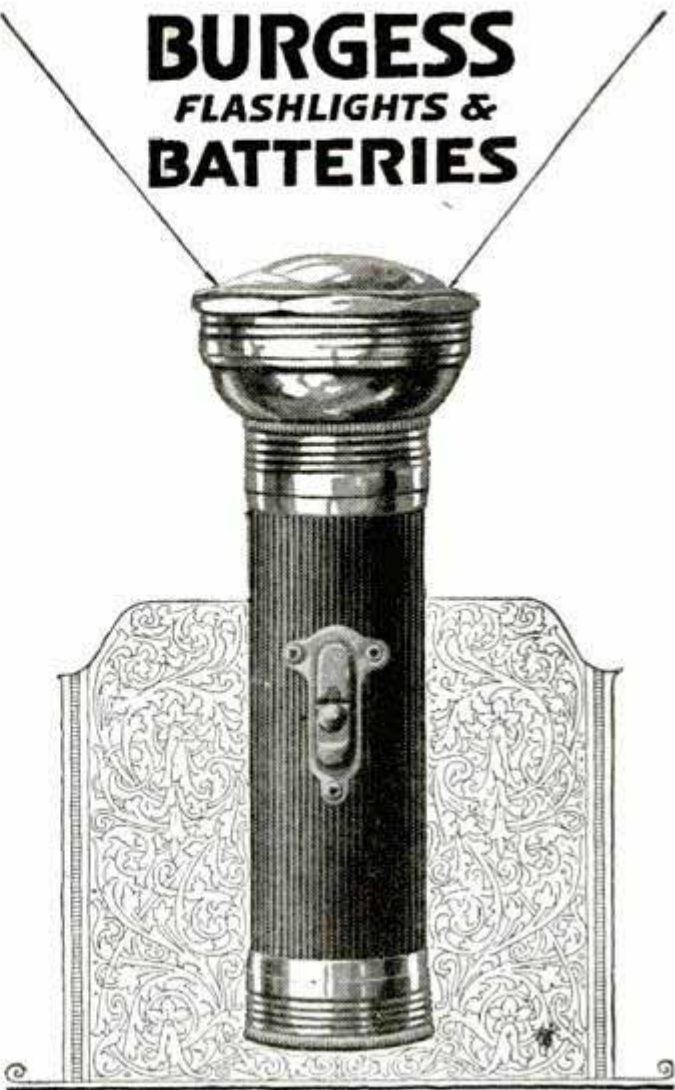

SOMETHING to remember is that any good flashlight case practically never wears out. Filled with a Burgess Flashlight Battery, you have done about all that you can to insure yourself against the inconvenience and danger always present in darkness.

Burgess Flashlight Uni-Cels will fit any case you may have. Try them—no better batteries are made.

A Laboratory Product

BURGESS BATTERY COMPANY
GENERAL SALES OFFICE: CHICAGO

*Canadian Factories and Offices:
Niagara Falls and Winnipeg*



Suppose You Were Offered Diamonds at 60% of Market Price

Suppose a reason you rarely think of makes possible here radically low prices, even for finest quality diamonds. Thousands of representative people, bankers, lawyers, merchants, others—continually reap this real advantage. Everything sent for Free Examination. This 3/4 century, oldest, largest diamond banking institution in the world, rated over \$1,000,000.00,—converts into cash the diamonds on which money was loaned and not repaid. Loan values, a fraction of market values, are the price basis. Diamonds too from big cash deals direct with European cutters. Must sell now



Why Pay Full Prices

When Much Less Buys the Same See this 3/4 less 1/16 ct., snappy solitaire for \$69.50. Try to match at \$115.00. Examine free any bargain at our risk. Startling, legitimate offers here of diamonds at 60% of market price. Send now for full details. Diamonds of unusual qualities (also watches) from unpaid loans, offered at radically low prices based on mere loan values. Then, too, we have hundreds of diamonds from big, cash, European deals with diamond cutters, who sacrificed these gems away under the market. Send now for our latest offers of this internationally known cash headquarters.



Unpaid Loan Listings Ready

As low as \$60 a Carat Radically different from a catalog. List accurately describes every diamond in full detail with guaranteed exact weight, color, quality, etc. Explains **Guaranteed Cash—like Insurance Policy Loan guarantee.** Also **Unlimited Exchange** privilege at price paid us. Gives full details of free examination offers. Don't wait, the very diamond you want may be in this very list at a price that will amaze you. Costs nothing to see. Write today. A postal will do, or—

Mail Coupon NOW!

JOS. DE ROY & SONS
Only Opposite Postoffice
1949 De Roy Bldg., Pittsburgh, Pa.

Without obligation to buy, send me free, in plain envelope, your Latest Bargain List of Diamonds, Watches, and other Jewels.

Name _____
Address _____

City _____ State _____

References by Permission:—Bank of Pittsburgh, N. A.; Marine National Bank; Union Trust Co., Pittsburgh, Pa. Your bank can look us up in the mercantile agencies.



Command Recognition & DIAMOND Does It



"Independent" GOLD POINT \$2
Lever, Self-Filler Stylopen
"Makes Writing a Pleasure"
Jumbo, \$3.50; Red, \$3.00; Black

J. C. ULLRICH & CO., 161 Washington St., N. Y. Est. 1884 Agents Wanted

Tire AGENTS WANTED

Use and introduce **MELLINGER CORD TIRES** 15,000 MILES GUARANTEED Lowest Wholesale Prices in America. Shipped prepaid on approval. Make big money all or part time. No capital or experience. Sample sections furnished.

YOUR TIRES FREE! Simply send name today for valuable FREE BOOK: tells how thousands have gone into big business. **SPECIAL AGENTS' OFFER.** Wholesale Prices and FREE SAMPLE KIT. Write nearest address.
MELLINGER TIRE & RUBBER CO.
Dept. 415, Kansas City, Mo., Dept. 415, Philadelphia, Pa.
Dept. 415, Oakland, Calif. WRITE NEAREST OFFICE



MAKE YOUR Ford INTO THIS Sport Car—Save \$50 to \$150 with Red-i-Kut Life-Size Patterns \$5.00

Famous sure-fit **RED-I-KUT** life-size patterns and picture instructions show how you can easily convert your Ford into this **Fast, Saucy, Sport Car** as thousands have done, with easily obtained materials. No need to look at Wilfred Eng's. Eng says: "It took me 5 Sundays to build it and I sure am proud to hear them say, 'He built that snappy sport car.' I never cut any steel or did any wood-work before, but one can't go wrong with Kumpel patterns." St. Louis, Mo.



The Lark life-size patterns for each part of the body so you can't go wrong, picture instructions and **CONICAL DISK WHEEL PATTERNS.** Only \$5.00 delivered. \$4 extra brings patterns for Jifty Top and Geom windshield. **RKO Steel for Lark \$10 complete.** Extreme West \$13. Order now while we can make good delivery, and really enjoy the wonderful spring days in your Lark. **Keen, Classy, Up-to-the-minute. You can build it. Over 11,000 in use. Don't hesitate. "Swing Lo" Underling Irons, no frame cutting kind, \$5.99. Only \$4.99 when ordered with Lark patterns. Send 10c coin for actual body photo and new manual of other distinctive sport body patterns from \$5.00 up—RKO "Steel" "Swing Lo" Irons, Tonz and Wheelsets. ORDER RIGHT NOW.**

KUMPEL CO., 77 Kumpel Bldg., Guttenberg, Iowa

\$15 a Day Easy SELLING SHIRTS



FREE SAMPLES

Yes, hundreds make more than that! But no wonder Fashion Wear Shirts in the latest styles and fabrics take prospects "off their feet" when you tell them the amazingly low prices for these fashionable, smart shirts.

EVERYBODY BUYS THREE FINE SHIRTS FOR \$4.95

Every man is a prospect. And they usually take advantage of our big special offer on 3 shirts—with a good profit margin for you. Don't waste time in correspondence. Just send postal for Free Samples—complete line. Make \$10 to \$20 the day it arrives visiting offices, factories, garages, etc. Write quick. Address **FASHION WEAR SHIRT CO.** 1200-20 Jackson Street, Dept. M-352 Cincinnati, Ohio

READ
"I walked into a little factory in Chesterfield and a half hour later walked out with orders that gave me a profit of \$40 and I had the cash in my pocket."
J. E. Burns.

MOTORCYCLES

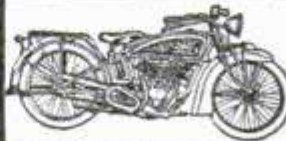

RELIABLE STANDARD MAKES that you can **DEPEND ON.** Enjoy the glorious experience of going wherever you like—when-ever you like. The price is within your means—25% to 50% less than others. These machines are slightly used, thoroughly overhauled or rebuilt. Send for catalogue, **MYEROW BROS.,** 15 Berkeley St., Boston, Mass.

\$45 Buys This Motor Cycle

It's a Harley-Davidson, 16 H.P., twin chain drive, magneto and clutch. It has power and can get up and go on the open road at a speed which thrills. This is only one of hundreds of bargains in used motor cycles which you can get. Send for Free Catalog. It tells of big bargains and tremendous values in used motor cycles. Repairs quickly done. Motor cycles exchanged. Send us your machine to be overhauled.



Oliver Cycle & Motor Co., 1045 N. Grand Ave., St. Louis, Mo.

INSTANT WELDS RUBBER INSTANTLY

Make \$200. to \$500.00 Per Month
A New Scientific Principle without heat or cement. Instantly repairs punctures or blow-outs. Better—Quicker—Easier than vulcanizing. **ONCE ON—ALWAYS ON.** Every auto owner is a prospect. Repeat orders sure. Big profits. Appoint sub-agents.



Write for Free Sample Today.
TOURISTS PRIDE MANUFACTURING CO.
Desk 50-J MINNEAPOLIS, MINN.

Makes Old Ford a Tractor

We furnish everything for converting Ford Auto Chassis with Engine into a handy Farm Tractor. Just right for truck growers, small farms, nurseries, etc. Pulls 16' Plow, Discs, Seeds, Cultivates; Runs Belt Machinery. We also build Garden Tractors and Cutter Bar Mower Attachments.

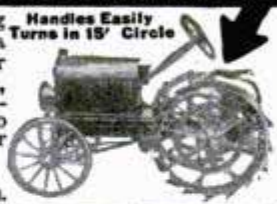

STOP FORD CRANKSHAFT END-PLAY!

C-A ADJUSTABLE BEARING corrects and prevents end-play without removing motor. Eliminates many troubles. Easy to install—simply drop pan. Only \$3.75. Ask your dealer or sent prepaid by **ADJUSTABLE BEARING CO., Dept. P, 405 Virginia Ave., Indianapolis, Ind.**



The "Lark" Class — Snap



\$5 DOWN Buys Any WITTE STATIONARY ENGINE

FROM 1½ TO 7 HORSE POWER

The One Profit Engine

NO INTEREST CHARGES

NOW, more than ever, the need for economical, dependable power is felt by the producer who is faced with ever-increasing labor costs. WITTE Throttling Governor ENGINES answer this important question perfectly—now an economical, dependable power plant is within the reach of everyone.

To-day the WITTE ENGINE sells at the lowest price in history. Into this WITTE has gone the ripe experience of more than 42 years of engine building—over 150,000 users all over the world have placed upon it their stamp of approval. You, too, can put a WITTE on your place, secure in the knowledge that it represents the Standard of Power.

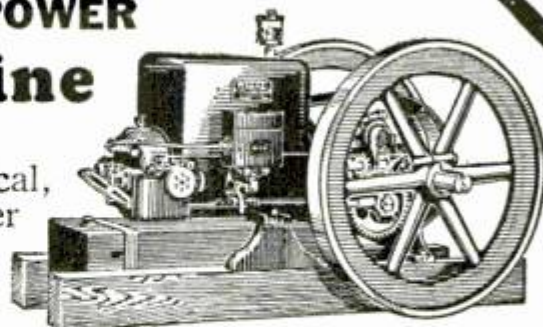

The Most Modern Engine

The WICO Magneto

—the most perfect system of high tension ignition known. Makes starting easy, even at 40 below zero.



Sure performance in any climate or temperature. Not affected by rain, hail, snow or sleet. The perfect replacement for old style battery-equipped engine.



Makes All Jobs Easy and Cheap

No need to do the hard, back-breaking work—no need to pay high prices for poor labor—you can show \$1,000 more profit every year you have a WITTE working on your place. Investigate now!

All sizes 1½ to 30 H.P. Easy Terms. Scrap the Old One—Pay a Little of It Down on the New WITTE.

Ask for FREE Catalogue

Our Big FREE Catalogue or if interested, ask about Log and Tree Saws, 3 in 1 Saw Rigs, or Pump Outfits.

The Witte Throttling Governor

the original and leader of the throttling-governor type. An even, steady speed with a big surplus of power for the heavy loads.



The minimum in fuel consumption—the WITTE ENGINE burns kerosene, gasoline, gas-oil, distillate or gas at a

fuel cost of less than 2c an hour per H. P. Simple, trouble-proof and guaranteed for a life-time of hard work. Completely equipped with WICO Magneto, speed and power regulator and throttling governor, square, protected tank and die-cast removable bearings.

WITTE ENGINE WORKS

(FOUNDED IN 1870)

1747 Witte Bldg., Kansas City, Mo.

1747 Empire Bldg., Pittsburg, Pa.

1747 Witte Bldg., San Francisco, Cal.

Quick shipments also made from nearest of these warehouses: Minneapolis, Minn.; Atlanta, Ga.; Trenton, N. J.; Richmond, Va.; Tampa, Fla.; New Orleans, La.; Dallas, Tex.; Laredo, Tex.; Denver, Colo.; Billings, Mont.; New York, N. Y.; Albany, N. Y.; Bangor, Me.; Portland, Ore., and Los Angeles, Calif.



Match Your Coat and Vest with New Trousers

DON'T DISCARD YOUR OLD SUIT. Wear the coat and vest another year by getting new trousers to match. Tailored to your measure. With 90,000 patterns to select from we can match almost any pattern. Send sample of cloth today, and we will submit FREE best match obtainable.

AMERICAN MATCH PANTS CO.

Dept. B. F. 6 West Randolph St., Chicago, Ill.



WHAT EVERY MASON WANTS

We have Masonic books and lodge supplies for Blue Lodge, Chapter, Commandery, Scottish Rite, and Shrine.

Our Rituals Are Used the World Over

Send for free catalog of books and rituals for Masons, Odd Fellows, Knights of Pythias, Knights of Columbus, Elks, etc.

EZRA A. COOK, Publisher, Inc. 1350 N. Clark St., Dept. M, Chicago, Ill.

UNBREAKABLE TWO YEAR GUARANTEED TRIO PEN

SELLS FOR
\$1.25

SAMPLE 67c

Writes like a \$7 Pen

"IT'S THE
POINT" →



Pens finished in beautiful green, red, black, or purple, ladies' or men's style. Money refunded if not pleased. Write for wholesale prices and selling plans. \$15 Daily easily made.

F. SPORS & CO., 355 Main St., LESUEUR CENTER, MINN.

SIMONDS

Why men who KNOW say "SIMONDS"

Watch a carpenter buy a hand saw! Watch him choose a Simonds Blue Ribbon! Men who count upon cutting tools most, know that Simonds Saws hang right, that they are balanced right, and the Simonds trade-mark signifies that they are made right. For Simonds Saws are made of specially treated steel and backed by Simonds' near-century of experience in the manufacture of the finest cutting tools. Next time you buy a saw, say "Simonds" to your dealer.

SIMONDS SAW AND STEEL CO.

"The Saw Makers" Fitchburg, Mass. Established 1832

Branch Stores and Service Shops in Principal Cities

Light Weight Marvel

Power $\frac{1}{2}$ to over 1 H. P.—Air cooled—Rated $\frac{3}{4}$ H. P. normal. Used for a multitude of power services for practical uses of individual or manufacturer in place of electric motor. Power from crankshaft at full speed—jack shaft at quarter speed. Spark speed control with simple make-and-break ignition or magneto.

WEIGHS ONLY 22 POUNDS

With carburetor, gas tank and base, complete, weighs 28 pounds. Furnish V or flat belt type pulley for crank or jack shaft. Power take-off pulley, 4 to 1 reduction. Ideal for applied power. Tell us your needs.

Write — CUSHMAN MOTOR WORKS

Builders of High-Grade, Light-Weight Engines
882 No. 21st Street, LINCOLN, NEBRASKA



Imperial Sanitary Floor

Base and Floor one solid piece

Put on like Plaster
Wears like Iron
-waterproof
-fireproof
-resilient
-noiseless
-dust-less

A composition material easily applied in plastic form over practically any kind of floor. Laid about $\frac{3}{8}$ inch thick. Imperial floor does not crack, peel or come loose from foundation. A continuous, fine-grained, smooth, non-slipping surface. No crevices to gather grease, dirt, dust, disease germs or moisture.

Ideal Floor for Kitchen, Pantry, Bath Room, Laundry, Porch, Garage, Restaurant, Theatre, Hotel, Factory, Office Building, Railroad Station, Hospital—wherever a beautiful, substantial floor is desired. Several practical colors. Full information and sample FREE of your first and second choice of colors.

Imperial Floor Co., 61-65 Halstead St., Rochester, N. Y.

A Success for 15 Years

Please Mention Popular Mechanics



Effective and Positive System is secured by

Gerstner TOOL CASES

for MACHINISTS and TOOL-MAKERS. Avoid lost, mislaid or damaged tools. Catalog free.

Gerstner Sons

434 Columbia St., DAYTON, OHIO.

BURN YOUR NAME ON TOOLS

WITH THE ARKOGRAF

PROTECT YOUR TOOLS FROM THEFT

Write with electricity any name or design on the hardest and finest tools and instruments, or any metal, like writing on paper with pen or pencil. Complete Outfit \$3.50—Prepaid Anywhere. Interesting Illustrated circular free. Write today. Agents wanted.

ARKOGRAF PEN CO., 1171 E. Stark St., Portland, Oregon



CALCULATIONS

in Office, School, Store and Shop can be instantly made with the Midget Slide Rule. It gives the answer to any problem involving fractions, mixed numbers, decimals, whole numbers, roots, powers, Logs, and Trig. Functions. Thousands of these rules are used by Accountants, Engineers, Clerks, Students, etc. It is the most versatile calculator ever invented. If you have any figuring to do, order a Midget Slide Rule on trial. Made of aluminum with figures on white celluloid. Size 4". Price with Instruction Book, \$1.50. Leather Case, 50c extra. Catalogue Free. Sent C. O. D. if desired.

Your money back if you are not satisfied.

GILSON SLIDE RULE CO., Niles, Mich.

Interlox MASTER SLIDE RULE

Takes accurate inside or outside measurements

MASTER RULE MFG. CO., 813 E. 136th St., NEW YORK

Dealers and Agents: request attractive proposition



Works fast. Slides in and out quickly. Durably made of brass trimmed boxwood. Any length 2 to 8 feet, 20 cents per lineal foot. If not at dealer's, sent postpaid.

Ingersoll

PRICES REDUCED!



The New **YANKEE**
Now \$150

Reduction Applies to Entire Line

Efficient Speed Reducers
write for free book on your letterhead

FOOTE BROS. GEAR & MACHINE CO.
216 N. Curtis Street CHICAGO, ILL.

CRESCENT WOODWORKING MACHINERY

High in quality, moderate in price. Ask for circulars describing bench machines for the small shop.

If you are interested in the larger machines we can supply you with Band Saws, Saw Tables, Self Feed Rip Saw, Shapers, Jointers, Variety Wood Workers, Planers, Planers and Matchers, Disk Grinders, Cut Off Table, Swing Cut Off Saws, Borers, Hollow Chisel Mortisers, Tenoner, Universal Wood Workers. Ask for circulars.

The Crescent Machine Co.,
93 Columbia St. Leetonia, Ohio

BIASCOPE
FIVE-POWER
American made Binocular

SEE ALL THERE IS TO SEE!!

Wonderful for outdoor folks, farmers, hunters, fishers, campers, tourists, scouts, naturalists. Light, compact, easy to adjust, optical qualities excel many foreign glasses costing much more. At dealer or direct, postpaid. Money back guarantee.

WOLLENSAK OPTICAL COMPANY
826 Hudson Avenue Rochester, N. Y.

PARKS

WOODWORKING MACHINES

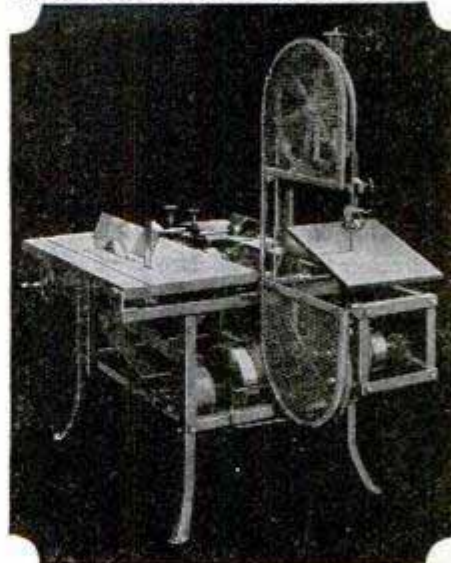

Cabinet Shop Special
\$290
with motor

See this Parks this month!

October is "Parks Cabinet Shop Special month" with Parks dealers everywhere. In their showrooms this wonderfully popular woodworker will be on display and in many instances in actual operation. Parks Cabinet Shop Special No. 10 at \$290.00 is the handiest machine Parks ever built! Big enough to turn out first-class work—small enough to fit in a small shop or basement—a real machine built for real work without freakish "stunt" designing. It makes practically any cut and includes rip and cut-off circular saw, jointer, and band saw. Lathe and shaper may be added at small extra cost. Every man who does cabinet making or woodworking of any kind wants this splendid machine. It is the biggest woodworking machinery value on the market today. Be sure to see this Parks this month

in these dealers' showrooms

ALA.: Moore, Handley Hwde. Co., Birmingham; McGowan-Lyons Hwde. & Supply Co., Mobile; Alabama Mch. & Supply Co., Montgomery; ARK.: Ben D. Schaad Mch. Co., Little Rock; CAL.: Shaw-Palmer & Bakewell Co., Los Angeles; Harron-Rickard & McCone Co., San Francisco; COLO.: H. W. Moore Equipment Co., Denver; CONN.: Lunt, Jillson Co., Manchester; FLA.: Cameron & Barkley Co., Jacksonville; Cameron & Barkley, Miami; Cameron & Barkley Co., Tampa; GA.: R. S. Armstrong & Bro. Co., Atlanta; ILL.: Woodworkers' Tool Works, Chicago; KY.: Roy C. Whayne Supply Co., Louisville; LA.: Clark D. Shaughnessy Co., New Orleans; MASS.: Lunt, Jillson Co., Boston; MICH.: Riverside Mch. Depot, Detroit; McMullen Mch. Co., Grand Rapids; MINN.: Raymer Hwde. Co., St. Paul; MO.: Standard Tool & Supply Co., Kansas City; S. T. Hatcher & Co., St. Louis; NEB.: Diehl Mch. & Supply Co., Omaha; N. Y.: Interstate Mch. Co., Troy; Chas. E. Mapps, 178 Lafayette St., New York City; N. H.: Brackett & Shaw Co., Somersworth; N. CAR.: Amer. Hwde. & Equip. Co., Charlotte; Raleigh Iron Works Co., Raleigh; OHIO: J. C. Baker, Columbus; OKLA.: Universal Supply & Mch. Co., Tulsa; ORE.: Portland Mch. Co., Portland; PA.: K. O. Ditmars, Bourse Bldg., Philadelphia; Coblents Tool & Supply Co., Erie; S. CAR.: Cameron & Barkley Co., Charleston; TENN.: Peglar Mch. Co., Chattanooga; Iddins Mch. Co., Knoxville; Harvill Supply Co., Nashville; Carriage & Wagon Supply Co., Memphis; TEX.: Universal Supply & Mch. Co., Amarillo; Southern Implement Supply Co., Dallas; Don A. Carpenter & Co., El Paso; Peden Iron & Steel Co., Houston; Peden Iron & Steel Co., San Antonio; UTAH: Salt Lake Hwde. Co., Salt Lake; VA.: James McGraw, Inc., Richmond; W. VA.: Lance Equip. Co., Huntington; WIS.: Shadbolt & Boyd Co., Milwaukee; WASH.: Union Mch. & Supply Co., Seattle; FOREIGN: Sipe Mch. Agency, San Jose, Costa Rica; P. I.: Zayas, Havana, Cuba; Weir Mch. Co., Vancouver, B. C.; Morris, Black & Matheson, Ltd., Auckland, N. Z.; West India Mch. & Supply Co., San Juan, P. R.; Bournival & Co., Montreal, Can.; Engineering Supply Co. of Australia, Ltd., Brisbane, Australia.

See this Parks by all means! If you can't, then write us for circular No. 10 and the new Parks catalog.

THE PARKS BALL BEARING MACHINE CO.
1500-40 Knowlton Street CINCINNATI, OHIO
Canadian Factory: 200 Notre Dame East, Montreal, Canada

Fastest Cutting

Saws Fifteen Cords
a Day!



Men—
Let Me Send You My
Greatest LOG SAW Offer!



It's easier now than ever before to own this fastest-cutting, easiest-moved, most powerful Log Saw. Now, you can make big money sawing firewood, stove-bolts, ice, shingle timber, etc. Write today for full details of this most wonderful offer. Know how easy it is to make big money sawing fifteen cords of wood a day with no hard work.

350 Saw Cuts a Minute—

nearly six each second. Just think of it—now you have a log—in a few seconds it's all sawed up into lengths you can use—without any hard work! The OTTAWA has balanced crank shaft, power force feed, friction clutch.

Make BIG MONEY—

Wood selling at \$3 a cord brings owner \$45 a day. Saw your own wood—go into the wood business. Don't let the lack of ready money stop you. Remember, we sell on very easy terms. More in use than all others combined.

ONLY \$39

Puts the OTTAWA Working for YOU!

I average \$20 profit a day with my OTTAWA. —J. Schill, New York. "My OTTAWA has earned \$700 for me." —S. Graham, Wisconsin. "I can make more money with the OTTAWA than by farming." —D. Goff, Missouri.

OTTAWA 4.H.P. LOG SAW

30 Days to Try—one whole month to use the OTTAWA at your own sawing. Shipped on trial only—backed by 10-year guarantee. Prove to yourself how easy you can saw 15 cords or more a day—at a cost of 1 1/2¢ a cord.

To Save You Freight—and get your machine to you a few days after you order, I ship from: Ottawa, Kan.; Pittsburgh, Pa.; St. Paul, Minn.; Albany, N. Y.; Memphis, Tenn.; Indianapolis, Ind.; Pueblo, Colo.; Ft. Worth, Texas; Portland, Ore.; San Francisco, Cal.

FREE Send me your name and address on postcard today, so I can send you my wonderful new edition of the "Wood Sawing Encyclopedia." Educational, instructive. Be sure to investigate—will help you to make big money.

HARRY OVERMAN, Pres. OTTAWA MFG. CO.
1742-P Wood St., Ottawa, Kans. Room 1742-P, Magee Bldg., Pittsburgh, Pa.



Here Men!

A CHANCE FOR QUICK Success

No fancy selling to make big money with the new Fall line of Wright tailored to measure clothes. Two prices—\$23.50 and \$31.50. Suits every taste. All wool fabrics. Guaranteed fit and tailoring. Orders come easy—you just take measures and pocket \$3.00 to \$7.00 profit on the spot. We attend to everything else. Complete outfit furnished you to do big business. **130 all wool 9x13 samples.** Advertising helps and complete instructions so clear you can't fail—all **FREE.** No deposit. Exclusive territory given. Rush application today. Tell us your past experience.

WRIGHT & COMPANY, Dept. 29, 2226 to 2302 Wabansia Ave., Chicago, Ill.

ALL WOOL MADE TO MEASURE SUITS

\$23.50



Be a Taxidermy Artist

Marvelous Book Sent FREE

You can now learn Taxidermy, the wonderful art of mounting birds, animals, tanning skins, etc. Learn at home, by mail. The free book tells how. Mount your own trophies. Decorate home and den. Hunters, trappers, nature lovers, you need taxidermy. Interesting, fascinating, big profits. Join our school. 100,000 students. Success guaranteed. Get our free book without delay. Send right now—today.

N. W. School of Taxidermy, 1777 Elwood Bldg., Omaha, Neb.



Big Money

Made by agents selling our wonderful Facial Soap, Perfumes, Toilet Articles, Spices, Extracts, etc. Free cake of soap and agents' terms mailed to any address.

LACASSIAN CO. Dept. 455 ST. LOUIS, MO.



WADE AMATEUR MECHANICS, REPAIR SHOPS, INVENTORS, STUDENTS

BENCH LATHE
A real machine tool for the home work bench—capacity 4" dia. x 12" length. For Metal—Wood—Composition Materials. Turning—Facing—Boring—Drilling—Winding—Thread Cutting. Accurate—Strong—Quiet—Compact. Slide-rest has travel entire length of bed. Leadercrew inside bed. No. 1 Lathe, plain headstock, \$28.00. No. 2 Lathe, back-gear headstock, \$58.00. Extra fer lathes with 18 inches between centers, \$7.00. Complete line of accessories at equally low prices. Write for free catalog.

THE GEROLD CO., Dept. P-27, 120 Liberty St., New York

CALIBRE 30-40



U. S. ARMY KRAG CARBINES \$15

The OLD reliable. The choice of hundreds of big game hunters. Barrel refinished. Other parts New. First Class serviceable condition.

Krag 30-40 220 Steel Jacket Cartridges \$8.00 a 100
Krag 30-40 Soft Nose Cartridges 9.00 a 100
Krag Bayonets 40c each

POSTAGE EXTRA NO C. O. D. SHIPMENTS

CATALOGUE FREE ON REQUEST

W. STOKES KIRK 1627 P. M. North 10th St. Philadelphia, Penna.

I easily made



"I worked six days, six hours each day, and made \$123 quick, cash profit my first week. Have been going strong ever since—Stay-Prest is the best seller ever."

J. W. VARNER, Iowa

\$123
QUICK CASH
PROFIT FIRST
WEEK!

Startling New Invention



Folds to 15 inches

Stay-Prest

TROUSER PRESSER

Brings Big, Quick, Cash Profits in Advance

Hundreds of men and women are reaping a golden harvest of profit with this fastest selling, biggest repeating selling sensation! Your big cash profit in your pocket the minute order is taken—no waiting! Stay-Prest puts **New!** perfect crease in pants—takes out wrinkles and baggy knees—no steam—no heat—makes clothes last longer. Durably made—fully guaranteed. Every man a sure prospect—average sale **Big Profits!** takes only 8 minutes—many men order 6 or more! Send today for **FREE Super-Selling Outfit**—learns how we guarantee your sales. Start now to make \$35 to \$50 a week spare time—\$100 to \$150 a week full time **Sure Sale!**

FREE Selling Outfit

THE GETGEY-JUNG COMPANY

R 121 G-J Building

Cincinnati, Ohio



Print Your Own

Cards, stationery, circulars, tag, labels, paper. **Complete Outfits, \$8.85 up, Job Presses \$11 up, Rotary \$149, Card Cutters, \$3.** Save money. Print for others, big profits. All easy rules sent. Write for catalog presses, type, paper cards, ink etc. **THE KELSEY CO., H-37, Meriden, Conn.**

SEND NO MONEY

Genuine Full Cut Diamonds

Terms If Desired—6 Months to Pay. Outside U. S. Cash with Order.
\$25



New No. 6132

This Reg. Trade Mark guarantees you genuine diamonds.

No. 6598—Any initial (raised gold) or Eastern Star, Rebecca, Mason, Shrine, K. of C. emblem instead of initial if desired. Send number of ring, size of finger, initial or emblem desired and ring will be sent for inspection.

Ask for Free Catalog

BUFFALO JEWELRY MFG. CO.

"The Mail-Order House"

Dept. P

501 Washington St., Buffalo, N. Y.

No Chips

No. 6132—Solid Gold Men's Initial or Emblem Ring. 2 Genuine Diamonds 4-100 **\$25** each.....

14-Kt. White Gold Top. Gold Emblem (any Lodge) or any initial (Old English) yellow or white Gold, in-laid in Genuine

HOPE RUBY
Also, in Black Onyx



No. 6598

No. 6598—Ladies' Ring.... **\$15**
Genuine Black Onyx with Genuine Full Cut Diamond. 14-Kt. White Gold.

When do Men start to get young?

When they shave with Barbasol. Saves time, looks better, feels like a million. No brush. No rub-in. You just try it—three times—according to directions. 35c and 65c tubes.

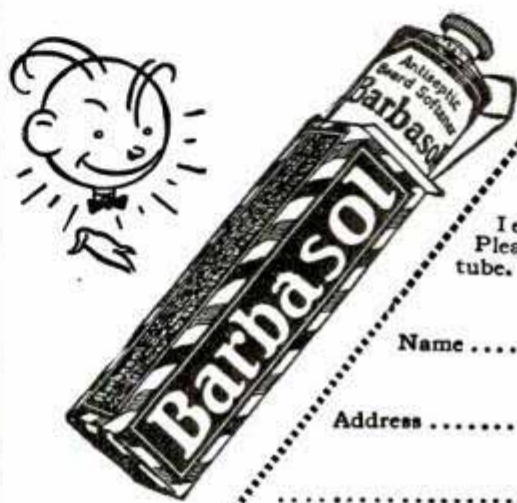

The Barbasol Co. Indianapolis Ind.

I enclose 10c. Please send trial tube.

Name

Address

P-M-10-26

For Modern Shaving

Mr. Brush Salesman

Unusual opportunity is offered for aggressive, ambitious, hustling men to sell an old established high grade guaranteed, fastest selling line of Sanitary Twisted in Wire Brushes, sold direct to the home. We have openings for experienced brush men as managers in all territories. We want live wire, energetic Go-Getters. We pay larger commissions than any other Brush House in the Country. If you want to earn some real money, it will pay you to write us immediately for our proposition.

WIRE GRIP SANITARY BRUSH CORP., 15 Mercer St., New York City

Industrial SMOKE Nuisance Ended

by wonderful devices which prevent formation of smoke in boilers, and cut down fuel consumption.

CROWN SMOKE PREVENTORS

meet the requirements of strictest smoke abatement laws. Separate system for each type of boiler. Built under supervision of the country's greatest combustion experts. Comparatively inexpensive. Send for folder S.

CROWN FUEL SAVER CO., Richmond, Ind.

Distributors Wanted—Wonderful Opportunity



PA INVENTORS.

**JUST
ACROSS
STREET
FROM
U. S. PAT.
OFFICE.**

At the right is a view of my drafting and specification offices where a large staff of experienced experts are in my constant employ. All drawings and specifications are prepared under my personal supervision.



PROTECT YOUR IDEAS Take the First Step Today

If you have a useful, practical, novel idea for any new article or for an improvement on an old one, you should communicate with a competent Registered Patent Attorney AT ONCE. Every year thousands of applications for patents are filed in the U. S. Patent Office. Frequently two or more applications are made for the same or substantially the same idea (even though the inventors may live in different sections of the country and be entirely unknown to one another). In such a case, the burden of proof rests upon the last application filed. Delays of even a few days in filing the application sometimes mean the loss of a patent. So lose no time. Get in touch with me at once by mailing the coupon on the opposite page.

Prompt, Careful, Efficient Service

This large, experienced organization devotes its entire time and attention to patent and trademark cases. Our offices are directly across the street from the U. S. Patent Office. We understand the technicalities of patent law. We know the rules and requirements of the Patent Office. We can proceed in the quickest, safest and best ways in preparing an application for a patent covering your idea. Our success has been built on the strength of careful, efficient, satisfactory service to inventors and trademark owners located in every state in the Union.

Clip this Coupon and Mail

TENTS

Write for these FREE BOOKS

NO CHARGE for Information On How to Proceed!

The booklet shown here contains valuable information relating to patent procedure that every inventor should have. And with it I will also send you my "Record of Invention" form on which you can sketch your idea and establish its date before a witness. Such evidence may later prove valuable to you. Simply mail the coupon and I will send you the booklet, and the "Record of Invention" form, together with detailed information on how to proceed and the costs involved. Do this NOW. No need to lose a minute's time. The coupon will bring you complete information entirely without charge or obligation.

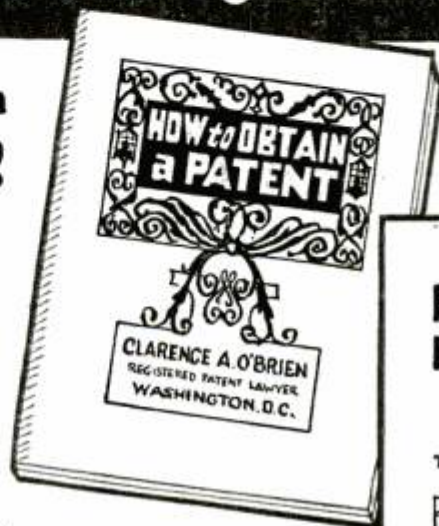

STRICT SECRECY PRESERVED

All communications, sketches, drawings, etc., are held in strictest confidence in strong, steel, fireproof files, which are accessible only to authorized members of my staff. Feel free to write me fully and frankly. Your case will have my personal attention. It is probable that I can help you. Highest references. But FIRST—clip the coupon and get my free book. Do THAT right now.

Clarence A. O'Brien

Registered Patent Attorney

Member of Bar of: Supreme Court of the United States; Court of Appeals, District of Columbia; Supreme Court, District of Columbia; United States Court of Claims

Practice confined exclusively to Patents,
Trademarks and Copyrights

FREE COUPON

CLARENCE
A. O'BRIEN

Registered
Patent Attorney

70-M Security Savings and
Commercial Bank Bldg.,
Washington, D. C.

Please send me your free book, "How to Obtain a Patent," and your "Record of Invention" form without any cost or obligation on my part.

Name.....

Address.....

(Important: Write or Print name clearly)

It Now!

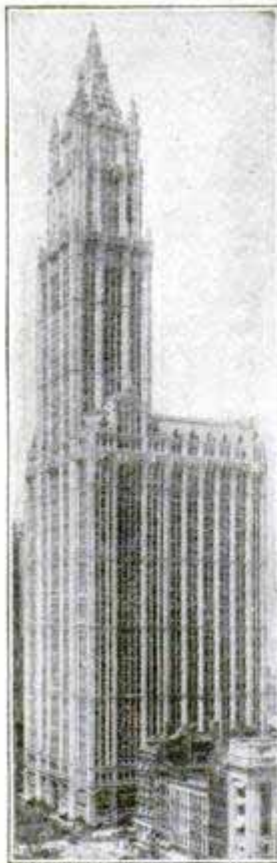

Our New York Office
Suite 1007 Woolworth Bldg.



Our Philadelphia Office
Suite 714-15 Liberty Bldg.



Our Washington Office
Victor Building

PATENTS TRADE-MARKS AND COPYRIGHTS

Have You An Idea?

Our Offer: FOR THE PROTECTION OF YOUR INVENTION YOUR FIRST STEP

Before disclosing an invention the inventor should write for our blank form

"RECORD OF INVENTION"

This should be signed and witnessed and returned to us together with model or sketch and description of the invention for INSPECTION and INSTRUCTIONS

No Charge for the Above Information

Our Four Books Mailed Free to Inventors

Our Illustrated Guide BOOK

How to Obtain a Patent

Contains full instructions regarding U. S. Patents. Our Methods, Terms, and 100 Mechanical Movements illustrated and described.

Our Trade Mark Book

Shows value and necessity of Trade Mark Protection. Information regarding *Trade Marks and unfair competition in trade.*

Our Foreign Book

We have Direct Agencies in Foreign Countries, and secure Foreign Patents in shortest time and lowest cost.

Progress of Invention

Description of World's Most Pressing Problems by Leading Scientists and Inventors.

We Regard a Satisfied Client as our best advertisement, and furnish anyone, upon request, lists of clients in any state for whom we have secured patents.

*Highest References—Prompt Attention
—Reasonable Terms*

VICTOR J. EVANS & CO.

PATENT ATTORNEYS

Main Offices: 956 9th St., N. W., Washington, D. C.

Opposite U. S. Patent Office

PATENTS TRADE-MARKS AND COPYRIGHTS

IMPORTANT

TO HAVE YOUR CASE MADE SPECIAL AND AVOID DELAY YOU SHOULD HAVE YOUR CASE MADE SPECIAL IN OUR OFFICE to secure protection, save correspondence and secure early filing date in Patent Office. To secure special preparation of your case send \$25.00 on account with model or sketch and description of invention.



MAIN OFFICE, VICTOR J. EVANS & CO.—VICTOR BUILDING, WASHINGTON, D. C.

Our Lawyers Practice in all U. S. Courts and defend Clients in Suits involving Patents, Trademarks and Copyrights

All Communications and
Data Strictly Confidential.
Interference and Infringe-
ment Suits Prosecuted

OUR ORGANIZATION OFFERS
PERSONAL SERVICE
By Experienced Patent Lawyers,
Solicitors and Draftsmen

**FREE
COUPON**

**VICTOR J. EVANS & CO.
PATENT ATTORNEYS**

NEW YORK OFFICES
1007 Woolworth Bldg.

CHICAGO OFFICES
1114 Tacoma Bldg.

PHILADELPHIA OFFICES
714-715 Liberty Bldg.

PITTSBURGH OFFICES
514 Empire Bldg.

SAN FRANCISCO OFFICES
Hobart Bldg.

MAIN OFFICES: 956 9th Street, N. W., WASHINGTON, D. C.

Gentlemen: Please send me *Free of Charge* your books as described on preceding page.

Name

Address



Our Chicago Office
Suite 1114 Tacoma Building



Our Pittsburgh Office
Suite 514 Empire Building



Our San Francisco Office
Suite 1010 Hobart Building

PATENTS

Booklet Free **Highest References**
Promptness Assured **Best Results**

Send drawing or model for preliminary examination of Patent Office records.

ALL BUSINESS GIVEN PROMPT AND PROPER ATTENTION

Listed Patent Lawyer in the latest editions of the Rand-McNally Directory of Bankers and Attorneys, of Chicago, Ill.; The Baggott & Ryall Directory of Attorneys, New York City; The Lawyers Guaranteed Directory, Detroit, Michigan; The Lawyers and Bankers Quarterly, published by the Legal Directory Publishing Company of St. Louis, Mo.; the American Lawyers Annual, Cleveland, Ohio.

WATSON E. COLEMAN,
 REGISTERED PATENT LAWYER

644 G Street, N. W., Opp. U. S. Pat. Office
WASHINGTON, D. C.

PATENTS

As one of the oldest patent firms in America we give inventors at lowest consistent charge, a service noted for results, evidenced by many well known patents of extraordinary value. *Book, Patent-Sense, free.*

LACEY & LACEY
 Established 1869
 704 F St., Washington, D. C.

INVENTIONS

WANTED! Responsible direct selling organization—operating nationally—can secure widespread distribution overnight—at no expense! We want patented articles of merit—preferably household articles or products for everyday use. Tell full details in first letter. Confidential.
PRESIDENT, 715 Apple Street, DAYTON, OHIO

Have You An Invention?

If so the WORLD PROGRESS will send you upon request sample copy Free containing SUGGESTIONS TO INVENTORS as to Inventions Needed. We invite manufacturers to address us regarding inventions they want.

Subscription for one year 60 cents

WORLD PROGRESS PUB. CO., Inc.
 Room 203 Victor Bldg WASHINGTON, D. C.

INVENTORS PROTECT YOUR IDEAS

Before disclosing your invention send for our Evidence of Invention Blank. This should be signed and witnessed and returned to us with a model or sketch and a description of your invention for our *Inspection and Instructions* which are free.

Also send for

Our guide book "**How to Get Your Patent**" which is sent free upon request. This book includes full instructions regarding U. S. Patents, Trade Marks, our Terms, Methods, etc.

WRITE TODAY

RANDOLPH & COMPANY
 300 Victor Bldg., Washington, D. C.

Please send me **FREE OF CHARGE** your Evidence of Invention blank and your guide, "**How to Get Your Patent.**"

Name.....

Street.....

City..... State.....

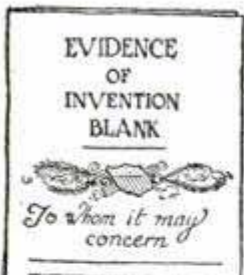

Terms
Reasonable
Best
References

RANDOLPH & CO.
 300 Victor Bldg. Washington, D. C.

U.S. PATENTS



SEND FOR THIS FORM

DON'T LOSE YOUR RIGHTS TO PATENT PROTECTION

Before disclosing your invention to anyone send for blank form "EVIDENCE OF CONCEPTION" to be signed and witnessed. A sample form together with printed instructions will show you just how to work up your evidence and establish the same before filing application for patent. As registered patent attorneys we represent hundreds of inventors all over the United States and Canada in the advancement of inventions. Our schedule of fees will be found reasonable. The form "Evidence of Conception," sample, instructions relating to obtaining of patents and schedule of fees sent upon request. Ask for them—a post card will do.

PATENTS AND TRADE MARKS

LANCASTER & ALLWINE

Registered Patent Attorneys D.C. In U. S. and Canada.

480 Ouray Bldg., WASHINGTON, D. C.
Originators of forms "Evidence of Conception."

PATENTS

To the Man with an Idea

I offer a comprehensive, experienced, efficient service for his prompt, legal protection and the development of his proposition.

Send sketch, or model and description, for advice as to cost, search through prior United States patents, etc. Preliminary advice gladly furnished without charge.

My experience and familiarity with various arts frequently enable me to accurately advise clients as to probable patentability before they go to any expense.

Booklet of valuable information and form for properly disclosing your idea free on request. Write today.

Richard B. Owen, Patent Lawyer
9-303 Owen Bldg., Washington, D.C.
41-E Park Row, New York City

TRADE-MARKS REGISTERED

PATENTS

Trade Marks, Copyrights, Patent Litigation Handbook with illustrations, 100 mechanical movements. Sent free on request.

ALBERT E. DIETERICH
formerly member examining corps U. S. Patent Office
PATENT LAWYER and SOLICITOR

621-A, Ouray Bldg.
27 Years' Experience Washington, D. C.

BLUE BOOK ON PATENTS AND PRIORITY RECORD BLANK GRATIS.

MONROE E. MILLER, PATENT LAWYER
411-2 Ouray Building, WASHINGTON, D. C.
ELECTRICAL AND MECHANICAL EXPERT

Inventors Service Reliable information on any mechanical subject \$2.00. Buying information on any article \$1.00. Engineering, drafting, patent drawings, machine and experimental work, patterns, castings, models made. All work confidential, prices reasonable. Send for further information. Prices quoted on request. TECHNICAL RESEARCH BUREAU, Dept. C, 377 National Ave., MILWAUKEE, WIS.

BOW LEGS?

OUR GARTER (Pat'd)

Makes Trousers Hang Straight

If Legs Bend In or Out. Self Adjustable.
Free Booklet—Plain Sealed Envelope

THE T. GARTER CO. Dept. 2, New London, New Hampshire

NO JOKE TO BE DEAF

—EVERY DEAF PERSON KNOWS THAT

I make myself hear, after being deaf for 25 years, with these Artificial Ear Drums. I wear them day and night. They stop head noises and ringing ears. They are perfectly comfortable. No one sees them. Write me and I will tell you a true story, how I got deaf and how I make you hear. Address



GEO. P. WAY, Artificial Ear Drum Co. (Inc.)
80 Hoffman Bldg., 2539 Woodward, Detroit, Mich.



PATENTS



Send us sketch or model for advice and exact cost of patent. Our book "How to Obtain a Patent" sent free. It tells how to apply for Patents, Trade Marks, Foreign Patents, Copyrights, etc.; gives information on Patent Procedure; tells what every inventor should know. Thousands of inventors, who are our clients, are our reference.

CHANDLEE & CHANDLEE, 25 Years' Experience
473 7th St. Washington, D. C.

PIMPLES

Cleared up—often in 24 hours. To prove you can be rid of Pimples, Blackheads, Acne Eruptions on the face or body, Barber's Itch, Eczema, Enlarged Pores, Oily or Shiny Skin, simply send me your name and address today—no cost—no obligation. **CLEAR-TONE** tried and tested in over 100,000 cases—used like toilet water—is simply magical in prompt results. You can repay the favor by telling your friends; if not, the loss is mine. **WRITE TODAY.**
E. S. GIVENS, 429 Chemical Bldg., Kansas City, Mo.

Why Men Start Failing at 40

Many men feel old at 40 because a disorder of the prostate gland brings on such symptoms as aches in back, legs and feet, sciatic pains, disturbed sleep. Medical authorities claim that nearly two-thirds of all men past a certain middle age suffer with a disordered prostate. But now, without drugs or surgery, you can reach the source of trouble with an amazing new hygiene. Full details of this simple treatment are explained in a copyrighted, illustrated book, "Why Many Men Are Old At 40." Sent Free, without obligation, while the edition lasts. Simply write or drop a postcard requesting it to The Electro Thermal Company, 2162 Main Street, Steubenville, Ohio. Western Address: Suite 21-E, 303 Van Nuys Bldg., Los Angeles, Calif.

PATENTS

TRADE MARKS • DESIGNS • FOREIGN PATENTS

MUNN & CO.

PATENT ATTORNEYS

Associated since 1846 with the Scientific American

1572 SCIENTIFIC AMERICAN BLDG.
New York City

523 SCIENTIFIC AMERICAN BLDG.
Washington, D. C.

1312 TOWER BUILDING
Chicago, Ill.

665 HOBART BUILDING
San Francisco, Cal.

520 VAN NUYS BUILDING
Los Angeles, Cal.

Books and Information on Patents and Trade Marks by Request. Associates in All Foreign Countries.

\$9 first day

Big **Nimrod** Line includes shirts of all kinds, overalls, coveralls, play suits, work pants, etc., etc.

FREE OUTFIT OFFER

Write for it—also *The Book* that makes up for the experience you might need. Gives you all information and instructions you need to start making big money.

THE NIMROD SHIRT CO.

Dept. 52, 4922-24-26-28 Lincoln Ave., CHICAGO

NIMROD



—says J. S. Shirley of Iowa. "Did \$49.79 business in less than one day" — writes H. E. DesChamps of S. D. Men without experience make big money under our instructions.

Great New Invention

For Better Health—More Power—Greater Vitality to Enjoy Life's Pleasures.



ELCO Health Generators

generate Nature's Four Greatest Curative Powers—Violet Ray, Vibration, Ozone, Medical Electricity. Leave Bad Health and Weakness Behind Forever—Revitalize Yourself—Bring Back Lost Energy—Be Wholly Alive.

20 Home Trial Treatments with Physician's Directions FREE. Quick Results—No Medicine—No Dying—No Exercise—No Drugs. AGENTS WANTED. Lindstrom & Co., 30 W. Lake St., Dept. 13-57, Chicago



Write For Free Book

The man who studies gets ahead. Popular Mechanics Press will advise you what books to read to advance in your trade. 200 East Ontario Street, Chicago, Illinois.

Information on any book free. Write Popular Mechanics Press, Chicago, Ill.

Making It Easy to Build Things!

Boice can help you build practically any job of woodwork quicker, easier and better with

Boice-Crane Bench Machines

14' Band Saw uses blades 3/16" to 1/2" wide. Saws 7' stock. Table 12' x 14' tilts 45 degrees. Bronze bearings.

Handisaw Model 2 does ripping, mitering, grooving, sanding, grinding and drilling with accurate ease. Table 10"x13". Saw 7" dia. Cuts 2 3/4" stock. Dadoes 3/8" x 3/8". Cuts moulding.

8' Bench Lathe does turning, drilling, sanding, sawing, grinding and jig sawing in wood or

soft metal. Swings 8". Capacity C. to C. 19". Metal working model has compound slide rest. All Boice machines sold with or without 1/4 to 1/2 h. p. motor, which attaches to light socket.

Send 10c stamps or coin for Boice's new 64-page booklet containing helpful information and 60 illustrations and describing the complete line of Boice-Crane circular saws, jig saws, band saws, mortisers, jointers, lathes and drills.

Send now! **W. B. & J. E. Boice, Dept. P.M. 10-B, Toledo, Ohio**

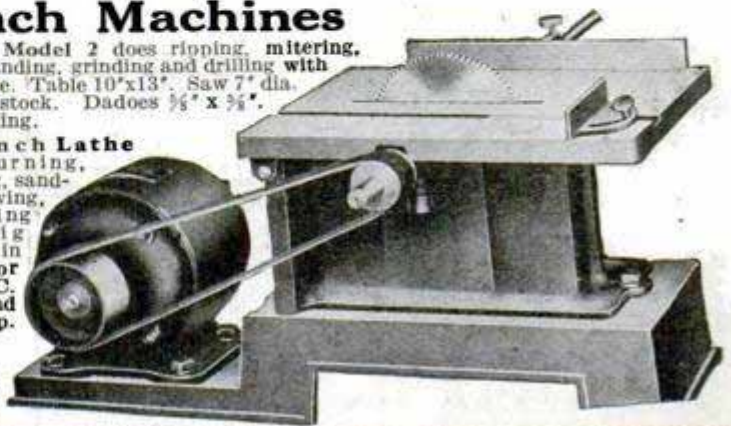

FREE

*This 84 Page
Wonder
Book of
RADIO
Bargains*



Send for this guide to Radio price and Radio quality. All of our vast resources and radio experience have been utilized to assemble for you in one gigantic institution, the best and newest things in radio. The Randolph catalog is indeed the radio market place of the world—a masterpiece of merchandising that befits our house, the largest exclusive radio mail order house in the world.

What Our Catalog Contains

Over 2,000 items—from the most beautiful, fully equipped console model radio set, down to the smallest part or tool for the set builder—kits, parts and supplies of every conceivable type and style. All beautifully illustrated and interestingly described. And to give the book added value, we have included radio data that makes it an invaluable text book for every lover of today's most fascinating and most wonderful achievement—RADIO.

Radio Sets

In this great radio market place you will find table model sets and console types with built-in loud speakers; the newest ampliphonic console sets; new Spanish period consoles; five, six, seven, and eight tube sets, with three dial, two dial, and the newest and most popular single simplified control. All sets are assembled in beautiful, genuine mahogany and walnut cabinets in a choice of latest types and designs.

5 Tube sets as low as \$24.90

Latest 1927 Models

All Randolph sets are sold at amazingly low prices. No matter what kind of set you want—no matter how little you want to pay—you can select YOUR SET AT YOUR PRICE from the Randolph catalog.

Radio Kits

Include the following well known circuits, designed and approved by the world's foremost radio engineers: Madison Moore Super; Victoreen Super; Silver Marshal Six; Sargent's Infra-dyne; Remlar Super; Short Wave Kits; 9-in-Line Super; New Acme Reflex; Cockaday; Neutrodyne; Browning-Drake; all classes of radio frequency. Super Heterodyne and every other approved popular circuit.

YOU MUST HAVE THIS BOOK

Space limitations here prevent our telling you more about the Randolph Catalog. Simply fill out and mail the coupon—or you may send a postal or letter—and this truly remarkable Radio book will come to you **ABSOLUTELY FREE.**

MAIL THE COUPON NOW.

Radio Parts and Supplies

The Randolph catalog also contains a most complete line of "B" Battery Eliminators, including the famous Raytheon Eliminators; the latest type Loud Speakers, Cone Speakers, a complete line of quality "A" power units—in fact, you will find listed in this wonder book every part that goes into the construction of a radio set, or any accessories you desire, at prices that mean a substantial saving to you.

Free Radio Service

Everyone has need for radio service. We employ Radio Engineers who have made Radio their life work. Their expert advice and helpful suggestions solve every radio problem of our customers.

Our Guarantee

Every article in our catalog is based on careful laboratory analyses and tests. We guarantee to back up every item in our catalog with our own as well as manufacturer's assurance of quality.

**Save
1/3 to 1/2**

Why We Save You Money

Because we handle radio exclusively and sell a tremendous volume of everything in Radio, we can concentrate our buying power for the benefit of your customers.

Volume purchase regulates prices. We command rock bottom prices from manufacturers, and in many cases we contract for entire factory output of exclusive products. You will benefit by our great volume of purchases and sales, by securing anything you may want in radio at a substantial saving.

This Coupon Brings the Great RADIO Book FREE

RANDOLPH RADIO CORPORATION
180 N. Union Ave., Dept. 13
Chicago, Illinois

Send me—free—your 84-page, 1927 Radio Book.

Name.....

Street and No.....

R. F. D.....Box.....

City.....State.....

Randolph Radio Corporation
180 North Union Avenue, Dept. 13, CHICAGO, ILL.

WINTER Comfort

CROWN FUEL SAVER

mixes RED HOT
OXYGEN
WITH GASES OVER
FURNACE FIRE BED.
SAVES 20% of FUEL

*Less furnace drudgery—
warm rooms—no draughts
—smaller coal bills—heat
evenly distributed.*

The saving of 20% of fuel is but one of the advantages of the Crown Fuel Saver. Users praise it for many other reasons.

One user likes the Crown because it keeps his wife from shoveling coal during his absence. This man tends the fire in the morning, and it does not have to be touched again until evening. Another user finds he can burn lower grade coal, get as much heat—and make a double money-saving.

Still other users find that the Crown does away with smoke, coal gas, and clinkers—lessens the amount of ashes—and sends a glowing warmth through every room in their houses.

It will pay you to learn about the CROWN

—indeed it will pay you to order one now, and place it on your furnace door ready to give you its benefits when the cold weather sets in. You can't lose—for we absolutely guarantee that the Crown must save at least 20% of the coal you ordinarily use—or we will refund its purchase price.

Proved by 11 years' use

The Crown fits the feed door of any furnace or boiler—home or industrial—requires no regulation as it works automatically.

Write today

for full details and special low price of Crown with money-back guarantee.

CROWN FUEL SAVER CO.

410 N. 10th St. RICHMOND, IND.

DISTRIBUTORS WANTED—Men who seek a solid business connection and a steady income, write today. Wonderful opportunity as there is a Crown Fuel Saver or a Smoke Preventer to meet the needs of any heat producing plant from the parlor Arcola to the largest power plant.

Get These Coils!

T. R. F. Kit
List \$12.00



—and greatly improve the
performance of your set!

The Aero Coils composing this kit are extremely supersensitive, due to the fact that they have a much lower high frequency resistance than other types of inductances.

The use of Aero Coils in place of other inductances has never failed to improve set performance. They prove their supersensitivity by tremendously increasing power, by improving quality of tone, and by their extreme selectivity.

If you would obtain best results from any circuit, be sure to use Aero Coils. Order from your dealer or direct from us.

Big 8 page 4 colored layout system (actual size blue prints) and complete instructions for building the Aerodyne Receiver free with each kit.

AERO PRODUCTS, Inc.

Dept. 107, 1772 Wilson Ave., Chicago, Ill.

25¢ CLASS FREE PINS CATALOG 25¢
Design shown made with any equal amount lettering, 2 colors enamel, BASTIAN BROS. CO. 728 Bastian Bldg. Rochester, N. Y.
Silver Plate 25¢ ea; \$2.75 doz. Sterling silver 40¢ ea; \$4.00 doz.

Radio Blueprints

Blueprints for the most popular sets described in Popular Mechanics Magazine can be obtained for a charge just sufficient to cover the cost of production and mailing. The sets for which blueprints are available are:

Simple One-Tube Receiver	April 1926	15c
One-Tube Pocket Receiver	July 1925	10c
Two-Tube Loud Speaker Set	May 1925	10c
Three-Tube Cockaday Receiver	April 1925	10c
Three-Tube Low-Loss Short Wave Set	Oct. 1925	10c
Four-Tube Loop Set	Aug. 1925	10c
Four-Tube Portable Loop Set	Aug. 1926	15c
Five-Tube No-Battery Set	July 1925	10c
Five-Tube Browning-Drake Receiver	May 1926	15c
Six-Tube Self-contained Receiver	July 1925	10c
Six-Tube Perfect-Tone Receiver	Nov. 1925	10c
Six-Tube Counterphase Receiver	Feb. 1926	15c
Six-Tube Portable Loop Set	June 1926	15c
Eight-Tube Superheterodyne 1927 Model	Oct. 1926	75c
Set of blueprints including drilling templates		
B-Battery Eliminator	Mar. 1926	15c
Non-Radiating Unit	May 1926	15c
Simple Tube-Tester and Chart	July 1926	15c

Address the RADIO DEPT.
Popular Mechanics Magazine
200 E. Ontario St., CHICAGO

Back numbers of the magazines describing the construction of the sets can be obtained from our Circulation Department, price 25 cents each.

Easy to Solder

This New Way

Indispensable
for all soldering
work. Simple
—Speedy—
Economical.

3.75

Complete

Press-to-Feed Electric Soldering Iron

One hand does the work of two. Speeds up radio set construction. Simplifies all kinds of soldering work. Far better than a blow torch. Solder will not melt until it reaches Soldering Point. Porcelain insulation prevents heat from entering handle.

AGENTS—DEALERS—JOBBER

This newly invented electric soldering iron offers big money making opportunity. Order a sample today \$3.75. Discounts in quantities on request. Write to

ILLINOIS STAMPING & MFG. CO.
220 N. Jefferson St., Dept. 17, CHICAGO



Pioneers in the Radio Industry



KESTER

READY TO USE

METAL MENDER

The Household Solder

Here's why thousands use Kester Metal Mender.
Simple—Requires Only Heat! Anyone can use it.
Safe—No messy pots or dangerous acids.
Sure—Genuine Solder makes firm metal joints.
Satisfactory—Works equally well on light or heavy, old or new work.
Economical—Saves many times its price.
Your Dealer Can Supply You

Soldering
Booklet
"It's a
Cinch to
Solder"
Upon
Request



CHICAGO SOLDER COMPANY
4201-335 Wrightwood Ave., Chicago, U.S.A.

The Tower Cone

A Remarkable Achievement
in Quality and Price!

DUE to its original and exceptionally ingenious design, the Tower Cone is setting a new and better standard in radio reproduction — approximated only by the most expensive speakers. Its refreshing naturalness of tone, with greatly increased volume, creates an entirely new conception of the capabilities of ANY receiver.

Ask Your Dealer to Show You the exclusive Tower features. On Sale from Coast to Coast.

TOWER MFG. CORP. **\$9.50**
BOSTON, MASS.



Tires Hammered Full of NAILS LEAK NO AIR



AGENTS MAKE \$5,000 to \$10,000 A YEAR

MAKE YOUR TIRES PUNCTURE-PROOF In ONE Minute

Galacite The new scientific invention—has the marvelous property of sealing all punctures the moment they occur. ACTS INSTANTLY. You can pick up any number of nails WHILE RIDING without the loss of a pound of air. One application, made in a minute, without taking tire off wheel or rim, actually makes tire puncture-proof for life. Guaranteed not to injure tire, tube or valve. On the contrary Galacite preserves rubber, lengthening the life of both tube and tire,—

Often Increasing Tire Mileage from 10,000 to 12,000 Miles
MAKE THIS TEST Take a hammer and drive as many nails into a tire as you wish, 10, 50, 100, it makes no difference; all punctures are sealed instantly. Used in all kinds of tires including low pressure BALLOONS. Galacite is inexpensive and can be tried out at our risk. Warranted for one year but will last indefinitely.

GUARANTEED TO DO ALL WE CLAIM

Don't confuse Galacite with anything else ever intended for the same purpose; it is new and different—a revolutionary invention, the result of years of research and experiment. We are a long established highly rated concern. Galacite is backed by our Money Back Guarantee. It must make good—or we will. *You take no risk.*

AGENTS—Earn \$5,000 to \$10,000 a Year

TREMENDOUS PROFITS Galacite agents make almost unbelievable success. A NAIL DRIVING demonstration does the selling. No lengthy arguments. Demonstrate and sell to car owners, Garages, Filling Stations. Work all or spare time in your home town or travel. You can also manufacture and sell GALACITE PUNCTURE PROOF inner tubes. *The market for Galacite is inexhaustible.* EXCLUSIVE territory and splendid FREE ADVERTISING HELPS make your business permanent. RUSH your name to us for full particulars. TERRITORY IS GOING FAST. Delay may cost you the chance to make \$5,000 to \$10,000 a year. Send no money, just your name, but **WRITE TODAY.**

C.F. JOHNSON & CO. 19W. Jackson Blvd., Dept. 377 CHICAGO

"GALACITE" Trade Mark Registered
 Licensed under Folmir-Hewitt Process

AGENTS MAKE BIG MONEY SELL FIBRE BROOMS

A Customer in every Home. 100% Profit on every Sale. Write for Free Sample. **National Fibre Broom Co., St. Louis, Mo.**

NEW VEST POCKET ADDING MACHINE

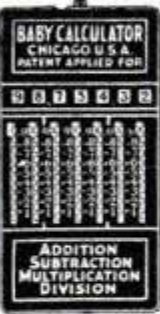

ADDS, SUBTRACTS, MULTIPLIES, DIVIDES
 Does work of \$300 machine. Guaranteed 5 years. NOT A TOY.
 Made of steel and indestructible. Million dollar capacity. Fits in pocket. Will not make mistakes. So simple child can operate it. Everybody should carry one for figuring.

FREE TRIAL \$2.50 Total Cost

SEND NO MONEY—Just name and address. We will ship Calculator immediately. On delivery pay postman \$2.50 (Plus few cents Postage). (If outside U. S. send cash). If not satisfied after 10 day trial you get your money back. THOUSANDS OF SATISFIED USERS. This is lowest priced practical calculator made. "Why pay more for inferior imitations?" Order from this ad.

-----Mail Coupon Today-----

BABY CALCULATOR SALES COMPANY
 Dept. 41, P. O. Box 1118, CHICAGO, ILL., U. S. A.

- I am enclosing \$2.50—send adding machine prepaid.
- Send Adding Machine C. O. D. \$2.50 plus postage.

Name.....
 Address.....
 City..... State.....

AGENTS Write for big commission and territory proposition.

Agents—Here It Is

The New Serenola Something new and different. Wonderful loud tone. Sells easily and quickly. Meets every demand. Low priced. Taking the country by storm. Carried with you anywhere. Built in just like a suit case. Fully guaranteed.



\$84 to \$126 a Week Extra Bonus Besides

The fastest selling musical invention known. Beats Radio. You book the orders. We deliver and collect. Pay you daily in advance. No experience needed. Exclusive territory given. Part time brings \$3 an hour. Write for sample.

PERRY LUDLOW CO., S- 231 Dayton, Ohio

RADIO BOOK FREE

Tells how you can make big money in world's newest and greatest field. Presents lifetime opportunity in Radio. Right now we want live agents and dealers in every locality, \$60 to \$100 a week easy.

40% TO 60% PROFIT

FREE Simply send name for this big illustrated book explaining liberal profit proposition and how to get latest radio goods at wholesale. Also prices on parts, sets and accessories and amazing special offers—all free. Write today.

STANDARD RADIO CO. 1402 Walnut Street KANSAS CITY, MO.



5 Tube Set
 only \$39.50 RETAIL

Home
No. 616
5 Rooms
Materials
\$1511.00



Buy Your Home Direct From Mill!

You can buy at wholesale prices just the home you want, and save \$200 to \$2,000. Materials shipped direct from mill to your station.

Ready-Cut Enables You to Do Own Building

Studs, joists, rafters and sheathing cut and fitted at mill. Plans so easy to follow and material so accurately cut, many buyers put up own houses. Save in both labor and lumber.

Send For Book of 200 Plans!

Through the Gordon-Van Tine system we furnish complete plans, architectural service, lumber and building material shipped direct to you from our forest mills. Many built-in

conveniences to save steps and lighten house-work. Homes planned for utmost comfort and beauty. Over 200,000 customers. Many write we save them up to \$2000.

Shows photos, floor-plans, prices of town and country homes. 144 pages.

Send Us Your Bills to Figure We carry largest stocks of lumber, mill-work and building material in the country. Send us your bills and we will figure them free at wholesale prices.

Gordon-Van Tine Co.

ESTABLISHED 1868

Satisfaction Guaranteed or Money Back
842 Case Street DAVENPORT, IOWA

Garages \$89 UP
Build it yourself. Material Ready-Cut.

CLIP COUPON OR SEND POSTCARD

Write!

Gordon Van-Tine Co.
842 Case St., Davenport, Iowa
I am interested and expect to

- Build a.....
- Repair a.....
- Send me proper catalog.

Name.....

Address.....



Lighting Fixtures
READY TO HANG
(Direct from the Manufacturer)
Completely wired, including glassware. Send for New Catalogue No. 27. Just reduced prices.
Special proposition to DEALERS.
ERIE FIXTURE SUPPLY CO.
STA. A ERIE, PA.

AGENTS Some Seller At **\$2.00**
Looks Like \$5.00 Worth Gives You \$1.00 Profit!

With Our Great Introductory Offer
Giving These \$1.25 Dress-Making Shears **FREE**



With each sale of our wonderful 11 piece Toilet Article Assortment for only \$2.00. Total Store Value \$4.60



MY! HOW THEY SELL!

You get the attention with the free Shears. Walter Harris sold 800 boxes in six weeks. Profit over \$100 a week. You can do this too.
ACT NOW! Sell like hot cakes year round. A baby could sell Lucky 11. Don't wait a minute. Save time. Send \$1.75 for complete outfit including display case. At least write for circulars explaining our **unique plans**, including 30 other packages.
E. M. DAVIS CO., Dept. 5646, CHICAGO, ILL.

HEAT Without Coal!

Amazing new invention does away with coal or wood. The New International Oil Burner is the first inexpensive oil burning device for homes with low operating cost; sets in fire-box of any stove or furnace; transforms oil into Instant-Gas which burns without waste. Gives three times the heat of coal and cheaper. Better cooking and baking. Installed in a few minutes; no damage to stove or furnace. Over 60,000 users. Sold on money-back guarantee. Write today for 30 day free trial offer. Specify whether for stove or furnace



SPARE TIME AGENTS: WE PAY \$60.00 A WEEK

Men and women wanted as local agents to demonstrate and take orders for this wonderful invention. Experience unnecessary. Write quick for free sample offer and free book "Scientific Oil Burning."



We Can Use Your Spare Time
Write for \$60 a week spare-time plan to first users in locality.

INTERNATIONAL HEATING COMPANY
DEPT. 37-K 3324 LOCUST, ST. LOUIS, MO.

This Most Modern LOG SAW

Saws 15 to 25 Cords a Day

MANY of our customers saw 25 cords a day with a WITTE One-Man Log Saw. One man felled fifty 18-inch trees in 5 hours. Another says: "My WITTE goes anywhere and saws more wood than forty able-bodied men could with hand saws." One man made \$500.00 the first season in hilly country. Another sawed sixty cords in two days at a cost of \$1.85—showed a profit of over \$200. Still another says: "Far cheaper than hired help."



WITTE Log and Tree Saw

makes you money, rain or shine. Has long, clean, "arm-swing" stroke. Steady running, fastest and most dependable. Cannot bind or clog, blade won't "whip or ride." Simplest and easiest to operate, yet trouble proof. Makes any cut you want—merely turn a screw to change speed. Easily moved from place to place. Weighs only 38 pounds at the handles.

Burns Kerosene, Gasoline, Gas, Gas-Oil or Distillate

Cheapest to operate—runs all day at cost of 2c an hour per H-P. Burns any fuel with a big surplus of power for any work. USE IT FOR OTHER WORK. Completely equipped with WICO Magneto, speed and power regulator, throttling governor and 2 flywheels so can be used for any other jobs—pumping water, grinding grain, etc.—an all-purpose outfit that will work every day in the year.

The WITTE Throttling Governor Engine is in use all over the world. For 40 years it has been known as the standard of farm power. More than 150,000 in use, always giving satisfaction. Buy on your own terms. **No Interest Charges.**

WRITE TODAY for Our FREE Book

or ask about our 1½ to 30 H-P. Engines, 3-in-1 Saw Rigs or Pump Outfits if interested. No obligation.



Only 3 minutes to change from log saw to tree saw—10 seconds to clamp to tree. Fastest felling ever known. Fells trees from any position—clear down level with the ground.

WICO Magneto

Equipped with famous WICO Magneto—the most perfect ignition known. Sure performance in any climate or temperature—40 below zero or 100 in the shade—not affected by oil or water. The WITTE Log Saw could go through a flood and "work like a charm" instantly. Starts Easy at 40 degrees below zero.

WITTE ENGINE WORKS

6748 Witte Bldg., Kansas City, Mo.
6748 Empire Bldg., Pittsburgh, Pa.
6748 Witte Bldg., San Francisco, Cal.

Quick shipments also made from nearest of these warehouses: Minneapolis, Minn., Atlanta, Ga., Trenton, N. J., Richmond, Va., Tampa, Fla., New Orleans, La., Dallas, Tex., Laredo, Tex., Denver, Colo., Billings, Mont., New York, N. Y., Albany, N. Y., Bangor, Me., Portland, Ore., and Los Angeles, Calif.

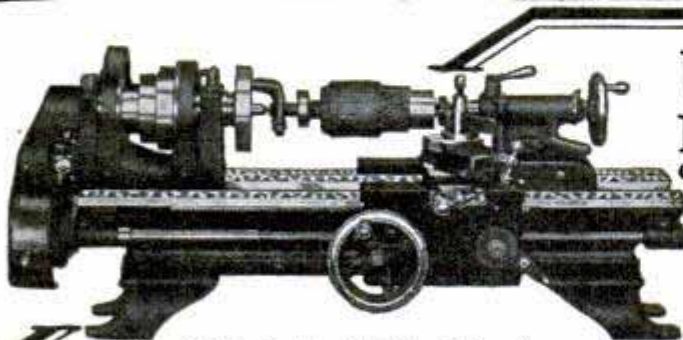

The 9-Inch South Bend Junior

A Practical Back Geared Screw Cutting Bench Lathe

Shipping weight, 350 lbs.; distance between centers, 18 in.; width of cone belt, 1 in.; length of bed, 3 ft.; power required, ¼ H. P.

SOUTH BEND LATHE WORKS, 814 East Madison Street, South Bend, Indiana

Unusual Value In 9-Inch LATHE

\$150

Complete with Countershaft and Equipment

Here is a Back Geared Screw Cutting Bench Lathe that will meet practically every need in your shop. It is a quality Lathe throughout. In fact, the Compound Rest, Back Gearing, Lead Screw, Head Stock and Tail Stock are exactly the same in design, quality and workmanship as on our finest

SOUTH BEND LATHES

With this one tool you can turn Commutators, undercut Mica, make bronze Bushings, reface Valves, finish semi-machined or oversize Pistons, cut Threads, do turning, boring, drilling, polishing, filing and hundreds of other jobs. Why not put in the one tool that does all? Write for Folder No. 22-J on the South Bend 9-inch Junior Special. *Easy Payments if Desired.*

What I Will Do!

Yes, only \$1 will bring your choice of these Big Bargains for your approval and 15 DAY TRIAL. Simply pin \$1 bill to this ad, indicate your selection and mail it TODAY. If you can duplicate your selection for less money elsewhere, send it back and your \$1 will be refunded. If satisfied, pay balance in 10 equal monthly payments. NO RED TAPE—PROMPT DELIVERY. DEALINGS CONFIDENTIAL.

B80--Ladies 18K White-Gold Ring; beautifully designed. AA 1 Blue-white Diamond. \$50 \$4.90 a Month.

B81--Ladies hand-engraved 18K White Gold Birthstone Ring set with 2 Blue-white Diamonds. Any birthstone furnished. \$25. \$2.40 a Month.

B82--Ladies hand-carved 18K White Gold ring, with 3 Blue-white Diamonds. \$45. \$4.40 a month.

B83--Gents 14K Solid Gold hand-engraved Ring with AA1 Blue-white Diamond set in White Gold square-top \$42.50. \$4.15 a Month.

B84--14K White Gold Wrist Watch: 4 Blue, white Diamonds; 4 Blue Sapphires. Guaranteed 15 Jewel movement. \$42.50. \$4.15 a Month.

B85--Famous Bulova Gents Strap Watch 14K Gold filled case; guaranteed 15 Jewel movement. \$28.50. \$2.75 a Month.

B86--12 size 21 Jewel Illinois Victor Watch; 14K Green Gold filled case. Price \$45. \$4.40 a Month



3000 Big Bargains in Diamonds, Watches and Jewelry shown in this catalog. Send for it Today—it's FREE.

L.W. SWEET Inc.
DEPT. 66-R 1660 BROADWAY NEW YORK

30 Days' Free Trial

Select from 44 Styles, colors and sizes, famous **Ranger** bicycles. Delivered free on approval, express prepaid, at **Factory Prices**. You can easily save \$10 to \$25 on your bicycle. Prices \$21.50 and up. \$5 a Month on any Ranger. If desired, Parents often advance first deposit. Boys and girls can easily earn small monthly payments. Pay as you ride, best quality, at factory prices, express prepaid. Tires, Lamps, wheels and equipment, low prices. Send No Money, do business direct with makers.



Mead CYCLE COMPANY
DEPT. T-109 CHICAGO

Write today for free Ranger Catalog, Inc. factory prices and marvelous easy payment terms

"Best Pen I Ever Had—and costs less!"

That's what users of the Postal say. New filling method—easiest ever devised. Holds 4 times usual amount of ink. Transparent (always know how much ink you've got!). Unbreakable. Only \$2.50! Sent C. O. D. Order now and try it! Money back if you don't like it. **Postal Pen Co., Inc., Dept. P. M. 10, 25 W. 43rd St., New York City**

\$10 to \$20 A DAY!



If you want to make \$10 to \$20 a day, write at once. We need representatives everywhere for Mason Shoes. Neither experience nor capital required. Just take orders. Many Mason Salesmen make \$100 to \$150 weekly.

Get FREE Sales Outfit

Mason Shoes for men, women and children are sold direct from factory. Amazing values. Finest leather throughout. Expert workmanship. Several exclusive features insure styles, better fit, comfort and longer wear. Prices half of what customers pay at stores. That's why orders come quickly—why Smith cleared \$60 in a day, and St. Amour made \$600 in one month. Send for FREE outfit and begin to make the same big money. Dept. A-10, 124 Mason Ave. **MASON SHOE MFG. CO. CHIPPEWA FALLS, WISC.**



Penalize unruly hair—

Train it to stay in place—all day!
Try this dressing—FREE

Off-side! . . . Penalized five yards . . .

Penalize your unruly hair!—it's off-side most of the time. Out of place, straggly-looking—an hour after you brush it.

Stop experimenting with your hair! Start now to use the dressing more fellows rely on than any other. *This dressing is Stacomb.*

No matter how you wear your hair, Stacomb will keep it that way—until further notice!

Yet Stacomb never leaves your hair sticky-looking nor greasy. Nor dry and brittle—an easy prey to dandruff—as daily wetting with water makes it. Stacomb is actually beneficial, since it helps to prevent dandruff.

And whether you prefer the combing cream (in jars and tubes) or the new Liquid Stacomb, you will find that both forms are equally pleasant to use and either one will really keep your hair in place. At all drug and department stores.

FREE OFFER — Stacomb

Standard Laboratories, Inc.,
Dept. BB-2, 113 W. 18th Street, New York

Send me free sample of Stacomb as checked:
Original, cream form New liquid form

Name

Address

Do Wonderful Chemical Tricks and Experiments with CHEMCRAFT Junior!



Make your own ink, dye cloth, test water and soil, and learn about Chemistry. Surprise and puzzle your friends with Magic Chemical tricks; write secret letters with invisible ink; pour blue, brown and black liquid from a glass of water; make a magic pitcher of blueing; make your own magic writing paper. It's all easy if you have CHEMCRAFT JUNIOR. Order right away and get a FREE copy of The Chemcraft Chemist magazine; full of interesting chemical information, experiments, pictures and news from club members. You'll like it. Be sure to send today.



ONLY 50¢ POSTPAID

The Porter Chemical Co.,
113 Summit Ave. Hagerstown, Md.

FINEST QUALITY GENUINE DIAMONDS

CASH OR CREDIT
SATISFACTION GUARANTEED OR MONEY REFUNDED

Our values are unexcelled—prove it for yourself by investigation and comparison. Blue-white Diamonds of dazzling brilliance and colorful fire, in latest style ring mountings. Priced especially low for quick selling—order now!

Every ring sent in handsome gift box.

No. 841 \$143.75 \$3.25 per wk.
No. 27 \$97.50 \$2.50 per wk.
No. 831 \$97.50 \$2.50 per wk.
No. 28 \$37.50 \$1.00 per wk.
No. 12 \$48.75 \$1.25 per wk.

Send for Free Catalog

Write now for our big Diamond Book—absolutely free! Fully illustrates Diamonds, Watches, Silverware, Toilet Sets and Gift Novelties.

All goods delivered on payment of one-tenth purchase price. Balance weekly, semi-monthly, or monthly as convenient.



WEDDING RINGS

No. 824—The "Elite" 18-K white gold, \$7.50. Set with 3 Diamonds, \$22.50; 5 Diamonds, \$32.50; 7 Diamonds, \$42.50; 9 Diamonds, \$52.50; 12 Diamonds, \$67.50. All Platinum, \$25 up. With 3 Diamonds, \$50; 5 Diamonds, \$70; 7 Diamonds, \$80; 9 Diamonds, \$100; surrounded by Diamonds, \$200.



WRIST WATCH No. 839
11-K white gold hand engraved case. Fancy wing ends. Silver dial. High grade 15-Jewel movement, \$25. \$2.50 down and \$1.00 a week.

Railroad Watches—Guaranteed to Pass Inspection

- HAMILTON No. 992. 21 Jewels, Adjusted to 5 Positions. Gold filled 25-Year Case \$55
- ELGIN'S LATEST RAYMOND. 21 Jewels, 8 Adjustments. Runs 40 hours one winding. Gold filled 20-Year Case \$55
- ILLINOIS "BUNN SPECIAL". 21 Jewels, Adjusted to 6 Positions. Gold filled 25-Year Case \$50
- HOWARD RAILROAD WATCH. 21 Jewels, 8 Adjustments, 25-Year Gold filled Case \$80

Railroad Watches sold on our regular credit terms.



LOFTIS The National BROS. & CO. Jewelers
DEPT. E-894

108 N. State Street, Chicago, Ill.
Stores in Leading Cities

17-Jewel ELGIN No. 15
Green gold. Elgin Watch. 25-year quality case. 12 jewel gilt dial. \$30. \$3 down \$1 a week

FREE New Catalog Just Out

Shows over 30 items with photos

To give an idea of this illustrated, twenty-four-page catalog, here is a partial list:

Hunting Boots, Leather Caps, Suits for Deer and Duck Hunting, Rain Suits, Duffle Bags, etc. Write Mr. L. L. Bean, Dept. 21, Freeport, Me. and be surprised at the many delightful necessities he offers.

Information on any book free. Write Popular Mechanics Press, Chicago, Ill.



Kingsbury Aerial Ladder Truck, No. 259, 34 ft. long, \$12. (West of Miss. slightly higher.)

Come Put Out the Fire!

Hear the gong as you roll your truck down the street! Turn the crank and see the ladder rear up. Turn the revolving platform around and the ladder points where you want. See the bright red enamel frame and hood, the shiny nickel serial ladder, the solid rubber tires vulcanized to the wheels. A detachable handle steers while drawing—no scratched furniture. Write for Free Catalog, describing this and other Kingsbury toys. KINGSBURY MANUFACTURING CO., 83 Myrtle St., Keene, N. H.

KINGSBURY

MOTOR DRIVEN TOYS

Invents New Saxophone Easier to Play

A startling new invention that makes learning the saxophone much easier, according to teachers, has been perfected by one of the oldest musical instrument houses in the country, the York Band Instrument Co., 126-J Division Ave., Grand Rapids, Mich. A remarkable change in tone hole construction eliminates the necessity of excessive blowing, banishes flat, quavering notes and gives only full-rounded tones of amazing richness even to the beginner. Now, if ever, is the time to learn the saxophone. This superior saxophone costs no more than ordinary quality instruments. You can take ten months to pay. Send for FREE CATALOG of York saxophone and other musical instruments. Act now, and see for yourself how easy you can now learn to play.

NEW MAGNETIC DISCOVERY BUILDS HEALTH



An electro-magnetic appliance has been perfected that builds robust health and vitality. This appliance, known as the Vit-O-Net Electro-Magnetic Blanket, eliminates poisons, relieves pain and promotes rest and sleep. Dissolves congestions responsible for many ailments. Endorsed and used by hundreds of physicians and hospitals. Successfully used for such cases as Rheumatism, Nervousness, Neuritis, Blood Pressure, Catarrh, Kidney troubles, etc. The manufacturers will send free to any one interested, copy of Health Document revealing valuable health secrets. Write to Vit-O-Net Mfg. Co., Desk 5106, 4105 Ravenswood Avenue, Chicago, Illinois. Representatives wanted.

MOVIES



We'll swap you your name and address for our catalogue on the greatest real home MOVIE-MACHINES in the world with dazzling models as low as \$3.75 postpaid. And say folks! We've also got the slickest regulation film at ridiculously low prices—and we don't have to tell you our films are the best. Let's not miss this opportunity — Write TODAY—NOW

PARAMOUNT MFG. COMPANY
Dept. MC Boston, Mass., U. S. A



BUILD SHIP MODELS!

Easy to build and sell. Plans and instructions: "Santa Maria" \$1.02—Viking Galley, 42c—Magellan's "Victoria" 77c—Hudson's "Half Moon," 92c—Cipper Ship, 82c—or all for \$3.75.

SEA ARTS GUILD, 405A Eleventh Ave., Milwaukee, Wis.

El Diablo RAZOR STEEL

A Genuine \$2 Knife for \$1.18 Postpaid
Handy shaped Blade makes this knife best for mechanics, sportsmen and farmers; light but strong; re-sharpened easily. Stag handle. German silver finish; blades file tested, hand forged from razor steel and warranted.

No. 57

Direct at Factory Prices

Sample \$1.18 3 for \$3.00 Postpaid

Hand Forged Razor Steel Blades

Send for our 100-page FREE List and "HOW TO USE A RAZOR."

Maher & Grosh Co.
106 A St., Toledo, Ohio

DEALERS GARAGEMEN

Used Car Dealers
Car Wreckers
Auto Supply Stores
Fleet Owners
Repair Shops



GET OUR BIG 80-PAGE CATALOG

Everything listed at cut prices—less than regular wholesale. Quantity purchases make our low prices possible. Nationally advertised products. All new except where specified—Timken Axles and Bearings—Standard Timing Gears—Brown-Lipe Transmissions—Pistons—Rings—Hayes and Firestone Wheels—Rims—Tires—Tubes—also a complete line of Accessories.

Write for our big new 80-page Wholesale Catalog today!

WARSHAWSKY & CO.

World's Largest Replacement Parts House
1915-35 So. State St., Dept. PM-10, CHICAGO, ILL.



Write
Quick
for
Details

\$25.⁰⁰ a DAY-CLEAR

SURFACING FLOORS

Scores of inexperienced men whom we started as American Universal Floor Surfacing Contractors are making up to \$10,000 a year in this wonderful, new, uncrowded field. Electrically driven American Universal Machines do 500% more work and 100% better work than most expert hand scraper, and earn six men's pay. Work is plentiful, fascinating, immensely profitable. Experience unnecessary. Small amount starts you. We furnish everything, teach you, help you succeed. Opportunity of lifetime to be your own boss and make big money.

AMERICAN FLOOR SURFACING MACHINE CO.
523 So. St. Clair St. TOLEDO, OHIO



M-m-m! TENDER STEAK

Meat Tenderer
Mince Knife
Cleaver
Ice Tool
Food Chopper
Fish Scaler
Nut Crumbler

Ideal Fiber Cutter tenders meat to juicy tastiness. Housewives all say, "Just what I want." Tested and Approved by Good Housekeeping Institute. Two minute demonstration sells it.

AGENTS • Year 'Round Seller
This handy kitchen aid has no dull season. Needed every day. 100 per cent Profit. Agents make \$8 to \$20 a day. **Boorem, Pa., writes, "Made \$25 clear profit today."** You can do as well. Work spare or full time. Our time-tested sales plan shows you how. Write for details at once.

THE TYLER MFG. CO., Dept. M-6, Muncie, Ind.

Protect Your Feet



For men who are on their feet all day, or who want real comfort for sensitive feet—our Foot Protection Bureau unqualifiedly recommends the HERMAN Police Shoe No. 19. It is made to the specifications of the New York City Police Department—and is endorsed for comfort and foot-protection by doctors and specialists all over the country.

Its genuine Munson last, built-in leather arch-support and water-proof storm-welt makes it an unsurpassed extra-service comfort shoe. And the fine gunmetal leather adds the final touch of dress and style.

Write for new illustrated booklet showing the full HERMAN line of Dress and Service Shoes.

Joseph M. Herman Shoe Co.

Dept. 34 MILLIS, MASS.

Makers of over 4,000,000 pairs of shoes for the U. S. Government.
Makers of Herman Official Boy Scout Shoe

HERMAN POLICE SHOE

MOTORCYCLES



Used and Rebuilt Indian, Harley-Davidson, Ace, Henderson and Cleveland motorcycles at a saving of 50%. Send for our latest list.

"Motorcycles shipped to all parts of the world."

WALKER-INDIAN CO., 188 Mass. Ave., BOSTON

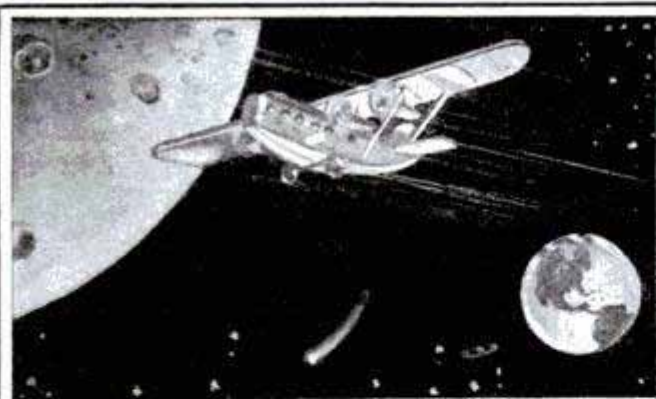

Will we fly to the Moon in 1986?

WHO knows! Even now, someone may be developing a new type of machine that will fly to the moon! Some day people will ride in 'planes as they do now in automobiles. Find out how these marvelous machines are built, and how they fly; learn the principles of aviation.

Build a Flying Model Airplane. See how the body and wings are made and covered; how the different sections are joined together. Fly your Model in the air under its own power and you'll see how big machines "take off" and land. It's an instructive and interesting science for every man and boy.

Ideal Plans (Drawn-to-Scale) and Building-Flying Instructions show you how to Build and Fly accurate 3-ft. Models of any of the following Famous Airplanes. **Anybody can build one.** Send now for the set you want.

J N Type—Curtiss Training Plane
D H Type—DeHavilland World Flyer
N C 4—Naval Seaplane
Bleriot, Nieuport or Taube Monoplane
Cecil Peell Racer

Plans and Instructions

25¢

per set postpaid
 7 sets \$1.25

This is the J N 4 D-2

Curtiss Training Plane

Complete Construction Outfit contains everything needed to build this 3 ft. Model: rubber tire disc wheels, carved propeller, formed ribs, etc. including full plans and instruction. Complete Outfit..... Postpaid

\$7.00

Catalog of Model Airplanes, Parts and Supplies, 48 pp. . . 5¢



Ideal Aeroplane & Supply Co.

408 West Broadway

New York

Art Corner Your Pictures—Album

where you can keep them safe and enjoy them always.



5 Styles **Art Corners** 5 Colors

are on sale at Photo Supply and Album counters everywhere. They are the only Quick, Easy, Artistic, No Paste, No Fold way to mount Kodak Prints. A dime brings 100 and 7 samples to try. Write

10¢ Buys

ENGEL MFG. CO.
 100 Dept. 80K, 4711 N. Clark St., Chicago



AGENTS EVERY AUTOIST WILL BUY

AUTO MITTEN DUSTERS

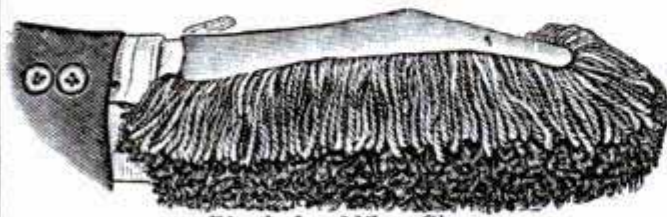

Fits the hand like a Glove

Chemically treated yarn MITTEN DUSTER, for auto and home use. Dusts, Cleans and Polishes. Agents are Cleaning Up Big. Costs you 25c each in gross lots, sells for 75c. Sample and selling instructions Postpaid 50c.

Send for Free Details and Sample Case Offer

NATIONAL FIBRE BROOM CO., ST. LOUIS, MO.



SHALER 5 MINUTE VULCANIZER

Clamp on a Patch and Light the Fuel!

Easiest Way to Fix Punctures

Fixing punctures is an easy, sure job with the handy little Shaler 5-Minute Vulcanizer. When the emergency comes, no matter where you are, simply clamp a Unit over the puncture with the Shaler Clamp, and light the solid fuel.

In five minutes unscrew the clamp, take off the Unit and throw it away. That's all. The repair is part of the tube—vulcanized (HEAT-WELDED). That's why nearly five million motorists use it.

Get the complete outfit for your car today for only \$1.50 wherever auto supplies are sold. Slightly higher in Canada and far West.

C. A. SHALER CO.

2710 Fourth Street

WAUPUN, WIS.



\$100 to \$125 PROFITS WEEKLY

New line of quality toilet goods sells like wildfire. No experience required. All you do is take orders from this beautiful sample case. Finest perfumes, soaps, facial creams, bath salts, face powders—wonderful products at prices that appeal to all women. Just send name and address for FREE CATALOG.

NATIONAL SOAP & PERFUME CO.
 512 W. Huron St. Dept. A-10 CHICAGO

WHITE FLAME

BURNERS make your old kerosene lamps and lanterns give a brilliant white light better than electricity or gas. Doubles your light. Saves oil. **NO MANTLE TO BREAK.** Guaranteed Safe and Reliable. Delights every user. Send now for complete sample postpaid 50 cents, stamps or coin, 3 for \$1.25. Money Back if Not Satisfactory. Live Representatives Wanted. Exclusive Territory. **WHITE FLAME LIGHT CO., 68 Clark Bldg. Grand Rapids, Mich.**



Next Month! See Announcement of
The New "Lionel Standard"
 100% Electrically Controlled Model Railroad

TYPEWRITER PRICES REDUCED

FREE TRIAL

ON ALL STANDARD MAKES

Big bargains, easy payments on late model Underwoods, Royals, L. C. Smiths, Remingtons, etc. — perfect machines expertly remanufactured by the "Young Process" guaranteed like new for five years. Shipped direct from our factory to you at big saving. Our big illustrated catalog sent free and without obligation to buy. Write for yours today.



Young Typewriter Co., Dept. 110-A, 524 W. Randolph St., Chicago, Ill.

*You too
can make
Big Money*

Filing Saws!

WITH THE FOLEY ^{AUTO}MATIC SAW FILER

\$15 to \$20 a day—that is the big money others are making with the Foley. Here's what Mr. Wm. Burnett, 143 Villard Ave., No. Milwaukee, just wrote: "I am having good success with the Foley Saw Filer. It has paid for itself twice in the three months since I got it. I have all the work I can do in the evenings. I have all the way from 2 to 8 saws every evening."

You get 50c or more filing hand saws and \$1.25 to \$1.50 for retoothing. Anyone can run it and turn out better work than experts, six times as fast. Big business from carpenters, contractors, woodworking shops, meat markets, schools and homes, is ready for the first man with a Foley.

Model F-5
Motor Driven.
Also Hand
driven models

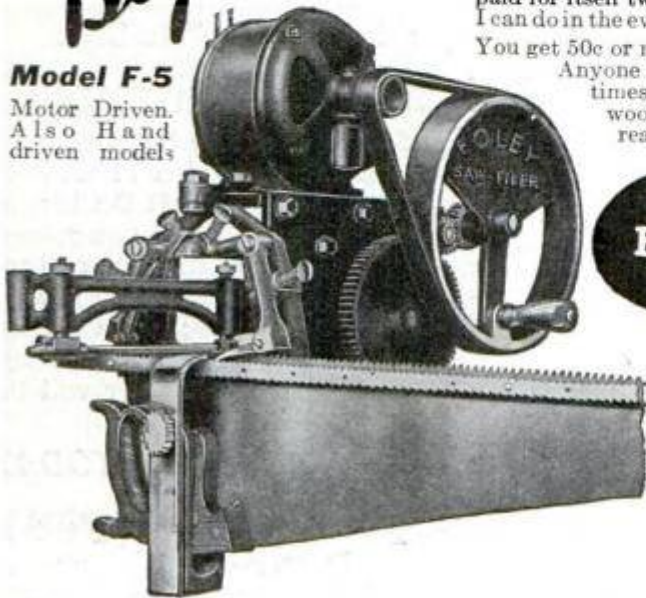

**\$10
BRINGS IT
TO YOU**

Guaranteed!

You don't take a chance either. Use the Foley for 30 days and if it doesn't sharpen saws as perfectly and easily as stated we will take it back and return your money. Mail this coupon now.

FOLEY SAW TOOL CO.

208 FOLEY BLDG. 914 EAST LAKE ST.
MINNEAPOLIS, MINNESOTA

Send me complete information about Foley Money-making Saw Filers.

Name.....

Address.....

I WANT A PARTNER

Someone to take care of my business in your locality. Make \$15.00 daily: show samples; distribute Teas, Coffee, Spices, Extracts, things people eat. I furnish everything complete, including world's finest super-sales outfit. Highest quality products; lowest prices; big permanent repeat business—quality guaranteed by \$25,000.00 Bond. With the person I select as my partner, I go 50-50. Get my amazing offer of Chrysler closed car, "free." Write or wire today.

C. W. VAN DE MARK

Dept. 100 KK, 117 Duane Street Cincinnati, Ohio

Make More Money



THE professional musician of to-day is in one of the most highly paid professions—and also one of the most enjoyable. A good musician is always sure of his income.

You can easily learn to play some instrument and soon take your place in the musical profession. Choose a high quality instrument that will help you to learn quickly—a "King".

Every "King" instrument has the latest improvements—is built by experts and is laboratory tested before being shipped. Every "King" is fully guaranteed.

It is easy to own a "King" instrument. They are sent on 10 days free trial and sold on convenient payment terms.

King Band instruments and Saxophones are fully described in beautifully illustrated catalogs. Send for a free copy.

THE H. N. WHITE CO.
5211 - 80 Superior Ave.
Cleveland, Ohio

KING Band
Instruments

Please send me free your latest catalog of KING

_____(Instrument)

Name _____

Address _____

City _____ State _____

A Lifetime Watch!

Sent for
\$1.00
DOWN



STUDEBAKER 21
The Insured Watch Jewels

Only \$1.00 down! Balance in easy monthly payments. So good we insure it for your lifetime. 21 Ruby and Sapphire Jewels. 8 adjustments including heat, cold, isochronism and 5 positions. Amazingly accurate. Sold direct from factory at lowest prices. You save at least 30%. Over 100,000 sold. Investigate!

Write for FREE CATALOG

Send at once for our \$1.00 down offer and beautiful six color catalog showing 60 newest Art Beauty cases. Latest designs in yellow gold, green gold and white gold effects. Men's strap watches and Ladies' bracelet watches also. Special sale now on. Write!

**Magnificent
Watch Chain
FREE!**

For a limited time we are offering an exquisite watch chain FREE. Write at once—while this offer lasts.

STUDEBAKER WATCH CO., Dept W22 South Bend, Indiana
WATCHES • DIAMONDS • JEWELRY
Canadian Address—Windsor, Ontario

SEND NO MONEY
ONE FULL YEAR TO PAY

\$49.50
\$1 Weekly

DIAMONDS
Pick Yours Now!
We Deliver and Trust You

Again country's foremost diamond merchants lead in startling offers. Look over these bargains, at almost unbelievable low prices. Read descriptions. Your opportunity to secure the gem you longed for. **Easy Terms**—lower than cash prices.

Your Guarantee
We have faithfully served the public for nearly 100 years. Make your selections. Our money back guarantee fully protects you. Order from this ad, on 10 days' free trial.

Send No Money Now!
Keep your money in your pocket. Select the gem you want and wear it for 10 days. No. 1—Ladies' 18 kt. white gold ring, genuine blue white diamond, \$49.50—**\$1 weekly**. No. 2—Ladies' 18 kt. white gold ring, blue white diamond, blue sapphire at each side, \$59.50—**\$1 weekly**. No. 3—Ladies' friendship ring, 18 kt. solid white gold, 3 snappy, genuine blue white diamonds, 4 blue sapphires, \$65.50—**\$3.50 monthly**. No. 4—Gents' 18 kt. solid white gold, genuine blue white diamond, \$69.75—**\$4.65 monthly**. No. 5—Ladies' 14 kt. solid white gold wrist watch, 15 jewels, 2 genuine diamonds, 4 blue sapphires, \$38.25—**\$2.50 monthly**.

Million Dollar Bargain Book—FREE
Contains up-to-the-minute gift suggestions at startling low prices and very liberal terms—write for a copy now!

FREE MILLION DOLLAR BARGAIN BOOK

J. M. LYON & CO., INC.
Dept. 1010 2 Maiden Lane
New York, N.Y.

BOYS SEND FOR FREE COPY of the "Meccano Magazine." Full of news that boys like—stories, contests, articles on engines, airplanes, bridges, model-building, etc. **WRITE TODAY.**
MECCANO MAGAZINE P.O. BOX 264 ELIZABETH, N. J.

RADIO DEALERS

Radio Set Builders
Get the new 1926-27 Van-Ashe Catalogue!

It shows all the newest parts, circuits and kits—all the hard-to-get items that set-builders demand. 12-hour shipments—extra-good discounts.

Dan-Ashe Radio Co.
206 North 10th St. ST. LOUIS, MO.

A&B Battery Charger ONLY \$2

Charges any type of storage A or B battery, using a few cents worth of ordinary house current. Cannot injure battery. Complete directions enclosed—anyone can operate. No expensive "Extras" to buy.

Satisfaction Guaranteed
Why pay \$10.00 to \$15.00 for a charger when you can get this splendid GUARANTEED R. B. Charger by mailing us two dollars (bills, money order, check or stamps). Enclose 10c in coin or stamps to cover mailing costs. Charger will be sent postpaid.



Act at once. TODAY

R. B. Specialty Company
Dept. A-53
308 East Third Cincinnati, Ohio

No. 1 Yale GROUND HOG
The Perfect Ground
DOUBLES POWER AND DISTANCE

Marvelous newly-invented ground gives 100% improved reception. Doubles power and distance. Stops leakage. Reduces static. Stops jangling even in mid-summer. Results never before equaled, users say. Satisfaction Guaranteed.

Proven absolutely essential to clear, powerful distance reception. Draws and holds moisture indefinitely. Highly sensitive to radio energy.

SEND NO MONEY—To introduce, we offer to those who act at once, regular \$5.00 size for only \$2.00. Send name today and pay \$2.00 plus 17c postage on delivery. Or send only \$2.00 with order and save postage.

FREE—Complete description of Ground Hog and full details of amazing special offer on request—Write today.

Yale Specialty Supply Co.
127 W. 4th St., KANSAS CITY, MO.



AGENTS AND SIGN MEN
Now Making \$50.00 to \$100.00 and Up Per Week Selling Our

GOLD LEAF SIGN LETTERS

R For store and office windows, board signs, trucks and glass signs. We also make to order script signs and business emblems singly or by the thousands. A permanent business. No capital or experience required. Big demand in every city. *Samples and Literature Free.*

CONSOLIDATED SIGN LETTER CO. 69X W. Van Buren CHICAGO, ILL.

SOLDERALL
METAL IN PASTE FORM

The Only convenient metal solder



Every Electrical Connection needs Solderall for perfect reception

25c

The SOLDERALL CO., NEWARK, N.J.

**Hitch your
Cutting
Problems to a
STAR**

The wise mechanic hitches his cutting problems to the

STAR HACK SAW

He knows through his years of experience that this blade has always been the leader in cutting efficiency.

The new Special Flexible Blade combines flexibility and cutting qualities that you have never experienced in other blades.

STAR HACK SAWS

Let us send you samples of this blade free

CLEMSON BROS., Inc., Middletown, N. Y.

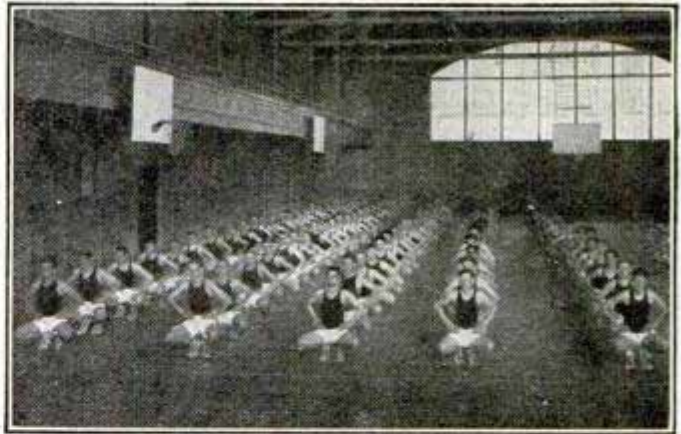

EVERY ONE IN KEDS—At De Pauw University, as at other prominent colleges and schools, Keds are worn for all kinds of athletic work.

On the "Gym" Floor in the Shoe of Champions

SPEED—comfort—long wear. These are the things champions look for in athletic shoes. That's why the great tennis stars and leading basketball teams today choose *Keds*.

No wonder! *Keds* soles give the same sure grip on the "gym" floor they give on the open trail or on the tennis courts. They are light and springy, but so tough they outwear 2 or 3 pairs of ordinary "sneakers."

And *Keds* uppers are wonderfully light and strong. They keep your feet well ventilated and comfortable, yet give you just the support you need.

For gymnasium work, indoor baseball, and for basketball, you'll find you have more fun and play a better game in *Keds*. But be sure they are real *Keds*. Look for the name *Keds* on the shoe.

Keds come in all popular styles and at prices from \$1.25 to \$4.50.

United States Rubber Company

The "METEOR"
A popular *Keds* basketball shoe with sponge rubber heel seat and narrow shank to support the arch. Its tough laminated sole gives a sure grip. In white or brown; black trim.

The "SPORTSTER"
A sturdy athletic-trim *Keds* for the hardest gymnasium and general wear. White with black trim or brown with gray trim—both models with gray corrugated soles.



They are not *Keds* unless the name *Keds* is on the shoe



Please Mention Popular Mechanics

|| \$2000 IN 3 MONTHS SPARE TIME ||

Men and women let me tell you how I've sold, by mail, 2000 \$1 orders in three months. Mdse. cost 12c per order. Send name.
QUINCY CO., 339 Quincy Bldg. Chicago

CARPENTERS WANTED

To try the Ellingson Lock, Butt, Mortise and general purpose Gauge. If it is not satisfactory after thirty days trial your money will be refunded. Price \$2.35 postpaid.

ELLINGSON GAUGE CO., BEMIDJI, MINN.

\$25 to \$45



GET THE **NEW IDEA**
BATES MOTOR SAW
— 6 SAWS IN 1 —

Does the work of band-saw, rip-saw, cross-cut, miter, bevel and scroll-saw. A wonder worker for the home shop. Direct drive! Can't stick! Cuts 2" wood. Most amazing variety saw ever invented. Does more, costs less! Write for circular.

BATES MOTORCRAFT COMPANY
Dept. M 28 N. Clinton CHICAGO, ILL.

**Don't Be
a
Slave**

Be independent and make big profits with the

BEISSER KEY MACHINE

You can start a business of your own, no experience necessary. Only machine that will make first keys without taking lock apart. Makes a dozen duplicate keys per minute.

Write Today for Full Particulars

BEISSER KEY MACHINE CO.

407 Fort Street, East Detroit, Michigan

CRESCENT Smith & Hemenway

the *all around* line of mechanics' and electricians tools



WHEN you want a plier, a wrench, or a screwdriver of special size or shape for some unusual job, go to your hardware dealer and ask to see his line of Crescent-Smith & Hemenway Tools. The chances are ten to one you will find exactly what you want—and you can be sure the quality is up to the standard which has made the Crescent Wrench a standard of excellence among mechanics all over the world.

Every Crescent-Smith & Hemenway tool is guaranteed satisfactory or your money refunded.

CRESCENT TOOL COMPANY
210 Harrison Street
Jamestown, N. Y.

Originators
of the
Crescent Wrench

Douglas MacLean says, "You can't beat a Lyon & Healy saxophone for tone or for ease of playing!"



"I've heard 'em all and I can tell the difference with one ear. The Lyon & Healy is *some sax!*" Doug's own words.

Douglas MacLean, Famous Players film star, is an amateur musician—but he knows real music when he hears it. He has found, too, the secret of popularity—knowing how to do things! Like Doug, you will find our simplified instrument easy to finger, easy to play clear, loud and mellow. The choice of professional musicians, also, because of its perfect pitch, accurate adjustment and beautiful finish.

Discover for yourself the advantages of our special "Easy to pay while you play" plan by mailing the coupon *today*. Popularity, friends, fun, money are yours when you play a Lyon & Healy Saxophone. Let us help you learn quickly, easily. But act now!

LYON & HEALY

61 E. Jackson Blvd. Chicago, Illinois
Everything known in Music

FREE!
Mail the coupon
to day!

The real facts about saxophone playing, its opportunities for pleasure and profit are told frankly in this fascinating, illustrated book. Send for your **FREE** copy today!



LYON & HEALY, Inc.
61 East Jackson Blvd., Chicago.

Factory Sales
Division

Please send me **FREE**, your remarkable new Saxophone Book, and full details of your special "Easy to pay while you play" offer.

Name _____
Address _____
City _____ State _____

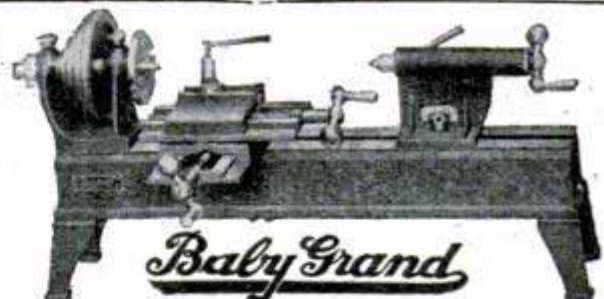

A practical lathe for shop or home. Cone or Back Geared Head; 6" swing, 12" or 18" between centers; speed 180 to 1750 R. P. M. Will do wood or metal turning. Low price, high quality. Send for complete information on Baby Grand Lathe, Drill, Grinder, etc.
The Watson Mfg. Co., 110 Watson Bldg., Toledo, O., U.S.A.

Plumbing and Heating Supplies



Save **up to 40%**

Buy
now

Bath Room OUTFITS COMPLETE **\$58²⁵ UP**

INSTALL THEM YOURSELF

Full line of plumbing and heating supplies at big savings. All made of finest materials brand new and perfect.

EVERYTHING GUARANTEED
Hot water and steam heating plants. Water supply systems. Radiators, fittings, etc.

HOT WATER PLANT 700 ft. Rating **\$71.15**

Send us sketch of your rooms for estimate or tell us your wants. Price list on request.

B. Karol & Sons Co. 800 S. KEDZIE AVE. DEPT. 20 CHICAGO

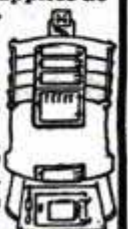

Play a Tune in 10 Minutes!

—on your favorite stringed instrument



Yes, YOU can play almost at once. No knowledge of music required. No weeks of tiresome practice. No costly music lessons. Works like a typewriter—just press the keys. Astound and entertain your friends. Play all the popular hits with this

Amazing New Invention

Play by numbers instead of notes. Marvelous music on the Ukulele, Banjo Uke, Tenor Banjo, Guitar and Mandolin. Famous Vaudeville Star, Trixie Friganza, writes: "I learned to play in 3 minutes and had never touched a stringed instrument before" John Matise: "Played tunes on the Guitar the same day and am delighted. Anyone can play it." Leonard Cleary: "In only a few days I have had my money's worth in fun." Constance Sedler: "I was playing in four minutes."

6 Day FREE TRIAL To prove that you can play as thousands are doing who never played before, we will arrange to send an instrument on trial. Just write. "Send me (name of instrument)." That's all. Or write for **FREE BOOK** telling how to select the instrument best suited for you that will add to your popularity. No obligation. Write today.

FERRY & CO. 3222 North Halsted Street Dept. 1777, CHICAGO

Pattern Makers—Carpenters—Cabinet Makers

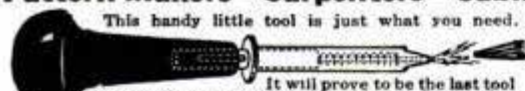

ADNELL MAGNETIC BRAD-SET at this remarkably low price

This handy little tool is just what you need. It will prove to be the last tool in your kit with which you would part. For putting Leather Filets on patterns it has no equal. Works in hard as well as soft wood, leather, etc. No nail set required. As Brad will be set beneath surface far enough to cover with putty or wax. A push with this handy little tool does the trick. The Magnetic Ram Picks 'Em up in a jiffy. Easily reaches most unhandy places. Ask for **FREE** catalog of complete line of tools for Pattern Makers, Cabinet Makers, and Wood Carvers. Enclose 10 cents in stamps to cover cost of mailing which will be refunded with first order.

\$1.25

ADAMS & NELSON CO., Dept. PM-10, 4125 Fullerton Ave., CHICAGO, ILLINOIS

Boils 50 Gallons In Less Than Hour

No Other Compares With This

Improved Oil Burner

Use Ordinary Kerosene or Coal Oil

[Burns Outdoors as Well as Indoors]

THE most remarkable Kerosene Burner ever built. Boils down apple cider, maple syrup, molasses, etc., in half the ordinary time. Ideal burner for dairies, butchers, indispensable on the farm.

PRODUCES TERRIFIC HEAT WITH SILENT BLUE FLAME

NO NOISE SMELL SMOKE SOOT



So efficient it produces twice the amount of heat of City gas at half the cost. So simple anyone can install and operate. Double generator assures continuous operation without shut-downs. Nothing to wear out, starts in a jiffy, will last a life time. Every burner guaranteed fully. Write for special introductory price. Free descriptive catalog.

HOME MANUFACTURING CO. Dept. B-3, 18 E. Kinzie Street, CHICAGO



You Can Be a Fire Prevention Expert - Earn \$5000 to \$8000 a Year!

Factories, stores, homes and farms everywhere are being equipped with a marvelous new fire protection—a Fire Gun that shoots a flame-smothering gas 30 feet or more. So powerful is this gun, and so easily handled, that great industries are adopting it as standard equipment. And hundreds of men are needed at once to demonstrate this amazing new invention. No matter where you live or what you are doing now, you can earn \$5,000 to \$10,000 a year and more, acting as a representative of the Weldon Manufacturing Company.

\$67.50 IN ONE DAY

L. J. Clement of Michigan, earned \$67.50 a day in one small town; La Barr of Minnesota made \$167 in one week; Butters of Florida drew \$592 in one month. Scores do as well. And in your community you, too, can earn big money. You can quickly become a Weldon Fire Prevention Expert and be the recognized fire authority in your territory. You will find money rolling in like you never dreamed, because the Weldon Fire Gun has become the sensation everywhere.

People everywhere want the Weldon Fire Gun because it is not a pump gun—no complicated mechanism to jam up at crucial moments. No leakage to render the extinguisher useless when so sadly needed. The Weldon operates by the mere turn of the wrist and from a NATURAL position. Big industries like the Standard Oil, Goodyear, General Motors and U. S. Government departments have chosen Weldon Fire Guns as standard equipment. And everywhere you turn you find people eager for adequate fire protection—they want the Weldon Fire Gun.

MAIL THE COUPON

We furnish you with the famous WELDON SUCCESS PLAN that enables you to start right out earning big money. No Weldon Fire Prevention Expert is satisfied with a mere \$10.00 a day—Weldon is too much in demand. So if you really want to better your income, if you really want to earn exceptional money, fill out the coupon below and learn what Weldon offers you. It will cost you only two cents to take the first step—and the first step leads you quickly into **SUCCESS—REAL MONEY—A LIFETIME CAREER.** But just sending the coupon places you under no obligation. Fill it out now.

Weldon Manufacturing Company DEPT. 7-L Grand Rapids, Mich.

Weldon Manufacturing Company, Dept. 7-L, Grand Rapids, Mich.
 Send me at once full details of the Weldon plan, and show me why it will double my earnings.

Name.....
 Address.....
 City..... State.....

Only Conn Gives You these Features



FOR quick success and lasting satisfaction choose a Conn saxophone. Its exclusive features enable you to win both pleasure and profit playing the music you like best. Remember only with a Conn you get the improved key system, patented tuning device, integral sockets with rolled edges, straight mouthpipe and above all, the new Conn-foil pads; features which make Conn the choice of world-famous artists.

Free Trial—Easy Payments

Conn is the only maker of every instrument for the band. Send now for free book describing Conn features in detail; mention instrument. C.G. Conn, Ltd., 1031 Conn Bldg., Elkhart, Ind.



1200 LETTERS AN HOUR. Sealed and Stamped

With a So-Easy Moistener. Always ready, sanitary, saves licking your stamps, envelopes, gummed labels. Used by Sears-Roebuck and Montgomery Ward & Co. Thousands sold everywhere. Price \$1.25. SPECIAL—10 Days. Send \$1.00 bill for moistener, big office supply catalogue, "How to stamp and seal letters."

C. MOHLER, Box 453, CHICAGO, ILL.



Chicagoan Discovers Gasoline Miracle

What is this strange new miracle guaranteed to give 1,250 gallons of gasoline every 50,000 miles at only 1-4c a gallon and to instantly remove and permanently prevent carbon? Never before anything like it! Not a mechanical contraption or gasoline dope. It is called Motor-Mystery, discovered by the eminent scientist, L. Forgrave. New, different, amazing! Needed every 50,000 miles. Costs practically nothing. \$1,000.00 reward backs our guarantee. Thousands of users and testimonials.



Try It Free

Send no money. We trust you. Send quick for Free Trial, SWORN Proof, \$100.00 Weekly Salary Guarantee and Free Dodge to Producers. Big plan for agents. M-M LABORATORIES 6952 N. Clark St. CHICAGO, ILL.

M-M Laboratories, 6952 N. Clark Street, Chicago, Ill. I am interested in your FREE TRIAL of MOTOR-MYSTERY, \$100.00 a week Salary guarantee to Producing Agents and Free Dodge. No obligation on my part.

Name _____
 Street or R.F.D. _____
 City _____ State _____

BE PRESIDENT OF YOUR OWN COMPANY

CONCEIVE that of all methods present or past, the Nestler Rubber Fusing Process (U. S. Pat. No. 1,354,992) alone, produces a positive fusion or welding of new and old rubber! —The first and only practical and successful method of re-rubbering a tread worn tire, is here—a simple, quick, inexpensive process that makes tires new again and cuts tire costs in half!



Each year since 1917 thousands of tires have been successfully Nestlerized annually by ourselves and licensees. Due to increased demand caused by high tire prices we have decided to issue a limited number of additional licenses. License rights will include protected territories, free instruction, and full cooperation. 17 million cars and 34 million tires replaced annually constitute a limitless opportunity for business and profit.

The demand for territories is great and prompt action is vital. A printed proposition with full facts and detailed information is now ready. Write for it TODAY.



NESTLER RUBBER FUSING CO., Inc. DEPT. P10 245 W. 55th Street, New York City

Wear These Shoes Free

Make \$95 a Week—Easy Money!

Men! Women! Here's a chance to get your own shoes FREE, and to make the easiest money of your life. Take orders for tailor-made shoes from your friends and neighbors. Unheard of values because sold direct from makers. Every pair guaranteed to fit perfectly and give comfort and satisfaction. Shoes tailor-made to fit six actual foot measurements. Choice of 24 different leathers—made in 55 styles (in men's, women's and children's shoes. Unlimited market.

Get FREE Outfit

No capital—no investment necessary. Big commissions for you in advance. I do the collecting and delivering. Send for FREE outfit immediately and get FREE shoes.

TAILOR-MADE SHOE SYSTEM Dept. L-1710, 932 Wrightwood Ave., Chicago, Ill.

YOU, TOO, CAN BE A MAGICIAN

Earn extra money, give shows. Catalogue 20c. OAKS MAGICAL CO. Dept. 100 OSHKOSH, WIS.

RADIO AGENTS: NOTICE!

Just out—latest, greatest, 5 tube set made. Built-in speaker, front drop panel, piano hinged top. Temple speaker with finest unit, walnut finish two toned cabinet etched in gold 32x10x9 all complete with 5 matched tubes, and complete aerial outfit to retail at only \$59.50 less handsome commissions to you. Wire or write for details quick! AERIAL ELECTRIC CO. LA SALLE and KINZIE. CHICAGO, ILL.

AGENTS \$10 to \$25 DAILY!



Here is your lifetime opportunity! \$10.00 to \$25.00 every day selling America's Finest Shirts direct from our own big, honorable factory. Easy work, lowest factory prices, individual patterns and remarkable values. Big steady demand in every locality.

No experience or money necessary. We show you how and furnish everything you need. Your success is assured, with a steady income every month. Every customer satisfied. Big Repeat Business. Be our factory agent and supply big demand for Packard Tailored Shirts in your locality. Failure impossible. Essex Coach free for selling Shirts.

Write Now for Free Samples

Just send your name and address now for Free Samples. Be first before some one beats you to it. WRITE TODAY.

PACKARD MANUFACTURING CO. Dept. 307, 829 Orleans St., CHICAGO, ILL.



Big 3-ft. Telescope

Makes people and objects miles away seem close. Brings new pleasures to home, farm, camp, travel, sport. See moon and stars as never before. New Ferry "Wonder" telescope has 5 sections—over 3 ft. long open, 12 in. closed. Fully brass bound. Powerful lenses.

FREE! Yes, Absolutely FREE! Handsome leatherette covered Carrying Case, light, strong, complete with strap. Handy for farmers, auto tourists and hikers.



Only **\$1.85**

5 Sections 8-Power Lenses Thousands Delighted!

"I am delighted with the 'Wonder' telescope. Today I have been watching submarines 3 miles off the coast."—Philip Brush. "I can see across the Mississippi 3 miles and see people fishing."—M. L. Thorn. "I am nearly 80 years old and if I could not get another would not take \$10.00 for it."—A. R. Walker. "I can tell time on the church clock 5 miles away."—Edward Foster. "Could tell color of aeroplane 4 miles away."—Mrs. L. M. Yarbrough. "I saw a Light House 18 miles away."—Clyde Scribner.

Send No Money

Send name and address and Ferry Wonder 3-ft. Telescope with free Carrying Case will come by return mail. Pay postman special bargain price of \$1.85 plus a few cents postage. Satisfaction guaranteed or your money back. Supply limited.

Order Today! **FERRY & CO., Dept. 9777, CHICAGO**

Sensational Typewriter Offer

Yours for
10 Days FREE



The World's Only Ball Bearing Typewriter

NEVER has there been such a typewriter bargain on as *easy terms!* A genuine Silent Ball Bearing L. C. Smith at a **40% saving!**

Only the L. C. Smith has all these features: Ball bearings (636 of them) at all points of wear. All the writing visible all the time. Non-shift carriage. 2-color ribbon. All the latest operating conveniences. Beautiful—re-newed. Easiest running, longest wearing of typewriters.

If you decide to keep it
only **\$3.00**
DOWN
BALANCE
EASY TERMS

GUARANTEED 5 YEARS

Money cannot buy a better typewriter. Recognized for 20 years as the finest typewriter made. U. S. Government bought 50,000. The choice of railroads, big corporations like the Standard Oil Co., etc., because of its exclusive ball bearing feature.

SEND NO MONEY

Just mail coupon. Without delay or red tape, typewriter will be shipped you. Use it 10 days. See how speedy and easy it runs, the perfect work it turns out. No one will urge you to buy; typewriter must sell itself. If you're not delighted with it, return at our expense. You'll want to keep it. You can, for \$3 down—and \$5 monthly. Now is the time to buy. \$3 worth of extras free. Send coupon now before offer is withdrawn.

DOUBLES TIRE MILEAGE

and **Makes Pumping Up Tires Unnecessary**



Line up with big money. The Hughes "Airlox" Valve Cap is a proven success. Air-tight. Eliminates all troubles due to under-inflation; lasts life of tire. Positive necessity to auto owners. Doubles tire mileage. Tested and approved by leading auto manufacturers. \$100 a week for hustlers. Unlimited demand. No competition.

FREE SAMPLES TO AGENTS to use and introduce in exclusive territories. Immense uncrowded field. Don't hesitate. Write today for facts and FREE SAMPLES.

AIRLOX RUBBER CO.

424 N. Homan Ave. Dept. 805-K, Chicago, Ill.

I Offer You \$12.00 a Day ~and a

CHRYSLER 4 Coach



Write quick for new proposition. We offer \$12.00 a day and a new Chrysler-4 Coach, for demonstrating and taking orders for Comer Suits. Smart styles. Wonderful values. Work spare time. No experience required. Sample outfit given. Write now.

COMER MFG. CO., Dept. W-5118, DAYTON, O.



ADD Quick! NEW EASY WAY

Amazing new pocket adding machine does all kinds of figuring in a jiffy. Eliminates all need of paper and pencil. Works as easily and quickly as a \$300.00 machine. Counts up to a billion, yet fits vest pocket and weighs only 4 oz. Total always visible. Clears instantly. Made of steel and brass in fine fm. leather case.

SENT ON TRIAL!

Send no money—just name and address. We will mail machine at our risk for FREE TRIAL. Pay postman only \$2.95, plus few cents postage on delivery. Use the machine for 10 days. If not completely satisfied, return and get your money back. Avoid any more costly arithmetic errors—save time and money. Order NOW.

Reliable Adding Machine Corp., Dept. 47
184 West Washington St., Chicago, Ill.

AGENTS

Wonderful money-maker for live wires. VE-PO-AD sells on sight to anyone who uses figures. Write for special BIG-PROFIT OFFER.



\$40 SAVED by Using this Coupon

SMITH TYPEWRITER SALES CORP.
11A-360 E. Grand Ave., Chicago

Ship me the L. C. Smith F. O. B. Chicago. On arrival I'll deposit \$3 with express agent. If I keep machine, I'll send you \$5 a month until the \$66.70 balance of special \$69.70 price is paid; the title to remain in you until then. I am to have 10 days to try the typewriter. If I decide not to keep it, I will repack and return to express agent, who will return my \$3. You are to give your standard 5-year guarantee.

Name.....
Address.....
City.....State.....
Occupation.....
Employed by.....

FROST-RADIO

New Parts for Your Set



Type 700
Metal Frame
Rheostat

Here is a rheostat that can be operated for hours without any noticeable change whatever in resistance. The windings will take 25% to 50% overloads without overheating. Simple and rugged in construction. Contact arm slips smoothly over windings with no wear, yet always with positive contact. Supplied in resistances of 2½ to 75 ohms. Equipped with pointer knob. Price 50c at your dealer's.

The Super Variable Resistance

A New FROST-RADIO Unit

This non-inductive high resistance unit has withstood 46,000 turns of the roller contact arm without appreciable wear or change in resistance. Its action is smooth and noiseless. Cannot overheat. Used for controlling volume, tone, regeneration, grid bias, etc. Type 880 has 2 terminals and is supplied in 50,000, 100,000, 200,000 and 500,000 ohm sizes. Type 890, 3 terminals, is furnished in 400, 2,000, 50,000, 100,000, 200,000 and 500,000 ohms. Price of both types, \$1.25 each.



Type 890



HERBERT H. FROST, Inc.

160 N. La Salle St., Chicago New York Los Angeles

A \$5,000 A Year Opportunity for the Right Man

Here's an opportunity if you can measure up to the Davis standards. You can be the local representative for this company—America's largest direct distributors of quality clothes for men. A permanent, profitable business awaits you, taking orders for Davis nationally known made-to-measure suits and overcoats at \$29.50, \$34.75 and \$42.50. Finest hand-tailored, perfect-fitting garments guaranteed — or money back. Thousands of repeat customers assured.

No Experience Necessary

Some of the highest paid men in the Davis organization never sold clothes before. And hundreds of our Representatives are making phenomenal incomes. Send immediately for 40-page FREE book which tells you all about this \$5,000 to \$7,500 opportunity.

P. H. DAVIS TAILORING CO.

2087 IOWA AVE., DEPT. A-10, CINCINNATI, OHIO



Agents Wanted

You can make \$75.00 to \$150.00 a week easy selling Illinois Shirts

Best Shirts at Lowest Prices

1501 live numbers. Every man buys. No previous experience necessary. Your pay in advance. We deliver. Work full or part time. Illinois Sure Sales Plan assures your success.

Write for Free Sample Outfit

ILLINOIS SHIRT CO., Dept. 30, 506 So. Wells St., CHICAGO, ILL.



VULCANIZES the— HEATLESS, CEMENTLESS WAY!

—Sell "Seal-R-Tite" All Rubber Repair (the new Chemical Method of Vulcanizing) for Tubes, Casings, and All Rubber Goods. No cement, heat or gasoline used. Instant and permanent repairs in less than two minutes. Any size from a pinhead to a 17-inch blowout. Write today for sample and territory.

Dept. 103 SEAL-R-TITE PATCH CO. 1354 S. Wabash Chicago

You Can Play a Pan-American Clarinet!

Everybody likes a Clarinet, the sweetest singer of them all. Clarinet players are in constant demand, at big salaries. The Pan-American Clarinet is a beautiful solo instrument for home, church, school, or private entertainment. Famous band leaders learned the Clarinet first! You can! They are so easy to blow—and to learn to play.

Remarkably LOW-PRICED

Pan-American Clarinets are called "the greatest value for the money on the market" by America's foremost band and orchestra leaders. Tested and found superior by the leading artists. Send coupon below today for our remarkably low price offer. Easy Payment Plan—and catalog of complete line of Pan-American Band and Orchestra instruments.

FREE TRIAL OFFER

SEND NO MONEY MAIL COUPON

The Pan-American Band Instrument & Case Co., Elkhart, Indiana Dept. G-2

YES—Send me complete information on PAN-AMERICAN Clarinets and other band instruments. I would like to learn to play. (instrument)

Name
Address
My local Music Dealer is

\$15 a Day Making Doughnuts

This machine makes 500 dozen Doughnuts per day, \$15 to \$40 daily profit. No experience needed. Put dough in hopper—turn crank—out drop delicious golden doughnuts. Machine in store window attracts crowds. You take in money fast. Pay for machine first week. Big money wholesaling to grocers, restaurants, etc. Mrs. Humphrey, Iowa, averages 140 doz. per day (\$758 per month). Henderson, Illinois, averages 100 doz. per day, (profit \$20 daily). This machine also makes delicious potato chips. Write for FREE details.

C. A. BUTLER, 233 N. Taylor Ave., Oak Park, Ill.

Gas Blow Torch and Solder Iron Heater



Connects to any gas jet or gas connection. No air attachment necessary. Heats solder iron in less than a minute. For home use, repair shops, laboratories, manufacturing plants, and foundries. A wonder for the mechanic's work bench, jewelers, dentists. A Blast 8" long, 1" in diameter—Intense Heat. Postpaid \$1.00; Canada \$1.40

Tri-une Company, Dept. 802B, 215 S. 15th Ave., Maywood, Ill.

A SCHOOLBOY CAN NOW "KEEP BOOKS"



Bookkeeping troubles made so easy with a So-Easy Loose Leaf Outfit. Binder, 200 sheets ruled to use in your business, A-Z index. Price \$3.00. SPECIAL for 10 Days. Send \$2.50 for book. I will include samples of 60 stock forms and "How to Find Errors in Trial Balances."

B. MOHLER, Box 453, CHICAGO, ILL.

Sewage Disposal for Country Home, Camp, or any building in unsewered districts.

Protect health and increase property values with **SANEQUIP SEPTIC TANKS**. Perfect sanitation. Thousands in use. No failure. Ask our specialists for Free Plan Sheets.

CHEMICAL TOILET CORPORATION
894 Free St. Syracuse, N. Y.
Makers also of sanitary waterless toilets.

FREE

NEW 1927 **Radio Catalog**

WRITE TODAY TO

Chicago Salvage Stock Stores
509 S. State St. Dept. PM Chicago, U. S. A.

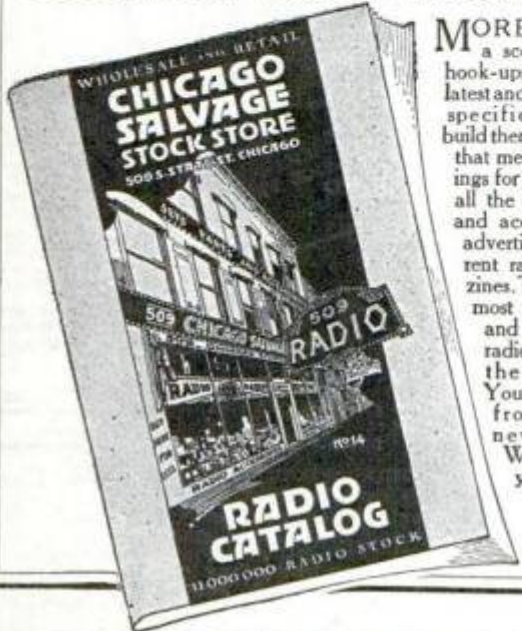

MORE THAN a score of new hook-ups—all the latest and best—with specified parts to build them—at prices that mean big savings for you. And all the latest parts and accessories as advertised in current radio magazines. The largest, most complete and up-to-date radio stock in the world. Yours to choose from in this new catalog. Write for your copy.

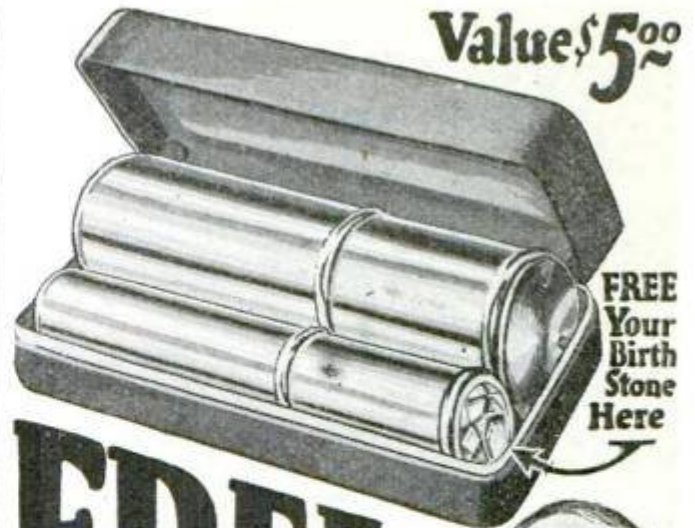

FREE Gold De Luxe Master-Lite

The Mystery Pocket Lighter

You will be proud to carry a **Gold De Luxe Master-Lite** with your own birthstone. Not only is this De Luxe Master-Lite a beauty in every respect, but it is useful. It makes an ever faithful servant and can be yours free according to our new introductory plan. Read on and learn how to secure yours.



**No Flint
No Trouble
No Matches
No Misses**

Master-Lite Features How to Get Yours Free

Made of first quality gold plate. Requires no flint, no matches and cannot light unless you want it to. The wind can't blow it out. Your friends will marvel and become mystified as to how you make it work. It is the greatest useful novelty ever invented. Every one of your friends will want one when they use it. Sold in high grade jewelers, gift shops and department stores for \$5.00. You can get yours free!

Merely introduce the Gold De Luxe Master-Lite in your neighborhood. Show it to five friends and get yours free. You just order one lighter and we furnish five coupons worth 50c each, which you sell to your friends. They buy quickly because everyone will want a lighter like yours when they see it.

RUSH Coupon

Your Guarantee

The Master-Lite De Luxe pocket lighter is guaranteed to give entire satisfaction or money back. It is guaranteed to work faithfully for 10 years.

Send No Money—Rush Coupon

Merely mail the coupon below. It entitles you to a gold De Luxe Master-Lite on approval. When your Master-Lite arrives deposit only \$2.50 with postman. If after examination and five days trial you are not satisfied that it is the best pocket lighter you ever saw or had, return it and your \$2.50 will be promptly refunded. At the same time we ship your five coupons each worth 50c on the purchase price of another lighter. Sell these to your friends for 50c each and earn back the full price of your lighter. Your friends return these coupons and get the same opportunity to secure a Master-Lite free as you. **Rush coupon now.** Be sure and fill in birth month.

Agents Make Money

It's easy to sell ten to fifteen De Luxe Master-Lites a day. We pay you liberally for selling them. Send coupon for a lighter today, and get your sales plan. When ordering mark "X" in box if you want to get our sales plan []

MASTER-LITE MFG. CO.
Dept. 1610, 110 E. 23rd St., New York

Please send me your regular \$5.00 gold De Luxe Master-Lite in leather case, and five special premium coupons which I may give away or dispose of at 50c each. I will pay postman only \$2.50 upon receipt of the lighter. If after five days use I desire to return my Master-Lite you agree to refund the full purchase price.

Birth month.....

Name

Street.....

City.....State.....

If you live outside the United States send International Money Order with coupon.

EASY \$100 a Week FUGO FIRE EXTINGUISHER



Unusual opening for live agents in every locality. Make \$5000 or more a year—easy. Fugo—the instantaneous automatic fire extinguisher—is needed and wanted in every home, store, theatre, garage, shop, school, automobile, etc. Cheapest fire protection available today. Within reach of all.

1 Qt. Size \$5.00 2 Qt. Size \$7.50

Recharged in 15 sec. Amazing 30-second demonstration clinches sale—each one sold sells others. Territory going fast. Write at once for wonderful proposition that will **MAKE YOU BIG MONEY.**
THE NATIONAL FORMETAL CO.
6535 Metta Ave., N. E. Cleveland, Ohio



AGENTS AMAZING DISCOVERY Abolishes Metal Polish

Experience unnecessary. Astonishing new cleaner for silver, copper, brass, nickel, etc. No liquid. No paste. Clean, dry, floss. Touch, and article shines like new instantly. Demonstrations amaze! Everyone a sale. Sell Lightning Polishing CLOTHS and FLOSS to Housewives. Autoists, Stores, Offices, Factories buy large quantities of both. Sure, big, quick money getters. **SAMPLE FREE!** Exclusive territory. Triple profit. Don't delay. Clinch your territory NOW! Write—**A. X. LIGHTNING CORP.** 1773 Greenleaf Ave. CHICAGO

Catch Fish!

Eels, Mink, Muskrats with our new folding galvanized **STEEL WIRE TRAP.** Write for our **FREE TRAP OFFER** and Bargain Catalog. **\$1 Box** of our famous Fish Bait **FREE** to introduce our traps. **WALTON SUPPLY CO., 3500 JUNIATA AVE., ST. LOUIS, MO.**



66 Miles on 1 Gallon

Amazing, New, Auto Gas Saver
All Makes. Spare or full time. Factory Agencies Wanted Everywhere
1 FREE TO INTRODUCE
BIG PROFITS to any **MAN WITH CAR**
CRITCHLOW, Inventor, N-805, WHEATON, ILL., U.S.A.

Magic

**Learned
Easily
At
Home**



Dr. Harlan Tarbell
Master of Magic who has mystified magicians as well as laymen with his marvelous tricks.

Astonish Your Friends

Gain that magnetic popularity that makes you the center of any crowd. Business and social success is assured the man who can perform mystifying tricks. You can earn big money either on the side or as a professional, as well as being the most popular person in your crowd. Why envy others' skill? You can learn Magic yourself, quick and easy.

Earn \$250 to \$1000 a Month

Even sleight-of-hand, generally supposed to require long practice, is NOW made simple to learn. For Dr. Harlan Tarbell, one of the really Great Magicians, has finally opened up the secrets of his profession in a completely illustrated course offered at a merely nominal cost. Through the wonderful Tarbell System you will be able to mystify and entertain your friends with simple tricks taught in your very first lesson. After that Dr. Harlan Tarbell takes you through the entire maze of sleight-of-hand, card tricks and elaborate stage diversifications. The apparently superhuman doings of the accomplished magician become as simple as ABC when you just know how.

Mail Coupon for Special Offer

There is a tremendous demand for magic entertainment. Clubs, Lodges, Charity and Social affairs—all will pay high fees to the man who knows Magic. Dr. Harlan Tarbell really gets as high as \$250 for an half hours work right now. Opportunity everywhere to make money aside from your regular occupation. Salesmen find it a tremendous asset. Find out all about this unprecedented opportunity to learn Magic. The coupon brings full details without any obligation. Mail it TODAY.

Tarbell System, Inc.

1926 Sunnyside Ave., Studio 93-57 Chicago

Tarbell System, Inc.

1926 Sunnyside Ave., Studio 93-57 Chicago

Tell me all about Dr. Tarbell's new and simple system by which I can learn the secrets of MAGIC. No obligation on my part.

Name.....

Address.....



**Send
No Money**

Shop Notes

393
Articles

FOR
1926

517
Pictures

This announcement has been eagerly awaited by thousands because they have learned that each yearly issue of Shop Notes contains dozens of short cuts that save time and money. Every article is written by some man who has tried the idea and found it worth money. The variety of subjects covered is one reason why so many folks buy Shop Notes each year. In many ways the 1926 issue surpasses previous numbers. The following brief list will give you an idea of the variety of subjects covered.

SOME OF THE SUBJECTS

- | | | |
|--------------------------|------------------------------|----------------------------------|
| Auto repair tools | Machine shop practice | Printer's aids |
| Farm equipment | Well drilling discoveries | Dairy equipment |
| Service station ideas | Garage equipment | Electrical equipment |
| Shop tools | Poultry raising helps | Machinist's tools |
| Blueprinter's helps | Sheet metal worker's helps | Contractor's aids |
| Merchant's shortcuts | Concrete working ideas | Small-shop machines |
| Paint formulas | Special grinding attachments | Tool boxes |
| Ice harvester | Tree protectors | Boat repair suggestions |
| Builder's equipment | Carpenter's shortcuts | Photographic discoveries |
| Emergency heating plants | Painter's equipment | Auto trailer |
| House-moving suggestions | Home-made bench saw | Welding equipment |
| Making magnetic chuck | Draftsman's secrets | Overcoming dredging difficulties |
| Storage battery kinks | Store room time-savers | Septic tank |
| Merchandise display | Electrician's methods | Using twist drills |
| | Lathe fixtures | Pulley and gear speeds and sizes |

5,510 Ideas on All Shop Work

There are now 14 volumes of Shop Notes available. And this unrivaled library of shop helps may be had for a special price of \$6.50. If you do not have the back numbers of Shop Notes, you should purchase the entire library. The following are now available:

- 1908, 1912, 1913, 1914, 1916, 1917, 1919
1920, 1921, 1922, 1923, 1924, 1925, 1926

Amateur's Guide PROFESSIONAL'S HANDBOOK

Both amateurs and professionals find Shop Notes of wonderful value. The articles are so clearly written and so thoroughly illustrated that even a boy can follow them. Teachers of Manual Training should have the complete library.

SEND NO MONEY

Don't send a penny. Just fill in the coupon with your name and complete address, indicate whether you want the whole library or the special offer of 1926 Shop Notes and Lathe Handbook for 98 cents. When the books are delivered to you, pay the few cents postage and deposit price of books with postman

SPECIAL OFFER COUPON

POPULAR MECHANICS PRESS,
200 E. Ontario St., Room 703, Chicago, Ill.

Send me, as per your special offer, the following books. I will pay postage and the price of books when they arrive. My money will be refunded if I am not satisfied. (Check what you want.)

- 1926 Shop Notes and Lathe Handbook, 98 cents Complete Shop Notes Library (14 vols.) \$6.50

Name.....

City..... State.....

Street and No.....

NOW! Fords Run on 8¢ gas -



Earn \$20.00 Daily Easy

Cash in on the high cost of gas. Establish yourself in a permanent business with a field that increases as fast as Henry Ford can produce his cars.

You don't have to be a master salesman to sell a device that eliminates two-thirds gas consumption, thus making a Ford actually run on 8¢ gas. Every Ford owner an instant buyer the minute the unique features of the new improved Weeks' Super Carburetor are explained.

SELL EVERY FORD OWNER

The gas saving feature of the Improved Super in itself is sufficient to make it an absolute necessity, but gas saving is only one of the many things it does. Think of the demand for this marvelous device that eliminates carbon, creates amazing power making it possible for Fords to climb steep hills in high, gives amazing pick-up, instant starting, quiets Ford motor, stops oil pumping and increases life of your car considerably.

\$5,000 to \$10,000 YEARLY EASY

Weeks' salesmen every where are making big money. Our selling plan provides a tremendous profit and backed by our national advertising the way is paved for quick easy sales. Get out of the rut. Don't be satisfied with a small income. Put yourself in the big money class as a Weeks' salesman.

GET YOUR TERRITORY NOW

Real money-making propositions do not remain open long. Unless you act quickly someone may get in ahead of you. Our territory plan gives you a large field to work. Therefore, your earning capacity is practically unlimited.

FREE SAMPLE OFFER

We provide our workers with a FREE SAMPLE so that they can first convince themselves of the sterling features of the Weeks' Improved Super Carburetor. Get this FREE SAMPLE offer and big money-making proposition at once.

READ THIS PROOF

In our office files we have thousands of letters received unsolicited from our agents reporting sales results that to those unacquainted with the possibilities of the Super may seem almost unbelievable. Below are reproduced a few of the many letters to give you an idea of what others are doing as Super agents.

\$74.00 Earned in One Day

"I like to sell 'SUPERS' because they are something that every Ford owner needs and will buy. My best day's work was on a Saturday not long ago, when there was a good crowd in town and I put on a demonstration. In about one hour's time I had sold 12 'SUPERS' and sold 37 in all that day."

Salesman Seward

\$218.00 Profit in Two Days

"I sold and banked \$104 today and on another day I sold and banked \$114."

A. W. Leonard.

Makes Nearly \$200.00 in a Week

"Rush my order first express. My 100 order last week almost gone."

J. A. Perdue.

Sold Six in Two Hours

"I sold six 'SUPERS' in less than two hours tonight. I think it's a pretty good start—for it's the first thing I ever sold."

E. Mangold.

\$1,000,000 Divided Among Our Men

Think of it! A million dollars has actually been made by our agents. Millions more yet to be made. Are you going to get your share? You owe it to yourself to obtain full particulars of our proposition when you can do so without any obligation, by simply sending in the coupon—TODAY.

WEEKS SUPER CARBURETOR CO.
426-1649 ELEVENTH STREET MILWAUKEE, WIS.

Act Now!

WEEKS' SUPER CARBURETOR CO.
426-1649 Eleventh St., Milwaukee, Wis.

Gentlemen: I am interested in establishing myself in a business that will make me independent and want you to send me without obligation complete particulars of your territory plan and FREE SAMPLE offer.

Name.....
Local Address.....
County.....
Town.....
State.....

Mail This Coupon

The New Triple Duty GOLD SEAL HOMCHARGER

\$19⁵⁰
complete



Charges three times faster!
Rejuvenates lifeless tubes •
supplies current for 8-volt power tubes!

It's more than just a battery charger—the new Triple Duty Gold Seal Homcharger Charges radio or auto batteries at a fast 5-ampere rate—three times as fast as most other chargers. Rejuvenates lifeless radio tubes. Can also be used as a light socket power unit—supplies current for operating 8-volt A. C. power amplifying tubes.

With its many exclusive features Homcharger costs no more than ordinary battery chargers. Insist on Homcharger.

“Behind the Scenes in a Broadcasting Station,” an interesting 24-page booklet will be mailed on request together with literature describing the Homcharger.

THE KODEL RADIO CORPORATION

517 E. Pearl St. Cincinnati, O.

Owners and Operators of Broadcasting Station WKRC

Battery Chargers **KODEL** Radio Receivers
Power Units Loud Speakers
POWER SPECIALISTS SINCE 1912

BETTER THAN A SLIDE RULE



Otis King's Patent CALCULATOR

A new instrument with spiral scales that provides the calculating facilities of a slide rule 66 in. long. All the speed of a “slip stick,” with exact readings to four or five significant figures. Easy to operate. Extremely flexible. Can be used for multiplication, division, fractional and decimal conversions, proportions, ratios, powers, roots and other forms of logarithmic calculations. Ideal for “constant-factor” problems. Of highly nicked brass—pocket size—1 1/4 in. diameter by 6 in. long. Leather case. Full instructions included. Priced \$8.00—Sent C. O. D. if desired. Order now—use it for ten days. If not entirely satisfactory, return and money will be refunded in full. A. S. Aloe Co., 1830 Olive Street, St. Louis, Mo. References: Dun's and Bradstreet's. Resources \$1,000,000.



Brushes—

that have the right to bear either or both of these famous names

WHITING'S or ADAMS

on their handles have all the quality, all the finish, and all the balance of perfect tools. Otherwise they would not be the first—and often the only choice—of the vast majority of painters day in and day out.



WHITING-ADAMS BOSTON BRUSH MAKERS FOR 118 YEARS



\$5,000 A Year

Without previous experience selling Surety, the original powdered hand soap, direct to users and dealers. We assure your success. Everyone everywhere demands SURETY, the GENUINE product. Don't waste your time on something inferior but write today for FREE SAMPLE and exclusive territory.

SURETY MANUFACTURING CO.
26 W. Washington St., Dept. 12, CHICAGO

“Red Devil” Glass Cutters



SHOULD be YOURS—the handy “6 Shooter” Red Devil Glass Cutter No. 48. 6 hand honed wheels—a sharp one always ready—5 in reserve. At Hardware and Paint stores.

“It's all in the Wheel”

LANDON P. SMITH, INC.
106 Coit St., Irvington, N. J.



65 Mile Speed for FORDS!

LAUREL Overhead Valve System increases power 50 per cent. Saves Gas and Oil. Gives speed up to 65 m.p.h. to the motor. The “LAUREL” is the original overhead valve system for FORD, Overland and Dodge cars. Easily and quickly installed. Beware of imitations. Thousands of LAUREL Heads in use, fits all FORDS, including new 1927 model. Also LAUREL Racing Heads, Water Pumps, etc. Low prices, easy terms.

LAUREL RADIO SET

Very Low-priced, 5 tubes, coast to coast reception. Embodies latest developments in radio engineering to bring clear, loud reception. Great selectivity. Beautifully finished. Write for literature. Big profits for dealers and agents selling LAUREL Specialties.

LAUREL MOTORS CORP., Dept. M, Anderson, Ind.

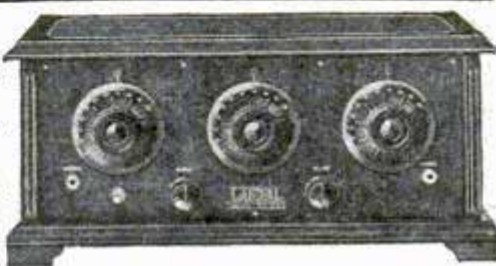

Personal— to all Palmolive Shaving Cream users

GENTLEMEN:

We have developed a new-type talc for you. A talc that takes all that after-shave shine away; yet that's invisible on the face.

A talc that provides the well-groomed appearance gentlemen want, without the "powdered" look that followed old-time talcs.

Please accept a two-weeks trial can to test. Just mail the coupon below.

A new-principle creation

We are experts in skin care, as you know. We make Palmolive Soap, the leading toilet soap of the world. Palmolive Shaving Cream—the most amazing success in its field—is another of our creations.

Palmolive After Shaving Talc is the result of long experiment in the noted Palmolive laboratories. Before offering it to you, we spent some years in perfecting it.

We tried scores of formulas. We consulted skin specialists on what was best for the skin. Then in collaboration with them,

perfected this scientific creation providing two unique features unknown before, we believe, in either talc or powder.

First: It is invisible. Men don't like powder to show. Second: It is a scientific combatant of skin roughness—keeps the skin smooth and soft.

On the market but a short while, thousands of men are making its use a twice a day habit—after shaving in the morning; before dinner in the evening.

We believe it will delight you. Send us the coupon. Do it now. We'll send you a can of this talc, also a 10-day tube of Palmolive Shaving Cream.

3775



TRY IT—FREE

and a 10-day tube of Palmolive Shaving Cream

Simply insert your name and address and mail to Dept. B-1247, The Palmolive Company (Del. Corp.), 3702 Iron St., Chicago, Ill.

Residents of Wisconsin should address The Palmolive Company (Wis. Corp.), Milwaukee, Wis.

Please print your name and address clearly

PALMOLIVE AFTER SHAVING TALC

FREE 1000 Illustrations **ELECTRIC FIXTURE CATALOG!**

Write today for your copy. Save 50% direct from Manufacturer. No Middleman's Profit. **OUR SPECIAL:** 8 Room Electric Set, ready to hang, \$24.50—Other bargains.

UNITED LIGHTING FIXTURE CO.
83 Flatbush Ave. Dept. P, Brooklyn, N. Y.

DARCHE "CALL-ME" ELECTRIC ALARM AND LIGHT CLOCK

Will ring until you get up and STOP it. No home complete without one. Can be used as an "alarm clock" or "mantel clock." With a little effort on your part you can get one.

FREE Our offer tells you how Agents, here is a big money-maker, no competition, sells on sight. A good punch board proposition. Write today for our descriptive literature. An ideal GIFT for any occasion. Mahogany finish. Size 10 1/4 x 8 1/4 x 4. This applies to U. S. only.

Darche Mfg. Co., 645 Washington Blvd., Chicago

The New Sypher No. 10

Biggest lathe value on the market. Length over all 30 in.; between centers 14 in. Swing over bed 7 1/4 in. Includes counter shaft, Bronze taper bearings. Weight 60 lbs. No. 11 Lathe, 40 in., over all; 24 in. centers, 7 1/4 in. swing. Price \$75.00. Time Payments if desired.

\$60

Write today for circular.

The Sypher Mfg. Co. Dept. D Toledo, Ohio

MAKE MONEY QUICKLY

raising guinea pigs, squabs, etc., at home in spare time. Highest prices paid to raisers. Market guaranteed. No experience necessary. Free illustrated booklet.

Mutual Food Products Co., 1459 Broadway, New York

South Bend

No. 20-B Special Lathe

9-in. x 2 1/2-ft. 11 1/2-in. between Centers

Specifications

Swing over Bed 9 1/4 inches, 11 1/2 inches between Centers, Back Geared, Set Over Tail Stock, 1-inch Belt, Length of Bed 2 1/2 feet, Power Required 1/4 H. P. driven from Lamp Socket. Weight 270 lbs.

Countershaft included in price

No. 20-B Special Lathe \$100

No. 20-B is our regular Quick Change Gear Lathe stripped of all extras that are not needed in the small shop. Can be furnished with 3, 3 1/2 or 4-foot Bed—also Compound Rest and Long Legs at slightly extra prices.

Can Do All This Work

—turn Commutators, undercut Mica, turn Pistons, can be fitted with 6-in. Chuck, will bore, drill, etc., can also be fitted with our draw-in chuck attachment, capacity of Collets 0 to 1/2-inch. Write for Folder No. 20-S.

—Easy Payments if Desired—

South Bend Lathe Works
1814 E. Madison Street, South Bend, Indiana

LUMINOUS PAINT

Make Your Watches, Clocks, Etc., Visible by Night The very latest discovery in the scientific world, hitherto, practically unobtainable. LUMINOUS PAINT, which, applied to the surface of any article, emits rays of white light, rendering it perfectly visible in the dark. THE DARKER THE NIGHT, THE MORE BRILLIANT IT SHINES. Quite simple to use. Anyone—you can do it. A little applied to the dial of your watch or clock will enable you to tell the time by night. You can coat the push buttons or switch plates of your electric lights, match boxes, and innumerable other articles; make your own Luminous Crucifixes, Luminous Reserves, etc. Small bottle, price 25c. Larger sizes, 50c and \$1 postpaid.

JOHNSON SMITH & CO., Dept. 587, RACINE, WIS.

Serpent's Eggs Exploding Cigarettes
Box contains 12 eggs. When lit with a match, each one gradually hatches itself into a snake several feet long, which curls and twists about in a most life-like manner.
Price per box, 10c postpaid, 3 for 25c.



CIGARETTE MAKER
Roll your own and save money. Makes them better and quicker besides saving more than half. Use your favorite brand of tobacco. Neat, useful and handy. Pocket size, weighs 1/2 oz. Made entirely of metal, nickel-plated. Price 25c postpaid.

MIDGET BIBLE
GREAT CURIOSITY
Smallest Bible in the World. Size of a postage stamp. 200 Pages. Said to bring good luck to the owner. A genuine work of art. Must be seen to be appreciated. Make good money selling them to friends, church acquaintances, etc. PRICE 15c each, 3 for 40c, 12 for \$1.35, 100 for \$7.50. Also obtainable in Leather Binding, with gold edges. Price 50c each, 3 for \$1.25, \$4.50 per doz. Magnifying Glass for use with Midget Bible, 15c.



STAGE MONEY
With a bunch of these bills, it is easy for each person of limited means to appear prosperous by flashing a roll of these bills at the proper time and peeling off a genuine bill or two from the outside of the roll. The effect created will be found to be all that can be desired. Prices, postpaid: 40 Bills 20c, 120 for 50c, or \$3.50 thousand postpaid.

Wonderful X-Ray Tube
A wonderful little instrument producing optical illusions both surprising and startling. With it you can see what is apparently the bones of your fingers, the lead in a lead pencil, the interior opening in a pipe stem, and many other similar illusions. A mystery that no one has been able to satisfactorily explain. Price 10c, 3 for 25c, 1 dozen 75c. Johnson Smith & Co.

Good Luck Ring
Quaint and Novel Design
A VERY striking and uncommon ring. Silver finish, skull and crossbones design, with two brilliant, flashing gems sparkling out of the eyes. Said by many to bring Good Luck to the wearer, hence its name, Good Luck Ring. Very unique ring that you will take a pride in wearing. ONLY 25 CENTS.

JOHNSON SMITH & CO. Dept. 587 RACINE, WIS.

A De Luxe Edition of our new 1927 CATALOG mailed on receipt of 25c. Handsome binding. Bigger and better than ever. Only book of its kind in existence. 550 pages of all the latest tricks in magic, the newest novelties, puzzles, games, sporting goods, rubber stamps, interesting books, curiosities in seeds and plants, etc., unobtainable elsewhere. Remit by Stamps, Coin, Money Order, Check, etc. Unused Canadian and Foreign Stamps also accepted.



JUST LIKE ORDINARY CIGARETTES, BUT SUCH REAL STARTLERS! The box contains ten genuine cigarettes of excellent quality. They appear so real, but when each cigarette is about one-third smoked, the victim gets a very great surprise as it goes off with a loud BANG! A great mirth provoker yet entirely harmless. Price 25c per box.

Popular Watch Charms
15c
ONLY 3 for 40c; \$1.35 doz.

Very pretty little curiosities and decidedly novel. Fitted with Magnifying Lenses that enlarge the picture to a very surprising degree; in fact, it seems almost incredible that a clear picture could be possible in such a small compass, and how sharp and distinct they show up when you look through. Come in assorted views—Actresses, views of Panama Canal, Lord's Prayer in type, etc.

Mystic Skeleton
A jointed figure of a skeleton 14 in. in height, will dance to music and perform various gyrations and movements while the operator may be some distance from it.
10c & pd.

Novelty Badges
Kissing Permit 10c
Garter Inspector 10c
Two very novel metal badges, nickel plated, that you can wear, giving you fun out of all proportion to their trifling cost. 10c, each badge, 3 for 25c, or 75c per doz. p.pd.

MAGIC FLUTE
Wonderfully Sweet Toned and Musical
The Magic Flute, or Human-stone, is a unique and novel musical instrument that is played with nose and mouth combined. There is just a little knack in playing it which, when once acquired after a little practice, will enable you to produce very sweet music that somewhat resembles a flute. There is no fingering, and once you have mastered it you can play all kinds of music with facility and ease. When played as an accompaniment to a piano or any other musical instrument, the effect is as charming as it is surprising.

Female Sex Indicator
25c
Hold the MAGIC INDICATOR over a man's hand—instantly it moves in a straight line, backward and forward. Hold it over a woman's hand and it describes a complete and continuous circle. The same action can be obtained over a letter written by a man or woman, etc. It is fascinating; baffling. We have never been able to figure out how it's done, but we've never seen it fail. Many novel and entertaining feats may be performed with the Sex Indicator. For example, similar results can be obtained with animals, cats, dogs, rabbits, over birds, chickens, canaries, etc. Also used to predetermine the sex of chickens and birds, etc. In fact it is sold as a patented egg tester in Europe. Price 25c, or 3 for 65c, p.pd.

BLANK CARTRIDGE PISTOL

Protection against Burglars, Tramps & Dogs
Prices 50c \$1.00 Post-paid
Well made and effective; modified on latest type of Revolver; appearance alone is enough to scare a burglar. When loaded it may be as effective as a real revolver without danger to life. It takes standard 32 Cal. Blank Cartridges obtainable everywhere. Price 50c, superior quality, \$1.00 each. Blank Cartridges, by express, 50c per 100. Holster (Cowboy type) for Blank Cartridge Pistol, 50c. Johnson Smith & Co., Dept. 587, Racine, Wis.

BOYS! BOYS! BOYS! THROW YOUR VOICE

Into a trunk, under the bed or anywhere. Lots of fun fooling the teacher, policeman or friends.
THE VENTRILLO
a little instrument, fits in the mouth out of sight, used with above for Bird Calls, etc. Anyone can use it.
Never Fails. A 32 page book on ventriloquism, the Ventrillo, ALL FOR 10 CENTS

K.K.K.
Everything about the Ku Klux Klan told in a clear, fearless manner. Book tells all—How it started and was oppressed in 1871—The New Ku Klux Klan—How Organized—How Members are Enrolled—Oath of the Klan—Questions for Candidates—Creed—Objects of the Order—Obedience—Fidelity—Pledge of Loyalty—Ku Klux Klan and the Masons—The Jews—The Masons—Real K. of C. Oath—The Negro Ku Klux Klan, etc., etc. Latest and most complete book on the Klan published. Price 35c, Postpaid. Stamps or Coin

PISTOL, OPERA & FIELD GLASS

PRICE POSTPAID, \$1.00
LOOK!

It is made in the shape of and looks like a regular Automatic Pistol. No one is likely to stop and ask you whether it is real or not. Thus it is likely to prove itself very handy in an emergency. On pressing the trigger it opens up, as shown in the illustration at the right, revealing nine most useful articles—Opera and Field Glass, Telescope, Mirror, Magnifying Glass and Burning Lens, Reading Glass, Sun Dial, Sun Compass, etc. In the handle of the revolver there is a place for various pocket necessities, such as First Aid Articles, Buttons, Pins, etc. The Pistol is of sheet metal, blued finish, that can be carried comfortably in pocket. PRICE \$1.00.

HOT DOG! SENSATIONAL NEW NOVELTY
It is made of rubber like a small balloon. Contains a curious chemical that acts in a most remarkable way. Squeeze the deflated balloon with the hand and it suddenly becomes quite warm and fills itself up with air. It is SELF-BLOWING. Play all sorts of jokes with it. Lay it on a chair; place it secretly underneath anyone; under-neath anyone's pillow; drop it in someone's pocket, and after a short time, when friction causes the chemicals to act, a large and superbly colored balloon develops. Each Hot Dog in a small box. Quite harmless, but loads of fun. 15c, each, 3 for 40c., \$1.35 doz. postpaid.

Female Sex Indicator
25c
Hold the MAGIC INDICATOR over a man's hand—instantly it moves in a straight line, backward and forward. Hold it over a woman's hand and it describes a complete and continuous circle. The same action can be obtained over a letter written by a man or woman, etc. It is fascinating; baffling. We have never been able to figure out how it's done, but we've never seen it fail. Many novel and entertaining feats may be performed with the Sex Indicator. For example, similar results can be obtained with animals, cats, dogs, rabbits, over birds, chickens, canaries, etc. Also used to predetermine the sex of chickens and birds, etc. In fact it is sold as a patented egg tester in Europe. Price 25c, or 3 for 65c, p.pd.
JOHNSON SMITH & CO., Dept. 587, RACINE, WIS.

Send only \$100 with Order



**WRIST WATCH
4 DIAMONDS
4 SAPPHIRES**

FR6—Special offer in lady's wrist watch; solid 14 Kt. white gold band engraved case set with 4 genuine diamonds and 4 French Blue Sapphires; 16 jewel movement. Lifetime guar. **\$39.75** antec.



FR7—Newest design, lady's 18 Kt. solid white gold mounting set with large size sparkling blue white genuine diamond. Unusual **\$56.75** value.



FR8—Exquisite dinner ring, 18 Kt. solid white gold mounting beautifully hand pierced; set with 6 fiery, genuine diamonds and 2 French Blue Sapphires. **\$56.75** Special.

**A full year to pay
All transactions strictly confidential
10 DAYS FREETRIAL**

Pin only \$1 to your order, and your choice comes to you parcel post prepaid on 10 Days FREE Trial. Then pay postman only \$1 more on delivery, and after free trial pay balance in 12 equal monthly payments. Satisfaction guaranteed or your money back.

**FREE
"Royal Book of Gems"**

Thousands of special values in genuine diamonds, watches and jewelry illustrated. Your copy sent immediately on request.

No interest, no extras

ROYAL DIAMOND & WATCH CO.
ESTABLISHED 1895
ADDRESS DEPT 1672, 170 BROADWAY N.Y.

**LATEST CATALOG OF
NEWEST PARTS AND KITS**

RADIO FREE

Fresh from the press. Shows all the newest standard parts and kits at big savings. Most complete line in America.

Send name and address, also name of friend. Send at once.

BARAWIK COMPANY, 102-168 So. Canal St. ILL.

THE WOTEN GASOLINE ENGINE 2-cycle 3-port

Air-cooled—Water-cooled. One H. P. in 20 pounds. Handiest little engine ever made. Ideal wherever power is needed. Also the Metalumen Model Airplane Engine, one-half H. P. in 3 1/4 pounds. The market demands them in thousands. Generous agency propositions on request. Complete line of small gasoline and steam engines, battery chargers, etc. Catalogue Free.



DYNAMIC MANUFACTURING CO.
First Nat'l Bank Bldg., Dept. 7, CHICAGO

Agents Wanted!

SALESMEN—DISTRIBUTORS

to use and introduce attachment that makes Fords run on 94% air. THERMOSTAT on exhaust automatically turns down needle valve as engine warms, exactly as Ford Manual says do by hand.



BLANCHE AUTO THERMO
An Automatic Carburetor Control

Makes Fords start easier winter or summer—saves half gas and oil—cuts repair bills one-half—reduces carbon formation one-half. Sells on sight to every Ford owner as easily as giving him a \$100 bill, because it saves \$100 every 10,000 miles. Cadillac now uses as standard equipment thermostatic carburetor control under Blanche license. You can make Big Money selling this wonderful proven device. Experience not necessary. Blanche plan will start you without capital in a business of your own that makes you from \$250 to \$2,000 a month profit.

Write for free circulars Now!

BLANCHE AUTO DEVICES CO.
247 E. Illinois St. Dept. 805 N., CHICAGO

Pay Nothing Until November 15th Then Only \$10 a Month!

We will send you a Bulldog Pipeless Furnace for free inspection. If you want it, pay nothing until November 15th. Then pay only \$10 a month at our amazingly low price. Don't consider buying any furnace until you find out about the Bulldog. Write today.

Comes Completely Erected!



BULLDOG PIPELESS FURNACE

2 1/2 Tons Heats 5 Rooms!

"There is no heater to compare with the Bulldog. I burned 2 1/2 tons of coal last winter and heated 5 rooms and bath."
—Walter Geary, Gloucester, Mass.

That's what the Bulldog does with coal! Here's what it does with about the lowest grade of fuel you can think of!

"I can run my Bulldog Furnace steady for fourteen days in normal weather conditions on the actual cost of 50 cents." So writes F. R. Redetzke, of Cleveland, North Dakota, and he adds: "Hard to believe, is it? That's what some of my neighbors thought until I showed them! We have an unlimited amount of green screenings in this country. That's the fuel I am using."

Write! Send today for our free book and "Pay Nothing Now" offer — also get the wonderful record of Bulldog Success. Factory connections in both East and West. We ship from nearest point. Get ready for winter NOW! Mail this coupon TODAY!

Bulldog Furnace Co.

Babson Bros., Sole Distributors
19th and California Ave., Dept. 13-57 Chicago, Ill
Without obligating me in any way please send me your free catalog and special offer on the Bulldog Pipeless Furnace.
(Print name and address plainly.)

Name _____

Address _____

HOT—HOT—HOT—HOT—HOT—HOT—HOT—HOT—HOT—HOT—HOT—HOT

A Lot Hotter And Absolutely Safe

The mechanic or the handy man wants heat he can depend on—steady, unfailing in wind or intense cold—yet perfectly controlled. The "man who knows" always insists on the

TURNER BLOTORCH
Safe as a candle

MASTER No. 45



They are a lot hotter—400° more heat, even with the inferior gasoline or kerosene of today.

And as for safety—they simply can't blow up. The patented, exclusive safety release prevents excess pressure, and leakage is impossible. The Turner Master No. 45 Blotorch is the aristocrat of the "heat machines."

IT IS FEARLESSLY GUARANTEED

Ask your supply house or hardware man for a

Turner Master No. 45 Blotorch \$7.75
and refuse all substitutes—or mail the order with remittance, \$7.75, direct to us and we will send torch postpaid.

POST PAID

THE TURNER BRASSWORKS
Industry Ave., Sycamore, Ill.

SAFE—SAFE—SAFE—SAFE—SAFE—SAFE—SAFE—SAFE—SAFE—SAFE



PLAY THIS HAUNTING "JAZZITHA" The one string Hawaiian O Guitar

Have you seen the latest Jazz instrument? Everybody is talking about the curious, unusual "Jazzitha." If you hear it you will want to own one.

The simplest instrument in the world to play. Absolutely no instructions or lessons necessary. Music is written in numbers. The numbers on finger board correspond with Music numerals. "Boy"—what Music! In ten minutes you'll have everybody stepping. If you want your friends to sit up and take notice get yourself a "Jazzitha." Take it wherever you go. You're sure to have the time of your life. Be original—be the first one in your "crowd" to introduce this weird Jazzitha. Play all the latest song hits.

The Jazzitha is made of fine grained hard wood with specially designed metal sound box. Handsomely decorated and beautifully finished in lacquer—19 inches in length—played with bar and pick.

\$1.47

Send No Money

Just your name and address when Jazzitha and sheet music arrive, pay postman only \$1.47—plus a few cents extra for postage.

FREE—with every instrument we will include 3 extra Jazzitha strings worth 25c.

JUST OUT Book of 5 Latest Song Hits, written in numbers... 25c

THE JAZZ STUDIOS

2512 41st Ave., Dept. 500, LONG ISLAND CITY, N. Y.



WHAT MOVES ANDY'S EARS?

What makes Andy's ears, eyes and nose move? A real mystery. Your friends will never know what makes Andy wiggle so. It's a secret—lift one end of stick tape and put in a live fly. The fly causes the movement. Made of heavy cardboard and lithographed in bright colors. 4 1/2" mounted on stand, 3" wide.

Each..... **35c**

MYSTIC CHINESE RING

Lucky charm ring, said to protect wearer from harm and bring good luck. Unique design. Heavily silver-plated. Split shank fits any finger.

Each..... **25c**



INVISIBLE INK

Can't be seen unless you know the secret—makes no mark! Great fun for jokes; invaluable for confidential messages, postals, etc. 3 for 40c.

Per bottle, only..... **15c**

CAT CRY

Colored rubber-cloth pocket voice bellows. Makes sound startlingly like real cat. Brightly decorated. Dandy souvenir, toy or favor. 3 for 20c 50c. Each... **20c**

SQUIRT ROSE

The flower in your coat looks so fresh. Every one is tempted to inhale the delightful perfume. Then press the bulb. Geewhillikens! How they jump! Long rubber tube easily reaches pocket of coat or trousers; bulb large enough to make a dozen shots with one loading.



Each **25c**, or 3 for 65c.

Prompt shipment, prepaid. Stamps accepted.

Dan Taylor & Co. Dept. 210, 1418 Vine St. CINCINNATI, OHIO

Include 10c extra and ask for catalog of latest magic, puzzles, plant curiosities, wonderful novelties, etc., otherwise unprocureable. Remit by money order, check, coin or stamps.

GET YOUR SLICE OF BIG PROFITS

with this amazing new



DOUBLE EDGED RAZOR BLADE PARING KNIFE

The fastest selling home necessity ever offered. Sells for 25c. Your price \$1.50 dozen, prepaid. Guaranteed.

MORGAN MANUFACTURING CO., 440 S. Dearborn St., Dept. G, Chicago

Information on any book free. Write Popular Mechanics Press, Chicago, Ill.

HOTTER THAN COAL

—and no dirt



Do away forever with the drudgery of wood or coal. The most simple and economical invention on the market is now giving perfect satisfaction to enthusiastic users everywhere. The OKAY Oil Burner fits in the fire box of your furnace or stove. Installed in a few minutes. Burns 96% air and 4% cheap oil (Distillate). No noisy motor or complicated parts. Simply turn one valve and you have all the heat you want. Cleaner and better for heating and cooking.

30 Days FREE Trial Offer

Try this wonderful OKAY Oil Burner right in your own home at our risk. Act quick and get our special low introductory price. Sold under absolute money-back guarantee. Write at once for free booklet on home heating.

AGENTS—Our men are making big money introducing OKAY Oil Burners. The demand is enormous. We want spare or full time workers immediately. If \$500 a month and more interests you, write or wire us for our protected territory offer.

OKAY MANUFACTURING COMPANY
Dept. 174 East St. Louis, Ill.

Look *sent on* Approval

Adjusted to the Second
 Adjusted to Temperature
 Adjusted to Isochronism
 Adjusted to Positions
 21 Ruby and Sapphire Jewels
 25 Year Gold Strata Case
 Your choice of dials
 (Including Montgomery R. R. Dial)
 New Ideas in Thin Cases

The *21 Jewel* Santa Fe Special

We will send this famous watch, express prepaid, for you to examine, to inspect, to admire, to approve without one penny advance payment. Examine the watch and be convinced it's the best watch buy you ever saw. Just a small payment down, the balance in easy MONTHLY payments. You use the watch while paying for it.

Save 1/3 to 1/2 of Your Money

By purchasing this Famous Santa Fe Special Watch. Not only are you saving money from the present day prices of watches, but you can still secure the "Santa Fe Special" Watch, at the same low prices and terms that have made our watches famous.

Ladies' Wrist Watches

Artistic, dependable ladies' wrist watches—perfect timepieces, beautiful hand engraved cases in white or green gold. Send for New Watch Book and see the new shapes and designs. Sent on approval and sold on payments.

Write for "Santa Fe" Watch Book

Clip the coupon, fill out and receive the FREE WATCH BOOK just off the press. All the newest watch case designs in white or green gold, fancy shapes and thin models are shown. Read our easy payment offer. Wear the watch 30 days FREE. Watch sent for your examination and approval without a penny down. Nothing to risk. See the watch before you buy.

Write for New Book Today and Select Your Watch.
 Mail Coupon.

SANTA FE WATCH COMPANY

A 6 Thomas Building, Topeka, Kansas
 (Home of the Great Santa Fe Railway)

A Limited Offer!

With every Santa Fe Special, a beautiful gold chain or strand of exquisite pearls.

FREE

Write while offer lasts.

FREE BOOK COUPON

Santa Fe Watch Company
 A 6 Thomas Building,
 Topeka, Kansas.

Please send prepaid and without obligation your New Watch Book Free, explaining your "No Money Down" Offer on the Santa Fe Special Watch.

Name.....

Address.....

State.....

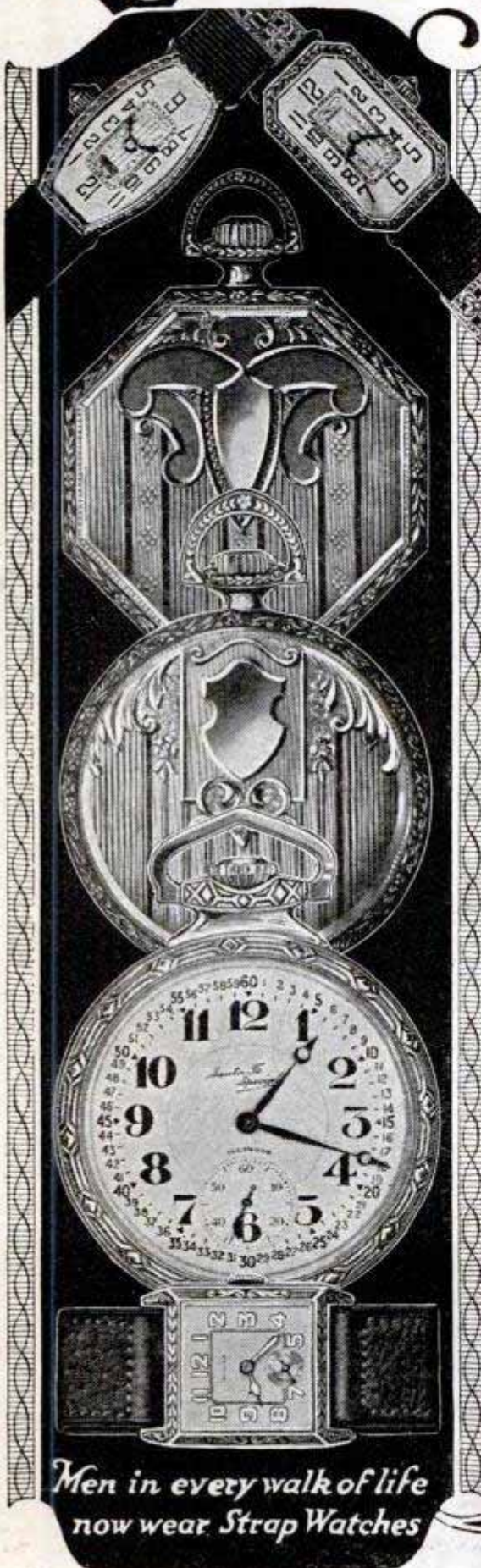

Men in every walk of life
 now wear Strap Watches



Patented
Dec. 8, 1925 . .
Others pending

Motorize your Workshop with an Electric Drill

A GOODELL-PRATT Electric Drill will double the joys of your workshop.

Besides being efficient, powerful machines for fast drilling in wood or metal, they are in reality portable power plants that any ingenious craftsman can adapt to drive light lathes, bench saws, polishing and grinding heads, jig saws, bench planers, etc.

Just think of the innumerable possibilities

such a shop offers. How much more fun you can get out of it with power-driven equipment to do the roughing out and uninteresting parts of your work.

Goodell-Pratt Electric Drills are made in six sizes with Universal Motors for either Alternating Current or Direct Current at 110 or 220 Volts.

Write for descriptive folder and prices.

The Goodell-Pratt Electric Drill is made in

1/4 Inch Heavy Duty
3/8 Inch Heavy Duty

1/2 Inch Light Duty
1/2 Inch Standard

1/2 Inch Heavy Duty
3/8 Inch Heavy Duty

Powerful motor; long, patented, high-speed, self-oiling armature bearings; wide-faced, specially heat-treated gears that run in bronze bearings; new self-tightening chuck; ample ventilating system; quick accessibility of all parts; handy switch control and absolute cleanliness—these are some of the improvements that make the Goodell-Pratt Electric Drills truly remarkable in performance and wonderfully free from trouble.

GOODELL-PRATT COMPANY, GREENFIELD, MASS., U. S. A.

MAKERS OF *Toolsmiths* MR. PUNCH

GOODELL-PRATT

1500 GOOD TOOLS



SM

PARTS THAT ARE BETTER

INTERCHANGEABLE COILS

Designed for extremely low losses and permanent uniformity. Space wound with enameled wire upon threaded moulded bakelite forms and sold under a guarantee of accuracy of less than one-half of one percent. Made in several models—for use wherever the best in coils is required—and in a variety of ranges from 18 to 1500 meters. Prices, \$2.50 to \$3.25 each, depending upon type. Universal 6 contact socket, \$1.00. Send for descriptive circulars.



Plug-In Coils

220 AND 221 AUDIO TRANSFORMERS

S-M 220—the big, husky audio transformer you hear in the finest sets — the only transformer with the *rising* low note characteristic that means real quality—not only on paper—but when you hear it. It is a power job—yet this finest of audio amplifying devices is sold, with a guarantee, for but \$6.00.

The S-M 221 is an output transformer that will bring out the low notes on your present set. Used between the last audio tube and the loud speaker—it eliminates blasting and will increase speaker capacity for handling strong signals without distortion. \$6.00.



220 and 221

210 AND 211 LONG WAVE TRANSFORMERS

Accurately measured and tested. Actual amplification to the fraction of one percent is predicted in the tests that these transformers have to pass. Type 210 is an untuned iron core transformer and the 211 a Sharply air core filter. Available peaking at any frequency between 40 and 65 K. C. for 199 or 201A tubes, price \$6.00 each.



210 and 211

631 STAGE SHIELD

An aluminum shield, $7\frac{1}{2}$ by 5 by $3\frac{3}{4}$ inches—for oscillator, detector, R. F. amplifier and other circuits. Pierced for a condenser, coil socket, tube socket, choke, bypass condensers and lead wires. It opens at the bottom allowing easy wiring and the top seals it tightly from outside interference. May be used in any standard circuit to improve results. \$2.00.

See them at your Dealer

SILVER-MARSHALL, INC.

840 WEST JACKSON BLVD.

CHICAGO, U. S. A.

"I could almost shave with this"



IT'S the cutter of chromium steel from the Sargent Auto-Set Bench Plane. Keen. Edge-holding. Easy to sharpen when necessary because of the exclusive Auto-Set feature. This permits cutter to be removed and replaced in a jiffy without changing original adjustment.

Sargent Auto-Set is the most convenient all-round plane you can use. Designed and built primarily for professional use, it has also been enthusiastically welcomed by manual training students and instructors and by folks with

SARGENT & COMPANY, Manufacturers, 49 Water Street, New Haven, Conn.

home workshops. Its simplicity will save you time and fussing. It is so strongly built of finest materials that you may never have to replace it.

Sargent Steel Block Plane should also be on every school and home work-bench for the smaller jobs and for finishing. As in all Sargent Planes, its cutter is of chromium steel, placed at a low angle; it is particularly fitted for end work. See Sargent Planes at almost any good hardware store, and write us for interesting booklet.

SARGENT PLANES



*Sargent Steel
Block Plane
No. 5206*

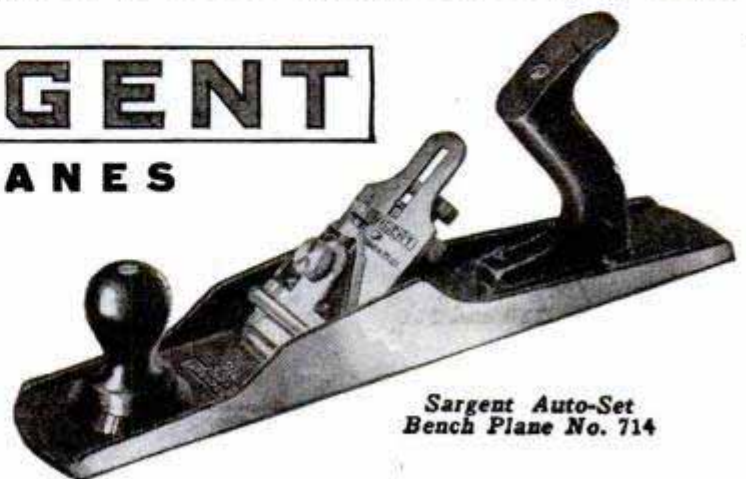

*Sargent Auto-Set
Bench Plane No. 714*

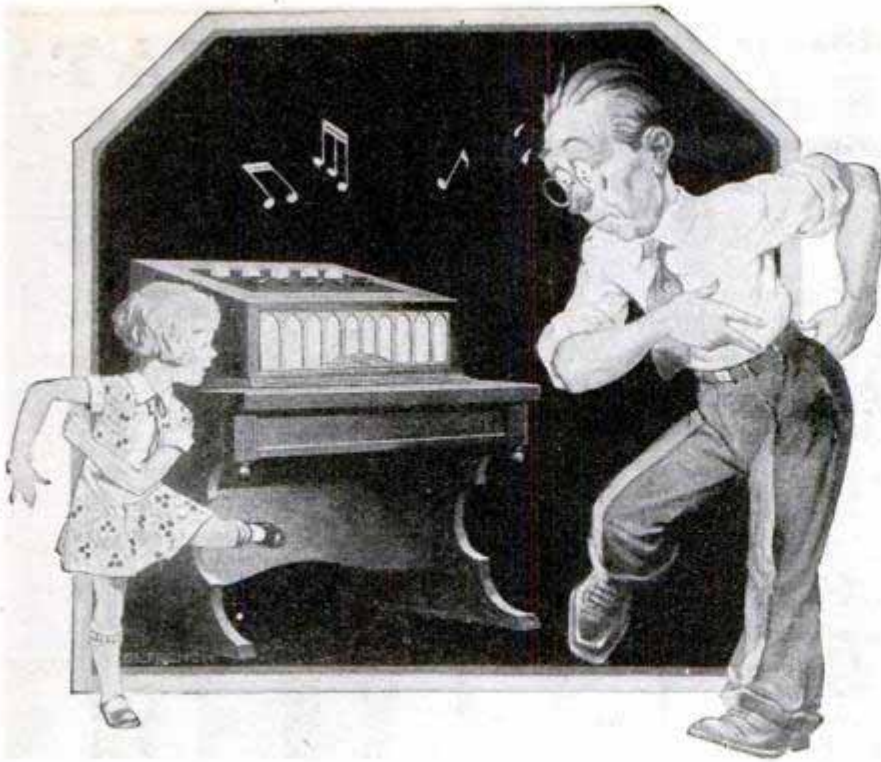

Some People Will Never Learn —The Truth About Radio

MANY a new radio will perform perfectly. Whether it continues to do so or not will depend entirely on one thing—the very truth that is seldom discussed.

Do you drive a car?

Don't little troubles happen occasionally?

Do you depend on a handy man for service or do you prefer a mechanic who has been factory trained on *your* make of car?

Experience has, no doubt, proven to you that men who know *all* about *all* makes of cars generally don't make the best mechanics to work on *your* car.

You wouldn't think of buying any car, no matter how low its price, unless you knew you could receive service by men who know how.

Treat the purchase of a radio instrument in exactly the same manner if you wish lasting satisfaction.

Service is just as necessary, just as important on a radio instrument as it is on an automobile.

Occasionally little things will go wrong. They will be serious to you and almost as serious to the handy man who can fix all radios but—

Such troubles will mean just a few seconds' time to a factory trained service man who knows that make of radio as he should.

While radio is rather a new industry, even now there are 4364 factory trained Ozarka service men—let us give you the name and address of the one nearest you.

Allow him to set up an Ozarka in your home.

He will let you do all the tuning so that you can satisfy yourself as to exactly what it will do for distance, volume, tone and ease of tuning.

His factory training enables him to keep every Ozarka which he sells, working just as it did when new.

Any radio, no matter what its price may be, will only be as satisfactory as the trained service behind it.

OZARKA

INCORPORATED

120 W. Austin Avenue C

CHICAGO, ILL.

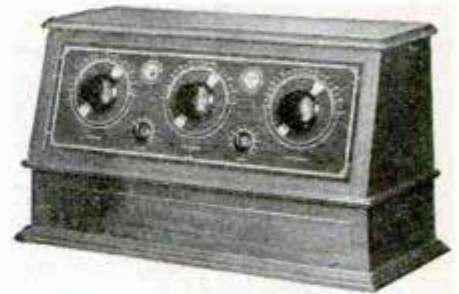

\$132⁵⁰ Plus installation and transportation; Ozarka Senior 5 Tube Model complete with Loud Speaker and all accessories.



\$100 Plus installation and transportation Ozarka Junior 5 Tube Model complete with built-in speaker and all accessories.

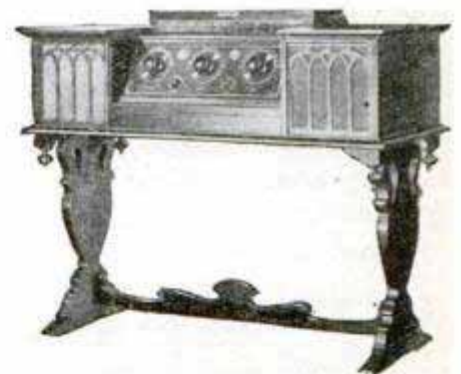

\$215 Plus installation and transportation Ozarka Console 5 Tube Model, solid walnut cabinet, complete with all accessories.

We have a few Openings for the Right Men

WHILE there are today 4364 Ozarka representatives, some territory is still open. We want men who believe in the future of radio—men who are tired of working for some one else—men who would like to add to their present income by devoting their evenings to Ozarka.

At the start, you can keep your present position. Later on, after you have proven what you can do, then you will give us all your time because it will pay far more than your present position.

The man we want may not have much money but he is not broke. He has lived in his community for some time—he has a reputation that his word is good. He may not have made any startling success but he has never "put over something" just to make money. He may know nothing about radio or salesmanship but he will be successful if he is willing to study what we are willing to teach him, without cost.

The field in radio is wide open for the trained man. The success of the 4364 Ozarka representatives proves what men can do. If you are interested, ask for a copy of the Ozarka Plan, a 108 page book which tells a true story of how big money and a permanent business can be built in radio.



THE WONDERFUL "SAFETY FIRST" HEATER

The cheapest, cleanest, most efficient method of producing heat known to science! For heating garages, filling stations and small homes. Absolutely safe under all conditions, even in a room filled with gas. The SAFETY FIRST HEATER automatically makes and burns a blue flame gas of high heating efficiency from common kerosene (coal oil), costs less than dirty coal and is cheaper to install than an ordinary coal stove. An ornament wherever installed. Send for descriptive circular.

GLORIA LIGHT COMPANY 111-10 North May Street
CHICAGO, ILL.



OIL HEAT
INCANDESCENT
ROTATING FLAME
**THE HI-LO
OIL BURNER**

in your heating plant (Hot Water, Steam or Hot Air) will automatically and economically maintain the desired temperature under all weather conditions. The simplest, most efficient yet lowest priced Oil Burner in the field.

Responsible Distributors Wanted.

Shoot the Best Gun

The NEW BENJAMIN is the finest air rifle ever made. Unlike all others. Has amazing accuracy—shoots hard and far. It's the original American genuine AIR operated rifle. One to six pump strokes compress air to any desired degree of power. Same force as in air drills and air hammers except you control the shooting force. Never loses force—no springs or levers to get out of order. Makes crack shots quickly, inexpensively. Gives years of delightful recreation with utmost safety. At your dealer's, or sent postpaid for \$5.00.

Shoot 5 Days FREE

We give you five days, ammunition supplied, to test the NEW BENJAMIN. If in this time you don't believe it to be the finest air rifle you've ever seen or used, and if you don't believe it is the one and only air rifle for you, return it, postpaid, and your money will be refunded at once.

The NEW BENJAMIN AIR RIFLE

America's Original Air Rifle

\$5 at your dealer's or sent postpaid direct from factory on FREE Trial as above if dealer does not handle it—write for our wonderful offer.

Get This Book and Details FREE

BENJAMIN AIR RIFLE & MFG. CO.
635 N. Broadway, St. Louis, Mo.

Please send your amazing offer and free copy of "The Shooter's Art," telling how to become a crack shot, how to hold, aim, and handle guns and guide others in use of guns.

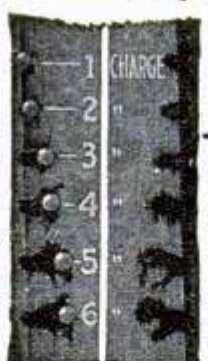

Name _____
Address _____

DEALERS

Lowest Wholesale
RADIO Prices

Immediate deliveries from our tremendous stock of new, up-to-date radio sets, kits, parts and supplies. Write on your business letter head for free copy of our 1927 catalog.

Columbia Radio Corp.
711 W. Lake St. Dept. 303
CHICAGO, ILL.



Real MOVIES

—Make them yourself with
**VICAM Standard
MOVIE CAMERA**



Camera, Tripod, Projector and 2 Magazines Complete outfit for taking and showing standard size pictures. Equal to biggest cameras. Loads in daylight. Projects on wall or sheet.

\$37

Send 10c in Stamps for illustrated BOOKLET
VICAM PHOTO APPLIANCE CORPORATION
1224 Belmont Avenue, PHILADELPHIA

FORD OWNERS

This is Lane's Unique Ratchet Socket Wrench Set, especially made for you, **\$25.00**

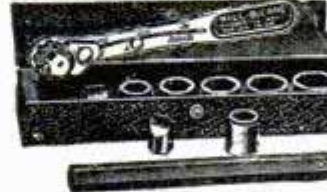

Consists of 7" Drop-Forged Unique Reversible Ratchet Wrench, 6" Extension Bar, 2 Screw Driver Bits and 6 Guaranteed Hardened Sockets 1/2", 3/4", 5/8", 11/16", 3/4", and 7/8" openings. Fits all hexagon cap screws and nuts on Ford Cars. Replacements Free. Also descriptive circular of complete line of Unique Ratchet Socket Wrench Sets. Representatives wanted everywhere to handle our complete line. Liberal commission.

Lane Unique Tool Co., Dept. P. M. 10, 422 S. Dearborn St., Chicago

MAKE MONEY EVENINGS

Let me show you how 4364 men, without experience add \$25 to \$75 weekly to their income without giving up their present position.
A. T. FISCHER, 122 W. Austin Ave., Chicago, Ill.



150 TO 300 MONTHLY FROM ONE DAY BATTERY CHARGING

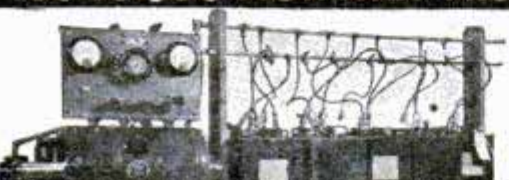

Start a Big Profit-Making Business of your own—"One Day Battery Charging." Requires small space and practically no investment. Anyone can successfully operate. Charges batteries in 1/2 the usual time at 1/2 the cost. Every car owner a customer. The HB One Day Battery Charger will pay for itself on easy monthly payment plan with practically no expense to you—and bring you a handsome profit besides. Write for full particulars in Bulletin M. NOW!
HOBART BROS. CO. Box M-100 TROY, OHIO

**30
DAYS
FREE
TRIAL**
ON ABSOLUTE
MONEY BACK
GUARANTEE

ONLY \$16 MONTHLY—MORE THAN PAID BY INCREASED PROFITS



Follow this Man!

Secret Service Operator 38 Is on the Job

Follow him through all the excitement of his chase of the counterfeit gang. See how a crafty operator works. Telltale finger prints on the lamp stand in the murdered girl's room! The detective's cigarette case is handled by the unsuspecting gangster, and a great mystery is solved. Better than fiction. It's true, every word of it. No obligation. Just send the coupon.

FREE The Confidential Reports No. 38 Made to His Chief

And the best part of it all is this. It may open your eyes to the great future for YOU as a highly paid Finger Print Expert. More men are needed right now. This school has taken men just like you and trained them for high official positions. This is the kind of work you would like. Days full of excitement. Big salaries. Rewards.

Earn \$2500 to \$10000 a Year *You study at home in spare time*

No advance education is needed. Any man who can read and write, and think can make good. A wonderful book tells all about what others have done. Shows pictures of real crimes and the men who solved them. We'll send you a FREE copy with the free reports. Get the special offer now being made. Mail the coupon.

UNIVERSITY OF APPLIED SCIENCE
1920 Sunnyside Ave., Dept. 93-57 Chicago, Illinois

UNIVERSITY OF APPLIED SCIENCE

1920 Sunnyside Ave., Dept. 93-57 Chicago, Illinois

Gentlemen:—Without any obligation whatever, send me your new, fully illustrated Free book on Finger Prints and your offer of a FREE course in Secret Service Intelligence and the Free Professional Finger Print Outfit.

Name.....

Address.....

.....Age.....

A·B & C Radio Power from your light socket

SILITE

TRICKLE CHARGER

.6 ampere charging rate.
Absolutely noiseless—no
bulbs—makes a power unit
of your battery.

\$10.00

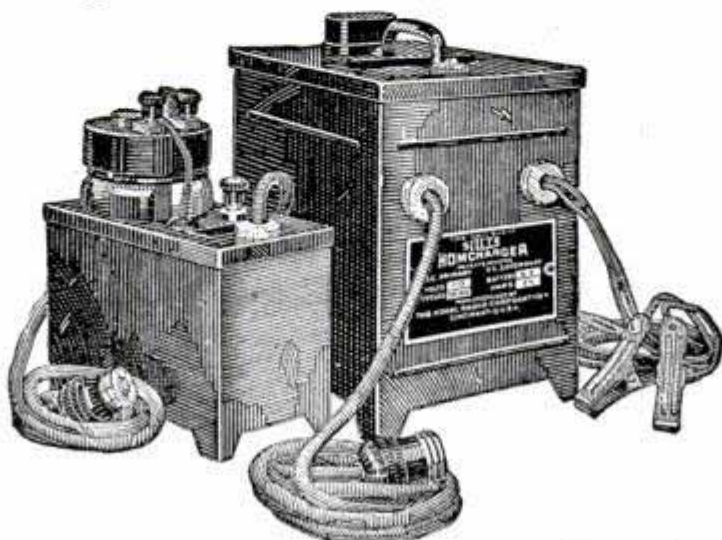

SILITE

HOMCHARGER

Charges at 2½-3 ampere.
Absolutely noiseless—no
bulbs—can be used while
set is operated.

\$19.50

Your battery troubles are over at last! Now ALL radio power is in your light socket, for ALL circuits, A, B, and C.

Silite, the marvelous new metallic glass rectifying element, provides perfect rectification of light socket current into "A" battery power. Leave the Silite Trickle Charger permanently connected to your storage

battery and on charge—then forget battery charging forever. Silite Trickle makes a power unit of your battery—insures constant, never-falling "A" current that operates your set at highest efficiency. For very large sets, where a higher charging rate is necessary, Silite Homcharger is recommended. Either model may be used while the set is operated.

Kodel A&B Transifiers

Kodel A and B Transifiers actually supply all A, B, and C current direct from the light socket—no batteries of any kind are needed. Just plug the Transifiers into the wall socket and turn on your receiver—smooth, uniform A, B, and C power operates your set as it has never operated before. Watch the new life, new pep it gives your set—the longer range, the much greater volume. Transifiers give quiet, noiseless reception that was never

before possible, even with fresh, new batteries.

Vastly different from and superior to the ordinary power units, Transifiers consume electric current only while you operate the set—maintenance cost is much less—it costs less than one-half cent for every hour the set is operated, for all A, B, and C power.

Ask any radio dealer to show you the Silite Chargers and Kodel Transifiers.

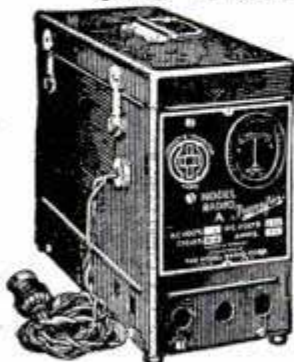

MODEL 10 "A" TRANSIFIER—Supplies 2, 4, or 6-volt "A" current direct from the light socket. For sets using up to 10 tubes \$42.50

MODEL 10 "B" TRANSIFIER—22½ to 150 volts "B" current; 4 to 10 volts "C" current for any size set. Operates power tubes \$42.50

MODEL 61 "B" TRANSIFIER—22½ to 90 volts noiseless "B" power for sets up to 6 tubes \$28.50
(Bulbs extra)

["Behind the Scenes in a Broadcasting Station" an interesting 24-page booklet, will be mailed free on request, together with literature describing Silite Chargers and Kodel Transifiers.]

THE KODEL RADIO CORPORATION

517 E. Pearl St. • Cincinnati, O.

Owners and Operators of Broadcasting Station WKRC



Battery Chargers
Power Units

KODEL

Radio Receivers
Loud Speakers

POWER SPECIALISTS SINCE 1912

Just Out! **30 Days FREE TRIAL** *1927 Models*



ON ANY



**1-Dial
5-Tube
\$55.00
Retail Price**

Westingale **RADIO**

**2-Dial
5-Tube
\$47.00
Retail Price**

NOW!—after months of painstaking work, designing and testing, these two brand new 1927 Westingale Radio Models are ready for you to try. New and far better in performance. Newer and much simpler in construction and control.

They are the last word in every way,—the finest, most up-to-date Radio Receivers on the market, embodying every new feature—and priced at just about half the usual cost.

Why not have the NEWEST Radio? Why pay high prices? Why take chances when you can put either of these last minute Westingale Models in your home for 30 Days' Trial on the absolute guarantee that if you don't find it the most beautiful and the most satisfactory Radio set for the money, you have ever seen or heard—you don't have to keep it.

The Last Word in Guaranteed Radio Sets and the Biggest Values Ever Offered

Agents Make Big Money

We want agents in every locality to demonstrate and take orders for these amazing, low-priced, last-minute Westingale Radio Models. The easiest kind of work. Just like play. Quick sales and big profits. No radio experience necessary,—we show you how. This is your chance to get into the RADIO business for yourself without capital. Build a money making business of your own or a profitable side line in your spare time.

\$50 to \$100 a Week—Easy FULL OR SPARE TIME

No home is complete without a good radio. Millions will be sold this fall. Get a Westingale set on 30 Days' Trial,—use it as a demonstrator and get your share of these profits. Demonstrate to your neighbors and friends, and see how the beautiful appearance, simple control, powerful performance and remarkable low price of Westingale models make them sell on sight.

Your Own Radio FREE

We also have a plan whereby you can put a Westingale set in your home on 30 Days' Trial and make enough demonstrations in your spare time to get your own set without cost before the trial period is up.

Special Discount to Agents

To quickly introduce these two wonderful new 1927 Westingale Models we are offering, for a limited time, a big reduction, way below retail prices on the FIRST Westingale outfit placed in each community. Don't wait. Be first in your locality and mail the coupon or a post card today for our FREE Radio catalog, special discount offer and full particulars.

Westingale Electric Company
Dept. 15 1751 Belmont Ave., CHICAGO, ILLINOIS

Big—Powerful—Dependable 5-Tube, Coast to Coast Sets

Every late feature,—every new, worth-while idea is built into these two 1927 Westingale Models—yet 15 unnecessary parts and many feet of useless wiring have been discarded to simplify—improve—perfect them and eliminate your radio troubles. All we ask is a 30-Day Trial at our risk to convince you that this ultra simplicity really puts Westingale Radios years ahead of all others in powerful reception,—wonderful loud, clear tone—dependable service and EASY control.

The Utmost in Distance, Volume and Attractive Appearance

Built in the new style, big, massive, period type cabinets, hand rubbed brown Walnut finish. The front panels enhanced with a beautiful Renaissance design, embossed in dull gold, these new Westingale Models are as pleasing in appearance as they are in performance. Either the 1-Dial or 2-Dial Model will reach out and bring you music, concerts, speaking, sports or market reports from hundreds of broadcasting stations all over the country with enough volume to fill your home. Unbeatable for performance, appearance or price.

Don't buy a radio until you get our FREE Catalog which fully pictures and describes these two newest of all radio models and explains our 30-DAY TRIAL OFFER. Don't wait—a special introductory discount for those who write quick. Mail the coupon today. Get posted before you buy.

Mail Today—Don't Delay

WESTINGALE ELECTRIC CO.
Dept. 15—1751 Belmont Ave.,
Chicago, Illinois

Please send me your FREE Catalog on the new 1927 Westingale Radio set. Also full particulars of your Special Discount offer on the first outfit placed in each community.

Name.....
Address.....
.....

**30
DAYS
FREE
TRIAL**

7 Tube Set Single Dial Radio

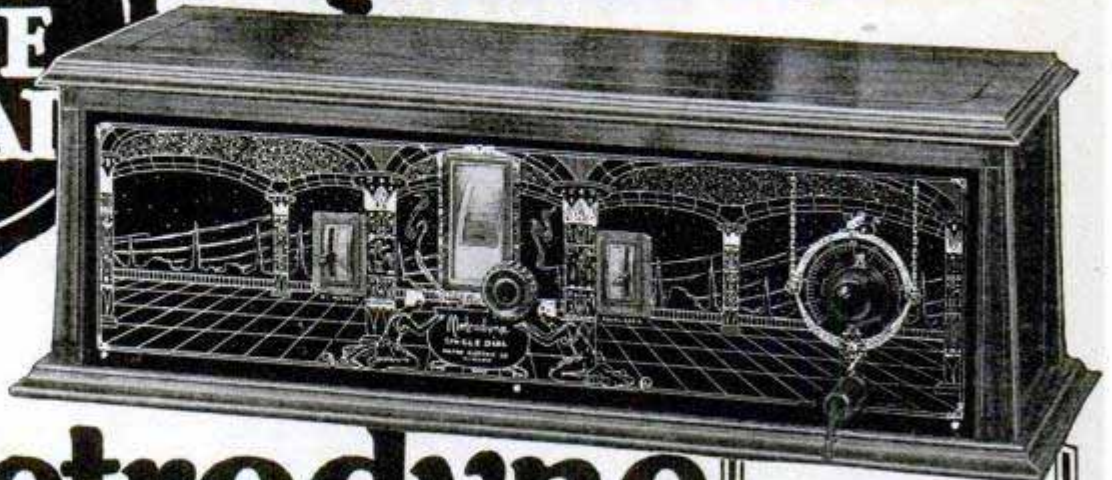

The Metrodyne

ONLY ONE DIAL TO TUNE

Retail Price
\$75

Completely Assembled
**BIG DISCOUNTS
TO AGENTS
AND DEALERS**

Wonderful offer direct from the factory! The world's greatest radio. A perfect working, single dial control, 7 tube receiver. And just to prove our claims, we will ship it to your home for 30 days' free trial. Test it under all conditions. Test it for distance, volume and tonal quality—and if you are not convinced that it is the best single dial set you ever heard, return it to the factory. We don't want your money unless you are completely satisfied.

**BIG PROFITS TO
AGENTS AND DEALERS**

Our Agents and Dealers make big money selling Metrodyne Sets. You can work all or part time. Demonstrate the superiority of Metrodynes right in your home. Metrodyne Radios have no competition. Lowest wholesale prices. Demonstrating set on 30 days' free trial. Greatest money-making opportunity. Send coupon below—or a letter—for our agent's proposition.

Metrodyne Super-Seven Radio

A single dial control, 7 tube, tuned radio frequency set. Approved by America's leading radio engineers. Designed and built by radio experts. Only the highest quality low loss parts are used. Magnificent, two-tone walnut cabinet. Artistically gilded genuine Bakelite panel, nicked piano hinge and cover support. All exposed metal parts are beautifully finished in

24-k gold. Easiest set to operate. Only one small knob tunes in all stations. Dial is electrically lighted so that you can log stations in the dark. Volume control regulates reception from a faint whisper to thunderous volume, 1,000 to 3,000 miles on loud speaker! The Metrodyne Super-Seven is a beautiful and efficient receiver, and we are so sure that you will be delighted with it, that we make this liberal 30 days' free trial offer. You to be the judge.

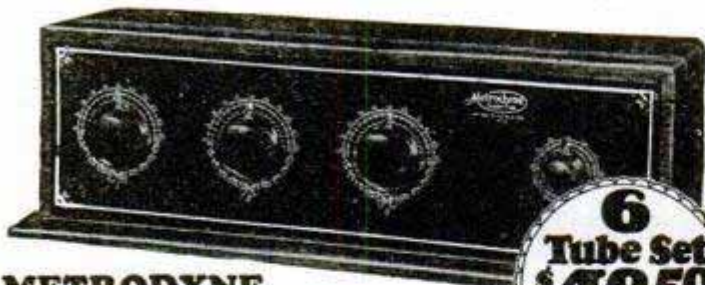

**METRODYNE
SUPER SIX RADIO
ON 30 DAYS' FREE TRIAL**

Wonderful 6 tube, long distance radio set. Approved by America's leading Radio Engineers. Easy to operate. Dials log easily. Tune in your favorite stations instantly on the same dial numbers every time. No guessing. 30 days' free trial.

Mr. Howard of Chicago said, "With 5 Chicago Stations on the air I tuned in 17 out-of-town stations, including New York and San Francisco on loud speaker very loud and clear.

We are one of the pioneers of radio. The success of Metrodyne sets is due to our liberal 30 Days' Free Trial Offer, which gives you the opportunity of trying before buying.

**6
Tube Set
\$48.50
RETAIL PRICE
Completely
Assembled**

**MAIL THIS
COUPON** 
or send a postal or letter. Get our proposition before buying a radio. Deal direct with manufacturer—**Save Money.**

METRO ELECTRIC COMPANY
2161-71 N. California Ave., Dept. 147, Chicago, Illinois

Mail COUPON Below!

Let us send you proof of Metrodyne quality

C. J. Walker, Mariposa, Calif., writes: "Received my Metrodyne Single Dial set O. K. I believe that these one-dial sets are going to be excellent sellers. I had no trouble in tuning in stations enough to satisfy anyone, so you will please send me another set."

Roy Bloch, San Francisco, Calif., writes: "Very often we travel from New York to the Hawaiian Islands quickly—from station to station—by means of the little tuning-knob which operates the electrically-lighted dial. The Metrodyne Single Dial Set is much easier to operate than any radio set I've ever seen."

We will send you hundreds of similar letters from owners who acclaim the Metrodyne as the greatest radio set in the world. A postal, letter or the coupon brings complete information, testimonials, wholesale prices, and our liberal 30 days' free trial offer.

METRO ELECTRIC COMPANY
2161-71 N. California Ave., Dept. 147
Chicago, Illinois

Gentlemen:

Send me full particulars about Metrodyne 6 tube and 7 tube sets and your 30 days' free trial offer.

Name.....

Address.....

If you are interested in AGENT'S proposition, place an "X" in the square

NEW DOUBLE-HEAD REVERSIBLE SPARK PLUG

ABSOLUTELY GUARANTEED FOR 2 YEARS

USERS "WILD OVER IT"

A New Spark Plug with increased value and efficiency—for all makes of cars, trucks and tractors. Double head means double service. Usable at both ends. Two plugs in one. Automatically cleans itself by running; without detaching wires. Color of spark, visible on top; shows how efficient they fire. Positively a sensation. Entirely new. Exclusive principle. In a class by itself. Everybody wild over it. All say it's a wonder.

MORE PROOF—G. Engessor of Iowa says:

"Your Double Head Reversible Spark Plug is the best I've ever used. I had to clean plugs daily before using yours."

EVERYBODY SATISFIED

There is nothing else like it—means unlimited spark plug service. Its life is perpetual. That's the reason we do not hesitate to guarantee it for two years.

NEW PRINCIPLE—SELLS ITSELF

Wherever demonstrated everyone is convinced of the increased value in this new principle and easily sells itself. Every user is a sales booster.

SPECIAL INTRODUCTORY OFFER

To the first person in each locality we are willing to send a set under a very special offer.

BE THE FIRST IN YOUR LOCALITY

CHICAGO TIRE LUG COMPANY, INC.,
 SPARK PLUG SALES DIVISION
 500-338 W. 47th St. CHICAGO, ILLS.



AGENTS "MAKE BIG MONEY"

This field is tremendous. The money-making possibilities are wonderful. Spare time or full time. They all make money. No experience necessary. Your profits are only limited by the number of automobiles in your locality. Every car owner that sees this new plug is interested and wants to buy.

VISIBLE CAP FITS EITHER END

\$60 TO \$120 PER WEEK

Ordinary profits do not belong in this class, because the advertising value of each satisfied user creates a bigger demand and this demand must be supplied. That's why we want distributors everywhere. This means big money to each distributor. Irregardless of what you may have sold before, here is a real article, with a real proposition, in an unlimited field.

Agents Wanted Everywhere

The demand for territory will be big, so we advise you to act promptly. Remember, we want to be fair to everyone.

COSTS NO MORE

Than Any Ordinary Spark Plug—Outlasts Them all

MAIL TODAY

CHICAGO TIRE LUG CO., Chicago, Ills.
 500-338 W. 47th St.
 Gentlemen—Kindly mail me free particulars about your latest invention and direct-from-factory-selling plan.

Name.....
 St. or R. F. D.....
 City.....
 State.....

BIGGEST SENSATION OF THE YEAR

TRIPLE SERVICE BRAKE BAND LININGS

FOR FORDS —Outlasts 3 Ordinary Linings—



Here is a New Trouble-Free Triple Service Transmission Brake Band Lining for Fords that is entirely different—a scientific lining that actually outlasted three sets of ordinary linings under comparative tests—a real sensation for Ford Owners—No more slipping, each pedal pressure results in the oil being correctly and continuously forced between the brake surface and the steel drum, preventing burning, unraveling or glazing.

Scientifically Constructed—Chemically Processed—Selected Wood

Triple Service Brake Band Lining is positively a New Sensation and has already proven its value on Fords—They are made of Chemically Processed, Scientifically Constructed, selected wood (instead of the old style easy-to-burn-out fabric). Transmission linings for Fords previously placed on the market have, in most cases, been a source of trouble. The life of Triple Service is practically unlimited. Permits gradual stopping with non-chattering smoothness that is surprising.

Grooved With Heavy Lubricating Strip of Long Fibre Asbestos

Affords an extremely powerful grip on full pressure—yet a smoothness that is non-chattering—Costs no more than ordinary linings—yet lasts 3 times as long and gives more efficient service.

AGENTS WANTED EVERYWHERE

We want agents in every locality to take care of the demand and to the first person in each new locality we are willing to send a set under a very special offer.

Special Offer to Introduce

CHICAGO TIRE LUG CO. INC.,
 BRAKE BAND SALES DIVISION
 600-336 W. 47th St. CHICAGO, ILL.

MAIL TODAY

CHICAGO TIRE LUG CO. INC.,
 600-336 W. 47th St., Chicago, Ill.

Gentlemen:—

Please mail me free particulars about your wonderful brake band linings and direct-from-factory-selling plan.

NAME

ST. or R. F. D.....

CITY..... STATE.....



**THIS
BIG FREE BOOK**
tells you exactly how—



Richly illustrated; full of explicit practical counsel from experts to amateurs. Well worth a quarter— but you get it for nothing! Use the coupon below.

Furniture Finishing as experts do it—

YOU can practically duplicate the fine work master-craftsmen do on expensive furniture and costly cabinetwork. Your home-built creation will do you proud, finished as our **FREE BOOK** tells you how. Make use of its easily-followed instructions given by professionals. Send for it right away!

Make Shabby Things Look New Again

You can refinish worn, shabby, scuffed, old furniture so it will look almost new, and save yourself many a dollar—through this book. It tells you in plain English just how to finish all kinds of wood—old or new, hard or soft; how to stain wood expertly; how to do everything in wood-finishing for yourself at home. You will find the book mighty useful!

JOHNSON'S WOOD DYE

(Penetrating Stain)

With Johnson's Wood Dye you can treat inexpensive soft woods so as to rival costly hardwood in beauty. It is extremely easy to apply, dries perfectly in four hours, and never will rub off nor smudge. So deeply does it penetrate that the original color of the wood is not betrayed even though the surface is marred. Comes in 17 handsome shades, including these very popular numbers:

No. 124—Golden Oak No. 140—Early English
No. 129—Dark Mahogany No. 123—Dark Oak
No. 127—Brown Mahogany No. 131—Walnut
And all other fashionable and standard wood colors.

S. C. JOHNSON & SON, Dept. P. A. 10, RACINE, WIS.

"The Wood Finishing Authorities"

(Canadian Factory—Brantford)

Please send me Free your 25c Instruction Book on Home Beautifying and Wood Finishing.

My Dealer is.....

My Name.....

Address.....

City and State.....

Leading Paint and Hardware Stores often have a supply of this 25c Book to present to customers. Ask at such a store first for your copy FREE. Or just mail coupon and let us send you one.

Everything in Highest Grade PLUMBING-HEATING at Wholesale

SAVE HALF-
Install
your OWN
Complete
Hot Water
Heating Plant
AS LOW AS

HOT WATER HEATING PLANT
CUT-TO-FIT GUARANTEED

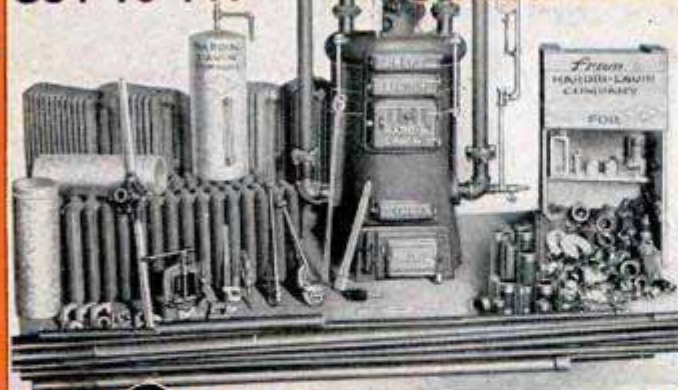

\$198⁰⁰



62⁹⁵

The Hardin-Lavin Company founded 50 years ago has specialized exclusively in highest grade Plumbing and Heating to the consumer direct at wholesale. Our new catalog is filled with Golden Anniversary Bargains. Send for copy today and save from one third to one half on everything in Plumbing and Heating Outfits and Supplies.

FREE Planning Service

Send us a rough sketch of your room arrangement and our trained engineers will figure the exact cost of hot water or warm air heating plant, bathroom outfit, kitchen and laundry plumbing, water supply system or complete equipment. Every system is individually designed to eliminate long runs of pipe, expensive material and costly labor. Our New Easy Method of Installing and low price will surprise you.

This big FREE Book will bring you FULL particulars MAIL COUPON Get your copy TODAY



HARDIN-LAVIN CO.,
107-17 W. Pershing Rd., Chicago, Ill. P. M. 10-26

Gentlemen: Please send me your FREE BARGAIN CATALOG with special wholesale prices. I am interested in:
 Water Sply. System Steam Htz. Plant Plumbing Fixtures
 H. W. Htz. Plant Pipeless Furnace Bathroom Outfit
 I am interested in Easy Terms. Pipe Furnace

NAME.....

ADDRESS.....

P. O.....STATE.....



'ROYAL Bathroom Outfit' - the latest design at low price.

Grade A Quality Guaranteed Plumbing Outfits

You will find in our 50th Anniversary Catalog everything in latest design plumbing fixtures and supplies: Built-in Bath Tubs, Pedestal Lavatories, One Piece Deep Apron Kitchen Sinks, Laundry Tubs, fixtures, Accessories, etc., all of highest quality possible to manufacture at lowest wholesale price. The Hardin-Lavin Method of Easy Installing enables you to put in your own plumbing or heating plant. Crystal clear diagrams and simple instructions guide you every step of the way. All goods factory fitted—ready for quick assembly—guess work is eliminated—time and money saved. We loan you installing tools FREE.

FURNACEOLA
Small, beautiful, efficient
The New Home Heater \$67⁵⁰

Represents the latest development of a strictly high class furnace that can be set on the first floor and heat the whole house to uniform temperature. Designed to take the place of old style, inefficient stoves in homes, stores, schools, churches, etc., where there is no basement.

Furnace Heat Love Economy

Constructed just like high class furnace. Circulates moist air to the front corner of every room in any weather. The "Furnaceola" has heavy iron jacket, open bottom top, for rapid air circulation. Holds fire full 24 hours under test. Burns fuel. Can be equipped with magazine for burning only hard coal. Heat six or seven good rooms with no more than old style stove. 47 inches high over floor space occupied 22 inches. Takes 7-in. pipe.



More Heat—Less Cost

A-1061—Cast iron, nickel trimmed. **\$67.50**
A-1057—Grain mahogany, enameled **\$74.50**

Golden Anniversary Bargains and Easy Terms

In addition to highest grade goods at wholesale and the many other Hardin-Lavin advantages of easy installing, free plans, etc., we also GIVE YOU EASY TERMS. Nowhere else can you find this complete combination of quality goods, wholesale prices, easy method of installing and budget plan of payment, and remember every system or fixture is backed by our label and bonded guarantee, million dollar plants and 50 years reputation for highest quality goods at wholesale price.

Send Coupon Today for Bargain Catalog

We are helping thousands to save money and to make money. Our free bargain catalog explains how. Send for your copy today. Every outfit is cut-to-fit the exact job. Our many years experience with all kinds of conditions and all types of constructions means practical money saving service to home owners, builders, realtors, contractors, mechanics, institutions, etc. Write us about any plan or problem you have. We will help you without obligation. Estimates free.

All orders are shipped from our Chicago plant the day they are received. It means a lot to know that you will get prompt service and square dealing.

Our Label and Bonded Guarantee Protects You
 We guarantee that every water supply system, plumbing outfit, heating plant or any article that you buy from us, from the smallest fitting to a complete installation is perfect and exactly as shown and of the HIGHEST GRADE possible. We further guarantee that if for any reason you are dissatisfied you can return any goods bought from us and we will immediately refund your money plus freight charges you have paid. Could anything be fairer?
 (Signed)
HARDIN-LAVIN CO.
Coupon brings FREE Catalog chock full of big bargains.

You can buy on Easy Terms

“True to form
as usual”

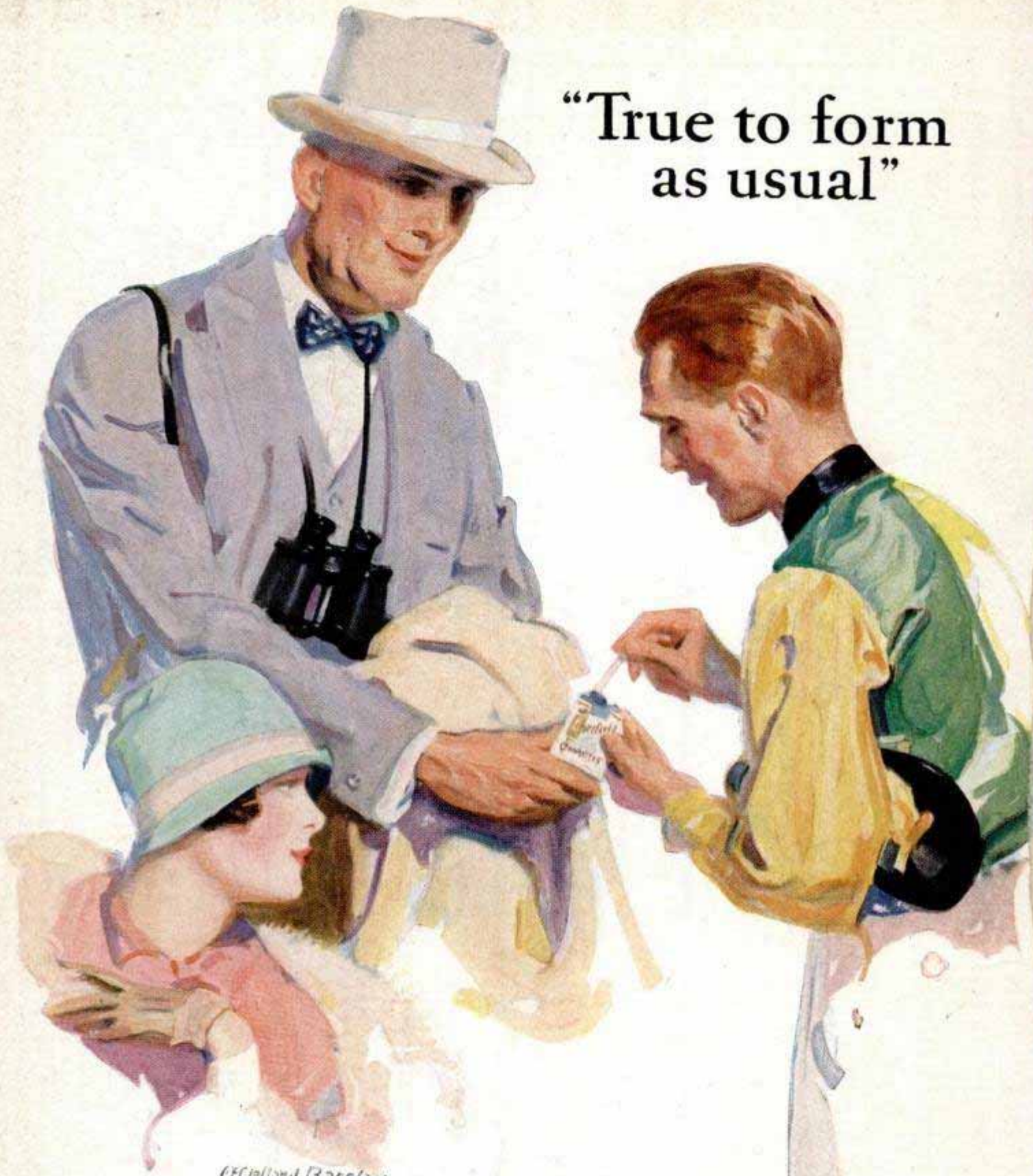

(F. Holland Barclay)

Chesterfield