

POPULAR MECHANICS

MAGAZINE

WRITTEN SO YOU CAN UNDERSTAND IT

REG. TRADE MARK GREAT BRITAIN No. 410426

REG. U.S. PAT. OFF.



THE TAILLESS AIRPLANE
Page 366

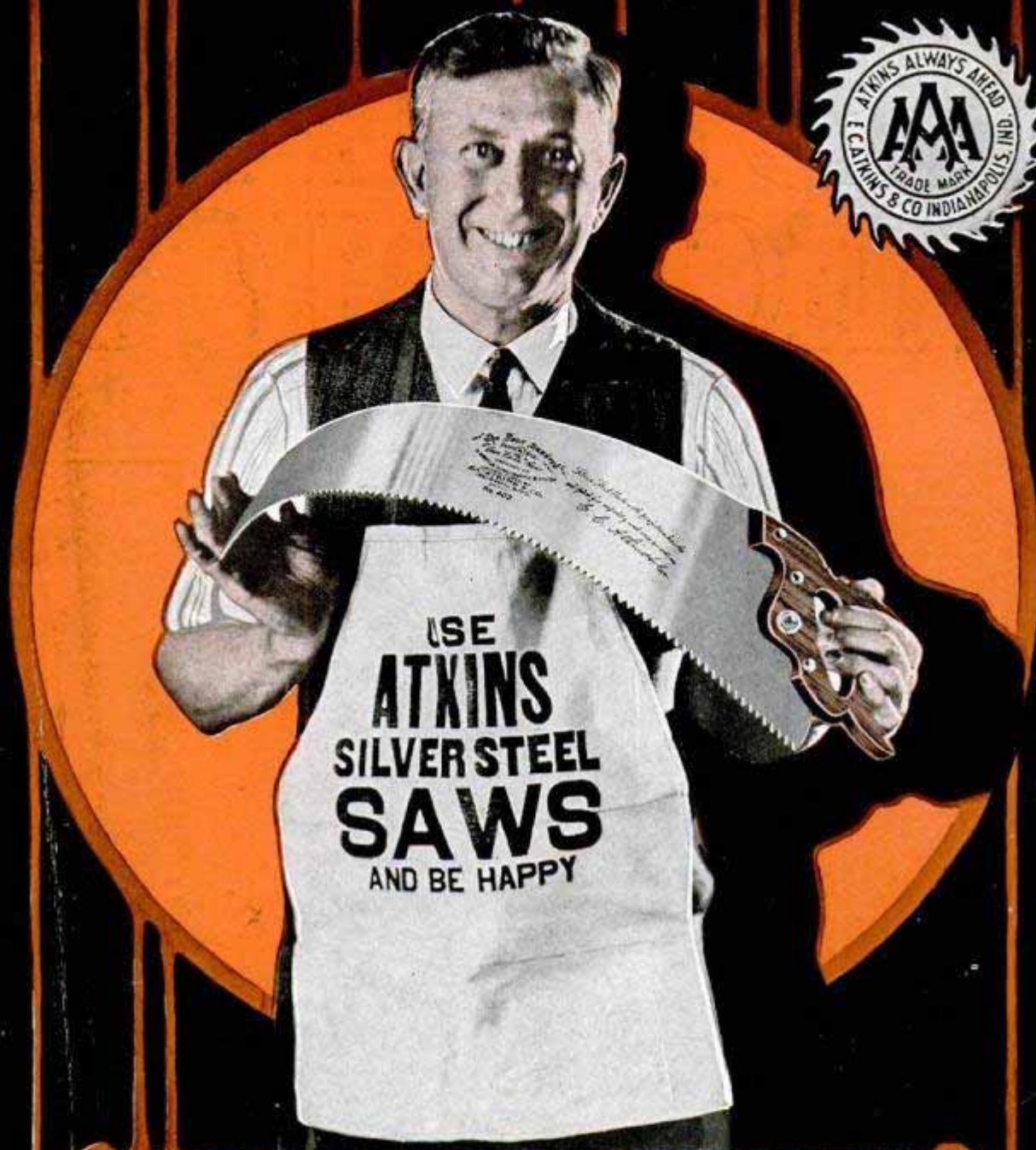

After You Try This Saw -

It will be your favorite always. ATKINS "No. 400" is the aristocrat of the ATKINS line—the finest saw that bears this world-famous name on the blade.

Only ATKINS Saws are made of "Silver Steel" to hold their edge through added years of satisfactory sawing service. "Taper Grinding" makes ATKINS Saws cut faster and easier.

There's an ATKINS Saw to save you time, labor, material and money no matter what material you saw. Ask for our FREE folder—"Atkins Saws in the home."

E. C. ATKINS & CO. *Estab. 1857* Dept. P INDIANAPOLIS, U. S. A.

ATKINS SILVER STEEL SAWS

Be President of Your Own Company

Nestler Licensees earning \$4,000 to \$15,000 annually — get into this growing business now.

WE would like to tell every man who wants a profitable business in his own name the full facts concerning the amazing Nestler Rubber Fusing Process. Only a bare outline can be given here. In 1839 Goodyear discovered the process of vulcanization. Vulcanization made pneumatic tires possible. Since 1839 vulcanization has been an irreversible process. This is the real reason why the servicing of pneumatic tires has been so unreliable and uncertain in the past and why tire retreading has been a commercial impossibility.

In 1917, Emil Nestler, an officer of this company, discovered a method of de-vulcanizing the rubber on a pneumatic tire without removing it from the tire. Because of this discovery, it then became possible to join new rubber to old so that an actual fusion or welding of the two took place. It welds rubber to rubber like steel is welded to steel with the electric arc.

Enormous Market

There are now more than 17 million automobiles in the United States, each of which have four tires. Every year more than half this number of tires—more than 34 million tires—are junked merely be-

From \$750 a Year Shop to \$8200 a Year Building In One Year

In February, 1925, the Hartford Tire Retreading Co. secured a license to operate the Nestler Process. In twelve months, without any previous tire experience, they built up the largest tire servicing business in Hartford. Read what they say.

"We know that without the advantages of the Nestler Rubber Fusing Process and Equipment no such progress as we have made would have been possible. We do a great deal of retreading and have hundreds of steady customers in this city and adjoining territories. In addition, we have always done a quantity of repair work and have built up a reputation on this work.

"In a period of eight months, during which we turned out an average of eight tires a day, we never had a job come back. The work is fast, simple and very profitable as we have demonstrated."

Nestler licensees throughout the world have achieved a like success. Your community, too, needs Nestler service. ACT NOW—and establish a substantial, profitable business in your own name.

cause part of the rubber has worn off the treads. A large proportion of these tires could be made to do **DOUBLE DUTY!** A new, tough durable rubber tread could be fused or welded to these worn tires by the Nestler Rubber Fusing Process. They would look and wear like new. Car owners would cut their tire costs squarely in half.

The Nestler Rubber Fusing Process was patented in 1920 and since then, has been in actual use. Hundreds of thousands of tires Nestlerized have demonstrated the soundness of the Nestler Process beyond all argument. In addition to retreading, the Nestler Process also makes possible tire repairs that literally outlast the tire.

Think of the opportunity for a Nestler Rubber Fusing Station in your community! Previous experience is unnecessary. Only moderate capital required and there is a big profit in each tire you do. Earnings of \$4,000 to \$15,000 and more annually now being made.

No Experience Necessary

The Nestler Rubber Fusing Process is not complicated—it is simple. It is not costly—it is cheap. It is not slow—it is fast. Nestler Steamless Equipment is not costly—it is moderately priced. Any man of average intelligence can master the Nestler Rubber Fusing Process in a few days' time. Free instruction either in our demonstration schools or by mail is given to all licensees. A new plan makes it possible to *earn while you learn*. Nestler licensees are glad to say that Nestler Cooperation has been one of their biggest assets.

FREE BOOKS

We have printed several books. "The Nestler Plan" describes the business end of a Nestler Shop. "The Nestler Catalog" shows the Improved Equipment and prices. A third book presents a history of tire servicing methods. These books give **FACTS**. We will gladly send them without obligation to any man who is interested in the possibilities in a proven, new, uncrowded field, to build a large business with splendid profits. Because of the demand due to present unusually favorable conditions you are urged not to delay. Write for these books today.

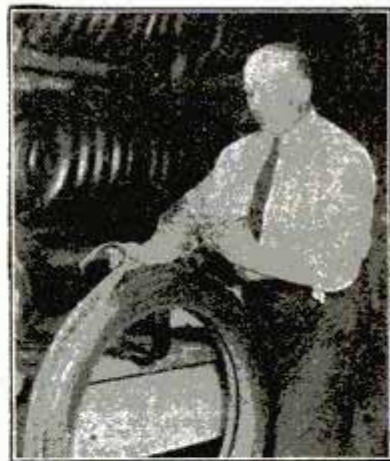

Emil Nestler, the inventor of the Nestler Rubber Fusing Process, demonstrates one of the seven simple steps in Nestlerizing a tire.



"New Tires from Old"

That is the Nestler proposition in a nut shell. The worn tread is replaced with a new tread. The new tread and the tire become as one. It will look and wear like new. You can guarantee it. No other process or method will produce the same results.



Write for It TODAY!

Nestler Rubber Fusing Co., Inc.
Dept. P9, 245 W. 55th Street, New York, N. Y.

Why hadn't someone told him before?

HE understood at last—understood why he had been left alone so often, why his invitations had been refused. He knew now—but he could have been spared so many disappointments, so many lonely hours—if someone had only told him before.



A great many young men are inclined to have a grimy-looking skin spotted with blackheads and dull in appearance. Few realize that this hinders their success in life. Pompeian Massage Cream helps you overcome this handicap by giving you a clear, ruddy complexion.

Clears the Skin: Pompeian Massage Cream thoroughly cleanses the pores. It helps clear up blackheads and pimples by stimulating healthy circulation, and by keeping the skin clean and the pores open.



Easy to Use: After shaving or washing, rub the cream in gently. Continue rubbing and it rolls out, bringing with it all the dirt, grime, and skin impurities. Result—a clean, healthy skin with clear, glowing color.

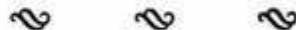

Use Pompeian Massage Cream regularly at home—then you'll get the full benefit. At all druggists.

SPECIAL TRIAL OFFER

1/3 of a 60c jar—for only 10c

For 10c we will send a special trial tube containing one-third of contents of a regular 60c jar of Pompeian Massage Cream. Trial tube contains sufficient cream for many delightful massages. Positively only one trial tube to a family on this exceptional offer.

Use the coupon now.



THE POMPEIAN LABORATORIES
Dept. 82, Cleveland, Ohio

Gentlemen: I enclose a dime (10c) for a special trial tube of Massage Cream containing 1/3 of a 60c jar.

Name.....

Street
Address.....

City..... State.....

Popular Mechanics Magazine

200 E. Ontario Street, Chicago, U. S. A.

H. H. WINDSOR, Founder

H. H. WINDSOR, Jr., Editor and Publisher

London: Hachette & Cie.,
16-17 King William Street, Charing Cross, W. C. 2

Paris: Hachette & Cie.,
111 Rue Reaumur

Melbourne: Gordon & Gotch
509-513 Little Collins St.

ISSUED MONTHLY

SUBSCRIPTION:

SINGLE COPY, 25 CENTS

In United States and its possessions, also Canada, Cuba, and Mexico, per year, postpaid - \$2.50
To all other countries in the Postal Union 3.00
All subscriptions are discontinued at expiration. Please examine the date printed on your wrapper.

Entered as Second Class Matter Sept. 15, 1908, at the Post Office at Chicago, Illinois, under Act of March 3rd, 1879.
Entered as Second Class Matter at the Post Office Department, Canada.

Published monthly by POPULAR MECHANICS CO.

Copyright, 1926, by Popular Mechanics Co.

Copyright in Australia. Copyright in France

Bathing cap collar 403
Clothing smoother rack 406
order 386
Contents for September, 1926

Labels, instructions on packages No. 3

Read from columns

plane bombing	377
life saver patrol	395
prizes for safer	403
tailless, is fool-proof	366
wind tunnel tests full-size planes	448
with ten motors	374
Airship—big, building in Germany	397
Asphalt—cut from hot lake	406
Automobile—things to avoid in buying a car	468
Automobile Driving—light for front hub of auto	369
Automobiles—Design	
auto top used for duck boat	447
drop guard on auto wheels	393
folding paddle wheel auto	376
high-speed auto carries motor in rear	450
two-motor racer for speed	400
Automobiles—Ignition—generator control on auto	382
Automobiles—Lighting	
front and rear auto signals run from steering post	358
glareless auto headlamp	432
light shield	472
Automobiles—Motor	
European small car engines quarter American size	405
how taxis are kept free from engine trouble	412
Automobiles—Parking—autos parked in skyscraper	439
Aviation—tests for air pilots tried at home	441
Barrel—non-shrinking paper	382
Basket—racing with basket on head	369
Bee—farms on Berlin roofs	368
Bell—St. Dunstan's in home for blind	363
Bicycle	
wheeled braces on child's bicycle	375
with jointed frame	433
Boats and Boating—fabric boat carried in bag	407
Bridge	
biggest, to span Hudson	440
flood-swept river bridged	356
Brush—fountain, for cleaning	460
Building—gas station like mushroom	307
Bunker Hill—monument lighted with six big lamps	367
Butterfly—woman as hunter of	403
Canal—ship, under hills	460
Cattle—record of growth by photography	413
Chair—high, for child, folds up	405
Ciphers—machine writes and decodes	400
Circus—hot tamer's bluff	362
Clock	
hands of mammoth	400
ink straw hat	415
Clouds—light tells height of clouds	454
Comb—novel, easily kept clean	440
Concrete—truck body, mixer	405
Dancing—meter helps to keep time	418
Diesel Engine—big, for train service in Germany	383
Divers—risk lives in raising submarine	365
Dog	
crippled war veteran's dog as toy model	385
puppy model for art class	437
Electric Battery—tester for auto	449
Electric Current—test of high voltage line	386
Electric Lighting	
bulb with luminous cross	437
music light rack for piano	448
Ericsson, John—a poor boy who changed the world	426

Eyes—how yours deceive you	370
Fan	
electric, in safety stand	401
veteran whittles, from wood	417
Fire—skill of fireman chauffeur	472
Fire Apparatus—hose and life belt combined	425
Fish—leaping, fighting for life	359
Fishing—hook kept from weeds with bait protector	416
Floor—of tile wears longest	377
Flowers—bouquet modeled in dough	447
Food	
cottonseed and wheat make good bread	384
old fallacies about, refuted	465
powdering, for preservation	460
square-shaped doughnuts	413
Fossil—footprints ages old found	433
Fruit—picker saves trees and time	412
Furniture—steam cleaned	377
Garage—doors open by light from auto headlamps	396
Germs—race track built for	434
Golf	
adjustable putter	441
bag opened like book	383
weighted driver tests balls	357
Hanger—for clothes when journeying	429
Heater—oil burning asphalt heater	376
Horse—monument to war horses	439
Horse Racing—other side of track	378
Hose—clamp without screws	455
House—of concrete slabs built in day	471
House Plans—home building	528
Household Devices	462
Hydrometer—holder for	478
Illumination—turning night into day	443
Insurance—against too much laughter	360
Jack—air, lifts cars for washing	403
Kitchen Utensil—marker for pies and cakes	418
Kites—letters flown from, for advertising	406
Ladder—for water gun against fires	450
Life Saving Apparatus—preserver used as boat by hunters	449
Lighthouses—marked to guide aviators	415
Lighting—quaint collection of lamps tells story of	455
Locomotive—how an engine breathes	450
Lubrication—improved auto-oil filters	467
Magic	
card tricks	387
secret of mystic wonders of Orient	353
Mask—paper eyes worn as	416
Model	
first, of famous inventions	466
of highway system	397
tiny town in Colorado	414
Motor—smallest and largest, compared	424
Motorbus—eight-wheeled motor coach	441
Motorcycle—as taxicab	364
Mountain Climbing—building cable ladder up Half Dome	375
Moving Picture—girl in movie stunt	464
Moving Picture Projector—for amateurs	364
Mower—lawn shears on stick handle	464
Musical Instrument—singing topsy on ukulele	393
National Park—Bryce canyon	401
Neurology—electric current in nerves detected by radio	448
Numbers—luminous house numbers on sidewalk	457

Rack 406

[Continued on Page 4]

Camera

Furniture cleaned by steam 377
clothing 386

Ocean Currents—mystery of, solved by bottles	429
Pantograph—chart plates by, save engineers' time	364
Parachutes—as back of coat	459
Pests—boys in rat and insect garb warn against pests	465
Petroleum	
gas bags save motor fuel in storage	376
hunting oil in frozen north	451
Phonograph—records on film to replace disks	461
Photography—metal tape for photo flash	368
Pillow—leather case takes place of	360
Pipe—gas embalmed in tape	467
Porcelain—where it takes three months to make a cup	404
Postal Service—mail delivered by tricycle in factory	411
Printing—metal sheet prints copies from writing	471
Rack—inclined, for auto	406
Radio—test radio under mountain	416
Radio Aerial	
installing in attic	474
neighborly installation	480
Radio Application—control of train by radio	386
Radio Battery	
permanent hydrometers simplify battery testing	476
power control unit	478
Radio Broadcasting	
automatic transmitter checking Byrd expedition calls	477
power loss in broadcasting	396
relayed two miles on barbed wire fence	407
Radio Cabinet—waterproof	477
Radio Coil—of Rugby, England	477
Radio Condenser	
variable has triple range	476
variable has wedge-shaped plates	473
Radio Construction—tool kinks for radio builders	479
Radio Loop—webbing for connections	482
Radio Loud Speaker—cone speaker for wall or easel	473
Radio Operation—moist ground offers least resistance	473
Radio Receivers—bring in those distant stations	483
Radio Rheostat—dustproof case on	481
Radio Telephone—wireless on airships	457
Radio Tube	
first and latest styles	477
power tube has external posts	482
rejuvenator operates from radio batteries	475
terminal clips for a.c. tubes	486
that won't burn out	477
Railroad	
dance hall, theater and gym on wheels	402
stay on track	419
Razor—drier on lamp shade	460
Safety Devices and Measures—inflated bathing cap collar	403
Saws—electric handsaw outfit	457
Scales—pocket, tells ranges, heights and angles	416
Shears—crank operated metal	395
Ships—Nelson's "Victory" in splints for rebuilding	357
Shoes—electric shining stand	465
Signs and Signboards—converted into movie by colored lights	467
Sleep—how loss affects you	408
Soap—pulverizer cuts waste	432
Spider—trapdoor spider's skill	385
Stadium—raincoat for	361
Stairway—ramps instead of	360
Steam Shovel—dipper of huge steam shovel	386
Stereotyping—caster prepares small cuts direct from linotype metal	412
Street Cleaning—how highways of world are kept clean	394
Street Traffic Regulations—fabric strip traffic marker	411
Telegraphy—fastest cable to span Atlantic	430
Tennis—racket kept straight with clamps	363
Throne—of imperial Russia reproduced for film	358
Tire—locked at press of finger	455
Transformer—electric bell	449
Trees—hotel around to preserve them	415
Turbine—fifty ton	439
Typewriter	
tiny three-inch	470
with many keys	367
Umbrellas—short for autoists	384
United States Navy	
birthplace claimed by three ports	368
"Old Ironsides" in movies	398
Vaporizer—in socket runs without motor	365
Watch—hands on fan-shaped	412
Waves—harnessed by floats to produce electricity	396
Whale—hunters use airplane and radio	447
Wheel—water, for diving	384
Wilson, Henry—cobbler's shop as memorial	417
Wire—cutter on auto front helps foil bandits	454
Woodwork—motor-driven tools	396

Workshop—compact home	471
Zoological Gardens—cageless	459

AMATEUR MECHANICS

Anchors—made of concrete	492
Aquaplaning—build a "water sprite"	487
Automobile—washing a car	491
Automobiles—Repairing—removing broken transmission key	502
Camera—lock for box shutter	490
Camping—tricks of	493
Chain—wooden lawn	507
Clothing—children's clothes hanger	491
Electric Wiring—improving appearance of bell wiring	500
Fish—rattrap for scaling	506
Ford Car	
high-speed commutator needs plenty of oil	503
stopping crankcase leaks	504
Hats—cleaning straw	491
Honey—reservoirs for	499
Hose—quickly detachable for lawn	503
Kite—tailless "wise owl"	502
Lens—mounted on sewing table	489
Mower—grass catcher for	500
Photography—electric illuminator for amateur photographer	507
Puzzles—two simple wire	501
Sharpener—screen wire for crayons	508
Smokers' Accessories—chair-arm ash trays	490
Steps	
combination with driveway	489
veneering old	500
Stilts—painting on	508
Toys	
amusing crazy clown	505
jumping disk	492
Traps and Trapping—crows	498
Trees—cutting large branches	490
Washing Machine—outboard motor doubles as washing machine	504
Windmill—control for rotor	503

SHOP NOTES

Air Press	511
Automobiles—Repairing—fixture for lather refaces brake drums	512
Boat—attachment holds ferry boat to dock	512
Bridge—double track for narrow	513
Calipers—attachment for, makes precision tool	514
Coils—spring wound by hand	513
Corn—forming stacks	516
Crates—improved, cost less	521
Dairy—homemade milk bottle washer	520
Eaves Troughs—hanging	514
Electroplating—lead	511
Faucet—how to fix dripping	517
Feed Box—on manger front	518
Felt—rotary punch for	516
Ford Car	
shortening valve stems	513
spring compressor for Ford clutch	522
Gauge—fixed line	511
Hay—filling in mow	522
Knurling—in the vise	520
Loading and Unloading—rig for rolling veneer logs	510
Lubrication—automatic oiler for line shaft	516
Magnet	
for removing chips	515
removing steel wool shreds from crevices	516
Mechanical Drawing—stamp for dimension line points	514
Piston Rings	
cutting off	510
filing	512
Refrigerator—water-cooled meat house	526
Repairs—leaks in walls, pipes and purses	523
Revolver—holster for, in auto	521
Saws—handy saw rack	527
Shears—effective pruning	515
Springs—cutting off spiral	522
Steel	
ball punches spring	518
test distinguishes steel from iron	521
Storage Batteries—electric knife for opening	519
Tailoring—stand for tailors' goose	510
Tile—trenches dug with tractor and plow	512
Woodwork—self-measuring wood turning tool	519
Workshop—power plant	509
Wrench—knob makes acetylene tank	511

DRAKE'S PRACTICAL MECHANICAL BOOKS

THEY WILL RAISE YOUR PAY—

ORDER ON 5-DAY TRIAL

The books listed below will perfect you in your chosen trade—pave the way to the big positions. Written in non-technical language—easy to read and understand. **Every book covers its subject completely. An entire course of instruction condensed into one volume.** Your choice sent postpaid—your benefit 5 days—money refunded in full if not entirely satisfactory. Order direct from this page.

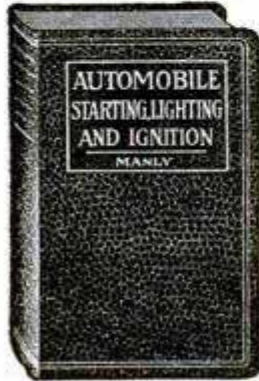

Automobile Books

Automobile Starting, Lighting and Ignition, by Manly... 700 pp. \$3.00
Brookes' Automobile Handbook. \$2.00
Ford Motor Car, Truck and Tractor, by Manly... Cloth \$1.50
Automobile Battery, Care and Repair, by Manly... Leatherette \$2.00
Motorcycle Handbook, by Manly \$1.50



Shop Practice Books

Sheet Metal Workers' Manual... \$2.00
Oxy-Acetylene Welding and Cutting... Cloth \$1.25
Slide Rule and Logarithmic Tables. \$2.00
Handbook for Millwrights... Cloth \$2.00
Machine Shop Practice... Cloth \$2.00
Mechanical Drawing and Machine Design... Cloth \$2.00

ORDER DIRECT FROM THIS PAGE —ON OUR MONEY-BACK PLAN

The books listed above are only a few of the many in our catalogue, which you will receive promptly after filling out and mailing us the attached coupon. For quick action order direct from this page—cross name of each book wanted and send in with price quoted. We prepay postage and send the books on our money-back plan.

FREDERICK J. DRAKE & CO.
PUBLISHERS

1008 Michigan Ave., Chicago
Drake Books Are For Sale at All Book Stores

Mail Coupon For Free Catalogue
Your Guide to Home Study

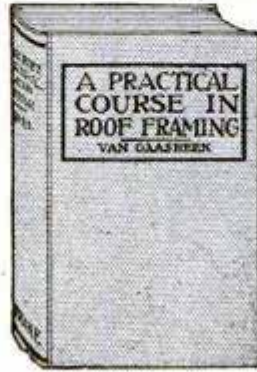

Carpentry Books

Cloth Binding
Modern Carpentry, 2 vols. \$3.00
The Steel Square, 2 vols. \$3.00
Modern Estimator... \$1.50
Timber Framing... \$2.00
Builder's Architectural Drawing... \$2.00
Concretes... \$1.50
Practical Bungalows... \$1.00
Roof Framing, by Van Gasbeek... \$1.50

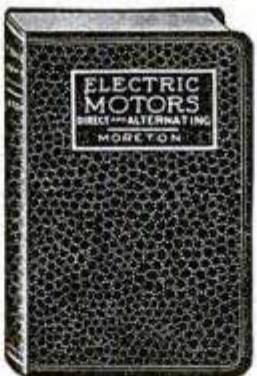

Electrical Books

Telephony, Including Automatic Switching, by Smith, 450 pp. Leatherette \$2.50
Practical Applied Electricity... \$2.00
Wiring Diagrams and Descriptions. \$1.50
Armature and Magnet Winding... \$1.50
Electric Motors, D. & A... \$1.50



Painting and Decorating

Ross Crane Book of Home Furnishing and Decoration... Cloth \$3.00
House Painting Methods with the Brush and Spray Gun, by Vanderwalker. Cloth... \$2.00
Interior Wall Decoration, by Vanderwalker... Leatherette \$4.00
The Mixing of Colors and Paints, by Vanderwalker... Cloth \$2.00
A Show at Sho' Cards... Cloth \$4.00
Sign Painting, by Atkinson... Cloth \$4.00
Strong's Book of Designs, Leatherette \$4.00
Modern Painter's Cyclopaedia. Cloth \$2.00
Automobile Painting... Cloth \$1.50
New Hardwood Finishing... Cloth \$1.50
Wood Finishing, Plain and Decorative... Cloth \$2.00
Owen's Paint Guide... Cloth \$1.00

Steam Engineering

Swingle's Handbook for Steam Engineers and Electricians. Leatherette.. \$4.00
Examination Questions and Answers for Marine and Stationary Engineers. Leatherette... \$2.00
Steam Boilers... Leatherette \$2.00
Swingle's Catechism of Steam, Gas and Electrical Engineering. Leatherette \$1.50

Modern Languages

By Prof. P. S. Allen, U. of Chicago
French without a Teacher... Cloth \$1.25
Spanish without a Teacher... Cloth \$1.25
German without a Teacher... Cloth \$1.25
Everyday French... \$1.25
Everyday Spanish... \$1.25

FREDERICK J. DRAKE & CO.
1008 Michigan Avenue
Chicago, Ill.

GENTLEMEN:—Please send me free, postage paid, your illustrated catalogue which lists and describes 200 Practical Mechanical Books for Home Study.

My name is

and my address



J. R. MONROE, President
Monroe Calculating
Machine Co., Inc.,
Orange, New Jersey

At the right—
J. L. ALDRICH,
District Manager, Fargo,
N. D., Monroe Calculating
Machine Co., Inc.



"One of Our Most Consistent Producers"
"I have been interested in learning that Mr. J. L. Aldrich, manager of our Fargo District, has been a student of your Business Management Course.
"Mr. Aldrich joined our sales organization two years ago, and has increased steadily the volume of his sales. His work is of a very high order, and he is one of our most consistent producers."
(Signed) J. R. MONROE, Pres. Monroe Calculating Machine Co., Inc.

Increases Income—Wins Big Opportunity
"When I enrolled for LaSalle training in Business Management I was an order clerk. I had never sold anything. After completing about three-quarters of the training, I stepped out from my salaried office job to a commission proposition selling Monroe Calculating Machines.
"At the end of eighteen months, my income was 153% per cent greater than during any six months before I enrolled with LaSalle. Better yet, on April 1st of this year I was appointed Monroe District Manager for North Dakota. I am counting on a real success in this new opportunity."
(Signed) J. L. ALDRICH.

Learns "Management"—Increases Income 153³/₄%



Order Clerk Becomes District Manager—Gives Credit to LaSalle Training

J. L. ALDRICH, Fargo, N. Dak, was an order clerk. He had never sold goods; had never held a managerial position. Today he signs himself "District Manager." His territory is all of North Dakota, and the firm he represents is the Monroe Calculating Machine Co., Inc.

What this advancement means to Mr. Aldrich—aside from an increase of 153³/₄% in income—may be grasped from the fact that the Monroe Calculating Machine Co., Inc., operates the largest factory in the world engaged exclusively in the production of calculating machines (at Orange, N. J.); maintains offices in all the principal cities of the United States and Canada; sells its product in every corner of the globe.

Mr. Aldrich frankly attributes his advancement in large measure to LaSalle training in Business Management. LaSalle, he says, gave him the confidence to cut loose and start selling on commission. *He is one of twenty Monroe men who are winning advancement thru*

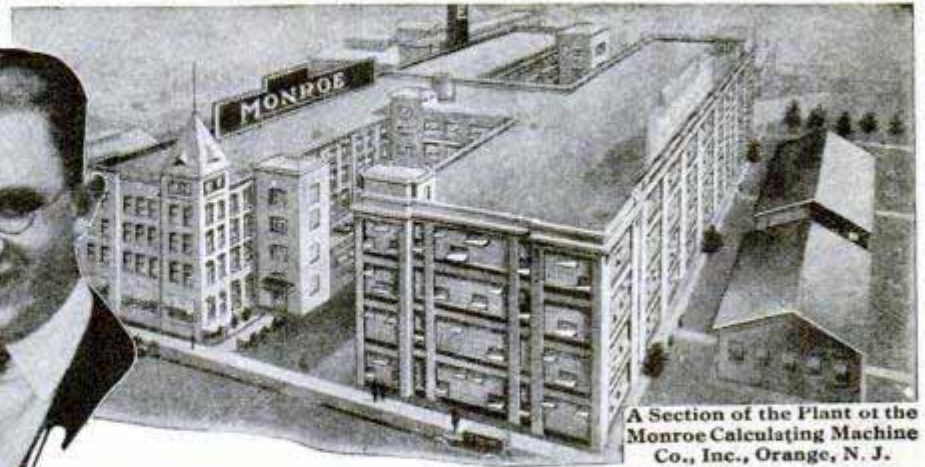

A Section of the Plant of the Monroe Calculating Machine Co., Inc., Orange, N. J.

LaSalle. Read his letter—and that of his employer—quoted in the column at the left.

Send for Free Book—
"The Making of a Modern Executive"

Are you content to peg away at tasks far below your possibilities—simply for lack of training in Business Management?—Especially when it can be so readily acquired in your spare time at home, without loss of an hour from work or a dollar of pay?

The particulars of LaSalle training and service in Business Management are fully outlined in a 64-page book, "The Modern Executive and His Training." It will pay you well to read it.

The coupon brings it to you free, together with a copy of "Ten Years' Promotion in One"—the story which has set thousands of men on the road to swift advancement. "Tomorrow" means next month—a year from now—NEVER! For the sake of a brighter future, clip and mail the coupon NOW!

LASALLE EXTENSION UNIVERSITY

THE WORLD'S LARGEST BUSINESS TRAINING INSTITUTION

FIND YOURSELF THRU LASALLE!

LA SALLE EXTENSION UNIVERSITY Dept. 964-AR

CHICAGO

Other LaSalle Opportunities: LaSalle opens the way to success in every important field of business.

- If more interested in one of the fields indicated below, check here:
- Modern Salesmanship: Leading to position as Sales Executive, Salesman, Sales Coach or Trainer, Sales Promotion Manager, Manufacturer's Agent, Solicitor, and all positions in retail, wholesale, or specialty selling.
 - Higher Accountancy.
 - Law: Training for Bar; LL.B. Degree.
 - Traffic Management—Foreign and Domestic.
 - Industrial Management.
 - Modern Business Correspondence and Practice.
 - Banking and Finance.
 - Modern Foremanship and Production Methods.
 - Personnel and Employment Management.
 - Railway Station Management.
 - Commercial Law.
 - Expert Bookkeeping.
 - Business English.
 - Commercial Spanish.
 - Effective Speaking.
 - C. P. A. Coaching for Advanced Accountants.

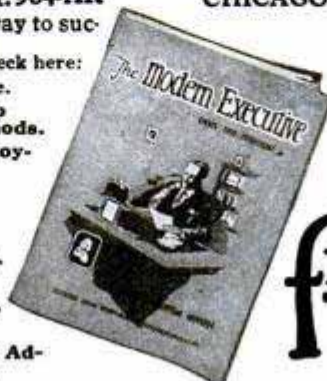

Opportunities in Business Management—I would welcome an outline of your salary-doubling plan, together with a copy of "The Modern Executive and His Training," also copy of "Ten Years' Promotion in One," all without obligation.

Business Management

Training for Official, Managerial, Sales and Departmental Executive positions.

Name

free! Address

mail coupon now Present Position

Age

BUILDERS TRADE GUIDES

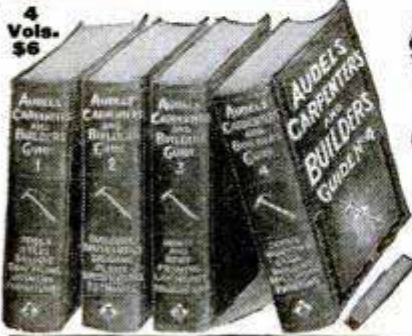

4 Vols. \$6

AUDELS CARPENTERS AND BUILDERS GUIDES—4 VOLS. \$6

Inside Information for Carpenters, Builders, Joiners, Building Mechanics—all Woodworkers. **1600 pages; 3700 diagrams; flexible; pocket size.** Short-cut instructions, new methods, ideas, solutions, plans, systems—money saving suggestions. An easy progressive course for the apprentice. A practical daily helper and Quick Reference for the master worker. A Helping Hand to Easier and Better Work and Better Pay. To get this aid for yourself, simply fill in and mail the FREE COUPON below.

INSIDE TRADE INFORMATION ON:

How to use steel square; How to file and set saws; How to build furniture; How to use mitre box; How to use chalk line; How to use rules; How to make joints; Carpenters' arithmetic; Mensuration problems; Estimating strength of timbers; How to set girders and sills; How to frame houses and roofs; How to estimate costs; How to build houses, barns, garages, bungalows, etc.; How to read and draw plans; Drawing up specifications; How to excavate; How to use settings 12, 13 and 17 on the steel square; How to build hoists and scaffolds—skylights; How to build stairs; How to put on interior trim; How to hang doors; How to lay floors; How to paint.

"Audels Guides worth four times their price—handy too as I carry them in pocket for reference." W. J. Bates, Knoxville, Pa.

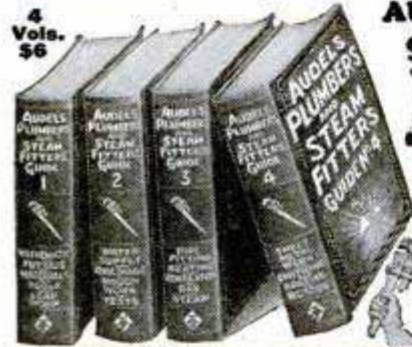

4 Vols. \$6

AUDELS PLUMBERS AND STEAMFITTERS GUIDES—4 VOLS. \$6

A new set—just out! A practical, illustrated, Reference Library and Study-Course for Master Plumbers, Journeymen and Apprentice Steamfitters, Gas Fitters and Helpers, Sheet Metal Workers, Draughtsmen, Master Builders, Engineers and all Building Trade Students. **1670 pages; 3642 diagrams; flexible; pocket size.** Guides explain all the principles, advances and short cuts of the Plumbing and Heating trade. Contains instructions on how to figure and estimate jobs. Use FREE COUPON below to examine, without obligation, this valuable work.

INSIDE TRADE INFORMATION ON:

Soldering, tinning, joint wiping, bending, beating. Pipe—iron—steel, threading. Mathematics, tables, physics. Materials—iron, steel, copper, brass, lead, tin, antimony. Sheet metal—galvanized—plate. Sanitation, syphonage, tanks. Drainage, sewage, purification. Fixtures—bath—kitchen. Pipe fittings, soil pipe, tools. Laying out work. Roughing. Screwed fittings, flanges, joints. Pipe bending, examples. Elbows. Heating, ventilation, refrigeration. Water supply, mains, wells, tanks. Gas-fittings. Underwriters. Sheet metal work, problems, methods, brazing, heating, lead burning. Welding, various welds, methods. Blacksmithing, forges, tools.

"Audels Guides are practical, easy to understand, reliable. Cover the field in plain language." W. F. Arming, Ann Arbor, Mich.

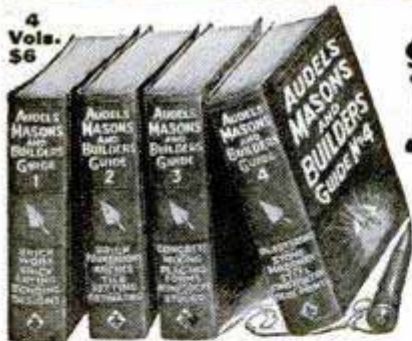

4 Vols. \$6

AUDELS MASONS AND BUILDERS GUIDES—4 VOLS. \$6

A new, complete, illustrated trade reference library, for Bricklayers, Cement Workers; Plasterers, Tile Setters and Stone Masons, including a practical outline of Steel Construction. **1100 pages; 2067 diagrams; flexible; pocket size.** A practical Trade Assistant explaining modern methods of masonry construction. Easy to understand and apply. A reliable and authentic reference work and study-course for Master Journeyman and Young Mechanic. Use FREE COUPON below and find out for yourself, without obligation, whether this set will benefit you.

INSIDE TRADE INFORMATION ON:

Bricklaying, tools, materials; Brick designs, patterns, bonds; Setting frames and foundations; Mortars, scaffolds, estimating; Mortars and mortar mixing; Tile setting, mosaic, hollow tile; Straight edge test, troweling; How to figure brick work; Safe loads, piers, chimneys; Boiler settings, anchors, fire stops; Labor tables; Concrete, forms; How to figure concrete work; Stucco—on old and new buildings; Plastering—wood lath—metal; Plasterers agreement; Plastering on various surfaces; Stonemasonry; Cutting, finishing, estimating stone; Derricks, rigging; Steel construction; Fire proof; How to read blue prints.

"Audels Masons Guides are the best books on the subject. Have laid brick 12 years and am able to judge." H. A. Bennett, Corlies, Pa.



PRACTICAL ELECTRICITY — 1 VOL. \$4

Audels Handy Book of Practical Electricity is a simplified Ready Reference and Study Course in one pocket size, leather bound volume—for Engineers, Professional Electricians and Students. **1040 pages; 2600 diagrams; flexible red leather bound.** A reliable authority and handy helper for every electrical worker. Contains important and valuable wiring diagrams, calculations, machine sketches, helps on maintenance and repair. Use this FREE COUPON today and find out, without obligation, how this handy book will help you in your daily work.



Complete in one handy, red leather bound volume

1040 Pages 2600 Diagrams

INSIDE TRADE INFORMATION ON:

Electro-Therapeutics, X-Rays, Shocks, Welding, Brazing, Radio Hook-ups, Motion Pictures, Telephone, Telegraph, Cranes, Bells, Elevators, Pumps, Tools, Ship Drive, Railways, Vehicles, Automobile Electric Systems, Ignition, Generation, Lighting, Plant Management, Power Plans, Armature Winding, Repairing, A. C. Motors and Apparatus, D. C. Motors and Apparatus, Alternator Construction, Dynamos, Wiring Diagrams, Sign Flashers, Cable Splicing, Power Wiring, Outside Wiring, Switches, Lighting, Rectifiers, Converters, Transformers, Fuses, Circuit Breakers, Rheostats, Electro Plating, Electrolysis, Storage Batteries, Magnetism, Electrical Energy, Conductors, Insulators, Static, Dynamic, Radio Electricity, Applications, Ready Reference and Index Covering the entire field of Modern Electricity.

Learn More and You Will Earn More!

Know your job and you'll never be without one. The skilled man is always in demand. Knowledge is power. Learn your trade thoroughly by easy reading. This coupon is your opportunity for advancement and better pay. You risk nothing in sending for Audels Guides for free examination. Send it NOW!

FREE EXAMINATION COUPON

THEO. AUDEL & CO., 65 W. 23 ST., NEW YORK CITY

Please mail me for free examination the books marked (x) below. If I find them satisfactory, I agree to mail \$1 in 7 days, on each set ordered, and to further mail \$1 monthly on each set until I have paid the purchase price.

4 CARPENTERS GUIDES \$6 4 PLUMBERS GUIDES \$6

4 MASONS GUIDES \$6 1 ELECTRICIANS HANDY BOOK \$4

NAME

ADDRESS

OCCUPATION

EMPLOYED BY..... 9-T-30

NOW FREE



B. W. COOKE
Directing
Engineer

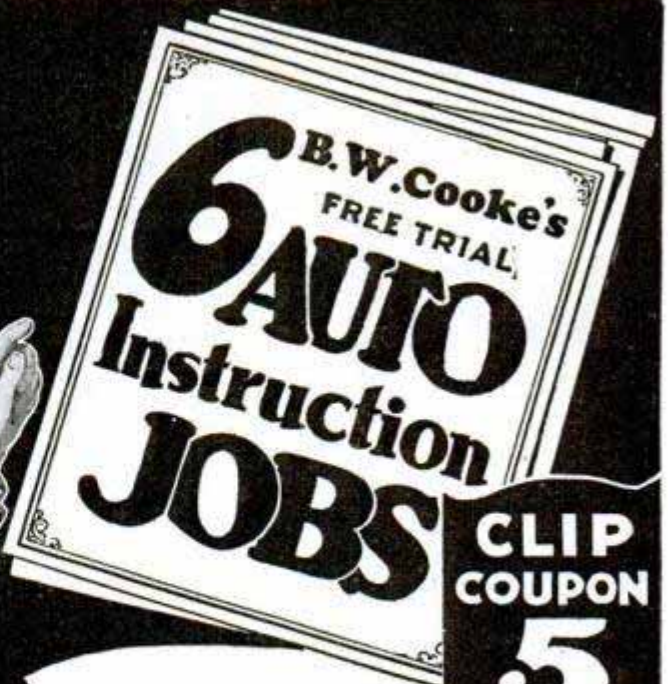

CLIP COUPON
5 BIG OUTFITS
Free
OF EXTRA COST

EARN up to \$150 a Week!

If you're earning a cent less than \$60 a week, *clip coupon now*. Get the **PROOF** that you can be on your way to **BIG PAY** as an Auto Expert **QUICK!** See for yourself how *fascinating* this training is—how easily you can master Auto Work right in your own home—and how **quickly** you can get in line for the **big Auto Jobs** that pay up to **\$150 a week and more**—or a Money-Making Auto Business of your own! Remember these Instruction jobs come to you **ABSOLUTELY FREE** and without obligation. *Clip coupon now.*

TO PROVE that "JOB-WAY" is "PAY-RAISE" Training

Clip coupon now. I'll send you **absolutely FREE OF CHARGE**—with positively *no obligation* on your part—**6 "JOB-WAY" Instruction JOBS!** and my big book. I want you to *SEE for yourself* just why "JOB-WAY" Training is bringing so many men **Big Money** in such *remarkably quick time*. I want you to see how men *without a day's previous auto experience*—and only *common schooling* become Garage Owners, Superintendents, Managers, and earn up to **\$150 a week and more!** I want you to see why Hundreds of men have found "JOB-WAY" Training to be such interesting, most practical money-making training!

That's why I make you this unusual offer—with **absolutely no strings on it and not a single penny's charge.** Clip coupon now and I'll rush your jobs to you *absolutely Free!*

Coupon Brings Full Details of My 5 OUTFITS OFFER

Includes Tools, Tool Bag, Electrical Test Bench and Radio Receiving Set—all Equipment. Also 303 Wiring Diagram Charts, also Socket Wrench and Ignition Wrench sets.

I'll train you AT HOME Get these free Instruction Jobs now. See how thorough, how complete "JOB-WAY" Training is—includes all Electrical work—Ignition, Starting, Lighting—all Mechanical, also Welding, Brazing, Vulcanizing—also Business Course, Salesmanship, Advertising—How to keep simple Books—also Students' Magazine, also 5 working Outfits. Nowhere else can you get this original genuine, copyrighted B. W. Cooke "JOB-WAY" Training.

Be An Auto Expert

The World's Biggest Business Needs You!

This Big Auto Book Also FREE Coupon brings this startling, revolutionary Auto Book, too, absolutely Free! Shows how hundreds of men have reached Big Pay in amazingly quick time! Shows what you can do. Send for it now!



There are so many tremendous Opportunities in this gigantic Auto Industry that I want every ambitious man *who really wants to make more money, to have these 6 Instruction Jobs, just to see how easily and quickly I can boost his pay*

way up. Just think! Seven thousand Millions of Dollars are paid to Auto men every year for *upkeep alone*—**Nineteen Million Dollars a day!** Think what that means to you—the Big Pay Opportunities open to you as a Cooke trained auto expert! It's the one field for the man who wants a **BIG pay check!** Learn all about it now!

SEND ME LESSONS and BOOK FREE

B. W. COOKE, 1916 Sunnyside Ave., Dept. 616, Chicago
Send me **absolutely FREE** and without any obligation on my part, 6 Auto Instruction Jobs. Also your Auto Book **FREE** and full particulars of your 5 Outfits Offer.

Name
Address
Town State

Don't delay a minute. Send coupon right now while I can still make you this special offer of 6 Auto Instruction Jobs absolutely free—as well as my Big Auto Book, free too! Act now!

Act Quick!

B. W. COOKE Directing Engineer
Chicago Motor Training Corporation
1916 Sunnyside Ave. Dept. 616 CHICAGO, ILL.



“The Boss Didn’t Even Know My Name”

“HE SAID my face was more or less familiar and he remembered seeing me around, but he didn’t even know my name until the I. C. S. wrote him that George Jackson had enrolled for a course of home study and was doing fine work.

“‘Who’s George Jackson?’ he asked. Then he looked me up. Told me he was glad to see I was ambitious. Said he’d keep his eye on me.

“He did too. Gave me my chance when Frank Jordan was sent out on the road. I was promoted over older men who had been with the firm for years.

“My spare-time studying helped me to get that job and to keep it after I got it. It certainly was a lucky day for me when I signed that I. C. S. coupon.”

How much longer are you going to wait before you take the step that will bring you advancement and more money?

It takes only a moment to mark and mail this coupon and send it to the

International Correspondence Schools at Scranton. Isn’t it better to do this today than to wait a year or five years and then wish you had? It surely is.

Mail the Coupon for Free Booklet

INTERNATIONAL CORRESPONDENCE SCHOOLS
Box 5595-E, Scranton, Penna.

Without cost or obligation, please tell me how I can qualify for the position or in the subject before which I have marked an X:

BUSINESS TRAINING COURSES

- | | |
|--|---|
| <input type="checkbox"/> Business Management | <input type="checkbox"/> Salesmanship |
| <input type="checkbox"/> Industrial Management | <input type="checkbox"/> Advertising |
| <input type="checkbox"/> Personnel Organization | <input type="checkbox"/> Better Letters |
| <input type="checkbox"/> Traffic Management | <input type="checkbox"/> Show Card Lettering |
| <input type="checkbox"/> Business Law | <input type="checkbox"/> Stenography and Typing |
| <input type="checkbox"/> Banking and Banking Law | <input type="checkbox"/> Business English |
| <input type="checkbox"/> Accountancy (Including C.P.A.) | <input type="checkbox"/> Civil Service |
| <input type="checkbox"/> Nicholson Cost Accounting | <input type="checkbox"/> Railway Mail Clerk |
| <input type="checkbox"/> Bookkeeping | <input type="checkbox"/> Common School Subjects |
| <input type="checkbox"/> Private Secretary | <input type="checkbox"/> High School Subjects |
| <input type="checkbox"/> Spanish <input type="checkbox"/> French | <input type="checkbox"/> Illustrating <input type="checkbox"/> Cartooning |

TECHNICAL AND INDUSTRIAL COURSES

- | | |
|---|--|
| <input type="checkbox"/> Electrical Engineering | <input type="checkbox"/> Architect |
| <input type="checkbox"/> Electric Lighting | <input type="checkbox"/> Architects’ Blue Prints |
| <input type="checkbox"/> Mechanical Engineer | <input type="checkbox"/> Contractor and Builder |
| <input type="checkbox"/> Mechanical Draftsman | <input type="checkbox"/> Architectural Draftsman |
| <input type="checkbox"/> Machine Shop Practice | <input type="checkbox"/> Concrete Builder |
| <input type="checkbox"/> Railroad Positions | <input type="checkbox"/> Structural Engineer |
| <input type="checkbox"/> Gas Engine Operating | <input type="checkbox"/> Chemistry <input type="checkbox"/> Pharmacy |
| <input type="checkbox"/> Civil Engineer | <input type="checkbox"/> Automobile Work |
| <input type="checkbox"/> Surveying and Mapping | <input type="checkbox"/> Airplane Engines |
| <input type="checkbox"/> Metallurgy | <input type="checkbox"/> Navigation |
| <input type="checkbox"/> Steam Engineering | <input type="checkbox"/> Agriculture and Poultry |
| <input type="checkbox"/> Radio | <input type="checkbox"/> Mathematics |

Name.....

Street.....

Address.....

City.....State.....

Occupation.....

Persons residing in Canada should send this coupon to the International Correspondence Schools Canadian, Limited, Montreal, Canada.

The International Correspondence Schools are the oldest and largest correspondence schools in the world

Aviation Booms!



If You Want Thrills- Popularity-Big Pay LEARN AVIATION QUICK!

Aviation, With All Its Fascinating Adventure, Demands Red-Blooded Young Men! And Will Pay Them Magnificent Sums! Read How Aviation's Best-Known Pioneers Will Help YOU to Qualify for One of the Big Jobs! Send Today for Your Copy of Our FREE Illustrated Book, Listing and Describing Positions That Pay \$4000 to \$10,000 a Year!



AVIATION, the most thrilling of all 20th century professions, is growing so swiftly that one can hardly keep track of all the astonishing new developments. Air-mail routes have just been extended to form a vast aerial network over the entire U. S. Air-lines and airplane factories are springing up all over the country. Men like Henry Ford are investing Millions in the future of commercial Aeronautics in America! The possibilities are so tremendous that they stagger imagination!

Everything is set for the greatest boom in history. The fortunes that came out of the automobile industry and out of motion pictures will be nothing compared to the fortunes that will come out of Aviation! There is just one thing holding it up:—lack of trained men! Even in the beginning thousands will be needed—and generously paid. The opportunities open to them cannot be over-estimated. Those who qualify quickly will find themselves on the road to undreamed of money—success—popularity—and prominence!

jobs, at home, in spare time. Experts will teach you the secrets—give you all the inside facts that are essential to your success. And, best of all, the study of Aviation is almost as fascinating as the actual work itself. Every Lesson is chock-full of interest—and so absorbing that you actually forget you are studying. But best of all are the ultimate rewards you are fitting yourself to gain!

Prepare for One of These BIG PAY JOBS

- Aeronautical Instructor, \$60 to \$150 per week
- Aeronautical Engineer, \$100 to \$300 per week
- Aeroplane Inspector, \$50 to \$75 per week
- Aeroplane Salesman, \$5000 per year and up
- Aeroplane Builder, \$75 to \$200 per week

Send for FREE Book

Send the coupon for our new, free book, just out—"Opportunities in the Airplane Industry." It is vitally interesting, reads like a romance and tells you things about this astonishing profession you never even dreamed of. This book is so fascinating it could easily sell for a dollar. We offer a limited number FREE. Write for yours today.

AMERICAN SCHOOL OF AVIATION
Dept. 1356, 3601 Michigan Ave., Chicago, Ill.

Start by Becoming an Aviation Expert This Easy Way

Think what Aviation offers you. Thrills such as you never had before! The praise and plaudits of the multitude. Ordinary salaries from \$75 to better than \$400 a week! And a chance to get in on the ground floor where rewards will be unlimited!

Get into this thrilling profession at once while the field is new and uncrowded. Now—by a unique new plan—you can quickly secure the basic training for one of these wonderful high salaried

American School of Aviation,
Dept. 1356, 3601 Michigan Ave.,
Chicago, Illinois.

Without any obligation please send me FREE book "Opportunities in the Airplane Industry." Also information about your course in Practical Aeronautics.

Name.....

Address.....

City..... State.....

Learn Electricity

in Great Shops!



**Not by Correspondence
All PRACTICAL Work at**

COYNE

IN 12 WEEKS

EARN BIG PAY MAKE \$200 to \$800 A MONTH

Why work for small pay? Why make \$25.00 or \$30.00 or even \$40.00 a week in a hard job doing dirty, disagreeable work, and never sure of your job? With COYNE ELECTRICAL TRAINING you can make \$200.00 to \$800.00 a month. You will do pleasant work, and many jobs give you an opportunity to travel. Advancement will be quick—steady work the year around. YOUR SERVICES WILL ALWAYS BE IN DEMAND ANY PLACE, or you can own your own business.

**No Books — No Lessons
— You Do Actual Work**

I don't teach you a lot of useless theory. I give you a useable knowledge on the same kind of Electrical Machinery as used in Power Houses, plants and big industrial businesses.

**You Don't Need Education
or Previous Experience**

I don't require that you have a lot of book learning. You don't need advanced education or any previous education to master my course. Put your faith in me and I'll make you independent and happy.

COYNE ELECTRICAL SCHOOL
Dept. 6726 1300-1310 W. Harrison St.
CHICAGO, ILL.



H. C. Lewis, Pres.

**Free Railroad Fare
and Two Big Courses**

For a short time I will pay your RAILROAD FARE to Chicago from any part of the United States, and besides, I'll include my RADIO and Automotive Electrical Course. All given Free with my big NEWLY ENLARGED ELECTRICAL COURSE for a short time only.

**Earn While
You Learn**

My Employment Department will assist you in securing a part time job to earn living expenses while training, and will assist you to a big pay job on graduation and any time thereafter for life.

Get My Free Book

This big handsome new book size 12x15 with over 150 actual photographs will be sent absolutely Free if you send coupon now.

FREE RAILROAD FARE

H. C. Lewis
President
COYNE
Electrical School
1300-10
W. Harrison St.
Dept. 6726
Chicago, Illinois

Dear Sir:—Please send me absolutely FREE your big new book and full particulars of your special offer of two extra courses FREE and Free Railroad Fare.

Name _____
Address _____
Town _____
State _____

MAIL THIS COUPON NOW!

This One



S8CL-PNP-A6CR



Earn Big Money as a Cartoonist!

Millions of dollars were spent last year on comic strips, political and sport cartoons, animated cartoons, etc. Scores of new cartoonists are needed now to meet the ever-increasing demand for this work. Never before have the opportunities in this fast-growing field been so many, so varied or so high-paying.

Easy Now to Learn CARTOONING at Home

Regardless of how little you know about cartooning now, you can easily qualify for a position in this attractive, high-salaried business. This home-study method starts you at the simplest fundamental principles of cartoon-making and takes you through every branch of humorous and serious cartooning.

You will be amazed at how quickly it teaches you to draw salable work. Many students of this method began to sell their drawings before they were half through their courses. The training paid for itself long before they finished it.

Learn cartooning this easy way. Enjoy the fascinating life of a successful cartoonist—easy hours, freedom from routine, your own boss, and \$3,000 to \$15,000 a year for this work that is play!

Send for FREE BOOK

Learn more about the wonderful opportunities in Cartooning, and details about this remarkable home-study method. A handsomely illustrated booklet has just been prepared which, upon request, will be sent to you without the slightest obligation. This booklet gives a thorough outline of the cartooning field, and explains in detail this wonderful method of teaching Cartooning. Send for it today! Washington School of Cartooning, Room 309-D, 1113-15th St., N. W., Washington, D. C.

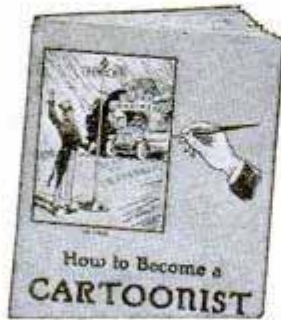

Washington School of Cartooning
Room 309-D, 1113-15th St., N. W., Washington, D. C.

Please send me, without obligation, your Free Booklet on Cartooning and full details of your home-study method of teaching Cartooning.

Name.....
(Print Name Plainly)

Address.....

City..... State.....

(If under 16, please give age.....)

Manage a Restaurant or Cafeteria

Earn \$2500 to \$10,000 a Year



81,410 Positions Annually for Trained Men and Women. Read How You Can Win Success in This Uncrowded Field.

Restaurants and cafeterias everywhere need trained executives. Over 81,410 high class positions paying up to \$10,000 a year open annually in the restaurants and cafeterias of the United States. Thousands of new restaurants, cafeterias and lunch rooms being opened in industrial plants, department stores, hotels, factories, banks, chain stores, etc., all need trained executives.

Big Pay Positions Open

There are openings for managers, assistant managers, buyers, hostesses, cashiers, stewards and numerous other executives—positions that pay salaries ranging from \$2,500 to \$10,000 a year.

No Previous Experience Needed

The famous Lewis Course trains you for these high-class, big-pay positions right at home, in your spare time. Previous experience unnecessary. The Lewis Schools guarantee to give you the valuable knowledge that it has taken successful restaurant operators years to obtain—men now earning \$5,000 to \$50,000 a year. We put you in touch with big opportunities. Lewis Students everywhere are "making good" in this uncrowded field. Mrs. Edith V. Mair writes: "I have a position as manager of a cafeteria for the Pacific Spruce Corp. here at Toledo." Same Chase says: "I can trace my ability to assist in managing a cafeteria where 1,500 persons are served at each meal to my course of training in your institution." Bradley Knoche writes: "When I first wrote you I was foreign to restaurant business—today I am one of the managers for Bunn Bros. Cafeterias." The Lewis Course has helped thousands to success. It can do the same for you!

Free—Complete Details Send today for full information about this wonderful new field and how the Lewis Course can quickly train you for a well-paid executive position.

LEWIS HOTEL TRAINING SCHOOLS
Dept. D-R306 Washington, D. C.



SAXOPHONE MUSIC Catalog

Just out—complete catalog FREE of latest jazz hits, also standard saxophone solos, duets, trios, quartettes—2,000 selections. Largest general dealers of saxophone music and supplies in the world. Expert repairing. Send for free catalog today.

FINDER & URBANEK Inc., Dept. 1857, 1322 West Congress St., Chicago

Tri-State College of Engineering

Makes you a civil, mechanical, electrical or chemical engineer in 96 weeks. No entrance examinations. High school diploma not required. Compact courses of essentials only. Expenses low. Degree granted on completion of course. For catalog address, Box M-96, Angola, Ind.

Deagan Free trial! Xylorimba



Become a crack Xylorimba player right in your own home. Easy to play. Learn in a few hours with our 14 free complete lessons. Earn \$80.00 to \$200.00 a week!

FREE LESSONS—A YEAR TO PAY

Free trial, easy payment plan. Earn while you learn. Write for details special free trial offer. J. C. DEAGAN, Inc., Dept. 1356 1770 Berleau Ave. Chicago, Ill.

\$141⁶⁷ to \$275 Month



Mail Carriers (City or Rural)

Steady—common education sufficient. Big chance for men, 18 up.

FRANKLIN INSTITUTE Dept. A 313 Rochester, New York

Mail Coupon Today Sure

Rush to me, WITHOUT CHARGE, pointers on how to get a position as Mail Carrier or City Post Office Clerk. Give full particulars and send Free Sample Franklin Institute Coaching Lessons.

Name.....

Address.....

Repair Any Auto or Auto Truck

Examine These NEW AUTO BOOKS FREE

Be an expert auto repair man. You can have the skill that makes every complicated trouble as easy to fix as taking out a spark plug. Learn every detail of all makes of cars and trucks. Know exactly how to find what's wrong and how to make all repairs quickly. These great new Auto Books show you how.

MAKE MONEY REPAIRING AUTOS

Over 12 million cars are in operation and thousands of men are needed to keep them in good going condition. There are more jobs open than there are good men to fill them. Never before have expert auto repair men been in such great demand and made so much money. Now is your great money-earning opportunity in the auto repair business. Every mechanic, every chauffeur, every car owner needs this great New Library of Automobile Engineering.

Tells About
 Explosion Motors, Welding, Motor Construction and Repair, Carburetors and Settings, Valves, Cooling, Lubrication, Fly-Wheels, Clutch Transmission, Final Drive, Steering Frames, Tires, Vulcanizing, Ignition, Starting and Lighting Systems, Shop Kinks, Public Garage Design, Equipment and Operation, Electrics, Storage Batteries—Care and Repair, Steam Cars, Motorcycles, Commercial Trucks, Glossary. More than 100 blue prints Wir'g Diagrams.

Shipped Free You Make No Deposit

Let us send you the complete five-volume set of Automobile Engineering for one week's examination. Read the simple directions for repairing every automobile trouble. Five thick volumes, 5 1/2 x 8 3/4 inches, flexibly bound and stamped in gold, 2,000 pages, 2,100 illustrations, wiring diagrams, etc. Everything in plain, every-day language, simple to understand. If you decide to keep them, send only \$2 in ten days, and \$3 a month thereafter until the special introductory price of \$24.80 has been paid.

Employment Service Free

In addition to all this, those who send now will be entitled to the services of our Employment Department without charge. We are in daily contact with firms all over the country who need good men and are willing to pay big. This service costs you nothing. Don't miss this special offer. Send now.

Send No Money

Don't send a penny! Your name and address in the coupon brings the five books to you at once for ten days' trial. Mail Coupon NOW.

American Technical Society
 Dept. A-619, Chicago, U. S. A.

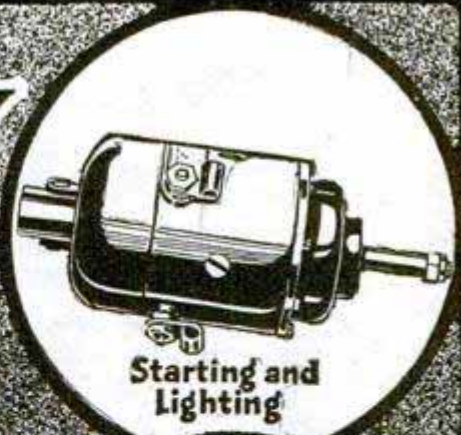

Starting and Lighting



Welding

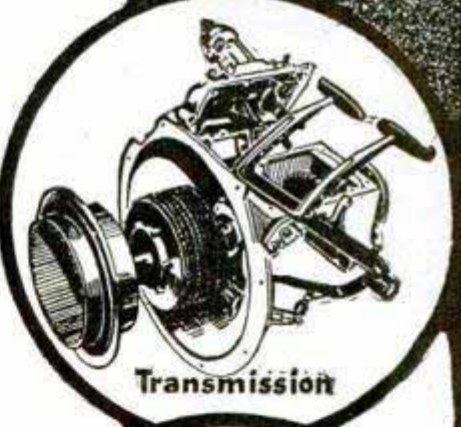

Transmission

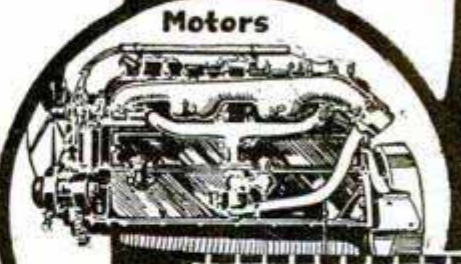

Motors

AMERICAN TECHNICAL SOCIETY
 Dept. A-619, CHICAGO, U. S. A.

Please send me the five-volume set of Automobile Engineering for ten days' examination. If I decide to buy I will send \$2.00 within ten days and balance at \$3.00 a month until \$24.80 has been paid. Then you will send me a receipt showing that the set of books are mine and fully paid for. If I think I can get along without the books I will return them, after 10 days, at your expense. To insure prompt shipment fill out all lines.

Name.....
 Address.....
 Reference.....

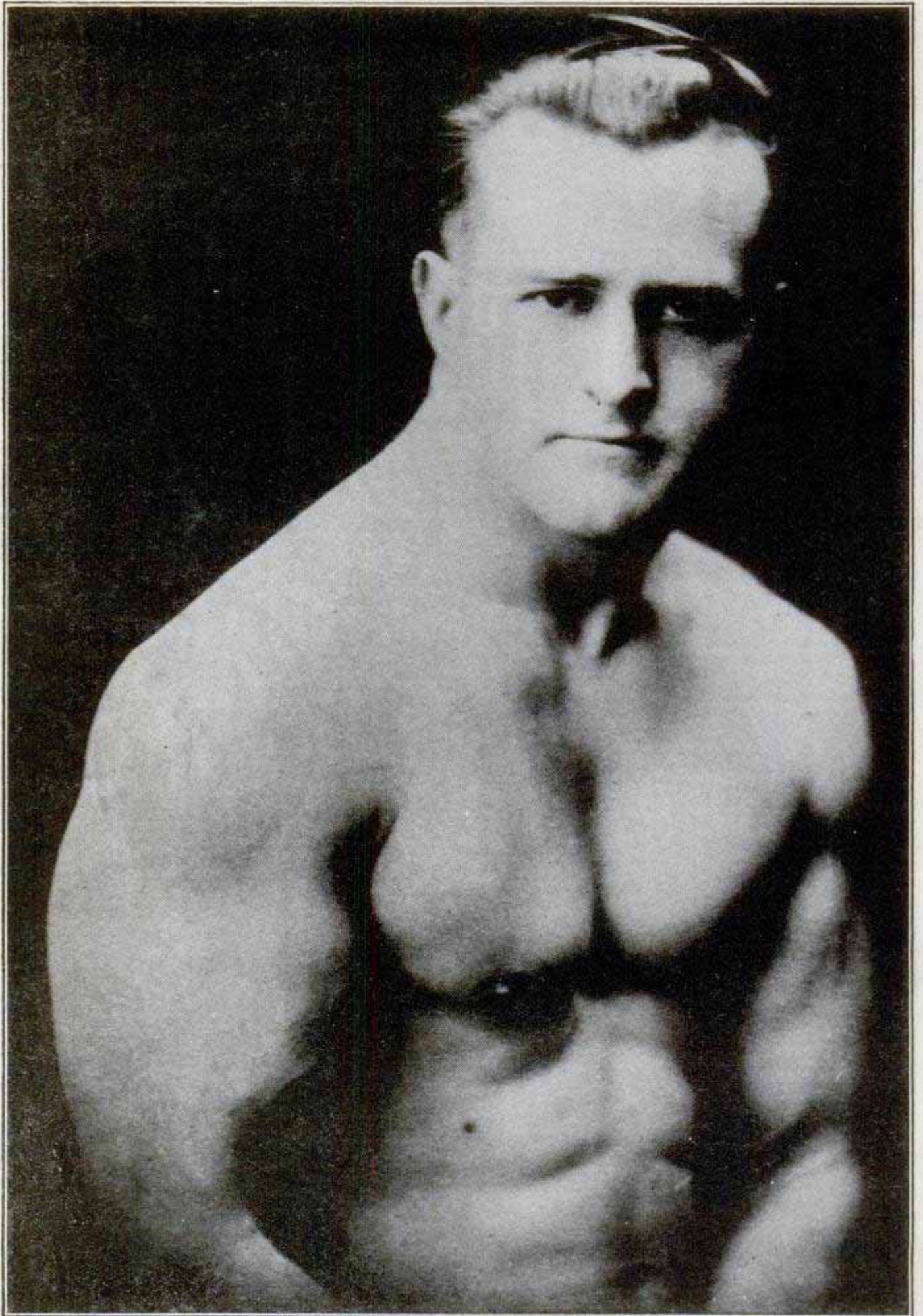

EARLE E. LIEDERMAN, *The Muscle Builder*
Author of "Science of Wrestling," "Muscle Building," "Secrets of Strength," "Here's Health," etc.

Kill This Man!

THERE'S a devil inside of you. He's trying to kill you. Look out for him! He tells you not to work so hard. What's the use? the boss only piles more work on you. He tells you not to bother with your body. If you're weak—you always will be weak. Exercise is just a lot of rot. Do you recognize him? Of course you do. He's in us all. He's a murderer of ambition. He's a liar and a fool. *Kill him!* If you don't, he will kill you.

Saved

Thank your lucky stars you have another man inside of you. He's the human dynamo. He fills you full of pep and ambition. He keeps you alive—on fire. He urges you on in your daily tasks. He makes you strive for bigger and better things to do. He makes you crave for life and strength. He teaches you that the weak fall by the wayside, but the strong succeed. He shows you that exercise builds live tissue—live tissue is muscle—muscle means strength—strength is power. Power brings success! That's what you want, and gosh darn your old hide! you're going to get it.

Which Man Will It Be?

It's up to you. Set your own future. You want to be the Human Dynamo? Fine! Well, let's get busy. That's where I come in. That's my job. Here's what I'll do for you:

In just 30 days I'll increase your arm one full inch with real live, animated muscle. Yes, and I'll add two inches to your chest in the same time. Pretty good, eh? That's nothing. Now come the works. I'll build up your shoulders. I'll deepen your chest. I'll strengthen your whole body. I'll give you arms and legs like pillars. I'll literally pack muscle up your stomach and down your back. Meanwhile I'll work on those inner muscles surrounding your vital organs. You'll feel the thrill of life shooting up your old backbone and throughout your entire system. You'll feel so full of life you will shout to the world, "I'm a man and I can prove it!"

Sounds good, what? But listen! That isn't all. I'm not just promising these things. *I guarantee them!* It's a sure bet. Oh, boy! Let's ride.

Send For My New
64 Page Book

"Muscular Development"

IT IS FREE

What do you think of that? I don't ask one cent. And it's the peppiest piece of reading you ever laid your eyes on. I swear you'll never blink an eyelash till you've turned the last cover. And there's 48 full-page photos of myself and some of my prize-winning pupils. This is the finest art gallery of strong men ever assembled. And every last one of them is shouting my praises. Look them over. If you don't get a kick out of this book, you had better roll over—you're dead. Come on, then. Take out the old pen or pencil and sign your name and address to the coupon. If you haven't a stamp, a postal will do. But snap into it. Do it *now*. Tomorrow you may forget. Remember, it's something for nothing and no strings attached, no obligation. *Grab it!*

EARLE E. LIEDERMAN

Dept. 2009, 305 Broadway, New York City

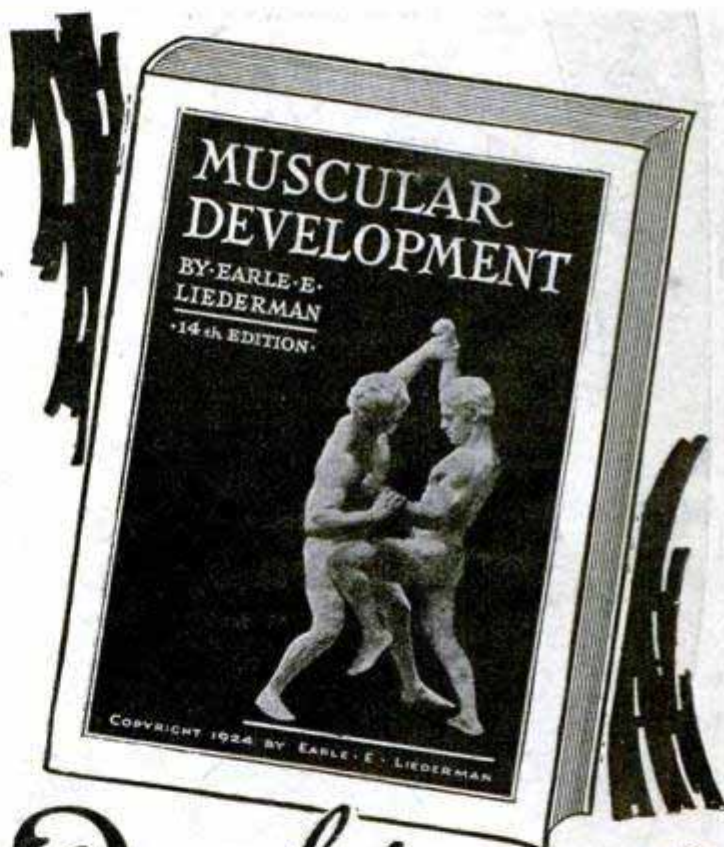

**It
Is
F
R
E
E**

**DON'T
SEND ONE
PENNY
—
YOUR
NAME AND
ADDRESS
ON A
POSTAL
WILL DO**

EARLE E. LIEDERMAN
Dept. 2009, 305 Broadway, New York City

Dear Sir: Please send me, absolutely FREE and without any obligation on my part whatever, a copy of your latest book, "Muscular Development."

Name.....

Street.....

City.....State.....

(Please write or print plainly.)

These Men Earn \$40 to \$125 a Week as Mechanical Dentists

These are actual pictures of dental laboratories owned by McCarrie graduates. This live, up-to-date profession offers any ambitious man the opportunity of a lifetime to become financially independent. Read the letters below. Many dental "labs" do a \$25,000 annual business. Mechanical Dentists earn \$40 to \$125 a week.

You Can Learn Mechanical Dentistry in a Few Months

Learn to make crowns, bridges, plates, etc., for dentists by our practical method of individual training. Many students complete the course in a few months. Day and evening instruction in all of our 5 big schools in Chicago, Detroit, Cleveland, Boston and Philadelphia. We help you secure spare time job while learning. No educational requirements for entering McCarrie School. No mechanical experience required.

No Classes — No Books Learn by Doing

Each student trained individually. You work with new set of tools and with precious metals. Training is practical, thorough and quick so that you can start your own laboratory after completion of course.

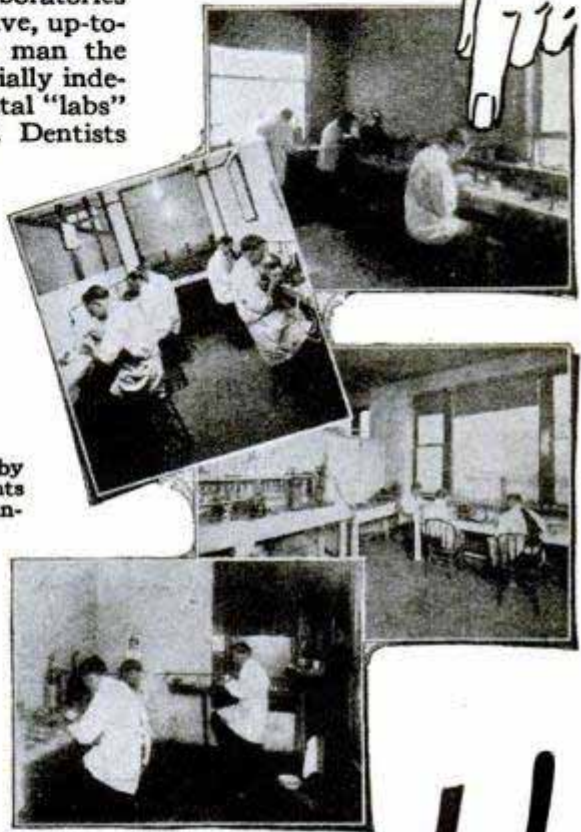

FREE

R·R·FARE

to any McCarrie School. Send coupon for details.



Read!

What Some McCarrie Graduates Write:

- A. K. writes: Am making good as manager of laboratory. Just turned down an offer of \$75 a week.
- C. M. writes: I am now doing laboratory work for D. D. N. M. at a salary of \$50 a week.
- S. K. H. writes: Some months I take in \$500. Last month I took in \$674.80.
- G. P. W. writes: Am making \$50 a week straight time turning out bridges, plates, etc.
- W. M. E. writes: I have an excellent business. I average \$75 to \$150 a week.
- R. W. B. writes: I secured one of the very best responsible positions immediately upon completion of my course.

These are specimens of hundreds of letters on file here from McCarrie graduates.

Facts About This Money Making Opportunity

There are 64,000 dentists in the U. S. Thousands of dental "labs" and expert mechanical Dentists are needed to handle the great volume of work required by dentists. Mail coupon for free book that gives all details of this great opportunity and **SPECIAL OFFER.**

McCarrie Schools of Mechanical Dentistry
1338 S. Michigan Ave. Dept. 26 CHICAGO, ILL.

McCarrie Schools of Mechanical Dentistry
1338 S. Michigan Ave., Dept. 26, Chicago

Without cost or obligation, send me your illustrated book containing complete information as to my opportunities in the dental laboratory profession and details of your special offer.

Name

Address



Consider These Facts!

If You Want to Make More Money!



"Thank you for the real good that your training has accomplished for me. It has enabled me to learn more, earn more and be more."

"I owe much of my success to your Training and it may interest you to learn that I am now President and Treasurer of a national organization."

C. V. CHAMPION & Co.,
Chas. V. Champion, President.

"The day I sent for your literature was the turning point in my career. Last month I earned \$1350.00 as a salesman. My earnings during the past year have averaged around \$1000 a month. I know I could not have done this without N. S. T. A. training, for upon my return from service in France, I had an earning capacity of only \$25 a week."



A. H. WARD,
Postl's of Chicago.



"After 10 years in the railway mail service, I decided against the advice of friends to change. Some of them laughed at me. But when I went out upon completion of the N. S. T. A. course, I made more than \$1000 in 30 days—multiplied my earnings four times the first year—then the laugh was on the other side."

WARREN HARTLE,
Chicago.

"I have received great good from your training. So thorough is the course in salesmanship given by the N. S. T. A. that I have been enabled to step into a position as SALES MANAGER, and find myself immediately in the \$10,000 a year class."



O. H. MALPROOF,
Boston.

- 1 Opportunities in the selling profession are ten to one in any other line of endeavor.
- 2 Salesmen top the list of money-makers because they are the motive power of business.
- 3 Thousands of former routine workers are now enjoying good incomes as a result of N. S. T. A. Training and Employment Service.
- 4 Inside 20 weeks you can be ready to step into a good selling position as city or traveling salesman with unlimited opportunities to make real money.
- 5 The fact that requests for 48,890 trained salesmen were received during 1925 by the Employment Service Department of the National Salesmen's Training Association proves the demand.
- 6 N. S. T. A. specializing for over 18 years in salesmanship, offers you a service that cannot be duplicated by others teaching a variety of subjects and specializing in none.

IF you really want to make more money, or if you are a believer in that old fallacy about the "born" salesmen—then this is an invitation for you to send for some startling facts.

Any ambitious man is invited to ask us to prove two things: (1) That any man of average intelligence can quickly be taught to be a producing salesman and (2) That trained salesmen outsell those who rely on native ability.

Do you realize the extent to which your income would be increased if you were a real producer on a sales force? Mentioning exceptional earnings is not our policy—but what would it mean to you if you were earning as much as the men whose letters appear to the left?

You, Too, Can Be a Producing Salesman

Without any reservations we say that the Association can make any man of average intelligence a real producer on any sales force if he will but apply the knowledge he will get from our System of Training.

For the past eighteen years the Association has been making Master Salesmen out of men from all walks of life. There's some real proof on this page. You might attribute these successes to "luck"—but when thousands have left routine jobs and made good as salesmen after a short period of training with the Association then luck is eliminated.

Salesmanship is governed by fundamental rules and principles. There are certain ways to approach different "types" of prospects, certain ways to stimulate keen interest, certain ways to

overcome objections, batter down prejudice and make the prospect act. Know these secrets of successful sales procedure and a big future awaits you in the selling field.

Send for All the Facts and a Remarkable Free Book

You won't increase your earning power five cents while "thinking things over." ACTION—DECISION—has brought success to thousands—will bring success to you.

Not "tomorrow" or "next week" but THIS VERY MINUTE is the time to mail the coupon below. We will promptly send you a remarkable book, "Modern Salesmanship," and full details of our result-securing System of Salesmanship Training and Free Employment Service. There is no cost or obligation—so act today for bigger pay.



Dept. M-12 N. S. T. A. Building
CHICAGO, ILLINOIS

National Salesmen's Training Association, Dept. M-12, N. S. T. A. Bldg., Chicago, Ill.
Send me a free copy of "Modern Salesmanship."

Name.....
Address.....
City.....State.....
Age.....Occupation.....



“Real Money in the Bank”

“Think of it, Nell—\$460! And to think that just a few months ago we couldn't save a cent.

“Remember the night we talked it over and you persuaded me to send in that I. C. S. coupon? It was the best investment we ever made.

“The boss says there will be a still better position open for me soon if I keep on showing the same interest in my work. It certainly does pay to study in spare time.”

Thousands of men now know the joy of happy, prosperous homes because they let the International Correspondence Schools prepare them in spare time for bigger work.

One hour after supper each night, spent with the I. C. S. in the quiet of your home, will prepare you for the position you want in the work you like best.

This is all we ask: Without cost or obligation, put it up to us to prove how we can help you.



Mail the Coupon for Free Booklet

INTERNATIONAL CORRESPONDENCE SCHOOLS
Box 5599-E, Scranton, Penna.

Without cost or obligation, please tell me how I can qualify for the position or in the subject before which I have marked an X:

BUSINESS TRAINING COURSES

- | | |
|--|---|
| <input type="checkbox"/> Business Management | <input type="checkbox"/> Salesmanship |
| <input type="checkbox"/> Industrial Management | <input type="checkbox"/> Advertising |
| <input type="checkbox"/> Personnel Organization | <input type="checkbox"/> Better Letters |
| <input type="checkbox"/> Traffic Management | <input type="checkbox"/> Show Card Lettering |
| <input type="checkbox"/> Business Law | <input type="checkbox"/> Stenography and Typing |
| <input type="checkbox"/> Banking and Banking Law | <input type="checkbox"/> Business English |
| <input type="checkbox"/> Accountancy (including C.P.A.) | <input type="checkbox"/> Civil Service |
| <input type="checkbox"/> Nicholson Cost Accounting | <input type="checkbox"/> Railway Mail Clerk |
| <input type="checkbox"/> Bookkeeping | <input type="checkbox"/> Common School Subjects |
| <input type="checkbox"/> Private Secretary | <input type="checkbox"/> High School Subjects |
| <input type="checkbox"/> Spanish <input type="checkbox"/> French | <input type="checkbox"/> Illustrating <input type="checkbox"/> Cartooning |

TECHNICAL AND INDUSTRIAL COURSES

- | | |
|---|--|
| <input type="checkbox"/> Electrical Engineering | <input type="checkbox"/> Architect |
| <input type="checkbox"/> Electric Lighting | <input type="checkbox"/> Architects' Blue Prints |
| <input type="checkbox"/> Mechanical Engineer | <input type="checkbox"/> Contractor and Builder |
| <input type="checkbox"/> Mechanical Draftsman | <input type="checkbox"/> Architectural Draftsman |
| <input type="checkbox"/> Machine Shop Practice | <input type="checkbox"/> Concrete Builder |
| <input type="checkbox"/> Railroad Positions | <input type="checkbox"/> Structural Engineer |
| <input type="checkbox"/> Gas Engine Operating | <input type="checkbox"/> Chemistry <input type="checkbox"/> Pharmacy |
| <input type="checkbox"/> Civil Engineer | <input type="checkbox"/> Automobile Work |
| <input type="checkbox"/> Surveying and Mapping | <input type="checkbox"/> Airplane Engines |
| <input type="checkbox"/> Metallurgy | <input type="checkbox"/> Navigation |
| <input type="checkbox"/> Steam Engineering | <input type="checkbox"/> Agriculture and Poultry |
| <input type="checkbox"/> Radio | <input type="checkbox"/> Mathematics |

Name.....
Street Address.....
City..... State.....

Occupation.....
Persons residing in Canada should send this coupon to the International Correspondence Schools Canadian, Limited, Montreal, Canada.



Double Your Pay This Easy Way

SCORES of ambitious fellows earn more than their regular salaries simply by using a few pleasant hours a week of their spare time making show cards for local stores. Every retailer in your neighborhood will pay big money for clever sales-producing display cards. Learn at home through easy professional method. Earn \$25 to \$50 a week spare time—\$50 to \$100 a week in full time. Business of your own. Wonderful future. Earn even while you learn.

Send for new illustrated booklet, “Quick Success in Show Card Making.” Also for details on Show Card Outfit given to new students. No obligation. Write now to

WASHINGTON SHOW CARD SCHOOL
Dept. 309-D, 1117-15th St., N. W., WASHINGTON, D. C.

ELECTRICAL ENGINEERING Course for men of ambition and limited time. Over 4000 men trained. Condensed course in Theoretical and Practical Electrical including the closely related subjects of Mathematics and Mechanical Drawing taught by experts. Students construct motors, install wiring, test electrical machinery. Complete course



IN ONE YEAR

Prepare for your profession in the most interesting city in the world. School established 1893. Send for catalog.
BLISS ELECTRICAL SCHOOL
419 Takoma Ave. WASHINGTON, D. C.

STAMMER

If you stammer attend no institute till you get my large FREE book entitled “STAMMERING, its Origin and The Advanced Natural Method of Treatment.” Ask for special tuition rate and a FREE copy of “The Natural Speech Magazine,” published monthly in the interest of those afflicted with stammering, stuttering and other speech impediments. Largest, best equipped and most successful school in the world for the cure of stammering. Established 20 years. No sing-song or time-beat. Write today. **MILLARD INSTITUTE OF NORMAL SPEECH**, 2317 Millard Bldg., MILWAUKEE, WIS. Branch Summer School, Philadelphia, Pa.

Learn Watchwork, Jewelrywork and Engraving A fine trade commanding a good salary, and your services always in demand. Address **Horological**, Dept. P, Bradley Institute, PEORIA, ILLINOIS, for our latest catalog.

Learn Advertising at HOME

The highest paid men in the world are advertising men. You can learn easily and quickly at home during your spare time. Bigger opportunities now in advertising than ever before. Tremendous demand for our graduates at big pay.
Send for **FREE Book**. Giving interesting information and vital facts—just what you want to know about advertising. Write today!
PAGE-DAVIS SCHOOL OF ADVERTISING
Dept. 1356 3601 Michigan Ave., Chicago, U. S. A.

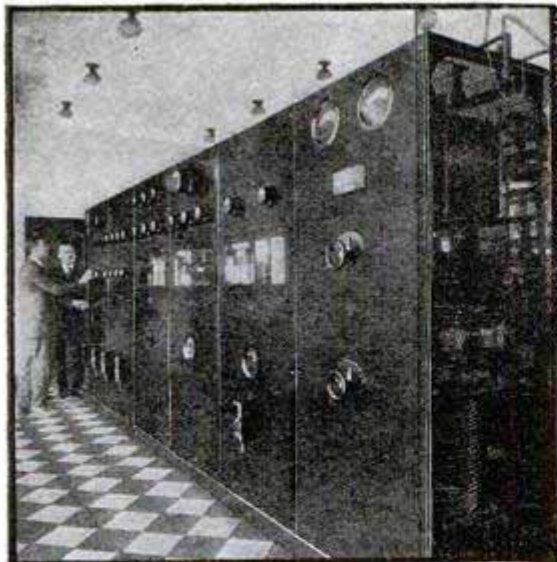

**\$50. to \$250 a week
IN WORK THAT IS
ALMOST ROMANCE**

Be a Radio Expert

Get into the great new Big-Pay Industry—Radio. If you're earning a penny less than \$50 a week, clip coupon now. Send for AMAZING FREE BOOK. Be a Radio Expert, and draw down big money for the easiest

and most fascinating work in the world. Positions everywhere. Thoroughly-trained men are in big demand. Need for Radio Experts in every community. Short hours. **BIG PAY. Free book gives all the facts.** Astonishing opportunities—thousands of them! Every day N. R. I. trained men are taking good places in the Radio field. Free book tells all about their success. Send for it now!



**Learn Quickly and Easily
AT HOME**

Master Radio Engineers will show you how to qualify quickly and easily at home, for Radio's fine jobs. We guarantee to train you successfully. Lack of experience no drawback—common schooling all you need. Our tested, clear methods make it easy for you. Send coupon now for free proof.

**Instruments Given
with Course**

All instruments shown here and many others given to students for practice work while learning. Receiving sets, from simplest kind to thousand mile receiver. An **UNEQUALLED OFFER.** Many other big features for limited time only.

**Famous Training
That "Pays for
Itself"**

Spare time earnings are easy in Radio. Increase your income almost from the start through practical knowledge we give you. This is the famous practical training that pays its own way.



Operates WMAQ

"Accepted a position with Chicago Daily News—Station WMAQ. My income practically doubled, thanks to your fine course."
KEITH KIMBALL, Chicago.



Gets Big Job

"Just been made Sales Manager of this Radio concern—a big raise in pay. Regret I did not take course sooner."
R. E. JONES, Bay City.

Get
this
Amazing
Book

Most amazing book on Radio ever written—full, interesting facts about this great field and how we prepare you and help you start. You can do what others have done. GET THIS BOOK.

Send Coupon

Send coupon today for special limited offer, including all instruments—you'll get full particulars by return mail.

**National Radio
Institute**

Dept. KT7, Washington, D. C.

You get
all of
these



MAIL THIS NOW

**NATIONAL RADIO INSTITUTE
Dept. KT 7, Washington, D. C.**

Without obligating me in any way, send me your free book, "Rich Rewards in Radio," and all information about your practical, home-study Radio course.

Name.....

Address.....

Town..... State.....



ORIGINATORS OF RADIO HOME-STUDY TRAINING

ESTABLISHED 1914



**—now he enjoys
an \$8,000 income
thru Higher Accountancy**

From a routine job that offered him little or no opportunity for advancement, Fred F. Ames has been able in a comparatively short time to lift himself to a position where his income is now more than \$8,000 annually.

Mr. Ames was employed by a railroad; his salary was \$91.65 a month. The deadly sameness was robbing him of his initiative. He looked into the future and he saw his inability to hold a better position.

He enrolled with LaSalle Extension University. Higher Accountancy was his goal. Now he is a Public Accountant and a Tax Specialist, with offices of his own. "My success is due chiefly to your course," he writes; "if I had not enrolled with you, it is quite probable that I would still be a railroad clerk at a salary which would not exceed \$200 per month."

**Send for Free Book—
"Accountancy, the Profession that Pays"**

Higher Accountancy—a profession on the same plane with law or medicine—is offering untold opportunities to ambitious men and women. Questions of income tax, auditing, cost accounting, have created hundreds of new executive positions. Accounting knowledge is fundamental to the successful management of business.

A complete plan whereby you can advance to positions of responsibility and power in the Accountancy field is clearly outlined in LaSalle's new 64-page book, "Accountancy, the Profession that Pays." The information it contains is of priceless value to the man eager to achieve success in business—and LaSalle will send it to you free.

If you have the urge and the will to increase your income—clip and mail the coupon NOW.

**— — — Find Yourself Thru LaSalle! — — —
LASALLE EXTENSION UNIVERSITY**
The World's Largest Business Training Institution

Dept. 964-HR Chicago

I would welcome details of your salary-doubling plan, together with copy of "Accountancy, the Profession that Pays," also a copy of "Ten Years' Promotion in One," all without obligation.

Higher Accountancy
Training for positions as Auditor, Comptroller, Certified Public Accountant, Cost Accountant, etc.

Other LaSalle Opportunities
LaSalle opens the way to success in every important field of business. If more interested in one of the fields indicated below, check and mail now.

- | | |
|--|--|
| <input type="checkbox"/> Business Management | <input type="checkbox"/> Personnel and Employment Management |
| <input type="checkbox"/> Modern Salesmanship | <input type="checkbox"/> Banking and Finance |
| <input type="checkbox"/> Traffic Management | <input type="checkbox"/> Modern Business Correspondence and Practice |
| <input type="checkbox"/> Railway Station Management | <input type="checkbox"/> Expert Bookkeeping |
| <input type="checkbox"/> Law—Degree of LL.B. | <input type="checkbox"/> C. P. A. Coaching |
| <input type="checkbox"/> Commercial Law | <input type="checkbox"/> Business English |
| <input type="checkbox"/> Industrial Management | <input type="checkbox"/> Commercial Spanish |
| <input type="checkbox"/> Modern Foremanship and Production Methods | <input type="checkbox"/> Effective Speaking |



Name

Present Position

Address



Think of being able to offer a suit or topcoat made of the finest quality of pure Virgin Wool; fit, fabric and fashion guaranteed, at the powerfully attractive price of \$23.50! Can you sell such values? You can, if the experience of 2,500 other salesmen means anything. And you don't have to know anything about selling clothing. We'll take you, train and equip you to go out and make a success of this work if you are honest, ambitious and willing to work. If you are, write us. You'll hear from us promptly with the full facts. Address Dept. 981.

William C. Bartlett, Inc., 850 Adams St., Chicago

Gentlemen: I'm interested in the opportunity you offer. Please send the facts without obligation to me. 981

Name

Address

Town..... State.....

Learn How to WRESTLE
In Your Own Home By Mail

WRITE for big book on wrestling. Tells secrets you've always wanted to know.

Yes, learn to become an expert wrestler right in your own home, by mail, from the greatest wrestlers the world has ever known. Be an athlete, be strong, be healthy. Learn how to throw and handle big men with ease. Learn to defend yourself. Learn from the World's Champions.

Farmer Burns and Frank Gotch Secrets

Farmer Burns, who taught Frank Gotch—trainer of SEVEN World's Champions, will teach you Scientific Wrestling—Physical Culture—Jiu-Jitsu and Self-Defense. Write today for big wrestling book, illustrated with many fine pictures—shows holds and secret tricks used by champions. Tells how easy it is to learn the marvelous breaks, falls and holds that make you an expert. Send today for this wonderful book. Enclose only 10c to help cover cost of wrapping and postage. Be sure to state age. No obligation.

Farmer Burns, 1776 Ry. Exch. Bldg., Omaha, Neb.

Send Now for Farmer Burns' Book

Learn to Mount Birds

Learn at home by mail, to mount birds, animals, game heads; tan furs, make rugs and robes. Complete lessons. Easily and quickly learned by men, boys and women.

FREE Write today for Free Taxidermy Book. Tells all about it. Every Sportsman, Hunter, Trapper and Nature lover should know this wonderful fascinating art. Save your trophies. Big profits. Success guaranteed. Our school is 20 years old—75,000 graduates. Investigate today. Write for Free Book.

Northwestern School of Taxidermy 1776 Elwood Bldg., Omaha, Neb.

LEARN to PITCH

56 Illustrations—How to pitch the "Fade-away," "Knuckler," "Smoke Ball," and Speed. How to keep in condition. Lessons by Matty. Johnson, W. J. Walsh, White and Rucker sent postpaid for 25 cents.

J. C. DORN, 721 S. Dearborn St., Dept. 65, CHICAGO, ILL.

GOV'T. POSITIONS

<input type="checkbox"/> Railway Mail Clerk	<input type="checkbox"/> Meat Inspector
<input type="checkbox"/> P. O. Clerk	<input type="checkbox"/> Special Agent (Investigator)
<input type="checkbox"/> Forest Ranger	<input type="checkbox"/> Stenographer-Typist
<input type="checkbox"/> File Clerk	<input type="checkbox"/> Immigrant Inspector
<input type="checkbox"/> Matron	<input type="checkbox"/> City Mail Carrier
<input type="checkbox"/> General Clerk	<input type="checkbox"/> U. S. Border Patrol
<input type="checkbox"/> Chauffeur-Carrier	<input type="checkbox"/> Typist
<input type="checkbox"/> Skilled Laborer	<input type="checkbox"/> Seamstress
<input type="checkbox"/> Watchman	<input type="checkbox"/> Steno-Secretary
<input type="checkbox"/> Postmaster	<input type="checkbox"/> Auditor
<input type="checkbox"/> RFD Carrier	

Mr. Ozment, Dept. 111, St. Louis, Mo.
Send me particulars about positions marked "X"
—salaries, locations, opportunities, etc.

NAME

ADDRESS

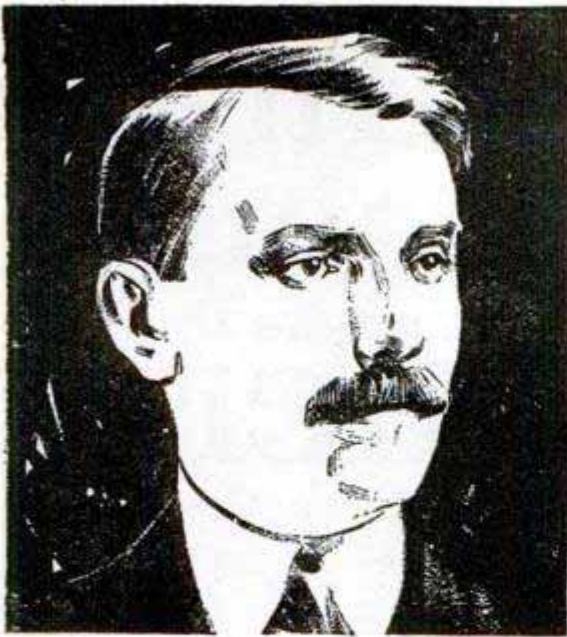

J. A. Stransky



Inventor Cuts Gasoline to 9¢ a GALLON!

NOW you can cut your gasoline cost as low as 9c a gallon. An amazing new invention makes practically any car give twice its regular mileage to the gallon. Many run from 37 to 57 miles and up to 61 miles on a gallon! This wonderful invention is the work of Mr. J. A. Stransky of Pukwana, S. Dakota. Already it is being used by over a million satisfied car owners—on all makes and models of cars. And now the inventor will send you a sample at his own risk! Read his offer below.

The Stransky Vaporizer is one of the biggest inventions of the century—an invention almost as revolutionary as the invention of the auto itself—and it is making fortunes for agents and distributors. Now you, too, can make big money just telling your friends about it. J. M. James made \$120 in one day. Vernon Gaines netted \$94 in eight hours. You can easily earn astonishing big profits in full or spare time.

61 Miles on a Gallon

Here's how this amazing new invention works. Your carburetor is adjusted to make starting easy—it gives a rich mixture to start a cold engine. But once your engine gets heated up, the mixture is far too rich, resulting in faulty explosion. Half the gasoline is drawn into the cylinders in a raw state and, instead of exploding, it burns. This causes a heavy deposit of carbon.

But with this startling little device in your car all this is changed. As soon as the engine warms up, this device automatically begins to admit a much larger volume of air, thoroughly vaporizing all the gasoline, giving it fully 50% more power—breaking it up so that it explodes instead of burning!

**\$120 in
One
Day!**

Agent Earns Big Money

I took forty orders in one day and wasn't out long. My Ford runs better than it ever did.—
J. M. JAMES.

\$51 in One Hour

The results of one hour's work—17 men gave me orders for the Vaporizers.—J. W. CRONK.

\$48 in 3 Hours

I went out Saturday about three hours and secured 16 orders.—J. A. WILLIAMS.

Not only does this invention save you half your gasoline, but it also removes carbon, saving you the expense and time of having carbon scraped out—a job costing from \$5 to \$25.

One Million Satisfied Users

The Stransky Vaporizer and Decarbonizer is absolutely automatic and self-regulating. It has no springs, shutters, diaphragms or delicate parts to get out of order. It requires no adjustment—you can attach it in three minutes. It will lengthen the life of any car—and it's guaranteed to last the life of your car.

Introductory Sample Offer

To introduce this new invention in your community, Mr. J. A. Stransky, the inventor, will send a sample at his own risk. Write at once for his proposition. The price is so low that all your neighbors will want to order through you, giving you a generous profit. Send the request blank for full details of our amazing offer.

J. A. STRANSKY MANUFACTURING CO.

L-10 Stransky Bldg.,

Pukwana, So. Dakota

J. A. Stransky Mfg. Co.
L-10 Stransky Bldg., Pukwana, So. Dakota

Please send me full details of your special introductory offer.

Name.....

Address.....

City..... State.....

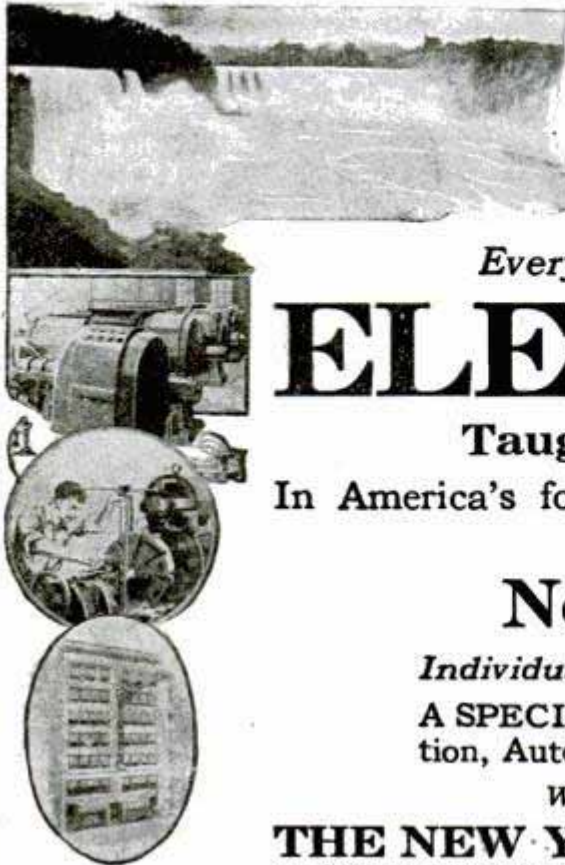

Learn By Doing!

Every phase of all branches of

ELECTRICITY

Taught By Actual Practice

In America's foremost institution for trade training.

Established 1902

No Books Used

Individual Instruction. Start Any Day.

A SPECIAL and SEPARATE Course in Ignition, Auto Lighting and STARTER Systems.

Write for FREE 64-Page Catalog

THE NEW YORK ELECTRICAL SCHOOL
44 West 17th Street
NEW YORK CITY

Do You Make These Mistakes in English?

Did you hear from him yet!
That's between you and I.
Who was it sent to?

I will be pleased to go.
Everyone stood up in their places.
I have three sister-in-laws.

FREE—New Book on English

No one willingly makes mistakes in English. But such mistakes do untold harm, for poor English makes others judge us unfairly as uneducated and lacking in culture. Remove the handicap that poor English may be causing you. Sherwin Cody's remarkable new method automatically gives you masterly command of English in only 15 minutes a day. Increases power of expression, enlarges vocabulary, improves spelling, grammar, diction. No rules to memorize. No drudgery. Like a game. Over 40,000 already helped. Free book explains everything. Write for it today.

Sherwin Cody School of English, Dept. 59, Rochester, N. Y.

Book on Law Free



Write today for this new book. It tells you how a law training will shorten your road to success. It also carries a vital and inspiring message to every ambitious man! Find out about the opportunities that await the law trained man. Find out how you can learn law right in your own home. No obligations. The book is absolutely FREE. Write Today, now while we are making a special reduced tuition offer.

American Correspondence School of Law
3601 Michigan Ave. Dept. 1356 Chicago, Illinois

LEARN PIANO TUNING AT HOME



Send for FREE copy of the 28th ANNIVERSARY EDITION of our book "Winning Independence." Read how students master TUNING with our Tune-A-Phone, and WHY our graduates head the profession in all parts of the world. With Bryant's patented devices, tools, charts, and lessons, one learns quickly and easily. Low tuition, easy terms, Diploma granted, MONEY-BACK GUARANTY. \$10 to \$25 a day, exceptional opportunities, and an ideal profession await you. BRYANT SCHOOL OF TUNING (71) Bryant Bldg., Augusta, Michigan

WANTED—RAILWAY MAIL CLERKS

MAIL CARRIERS—POSTOFFICE CLERKS
\$1700 to \$2700 a Year for Life

No "lay-offs" because of strikes, poor business, etc.—sure pay—rapid advancement. City and country residents stand same chance. Common sense education sufficient—no political influence.

TRAVEL—SEE YOUR COUNTRY

We coach you for the examinations without your leaving home.

MEN—BOYS
18 to 45

Use Coupon Before You Lose It

COUPON

FRANKLIN INSTITUTE, Dept. A-174, Rochester, N. Y.
Rush to me, entirely free of charge, (1) A full description of the position checked below; (2) Sample examination questions; (3) Free Sample coaching lessons; (4) Tell me how to get the position here checked.

- .. Railway Mail Clerk (\$1900 to \$2700)
- .. Postoffice Clerk (\$1700 to \$2300)
- .. City Mail Carrier (\$1700 to \$2100)
- .. Customs Positions (\$1140 to \$1860)
- .. Internal Revenue (\$1140 to \$1860)
- .. Rural Mail Carrier (\$2100 to \$3300)

Name

Address



Easy as A-B-C



Here's a Queer Way To Learn Music!

No teacher — no monotonous exercises. Just a simple, easy home study method. Takes only a few minutes—costs only a few cents a day. Every step as clear as A-B-C.

WHO would have ever thought that the learning of music could be simplified? Seems almost too good to be true to think of learning to play your favorite instrument without long hours of practice—tedious scales and expensive teachers, doesn't it? Yet that's exactly how you learn this new way. The only thing that is queer about this amazing method is the fact that it's so different from all ordinary methods.

But although this marvelous home-study method is different and comparatively new, it has already been carefully tested and proved by almost half a million people all over the world. Judge from that how satisfactory, reliable and easy it must be.

Musical Talent Not Needed

Even if you have never touched an instrument before you can't go wrong this amazingly easy way. For every step, from beginning to end, is right before your eyes in print and picture. You always know

what to do and how to do it. No guesswork. No delays. If you make a mistake you correct it yourself and continue. It's really *fun* learning to play this way, you proceed so rapidly. From the start you are playing real *tunes* perfectly by *note*. And almost before you realize it you will be able to play anything—the popular "Jazz" or those classical selections for which there is always a big demand at concerts

PROOF!

"I have completed only 20 lessons and can play almost any kind of popular music I wish. My friends are astonished."
TURNER B. BLAKE, Illinois.

"Since finishing the course I have been teaching, playing in churches and at recitals, and receiving a fine salary. I have made money, come into contact with new friends, and greatly increased my popularity."
RUTH M. PEACOCK, North Carolina.

"Since I have been taking your lessons I've made over \$200 with my violin."
MELVIN FREELAND, N. J.

and home entertainments. Best of all, no matter which instrument you choose the cost of learning is just the same in each case, just a few cents a day!

Have Fun—Win New Friends

Just think of all the pleasure you've been missing by not being able to play some musical instrument. Instead of being the center of attraction at parties—you've been unnoticed—out of the social picture. While you've been playing wallflower others have always had something to offer. Now you have a wonderful chance to turn the tables—to treat yourself to some real fun—to surprise your friends! Take some good advice. Learn to play this new easy way. Get your share of a musician's pleasure, popularity, profit. Start Now!

Free Booklet and Demonstration Lesson

If you are in earnest about wanting to join the crowd of entertainers and be a "big hit" at any party—if you really *do* want to play your favorite instrument, to become a performer whose services will be in demand—fill out and mail the convenient coupon asking for our Free Booklet and Demonstration Lesson. These explain our wonderful method fully and show you how easily and quickly you can learn to play like a professional at little expense. Instruments are supplied when needed—cash or credit. U. S. School of Music, 79 Brunswick Bldg., N. Y. C.

U. S. School of Music

79 Brunswick Bldg., New York City.

Please send me your free book, "Music Lessons in Your Own Home," with introduction by Dr. Frank Crane, demonstration lesson and particulars of your special offer. I am interested in the following course:

Have you the above instrument?.....

Name.....
(Please Write Plainly)

Address.....

City.....State.....

What Instrument For You?

Piano	'Cello
Organ	Guitar
Violin	Ukulele
Drums and Traps	Hawaiian Guitar
Banjo (Tenor, 5-String or Plectrum)	Harp
Mandolin	Cornet
Clarinet	Piccolo
Flute	Trombone
Automatic Finger Control	Saxophone
	Harmony and Composition
	Sight Singing
	Voice and Speech
	Culture
	Piano Accordion

\$100 for One Good Commercial Drawing



Become An Artist This Easy Way

Thousands who never dreamed they could draw can now easily become artists. You, too—without any previous training—and no matter how little apparent talent you have—can now easily learn illustrating, designing and cartooning, through this amazingly easy method.

You learn at home yet your work receives the personal attention and criticism of one of our competent instructors. Many students actually sell enough work during their training to pay for it many times over.

Big Money in Commercial Art

Millions of dollars are being spent this year on advertising and story illustrations, commercial designs, and cartoons. And even more will be spent next year. Commercial art is a tremendous field—and a field where very big money is gladly paid anyone who can produce good art work. Advertisers, magazines, newspapers, printing houses, business concerns all need trained artists. Competent artists easily earn from \$50 to far over \$300 a week. And now you can easily enter this "world's most fascinating, best paid business."

Mail Coupon for Free Book

A new handsomely illustrated book has just been printed, which gives all the most up-to-date information on the thousands of wonderful opportunities in Commercial Art and shows how this startling short-cut method easily enables you to enter this field. It tells about our students—their success—what they say—actual reproductions of their work—how they made big money while studying. This attractive book will be sent without cost or obligation. Send for it. Mail coupon now. **Washington School of Art, Room 309-D, 1115-15th St., N. W., Washington, D. C.**

WASHINGTON SCHOOL OF ART
Room 309-D, 1115-15th St., N. W., Washington, D. C.

Please send me without cost or obligation your new book on art, "Quick Easy Way to Become an Artist," and details of your special offer.

Name.....
Please write plainly Mr., Mrs., or Miss

Address.....

City..... State.....



1,000 Hotel Positions Open!

HOTELS, restaurants, clubs, apartments everywhere need trained men and women. Over 70,000 high-class positions paying up to \$10,000 a year are open each year in the hotels of the United States. In 1926 the Hotel Business is America's largest industry in new construction. Over a billion dollars' worth of New Hotels and Restaurants being built this year will need nearly 200,000 trained men and women.

Hotels start you at salaries up to \$3,500 a year, with your living usually included. At any time you have your choice of over 1,000 hotel positions open.

You can have one of these high-class big-pay positions, fascinating work and with luxurious apartment and meals usually furnished FREE! No previous experience necessary. The Lewis Schools guarantee to give you the valuable knowledge that it has taken some of the most successful hotel men years to obtain—men who are now making \$5,000 to \$50,000 a year. We train you by mail in your spare time at home with the Lewis Simplified Study Plan, and put you in touch with big opportunities. All of your training under the personal direction of Clifford Lewis, former U. S. Government Hotel and Restaurant Expert, now Managing Consultant for over 225 Hotels of 50 to more than 600 rooms each, throughout the United States, totaling over 26,000 rooms. Our students employed, our methods endorsed by leading hotel men everywhere.

Send today for FREE BOOK, "Your Big Opportunity," showing how we can train you for one of these splendid positions, and explaining our Money-Back Guarantee.

LEWIS HOTEL TRAINING SCHOOLS
CLIFFORD LEWIS, Pres.
Room D-376 Washington, D. C.

ACCOUNTANCY

Training at Home
WITH PERSONAL COACHING

Prepares you for the C.P.A. Certificate, or for the position as Chief Accountant, Cost Accountant, Auditor or Comptroller.

Write for our free interesting booklet which explains how you can secure this training in your spare time, and receive personal coaching by a professional accountant in your own community. Our guarantee protects you in case of inaptitude, sickness or straightened circumstances.

AMERICAN EXTENSION INSTITUTE
Dept. PM 2095 Broadway, N. Y.

Learn Photography at HOME

Earn \$3,000 to \$10,000 a year. Prepare quickly during spare time. Also earn while you learn. New easy method. Nothing else like it. Send at once for free book, "Opportunities in Modern Photography" and full particulars. Special offer open now. **International Studios, Inc., Dept. 1356, 3501 Michigan Ave., Chicago, U. S. A.**

DON'T STAMMER

Quick, easy, complete cure guaranteed. Information, diagnosis, phonograph record and catalog free. America's foremost school. Est. 1894. Act before it is too late.
153 Stinson The LEWIS INSTITUTE Detroit, Mich.



SHORTHAND IN ONE MONTH

Boyd—the Wonderful, New Easy System. Writers hold World's record. 100 to 150 words a minute in 30 days guaranteed. New Principles—dictation first week. Best for Court Reporting and Secretaries. Also Typewriting, Bookkeeping and Commercial Law. Send today for Catalog and Money-Back Guarantee.
CHICAGO HOME STUDY SCHOOLS, 302 Resper Block, CHICAGO, ILLINOIS

Money-Making Tools

To those who enroll in near future—tools **Free** of any extra cost whatever. Also, a drafting table! Act Now!

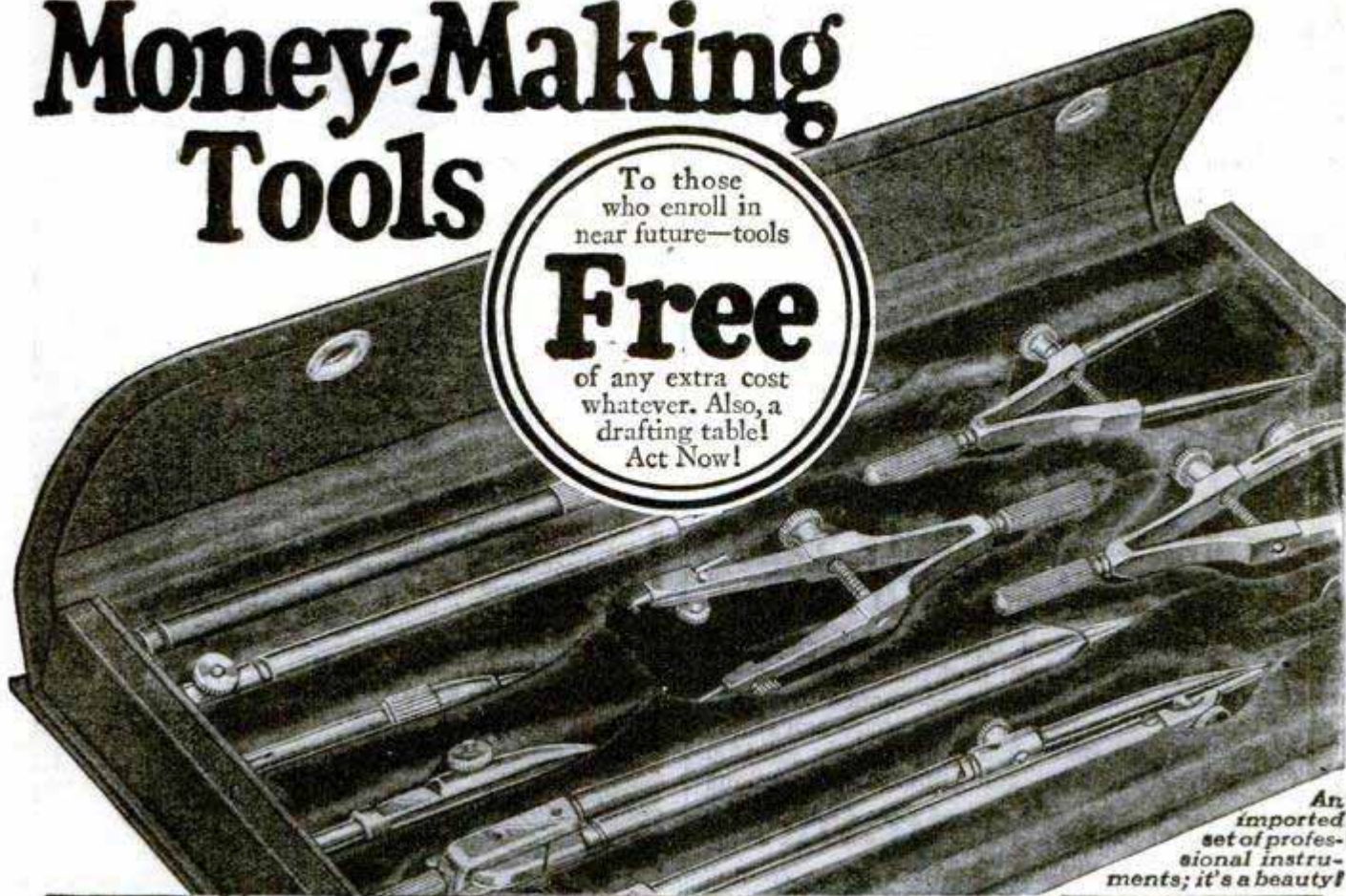

An imported set of professional instruments; it's a beauty!



FRED'K W. DOBE, M. E.

I need YOU with 100 firms BEGGING ME to send them more DRAFTSMEN. Many offer to take BEGINNERS, at \$50 a WEEK. Graduates can start at \$90 and \$100! GET BUSY!

Drafting is the BIG field, men. Every industry you can name BEGINS with the draftsman. Without mechanical drawings—by the thousands—every shop in the land would be STOPPED.

In fact, it is the SERIOUS SHORTAGE of draftsmen that brings this offer: *I will furnish all instruments, supplies, even to the table, to those who start now!*

PAY AS YOU GO Don't give me the excuse that you have no ready money for this golden opportunity. I am not so interested in cash; I want your application. I want at least 200 men to start *right now*. I want them ready to recommend by Spring! We will get a flood of letters saying "send us draftsmen," from every sort of industrial and engineering concern, and we must make good.

The first week's pay envelope of many a Dobe-trained draftsman has held enough to cover the entire cost of the course! Most students learn evenings, keeping on with their old work until ready to step into somebody's drafting room. The first month equips you to take on simple drafting jobs on the side. It helps you learn; I gladly permit this.

Well-Paid Positions Every Way You Turn

A draftsman soon forgets the days when he used to wonder where to get a job. Instead, he asks "What line of work interests me most?" And "What part of the country suits me best?" Twenty of my graduates went to Florida this year; three are in Japan; last month one wrote me from Ceylon. And I wish we had the count of how many Dobe draftsmen have become chiefs!

Positions loom up almost as soon as you are enrolled in a Dobe class! We receive requests

daily for junior men—for men only partly through our course. "We'll take a beginner," some concerns write us, "so long as he is a Dobe trained man and has begun *right!*"

IT'S EASY and interesting to learn drafting. For drafting isn't "drawing!" You don't need any "talent." A draftsman uses tools for every line and every curve. You couldn't make them crooked if you tried! That's why drafting is so easily learned—and so interesting. *For you do everything by rule.* So, I guarantee to make anyone a finished draftsman; if you can read and write, you can learn this line. One of my students is 51 years old; another is just seventeen. *But they'll all be making a grown-up salary by Spring!*

WARNING! The special offer of tools is for immediate action. Don't expect me to hold it open indefinitely. Clip the coupon *now* for free book:

Can a man learn drafting without any previous training or talent for drawing?

YES!

Does Dobe really turn out practical draftsmen in a few months?

YES!

Is it so that men who haven't even finished the Dobe home course receive offers of positions?

YES!

Is there always such a big call for men who can draft as Want Ads in the newspapers show at the present time?

YES!

Do I actually get all instruments and supplies without one dollar's extra cost?

YES!

CHIEF DRAFTSMAN DOBE, Div., 13-56
1951 Lawrence Avenue
Chicago

Special Tool Offer

Send me FREE and POSTPAID Successful Draftsmanship Book and material telling all about your home course, terms, etc.



Name.....Age.....

Address.....

Say Good Bye to Poor Pay!



Several Hundred more trained men needed NOW.

Several thousand more will be needed soon.

Your ONE BEST Opportunity to rise above small pay.

AGE NO BARRIER!

VERY PROFITABLE TRADE NOW OPEN TO ALL

Those looking for a Real Opportunity—good salaries, steady work, dignified and pleasant—demand great now and always will be—a chance to establish a business of your own if desired—can count their search at an end when they merely send us their name to receive full information about

MECHANICAL DENTISTRY

This is not a *new* trade. Dentists today do not have the time to make plates, bridges, crowns, etc., so they employ a mechanical dentist or send this work away to a dental laboratory. There is thus a wonderful demand for Mechanical Dentists—and the demand is only beginning!

IN THREE MONTHS

Easily learned by actual practice—no classes whatever—no previous training required. Ages range from 16 to 50. Opportunity, good pay, and advancement for all! Bodee training is recognized as best by dentists everywhere owing to our 34 years' experience at this work. Bodee-trained men have the ability, skill and knowledge to enable them to easily lead the field.



JUST COMPARE

Compare this with what you are now doing or with the best you can find in any other line! Then compare the unrivalled training we have developed in 34 years' teaching experience—step by step—every point thoroughly covered—no time or effort wasted! Compare also the very reasonable cost with the high charges of the newer and smaller schools which have sprung up!

\$3500 to \$5000 A YEAR

EARN WHILE YOU LEARN

For those who need financial assistance while in training we secure whole or part-time positions to meet their expenses.

OTHER ASSISTANCE

Besides providing the best of training at the lowest possible cost, securing jobs for students who need to earn while learning, giving free R. R. fare, etc., we help you secure good board at moderate price, conduct a Placement Bureau to select suitable positions for graduates and, should

FREE

R. R. FARE

To make this exceptional opportunity equally available to all, we pay the student's railroad fare to our nearest school.

you desire to open a laboratory of your own, we assist you in securing a suitable location and equipping your laboratory.

Send AT ONCE for Bulletin 2 giving all details and interesting information

BODEE DENTAL INSTITUTE

NEW YORK PHILADELPHIA BUFFALO BROOKLYN
1755 Broadway 1305 N. Broad St. 501 Washington St. 85 Court St.

Please Mention Popular Mechanics

Learn to Write

I Teach by Mail

I CAN make a good penman of you at your home during spare time, no matter where you live or how poorly you now write. My simplified system has shown thousands of others the way to good penmanship during the past twenty years—it can and will do the same for YOU!

Beautifully Illustrated Book
"How to Become a Good Penman"

It contains general information, with testimonials and beautiful specimens of penmanship showing what others have accomplished by the Tamblin System. (Your name elegantly written on a card if you enclose stamp for postage.) WRITE TODAY. Address

F. W. TAMBLIN

418 Ridge Bldg., Kansas City, Mo., U. S. A.



BE AN ARTIST

WE CAN TEACH YOU DRAWING in your own home during your spare time. Twenty-five years of successful teaching proves our ability. Artists receive large salaries.

Write Today for Art Year Book

SCHOOL OF APPLIED ART
ROOM NO. 2, BATTLE CREEK MICH.



LEARN WATCH REPAIRING



You can learn by our modern and original system of instruction every part of the Watch Repairing Trade at home as good or better than at a shop. You can earn money while learning and secure a well paying position or start in business after completing our course of instruction. Good watch repairers are always in demand and earn from \$50 to \$75 per week. For particulars apply to the Wisconsin School of Watch Repairing
166 Mason St., MILWAUKEE, WIS.

MUSIC LESSONS FREE



IN YOUR OWN HOME

You can read Music like this quickly
Write today for our FREE booklet. It tells how to learn to play Piano, Organ, Violin, Mandolin, Guitar, Banjo, etc. Beginners or advanced players. Your only expense about 2c per day for music and postage used. American School of Music, 51 Lakeside Bldg., Chicago

"STAMMERING"

Its Cause and Cure

You can be quickly cured if you stammer. Send 10 cents, coin or stamps, for 288 page cloth bound book on Stammering and Stuttering. It tells how I cured myself after Stammering and Stuttering for 20 years. BENJAMIN N. BOGUE
6937 Bogue Building, 1147 N. Ill. St. Indianapolis

Play the HAWAIIAN GUITAR and be Popular!

Play all the latest hits just as the Hawaiians do. Be the most popular member of your set. Get in on all the good times. Entertain your friends—or play professionally. Be in demand everywhere. We will help you.



\$15
HAWAIIAN GUITAR
 with Genuine Seal Grain
 Fabrikoid Cover
FREE
 when you enroll



This sweet-toned, mellow Hawaiian Guitar would cost you at least \$15 in any music store without the Genuine Seal Grain Fabrikoid Case. We can afford to give you the entire outfit free when you enroll, including picks, steel playing bar, etc., because we make them in huge quantities in our own factory. Nothing to buy—everything is furnished.

Learn in Spare Time at Home

You study in spare time—when you like—as long as you like. And even if you don't know one note from another, our method is so simple, plain and easy that you begin a piece your first lesson. In half an hour you can play it!

Famous Native Hawaiians Teach You

You receive expert instruction from such world famous players as Kolomoku, Kalaluki, Ferara and Seville. They quickly teach you the secrets of this fascinating instrument.

Complete Conservatory Course. You get 52 complete printed lessons. Nothing is omitted. Pictures explain every move. And no matter how little you know about music when you begin, no matter if you have never touched a musical instrument, you can positively learn to play by our plain, easy, picture method.

Only 4 Motions to Learn

Then you can play any music—popular songs, classical, old-time melodies, native Hawaiian airs—or real jazz—separately or with accompaniment. You'll never be lonesome after you learn to play on this beautiful Hawaiian Guitar.

Pay as You Play

We make it easy for you. You start any time—with a small first payment—then pay while learning. Write for liberal offer.

Our Written Guarantee

We guarantee in writing to teach you. 45,000 successful students. And we coach and advise you after graduation—no extra cost.

Other Courses under famous teachers—Tenor Banjo, Violin, Mandolin, Banjo Ukulele and Ukulele.

FIRST HAWAIIAN CONSERVATORY OF MUSIC, INC.
 9th Fl., Woolworth Bldg., Dept. 248. New York, N. Y.

Approved as a Correspondence School Under the Laws of the State of New York

ACT! Mail This Popularity Coupon NOW!

FIRST HAWAIIAN CONSERVATORY OF MUSIC, Inc.
 9th Fl., Woolworth Bldg., Dept. 248 New York, N. Y.

Please mail full information about your 52-lesson Hawaiian Guitar Course. I am not obliged to enroll unless I want to.

Name _____
 Address _____
 City _____ State _____

Know
 the
 School



By
 the
 Emblem

Choose Business

Young men and women of initiative are turning to this modern profession, which offers the widest scope for trained ability.

Decide now to get your training in one of America's leading business schools—300 of which are Accredited by this Association because of their proved merit.

It is a badge of honor to be a graduate of an Accredited school. Write for booklet E, "The Sure Way to Success," with list of Accredited schools.

National Association
 Accredited Commercial Schools
 1618 Mallers Building, Chicago

Charleston!



Everybody's doing it! Arthur Murray, world's foremost dancing teacher, has invented a remarkable new method which enables anyone to learn all the newest dances at home—in a few hours—at very little cost! No music or partner needed. Success positively guaranteed! "300,000 learned dancing by mail."

FREE! 32-Page Book and TEST LESSON To prove you can learn easily and quickly, Arthur Murray will send you his 32-page book and Test Lesson FREE. To cover mailing, please enclose 25 cents. Act NOW and be a good dancer quickly.

Send for
**Free Book and
 Test Lesson**

ARTHUR MURRAY
 Studio 649 7 E. 43rd St. NEW YORK CITY

BIG MONEY IN POULTRY

Get into the poultry business NOW. This fall eggs and fowls will jump way up in price. Easy to make \$1,000 a year in spare time; or \$5,000 a year for full time. Free book tells all about our new, up-to-date, money-making poultry course and our remarkable plan of close, careful, individual assistance. Thousands use our methods.

Write for FREE copy today.
NATIONAL POULTRY INSTITUTE, Dept. 406-X, Washington, D. C.

LEARN WATCHMAKING

and become independent. We help you secure a position. Easy to learn. Send for FREE CATALOG.
ST. LOUIS WATCHMAKING SCHOOL, Dept. 5, ST. LOUIS, MO.

Factory to Rider

Saves \$10 to \$25 on the Ranger Bicycle you select. You can have your choice of 44 Styles, colors and sizes. Delivered free on approval, express prepaid, for 30 DAYS' FREE TRIAL. Bicycles, \$21.50 up. \$5 a Month if desired. Possession and use at once on our Liberal Easy Payment plan. Parents often advance first payment. best quality, at factory prices, express prepaid. Lamps, wheels and equipment, low prices. Send No Money, do business direct with makers.



Mead CYCLE COMPANY
 DEPT. 5- CHICAGO

Write today for free Ranger Catalog, factory prices and marvelous easy payment terms



Do This To An Old Tire and Make \$150 Every Week!

Simply Drive Nails Into an Old Tire in Front of Big, Interested Crowds and Make from Ten to Twenty Sales an Hour! This is Absolutely the Most Startling, Spectacular, and Thrilling Demonstration You Ever Saw! Just Think—No Matter How Many Nails You Drive Into an Old Tire It Won't Puncture—It Won't Leak a Bit of Air—You Can Pull the Nails Out and Drive Right Away!

Mr. O. S. Nelson of Mitchell, South Dakota, a chemist of unusual ability, has discovered an amazing new way to make any tire puncture proof! So startling is this new invention, so marvelously successful, that salesmen are piling up big, liberal commissions for just a few hours' work. Every auto owner, whether he drives a Ford or a Cadillac, is interested—he detests the fuss and bother of changing tires on the road and mending tubes.

Punctures Sealed While You Drive

This wonderful new, scientific discovery is called Aer-Pruf. An old tire, after being treated with Aer-Pruf, was punctured with 857 nails without a single leak! Aer-Pruf seals punctures instantly while you are driving, so that you never know you have a puncture. Not only that, but it seals slow leaks, valve leaks, and porous tubes. It prevents rim cuts and broken side walls. It doubles tire mileage because it prevents driving with partly flat tires—the biggest cause of tire trouble. It has no injurious effects on casing or

tube. Will last the lifetime of the tube.

J. O. Bright sold fourteen sets in two hours—profit \$29.40, or over \$100 a day! W. R. Wook started out with demonstration samples. Then he secured some good territory and writes that he disposed of 700 sets in only three weeks' time.

We grant you Exclusive Territory Rights so that you can appoint sub-agents who will earn a splendid income for you. A good sub-agent should make you, at the very least, \$5 a day clear. If you appoint only three sub-agents, your profits from their work would be \$15 a day—\$400 a month—\$4,800 a year! And that is besides your commissions on your own work!

FREE Sample Offer

Right now we are making a big special offer to send you a FREE Sample Set of Aer-Pruf and to pay you for the time required to test the sample if you are not amazed and delighted with it! You never before heard of such an unusual offer! Investigate this offer today. Just send the request blank for full details.

AER-PRUF MFG. CO.

M-2212 Logan Bldg.

Mitchell,

South Dakota



Frank Ryman says, "Have punctured all four of my tires at least four hundred times and they still stand up." Buford Houska says, "One of my Aer-Pruf treated tires was punctured 150 times by actual count on a long trip. It is still standing up under full pressure."

Makes Old Tires Like New

Aer-Pruf doubles Tire Mileage, making an old Tube practically as good as new. C. A. Anderson says, "My old tires had to be pumped up every day until I had them treated with Aer-Pruf. They stayed up after that."

Aer-Pruf goes wherever the air goes, sealing up any and every leak—big and little punctures, slow leaks, valve leaks, and porous tubes.

Aer-Pruf Mfg. Co.
M-2212 Logan Bldg.,
Mitchell, South Dakota.

Please send me full details of your
FREE Sample Offer.

Name.....
Address.....
City.....State.....



Salary increased 300% in few months

Chief draftsman of big company received big increase even before he had completed his course with the I. C. S.

"AT THE time I started my I. C. S. course I was working in a paper mill," writes A. J. Hutchins, Chief Draftsman for the American Strawboard Company.

"Before I had completed the course I was called upon to make drawings in one of the company's largest mills and was appointed Superintendent of Construction at an increase in salary of 300 per cent."

Every mail brings letters from students of the International Correspondence Schools telling of increases in salary due to spare-time study.

Why don't you study too and prepare for a real job at a real salary? You can do it if you really try.

Just mark and mail the coupon and we will send you complete information about the I. C. S. Drafting courses or any other course in which you are interested.

INTERNATIONAL CORRESPONDENCE SCHOOLS Box 5600-E, Scranton, Penna.

Oldest and largest correspondence schools in the world

Without cost or obligation on my part, please tell me how I can qualify for the position or in the subject before which I have marked an X:

- | | |
|---|--|
| <input type="checkbox"/> Mechanical Drawing | <input type="checkbox"/> Structural Drafting |
| <input type="checkbox"/> Draftsmen's Course | <input type="checkbox"/> Ship Drafting |
| <input type="checkbox"/> Architectural Drawing | |
| <input type="checkbox"/> Electrical Engineering | <input type="checkbox"/> Architect |
| <input type="checkbox"/> Electric Lighting | <input type="checkbox"/> Architects' Blueprints |
| <input type="checkbox"/> Mechanical Engineer | <input type="checkbox"/> Contractor and Builder |
| <input type="checkbox"/> Machine Shop Practice | <input type="checkbox"/> Concrete Builder |
| <input type="checkbox"/> Railroad Positions | <input type="checkbox"/> Structural Engineer |
| <input type="checkbox"/> Gas Engine Operating | <input type="checkbox"/> Chemistry <input type="checkbox"/> Pharmacy |
| <input type="checkbox"/> Civil Engineer | <input type="checkbox"/> Automobile Work |
| <input type="checkbox"/> Surveying and Mapping | <input type="checkbox"/> Airplane Engines |
| <input type="checkbox"/> Metallurgy <input type="checkbox"/> Mining | <input type="checkbox"/> Agriculture and Poultry |
| <input type="checkbox"/> Steam Engineering <input type="checkbox"/> Radio | <input type="checkbox"/> Mathematics |
| BUSINESS TRAINING COURSES | |
| <input type="checkbox"/> Business Management | <input type="checkbox"/> Salesmanship |
| <input type="checkbox"/> Industrial Management | <input type="checkbox"/> Advertising |
| <input type="checkbox"/> Personnel Organization | <input type="checkbox"/> Better Letters |
| <input type="checkbox"/> Traffic Management | <input type="checkbox"/> Show Card Lettering |
| <input type="checkbox"/> Business Law | <input type="checkbox"/> Stenography and Typing |
| <input type="checkbox"/> Banking and Banking Law | <input type="checkbox"/> Business English |
| <input type="checkbox"/> Accountancy (including C.P.A.) | <input type="checkbox"/> Civil Service |
| <input type="checkbox"/> Nicholson Cost Accounting | <input type="checkbox"/> Railway Mail Clerk |
| <input type="checkbox"/> Bookkeeping | <input type="checkbox"/> Common School Subjects |
| <input type="checkbox"/> Private Secretary | <input type="checkbox"/> High School Subjects |
| <input type="checkbox"/> Spanish <input type="checkbox"/> French | <input type="checkbox"/> Illustrating |

Name.....
Street.....
Address.....
City..... State.....
Occupation.....

If you reside in Canada, send this coupon to the International Correspondence Schools Canadian, Limited, Montreal



Will You Wear This Suit?

Show it to your friends and neighbors as a sample of our fine quality, hand-tailored All-Wool Suits, guaranteed \$40 values at amazing low price of \$23.50, take their orders, keep handsome profit for yourself and send orders to us.

Agents Making BIG MONEY

\$3.00 to \$5.00 an hour in spare time, \$75 to \$150 a week for full time. We supply handsome Swatch Line Outfit, large size samples and all latest styles in elegant Leather Case. Positively finest selling outfit ever furnished salesmen. Write for yours at once, pick out your suit and get started making the Big Money right away. Address Dept. 751.

JAMES OLIVER, Inc., 848 W. Adams St., Chicago
Write name and address below and mail at once.

Name.....751
St. and No..... R. F. D..... Box.....
Town..... State.....

PIANO JAZZ

By Note or Ear. With or without music. Short Course. Adult beginners taught by mail. No teacher required. Self-Instruction Course for Advanced Pianists. Learn 259 styles of Bass, 684 Syncopated Effects, Blue Harmony, Oriental, Chime, Movie and Cafe Jazz, Trick Endings, Clever Breaks, Space Fillers, Sax Slurs, Triple Bass, Wicked Harmony, Blue Obligato, and 247 other Subjects, including Ear Playing. 133 pages of REAL Jazz, 25,000 words. A Postal brings our FREE Special Offer.

Waterman Piano School, 1826 W. Adams St. Los Angeles, Cal.



Wonderful, new device, guides your hand; correct your writing in few days. Big improvement in three hours. No failures. Complete outline FREE. Write C. J. Oment. D-34, St. Louis, Mo.

MAGIC

Earn \$250 to \$1000 Monthly

New! Different! Teaches you Big Tricks, Illusions, Stage Stunts, "Patter" and the Principles of Magic. Learn at home. Earn \$250 to \$1,000 a month. Write today for special offer.

Tarbell System, Inc., 1926 Sunnyside Ave., Studio 93-56, Chicago, Ill.

"BECOME A LIGHTNING TRICK CARTOONIST"

Send \$1.00 for Laugh Producing Program of 23 Trick Drawings with Instructions. Catalog of Chalk Talk Supplies Free.

BALDA ART SERVICE, Dept. 1, Oshkosh, Wis.

FOREST RANGERS

Men wanting forest ranger, mail clerk, or other government positions, write for particulars.

MOKANE, 236, DENVER, COLO.

Every Boy His Own Toymaker

Greatest boys' book ever written. Tells how to make a Steam Engine, Telephone, Magic Lantern, Boats, Kites, Balloons, electrical and mechanical toys, traps, fishing tackle, sleds, stilts, diving board, Bird Houses, etc. Fully illustrated 10c, 200 kinds. Iron, Wood and Wire Puzzles. Sample leader and Catalog 10c. WESTERN PUZZLE WORKS, SAINT PAUL, MINNESOTA.

Skin Troubles

Cleared up—often in 24 hours. To prove you can be rid of Pimples, Blackheads, Acne Eruptions on the face or body, Barbers' Itch, Eczema, Enlarged Pores, Oily or Shiny Skin, simply send me your name and address today—no cost—no obligation. CLEAR-TONE tried and tested in over 100,000 cases—used like toilet water—is simply magical in prompt results. You can repay the favor by telling your friends; if not, the loss is mine. WRITE TODAY.

E. S. GIVENS, 428 Chemical Bldg., Kansas City, Mo.

Keep on ailing and you'll KEEP ON FAILING!

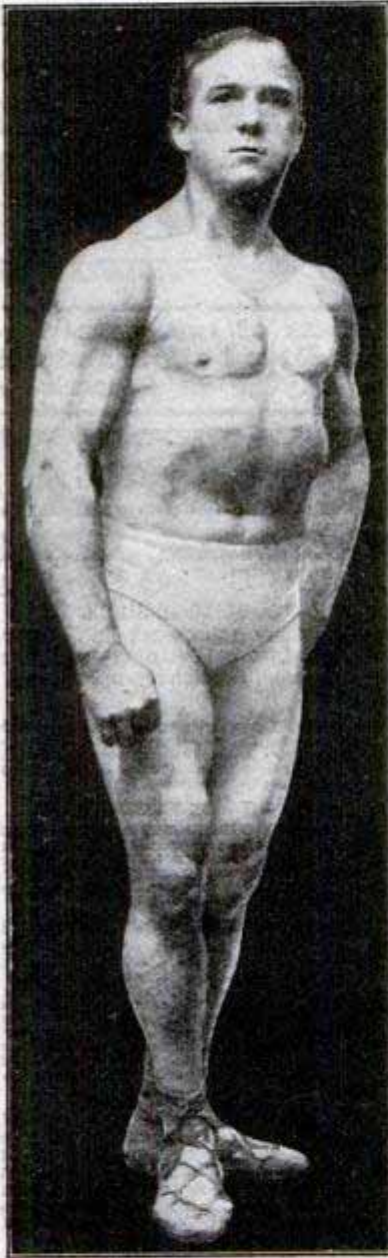

STRONGFORT
Builder of Men

plight. It will tell you frankly how you can make yourself over into a vigorous specimen of vital manhood with 100% pep, power, and personality. It doesn't mince words. It will show you how to be true to the best that is within you—teach you how to be a real fellow. It is a man-builder—a success-maker, and a life-saver. Just check the subjects on the free consultation coupon on which you want special confidential information. Send for your copy of this book right now—TODAY!

LIONEL STRONGFORT
Physical and Health Specialist for over 25 Years

STRONGFORT INSTITUTE

Dept. 226 NEWARK, NEW JERSEY, U. S. A.

DEFFECTIVE vitality, disease and chronic ailments are dragging you down to the lowest depths. Weakness of body is robbing you of every chance of a life of happiness and success. Your physical defects stick out all over you—tell on you wherever you go—mark you as a misfit and a weakling! You find yourself a reject in social circles—a nuisance in your home, with your constant ailing and complaining. Your sallow complexion, your anaemic look, your nauseating breath, your nervous fidgeting all contribute to make real men and women shun you wherever you try to mix with them.

Take a Look at Yourself

Look in the mirror. Look inwardly at your conscience—ask yourself if you believe you are a manly man who deserves any success, or favor, or friendship in the world. Ask yourself if you are getting the joys out of life that healthy and red-blooded, vigorous men get out of it. In your own timid soul you know you don't deserve a thing—you know you are worthless because you are one who has neglected and abused the powers that Nature gave you—who has, by late hours, dissipation, booze-fighting or drugs and dope acquired nasty physical ailments that keep dragging you down physically and mentally until you feel dejected and hopeless. Notwithstanding all you have been guilty of, no matter what your condition, I hold out a helping hand to you—I CAN PUT YOU ON YOUR FEET.

STRONGFORTISM

Science of Health and Strength—

has helped thousands overcome the vitality sapping disorders that afflict so many. It will by natural methods, without the use of drugs or apparatus of any kind, enable you to develop your muscular system internally and externally, and banish weakness and the results of neglecting your body, and to again feel the thrill of vigorous life, buoyant health and cheerful mentality. It will build you up speedily. There isn't any doubt about this. You will realize the truth almost from the moment you start, in the privacy of your own home, following my easily understood directions.

You Won't Get Anywhere

so long as you go on snuffing, coughing, ailing, aching and complaining. You won't score until you've banished weakness and stood up straight and looked men and women square in the face. If you are suffering from nervousness, constipation, indigestion, weak heart, catarrh, colds or other afflictions, write me frankly and I will tell you how, in the privacy of your own home, you can rid yourself of these horrors and become a real he-man—vigorous, energetic, strong, magnetic. You can't afford to drag through life, half dead, wretched! I will help you out of this pit of despair if you will just tell me your trouble.

Send for My Book

*It Will Prove
A Revelation*

I've packed the experience and research of a lifetime of physical and health building into my startlingly interesting book, "PROMOTION AND CONSERVATION OF HEALTH, STRENGTH, AND MENTAL ENERGY." IT IS PRICELESS!

In it are plain facts that will astonish you and help you out of your sorry

Clip and Send this Coupon

CONSULTATION COUPON

ABSOLUTELY CONFIDENTIAL

Mr. Lionel Strongfort, Strongfort Institute, Dept. 226, Newark, N. J.—Please send me copy of your book, "PROMOTION AND CONSERVATION OF HEALTH, STRENGTH AND MENTAL ENERGY." I have marked (x) before the subjects in which I am most interested.

<input type="checkbox"/> Catarrh	<input type="checkbox"/> Weak Back	<input type="checkbox"/> Weak Heart
<input type="checkbox"/> Colds	<input type="checkbox"/> Weak Eyes	<input type="checkbox"/> Great Strength
<input type="checkbox"/> Asthma	<input type="checkbox"/> Flat Chest	<input type="checkbox"/> Lung Troubles
<input type="checkbox"/> Headache	<input type="checkbox"/> Despondency	<input type="checkbox"/> Poor Circulation
<input type="checkbox"/> Rupture	<input type="checkbox"/> Emaciation	<input type="checkbox"/> Round Shoulders
<input type="checkbox"/> Thinness	<input type="checkbox"/> Rheumatism	<input type="checkbox"/> Skin Troubles
<input type="checkbox"/> Pimples	<input type="checkbox"/> Nervousness	<input type="checkbox"/> Stomach Disorders
<input type="checkbox"/> Jaundice	<input type="checkbox"/> Constipation	<input type="checkbox"/> Increased Height
<input type="checkbox"/> Overweight	<input type="checkbox"/> Short Breath	<input type="checkbox"/> Muscular Development

Name

Age..... Occupation.....

Street.....

City..... State.....

MAKE BIG MONEY IN ELECTRICITY!



800% Pay Increase "I now make 8 times my former pay. I used to get \$50 a month—now it's \$400." Carroll Moechler, Chaska, Minn.

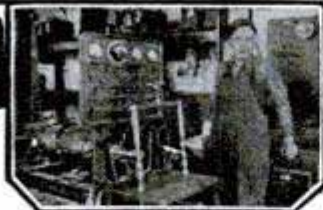

\$9,000 a Year Auto Electricity pays W. E. Pence, Albany, Ore., over \$9,000 a year. 68 men enrolled for this training on his recommendation.



\$1,000 a Month John Jirinec 336 Dismars Ave., Astoria, L. I., now earning \$12,000 a year, says, "Cooke Training alone is responsible for my success."

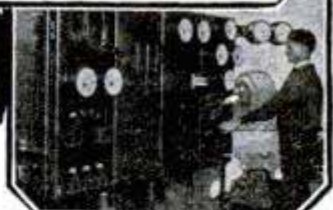

\$125 a Week "Depend on me as a booster," says A. Schreck, Phoenix, Ariz. "I make over \$500 a month. Your advertisement started me to success."



\$700 in 24 Days "Thanks to you I made \$700 in 24 days in radio," says F. G. McNabb, 7 W. 16th St., Atlanta, Ga. "I recommend your training."

Thousands of Cooke Trained Men Earn \$70 to \$200 a Week!

Send the Coupon below for full particulars of my great pay-raising training—the training that has fitted thousands of men for jobs paying \$3,500 to \$10,000 a year in Electricity



L. L. COOKE, Chief Engineer, Chicago Engineering Works, who has trained thousands of men for Big-Pay Jobs in Electricity.

Be an ELECTRICAL EXPERT Learn at HOME in your SPARE TIME!

Don't you keep on working for only \$25 or \$35 a week. Get into Electricity.—Thousands of Cooke Trained Men who knew nothing about it a short time ago are now earning \$70 to \$200 a week in the Electrical Field—and they don't work half as hard as you do. Why stick to your small pay job? Why stick to a line of work that offers no chance—no promotion—no big pay? Get into the world's greatest business. Electricity needs you. I'll show you how to do it. Get ready for the big pay job now.

Electrical Experts Are In Big Demand

Even ordinary electricians—the "screw driver" kind—are making big money, but trained men—Electrical Experts who get the top salaries—are needed more now than ever before. Thousands of Cooke Trained Men easily earn \$3500 to \$10,000 a year. That's the kind of a job you want—where you can plan, and boss and supervise the work of others or go into business for yourself. Get started toward one of these big-pay jobs now. Learn to earn \$70 to \$200 a week—you can do it with Cooke Training—recommended by more than ten thousand successful graduates. Just mail the coupon below.

Employment Service and Help—No Extra Charge

I will train you for a big pay job and then help you get it without extra charge. Hundreds of Employers look to me for the electrical men they hire. Last year I placed over one thousand men at big raises in pay. Hundreds of others were promoted by their employers through the help of my Vocational Service and other hundreds went into business for themselves with the help of my special Business Training. Mail coupon for big free book which explains this service and fourteen other features, many of which cannot be had anywhere else.

Age or Lack of Experience Bars No One

You don't need experience. You don't have to be a College man. You don't have to be even a high school graduate. As Chief Engineer of this big two million dollar institution, one of the world's greatest Training Schools, I know just what training you need to make a big

success in electricity. Let me give you that training with my simplified, complete home course,—the world's famous "Cooke Training"—built on my 39 years of engineering experience with the help of nearly 50 other engineers. Learn to earn \$70 to \$200 a week—only spare time needed.

My Training Pays for Itself!

You can start earning extra money a few weeks after you start my training. I give you special instructions for doing simple electrical jobs in your spare time—show you how to get these jobs and tell you what to charge. Many of my students make as high as \$25 a week extra this way while studying. My Course more than pays its own way.

Your Satisfaction Guaranteed

I am so sure I can make you a big success in Electricity, just like I have done for the men whose pictures you see here and thousands of others who now boast my training that I will guarantee your satisfaction with a signed money-back guarantee bond. If my training doesn't satisfy you after you have finished, you get back every penny you pay me. A two million dollar institution stands back of this guarantee.

Mail Coupon NOW

Get my big free book—"The Vital Facts about Electricity." Read about the success of hundreds of other men—men who recommend this training and whose names and addresses are given in my book. Get the real dope about your opportunities in Electricity.

Don't deny yourself this chance to make big money. Get the facts NOW—Mail coupon at once for facts and my guarantee.

L. L. COOKE, Chief Engineer CHICAGO ENGINEERING WORKS, Inc.

Dept. 16
2150 Lawrence Ave.,
Chicago, Ill.

L. L. COOKE, Chief Engineer
CHICAGO ENGINEERING WORKS
Dept. 16
2150 Lawrence Ave., Chicago, Illinois

Send me at once, without obligation, your big illustrated book and complete details of your Home Study Course in Electricity, including your outfit and employment service offers.

5 WONDERFUL WORKING OUTFITS GIVEN WITHOUT EXTRA CHARGE

- 1 LABORATORY AND EXPERIMENTAL OUTFIT.** Complete material for interesting experiments.
- 2 BELL AND ALARM OUTFIT.** Electrical apparatus, material and tools—a complete installation kit.
- 3 ELECTRIC LIGHTING OUTFIT.** Switches, Wire, Lights, etc. Everything needed to make up all complicated electric lighting circuits.
- 4 ELECTRIC POWER OUTFIT.** The Famous "Cooke" Motor and other apparatus. Not a toy—but a real, honest-to-goodness workable machine.
- 5 TRANSFORMER OUTFIT.** Complete parts for building and winding this widely used equipment.

MAIL THE COUPON FOR FREE BOOK OF FACTS

Name.....
Address.....
Occupation.....

The 'Cooke' Trained man is the 'Big Pay' Man

Classified Advertisements

WORLD'S BEST WANT AD MEDIUM

Advertisements in this section, 25 cents per word, each insertion, minimum 10 words, payable in advance. To be inserted under proper classification in October issue, copy should be in our office August 18th.

ADVERTISING AGENCIES

ADVERTISE in the classified section of newspapers and magazines, to secure help, money, or to sell. 24-word advertisement in nine big Metropolitan papers \$10.00. Nearly two million circulation. Many other bargain lists. Write for Free 58-page Directory No. 26. Brinckerhoff Advertising Agency, 37 W. VanBuren, Chicago.

A TEN Dollar Ad may put your proposition over. \$10 pays for a 4 line 24 word classified ad one Sunday in 10 of the largest newspapers. Reach over 7 million readers. Minneapolis Tribune, Buffalo Courier, St. Louis Post-Dispatch, Pittsburgh Press, Indianapolis Star, Atlanta Journal, Detroit Free Press, Birmingham News, Cincinnati Enquirer, Little Rock Gazette. Free catalogue showing other lists of newspapers and magazines sent on request. Ankrum Advertising Agency, 22 W. Jackson Blvd., Chicago. Largest classified advertising agency in the world.

ADVERTISE in 24 Big Sunday Newspapers, 24 words \$15.00. Excellent for securing Agents, Salesmen, and Business Opportunities. Catalog listing 1,000 leading Dailies, Weeklies, Mail Order Magazines. Everything Free. Wade Advertising, Baltimore Bldg., Chicago.

"ADVERTISING Simplified," a handy book of rates and valuable information mailed free on request. Charles H. Touzalin Agency, 706 Union Trust Bldg., Chicago, Ill.

INCH Display 100 Monthly Magazines, \$4.00 Ad-Meyer, 4112M Hartford, St. Louis, Mo.

COUNTRY papers. All publications, European, Foreign. Lowest rates. Catalog. Owl Agency, Times Building, New York.

FOR ADVERTISERS

YOUR Business Broadcast through C-B-C. Cheapest way for advertising. Write for full particulars. Stephens, Valhalla, N. Y.

GUARANTEED Lists, agents, mail order buyers, others, 1,000, \$4.00; 500, \$2.25. Co-operative mailing that gets results. Price lists free. Demuth Co., Englewood, N. J.

YOUR 28 word ad. 100 weeklies, monthlies, \$5.00, thrice \$10.00. Dolsen, 36 Liberty, Brooklyn.

ADVERTISERS. 28-word adv. 161 Rural Weeklies. Covering New England States, \$8.78; list free. Vorton, Advertiser, B-373-P.M. Syracuse, N. Y.

HEADQUARTERS for mailing lists of every description. Female Buyers; Opportunity Seekers; Juveniles; Tradespeople. Cooperative Mailing Service, \$2.50—1,000 Particulars Free. Field Co., 1145 East 99th St., Cleveland, Ohio.

AMAZING results! Powerful literature—Successful selling plans—guaranteed mailing lists. Investigate! Finkel-Advertising, 15 Fairless, Jersey City, N. J.

I WRITE letters, folders, booklets, complete followup for manufacturers, mail-order dealers. Long experience. Write for details. L. Taylor, 315 Brown Bldg., Rockford, Ill.

CIRCULARS mailed to proven buyers. Submit sample for rates and further particulars. Penn Advertising Service, Glen Rock, Penna.

ADVERTISE in 300 country newspapers, 28 words, \$10.00. Keator, Hartford Bldg., Chicago.

25 WORDS 88 magazines; \$1.00. Thrice \$2.00. Smith's Service, 1194, Wenatchee, Wash.

SALES PROMOTION

\$50 TO \$50,000 Daily Sales Developed During 28 years for clients by our direct mail plans, copy, campaigns. One product, 1923, an idea; this year \$100,000 orders booked. Fifty year old concern desired 50 national representatives in 1925; we produced 40 in three months. 700 dealers in 10 months at \$3 each, for another. Ten years Sales Promotion Manager Larkin Co. Submit sales problems for Free diagnosis. James C. Johnson, 118A Woodbridge Ave., Buffalo.

SALES creating letters written. G. W. Anderson, Box 1244, Phoenix, Ariz.

LETTERS, folders; criticism free. Lewis, 37 E. 28th, New York.

AUTOMOBILE SUPPLIES

MANUFACTURE Fibro-Seal, Guaranteed Puncture Plugger; Para-vulking, No-cement Instant Weld Patch; Super-Radiolyte, 20-Minute Battery-Charging Fluid. I'm headquarters for Guaranteed Formulas for High-class Automobile Specialties and all lines. Investment small—profits enormous. No Machinery necessary. Valuable literature Free! Start a worth-while business with unlimited possibilities! Miller, Chemist, 1706-A Jetton, Tampa, Fla.

CLEAN your auto for 10c. Dri-Klean-It removes mud, dirt, dust. Makes it look like new. No soap or water used. Write for free sample. Agents wanted. American Accessories Co., Desk 31, Cincinnati, Ohio.

AUTOMOBILE Paint Rejuvenator—Send 25c for formulae and instructions to make old automobiles shine like new. Rejuno Co., Box 147, New Rockford, N. D.

GEARS—Guaranteed Steel Flywheel Starter Bands, \$3.50 Postpaid. Westinghouse Micarta Timing Gears, Ring Gears and Pinions. Rifner's Auto Supply, Salina, Kans.

66 MILES on 1 Gallon—Amazing Gas Saver. All autos. 1 free. Critchlow, B-805, Wheaton, Ill.

BATTERY Tester and Inspector. Regular \$50.00 value; \$32.00. Battery Shop Equipment and Supplies at Wholesale. Adams-Barr, Columbus, Ohio.

VULCANIZING Auto Tires is a Paying Business on account of new tires advancing. We have Plants near you from \$100 up. We save you 50%. Catalog Free. Instruction Book \$1. Equipment Exchange, 108 East 11, Los Angeles, Calif.

VULCANIZER—service station sizes. Reasonable prices. Adams-Barr, Columbus, Ohio.

BARGAINS on Radiators. All standard makes radiators furnished at bargain prices. State Make and model. We guarantee satisfaction. Independent Radiator Co., 1119 Wabash Ave., Chicago.

USED Auto Parts for Any Car. Allen's Parts Co., 2091 So. 9th, St. Louis, Mo.

AUTOMOBILES

PATENTS. Time counts in applying for patents. Don't risk delay in protecting your ideas. Send sketch or model for instruction or write for Free book "How to Obtain a Patent" and "Record of Invention" form. No charge for information on how to proceed. Communications strictly confidential. Prompt, careful, efficient service. Clarence A. O'Brien, Registered Patent Attorney, Security Bank Building (directly across street from Patent Office), Washington, D. C. See pages 140 and 141.

\$50.00 WEEKLY, reseating valves, illustrated instructions free. Write Donick Manufacturing Co., Battle Creek, Mich.

FOR FORD OWNERS

DELIVERY bodies for Ford Model T. Chassis with included Cab, suitable for Contractors, Grocersmen and farmers. Three styles. Price \$42.00. Write Daniel Zimmerman, Craigville, Ind.

PUT a "Bingo Timer" on your Ford. Guaranteed best made. Thousands in use. Requires no oil. No more trouble. All Dealers or direct with full particulars—\$1.50. Agents make big money. United Machinery Company, Cincinnati, U. S. A.

60 MILES on 1 Gallon—Amazing Gas Saver. All autos. 1 free. Critchlow, C-805, Wheaton, Ill.

DIRECT Engine Driven Tire Pumps for Ford Cars. Clagett Mfg. Co., Upper Marlboro, Md.

UNDERSLING with "RKO" Swing Lo Irons. See "Red-i-Kut" Ad page 134.

HAVE a Martin Crank Holder put on your Car. Send for Circular. John Klein, 308 Johnson St., Buffalo, N. Y.

MOTORCYCLES, BICYCLES AND SUPPLIES

MOTORCYCLES \$9—\$65.00. Typewriters \$6—\$28. Send Cash. Knights, 1512 Locust, St. Louis, Mo.

BICYCLES—Racers, Tandems, Tandem frames, Triplet, Reducers, Trainers, Exercisers. McDougald, 175 W. Lake St., Chicago.

EXCELSIOR and Henderson Parts for any model, used, half price; complete line of parts, repairs and accessories for Motorcycles, Bicycles and wheel toys. Catalogue 10 cents. John F. Ballak & Co., 100 N. 12th, St. Louis, Mo.

1923 INDIAN and Sidecar \$110; 1921, \$55; 1925 Harley-Davidson \$165; 1923, \$90; 1920, \$55; 1917, \$35. Hoffman's 6074 Butler St., Pittsburgh, Pa.

SPEED! Make your old motor twenty miles faster. Complete speed Manual with blueprints, \$2.00. Macks Motor Service, 54 Cabot, Beverly, Mass.

GOOD Second Hand Parts for Indian, Harley, Henderson, Ace and Excelsior Motorcycles. No Junk. Ship C.O.D. No Lists. J. B. Dahl, 3661-63 Archer Ave., Chicago, Ill.

1923 HARLEY-DAVIDSONS, \$168; 1922, \$118; 1921, \$111; 1920, \$85; 1919, \$65; 1917, \$50; 1916, \$45; 1915, \$40; 1914, \$35. Guaranteed. Money refunded if not satisfied. Circular free. Wisconsin Cycle Sales Co., 726 National Ave., Milwaukee, Wis.

DON'T buy a Bicycle Motor Attachment until you get our prices. Shaw Mfg. Co., Dept. 27, Galesburg, Kans.

SEND for Barzan Bulletin. All makes of rebuilt motorcycles at lowest prices. Used parts half-price. Ash Motor Corporation, Rochester, N. Y.

OVERSTOCKED Used Motorcycles, 1923 Indian Chief \$95.00, 1923 Harley Davidson \$95.00, 1923 Henderson Deluxe \$120.00. Two hundred others; write for free list. Myerow Brothers Co., 15 Berkeley St., Boston, Mass.

ALL used Harley-Davidson parts at big discounts. Tremendous bargains in used motorcycles. Don't fail to get our prices before buying. Oliver Cycle & Motor Co., 1045 N. Grand, St. Louis, Mo.

AVIATION

LEARN to Fly; \$100.00 including Solo. We guarantee to solo you regardless of the number of flying hours required. Our instructors are ex-army aviators and air-mail pilots with wide experience. Our training equipment is the best obtainable. Our course requires about two weeks, depending on the individual. No bond required, no charge for breakage. Eight years without an accident. 76 students graduated in 1925. Commercial aviation is a rapid growing industry. Don't delay! Enroll now in one of the oldest and best known flying schools in America. Robertson Aircraft Corporation, operators of the United States Air Mail, St. Louis-Chicago, Lambert-St. Louis Airport, Anglum, Mo.

THIS material guaranteed new or same as new. High compression Liberties \$1,250.00; Hispano 300 H.P. \$675.00; Hispano 180 H.P. \$450.00; LeRhone 80 H.P. \$75.00; Fiat 300 H.P. \$550.00; Maybach 240 H.P. \$395.00; Mercedes 160 H.P. \$350.00. Also Anzani, Clerget, Renault, Salmson, etc. Air speeds complete \$6.00. Bosch Booster mags \$8.75. Jaeger Tachometers \$6.00; altimeters \$3.00 up. Compass, dash type \$7.50. Pure Aeroplane linen 600 yard. Other Material proportionately reasonable. N. J. Burke, Cie. International Aeromatique, 803 University Parkway, Baltimore, Md.

AIRPLANE, Sled, Boat, Propellers \$5.75 upward. Leather Helmets, \$3. "Aerodrive" Boat, Sled Blueprints, \$1. Ostergaard Aircraft, 4269 No. Narragansett, Chicago.

AIRPLANES, motors and supplies; 80 H.P. LeRhone rotary motor \$125; 100 H.P. Gnome Rotary Motor \$100; Clerget Rotary Motor \$200; Lawrence 28 H.P. Motor \$125; Curtiss 90 H.P. \$500; slightly used \$350; tan leather helmets \$3.75 and \$5; non-shatterable goggles, Oval, \$2.50; wide vision, \$4; temperature gauges with 12-ft. tubing \$7.50; leather breeches \$12; airplane cloth 63c yd.; dope \$2.50 gal.; compass \$10; aerial camera \$100. Logan Aircraft, 716 W. Superior Ave., Cleveland, Ohio.

PATENTS. Time counts in applying for patents. Don't risk delay in protecting your ideas. Send sketch or model for instruction or write for Free book "How to Obtain a Patent" and "Record of Invention" form. No charge for information on how to proceed. Communications strictly confidential. Prompt, careful, efficient service. Clarence A. O'Brien, Registered Patent Attorney, Security Bank Building (directly across street from Patent Office), Washington, D. C. See pages 140 and 141.

CURTISS Pulitzer Racer Construction Set Including Full Sized Plans and Genuine Curtiss Reed Propeller \$4.00 Postpaid. Special Offer: Wonderful Scientific Air-glider with Ground Launching Device 50c Postpaid. Plans: Curtiss 35c; S. E. V. 75c; Loening 75c; "Bat" Catboat 17" Long. Construction Set, \$1.50; Plan 25c. Big Catalog Listing Latest Types of Model Airplanes, Boats and Supplies 5c. W. Phipps Company, 367 Wilson Avenue, Brooklyn, N. Y.

IF in need of aircraft supplies, tell us your needs. Our prices will interest you. Propeller circular 4c; motorcycle biplane circular 4c. Heath Airplane Company, Chicago, Ill.

AIRCRAFT Inspectors Handbooks valuable help pass civil service examination for positions under air commerce law. Price Two Dollars. McMinnies, Blue Ash, Ohio.

THE Aviators Preparatory Institute, under the personal direction of Walter Hinton, noted Trans-Atlantic pilot and aerial explorer, offers, at low cost to those interested in operation of aircraft, a complete home study course in all subjects of practical aeronautics. Walter Hinton, 475 Fifth Avenue, New York, N. Y.

TEN lessons in the air of twenty minutes each will make you a pilot by our advanced method of training. This, together with our five weeks shop course at \$100.000 makes America's oldest aircraft factory the most popular flying school. Work after class hours guaranteed. Heath Airplane Company, Chicago, Ill.

EARN \$3,500 to \$10,000 a year. Prepare for flying. Complete ground course in mechanics of aviation. Write for free catalog. Western Airplane Corporation, Desk K-9, Monadnock Block, Chicago.

FUTURE Aviators, Attention! Short cut information on flying, costs, what to buy, condensed facts on aviation, by Army and Commercial Pilots; Nine Years' Experience. Send \$1 for course. Jelks and Hay, 2734 So. Normandie St., Los Angeles, Calif.

THREE foot model airplane. Price \$1.00. Circulars free. Aero Shop, 3050 Hurlburt Ave., Detroit, Mich.

NEW and used JNs and Standards, Hispano and OX5 motors. Thomas Morse Scouts, Parts, supplies, wings, propellers. Write for quotations on whatever you need. Flying training hundred dollars up. Southern Airways Inc., San Antonio, Tex.

NEW Standard, flown 2 Hours—\$850. Aviator's Leather Coats, \$8 and \$10. Airplane propellers, New, \$5 to \$25. Motors, 28 to 200 Horse, \$30 up. Smith Machinery Co., Box 153, Houston, Texas.

KING Bird, three place luxury plane. Write Western Airplane Corporation, Suite 403, Monadnock Block, Chicago.

AIRPLANES. How to build them and be sure they will fly. Learn the two most powerful influences on the stability and operation of an airplane. Get our free information, blue prints and propeller literature. Crawford Airplane Mfr., 2225 American Ave., Long Beach, Calif.

COMPLETE Scale Plans with Building-Flying Instructions for following 3-foot Model Aeroplanes, 25c each postpaid: JN4D-2; DeHavilland; NC-4; Bleriot; Nieuport or Taube Monoplanes; Cecil Peoli Racer. Complete 48 pp. catalog 5c; listing hundreds of parts and supplies for experimenters. Ideal Aeroplane Co., 165 1/2 Spring Street, New York.

VARIOUS makes of Motorcycle engines complete with propellers. Prices—\$15 to \$30. H. M. Sensenich, Litz, Pa.

LIGHT sport plane \$300.00. Practically new. Excellent performance with special 4 cyl. air cooled 25 H.P. motor. Price for quick sale without motor \$300.00; with above motor \$600.00. Also large airplanes at surprisingly low prices. Heath Airplane Company, Chicago, Ill.

THE American School of Aviation announces a new correspondence course in Mechanics of Aviation. A thorough training in Practical Aeronautics. American School of Aviation, Dept. 1861, 3601 Michigan Ave., Chicago, Ill.

MOTORS: Curtiss OXX-6 Class A (under Fifty Hours) for Plane, Sea-Steed, Motor boat, etc., \$275.00. All Motor and Plane Spares at Best Prices. Send for Catalogue. Monumental Aircraft Co., 339 N. St. Paul Place, Baltimore, Md.

WELDING AND SOLDERING

ALUMINUM Solder—Applied with soldering iron same as soldering brass. Sample 35c. Large bar \$1.00. Modern Machine & Pattern Co., Terre Haute, Ind.

BOOKS AND PERIODICALS

"THE Personal Liberty Course"—A clever combination of mirth, information and instruction for quickly overcoming fear, bashfulness and physical complexes in men. No drugs, no gymnastics. Full particulars free, sealed. The Gardener Pep Club, Lock Box 607, Station C, Los Angeles, Calif.

HYPNOTISM—25 easy lessons and 248-page illustrated reference guide, \$2.00. "Mindreading" (any distance), Wonderful, \$2.00. Popular Institute, 8-430 Milwaukee Ave., Chicago.

HYPNOTISM easily learned. Lessons guaranteed. Postpaid \$1.10. Smith Pub. Co., Dept. 3, Springfield, Mass.

PRACTICAL Psychology Teaches Hypnotism, Personal Magnetism, Magnetic Healing, Auto-Suggestion, Cure Habits and Disease. Easy Lessons. Send for Booklet, 4 cents stamps. Fernando, Dept. M, Springfield, Mass.

FREE—Send for my Newthought, Self-culture, Occult, Mystic and Scientific book literature. Martens Publisher, Burlington, Iowa.

INDUSTRIAL Alcohol. Wright's book. Full directions for making, fully illustrated. \$2.50. Spon & Chamberlain, 120 P. M. Liberty Street, New York, N. Y.

SCIENTIFIC Books. Send for descriptive circular. Levi Bryant, 543 East 47th St., Chicago, Ill.

MANUSCRIPTS Wanted—Meador Publishing Co., 27 Beach St., Boston, Mass.

PICTURES AND POSTCARDS

ART Photos—1—\$1.00. Ben Meyer, 35 West 31st., New York.

ART Pictures, Books and Novelties. 200 Pictures and Catalog \$1.00. Howard Sales Co., Dept. 15, 1188 Folsom St., San Francisco, Calif.

75 BEAUTIFUL Art Pictures and Bathing Beauties 25c (coin). Photo Sales Co., 3242 Riehton, Suite 400, Detroit, Mich.

JOIN Live Postcard Club; Membership lists including Catalog, 10c. Harvey Teeple, Decatur, Ind.

GAMES, ENTERTAINMENTS AND PLAYS

VENTRILOQUISM taught almost anyone at home. Small cost. Send 2c stamp today for particulars and proof. George W. Smith, Room 8-94, 125 N. Jefferson Ave., Peoria, Ill.

100 LIGHTNING Chalk Talk Stunts \$2.00. Cartoonist, 2925 Euclid, Kansas City, Mo.

LEXINO Card Games, Fascinating—educating. 50c postpaid. Lexino, 1216 Colusa, Berkeley, Calif.

MAGIC TRICKS, BOOKS AND JOKER NOVELTIES

MAGIC—Tricks, Books and Supplies. For Amateurs as well as the great professionals. Anyone can learn through our instructions. Feature Acts in Mind-Reading, Spiritualism, Rope Ties, etc. Large illustrated Professional Catalog, 20c. Chicago Magic Co., 140 S. Dearborn St., Dent, B. Chicago, Ill.

CARD tricks. Coin tricks. Hypnotism. Ventriloquism. 64-page books, complete guides, 10c each. Geo. Fenner, 2401 Jefferson, Louisville, Ky.

TRICK Cards, any brand desired, \$1.25 a pack, pocket novelties, sales boards, Trade checks, games, etc., catalog free. Central Novelty Co., 112 No. LaSalle St., Chicago, Ill.

FOR something different, send 10c for "Fun-Magic-Mystery." New 80-page Book of 500 Tricks. Also contains Catalog largest line Magic Tricks and Supplies in South, at lowest prices. Send 10c today! Lyle Douglas, Station A, Dallas, Texas.

BOOKS, Magic, Mysteries, Magic Tricks, Novelties. Catalog Free. Singer, 555, Hancock, Wis.

FREE with \$25 order die box. Send 20c for our large catalogue of tricks, wigs, sensational escapes. Oaks Magical Co., Dent, 518 Oshkosh, Wis.

SEVEN Magical Delusions and Catalogs—25c. Gilmaglio, Morgan Park, Ill.

STAMP COLLECTING

READY SEPTEMBER 27th, 1927 Edition Scott's Postage Stamp Catalogue. About 1,600 pages. No increase in price. Scott's Catalogue is the complete and authoritative handbook of Philately. It lists, describes, and illustrates every stamp ever issued by any government in the world up to the time of its going to press. Gives perforation, watermark, color, paper, and price at which each stamp may be purchased, used or unused, from this company. Indispensable to the collector. 83rd edition. Cloth bound \$2.00; with thumb index \$2.50; shipping weight 3 lbs.; postage extra. For sale at all dealers. Note: Due to the large number of philatelists visiting America to attend the International Stamp Exhibition the advance sales of the Catalogue are unusually heavy and you are advised to order now. Send for free price list of sets, Scott Seal packets, albums, catalogues and accessories. Scott Stamp and Coin Company, 1 West 47th St., New York, N. Y.

MAGNIFICAROUS 10c Snap, with Approvals. Over 111 diff. stamps. Some from far off heathenish man-eating lands, of guarded secret rites and fever jungles, where white men seldom tread. Also many issued during money panic. That scarce Liberia, Hidden Hyderabad, Remote Travancore, Quaint Cochlin with bumper-shoot watermark, Old Canada, Hong Kong (George), Bandit-ridden Albania. Huge stamp from land of ginger and Capt. Kidd's travels, Ceylon (isle of rare spices), Malay (tiger), Nyassa (bull rubberneck), Gabon (savage with snakeskins), Congo (lady), Venezuela (large map stamp). Also mammoth costly Catalogs. Fine approvals for adults furnishing reference. Stamps Bought. Payn Stamp Co., 945 Grande Vista Drive, Los Angeles, Calif.

GUARANTEED the greatest bargain ever offered in our Mammoth Illustrated price list 2c or Free with Manor Packet of over 130 different stamps, mostly scarce and obsolete, such as Zanzibar, Victoria, Rouad, Sarawak, Cyprus, Malta, Kenya, Cayman, Turks, Wallis, Sierra Leone, Sudan, Johore, Syria, Palestine, Iraq, Belgian Congo, Nyassaland, Nigeria, So, Rhodesia, and 12 mint Azerbaijan. 25c to Approval Applicants Only. Penna, Stamp Co., Manor, Pa.

MYSTERY Packet—Stamps from Lands of Cannibals, heathens, sun-worshippers, wild savages, including Albania, Herzegovina, Antioquia, Chad, Congo, Cochlin, Cape Good Hope, Dutch India, Dominican Republic, Guadeloupe, Gold Coast, Kouang-Tcheou, Malay, Siam, Togo, Travancore, Ubangi, Volta; (many unused) and other mysterious, far-off places. 105 stamps, all different, only 5 cents to approval applicants! Big illustrated lists free with every order. Write today! C. D. Belmers Co., 101 Flatiron Bldg., Ft. Worth, Tex.

ARABS! Bandits! Head-Hunters! Egypt (sphinx); Malaya (tiger); Benadir (elephant); Tunis (arab); Turkey (sacred mosque); Belgium (showing battle between angel and "old horns"); Congo (head hunter)—All of these mysterious and remarkable stamps are contained in our Famous Phantom Packet—53 fine varieties (to approval applicants only) for 8 cents. Nothing like it; order at once! Pacific Stamp Co., Box 138, Helena, Mont. Extra! Send us, with your order for the Phantom Packet at 8c, the names of three of your friends who collect stamps; and we will give you, free of charge, a scarce set of 11 diff. Albania—bandit land!—cataloguing over \$1.50. Supply limited; write immediately!

O-O-O-O-H, Boys! What a Thrill! The Fenway "Jungle" Packet!—Contains scarce stamps from jungle and cannibal-land! Included are: Abyssinia, Congo head hunters, Kenya and Uganda, Nyassa camels, Mozambique, Ivory Coast, Upper Volta, Togo, Ubangui, Tanganyika, Fiji Islands (cannibals!) and other savage lands. This wonderful packet from far-away countries to new approval applicants for only ten cents! Fenway Stamp Co., 161 Massachusetts Ave., Boston, Mass.

ANCHERS \$\$\$ Outfit—only 12c! Fine triangle stamp; set German stamps with (pre-war) value forty million dollars (interesting!); perforation gauge, mm. scale; small album; airmail set; scarce stamp from smallest republic on earth; newspaper set; packet good stamps from Travancore, Johore, Dutch Indies, etc. Entire outfit for 12c to approval applicants! (Nice pocket stock book, value 25c, with every order!) Ancher Stamp Co., 148½ Clerk St., Jersey City, N. J.

FREE—A Monstrous Menagerie! The ferocious tiger; the kangaroo, leopard, oxen, camel, ant-eater, snake, caribou, swan, giraffe, flying horse, screaming eagle, wild elephant, etc. This wonderful packet of hard-to-get stamps—all containing pictures of curious birds, beasts and reptiles—free to approval applicants enclosing 5c postage! Big illustrated lists also free. Write today! Mystic Stamp Company (Dept. 8), Camden, N. Y.

SESQUICENTENNIAL Specialty! "Exhibition," "Charity," "Coat-of-Arms," "Pictorial," "Airmail," "War Sufferers," six wonderful sets; packet beautiful British, French, Portuguese Colonies; 100 different foreign. Big value, 15c, to approval applicants. Deering, 38 Fairmount, Marlborough, Mass.

SNAPS—200 different stamps, 10c; 60 different United States Stamps, 12c. With each order we give free our price list of sets, packets, albums, etc., and our pamphlet which tells "how to make a collection properly." Queen City Stamp Company, Room 38, 604 Race, Cincinnati, Ohio.

STAMP Collector's Complete Outfit only 25c includes book telling "How to Collect Stamps"; Album (fully illustrated); 106 different stamps from Algeria, Chad, Gabon, Sudan, Ubangi, etc.; "Free Stamps" coupon and trial approvals. Harry Ioor, 802 State Life Bldg., Indianapolis, Ind.

STAMPS collected by missions. 1 lb. 35c; 5 lbs \$1.50. Robinson, 7144 Cornell, Chicago.

500 DIFFERENT, \$3.45; 1,000, \$1.00; 2,000, \$1.00. Fred Onken, 630 79th Street, Brooklyn.

BIG Illustrated Bargain Lists Free: 500 different stamps 25c, 1,500 75c, 2,000 neatly mounted \$3.30, 500 different British Colonies, major varieties only, mounted \$3.15. R. W. St. Benno, Glen Ellyn, Ill.

FREE stamps to approval applicants. Joseph Dempsey, 1701 Quincy Ave., Scranton, Pa.

BEST one-cent approvals in America. F. P. Hand, 1117 South 60th St., Philadelphia, Pa.

\$10.00 FOR 25c. A choice assortment of 500 all different stamps guaranteed to catalogue over \$10.00, offered to approval applicants for only 25c. Edgewood Stamp Co., Dept. C, Milford, Conn.

100 STAMPS, all diff., 10 Cents. Shacklett, 3915 Westminster, St. Louis, Mo.

RUBBER Stamps, Stencils. Adamec, 180 Harman St., Brooklyn, N. Y.

FINE Approval Selections at 50% discount. 100 stamps free for 3c postage. Write Now. Winholt Stamp Co., Woodbine, Nw. Penna.

AIR Mail Stamps and Covers. Ask for price list. R. P. Brook, Rockville Centre, N. Y.

REAL Bargains. ¼c up. Babcock, 3821 E. Lake, Minneapolis, Minn.

CUBAN stamps, 25 different, 14 cents. Five hundred different stamps, 38 cents. Thousand mixed foreign stamps 42 cents. Thousand unused stamps 68 cents. Avery, Industria 96, Habana.

DANZIG Stamps Free—Interesting Packet from Danzig with big catalogues free for 2c. Midland Stamp Company, Toronto, Canada.

1,000 DIFFERENT stamps, only 60c. Guaranteed to please or money back. "Washington Stamp News" tells stamp collectors about new United States stamps that are to be issued. Sample copy, 2c. C. E. Nickles, 201 Seaton, N. E., Washington, D. C.

PRECANCELED stamps, 110 diff., 25c. W. Grosser, 1525 North Lawndale Ave., Chicago.

100,000 MARKS German Currency Free to approval applicants furnishing stamp. Joseph A. Lux., 211 Memminger St., Greenville, S. C.

NEWFOUNDLAND Stamp on Approval. None better—none cheaper. Send want list and references. Try these—38 all different face. (Cat. about \$5) for \$1.00. Rev. Butler, St. Georges, Newfoundland.

IDENTIFY water marks with Hussman Water Mark Detector. Lacquered tin box with directions and 1,000 stamp hinges. 15c. Bargain Packets, 100 British Colonies, 35c; 100 French Colonies, 30c; 100 Portuguese Colonies 40c; 100 New Europe 10c; 50 Asiatic, 15c; 50 African, 25c; 50 Australian, 25c; 50 So. & Cent. America, 25c; 500 all different 35c; 1,000 all different 95c. Hussman Stamp Co., Dept. PP, 620 Olive St., St. Louis, Mo.

\$1.00 CATALOG 20c. Edwin Bailey, Farmingdale, N. Y.

¼ AND up, approvals. C. Schulz, 608½ Sweetzer St., Los Angeles, Calif.

100 DIFFERENT French Colonies—35c. To Approval Applicants. Norman Albright, Independence, Kans.

PROCURE Russian stamps direct from Soviet Collectors. Join the Philatelic International, I. Tverskaja, Jamskaja 3, Moscow, U. S. S. R., or the American Branch, P. O. Box 388, San Francisco, Calif.

ILLUSTRATED album, 50 different foreign stamps, packet hinges, perforation gauge, hints to collectors, and big illustrated price list—complete outfit, all for 10c to approval applicants. Special: 1,000 unused stamps only 50c. W. Betts, Clearfield, Pa.

MAGNIFICAROCIOUS Packet Foreign Stamps. Beauties from Distant Lands. (Many Richly Colored, unusual designs) free for 2c. Gray Stamp Company, Toronto, Canada.

200 STAMPS, Bargain List, Magazine, 15c. Harvey Teeple, Decatur, Ind.

OVER 200 diff. stamps, from all over the world—and 1,000 stamp hinges—25c. Mountain City Stamp Co., P.O. Box 335, Mannington, W. Va.

100 STAMPS from 30 countries, 5c. Luffery, Port Orange, Fla.

STAMPS sent on approval at 70% discount. Reference required. Emory Renoll, Hanover, Pa.

AIR Mail Stamp—Used—on original snappy design envelope—also four unused snappy design envelopes 50 cents. Thomas P. Martin, Box 998, Oklahoma City, Okla.

FREE stamp packet, Approval applicants. M. M. Naugle, Easton, Pa.

APPROVAL Stamp Packet, Sent Free. Cornish Co., Schenectady, N. Y.

STAMPS on approval ¼c up. Free premium. Herbert Kelgwin, Middletown, N. Y.

STAMPS, 100 all different, Postage 2c. Lists free. P. M. Quaker Stamp Co., Toledo, Ohio.

110 NEW Europe All Different, a wonderful collection cataloguing several dollars, free to collectors requesting our Net Approvals. Postage 2 cents. Badger Stamp Co., Milwaukee, Wis.

500 DIFFERENT only 25c (regular price 50c), many unused, from British, French, Italian and Portuguese Colonies, Chile, Fiume, Guatemala, Persia, Slam, etc., to all approval applicants. Big bargain lists free. Victoria Stamp Co., London, Can.

STAMPS, 100 varieties, Africa, Brazil, Peru, Cuba, Mexico, etc., 10c. 50 different U. S. 25c; 1,000 mixed, 40c; 1,000 hinges, 10c. List free. C. Stegman, 5941 Cote Brillante, St. Louis, Mo.

FREE! 25 different United States with 60% discount approvals to reliable parties. Seidenberg, Baroda, Mich.

UNITED STATES—Send on approval. Send me your want list. Ref. Please, M. Hanna, New Kensington, Pa.

SPECIAL. 50 Varieties French Colonies, very fine, to Approval Applicants only, 10c. Richard Lamprecht, Valparaiso, Ind.

110 DIFFERENT Stamps, many unused, high values, free to collectors requesting our Net Approvals. Postage 2 cents. Christensen, Milwaukee, Wis.

24 VARIETIES Cuban stamps, 10 cents. List of 6,000 low-priced stamps free. Address Chambers Stamp Co., 111P, Nassau St., New York City, N. Y.

50 FRENCH Colonials, 30 British Colonials, 20 Portuguese Colonials, 30 South and Central America, all different; price lists, etc., all only 25c to introduce approvals. Fennell Stamp Company, Dept. P, St. Louis, Mo.

FREE, Hungary Charity No. 565 to 567 and a surprise packet given to those requesting for my 1, 2 and 3c approvals and also my 50% discount and better. Chas. W. Schmidt, P. O. Box 4832, Frankford Station, Philadelphia, Pa.

1,000 MIXED U. S. and Foreign Stamps 25c. Phil. Lundsted, Cape Cottage, Me.

FREE! Loose Leaf Postage Stamp Album at rate of 8 pages each month given with subscription to monthly Journal. Send 2c stamp for prospectus. United Stamp Co., Marquette Bldg., Chicago, Ill.

20 UNUSED stamps free. All different. Postage, 2c. P. M. Fisk Stamp Co., Toledo, Ohio.

105 CHINA, etc., 2c. Album (500 illustrations) 3c. Bullard, Sta. A, Boston

50 VAR. Scandinavians 10c. Gronberg, Box 5441, Philadelphia, Pa.

STAMP packets, 1,000 Varieties, \$1.10. Two Thousand Varieties, \$4.50. 100 Varieties and list, 10c. Norman Shultz, Colorado Springs, Colo.

200 DIFFERENT stamps, Triangle, Pictorial, etc., 10c. R. H. Carlton, 380 W. So. Temple, Salt Lake, Utah.

COVERTCO Packet, 250 varieties unused and used stamps 15 cents. Covert Stamp, 39 State, Rochester, N. Y.

ZANZIBAR, Abyssinia, Travancore, Herzegovina, Quelimane, Mozambique, Stamps, Menagerie Collection, Album, 10c. Liberty, 3974 Arsenal, St. Louis, Mo.

PACKET of 23 stamps, no two countries alike. Packet hinges. Set of \$1 and \$2 U. S. Rev., all for 5c. P. M. Miami Stamp Co., Toledo, Ohio.

RARE COINS

RARE Coins Bought and Sold, Stocks, Bonds, Notes, 3 Curios, 2 Coins and Price List 10c. G. Best, Cedar Rapids, Iowa.

25 OLD coins, all different, 50c. 40 different coins \$1.00. 100 different coins \$3.00. Monroe Half-Dollar, Uncirculated, \$1.00. Sesqui Half-Dollar, Uncirculated, \$1.25. Claud Denner, Box 315, Dallas, Texas.

BILLION Mark German Government Bond \$1.00; ten bonds \$3.00. American Sales Co., Box 1278, San Francisco.

TRADE Dollars \$1.00. Lexington Half Dollars 99c. 2c Bronze and bargain price list 10c. Arey, Box 483, Muskogee, Okla.

LARGE curious Japanese Tempo, 35c. Coins bought. Durso, 25 Mulberry, New York City.

100 WAR coins \$1.00, 50 foreign coins 50c, 30 curious coins 30c, 10 large foreign bills 30c, 10 German bills 20c, 5 Mexican bills 30c, Revolutionary War bill, 1776, 35c, 5 Roman coins 75c. Retail catalogue free. Nagy, 8P South 18th, Philadelphia.

12 Different Coins, 25c; 5 Large Cents, 45c. Brooks, 2725½ Live Oak, Dallas, Texas.

STOCKS — Bonds, Domestic — Foreign, bought—sold. Dealers in all marketable securities. Frank O. Everett & Co., 20 Broad St., New York.

\$2 TO \$500 Each Paid for hundreds of Old or Odd Coins. Keep All Old Money, it may be very valuable. Send 10 cents for Illustrated Coin Value Book, 4x8. Get Posted. Guaranteed Prices. We Buy and Sell. Clarke Coin Office, LeRoy, N. Y.

UNITED STATES, Large Cent, two-cent bronze, three-cent nickel and Bargain List, 25c. Fifteen dates large cents, \$1.00. George Coffin, Greenwood Mountain, Me.

UNITED STATES and Foreign Money, Medals, Catalogue and Villa Bill 10 cents. Alexis Mengelle, Colorado Springs, Colo.

GET Profit and Pleasure in collecting Old Coins. Send 10c for Sample Old Coin, together with my Large Illustrated Coin Catalogue. You'll be delighted with it. Send for it right now. B. Max Mehl, Professional Numismatist, Mehl Bldg., Dept. P, Fort Worth, Texas. Largest Rare Coin Firm in U. S.

FOR BOYS

BOYS and Girls, Earn Xmas Money. Write for 50 sets St. Nicholas Christmas Seals. Sell for 10c a set. When sold send us \$3.00 and keep \$2.00. No Work—Just Fun. St. Nicholas Seal Co., Dept. 43PM, Brooklyn, N. Y.

CAMERAS AND PHOTO SUPPLIES

PHOTOGRAPHIC equipment and accessories of every description are listed and illustrated in our 228-page catalogue. It will pay you to secure a copy which is issued free, as our prices are low. We also deal in used goods which are sold under the same guarantee as new goods. Ask for our Bargain Book. Central Camera Co., Dept. E-109, 112 S. Wabash Ave., Chicago, Ill.

SPECIAL, a beautiful enlargement 5x7 inches given with your first developing and printing order of any size. 6 exp. roll for 25c in coin. America's finest photo finishing. Photogram Laboratories, Box 185-S, Newark, N. J.

WE do fine Photo Finishing. Trial roll and 6 prints developed 25c. Enlargement free with order. Pokorny Art Studio, 1822 So. Throop St., Chicago, Ill.

BARGAINS—View camera, Lenses, Accessories, Photographic books, Magazines. E. A. Roberts, Middletown, Conn.

FREE with 50c worth of work, a 5x7 enlargement from your best negative. Trial Offer. Send us your films for quality work. Corp. Pharmaceutical Co., Auburn, N. Y.

25 CENTS—coin—6 exposure roll and 1 print each good negative. Photo Finishing Co., Waterloo, Iowa, Box 26.

HAVE You a Camera? Write for Free sample of our big magazine, showing how to make better pictures and earn money. American Photography, 116 Camera House, Boston, 17, Mass.

BARGAINS in Kodaks. Ray, 296 5th Ave., New York.

KODAK Films—Special trial offer; your next kodak film developed, 5c—prints, 2c each. Moser & Son, 1917 St. James Ave., Cincinnati.

EXPERT Kodak finishing. Trial Order. Your next Roll film developed free. Beautiful Glossy-tone Prints, 4c each. Immediate Service. Herman Studio, 706 Calhoun, Ft. Wayne, Ind.

SEND 10c for the latest and greatest Bass Book of Cinema Apparatus; gives full description of all types of instruments as well as the price. Or, send \$3.00 for a 500-page Cinema Hand Book containing full instructions of the making and taking of films. Bass Camera Company, 105 N. Dearborn St., Chicago, Ill.

KODAK Film—Special Trial Offer—Your next roll developed 5c, prints 3c each. Beautiful 6x10 mounted Enlargement 40c. Sameday Service. Fleet Photo Service, 1210 G. N.W., Washington, D. C.

MODERN Photography in all its branches now taught by mail. New Successful Method. Students earning \$300.00 while learning. Big opportunity. Write for particulars and unusual offer open for short time. Dept. 3431, International Studios, Inc., 3601 Michigan Ave., Chicago.

FILMS Developed. Special Trial Offer. Any Size Kodak film developed 5c, prints 3c each. Trial 6x10 Enlargement in handsome folder 40c. Overnight Service. Roanoke Photo Finishing Co., 209 Bell Ave., Roanoke, Va.

UNEXCELLED Gloss Prints. Trial Offer. Your Kodak Film Developed and printed only 10c. F R B Photographers, Dept. "C," 1503 Lincoln Ave., Cincinnati, Ohio.

ROLL Developed 5c. Prints 2c each Cash. Eastman Kodak Studio, Armstrong, Iowa.

MOTION PICTURES

MOVIE films. Complete stories in two reels (2,000 Ft.) \$5 per subject. Remittance with order. Independent Films, 177 Golden Gate Ave., San Francisco, Calif.

FILMS—Features, Comedies, Weeklies, \$3.00 Complete. Exchange Privilege 1/2 rate. Howard Leiber, 623 W. 170th St., New York City.

BARGAINS. Machines. Films. Stereopticons. Slides. National Equipment Company, Duluth, Minn.

SACRIFICING New \$150 Sept spring motor Movie Camera and leather case, \$37.50. Eastman negative Film 2 1/2 cents foot. Printer \$25. Movie Projector \$37.50. Motor driven suit case Projector \$85. Movie Films \$2 reel. Ray, 296 5th Ave., New York.

NEW and Rebuilt Machines for Big Theatres—Schools—Churches—Traveling Shows. Also Films—Supplies and Complete Theatre Equipments. Bargain List Free. Monarch Theatre Supply Co., Dept. P, Memphis, Tenn.

FILM—Million Feet for Sale. Cowboy—Drama—Comedy and Feature Specials. Mix—Hart—Chaplin and best Movie Stars. \$3.00 per reel up. Genuine List Free. We Supply the World. Dept. G. Monarch Films, Memphis, Tenn.

\$\$\$ FOR Photoplay Ideas. Let us help you market your story. Write for particulars. Universal Scenario Company, 206 Security Bldg., Western and Santa Monica Blvd., Hollywood, Calif.

SCENERY TO RENT

SETTINGS for Opera, Plays, Minstrels. Plush drops. Address Amelia Grain, Philadelphia.

EDUCATIONAL AND INSTRUCTION

BARBERING. Learn Modern Barbering at Home. Practice on the Family. Practical, Scientific Instructions Complete for 50c. Send Money Order or Dimes. Foster, Expert Barber, Dept. A, 613 E. 60th St., Chicago, Ill.

EARN \$25 weekly, spare time, writing for newspapers, magazines. Experience unnecessary. Details Free. Press Syndicate, 981 St. Louis, Mo.

AN Embalming or body preserving process. Obviously permanent and may be made visible. F. L. Jones, 669 G. P. O., New York.

YOU can have a business profession of your own and earn big income in service fees. A new system of foot correction; readily learned by anyone at home in a few weeks. Easy terms for training; openings everywhere with all the trade you can attend to. No capital required or goods to buy, no agency or soliciting. Address Stephenson Laboratory, 1 Back Bay, Boston, Mass.

BE a Laboratory Expert. Earn from \$300 to \$500 Monthly. Study Microbiology Sanitation, Day, Evening classes. Diplomas, Degrees Granted. 71-piece outfit Free to students. Write for our Free Prospectus To-Day. International College of Microbiology, 7202 W. Grand Ave., Chicago, Ill.

STEAMSHIP Positions—Europe, Orient. Good pay. Experience unnecessary. Details free. Box 122-N, Mount Vernon, N. Y.

ARTIFICIAL Marble sanitary flooring instructions, ornamental casting, concrete, plaster, papier-mache decorations, garden furniture, statuary, Rubber-moulds, 17 years instructing the public; particulars and illustrations free. Chris. Mahler, Huntington, N. Y.

INSTRUCTIONS in Mail Order. Free. Popham, Box 431-D, Chicago.

MEN wanting forest ranger positions. \$1,500—\$2,400. Write for particulars and list Natl. forests. Mokane, A-21, Denver, Colo.

INSTRUCTION books, all kinds. Catalogue free. Wincholt Book Co., Box 4, Woodbine, Penna.

WORLD-ROMIC System. Masterkey 5,000 languages. Primers, \$1.98: Arabic, Chinese, French, German, Italian, Japanese, Russian, Spanish. Languages, 8 West 40th, New York.

ENGINEERING Courses Simplified. Lowest Prices. Descriptive Circular free. Lightning Method, Box 999, Long Beach, Calif.

MECHANICAL Engineering. Interesting. Highly Paid Work. Special Home Study Course. Write for Particulars and Free Copy of "Machine Designer's Manual." Harbor Technical College, 831 Pine Ave., Long Beach, Calif.

ALL men—women wanting Government Positions, \$140—\$225 monthly, should get our "Exam. Coaching" immediately. Write, Ozuent, 101, St. Louis, Mo.

FINGER Print Experts—Excellent paying positions; particulars free. Finger Print Headquarters, 188 East 79th, New York.

\$115—\$400 MONTHLY paid—Ry. Station—office positions. Free passes, experience unnecessary. Write Baker, Supt., (ABT) Star Bldg., St. Louis, Mo.

TRACE missing people; earn big money; free particulars. National Headquarters, 188 East 79th, New York.

ARE You Interested in Writing short stories, poems, songs, photoplays. For Profit? Then send for our new edition of actual letters from prominent editors, who want your manuscripts. It's Free if you send for it Now. Address M. Mendelsohn, Editor, Dept. 102, Writer's Digest, 22 E. 12th St., Cincinnati, Ohio.

DOUBLE Entry Bookkeeping mastered in 60 hours with 8 keys; guaranteed; diplomas. International Bookkeeping Institute, Dept. 8, Springfield, Mo.

SIMPLIFIED Shorthand or Bookkeeping, 25c. Marr, Teacher, 605, Nashville, Tenn.

USED educational matter of all kinds. Sold on repurchase basis. Big saving. Money-back guarantee. List free. (Courses bought.) Lee Mountain, Pisgah, Ala.

USED educational matter. Lowest prices; terms. Catalog free. Mention Subject. Fred Goetz, 440-A Sansome, San Francisco.

RADIO OUTFITS AND SUPPLIES

FIVE Tube Receivers. \$22.50 Delivered. Tubes 95c. Literature Free. Agents wanted. Seminole, 427 East 16th, New York.

BUILD Super using Davisco Long Wave air core transformers and standard parts. Selectivity unparalleled, freedom from interference, tone unsurpassed, volume equal to power amplifier. Long range loop reception. Entirely new principle in Super-Het. Ask for literature, blue prints 50 cents. We can furnish parts to commercial set builders at special discount. Davisco, 30 Euclid Arcade, Cleveland, Ohio.

600 MILE Radio \$2.95 Postpaid. Needs no tubes nor batteries. Over 200,000 sold. Order direct from this ad. Crystal Radio Company, Wichita, Kans.

MANUFACTURE Crystals—Big profits—particulars free. Box 313, Wichita, Kans.

AUDIO Transformers 70c up. 50H chokes unmounted \$2.00, for "B" eliminators, speaker bypass, etc. prepaid. Write for list. Radio Parts Sales Co., Box 24, Orange, N. J.

RADIO Fans! Hoff's Radio Trouble Finder makes "tuning in" a pleasure. Investigate! John Englund, Box 267, Ontonagon, Mich.

TRADE AND TECHNICAL SCHOOLS

GET a Foreman's Job in any trade. Train yourself to earn more money. Become an expert Blue Print Reader. You can do it in spare time. My training will give you advancement in a few weeks. Write now—tell me what trade you want—I will send my plan at once. Carroll Rumsey, 165 Drexel Bldg., Philadelphia, Pa.

TELEGRAPHY—Both Morse and Wireless—taught thoroughly and quickly. Tremendous demand. Big salaries. Wonderful opportunities. Expenses low; chance to earn part. School established fifty years. Catalog free. Dodge's Institute, Fern St., Valparaiso, Ind.

SEE our display ad on page 65 this issue. Chicago Painting School, 150 W. Austin Ave., Chicago, Ill.

LEARN Bricklaying at home or in school run by contractors. Catalog free. Associated Building Employers, C400, A. B. E. Building, Grand Rapids, Mich.

BUSINESS OPPORTUNITIES

QUIT Slaving for the other fellow and Hire Yourself as Boss! Manufacture These Biggest-Selling Specialties. 300 to 900% profit. Investment Small. No Machinery Necessary. I'll tell you how to make; Fibro-Seal. Guaranteed Puncture Plugger; Para-Vulkine, No - Cement - Instant - Weld Patch, Super-Radiolyte, 20-Minute Battery Charging Fluid; Guaranteed Metal Polishing Cloth; Non-Thermic Ice Saver Cloth; Tufnit—Prevents Runs in Silk Hosiery; Fly-Nox, Instant Fly-killing Spray. Valuable Literature describing these, also sixty others. Free! Write today! Miller, Chemist, 1706-C Jetton, Tampa, Fla.

PATENTS. Time counts in applying for patents. Don't risk delay in protecting your ideas. Send sketch or model for instruction or write for Free book "How to Obtain a Patent" and "Record of Invention" form. No charge for information on how to proceed. Communications strictly confidential. Prompt, careful, efficient service. Clarence A. O'Brien, Registered Patent Attorney, Security Bank Building (directly across street from Patent Office), Washington, D. C. See pages 140 and 141.

66 MILES on 1 Gallon—Amazing Gas Saver. All autos. 1 free. Critchlow, D-805, Wheaton, Ill.

START a business of your own. Nichel, silver, copper and gold plating. Large profits. Two dollars for full information or twenty cents for samples and particulars. Electro Platers Supply Co., 547 Conside Ave., Norwood, Ohio.

VALUABLE Mail Order Information for Stamp. Wm. Bickley, Lockland, Ohio.

ATTENTION. Start a profitable business in your home during spare time. Practically no capital needed. Particulars and personal letter explaining fully, 25c. Wm. Rohlfing, 809 Allen Ave., St. Louis, Mo.

MEN with Ford Cars, some mechanical ability. Part or full time. Profits \$200 per week. Cleveland Motor Parts Co., 1916 Station E, Cleveland, Ohio.

COMPOSITION Floor Making earns industrious men \$12 and more daily if used as trade. Or make business of it with profits up to \$15,000 yearly. We teach everything, show opportunities, explain how to make good. Openings everywhere. Write Semi Title, Dept. C, Hollis, N. Y.

START—Magazine—32 pages, 6x9, \$2.50 hundred prepaid. Plan 10c. Dolsen, 36 Liberty, Brooklyn.

MAKE Money at Home—Operating small Manufacturing and mail-order business. I furnish full instructions, how to manufacture and how to sell. Something new, capable of returning steady income \$20 to \$80 a week. Method is known as The Practical Profit Plan. Send for a free circular that tells the full facts. Freitas, Dept. M. Box 1232, Lowell, Mass.

PROFITS \$350 monthly earned by Sigel. Only cost him \$16. One-Day Battery Charging doing it. Small space required. Write for free Bulletin CP. Hobart Bros., Box CL-1, Troy, Ohio.

ONE Storekeeper Agent in Every Town. 500% and Free Advertising. Cameron, 1125 Royal, New Orleans.

SHERIDAN'S Directory. Latest. Largest and Best Buyers' Guide. Wholesale Supply Sources for Thousands of Articles, \$1.00. S. Van Auken, 34 Riehton, Detroit, Mich.

THAT Man Florian—The most interesting tale of big business you ever read. Mailed free. Harrison & Harrison, 360 Wilcox Building, Los Angeles, Calif.

MARBLE mixing instructions, covering wood or cement flooring 1/2 inch thick, fire-proof, waterproof, low cost, sanitary, all colors. Particulars and illustrations free. Marble and flooring samples 12c. Chris. Mahler, Huntington, N. Y.

BIG Money working mail-order schemes. Pleasant work. Our \$5.00 book contains 100 plans; special price \$1.00. D. Kandel, 817 W. 28th St., Norfolk, Va.

MAKE Big Money Operating a Collection Agency; whole or part time; no capital required. Write George H. Cole, Pres., 322 Waverly, Syracuse, N. Y.

WANT More Money? Start Little Mail Order Business. Samples and Plan Free. Mailing Charges 10c. Snydam, 10748 112th St., Richmond, Hill, N. Y.

SUCCEEDED—Our twenty scientific processes put you wise. Excellent. 50c. Holland, Box A-473, Astoria, Ore.

GO into Business. Send for live propositions. Merry Specialty Co., Somerville, N. J.

ONLY shop in county seat, heart or wheat belt, for sale. 50 lb. trip hammer, disk roller, drill, emery, power hack saw, forges and small tools. Reason for selling lost part of right hand by blood poison. Address M. A. Pullins, P. O. Box 161, Sublette, Kans.

STARTING—Lighting—Ignition. Service most profitable in Automotive field. Small investment, Big Profits, Pleasant work. HB Test Bench brings you this business. Write for free bulletin TB. Hobart Brothers Co., Box CL-3, Troy, Ohio.

START Mail Order business. Write Public Correspondence Association, Box 326, 601 E. 38th St., Chicago, Ill.

PUBLISH a Magazine of your own and start a mail order business on \$1.00 capital. Sample magazine and plan, 25c (coin). E. D. Tupper, P. O. Box 184, Los Gatos, Calif.

MIRRORS Resilvered at Home. Costs Less 5 cents per square foot; you charge 75 cents. Immense profits plating like new, brassy, worn-off autoparts, reflectors, tableware, stoves, etc. Outfits furnished. Details Free. Sprinkle, Plater, 127, Marion, Ind.

INVENTIONS Wanted which are simple to manufacture and possible of volume distribution through national sales organization. Either patented or unpatented. United Factories Bureau, 910 Woodward Bldg., Washington, D. C.

MONEY-MAKING Business Chances, Local and Mail Order. Particulars for stamp. Paul Lease, Norfolk, Nebr.

CAPITAL secured quickly, inexpensively for invention, or any business proposition. Interstate Service, Elizabeth, N. J.

MAIL order Booklet, where to buy Books, Novelties, Specialties, 10c. Harvey Teeple, Decatur, Ind.

THANLY Formulas, Processes, Trade-Secrets produce perfect products. Latest, fast-selling specialties in all lines. Send for interesting catalog, circulars, money-back guarantee and "What Our Clients Say." B. Thanly Co., Washington, D. C.

CHEMIST furnishes reliable, guaranteed formulas for manufacturing your own household, toilet, laundry preparations, etc. Write for sample labels and details of the latest and best sellers. Scheld & Co., Box 1199, New Haven, Conn.

MAKE Mexican Confection, candied fruit, at home. Something new. Very big profit. Send dollar for guaranteed formula. Garcia, Box 347, Nogales, Ariz.

MAIL Order News contains latest money-making schemes, opportunities and suggestions showing big profits. Complete instructions how to start profitable Mail Order Business of your own. Everything explained. Sample copy of this big magazine 25c. None Free. Established 23 years. Mail Order News, 360 Bristol Bldg., New York.

DEPENDABLE Air Service brought Caldwell 80% increase in business the first month. More than paid for itself on easy payments. Write for free bulletin AC. Hobart Bros. Co., Box CL-2, Troy, Ohio.

NEW. You are neglecting your biggest opportunity in not writing us at once. Our System has been founded for the purpose of helping everyone. Send 4 cents in stamps for information. James H. Regan, Dillon System, 309-311 5th Ave., Room, 209, New York City.

START Mail Order Business of your own at home. We supply catalogues with your address on. Wineholt Sales Co., Box 4, Woodbine, Penna.

MECHANICUS, painters, carpenters, start furniture refinishing, painting, handyman shop on nearly nothing; winning plan brings customers quickly. John Bracland, 1429 So. Ninth, Philadelphia, Pa.

TATTOO Valuable Fox's, etc. Positive Identification, Booklet Free. "Waters," 945 Putnam, Detroit.

YOUR favorite products; manufacture them yourself. Guaranteed manufacturers' formulas supplied. All lines. Latest specialties. Romig, Box M, Station W, New York.

DON'T miss this opportunity! Send \$1 for our book on mail order plans. Also a \$5 book containing 100 money making plans. Both for \$1. D. Kandel, 817 W. 28th St., Norfolk, Va.

ARE You Old at Forty? See our advertisement on page 156 of this issue. The Electro Thermal Company, 2161 Main Street, Steubenville, Ohio.

MAKE your own renewable fuse plugs. Renew 8 times for five cents. Instructions, 2 sample plugs, and 24 renewals for one dollar. A. L. Krauth, 213 Cherry St., Quincy, Ill.

CHEMICAL Expert furnishes Manufacturing Formulas and Processes with complete working directions. Reliable individual service only. No lists. Charges reasonable. Correspondence invited. Dr. Arthur Van-Heeden, 508 South Oakley, Chicago.

ATTENTION! You can have a business of your own. Establish and operate New System Real Estate Business, brokerage and insurance agency in your community. Office at home. Earn \$5,000 year. Representatives wanted everywhere. Send stamp free booklet. Hayes Realty Association, Cincinnati, Ohio.

DODGE the Rut! Profitable, Whole or Sparetime Work. Information 2c Stamp. Interstate Specialty Co., 120 East Eighth St., Lawrence, Kans.

\$750,000,000 MAIL-ORDER business in 1925. Many grow rich in this great trade. Sell merchandise, information, patented articles, various preparations. Breniser's Famous Mail-Order Handbooks tell how. Eleven brochures \$3. One book with complete catalog, 25c; none free. Breniser, (Established 1909) 355 Walnut, Philadelphia.

DON'T gamble in mail order business. Be sure. Free circular puts you wise. MacKao, M40 Oregonian Building, Portland, Ore.

START your own business; no capital nor experience required. Gold Leaf Window Sign; 500% profit. Samples free. Consolidated, 69 T—West Van Buren, Chicago.

INVENTORS—Write for our Guide Book, "How to Get Your Patent" and Evidence of Invention Blank. Send model or sketch of your invention for our free Examination and Instructions. Randolph & Co., Dept. 435, Washington, D. C.

ENTER a new business. Earn \$3,000 to \$6,000 yearly in professional fees making and fitting a foot specialty, openings everywhere, with all the trade you can attend to; easily learned by anyone at home in a few weeks, at small expense; no further capital required, no goods to buy, job hunting, soliciting or agency. Address Stephenson Laboratories, (1) Back Bay, Boston, Mass.

COST \$5.00, your profit \$104.75. Transferring Decalcomania letters on autos, trunks, bags, etc. Send today for outfit or free samples. World Monogram, Dept. 73, Newark, N. J.

EARN \$10 daily silvering mirrors, plating and refinishing metalware, autos, chandeliers, bedsteads, headights. Outfits furnished. E. Decie Laboratories, 1133 Broadway, New York.

SCHMER Magazine, Alliance, Ohio, 28th year, prints big profit Schemes, Ideas, Formulas. Subscriber made \$25,000; another \$10,000. Try your luck. Year \$1.00; three months, 30c. None free.

TATTOOING Supplies, Complete Electric Outfits, Lowest Prices. Catalogue. "Waters," 965 Putnam, Detroit.

LEARN the collection business. Good income, quick results. Interesting booklet, "Skillful Collecting" free. National Collectors Assn., Long St., Newark, Ohio.

\$3,000 TO \$7,000 Yearly. Want It? Others are making it. Send check or money order today for our invaluable books "How to Sell Real Estate," \$3.00—and "How to Conduct Real Estate and Insurance Business," \$1.50. Absolute satisfaction guaranteed. Free circulars. Realty Book Co., Dept. 52, Cleveland, Ohio.

PATENTS Procured; Trade Marks Registered—A Comprehensive, experienced, prompt service for the protection and development of your ideas. Preliminary advice gladly furnished without charge. Booklet of information and form for disclosing idea free on request. Richard B. Owen, 30-Owen Bldg., Washington, D. C., or 41-R Park Row, New York.

CHEMICAL Expert will furnish Formulas and Trade Secrets. All lines. Lists Free. W. L. Cummings, Ph. D., 223 Gordon Ave., Syracuse, N. Y.

RESPONSIBLE manufacturer wants competent men to manage office and salesmen. \$500 to \$1,500 necessary; will allow expenses to Trenton if you qualify. Address Manager, 536 Forst Richey Bldg., Trenton, N. J.

SIGNS and Showcards Easily painted with Letter Patterns. Large variety of Styles and Sizes. Samples for stamp. John Rahm, a2120 Neva Ave., Chicago.

UNPATENTED Ideas Can Be Sold. I tell you how and help you make the sale. Free particulars (Copyrighted). Write W. T. Greene, 810 Jenifer Building, Washington, D. C.

WE Start You in Business, furnishing everything; men and women. \$30.00 to \$100.00 weekly operating our "New System Specialty Candy Factories" anywhere. Opportunity lifetime; booklet free. W. Hillier Raggsdale, Drawer 4, East Orange, N. J.

TELEGRAPHY

TELEGRAPHY—Both Morse and Wireless—taught thoroughly and quickly. Tremendous demand. Big salaries. Wonderful opportunities. Expenses low; chance to earn part. School established fifty years. Catalog free. Dodge's Institute, H St., Valparaiso, Ind.

CHEMISTRY

FORMULA by Richards means the best. Your chemical problem solved and working process furnished \$5.00. Write me. W. Stedman Richards, Consulting Chemist, Box 2402, Boston, Mass.

CHEMICAL Analysis, Processes, Technical Information. Robert Henderson, Laboratory, Madison, Maine.

FORMULAS AND TRADE SECRETS

GUARANTEED formulas of the better grade supplied by chemist. Best sellers duplicated. Latest specialties. All lines. Romig, Box N, Station W, New York.

500 VALUABLE Formulas, 25c. Circular Free. Harvey Teeple, Decatur, Ind.

FORMULAS, Cosmetics, etc for \$1.00. Mildred Turner, 1298 Lillibridge, Detroit, Mich.

THANLY Formulas, Processes, Trade-Secrets produce perfect products. Latest, fast-selling specialties in all lines. Send for interesting catalog, circulars, money-back guarantee and "What Our Clients Say." B. Thanly Co., Washington, D. C.

CHEMIST furnishes reliable, guaranteed formulas for manufacturing your own household, toilet, laundry preparations, etc. Write for sample labels and details of the latest and best sellers. Scheld & Co., Box 1199, New Haven, Conn.

SPECIAL formulas for Manufacturing and Business purposes. Any one you want, including full manufacturing instructions and where to get all supplies, sent for \$5. Satisfaction guaranteed. Announcements of latest formulas for quick-selling seasonable products sent monthly without charge. Write today. National Information Bureau, 316E Shepard Building, Grand Rapids, Mich.

CONCRETE Waterproofing Processes, making Hard, Light Colored Dampproof concrete building blocks. Concrete Machine Co., 5 Main St., St. Louis, Mo.

SAWDUST, and Chemicals make sanitary flooring. Directions \$1.00. Universal Supply Co., Auburn, N. Y.

THREE Extra Special Formulas 10c. Fireproofing Celluloid, Fly Spray, Solid Alcohol (New, easier process). Bargain Introductory Offer. Pacifico, Prineville, Ore.

FORMULAS: New, different. Make beverages, extracts, syrups, flavors, etc. Home and manufacturing specialties. Valuable information free. Western Formula Co., 1613 Queen Anne Ave., Seattle, Wash.

FORMULAS—Silvering Mirrors and hundreds others, with Business Library for \$1.00 Prepaid. Globe Novelty Co., South Bend, Ind.

FORMULAS, Guaranteed Best Chemical Science can devise. Stamp brings big bunch valuable literature describing Latest Reliable Processes for Manufacturing All Lines. Don't Buy till you've received these Profitable Propositions. No recipe-book Trash. 29 years giving satisfaction. Miller Chemist, 1706-U Jetton, Tampa, Fla.

FORMULAS—Processes—Any Formula Dollar Bill. Hance, Chemist, 57 Saratoga, Yonkers, N. Y.

EASY money maker, just like I use myself; why not you? Particulars for red stamp. W. P. Stump, Hemet, Calif.

500 FORMULAS including Luminous Paint—Renewing Dry Batteries—Resilvering Mirrors—Gas Tonic Puncture Plugger, 27c. Catalog Free. Ideal Book Shop, Park Ridge, Ill.

\$5.00 WILL furnish you with guaranteed formula for manufacture of any article. Chemical analysis of any nature. Chemical Technical Laboratories, 173 State St., Boston, Mass.

AGENTS WANTED

NO Dull Times in the Food Business. Selling Federal Pure Food Products is the greatest, surest and safest business in the world today, and here is your opportunity to get into it. You can make \$3,000, \$5,000, \$10,000, or more per year—the only limit is your ability to take care of the business. You will need no experience or money to get into this business. Your \$20.00 starting order sent on trust. We teach you everything you need to know. We furnish you with license. No Dull Times, for the People Must Eat, and our food products are the fastest selling, surest and quickest repeat order goods in the world. Sell on sight in every home where food is used—repeat orders immediately and every week thereafter. A real big business all your own. Every new customer adds a great deal to your weekly income. Your business once established, has a market value just like a store and can be easily sold. The greatest money-making opportunity of your lifetime because you risk absolutely nothing, as we guarantee your sales, and we will not let you fail. Remember! Guaranteed! Best products, biggest sellers, surest repeat orders. No capital or experience is required. We furnish capital and everything necessary for you to become a Federal Distributor. Exclusive territory will be given honest men or women who write at once. Federal Pure Food Company, 2309 Archer Avenue, Dept. A, Chicago, Ill. Largest packers of Pure Food specialties in the world. Reference, any bank, Dun or Bradstreet rating agency, Express or Railway Company in America.

MANUFACTURE Very Latest, Biggest-selling Advertiser Specialties yourself—No Machinery investment small—All lines. Stamp brings Valuable Interesting Literature explaining how others sell your products and big bunch lists Guaranteed Formulas, 300 to 1,200% profit to you. Reliable Information Only. No "Master Formula" trash. Miller, Chemist, 1706-V Jetton, Tampa, Fla.

"AMAZING New Cleaner." Cleans Everything. Sells like wildfire. Quick Repeater, 300% Profit. Miller, New York, made \$1,000 in 6 weeks. Beck, Illinois, \$98.00 in 2 days. Premium sales plan and Free Samples make selling easy. Work full or spare time. Write quick. Bestever Products Co., 1915E, Irving Park, Chicago.

400 MORE active men to introduce Chieftain Guaranteed Tailored Shirts 3 for \$4.95. Latest novelties, colors. Dickmann, Illinois, in 3 weeks made \$589; Sinton, Texas, in 12 days, \$219.60; Bend, Iowa, in 16 days, \$334.80. You should do as well. No experience or capital needed. We deliver and collect. Full working outfit Free. Cincinnati Shirt Company, Secy, 13813, Cincinnati, Ohio.

AGENTS, Salesmen, Crewmen. You'll Have the Devil's own time finding a better seller than "Zippo." Splendid profit on snappy 50c "Go-Getter" repeat article that sells on a ten-second demonstration. Works while you watch it! Demonstrates value while others waste time making claims. New development! Greatest scientific triumph of the age. It's the berries. Write immediately for complete proposition. Karam-Smith Company, 609 F St., Fort Wayne, Ind.

AGENTS—\$90 a Week—\$2 to \$5 an hour spare time. Make this with the celebrated line of Ho-Ro-Co Soaps, perfumes, toilet articles and specialties; over 200 items. Big profit makers. La-Em-Strait Hair Dressing selling like hot cakes. Write for Free Sample Case offer. Ho-Ro-Co Mfg. Co., 789 Ho-Ro-Co Bldg., St. Louis, Mo.

\$75 WEEKLY. Man or Woman Wanted with ambition and industry, to distribute Rawleigh's Household Products to steady users. Fine openings near you. We train and help you so you can make up to \$100 a week or more. No experience necessary. Pleasant, profitable, dignified work. Write to-day. W. T. Rawleigh Co., Dept. IL8253, Freeport, Ill.

FREE—Get This Quick! Chicago's Wonder Shirt Line. Sell newest, stylish, snappy, Stylemor Shirts. Amazing values at low prices. Make \$100.00 weekly easy. Complete assortment of large swatches makes selling Stylemor Shirts a cinch. Experience or capital unnecessary. Be your own boss. We will show you how to build a big business of your own. We will deliver and collect. Exclusive territory open. Write today for big free outfit. Stylemor, 81 W. Van Buren, Chicago, Ill., Dept. 1008.

66 MILES on 1 Gallon—Amazing Gas Saver. All autos, 1 free. Critchlow, G-805, Wheaton, Ill.

EASY pleasant work for Mechanics, Shop Men, Clerks, during spare hours; will add many dollars to their salaries. Also want persons who can give full time. Big wages assured. Novelty Cutlery Co., Dept. 231, Canton, Ohio.

TAKE It Easy! You don't have to work your head off this Summer if you take orders for Carlton's ready to wear dresses. \$35 to \$75 commissions easy in 5 half days! Every woman, every home means a sale. 90% repeat orders. No selling experience needed by our plan. Sample line actually Free to first applicant in each town. Write quick! Carlton, Inc., 337 S. Franklin St., Dept. 653-A, Chicago.

FREE samples Personal and Business Stationery. Agents Wanted. American Specialty Shops, Dept. A, Niagara Falls, N. Y.

PORTRAITS, photo pillow tops, frames, sheet pictures, medallions, merchants' signs, food products, photo jewelry, guaranteed hose, toilet requisites, luminous crucifixes. Catalog 50 specialties free. 30 days' credit. Jas. C. Bailey Co., Dept. C-9, Chicago.

AGENTS: \$15.00 daily easy with amazing fluid. Mends hosiery, dresses, and 1,000 other articles in few seconds. 50% to 200% profit. Free outfit. Nu-Way Laboratories, Desk 41, Mt. Healthy, Ohio.

AGENTS: 100% profit selling our low-priced beautiful and attractive Felt Rugs. Easiest and surest way of doubling your money. Perfect color combinations win instant admiration and insure quick sales. Excellent opportunity to build substantial business. Eastern Mills, Everett, Mass.

\$20 DAILY: Self threading needles; sell at sight. Sample, Self-Selling Plan stamp. Newmyr, Eters, Penna.

AGENTS wanted everywhere. Salesmen and House to House Canvassers. Men and Women to Sell the Frisco Can Opener. Every home, Restaurant, Hotel and Hardware store will buy. They sell themselves. You collect the money. Opens any can, square as easy as a round can. Send 50c today for sample and our special money-making offer. Chicago Tool & Engineering Co., 1034 W. Lake Street, Chicago, Ill.

DOUBLE your profits by manufacturing the products that you sell! Any formula you want \$5. Satisfaction guaranteed. Announcements of latest formulas for quick-selling seasonal products sent monthly without charge. Write today. National Information Bureau, 316T Shepard Building, Grand Rapids, Mich.

PATENTS. Time counts in applying for patents. Don't risk delay in protecting your ideas. Send sketch or model for instruction or write for Free book "How to Obtain a Patent" and "Record of Invention" form. No charge for information on how to proceed. Communications strictly confidential. Prompt, careful, efficient service. Clarence A. O'Brien, Registered Patent Attorney, Security Bank Building (directly across street from Patent Office), Washington, D. C. See pages 140 and 141.

\$2,000. ANNUALLY Spare Hour Daily. Vacufile, Santa Monica, Calif.

STARTLING Selling Plan! \$1.25 premium free to every customer on \$2.00 sale of 8 ounce Vanilla, 6 ounce Shampoo and 4 ounce Lemon Lotion. Details and samples free. C. I. Toestad, Dept. 18M1, 29 S. Clinton, Chicago, Ill.

AGENTS—Can assess—General Stores. Sheridan's Directory tells you where to buy 250,000 articles at lowest wholesale prices. Circular free. The Hoosier Specialty Co., Dept. 8, Rising Sun, Ind.

CAN You Organize a Sales Force? Are you a salesman? Do you want to become one? Have real opportunity for you. Your time, combined with our plan, will give you the most money you ever made. Write First-McNess Co., 506 Sunlight Bldg., Freeport, Ill.

WOMEN—\$2 an hour spare time; new idea sanitary necessity; sells on sight; every woman buys; new feature never before used; designed by physician; revolutionizes old uncomfortable methods; pay every day; no deliveries, no collections, no experience or capital required. Particulars mailed in plain envelope. Don't delay; Write Mrs. Mary P. Coleman, Meriden, Conn.

WHOLESALE Guidebook—Where to buy thousands of fast-selling specialties wholesale—why pay more? Only 10c. F. Schultz, Noel, Mo.

SOMETHING that sells to everybody. Sure repeater. Big profits. Particulars free. Box 29C, Station L, New York.

WONDERFUL, Magical, Auto Cleaner Polish. One operation anything; guaranteed; registered; 12 oz. \$1.00 delivered. Agents Wanted. Piant & Company, Weslaco, Tex.

MANUFACTURE chipped glass numbers. Particulars free. Beverage, 160-22 Locust Avenue, Jamaica, N. Y.

ARVEO Cedar Bars, the modern moth preventive. Every housewife needs them. Sample and particulars 25c. Write for exclusive territory. Arveo Company, Grosse Ile, Mich.

SELL Oriental Perfumes—Bridal Bouquet, Hindu Rose, Flor-Amour, Bokul—and make 100% profit. Romola Parfumerie, Inc., 111 Romola Bldg., 2934 Michigan Blvd., Chicago.

PEARL Necklaces, \$2.50 dozen up. Write for wholesale prices. Jerrold, 439 73d St., Brooklyn, N. Y.

AGENTS, Men and Women, to Sell Indispensable Automobile Accessory. No Competition. Every Car Owner a Prospect. No Heavy Samples. Sells on Sight. Pleasant Work. Good Profits. Only One Live Agent to Town. Write Today. Autoskills Company, 320 Broadway, New York.

AGENTS—Best seller; Jem Rubber Repair for tires and tubes; supersedes vulcanization at a saving of over 800 per cent; put it on cold, it vulcanizes itself in two minutes, and is guaranteed to last the life of the tire or tube; sells to every auto owner and accessory dealer. For particulars how to make big money and free sample, address Amazon Rubber Co., Philadelphia, Pa., Dept. 565.

CHRISTMAS Cards are big money-makers. Attractive box of 24 engraved cards with lined envelopes. Send \$1.00 for samples. Big discount. F. G. Post, 11 Murkham, Buffalo, N. Y.

\$8.50 TO \$20.00 daily pay. Introducing New Insured Hosiery for men, women, children. 57 styles, 40 colors. Must wear or replaced free. Repeat orders sure. Nyland made \$595 in one month. Edwards, \$460.60. Mrs. Bone, \$445.25. Why not you? Even spare time should pay \$3.00 per hour. Your Pay Daily in advance. You simply write orders. We deliver and collect. No experience or capital needed. We furnish samples. All grades, colors, including silks. No matter what you are doing now, write for our offer. Maceochee Textile Company, Card 2569 Cincinnati, Ohio.

TRUST Honest Agents. Particulars and Sample 15c. S. Parker, 813 Third N. W., Washington, D. C.

\$11.80 DAILY in advance (Send for sworn proof) Introducing New Insured Hosiery, 57 styles, 40 colors, guaranteed seven months. No capital or experience required. You simply take orders. We deliver and collect (or you can deliver, suit yourself). Credit given. Pay You Daily, monthly bonus besides. School line now ready. We furnish samples. Spare time satisfactory. M. H. Mathews, Card 5869, Cincinnati, Ohio.

AGENTS Magic Razor Paste Every Man a Prospect. 500 Per Cent Profit. Gives That Velvet Shave. Send for Sample and Particulars. Magic Razor Paste Co., Cedar Rapids, Iowa.

SAVE the manufacturer's profit. Manufacture your favorite products yourself. Guaranteed manufacturers formulas supplied. All lines. Latest specialties. Best sellers duplicated. Analytical work carefully performed. Romig, Box X, Station W, New York.

IF I Send You a Suit made in the latest style from the finest goods, will you keep it, wear it, and show it to your friends as a sample of my sensational \$25.00 suits guaranteed regular \$50.00 values? Could you use \$3.00 an hour for a little spare time? If so, write me at once for my wonderful new proposition. Just write your name and address on a card and mail to Dept. 375, Salesmanager, 133 So. Peoria St., Chicago.

McDONALD Polishing Cloth cleans gold, silver, nickel. Sample, terms, 15c silver. Daniel McDonald, 18 Agawam St., Lowell, Mass.

THREE pair Ladies' All Silk Hosiery \$5.00 and one pair free. 35 Hosiery and Neckwear Styles, 50 Shades, we deliver, largest commission, 10% Bonus. \$20.00 Set of Initial China to representatives. Send three references for Sample Outfit. Dept. 107, S. Q. S., Lexington, Ky.

\$200 WEEKLY. Brand new proposition Sells on sight. Particulars and Samples 10c. I. Jankow, 41 Forsythe, New York.

DISTRIBUTORS wanted for new shield for night driving. Also protection against sun glare. Used extensively by golfers, bathers, tennis, etc. Earn \$15 daily. Crescent Glare Shield Co., 6141 Jenkins Arcade, Pittsburgh, Pa.

MAKE \$100 a week and up, selling fine, made-to-measure, all-wool suits \$31.50. All one price. \$5 commission on each sale, in advance. Extra bonus for producers. 6x9 cloth samples furnished. Write today. W. Z. Gibson, Inc., 161 W. Harrison St., Dept. W517, Chicago.

AGENTS \$240 month. Bonus besides. New auto given. Introduce new guaranteed hosiery—126 styles, colors. Finest silks. Credit given. Samples furnished. Wilkmit Hosiery Co., Dept. 831, Greenfield, Ohio.

AMAZING Large Cash Commissions Introducing Beautiful \$1.95 and \$1.95 Fit-to-Measure Guaranteed Shoes. Actual Samples Furnished. Write for your territory. Style Arch Shoe Co., Dept. 129J, Cincinnati, Ohio.

YOU Are Wasting Time working for other people. Let us show you how to control your own business and make \$100 a week. Capital unnecessary; immediate profits. American Products Company, 6097 American Bldg., Cincinnati, Ohio.

SALESMEN Selling to Men. We have logical side line for you that will sell along with any other line you may now be handling and probably make more money for you than your present line, provided you are now selling to men. Get full facts at once by addressing Salesmanager, 844 West Adams St., Dept. 562, Chicago.

CAN you sell Ford size tires at \$3.50 each? Write for plan. Details free. American Accessories Co., Station 231, Cincinnati, Ohio.

BOSTON Maid Frocks for Women and Children—nationally known—famously popular. From mill to wearers \$3.50 to \$20. Great income producers for men and women agents. Write for selling outfit. Bosworth Mills, Melrose, Mass.

\$50,000. PICTURE Man Friedman made canvassing. Beginners can make \$100.00 weekly with my sales talk. Experienced men make more. Free book. "Profits in Portraits" explains. Samples Free. Picture Man Friedman, Dept. 8L, 541 W. Lake, Chicago.

\$100 WEEKLY representing large Direct to Wearer Company; Complete shirt, necktie and work clothes line. Unbeatable combination means selling everyone. Advanced commission and bonus. Sales-compelling outfit free. Howard Shirts, 1213 Van Buren, Dept. M10, Chicago.

AGENTS, side line and specialty men everywhere to handle the Nordendale Hat Holder; earn \$10-\$15 daily; something new; sells on sight; free folder tells how to start money coming fast. Nordendale Mfg. Co., 1638-B N. Paulina St., Chicago.

EARN \$45 to \$85 extra a Week. Selling beautiful Shirts. Commission in advance. We deliver and collect. Write quick. Fashion Wear Shirts, Dept. L-942, Cincinnati.

BIG season on. Rhinestone Initial Buckles sell on sight. \$15.00 daily in advance. No investment. Exclusive territory. Chaton Novelty Co., 606 Blue Island, Chicago.

MIRRORS Resilvered at Home. Costs Less 5 cents per square foot; you charge 75 cents. Immense profits; plating like new; brass, worn-off autoparts, reflectors, tableware, stoves, etc. Outfits furnished. Details Free. Sprinkle, Plater, 128, Marion, Ind.

REAL Selling Sensation! Tremendous earnings whole or part time. Patented Hot Water Kettle. Invention needed everywhere. Big commissions. Extra bonus. We deliver. Write quick, C917, Lobl Corp., Middleboro, Mass.

AGENTS: Milk Bottle Holders. Something New. Big Profits. E. A. Barr & Co., Shamokin, Pa.

AGENTS: Coin money selling new fabric table cover. Need no laundrying. Housewives wild about them. Free offer. E. Condon, 120 High, Boston, Mass.

AVERAGE \$300 monthly selling Patented Orenette, hanger and other Novelties. Reliable Mfg., 3239 N. Central Park Ave., Chicago, Ill.

THANCO Vanilla—Bottle Yourself! Concentrated; add water; free labels. Crushes competition! 500% Profit! Immense seller, homes, bakeries, stores. Write Thomas Manufacturing Company, Indianapolis, Ind.

NEW camera finishes regular black and white photographs inside camera quickly. Make money taking photos, selling cameras. Crown, 439 Canal, Dept. 202, New York.

SELL Columbia Records. Particulars. Weisburd Company, 1237 Hoe Ave., New York.

AGENTS, over 100%! Sell quality dresses \$2.00 each. Make \$13.00 dozen. Sales outfit free. Trial sample \$1.00 C.O.D. Economy Sales, 2510, Boston, Mass.

AGENTS—\$25 to \$110 weekly, selling silk by yard. Commissions daily. Big repeat business. Beautiful outfit free; representing \$500,000 stock. New field. Full or Part time. No capital or experience required. Write Burton Silk Mills, Dept. J418, 250 West Lafayette, Detroit, Mich.

REPRESENTATIVES wanted for easy selling wonderful line of Women's and Men's Fashion Shoes and Hosiery sold at wholesale price direct to the home. Big money for your spare or full time. We deliver and collect. Powerful selling outfit absolutely free. Write quick, Castle Blair, 318 S. Michigan, Dept. C-310, Chicago.

WE pay \$48 a week, furnish auto and expenses to introduce our Soap and Washing Powder. Buss-Beach Company, Dept. A42, Chilton Falls, Wis.

\$30.00 DAILY; share \$75,000.00 bonus; write orders guaranteed shirts; experience unnecessary; undersell stores. Unique sales outfit free. Tailor-Made Shirt Co., Dept. A, Pontiac Bldg., Chicago.

SELLING Like Blazes—Eleven-piece toilet goods assortment at \$2.00 with two-piece carving set Free to your customers. 100% profit. Davis Products Co., Dept. 56, 1321 Carroll, Chicago.

AGENTS—Make a dollar an hour. Sell new kind of sharpeners. Sharpens all knives and tools quickly. Demonstrating sample free. Premier Mfg. Company, Dept. 59, Detroit, Mich.

MAKE \$75 a Week and Liberal Bonus. Commissions paid in advance. Sell Pioneer tailored-to-measure, all-wool suits at \$23.50. Striking leather brief case and 100 large swatch samples furnished. We train the inexperienced. Write Pioneering Tailoring Co., 159 W. Harrison St., Dept. W1117, Chicago.

AGENTS, three lines, rubber specialties, house dresses, undergarments combined for big earnings. This proposition satisfies. B. & G. Mfg. Co., Dept. 943, Pittsburgh, Pa.

SHOVEY'S Profits \$75 Three Days after receiving sample Morey Auto Rim Tool. Big profits for live agents. M. Morey Rim Tool Co., Blissfield, Mich.

EARN \$100 weekly in advance! Sell our complete Guaranteed line direct to consumer. Big variety of shirts including silks, union-made work and flannel shirts, overalls, coveralls, work pants, play suits, leather coats and vests, flannel blouses and lumberjacks. Our booklet teaches how to make quick easy sales. Full cooperation. Complete selling outfit free. The Nimrod Shirt Co., Dept. 8, 4922-28 Lincoln Ave., Chicago.

66 MILES on 1 Gallon—Amazing Gas Saver. All autos. 1 free. Critchlow, E-805, Wheaton, Ill.

FREE Sample. "Rain Shield Winer." Retail \$1.00—Cost (25 cents). Sold Clear and Rainy Days. No Cloth—No Paste—No Attachment. (1) Rub keeps windshield clear (45) hours. Experience Unnecessary. NuLife Corporation, Hartford, Conn.

AGENTS—Want \$2,000 quickly? New sensational automobile patent; 20,000,000 prospects; wonderful proposition; no investment; free sample; write quickly. American Mfg. Co., 2206E Powell, Chicago.

HOW would you like to own Big Paying Shoe Business and make \$25.00 daily? We start you. No investment or experience necessary. We pay daily. Tailor Made Shoe System, Dept. B179, 932 Wrightwood Ave., Chicago.

200% PROFIT, fast repeaters, pure fruit Orangeade—Lemonade powder; every home, soft drink dealer buys. Free sample. Sol P. Rich Co., 622 Sangamon, Chicago.

NEW, Wonderful Invention—Nationally Advertised. No competition, large sales, quick profits. Agents credited mail orders. Dept. H, Perfect Hot Spot Co., Mitchell, S. Dak.

AGENTS, Keep all the profit. Make your own goods. Any desired formula, \$1, guaranteed. Laboratories, 233P, Champaign, Ill.

AGENTS sell office supplies. Dignified work, meet big business men. Pay daily. Catalogue free. A. Mohler, Box 453, Chicago.

AGENTS sell slickers, raincoats, suits. Whirlwind sellers. Prospects everywhere. Pay daily. Free samples, exclusive territory. Chicago Super-Built Garment Co., Box 453, Chicago.

NEWEST Invention! Abolishes kinks, snarls and automatically coils telephone, electric iron and lamp cords. Housewives, business men, companies actually buying 5 to 50. Free sample to workers. Neverknot, Dept. B-9, McClurg Bldg., Chicago.

EVERY Autoist will buy Auto Mitten Dusters. Big Profit. Sample and Particulars Free. National Fibre Broom Co., St. Louis, Mo.

SELL Surety, the Original, Genuine Powdered Hand Soap and make \$5,000 yearly. We furnish sales plans, advertising and Free Samples. Write quick. Surety Mfg. Co., 26A W. Washington St., Chicago.

SELL Attractively Displayed 5c Confectionery Specialties to Stores. Big Repeaters. Neat Profits. Dept. A, Box 971, Richmond, Va.

GOLD-LEAF Sign Letters; make and sell; 1,000% profit. Particulars, Johnston Co., Quincy, Ill.

THE best toothpaste for Pyorrhea is Zi-O-Dine. Every tube guaranteed. Taste and cleansing qualities wonderful. Fifty cent tubes. Agents wanted. Iodine Products Co., Laurel, Miss.

\$20.00 DAILY selling newest self Vulcanizer for Tubes, Casings, rubber goods. No cement, heat or gasoline used. Free sample. Seal-R-Tite Co., 1354 Wabash, Chicago.

START in a permanent business of your own selling guaranteed Hosiery and Underwear worn all over the world. No capital or experience needed; many representatives make \$3,000 to \$5,000 per year. Become our district manager—get others working for you. Write for details to Malloch Knitting Mills, 569 Grand St., Grand Rapids, Mich.

\$16 A DAY Easy—I start you in Auto Accessory business; no investment, no experience necessary. Landin, 3433 Montrose Ave., Chicago.

ADVERTISING in all magazines and newspapers at publisher's lowest rates. Book giving rates, closing dates, etc., 25c—refunded first order. Taylor's Advertising Service, 314-16 Brown Bldg., Rockford, Ill.

AGENTS—500% profit selling genuine gold window letters; Scripts. Experience unnecessary. Free Sample. Premier Letter Co., 121 N. Francisco, Chicago.

ONLY 1 Sale Daily Means \$135 per Month Profit! Full or spare time. New \$5,000 Accident and Sickness Policy, \$25 Weekly Benefit, Premium \$10 yearly. Tremendous demand—amazing profits. \$100,000 guaranteed with State. Write quick for territory and special contract. Underwriters, Dept. 702, Bonnell Bldg., Newark, N. J.

JUST Out—It's a new, patented apron without strings, straps, buttons or hooks. On or off in a jiffy. Not sold in stores. Attractive patterns. 9 out of 10 women buy. Big profits—\$1 an hour to \$12 a day. We deliver and collect. Write today sure for sample offer and details. Sta-Put Co., Dept. 229-C, 721 N. 11th, St. Louis, Mo.

AGENTS—Be my partner, make \$15 daily; ride in Chrysler closed car; show samples; distribute teas, coffee, spices, extracts, things people eat. This unusual offer to the first person answering in your locality. Write or wire Health-O Products Company, Dept. 40-J, Cincinnati, Ohio.

WANT distributing agent for Hanslick, powdered handsoap; removes anything from the hands without injury to skin; everybody a customer; great opportunity for hustler to get in business; sample free. Solar Products Co., 2144A So. Troy, Chicago.

NEW line—New full time, biggest commission. \$90 weekly full time—\$30 spare time, taking orders Furniture, Rugs, Dishes, House Furnishings direct from catalog. Easy payments. No collections. Outfit, Free. Fish Furniture, Dept. A99, 2225 Pershing, Chicago.

NEW Invention—First agent made \$185 first 3 days. We pay 500%, giving free sample, exclusive territory. Write quick. Safe-Vu Co., Dept. 1, 701 Market St., St. Louis, Mo.

WANTED: Local and State Representatives for famous ready made Artistic Signs, price tickets, etc. No competition. Full protection. Large profits. For particulars write Artistic Signs, 799R Broadway, New York.

AGENTS—Mesco Corn and Callous Remover will build you a steady repeat business. Send today for pocket-size trial outfit. The Moss Co., 298 Searle Bldg., Rochester, N. Y.

FIFTY weekly, Circulating Magazine Clubs. Spencerkiln Agencies, W. Los Angeles, Calif.

SALESMEN: Write your name and address on a postal and mail to us. We'll show you sure earnings of \$20.00 a day. Will you risk one minute and a one-cent stamp against \$20.00? Mind you, we say we'll show you. Address Dept. 980, William C. Bartlett, Inc., 850 W. Adams St., Chicago.

AGENTS—Write for lowest prices, household supplies, ammonia, cedar spray, disinfectants. Congdon Co., 665 Somerset Ave., Taunton, Mass.

FREE Sample—Just invented. Never Loose Comb, for ladies, gents. Spors Co., Lesueur Center, Minn.

FREE. Large wholesale specialty catalog, showing best sellers, from all parts of the world. Spors Co., Lesueur Center, Minn.

AGENTS—Window demonstrators. Big Money Maker. A new patent device. Station Trousers Supporter does away with hot suspenders and tight belts. Retail price \$1.00. The Sta-on Co., Dept. 11, St. Louis, Mo.

YOU know every home uses a mop. Write us about the largest floor dusting mop on the market today that you can sell for one dollar, and make 100%. O'Connell Mfg. Co., 38th and Wentworth, Chicago.

AGENTS wanted to sell Platex, the new discovery by which automobile parts may be replated as easily as polished. Liberal proposition. Ira L. Hicks, 1117 North Franklin, Chicago.

AGENTS or distributors for perfumed candy product, 5 and 10c seller; big profits; good repeater. Restricted territory. Mirador, 114 East 28th st., New York.

66 MILES on 1 Gallon—Amazing Gas Saver. All autos. 1 free. Critchlow, H-805, Wheaton, Ill.

THAXLY Formulas, Processes, Trade-Secrets produce perfect products. Latest, fast-selling specialties in all lines. Send for interesting catalog, circulars, money-back guarantee and "What Our Clients Say." B. Thaxly Co. Washington, D. C.

NECKWEAR — Wonderful proposition. Get details. Astor, 318-M Broadway, New York.

AGENTS, our newly invented Automatic Watering Valve sells on sight to poultry raisers. Sample with galvanized iron trough prepaid \$2.35. The Dry-Not Mfg. Co., 68 Wheelock Pkwy., St. Paul, Minn.

AGENTS—\$11.25 starts 15 stores working for you, bringing \$47.25 week steady; no selling; Samples displayed in stores work for you. Write "Master," 816½ Chestnut, St. Louis.

\$31.00 PROFIT—with \$1.50 Outfit—Big Money—Easy Work. Selling Gold Monograms for Automobiles, Luggage, Windows, Wagons. No Experience. No License. "Samples Free." NuLife Monograms, Hartford, Conn.

MOCCASIN Manufacturer Wants Agents Everywhere to sell a complete line of moccasins to wearers. Entire new line. No competition, repeat orders. Get details. Daley Moccasin Co., Fort Covington, N. Y.

AGENTS—Biggest money makers ever offered. Sell offices, homes Bestufone, which makes both hands free while telephoning; Midget Collapsible Garment Hangers which everybody wants; and Everin Keypurse to hold change and keys. G. Kalina Company, 1508 Avenue N, Brooklyn, N. Y.

SHOW Us the Housekeeper who likes to clean stair corners. Earn \$50 weekly selling Ideal Corner Dust Shields. Ambitious men, women write. Ideal Stairway Equipment Co., Canton, Ohio.

FORDS; no freezing, no boiling, big gas saving. Airlock absolutely does it. Sells like machine guns fire. Free trial always. Airlock Products, Burnett, California.

"LIQUID-LEATHER" Fills Holes in Shoes, Rubbers, Tires. Dries Instantly. Pliable, Waterproof. Just Imported from France. Tube Retail 75c—Cost 35c. Sells Housewives, Sub-Agents. Nullife Leather, Hartford, Conn.

AGENTS—New Plan, makes it easy to earn \$50.00 to \$100.00 weekly, selling shirts direct to wearer. No capital or experience needed. Represent a real manufacturer. Write now for Free Samples. Madison Company, 506 Broadway, New York.

AGENTS wanted to sell Men's Hats direct from Factory. Send for Catalogue. Model Hat Mfg. Co., Dept. 5, East Orange, N. J.

GOLD Initials, easily applied on Automobiles. Biggest moneymaker today. Cost 5c, you get \$1.50. No experience needed. Free samples. "Raleco." Monograms, 1043 Washington, Boston, Mass.

SELL Glo-Zo polish—big demand—large profit, been a repeater for 15 years. Munson Co., Falconer, N. Y.

PERFUMED Beads from California. Fast Sellers. No Competition. License unnecessary. Big margin. Hire subs. Clean up. Mission, 519PM, 2328w, Pico, Los Angeles, Calif.

\$60-\$200 A WEEK. Genuine Gold Letters for store windows. Easily applied. Free samples. Liberal offer to general agents. Metallic Letter Co., 438-B North Clark, Chicago.

GREATER Profits, Tremendous repeat orders with Wear-Ever Rubber Repair. Sample Free. Wear-Ever Company, 68 Houghton, Worcester, Mass.

KLEENZIT Kleening Pencil—New, different, instant appeal to housewives and tailors. Sell like hot cakes. Removes spots from clothes without leaving marks or rings. 50c seller—big profit. Agent's sample 25c. Write quick. Exclusive territory. Argyle Specialty Co., Dept. P, Argyle, Wis.

LOOK!—71% profit selling Wonder-Glo Hairdressing. Sample and particulars 10c. Abbott Specialty Co., 3 Smith St., Court, New Bedford, Mass.

YOU Can Make Good Durable Paint and Varnish 40c per gallon. Write Dept. 2 Esmellmann Bros. Mfg. Co., Indianapolis, Ind.

WE Pay \$50 a Week and Expenses and give auto to men and women introducing our goods. Marfax Co., D-20, 4520 Magnolia, Chicago.

GOLD Sign Letters, \$9.75 for Thousand. Non-Tarnishable. Free Sample. Catalogue. Ford Sign Works, 438 Broadway, Denver, Colo.

GENERAL Agents Wanted to Sell Post Cards through Our Original, Trust Scheme Method. No Talking required. Big Profits. Sample and Selling Plan 10c. Herman Studio, 706 Calhoun St. Ft. Wayne, Ind.

\$60-\$200 A WEEK. Genuine Gold Letters for store windows. Easily applied. Free samples. Liberal offer to general agents. Metallic Letter Co., 438-A North Clark, Chicago.

DISTRIBUTORS wanted for Mystifying Radio Gas Lighters and Masterlite Cigar Lighters. Everybody interested. Sell to consumers, dealers. Big profits. Steady business. Selling plans free. M. Masterlite Co., 110 East 23rd St., New York.

DISTRICT Agents—Sell \$23.50 suits and overcoats, all wool, one price. Wonderful values, liberal commissions in advance; money back guarantee; 9x13 swatch outfit free. Write R. P. Harvey, Mgr., Box 99, Chicago.

AUTO owner tire agent wanted each locality to use and take orders for hand-made Mellinger cord and balloon tires; guarantee bond 15,000 miles; shipped prepaid on approval; get your tires free; no capital or experience required; make \$100 to \$300 weekly. Write for wholesale prices and sample kit. Address Mellinger Tire Co., Dept. 400, Kansas City, Mo., or Dept. 400, Philadelphia, Pa., or Dept. 400, Oakland, Calif.

TAILORING Agents—Sell Simpson's new \$23.50 virgin wool union made to order suits and overcoats. Commission in advance. Exclusive territory. Big outfit 175 samples free. Write J. B. Simpson, 843 Adams St., Dept. 1225, Chicago.

GOLD Leaf Window Letters and Script Signs. No experience; 500% profit. Samples free. Consolidated, 69U—West Van Buren, Chicago.

AGENTS make 500% profit handling auto initials, sign letters, novelty signs, etc. Catalog free. Hinton Co., 4317 Homerlee Ave., East Chicago, Ind.

AGENTS. New Patent Just Out! Nothing like it ever sold—makes perfect Buttonhole in few seconds. Retail \$2. Sells on sight. Women can't resist. Acts make \$25 up daily. Get our free sample offer. The Marvel Corporation, Box 150D, Mesilla Park, N. M.

MAKE \$15.00 daily selling "Fixit" Rubber Repair (Liquid Rubber). Doubles mileage of tires and tubes. Sensational seller and moneymaker of 1926. Sample free. Marquette Rubber Co., DD2327 Wolfram St., Chicago.

EASY to Earn \$10 Daily selling our Seven-in-One Vest Pocket Wonder Tool for Radio, Automobile, Electrical or Home use and other live, popular priced specialties. All 100% profit items—and Ready Sellers. Write Today for particulars. G. M. Z. Co., 309 Sixth Avenue, New York.

AGENTS—Here's a New One. "Best-ever Powdered Hand Soap." Sells like wildfire. Marvelous Discovery. Removes grease, paint, ink, oil, in fact anything from the hands. Cannot harm skin. 150% Profit. Great Repeater. Agents simply coin money. "Free Samples Get the Business." Write immediately. Bestever Products Co., 1917 E. Irving Park, Chicago.

DO you want good live agents—fellows who can get the business? Ask me how others are doing it. I'll gladly render the necessary assistance without cost to you. Address, M. L. Rund, Mgr. Classified Advertising, Popular Mechanics Magazine, Chicago.

YOU can be your own boss with our Key-Check outfit. Good for \$5 a day stamping names on pocket key checks, fobs, etc. Sample check with your name and address, 20 cents. Pease Die Works, Dept. M, Winchester, N. H.

DISTRIBUTORS To Sell Retail Stores and Hire Agents. Exclusive territory. Article retails for one dollar. Attractive display carton holds twelve. Strong appeal to motorists. Protecto Shield, Ind., 156 Edinboro St., Boston, Mass.

\$1 PER hour selling Dirt-Solve Washing Powder. Big repeater; exclusive territory. Premiums for customers. Sample free. Goodspeed Products Co., Rutland, Vt.

OUR Luminous Crucifix Shines in the Dark. Every one amazed at the wonderful effect. Easily demonstrated. Easily sold. W. G. Hannan Co., Dept. B, 2529 So. State St., Chicago.

FORMULAS—All Kinds, Catalog Free. Clover Laboratories, Park Ridge, Ill.

AGENTS Get our proposition selling United No-Cement Tube Patch. United Patch Company, Covington, Ky.

MANUFACTURER lamb wool polishers, dusters. Newhall, 358 Broad St., Lynn, Mass.

MILLIONS stolen. Remarkable new \$5.00 Check Protector stops forgery. Inks, protects two colors. Sensational sales, profits. Write, Safety Devices Corp., Grand Rapids, Mich.

WASH Clothes the new way. Use the **Torrent Automatic Washer**. You will be delighted. Special offer to one in each locality. **Storm Royalty Co.**, 3601 Enright Ave., St. Louis, Mo.

EVERY Autoist will buy **Auto Mitten Dusters**. Send for Particulars and Free Sample. **National Fibre Broom Co.**, St. Louis.

CALIFORNIA Rosebuds selling like hot cakes. Agents coinng money; new stuff. Big profits. Catalog free. **Mission Factory PM**, 2328 West Pico, Los Angeles, Calif.

REMNANT Store, Bethel, Ohio. Greatest Dry Goods Bargains on Earth. Agents and Dealers.

A BUSINESS of Your Own—Making Sparkling Glass Name and Number Plates, Checkerboards, Signs. Big Book and Sample Free. **E. Palmer**, 512 Wooster, Ohio.

AGENTS wanted—To sell **Ray-O-Lite** cigar and gas lighters. Big earnings. Sample 50c. **Rapid Mfg. Co.**, 799-E Broadway, New York.

AUTOMOBILE Specialties. Guaranteed formulas for all latest money makers. Lowest prices. Write for free lists. **Murphy, Chemist**, Tujunga, Calif.

MAIL-ORDER Houses and Distributors; We pack French made beauty creams, face powders, perfumes, toilet preparations with your label. **Chemist**, A2700 Wabash Ave., Chicago.

BIG Money Selling New Household Cleaning Set. Washes and dries windows. Sweeps, scrubs, mops. All complete only \$2.95. Over half profit. Write **Harper Brush Works**, 132 3rd St., Fairfield, Iowa.

AGENTS—Wonderful seller, new discovery. Auto Rubber Repair for tires and tubes. Superior to vulcanizing. Put on cold at very little cost. Outlasts tire or tube. Sells to every auto owner and accessory dealer. Agents if you want big profits, made quick, write for particulars and free sample to **Waltham Rubber Co.**, 13 South St., Waltham, Mass.

MAN in each town to plate auto parts, reflectors, bathroom fixtures, refinish beds, mirrors, chandeliers; by new method. No capital or experience required. Simple plan of manufacturing at home starts you in big money-making business. Outfit furnished. Free particulars and proofs. **Gun Metal Co.**, Ave. H, Decatur, Ill.

WE Start You Without a Dollar. Soaps, Extracts, Perfumes, Toilet Goods. Experience unnecessary. **Carnation Co.**, Dent, 2480, St. Louis.

GIVE Away finest laundry soap Free. You'll make \$10 daily easy by new selling plan. Big repeat business. Write quick. **Wolverine Soap Co.**, 28 Wolverine Bldg., Grand Rapids, Mich.

AT Last! Diamond Rival Discovered! Amazing blue white Rajah Gem astounds jewelry world and deceives experts! Beautiful Sample case Free! \$100 weekly! Write Quick! **Rajah Diamond Co.**, Dept. F-7, Salisbury, N. C.

SELL by mail! Big Profits! Books, Formulas, Novelties, Bargains. Particulars Free! **Elfco**, 523 South Dearborn Street, Chicago.

AGENTS—Clever Invention! **Inkspoon** makes every pen a fountain pen. Fast office seller; big profit, demand increasing everywhere. Exclusive territory offered. Sample free. **H. Marul Company**, Tribune Bldg., New York, N. Y.

AGENTS make \$100 week placing advertising Cigar Lighters with glass front. Every dealer wants one. Write for free plan. **Drake Mfg. Co.**, Dept. M, Milwaukee, Wis.

AGENTS—Make a dollar an hour. Sell **Mendets**, a patent patch for instantly mending leaks in all utensils. Sample package free. **Collette Mfg. Co.**, Dept. 404, Amsterdam, N. Y.

\$5,000 YEARLY easy, selling our money-making specialties; we undersell them all. Catalog free. Samples 25c. **Mills Sales Co.**, 13 East 16th Street, New York.

BIG Money and Fast Sales. Every owner buys **Gold Initials** for his auto. You charge \$1.50; make \$1.35. Ten orders a day easy. Write for particulars and free samples. **American Monogram Co.**, Dept. 40, East Orange, N. J.

EASY, pleasant work for Mechanics. Shop Men, Clerks, during spare hours; will add many dollars to their salaries. Also want persons who can give full time. Big wages assured. **Novelty Cutlery Co.**, 67 Bar St., Canton, Ohio.

FIBRE Brooms—detachable handles, fine finish. Good profits, repeat sales. The **Fibre Broom People**, 147 New Jersey Ave., Brooklyn, N. Y.

AGENTS—N-R-G Laundry Tablets, the old reliable moneymaker for live agents. Millions sold—200% profit—sales waiting for you. Clothes washed spotlessly clean in 10 minutes without rubbing. Free samples. **N-R-G Company**, 230 W. Superior, Chicago.

AGENTS: 500% profit. "Happy Home Make Shampoo" builds your own big business. **Martin of Indiana** made \$75.00 in one day. **Missouri man** made \$750.00 one month. Exclusive territory. **Gen. A. Schmidt & Co.**, Dept P, 236 W. North Ave., Chicago.

AGENTS \$1. Retail \$3. Your Profit \$2. Wonderful pocket Adding Machine with **Magic Writing Pad**. Particulars Free. **Typewriter Supply**, 905 Hersh Bldg., Pittsburgh, Pa.

WILLIAMS' No-Water Hand Soap, in tubes, has taken Auto owners by storm; washes dirtiest hands perfectly clean without water; easy demonstration makes quick sale. 150% profit. **Williams Co.**, Dent, 265 Montclair, N. J.

GET Our Free Sample Case—Toilet articles, perfumes and specialties. Wonderfully profitable. **La Derma Co.**, Dept. A, St. Louis, Mo.

AGENTS make \$3.00 an hour taking orders for our 40 Fascinating Kitchen Specialties. No competition. Write quick. **General Products Co.**, Dept. 7K, Newark, N. J.

POLMET—The Wonderful Polishing Cloth that cleans all metals without liquid, paste or powder. Approved by "Good Housekeeping" and "Modern Priscilla"—sells fast at 25c. Sample free. **Gale & Co., Inc.**, 15 Edinboro St., Boston.

BIG Money—fast sales; everyone buys gold initials for their autos; sell \$1.50, profit \$1.44. Ten orders daily easy. Samples, information free. **World Monogram**, Dept. 16, Newark, N. J.

EARN \$10 daily silvering mirrors, plating and refinishing metalware, autos, chandeliers, bedsteads, headlights. Outfits furnished. **E. Deale Laboratories**, 1133 Broadway, New York.

AGENTS: Big Money Monogramming by Transfer Method. Catalog Showing Over 50 Styles and Particulars Free. **Motorists' Accessories Co.**, Mansfield, Ohio.

AGENTS: Our gold-eyed Needle Cases are wonderful sellers; immense profits; \$50 to \$300 weekly; proof and particulars free; sample outfit 15c; factory prices. **Paty Needle Co.**, 231 Davis Square, Somerville, Mass.

AGENTS—Sell 5c fast selling candy specialties to stores. Big profits. **Lorrac Products Co.**, Albany, N. Y.

INSTANT Weld. Repairs largest punctures without cement or heat. **Lenn's** profit one day, \$56. Write quick. Free sample; territory going fast. **Tourists' Pride Mfg. Co.**, Desk T, Minneapolis, Minn.

OVER 100% Profit. Self Lighting Gas and Cigar Lighters; Everybody interested, repeat business. Sell individuals, dealers, subagents. Particulars Free. **P. Bernhardt**, 127 West 30th St., New York.

SOMETHING New—"Handy Packet." An attractively put up package of useful household necessities. Positively a sale in every home; fine side line; big profits. Send for sample. **Prentice-Lee**, 145 East 23rd St., New York.

HIGH-GRADE SALESMEN WANTED

\$500,000 CORPORATION is marketing house to house a much needed, thoroughly successful kitchen accessory and needs local distributors—men of ability and experience who can organize and supervise a field force. Very little capital required, with great opportunity to make big money. Sell yourself by letter. **Dept. 1, Indianapolis Pump and Tube Company**, Indianapolis, Ind.

EXPERIENCED Tailoring Salesmen Sell the most complete line of Boys' and Youths' Clothing direct to the consumer. Suits, overcoats, mackinaws, novelty suits, separate knickers, longie pants. Guaranteed values, ages 3 to 22; biggest commissions; free business stimulators. Fall line ready. Sample Outfit Free to real workers. Write now. **Craige-Wilson**, Ten Waverly Place, New York City, Dept. 5.

TAILORING Salesmen: Join million-dollar tailoring firm organized in 1916. Carry biggest value line in America. You can develop into big-pay district manager within short time. Good men are promoted quickly—they don't remain salesmen all their lives. We have an absolutely unique plan for you. Write to-day. **National Woolen Mills**, Desk 58, Parkersburg, W. Va.

BIG Money for Men. Let **Fairbanks**—with 40 years' success—put you into business introducing—taking orders—full or spare time—for America's greatest made to measure suit and overcoat values—all wool and all one price—\$23.75. Just show the big 9x13" samples—139 new stylish fabrics—in 30 fashion styles. Get orders on the spot. Pays you \$4 profit on every sale—cash in advance. We ship and collect—guarantee perfect fit, style, workmanship, and satisfaction. No investment—no deposit—no capital needed. Big complete outfit given free. Sales course, just what to do and say, accompanies outfit—all free. Write quick for exclusive territory and all particulars. Tell us if you have had previous selling experience. **Fairbanks Tailoring Company**, Dept. 770, Oakley Blvd., at Wabasha Ave., Chicago, Ill.

SALESMEN—Newest, fastest selling auto necessity; sells on sight; 100% profit; no competition; write quick. **The Todd Oil & Paint Co.**, Cleveland, Ohio.

SIDELINE worth \$5,000 yearly. Wonderful inexpensive flashing light attachment. Sells to merchants, garages, filling stations, etc. Stimulates trade, excites and attracts attention. Free sample. **Phelps Co.**, 29 S. Clinton, Chicago.

SALESMEN or Distributors. Sell Auto Accessories under a new plan direct from Factory proposition; own your own business. Good repeater all year round. Territory going fast. Write for particulars. **Jiffy Manufacturing Company, Inc.**, Huron, S. Dak.

MADE-TO-ORDER Christmas Cards. Our cards are offered at half the usual price for less attractive cards. Business concerns and individuals everywhere save money year after year buying **Fletcher cards**. Customers name and monogram or society emblem printed with messages selected. A few more live wire salesmen wanted in unallotted territory. Season now on. Write for samples. **The Fletcher Company, Inc.**, Box O, Orleans, Vt.

SALESMEN—Experienced hustlers to sell men's overcoats, satin trim, 30 oz. all wool, price \$21.50, commission \$5. Quality, price and commission best ever. Apply give experience and reference. **Craiburn Inc.**, 37 S. Wabash Ave., Chicago.

SHOP Representative. Sell **Reed Micrometers** to shop friends. Liberal commission. **Reed Small Tool Works**, 35 Hermon St., Worcester, Mass.

CALENDAR salesmen: Our line is the only one that covers entire field. Calendars—Fans—Signs—Pencils—Blotters—Aluminum—Wood—Celluloid. Remembrance advertising for every merchant. Full or part time. **Dept. 226, Model Calendar Co.**, South Bend, Ind.

SALESMEN: Want \$6,000 this year? Write us today. Strong retail line, nationally advertised. Company established 26 years. Liberal advances to producer. **Continental Co.**, 1300 Liberty Bldg., Cleveland, Ohio.

PROOF—thru-test order! Fifteen fifty 1/2 dram purse phials presenting fifteen quality perfumes sent postpaid, \$1.65; retail for \$4.62. Liberal free goods for discounts, transportation, bonus awards; selling quality guaranteed perfumes and toilet preparations for **LeMaire Perfume Co.**, 3330 Carroll Ave., Chicago, Dept. 68.

SALESMEN. Profitable sideline selling useful advertising specialty. **Jotsworth**, 544 W. Lake St., Chicago, Ill.

SALESMEN—Get this big sensational order-getting shirt outfit Free. Sell **Style-nor Shirts** all year round. It's Chicago's Wonder shirt line. Advanced Spring Showing of Smartest, snappy patterns. Large double swatches, low prices, quick service, makes shirt selling easy. **Bellard of Texas** made \$46.00 in two days. We deliver and collect. Write today for big free outfit. **Style-nor**, 81 W. Van Buren, Chicago, Ill. Dept. 1168.

SALESPERSON: Make bigger, easier, quicker profits selling the amazing 26 ounce All-Purpose Waterproof Featherweight Coat. Men's coat \$6.50, ladies' \$5.95. Remarkable value, up-to-the-minute style. Write now for full details of selling plan. **Featherweight Coat Co.**, 5719 Euclid Avenue, Cleveland, Ohio.

WE have a line of goods for which every man in America is a prospect. It has everything any competing line has and something besides. It can be handled profitably by tailoring, shirt, hosiery, necktie, shoe, raincoat, and other salesmen now selling to men. For full facts, address **Madison Bros.**, 125 So. Peoria, Dept. 41, Chicago.

FREE deluxe selling outfit—big commissions—valuable prizes—"immediate" bonus—six prices that meet every purse—guarantee label sewed into every coat. Make good money selling this tailored-to-measure line at \$10 to \$15 below local tailor prices. High quality, all wool, perfect fitting garments—\$18.50 to \$45.50. 200 distinctive cloth samples. Positive 8-day tailoring service. Protected territory. Free advertising. Side line of fine neckties and raincoats at surprisingly low prices. Experience unnecessary—we teach you "how." Write all about yourself giving two business references. Wholesale Direct Tailors, 1297 Ellicott St., Buffalo, N. Y.

SALESMEN: Galacite, the most successful patented puncture-proofing compound for auto tires, is making \$5,000 to \$10,000 a year for our hundreds of authorized representatives. Sells to car owners and dealers in big quantities. Seals any puncture instantly and makes tire puncture-proof for life. Positively guaranteed. Backed by a large, well financed corporation of long standing. Complete elaborate outfit and extensive advertising co-operation ready to back you in your community. The best money-making proposition ever offered you. Write at once to C. F. Johnson & Co., 19 West Jackson Blvd., Dept. 340, Chicago.

DISTRICT Salesman: Must be reliable. Prefer married man, 30 years old or over, and permanent resident in his community. Exceptional opportunity for good man. Address Dept. 563, Goodwear Chicago, Inc., 844 W. Adams St., Chicago.

\$40.00 SUITS for \$23.50! All one price. Union made of finest quality Virgin Wool. You don't have to know anything about selling clothing. We'll train and equip you to make success. If you are honest and willing to work. Write at once. Dept. 979, William C. Bartlett, Inc., 850 West Adams, Chicago.

SALESMEN—New line, new field, \$6.50 profit every sale; sell Radium Health products. A Scientific, drugless treatment needed in every home. The \$2,500,000,000 spent yearly for health assures you a permanent and profitable business with no dull seasons; pleasant fascinating work. Exclusive territory. Write Radium Applicator Co., 359-P Riley, Buffalo, N. Y.

MILLION Dollar Paint Factory has permanent good job for \$60 to \$150 a week selling roofing and paints direct to user. On Credit. Outfit free, training free, and real cooperation. Progress Paint Co., Dept. C-107, Cleveland, Ohio.

GREAT neckwear line now free! Features finest quality neckwear at factory prices. Collect big commissions daily. Write for Free tie offer and Free outfit. Nawco Neckwear, Desk 9-B, Corington, Ky.

A PAYING Position Open to representative of character. Take orders shoes-hosiery direct to wearer. Good income. Permanent. Write now. Tanners Shoe Mfg. Co., 7-410 C St., Boston, Mass.

"LUMINITE"—Magic Color-Action Window Salesman. Proof our Improved Quick Change Letter System boosts users' sales 200%. Only dead dealers indifferent. If you can spot a winner, start making 20-minute demonstrations and pocket \$100 weekly. Protected territory. Display Products Co., A-210, West Eighth, Kansas City, Mo.

SALESMEN—Earn \$20 daily, established income for life, selling for \$1 a year, \$1,000 accident policy. Write W. C. Stone, 11 So. LaSalle, Chicago.

\$7.00 AN hour actually earned in spare time selling for the largest direct-to-wearer shoe firm in the world. \$5.00 values at \$2.95. Write quick for free particulars. The Double-Wear Shoe Co., Minneapolis, Minn.

TAILORING Salesman, \$100-\$150 Week selling union hand tailored made-to-measure suits. \$23.50-\$29.50. Liberal commissions advanced. Wood & Co., 651 S. Wells, Chicago.

YOU Can Make \$50.00 to \$200.00 a week traveling and appointing agents for us. Write immediately for particulars. J. M. Pitkin & Co., 100 Pitkin Bldg., Newark, New York.

\$100-\$200 WEEKLY. Retailers' live-wire specialty. \$40 weekly guaranteed against com. Reliable house. Guarantee dealers turnover or money back. Pay you to investigate. Appleton Specialty Co., Cedar Rapids, Iowa.

DISTRIBUTOR wanted Radium active water Generators; handsome returns quickly and easily obtained for small financial requirements necessary secure exclusive selling rights. Radium Laboratories, Key Route Inn, Oakland, Calif.

GENUINE Gold Leaf Letters anyone can put on Store windows. Guaranteed to never tarnish. Large Profits. Enormous Demand. Free Samples. Write today. Metalite Letter Co., 438-D North Clark, Chicago.

ANY Salesmen Can Sell Them! Merchants everywhere use punchboards. Someone sells them, why not you? Collect big commissions daily. Newest, largest, elaborate catalog sent upon request. Lincoln Sales Co., 9 So. Clinton, Chicago, Dept. D.

GOLD Leaf Window Letters and Script Signs. No experience; 500% profit. Samples free. Consolidated, 69V—West Van Buren, Chicago.

SELL Men's Shoes direct. \$50 to \$100 weekly. Every man a prospect. Easy sales. Low priced. Real comfort, long wear. You take orders, keep big deposit. We deliver and collect. Full or part time. We help you succeed. Easywear Shoe Company, Dept. 229, Indianapolis.

BECOME Your Home Town's Leading Business Man. Big money. Easy work. Selling groceries, coffee, canned goods, auto oils, men's shirts, ladies' hosiery direct to consumer. Undersell competition. Commission advanced. Liberal credit plan. No experience or capital necessary. Lovell & Brown Co., 1775 So. State, Chicago.

MINUTES Pay Dollars demonstrating wonderful three pound Calculator. Retail \$15.00. Work equals \$300 machines. Adds, subtracts, multiplies, divides automatically. Five year guarantee. Big demand; large profits, experience unnecessary. Write quick for liberal trial offer and protected territory. Lightning Calculator Co., Dept. F, Grand Rapids, Mich.

SALESMEN—Become Independent. Own Your business, experience unnecessary selling our \$7,500.00 Accidental Death; \$50 Accident; \$25 Sick Weekly Benefits—\$12.50 Yearly. Other Amounts proportionate. Guaranteed steady income from renewals. \$250,000 Deposited Insurance Department. Universal Policy, Dept. A, 30 Clinton St., Newark, N. J.

FOUR \$7.50 sales to merchants net you \$20.00 daily. Savers Systems, 2803 Sheffield Ave., Chicago, Ill.

CALIFORNIA Rosebuds selling like hot cakes. Agents coinng money. Absolutely new. Big profits. Catalog free. Mission Factory SP, 2328 West Pico, Los Angeles, Calif.

WANTED—Tailoring Salesmen, make \$60 to \$125 per week. Biggest merchants in many towns have started with our line. We are the largest made-to-measure tailoring house in the country, furnishing elaborate sample equipments, including 500 all-wool fabrics. You make your own profits from \$8.00 to \$15.00 on each order. Guaranteed absolute satisfaction, perfect fit, best workmanship, or no sale. Write for our line and all accessories to be sent free. Tell us all about yourself. Address N. O. Perry, Sales Manager, Box 483, Chicago, Ill.

SALESMEN—Selling Supreme Shirts means big business, big repeats, big commissions. Write today for Free Kit. Supreme Shirt Co., 276-m Fifth Ave., New York.

SELLS for \$9.75. Prints ad on wrapping paper, envelopes, etc. \$4.00 commission. Send 10¢ for sample work. Automatic Ad-Stamp, Joplin, Mo.

TAKE orders for coffee, sugar, flour, meats, canned goods, staple groceries also paints, radio sets, tires, auto and tractor oils. No capital or bond required. We deliver and collect. Permanent business. Big pay. Write at once. Hitchcock-Hill Co., Dept. 50, Chicago.

SELL Printing. Low prices. High quality. \$1.00 per thousand commission. Send 10¢ for outfit. Ozark Press, Joplin, Mo.

HELP WANTED

MR. BRUSH Salesmen—Old Established New York Brush Manufacturers require the services of men in all territories to sell their extensive line of Sanitary Twisted in Wire Brushes. We pay larger commission than any other Brush House in the country. Write immediately for our proposition. Wire Grip Sanitary Brush Corporation, 15 Mercer Street, New York.

WHY not sell your spare time? \$2.00 an hour, \$19.70 daily easy full time. Introducing latest guaranteed hose for men—women—children. 57 styles, 39 colors. Capital, experience unnecessary. We deliver and collect. Pay daily. We furnish samples. Maceochee Company, Card 2609, Cincinnati, Ohio.

WORK for Uncle Sam. Get Government Jobs. Men—women, 18 up. Commence \$95 to \$158 month. Steady work. Short hours. Paid vacation. Pull unnecessary. Common education sufficient. Candidates coached without leaving home. Full particulars and 32-page book—Free. Write immediately. Today sure. Franklin Institute, Dept. A3, Rochester, N. Y.

MIDDLE-AGED Man: It will not injure your health. Pocket Book or Reputation. Stamp for Particulars. N. E. Badgley, 1063 W. Madison, Chicago, Ill.

WANTED—Boys, Men 16 up. Learn Expert Auto Repairing. Earn \$25.00—\$75.00 week. Learn at home while earning. Experience unnecessary. Sample Lessons Free. Write immediately. Franklin Institute, Dept. A400, Rochester, N. Y.

MEN wanting to prepare for forest ranger or railway mail clerk examinations Write Mokane, A-23, Denver, Colo.

MEN, 18 up, wanting to qualify for U. S. Mail Service positions, \$142 to \$225 monthly. Write immediately for free particulars. P. Bradford, 112 Bergen Ave., Jersey City, N. J.

RAILWAY Mail Clerks, \$158—\$225 month. Sample coaching and particulars Free. Write today. Franklin Institute, Dept. A16, Rochester, N. Y.

WE Start You in Business, furnishing everything. Men and women, opportunity to earn \$35 to \$100 weekly operating Ragsdale's original "New System Specialty Candy Factories" anywhere; wholesale or retail. Big commercial candy book free. W. Hillier Ragsdale, Drawer 359, East Orange, N. J.

WORK for "Uncle Sam." Postoffice Clerks—Carriers—Railway Postal Clerks, \$1,700—\$2,700 year. Men 18 up. Sample coaching Free. Write immediately. Franklin Institute, Dept. A16, Rochester, N. Y.

DON'T prepare for any Civil Service Examination without seeing our catalogue. Free. Columbian Correspondence College, Washington, D. C.

EARN \$10 daily silvering mirrors, plating and refinishing metalware, auto, chandeliers, bedsteads, headlights. Outfits furnished. E. Decie Laboratories, 1133 Broadway, New York.

SILVERING Mirrors, French plate, easily learned; immense profits. Plans free. Address, Wear Mirror Works, Dept. 34, Excelsior Springs, Mo.

INVENTORS desiring to secure patents should write for our book "How to Get Your Patent," tells our terms and methods. Send sketch for our examination and instructions without charge. Randolph & Co., Dept. 418, Washington, D. C.

U. S. GOVERNMENT wants men, \$1,700—\$1,900 and up at start. Railway Mail clerk examination coming. Let our expert (former Government examiner) prepare you for this and also Rural Carrier, Post Office, Customs, Internal Revenue, and other branches. Write today for free booklet, Dept. 8, Patterson Civil Service School, Rochester, N. Y.

RAILWAY Mail Clerks, \$1,900 year. Men 18-35. Sample coaching, Free. Franklin Institute, Dept. A16, Rochester, N. Y.

BUSINESS SERVICE

BUSINESS Problems Solved—all kinds— where to buy, how to sell, increasing business, advertising, getting agents, special formulas for all kinds of products, etc. Complete solution of problem \$5, particulars free. Satisfaction guaranteed. All confidential. Write today. National Information Bureau, 316F Shepard Building, Grand Rapids, Mich.

LET us solve your business problems. Original, distinctive ideas will increase your sales. Submit proposition for confidential analysis. Arvor Business Service, 245 West 112th Place, Chicago.

MAKE 'Em Pay—My system will make them pay their bills. Write for the acid test. Literature free. Burleigh L. Horr, Horr Onella Block, Rhinelander, Wis.

REPRESENTATION in Washington, D. C. Mail address, information, Anything, Anytime. Service, 223 Victor Bldg.

MAIL Address and Branch Office Service. Bonded Service Breau, 1115 Denrike Building, Washington.

DELAWARE Incorporator. Charters: Fees Small; forms. Chas. G. Guyer, 901 Orange St., Wilmington, Del.

INFORMATION

FOREIGN Service—With mining, oil, electric, railway, fruit, sugar and other companies in Latin America. Send ten cents for further particulars. Foreign Service, Box 69, Station D, New York City.

LETTER SPECIALISTS

GUARANTEED Letters \$4. Bonded Service Bureau, 1115 Denrike Building, Washington.

TYPEWRITERS AND SUPPLIES

TYPEWRITERS, all standard makes, thoroughly re-manufactured by the famous "Young Process" and shipped direct from factory to you on 10 days' trial. Guaranteed 5 years. Easy monthly payments. Write today for free catalog. Young Typewriter Company, Dept. 5759, 654 W. Randolph St., Chicago.

TYPEWRITERS, all standard makes. \$10 up. Fully guaranteed. Free trial. Write for complete illustrated lists. Northwestern Typewriter Exchange, 121 N. Francisco Ave., Chicago.

100 TYPEWRITERS Free. Overstocked. Rent rebuilt Underwood or Remington \$3.00 month. If you pay its value in rental, we give machine free. Particulars free. Pittsburgh Typewriter Exchange, 945 Hersech Bldg., Pittsburgh, Pa.

TYPING SERVICE

TYPEWRITING, considerate revision, make your poems publishable. Blakewhitting. Branford, Conn.

PRINTING, ENGRAVING AND MULTIGRAPHING

CONTRACTORS and Allied Trades Get our samples and prices on Estimate and Contract forms. Also other printing. State line of business. Reliable Press, 151 Willis Ave., Mineola, Long Island, N. Y.

PRINTING—250 Bond Letterheads and Envelopes \$2.50. Classic Service, Warren, Pa.

250 EACH "Neargravure" Process letterheads, envelopes, cards \$4.44 postpaid. Soliday's, Knox, Ind.

GUMED Labels, 500 name and address, 2 lines 35c. 3 lines 55c. Catalogue. Eastern Label Co., B. Clintonville, Conn.

200 BUSINESS cards, \$1.00; 1,000, \$2.75. Delivered. 250 Bond Letterheads or Envelopes, \$1.50. Samples. Acorn Press, Box 273, Newport, Ky.

DISTINCTIVE Printing! Samples free! Write—Franklinpress, B-32, Milford, N. H.

DISTINCTIVE—Artistic Business Stationery that Creates Confidence. 1,000 Letterheads or Envelopes \$3.00. Samples. Moulton Printing Company, 1410 E. 8th, Kansas City, Mo.

PICTURES Make Printing Powerful. Cut catalog 10c. Superior, 2602 Brooklyn, Detroit.

DRAWINGS and Cuts made to order. Samples. Cressman, Washington, N. J.

\$3.00 DELIVERED. 500 Watermarked Bond Letterheads, 8 1/2 x 11, and 250 envelopes, money with order. Job Printing Specialty, National Printing Company, Goshen, Ind.

CALLING and Business Cards at Special prices—Samples and prices for stamp. B. C. S. S., P-13, Jackson, Mich.

HAMMERMILL Bond letterheads or envelopes 200—\$1.00, 1,000—\$3.50. Free samples. Zippo, 3597 East 118, Cleveland, Ohio.

PRINTED Tags; 5,000—\$7.75; 10,000—\$13.00; 25,000—\$26.25. Standard Tags, 76 Beekman, N. Y.

QUALITY Printing—5,000 Letterheads \$12. Banner Printing Company, Statesboro, Ga.

225 BOND letterheads, envelopes, billheads, cards, \$1.25 each. Combination, \$4.00. Economic Press, Leonia, N. J.

250 EACH Hammermill Bond Letterheads. Envelopes, \$3.00. Samples. Midland Press, 543 West Hickory, Kankakee, Ill.

COMMERCIAL Printing. Prices Right. Samples Free. The Fox Press, Frankfort, N. Y.

QUALITY Printing! Reasonable Prices! Send for Free Standardized samples and prices. Folders, Circulars. Catalogs our specialty. Ernest Fantus, 525 South Dearborn, Chicago.

250 LETTERHEADS. 250 white envelopes printed and mailed \$3.00. Samples printing free. Sunco, Mohawk, N. Y.

250 Hammermill Bond Letter Heads or envelopes, \$1.50; 500, \$2.25. Pfleger Bros., Hackensack, N. J.

MULTIGRAPH typewriting business correspondence, two dollars thousand. Hammermill Bond Letterheads, four dollars. Mayera Corporation, Monmouth, Ill.

PRINTING. Catalogues, Periodicals, Stationery, Etc. Prices Right. Quotations. Anville Printing Company, Anville, Pa.

GUARANTEED Printing should have your preference. Fifty expert printers. Secure our prices. We print anything but money and postage stamps. Waverly Publishing Co., Box 0, Waverly, Iowa.

1,000 BOND Letterheads; \$2.95 Delivered. Atoka Press, Atoka, Okla.

WE print Stationery, Booklets, Catalogs, Circulars, Samples. Commercial Press, Batavia, Ohio.

PRINTING OUTFITS AND SUPPLIES

PRINT your own cards, stationery, circulars, paper, etc. Complete outfits \$8.85; Job Presses \$11, \$29; Rotary \$149. Print for others, big profit. All easy, rules sent. Write for catalog presses, type, paper, etc. Kelsey Company, F-11, Meriden, Conn.

PRESSES, Type 40 font, everything needed. Armstrong West, Statesboro, Ga.

PRE-USED Printing Presses, Type supplies. List for 2c stamp. Popular Bargains, Richland, Pa.

PRINTING Outfits—Presses, type supplies, type novelties. Send stamp for catalogue. Model Press, York, Penna.

DUPLICATORS AND DEVICES

YOU can make 50 to 100 copies of a letter, notice, etc., at a cost of three cents on a Heyer Quality Duplicator. Write for free trial offer. The Heyer Duplicator Co., 14 S. Wells St., Chicago, Ill.

ADDING MACHINES

FREE Trial. Marvelous new Adding Machine. Adds, Subtracts, Multiplies, Divides, automatically. Work equals \$350.00 machine. Price only \$15.00. Speedy, durable, handsome. Five-year guarantee. Used by largest corporations. Write today for catalogue and free trial offer. Lightning Calculator Co., Dent, E. Grand Rapids, Mich.

NEW \$3.50 Automatic Adding Machine. Adds, Subtracts, Multiplies. Absolutely accurate. Capacity \$999,999.99. Fully guaranteed. 75,000 pleased users. Makes adding easy, positive, quick. Eliminates Mistakes. Saves Time. Postpaid \$3.50. Bassett Co., 1458 A Hollywood Ave., Chicago.

MAILING LISTS

LIST of 350 Name buyers. We have sold over 900,000 Names. \$3.00. Slighs Service, 414 Masonic Temple, Jacksonville, Fla.

LISTS 27 States Farmers, Fruit, Vegetable, Produce Growers. Sample thousand names \$3.00. Slighs Service, 414 Masonic Temple, Jacksonville, Fla.

1,000 NAMES, \$1.00. Mention Classification. Wincholt Sales Co., 4, Woodbine, Pa.

SEVERAL Thousand Recent "Agents Wanted" Replies. Vaculite, Santa Monica, Calif.

350 FRESH country names \$1.00. Seminole, 427 East 16th, New York.

ANY part 10,000 latest Buyers, \$2.50 per thousand Circulars Mailed with ours, Franklin Products Company, Cincinnati, Ohio.

A RESULT Producing Mailing List. Lady buyers of beauty clays and toilet preparations, absolutely guaranteed all fresh names \$4.00 per thousand. W. A. Heise, 1315 Steiner St., San Francisco, Calif.

NAMES—100 \$1.00. Ben Meyer, 35 West 31st, New York.

FOR SMOKERS

NATURAL Leaf Smoking Tobacco. Aged in bulk, two years old, mellow and sweet; 5 lbs. \$1.00; 10, \$1.75. Satisfaction guaranteed. Farmers' Union, Mayfield, Ky.

SEND 10c, Silver or Stamps, for sample package 20 fine cigarettes. Large pocket tin Special Blend smoking tobacco also sent for 10c. Direct-to-smoker. French Tobacco Company, Dent, 14, Statesville, N. C.

MELLOW barn-cured tobacco. Finest Cigar wrapper leaf. Trial pound \$1.00; 5 lb. \$4.00. Short wrapper, 5 lb., \$2.00. Good leaf, 5 lb. \$1.00. Postpaid. Guaranteed. Pardew-Darden Co., Box 340, Springfield, Tenn.

BOATS AND LAUNCHES

HUBBELL Marine Coolers convert Ford engines into marine motors. Booklet free. Ford speedboat, easily built, blueprint and directions, sixty cents. C. C. Hubbell, 14B Cottage St., East Norwalk, Conn.

WANT old reverse gears, pumps, universals, any condition. Wm. H. Baker, 59 Pond St., Quincy, Mass.

MAKING Boat Models? Use Stanzall Waterproof Glue for permanence. Send 30c for 1/4 lb. trial size. L. W. Ferdinand & Co., 152 Kneeland St., Boston, Mass.

BUILD Your Own Boat during your leisure time this winter; plan now. 55 models, new designs. Send 25c for complete catalog. Brooks Boat Co., Inc., Rust Ave., Saginaw, West Side, Mich.

BOAT Building Plans for amateurs. Rowing, sailing, speed, cruising. Free catalog. The Rudder, 9 Murray Street, New York.

RAZORS AND BLADES

RENEW your old safety razor blades quickly and easily. Make new blades better. Apply Nura to your strop or strop-er, and see the difference. Nura makes blades last indefinitely. Straight razors seldom, if ever, need honing. Stop buying blades. Will not injure Strop. Guaranteed. Send 50 cents, no stamps. Nura Co., Box 342, Rochester, N. Y.

WE never sacrifice quality for price! Dull Gillettes, Durhams, hollow-ground 45c—all others 35c dozen. Satisfaction Guaranteed. Mail two blades for free trial. John Henry Company, 323 Gloyd, Kansas City, Mo.

GILLETTE style blades. Dozen 45 cents. Automatic stropper \$1.50. Wallace Kutz, 132 Chambers, Phillipsburg, N. J.

FOR THE HOME

GRANDFATHER'S Clock Works. \$5.00. Build your own case; Instructions free; make good profits selling your friends. Clock works with chimes for old or new cases. Write for full particulars. Clock Co., Ruffner St., Philadelphia.

FOODS from Twenty Lands. Popular Mechanics new Cook Book made up of recipes sent by our readers from 20 countries. Many delightful foreign dishes, and many American ones, too. Only a few copies for sale. Send No Money. Just order on a postal. When postman hands you book, pay \$1.50 and postal charges. Popular Mechanics Press, Room 809, 200 East Ontario St., Chicago, Ill.

HOUSEKEEPERS "Delighted." Catalogue "Free." Representatives Communicate. "Phoenix Oil Burner." Rochester, N. Y.

TEXAS Orchard run Pecans! 2 lbs., \$1.00; 5 lbs., \$2.25; 10 lbs., \$4.00 postpaid. Booking orders, October or later deliveries. Langham Bros., Melon, Texas.

NEW Crop Texas Comb Honey! 5 lbs. \$1.65 Postpaid. Langham Bros., Melon, Texas.

WATCHES, DIAMONDS AND JEWELRY

NEW Swiss Watches Cheap. 6 and 15 Jewel. Trial. Ralph Pile, Somerset, Pa.

WATCH REPAIRING

WATCHES: All makes repaired by experts. Write, International, Box 5P, Fordham Station, N. Y.

ANTIQUES, WAR RELICS AND INDIAN GOODS

FOR Dens. Relics from Europe's battlefields; also medals. Illustrated catalogue 25c, with Sample War Photos. Welsh, 1889 Albany Ave., Brooklyn, N. Y.

SEND 5c for fine, new list Indian relics, antique firearms. F. E. Ellis, Webster Groves, Mo.

PHONOGRAPHS AND SUPPLIES

BUILD your own phonographs. We can supply you with motors, tone arms and all accessories at wholesale prices. Write for catalogue AX. Pleasing Sound Phonograph Co., 204 East 113th St., New York, N. Y.

BUILD your own Phonograph. We furnish everything. Catalog sent free. American Phonograph Co., 3752 Belmont, Chicago.

MUSIC AND MUSICAL INSTRUMENTS

SONGS Wanted: Royalty Publication. Contracts on acceptance. Diamond Music Co., suite 1000, Broadway and 51st Street, New York.

FREE! Special this month only! Formula for re-silvering mirrors with each order for 5 Snappy Songs. \$1.00. Fred J. Gallo, Drawer 622M, Cleveland, Ohio.

ARTISTIC. National Anthem, woven words, music bars, U. S. colors, flag and gold star scrolled in gold with heavy silk, (12x13). Price one dollar. Maute Aircraft Specialties, 191 Bedford Ave., Brooklyn.

LEARN Keep time by impulse. Simplest, Best Method Known. Complete \$1.00 postpaid. Non-Pressure, Afton, Iowa.

PLAY Piano by Ear. Simple Method. New chart and instructions \$1. D. W. Shanahan, 682 S. Park Ave., Buffalo, N. Y.

SAXOPHONES, all other Band and Orchestra Instruments, best makes, new and used, on easy terms. Also buy, exchange, repair. Write today for free catalogs, bargain bulletin and "Musical Booster" magazine, all free. Get acquainted with the big Professional Supply House. Crawford-Rutan, 1010 McGee, Kansas City, Mo.

MUSIC written to lyrics, copyrights secured. Arrangements for Piano, Band and Orchestra. Wallace Brown, 35 W. Randolph, Chicago.

SONG Poem Writers—write Ray Hibbeier, D1, 2104 N. Keystone Ave., Chicago.

BANJOISTS (Tenor or Standard) prepared for Professional Orchestra. Latest Chord, Rhythm, Stroke and Modulation Charts, all for \$1.00. Weidt's Chord System, Box 557, Newark, N. J.

CORNETISTS—Trombonists—Saxophonists—Clarinetists. Get "Free Pointers." Name instrument. Virtuosi School, Buffalo, N. Y.

SHARPS and Flats—Free. Very interesting. Send for it Today. Harry L. Alford, 192 No. State St., Chicago, Ill.

WRITE Songs. Big money and reputation. Write for information. J. Gordon Pub. Co., 201 N. Hoyne Ave., Chicago.

VIOLINS. Deep, Mellow, Soulful — on credit. Easy terms for wonderful instrument. Get details today. Gustav F. Henning, 2424 Gaylord St., Denver, Colo.

I WANT Song Poems. Casper Nathan, 3514 N. Racine, Chicago.

"MUSIC Composed" to words. Bauer Bros., (formerly of Sousa's Band), Oshkosh, Wis.

BIG Song Hit! "When Eve Was Absent Without Leave." Copy, 30c. L. A. Washlin, Sayville, N. Y.

SONG Poem Writers—Stamp brings "Song Writers' Guide." Wm. Van Beaver, B1-1239 Elm St., Green Bay, Wis.

PATENT ATTORNEYS

PATENTS. Time counts in applying for patents. Don't risk delay in protecting your ideas. Send sketch or model for instruction or write for Free book "How to Obtain a Patent" and "Record of Invention" form. No charge for information on how to proceed. Communications strictly confidential. Prompt, careful, efficient service. Clarence A. O'Brien, Registered Patent Attorney, Security Bank Building (directly across street from Patent Office), Washington, D. C. See pages 140 and 141.

LACEY'S Patent Sense. Valuable book free. See ad page 144.

PATENTS Procured. Prompt Service. Personal, careful and efficient service. Highest references. Moderate fees. Send sketch or model for actual search and advice. George P. Kimmel, Master of Patent Law, 55L Legal Bldg., Washington, D. C.

PATENTS—Trademarks obtained. Information free. O. A. Michel, Registered Attorney, Box 624-B, St. Louis, Mo.

PATENTS. Booklet free. Highest references. Best results. Promptness assured. Send model or drawing for preliminary examination. Watson E. Coleman, Patent Lawyer, 644 G. Street, Washington, D. C.

EXPERIENCED patentees sell their own inventions successfully. "Know How" explained in free booklet. Chartered Association American Inventors, Barrister Building, Washington, D. C.

PATENTS—Write for our Guide Books and "Record of Invention Blank" before disclosing inventions. Send model or sketch of your invention for Free Inspection and Instructions. Terms Reasonable. See advertisement on pages 142 and 143. Victor J. Evans & Co., 934 Ninth, Washington, D. C.

PATENTS, Trade-Marks, Copyrights, and Patent Litigation. Write for advice and instructions how to proceed, costs, etc. Hand Book with illustrations of 100 Mechanical Movements sent free on request. Albert E. Dieterich, Patent Lawyer, and Solicitor, 621-B Ouray Bldg., Washington, D. C.

PATENT Applications prepared, \$15 (simple inventions). A. M. Benner, M-223, Victor Bldg., Washington, D. C.

INVENTIONS patented; Trade-Marks Registered; Reasonable charges; prompt service; plain advice, request particulars. Jaynes & Jaynes, 700 Kellogg, Washington, D. C.

ESTABLISHED 1864. Milo D. Stevens Company. Free Booklet. Patents, Trade-Marks, Copyrights. Offices, Monadnock Block, Chicago; Barrister Building, Washington, D. C.

RICHARD E. BABCOCK, Patent Lawyer, Washington Loan & Trust Bldg., Washington, D. C. Booklet.

PATENTS—Send for form "Evidence of Conception" to be signed and witnessed. Form, fee schedule, information free. Lancaster and Allwine, Registered Patent Attorneys in United States and Canada, 221-Ouray Bldg., Washington, D. C.

MONROE E. MILLER, Ouray Bldg., Washington, D. C. Patent Lawyer; Mechanical, Electrical Expert. Booklet and Priority Record blank gratis.

PATENTS, Trade-Marks, Designs. This firm has 27 years' experience and gives expert personal service at reasonable rates. We properly protect your invention. Write for free information and exact cost of procuring patent before proceeding. John B. Thomas & Co., 902 F St., N. W., Washington, D. C.

MILLIONS spent annually for ideas! Hundreds now wanted! Patent yours and profit! Write today for free book—tells how to protect yourself, how to invent, ideas, ideas wanted, how we help you sell, etc. American Industries, Inc., 500 Victor Bldg., Washington, D. C.

COMMERCIALIZE your inventions according to My Cooperation Plan before patenting. Write for booklet, Ralph Burch, Patent Lawyer, Jenifer Building, Washington, D. C.

UNPATENTED Ideas Can Be Sold. I tell you how and help you make the sale. Free particulars (Copyrighted). Write W. T. Greene, 807 Jenifer Building, Washington, D. C.

U. S. AND foreign patents, trademarks; moderate rates, 22 years' experience. George C. Heinleke, 32 Union Square, New York; registered in U. S. and Canada.

PATENTS Procured; Trade Mark Registered—A comprehensive, experienced, prompt service for the protection and development of your ideas. Preliminary advice gladly furnished without charge. Booklet of information and form for disclosing idea free on request. Richard B. Owen, 30-Owen Bldg., Washington, D. C., or 41-R Park Row, New York.

"INVENTOR'S Advisor", the valuable Patent book with 139 mechanical movements and illustrations, sent free upon request. MM. Labiner, Patent Attorney, 3 Parkrow, New York.

INVENTORS—Write for our Guide Book, "How to Get Your Patent" and Evidence of Invention Blank. Send model or sketch of your invention for our prompt examination and instructions free. Randolph & Co., Dept. 430, Washington, D. C.

PERCY S. WEBSTER, 203 Saving and Loan Building, Stockton, California. Long established organization. Patent booklet free.

"INVENTORS' Guide" sent free on request; this book contains illustrations of patented inventions and gives valuable information and advice for all who have original ideas or improvements. Frank Ledermann, Registered Attorney and Engineer, Woolworth Bldg., 1712, New York.

PATENTS, Trade marks, copyrights. Prompt, personal, reliable service. Over 36 years' active practice. Write for terms. Book free. Address E. G. Siggers, N. U. Bldg., 918 F Street, Washington, D. C.

FOR INVENTORS

PATENTS. If you have an invention which you wish to patent you can write fully and freely to Munn & Co., for advice in regard to the best way of obtaining protection. Please send sketches, or a model of your invention and a description of the device, explaining its operation. All communications are strictly confidential. Our Handbook on Patents is sent free on request. This explains our methods, terms, etc., in regard to Patents, Trade Marks, Foreign Patents, etc. "Scientific American" contains Patent Office Notes, Decisions of interest to inventors and particulars of recently patented inventions. Munn & Company, Solicitors of Patents, 1523 Scientific American Building, New York; 524 Scientific American Bldg., Washington, D. C.; 1313 Tower Bldg., Chicago, Ill.; 666 Hobart Bldg., 582 Market St., San Francisco, Calif.; 521 Van Nuys Building, Los Angeles, Calif.

UNPATENTED Ideas Can Be Sold. I tell you how and help you make the sale. Free particulars (Copyrighted). Write W. T. Greene, 807 Jenifer Building, Washington, D. C.

HOW to sell your invention without being swindled. Free instructions. Write today. Scholtz & Co., Wyanotte, Mich.

WE finance your application and offer the patent for sale. Patents Bureau, Times Bldg., St. Louis, Mo.

INVENTORS Universal Educator—contains 900 mechanical movements; 50 perpetual motions. Tells how to obtain and sell patents. Suggests new ideas. Explains how to select your attorney and avoid patent sharks. Price (revised edition) \$1.50 postpaid. Albert E. Dieterich, 621-Ouray Bldg., Washington, D. C.

PATENTS wanted, cash or royalty basis; send description, Box 126, Dowagiac, Mich.

I AM in touch with hundreds of moneyed men and manufacturers who wish to buy good inventions. Write Hartley, 38 Court St., Bangor, Me.

MECHANICAL Drawings. Engineering Services. Your Ideas Developed. Write George Baskerville, 1616 South Tenth Ave., Birmingham, Ala.

WILL buy improved invention. Write W. L. Kendig, 416 N. Duke Street, Lancaster, Pa.

YOUR ideas developed. Confidential. Drawings made. Experimental tests conducted. Models built complete. Low cost. The Practical Mechanic, South Haven, Mich.

PATENTS Wanted—We buy and sell practical patents. Big opportunity, undeveloped field. Describe briefly. M. Okamura, Box 1290, Honolulu, Hawaii.

INVENTORS—Write for our Guide Books and "Record of Invention Blank" before disclosing inventions. Send model or sketch of your inventions for our free inspection and instructions. Terms reasonable. See advertisement on pages 142 and 143. Victor J. Evans & Co., 157 Ninth, Washington, D. C.

LACEY'S Patent Sense. Valuable book free. See ad page 144.

PATENTS. Time counts in applying for patents. Don't risk delay in protecting your ideas. Send sketch or model for instructions or write for Free book "How to Obtain a Patent" and "Record of Invention" form. No charge for information on how to proceed. Communications strictly confidential. Prompt, careful, efficient service. Clarence A. O'Brien, Registered Patent Attorney, Security Bank Building (directly across street from Patent Office), Washington, D. C. See pages 140 and 141.

EXPERIENCED patentees sell their own inventions successfully. "Know How" explained in free booklet. Chartered Association American Inventors, Barrister Building, Washington, D. C.

HAVE You an Invention? If so, write for our free book, "How to Get Your Patent," tells our terms and methods. Send model or sketch for our free examination and instructions. Randolph & Co., Dept. 141, Washington, D. C.

GET your own patents. Legal blanks, complete instructions \$1. Cutting Sons, Campbell, Calif.

I SELL Patents. Established in 1900. The only man in America who has spent the past 25 years exclusively at this work. An experience highly valuable to you. If you have a good patent to sell. Charles A. Scott, 773PM Garson Avenue, Rochester, N. Y.

PATENTS Procured; Trade Marks Registered—A comprehensive, experienced, prompt service for the protection and development of your ideas. Preliminary advice gladly furnished without charge. Booklet of information and form for disclosing idea free on request. Richard B. Owen, 30-Owen Bldg., Washington, D. C., or 41-R Park Row, New York.

PATENTS FOR SALE

FOR Sale—patent No. 1,489,220. License plate holder and Luminator; only one visible at night. Andrew Kolister, Athens, R. D. 2, Ohio.

THREE Patents and One Trade Mark outright. All on market. Gypsy Queen Folding Cooking Stand, Wash Basin Holder, Folding Ironing-Board. Curious not wanted. Gypsy Queen Co., Pawnee, Ill.

OUTRIGHT or Royalty, newly patented removable and replaceable upholstery. Can be removed and taken apart for cleaning without use of any tools. No tacks. Will fit all automobiles, theatre seats, furniture, etc. G. O. N. Brandberg, 308 N. Main Ave., Sioux Falls, S. Dak.

ENDORSED by profession. Two basic patents, lack models. Sell quarter interest appallingly low. Inventor, G. P. O. Box 143, Brooklyn, N. Y.

WANTED party to help finance patent fee valuable invention. Liberal interest. Hacker, 6351, Glenwood, Chicago.

SALE, patent automatic Typewriter Eraser. T. G. Odell, 916 Taft Bldg., Hollywood, Calif.

OUTRIGHT, ash-sifting device—Pan positioned in furnace coupled with rotatable element mounted on closable housing. Otto Meyer, 1842 Stahlwood Ave., Toledo, Ohio, 1,585,195. Fire-escape to carry in pocket; fool-proof; cost a dollar. Thousands of unsolicited orders from City Fire Departments and hotels await manufacturer. 1,585,291. Automobile Jack, only three inches high; will raise car to any height. Every automobile owner wants one. Dr. Jordan, Chilli-wack, B. C. Canada.

U. S. PATENT—Compressed Air Pumping System for Supplying the home or deep well pumping, such as Oil Wells. Has been thoroughly tested for house use. J. G. Hampton, 115 North 3rd St., Fredonia, Kans.

CROSSING signal, simple, reliable. Shows intermittent visible signal at crossing only when train approaches. No wires, batteries, or moving parts at crossing. Suitable for grade railway crossings or highway intersections. Cheap enough to have one at every blind crossing in country. United States patent allowed, Canadian applied. Sale or royalty. Kenneth Bard, Manawa, Wis.

PATENTED, small portable Sewing Machine for mail order trade has no equal. Sell patent rights. W. McCabe, 265 West 118th Street, New York.

PATENT and Patent Pending—Device for separating and confining sediment and water from gasoline. Efficient and durable. Low manufacturing cost. For every auto. Hobbs, 1753 North Sawyer, Chicago.

PROTECT your patents, trademarks in case of infringement. Guaranteed by strongest bonding company, surplus \$1,000,000. Patent & Trademark Protection Co., Drawer 1345B, St. Louis, Mo.

FOR Sale or Royalty—Patent for inserting and removing Hassler Shock Absorber; only one that will do the work right. Can change spring in 2 minutes. H. E. Maples, Jackson, Tenn.

FOR Sale—Automatic Drag Saw Patent. Orvil Chandler, South Worcester, N. Y.

FOR Sale—Patent, quick Hosebib Coupling. Beatrice Blake, 907 Clay St., Oakland, Calif.

FOR Sale—Patent Waterer; Serial No. 758,418. Patent No. 1,566,176. Patented Dec. 15th, 1925. Joe Weber, Route 3, Grinnell, Iowa.

OUTRIGHT—Patented 1926. New Toy and Novelty Guns and Shooting Galleries; full line. Dies and machinery complete; samples. B. Keil, 1330 W. 8th St., Erie, Pa.

PATENT For Sale or Royalty: Combination Hair Brush. Patent Pending 1926. Great Money Maker. Address Mike Koske, Proberta, Calif.

FOR Sale—Patent on Refrigerating Display Box. This is a very neat and attractive box, and one which will be wanted in every store. Will sell patent outright or place on royalty. Also very attractive in lunch rooms, hotels, etc. For particulars, address George N. Rubieckow, 719 McKean Ave., Donora, Pa.

FOR Sale or Royalty—Patent for Rubber Heels. Patented March 16, 1926. The Victory Shoe Shop, Hollidaysburg, Penna.

OUTRIGHT or Royalty—Burglar-proof window-locking device or ventilator. F. L. Hanle, 43 Morgan Place, Arlington, N. J.

AMERICAN and Canadian territory to manufacture and sell newest Folding Clothes Dryer. Royalty basis. Home Art Kraft Co., Azalia, Mich.

OUTRIGHT or royalty, recently patented Cotton Pin, No. 1,548,688. Has many new advantages over old type. Write for sample. Ben Johnson, 465 Logan St., Bridgeport, Conn.

SURVEYING INSTRUMENTS

LARGEST stock of new and used surveying instruments in the country direct from factory. Satisfaction guaranteed or money refunded. Wissler, 619 N. Broadway, St. Louis.

DRAWING INSTRUMENTS AND DRAFTING SUPPLIES

MECHANICAL drawing, detailing and tracing executed by capable draftsmen; checked by experienced engineers. Write us your needs. Triangle Drafting Service, 5124 Sheridan Road, Chicago.

MODELS AND MODEL SUPPLIES

SPECIAL machine builders, tool and die makers, inventor's models, production work of all kinds. Dent, L. Quality Hardware & Machine Co., Ravenswood and Thordale Avenues, Chicago, Ill.

PATENTS. Time counts in applying for patents. Don't risk delay in protecting your ideas. Send sketch or model for instruction or write for Free book "How to Obtain a Patent" and "Record of Invention" form. No charge for information on how to proceed. Communications strictly confidential. Prompt, careful, efficient service. Clarence A. O'Brien, Registered Patent Attorney, Security Bank Building (directly across street from Patent Office), Washington, D. C. See pages 140 and 141.

SCALE locomotive castings and track. Racing marine engines, boilers and speed-boat construction sets. Small hexagon bolts and nuts. Castings from your patterns. Seamless steel copper and brass tube, rods, bars, angles. Any length cut. Singer, 15 Moore St., New York.

LET our experience be your guide. Models that are models; Tools and equipment for economic manfg. Patterns of all types; manufacturing in all branches. Satisfaction guaranteed. United Machinery Company, Cincinnati, U. S. A.

THE Modelmaker, a magazine for all interested in making working models. Sample 10 cents. Modelmaker, 122 Liberty St., New York.

WE make working models for inventors and do experimental work and carry a complete stock of brass gears and model supplies. Send for catalogue. The Pierce Model Works, Tinley Park, Ill.

MODEL steam engines and boilers. Boat and boiler fittings. Send 10c stamp for catalog. Refunded with first order. Model Machine Shop, P. O. Box 5, Station Y, New York City.

MODELS, Tools and Dies, and General Manufacturing, new invention, our specialty. Logan Machine & Manufacturing Co., 126 S. Clinton St., Chicago, Ill.

MANUFACTURING

METAL-CRAFT—Eventually—Metal-Craft. Competent Engineers, Designers and Producing Organization await your commands on dies, stampings, die-casting, deep pressing, screw-machine and wire products. Plating. Enamelling. Burnishing. Assembling. Wrapping and Packing to your specifications. Large completely equipped plant which guarantees prompt, efficient service. It is not the quality of raw materials alone, nor the precision in manufacture, and not just the service rendered that has given Metal-Craft the good reputation they bear—but all of these, as a constant certainty, in combination. Estimates promptly furnished. Metal-Craft Manufacturing Company, Chicago, Box 259-W.

A CAPABLE American Inventor—Improving, Designing, Inventing of Ideas, Inventions and Patents. Address H I P, 722 Mace St., Greensburg, Pa.

PATTERNS, wood and metal. Models, tools and dies. Brass, bronze, aluminum and iron castings. Screw machine work, production work of all kinds. Write Modern Machine & Pattern Co., Terre Haute, Ind.

MANUFACTURING Models, Dies, Stampings, Brass Work, one or thousands. Baum's Metal Specialties, Kansas City, Mo.

METAL Stamping—Manufacturing—Models—Tools—Dies. Henry H. Knabe Tool Works, 2150 Rusk St., Madison, Wis.

OUR factory will make your models, manufacture your articles as well as build your tools, dies and fixtures. Standard Die & Specialty Co., 1932 Austin Ave., Chicago, Ill.

WIRE goods made to order. Cooley Mfg. Co., 530 N. Western Ave., Chicago.

MACHINE work of any kind wanted by well equipped shop. The Greaves-Klusman Tool Co., Cincinnati, Ohio.

MACHINERY, TOOLS AND SUPPLIES

32"x16" WALCOTT engine lathe, \$750. No. 60 Heald auto cylinder grinder, \$750. 12" Drill press, \$32.75. 16"x8" Leblond lathe, \$250.00. 15" Hendy Shaper, \$185.00. Complete line machinery and supplies. Terms if desired. Write for latest list. Cincinnati Machinery Supply Co., 215 E. Pearl Street, Cincinnati, Ohio.

14"x5" MONARCH engine lathe, \$95. Power hack saw, \$12.00. 12" Speed lathe, \$35. 18"x10" Hamilton quick change lathe, \$270. Large quantity surplus machinery cheap. Electro Platers Supply Co., 547 Considine Ave., Cincinnati, Ohio.

WATCHMAKER'S Lathe, with complete screw cutting attachment at a bargain. R. Jaegermann, 5815 Easton Ave., St. Louis, Mo.

CONCRETE Building Block Machines and Molds. Catalogue free. Concrete Machine Co., 5 N. Main St., St. Louis, Mo.

ELECTRICAL

MOTORS— $\frac{1}{4}$ and $\frac{1}{2}$ hp., split phase and repulsion induction. Electrical books, Toy Motors. Catalog. Manhattan Co., 333b W. Manhattan Blvd., Toledo, Ohio.

ENGINES, MOTORS AND DYNAMOS

HERE is your opportunity to obtain grinders and buffers, brand new, they are full $\frac{1}{4}$ H.P., 110 volt, AC, 60 cycle, with cord and plug, with 6" emery wheel on one side and 6" buffer on the other, enclosed dust proof motor. We only have a limited number left at \$15.75 each. Cash with order. Brand new $\frac{1}{4}$ H.P., 110 volt, AC, 60 cycle, motors with pulley at \$10.00 each. Immediate shipment. General Distributing Co., Security Storage & Van Co., Duluth, Minn.

GOVERNORS for Auto Engines. Let us show you how to make a power plant for the shop or farm. A. C-S Governor Co., 215 W. Manchester Ave., Los Angeles.

DO you want an electric lighting plant on your farm, with your gasoline engine and one of our 1,000 Watt, 32 volt, Westinghouse generators. You can have electric lights in your house, barns, etc., at a very low cost. Run your washing machine, cream separators, etc. The cost of the above generators are \$48.00 each. Write for bargain catalog on engine driven lighting plants. General Distributing Co., Security Storage Bldg., Duluth, Minn.

MOTORS—Good, Practical. Twentieth horsepower, 115 volt alternating-direct current. Order now. Pay postman. Perry Trading Co., Dept. M7, 815 Lake Ave., Racine, Wis.

ALTERNATING current, single phase, rebuilt; guaranteed motor bargains. $\frac{1}{2}$ HP. Ellington, \$7.50; $\frac{3}{4}$ General Electric or Westinghouse, \$10.00; 1 Wagner, \$45.00; 3 Wagner, \$75.00; 5 HP. Century, \$85.00. Many other bargains. Tell us your needs. Send for motor price list. Hyre Electric Company, 615 R. G., So. Dearborn St., Chicago, Ill.

MOTORS: Alternating Current $\frac{1}{4}$ Horse, 110 V., 1750, \$8.50. New Direct Current $\frac{1}{2}$ Horse, 110 V., 3300 speed, \$3.75. Special lot 32 V., 25 Amp., new farm lighting plants with engine, \$55.00. Also other bargains. Queen City Electric Co., 1736 Grand Ave., Chicago, Ill.

STEAM Engines, one H. P., \$18.00; $\frac{3}{4}$, \$12.00. James Chambless, Bessemer, Ala.

BENDING MACHINES

THE famous Hossfeld Wrenchless Universal Bender is the last word in bending machines; bends metal, cold or hot, into most any conceivable shape, including Eye-bolts and Automobile Spring Eyes. Bends up to 1" bars or 1 $\frac{1}{2}$ " Pipe cold. Used by the largest corporations, yet so inexpensive that even a farm shop need not be without one. Send for Circular. Hossfeld Mfg. Co., Box 344, Winona, Minn.

BLACKSMITHS

BLACKSMITHS, Make More Money in Job Shop or Factory Doing Hard Jobs Easy. Be a Master Machine and Plow Blacksmith and Expert Tool Dresser and Tempering to a Standard with Collard Tempering Charts. All for One Dollar. Samples Free. W. M. Toy, Sidney, Ohio.

FOR SALE—MISCELLANEOUS

FOR Sale or Exchange—240 acres, Pueblo County, Colorado; improved; auto accessories preferred; what have you? O. L. Rifner, Salina, Kans.

ADDRESSGRAPHS, Letter Folders, Multigraphs, Envelope Sealers, Duplicators, less than half price. Guaranteed. Pruitt Co., 117 No. Market, Chicago.

EXCELLENT guaranteed bamboo fountain pens \$1. Walter Knowlton, Bushnell, Ill.

WANTED MISCELLANEOUS

MAIL us your discarded Jewelry, Gold, Crowns and Bridges, Watches, Diamonds, Silver, Platinum, and old False Teeth. Money promptly mailed. Goods returned if offer refused. United States Smelting Works, (The Old Reliable), Dept. 71, Chicago.

REAL ESTATE, FARM AND ORCHARD LAND

ATTENTION—"Get acquainted." Cash for your property. Farm, Hotel or Retail Store, no matter where located; confidential service. Hayes' Business Agency, Cincinnati, Ohio.

WANTED: Farms wanted at cash price. Will deal with owner only. J. Stiever, Dept. 2915, Wabasha, Minn.

OZARK land; ten acres near White River and proposed Dixie Dam, \$100; \$5 monthly. Alvin Zimmermann, 1800 N. Fifth, Kansas City, Kan.

HERE'S your land! \$10 down and \$10 a month buys 20 acres of my best land in Cent. Mich. for \$400, or 10 acres for \$250. Write at once for free 48-page picture book. G. W. Swigart, P1259 1st Natl. Bank Bldg., Chicago.

PECAN-Orange-Fig Groves "On the Gulf" Monthly payments. Guaranteed care. Big, quick returns. Suburban Orchards, Dept. M. Biloxi, Miss.

SELL your property quickly for cash, no matter where located. Don't pay big commission. Particulars free. Real Estate Salesmen Co., Desk B, Lincoln, Nebr.

DOGS AND PETS

FOXES, raccoons, muskrats, skunk, ferrets, rabbits, squirrels, mink, opossums, B. Tippet, Caledonia, Minn.

FOX Terriers, Collies, Bulldogs, Pretty Puppies \$10.00. Chas. Smiley, Judson, Ind.

RAISE Rabbits, Circular free. Chicago Rabbitry, 3003 Sarak Ave., Chicago.

CURES Running FHs in dogs. Guaranteed. \$1.00. O'Neill, Box 315-P, Greenville, S. C.

POLICE Dog priced for quick sale. H. Rayer, Carthage, Ill.

FOR Sale—100 Coon, Opossum, Fox and Rabbit Hounds. C.O.D. Trial. A. F. Doran, Murray, Ky.

POLICE pups, pedigreed, for sale. Jim Sullivan, Warrensburg, Mo.

PEDIGREED Flemish Giants "Guaranteed" Pamphlet, 10c. Close Rabbit Farm, Tiffin, Ohio.

PERSONAL

ASTROLOGY—Stars Tell Life's Story! Send birthdate and dime for character reading. M. Kleman, 90 Adelaide St., Winnipeg, Man.

RECEIVE Big Mail. Quarter (coin) puts name on list. Edw. Fletcher, Haddon Heights, N. J.

ASTROLOGER will read your life. Test predictions for one year, 20c. dimes or stamps. Send year and birthdate. Money back if dissatisfied. G. Niemeyer, 621 McConnell Terrace, Atlantic City, N. J.

UNUSUAL Horoscope Consisting of Extensive four page Special Horoscope, and Astro Analysis. Send 50c and birthdate. Money returned if dissatisfied. Prof. Bolles, Box 125, Cranford, N. J.

ARE you unlucky, in trouble, sick, a failure or surrounded by evil influence, worry and fear? (Advice free.) Send birthdate and quarter for horoscope reading; questions answered free. Hoffman's, 6074 Butler St., Pittsburgh, Pa.

SEND 25c coin and your date of birth for forecast of your vibrations for 1926. Arvel Synclare, Numerologist, Box 25, Patton, Calif.

TOBACCO or Snuff Habit Cured or no pay. \$1.50 if cured. Remedy sent on trial. Superba Co., N3, Baltimore, Md.

MISCELLANEOUS

TATTOOING—learn tattooing, with my outfits. Send for circulars; they explain everything. Sergt. Bonzey, 367 South Main, Providence, R. I.

HARRIS Tweed, cream of Scotch Home-spuns direct from Makers. Suit-lengths by Post. \$2.00 per yd. Samples free on stating shades desired. Newall, 270, Stornoway, Scotland.

CELLULOID—Want information on coating process for celluloid. Address H. E. Percival, Clarke & Stuart Company, Vancouver, B. C.

LET a dollar bill bring you a fountain-pen leader. Cherry-red in color. Self-filler. Surprise premium with each order. The Double W Company, 4935 Fountain, Saint Louis, Mo.

DECLARATION of Independence. Beautiful Sesquicentennial Souvenir for framing. Send one dollar. E. J. Fletcher, Haddon Heights, N. J.

HOMEOPATHIC and Biochemic preparations sent postpaid to all parts of the world. Manual and booklets free. Halsey Bros. Co., 645 St. Clair St., Chicago, Ill. Established 1855.

BUILD yourself an electric clock! Instructions and blueprints of a novel model everyone can make, \$1. Particulars free. Albert Deibig, Electrical Engineer, 1690 Park Ave., New York.

SEND us your key and 25c. We will duplicate and return same day. Tuerk Mfg. Co., 32 No. Jefferson St., Chicago.

SPRUCE Gum—Refined from high-grade stock fresh from Maine forest; twenty 5c packages to box, \$1 postpaid. Eastern Gum Company, Monson, Me.

STARTLING! Many making money! Send half dollar for our marvelous book, "101 Ways to Make Money." National Capital Pub. Co., Box 1926, Washington, D. C.

BEAUTIFUL, distinctive gifts for all occasions. High quality, low price. Catalog free. C. Crane Company, Racine, Wis.

MIRRORS Resilvered at Home. Costs Less 5 cents per square foot; you charge 75 cents. Immense profits, plating autoproducts, reflectors, tableware, stoves, refinishing metalware, etc. Outfits furnished. Write for information. Sprinkle, Plater, 288, Marion, Ind.

CAN You Draw? Make money at home. Something new. No canvassing. Sample and particulars 10c. "Straley," 1017 W. Mulberry, Springfield, Ohio.

MEXICAN made pistol holsters, cartridge belts, lariats, sombreros, horse-hair goods; list free. Ingersoll Leather Co., 307 Fannin, Houston, Tex.

WEEDS—Cut them with cutter bar on Shaw Garden Tractor. Also plows, cultivators and runs belt machinery. Low prices. Immediate delivery. Shaw Manufacturing Company, Department C, Galesburg, Kans.

CUTS anybody can make. Simple, cheap process. \$1. Specimens, particulars, 2c stamp. M. Day, Windfall, Ind.

AMATEUR Cartoonist's money making plan \$1.00. Particulars free. Smith's Service, Wenatchee, Wash.

I CATCH from 45 to 50 foxes in from 4 to 5 weeks' time. Can teach any reader of this magazine how to get them. Write for particulars. W. A. Hadley, Stanstead, Quebec.



Who will fly to the South Pole?

Airplanes are fast conquering the frozen wastes and desert plains; winning fame everywhere. They may even fly to the South Pole! Wouldn't you like to know how these marvelous machines are built, and how they fly? Build a Flying Model of your own and learn how big ones are made. Ideal Plans (Drawn-to-Scale) and Building-Flying Instructions show you how to build and fly accurate 3 ft. Models of famous 'planes.

Send for a set now.

JN Type—Curtiss Training Plane
DH Type—DeHavilland World Flyer
N C-4—Naval Seaplane
Bleriot, Nieuport or Taube Monoplane
Cecil Peoli Racer

PLANS AND INSTRUCTIONS
25c per set
 postpaid
 (7 sets—\$1.25)

48 pp. Catalog of Model Airplanes, Parts and Supplies—5c postpaid.

IDEAL AEROPLANE & SUPPLY COMPANY
 408 West Broadway New York City

DEALERS GARAGEMEN

Used Car Dealers
 Car Wreckers
 Auto Supply Stores
 Fleet Owners
 Repair Shops



GET OUR BIG 80-PAGE CATALOG

Everything listed at cut prices—less than regular wholesale. Quantity purchases make our low prices possible. Nationally advertised products. All new except where specified—Timken Axles and Bearings—Standard Timing Gears—Brown-Lipe Transmissions—Pistons—Rings—Hayes and Firestone Wheels—Rims—Tires—Tubes—also a complete line of Accessories.

Write for our big new 80-page Wholesale Catalog today!

WARSHAWSKY & CO.

World's Largest Replacement Parts House
 1915-35 So. State St., Dept. PM-9, CHICAGO, ILL.

NEW OPPORTUNITIES FOR HOME-TRAINED MEN IN ELECTRICITY

Electrical Expert's Complete Outfit FREE

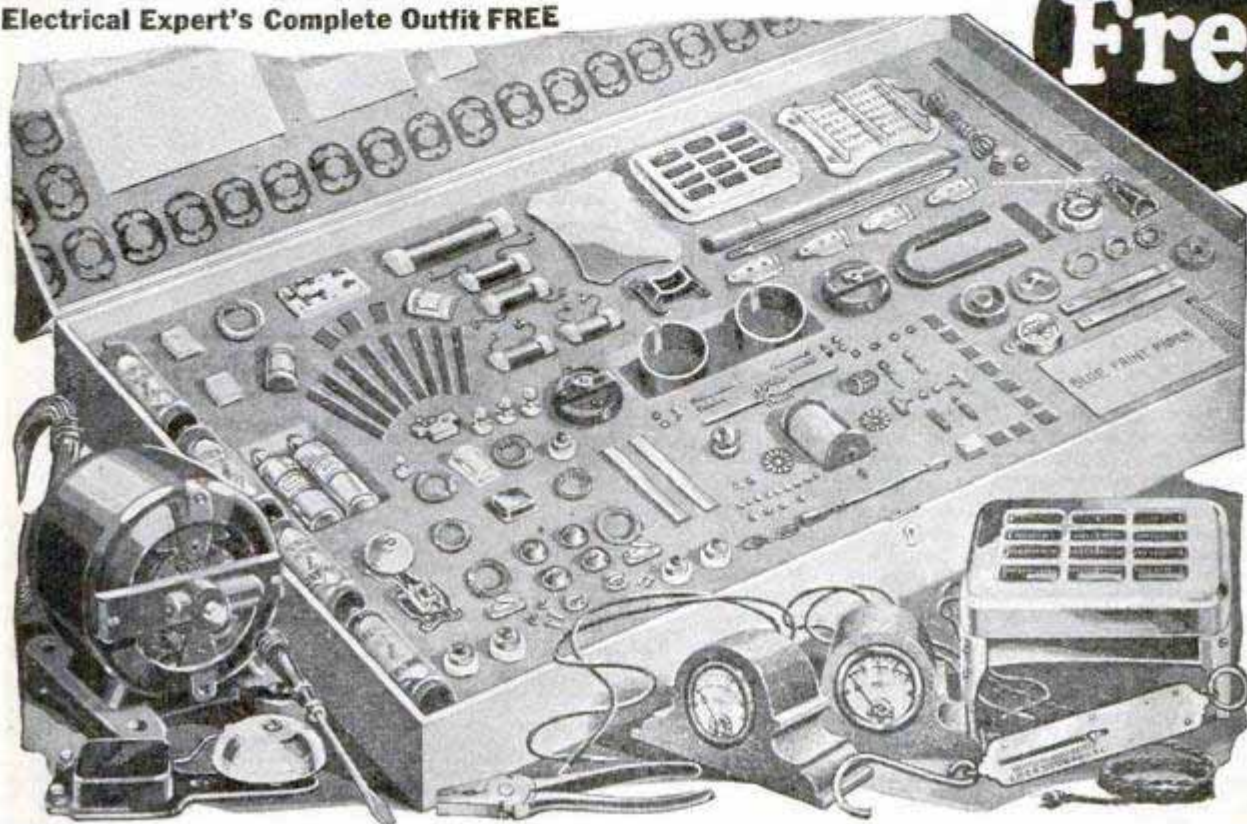

Free

Complete to those who enroll. Net value \$50. No Toys!

NOW IT'S EASY TO TRAIN AT HOME FOR BIG PAY!

ELECTRICAL EXPERTS are needed now as never before. Even electrical trades are making record money. But men with expert electrical training such as we give you, are earning \$3250 a year and up by the thousands. And the big modern electrical "boom" has only started. Jobs by the hundreds are opening up. Electrical refrigeration, power plants, battery stations. A profitable business for yourself. The kind of job you've always wanted. Where you do the bossing and let the other fellow do the \$25 a week hard work.

FREE EMPLOYMENT SERVICE

and it doesn't cost you a penny. Thousands of firms look to us for men. Allis-Chalmers, Harnischfeger

In Business for Yourself

Be your own boss. Tell others what to do. Hundreds of S. of E. men locate in business for themselves. With our help it's easy to get started. Just a few hours a week in work with a "kick" in it. Make a start—SEND COUPON.



Corp'n., Commonwealth-Edison are only a few places where S. of E. men get rapid advancement. Hundreds have been helped by us in selecting the right place to go into business for themselves. Coupon brings you big FREE book with all details.



Succeed with Concerns Like These S. of E. men are preferred wherever men are hired for electrical jobs. Our books sent FREE tells what S. of E. graduates are doing with concerns like these: Western Electric, Harnischfeger Corp., Commonwealth-Edison, Allis-Chalmers.

know and how to teach it to you to insure the quickest success when you go on the job. Earn \$65 a week and up. It's "in the cards" for you if you act and send the coupon.

SATISFACTION GUARANTEED OR MONEY BACK

is the way we stand behind S. of E. training. We can afford to because S. of E. men make good. They have the prestige for some of the biggest electrical men in America are S. of E. men. A signed money-back guarantee bond is yours the minute you enroll. Your training must satisfy you or every penny is returned.

GET STARTED—MAIL THE COUPON NOW. A big 72-page book in colors and illustrated with pictures of successful S. of E. men and their jobs will be rushed postpaid. Full details on S. of E. home training and the big opportunities that await you. **Mail coupon right now.**

My Personal Challenge

Whatever your age or experience we can train you for success in electricity. Put yourself in my hands. Ours is the training with prestige. Below is Uncle Sam's big Nordberg engine for the Panama canal for which S. of E. students made the acceptance test.

OSCAR WERWATH, President.



Clip Now for Action!

SCHOOL of ENGINEERING of Milwaukee

SCHOOL OF ENGINEERING OF MILWAUKEE
Dept. 46, Box 572, Milwaukee, Wis.

Send me FREE and postpaid without obligation your big 72-page book telling about S. of E. training and opportunities for me in electrical work. Also details of your employment service and money-back guaranty.

Name.....
Age..... Education.....
Address.....
City..... State.....



**If someone said to you—
“Let’s Go Into Business”**

I’ll put up all the money, furnish the factory and equipment; buy a \$1,000,000 stock; advertise for you; take care of your orders and guarantee your profits; all you have to do is sell—

WHAT WOULD YOUR ANSWER BE?

This is exactly the opportunity we offer you. We put our immense shops, force of 800 workmen, and tremendous stock of merchandise at your disposal. We advertise for you, teach you, train you, cooperate with you. We give you an elaborate selling equipment that fairly talks. We authorize you to take orders and collect a deposit, which you put in your pocket as your profit. After that the responsibility is ours. We fill the orders, ship them direct to your customers, collect the money due us, and absolutely guarantee perfect satisfaction. There is no chance for you to lose a single penny. This is the kind of partnership we offer you, if you are honest, industrious, willing to work hard for success, and have a clean record. If you have selling experience, so much the better, but it isn’t necessary. If you are interested and think you are the man we want, sign and send the coupon. Address Dept. 564.

GOODWEAR Chicago, Inc.

→ Send This Coupon for Facts! ←

**GOODWEAR Chicago, Inc.,
West Adams St. at Peoria, Chicago, Dept. 564.**

Gentlemen: Please send me the facts about your proposition. I am willing to work hard for success if the opportunity you offer is all you claim for it.

Name.....

Address.....

Town..... State.....



**BE AN OFFICER
in the U.S. Coast Guard
\$1700 Up to \$7,500 Yearly**

\$780 yearly at the U. S. Academy while training. You rank Ensign to Captain in service. Age requirements 18 to 24. Write Dept. A. for information.
**COAST GUARD PREPARATORY SCHOOL
4000 Ga. Ave. N. W. Washington, D. C.**

FREE

One recent issue copy of “STRENGTH MAGAZINE.” “Strength” is a large magazine which sells for 25c on the newsstand. “Strength” is a magazine on health, great strength and physical perfection. “Strength” shows you how to get them. No Cost. No Obligation. Dept. P. M. 9-26

MILO PUBLISHING CO., 2741 N. Palethorp St., Phila., Pa.

**AMAZING NEW
ADDING MACHINE**

**Fits Vest Pocket—Costs
Only \$2.95!**

C. M. Cleary, Suite 4C, 184 W. Washington Street, Chicago, Ill., has perfected an amazing new adding machine that does all the work of a \$300 machine yet fits the vest pocket and sells for only \$2.95. It does any kind of figuring in a jiffy. Weighs only 4 ounces. So simple a child can operate it. Business men, storekeepers and all who have seen it proclaim this ingenious machine one of the outstanding inventions of the last 25 years. The inventor wants it introduced everywhere and is making a Special Free Offer to agents. Write him today if you want to make money.

LEARN MECHANICAL DENTISTRY



IN 3 MONTHS—and qualify to earn \$2,000 to \$5,000 a year. Our free employment service enables you to **EARN WHILE LEARNING** this NEW money making Profession. Age no barrier and no previous training required. The only school in New York where students **LEARN BY DOING** actual work in gold before graduation. Day or night sessions. Write NOW for free catalog C and **SPECIAL GOOD OFFER.**

**N. Y. SCHOOL OF MECHANICAL DENTISTRY
147 West 33rd Street New York**

LEARN WATCH REPAIRING

Be a watchmaker—you can learn this profitable trade by correspondence in a few weeks in your own home by the DeSelms Chart System. After you complete the course you will know a watch from A to Z. You will know just what the matter is and how to repair one. When you graduate you will be a practical watchmaker and repairer and competent to fill any position. Positions for our graduates. Ask for our Free Book. It explains our system and terms.



**THE DeSELMS WATCH SCHOOL
LOGANSPORT, INDIANA**

DRAW CARTOONS

Turn Your Talent Into Money

Cartoonists earn from \$50 to \$300 per week—some even more. Remarkable new Circle System of Drawing teaches you in half the usual time. Send for **booklet** and sample **lesson plate** explaining full details of the Course.

**THE NATIONAL SCHOOL OF CARTOONING
623 Penton Building Cleveland, Ohio**



**Joy-STOMACH
for SUFFERERS**

I positively guarantee Macerated Wheat to relieve the worst cases of stomach trouble and banish constipation or it costs you nothing. Acid stomach, headaches and colds disappear. For more than 25 years Macerated Wheat has proved its benefits all over the world. Not a drug, but an uncooked food. Prepared ready to eat. People like it. Makes a good meal or side dish. Soothing to a weak stomach as a poultice to inflammation. Stays down and nourishes. Testimonials without number. My reputation backs my guarantee. Write for convincing proofs.

**BYRON TYLER, Established 1899
172 GIBRALTAR BLDG. KANSAS CITY, MO.**

Whatever Your Question;—be it the pronunciation of Fascista, the spelling of a puzzling word, the location of Esthonia the meaning of soviet, realtor, vitamin, etc., this Supreme Authority—

WEBSTER’S NEW INTERNATIONAL DICTIONARY

contains an accurate, final answer. 407,000 Words 2700 Pages. 6000 Illustrations. Regular and India-Paper Editions. **G. & C. MERRIAM CO., Springfield, Mass.** Write for specimen pages, prices, etc., and FREE Pocket Maps, per Popular Mechanics.



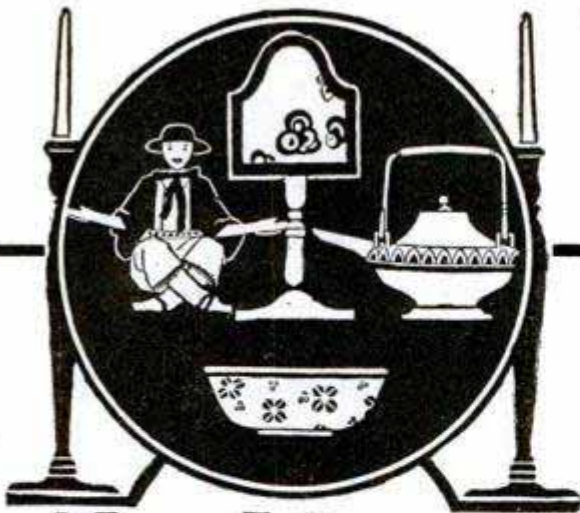

New Way to Make Money at Home



Gabriel Andre Petit
Art Director

WOULD you like to turn spare hours into dollars? Would you like an independent business of your own? Here is a new way to earn money, unlike anything ever offered before. There is no canvassing, no tedious drudgery. This is the most delightful kind of work. And it pays amazingly well. Many have earned from \$20 to \$50 a week and more.

No Special Ability or Experience Needed

The national organization known as Fireside Industries has openings for new members to decorate Giftwares at home. You have only to follow the simple directions for decorating all kinds of fascinating articles, hand-painted candlesticks, plaques, picture frames, greeting cards, wooden toys, parchment lamp shades, hand-painted furniture, batik and other beautiful art novelties. Under the wonderfully simple method devised by our Art Director, Mr. Petit, even a child could do the work. Complete outfit furnished every member, free.



Your Satisfaction Guaranteed

Think of decorating a pair of candlesticks, for example, in one hour and realizing a profit of \$2.00! Best of all, we are sure that you can learn to do the work successfully. There is absolutely no risk, nothing to lose.

Beautiful Book FREE

No matter where you live you can be one of the happy, successful members of Fireside Industries. Mail the coupon or write today for the beautiful illustrated Book that explains everything. We will send it FREE. But you must be prompt as new members are wanted at once; this golden opportunity may not come to you again. Enclose 2c stamp to help pay postage.



FIRESIDE INDUSTRIES, Dept. 66-M, Adrian, Mich.

**FIRESIDE INDUSTRIES, Dept. 66-M
Adrian, Michigan**

Gentlemen: Without obligation on my part, please send me, FREE, the book of Fireside Industries which tells how I may earn money at home by Decorating Giftwares; also particulars of your Money-Back Guarantee and special cooperative privileges and services. I enclose two cent stamp.

Name.....

Address.....

City..... State.....

(Write in pencil—ink will blot.)

Now! Let BUICK HIMSELF train you quick for big pay AUTO JOBS



D. D. BUICK, Chief Engineer

AUTO MECHANICS! Let this famous expert, D. D. Buick, train you right. Mr. Buick, pioneer of the Valve-In-The-Head Motor, and one of the organizers of the Buick Motor Car Company, knows just what you need to be trained quickly for big pay jobs. Come to this great school, operated under supervision of the State Board of Vocational Education, State of Michigan. Thousands are needed in auto work. And this great expert is devoting his life to training men like you.

Famous Expert heads Great Detroit Trades College

Where else can you get training like you can in the Detroit School of Trades, right here in Detroit, center of the world's automobile industry? This great university of trades trains you right on the job—no books. Its great corps of expert instructors fit you quick for big pay. An unexcelled employment department. Day and night classes. Every single branch of automobile work you learn easily, quickly and at amazing low cost. Graduates of this big school are earning amazing wages. They are in constant demand. You can't afford to take chances. Investigate the exceptional training of this wonderful college of trades.



15 Big Money Trades Taught

In this great college of trades each department is a big school in itself.

Besides Automobile Courses, this great school trains hundreds of men in other trades—you do the actual work. (Bricklaying, Plastering, Plumbing, Carpentry, Contracting and Estimating, Electricity, Sign Painting, Paper Hanging, Metal Finishing, Interior Painting, Painting, Acetylene Welding.) This is the one where you can get thorough training in every branch of trades. Don't work longer at pitiful low pay. In only a short time you, too, can be out on the job earning the big wages a trade offers you. Fill out the coupon right now and send it to Mr. Buick. Learn what wonderful opportunities this great college of trades offers you. But don't delay. Send in the coupon this very minute.

DETROIT SCHOOL OF TRADES Department 926-A Detroit, Michigan

D. D. Buick, Chief Engineer
Detroit School of Trades
Department 926-A
Detroit, Michigan

Send me at once your Free literature about the famous Detroit School of Trades. I want to earn big money.

I am interested in the trade of.....

Name.....

Address.....

City..... State.....

O. C. Miller,
Director
Extension
Work

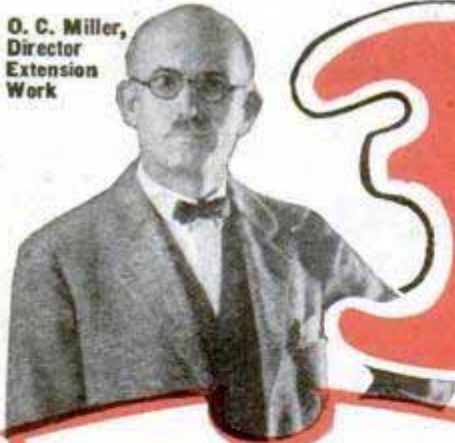

3 Drafting Actually

WHY I advised my best friend's son to go into Drafting.

"If you could go to a University, Bud," I told him, "it would be the making of you. But if you can't, go into drafting. Because, first, you can't get far in any engineering line without it. You must know how to make and read plans to succeed in Building, Electrical, Mechanical, Structural or Automotive work.

"Then, Drafting can be learned **QUICKER** than any other line of work paying equally large salaries. You can learn **EASILY**, at home in your spare time, without giving up your present job.

"Again, there are **MORE** Drafting jobs advertised than in any other well-paid field. In fact, Draftsmen are needed in **ALL** factories, in a hundred different industries.

"Finally, Drafting will appeal to you because you're *ambitious*. It leads to positions as Chief Draftsman, Superintendent of Construction, and other executive opportunities. Men go from Drafting into contracting on their own hook. Start with Drafting; it offers you **BIG MONEY** from the very beginning, and in the long run there's no limit to your progress."

I recommend Drafting to any ambitious fellow because it's the *foundation* of all industrial activity, because the **DRAFTSMAN** is the **KEY-MAN** in all building and manufacturing.

O. C. Miller
Director Extension Work



The American School

Chartered as an **EDUCATIONAL** institution in 1897. Not a dollar in dividends or profits has ever been paid out. Every cent received for tuition has been returned to our students in education and service. Over 200 noted educators, engineers, and executives have contributed to the courses we offer.



Building Draftsmen WANTED!

Architects and Contractors urgently need Draftsmen who have specialized in building construction, who can calculate and design **ORIGINAL** work. Beginners, travelers, detailers, or men with only general Drafting training will not do. We undertake, *under guarantee*, to supply this valuable training.



**\$60 to \$125
a week**

Mechanical Draftsmen WANTED!

There's an enormous demand for Draftsmen who have learned Mechanical Engineering subjects in addition to general Drafting practice. *Naturally*, Mechanical Drafting Experts earn larger salaries than those who are not specialized. Ours is the one home-training supplying advanced Mechanical Engineering and both to those who wish to specialize in this branch of the work.



First Time!

We could teach you the general principles of "Mechanical Drawing" in a few weeks. But that wouldn't prepare you for a **GOOD DRAFTING JOB**. If you tried to hold down a position as Mechanical Draftsman in a factory building machinery you would discover you needed to know how to calculate the size of parts, and how to design a machine to do a certain kind of work. The same would be true in a big Electrical or Auto plant. So now, for the first time in the history of home-training we give the advanced Engineering instruction you need to gain the **BIG SALARIES**, and fill the **BEST** positions.

"Fascinating as the Dickens!"

is the way one fellow describes Drafting work. And it's a fact, there's a gripping, thrilling fascination about Drafting that can't be described or explained. It may be white-collar work, but it surely attracts a fine, up-standing bunch of real **HE-MEN**. Fellows you'll be glad to associate with by day, and pal around with, by night.

O. C. Miller, Director Extension Work—

Lessons FREE



—to prove you can learn at Home!

Yes, Sir! With a guarantee in black and white, to get you ready for a fine Drafting job and a big raise in pay, or to refund every penny of your money. For 29 years we have turned clerks, mechanics, even laborers with only common schooling, into DRAFTSMEN—We've raised their pay from 50% to 400%—AND WE'VE FOUND THEM GOOD JOBS as soon as they were ready for it!

70,000 Drafting Jobs!

advertised in the past year. Salaries offered, \$35 to \$50 a week for men with little or no experience. \$60 to \$125 a week for Draftsmen capable of designing, calculating, and planning original work. \$5000 to \$12000 a year for Chief Draftsmen and Designers. Positions offered by practically every important industry. In all sections of the U. S. In cities of all sizes. That's the beauty of Drafting—it's the biggest, broadest, most varied and interesting field you can choose.

Electrical Draftsmen WANTED!
 Electrical Draftsmen, capable of designing Electrical machinery and equipment, earn larger salaries, of course, than the Electrical workers who usually do the job. After you have mastered general Drafting principles, you may choose this fascinating branch for advanced training, and we will give you Electrical Engineering instruction and Electrical Drafting Design, as definite preparation for the better paid positions in this important industry.

Easy to Learn Automotive Draftsmen WANTED!
 For the first time in the history of home-training in Drafting you may go farther than merely learning general Drafting principles. Now you may specialize! You may choose any one of the 5 great Engineering branches here mentioned. AUTOMOTIVE Drafting offers men interested in autos a wonderful field for advancement and profit.

Structural Draftsmen WANTED!
 —to plan and design bridges, steel structures, steel and concrete buildings and public works, etc. Our students who decide to go into this field are given thorough training in Civil Engineering subjects and advanced Structural Drafting.



Coupon Brings 3 Lessons FREE

JOBS!

for beginners and graduates

At enormous expense to us, but without extra charge to our students or graduates, we maintain a nation-wide Employment Service which keeps in touch with employers of Draftsmen everywhere. Frequently, we are able to place students after only a few months of training. Immediately after starting, our Employment Manager registers each student for his future job. The American School accepts all enrollments for Drafting instruction with a positive guarantee that it will lead to a better job and a big increase in pay, or money refunded.

American School Drexel Ave. & 58th St. Dept. D-674, CHICAGO

3 Drafting Lessons FREE

O. C. Miller, Director Extension Work
 American School,
 Drexel Ave. & 58th St., Dept. D-674, Chicago

I never realized the extent or possibilities of Drafting work. I am interested in getting the WHOLE story, and 3 Free Lessons to prove I can learn at Home in spare time.

Name.....
 St. No.....
 City.....State.....



"Don't tell me you never had a chance!"

"Four years ago you and I worked at the same bench. I realized that to get ahead I needed special training, and decided to let the International Correspondence Schools help me. I wanted you to do the same, but you said, 'Aw, forget it!' You had the same chance I had, but you turned it down. No, Jim, you can't expect more money until you've trained yourself to handle bigger work."

There are lots of "Jims" in the world—in stores, factories, offices, everywhere. Are you one of them? Wake up! Every time you see an I. C. S. coupon your chance is staring you in the face. Don't turn it down.

Right now more than 180,000 men and women are preparing themselves for bigger jobs and better pay through I. C. S. courses.

You can join them and get in line for promotion. Mark and mail this coupon, and find out how.

INTERNATIONAL CORRESPONDENCE SCHOOLS
Box 5598-E, Scranton, Penna.

Without cost or obligation, please tell me how I can qualify for the position or in the subject before which I have marked an X:

BUSINESS TRAINING COURSES

- | | |
|--|---|
| <input type="checkbox"/> Business Management | <input type="checkbox"/> Salesmanship |
| <input type="checkbox"/> Industrial Management | <input type="checkbox"/> Advertising |
| <input type="checkbox"/> Personnel Organization | <input type="checkbox"/> Better Letters |
| <input type="checkbox"/> Traffic Management | <input type="checkbox"/> Show Card Lettering |
| <input type="checkbox"/> Business Law | <input type="checkbox"/> Stenography and Typing |
| <input type="checkbox"/> Banking and Banking Law | <input type="checkbox"/> Business English |
| <input type="checkbox"/> Accountancy (Including C.P.A.) | <input type="checkbox"/> Civil Service |
| <input type="checkbox"/> Nicholson Cost Accounting | <input type="checkbox"/> Railway Mail Clerk |
| <input type="checkbox"/> Bookkeeping | <input type="checkbox"/> Common School Subjects |
| <input type="checkbox"/> Private Secretary | <input type="checkbox"/> High School Subjects |
| <input type="checkbox"/> Spanish <input type="checkbox"/> French | <input type="checkbox"/> Illustrating <input type="checkbox"/> Cartooning |

TECHNICAL AND INDUSTRIAL COURSES

- | | |
|---|--|
| <input type="checkbox"/> Electrical Engineering | <input type="checkbox"/> Architect |
| <input type="checkbox"/> Electric Lighting | <input type="checkbox"/> Architects' Blue Prints |
| <input type="checkbox"/> Mechanical Engineer | <input type="checkbox"/> Contractor and Builder |
| <input type="checkbox"/> Mechanical Draftsman | <input type="checkbox"/> Architectural Draftsman |
| <input type="checkbox"/> Machine Shop Practice | <input type="checkbox"/> Concrete Builder |
| <input type="checkbox"/> Railroad Positions | <input type="checkbox"/> Structural Engineer |
| <input type="checkbox"/> Gas Engine Operating | <input type="checkbox"/> Chemistry <input type="checkbox"/> Pharmacy |
| <input type="checkbox"/> Civil Engineer | <input type="checkbox"/> Automobile Work |
| <input type="checkbox"/> Surveying and Mapping | <input type="checkbox"/> Airplane Engines |
| <input type="checkbox"/> Metallurgy | <input type="checkbox"/> Navigation |
| <input type="checkbox"/> Steam Engineering | <input type="checkbox"/> Agriculture and Poultry |
| <input type="checkbox"/> Radio | <input type="checkbox"/> Mathematics |

Name.....
 Street.....
 Address.....
 City..... State.....
 Occupation.....
 Persons residing in Canada should send this coupon to the International Correspondence Schools Canadian, Limited, Montreal, Canada.

Young outdoor men wanted



To a few sturdy young men—lovers of fresh air and sunshine—who want to get away from the grind of indoor work—John Davey's national organization, The Davey Tree Expert Company, offers an exceptional opportunity. Constantly increasing demand will create a limited number of openings. Those young men selected will be thoroughly trained by the Company and given a permanent position if they make good. If you are single, between 20 and 30 years of age, free to travel, healthy, industrious, having a good practical education, and able to furnish satisfactory references, you have a good chance to qualify. Pay is good at start, advancement assured on merit. We want only men who desire permanent employment in a growing organization and will accept only clean, sturdy young men, thorough Americans, not afraid of vigorous outdoor work. Write for additional information and qualification blank to serve in place of personal interview. The Davey Tree Expert Co., Inc. 635 Federal Bldg., Kent, Ohio.

A GREAT BOOK FREE WITH THIS LIBRARY

Special 1926 Offer

For a short time only every subscriber to the New Library of Machine Shop Practice will receive, absolutely free, a copy of Gardiner's Practical Foremanship—one of the greatest books on the principles and practice of modern foremanship ever written. This practical pay-raising book quickly prepares you for a foreman's job. It comes to you absolutely free with

Machine Shop Practice

9 volumes—3065 pages—3608 illustrations
(A combined home-study course and reference library)

The New Machine Shop Library is written for practical men. It gives you the best methods for every kind of machine shop work. It explains machine tools and their operation, drawing and design, tool work, gears and grinding, jigs and fixtures, automatic screw machines and their tools and all of the mathematics you will ever have to use. It is plainly written, completely illustrated—the very best kind of help to the machine shop man who wants to advance himself.

No money down—only 7c a day

FREE

FREE EXAMINATION COUPON

McGraw-Hill Book Co., Inc., 370 Seventh Ave., New York
 Send me for 10 days' free examination the New Library of Machine Shop Practice. If satisfactory I will send you \$1.50 in 10 days and \$2.00 monthly until the special price of \$19.50 is paid. If not wanted, I will return the books at your expense.
 On receipt of my first payment of \$1.50 it is understood that I am to receive, free of charge, a copy of Gardiner's Practical Foremanship.

Signed.....
 Address.....
 City and State.....
 Position.....
 Employer..... P. M. 9-1-26

Guaranteed for FIVE Years! A guarantee you'll never use; the average Underwood lasts for LIFE! © 1925, S-W Co.

Thousands use a typewriter at home—to their pleasure and profit. The type-written letter wins. Stories that are typed sell. There's always a wealth of work for a typist. Learn and earn on an Underwood—fast, spirited touch, and beautiful writer. See our offer!

Underwood

**Write Us a Check for
THREE DOLLARS
and Own an Underwood**

Don't go another week without a typewriter. And don't pay another month's rental on some relic. A genuine Underwood is a joy to use—and easy to own. Act in time to receive one from this new lot!

If you've been "saving" for a typewriter, the time has come to spend. The cash involved? *Three dollars.* That's all that stands between you and actual use of your Underwood complete!

The Shipman-Ward price on a factory rebuilt Underwood makes it folly to buy a second-rate machine. And our plan of payment makes it equally foolish to wait.

Don't send any money now. But do let us have your name and address at once—for the big typewriter book that's free.

The biggest concerns in the country buy Underwoods from us. You can make the same big saving, on one machine. So why pay the top price? This is a regular Underwood, the most popular model, with standard 4-bank keyboard, and every improvement; full size and complete equipment; tools and cover.

No other company makes such a wide-open offer; nor could we, on any other make of writing machine. See below.

N^o 5 UNDERWOOD

Why Be Old Fashioned?

Modern Letters — Business or Social — Are TYPED! Four hundred Underwood typewriters, fresh from our finishing room, ready for shipment. They will soon find homes! For the home use of typewriters is increasing by leaps and bounds. A man needs one constantly. A boy in school shouldn't be denied one. Girls who work get ahead much faster at the office if they have their own typewriters at home.

You'll be amazed at the uses everyone in your household will find for an Underwood typewriter. Don't try to do with a less perfect machine, though; it doesn't pay. It isn't necessary. Since Shipman-Ward started rebuilding Underwoods, a fine typewriter is not a luxury in any sense. Few things around your

house cost so little as will now buy your Underwood. Nothing you ever bought was purchased on such liberal terms. These machines are in sparkling condition, rebuilt from the platen down. Not a single worn part; not a fault nor a flaw; nothing but what is just as perfect as its gleaming nickel or enamel finish.

Send No Money! All we want is your name and address, and a chance to present the facts about the wonderful Shipman-Ward plan; a plan that has built one of the world's largest typewriter businesses; the plan that was made for the benefit of all consumers. You run no risk buying this way! We let the machine do all the selling. Our big book of typewriters in actual colors is the thing to think of now! Coupon brings it free.

Free Book Coupon

SHIPMAN-WARD MFG. CO.
2126 Shipman Bldg., Chicago

Please send FREE, full offer, catalog, typing manual, and outline your free course in Touch Typewriting without obligation!

Name.....

St. or R.F.D.....

P. O.....State.....

Learn a good Trade

In the air... on the field... in a

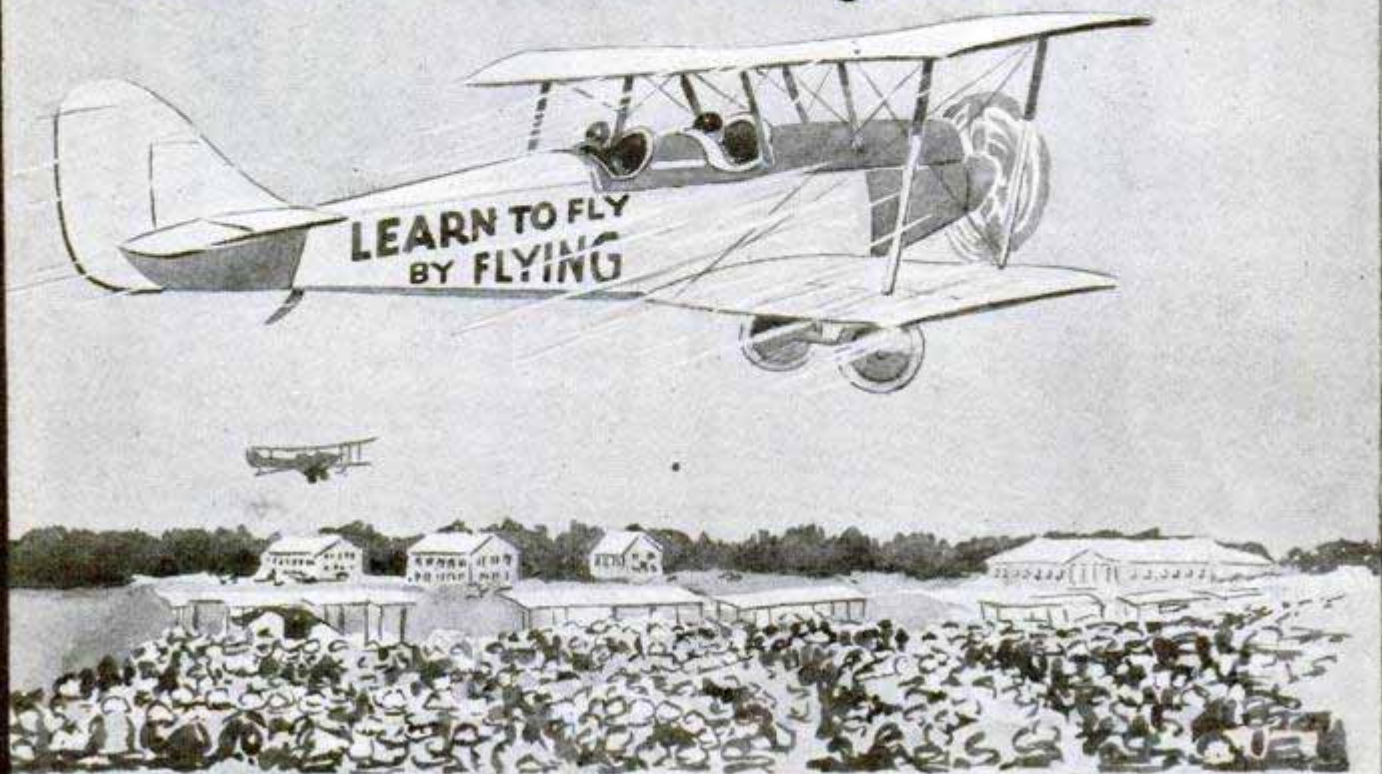

Sweeney Flying and Ground School Mechanics

OUT OF THE AIR COMES YOUR OPPORTUNITY. Here's the great business of the future. The Sweeney School teaches flying with skilled instructors, fine planes, a great flying field, all equipment. All the time in the air necessary to make you a skilled pilot. If you want to be a pilot, fit yourself for government mail or commercial service, exhibit at fairs, etc.—here's your chance.

SWEENEY ground school is a thorough course in practical airplane mechanics. You don't have to take flying unless you want to. Airplane mechanics in great demand. Five men on the ground needed to keep one man in the air. Learn by doing. Construction and repair of planes—all about motors—re-covering wings, etc. Mechanics and engineers earn from \$50 to \$125 a week.

YOU CAN TAKE BOTH GROUND WORK AND FLYING COURSE and be completely equipped for this great business—or you can take either flying or ground school. Send name today for full details—photographs of planes—hangars—flying field and students at work and full information as to the commercial end of flying and aviation mechanics. **THERE'S LOTS GOING ON—DON'T GAZE AND WONDER—FIND OUT THE FACTS—WRITE TODAY.**

Send for
FREE
Book

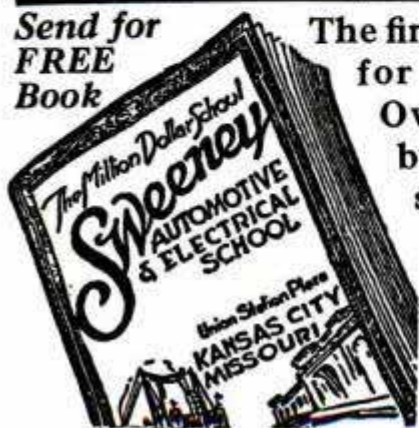

The first step is to send
for this free book.

Over 65,000 men, now busy and happy, got their start this way. Hundreds of photos. Tells all you want to know. Write today—no obligation. No colored students accepted.

MAKE BIG MONEY
In the Sweeney School

LEARN
Sweeney
AUTOMOTIVE &
2931 SWEENEY BLDG.

the sky's the Limit!
garage...on the road...in a shop.

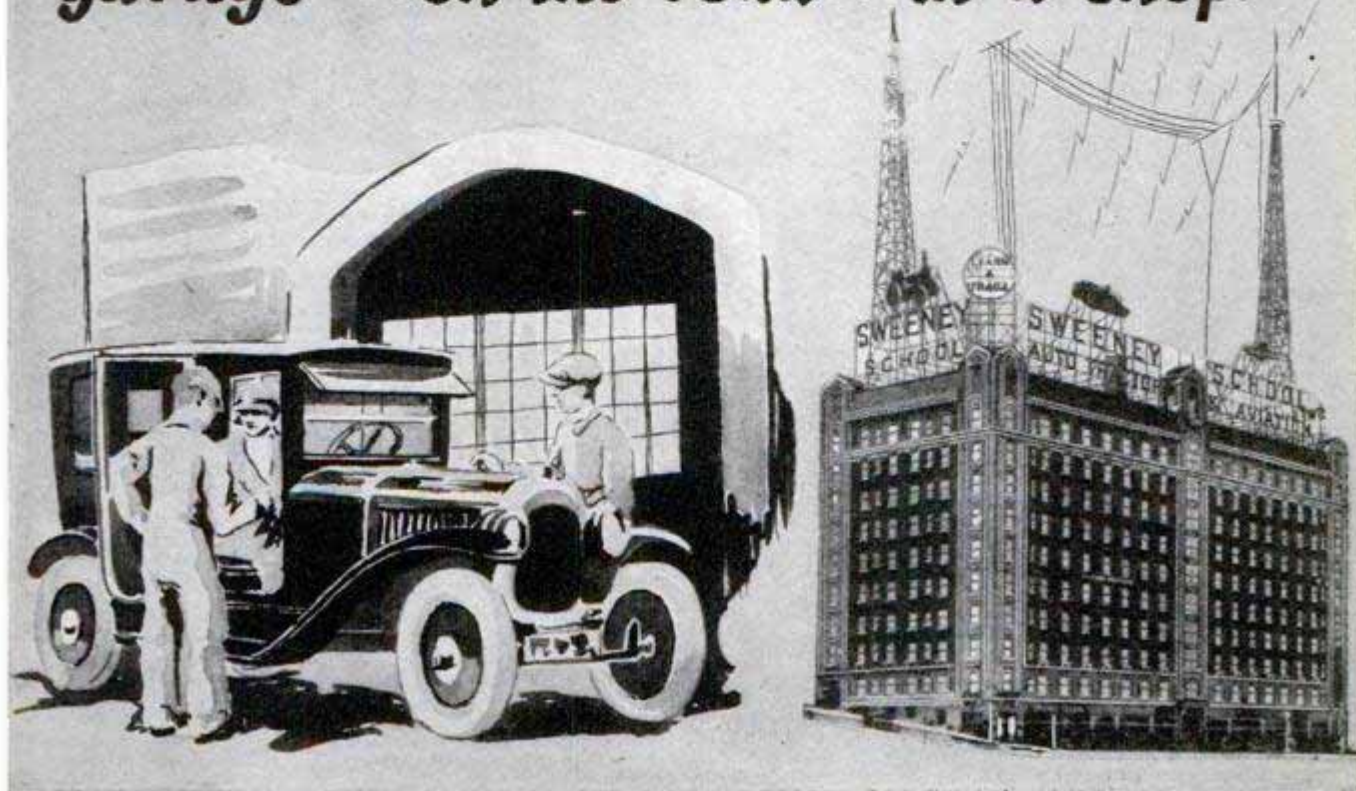

Million Dollar Sweeney Auto School

Auto Mechanics make \$50 to \$100 a week. Learning is easy by the Sweeney System of Practical Training. Use tools, not books. Be an auto mechanic—driver—truck driver—repair man—tire man—demonstrator. Own your garage or repair shop. Run a welding and vulcanizing shop. You can learn these trades separately or in a combined course.

If you are mechanically inclined, if you like to work with tools, you will learn under the "Sweeney System," by actually doing the work on the most complete gas engine and electrical equipment. Over \$200,000 invested, \$50,000 Radio Station WHB. You'll get dirty and greasy, but you'll learn through the Sweeney System of Practical Training that fits you for the big pay jobs waiting for Sweeney Trained Men.

Get my big FREE 64-Page catalog. It shows hundreds of actual photographs of men at work in my magnificent new school. Tells all about wages, profits, opportunities in auto business. Explains step by step how you learn. Interesting letters from graduates telling how they made good. Shows how men come from all over the world to this big school. Make you want to join the crowd. Tells everything you want to know. I will gladly send you a copy beautifully illustrated. I'll tell you how to get into business for yourself. No colored students accepted.

Doing Work You Like
Learn from the Ground Up

A TRADE
sweeney
ELECTRICAL SCHOOL
KANSAS CITY, MO.

*Mark X
in subject
that in-
terests you*

EMORY J. SWEENEY, President
2931 Sweeney Bldg., Kansas City, Mo.

Please send me your FREE 64-page catalog and full details of your courses leading to **Big Pay Jobs**. I am interested in—

- () Flying. () Airplane Mechanics.
() Auto Mechanics. () Welding and other Trades.

Please mark X opposite subject in your mind.

Name..... Age.....

Address.....

Town..... State.....

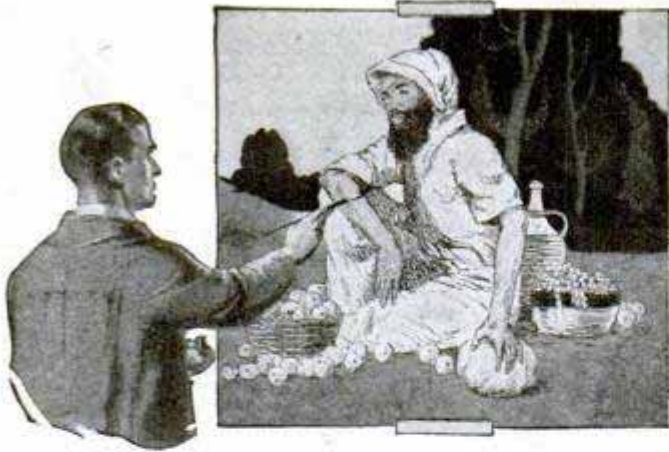

DRAWING *is a way to* FORTUNE

ALI HAFED, a Persian farmer, sold his acres to go out and seek his fortune. He who bought the farm found it contained a diamond mine which made him fabulously rich. Ali Hafed overlooked the great opportunity at his door to go far afield in search of wealth—which illustrates a great truth.

Do You Like to Draw?

If you do, it is almost certain that you have talent, a talent which few possess. Then don't follow Ali Hafed's example and look further for fortune. Develop your talent—your fortune lies in your hand!

Earn \$200 to \$500 a Month and More

Present splendid opportunities in the field of illustrating never excelled. Publishers buy millions of dollars' worth of illustrations every year. Illustrating is the highest type of art and it is fascinating as well as profitable.

The Federal Course includes illustrating, cartooning, lettering, poster designing, window card illustrating, etc. No one artist is competent to give instruction in all these branches. That's why the Federal School has established its "Master Course," in which every subject is written by a specialist. No other School can offer a course nearly comparable. No other institution in the country has such an array of artists as are on the Federal Staff.

Federal Course Gets Results

Its authors include such nationally known artists as Sid Smith, Neysa McMein, Fontaine Fox, Charles Livingston Bull, Clare Briggs, Norman Rockwell and over fifty others.

Exclusive lessons and drawings especially prepared by them are included in the Federal Home Study Course. They guide you from simple sketches to complex illustrations having a high market value.

Mail in the coupon below today and we will send you our free illustrated booklet, "A Road to Bigger Things."



Federal School of Illustrating

Federal School of Illustrating,
9136 Federal School Bldg., Minneapolis, Minn.

Name _____ Age _____

Occupation _____

Address _____

Why Don't YOU Earn This Money?



Many Earn \$50 to \$250 a Week

Let us start you making big money with a camera. No experience needed. Spare time work, big-paying positions, or a business of your own. Opportunities everywhere in all branches: Motion Picture Camera Work, Portrait and Commercial Photography.

Camera Given

Your choice of real Motion Picture Camera or professional View Camera, genuine anastigmat lens. Experts train you at home to become Professional Photographer. Free Employment Service.



WRITE FOR BOOK

Tells how to earn big money in this fascinating work. Send for Book NOW—it's FREE.

New York Institute of Photography

12 West 33rd St., New York City (Dept. 49)



NOTE:

If you prefer to come to our New York or Chicago Studios for personal instruction, day or evening classes, write for Catalog R-49 to nearest address: 10 West 33rd St., New York, or 630 So. Wabash Ave., Chicago, Ill.

& Music Lessons WITH AN ACCREDITED SCHOOL At Home

A Complete Conservatory Course By Mail

Wonderful home study music lessons under great American and European teachers. Endorsed by Paderewski. Master teachers guide and coach you. Lessons a marvel of simplicity and completeness.

Any Instrument Write telling us course you are interested in—Piano, Harmony, Voice, Public School Music, Violin, Cornet, Mandolin, Guitar, Banjo or Reed Organ—and we will send our FREE CATALOG with details of course you want. Send NOW.

University Extension Conservatory, 316 Siegel-Myers Bldg., Chicago, Ill.

BE A PLUMBER and HEATING EXPERT

Here's the opportunity of a lifetime for men who want to learn a real trade. Thousands of trained plumbers making from \$75 to \$150 a week.

A few short weeks in our shops will fit you for any branch in the plumbing field. Here you learn lead wiping, building and construction work, jobbing, estimating, blue prints and specifications.

No books, all actual, practical work under the supervision of master plumbers.

Plumbers' opportunities are everywhere. In the cities, small towns and the country. Send for our free booklet on how you can earn your expenses while learning.

ILLINOIS PLUMBING WORKS SCHOOL

512-514 N. La Salle St. Dept. 5, Chicago, Ill.



\$2500 Reward!

For the Capture of an Unknown Man

Twice he had entered the St. Clair Mansion. What was he after? Who? What was in danger?

Berteau, the famous detective, had warned St. Clair *that the mysterious marauder would come again*. And now—a noise in the passage! The creak of an opening door. A shot in the dark! A capture!

Is this wounded stranger the mysterious intruder? Who could tell? Yet Berteau identified the man without hesitation and won the \$2500 reward.

How did he do it? Easy enough for the Finger Print Expert. He is the specialist, the leader, the *cream* of detectives. Every day's paper tells their wonderful exploits in solving mysterious crimes and convicting dangerous criminals.

More Trained Men Needed

The demand for trained men by governments, states, cities, detective agencies, corporations, and private bureaus is becoming greater every day. Here is a real opportunity for YOU. Can you imagine a more fascinating line of work than this? Often life and death depend upon finger print evidence—and big rewards go to the expert. Many experts can earn regularly from \$3,000 to \$10,000 per year.

Learn at Home in Spare Time

And now you can learn the secrets of this science at home in your spare time. Any man with common school education and average ability can become a Finger Print Expert in a surprisingly short time.

Course in Secret Service

FREE

For a limited time we are making a special offer of a *professional Finger Print Outfit, absolutely Free, and Free Course in Secret Service Intelligence*. Mastery of these two kindred professions will open a brilliant career for you.

Write quickly for fully illustrated free book on Finger Prints which explains this wonderful training in detail. Don't wait until this offer has expired—mail the coupon now. You may never see this announcement again! You assume no obligation—you have everything to gain and nothing to lose. Write at once—address

University of Applied Science

Dept. 13-56 1920 Sunnyside Avenue, Chicago, Illinois

UNIVERSITY OF APPLIED SCIENCE

Dept. 13-56 —1920 Sunnyside Ave., Chicago, Illinois

Gentlemen:—Without any obligation whatever, send me your new, fully illustrated, FREE book on Finger Prints and your offer of a FREE course in Secret Service Intelligence and the Free Professional Finger Print Outfit.

Name

Street Address

City and State

CHOOSE AS YOUR PROFESSION ELECTRICIAN

FOUR 90-DAY PRACTICAL COURSES—COMMERCIAL ELECTRICAL ENGINEER

WE teach by scientific methods under practical working conditions, all branches of Electrical Engineering. No matter what your age or education there is a starting point for you at S. of E. Our **FREE** book tells all about it.

Twenty years of specializing enables us to give you better training in shorter time. Big concerns like Harnischfeger Corporation, Western Electric, Allis-Chalmers, Commonwealth-Edison endorse S. of E. training and try first to get S. of E. men. If you want to succeed in Electricity get the training with *prestige!*

IN 90 DAYS we give you complete practical training in Light, Heat, Power, AC and DC Armature Winding, Automotive Electricity, Testing or Radio. Ninety fascinating days of wonderful training in the *electrical center of America*—Milwaukee. We bring the finest engineering talent right into the class-rooms and laboratories. Men who know how to tell you to succeed in Electricity.



S. of E. Offers a B. S. Degree in 3 Years for High School Graduates or Junior Engineering Students.

\$3200 UP AWAITS the S. of E. graduate. S. of E. tops the list among schools for electrical training. Wherever men are hired for electrical work S. of E. men get the preference. S. of E. men will be found at the top in nearly every big electrical concern. Willing to help you succeed when you start in.

OUR FREE ILLUSTRATED BOOK gives full details of S. of E. training; complete information on your opportunity in Electricity, big electrical men and their salaries, what S. of E. graduates are doing.

YOUR SUCCESS IN ELECTRICITY can only be as great as your training is good. S. of E. offers you the best! The training that opens doors for you that men from electrical trade schools can never pass. As much difference between S. of E. training and others as there is between a high school and college. Yet S. of E. training takes no more time, and costs no more money.

THE GREAT ADVANTAGE from S. of E. training comes in the kind of men who teach you

Hundreds of thousands in equipment for you at S. of E. Below here is one of the seven Laboratories at S. of E.



U. S. Gov't Endorses S. of E.

At right is shown huge generating unit made by the Nordberg Mfg. Co. for Panama Canal for which S. of E. students made the Acceptance Test by special request.



CHARLES P. STEINMETZ, "electrical wizard of General Electric" was for the last six years of his life on the Advisory Council of School of Engineering.



and the equipment you have to work with. Men like Prof. John D. Ball, assistant to Dr. Steinmetz, for 5 years, work side by side with you at S. of E. Hundreds of thousands in electrical equipment help you to learn every single detail of your subject. When your fascinating S. of E. days are over you can go out and laugh at the other fellows—they won't stand a chance along side of you for you have the *real rock-bottom* training,

THE EMPLOYER AND THE MAN



"Perhaps the best recommendation is the number of students who have made good in our organization. I personally indorse the splendid educational work being done by S. of E."—H. Harnischfeger, Pres., Harnischfeger Corp.



"I am glad to submit a testimonial of my regard for your school. The early training received in your institution has assisted immensely in my accomplishments since graduation in 1907."

August Raasch, Chief Draftsman, Crane Dept. Harnischfeger Corp.

"Success is yours through a Commercial Electrical Engineering Course at S. of E. The instruction and equipment are there for you if you are man enough to try."—Charles M. Birkett, Commercial Electrical Engineer.



CAL ENGINEERING

TRAINING, 1 YEAR—B. S. DEGREE, 3 YEARS—NEW CLASSES SEPT. 1st & 27th

Work under practical conditions. Use the tools, talk the language of the real electrical business. That's why S. of E. excels. Your training is just like the real job!

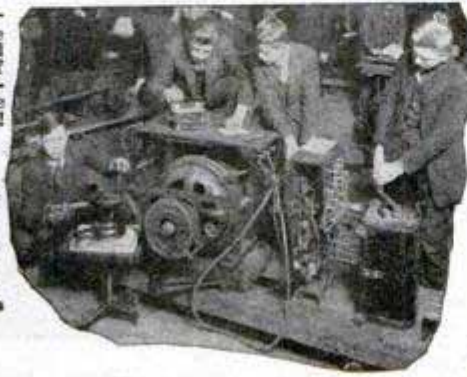

Catalogue FREE SEND COUPON

If you come to Milwaukee to prepare for your career in Electricity think of the advantages in being in the heart of the whole Electrical Industry. See the newest machinery, hear and talk to the biggest engineers, know the newest developments. Concerns like Allis-Chalmers, Harnischfeger Corp., Cutler-Hammer, make Milwaukee the electrical center of the country.



Good times are mixed with work. Fraternities, daily broadcasting from Station WSOE. At right is photo of the student parade.

ONE BUSINESS IS on the BOOM and that's electricity! Up—Up—Up—every day big new developments in power plants, central stations, electric refrigeration, battery stations, radio, commercial or residence wiring. The whole electrical industry is booming. Hundreds and thousands of new jobs are opening up every day. No slack times or lay-offs. And the man with S. of E. training is at a premium!

GET STARTED BEFORE IT'S TOO LATE—Don't wait to be pushed into an opportunity like this. Show your initiative and get started into a man's job—at a man's pay. Sit down right now and write us about your ambitions. Whatever branch of electricity, there is just exactly the right course at S. of E. to fit your needs. Our classes are purposely kept small so we can give every man lots of personal attention.

ACT NOW—CLIP and mail coupon for our illustrated catalogue. This book gives a complete picture of your opportunities in Electricity. All about salaries, progress of S. of E. graduates, where you may find opportunity, ways to go into business, etc. Act today—give yourself a chance—mail the coupon—Now!

My Personal Guarantee

"Whatever your age or experience we can train you for success in Electricity. Put yourself in my hands for a few weeks and success is yours."
OSCAR WERWATH, *President.*



GET READY FOR A CAREER! Whatever your past experience may be there is a place for you in electricity. You don't have to know anything about Electricity. S. of E. training will teach you everything you need to know to make a success.

Put away all your old ideas about success. The field of electricity will give you chances you never dreamed of. With the big concerns on a nice salary telling the other fellows how to do the hard labor. Or in business for yourself. We help and advise you in getting started.

"Thanks to the training you gave me I have never had difficulty in obtaining or holding very desirable positions. I am in the radio game and am bringing sound engineering principles to bear on the many problems that are usually solved by 'cut and dried' methods."—Waldorf A. Smith, Research Engineer, Carter Radio Co.



"The benefit of your training can best be attested by the product of the school. It is significant that the majority of S. of E. graduates obtain noteworthy and remunerative positions within a short space of time which is almost entirely due to the training received at their alma mater."—C. R. Lund, Electrical Engineer, Harnischfeger Corp.

SCHOOL of ENGINEERING of Milwaukee
Founded 1905, Dept. 126 415-17 Marshall St., Milwaukee, Wis.

SCHOOL OF ENGINEERING OF MILWAUKEE Dept. 126. 415-17 Marshall St., Milwaukee, Wis.

Without obligating me in any way, please mail free 72-page illustrated book, "Electricity and the One Best Way to Learn It," and particulars regarding the course I have marked with an X.

.... Commercial Electrical Eng. Armature Winding
.... Elec. Eng., B. S. Deg. in 3 yrs. Light, Heat, Power Wiring, Testing
.... Electrotechnics Practical Electricity
.... Automotive Electricity Junior Electrical Eng.
.... Radio Sales, Service and Broadcasting Home Laboratory Service

Name..... Age.....

Address.....

City..... State.....

Education.....

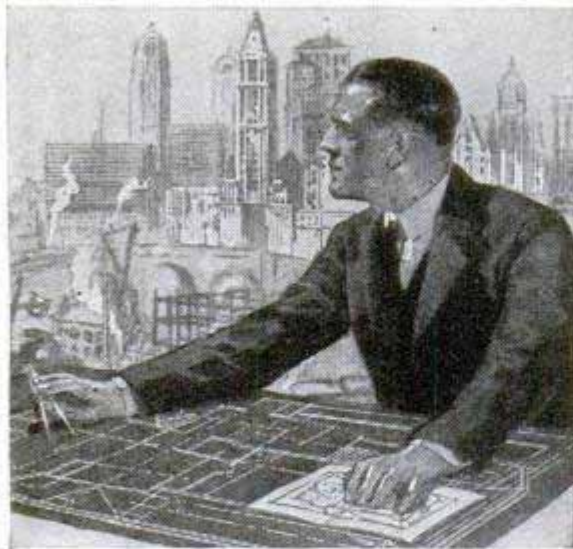

Former Bricklayer Now Earning \$12,000 a Year

"When I enrolled with the International Correspondence Schools, I was a bricklayer and I didn't know a thing about blueprints. Today I have my own contracting business and I am able to figure the most difficult jobs and execute them to the satisfaction of everyone concerned. My income is between \$12,000 and \$15,000 a year. It certainly was a lucky day for me when I sent in that I. C. S. coupon."

That's a true story of what just one student of the International Correspondence Schools has done. There are thousands of others. Every mail brings letters from men and women telling of increases in income and salary due directly to spare-time study.

One hour a day spent with the I. C. S., in the quiet of your own home, will prepare you for success in the work you like best.

Mail the coupon for Free Booklet

TEAR OUT HERE

INTERNATIONAL CORRESPONDENCE SCHOOLS

BOX 5596-E SCRANTON, PA.

Explain, without obligating me, how I can qualify for the position, or in the subject, before which I mark X.

- | | |
|--|---|
| <input type="checkbox"/> ARCHITECT | <input type="checkbox"/> Navigation |
| <input type="checkbox"/> Architectural Draftsman | <input type="checkbox"/> SALESMANSHIP |
| <input type="checkbox"/> Contractor and Builder | <input type="checkbox"/> ADVERTISING |
| <input type="checkbox"/> Building Foreman | <input type="checkbox"/> Window Trimmer |
| <input type="checkbox"/> Concrete Builder | <input type="checkbox"/> Show Card and Sign Painting |
| <input type="checkbox"/> Structural Engineer | <input type="checkbox"/> BUSINESS MANAGEMENT |
| <input type="checkbox"/> Structural Draftsman | <input type="checkbox"/> Private Secretary |
| <input type="checkbox"/> Plumber and Steam Fitter | <input type="checkbox"/> Business Correspondent |
| <input type="checkbox"/> Heating and Ventilation | <input type="checkbox"/> BOOKKEEPER |
| <input type="checkbox"/> Plumbing Inspector | <input type="checkbox"/> Stenographer and Typist |
| <input type="checkbox"/> Foreman Plumber | <input type="checkbox"/> Higher Accounting |
| <input type="checkbox"/> Sheet Metal Worker | <input type="checkbox"/> COMMERCIAL LAW |
| <input type="checkbox"/> CIVIL ENGINEER | <input type="checkbox"/> Common School Subjects |
| <input type="checkbox"/> Surveying and Mapping | <input type="checkbox"/> Mathematics |
| <input type="checkbox"/> Reading Architects' Blue Prints | <input type="checkbox"/> GOOD ENGLISH |
| <input type="checkbox"/> ELECTRICAL ENGINEER | <input type="checkbox"/> ILLUSTRATING |
| <input type="checkbox"/> Electric Lighting and Rys. | <input type="checkbox"/> Railway Mail Clerk |
| <input type="checkbox"/> Electric Wiring | <input type="checkbox"/> CIVIL SERVICE |
| <input type="checkbox"/> Telegraph Engineer | <input type="checkbox"/> Mining Engineer |
| <input type="checkbox"/> Telephone Work | <input type="checkbox"/> Gas Engine Operating |
| <input type="checkbox"/> MECHANICAL ENGINEER | <input type="checkbox"/> STATIONARY ENGINEER |
| <input type="checkbox"/> Mechanical Draftsman | <input type="checkbox"/> Textile Overseer or Supt. |
| <input type="checkbox"/> Toolmaker | <input type="checkbox"/> TRAFFIC MANAGER |
| <input type="checkbox"/> Machine Shop Practice | <input type="checkbox"/> AUTOMOBILES <input type="checkbox"/> French |
| <input type="checkbox"/> CHEMIST <input type="checkbox"/> Spanish | <input type="checkbox"/> AGRICULTURE <input type="checkbox"/> Banking |
| <input type="checkbox"/> Pharmacy <input type="checkbox"/> Poultry Raising | |

Name _____

Present Occupation _____ Business Address _____

Street _____

and No. _____

City _____ State _____

Persons residing in Canada should send this coupon to the International Correspondence Schools Canadian, Limited, Montreal, Canada.

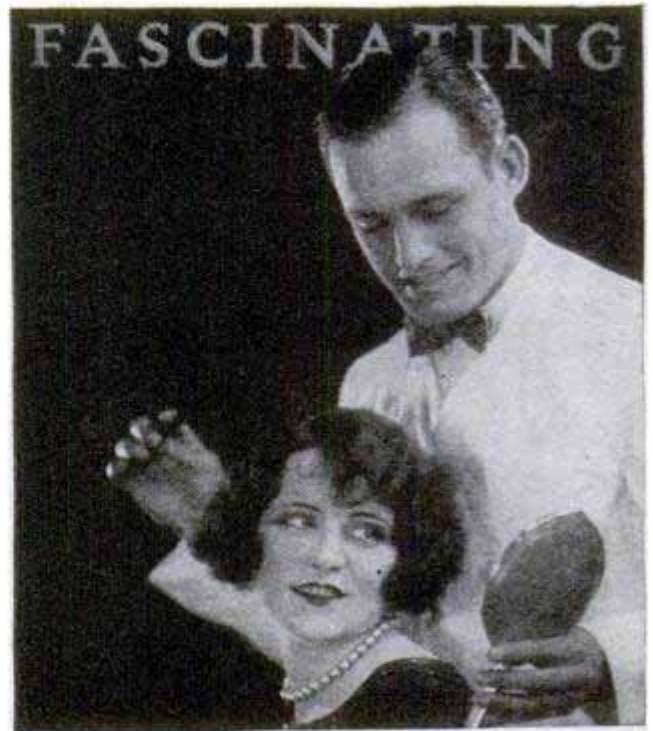

... and, perhaps you, too, due to the lack of money, time and education necessary to master a trade, wonder what to get into *quickly* and make the most out of. Haven't you *overlooked* the very thing you are looking for? 60,000 Moler graduates *know* Modern Barbering is easy to learn, *quick* to earn, *clean* and **FASCINATING!** FIND OUT! Write for catalog "B-9."

Address the Branch
of the MOLER SYSTEM OF COLLEGES nearest you.
(Street address not needed)

Chicago, Ill.	Denver, Colo.	Dallas, Tex.
New York, N. Y.	New Orleans, La.	Houston, Tex.
St. Louis, Mo.	Omaha, Nebr.	San Antonio, Tex.
Kansas City, Mo.	Milwaukee, Wis.	Seattle, Wash.
Cincinnati, Ohio	Atlanta, Ga.	Tacoma, Wash.
Cleveland, Ohio	Fargo, N. D.	Toronto, Ont., Can.
Detroit, Mich.	Memphis, Tenn.	

Learn Watchwork, Jewelrywork and Engraving

A fine trade commanding a good salary, and your services always in demand. Address **Horological**, Dept. P, Bradley Institute, PEORIA, ILLINOIS, for our latest catalog.

PREPARE FOR AN ART CAREER

—thru the *only* school operated as a department of a large art organization. Commercial Artists trained the "Meyer Both Way" earn as high as \$10,000 per year. We today have hundreds of students who had previously studied in other art schools. Why? Because your instruction is based upon our everyday experience in meeting the art needs of leading advertisers. Home study instruction. Write for illustrated book telling of the success of our students.

MEYER BOTH COMPANY

Michigan Ave. at 20th St., Dept. 16, Chicago, Ill.

NOW-Boys^{car} Men's Wages

\$75⁰⁰ to \$125⁰⁰ Weekly, Paid to

AUTO MECHANICS

Why go on begging for a raise? Why growl and complain because you don't get it? Why, when every city, town and farming community is pleading for more auto and tractor mechanics — trained as McSweeney students are trained, to know cars of every make and to know them "inside out"?

Every month my men are taking fine jobs formerly filled by half-trained students or half-baked, self-trained mechanical tinkers.

I Train You in 8 Weeks

Think of it! Working with real tools on real equipment you become in only EIGHT WEEKS a better auto mechanic than men who have "fiddled" around an ordinary garage for years trying to learn. Let me send you the proof, letters from former McSweeney students now earning up to \$10,000 a year. "Mac's SHOP WAY Means Bigger Pay."

Your Money Back Guaranteed

If, when you have finished your training, you are not perfectly satisfied; if you are not qualified to fill a big pay job, I will re-



McSWEENEY SCHOOLS
 AUTO, TRACTOR AND ELECTRICAL
 CINCINNATI, OHIO CLEVELAND, OHIO



BUCHSTEIN'S FIBRE LIMB
 is soothing to your stump—strong, cool, neat, light. Easy payments. Braces for all deformities.
D. BUCHSTEIN CO.
 610 3rd Ave., So. MINNEAPOLIS, MINN.

Send for Catalog Today

fund every cent of your tuition. There is a reason for my making such a convincing offer. Ask yourself why. Then write quick for my remarkable SPECIAL TUITION OFFER. Save one-third now. See what you get:

FREE Your Board for 8 Weeks and Your Railroad Fare

For a limited time only I will pay your railroad fare to Cincinnati or Cleveland and give you your board free for 8 weeks. Send the coupon NOW—before it is too late—for my big illustrated book and full particulars of this amazing offer. Don't delay.

McSWEENEY Auto, Tractor and Dept 10-14 Electrical SCHOOLS
 Cincinnati, Ohio
 Cleveland, Ohio

Please send your Special Offer and Big Illustrated Book.

Name

Address

City.....State.....

"THERE'S MONEY IN IT"

AT HOME LEARN TELEGRAPHY AT HOME

MORSE AND WIRELESS

TEACH YOURSELF in half usual time, at trifling cost, with the wonderful Automatic Transmitter, **THE OMNIGRAPH**. Sends unlimited Morse or Continental messages, at any speed, just as an expert operator would. Adopted by U. S. Government, and leading Universities, Colleges and Telegraph Schools. 3 Styles. Catalog free. **OMNIGRAPH MFG. CO., 13-19 Hudson St., NEW YORK**

If you own a Radio Phone Set—and don't know the code—you are missing most of the fun.

DO YOU LIKE TO DRAW?

It's Easy To Learn When Shown In The Right Way

Some of cleverest cartoonists and comic artists in America today learned how to draw quickly—by following **CARTOONIST EVANS' SIMPLE AND EASY METHOD**. This school is recommended by foremost cartoonists because they know the students are handled right. If you like to draw, send 6c in stamps for **portfolio of cartoons and full details**. The course is **NOT EXPENSIVE**.

The W. L. Evans School of Cartooning 821 Leader Building CLEVELAND, OHIO



WORK FOR "UNCLE SAM"
 \$1700 to \$3000 Year

RAILWAY POSTAL CLERKS MAIL CARRIERS

TRAVEL—See Your Country MEN, WOMEN, 17 UP SHOULD MAIL COUPON IMMEDIATELY

Steady Work No Layoffs Paid Vacations

RAILWAY MAIL CLERKS

FRANKLIN INSTITUTE
 Dept. A179, Rochester, N. Y.

Sir: Rush to me without charge (1) Specimen Railway Postal Clerk and Mail Carrier Examination questions; (2) FREE 32 page book with list of U. S. Government positions obtainable and sample coaching lessons.

Name.....

Address.....

COUPON →

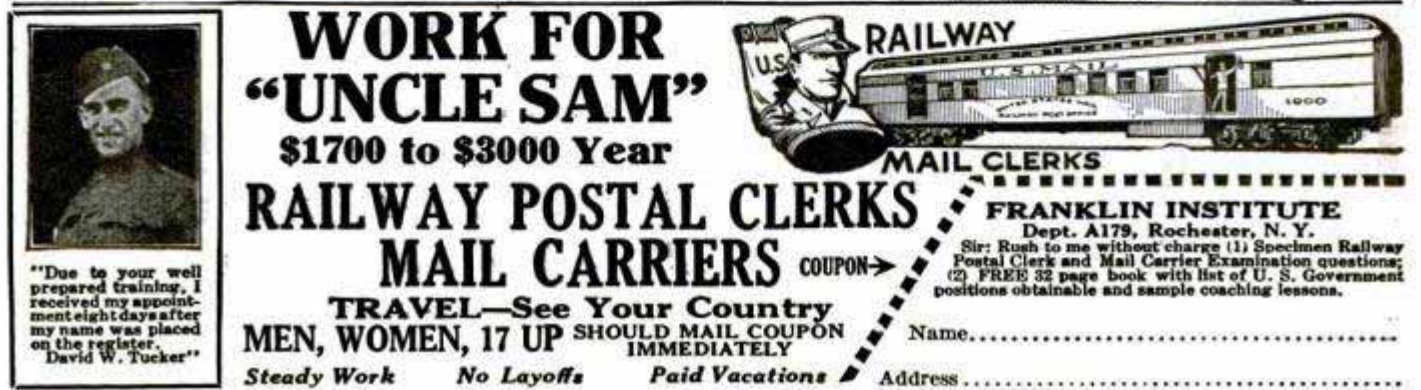

New Way to Learn

HERE'S BIG NEWS for men interested in Electricity, *men earning less than \$40 a week.* Here's the **QUICKEST** way to an Electrical **EXPERT'S** job at \$60 to \$125 a week. The first announcement of our new, rapid, simplified way to train you at Home in spare time, with **LESSONS, JOB-TICKETS** and **OUTFITS.** *Lessons* which take the mystery out of Electrical principles—*Job-Tickets* which apply what you learn in lessons, and give you step-by-step directions for doing actual Electrical Work. *Outfits* of standard tools and materials with which you **DO THE JOB.** Read this sensational announcement. It opens the way to a better job and bigger pay.

Chief Engineer
Dunlap

1 —with LESSONS!

The laws of Electricity **MADE EASY TO UNDERSTAND.** In simple language, written for the man with only common schooling. In the *first* half we cover the subjects usually found in many entire correspondence courses. Then in the *second* half we give you the advanced work, the Engineering subjects absolutely necessary if you aim to fill one of the **BETTER-PAID** jobs in Electricity.

Seven (7) Electrical Outfits Given!

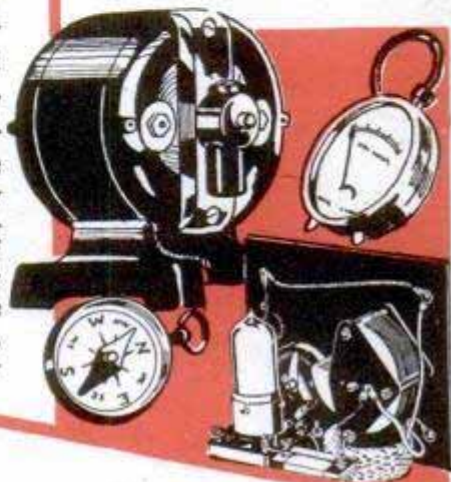

2 —with JOB-TICKETS

Job No. 11 Installing Service Box



A wonderful new system originated at the American School. After you have the **THEORY** you "out on the job" with **job-tickets** and **outfits.** These job-tickets are illustrated, and give one-step-at-a-time directions for doing practical work. They show which materials and tools to use and tell you the **short-cuts** and **new ideas** used by Electrical **EXPERTS.**

3 —with OUTFITS!

SEVEN (7) outfits of standard tools and materials now supplied without extra charge to every student. With lessons to explain *why* and job-tickets to tell you *how*, this valuable equipment enables you to get a practical slant on electricity—**quick!**

1. Soldering Kit and Furnace
2. Bell-wiring Equipment
3. Electric-light wiring equipment
4. Voltmeter and compass
5. Transformer
6. Radio Receiving Set
7. Man-size MOTOR

I send it to you "knock-down" with job-tickets for wiring the field and the armature. For changing the voltage. For converting it to a Generator. The same kind of work they pay experts big salaries to do.

**AMERICAN SCHOOL
CHICAGO**



ELECTRICITY!

BIG SALARIES

waiting for you in Electricity!

Electricity is one of the greatest, FASTEST GROWING businesses you can get into. Leaders like EDISON, MARCONI and INSULL say it offers bigger opportunities today than ever before, that young men can make more money and climb higher here than in other fields. Even skilled Electricians earn bigger pay than mechanics in other lines. But with my training you can prepare for the BOSS-JOBS in Electricity, positions as Chief Electrician, Superintendent of Power Plant, Electrical Draftsman, Electrical Contractor, Superintendent of Electrical Construction, etc. Positions paying from \$250 to \$500 a month and more.

Thousands of Opportunities!

Our Employment Service reports a big demand for trained Electrical men by Electrical Power Plants, Electrical Manufacturing Companies, Telephone, Radio and Cable corporations, by Contractors, Builders and Steamship lines.

FREE JOB SERVICE!

We can frequently help our students find a **beginner's job** in Electricity within a few weeks after enrolling. And in addition, we accept your enrollment with the positive agreement to help you find a well-paid Electrical position within 60 days after completing this training, **or your tuition will be refunded.**

GUARANTEED TRAINING!

When we accept your enrollment for this wonderful home-instruction in Electricity we give you an agreement in writing, that it will lead to definite benefits in position and salary, *otherwise every penny you have paid will be refunded.* The American School believes home-training, like other things, should be *guaranteed* as proof of its value.

NEW WAY TO START!

Find out if you LIKE Electrical work—find out if our lessons and job-tickets are EASY

to master. Don't take our word for it—SEE for yourself before you decide. START with the COUPON, below. We'll send you 3 Electrical Lessons and 5 Job-tickets absolutely FREE—the same material sent to new students when they pay their money and enroll—to prove that you can learn at home in your spare time—to prove this training is honest, complete and SIMPLE. The most amazing offer in the history of home-training to

enable you to get started IMMEDIATELY without risking a penny.

Start with the Coupon!

TRAINING built by 23 Noted Engineers

This is no one-man, one-idea school. Engineers from the leading Electrical corporations and Universities have helped me develop this complete home-instruction, men of such high standing, that they would not lend their names to any instructor or school which did not give honest service to every student. Lesson texts prepared by men from:

1. General Electric Co.
 2. Commonwealth Edison Company
 3. Crocker-Wheeler Co.
 4. Cutler-Hammer Mfg. Company
 5. American Telephone & Telegraph Co.
 6. Westinghouse Electric & Mfg. Co.
 7. Western Electric Co.
 8. Underwriters Laboratories, Inc.
 9. Columbus University
 10. Dartmouth College
 11. Massachusetts Institute of Technology
 12. Lehigh University
 13. University of Vermont
- AND MANY OTHERS



THE AMERICAN SCHOOL

Now beginning its 30th year of service. Chartered as an EDUCATIONAL institution. Not one dollar in profits has ever been paid out, every cent received for tuition has been returned to our students in instruction and service. Over 200 educators, executives and engineers have prepared the instruction we offer, Financial responsibility ONE MILLION DOLLARS.

CHIEF ENGINEER DUNLAP, Electrical Division

AMERICAN SCHOOL

DREXEL AVENUE and 58th STREET
Dept. E-674, CHICAGO

Send no Money

Chief Engineer Dunlap, Electrical Division
AMERICAN SCHOOL

Dept. E-674, Drexel Avenue and 58th Street, CHICAGO

Send me please 3 Electrical Lessons, 5 Job-tickets, absolutely FREE and facts about the great Electrical business, without obligating me in the slightest degree.

Name.....

St. No.

City.....State.....

CHICAGO TECHNICAL COLLEGE

**Drafting
Engineering
Electricity
and Architecture**

[23rd Year]

A MAXIMUM of practical training in a minimum of time is offered you by one of "America's oldest and largest schools of specialized engineering" ... technical training of college standard for men who have neither the time, money nor preliminary education to attend a university. Over 1000 men enroll each year in day and evening classes.

Short, Intensive Training

of a very practical sort puts you immediately into a high salaried position. Many of our students are assisted to responsible positions before graduation ... they earn while they learn.

Chicago Technical College Bldg.



If you can't come to Chicago STUDY AT HOME

Ten months from today you can be a trained draftsman... Trained men are in demand... at high salaries. Enter a profession, without sacrificing time. Study

DRAFTING

In your spare time... We have been giving technical training for 23 years... Instructors are experts, the same instructors as in the resident school.

FREE TRIAL LESSON

To see how much you will like this high-grade profession, and

FREE OUTFIT

a regular \$25 draftsman's outfit is included in the price of the course.

Send for 40-Page Book

of facts about drafting... send for it... free. Write today for the Free trial lesson in drafting, sample drawings made by students and the book of information. Address Dept. 930.

Courses are arranged to suit your needs: 2-year diploma; 3-year B. S. degree; special short courses adapted to the individual. Instructors are experts, actively at work in the very professions they teach. Tuition is low, terms easy. Enter any time.

Write for Free 72-Page Blue Book

It tells about the courses (full descriptions); about the great demand for Chicago Technical College trained men; about college athletics and other interesting facts you'll want to know. Send for the Blue Book now, without obligation! Address

Chicago TECHNICAL College

Dept. 18, 118 East 26th St., Chicago

ELECTRICITY

Practical-Technical TRAINING

Free

Great demand for practical-technical electricians and engineers. Fascinating work. Rapid advancement. Thousands of positions open. Finlay trained men earn \$10 to \$25 a day and more. Send today for latest catalog, beautifully illustrated, explaining One and Two year courses in Electrical Engineering. Also 12 weeks course in Practical Electricity. Degrees and certificates of efficiency awarded.



Courses to suit your needs

Finlay condensed method now in 24th successful year trains head and hand. Completely equipped shops and laboratories. Faculty of trained experts. Students assisted to positions.

EARN \$10 to \$25 A DAY

FINLAY ENGINEERING COLLEGE
111 Finlay Bldg., Kansas City, Mo.

Fall term starts September 15th

LEARN TENOR BANJO



Banjoists! Earn big money through Charles McNeil's famous Home Study Banjo Course. Simple as A B C—yet has all technical requirements. Includes phonograph records, demonstrating jazz strokes, "breaks" and chords, played by Charles McNeil, 5 years with Isham Jones-Brunswick Records. Easy payments. Send for Free Book.

Chicago Tenor Banjo Institute
Dept. 1356
621 N. Lincoln St. Chicago, Ill.

ASK FOR FREE BANJO OFFER NOW!



Hotels Start You With Salaries up to \$3500 a Year — with your living

HOTELS, restaurants, clubs, apartments, everywhere need trained men and women—salaries to start up to \$3500 a year with your living. Over 70,000 high-class positions paying up to \$10,000 a year are open every year in the hotels of the United States. Today this is the 4th INDUSTRY IN AMERICA—with over \$1,000,000,000 in new hotels and clubs being built in 1926. These new hotels, clubs, restaurants, etc., will need nearly 200,000 trained men and women. You can have one of these high-class big-pay positions, fascinating work and luxurious meals and apartment usually furnished FREE! No previous experience necessary. The Lewis Schools guarantee to give you the valuable knowledge that it has taken some of the most successful hotel men years to obtain—men who are now making \$5,000 to \$50,000 a year. We train you by mail in your spare time at home with the Lewis Simplified Study Plan, and we put you in touch with big opportunities. Our students employed, our methods endorsed by leading hotel men everywhere. Send today for Free Book, "YOUR BIG OPPORTUNITY," showing how we can train you for one of these splendid positions, and explaining our Money-Back Guarantee.

LEWIS HOTEL TRAINING SCHOOLS
Room D-388 Washington, D. C.

FREE BOOK COUPON
LEWIS HOTEL TRAINING SCHOOLS, Room D-388, WASHINGTON, D. C.
Send me without obligation the Free Book, "YOUR BIG OPPORTUNITY."

Name

Address

City.....State.....

Be an EXPERT DECORATOR

In a few weeks

EARN \$75⁰⁰ to \$150⁰⁰ a WEEK

SEND COUPON TODAY—for my FREE book



Thousands of men are now happily drawing BIG PAY CHECKS because they got my real practical training—They are top notchers getting BIG PAY.

LET ME HELP YOU

Let me help you to one of these big Pay jobs or better still, I'll show you how to start a business of your own. I've made hundreds of men successful and I will do the same for you.

The Best of All Trades

Sign Painting—Decorating—Paperhanging—Graining & Marbling—
Show Card Writing—Pictorial Painting—Auto Painting & Spraying

The American Painter & Decorator Journal says— **OVER 30,000 PAINTERS SHORT**

Over 30,000 Painters needed right now is proof that the field is not overcrowded and that is not all—These trades are not fads, they don't come and go as new things spring up—They have been growing ever since paint was discovered and are more and more in demand each year.

Learn a Trade that's Permanent

Get into this big paying profession at once, put on white overalls and cap, be a Clean, Healthy mechanic at the Best Pay of them all—Send Today for my big FREE CATALOG and Special offer of

FREE Railroad Fare to Chicago to All Who Enroll NOW

To celebrate our 25th year I will pay your R. R. Fare to Chicago. This offer is for a short time only—DON'T DELAY. Write at once—

Chicago Painting School
147 W. Austin Ave.
DEPT. 10 CHICAGO ILL.

SEND THIS TODAY!

MR. HARRY GLICK, Principal
CHICAGO PAINTING SCHOOL
147 W. Austin Ave., Dept. 10

Dear Sir: Send me your free Catalog, describing your courses, and Special offer with no obligation on my part.

Name

Street

City..... State.....

CHICAGO PAINTING SCHOOL

BOYS

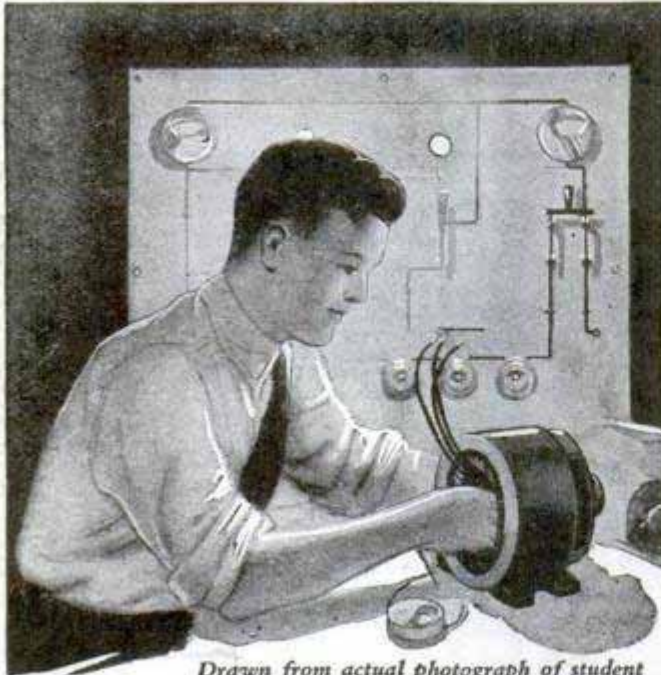

Drawn from actual photograph of student doing spare time electrical work

Learn Electricity Make Big Money

How would you like to earn two or three dollars every evening after school and prepare yourself for a fine big job at the same time? Here's the opportunity of a lifetime for you fellows who like Electricity. Begin right now to prepare yourself for a regular man's size job in this fascinating field. Your chances for a big success are simply wonderful—the pay is big (thousands of men earn \$70 to \$200 a week) and advancement comes swift and sure.

I Will Train You at Home

With my easily earned, spare time Electrical Course I will train you at home like I have trained hundreds of other boys who are now big successful men. It will not interfere with your school work and you can earn more than the small cost of the course doing odd electrical jobs in your spare time. The Course pays for itself. I will show you how to get this work and how to do it. Some of my boy students make \$10 to \$15 a week this way.

Tools, Apparatus and Radio Course —Given Without Extra Charge

Send me the coupon below and I will tell you all about the big outfit of tools, apparatus and instruments and a new Radio Course that I am giving to my students for a limited time. I will send you my big interesting Electrical Book and a sample lesson, too—all Free. You will be tickled with the things I will send you Free. Mail the coupon right now.

L. L. COOKE, Chief Engineer
Chicago Engineering Works
Dept. O16 CHICAGO

Look What This Boy Is Doing

"Although the School term is coming to a close, and I am pretty busy with my examinations, I manage to keep up with my electrical studies and work.

"I guess I forgo to tell you I am now in business for myself. Am doing fine, but owe it all to you. If it had not been for your Course, I, being under age, could not have secured my license in this town. But I got it, and now have all the work I can do, averaging \$20 to \$30 a week, thru spare time work.

"I went out on a job tonight after school, on which I made \$3 and brought home another on which I made \$2.50—\$5.50, for 4 hours' work and no material furnished by me."

ROGERS SMITH,
1215 Chestnut St.,
Greenville, N. C.

Use This "FREE BOOK" Coupon

L. L. COOKE, Chief Engineer,
Chicago Engineering Works,
Dept. O16 2150 Lawrence Avenue, Chicago

Send me your Big Outfit Offer, your big Electrical Book, Sample Lesson and particulars of your Electrical Course and Extra Radio Course. This will not obligate me in any way.

Name.....

Address.....
This Coupon only for use of boys 15 years old or more.

Be a REAL ESTATE Specialist

Learn my amazingly successful system—right at home—in your spare time. Let me train you for real success. Let me put you in touch with big business. Let me do for you what I have done for other wide-awake men and women. D. H. Garrett says: "Made \$630 in one week before I was half through your training." Mrs. A. Moore says: "Have a new car, a dandy office and money in the bank, all through my own efforts and without any capital to start with." M. I. Stokes says: "Made \$900 in three months in my spare time." Send your name and address at once for my new, free book, "How to Become a Real Estate Specialist," giving full facts about my remarkable Home-Study Course, my Free Business Service and positive proof of big success. Address DIRECTOR, Dept. 44-X, American Business Builders, Inc., 18 East 18 Street, New York, N. Y.



BART SUPPLIES

Quality art materials at lowest prices. Save on everything you need. Convince yourself—send today for catalog.

BART SUPPLIES, 417 Eustis Bldg., MINNEAPOLIS, MINN.

COOK WITHOUT COAL

At last the ideal way to cook in the summer without coal or wood has been discovered. This is a new invention called a "Heat Fountain" which converts any stove or range into a gas stove. It combines ordinary kerosene (coal oil) with air to have a perfect cooking gas. No piping—no changes to your present stove or range necessary. Simply slip this little device into it and you have instant cooking heat at the turn of a valve. Easily regulated to simmer a tea kettle or bake an oven full of bread. Already over 275,000 women have found this wonderful device a veritable life saver. Find out how you can do away with the misery of a hot kitchen in summer—get rid of soot, ashes, dirt, smoke and drudgery of coal and wood. Yet use your own range. Use this new invention on 30 days trial. Simply write for free book, and full details of our offer. Send name and address to

OLIVER OIL BURNER CORP.

Dept. L-130 210 Chestnut Street St. Louis, Mo.

How to Get a Position with the U. S. Government

Thousands of appointments are made yearly. Good salaries—short hours—liberal vacations (as much as 30 days in some branches of the service).

Common school education sufficient as groundwork for most positions. The International Correspondence Schools will help you prepare right at home to pass your Civil Service examination with a high mark.

Mail the coupon today for 48-page
Free Civil Service Booklet

INTERNATIONAL CORRESPONDENCE SCHOOLS
Box 5601-E, Scranton, Penna.

Without cost or obligation, please send me a copy of your 48-page CIVIL SERVICE BOOKLET, which tells how I can prepare to secure a good-paying position with the U. S. Government.

Name.....

Address.....

Discovered!

The Scientific Secret of Caruso's

Amazing Vocal Power

A post mortem of Caruso's throat showed superb development of his Hyo-Glossus muscle—again proving the soundness of Eugene Feuchtinger's theories of voice production.

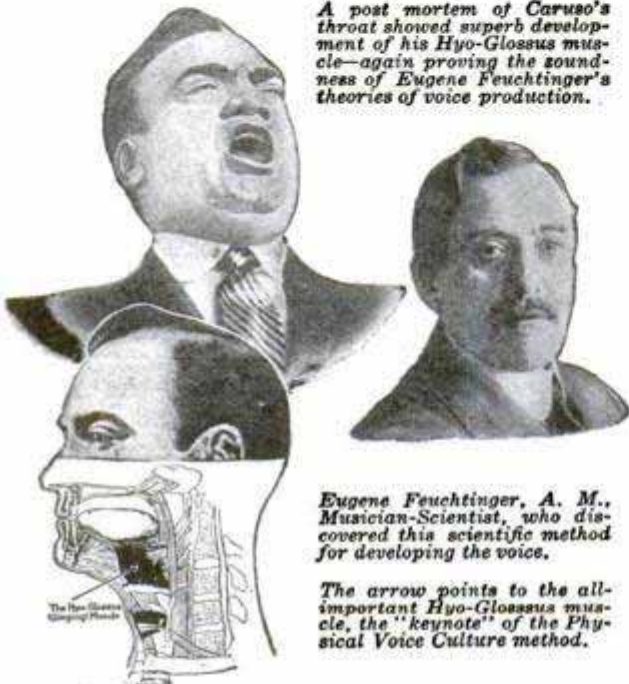

Eugene Feuchtinger, A. M., Musician-Scientist, who discovered this scientific method for developing the voice.

The arrow points to the all-important Hyo-Glossus muscle, the "keynote" of the Physical Voice Culture method.

The Great Discovery

Professor Feuchtinger, A. M.—famous in the music centers of Europe—discovered the secret of the Hyo-Glossus muscle. He devoted years of his life to scientific research and finally perfected a system of voice training that will develop your Hyo-Glossus muscle by simple, silent exercises right in your own home. Since the Professor brought his discovery to America—over 10,000 happy pupils have received his wonderful training.

100% Improvement Guaranteed

The Perfect Voice Institute guarantees that Physical Voice Culture will improve your Voice 100%. You are to be your own judge—take this training—if your voice is not improved 100% in your own opinion, your entire tuition will be refunded.

Inspiring Book FREE Send the coupon below and we'll send you FREE this valuable work, "Physical Voice Culture". You assume no obligation. It may be the first step in your career. Do not delay.

Perfect Voice Institute

1922 Sunnyside Ave., Studio 13-56 Chicago

Perfect Voice Institute 1922 Sunnyside Ave. Studio 13-56 Chicago

Please send me a copy of your new book, "Physical Voice Culture", FREE. I understand that it is mine to keep and there is no obligation on my part. I am interested in

Singing Speaking Stammering Weak Voice

Name

Address

Age

Learn



Aviation

At Home in your spare time. Be an expert Airplane Engineer.

Earn \$3,500 to \$10,000 a Year

Practical course—takes only a few months. Write for special offer on free airplane parts and free catalog.

WESTERN AIRPLANE CORPORATION
Dept. M-9 Monadnock Block CHICAGO

Don't Envy The Plumber BE ONE!

\$11.00-\$16.00 PER DAY and work **EVERY** day, is the Plumber's wage.

Every skilled workman will tell you that Plumbers have the best of it. WINTER and SUMMER the Plumber is busy at top wages. No skilled Plumber is ever out of a job—compare his opportunities with any trade, plus the opportunities of having your own shop.

We teach you Plumbing with **TOOLS** (not books) under Licensed, Master **PLUMBERS** in one of the finest equipped schools in America. We make you a Plumber, every branch is taught thoroughly—Lead Work—Blue Print for plan reading—all other tricks.

LEARN IN 8 to 12 WEEKS without previous experience. If you are making less than \$50.00 a week you owe it to yourself to investigate. Get **FREE** catalog that tells in pictures and words how we teach this trade. Special rates now.

KANSAS CITY SCHOOL OF PLUMBING
2030 Troost Ave. KANSAS CITY, MO.



NOW ONLY \$2.00

Giant Chest Expander

and Progressive Exerciser

Be a muscular Marvel. Have the muscles of a superman. Become strong for your health's sake or to astound your friends with extraordinary feats which only men of giant strength can do.



Free instructions. The Giant Chest Expander and Progressive Exerciser is made with new, live springy rubber so as to give it long wear and great resisting qualities. Sold with a guarantee to give entire satisfaction or money back. Made two ways, either

5 Cables or double strength 10 Cables

for **\$2** The double strength exerciser has resistance of over 200 lbs. for **\$4**

Order Today Send at once and get your Giant Exerciser at the present low introductory price. This price is made so low because we want everyone to enjoy muscles and strength at the lowest possible cost. Don't pay more—order from us—get the most for your money. Use coupon now.

PROGRESSIVE EXERCISER CO.,
4009 Langdon Bldg.,
Broadway and Duane Street, New York

Enclosed (\$4 for your 10 cable Progressive please find) \$2 for your 5 cable Exerciser. (Check the Exerciser you want.) It is understood that if I am not satisfied with this Exerciser, I will return it within 5 days and get my money back.

Name
Address
City State

Use This Money Saving Coupon

Learn How to BOX

JIMMY DeFOREST BOXING COURSE

Teaches by mail the same System he taught Champion JACK DEMPSEY

In 20 weeks, under the System of Jimmy DeForest, World's Greatest Trainer and Maker of Champions, you will master the priceless knowledge that made Jack Dempsey his millions, and fortunes for a host of other Jimmy DeForest-trained ring stars. Every 6 months 30 are selected from all classes and recommended to leading promoters for boxing engagements. That's how pupils are brought to the front at once. Boys who were once rank amateurs are today earning big money; weaklings have been made strong, courageous; men have learned the art of self-defense. Send today for the now famous book, "The Golden Age of Boxing," greatest book of its kind ever written; full of valuable information, photos of great fighters and pupils who became successes over night. Enclose 10c to cover cost of mailing, etc. Write now.



JIMMY DeFOREST BOXING COURSE 347 Madison Ave., Box 609, NEW YORK CITY



AXEL CHRISTENSEN

(Famous Vaudeville and Radio Star)

Will Teach You

JAZZ PIANO PLAYING IN 20 LESSONS

His wonderful system has made thousands of successful pianists since 1903.

There is a "CHRISTENSEN SCHOOL" in nearly every city—see your phone book for local address—or lessons given by mail.

SEND FOR FREE BOOKLET

GET AXEL'S COMPLETE JAZZ INSTRUCTION BOOK, showing how to "Jazz Up" any tune, with new breaks, fills, bass and chord work, from your local teacher or sent postpaid for \$2.

PIANO TEACHERS: If there is no "Christensen School" in your town, this is your golden opportunity—write quick for lucrative proposition.

CHRISTENSEN SCHOOLS OF POPULAR MUSIC
Suite 421 20 E. Jackson Blvd., Chicago

"The Palmer Course would have saved me years of labor."

Jim Tully



JIM TULLY, whose work recently appeared in five different magazines in the same month, one of them *Liberty*, says: "I recall writing my first short story . . . it was a tale of the ring called 'Battle Galore,' and Clayton Hamilton gave me advice on how to 'build it up.' . . . I am certain that the Palmer Course would have saved me years of labor."

Think what it would mean to you to have at your elbow as you write, a man who can impart to you that elusive something that makes characters live and stories grip—what most writers spend years to acquire. That, and more, the Palmer Institute can give you. Though you study in your home, in spare time, you find Palmer Courses uniquely personal.

PALMER INSTITUTE OF AUTHORSHIP
Palmer Building, Hollywood, Cal. 110 J

CLAYTON HAMILTON - - - - President
FREDERICK PALMER - - - - Vice-president

Please send me, without any obligation, details about the course I have checked.

- Short Story Writing
- English and Self-Expression
- Photoplay Writing

Name.....

Address.....

All correspondence strictly confidential
No salesman will call on you

Aviators

Preparatory Institute

INCORPORATED

475 Fifth Avenue - - NEW YORK



WALTER HINTON

YOUNG MEN

PREPARE NOW

Walter Hinton, President of the Institute, former United States Navy Aviator, piloted the famous NC-4 in the first flight across the Atlantic Ocean, in May, 1919. He flew the first plane between New York and Rio de Janeiro in 1922-23. In March, 1924 Mr. Hinton returned to Brazil as a member of the Alexander Hamilton Rice Expedition where he explored and mapped by air thousands of square miles of unknown jungle territory.

The Age of Flight is Here

A great industrial development in air transport has begun in the United States. The good places will go to young men with the necessary knowledge and training. These young men will be the aircraft engineers and executives, the operating officers and pilots who, during the next few years, will contribute to America's Air Supremacy.

You cannot learn to fly by home study, but the first step toward learning to fly or proficiency in any other branch of aeronautics is

ATHOROUGH KNOWLEDGE OF PLANES, AIRCRAFT ENGINES, CONSTRUCTION, INSTRUMENTS, AND WHY AN AIRPLANE FLIES.

This knowledge is now available in easily understood form in the Thorough and Comprehensive

Spare Time Study Course of the AVIATORS PREPARATORY INSTITUTE

Under Mr. Hinton's Personal Direction

Mail the Coupon for Complete Information and Synopsis of the Course

AVIATORS PREPARATORY INSTITUTE, INC.
475 FIFTH AVE., NEW YORK.

Without obligation, please send me full details of Walter Hinton's aeronautical study course.

.....
.....



High School Course in Two Years!

You Want to Earn Big Money!

And you will not be satisfied unless you earn steady promotion. But are you prepared for the job ahead of you? Do you measure up to the standard that insures success? For a more responsible position a fairly good education is necessary. To write a sensible business letter, to prepare estimates, to figure cost and to compute interest, you must have a certain amount of preparation. All this you must be able to do before you will earn promotion. Many business houses hire no men whose general knowledge is not equal to a high school course. Why? Because big business refuses to burden itself with men who are barred from promotion by the lack of elementary education.

Can You Qualify for a Better Position

We have a plan whereby you can. We can give you a complete but simplified high school course in two years, giving you all the essentials that form the foundation of practical business. It will prepare you to hold your own where competition is keen and exacting. Do not doubt your ability, but make up your mind to it and you will soon have the requirements that will bring you success and big money. **YOU CAN DO IT.**

Let us show you how to get on the road to success. It will not cost you a single working hour. Write today. It costs you nothing but a stamp.

American School

Dept. H674, Drexel Ave. and 58th St., Chicago

American School

Dept. H674, Drexel Ave. and 58th St., Chicago

Send me full information on the subject checked and how you will help me win success.

- | | |
|-----------------------------|---------------------------|
|Architect |Business Law |
|Building Contractor |Lawyer |
|Automobile Engineer |Machine Shop Practice |
|Automobile Repairman |Mechanical Engineer |
|Civil Engineer |Shop Superintendent |
|Structural Engineer |Employment Manager |
|Business Manager |Steam Engineer |
|Cert. Public Accountant |Foremanship |
|Accountant and Auditor |Sanitary Engineer |
|Bookkeeper |Surveyor (& Mapping) |
|Draftsman and Designer |Telephone Engineer |
|Electrical Engineer |Telegraph Engineer |
|Electric Light & Power |High School Graduate |
|General Education |Wireless Radio |
|Vocational Guidance |Undecided |

Name.....

Address.....

LAW

THIS BOOK **FREE!**

Study at Home

Become a lawyer. Legally trained men win high positions and big success in business and public life. Greater opportunities now than ever before. Earn \$5,000 to \$10,000 Annually!

We guide you step by step. Degree of LL.B. LaSalle law graduates practicing in every state. We furnish all text material, including 14-volume Law Library. Low cost. Easy terms. Valuable, interesting 96-page book free. Send for it NOW.

LaSalle Extension University, Dept. 964-L Chicago



Learn to PAINT SIGNS and SHOW CARDS

We quickly teach you by mail, or at school, in spare time. Enormous demand. Big future. Interesting work. Oldest, foremost school. **EARN \$50 TO \$200 WEEKLY**

John Vassos, N. Y., gets \$25 for single show card. Crawford, B.C., says: 'Earned \$200 while taking course'. Send today for free information, samples and guarantee.

DETROIT SCHOOL OF LETTERING
154 Stimson Ave. Est. 1899 Detroit, Mich.



FREE Electrical Training Book

Mail postcard for amazing FREE book on electricity. Shows you how to earn \$150 to \$600 a month in this immense field. Famous S & H shop-type training fits you quick at home for big jobs. Exclusive system. Lack of experience or education no bar. Write **S & H Engineering Co., 1422 W. Monroe St., Dept. L-1, Chicago, Ill.**

BE A RAILWAY TRAFFIC INSPECTOR

PAYS UP TO \$250 per Month

NO Hunting for a Position After Completing Your Training



Read what R. H. Kruger says: 'Having completed your course in Traffic Inspection, I find that it is very interesting work; also it is one of the most interesting studies of today. The work is very fascinating, and I would be glad to advise anyone wishing to take up this course, as it is sure wonderful work, with a splendid future. Your Diploma means Prosperity.'

Our students never worry about a position. You start at \$120.00 per mo. or more, expenses paid. Our guarantee explains how you take no risk.

Railway Traffic Inspection is a delightful, uncrowded profession with unlimited advancement opportunities. Regular hours, outdoor work, travel, reporting to high railway officials.

Hundreds of Satisfied Graduates

Send coupon for details and guarantee agreeing to refund your money if position is not secured upon graduation.

STANDARD BUSINESS TRAINING INST. Buffalo, N. Y.

Send me, entirely free, Booklet No. D-301, giving full particulars about course in Railway Traffic Inspection.

Name.....

Street.....

City.....

[R. R. FARE PAID TO CHICAGO]
[ON ALL CASH ENROLLMENTS]

This amazing New Idea means Big Pay *quicker*—for you

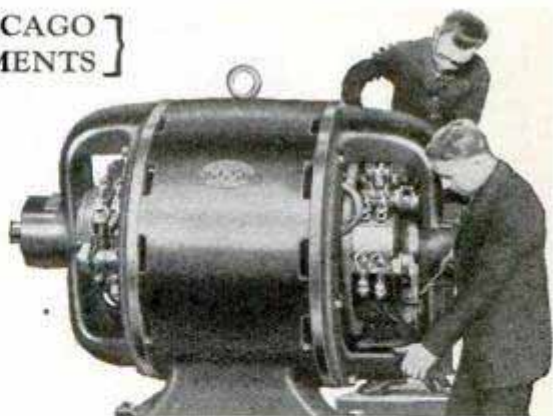

ELECTRICAL

Here at last is the chance you've been wanting. Now, a practical course in Electricity or Radio, made more fascinating and more valuable than ever before. Not a home study course. Not a lecture course. A real start into **actual electrical work** and Big Pay! Don't let this opportunity get away from you. Act now. Clip that coupon below and mail it right this minute. It brings you our big free book and offer.

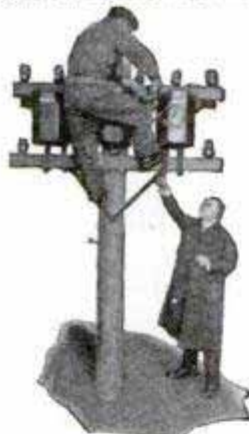

An experiment on the high tension line in the Greer Shops

Do you want to fit yourself for one of these jobs?

- Electrical Contractor Up to \$25,000 per year
- Electrical Estimator Up to \$15,000 per year
- Maintenance Engineer \$3,000 to \$5,000 per year
- House Wireman \$1.00 to \$2.00 per hour
- General Electrical Repairman \$1.00 to \$1.75 per hour
- Motor and Generator Expert \$1.00 to \$1.50 per hour
- Armature and Stator Winder \$1.00 to \$1.50 per hour
- Telephone Expert \$40 to \$75 per week
- Trouble Shooter \$40 to \$60 per week
- Radio Engineer Unlimited
- Sub-Station Engineer, Installer or Operator \$150 to \$250 per month
- Boss of your own shop Unlimited

Think what this means to you! You can finish this training in 12 weeks or less and change the whole course of your life. A good job with a *big future* awaits you when you finish this training.

Or—if you wish—you will be able to start a business of your own. A little shop, even with very small capital, can be made to grow quickly into a real money maker.

Whatever branch of Electricity you want to follow, here is your place to start. Training includes *practical* Radio, fitting you, if you wish, for commercial operator's license. We teach code as well as theory.

Be sure to send the coupon *right now* for big free electrical book and offer.

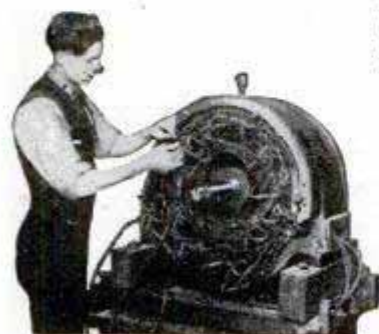

A 25 H. P. Motor for student practice

We have found that the men in our shops learn *easier, better and quicker* when allowed to take apart and reassemble any equipment on our floors. Instead of forbidding this, we now find it wise to *encourage* it—along with our regular methods of instruction.

None of our apparatus is enclosed in glass show cases nor by railings with "hands off" signs. It is real *working* equipment and serves its purpose only when you learn something valuable from it.

AUTOMOTIVE

If you are interested in Automobiles, trucks, tractors, motorboats or airplanes, here is the place to get your start. Turn your hobby into Big Pay in 8 to 12 weeks. Real experience on finest equipment. Individual instruction by experts.

Opportunities are steadily increasing in this interesting business. The number of cars keeps increasing faster than ever. Why don't you take advantage *now* of the need for trained men? No previous experience or higher education necessary. Every step is made simple and easy for you.

Don't you want a job like one of these?

- Automobile Repairman \$125 to \$250 per month
- Head Automotive Mechanic \$150 to \$500 per month
- Automobile Salesman Up to \$20,000 per year
- Garage Owners \$300 to \$5,000 per month
- Garage Managers \$150 to \$350 per month
- Storage Battery Men \$150 to \$350 per month
- Auto-Electrical Experts \$175 to \$350 per month
- Truck and Tractor Men \$6.00 to \$10.00 per day
- Tire Experts \$150 to \$250 per month
- Motor Boat Expert \$200 to \$300 per month



Using a Weaver crane on the repair floor of the Greer Shops

Greer-trained men are *practical* men. That is why they are given preference in great automotive establishments all over the country. That is why so many are able to go into business for themselves, with great success. They know what they are doing. They know how to get the big money. They are trained to *beat* the work of men who have not had this training.

Remember, this course fits you to start into any branch of the business, including Automotive Electricity.

Don't delay. Get our big free auto book immediately, by sending this coupon.



Every working part shows on this "split chassis"—one of the many Greer features that make this course so easy for you

Greer College of Automotive & Electrical Trades

Dept. 901 2024 S. Wabash Avenue CHICAGO

FREE Employment Service

Our employment department is ready to help you—while in training and *for life*. Jobs while learning for those who need them. Day and evening classes. Low cost. Easy terms.

ERWIN GREER, President, Greer College
Dept. 901— 2024 S. Wabash Ave.—CHICAGO.
Please send me your FREE BOOK and offer for Electrical
It is understood I am not obligated in any way Automotive course

Name

Address





He Climbed from \$1,800 to \$10,000 a Year! Can You Match This Record?

Eight years ago E. J. Dryden of Laredo, Texas, was an assistant bookkeeper at \$150 a month. Today he is a department manager with an income of more than \$10,000 annually. Mr. Dryden's progress illustrates the tremendous importance of *planning one's future and persistently following it thru to success.*

Bookkeeping was his work; so he first trained in LaSalle Higher Accountancy; then in Commercial Spanish, because Laredo is just across the border from Mexico. Then came Business Management, to give him an all-around training; law was next, because he knew this training is necessary for a successful executive.

Steadily he moved upward, even while he was studying. First, cashier, then credit manager and now department manager. Each step increased his income. Is it surprising that eleven other employees of his firm have trained with LaSalle?

Send for Free Outline of LaSalle Salary-Doubling Plan

How much is it worth to you to gain, in a comparatively few months, substantial promotion—a new confidence and self-respect?

The way to all these things is outlined in a fascinating book, "Ten Years' Promotion in One"—a book which has set thousands and thousands of men on the path to real achievement. The coupon will bring it to you FREE.

In addition we will send you a 64-page book describing the unusual opportunities in any of the business fields listed below. If you want to look back a year from today and see a record of real progress, then—TODAY is the day to start—and the moment NOW!

— — — Find Yourself Thru LaSalle! — — —

LASALLE EXTENSION UNIVERSITY!

The World's Largest Business Training Institution

Dept. 964-R

Chicago

I should be glad to learn about your salary-doubling plan as applied to my advancement in the business field checked below. Send also copy of "Ten Years' Promotion in One," all without obligation.

- Business Management
- Higher Accountancy
- Modern Salesmanship
- Traffic Management
- Railway Station Management
- Law—Degree of LL.B.
- Commercial Law
- Industrial Management
- Modern Foremanship and Production Methods
- Personnel and Employment Management

- Banking and Finance
- Modern Business Correspondence and Practice
- Expert Bookkeeping
- C. P. A. Coaching
- Business English
- Commercial Spanish
- Effective Speaking



Name.....

Present Position.....

Address.....

MEN WANTED

TO LEARN

Motion Picture Projection

\$2,000 to \$4,000 a Year

Quickly learned. Short hours, big pay. Best equipped school in Michigan. Projectionists for Movie Houses and Road Shows.

MOVIE OPERATORS SCHOOL

61 Sproat Street,

DETROIT, MICHIGAN

Health Food Directory — How to select the proper foods for gaining weight; reducing; building vitality; disease resistance; constipation; building muscle, etc. Rates and tabulates standard branded foods. No other book like it. 150 pages of valuable information. Special price 25c, postpaid. Limited edition.

Macfadden Publications, Inc., Dept. P. M. 9, 1926 B'way, N. Y. City

Information on any book free. Write Popular Mechanics Press, Chicago, Ill.



A General Reference Work
Covering
Electrical Principles, Direct Current
Dynamoes, Direct-Current
Motors, Storage Cells, Armature
Winding, Design of Small Motors,
Transformers, Motor Testing, Mag-
net Design, Controllers, Eleva-
tors, Signaling, Power Stations,
Switchboards, Station Man-
agement, Welding, etc.
—
Illustrated with over one
thousand engravings
—
Black Flexible Fabricoid
Binding, Stamped in Gold

Four Big
Volumes
Shipped
FREE
No
Deposit

This Secret Helps Make Money

Know how to find what you need to know, easily and quickly, when you need to know it. That's the Secret. No need for long, tedious hours pouring over "lessons" at home or in the classroom. Men who know this Secret get any job done, while others are wondering how to do it! How simple and easy this is, is here explained for every ambitious man who will take advantage of this Extra Special Offer to become an Electrical Expert.

SCANTY SCHOOLING NO BAR TO SUCCESS

Costly technical education, years of study not necessary. Steinmetz, of General Electric, was a poor, uneducated immigrant. Benjamin Franklin, who first drew electricity from the clouds, went to school only 2 years. Edison was a railway clerk. Volta, Faraday—ALL THESE WERE MEN OF SCANTY SCHOOLING. They had none of the advantages now offered you to help you become an expert in electricity.

INCREASE YOUR EARNINGS

Benefit by the knowledge and experience gained by hundreds of electrical experts. All the important facts are in these 4 compact volumes—everything that you will need to know about electricity. With these books you should increase your earnings far beyond what you can ever make if you go on in your present job. Clearly and simply written, anyone can understand. Dynamoes, motors, lighting, signals, wiring, radio—with these books you can design, build or repair them all. Whatever you need, it's there, instantly available.

The Secret. JIFFY INDEX shows at a glance any subject you need, everything about it, completely told, diagramed and illustrated, without reading pages and pages. Now offered at the lowest price and on the easiest terms we ever made.

SEND NO MONEY Only name and address—then when the books arrive show them to your friends. No lessons, no examination papers, no studying required. JIFFY INDEX shows anything you want in less than a minute. If convinced, send only \$2.00 in ten days, then only \$3.00 monthly until you have paid the special low price of only \$19.80 for all. **MEMBERSHIP FREE!** If you send now, we will make you a member of the American Technical Society, giving you all the privileges of consulting our experts any time without cost. This alone is a priceless advantage. Our Employment Department is also at your disposal. Keep the application blank we send with the books to be used if you decide to look for a better job. So send TODAY!

American Technical Society,
Electrical Division E-619, Chicago, Illinois.

You may send me your new complete Electrical Engineering Library (1926 edition), 4 big volumes, bound in flexible covers, for ten days' Free Examination. If satisfied, I will send you \$2.00 then and \$3.00 per month until the special low price of only \$19.80 is paid, otherwise I will return them and owe you nothing.

Name.....

Address.....

City..... State.....

Reference.....

STOP USING A TRUSS

Do Away With Steel And Rubber Bands

FREE TRIAL



Inner surface is made adhesive to secure the PLAPAO-PAD firmly to the body, keeping the PLAPAO continually applied and the pad from slipping. No straps, buckles or springs attached. Soft as velvet—easy to apply.

It's the Non-Slip-ping, yet Non-Rigid Pad and What is Within It That Counts

FREE to 5,000 Truss Sufferers

To the extent of 5,000 sufferers who may apply I will send, ABSOLUTELY FREE, a sufficient quantity of the Plapao to positively convince them that this is the only logical, common-sense way of treating rupture. Plapao is a highly astringent medication placed within the Plapao-Pad and being absorbed through the skin, creates a wonderful feeling of relief and at the same time tends to strengthen the weakened muscles and thus permanently close the rupture opening. The process of recovery is natural, so you'll have no use for a truss—you can throw it away forever! Old and young have testified under oath that the Plapao-Pads cured their rupture—many of them long-standing, aggravated cases—without delay from work. Patent allowed in U. S. and foreign countries. Awarded Gold Medal at Rome and Grand Prix at Paris.

Send No Money—for a sufficient quantity of the Plapao is sent without charge to enable you to give it a thorough test; you pay nothing for this trial now or ever. Write for it and full information today. Address: Plapao Laboratories, Block 1427 St. Louis, Mo.

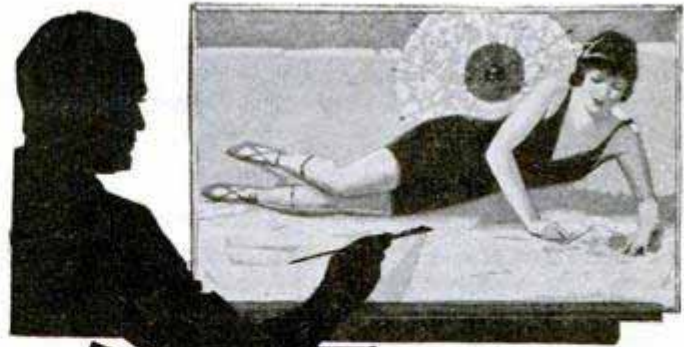

A Fortune At Your Fingertips

LARGE salaries are paid to commercial artists, both men and women. If you like to draw, there is a good income—perhaps a fortune—at your fingertips in this interesting, highly paid field. Make your spare time count; begin to turn your artistic talent into *real money* by studying the Federal Course at home. Hundreds of successful artists throughout the country will tell you they owe their present success to the efficiency of Federal training.

Federal Course Quick and Practical

The Federal Course, based on principles gained by 25 years of actual experience in producing commercial art, is thorough and concise. If you like to draw and will *train and develop your natural talent*, the Federal Course will bring you to the earning point in the shortest possible time. You receive *exclusive, individual instruction* in every branch of commercial art, learning all the "short cuts" professional artists use without wasting months of valuable time.

Nationally Known Artists are Federal Authors. Many of the best known and most successful artists and illustrators in the country have contributed exclusive lessons to the Federal Course. Think of learning the methods and secrets by which these famous artists have won success!

Send for Book "YOUR FUTURE"

If you are interested in learning commercial art, you will want our book "YOUR FUTURE," which explains the Federal Course in detail, shows typical work of students and clearly states the reasons for the splendid opportunities in this field. A book of real value for any amateur or prospective student. Send 6c in stamps today, stating age, occupation. Use coupon below.



Federal School of Commercial Designing

620 Federal Schools Bldg., Minneapolis, Minn.

Federal School of Commercial Designing
620 Federal Schools Bldg., Minneapolis, Minn.

Please send me "Your Future" for which I enclose 6 cents in stamps.

Name.....
Age..... Present occupation.....
(Write your address in the margin)

Keynote To Popularity

Popularity is yours. Everyone will seek your company, if you play tenor banjo. Enroll for our course. We start you with an \$18 professional gift tenor banjo. Prof. Six was director of Glee and Instrumental Clubs at N. Y. University. His picture, diagram and phonograph record method is so simple you play immediately.

Write for particulars about our course and we will reserve an \$18 gift tenor banjo for you. Write now for book and free first lesson. New York Academy of Music, Studio 1-C, 100 Fifth Ave., N. Y. C.



NO JOKE TO BE DEAF

—EVERY DEAF PERSON KNOWS THAT

I make myself hear, after being deaf for 25 years, with these Artificial Ear Drums. I wear them day and night. They stop head noises and ringing ears. They are perfectly comfortable. No one sees them. Write me and I will tell you a true story, how I got deaf and how I make you hear. Address



Medicated Ear Drum

GEO. P. WAY, Artificial Ear Drum Co. (Inc.)
80 Hoffman Bldg., 2539 Woodward, Detroit, Mich.

AGENTS \$10 to \$25 DAILY!

Men or Women

Here is your lifetime opportunity! \$10.00 to \$25.00 every day selling America's Finest Shirts direct from our own big, honorable factory. Easy work, lowest factory prices, individual patterns and remarkable values. Big steady demand in every locality.

No experience or money necessary. We show you how and furnish everything you need. Your success is assured, with a steady income every month. Every customer satisfied. Big Repeat Business. Be our factory agent and supply big demand for Packard Tailored Shirts in your locality. Failure impossible. Essex Coach free for selling Shirts.

Write Now for Free Samples

Just send your name and address now for Free Samples. Be first before some one beats you to it. **WRITE TODAY.**

PACKARD MANUFACTURING CO.
Dept. 307, 829 Orleans St., CHICAGO, ILL.





Save Doctor Bills with Violet Rays!

THOUSANDS of everyday people are saving doctor bills, costly medicines, enjoying better health because of Violet Ray Outfits. "After suffering from rheumatism two years," writes Mr. H. Crump, Piqua, O., "I cured myself with Violet Rays." His experience but one of many.

Every home should have a Violet Ray Outfit. It both prevents and overcomes sickness. Scientifically removes cause of an ailment. Our outfits are used by hundreds of physicians to treat ailments listed. Easy, safe, pleasant to use.

Violet Rays Heal and Protect

Violet Rays keep you well! A daily Violet Ray Massage will increase your bodily vigor and resistance to disease, improve your digestion, strengthen your nerves, enhance your appearance.

10 DAY FREE TRIAL! We'll arrange to let you try a Violet Ray Outfit for 10 days. You'll be amazed and delighted at the benefits it will give. Send for it today.

Send for FREE BOOK

Tells you about Violet Rays, treatment of different diseases. Gives body charts showing where pains start and how to stop them. Send for copy today and details of our 10 DAY FREE TRIAL OFFER.

THE VI-REX CO.
Dept. 29
2304 Warren Ave., Chicago

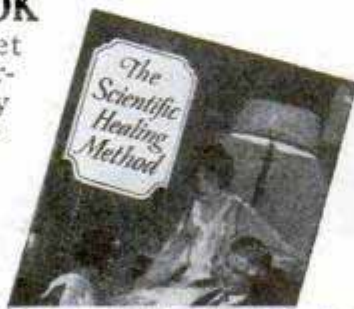

The Vi-Rex Co., Dept. 29, 2304 Warren Ave., Chicago
Send me your FREE BOOK and details of your 10 Day Free Trial Offer.

Name.....
Address.....
City..... State.....

brain glow

BRAVE MEN BECOME COWARDS. Many have told us they had not the courage to turn a door knob of another man's office to seek an interview. The timidity was due to taking UNSUITED FOOD that fermented and poisoned blood instead of nourishing BRAIN and NERVES. Could a brave man suffering from chronic fermentation, or diarrhea, have courage even to stand upright?

BRILLIANT MEN BECOME IDIOTS. Brilliant men, thrown into dungeons, deprived of NERVE food, have in a few months, become drivelling idiots, insane.

STUPID PERSONS BECOME INTELLIGENT. It has been our privilege to see dull, stupid school children restored by RIGHT FEEDING to normal condition, also the insane to normal condition. The excessive mucus, the swelling and the vacuous stare all disappear when mucus-less foods are eaten. Under proper conditions, neither tonsils nor adenoids need operation.

SUFFERED INDIGESTION BUT DID NOT KNOW. Tumors, boils, blood clots, etc. appear unexpectedly, the results of WASTE products in the blood from PARTLY assimilated food, yet there has been no pain in the stomach. Disease arises from unperceived INDIGESTION. Even sleeplessness is due to mild indigestion.

Write us for particulars of Government Bulletins describing experiments on convicts, hens, cows, etc. Deficient feeding produced disease, whereas FULL NUTRITION cured — e. g., paralysis, blindness in hens, mice, etc., pellagra, beri-beri, skin affections, etc., in men.

SAVED TEETH, TONSILS AND MEMORY. Pupil 1865. Sworn. "Pyorrhea specialist advised extraction. After two months on Brinkler meals, the five abscesses disappeared and dentist fixed all teeth without extractions.

"Tonsils also saved. Sticky film and pimples disappeared. Joints reduced. Large lump on wrist, one year, disappeared in a few weeks . . . Can now memorize music, and accomplish in half an hour more than formerly in two hours."

FOUR TIMES THE INCOME. "No mucus, voice stronger, head clear, gained 20 lbs., now earn 4 times as much."

Educational Booklet, 10 cents. BRINKLER SCHOOL OF EATING, Dept. 42J, 131 West 72nd St., New York

STUDY AT HOME

Directed by

The University of Chicago

Courses in English, History, Chemistry, Business, Education, Mathematics, Psychology, and 35 other subjects command credit toward a Bachelor degree. Begin any time. Address 15 Ellis Hall, University of Chicago, Chicago, Ill.

LEARN WATCHMAKING AND ENGRAVING

BY OUR PROFIT-SHARING PLAN
OUR GRADUATES SUCCEED



One of our Iowa students started in a very small way—now doing over \$30,000 a year. Another in Wisconsin, over \$10,000 the first year. Day or night classes. Call or write for FREE BOOK

Chicago School of Watchmaking, Dept. 2001, 4844 Lincoln Avenue, CHICAGO

HAIR GROWS!



when our Vacuum Cap is used a few minutes daily. Sent on 60 days' FREE trial at our expense. No drugs or electricity. Stops falling hair, cures dandruff. A postal brings illustrated booklet.

MODERN VACUUM CAP CO.

558 Barclay Denver, Colorado



BECOME A RAILWAY POSTAL CLERK

Pay has been raised from \$1900 to \$2700 a year. Steady job. Pleasant work. Common education sufficient. No "pull" necessary. Mail coupon for FREE Catalog.

Patterson Civil Service School

Dept. 89 ROCHESTER, N. Y.

Send me without charge your Catalog, describing this and other U. S. Government positions.

Patterson Civil Service School

Dept. 89 Rochester, N. Y.

Name.....
Address.....

Want \$158 Month Commence?

RAILWAY MAIL CLERKS

GET U. S. GOVERNMENT JOBS

Mail Coupon Before You Lose It



FRANKLIN INSTITUTE, Dept. A-176, Rochester, N. Y.
 Sirs: Rush to me without charge: (1) Sample Railway Postal Clerk Examination questions; (2) tell me how to get a U. S. Government job; (3) send list of places at which examinations are held and sample coaching lessons.

Name

Address

Steady Work—No Layoffs—Paid Vacations—Travel—See Your Country—Common Education Sufficient
MEN—BOYS, 18 UP—RUSH COUPON

LEARN CARTOONING



The Landon **PICTURE CHART** method of teaching makes **ORIGINAL** drawing easy to learn. Hundreds of sketches like the above explain every step in creating **ORIGINAL** heads, figures, animals, etc.

Successful Cartoonists Earn Big Salaries

The cartoonists who draw "Freckles and His Friends," "Winnie Winkle," "Regular Fellers," "Cicero Sapp," "Guss and Gussie," "Mom 'n Pop" and hundreds of other artists, including Dorman Smith, Ethel Hays and Edwina, credit their start to the Landon Course of Cartooning. They learned to draw through the Picture Chart Method in their spare time, at home, and are now earning from \$75.00 to \$300.00 and more per week. Send 6c in stamps today for sample Picture Chart and full explanation of this wonderful course and information showing possibilities for you. *Please state your age.*

The Landon School
 138 National Bldg., CLEVELAND, OHIO

YOU CAN OIL PAINT

Amazing new method teaches men or women to earn after first lesson. **OIL PAINT** photos—portraits, landscapes or art subjects. Earn \$18 to \$50 and more a week. **OIL PAINT OUT-FIT GIVEN**. Send now for free illustrated book. **PICTORIAL ART STUDIOS, Inc., Dept. MP, 3731 No. Clark St., Chicago**

MINNEAPOLIS LEGS ARMS

Largest Artificial Limb Center in the World
 More limbs and braces shipped daily than from any other city. Write: **MPLS. ARTIFICIAL LIMB CO., 242 S. 4th St., MINNEAPOLIS, MINN.**

Learn Autos in Los Angeles

I NEED men *quick* to fill jobs paying \$60 to \$100 a week. I train you in my great school of shops to be a real Auto Mechanic—and the best repair shops in Los Angeles are willing to pay top salaries to my graduates because they know my *quality* training makes you a real Auto Mechanic.

BIG PAY JOBS OPEN NOW!

This is Truth! I know I can find you a good job because this 21-year old auto school has a world-wide reputation for giving the most *complete* training. 16,000 successful graduates are boosting National. California has most autos—ideal training center—you learn by actual work on a half-million dollars worth of equipment—with expert instructors. I don't rush you through half-trained. I train you *right*. That's why National-trained men get the best jobs and salaries. And I have a special offer to make to men who can start training now.



If you live West of the Mississippi I'll GIVE you my big

\$1.00
Auto Book FREE!

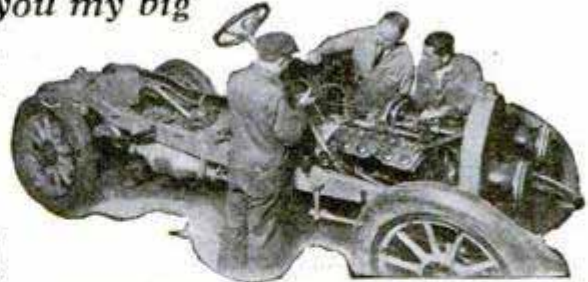

I NEED men now to fill jobs waiting. So I'll send you my 84-page illustrated catalog—*free*—if you live west of the Mississippi. It costs me \$1.00 a copy—and I must ask men in other states to send \$1.00 with the coupon below. I will credit the dollar to your account if you come to National. But I know you men in the West can come *now*. So I'll rush you a free catalog—give you a 30% discount on your tuition—get you a bargain railroad or boat fare to Los Angeles—get you part time jobs to pay your room and board while training—and help you get any big pay Auto job you want, after you finish training. But you must come **NOW**. Mail the coupon—*quick!* before this offer expires.

National Automotive
 & ELECTRICAL SCHOOL
 Dept. 451, LOS ANGELES, CALIF.



J. A. ROSENKRANZ, Pres., NAT'L AUTOMOTIVE, Dept. 451, 4004 So. Figueroa, Los Angeles
 Rush me your catalog and Special Training Offer. (If you live East of the Mississippi enclose \$1 which will be credited to your account at 6% interest.)

Name

Address

City..... State.....



SHOW CARD LETTERING

Learn at Home

HERE is the very course you need if you want to get a good paying position as a Show Card Letterer or Sign Letterer, or have a business of your own. This course is complete and practical and especially arranged to meet the needs of the student who studies at home. It was written by E. L. Koller, Principal of the School of Art of the International Correspondence Schools, member of the American Federation of Arts, and The National Society of Craftsmen.

Mr. Koller has had twenty years' teaching experience, and his success in helping other men and women is an indication of what he can do for you.

H. L. Wood, a clerk, made more than \$700 "on the side" before he had completed his course and also won \$125 in prizes. Harry William Lord writes that he has more than doubled his salary as a result of studying this I. C. S. course in spare time. William Whitman, a former wagon builder, now has a sign painting business of his own and is earning nearly three times as much as he did before enrolling with the International Correspondence Schools.

There is no doubt that Show Card Lettering and Sign Lettering offer a real opportunity to ambitious men and women. Just mark and mail the coupon and we'll gladly send you a booklet telling all about the I. C. S. course in Show Card Lettering, or any other subject in which you are interested.

INTERNATIONAL CORRESPONDENCE SCHOOLS

Box 5597-E, Scranton, Penna.

The oldest and largest correspondence schools in the world

Without cost or obligation on my part, please tell me how I can qualify for the position or in the subject before which I have marked an X:

SHOW CARD LETTERING

ILLUSTRATING

- Business Management
- Traffic Management
- Business Law
- Banking and Banking Law
- Accountancy (including C.P.A.)
- Nicholson Cost Accounting
- Bookkeeping
- Private Secretary
- Salesmanship

CARTOONING

- Advertising
- Better Letters
- French Spanish
- Stenography and Typing
- Business English
- Civil Service
- Railway Mail Clerk
- Common School Subjects
- High School Subjects

TECHNICAL AND INDUSTRIAL COURSES

- Electrical Engineering
- Electric Lighting
- Mechanical Engineer
- Mechanical Draftsman
- Machine Shop Practice
- Railroad Positions
- Gas Engine Operating
- Civil Engineer
- Surveying and Mapping

- Steam Engineering
- Architect
- Architects' Blueprints
- Contractor and Builder
- Architectural Draftsman
- Structural Engineer
- Chemistry Pharmacy
- Automobiles Radio
- Mathematics

Name.....

Street Address.....

City..... State.....

\$75 A WEEK

BUILDING RADIO SETS

—in your spare time

Join the Radio Association of America. Let it train you to build and repair sets, to be the "radio doctor" of your community. \$3 an hour easily made in spare time:

\$500 Earned in Spare Hours

Lyle Follick, Lansing, Mich., writes: "Have already made over \$500 in spare time." He is just one of many. Our members are starting radio stores, securing better positions, passing radio operator examinations, qualifying as big-pay Radio Experts, as well as making money spare time. Join the Association now!—By our Special Plan your membership need not cost you a cent. Number of these memberships limited. Write for details NOW!

RADIO ASSOCIATION OF AMERICA
Dept. A-9, 4513 Ravenswood Ave. CHICAGO, ILLINOIS

Drum Lessons With the Outfit

With each genuine Ludwig Trap Drum Outfit we furnish an instruction method. Ludwig drum sets from \$32.50 up. Call on your music dealer or write us for full particulars. Send for free catalog.

World's Largest Makers of Drums and Banjos

LUDWIG & LUDWIG
1611 N. Lincoln St. Chicago, Ill.

TELEGRAPH-RADIO

\$18 to \$35 a week while training for Radio and Telegraph Operator jobs at \$150 to \$300 per month. Write for particulars.

CHICAGO TELEGRAPH INSTITUTE
Dept. 1-9-6 1338 S. Michigan Avenue, CHICAGO

Big Money for You as an Automobile Mechanic

These four practical books, written by five well known teachers of automobile practice, will teach you right in your own home during your leisure time just what you need to know about automobile troubles and repair. They will teach you automobile construction, maintenance and repair as experts know them and will help you to earn an expert's pay.

Practical Automobile Library: Four Books—\$1.50 in 10 days and \$2 monthly for 6 months—only \$13.50 in all!

Hundreds of question-answering diagrams—hundreds of clearly-marked illustrations—make the books plain and readily understandable. All the explanations and descriptions are clear, simple, direct. Every chapter is packed with definite, step-by-step, how-to-do-it information. Here is your opportunity to enter a big-pay field.

Sent FREE

Send No Money
Mail the Coupon



FREE EXAMINATION COUPON

McGraw-Hill Book Co., Inc., 370 Seventh Ave., New York

Send me for 10 days' free examination the New Practical Automobile Library. If satisfactory I will send you \$1.50 in 10 days and \$2.00 monthly until the special price of \$13.50 is paid. If not wanted, I will return the books at your expense.

Signed.....

Address.....

City and State.....

Position.....

Employer.....

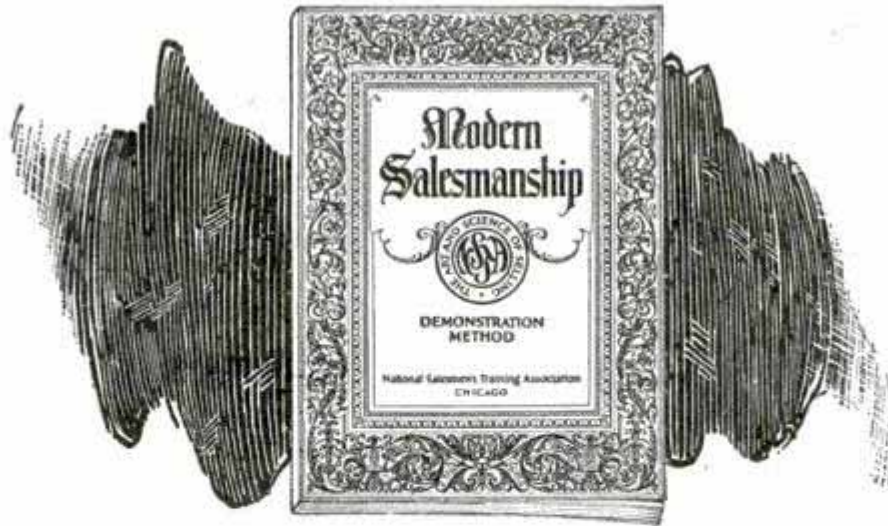

Where Shall We Mail Your Copy of this Book—FREE

Remarkable new book on Salesmanship just off the press will be mailed to you without cost or obligation

THE contents of this amazing new book—just published by the National Salesmen's Training Association—will prove a revelation to every man who is interested in making real money—and to those who realize the tremendous possibilities for high earnings in the selling field.

Thirty thousand copies of this book will be mailed free without cost or obligation to those who send for it while the supply lasts—and there is no time like the present for you to fill in the coupon below.

FULLY EXPLAINS NATIONAL DEMONSTRATION METHOD

Thousands have wondered why N. S. T. A. Members invariably make good, in a big way, right from the start, even though they have had no former selling experience, or why salesmen who have just plodded along with indifferent success quickly begin to outstrip their brother salesmen after becoming members of the Association.

Among other things, this remarkable free book explains just why success comes rapidly and surely to those who enroll for this amazing System of Salesmanship Training.

There are too many victims of that vicious superstition that "salesmen are born and not made," but after reading "Modern Salesmanship," you will realize the utter fallacy of that foolish notion.

QUICK SUCCESS THROUGH N. S. T. A. TRAINING

EMPLOYERS are invited to write to the Employment Dept. of the N. S. T. A. No charge for this service to you or our members. Employers are also cordially invited to request details about the N. S. T. A. Group Plan of instruction for entire sales forces. Synopsis and charts sent without obligation.

Whether you have had selling experience or not, it makes no difference. The N. S. T. A. System of Salesmanship Training will enable you to become a Master Salesman in an amazingly short period of time. It will teach you, in your spare time, at home, the fundamental rules and principles of selling—how to approach different types of prospects to get their undivided attention—certain ways to stimulate keen interest—ways to overcome objections, batter down prejudices, outwit competition, and make the prospect act.

Step by step this Training takes you through every phase of Salesmanship. Every underlying principle of sales strategy is made as simple as A B C. Through the National Demonstration Method, you get actual experience on practically every type of sales problem that may ever present itself. And through the instruction in Character Analysis, you will become an expert in reading character on sight—a valuable asset for any salesman.

JUST MAIL THE COUPON THE BOOK IS FREE

To fill in and mail the coupon will not obligate you in any way, but it, undoubtedly, will show you the way to be a "star" salesman. No matter what you may think now, it can only be a thought and it will pay you to let us send you this valuable and interesting book.

While this is before you, fill in and mail the coupon and get it into the mail some time today.



Dept. M-137

N. S. T. A. Building
Chicago, Ill.

National Salesmen's Training Ass'n, Dept. M-137,
N. S. T. A. Building, Chicago, Ill.

Without cost or obligation you may send me your free book "Modern Salesmanship," and proof that I can become a Master Salesman.

Name.....
Address.....
City..... State.....
Age..... Occupation.....

J.A. Rosenbranz
President
says..



"I want men and boys to train for **BIG PAY**

Electrical Jobs ...in California"

In this book I've written exactly of your wonderful opportunity here and how you will learn at National. A photographic trip through National. The TRUTH! To keep the book from curiosity seekers I charge Easterners \$1 a copy—which is deposited to your account at 5% interest until you come to school. If you live in the West and can come to National NOW—I'll send you this \$1 book free!



FREE
to men
west of the
Mississippi



Los Angeles Is Magic City of Opportunity

World's largest hydro-electrical projects surround Los Angeles. Constant demand for Electrical Experts. National graduates supply this demand. Ideal climate — beaches — mountains — sports — amusements year 'round. Your Big Opportunity awaits in California. Buy your ticket—Board a train and come—NOW.

Free Employment Service, Earn While Training

You can earn board and room while at National by new cooperative plan of practical work in leading electrical and auto shops in spare time. We help you land big pay job after graduation. Send for catalog with full details of how National helps you to succeed.

THERE are hundreds of high-pay electrical jobs going begging here in California! Employers are asking me to supply them with trained men. So I offer you the opportunity to come to Los Angeles, get practical training in my big shops and fill one of these jobs before 1927! I have **three-score expert instructors** and executives here to give you the training you need!

If you're ambitious to make money I'll guarantee to fit you to become a real Electrical Expert. I've trained 16,000 men. In my great shops covering acres, you perform all kinds of electrical work on \$1,000,000.00 worth of new equipment, with expert instructors helping you.

Most Unusual Electrical Training at National

You get absolutely thorough, complete training at National. You are not rushed through. You master every job. Lifetime scholarship entitles you to stay as long as you like and come back after graduation for extra training **free**. No expense spared to train you right. Endorsed by leading educators, electrical associations and employers, who say, "National produces the best trained men."

"Six Months at National Saved Me SIX Tedious Years as Apprentice."



"I have just passed Electrical Inspector's Examination and Electrical Repairmen's Examination for Civil Service with high grades. Only 27 men out of 134 passed the Inspector's Examination. I was eighth highest in Repairmen's Examination out of 126 men—thanks to National."—Alex Johnson.

"My Civil Service Exams. Made Easy by National Training."

"My grade of 95% was fourth highest among 140 men who took the Electrical Mechanic's Civil Service Examination. As this examination was supposed to be for men with at least two years practical experience, my marks created a sensation at the Commissioner's Office. I found the questions easy because of my National training."

E. C. Hall.

Tours World as Radio Operator



"Just heard that I passed Commercial Radio Operator's Examination with highest marks. Am starting a tour for India, the Orient and Africa as a 1st Class Commercial Radio Operator. And only a few months ago I was an Iowa farm hand. I investigated three schools and traveled 2,000 miles to get to National. Because of your thorough training I can also qualify as Chief Ship's Electrician."

C. R. Cunningham.

NATIONAL ELECTRICAL AND RADIO SCHOOL

Dept. 662
Santa Barbara & Figueroa Sts.
Los Angeles, Calif.

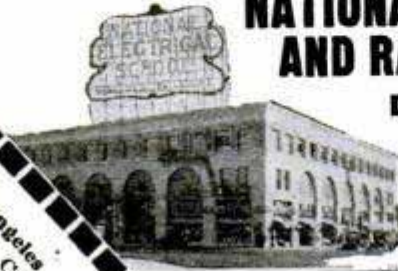

National Electrical School, Dept. 662, Santa Barbara & Figueroa Sts., Los Angeles
Send me your free 64-page Electrical Catalog describing National quality training methods. (If you live east of Mississippi enclose \$1.00 which will be deposited to your credit at 5% interest.)
Name.....
Address.....
City.....
State.....

Perhaps you, too, can cut your
"B" battery costs in half

Just follow the chart. It gives you
the secret of "B" battery economy

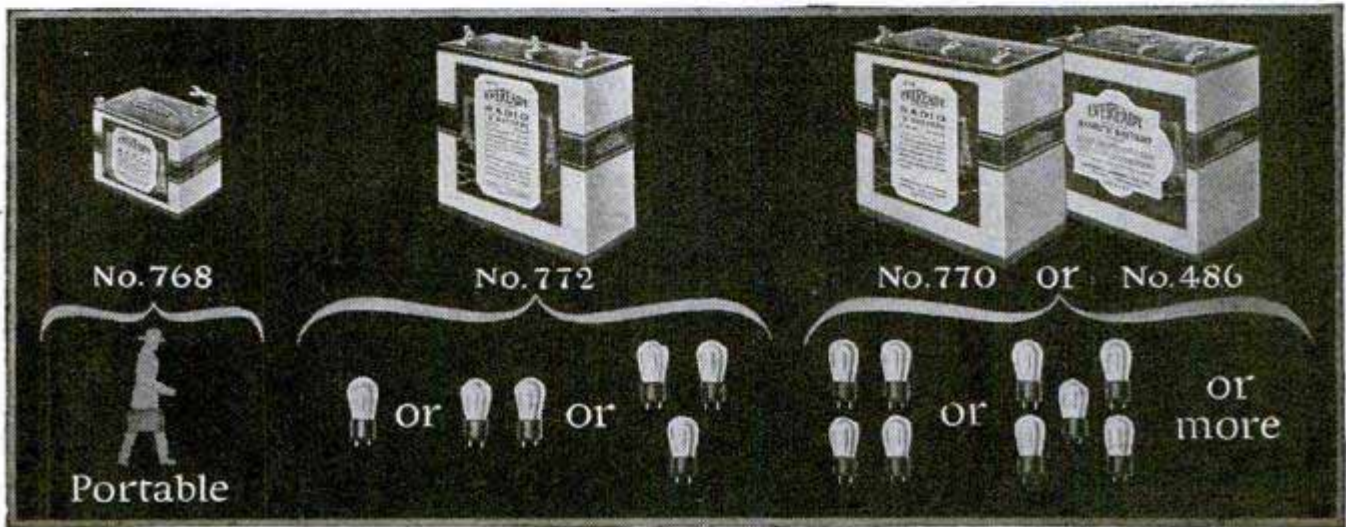

THOUSANDS of people have made the discovery that Eveready "B" Batteries, when used in the proper size, and on sets equipped with a "C" battery*, are a most economical, reliable and satisfactory source of radio current.

Here is the secret of "B" battery economy, reliability and satisfaction:

On all but single tube sets—Connect a "C" battery. The length of service given below is based on its use.*

On 1 to 3 tubes—Use Eveready No. 772. Listening in on the average of 2 hours daily, it will last a year or more.

On 4 or more tubes—Use the Heavy-Duty "B" Batteries, either No. 770 or the even longer-lived Eveready Layerbilt No. 486. Used on the average of 2 hours daily, these will last 8 months or longer.

These figures are based on the average use of receivers, which a country-wide survey has shown to be two hours daily throughout the year. If you listen longer, of course, your batteries will have a somewhat shorter life, and if you listen less, they will last longer.

Evereadys give you their remarkable service to the

full only when they are correctly matched in capacity to the demands made upon them by your receiver. It is wasteful to buy batteries that are too small. Follow the chart.

In addition to the batteries illustrated, which fit practically all the receivers in use, we also make a number of other types for special purposes. There is an Eveready Radio Battery for every radio use. To learn more about the entire Eveready line, write for the booklet, "Choosing and Using the Right Radio Batteries," which we will be glad to send you on request. There is an Eveready dealer nearby.

Manufactured and guaranteed by
NATIONAL CARBON COMPANY, INC.
New York San Francisco
Canadian National Carbon Co., Limited, Toronto, Ontario

*NOTE: A "C" battery greatly increases the life of your "B" batteries and gives a quality of reception unobtainable without it. Radio sets may easily be changed by any competent radio service man to permit the use of a "C" battery.

EVEREADY
Radio Batteries
-they last longer

Tuesday night means Eveready Hour—8 P. M., Eastern Standard Time, through the following stations:

WEAF—New York WSAI—Cincinnati
WJAR—Providence WTAM—Cleveland
WEEI—Boston WWJ—Detroit
WTAG—Worcester WGN—Chicago
WFI—Philadelphia WOC—Davenport
WGR—Buffalo WCCO—Minneapolis
WCBE—Pittsburgh WCCO—St. Paul
KSD—St. Louis

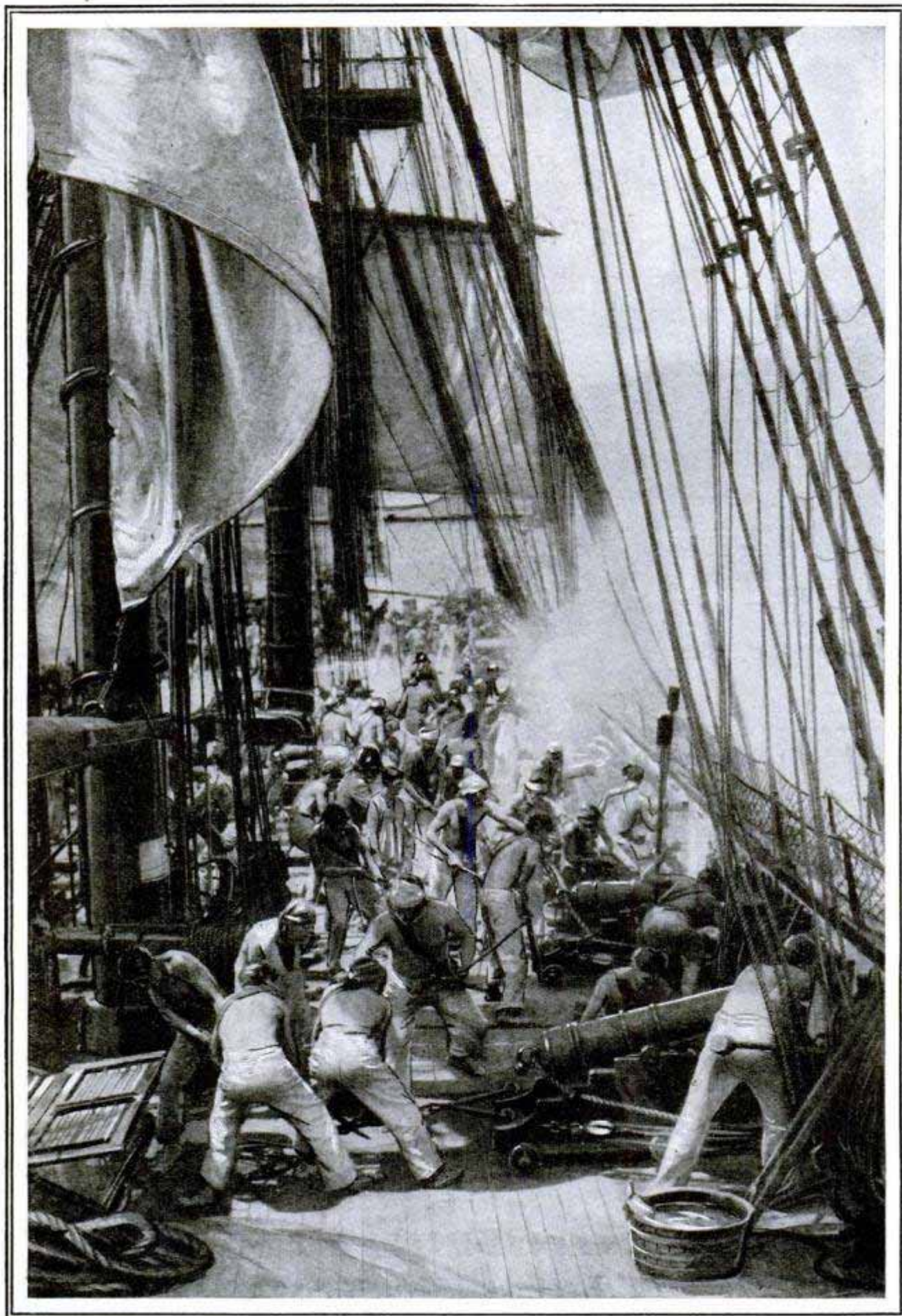

"Old Ironsides" in Action, a Replica of the Famous Frigate "Constitution," Built by a Movie Company for Use in a Film Story Involving the Historic Ship—See Page 398

Popular Mechanics Magazine

REGISTERED IN U. S. PATENT OFFICE

WRITTEN SO YOU CAN UNDERSTAND IT

Vol. 46

SEPTEMBER, 1926

No. 3

What is Secret of Mystic Wonders of the Orient?

2327

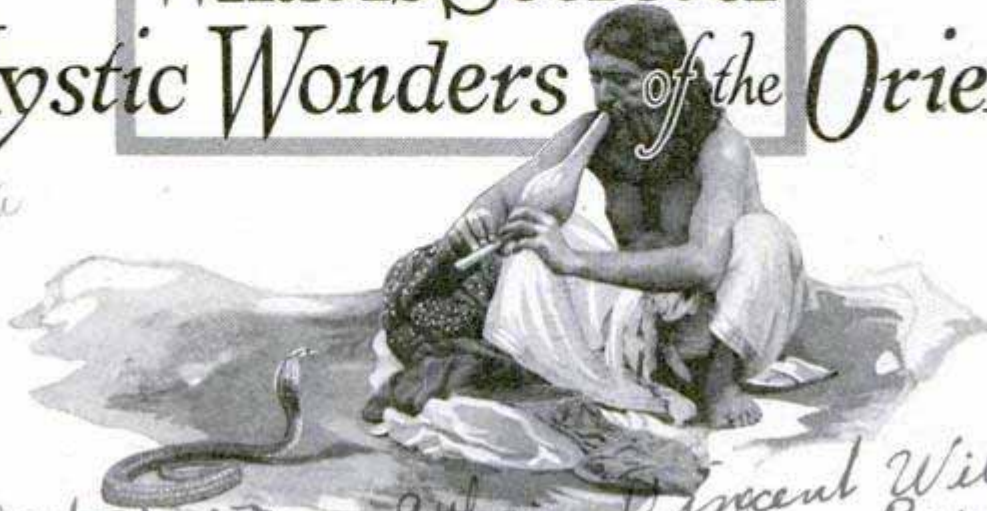

Contributor - Uthai Vincent Wilgor,
Takoma Park, Washington, D.C.

THE age-old mystery of how members of some of the sects in India are able to thrust knives and pins through their bodies without bleeding, lie at ease on a bed of spikes, permit themselves to be buried alive for hours, and perform other seemingly impossible feats has been brought to America by Rahman Bey, a fakir whose exhibitions have astonished Paris and London scientists, for possible solution.

There is no relation between the English word "faker" and the Indian "fakir"—the latter is simply a member of a cult that has taken a vow of poverty, and may, or may not, be a worker of wonders. Their feats are performed simply as religious rites, and with no particular idea of mystifying the public.

In a private exhibition given before twenty-seven doctors in London, before sailing for the United States, Rahman Bey thrust long pins through his cheeks, and permitted the physicians to insert others wherever they chose. He announced that none of the wounds would bleed, but at the request of one doctor, one wound did bleed and the others did not. When the pins were removed they left no marks.

Rahman Bey's explanation is simple—

by sheer will power, he claims, it is possible to do any of the things he does. One of his feats is to lie down on a bed of sharp spikes, while an assistant places a huge boulder on his chest and then breaks it with a mighty blow of a sledge hammer. Breaking the boulder on a man's chest is not new to Occidental "magicians"—the bigger it is the less the blow will be felt—but performing the stunt while reclining on spikes is something else again. When Rahman Bey got up the spike marks were plainly visible, but in a short time they disappeared.

Tested by the doctors, he demonstrated an ability to vary his pulse at will, one wrist recording increasing heart beats while the other wrist indicated the heart was slowing up. Following that, he applied pressure to nerves in his neck, collapsed, rigid and apparently dead, into the arms of an attendant, and let the doctors search in vain for any sign of life. After that he revived, his pulse started, breathing was noticeable once more, and the fakir got up fully conscious again.

An even weirder stunt was to lie down in a coffinlike box and permit himself to be covered with sand, after telling the audience to have him dug up whenever

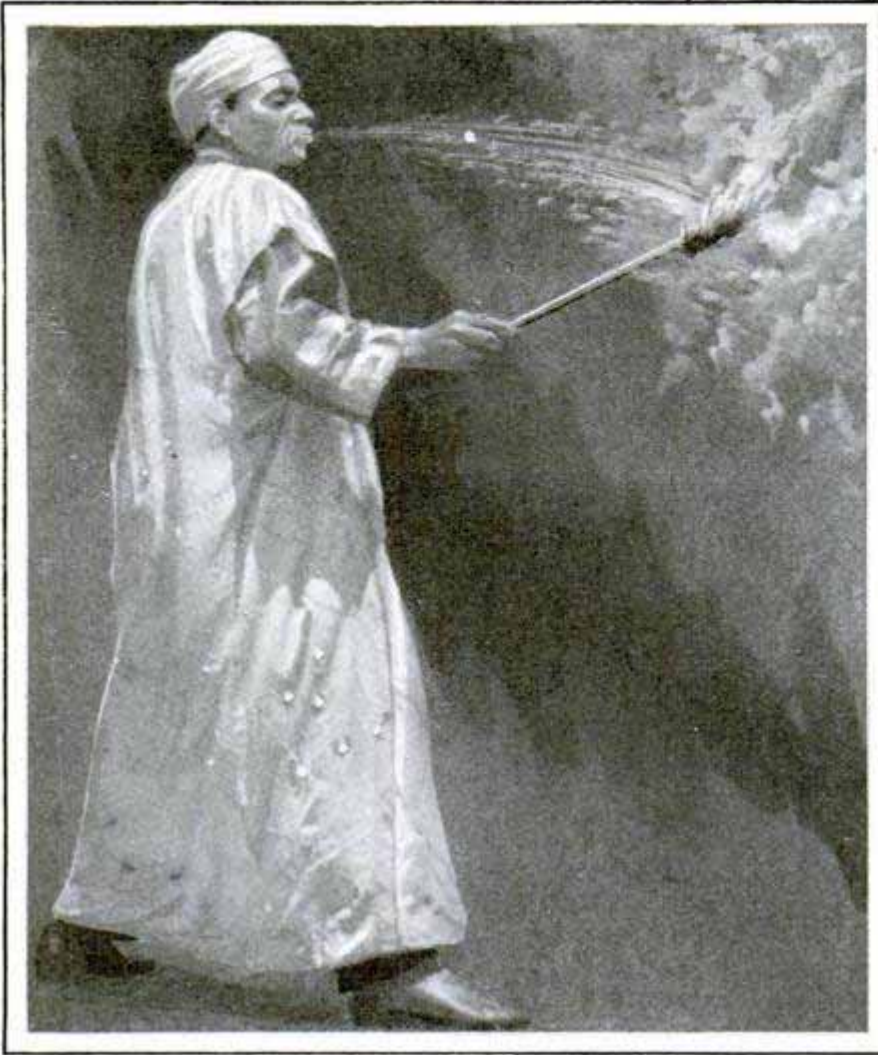

Hadj Ali from Egypt Spurts Kerosene and Then Water on a Torch; a Two-Compartment Stomach Probably Solves the Trick © U. & U.

they got ready. The doctors stood the suspense for five minutes, and then dug up the fakir and he immediately restored himself to life.

Science has never found a reasonable explanation for many of the things done by Oriental magic workers. They seem to defy the accepted belief that certain natural laws must operate and cannot be suspended, and for explanation assert that for thousands of years their forebears have been cultivating self-control until they mastered it to the point that they are able to suspend life itself for an interval and then resume it at will.

The number of fakirs who have demonstrated their ability to do such things is comparatively limited. The majority confine themselves to unusual forms of physical punishment as a species of religious devotion. The late Charles Bertram, an English conjurer and magician who made a trip around the world a quarter of a cen-

tury ago, devoted considerable time to studying the feats of the fakirs and magicians of the Orient. Like Kellar, the famous American magician, he expressed nothing but contempt for the performances of the average Indian magician, classing him as clumsy and his tricks as childish, but when he came to fakirs he had no explanation to offer.

One he visited had been holding one arm up over his head, he claimed, for six years, and explained that at the end of another six he would take it down and raise the other arm. The arm was atrophied and bore evidence that his claim probably was true. Another fakir spent his days sitting on a bed of sharp spikes, while a third had not sat down, it was claimed, for thirty years. Two others had held both hands over

their heads for several years, until the long finger nails curved down and grew back through the flesh of the palms. Their apparent ability to stand acute physical discomfort tends to bear out their claim that, through the teachings of their sect, they have made the will superior to the body. The ability, however, to stick needles through the flesh and lie on beds of spikes without suffering wounds is of another order, and it is in that American scientists will be interested. Whether trickery and illusion enter into their apparent feats has been a question for years.

Many of the stunts performed in the Orient can be duplicated by any first-class Occidental magician. Walking over beds of fire without being burned, one of the stock tricks in some sections of the South Seas, has been duplicated, while such feats as eating fire or molten metal are so well known that they have even been dropped from the circus side show.

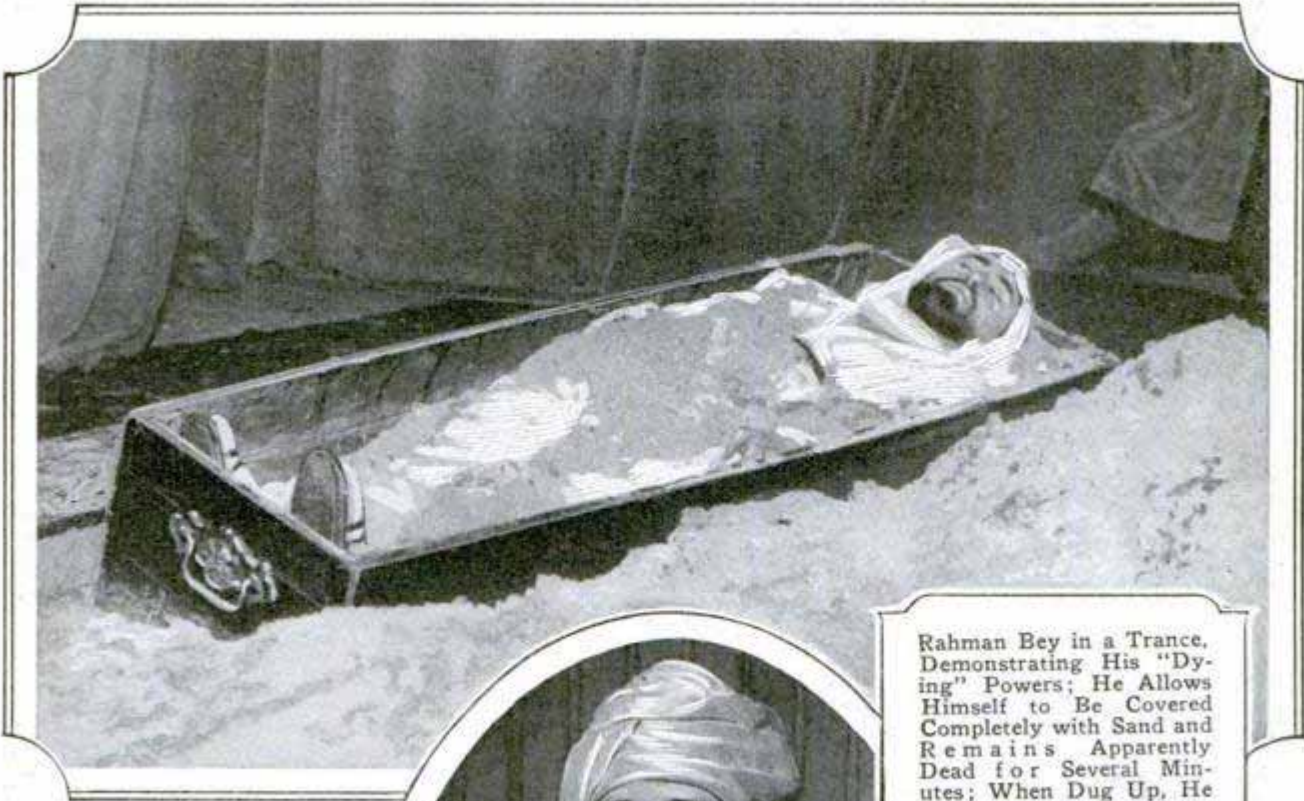

Rahman Bey in a Trance, Demonstrating His "Dying" Powers; He Allows Himself to Be Covered Completely with Sand and Remains Apparently Dead for Several Minutes; When Dug Up, He Revives Himself Quickly



Rahman Bey Asserts That He Can Control His Circulation by Will Power; to Prove It, He Sticks Pins through His Cheeks without Drawing Blood; Right, Indian Dancing on Glass without Cutting Himself



Trick by Which Many East Indian Beggars Make Their Living; Acrobat Climbs Pole Covered with Swords and Balances, Head Downward, on Top



2245

FLOOD-SWEPT RIVER BRIDGED TO LINK TWO STATES

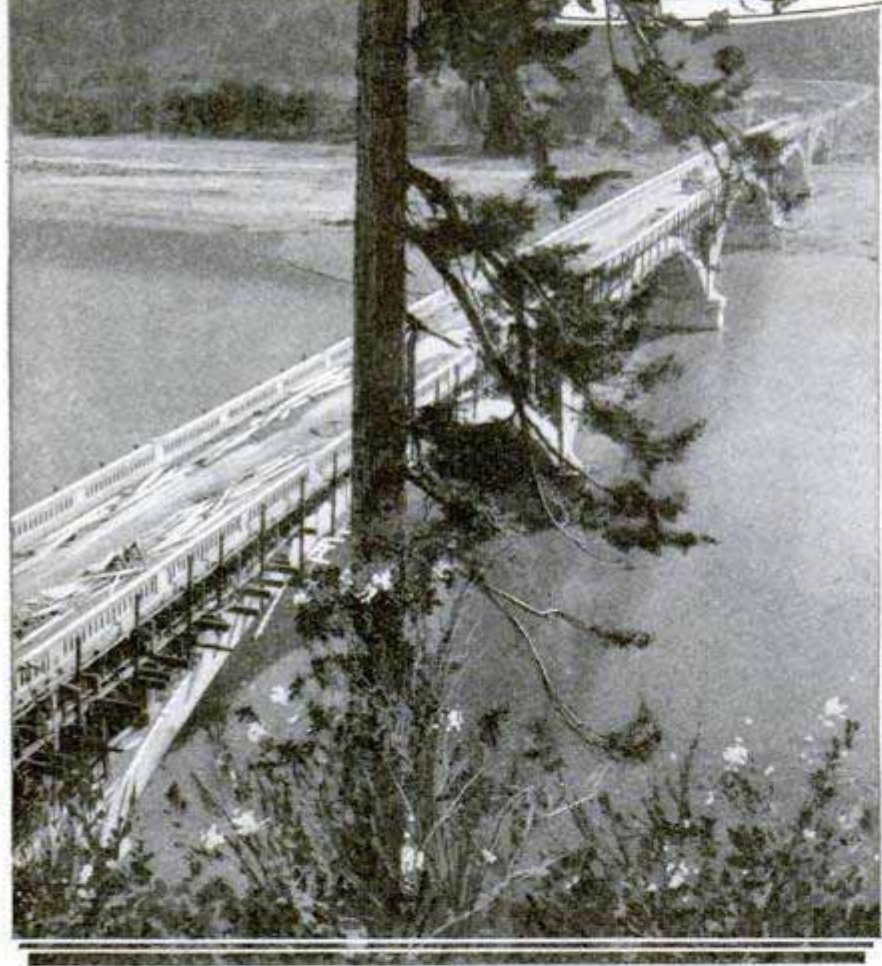
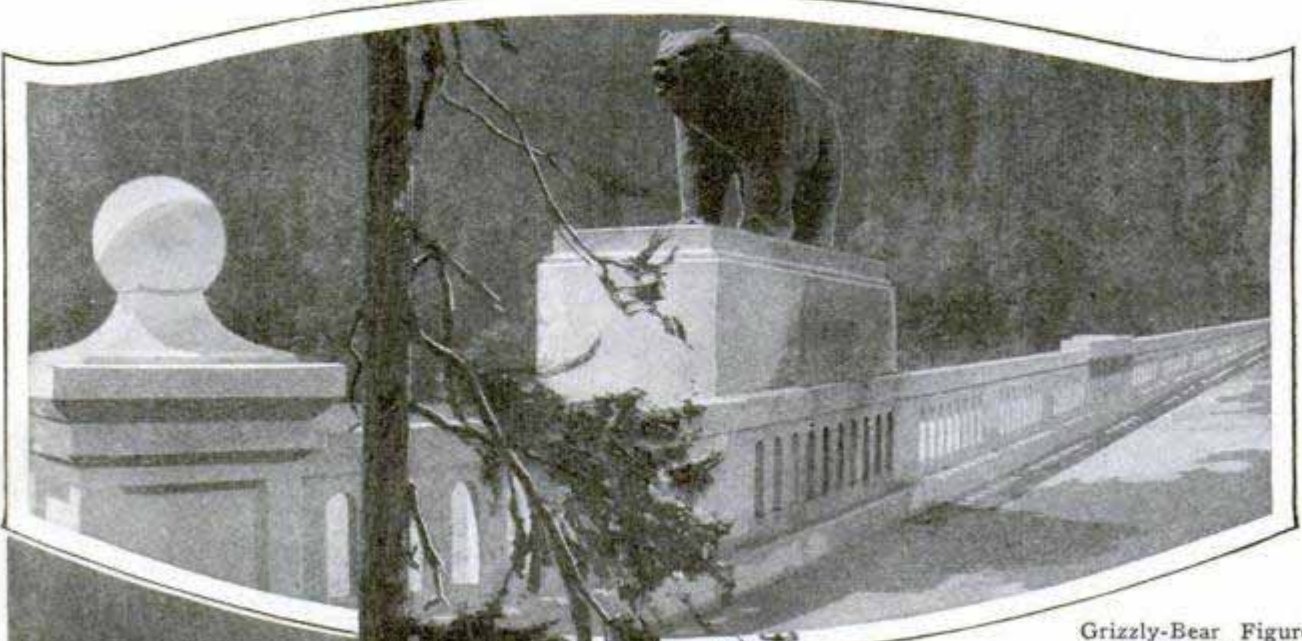

Grizzly-Bear Figure at Approach, and General View of the Douglas Memorial Bridge over the Klamath River; the Viaduct Opens a New California Territory to the Motorist

Man again has conquered nature and a triumph engineers consider notable has been recorded in the completion of the Douglas memorial concrete bridge over the Klamath river in northern California. It closes one of the few remaining gaps on the new highway to Oregon, opens a

virgin country of red-wood forests to the tourist and links Del Norte county permanently with the rest of the state. Before the bridge was built, floods in the river often isolated the district. The only way of getting out to the south was by ocean voyage. Three lives were lost and many thousands of dollars worth of materials destroyed during the two years required to complete the structure. The chief difficulty was encountered in the foundations. One abutment is on solid rock, but the others had to rest on wooden piles driven through a sand-and-gravel formation. The bridge is 1,147 feet long, each span being 210 feet, and the roadway is twenty-one feet wide and fifty-one feet above the water. A decorative feature is conspicuous on the pylons of the approaches—huge figures of grizzly bears, typical of the wild and rugged coun-

2231

try in which the bridge is located. The nearest railroad station was seventy-five miles, and the closest water point, thirty miles away.

WEIGHTED DRIVER TESTS GOLF BALLS 2244

A club swings, there is a loud crack the golfer describes as "sweet," and the ball, flattened momentarily to about forty per cent of its normal diameter, starts a graceful flight that will not stop for 250 yards or so. Every stroke is equally perfect; there is no slicing. This is not the performance of an expert player, but of a tester which shows if the balls are sufficiently tough, resilient, well-balanced and otherwise suited to the exacting demands of the game. The apparatus consists of a collection of weights attached to a special wooden club which swings in a perfect circle when the weights are released by a trigger and squarely strikes the ball, resting on an adjustable tee. The force of the blow and the distance of the drive can be regulated by changing the weights and the position of the tee.

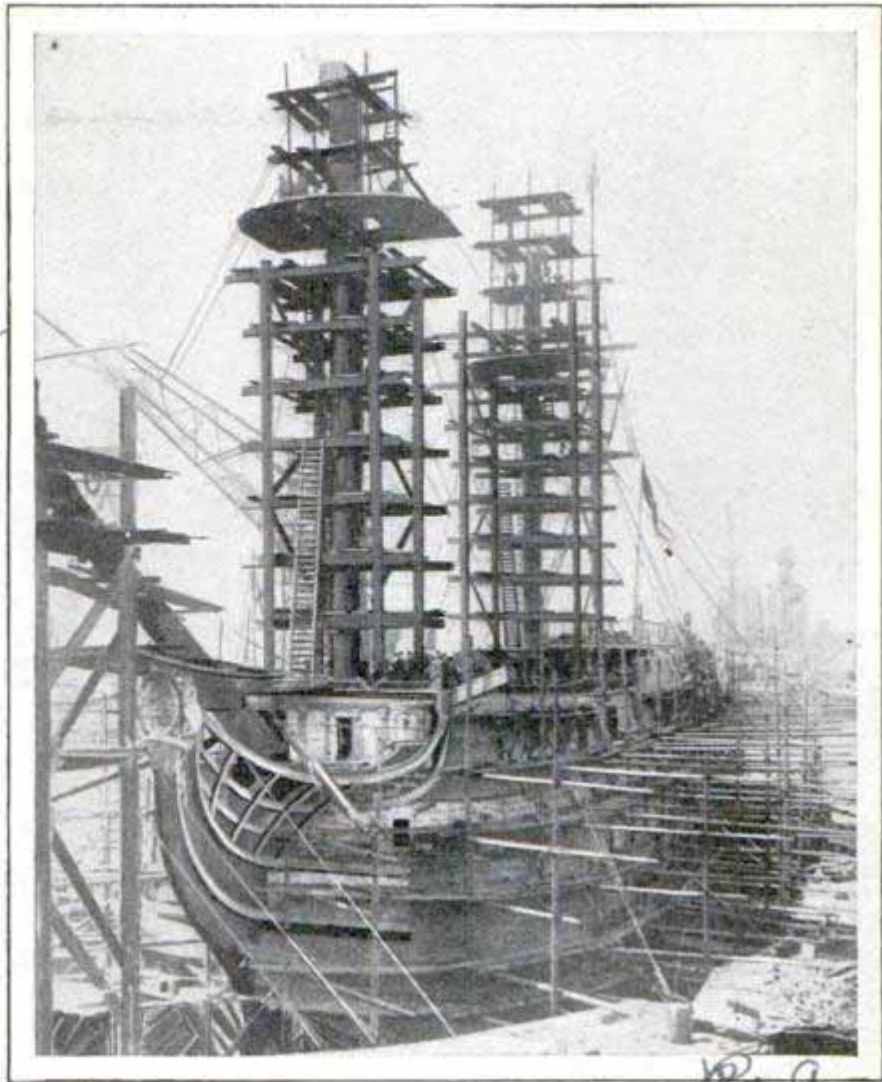

Lord Nelson's Flagship "Victory" during Rebuilding at the Portsmouth Dockyards in England; the Veteran Is More Than 160 Years Old

NELSON'S "VICTORY" IN SPLINTS FOR REBUILDING Ship Historical

More than 160 years old, Lord Nelson's famous flagship, the "Victory," is being rebuilt at the Portsmouth dockyards in England. The vessel is 186 feet long, has a beam of fifty-two feet, and when launched, weighed 2,162 tons and carried 100 guns. It has been used many years as a training ship. Its long life is in notable contrast to the comparatively short term of usefulness of modern vessels, although they are constructed of steel and cost many times as much as the "Victory," which was forty years old when in the battle of Trafalgar.

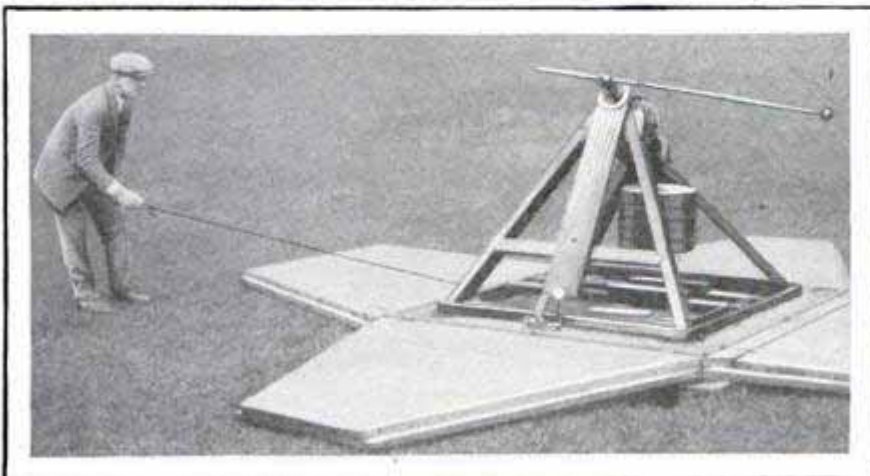

"Firing" the Golf Ball Tester; When Cord Is Pulled, Weighted Club Swings Round, Striking the Sphere a Lusty Blow

Isaodyear Co., Akron, Ohio.

United & ... 205 W. ... Chicago

**SHIPS THAT LAND TO LOAD
BUILT FOR GYPSUM TRADE**

Three vessels under construction in England for an American gypsum manufacturer are unique in that they are being constructed for a service in which the boats load on dry land and then take to the water with full cargoes. The trio will perform this unusual feat at the gypsum-quarry docks in the Bay of Fundy, where one of the highest tides in all the world flows in each day, and flows out again to leave the steamers stranded on dry land. Tides of more than forty feet are not unusual at the upper end of the bay. To get their loads of gypsum, the ships in the rock-carrying service race up the bay on the peak of the tide, reach the dock and make fast. The water flows out again, to return in approximately thirteen hours. During that period the boats must load, ready to leave on

Harverson. Ship building Co. Fred. M. Lee, England.



© P. & A.

Just a Detail for the Films, but Ten Men Are Said to Have Spent Three Weeks Carving This Russian Throne Replica

**THRONE OF IMPERIAL RUSSIA
REPRODUCED FOR FILM**

Ten wood carvers are reported to have worked three weeks in reproducing the throne of the deposed Romanoffs of Russia for a motion-picture play. Details of design and ornamentation were faithfully represented, although the piece was to be used but a short time during the action. Producers have found that such elaborate attention to what appear to be minor matters is often worth while and, when errors or omissions in such settings occur, critical audiences are quick to find them.

the next high tide. From charts and past calculations, the captains figure the probable height of the coming tide and the load the ships can safely carry. The peak of the tide lasts only a few moments.

**FRONT AND REAR AUTO SIGNALS
RUN FROM STEERING POST**



Light Signal and Switches Attached to the Steering Wheel within Easy Reach

Stop signals and those for right or left turn, which are lighted both at the front and the rear of the auto simultaneously, are controlled from switches on the steering-wheel post. The letters are visible at a considerable distance.

Automatic Services, Inc.

119 S. ...

14

14

LEAPING FISH FIGHTING FOR THEIR LIVES IN SOUTH

International

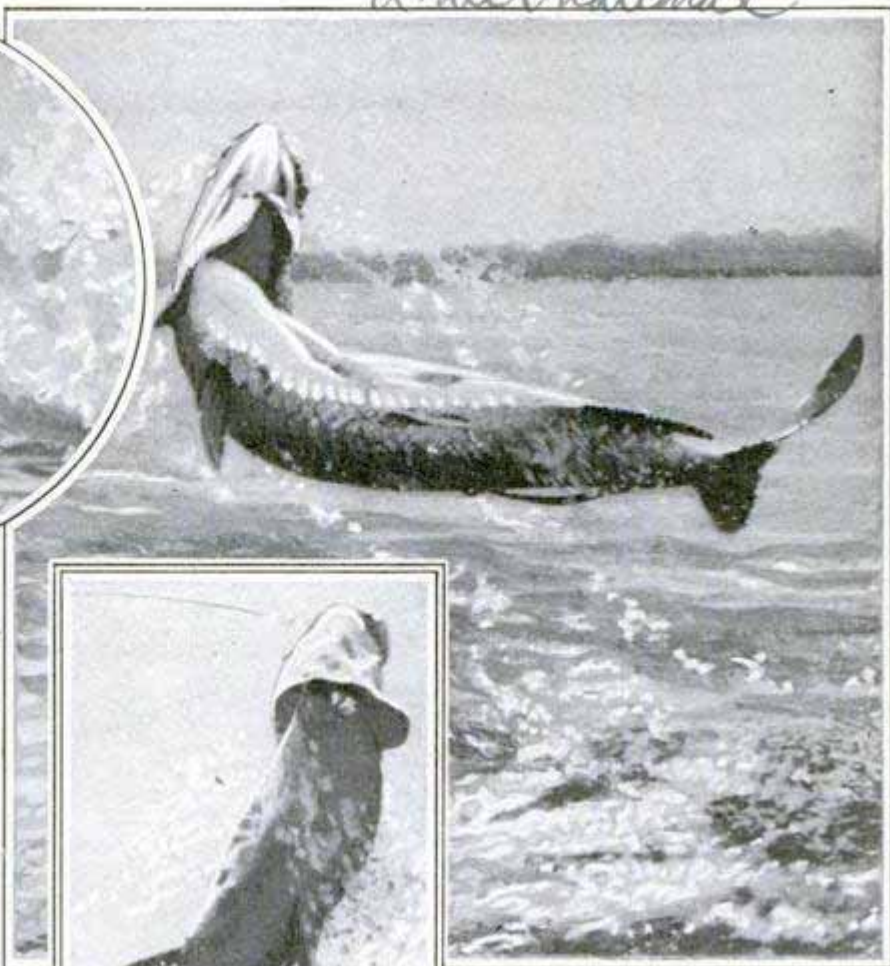
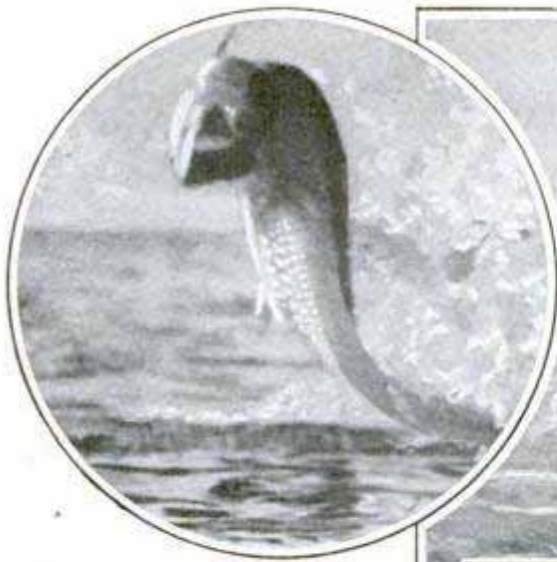

Tarpon Battling Like Wild Beasts to Break the Lines; Open Mouths and Distended Gills Indicate Their Anger; the One at the Right Weighed 180 Pounds



Two-Hour Struggles with These Mighty Jumpers Are Not Uncommon on Florida Fishing Grounds. Their Terrific Strength Is Shown Most Impressively in the Height of Their Furious Leaps for Freedom. Center Shows a Giant Tarpon, One of the First Hooked This Spring near Fort Lauderdale and Landed after a Battle That Taxed the Angler's Skill to the Utmost



A 176-Pound Tarpon at Left, Snapped While Fifteen Feet above the Water, and, at Right, a Rare Photograph of Leaping Sailfish, Greyhound of the Sea; They Can Jump across Forty Feet of Water at Almost Unbelievable Speed

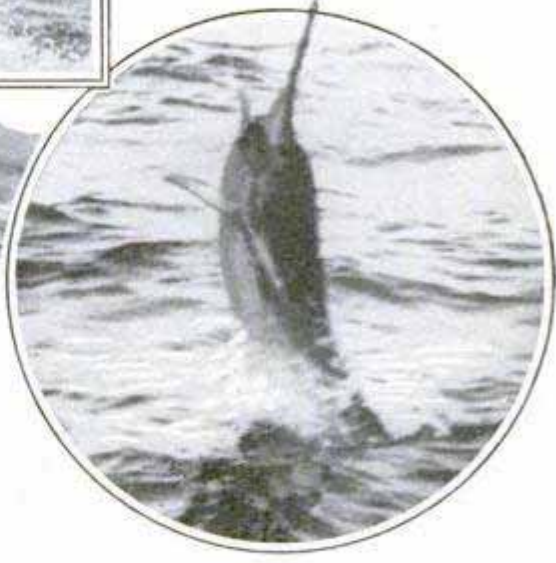

Shattering the Waters in Their Frantic Spurts to Free Themselves from the Hook, Giant Tarpon and a Sailfish. Photographed off Florida, Where the Skillful Angler, Seeking the Silver Monsters of the Sea, May Enjoy Many of the Thrills of Big-Game Hunting

360

SOFT LEATHER CASE AS PILLOW
ADDS TRAVEL LUXURY



Courtesy R. H. Macy & Co.

As a Pillow in a Steamer Chair, the Case Proves Serviceable and Practical on Voyage

With a roomy center pocket for books, purse or other articles, a soft leather pillow is carried like a traveling case. It is a source of comfort on long motor or train trips and in steamer chairs. The inner compartment is closed by means of a sliding tab between interlocking sides.

RISK OF TOO MUCH LAUGHTER
COVERED BY INSURANCE

Some motion-picture theaters are issuing cards to their patrons stating that they may "laugh their heads off for they are insured." The management has purchased a form of policy which reimburses them in case medical attention is needed for anyone suffering from hysteria as a result of laughing at the film. This is only one of the many queer "risks" now covered by insurance. A father of twin daughters, fearing that they might be kidnaped, obtained a burglary and theft policy on them which remained in effect for several years and was canceled when the twins grew up. In-

urance against the arrival of twins has been frequent, to indemnify parents for any financial setback. A driver of Eskimo dogs secured a policy to protect him against claims that might be set up by persons bitten. Marine companies insure all sorts of articles ranging from wooden cigar-store Indians, race horses and gold to flour and dead bodies. A gambler insured his gold and diamond dental work against holdup and theft and inventors obtained a policy on an ingenious model of the Holy City to reimburse them in case their valued possession was damaged by fire, shipping, or was stolen. A young woman journeying to this country from Europe to officiate as a judge at a conference of perfume manufacturers, had her nose insured against any accidental damage that might be suffered before the contest, impairing her efficiency.

RAMPS INSTEAD OF STAIRWAYS
ADD SAFETY TO HOUSE

Steps and stairs have been omitted in a California home for additional safety and convenience, substitutes being provided in the form of ramps and inclines at easy angles. Two sloping approaches lead from either side of the entrance instead of the conventional steps. The plan is considered a wise one where practical, as accident reports show that many of the most serious injuries that occur in homes are due to falling downstairs.

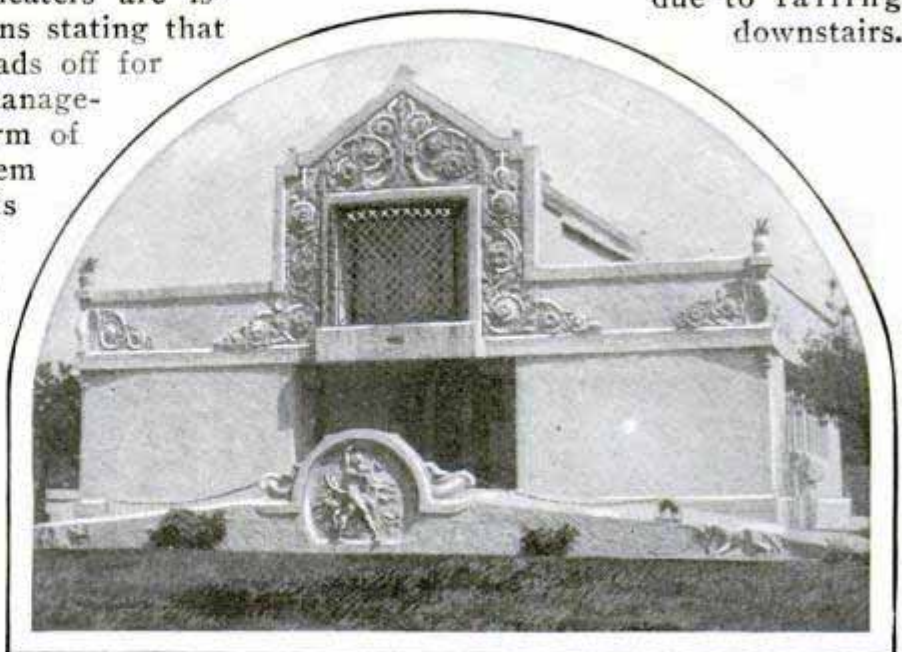

Unusual California Home Where Inclines Are Substituted for Stairways; Sloping Approaches to the Entrance Are Conspicuous.

at Santa Monica

Clarence J. Hubbard
New York World

2279

W. H. Macy & Co., 34th
New York City

RAINCOAT FOR STADIUM KEEPS GRIDIRON DRY

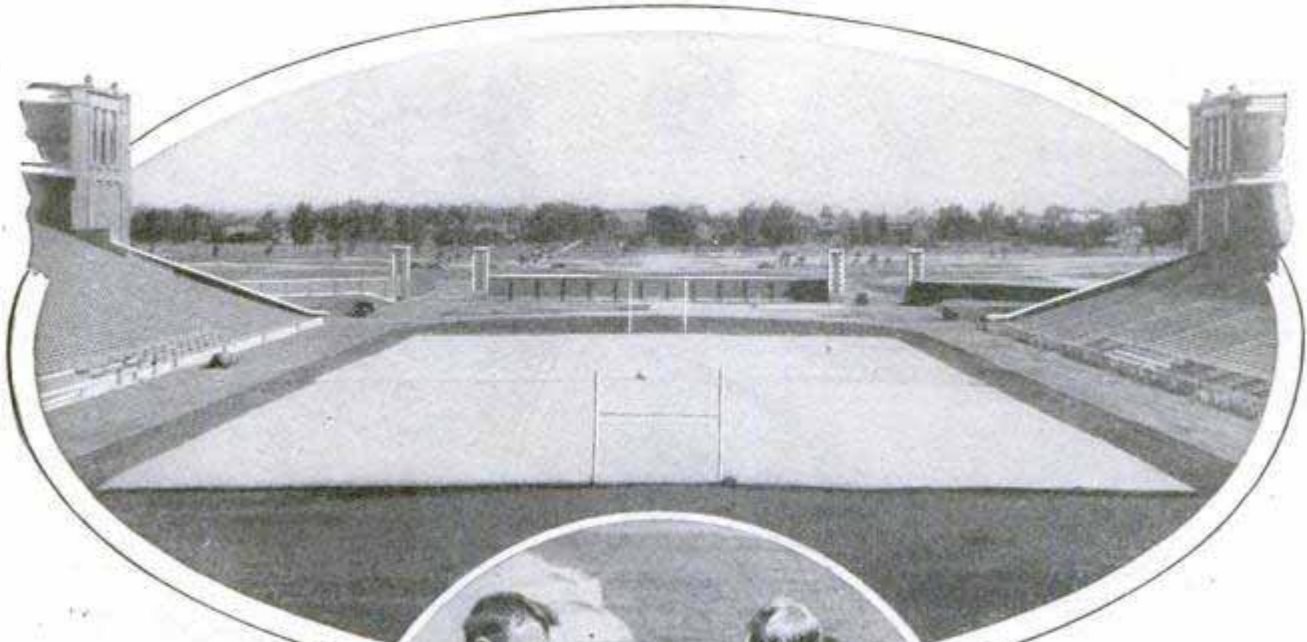

Raincoat Laid over Entire Gridiron, and Coach Zuppke Examining a Corner of the Fabric

To keep the football field at the university of Illinois in good condition for games, a huge covering of rubber fabric protects the entire gridiron from rains. It consists of four sections, each 158 by 83 feet, and cost \$10,000. No supports are needed for the shield, as the area is graded in such a way that it slopes from the center, allowing the water to drain off to the sides.

which became moist in transit. Carrying a shipment of carbide, the steamer "Mas-cot" caught fire on her way across the North sea. Although the decks became red-hot, the crew managed to jettison the whole of the perilous cargo and made port safely. Fruit of various kinds

CARGOES THAT KILL DREADED BY SHIPS' CREWS 2340

Cargoes of soft coal are dreaded by seamen for they are liable to spontaneous combustion and the fire is difficult to extinguish. Chemicals of various sorts are even more unwelcome, as they give off unpleasant odors and are dangerous. The steamer "Hardy" was blown to pieces when a cargo of metallic sodium took fire on contact with water. A number of sailors were injured. The crew of the coasting vessel "Sarah Jane" were suffocated by fumes from a load of shell lime

causes trouble. Bananas, for instance, turn black if they become chilled. To prevent this, the bunches are often wrapped in paper, then covered with straw and placed in stout canvas bags. In unloading, they are carried down hooded gangways into closed vans which are sometimes steam-heated. The smell of green coffee is not unpleasant at first, but on long voyages becomes obnoxious, often destroying the appetite, and sugar is unpleasant when it steams. It also attracts beetles and cockroaches which grow to great size and multiply rapidly, developing a sickening smell that taints all food. The odor of turpentine from yellow-pine lumber gets into the drinking water and causes serious sickness.

Answers Sept. 19, 1925

190 ✓ HOW SHEER BLUFF KEEPS LION TAMERS ALIVE

Lioness Showing Her Teeth to the Trainer and a Full-Grown Male Lion, One of the Most Intelligent of Big Beasts; Below, an Exciting Scene in the Circus Den, Where Pure Bluff and Fear of the Unknown Keep the Animal from Charging

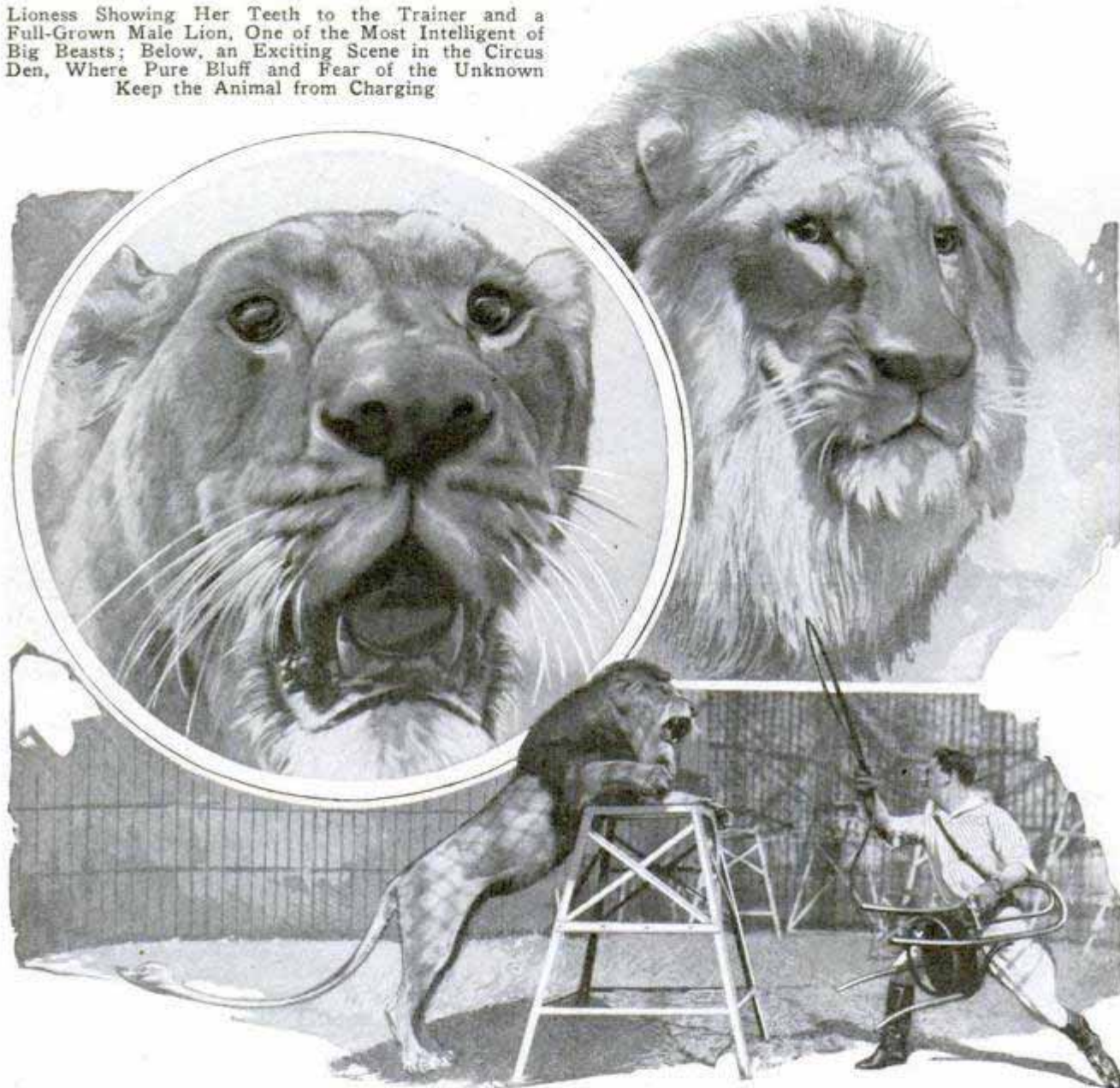

The revolver that roars as the lion tamer drives his charges through their tricks; the whip and the steel-tipped prod are bluff. The revolver is loaded with blanks, the whip is aimed at, but just misses, the lion's nose, and the prod merely waves before his eyes, but doesn't touch him. If it did, there would be another lion tamer missing at next roll call in the circus. The tricks of the trade, according to Christian Schroeder, a circus tamer who learned his business at the world's biggest animal farm in Germany, all center around one thing—bluff. "Keep 'em guessing" is the tamer's motto, and it holds good whether you are handling lions, jungle tigers or the slim and vicious panthers.

"You see," Schroeder says, telling how to do the job safely, "I bluff 'em. If they knew it, they could chew me up in the cage. I couldn't do a thing to stop them. These," handing over the whip, the "fork" and the revolver, "are absolutely harmless, but the lions don't know that. So I win. May be you thought I hit 'em with the whip. I didn't. May be I just touched them real easy once or twice. But I never hit. If I had, they'd been on me. I just cracked it—two or three feet away from the lions. That bluffed 'em.

"They were kind of bad today," the trainer admitted. "That was why I carried the steel fork in the cage instead of my usual wooden stick." The fork is a

long, light rod, tipped with two sharp steel prongs.

"Do you ever jab a lion with it," he was asked. Schroeder laughed.

"They'd be at me then, and nothing could stop them. No sir, I just chuck it at 'em. Bluff 'em. They don't know what it is, so they're afraid of it. But jab one of them once with the fork and his fear of it would be gone. Of course, if a lion jumped me, I would use the fork to try and save my life, but holding back a mad lion wouldn't be an easy job, and if one jumps you, the others probably would join in."

He displayed the revolver again. It had been used as a last resort to make the lions mind. Breaking it open, Schroeder withdrew the unfired shells. All were blanks. There hadn't been a bullet in the gun.

"Training a lion isn't a lot different from raising a baby. If you threaten either one too often, they begin to discount your threats. The only way is to save the threats as a last resort and, when you do use them, make them mean something."

TENNIS-RACKET KEPT STRAIGHT WITH METAL CLAMPS 2112

Quickly adjusted to the tennis racket to prevent warping, a pair of metal clamps are easy to put on and may be screwed up to different pressures. They are shaped so as not to damage the wood, weigh but little and take so small space that the racket can be carried in its usual case.



*Mitchell & Hess Co.,
1223 Arch St.*

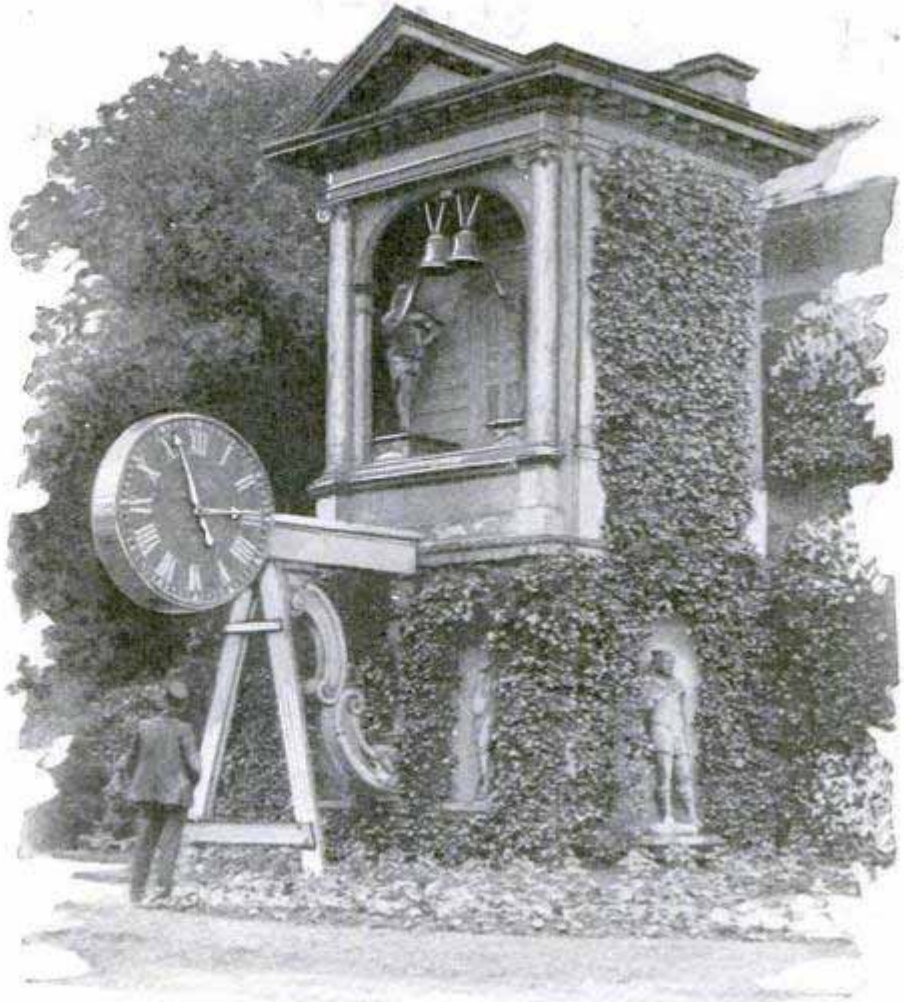

© P. & A.
Odd Clock and Bells from St. Dunstan's Church in Garden at Home for Blind British Soldiers, Victims of World War

ST. DUNSTAN'S ANCIENT BELLS TELL TIME FOR BLIND

The original clock and bells of St. Dunstan's church in Fleet street, London, were removed to a private estate when the structure was torn down, and are now in service at a home for blind soldiers of the World war. The projecting dial is a feature of the clock and at the foot of the belfry are some statues that stood in the ancient churchyard.

DRINKING GLASSES MADE OF ICE TO PREVENT DISEASE 2392

Sanitary drinking cups and glasses of ice are formed in a freezing apparatus devised by a Dutch engineer. They are said to last thirty minutes in a warm room and have an outer cover and an inner core for strength and easy handling. Besides keeping the liquid cool, they eliminate the danger of communicating disease, as frequently occurs with a common cup.

*Cmt. Max A. A. Primmer
Hofmannstr. 25,
Dresden-A. 21*

CHART PLATES BY PANTOGRAPH SAVES ENGINEERS' TIME

²To save time in preparing the copper plates from which navigation charts are made, two engineers of the navy department, after three years of experimenting, have devised what is said to be an entirely successful pantograph apparatus. The plates formerly were engraved by hand, a long and costly process. By the new method, they are produced from an original simply by tracing the lines as they appear under a glass, each movement of the tracer being duplicated to the scale desired and with varying depth of lines in the copper. This is accomplished by a diamond point arranged to scratch the metal as the tracer is moved. An additional feature of the system is that figures and other symbols can be quickly drawn on the copper in a uniform style, insuring a neat appearance and clearer legibility in the finished work. Inaccuracies in original drawings can also be properly corrected by making suitable adjustments with the pantograph.

USE MOTORCYCLE AS TAXICAB FOR FAST SERVICE

Sidecar motorcycle taxicabs, popular for some time abroad, have appeared in New York city. A charge of but ten cents a mile and rapid service are inducements to patrons, while reduction of congestion is another point claimed in favor of the adoption of this light-vehicle transportation system.

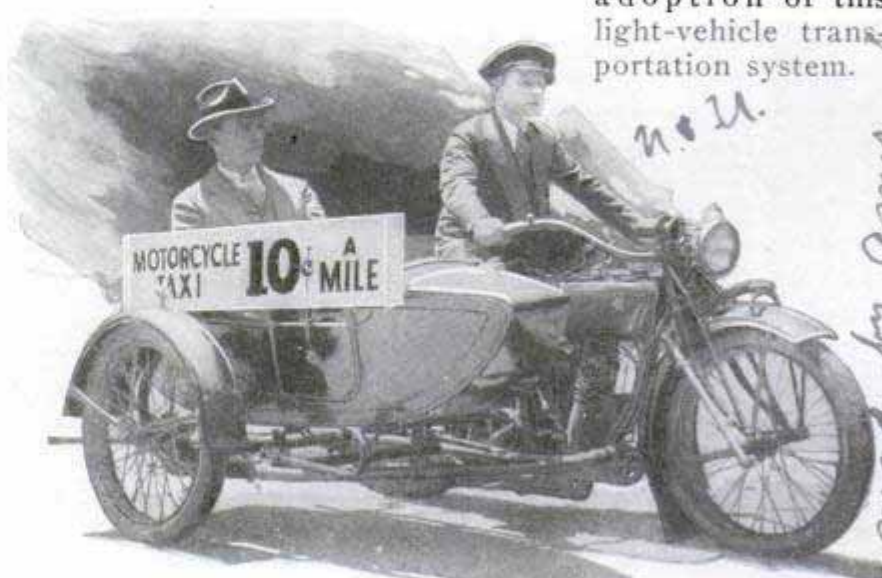

For Fast Service at Modest Rates, the Motorcycle Taxi; New York Enthusiasts Claim It Will Relieve Congestion

Sighting the Camera for Shot from Lofty Position; the Instrument Has Many Features of the Larger Outfits

MOVIE CAMERA FOR AMATEURS USES FULL-SIZE FILM

A light portable movie camera for amateurs, recently placed on the market, uses the standard-size film on which all professional moving pictures are made, yet, despite the added weight of its motor drive, is light enough to be operated in the hands, without a tripod. The case is made of steel with a crackled lacquer finish and all gears are machine-cut, with shafts of tool steel, operating in bronze bearings. The lens has a focusing range of from two feet to infinity, and the usual professional iris diaphragm is used. Two view finders enable the camera to be operated from the eye level, or swung at the hip, while a third one allows accurate focusing for titles, close-ups, trick photography and telescopic work. The camera takes 100-foot spools, and the spring motor is large enough to take fifty-five feet at one winding. The motor control can be locked so that the operator can walk around and into his own pictures, while a hand crank is provided for high-speed or slow-motion work.

*The U S Vry Corporation
1111 Center St. Chicago*

2275



Chicago Price \$150.00

hydrographer

navy dept. Wash. D.C. 1111 Center St. Chicago

Passenger Walter Houston

2296

DIVERS RISK THEIR LIVES IN RAISING SUBMARINE

flated, a hazardous task that called for leaping on the tossing floats and opening vents, while divers prepared for the task of rigging air lines and lashings anew. The 240-foot wreck had upended, as navy experts had predicted. But contrary to their plans, the

P. A.

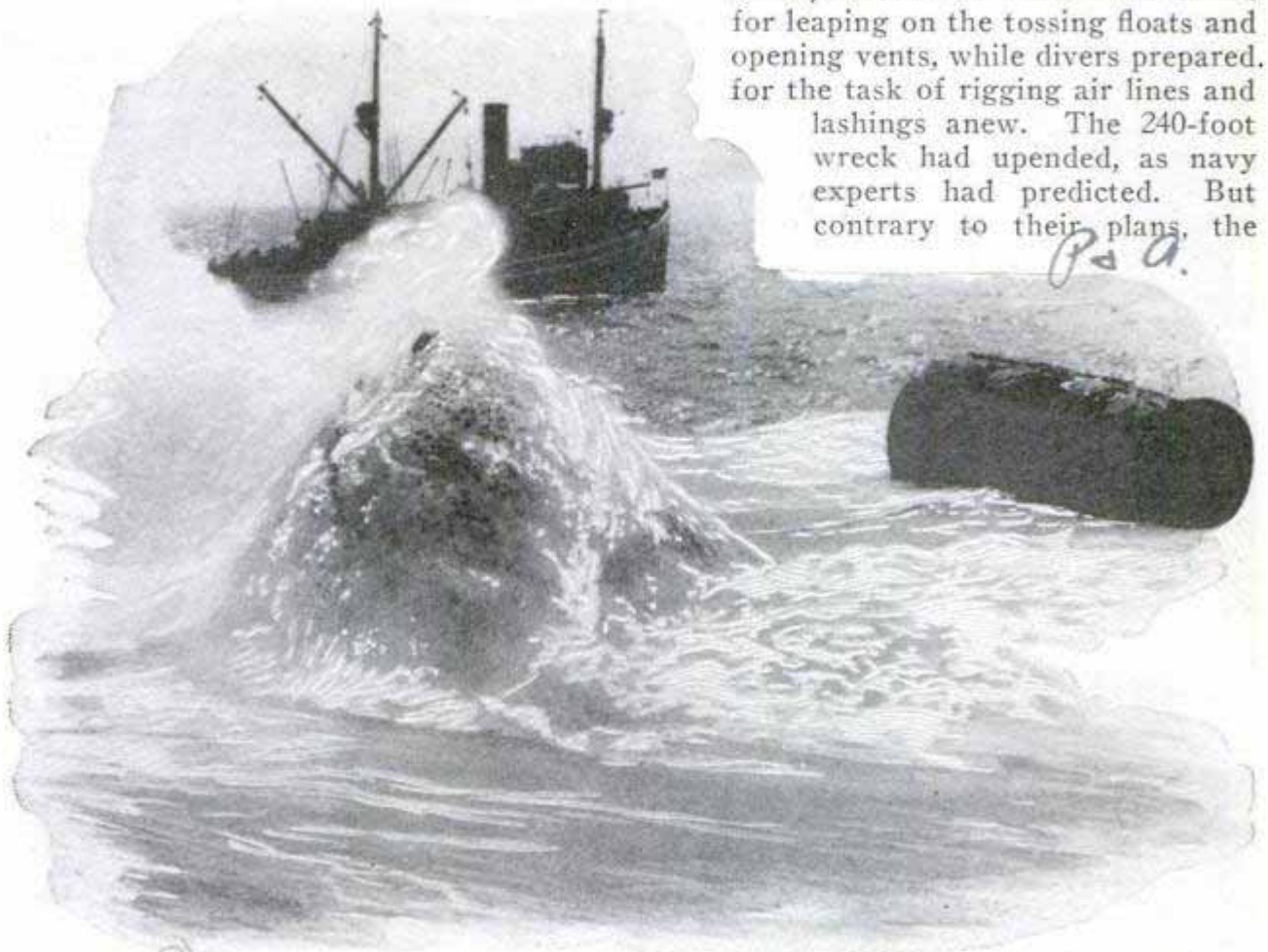

Why the "S-51" Slipped Back after the First Raising; Pontoons Lashed to the Stern Broke Loose and Leaped to the Surface; Photo Shows One Coming Up

Working among tangled, wave-tossed lines and grinding pontoons that threatened any moment to crush men and boats, divers and engineers fought a thrilling battle during the raising of the submarine "S-51." It was finally lifted and towed back to land, July 5, after an unsuccessful attempt a few days before. The gray, sand-scarred nose of the wreck, borne on the shoulders of four pontoons, suddenly broke the surface of the ocean June 22, the first time it had seen daylight since the sinking, Sept. 25, 1925, when thirty-three men lost their lives. Victory seemed assured. But a chain holding the pontoons at the stern gave way, releasing the floats. That accident cut off 120 tons of lifting power, and air that was being pumped into the stern of the submarine escaped through the check valves. Recognizing failure for the time being, engineers let the submarine settle back to the bottom again and the pontoons were de-

bow, where the "City of Rome" had struck, came up first, and before the workers were quite ready. Several weeks were spent in the salvaging operations.

VAPORIZER IN LIGHT SOCKET 1416 RUNS WITHOUT MOTOR

Operated from an electric-light socket, a motorless humidifier flashes on and off to keep cigars moist or it may be used as a vaporizer or deodorizer for rooms. It is constructed like a lamp and has a chamber for the liquid which is absorbed by a wick around the bulb. When the current is on, the heat of the lamp causes the vapor to form, no other attention than occasional renewal of the water supply being needed.



Herbert Bauer, 7425 South Shore Drive

*Hum. Air Humidifier Co.
6245 University Ave.
Chicago*

2010 TAILLESS AIRPLANE IS HAILED AS FOOL-PROOF

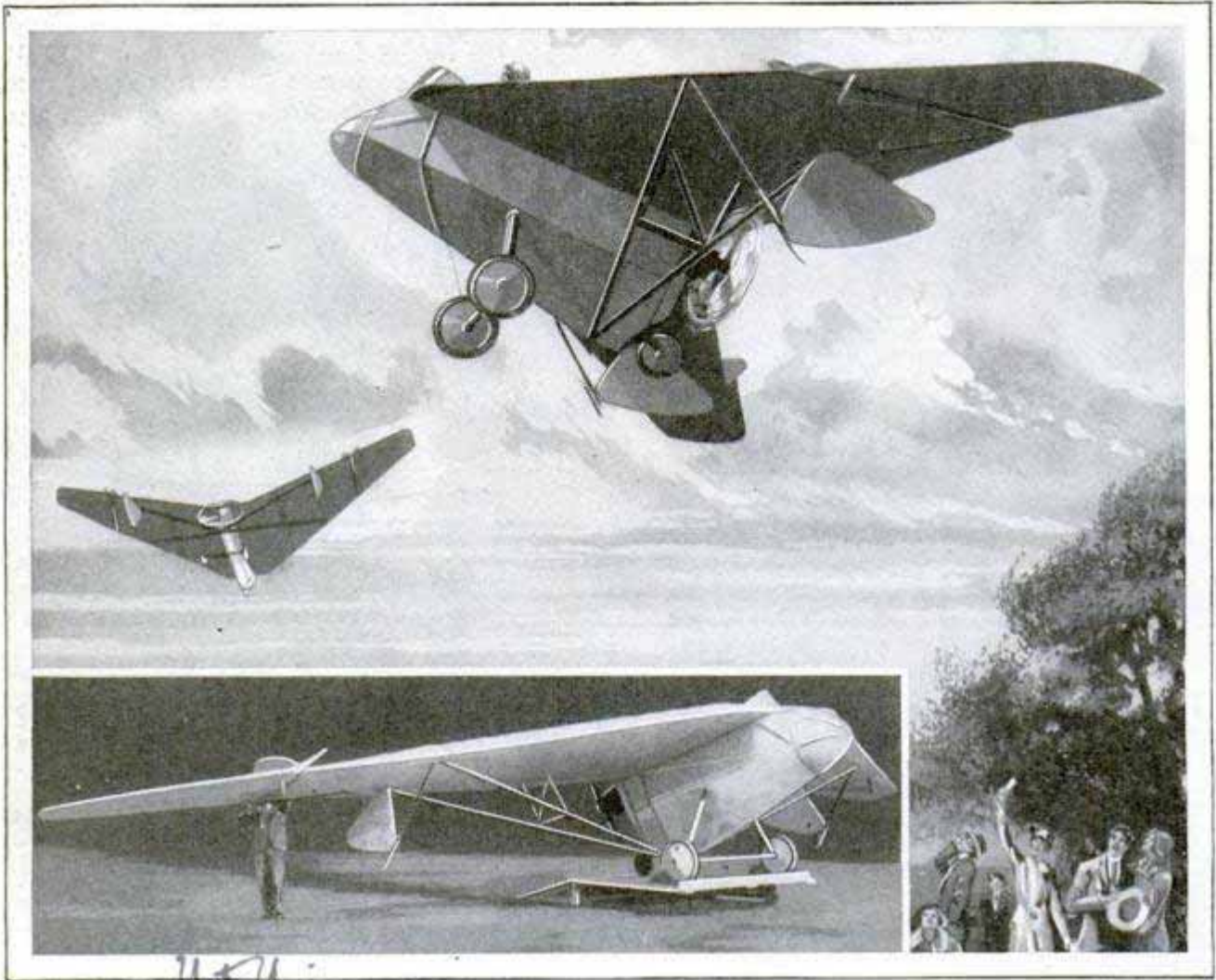

In Flight and on the Ground; the Hill Plane Has No Tail and the Usual Rudder Controls Are in the Wing Tips, While the Engine Turns a Propeller Pushing from Behind

Designed to eliminate accidents due to errors of judgment on the part of the pilot, a new type of tailless airplane, built by Capt. G. T. R. Hill, of England, is declared to make flying virtually fool-proof. Instead of the usual long fuselage, tipped with rudder and elevators, Capt. Hill's machine has a curiously shortened body, ending in a pusher propeller. The engine is near the rear of the body and the pilot sits in front of it, giving him a clear view ahead. The wing—the ship is a monoplane—sweeps back at a sharp angle, much like those of a bird in flight. On either side, at a distance from the body equal to the length of the fuselage of an ordinary ship of similar wing spread, rudders are fixed. The advantage of the machine is said to be that it is practically stable in any flying attitude, whether on a level course or pitched upward at a climbing angle so steep that an ordinary air-

plane would lose the lifting power of its wings and go into a stall—the cause of a large portion of all air accidents. With the ordinary plane, the normal flying range is limited to a comparatively small angle. Outside of that range, it is only possible to keep even a powerful machine climbing by constant adjustment of the controls. With the Hill plane, it is claimed, the ship will continue to fly in any attitude after the controls are once set, and keep on flying that way until they are changed. In other words, the ship is stable in many positions instead of one, somewhat in the same way that a watch is adjusted to operate properly whether held upright, face down, or leaning to one side or the other. Instead of the trailing skid under the tail, which furnishes the third point for the landing of an ordinary plane, the tailless ship has a third wheel under the short body.

PICTURE LABELS ON PACKAGES TO REDUCE BREAKAGE

One of the difficulties in international trade is that few of the men handling the shipments can read the different languages in which signs on the boxes are written. Breakage through ignorance of the contents is often the result. To eliminate this, the international union of railways has adopted a series of picture labels, a sort of commercial Esperanto in tags, so that everyone concerned will know the nature of the contents of the boxes. For instance, parcels of perishable goods have a label in blue and white with a design showing a fish, a flower and a bunch of grapes. Live-stock crates carry a tag in the same colors with pictures of a dog, a cow's head and a hen. Articles of a fragile nature are marked with red and white stickers showing a wine glass.

*The Danmarch Hotel
160 St. James St.
Atlanta City*

TYPEWRITER WITH MANY KEYS HAS FORTY ALPHABETS

Taking rapid dictation directly on the typewriter, without the use of shorthand, is said to be possible with an instrument on which the inventor, a former court reporter, asserts he has attained a speed of 283 words a minute. It differs considerably from the usual typewriter, the board, for instance, having 1,160 keys which cover no less than forty alphabets. The machine is the result of twenty-five years of study.



Attorney Fred A. Dolph at Model of Keyboard of His Typewriter, Which Contains Forty Alphabets

*cl no Washington
D.C.*

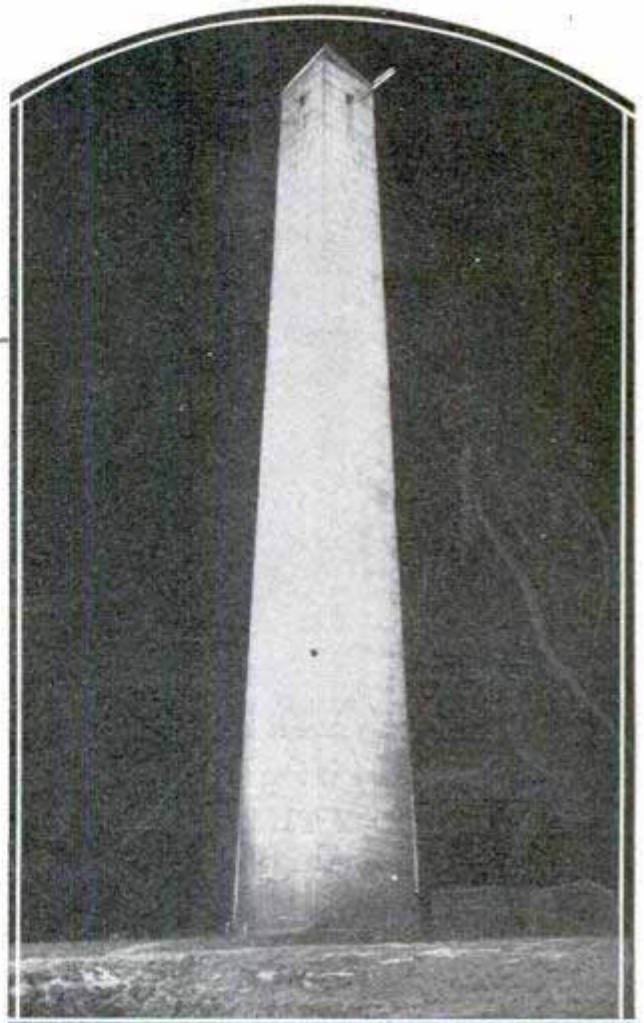

Courtesy General Electric Co. Bunker Hill Monument under the Glow of Six Big Floodlights Is Visible Twelve Miles at Night

LIGHT BUNKER HILL MONUMENT WITH SIX BIG LAMPS

Six big 1,000-watt searchlights with a total of 15,000,000 candlepower have been placed near Bunker Hill monument in such a way that they flood the entire shaft with radiance, making it visible from a distance of twelve miles by night. Each set of three lights on separate poles, one 190 feet and the other 250 feet away, illuminates two sides of the monument.

TEST PINE SHAVINGS AS "SNOW" FOR MOTION PICTURES

Pine shavings bid fair to play an important part in the silent drama if experiments with them as substitutes for snow prove successful. In filming "frozen-north" pictures, it is said that ten or fifteen carloads of imitation snow are often required. Bleached cornflakes have been used, but the shavings are cheaper.

*Minneapolis Tribune
6/27/26*

Answers 1/2/26

2263

2230

ny

2329

6/27/26

2200



Secretary of the Navy Wilbur, Center, at the Unveiling of the Memorial Tablet to First U. S. Warship

HONOR OF NAVY'S BIRTHPLACE CLAIMED BY THREE PORTS

The time and place of the beginning of the American navy was a disputed point between three Massachusetts towns recently. Marblehead claimed the honor from the fact that, in 1775, the schooner "Hannah" was chartered there as the first warship authorized by the colonies. On October 13 of that year, congress had passed an act establishing a marine committee consisting of John Adams, John Langdon and Silas Deane. Salem asserted its right to recognition as the navy's birthplace because the "Man-O'-War Ketch," which sailed out of the port in 1676, was the real nucleus of America's sea power; and Kingston, the third claimant, insisted that since three of its ships were taken into the naval service in 1775 and still another was built there the following year, it should be considered as the scene of the navy's beginning. Officials of the Massachusetts military and naval historical society upheld the claims of Marblehead.

BEE FARMS ON CITY ROOF TOPS PAY PROFIT IN BERLIN

Several citizens of Berlin have found that bee keeping is a paying proposition even in a city of 4,000,000 inhabitants. It is estimated that there are at least 200 fanciers there who keep the hives on the flat roofs of the buildings. The structure occupied by the Prussian diet has twelve and there are twenty on the roof of the academy of music. In all, more than 3,000 swarms are kept within the city, making a bee population estimated at upward of 150,000,000 or so.

METAL TAPE FOR PHOTO FLASH GIVES BRILLIANT LIGHT

Magnesium in thin tape form, and carried in a small igniter that fits in the vest pocket, has been prepared for photo flash-light purposes by a German chemist. A small portion of it is said to burn with brilliance equal to that of a 1,000-candle-power half-watt electric lamp, and since the small box in which it is contained may be moved about while the picture is being taken, shadows can be lighted up and thus better effects obtained in the photograph than are possible when powder is used. Snapshots can also be taken under the intense light and its use eliminates the bother of powder and excessive smoke. Added safety is another feature of the magnesium flash.

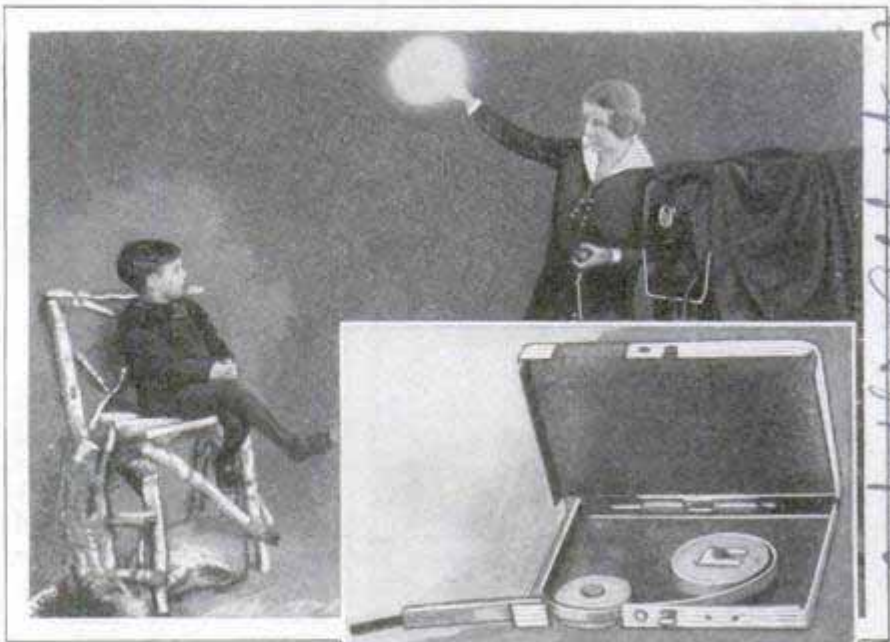

Taking Studio Flashlight with Magnesium Tape and Close View of Igniter Opened, to Show Material Coiled in Position for Use

Boehm Werke
Berlin, Germany

Unterfelde 4
Ent. Dr. Albert Nubinger
Berlin, W. 20, - - - - -



Where Steady Nerves, a Cool Head and a Sense of Balance Counted as Much as Speed; Race between Expert Basket Carriers at an English Athletic Meet

RACING WITH BASKETS ON HEAD ADDS THRILL TO MEET

One of the most spectacular races at the athletic meet of the Spitalfields market sports club at High Beach, England, was between a number of runners carrying high piles of baskets on their heads. The men become proficient in this task during their daily work and further demonstrated their skill at the contest. Dropping a basket disqualified an entrant.

MINNOWS SENT BY BATTLESHIP TO FIGHT MALARIA 2209

A unique force of fighters departed recently aboard the Argentinian battleship "Moreno" from the United States for Buenos Aires. They were 2,000 minnows hatched at the bureau of fisheries and sent to the South American republic to aid in the war on malaria by devouring the larvæ of carrier mosquitoes. These larvæ live only in stagnant water and, being air breathers, stay almost entirely on or near the surface, the favorite feeding grounds of the minnows. Many pools in this country, too large to be coated over entirely with a smothering film of oil, have been

successfully rid of the embryo mosquitoes by the minnow treatment. The first shipment was ordered by the international board of health for breeding purposes and for distribution throughout the fever-ravaged regions in Argentina.

LIGHT FOR FRONT HUB OF AUTO HELPS DRIVER STEER 1669

Directing a bright light on the curb, a lamp attached to the front hub of the automobile, illuminates the side of the road so that there is less danger of running into ditches or other obstructions

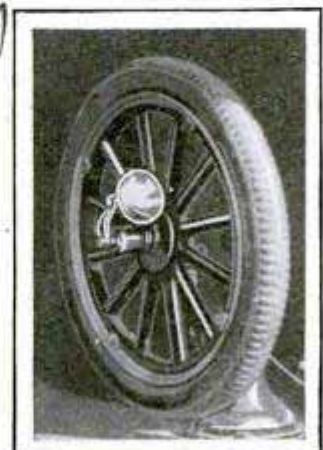

when turning or driving. It is fastened by a nut with a shank that protrudes through a hole cut in the hub and by a bracket. Grease is retained in the hub by felt and steel washers. Tests have shown that the light is of great aid when driving with headlamps dimmed or in the face of glare.

International

D.P. Hublite

Chicago Daily News 6/15/26

W.J. & Schooley Seattle Wash.

How Your Eyes

posed truths. Then, when something comes along to upset the adjustment, the eye promptly decides that "I am right and what I see is wrong." Some of the queerest pranks played on the eye are by combinations of lines, straight and curved. If you draw a thick horizontal line and rising from its center a thin vertical line, making them of equal length, your eye will try to tell you that the vertical line is much longer than the other.

Series of vertical and horizontal lines, spaced a short distance apart, and in each case filling a perfect square, give an equally strange illusion. The squares lose their squareness; the one with the vertical lines appears taller than its breadth and the



An Illusion of Looking through a Hole in Your Hand, Due to the "Sympathy" of One Eye for the Other

EVERYONE knows that the sky seems blue and that the full moon looks much larger when it just tops the horizon than an hour or more later, riding high in the sky. As a matter of fact, however, space is colorless and the moon is not larger at one time than at another. Both are optical illusions, as untrue as that transmitted by your eye when it tries to tell you that every distant object is partly obscured by a purple haze.

The moon probably looks larger at the horizon because the eye associates it with other objects.

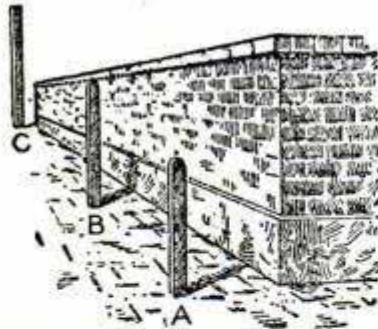

Perspective Produces Illusions Such as This; the Post C Is Really the Shortest and A the Longest

If you see a tree at that distance you readily imagine it being thirty feet high, because you are accustomed to thirty-foot trees; and when you see

the same tree in silhouette against the rising moon your eye naturally decides the moon is much larger. But an hour later, high in the sky, with nothing to compare it with, the moon has shrunk to the size of a barrel head, and the eye remarks to the brain, "how small it has grown!"

The two eyes do not actually see things as they are, but through long habit and training adjust themselves to a set of sup-

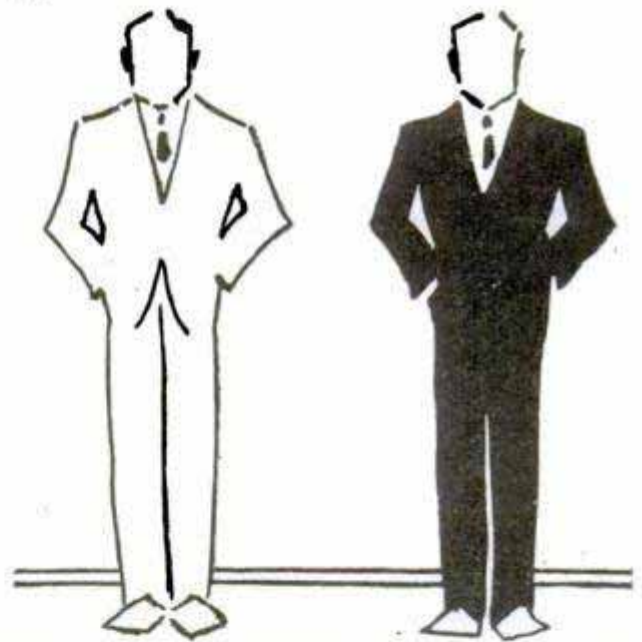

Two Figures of Identical Size, but the Light Clothes Make Their Wearer Look Larger

one with the horizontal lines becomes apparently, broader than it is tall.

As an illusion, that is interesting, but in its practical application toward fooling other people's eyes it accomplishes no end of good. A short, rather rotund person, for example, can wear clothes with a predominating vertical stripe or pronounced vertical lines, and thus appear much taller and thinner than he actually is. On the other hand a person who is too tall and thin can wear horizontal stripes, or, in the case of women, ruffles and laces in horizontal designs, giving an appearance of less height and greater width.

Deceive You

The same rule applies in decorating rooms. A room with a low ceiling appears squat and small if the walls are paneled in broad horizontal spaces, or if the wallpaper has a pronounced horizontal motif in its design. On the other hand, a room with a too high ceiling would appear even loftier and colder if the wall decorations ran to tall and narrow effects. So the one is made to seem bigger than it is by running the panels and paper designs vertically and the other is given a homy atmosphere by cutting off the high ceiling with a molding and using horizontal panels.

There is no end of the results that can be obtained by studying the effects produced by drawing combinations of horizontal and vertical lines. A girl who is too short should wear a close-fitting hat because a wide-brimmed one only accents her shortness. Similarly a girl who is too tall can offset that by wearing the big-brimmed hat.

Lines which are parallel can be bent or made to converge by crossing them with others; lines of the same length can be made to appear unequal by judicious use of other lines to create angles; circles of equal size can be made to look larger or smaller, or distorted, and a dozen and one other tricks played on the eye—and in real life every trick has its application.

Architects employ many of them, and their use was known even as far back as the ancient Greeks. The Parthenon at Athens still holds the record as one of the largest collections of optical illusions ever assembled in one building. For example, its majestic pillars, thirty-four feet high, bulge out three-quarters of an inch in the

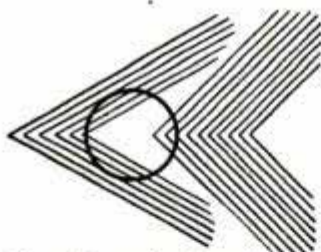

Lines Properly Placed Convince the Eye This Circle Is Distorted



Another Illusion, That Cross Hatching Has Bent These Two Parallel Lines Out of Shape

Small Men Should Avoid Wide Lapels, Big Hats, Bulky Coats or Big Checks

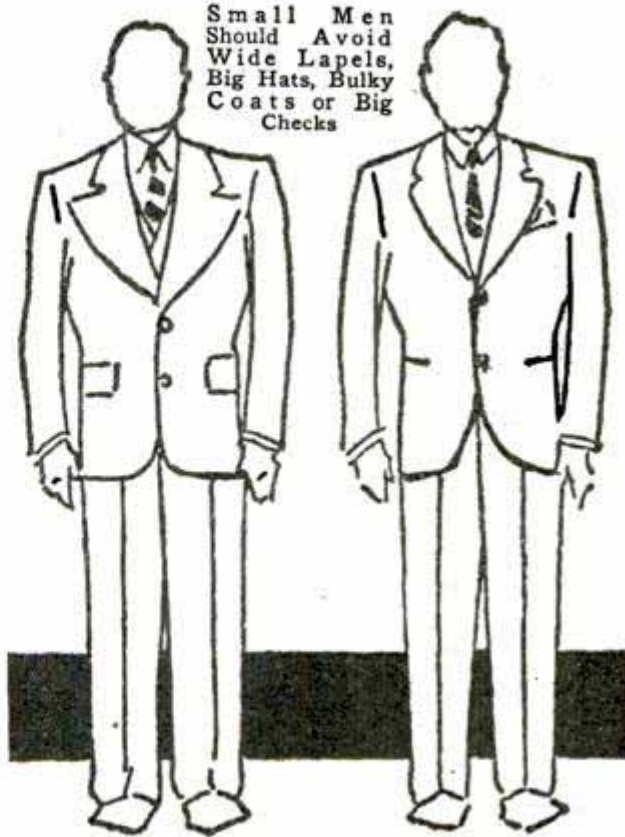

middle, because the Greek architects had discovered that a pillar with straight sides appeared too thin in its center section. The three-quarter of an inch excess there just nicely corrected the optical illusion by furnishing another—making the eye tell the brain that the pillar is straight. The long lines of the beams which surmount the columns appeared quite straight to the eye. Actually it had a curvature of several inches, otherwise it would have seemed to sag.

The same problems that faced the Parthenon builders are being met every day in modern public buildings and lofty sky-



Three Identical Faces, But the Horizontal Lines of the Bows Make the One on the Right Appear Broader; Even the Ribbon, in the Center, Helps

scrapers, and in addition the latter require visual tricks of their own. One of the worst faults is the checkerboard appearance given a lofty office building by its

1981



Long Overcoats Make Tall Men Short and Short Men Shorter, While Square Toes and Straight Lines in Shoes Make the Feet Look Bigger

rows upon rows of windows, all alike in size and shape. Architects have several ways of correcting this defect. One is to group double or triple windows together, separated by only a narrow surface, and on either side of the groupings leave wider spaces. The result of the combination of narrow and wider surfaces gives a tall column effect to the walls.

Another, and even more novel, method was employed recently in a tall Gothic-type tower built by a Chicago newspaper. The building, some thirty-five stories high, included an ornate tower for the upper dozen or so of floors. It was necessary to get straight, sweeping lines below so they would carry the eye upward to the highest peak. To accomplish this, the



A Pair of Parallel Lines That Seem Destined to Meet if Continued, Merely Because Series of Angular Lines Crossing Them, Convince the Eye of an Untruth

space beside the windows was filled in with stone, but that above and below them was covered with pressed sheets of dull-gray

metal, which, being recessed behind the stone front, did not attract the eye but left an impression of immensely tall stone columns.

A circular white spot on a black background and a similar spot, of exactly the same size, but colored black and placed on a white ground, form another interesting illusion. Laid side by side, the eye is convinced the white spot is the larger of the two. That is why dark polka dots on a white dress look smaller than white or light dots of the same size on a dark dress. Similar contrasts in brightness are applied in many ways in interior decorating, and in the arts and architecture. A dark line or spot always appears darker against a light background and a white spot always appears brighter against a dark background. Architects have found that columns, such as those of the Parthenon or of public buildings in this country, always appear smaller when viewed against the bright sky than they do when the observer stands outside and sees them against the deep shadows of the portico.

Besides the illusions with which the eye tricks itself in looking at everyday things, it is possible to fool the vision in many other ways. One of the easiest is a variation of the principle used in the familiar stereopticon, where two pictures, slight-

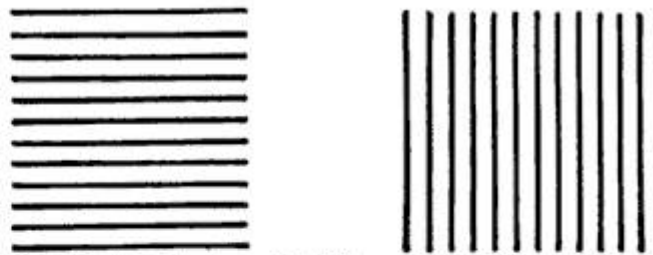

Two Perfect Squares, But They Appear Distorted Because of the Arrangement of the Lines

ly different, are viewed, one by each eye, and their images blended to give the illusion of depth. The same blending can be accomplished without the aid of a stereopticon. Draw two similar figures, circles or squares, of the same size, and a couple of inches apart on a sheet of paper. Hold them at arm's length and focus the eyes on a spot some distance beyond them—in other words "look through" the paper. After a trial or two in focusing the eyes, you will find the two figures blend together as one.

A similar illusion can be effected with

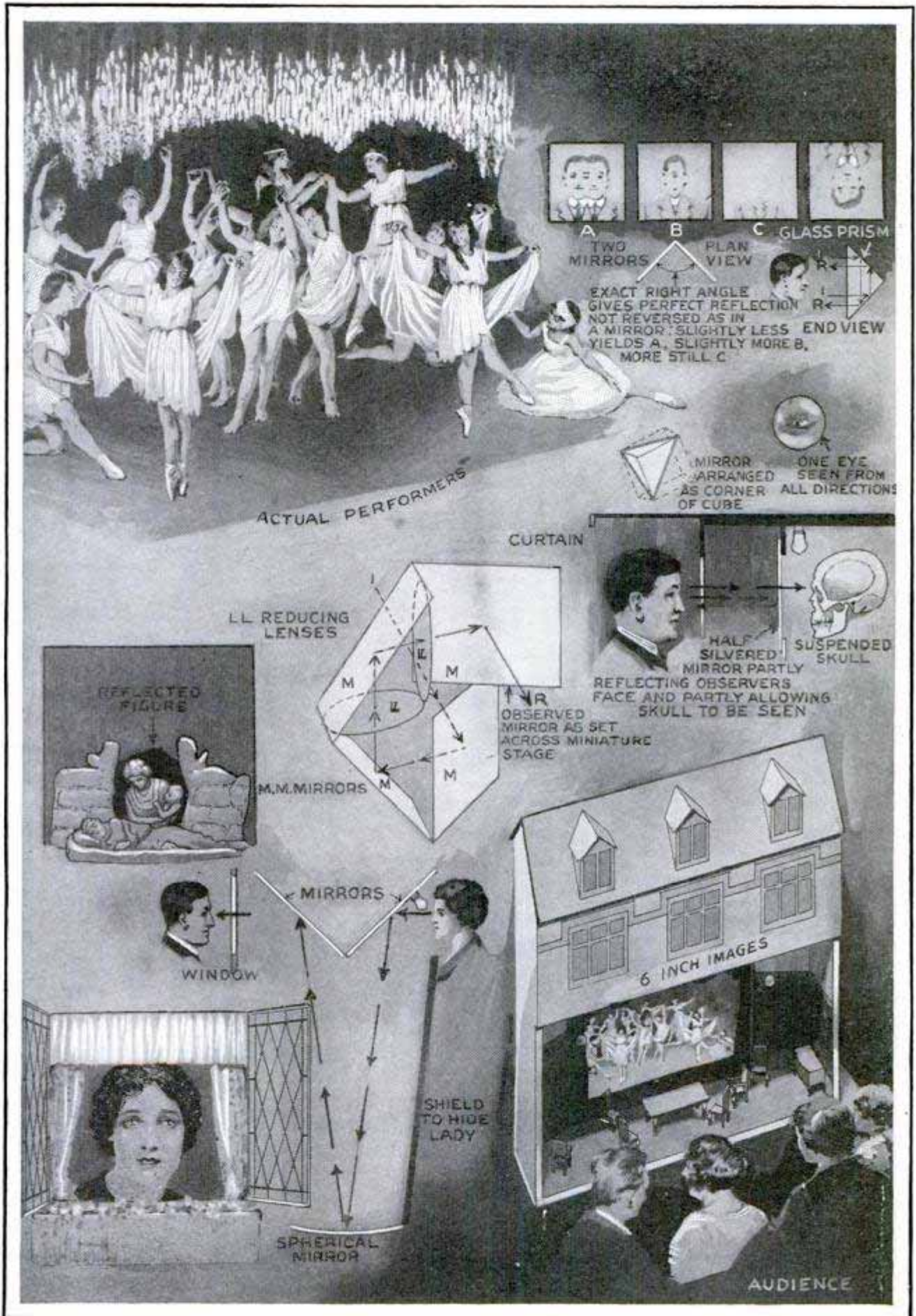

© S. W. Clatworthy

Six-Inch Dancing Figures, the Face at the Window and Some of the Other Startling Optical Illusions Recently Exhibited in London, with Sketch Drawings Showing How They Were Produced

1981

a sheet of paper, rolled into a cylinder an inch or so in diameter. Hold it before one

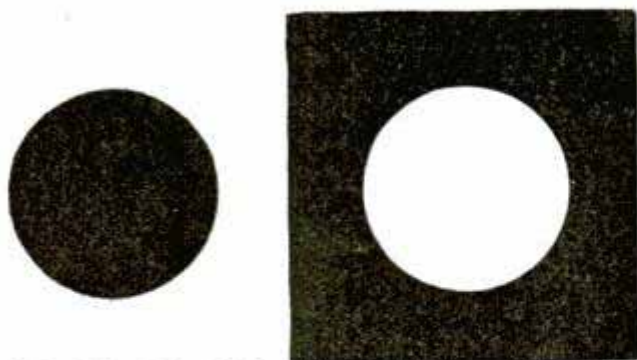

Why Light Suits Make a Man Look Bigger Is Revealed by a Study of These Two Spots

eye, look at some object, using both eyes, and then place the other hand over the end of the paper tube. You apparently continue to see the object with both eyes, looking through what seems to be a hole in your hand.

One of the greatest collections of optical illusions ever presented was shown at a recent meeting of the Optical Society in London. The skilled workers who are members of the society showed a miniature stage on which human figures, only six inches high, danced and presented plays; a window through which a woman looked, though, when the observer approached, no one was there, and many others equally mystifying.

The pygmy dancers were really reflections, through a series of reducing lenses and mirrors, of actual people who danced and acted on a hidden stage. The stage the observer saw was a reflection in a mirror. The illusion of a woman at the window was even simpler, employing two



Two Lines of Equal Length Again Mislead the Eye and Appear Unequal

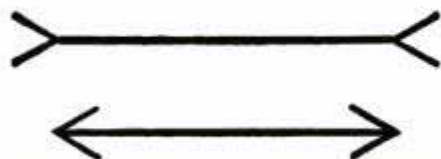

One of the Most Striking of All Illusions; It Takes Actual Measurement to Convince Many the Lines Are Equal in Length

plane mirrors, set at a forty-five-degree angle, and a third concave mirror. The woman stood behind the scenes and

looked into one mirror, which reflected her image down to the concave mirror, and from there up to the other plane glass. Looking through the window, behind which this last mirror was placed, the observer saw, apparently, the real person, only to find as he approached that she was not there.

Another illusion, worked in the same way, represented a soldier's dream of home. A plaster figure of a soldier asleep in a trench was visible to the visitors, while above his head appeared his wife and child, reflected from a plaster statue hidden behind the scenes. As the light illuminating the statue of the woman and baby was turned on and off the vision appeared and disappeared.

Pairs of mirrors adjusted at various angles gave series of queer figures, ranging from a double reproduction of the person looking in them, through thinner figures to one which was headless; while another mirror effect showed only one eye of the observer, yet the eye remained open regardless of whether he closed the left or right one. The effect was produced by an arrangement which superimposed the images of both eyes, so that shutting of either left the other still open.

Still another illusion combined a skull, suspended in a cabinet, with the body of any person looking in. The skull was hidden by a half-silvered mirror, which partly reflected the outlines of the observer's face, while allowing the image of the skull to show through, giving a weird sort of X-ray combination.

AIRPLANE WITH TEN MOTORS 2246 PLANNED IN GERMANY

One hundred and thirty passengers will be able to fly at one time from Hamburg to New York in thirty-six hours if plans for a giant airplane now under consideration in Germany are realized. The ship will have ten motors of 1,000 horsepower each, will weigh 230,000 pounds and have an average speed of 170 miles an hour. Besides the passengers, a crew of thirty will be carried, and the craft will be fitted with six pontoons for landing on the water. Duraluminum is the proposed material for the plane which will have a span of about 300 feet.

Mr. Kumpfer before Scientific Society of

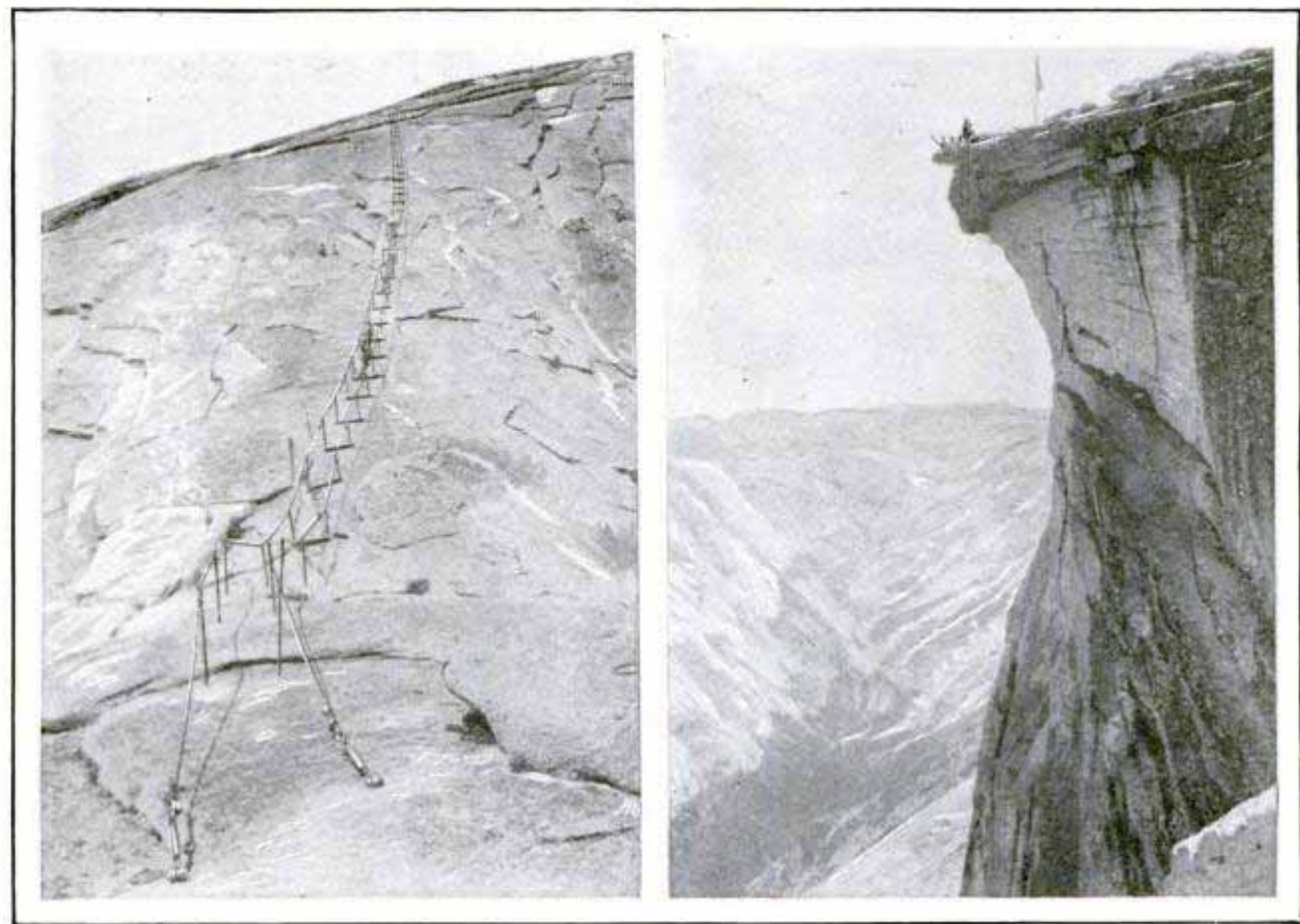

Left View Shows the Cable Way up the Steep Slope of Half Dome and the Other, the Summit and a Group on the Rim of the Ledge; a Radio Set Was Carried to This Point to Test Reception

GUIDES RISK LIVES ON CLIFFS BUILDING CABLE LADDER

in California

Clambering to the summit of the Half Dome, that rises a mile or so from the floor of Yosemite valley, and fastening a cable ladder to the steeply sloping rock so that tourists may ascend with ease, is the annual hazardous task of two western guides. They make their way inch by inch to the summit, sinking steel pegs at intervals for foot and rope holds. Lines are laid behind them to which are attached the cables, and these are finally pulled up and fastened in place when the ascent is completed. The ladder is taken down each fall so that avalanches will not sweep it away. On

the last construction of the cable way, the guides carried a radio set to the peak of the dome and tuned in on distant stations to prove that reception was satisfactory at that point. A Los Angeles studio broadcast a special program for the guides.



1879 WHEELED BRACES MAKE CHILD'S CYCLE SAFE

Designed especially for small children, a bicycle introduced in Paris has small wheeled braces on either side of the rear wheel in order to keep the machine from tipping. After the youngster has learned to ride, the extra wheels may be removed.

Further data

Braced by Small Wheels on Each Side of the Rear, This Bicycle Is Easy for Children to Ride

☐The nap on silk hats is sometimes made from the fiber of the milkweed.

Taken from illustrierte Technik für
 München. Herrscher 4.10. Jedermann
 1910



When Auto Is Driven into Deep Water, Paddles on Front Wheels Propel the Car like a Boat

FOLDING-PADDLE-WHEEL AUTO RUNS ON WATER

With a water-tight body and a collapsible set of paddles on the front wheels, a lightweight auto can be run from the beach into lake or river for navigation as a boat. An advantage of the folding paddles is that they lie flat in line with the direction of travel when the auto is on land to decrease interference from the wind. The rudder is underneath the body, the steering gear, which is operated by the wheel, being inclosed in a water-tight keel-like casing.

GAS BAGS SAVE MOTOR FUEL IN STORAGE

Regarded by experts as an important development in the oil-refining industry, large balloon bags have been adapted for catching the gasoline vapors that escape from storage tanks. They are each of 18,000-cubic-foot capacity, large enough for two or more tanks, and make possible a saving of \$1,500 a month on a standard-size tank, oil men assert. The vapors expelled through the vent pipe are retained until lowering temperatures condense them and the gasoline flows back into the tank, which is prevented from drawing in fresh air every night.

ASPHALT HEATER LOWERS STREET MENDING COST

Expense of fixing streets in an eastern city has been lowered from more than \$2 per square yard to about thirty-five cents with the aid of an oil-burning heater. It directs a blast of hot air upon the pavement without permitting the flame to strike the surface, and can be used to soften asphalt for removal, or for heating hard paving materials before coating them with asphalt.



At Work on Asphalt Pavement with the Oil-Burning Heater

Esord Roads Equipment Co.,
 City Centre Philadelphia Pa

Developed by Glendard Lee

2087

Esord Junior &
 Esord Superheater

2105

BOMBING PLANE TURNS TURTLE IN TAKING OFF

Newcastle Eng.

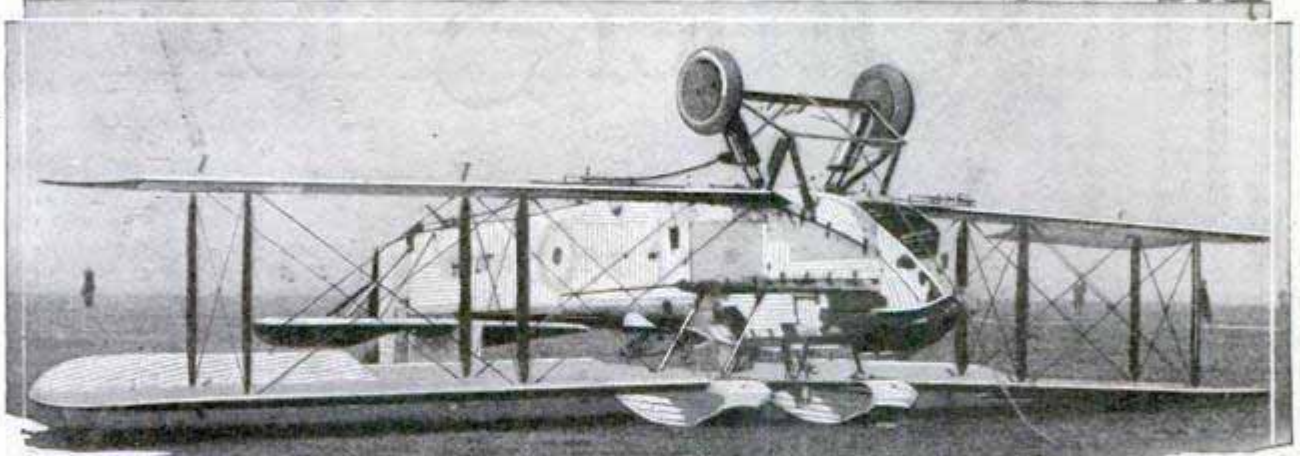

International

On Its Back; Huge Bombing Plane That Capsized While Taking Off from an English Flying Field; the Accident Was Caused by the Plane's Striking an Obstruction Just before Rising

An unusual accident occurred recently on an English flying field when a huge bombing plane struck a projection while taking off, and was turned upside down. The pilot was uninjured and about the only damage done was to the propeller, which was smashed.

were not considered wholly representative of actual performance, since no coverings such as varnish were used on the samples.

FLOOR OF TILE WEARS LONGEST, RUBBING TESTS SHOW

2182

Experiments with flooring materials at the Mellon Institute of industrial research in Pittsburgh, have shown that vitreous tile has the greatest resistance to wear. Marble, maplewood, rubber, linoleum, two kinds of cement, an asphaltic composition and cork tile were tested. Actual wearing conditions were nearly duplicated by means of a leather-shod wheel rubbing and pressing on samples of the materials. Sand was fed between the substances and the leather to produce the effects caused by dirt on an ordinary floor. After a test period of the same duration in each case, the pieces were weighed to determine the percentage of loss due to abrasion. It was found that the vitreous tile showed an average of only four and one-half per cent loss, marble and maple were about equal, with slightly more than twenty-three per cent, and more than four-fifths of the asphaltic composition had worn away. Nearly half of the cork tile had disappeared. While the results were held to indicate the relative endurance of the materials, the tests

FURNITURE IS STEAM-CLEANED FROM GAS-FIRED BOILER

2076

Water and fold marks are easily removed from upholstered furniture and the appearance of garments is brightened by using a gas-burning steam boiler with a spray nozzle and hose. The vapor is quickly generated and a superheater insures dry, hot steam. The apparatus is intended for stores and upholsterers.

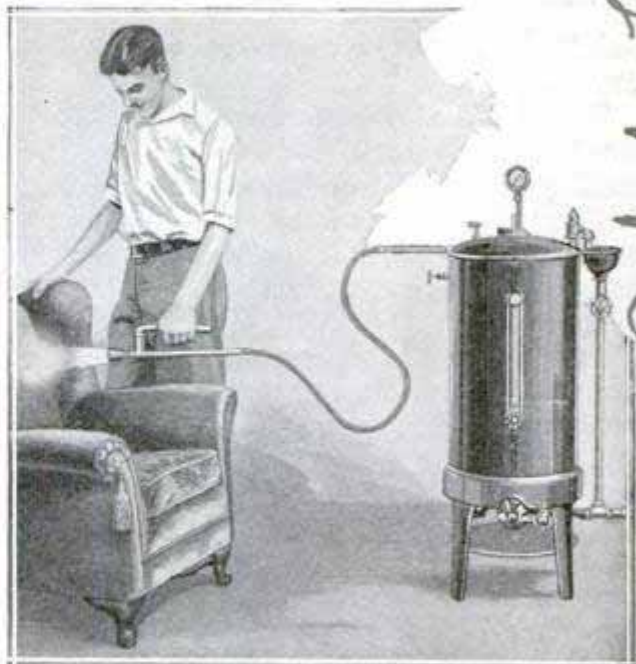

Steam Cleaning an Upholstered Chair with Handy Boiler Outfit; Control Nozzle Regulates Blast

Howard Rapaport Co. and Machinery Co. and Rapaport, Miel

Information Service
National Lumber Mfrs. Assn.
402 Transportation Bldg
Washington, D.C.

1466

The Other Side of the

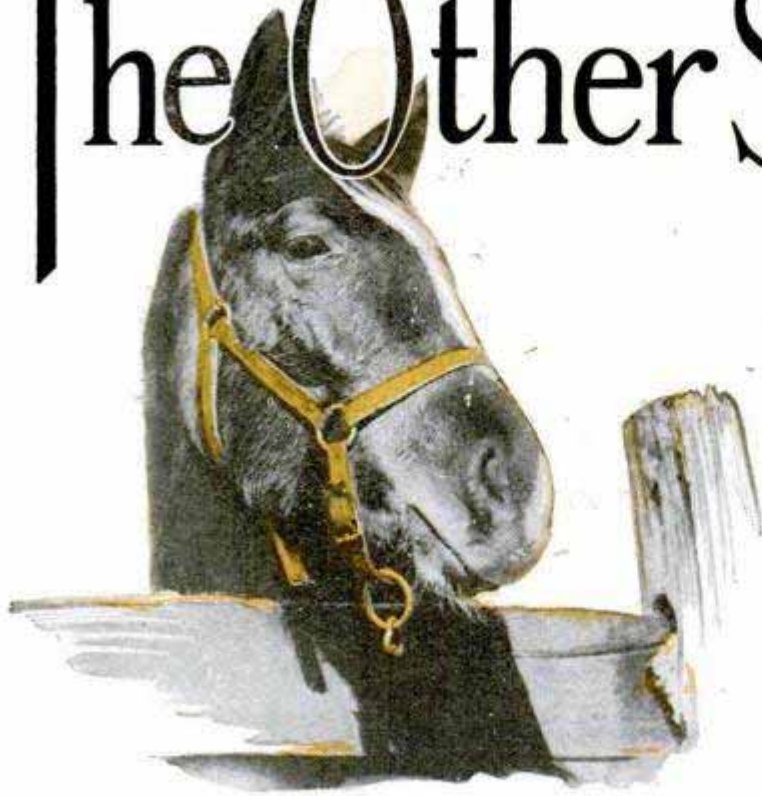

IT'S four a.m. and the first streaks of dawn are beginning to lighten the sky.

The place may be Churchill Downs or Latonia; Aqueduct or Hawthorne; Kenilworth or Derbyshire—anyone of the tracks where fast horses gather for the "Sport of Kings." No matter what the track, the scene is the same.

On one side the vast, deserted grandstands, silent save when an occasional sleepy watchman makes his rounds. On the other, the long row of low white-painted stables, just awakening for the day's business.

The day starts at dawn on the "other side" of the track, the side where the stables are, and it ends with the evening twilight, for horses keep sun-time hours, and the trainers and jockeys and stable hands who care for them must, perforce, keep the same.

Four a.m. and the first stable hands roll out of their cots in the tack rooms, stalls fitted up for light, very light, housekeeping. They live with their horses by day and sleep beside them at night.

Down the side of the long stables thoroughbred heads are poked out over the tops of the half doors, and a chorus of stamping and neighing greets the arrival of the first attendants. The stable side, sheltered by a wide overhanging porch roof, to keep out the rain and the direct

rays of the sun, is lined with rows of neat little medicine and supply cabinets, watering and washing tubs, all painted in the stable colors, and neatly coiled bandage rolls.

Stall doors are opened and the morning cleaning begins. Currycombs and brushes ply, fresh straw remakes the trampled night beds, soft flannel

cloths wash the night's dust from slim, fleet legs.

Breakfast time, for the horses, not the men, and the morning's ration of oats is distributed. Each stable hand has from one to three or four horses to care for, depending on the size of the stable and the wealth of the owner. Horses, like people, differ greatly, some requiring the almost undivided attention of a personal valet, and others getting along with a third or fourth the care.

With the morning meal out of the way, the day's limbering up begins. Stable boys and jockeys turn out and lend a hand. Carefully blanketed, the racers are led round and round the well-trodden dirt path beneath the overhanging porch roof, stretching and easing muscles cramped by the night. For a quarter or a half an hour, as long as the trainer thinks necessary, the exercise walk continues, then the animals go back to their stalls, and decks are cleared for the serious business of the day.

It is now half past five or six o'clock, and light enough to take to the track. The horses that are entered for the afternoon's races come first, usually for a brief exercise gallop, since their schooling is complete and only a workout is necessary. It is important that it be finished soon, to give as long a rest as possible.

Track

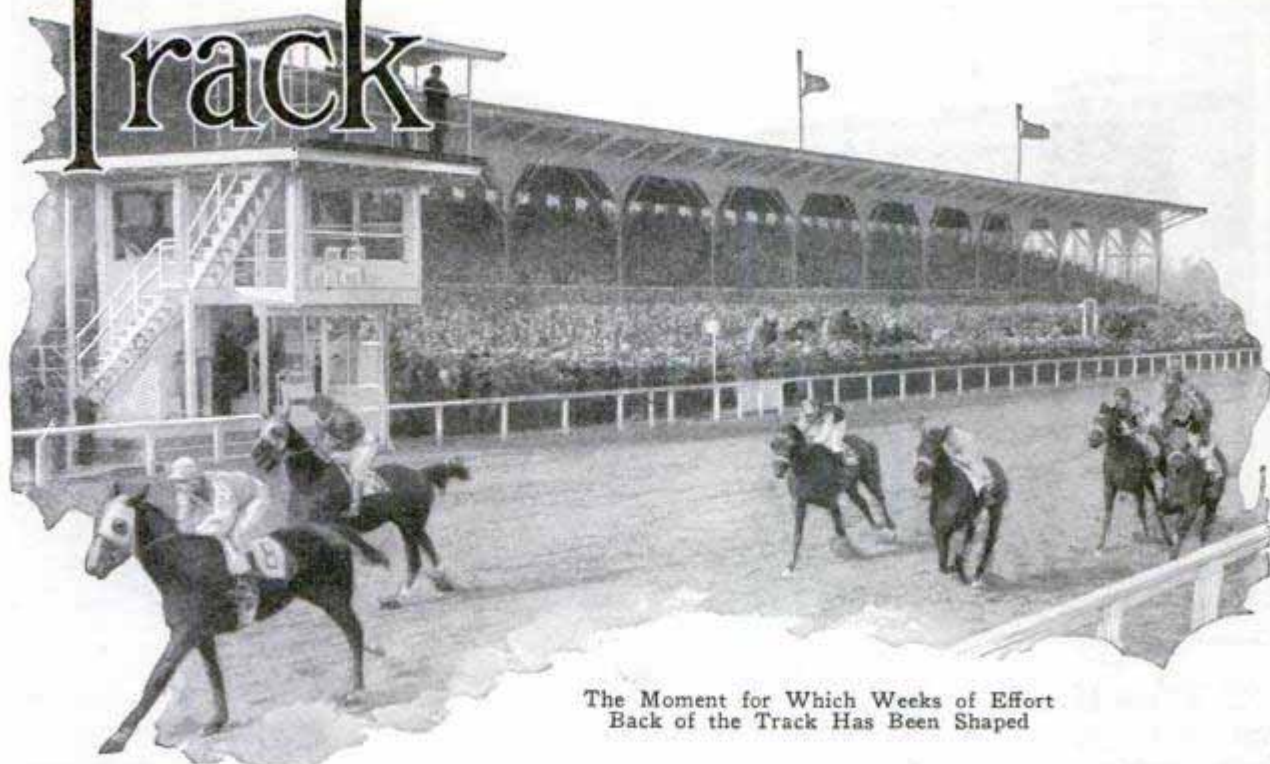

The Moment for Which Weeks of Effort Back of the Track Has Been Shaped

Despite the earliness of the hour, a good-sized gallery has already gathered, the professional race followers and bookmakers' touts, men of all sizes and races, but each wearing the two badges of his calling, a good pair of binocular field glasses and a stop watch.

Before this critical and professional audience, the afternoon's racers take their gallop, usually ridden "under wraps," that is, with a turn or two of the reins around the riders' wrist to give a good strong pull by which a too-eager horse can be kept from showing off more than necessary before the "clockers." Occasionally a willing performer is put through a stiff gallop, and then the stop watches come into play. Usually an occasional spurt for a furlong or so, coupled with the general behavior of the horse, is all the watchers have to go by.

As quickly as possible the afternoon's entries are led off the track, blanketed and walked up and down the side lines to cool them out slowly, then given a good rub-down and wash and returned to their stalls.

Next come the horses being groomed for future races. The trainer, mounted on his pony, a scrub of indeterminate breeding, watches critically, orders walks and gallops, and keeps a close eye on the work.

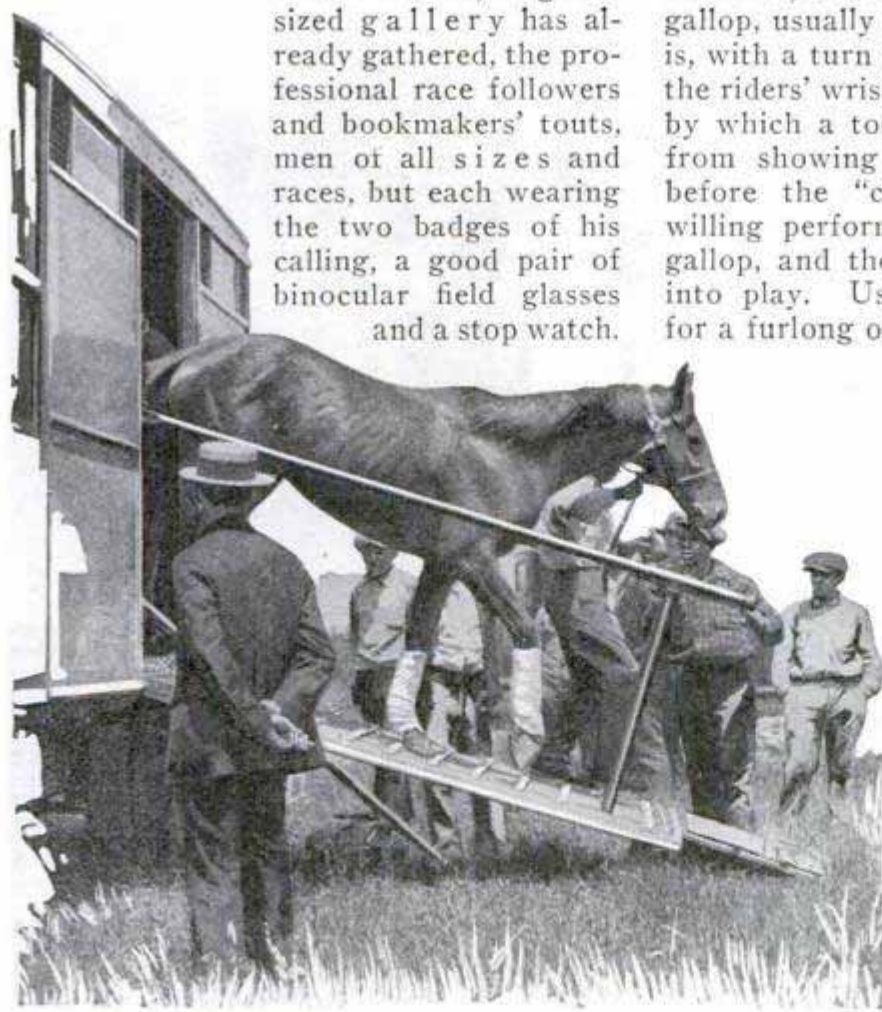

Unloading a Thoroughbred from a Special Motor Truck, the Newest Method of Transporting Horses over Medium Distances

1466

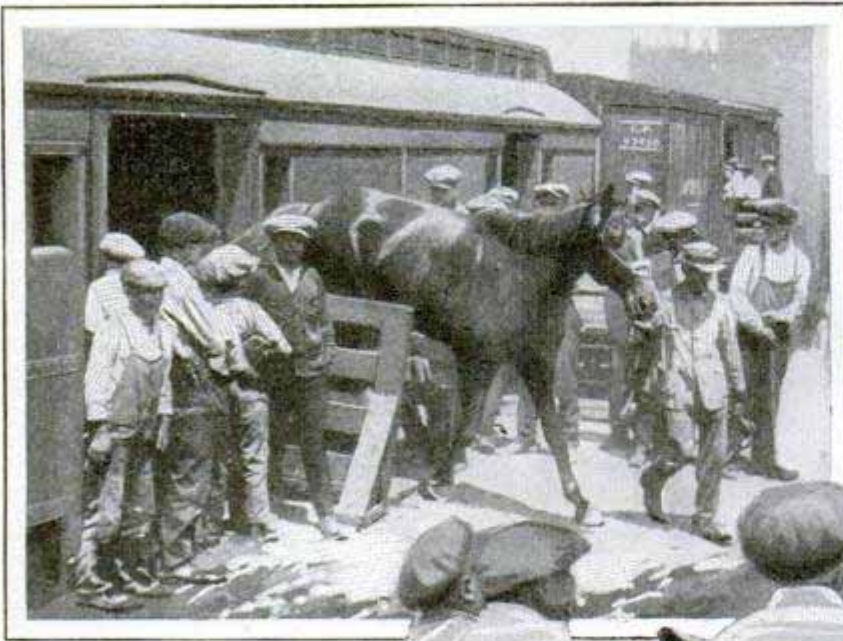

The "rail birds" are still on the job, getting an eye on future possibilities.

Finally only the youngsters are left in the stable, and then school starts for the day. The youngsters include all those who have yet to start in a race. They must be trained to respond to the jockeys' desires, to race with other horses and try to win, to get away to a flying start when the barrier is sprung, to keep their feet in the thick of a galloping tangle, and to take no fright whatever may happen. Skittish and full of fire, their workout usually starts with a walk around the mile of track, interspersed with a few short gallops. If they are very young and inexperienced, or easily frightened, the trainer on his pony or another jockey on a well-broken horse may ride alongside, possibly with a leading strap to teach obedience.

Finally nine o'clock comes. Barrier school has been called by the starter for nine, and must be over before ten to clear the track for the teams with scrapers and drags, who will level and work the dirt ready for the last ounce of speed in the afternoon meet. At the head of the back stretch lies the "chute," a short, straight



Unloading the Horse Pullmans, Top; a Stable Swipe Demonstrating Southern Airs to an Admiring Audience, and the Morning School Class at the Barrier

stretch leading into the track just where the turn straightens out. Through the chute the horses are led onto the track, and at the end of it, a barrier has been erected for the youngsters' school, with a crew of assistant starters in charge.

The first task is to convince the students that the inch-wide cloth webbing which forms the barrier is harmless. With an assistant starter at its head, each horse is led up in turn, allowed to inspect and sniff

the cloth, and finally it is rubbed over its muzzle and brushed up past its eyes to convince it that, when it is lifted, it means no harm.

Next the youngsters must be taught to line up before the web and keep their places. Trainers, stable hands and assistant starters lend a hand, soothe the frightened and urge the balky until they have been taught to take their places and hold them without too much fidgeting.

The last, and hardest, step is to spring the barrier and teach the horses to make a dashing getaway. A button on the starter's stand releases the electric catch and powerful springs jerk the tape out and away from the horses, swinging it up over their heads in the arc of half a circle. At the click of the springs and the swish of the rising webbing, the more frightened will back and bolt. Time and again they have to be led up to place, introduced to the look and smell of the tape, and made to stand while it is sprung.

With school over and the

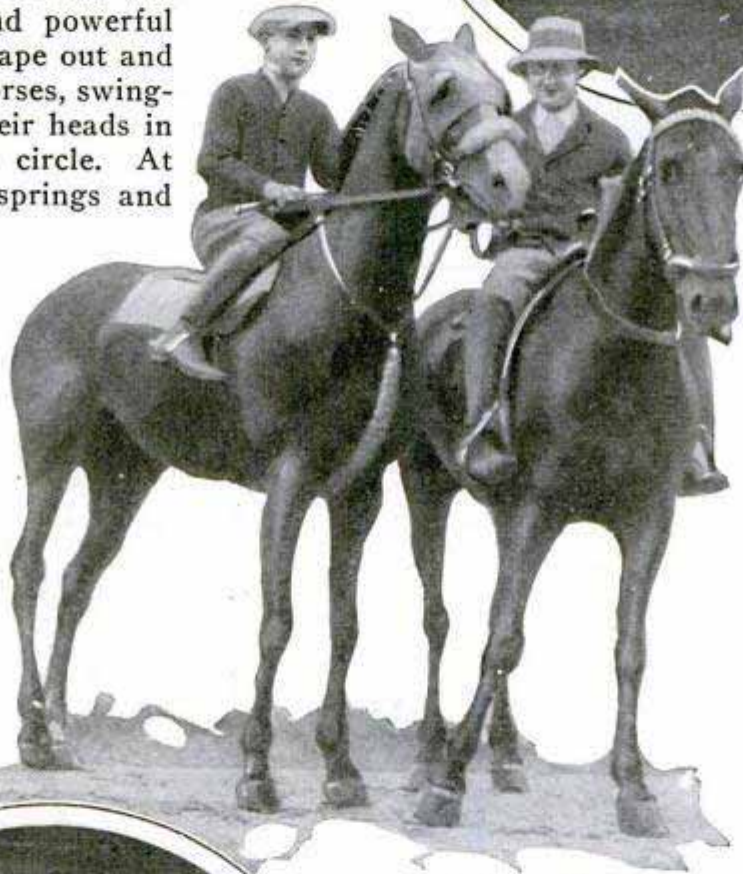

track cleared, the stables settle down to finish the day's cleaning, repair "tack"—the track name for all harness and gear—and look after the needs of the horses.

The cleaning is a job in itself. Despite the rough boards of the walls and the dirt floor, a stable is always neatly white-washed and scrupulously cleaned. The exercise path beneath the porch roof is worn deep by the daily sweepings of

The Jockey at Home in His Decorated Box Stall, Top; a Trainer Coaching an Apprentice Boy on a Young Horse, and Fixing of the Racing Bandages; Fine Horses Require Constant Attention



years. It must be kept free from dust if the horses are not to suffer. In the tack rooms, each incoming crew lays a wooden floor, papers the walls with building paper, hangs each oiled and polished saddle and bridle in its place, and finally decorates the whole with gay strips of bunting, pictures of famous racers and personal ornaments to make the living quarters home-like. Housekeeping on the back side of

any race track would do credit to a New England housewife.

By two o'clock the jockeys are arrayed in their racing silks and ready for the

noon the back side of the track is as busy a place as the public paddock before the grandstand. Three or four hours of bustling activity, then the evening feeding

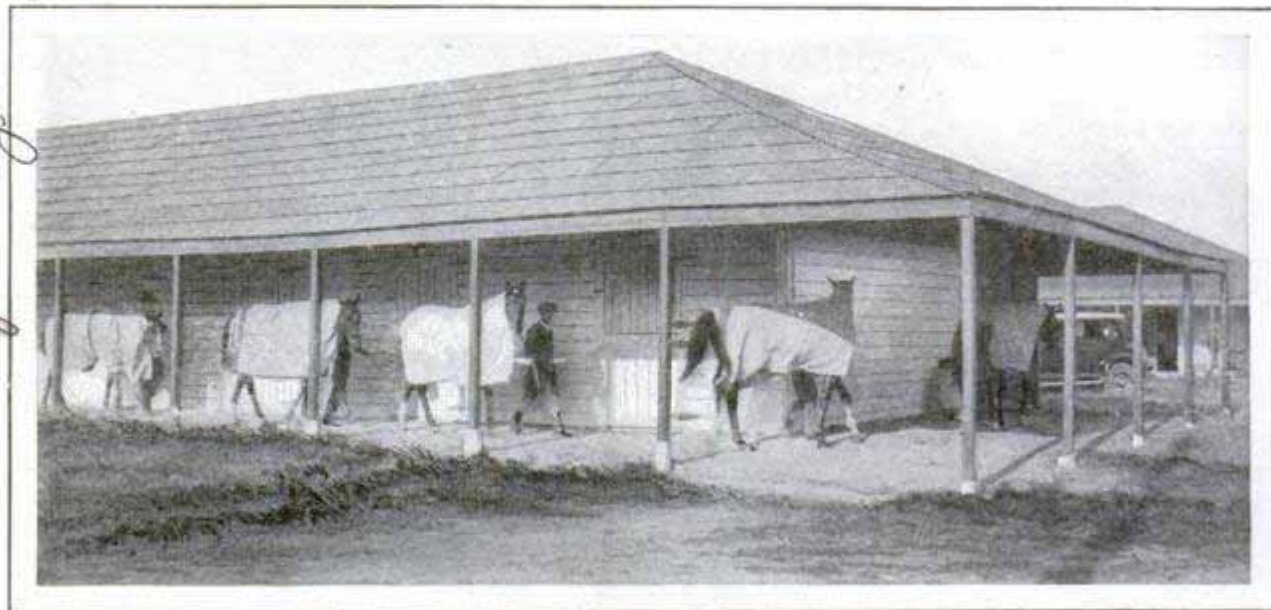

The Morning Parade That Starts Soon after Dawn, When Ghostly Lines of Sheeted Horses Tramp Round and Round under the Overhanging Stable Roof, Limbering Up for the Day

afternoon's events. Stable hands are busy with the day's entries, the owner, usually with his guests and anyone else who can find an excuse for getting past the gate-men, are crowding around. For the after-

and grooming, the final cleaning of the day, and with the last ray of twilight, the stables are asleep. Only an occasional jockey, with no ride booked for the next day, is seen abroad after dark.

NON-SHRINKING PAPER BARREL IS STRONGER THAN WOOD

Lighter, stronger and costing a third less than wood, a paper barrel for ship-

ping, packing and many other purposes, is said to be non-shrinking and, hence, proof against leaks. Steel or wooden hoops are not necessary, so that the outside surface is smooth and free from obstructions likely to damage other containers. The barrel is made by a special process involving the winding of heavy pressed paper.



©Kadel & Herbert
Illustrating the Lightness of Smooth, Hoopless Paper Barrel

ping, packing and many other purposes, is said to be non-shrinking and, hence, proof against leaks. Steel or

GENERATOR CONTROL ON AUTO SAVES BATTERIES

Eliminating the need of troublesome changes in the auto-generator third brush to increase or reduce the charging rate, a control placed on the cowl board is said to afford charging current from zero up to twenty amperes. It consists chiefly of a rheostat, with a dial like those of a radio set, which is so wired to the generator that the current through the field circuit must flow through the rheostat as well as being controlled by the third brush. With this attachment, overcharging batteries can be avoided without having to keep the headlights burning in the daytime.

Oridwell Generator Control Thomas Ark. \$5. for Ford outch

*1466
Cannot locate maker of Paper barrel made by Carpenter Containter Co., 137-41st St. Brooklyn, N.Y.
1962*

**FOODS GOOD FOR ONE PERSON
ACT AS POISON TO OTHERS** 2179

Practically every kind of food is a "poison" to some person or other, according to Dr. W. Soltan Fenwick, an English diet expert. The unpleasant feeling suffered after partaking of a heavy meal is often due to substances which act as poison to that individual rather than to the quantity or unwholesomeness of the food, he declares. Eating a small portion of the white of an egg, gives some persons intense pains. Oatmeal, strawberries, milk, meat and other nutritious foods are likewise apparently injurious to many. The difficulty, according to the doctor, is not in the food itself but in the individual. The person's system, likely, is hypersensitive to a particular article, often one protein or another. Doctors are now able to desensitize a patient in many cases so that he may eat foods, that formerly caused trouble, without ill effects. Poor digestion and not stupidity, Dr. Fenwick points out, is many times the cause of a child's failure to make satisfactory progress in school.

**BIG DIESEL RAILROAD ENGINE
PULLS HEAVY TRAIN** 2136

That the Diesel locomotive is adapted to heavy train service was indicated by tests in Germany with an engine of this type having a magnetically coupled toothed gear system. It is reported to have registered an efficiency of twenty-nine per cent as compared with the twenty-seven and one-half per cent shown by the Diesel-electric engine, or the eight and seven-tenths per cent by the steam locomotive. A maximum of 1,200 horsepower was developed. The locomotive weighs over 280,000 pounds and is so arranged that it can be placed on different sets of wheels for operating on narrow as well as broad-gauge tracks.

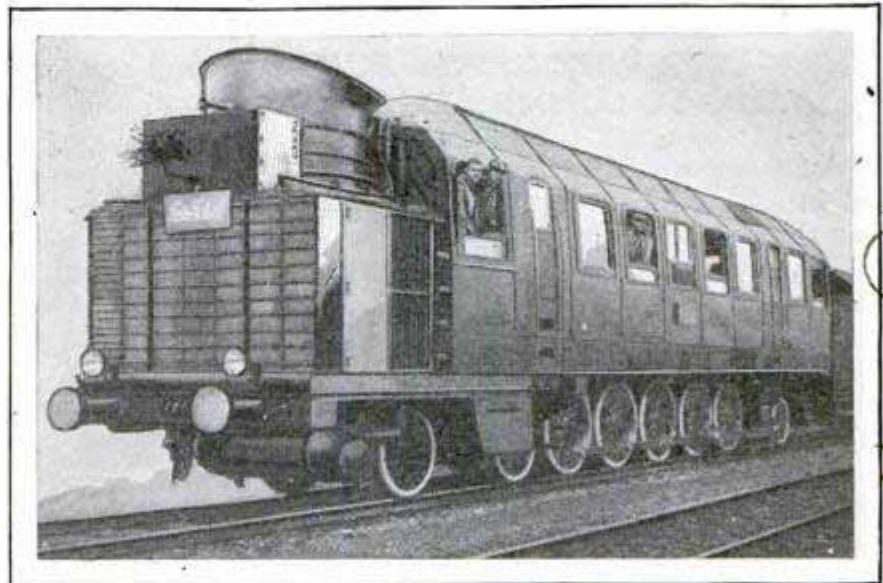

Big Diesel Locomotive for Heavy Train Service in Germany; It Is Said to Have Great Efficiency and Power

Mess. Hohenzollern A. S.
Musselhof - Krafenberg, Germany.

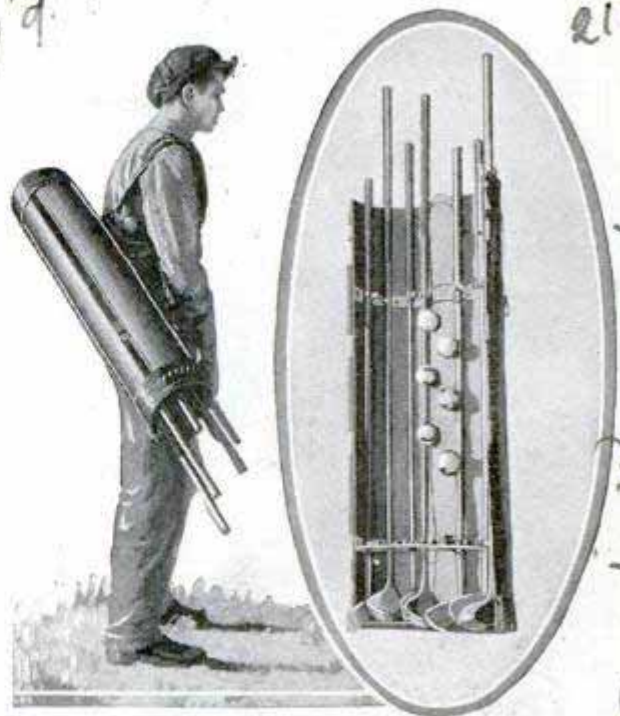

Golf Bag in Carrying Position, and Open, to Show How Clubs and Balls Are Attached

**GOLF BAG OPENED LIKE BOOK
PREVENTS THEFT OF CLUBS**

Theft or loss of clubs is prevented in a patented golf bag which opens and closes like a book and has special storage spaces for balls. The clubs are automatically locked in when the holder is shut, and are all exposed to view when it is opened, so that the player can readily select the one he wants. The bag is conveniently carried by a shoulder strap and each section is braced by a skeleton of metal.

2135

W. Bost Kennedy
Essexville, N.Y.

Smith for Quinman & Co
Cincinnati

Anderson, Ind.

Almer -
E. A. Baumgartner
Cuero, Texas

2156

2176 COTTONSEED AND WHEAT MAKE GOOD BREAD

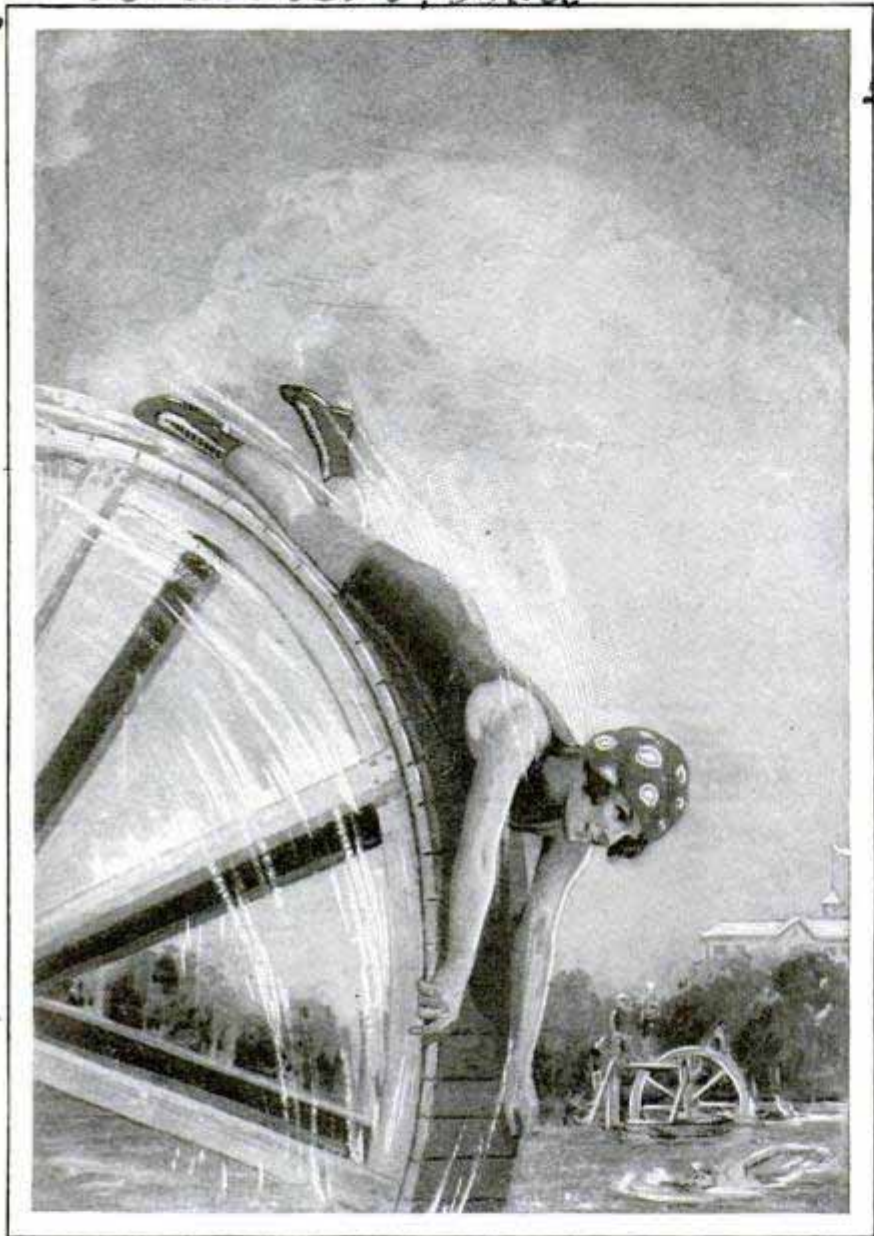

Wheel in Action; the Rider Slips Easily into the Water in a Safe Diving Position as the Wheel Turns

2156 BIG WATER WHEEL FOR DIVING ADDS TO SUMMER SPORT

Amusement and instruction are afforded in an eight-foot wooden water wheel for the swimming beach, to aid the diver. The person sits or lies prone on top of the wheel, which is eighteen inches wide, and, as it turns, slips into the water. A ratchet underneath prevents the wheel from going backward. A ladder and a platform are included in the apparatus which occupies not more than 120 square feet of ground. It is so constructed that fingers and toes cannot get caught.

Large snakes are among the prey of the secretary bird, a species found in Africa.

Edible flour that is said to produce good results when mixed with an equal amount of wheat is now being manufactured under a patented process at a southern mill. It contains about forty per cent protein and is extracted from the material left after oil is taken from the seed. Heretofore, most of this has been used for making stock feed or fertilizer. The flour process promises a new and important subsidiary industry to cotton production. Cottonseed oil in later years has commanded but low prices and many mills throughout the south have been closed. If the flour proves a success, a stimulating effect is anticipated.

same. inventors
letter retd.

1882 SHORT UMBRELLA FOR AUTOISTS FITS IN BOX

Carried in a small box attached to the rear or front seat of the automobile, between the floor and the cushion, a short-handled umbrella of a specially treated fabric, has been devised for the tourist. It can be folded away while wet as the material is not affected by moisture and may be cleaned with soap, water or gasoline. Venti-



Placing Umbrella in Box That Can Be Attached to the Auto Seat for Emergency Service on Tours

lation is afforded through small holes in each end of the metal carrier box.

Polan Katy + Co,
2 Market Place
Baltimore, Md

TRAPDOOR SPIDERS' SKILL RIVALS MAN'S

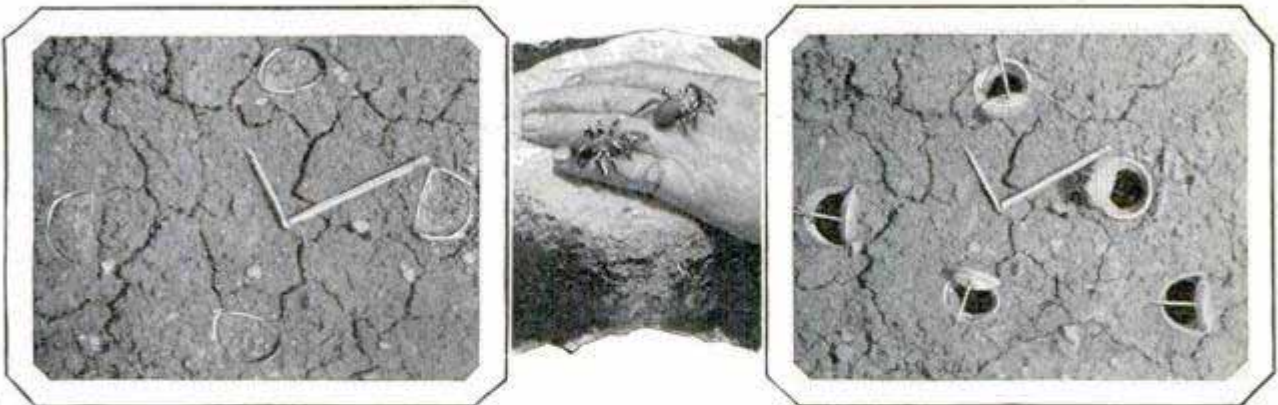

Trapdoor Nests Closed; the Spiders on the Photographer's Hand, Proving That They Are Not Ferocious, and the Doors Open; Matches Show Relative Size of the Holes

Trapdoor spiders long have been the subjects of study by nature lovers, architects and engineers by reason of the ingenious homes they build for themselves in the ground. A California naturalist recently found 227 trapdoor nests on a barren plot of soil, about twenty-two feet square, near San Fernando, and after diligent search discovered five of the borings so close together that they could be photographed on one plate. To keep the holes open for taking the picture, the lids were propped up with small sticks, but an assistant was required to keep the spiders in their holes to prevent them from knocking down the supports and closing the traps. There are several varieties of trapdoor spiders, some of which grow to large size. Most of them line their holes with soft web and the lid is fashioned of alternate layers of web and earth. It fits so tightly that the den is almost completely concealed

children showed that they were quickly able to identify objects in a room.

CRIPPLED WAR VETERAN'S DOG SERVES AS TOY MODEL

In spite of the handicap of serious wounds, Allen Johnson, of Sawtelle, Calif., a veteran of the Spanish-American and World wars is earning a livelihood modeling wooden toys. His success is partly due to his pet dog, "Kelly." The animal's comical face gave Johnson inspiration for making toy dogs with movable heads. "Kelly" was used as a model. Parts of the toys are shaped with a jigsaw.

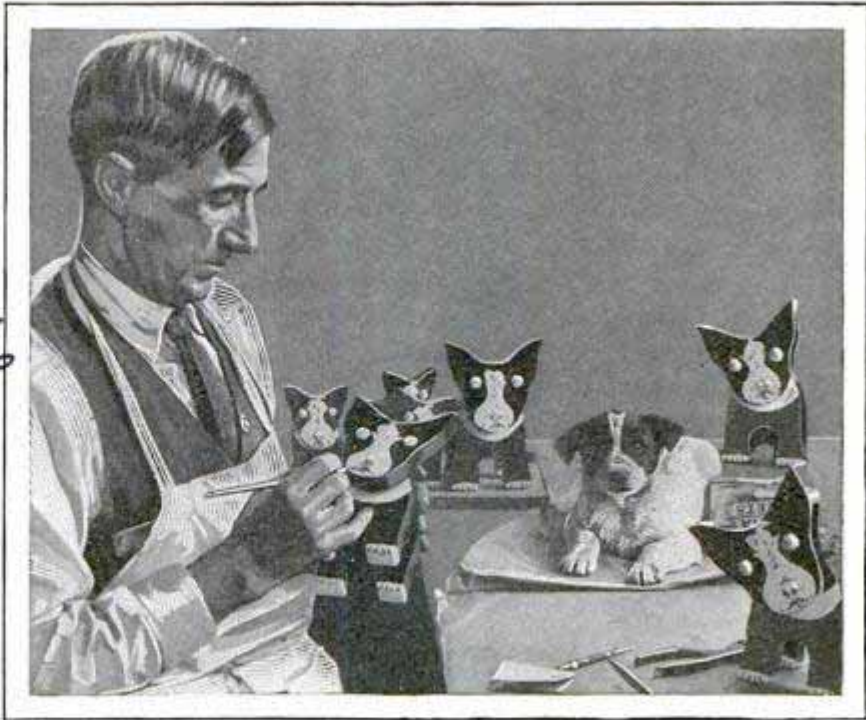

Johnson Finishing a Wooden Dog, While "Kelly" Holds a Steady Pose to Help His Master Catch the Right Expression

2226 READING BY SOUND

By means of different sounds for different letters, a Russian oculist has devised a system for teaching the blind to read. An apparatus produces the various tones, some of which represent objects as well as characters. Experiments with

*d. m. Prof. Posing, Oculist,
 Leningrad, Leningrad, Russia*

and Natural Soldier's Home,

2101

W. S.

CONTROL OF TRAINS BY RADIO TO IMPROVE SERVICE

That radio telephony indicates the "advent of a new era in freight operation," was the conclusion drawn from successful wireless tests between a locomotive and a caboose on the New York Central railroad. The demonstration was made with three-tube transmitters and four-tube receivers on a 115-meter wavelength. Conversations between persons in the caboose and the engine, and vice versa, were carried on for five hours without interference from passing trains, power lines or an electrical storm, according to reports on the tests.

Tests made by Gemith Radio Corp. of Chicago



Capacity of Huge Steam-Shovel Bucket Illustrated by Men; Thirty-Four Stand Comfortably in It at Once

DIPPER OF HUGE STEAM SHOVEL HOLDS THIRTY-FOUR MEN

Fifteen cubic yards is the capacity of the dipper of a huge steam shovel manufactured by a western firm. Its size was illustrated when thirty-four men stood in it at one time.

IRON SMOOTHS CLOTHING WHILE WORN

Clothing is said to be smoothed and the nap and texture "rejuvenated," even while the garments are being worn, with the aid of an electric steaming outfit. It consists of a small boiler heated by electricity and a perforated sadiron to which vapor is passed through a flexible tubing. The steam is played through the small openings in the iron, inside a heavy canvas bottom. The outfit does not require experienced operators.

Iron Smoother. Patd by S.A. Post

GIANT ELECTRIC FLAMES LEAP TWENTY-FIVE FEET

Some 3,000 horsepower were consumed in an electric flash that leaped from a grounded 220,000-volt line, during a recent test. The flames were more than twenty-five feet high and the experiment enabled engineers to gather data on long distance high-power transmission that they could not obtain in laboratory tests with artificial high-voltage discharges.

1978

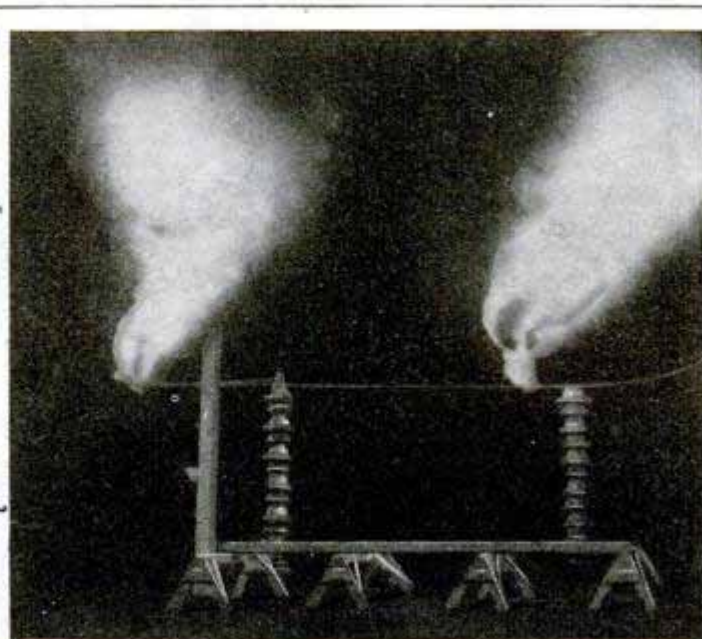

During Test of High-Voltage Line; Twenty-Five-Foot Electric Flames Leaping from Grounded Wires

Pacific Gas & Electric Co. Westinghouse

Steam generated by General Electric

225 South M. & Silverthorn Chicago - Ill. 168 (17) much to an



By J. EARLE MILLER

COUNT out two piles of playing cards on the table, tell one of your audience that you are going to hypnotize him and force him to pick up one of the piles, the description of which you will write on a slip of paper and intrust to a third person for safekeeping—do that and you will catch the attention of any crowd.

The trick itself is simple, one of many easy card tricks anybody can perform, with no more equipment than a pack of cards. The secret lies in not caring which pile is picked up, as both, though containing different numbers of cards, answer the description written on the paper. Take a deck which you have privately prepared by placing the four tens on top. Deal the four off on one pile, and then deal off ten cards, one by one, on the other, without revealing the exact number in the pile, but making it plain as you lay them down one by one that one pile has more cards than the other.

Select the person to be "hypnotized," look him searchingly in the eyes for a moment or two, then tell him you have willed him to make a certain choice, which you will now write on the slip of paper. You write down, "You will choose the ten pile," and hand the paper to another in the audi-

ence. Your prediction is bound to come true no matter which pile he picks. If he chooses the four tens ask him to look at them; and if he picks the ten cards ask him to count them, and in either case to compare the result with the prediction you wrote in advance. While that is being done, carelessly shuffle the other pile into the deck to prevent comparison of the two.

The card-trick entertainer needs at least two decks of cards, of different colors, to keep them separated. With a pair of decks it is possible to prearrange one, as for the trick above, while the audience has its attention centered on the other. The arrangement can be carried out under the guise of idly shuffling, to avert suspicion of a fixed deck.

A few false shuffles and cuts will prove a big help in satisfying the curious. One of the most baffling three-way cuts, which returns the deck to its original state, is easy to do. Grasp the deck in the left hand, holding it between the thumb and fingers, near the left end. Bring the right hand around the right end in the same way, catching the bottom third of the deck between the joint of the thumb and the second joints of the fingers, and



Ten Cards, from Ace to Ten, Placed on Top of the Deck, Are the Secret of One of the Best of Amateur Card Tricks

lift it out from beneath the top two thirds, which are still held in the left hand. Now bring the right hand over the deck and catch the top third between the tip of the thumb and the tips of the fingers. You now have the middle section in the left hand, the bottom between the joints of the right fingers, and the top between the right finger tips.

Next relax the pressure of the joints on the bottom section, which is uppermost in the right hand, and flip it out, face down, on the table. This is done by jerking the hand sharply backward at the same instant you relax the pressure. Next place the middle section, which is in the left hand, on the lower section, lying on the table, and complete the deck by laying the top third, still held between the right finger tips, on the others. The deck is now reassembled in exactly the same way as before the cut, but after practicing a half dozen times you can carry out the operation so rapidly that it will fool the eye of anyone but an expert.

The false cut and false shuffles can be worked in before or during any number of tricks in order to more completely baffle the audience. If you want to shuffle, and yet keep the bottom cards in their original position, hold the pack rather loosely in the left hand, with their backs toward the audience, and shuffle apparently as usual. But be careful, when rais-

ing part of the cards in the right hand, to leave the bottom cards with those retained in the left hand. The others can then be shuffled back in front of the bottom cards as much as you choose.

If you have prearranged cards on top, which you do not wish to disturb, take a number from the bottom and shuffle them in front of the top cards, taking care that their ends project slightly past those of the cards you wish to preserve. When the shuffle is over, give the deck a simple cut at this dividing line, bringing the former top cards back into place.

Another method, used in many tricks, is to have the card you wish to keep track of placed on top of the deck, holding it out in such a way during the process that you can note the bottom card. Then give them a simple cut, which brings the bottom card, that you know, next to the unknown card placed on top of the deck. Now shuffle by taking cards from the bottom and mixing them in the loosely held cards near the top; then cards from the top and shuffling them into the bottom, but taking care not to disturb the relation of the known and unknown cards, one above the other. You needn't care where you shuffle them into the deck, so long as they remain together. The unknown card can always be found by running through the deck and picking out the next one below your known card.

If you shuffle by riffing the cards on the table you can easily keep track of either a top or bottom card, or several cards. If they are on the bottom, let the bottom cards of that half pack fall to the table first. If they are on top, make sure that you let them fall last. If you note the bottom card of the deck **you** can have the cards selected for the trick placed on the table, drop the deck over them, riffle the deck several times, letting the bottom cards fall first, call for a simple cut, and then find the selected cards directly under the one you first noted.

It adds much to the effectiveness of a trick if the chosen card is disclosed in some dramatic manner. One of the best ways is to throw the deck, face down, on the table and have the unknown card appear mysteriously, lying face up on top. The method is simple. Bring the card you want to the top of the deck, hold the

cards in the left hand, with the thumb on top and the fingers beneath, pass them to the right hand, catching hold at the ends, and under cover of the maneuver use the thumb to push the top card a third of its breadth past the edge of the pack, the overhanging portion being concealed by the right palm. Now throw the deck on the table, releasing all of the cards together. The rush of air will catch the overhanging card and spin it over, so that it falls, face up, on top of the pack.

For variety the "sticky fingers" disclosure is equally dramatic. Get the card to be disclosed on top of the pack, moisten the first and middle fingers of the right hand, grasp the deck with the fingers on top and the thumb beneath, shove the hand holding the deck forward a few inches, and then jerk it back, at the same time removing the thumb pressure. The top card will stick to your fingers while the others drop to the table in a heap. The trick is done so quickly that the audience is unable to see how you got the card out of the deck, or how you could throw fifty-one cards down and hold the fifty-second in your hand.



Arrangement for Dealing Three Kings Over and Over, Above; a Trick in Hypnotism, Center, and, Below, a Close View of the Thumb Drawing Off One Card at a Time, While Apparently Shuffling the Deck



One of the most mystifying tricks which any amateur can perform after one trial, has another form of dramatic disclosure. Count off three cards, laying them face up and side by side, and then continue to add a card below each until you have three rows of seven cards each. Lay the rest of the deck aside and ask someone in the audience to mentally select one card in any one pile, and then tell you which of the three piles it is in. Pick up one of the other piles, then the one containing the chosen card, and finally the other odd pile, thus getting the seven containing the chosen card between the other two. Now count them off again in three piles, adding one card at a time to each pile, and again ask which pile the chosen card is in. Pick them up again with the pile containing this card between

the other two, and count them off a third time, and again pick them up. On this third time the chosen card, no matter where it may have been in the beginning, will be the middle card of the middle pile; in other words, fourth from the top of the center seven.

As you pick this pile up between the other two, the chosen card is the eleventh from either end of the twenty-one cards in your hand. Hold the deck, face down, and lay the cards out in sets of four, as shown in one of the photographs, remembering that the third card laid on the third pile will be the chosen one—in other words the eleventh card laid down. You will have one card left over, and this is discarded. Now ask someone to designate any pile. If it is one of the four which do not contain the chosen card, throw it aside, and continue asking for other piles to be pointed out until only the one with the chosen card is left. Should the one containing that card be chosen you simply pick up another pile, and the audience, thinking that has some-

thing to do with the trick, will rarely remark on the fact. After you get down to one pile, ask the audience to point out two cards, and throw them away if they are two you don't want, or throw the others away if the chosen one is one of the pair picked. Then have one of the last two pointed out, and follow the same course. If it is the odd card, throw it away and have the audience turn up the chosen one, or if it is the chosen one, throw away the other and have the audience turn up the one left. This trick will work with any odd number of cards which is a multiple of three—nine, fifteen, twenty-one, etc.

A good trick which catches the attention, particularly of poker players, enables you to keep dealing a good hand over and

over to the same person, while apparently redistributing them on each deal. Prepare a deck by placing three aces, next some other card, and then the fourth ace on top. Tell your poker-playing friend you are going to show him a useful way of dealing and deal off two hands of three cards each, one to

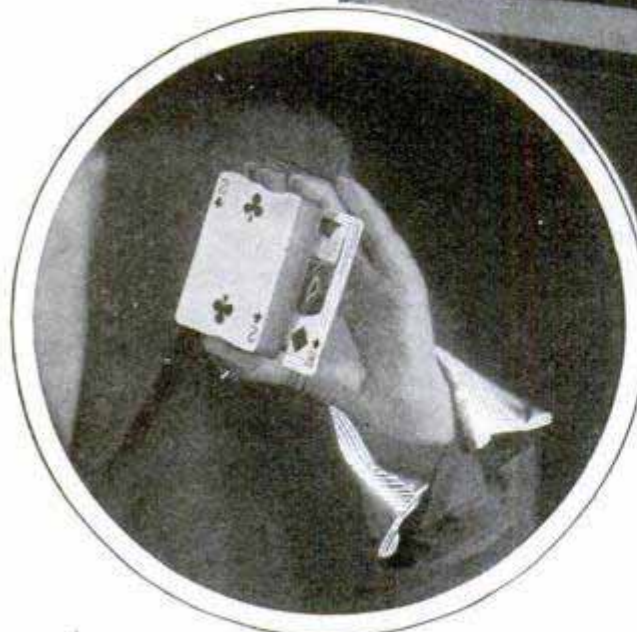

The Royal-Court Trick, Which Rearranges the Cut Cards into Suits, Top; a Close View of the Surprise Disclosure, Left, and, at Right, a Good Closing Trick, Tearing the Deck in Half

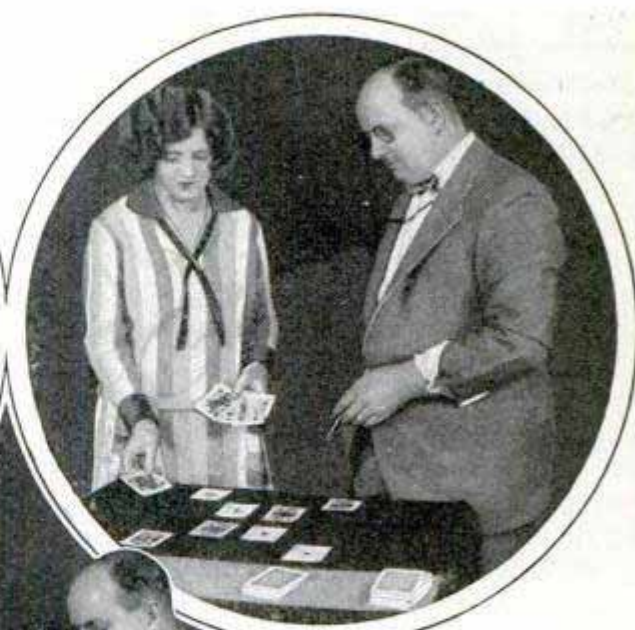

Using a Card with Turned-Up Corner in a "Hypnotic" Trick, Top, Left; the Court-and-Ace Puzzle, Right; and Below, the Final Step in the Surprise Disclosure of One of the Most Interesting Stunts of All



him and one to yourself. Naturally he will get the first ace, you the second, he the third, you the odd card, and he the fourth ace. Have him display his hand, and while he is doing that add a third card to your hand, and pick it up, but do this by holding the third card and shoving it under the other two, in the same way that many good dealers pick up cards. By doing this you get the one ace in your hand between two odd cards, and when you place them on the deck, an odd card is on top of the ace. Have your friend place his three aces on the deck, and repeat the deal. You can do it over and over without detection—the more times the greater the mystery. After several times, give the deck a false cut or a false shuffle, and still keep on dealing three aces. Finally lay your third card on top of the other two, pick up the three, place on the deck, let your friend place his on top, and hand him the deck to try it. He will deal you two aces and an odd card and find two aces and an odd card in his hand.

A trick that always puzzles is one of the simplest done with a prepared deck.

Place a jack on top, then two odd cards, and next the other three jacks. Pick up the six cards, display them fanwise, with the two odd cards concealed behind the next jack, so that the audience sees only the four similar face cards. Lay them back on top of

the deck, hold it up in your hand and explain you will now distribute the jacks through it. Lift off the top jack and place it on the bottom of the deck; next lift off the next two cards, which are the odd ones, placing them one at a time at separate places in the deck. The audience now believes you have one jack left on top, one at the bottom, and the other two spread through the deck. Invite someone to give the deck a simple cut, then hand it to him and explain that he will find the four jacks all together again. As one was on the bottom and the other three on top the simple cut brought all four back together.

A more complicated trick that is still more amazing enables you not only to tell how many cards a person has drawn from the deck, but to dramatically disclose a single card having the same number of spots as there were cards drawn. Arrange ten cards, from the ace to a ten spot, on

top of the deck, so that the ten is on top and the others follow beneath it in order, nine, eight, seven, six, five, four, three, two and ace. Now extend the deck, spread fanwise, and invite someone to withdraw any number of cards up to ten. In extending the spread deck, keep the previously arranged top cards well under your thumb, so that the choice will be forced into some other part of the deck.

Turn your back while the cards withdrawn are being counted, then have them placed on top of the deck. Explain that you do not wish to use the same cards in the trick, so give it a false cut. Then hold the deck in your right hand, with thumb at one end and fingers at the other, and apparently shuffle it, but each time let the thumb of the left hand draw one card off the front of the deck, and return it to the bottom of the deck. Count to yourself and continue until you have taken off ten cards. The next card on top of the deck will have as many spots as there were cards withdrawn and placed on top. Try the trick once for yourself and you will see why this never fails, provided not more than ten cards were withdrawn. After you have finished the apparent shuffle, the top card can be disclosed by either of the dramatic ways already described.

Another trick, which employs only the face cards, always excites wonder. Lay the

twelve royal cards out in three rows, getting one of each suit in each row, and starting the second row with a card of the same suit as the last in the first row, and the third row with the same suit as the last card in the second row, following in each case with the same suits as the first, second and third card in the row immediately above.

Glance over your layout, explain you are trying to get the cards well mixed, and if you have more than two of any one face value in a row, shift one of them for a card of the same suit in one of the other rows. This is not really necessary to the trick, but helps cover up what you are going to do. Then pick up the cards, one by one, starting with the last card in the bottom row, followed by the last card in the second and third rows, then the third card in the bottom row, and the similar ones above, and so on, until you have all twelve.

Offer the twelve cards to anybody, or to several persons, for cutting. They may be cut any number of times so long as only a simple cut is used. Then hold the deck, face down, and count off the cards into four piles, placing one in turn on each pile. Next turn the piles over one by one and each one will contain the king, queen and jack of the same suit.

Tricks supposedly using hypnotic force are always good. Look your sub-

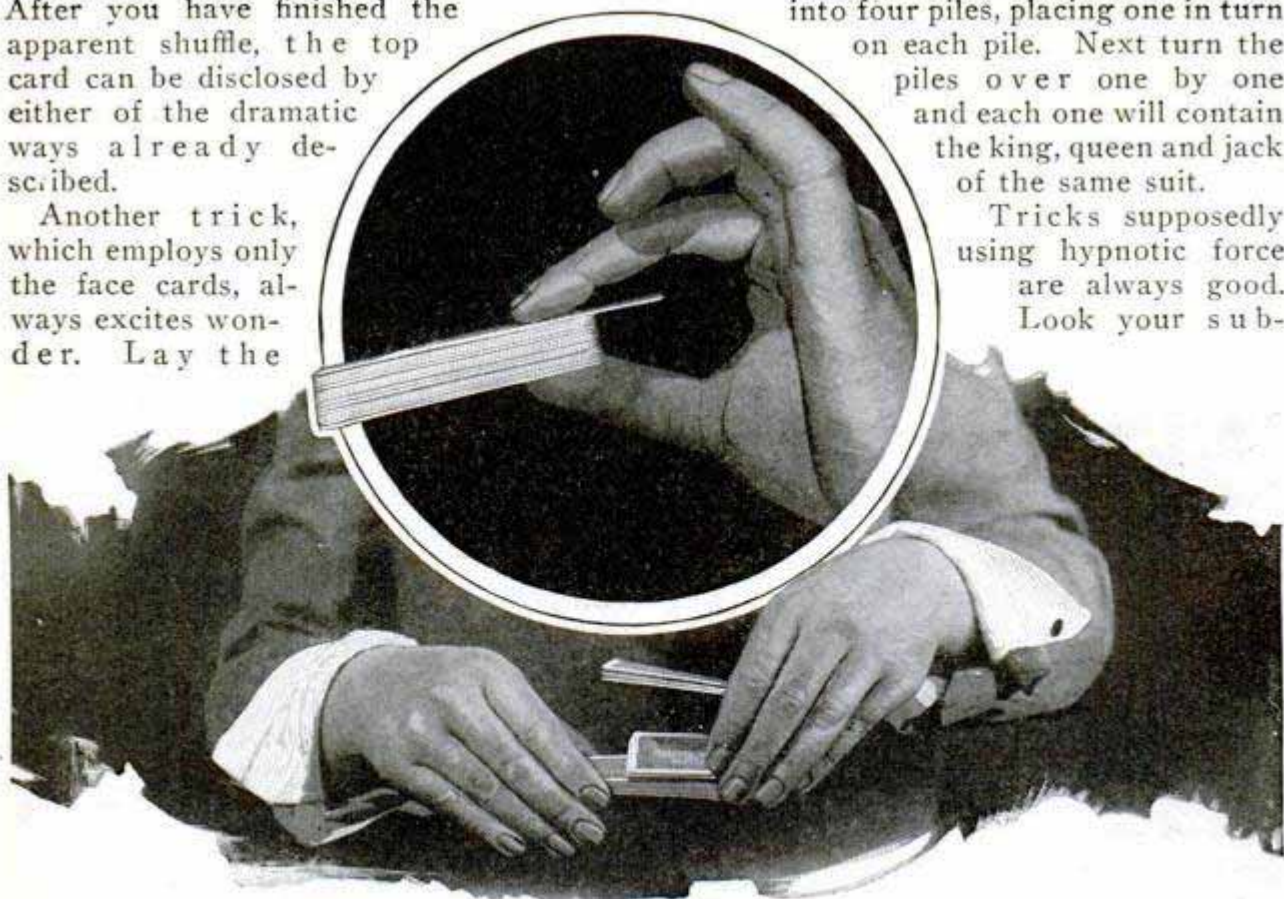

Above Is the "Sticky Fingers" Disclosure Just Before the Thumb Releases the Deck, and Below, the Details of the False Cut; the Parts of the Deck, Reading Down, Are Bottom, Top and Middle

1992

3224 N. Halsted St. Chicago

ject straight in the eye and direct him to count off any number of cards he wishes, piling them on the table, and then to look at the next card on top of the pack, return it to place, and put the pile on the table over it. As you give the directions demonstrate by counting off two cards on the table and then hold up the third, face toward your subject, to drive home the point that he is to look at the card at which he finally stops. As you hold the card up on a level with his eyes, with your thumb and forefinger grasping it at the upper corner, you bend the corner slightly with the finger, then place this card on the deck, and the two you counted out on the table on top of it. Hand him the deck, get him started, and then turn your back so you will not know how far he goes.



"Topsy" Ukulele with Special Keyboard to Help in Fingering; the Mouth Is the Opening in the Sounding Box, Which Is Round Like That of a Banjo

He looks at his card, places it back on the deck, and puts the pile from the table on top. As the card with the bent corner was the third from the bottom of this pile, the card he chose is now the third card past the one you marked. Count off the cards in a row on the table, keeping on until you are a dozen or so past the card with the bent corner. Now take the subject's hand in yours, have him extend his forefinger, and move his hand slowly back and forth above the pile, gradually narrowing the movement to the cards around the third one past the card with the bent corner. Finally place his forefinger on this third card and when he withdraws it he will find his chosen card. If you accompany the search with a running patter about hypnotic, psychic and magnetic forces you can make the subject believe that his finger was drawn down to the card, instead of your pushing it down.

A good way to end an evening of parlor tricks is to take one of the decks and tear it in two. It requires some strength, but

isn't hard when you know the secret. Square up the deck and take hold with one hand around each end, so that the two top joints of the fingers of the right hand touch the left wrist, and the two top joints of the fingers of the left hand touch the right wrist. Then start to twist the entire deck in opposite directions, bracing the left against the body or the table top. You will be surprised how easily the feat can be performed.

SINGING "TOPSY" ON UKULELE

Painted in eight bright colors, the face of "Topsy" appears on a novel ukulele. The opening in the sounding box forms the mouth, so that "Topsy" seems to be singing when the instrument is played. A special fingering device is provided to aid the beginner,

DROP GUARD ON AUTO WHEELS TO REDUCE ACCIDENTS

Guards for the front wheels of automobiles in England are being fitted so that a rubber tab at the bottom automatically drops down and prevents the wheel from passing over a person the car may happen to strike. Besides this feature, the metal shields over the tires protect the rubber in case of a collision with some hard or sharp object.

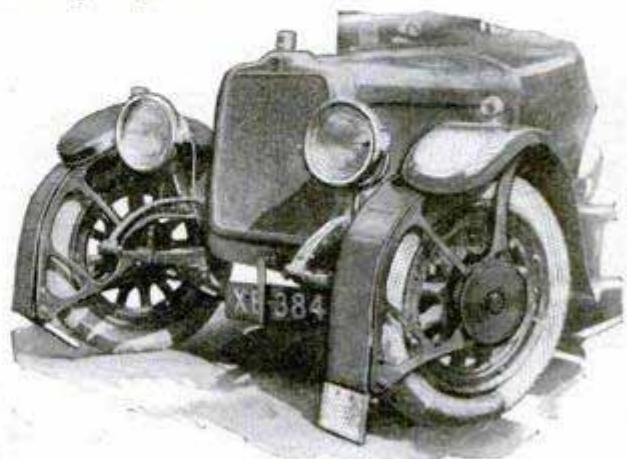

Front-Wheel Guards on Auto; One at Left Bent Back, Showing How It Protects Tire

d.w. Wm. G. Hatcliff & Co. Inventors Trading Co.

London, England.

1680

Cont. Ernest Oeterffy, 354 Fourth Ave
New York

HOW HIGHWAYS OF THE WORLD ARE KEPT CLEAN

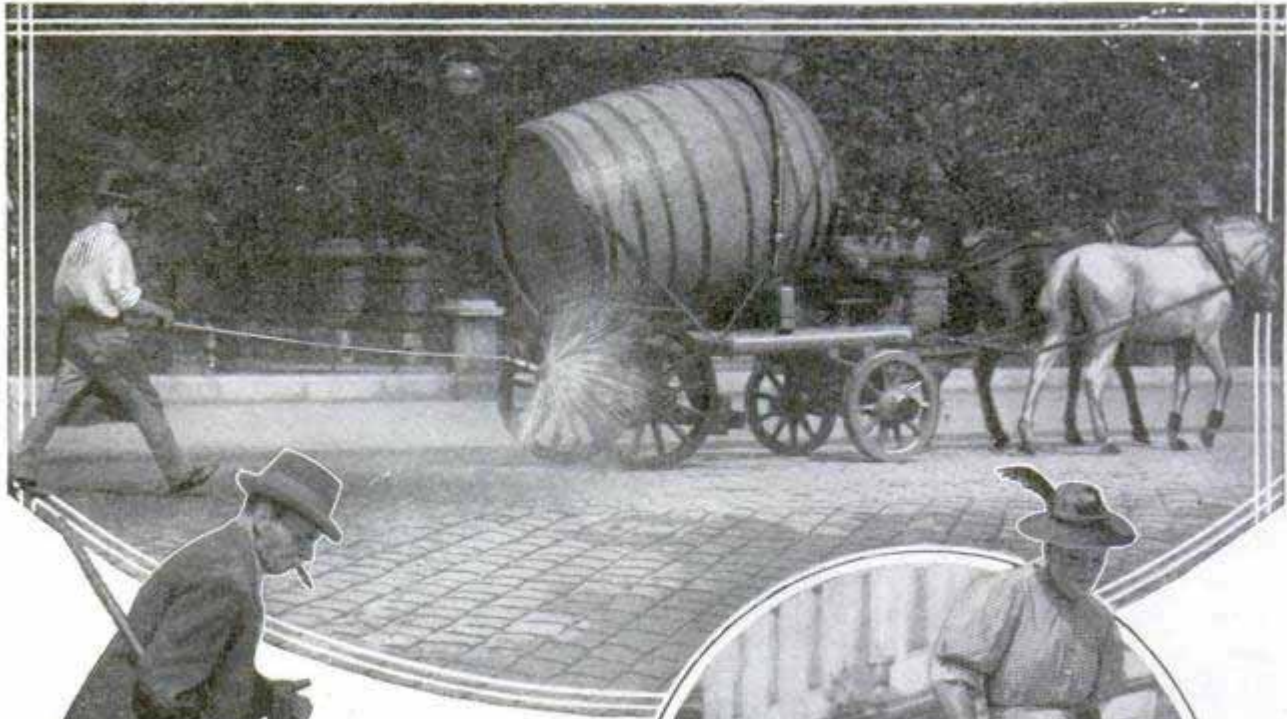

Type of Sprinkler Commonly Used in Vienna and Other Large Cities in Austria and Germany, and, at Right, Woman Worker in Munich, Skilled in Handling the Dustpan



Above, a Street Sweeper in Vienna; Below, a Greek White Wing Wielding a Coarse Broom to Clean the Highways of Modern Athens



About Fifty Women Are Included in the Munich Street-Cleaning Force; Most of Them Are Widows of Workmen, and Receive the Same Pay as the Males; They Are Accustomed to Hard, Unpleasant Work and Long Hours

Discovered by Robert G. Drake, owner of patent
 Omaha, Neb. Standard Seasoning
 POPULAR MECHANICS Society
 Cottage Grove, Ore. Santa Monica 395
 near Los Angeles

**LUMBER SEASONED
 BY COLD AIR
 IS BETTER**

Moisture is removed from lumber by cold air instead of by heat under a patented process said to produce a lighter and stronger material without shrinkage or checking. The seasoning houses are kept almost air-tight and at a temperature between fifty and seventy-five degrees Fahrenheit, and the lumber must remain under treatment thirty days for each inch of thickness. The boards are stacked on edge, in such a way that the largest possible surface is exposed to the cold air, which circulates naturally without the aid of mechanical means, partly due to the arrangement of open spaces between the walls of lumber. It is estimated that some 5,000 barrels of liquid, including pitch and turpentine, are removed from the 2,500,000 feet of lumber in three-inch planks that can be stored in a western seasoning house during the curing process. Oregon fir, seasoned by this method, is said to be 500 pounds lighter to the 1,000 feet than when treated by other systems. The reduced weight favors shippers, while the fibers are said to be softer yet stronger.

The Standard Seasoning
 The season houses at Cottage Grove, Ore.
 The season houses at Cottage Grove, Ore.



Patrolling the Beaches from the Skies; Guard Ready to Toss Life Preserver from Plane to Distressed Swimmer Below

**LIFE-SAVER AIRPLANE PATROL
 GUARDS OCEAN BEACH**

The bronzed life guards may be seen in an airplane flying over a California beach, ready to throw down a life preserver to any swimmer in distress. The pilot of the plane is specially skilled in guiding his craft close to the water. The plan enables two men to patrol a wide area and give speedy assistance.

CUT RAILROAD COSTS

Low operating costs and the ability to make long runs are features credited to the oil-electric type of locomotive. The Baltimore and Ohio railroad ran one engine, without a load, 733 miles at a fuel and oil cost of less than two cents a mile. On the Central railroad of New Jersey, a locomotive of this type pulled 44,346 tons at a cost of \$1.37 a thousand tons, whereas the expense of fuel with a coal-burning engine doing the same task was \$7.78 per thousand tons. A freight train ran 537 miles at five cents a mile.

**CRANK-OPERATED
 METAL SHEARS
 CUT CURVES**

Curved or irregular cuts are easily made in sheet metal with crank shears now on the market. The piece is held and guided with one hand and the shears operated with the other. The cutting is done by two circular blades and a clean, smooth edge is obtained.

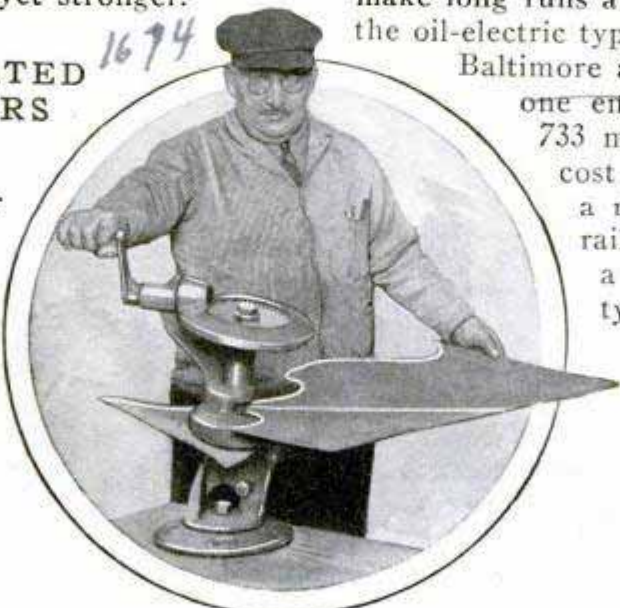

Metal Cutter in Operation; Curved or Irregular Pieces Are Easily Sheared Out

Joseph J. Oyersons & Son, Inc.
 2058 W. 16th, Chicago

1792

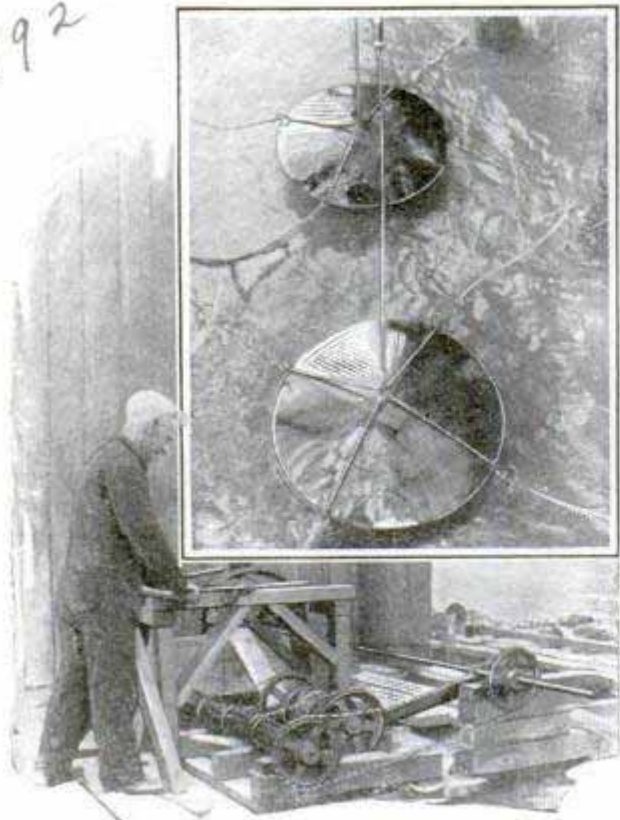

Insert Gives Close View of the Wave Floats; Below, Part of Gears to Springs

WAVES HARNESSSED BY FLOATS TO PRODUCE ELECTRICITY

Electric power is said to be produced successfully from the action of the sea waves by means of an apparatus which a Los Angeles inventor has devised. It consists essentially of a number of floats which are placed on the water and made to tighten a series of springs by their movements up and down. The inventor declares that the apparatus, working for four to six hours, will store up a considerable quantity of electrical energy, and says that the device can be used by ships while they are at anchor, for danger signals and for lighthouses.

GARAGE DOORS OPEN BY LIGHT FROM AUTO HEADLAMPS

Operating on the principle used in making radio photographs, an apparatus has been devised for opening garage doors simply by directing the rays of the automobile headlamps on the mechanism. The light actuates a sensitive unit in such a way that the doors roll wide, sparing the garage attendant the trouble of responding and the autoist the bother of sounding his horn for attention.

POWER LOSS IN BROADCASTING 27% LIMITS RADIO'S USE

Theories that unlimited power can be transmitted by radio are not upheld by Prof. Benjamin Bailey, of the university of Michigan. He points out that a broadcasting station may use electricity equivalent to five horsepower but power picked up by a receiving set will be equal to only an infinitesimal part of the energy sent out, less, he says, than that exerted by a fly in lifting its foot.

MOTOR-DRIVEN WOODWORKER 2134 IS WHOLE SET OF TOOLS

Several tools are combined in one portable motor-driven unit a western inventor has designed to save the cost of purchasing separate pieces and to aid the woodworker. Interchangeable parts are furnished to afford the services of a saw, a screwdriver, drill and jointer, while a planing attachment is one of the principal features. This has four cutters which revolve at high speed in a drum turning in the same direction at a lower rate of speed so that a cut as deep as one-fourth of an inch can be smoothly made at one time. Vertical action of the cutters is

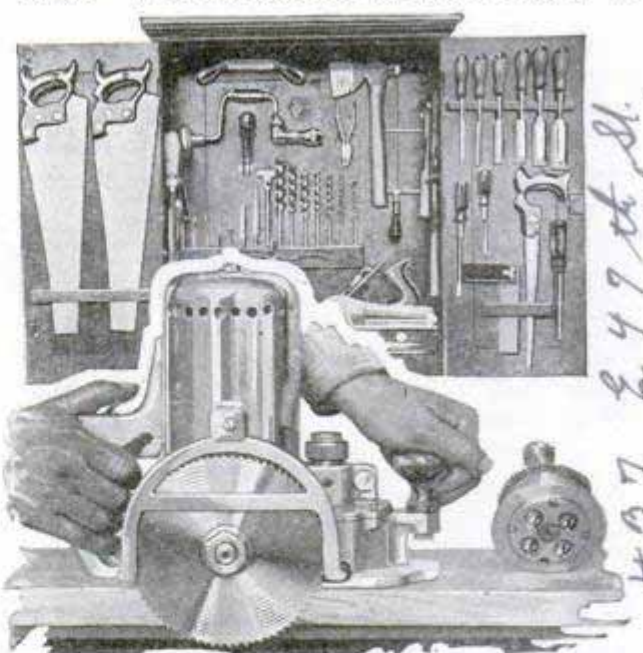

Motor-Driven Saw in Foreground Is Considered Nearly Equal to All of Tools in Cabinet Behind

said to reduce the amount of power required. Sanding, shaping, jig-sawing, mortising and grinding are some of the other jobs to which the tool can be applied.

497 E 49th St. Chicago

Auto industries 2177
5/27/26

Shamal National Electric Light Association

The Skolnik Mfg. Co.
1402 Dupont av. N.
Minneapolis, Minn

2203

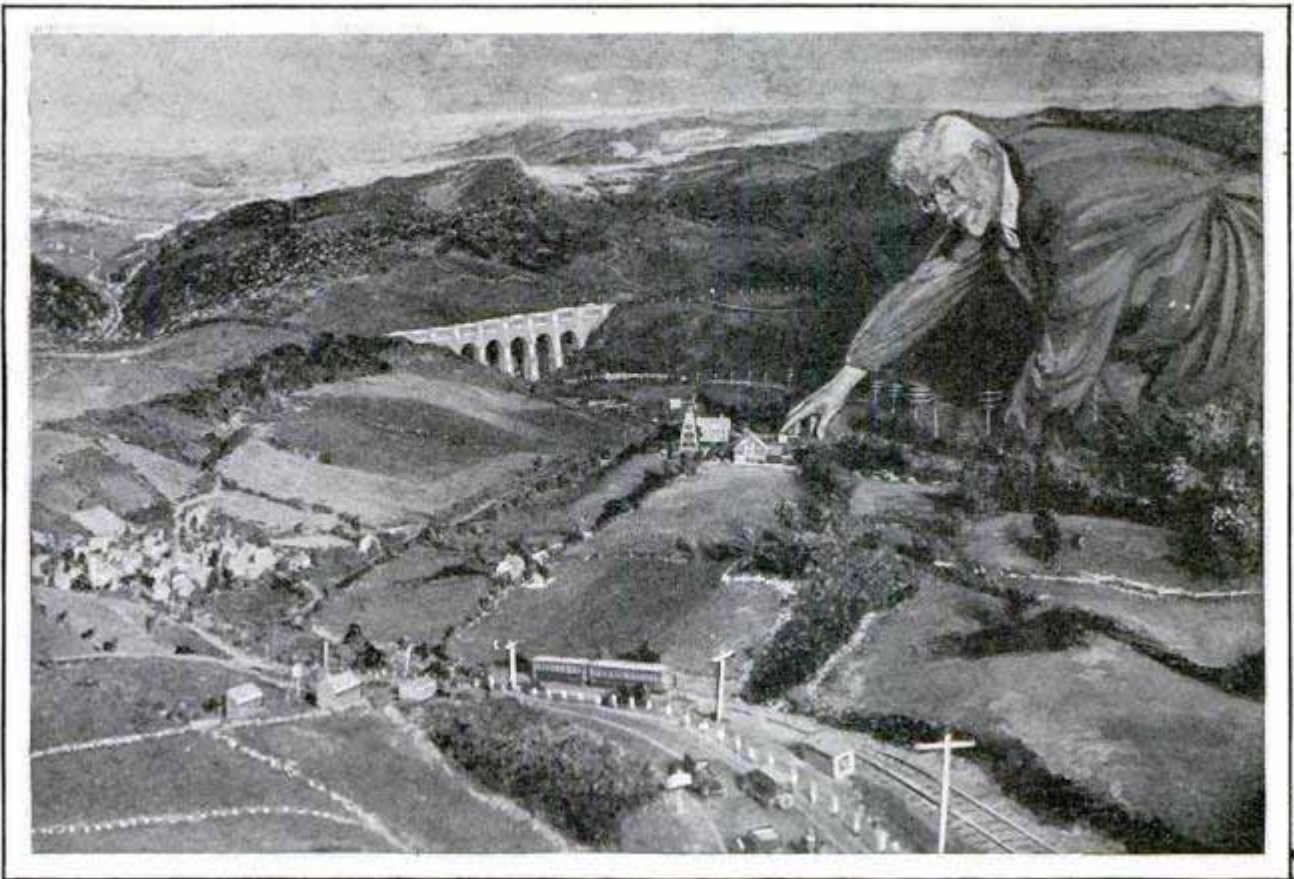

© Henry Miller

Ulric S. J. Dunbar with Realistic Landscape Model He Has Fashioned to Illustrate Special Features of Automobile Highways and Other Lanes of Travel for Sesquicentennial Exposition

MODEL OF HIGHWAY SYSTEM SHOWS ROAD PROGRESS

Modern types of auto-road construction are graphically presented in a realistic highway model on exhibit at the Sesquicentennial exposition. It was prepared by a well-known sculptor and shows bridges, culverts, pavements and other details in accurate scale. A scenic background in perspective increases the natural aspect.

BIG AIRSHIP BUILDING IN-GERMANY 2220

To be twice as big as the "Los Angeles," a huge airship now under construction in Germany will have five motors of 420 horsepower each. With word of this enterprise, it was also announced that chemists of the Zepelin works have



Stucco Gasoline-Filling Station with Mushroom-Shaped Roof; the Shingles Are Arranged like Thatch

discovered a fuel which is expected to replace gasoline. It is said to minimize the danger of explosions.

GAS STATION LIKE MUSHROOM AFFORDS WIDE VIEW 2191

Besides its distinctive appearance, which attracts the attention of patrons, a gas line-filling station in a western city is so constructed that it admits light from all directions and persons inside can command a view of the highways on all sides. The roof is shaped like a mushroom, a thatched effect being secured by an irregular arrangement of the shingles which are stained a suitable color. The sides are of stucco.

*Friedrichshaven
Germany.*

*The Waller Oregon.
Carlton Barrett
406 Langhlin*

2096 Pacific Atlantic Olygods
#red es. Japp. 400 d. Klamore Cas

HOW EARLY AMERICAN HISTORY WAS REMADE TO

Los Angeles Calif

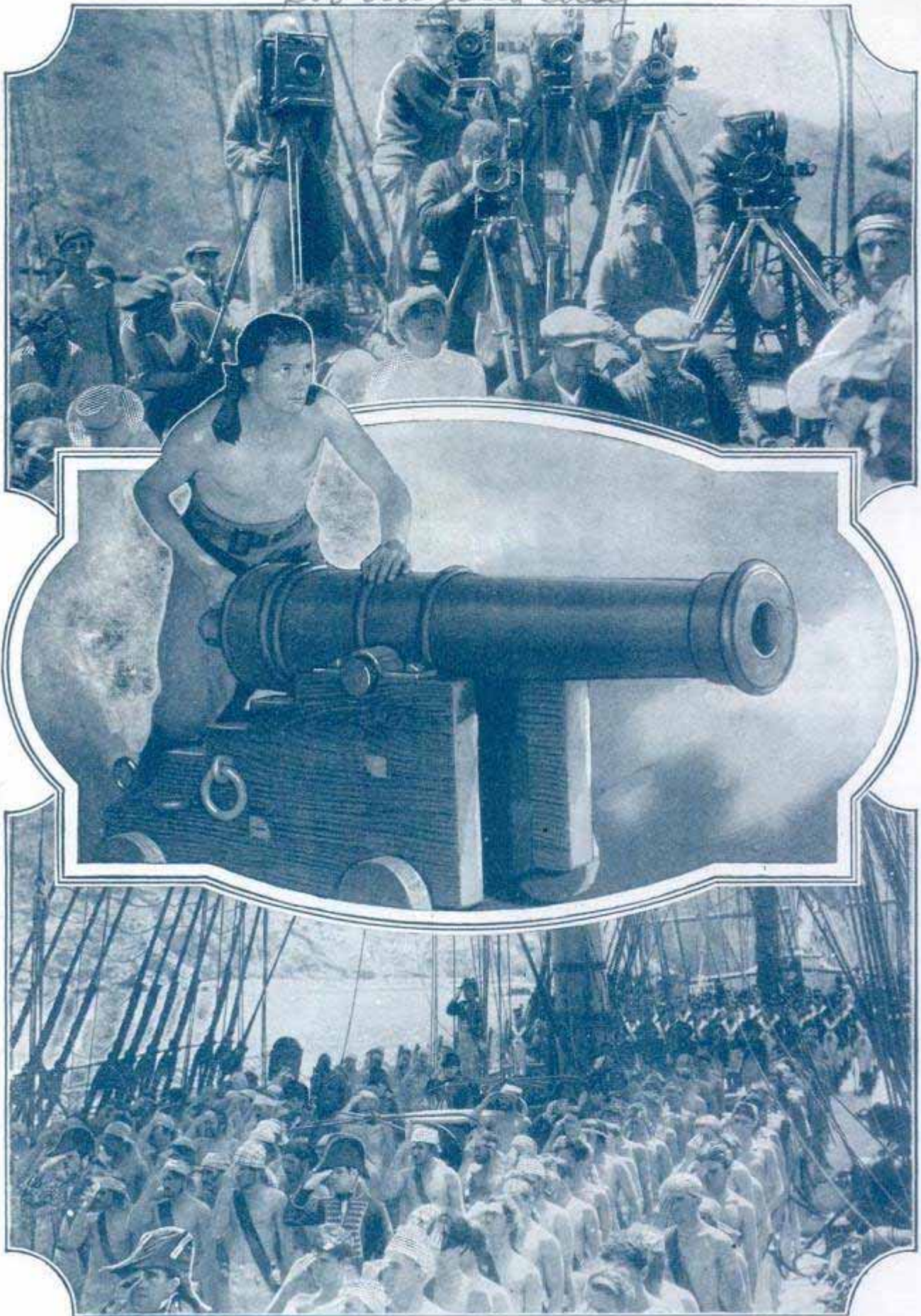

Cameras in Batteries Filming the Action as Hundreds of Movie Players Re-Stage the Battles That Made the Name of "Old Ironsides" One of the Most Famous in the American Navy's History

FILM THE THRILLING STORY OF "OLD IRONSIDES"

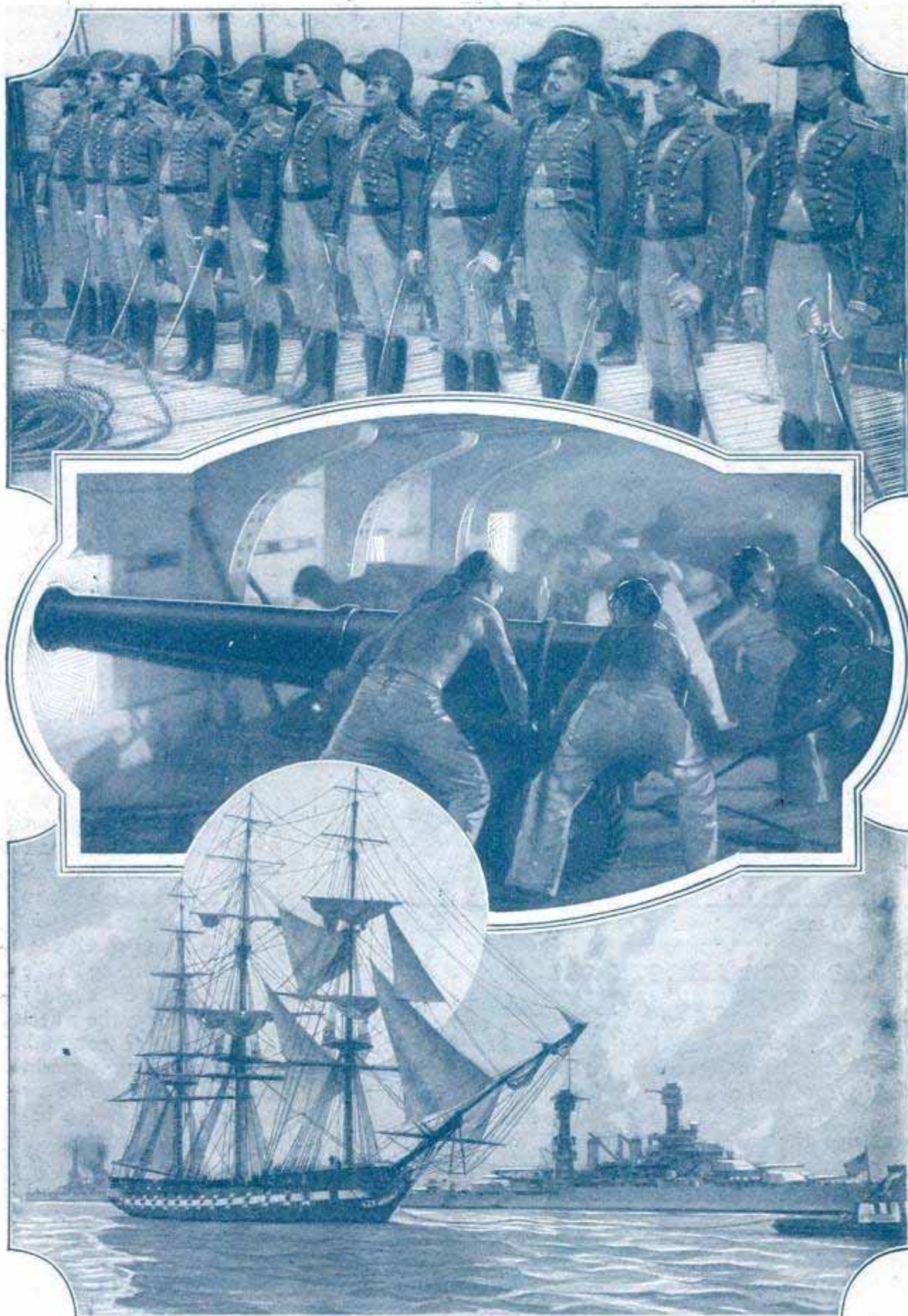

The Replica of a Great Frigate Fires a Seven-Gun Salute for the "West Virginia," the Latest Type of Battleship; Above, a Gun Crew at Work and Marine Officers Who Drilled the Movie Crew

*P. Laas-Oeyer,
% Copenhagen Engineering
College, Copenhagen.*

1923

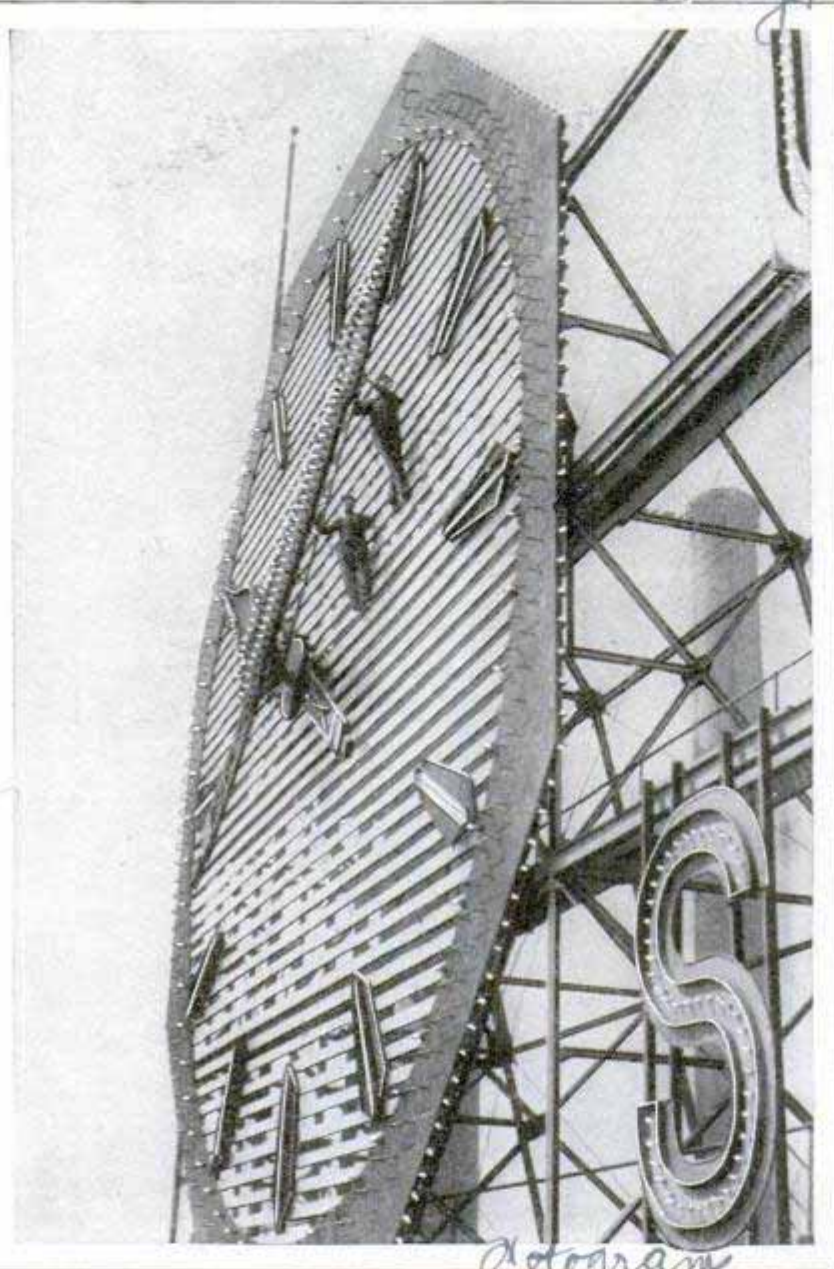

but the hands in this instrument were so large that it was considered unwise to allow such action.

MACHINE WRITES AND DECODES CIPHERS

2243

To simplify the use of ciphers in communication by telegraph or radio, a Danish inventor has devised two electrically connected typewriters. Typing on one of the instruments, automatically reproduces the message in code on the other. When this cryptogram is received, it is easily translated simply by reversing the sending procedure, the code yielding the original message as it was first typed.

TWO-MOTOR RACER FOR NEW SPEED RECORDS

2211

By coupling two twelve-cylinder aero engines together to form a single drive to the rear wheels, an English motor expert hopes to achieve a car which will lower existing speed records on short distances. According to the specifications, the racer will be slightly more than twenty-two feet long, the wheel base nearly twelve and one-half feet, and, running at full speed, the two engines will develop nearly 1,000 horsepower. The car will be a single-seater and will weigh between two and one-half and three tons.

Workers on Clock Dial Illustrate Enormous Size of Hands, and Figures Are Mere Markers to Represent the Hours

HANDS OF MAMMOTH CLOCK WEIGH TWO TONS

As nicely balanced as the tiny hands in your watch, the indicators that travel over the fifty-foot dial of a huge clock in Jersey City, together weigh two tons. The hour hand tips the scale at 1,800 pounds and the minute hand at 2,200. Heavy counterweights help control the movements, a slight slip ahead every three seconds. In many large clocks of this type, the minute hand makes a jump of a full minute,

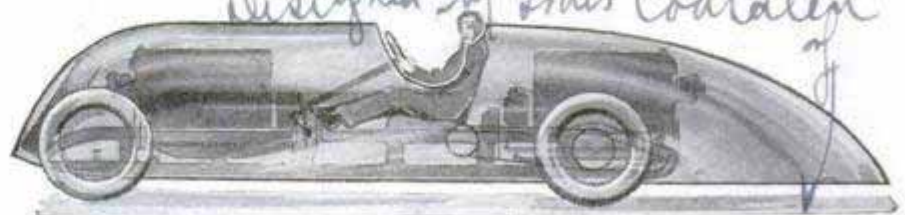

Sketch of Two-Engine Racer Planned by Englishman; Motors Are to Be Coupled to Form Single Drive

Designed by Louis Coatalen
Sunbeam Motor Car Co Ltd.
Wolverhampton, England.

on waterfront

matabelle

Материал энциклопедический словарь

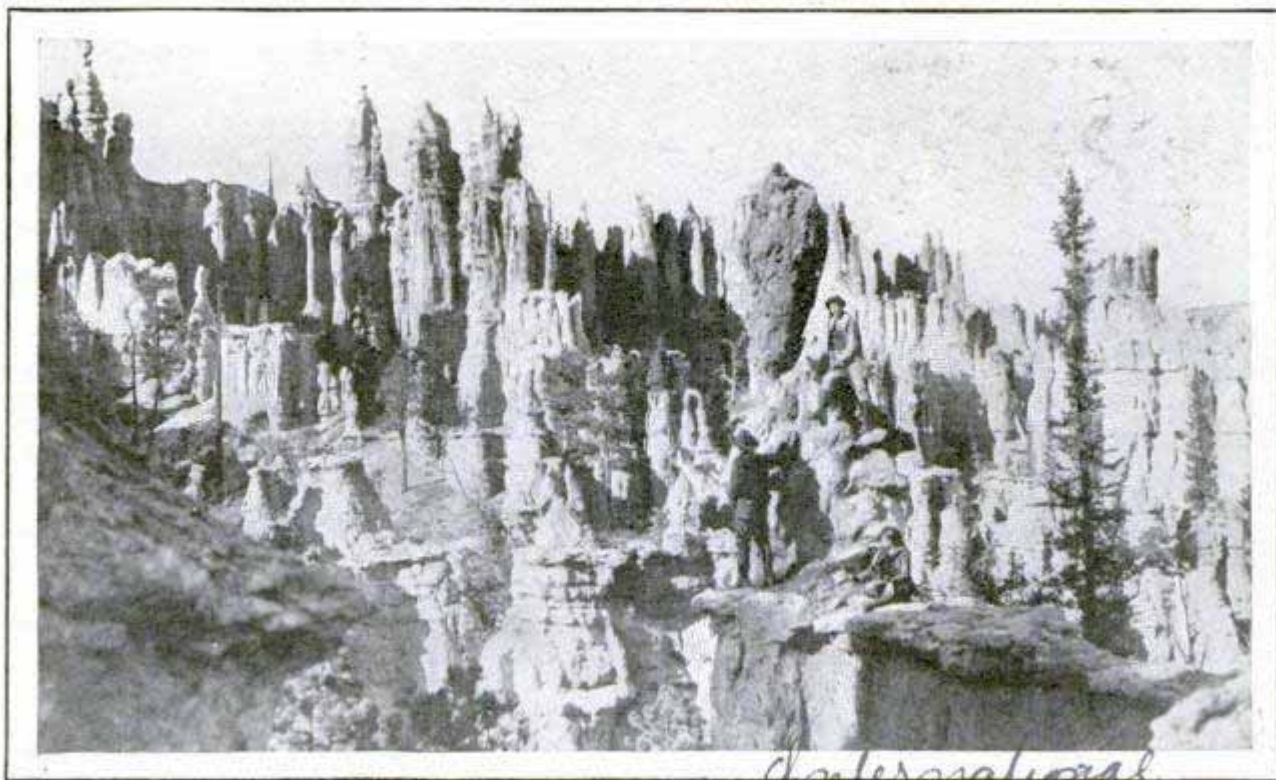

Nature's Weird Gallery of Rock Columns in Bryce Canyon, Where Wind, Rain and Frost Have Carved Fantastic Shapes in Hard and Soft Strata; Brilliant Coloring Enhances the Scene's Beauty

NATURE'S SKILL AT SCULPTURE REVEALED IN CANYON

2219

Wind, rain and frost are master sculptors in a magic studio of rainbow-colored rock. So many travelers speak of Bryce canyon, a picture spot of the west, near Zion national park in Utah. Here weird statues of fantastic design and mammoth proportions have been carved from strata painted in practically every color, shade and tint of the spectrum. Hard layers, overlying softer one, have protected the material below, producing tall columns like totem poles, capped with flat blocks, the edges of which form odd profiles against colorful backgrounds.

SAHARA DESERT ONCE A FOREST

2333

Dense forests once grew on the Sahara desert and a race of people who lived by hunting and tilling the soil inhabited the region, according to Prof. James H. Breasted, of the university of Chicago. A clue to this "lost chapter of history" has been obtained, he declares, by deciphering inscriptions and markings on a large rock in the desert. This monument has been called the "Lost Temple," but is not a structure made by man, simply a rock

shaped to resemble a temple by the winds and sands. Judging from small statues and other objects found in ancient graves during recent excavations, the early Egyptians and other peoples apparently thought of the life beyond as a realm where joy and merrymaking abound, he said.

ELECTRIC FAN IN SAFETY STAND GIVES EVEN CIRCULATION

2184



Safety and absence of unhealthful draft are two of the features claimed for an electric fan that may be placed upon the desk or table like a lamp and send the air in all directions. The revolving unit is entirely shielded by a globe-shaped grating and is said to run with practically no noise. It will not disturb loose papers and is recommended for winter use as well, to assure proper circulation of air in residences and offices.

S.A.X. Vertical Fan Co,
Esquette Times Bldg
Pittsburgh, Pa.

Temporary Chicago agent, L. Marhefer, R-514, 36 S. State, Chicago

2090 Pullman Co., 79 E. Adams Chicago
 DANCE HALL, THEATER AND GYM ON WHEELS



Conveniences Such as Real Beds, Dressers and Armchairs Are Features of Sleeping Quarters in Special Cars Constructed for Long Railroad Tours through Scenic Parts of the United States and Canada; the Land "Liners" Have Other Steamerlike Accommodations

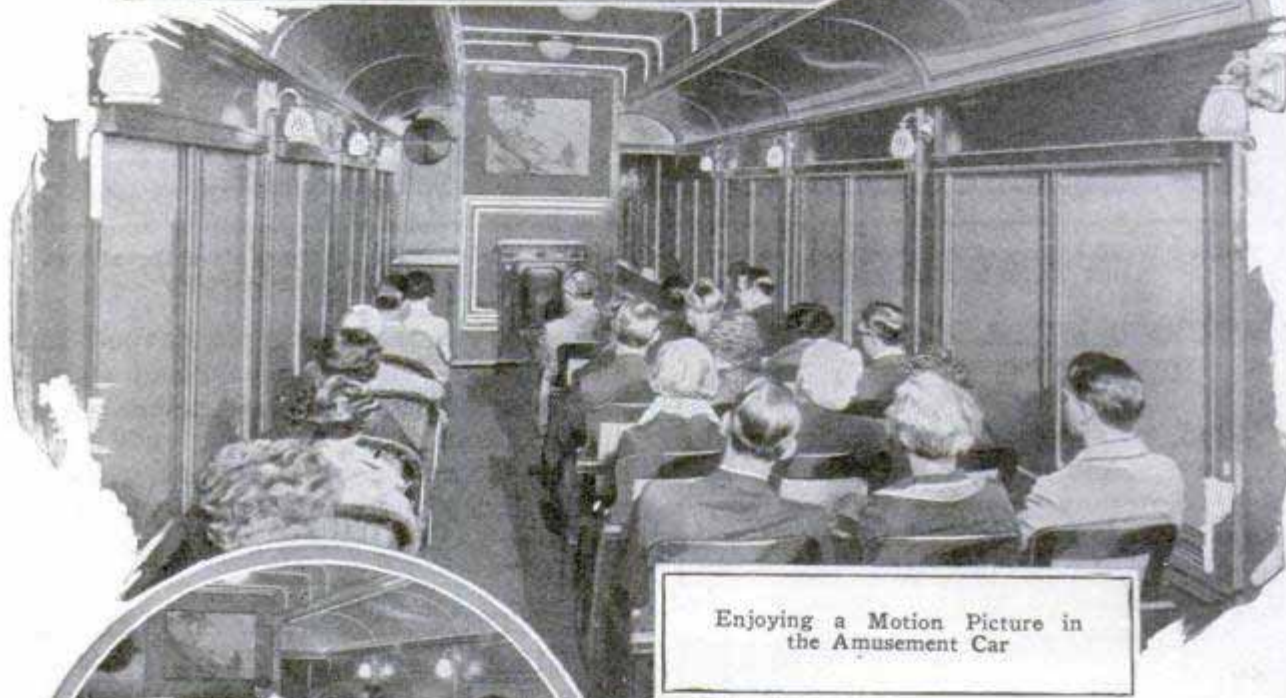

Enjoying a Motion Picture in the Amusement Car



When the Chairs Are Removed, the Theater, Thirty-Eight Feet Long, Becomes a Roomy Dance Hall with Music from Phonograph or Radio; at Right, a View in the Gymnasium

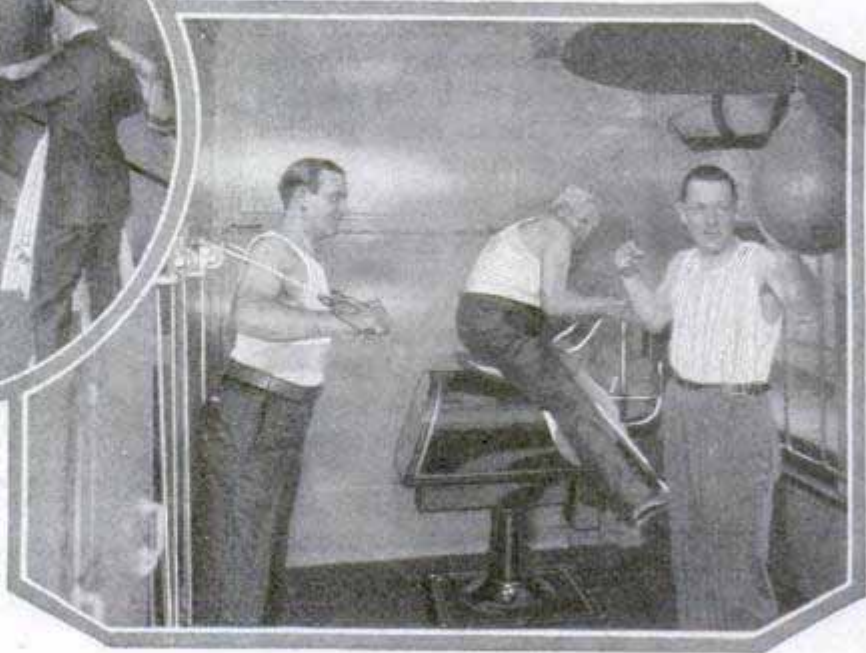

the in
informe
is the
Special

Planes on
1927 for conditions
New design - Aug

**WOMAN AS BUTTERFLY HUNTER
COLLECTS RARE SPECIMENS** 2247

Gathering collections of butterflies and other insects is a common pastime, but a Florida woman makes it her business and has established one of the country's largest laboratories for preparing the specimens. Scientific institutions, colleges, other collectors and jewelers are her customers. During her first season, she is reported to have sold \$400 worth of one variety of blue butterfly common in Florida but rare in other sections. She recently received another order for 10,000 grasshoppers at three cents each.

**PRIZES FOR SAFER AIRPLANES
TO AID AVIATION** 2270

Prizes totaling between \$150,000 and \$200,000 have been offered from the Daniel Guggenheim fund for the promotion of aeronautics, for inventions that will increase the safety of flying. It has been found that lack of public confidence in the stability of aircraft is the greatest handicap in the development of aviation. For that reason, the awards have been posted to encourage an international competition among manufacturers and designers toward solving some of the problems interfering with airplane safety. Included in the drawbacks to complete security in the craft as now constructed, are too high a landing speed, too great a run after landing, too flat a gliding angle, making approach to a given spot difficult, and the length of the run before taking off is too great. "Stalling" is one of the most common causes of accidents and means to prevent it are to be sought. Special investigation has been authorized into the development of radio and other aids to aerial navigation.



Blowing Up the Rubber Neckpiece, Which Is Part of the Bathing Cap and Serves as Buoy

**INFLATED BATHING-CAP COLLAR
SERVES AS BUOY** 2195

For the timid bather, a swimming cap has a neckpiece that may be inflated to help keep the head up and the nose and mouth out of the water. It has enough buoyancy to partly support the wearer.

**GARAGE AIR JACK LIFTS CARS
FOR WASHING UNDERSIDE** 2173

Time required to wash the automobile is reduced with the aid of a compressed-

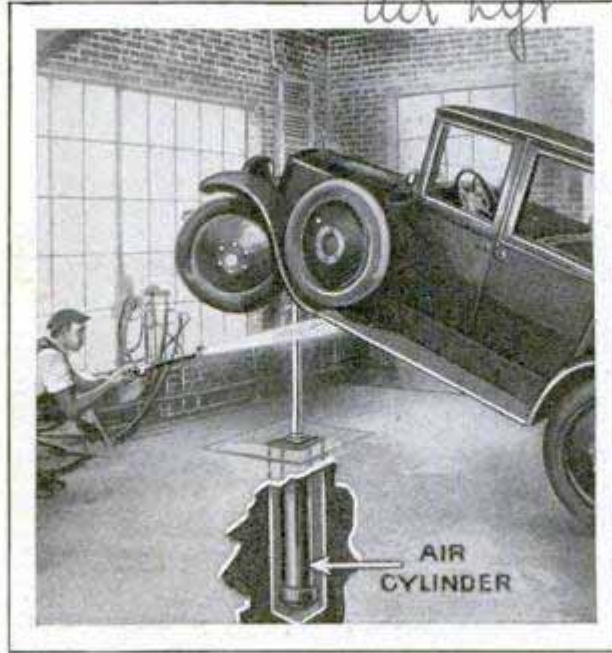

Car Raised for Washing or Repairing; Position of Air Cylinder Indicated Below

air lifting jack that raises the car at the front end to a height at which the underside can be thoroughly cleaned. The lift consists simply of a cylinder and piston; the piston is equipped with a saddle at the top to engage the front axle of the car, and is operated by air from the auto-washing system. When lowered, the lift rests flush with the floor so that it is not in the way.

\$240.00 - \$270.00

120 03 road way
New York City
598 Madison Ave

Curtis Pneumatic
Machinery Co.
150 2 Healy Ave

*Royal Porcelain Factory
Copenhagen, Denmark*

WHERE IT TAKES THREE MONTHS TO MAKE A CUP

750



Scenes from Porcelain Factory in Copenhagen, Where Practically All Processes Are Done by Hand; at the Left, a Dinner-Service Plate Is Being Shaped with a Safety-Razor Blade before Burning



Huge Vase Valued at Several Hundred Dollars and Woman Artist Painting a Design; Many of the Workers Are Members of Distinguished Danish Families

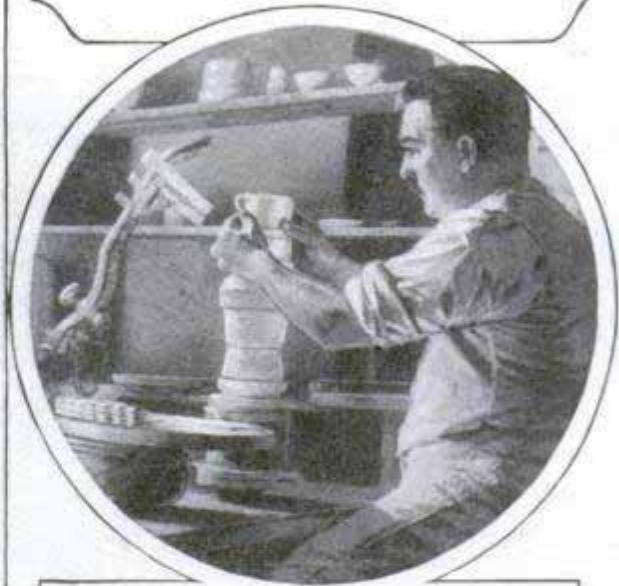
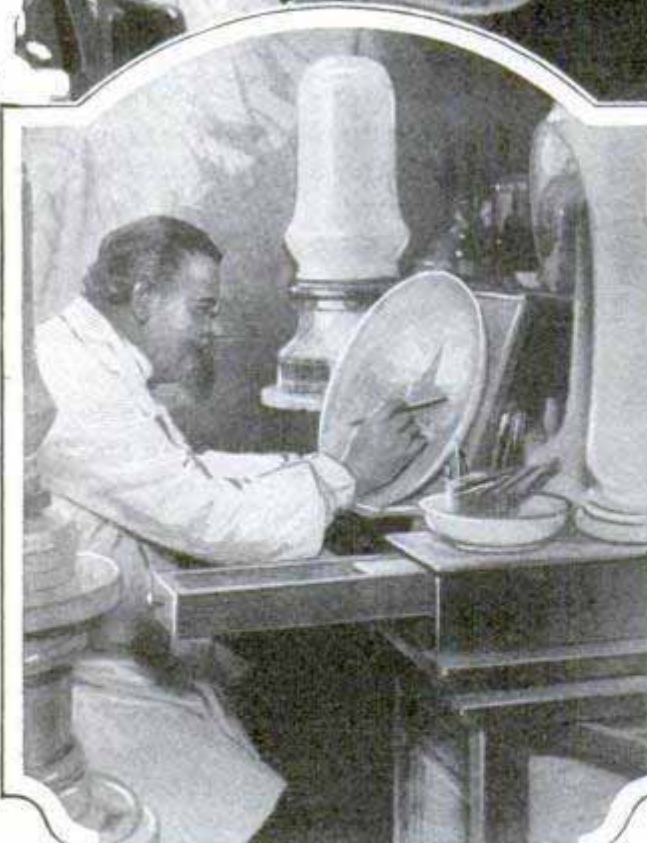

Painting a Plate for Sesquicentennial Exposition and Putting Handle on Cup

Motor age 7/10/26

H. P. Paris, 2214
N. 60th St. 405

POPULAR MECHANICS

2110 Seattle Wash

EUROPEAN SMALL-CAR ENGINES
QUARTER AMERICAN SIZE

2218

Introduction of racing cars with only 91½ cubic inches of piston displacement, at Indianapolis this year, indicates that American automobiles within the next two or three years will be using smaller and higher-speed engines. They will still have a long way to go, however, to reach the limits of smallness already in everyday use in Europe, where cars with engines less than half the size of the Indianapolis racers are quite common. That our cars ever will be as small as the Peugeot, for example, with a piston displacement of only 40.2 inches, is doubtful, for the small car abroad has been developed primarily to meet high taxes based on rated horsepower—a problem that has never faced American motorists. In England the British light Austin and the Italian Fiat, the one with 45 inches displacement and the other with 60, are rated at seven horsepower, and are taxed about \$40 a year, whereas taxes on imported American cars of average size run as high as \$150 or more. To get satisfactory operation out of such a small motor it is necessary to speed up the revolutions considerably, and make greater use of the lower transmission gears. The driver is required to do considerably more gear shifting than with the heavy, high-powered American cars. Anything over 2,200 revolutions per minute may be classed as high speed with American cars, while the small foreign machines usually operate at 3,500.

French. Amil Citroen

British A.C. - Morris Cowley

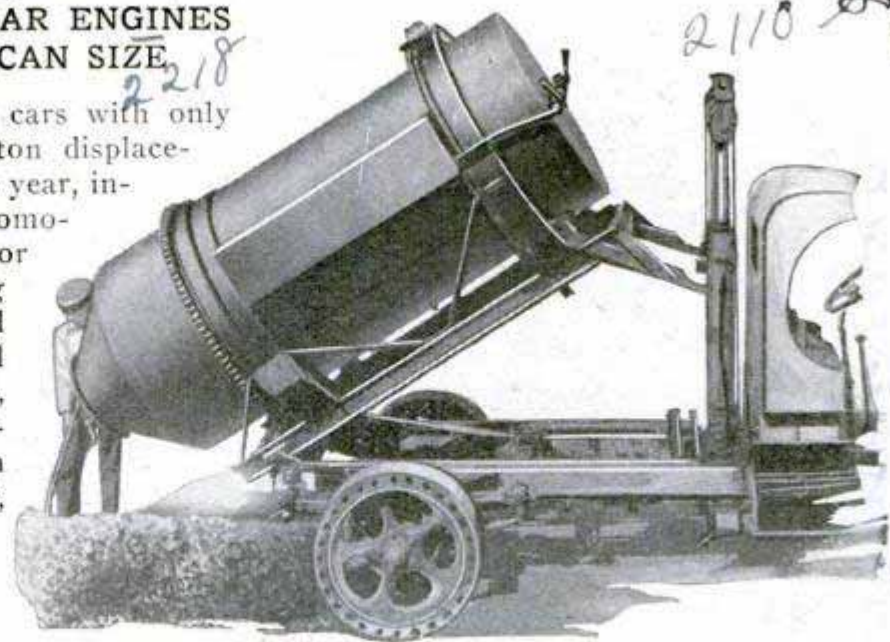

Truck Body Raised to Dump Contents of Mixer, Which Is Turned by Power from the Motor

TRUCK-BODY CONCRETE MIXER
REDUCES BUILDING COST

2110

Auto truck body and cement mixer have been combined in one to reduce hauling and construction costs on all sorts of concrete jobs. While operated as a mixer, the drum-shaped body is turned by power from the truck motor. When the batch is done, the cylinder is tipped and the contents pour out of a rear opening. It takes about five minutes to prepare one batch. The combination effects economy in hauling time and labor cost.

H. P. Paris, 2214 N. 60th St. Seattle Wash. Letter recd. 3/27/29



Seat Attached to Ordinary Chair; It Is Folded Up When Not in Use

HIGH CHAIR
FOR BABY
FOLDS UP 1890

Easily attached to any ordinary chair in a few moments, a baby's high chair can be folded into a small package for carrying or storing. It provides a safe and comfortable rest for the child and is especially handy when traveling.

Shown at Institute of Patents London, England. Local Russell St W.C.I.

Used by Williamson Candy Co,

4701 Armitage Ave. Chicago

Designed by General Advertising Co
433
Mayton Oldy
San Francisco Calif

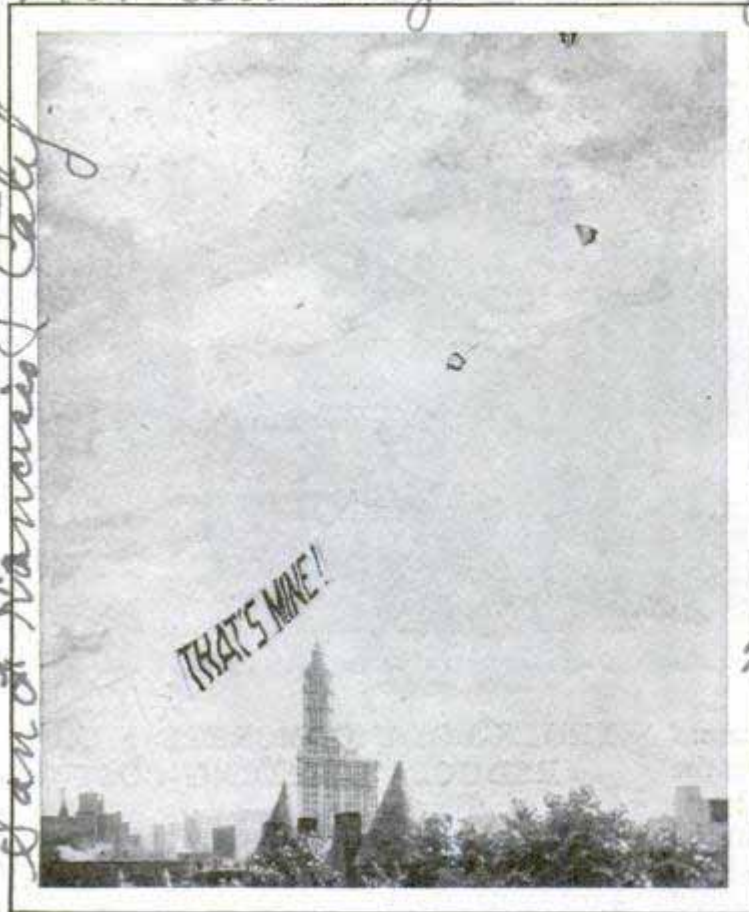

Sky Writing with Kites; Letters Attached to a Group of Box Kites Are Visible at Great Distances

LETTERS FLOWN FROM KITES FOR SKY ADVERTISING

Sky writing with signs attached to kite strings has been employed for advertising purposes in a western city. The letters are of silk sewn on a backing of thin netting. From three to six kites are needed, depending upon the size of the display. A wooden slat at the bottom of each character keeps it straight.

ASPHALT CUT FROM HOT LAKE OF UNKNOWN DEPTH

One of nature's most perplexing mysteries is the hot lake of asphalt on the island of Trinidad, a 100-acre kettle that apparently keeps filling up as fast as the contents is taken out. Annually, for more than a quarter of a century, almost 125,000 tons of asphalt have been removed from the deposit, but there seems to be as much in the big caldron today as when excavations were first started. Subterranean fires keep the mass warm. It is of unknown depth, borings having been made

N.Y. Herald
6/25/26

175 feet down without striking bottom. The only difference in the asphalt at that level is its soft, almost fluid, consistency. That exposed to air on the surface is firm and more nearly solid. The mining is done with hand mattocks, for the yielding surface of the lake prevents employing heavy units of machinery. The asphalt is cut out in large blocks, broken up and transported in small cars to the sea coast for shipment. The lake lies 125 feet above sea level.

INCLINED RACK FOR AUTO LEVEL UNDER LOAD

2285 Requiring less space and accommodating cars of longer wheel base than can be cared for on many such devices, a tilting rack, for the garage or filling-station yard, has wide tracks and assumes a horizontal position under the weight of the car. It is twenty-two feet long, the groove width for the wheels is sixteen inches and the flooring is constructed to prevent slipping and the accumulation of snow, ice or dirt. An additional feature is a flight of steps at the side and a strong bumper that prevents the car from rolling off the front of the rack.

\$115.00 7 A B.



Car in Level Position on Tilting Rack, and About to Ascend; Note Wide Runways for Wheels

Klein Structural
Steel
Oaklawn, Ohio.

Salvo - 232
Columbus, O.

Chicago

FABRIC BOAT CARRIED IN BAG ALSO SERVES AS BED

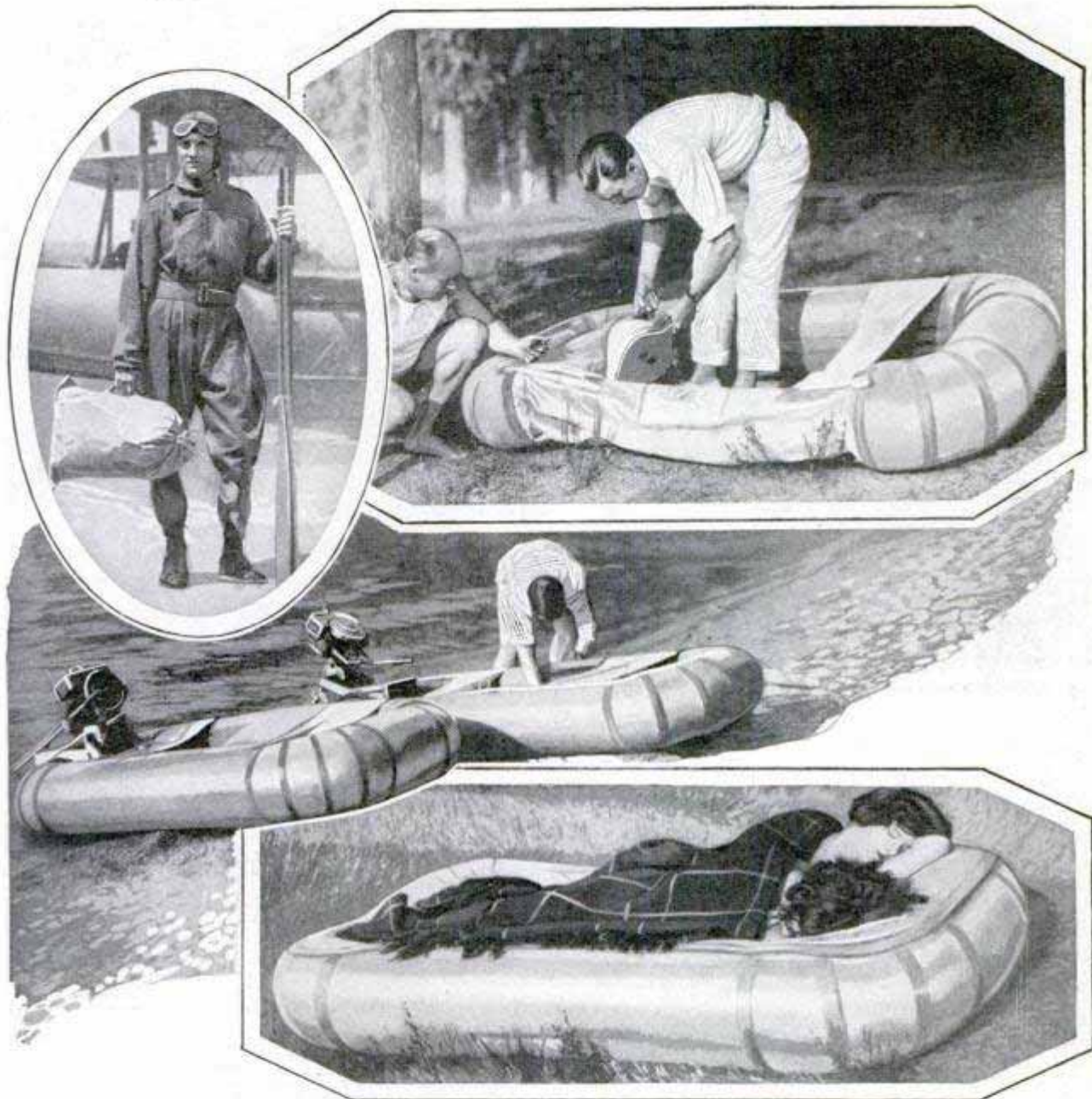

Lieut. Comm. Byrd with Boat in Bag; Blowing It Up by Sections for Use; Two with Outboard Motors, and in Service as a Bed; When Used for Latter Purpose, Canvas on Bottom Keeps Out Cold

Inflated with bellows, a waterproof-fabric boat, which can be packed into a small bag when collapsed, makes a comfortable bed for two persons when turned upside down. When wanted for water use, it may be propelled by oars or by an outboard motor and has cross strips for seats. As a mattress, it is said to be as conducive to rest as a feather bed. Cold or dampness is easily excluded by placing canvas or other substantial material between the bed and the ground. One of these combination outfits was carried by Lieut. Comm. Byrd on his flight over the

pole. Inflated in sections, it will remain afloat even if one part is punctured.

**RADIO ON BARBED WIRE FENCE
RELAYED TWO MILES**

Neighbors of a Kansas farmer, who own radio receivers, can enjoy distant concerts with him by connecting their loud speakers to a wire fence along which the programs are relayed. The plan is said to have worked successfully over distances up to two miles. The dry cedar posts form effective insulation.

*Perry Brown,
Sherman County
Kans.*



Visibly Affected by Period of Forced Wakefulness, Student Subjects Used in Experimental Tests at the End of Their Second Night without Slumber; Some Nearly Asleep Standing Up

How Loss of Sleep Affects You

Tests Show Ways to Conquer Insomnia and Obtain Greater Benefits from Hours Devoted to Slumber

A DEFINITE step in solving the mystery of sleep, which has baffled science from the earliest time, has been made by experiments in several American universities. The difference between sound and unsound sleep has been measured in electrical terms by Dr. Curt P. Richter, of Johns Hopkins, with an apparatus showing the amount of electrical current passed through the body of subjects in different states of wakefulness.

Another investigator has discovered that the average sleeper turns over as many as thirty times during a night's rest, and tests by Dr. F. A. Moss, of George Washington university, have caused him to conclude that sleep is caused by a chemical change produced in the waking hours, resulting in a state akin to intoxication. Sound sleep removes the poison.

Although Napoleon went through strenuous campaigns with only four

hours' sleep each night, Edison finds about the same amount sufficient, and others have managed to prolong their working hours by reducing the time spent in sleep, many authorities agree that at least eight hours of slumber out of the twenty-four is not too much for the average man.

Dr. Edmund Jacobson, of the university of Chicago, holds that cultivating sounder sleep, thereby achieving greater relaxation and refreshment, rather than attempting to reduce the number of hours spent in sleep is the wiser course. After some seventeen years of experimenting and study, he has originated a method of attaining more beneficial slumber and for relieving cases of insomnia and attendant nervousness.

While making tests at Harvard university in 1908, he found that, when their muscles were tense, the subjects jumped

and Dr. Nathaniel
Kleitman, Univ. of
Chicago

more at loud noises than they did when their muscles were relaxed. In other words, there seemed to be a direct connection between muscular contraction and the capacity of being disturbed. From this observation, he developed what he has called a system of "progressive relaxation" to induce slumber.

His subjects lie on their backs in a quiet room. Later on, they are shown how to relax in any position. They are instructed how to achieve such perfect relaxation, that sound, refreshing sleep will come easily. A first step is to demonstrate the presence of contraction in the muscles. This is done, for instance, by having the subject bend his arm against resistance offered by the physician. Having felt the sensation produced by tenseness, it is usually easier for the subject to let his muscles become limp.

"Many persons complain that they cannot go to sleep



Steps in the Relaxation Method to Induce Slumber; Top, Learning to Recognize Limpness in Arm Muscles by Resisting Force Offered by Physician; Center, Stretching and Then Relaxing Forehead and Eye Muscles, and Bottom, a Good Sleeping Position

because tunes keep running through their heads," said Dr. Jacobson. "What probably is happening is that they are whistling or singing the songs to themselves and making minute movements of the muscles of the lips and tongue. When these muscles are absolutely relaxed, the tunes are likely to cease. Repeated tests have shown that there is a direct connection between tenseness of the muscles and mental activity. When you think hard, you naturally scowl. By letting all of the muscles go, just doing absolutely nothing, you approach a way to shut off all the activity of the mind and sleep is the normal result."

In many cases, it takes months of practice to achieve this perfect muscular relaxation, Dr. Jacobson declared, and he advises persons who



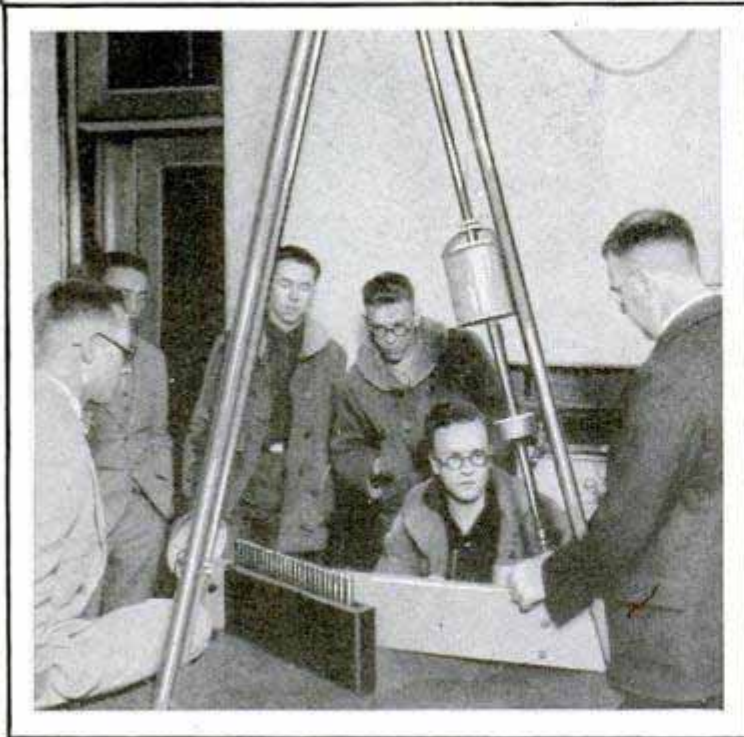

Sleep Subjects Trying to Catch Water Spilled from Swinging Pendulum, an Exercise Testing Eye and Hand Co-Ordination

suffer from insomnia to consult a reliable physician for an examination, so that any diseased condition may be discovered and given proper treatment, for relaxation is hindered if there is pain from some internal organ or if disease is present.

One of the interesting features of this relaxation system is that it can be practiced in a modified degree when you are at work. While sitting at a desk, for instance, you can relax any of the muscles not needed to maintain your posture. This rests and refreshes the whole body. Undue strain on the eyes can be avoided by relaxing the small muscles of the region even while working.

"There are several kinds and degrees of sleep," Dr. Jacobson continued, "but none is as refreshing as that which follows complete relaxation. Even if it is not necessary for a person to become perfectly relaxed, there are several important matters which will help to gain more rest and benefit from slumber. Insomnia often results from too much activity, mental, muscular or both, during the day. The skillful person is the one who learns to do things successfully with the least general tension. Avoid emotional excitement, arguments, all games that are too absorbing and too close reading just before going to bed. Never read or talk in bed.

"Don't count sheep while attempting to fall to sleep. This apology for a method most often fails, but when it succeeds, it does not lead to restful sleep, which should be invited not by mental activity like counting, but by the cessation of all mental activity. Do not partake of huge meals or exciting drinks like tea, coffee or liquors before going to bed. Some persons say that they cannot get along without their coffee. Well, perhaps they cannot, but they pay the price for their indulgence in less sound sleep. May be it helps the digestion and encourages good spirits, but it interferes somewhat with a really beneficial sleep, especially for those who do not drink it regularly.

"Everyone knows the importance of exercise, but if it is taken past the point of fatigue, it is likely to result in insomnia. It is best to intersperse your exercise with short rests so as to avoid becoming tired. One of the common mistakes made by parents who have small children is to 'show them off' to company before the youngsters' bedtime. This excites the children and often results in serious damage to the young nervous system.

"The proper occupation for adults before going to bed is not reading or animated discussion, but it is a good plan to devote an hour or so to doing little odd jobs in an idle way. This gives the mind and muscles time to calm down from the activities of the day.

"One of the frequent causes of insomnia is the drug habit. In the long run, even mild medicines given for sleep add to the sum total of sleeplessness. Drugs which produce sleep do so by poisoning a part of the nervous system, thereby leading to drowsiness. Sedative drugs are better avoided."

The kind of sleep and not the time devoted to it, is the important thing, Dr. Jacobson holds. It is possible, from six hours of sound slumber, to obtain the same benefits as might be derived from eight hours of sleep not so complete, but both Dr. Jacobson and Dr. Nathaniel

Kleitman, of the university of Chicago, believe that it would be unwise for every one arbitrarily to attempt to cut off two hours or so from his allowance for slumber. Their advice is "sleep all you can afford." Obviously, this does not mean prolonged napping, since hardly anyone can afford the time, and too much slumber produces lethargy. But if you are now devoting eight hours to sleep, your schedule is well balanced.

"One of the reasons why we have dreams is that the higher centers of the brain are not completely at rest, leading to confusing interpretations of communications that arise from the lower centers," says Dr. Kleitman. "For instance, the bite of an insect may be felt as the cut of a sword or discomfort arising from eating pickles and ice cream may be interpreted as a weight on the sleeper's abdomen."

MAIL DELIVERED BY TRICYCLE TO SAVE FACTORY TIME

Delivery of mail in large manufacturing plants is often an important and costly problem, but an eastern concern has simplified the task and reduced the expense by means of three-wheeled carriers operated like a tricycle. Girls can easily propel them, they are not difficult to steer and hold considerable mail in large packages or letters. It is estimated that each of the young women riders pedals the carrier some 3,500 miles a year.

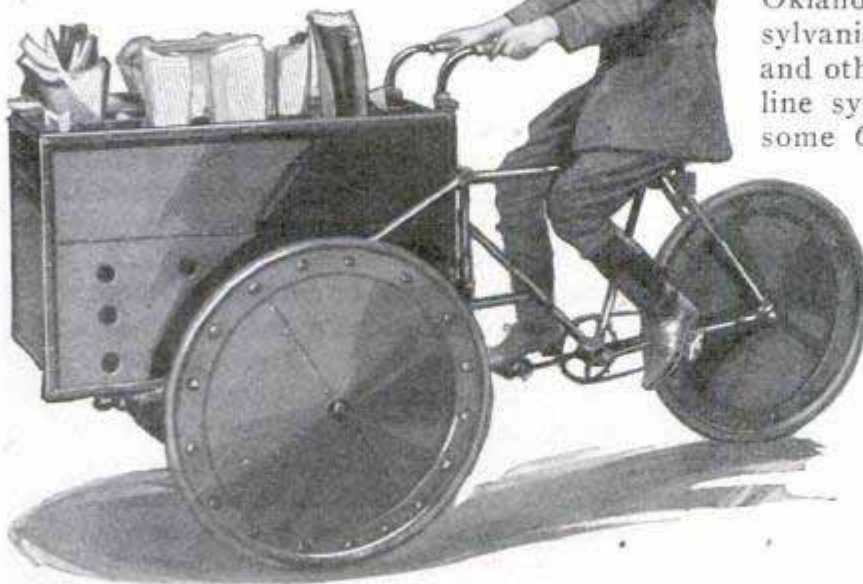

Efficient Delivery Tricycle Used in Large Manufacturing Plant; It Saves Time and Mail Is Kept Sorted

Westinghouse Electric & Mfg. Co.
East Pittsburgh, Pa.



Laying Canvas Strips as Traffic Markers Instead of Painted Lines; Adhesive Holds Them to Pavement

FABRIC-STRIP TRAFFIC MARKER SAVES PAINTING LINES

Durable strips of white canvas with adhesive material on one side for attaching to the pavement are being used as a substitute for painted lines to indicate passenger lanes at street intersections. They are laid in a few minutes and with less trouble than is involved in painting.

OIL-PIPE MILEAGE IN U. S. SIXTY-FIVE THOUSAND 2331

Serving to bring the crude product from the oil fields in Texas and Oklahoma to the refineries in Pennsylvania, New York, New Jersey, and other states, an elaborate pipeline system has a total length of some 65,000 miles. It is one of the busiest lanes of transportation in the world, the oil being kept steadily flowing from the wells to the city plants by means of pumping stations along the way. For the same purpose storage tanks are also scattered along the line to hold reserve supplies. The pipes are usually from four to eight inches in diameter.

crit
May 16, 1926

Suggs Clean Co. Elgin, Ill.

Duck quiver to my machine

Mr. Charles J. Dickerson
1968 Derby Conn.

at arlington + Boylston St. South Main

no 3 Markette U.

412
1458
Chas. Charuofsky
Progress Farm
Phillips, Wis.

Blanca. Fred Astaire
Empire Theatre
London Eng
to handle, casts type-high and has movable gauges. It is of particular service for preparing advertisements quickly.



As Fruit Is Cut Off, It Slides down the Pipe into the Picker's Bag

FRUIT PICKER SAVES THE TREES AND WORKER'S TIME

Cherries, plums, crabapples and other small fruits are gathered without using a ladder or climbing the trees by a picker that clips the stems and allows the fruit to fall down a chute directly into a large pocket worn by the worker. It is therefore not necessary for the human hand to touch the crop and, besides protecting the trees from broken limbs and damaged bark, the picker is said to nearly double the amount one man can gather in a day.

CASTER PREPARES SMALL CUTS DIRECT FROM LINOTYPE

Cuts up to four and one-half by five inches are made with the melted lead from the linotype machine, without heating a larger stereotyper, in a small caster now on the market. The mat is inserted, the platens clamped and metal dipped from the melting pot of the linotype. The unit is light and easy

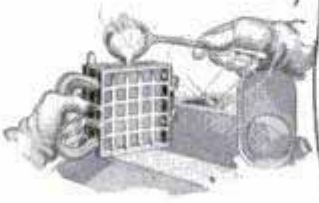

233

RECORD DANCE-STEP SOUNDS ON SPECIAL PHONOGRAPH

As an aid to dancing, a special phonograph introduced in London records the sounds of the footsteps made by the instructor so that pupils can have a permanent and accurate guide to follow. Previously, similar records were made with the aid of Chinese drums, but were not considered absolutely reliable. An English dancer recently used the apparatus and a plate-glass platform as a stage.

HANDS OF FAN-SHAPED WATCH RUN BACK AND FORTH

A watch owned by an eastern collector is distinguished by its shape and the movement of the hands. They run from side to side of the dial instead of around, snapping back automatically and starting again when the number twelve is reached. The watch is said to be about seventy-five years old and is the last of three made for German royalty



As awarded by
P. Schaeffer + Son 314 Terminal
Bldg. Youngstown Ohio.

HOW TAXIS ARE KEPT FREE FROM ENGINE TROUBLE

Motorists who are accustomed to engine trouble after the car has made 15,000 to 20,000 miles are amazed at the performance of taxicabs, which regularly make 75,000 to 100,000, or even more, before the motor is torn down for reboring and a general overhaul. One of the largest taxicab companies in the world, operating 2,900 cars in Chicago, regularly gets an average of 75,000 miles out of its engines, and in exceptional cases has run them as far as 114,000 miles before new pistons and piston rings were needed. The explanation of such remarkable performance lies in the fact that cabs, kept on the street

Psychyred in
South America

Awarded by L. O. Mathews
U.S.P. Columbian Bldg
Columbus

The Bonnet-Brown Corp.
Chicago
155 E. Superior St.
49

20th Century

*Yellow Cab Co.
578 21st Chicago
Wm. Stoffer, Supr.*

POPULAR MECHANICS

*Patented -
not for sale.*

around twenty hours a day, with engines running practically every minute, are operating constantly at the best engine temperature, instead of having the frequent cold starts customary for a private car. Each time a motor is started cold, it takes a short time to get the oil circulating freely, and in the meantime metal parts are being subjected to hard wear. Equally surprising is the oil record, at least to motorists who regularly drain the crankcase every 500 miles. The taxicabs run a month, which means between 4,500 and 5,000 miles, before the oil is changed. Each day, if necessary, fresh oil is added to bring the level up to the mark, but at the end of the month more than five-percent dilution is rare. Every two weeks the chassis is lubricated, and every thirty days the chassis and body are gone over, loose bolts tightened, and similar minor adjustments made. At each 5,000 miles, or about once a month, the carbon is burned out. At 25,000 miles, the valves are reground and at 50,000 miles connecting rods are taken up and the main bearings overhauled.

2224

RECORD DAIRY-CATTLE GROWTH WITH SCREEN AND CAMERA

Accurate records of the growth of dairy cattle on the department of agriculture's farm at Beltsville, Md., are kept with the aid of a camera and a specially ruled screen. The animal is led onto a level platform in front of the scaled background, which is marked into six-inch squares and is exactly the same distance from the camera each time a picture is taken, from the calf's birth to maturity, a post in the ground serving as a tripod. Comparison of the photographs shows the cow's development in terms of the increased area covered by its body.

☐ For treating slow-healing wounds, insulin has been found beneficial.



An Innovation in Doughnuts, the Square Pattern and the Cutter Used to Shape Them

SQUARE-SHAPED DOUGHNUTS LATEST COOKING NOVELTY

2287

As in other realms, the cooking art has its changing styles. A recent one is the square doughnut to replace those of the time-honored round shape. A special cutter has been devised, and cooks declare that they can stamp out more square doughnuts than round ones from a single rolling. Triangular crullers, easily cut in large quantities, have also appeared.

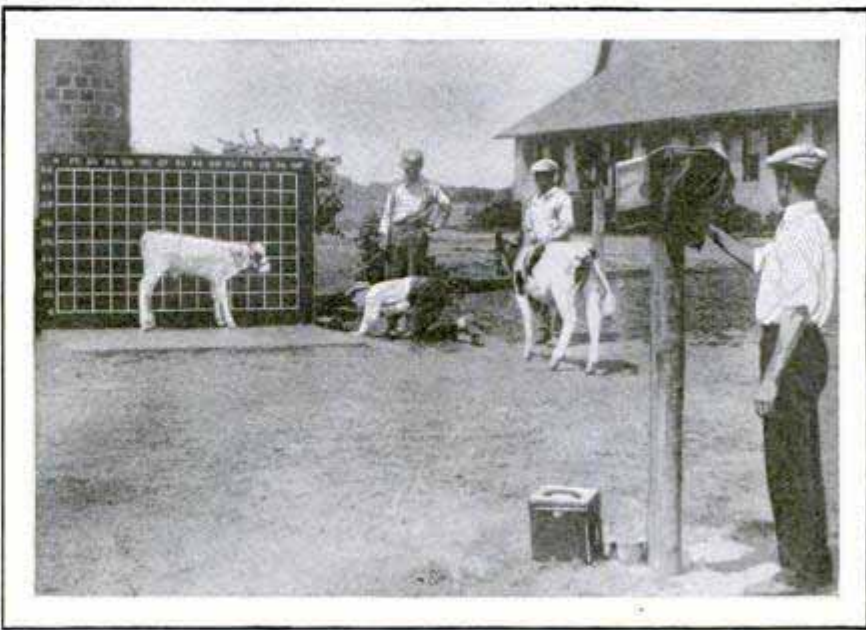

Posing a Calf for Its "Growth" Photograph; a Later Picture Will Show the Animal Hiding More Squares

Bureau of Dairying

*Used at Marlston Restaurant, Boston, Mass.
25 Barabale St*

2043 Built by George E. Turner
in Truckee Creek

TINY TOWN IS MECCA OF THOUSANDS OF TOURISTS

in mountains near Denver, Colo



Electrically Lighted and with Miniature Parks, Ponds, Bridges and Other Decorative Features Closely Modeled after Those of a Real City, This Tiny Town in the Mountains of Colorado Has Given an Architect Opportunity to Express a Variety of Ideas in Home Building and Landscaping. Besides Small Dwellings, the Lilliputian Settlement Has a Church, Garage, Filling Station, Grocery and Other Shops, a Miniature Railroad, Winding Walks and Well-Kept Streets. Laid Out at the Bottom of a Steep Slope, the Model Village Presents a Striking Appearance by Day or Night; as Can Be Seen by the Illustrations, the Little Buildings Are Strongly Constructed

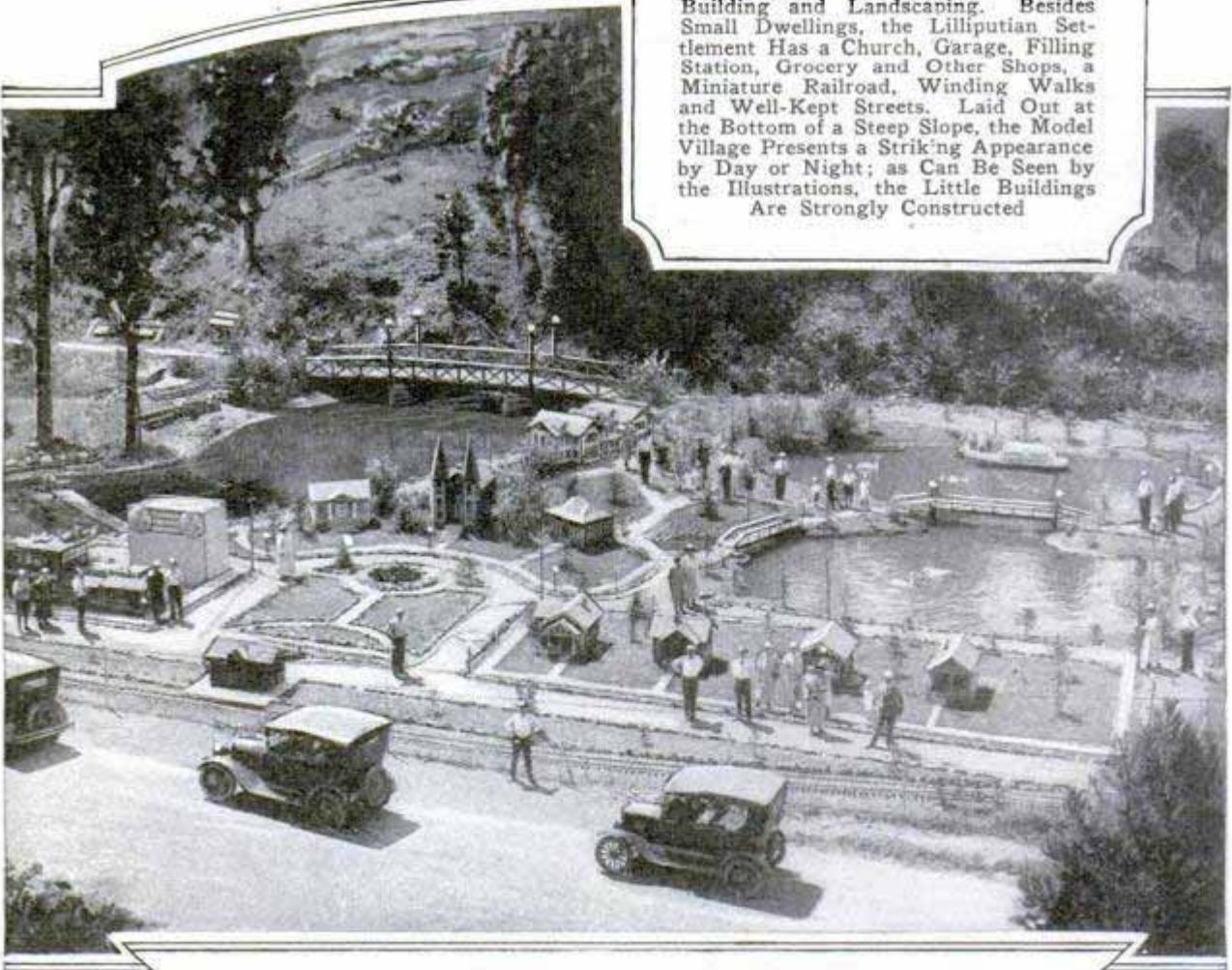

NATURAL OIL IN U.S. HARD TO REPLACE

Coal and shale are frequently considered as reliable and abundant sources of oil, but, according to one authority, great difficulties would be encountered should consumers have to turn to these materials if the supply of natural ground oil were exhausted. He declares that all the bituminous coal now mined and suitable for such treatment would not yield enough oil to care for the present annual increase in the consumption of motor fuel. With regard to shale, he says that it would take 1,000 tons of it to furnish sufficient oil to drive a single modern battleship at full speed for one hour. According to this estimate, the mining and processing of nearly 1,500,000 tons of shale would be required to provide fuel enough to send a battle fleet across the Atlantic ocean. This expert believes that it will take ten or twenty years to develop the shale-oil industry to such magnitude that it will count as a factor in solving the oil-supply problem.



The Columns on Each Side of This Restaurant Interior Are Trunks of Living Trees Spared for Their Shade

Oasis at Palm Spring Calif
BUILD HOTEL AROUND TREES TO PRESERVE OASIS 1893

Rather than destroy highly prized trees in a desert town east of Los Angeles, a hotel was constructed around them. The trunks served as columns in the dining room, artificial leaves being used to increase the outdoor effect. The real branches were allowed to grow above the roof of the hotel.

CLOCK IN STRAW HAT LONDON FAD

Straw hats with a clock mechanism in the crown and the top used as a dial, have appeared in London. The time-piece is said to run satisfactorily, saves the bother of consulting a watch and also serves others than the wearer.



Clock-Dial Straw Hats Were Seen This Year in London; the Mechanism Is Concealed in the Crown

LIGHTHOUSES MARKED TO GUIDE AVIATORS

2304
 Thirteen lighthouses in the lower Potomac river and Chesapeake bay have been marked so as to be guides for airmen. The roofs are painted with large arrows, pointing due north, and a number in figures, eight feet high, corresponding with those on the navigation charts. The system marks the seaplane route between Washington and Norfolk.

Cont. Verne Sankers' Washington, D.C. Navy Dept.

416
1839



False Paper Eyes Transform the Face Almost as Much as an Entire Mask

PAPER EYES WORN AS MASK TRANSFORM FACE

Amusing changes in facial expression are produced with a pair of compressed-paper eyes easily fitted in place and less troublesome to adjust than a regular mask. They afford an effective disguise without hiding the rest of the face.

POCKET SCALE TELLS RANGES, HEIGHTS AND ANGLES

Several instruments are combined in a celluloid rule that fits the pocket. It can be used for determining ranges or distances and heights of objects far or near. A plumb line with bob is attached for aid in measuring angles. In computing the size or distance of an object, the rule is



Using the Plumb-Line Attachment and Measuring Range of Distant Object with Gauge

held the full length of the line, twenty inches, from the eye. Results are obtained from a scale on the rule.

2300 ENGINES THAT RUN RED-HOT SEEN IN NEW STEEL

What engineers regard as an important aid to industry is a new steel alloy that resists extremely high temperatures. According to reports, it will work without injury at red heat so that the shaft of a turbine, for instance, could be run at the rate of as much as 1,000 revolutions a second, with a temperature of 900 degrees Centigrade. In the opinion of one authority, the material will help solve many industrial problems in the application of high-temperature gases.

Announced at Sheffield, Eng.

FISHHOOK KEPT FROM WEEDS WITH BAIT PROTECTOR

To keep the fishhook from becoming entangled in weeds and tearing the bait, a guard intended especially for use in trolling, has been devised in the form of a cone-shaped shield in front of the hook with a number of

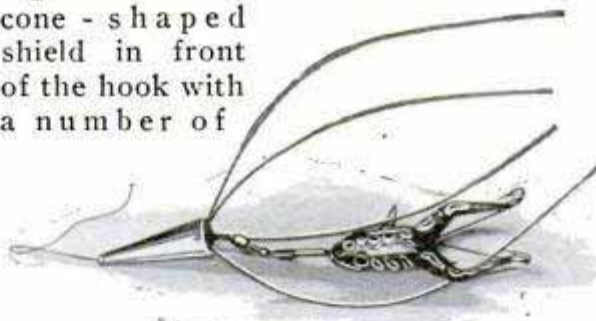

Trolling Bait with Its Protecting Wire Guards That Keep the Hook from Catching Weeds

spreading wires to brush away material likely to foul the tackle. It can be used with minnows, wobblers, frogs and practically every kind of bait.

Elfco Service, 525 S. Dearborn Chicago

2307 TEST RADIO UNDER MOUNTAIN SIX HUNDRED FEET HIGH

Definite measurements as to the transmission of radio signals through masses of rock have been made under Mount Royal in a tunnel of the Canadian national railways. The shaft is three and one-half miles long and, at the center, the mountain is between 500 and 600 feet high and composed of rock and limestone. Messages were received from Ottawa on a

Chicago Evening Post 6/25/26

by Sir Robert Christie Parkhead House Sheffield

Chicago Apparatus Co., 1735 N. Ashland Chicago

1,400-meter wavelength and from an American army short-wave station, broadcasting on forty meters. It was found that the short-wave signals were rapidly reduced in intensity as the receiver was carried to the interior of the tunnel. They were clear at the entrance, but were inaudible on penetrating only a few hundred yards into the passage. The long-wave signals decreased to five per cent of their volume at the center. Measurements were made with an audibility meter. The tests seemed to support the theory that short-wave signals pass to the upper atmosphere and are then reflected or bent by the so-called "heaviside" layer, arriving at their destination by that lofty path and not by that of the longer waves, which travel closer to the surface of the earth.

WHITTLING FANS FROM WOOD A VETERAN'S PASTIME *2154*

Assisted by his wife, an old war veteran in Washington occupies part of his spare time by fashioning fans from straight-grained fir and cedar. An ordinary pocket-knife is about the only implement used, and when the ribs have been shaped, they are steamed, spread to the position desired and interlaced with ribbons.

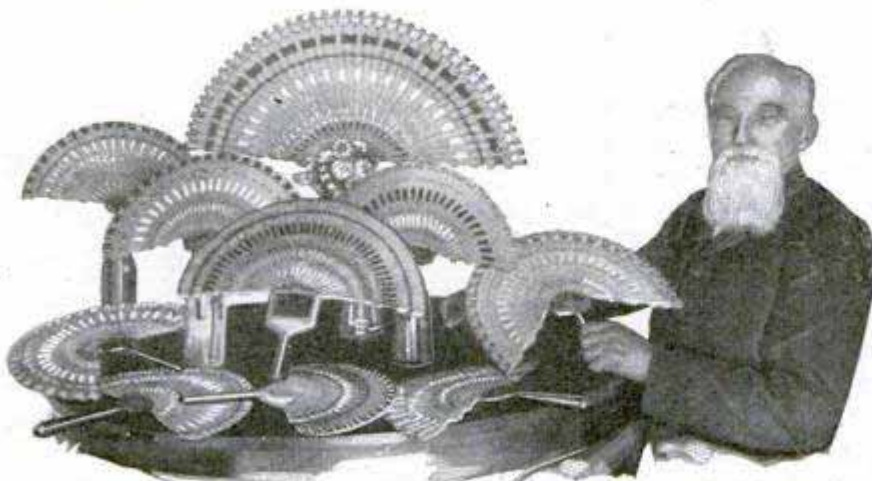

Mr. Ward and Some of the Decorative Fans Whittled from Fir and Cedar with an Ordinary Pocketknife

Mr. and Mrs. Ward, inmates of the Veterans Home at Oetrick, Wash.



2163
Where Vice President Henry Wilson Learned to Make Shoes; Cobbler's Shop at Natick, Mass., Preserved as Memorial

OLD COBBLER SHOP PRESERVED IN VICE PRESIDENT'S HONOR

Many government officials pass into obscurity soon after their years of service are over, but the memory of Henry Wilson, who was vice president of the United States during Grant's second term, is preserved in a modest little building at Natick, Mass. It is the shop in which he learned to make shoes and recalls the fact that he was known as the "Natick Cobbler." He died in 1875.

STEEL HEATED IN NITROGEN GAS *2207* TO LAST LONGER

Steel articles, heated in an atmosphere of nitrogen gas at a temperature about six times that of the boiling point of water, become exceedingly hard on the surface, according to discoveries at the Krupp works in Essen, Germany. It was found that grinding tools treated in this way, in some cases, lasted five times as long as those case-hardened in the usual manner. The nitrogen is created in the vessel in which the steel undergoes the heat treatment.

METER HELPS DANCERS KEEP TIME TO MUSIC

2132.

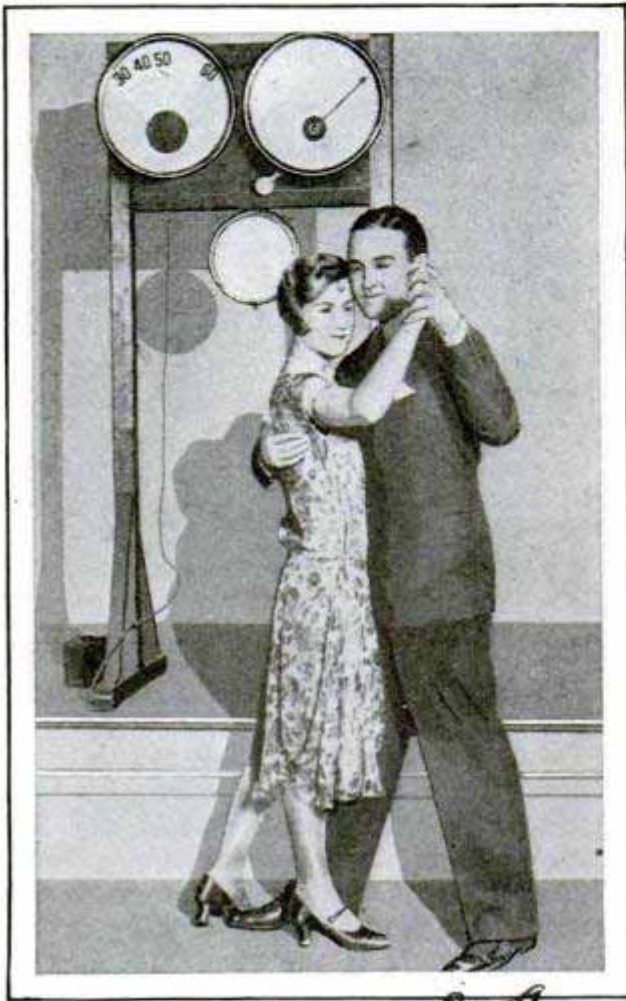

Dancing to the Rhythm Indicator, Which Shows Correct Tempo of Different Selections

As a ballroom novelty and an aid to both dancers and musicians, a rhythm meter has been introduced. A pendulum visually registers the beats, and a dial indicator shows the tempo of the selections.

MYSTERY ZONES OF SILENCE ADD TO SEA'S PERILS

2338

Besides the ordinary dangers of the sea, such as storms, fogs, rocks, and collisions with derelicts and icebergs, there are other perils, little known to the average person and some of them baffling to scientists. Possibly they may explain the sudden disappearance of craft that have been lost at sea and never found, and may be the basis for many of the early superstitions about the oceans. Not long ago, the "Manchester Brigade," while in mid-Atlantic, stopped suddenly and quivered so violently that the captain believed the boat

had struck a derelict. In a few moments, the ship trembled and shook from bow to stern. It developed that it was in the path of a submarine earthquake but the cushion of water, nearly two miles thick, prevented serious damage. The steamer "Nina" narrowly missed destruction when a submarine volcano exploded close by. An immense tongue of flame leaped upward out of the sea, terrifying the crew and giving rise to the belief that another vessel had blown up, but as no trace of wreckage could be found, this theory was abandoned. Falling meteors have contributed to the perils of navigation. In 1908, the Dutch steamer "Ocean" was on its way between Rotterdam and Philadelphia when a gigantic meteor fell so close that waves were flung up over the decks of the vessel and members of the crew were compelled to seek shelter below from the clouds of gas that shot up from the spot. Another meteor missed a tramp steamer by only half a mile while the vessel was sailing for Hamburg from Florida. A considerable number of wrecks off the southern end of Vancouver Island are attributed to a mysterious zone of silence, a "dead air" spot, which shuts out the sounds of fog horns and bell buoys.

MARKER FOR PIES AND CAKES INSURES EQUAL PIECES

2234

To mark pies and cakes so that they can be cut in equal portions, a sharp-toothed divider prevents waste and eliminates guesswork. The sections are attached to an aluminum handle which is placed in the center and the points pressed lightly down to form the indentations. Pies without crust and cakes without icing may be marked before baking. The divider can be had to give equal cuts of four to twelve, and for pies is adjustable up to a tin twelve inches in diameter.

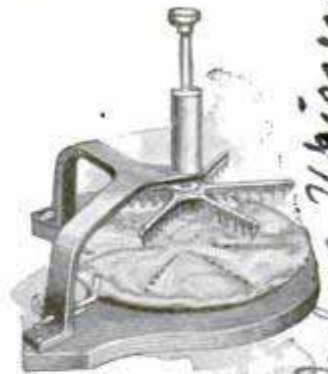

(Fish have the sense of smell, according to a German physiologist.

Chicago

Julius Wisconsin 177 N. State,

Chicago

Answer 5/15/26

Milwaukee Pattern & Mfg. Co., 1195-39 th St.

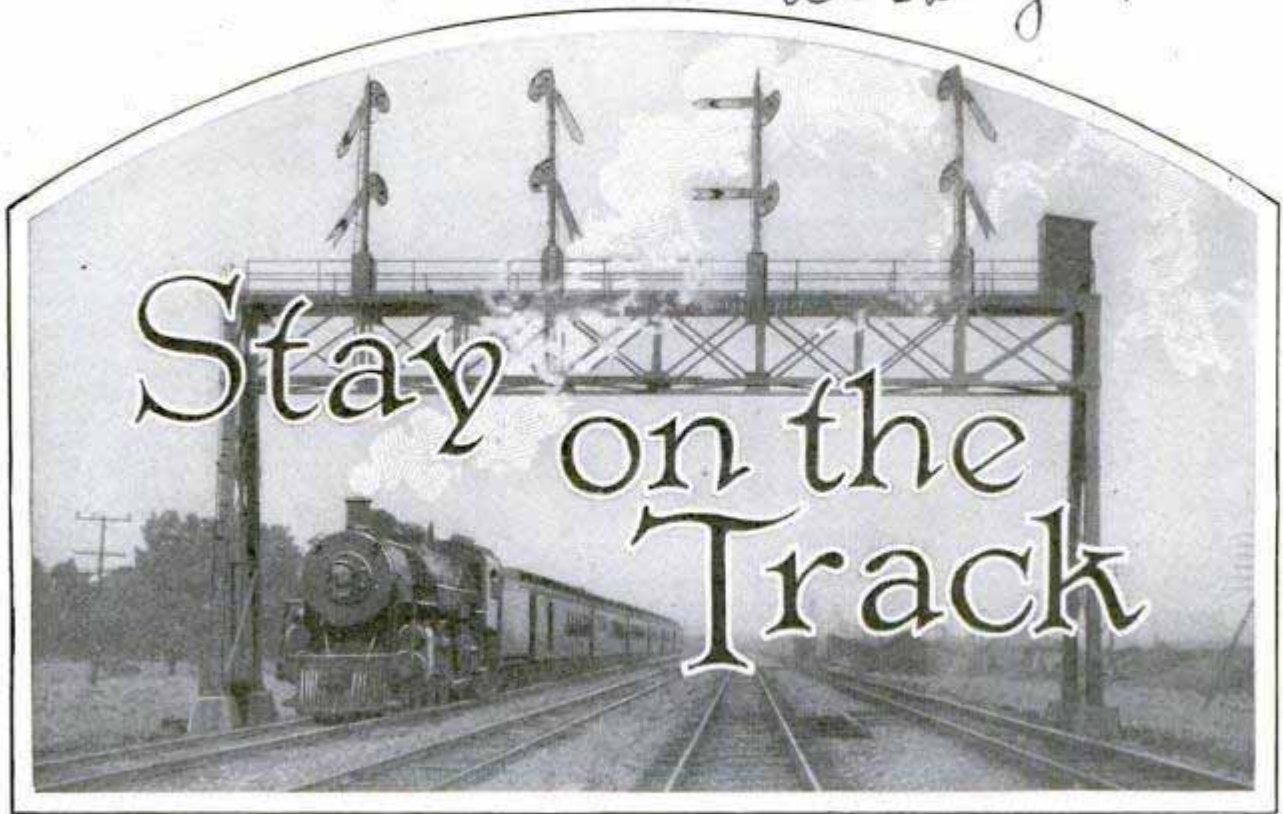

Dispatcher's Hail and Farewell Is the Watchword of the Men Who Keep Trains Moving through Storms and Darkness

MIDNIGHT, and the "second-trick" man rises to turn the train dispatcher's desk over to the newcomer of the third shift. Together they read over the "slow orders" in the dispatcher's book, run down the complicated columns of the train sheet to fix the position and the troubles of all the rolling stock on the division. Then, with a sigh of relief, the 4:00-p.m.-to-midnight man dons coat and rubbers, calls a cheery "stay on the track" and leaves. That is the hail and farewell of the men on whose shoulders rests the safety of every one who rides a railroad train. In hundreds of division offices, scattered from one end of the country to the other, the dispatchers work the clock around guiding thousands of passenger and

freight trains safely over a maze of tracks, past the switch points of innumerable sidings and cross-overs and over the junction cross lines.

Pull up a chair and plug in an extra headset on the dispatcher's telephone line, a circuit which keeps an open connection into every signal tower and station on the division. Before the dispatcher is a telephone transmitter on an extension arm, and it ends in a megaphone of loud-speaker size into which he can talk while he writes his orders, keeps the train sheet and takes the incoming reports.

This is a big-league division, double-tracked all the way, equipped with electric interlocking towers, head-end cross-overs and all the



Train Dispatcher at His Desk Getting Incoming Reports by Loud Speaker

other essentials which go to make up speed and safety. Across the desk sits the dispatcher of the branch-line division, a single track on which occasional trains must pause while others pass. His branch leaves the main line fifty miles away, and he handles it in the old-fashioned way, by telegraph.

On our side of the double desk is the main-line train sheet, on which the dispatcher plays a game more complicated than chess, with the lives of train crews and passengers as pawns.

Picture a chess game played on the columns and squares of a vast sheet of paper, six feet long and two feet wide. Rule it in half down the center and then subdivide each section again, the pair at the right for eastbound passengers and freights, and those at the left for westbound trains. Down the side run the symbols, in telegraphic code letters, of every station and signal tower on the division, which stretches for some eighty miles south and east to Chicago. Across the top the dispatcher fills in the numbers of the passenger trains and the regular freights, and, one by one as they go out,

the engine number of each extra freight, and most of them are extras. Add the names of engineer, fireman and conductor, the number of cars and the tonnage in each train, and the game is ready to proceed. The list of stations and signal towers down the side takes only the top eighteen inches of the sheet. The last six is divided into sections, each with a note directing that here is to be entered the particulars of any unusual occurrence or delay.

The second-trick man has his game well under way, using the unfinished moves left over by the first shift. All the trains that were on the line at 4:00 p.m., have been transferred to the new sheet, and more are being added every few minutes, for this is a busy division, running twenty passenger trains each way daily, as well as that many, or more, freights.

A voice speaks in the open circuit of the dispatcher's telephone. Without preamble it announces, "8075 stalled one mile east of Lake. The wind is so bad it blows the sand off the track." No. 8075 is an outbound freight, started not long ago for Chicago, and now it is in trouble only

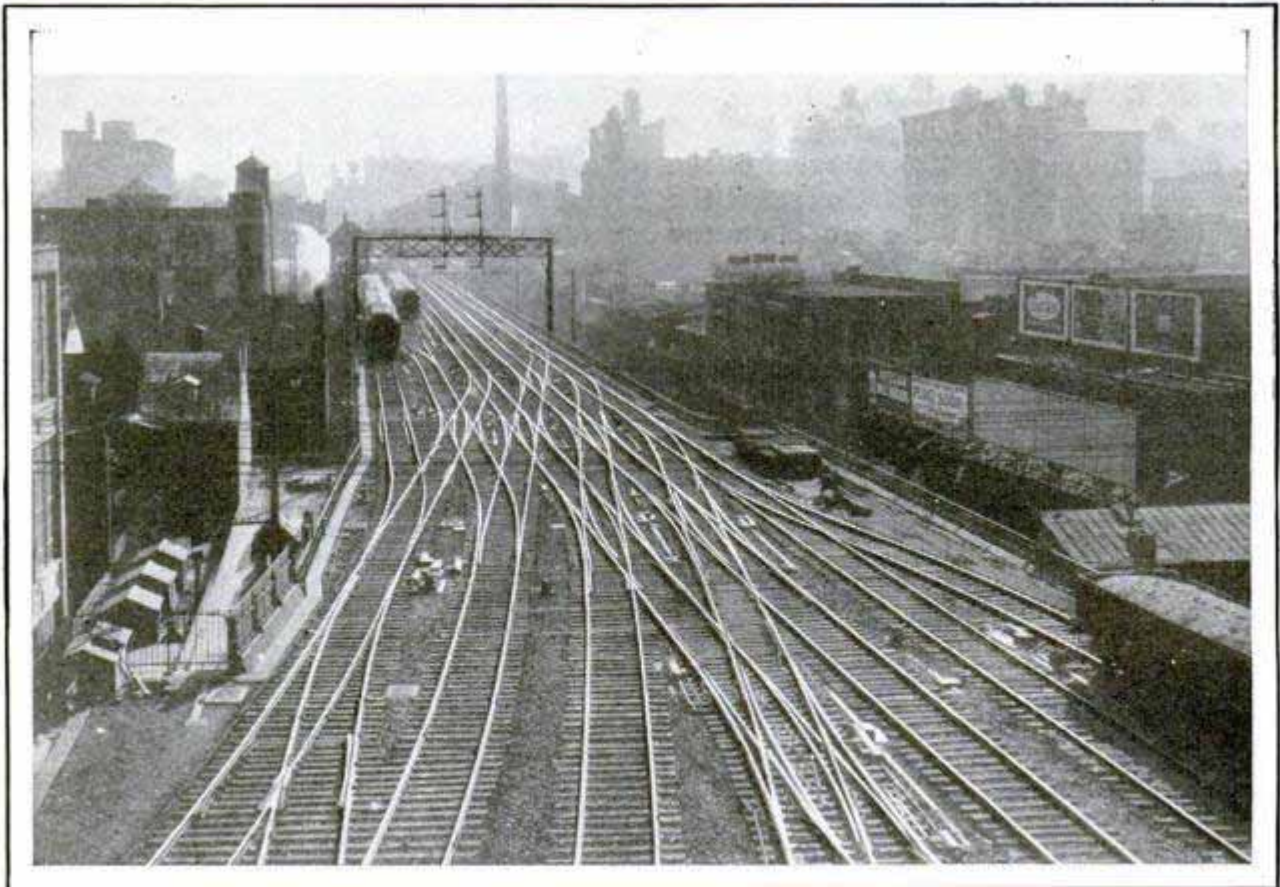

Electric Interlocking Signals Control the Network of Tracks Leading Out of the Terminal and Guide the Trains over the Route Designated by the Dispatcher's Office

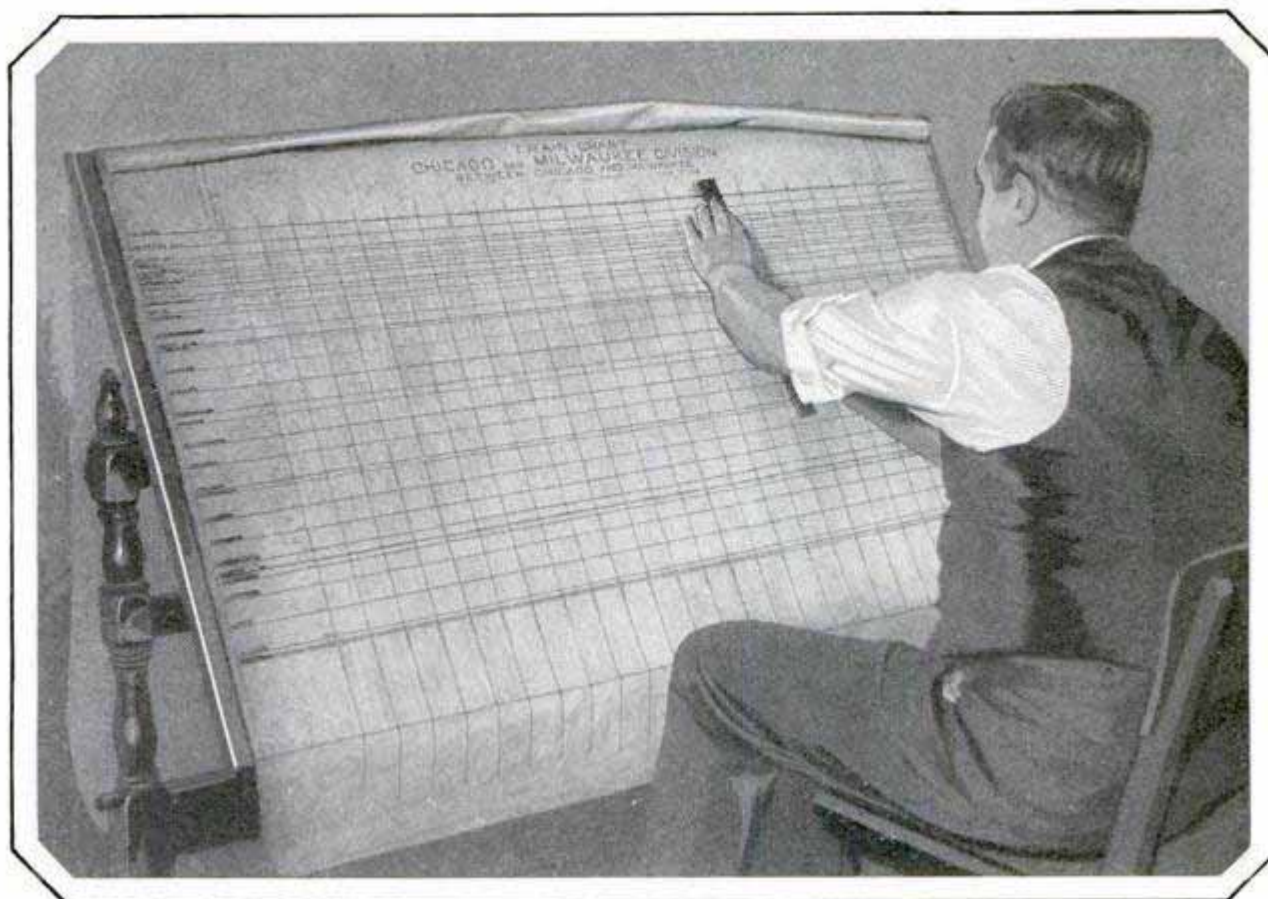

When a New Time Table Is Required, the Dispatcher's Office First Lays It Out on a Chart, So That Wherever Two Lines Cross the Meeting Will Take Place at the Nearest Passing Track

eight miles on its way. Outside a howling blizzard, sprung up since noon, is raging, and, while the wind blows so hard it keeps the snow from drifting over the rails, it likewise takes off the sand that would give traction.

The dispatcher runs a pencil down the columns of the train sheet and finds a pawn to move to the rescue. A patrol engine is near Lake tower, shifting empty and loaded cars on industrial sidings. Lake is directed to hail it as soon as it approaches and send it down as a helper to get 8075 started.

There is a more serious problem on the train sheet, calling for the skill of an expert chess master. The morning dawned fair and mild, with a promise of spring in the air, so the trainmasters made up seventy-five car trains, with loads of better than 4,000 tons, and sent them on their way. Four thousand tons is an average fair-day load, but at noon, when the weather broke, the blizzard changed conditions completely.

No. 8237 left Chicago just before noon and at tower 13, thirteen miles out of the yards, ran into the storm. The big freight

hog puffed along to tower 20, where it took a siding to let a passenger train pass. And then it couldn't get started again. Lubricant in the axle journals was frozen, sand wouldn't stay on the track, and the biggest freight puller was left helpless. Added to that the freight was "in the dark," lost to the dispatcher, for tower 20 had been abandoned and no longer had a switch tender to report progress. A short-line telephone, from a near-by pole to the next tower, finally put the freight conductor in touch with the world again, just as the dispatcher had begun to get anxious over his lost train.

But 8237, which should have made the run in five or six hours is still on the siding, and an hour overdue. The train sheet shows a patrol at Racine "spotting," or distributing cars to factory sidings. It is ordered to the rescue, but then new trouble develops. No. 63, a regular freight, is stuck with too many tons and a grade to climb. The Racine patrol is nearest, so the order is changed and it starts to aid No. 63, help it down to tower 20, and then pick up the stalled freight and help it back north again.

833

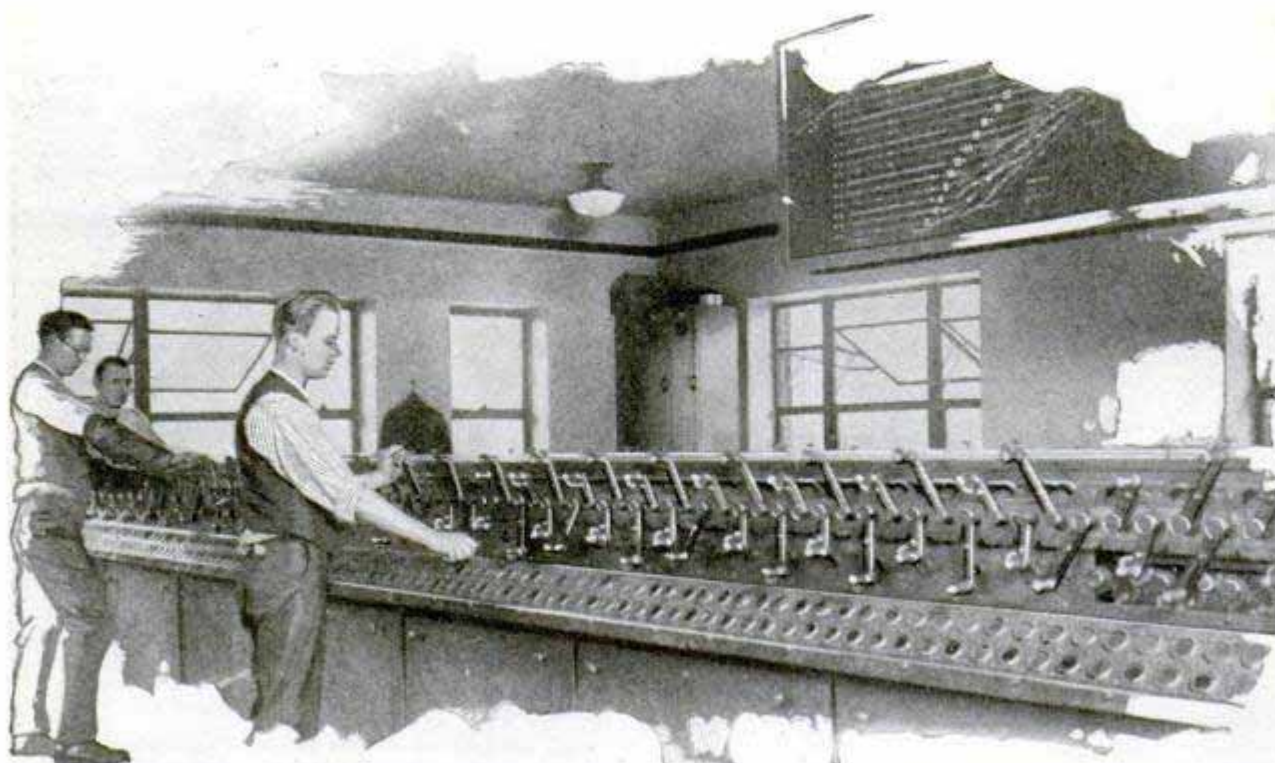

Electric-Signal Controls in a Terminal Office; an Electric Chart in the Background Shows in Colored Lights the Movement of Every Train through the Yards and Prevents Accidents

Everything is serene—for less than half an hour. The patrol was nearly out of coal, and the extra demands of pushing a heavy freight exhausted it. The two engines were cut off and the freight hog towed the patrol to the nearest coal pocket—to find the fuel frozen in the chute. The near-by tower reports the thermometer down to 12 above zero and the engine crews chopping the coal loose.

Then a new difficulty arises. The patrol has been out all day, doing extra work because of the storm, and can't help the freights and get back again before its sixteen-hour period expires. No matter what happens, no crew can work more than sixteen hours, for that is a violation of federal law. So the patrol is laid up and the crew sent home, after getting No. 63 under way. That leaves extra 8237 still stuck on its siding at tower 20, sixty miles away.

The hours are passing, the crew has been out eight hours, and now starts drawing double pay, which will show in red when the dispatcher's reports are filed tomorrow, and call for an explanation, as extra pay always does.

The branch-line dispatcher, across the desk, has a patrol at work, and the branch joins the main line only a few miles from tower 20. The patrol gets down to the

main line by nine in the evening, but still has an hour or two of work there, and then its crew must be relieved. A special crew is ordered out and "dead-headed" south on a passenger to take over the patrol. By the time they get there and receive the engine it is 11:00 p.m., and the freight which left Chicago around noon is still only twenty miles out.

In the meantime the columns of the train sheet are filling up as each freight and passenger leaves the division ends. With every added train comes added trouble. No. 57, the fast mail, which won fame when a robber gang using tear-gas bombs stuck it up and made off with a million dollars in cash and bonds, should have left Chicago at 9:00 p.m., but didn't get away until 9:38. Because of the storm, the eastern mails were late and the government ordered 57 held for the Lake Shore pouches from New York. The government can hold the fast all-mail trains up to forty-five minutes, if desired.

The fast night express from Chicago is late in starting, held up by delayed express shipments from the east. Frequently the all-express trains are held three or four hours, if necessary, to make connections. Extra 8209 loses twenty minutes, and the cause goes down on the sheet. Section men were replacing a broken rail discov-

ered by a track walker. Passenger trains can't be delayed for such causes. No. 146 will have to cross over to the wrong main and round the obstruction. Orders are issued, and as the dispatcher talks into the phone he writes his words on a message blank for his record. Verbal messages not backed by written records don't go in railroading. Out comes a bottle of red ink and a zigzag line is drawn on the train sheet from the point where No. 146 takes to the wrong main to the point where it will go back on its own track. That red line must be watched and remembered until the maneuver is complete. The tower men have their orders, and, as this railroad has head-end crossing tracks, the passenger slips

from one track to the other, and then back again without a pause. There is no stopping to back, or to open or close switches, since the latter are controlled by the interlocking electric system, which provides three interlocking safeguards against carelessness or accident.

Chicago comes in on the telephone, reporting the night merchandise train made up and ready to leave, with sev-

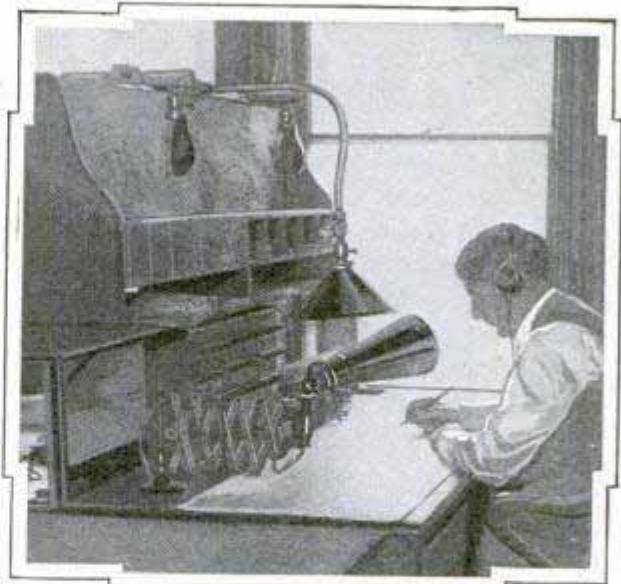

Train Dispatcher Working at His Chart; Electrician Repairing Lights, and, Below, Part of the Levers in an Interlocking Tower



enty-six loaded cars and nine empties, a load of 2,650 tons. There is a car of horses, eleven cars of cattle and two of hogs, followed by the notation that they must be rested, fed and watered not later than 5:00 a.m. of the day after tomorrow. The feeding time of cattle in shipment is one of the charges which the dispatcher is required to watch. The government stipulates that they must have feed, water and rest at least once every twenty-eight hours, unless the shipper signs a waiver, in which case they can go thirty-five hours, but no longer. Feed costs money, and the unloading, feeding and reloading require men, so the good dispatcher tries to get the cars delivered to a connecting line before the time limit expires, and so let the other line pay the bill. And, of course, the other line is trying to do the same thing to him.

So the night goes, first one

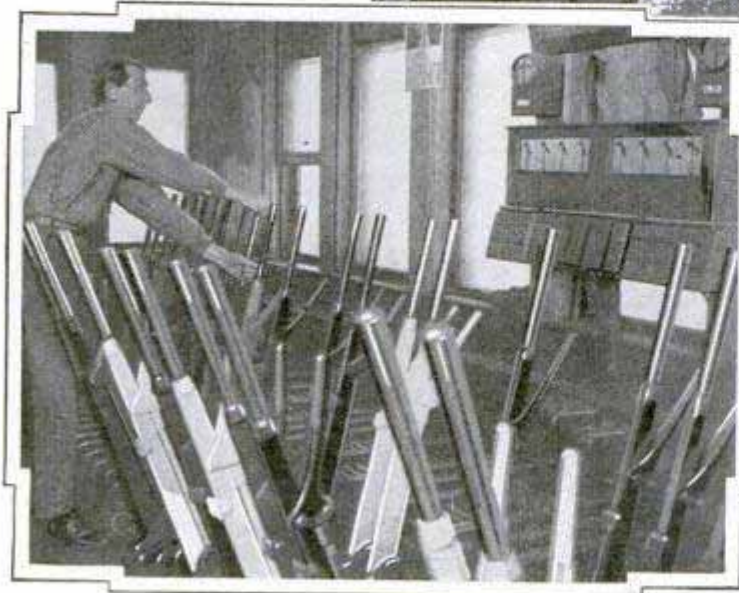

823 trouble and then another, and the dispatcher must meet and solve them all. At midnight the third-trick man comes on for the "graveyard shift," which runs to 8:00 a.m., takes the uncompleted train chart of his predecessor and operates it while making up his own for the early morning hours. Business isn't so heavy during the third trick, with only through passenger trains and night freights under way, so the dispatcher has time to catch up on some of the bookkeeping of his job. The completed records for twenty-four hours must be ready when the office force comes on duty in the morning. The tonnage of all the trains handled must be footed up and divided by the number of trains to give the average for each. Back of the dispatcher, on the wall, hangs a chart, showing in red the average on each day of the corresponding month last year, and on each day of last month. It is the dispatcher's job to try and break those records each day, so that his final figures for the month will show that more business was moved with less cost than in any previous period.

Then there are the books of the daily business to be balanced. The dispatcher handles cars like a banker handles dollars. He starts the day with so many cars on hand; his depositors—the branches and connecting lines—place so many with him during the day, and to them he pays out so many, while he assigns others to specific duty on side tracks, industrial switches and the repair or storage yards.

When the end of the day comes the books must balance again, so that the general office will know each day just how many cars the system has and where they are. Also, there is power to be watched and kept distributed where it will be needed most. If the heavy freight movement is mostly in one direction, that end of the division soon would have most of the engines, unless they were brought back with smaller trains.

This is only the story of an average night, when the trains all stay on the track. Given a derailment or a wreck, the game becomes more complicated. Because of that, the dispatcher's hail and farewell is "stay on the track." It is the one thing he hopes for in this life.

SMALLEST AND LARGEST MOTORS GIVE CONTRAST IN SIZE

2189 The smallest practical motor in general use and one of the largest made recently were contrasted in the General Electric shops at Schenectady. The smallest motor, fitting in the palm of a man's hand, has a power output of only one-quarter of a millionth part of one horsepower, and is used in certain types of electric meters. The largest motor, fifteen feet in diameter and weighing 110 tons, has an output of 22,500 horsepower, enough to turn the propellers of a giant ocean liner.

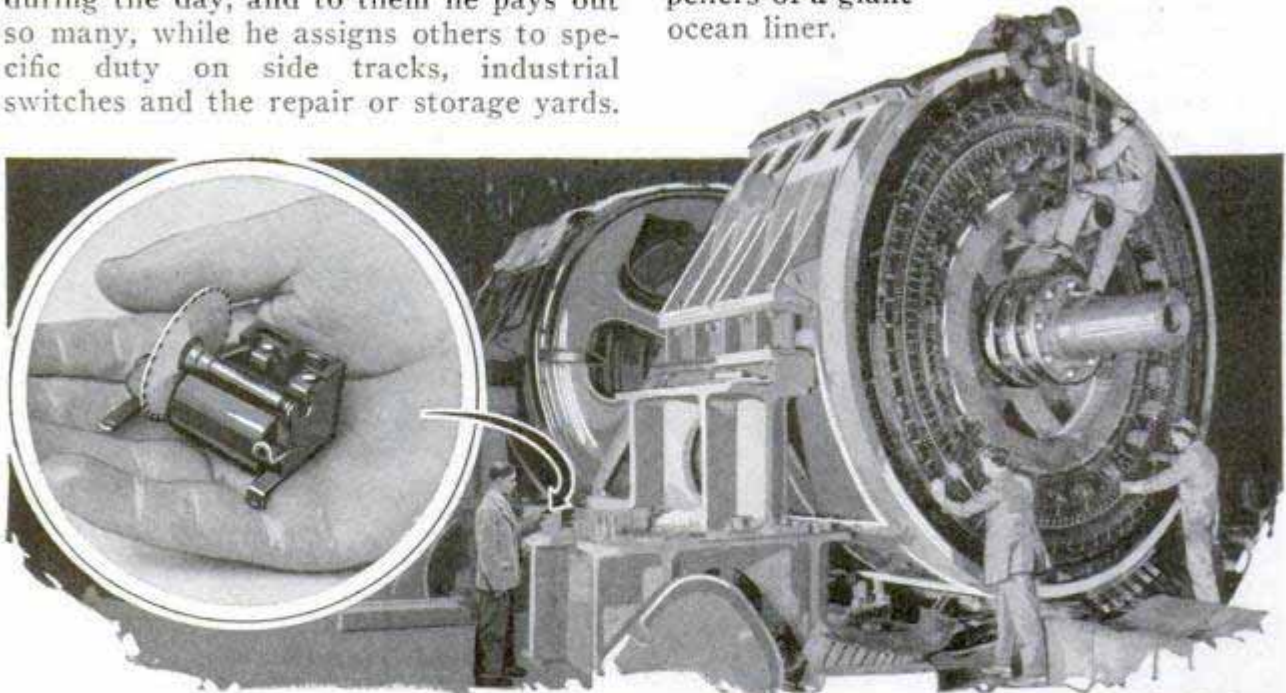

Courtesy General Electric Co.

Smallest and Largest Motors, the One Fitting in the Palm of the Hand and the Other Standing as High as Several Men; Both Are Standardized Products Built for Regular Use

HOSE AND LIFE BELT COMBINED FOR FIRE FIGHTERS *are*



Three Important Uses of the Combination Belt; Rescuing, Taking Hose up Ladder and Steadying Nozzle

More effective fire fighting is made possible by a combined hose and life belt, devised by a fireman who realized the need of it through his own experiences. It not only aids in fighting fires but is expected to save the lives of many persons caught in burning buildings who might otherwise be lost. Primarily, the belt is for the use of hosemen. It can be attached to the nozzle of a hose so that two firemen can handle it much more easily and effectively than in the ordinary way, which is for one fireman to place the hose under the arm and hold it there against the body, while another fireman behind him steadies it to direct the stream on the fire. With the belt attached to the nozzle, two firemen have successfully directed a stream of water with a pressure of 275 to 300 pounds, which usually would be a task for four or five men. The belt is easily and quickly adjusted and can be made into a life belt at a moment's notice. Recently, in a test, one fireman carried another on his back down a perpendicular ladder from the top

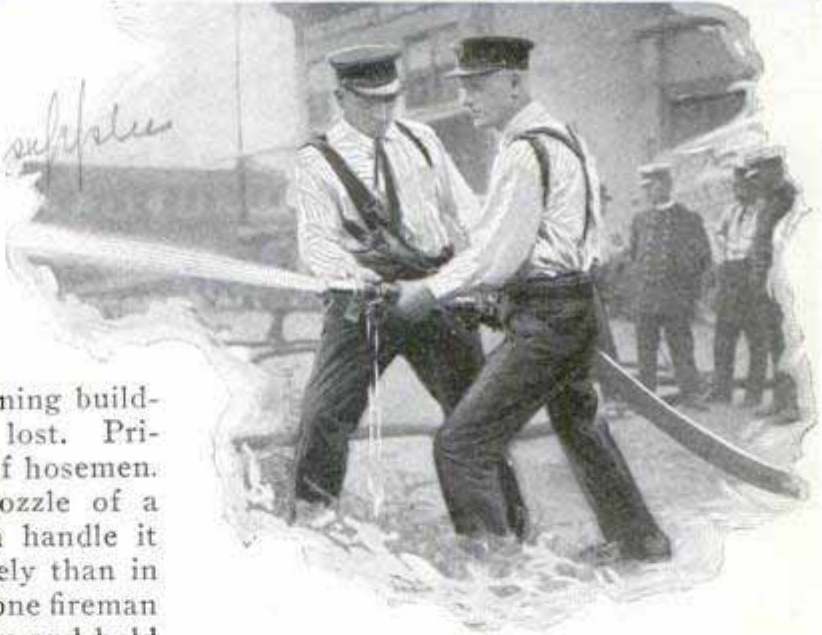

of a fifteen-story building. The belt holds the victim by his own weight to the rescuer, whose movements are left free because the weight of his burden falls on his shoulders and body in such a way as to be least bothersome. The belt also is proving of value in carrying heavy lengths of hose up ladders and fire escapes.

When you want anything and do not know where to get it, write Bureau of Information, Popular Mechanics, Chicago.

2133

A Poor Boy Who Changed

THIRTY-SEVEN years ago, in a weather-worn old brownstone mansion, next door to a railway yard in New York city, there died one of the world's greatest geniuses, a Swede by birth and an American by adoption. His brain had reshaped the whole course of the world,

saved the Union in one of its darkest hours, taken the navies of the world out of their wooden walls and put them behind steel and iron, driven sails and paddle wheels off the sea, made high-speed locomotives and ships possible, done scores of other wonderful things—and he died a poor man in the shabby gentility of a run-down neighborhood.

John Ericsson
Statue at Base of
Monument Un-
veiled at Wash-
ington, D. C.

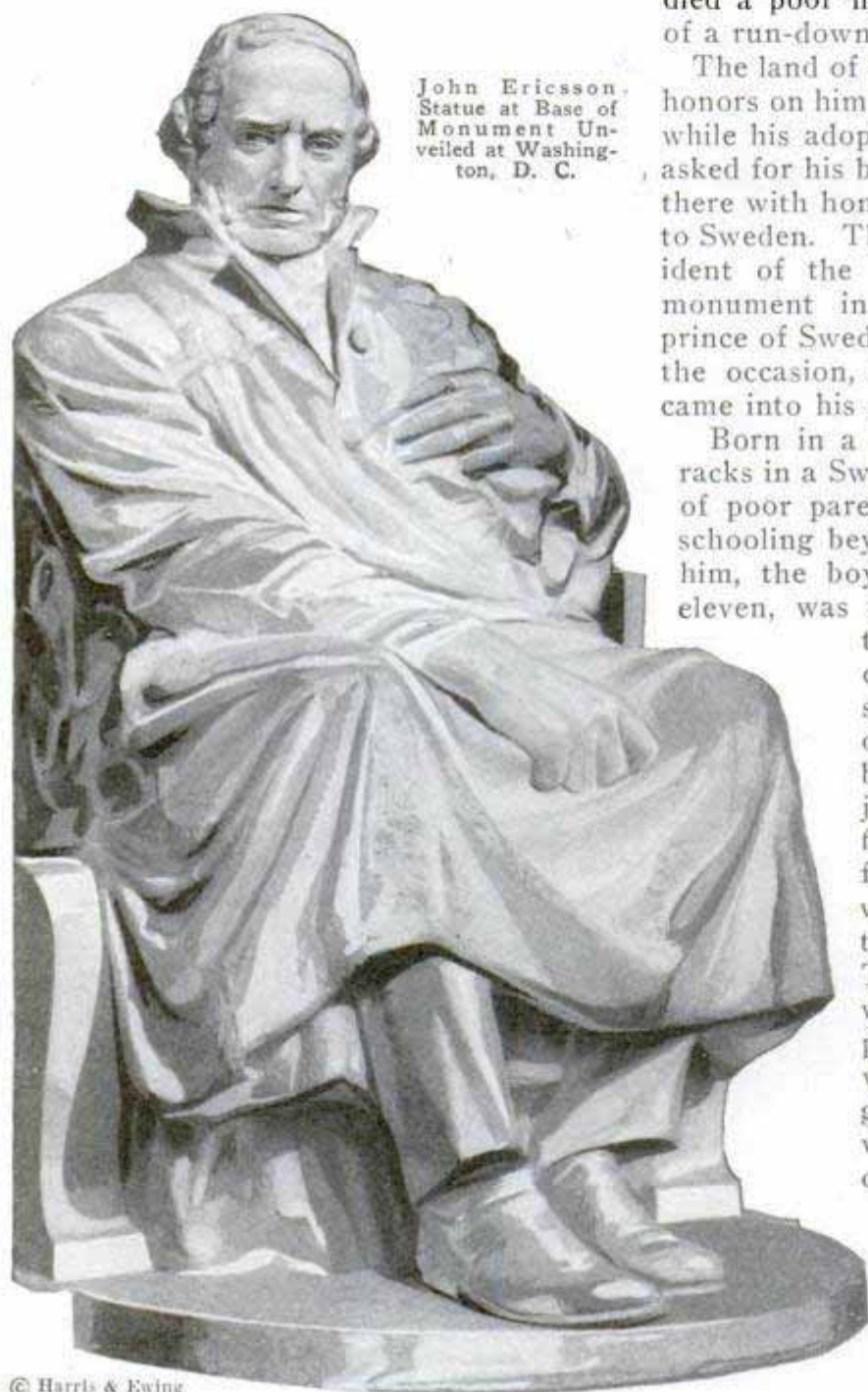

The land of his birth, which had heaped honors on him for more than twenty years while his adopted country neglected him, asked for his body that it might be buried there with honor, and so it was sent back to Sweden. Then, the other day, the president of the United States unveiled a monument in his honor. The crown prince of Sweden came across the seas for the occasion, and John Ericsson finally came into his own.

Born in a log-timbered barnlike barracks in a Swedish mining camp, the son of poor parents, and with virtually no schooling beyond what his mother gave him, the boy Ericsson, at the age of eleven, was an inventor with at least two achievements to his credit. One was a practical sawmill, the working model of which was built with a borrowed file, gimlet and a jackknife, using a carefully filed strip of clock spring for a saw blade. The other was a windmill-driven pump to lift water from the mines. The boy had never seen a windmill, but from other people's descriptions he worked out the necessary gears and linkage to convert the rotary movement of the mill to the reciprocating stroke of the pump. His drawings of the apparatus were so well done they attracted the attention of Count Platen, president of the

the World

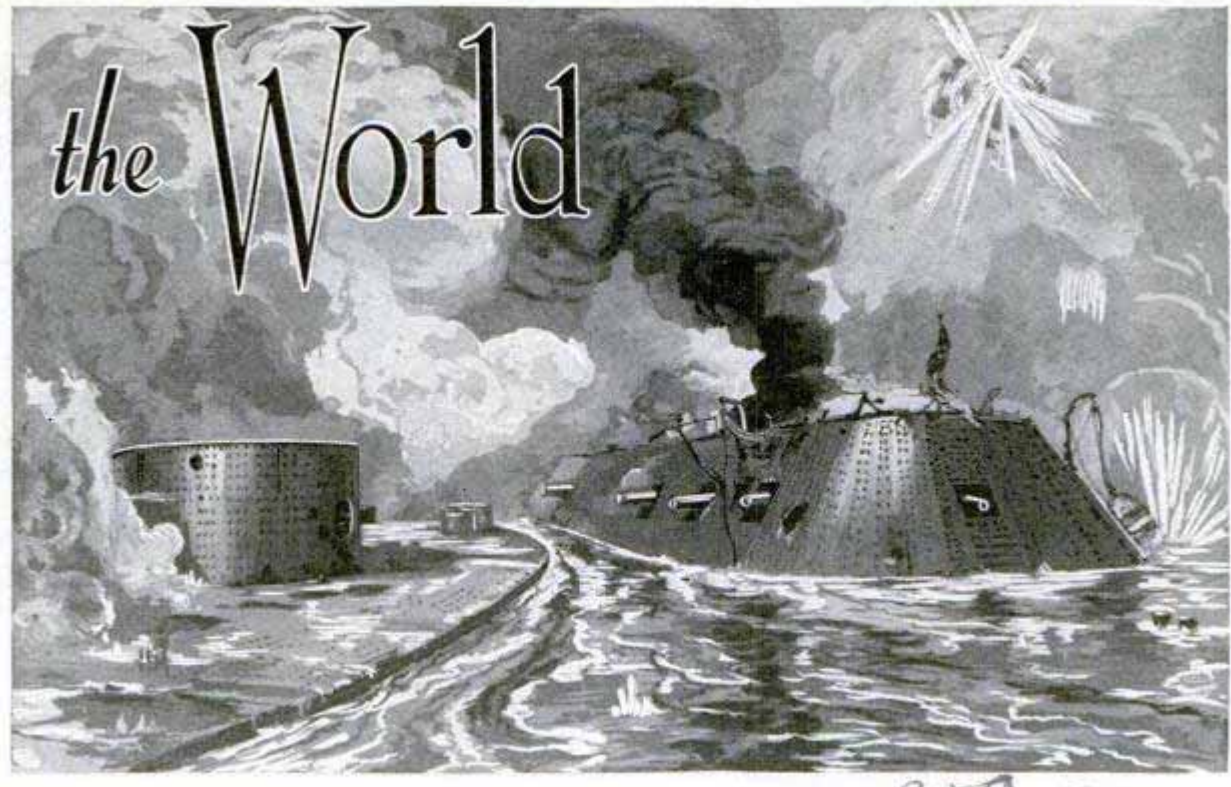

Attacked by the "Cheese Box on a Raft," as the Monitor, at the Left, Was Dubbed by Navy Men, the Iron-clad "Merrimac," Right, Pride of the Confederate Navy, Finally Met Her Match

Gotha ship canal, then in process of building, and won for the boy, barely twelve years old, a place in the surveying crew. The drawings, by the way, were executed with no tools save a quill pen, dividers made of birchwood, and a ruling pen manufactured from a pair of steel tweezers.

Before he was fourteen, Ericsson was placed in charge of an entire section of the survey, with 600 soldiers working under him. One soldier was detailed to follow the boy around with a stool, on which he stood to peep through his instruments.

With such a start, he progressed rapidly. His next step was into the government survey corps, and from there to the army engineers, where he attained the rank of captain. In the meantime he

illustrated a book on the Gotha canal with sixty-four large plates, and incidentally invented an engraving machine to turn them out.

From engraving, he turned to the possibilities of flame as a source of power, and invented a hot-air engine. As late as forty years afterward a large part of the income he spent building model warships was derived from the sales of thousands of his engines, used to pump water to upper floors of New York buildings.

He obtained leave of absence to go to England to introduce his invention, and never thereafter returned to Sweden for any length of time. In England he turned out new inventions in wholesale lots. Arriving in 1826, by the year 1828 he had patented a new type of pump-

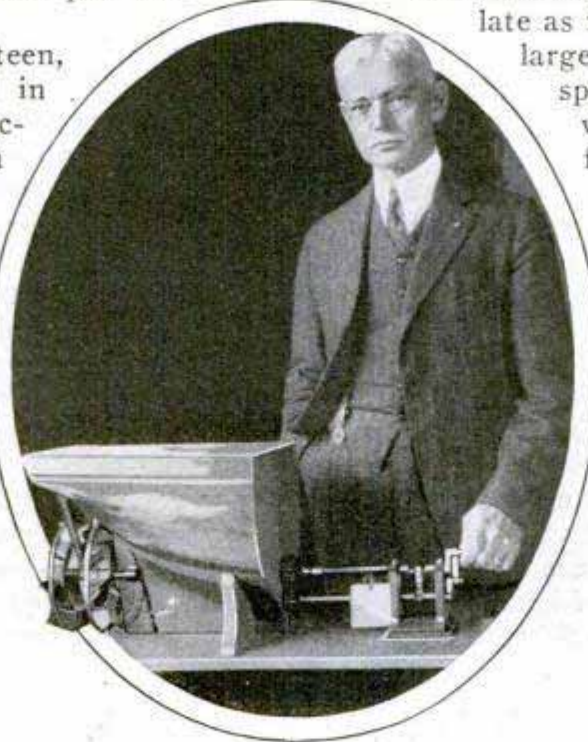

The Original Model of Ericsson's Double Propellers, Now at the Navy Department

2133

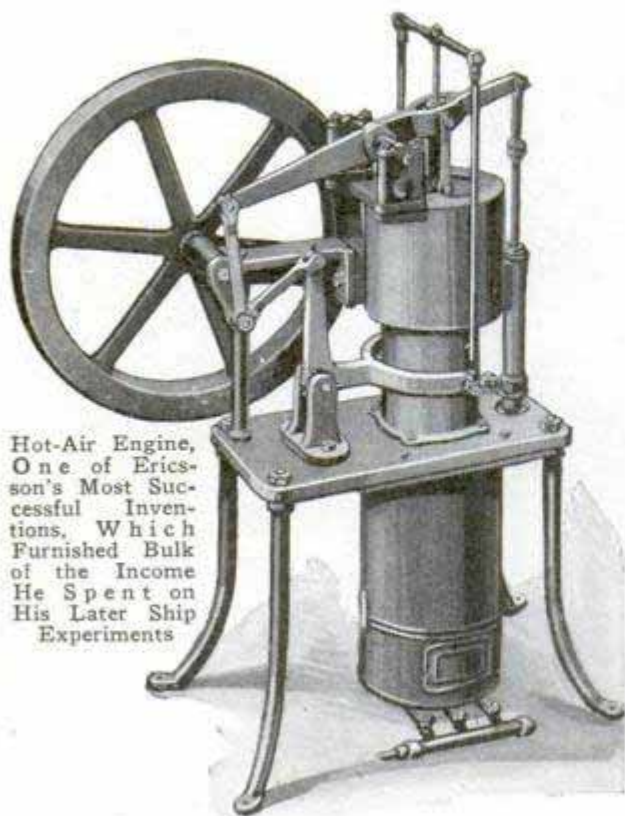

Hot-Air Engine, One of Ericsson's Most Successful Inventions, Which Furnished Bulk of the Income He Spent on His Later Ship Experiments

ing engine, engines with surface condensers and no smokestack, and built a ship utilizing them; an apparatus for making salt from brine, for propelling boats on canals, a hydrostatic weighing machine, an instrument for taking deep-sea soundings, a file-cutting machine, and many others. The list includes fourteen inventions and forty new machines.

In 1829 he entered the competition for a steam locomotive, the rules calling for a minimum speed of ten miles an hour. Stephenson's Rocket and Ericsson's Novelty were two of four types entered. The Novelty ran away from the Rocket, going thirty miles an hour to the latter's twenty, but the Englishman's engine weighed twice as much and had greater pulling power, so it won the prize. Ericsson came back the next year with the invention of the forced draft, to which the development of railroads owes much. The same year he invented the first steam fire engine, and built one for use in London and another for the King of Prussia.

His active mind was still at work on improving the flame engine, and experiments continued until 1851, long after he came to America, when he finally abandoned it after a trial in the steamship "Ericsson," 260 feet in length. He discovered that the

efficiency of small engines did not extend to big ones needed for marine use. At the same time he was experimenting with engines to utilize solar rays, and actually built a small working model.

In the early eighteen-thirties he began experimenting with screw propellers to replace paddle wheels on boats, and built a successful working model. Next he constructed a twin-screw tug and tried it out on the Thames, achieving a speed of ten miles an hour and towing a fair-sized schooner. The admiralty agreed to give the new boat a trial, and Ericsson steamed up the river to Somerset house, took the naval barge in tow, hauled it down the river, around many bends, and back again. After that very satisfactory demonstration one of the authorities on board the barge, pronounced the screw impractical because, he said, "even if the propeller had the power of propelling a vessel it would be found altogether useless in practice, because, the power being applied at the stern, it would be absolutely impossible to make the vessel steer."

Disgusted with such stupidity from one who had just been steered all over the river by a screw-propelled boat, Ericsson accepted an invitation from Francis B. Ogden, American consul at Liverpool, and Capt. Robert F. Stockton, U. S. N., to come to America. A vessel called the "Princeton" was ordered for the navy, and the screw propeller proved a success.

As early as 1854 the inventor conceived the idea for an armored turret mounted on a raft, and submitted it, without success, to Emperor Napoleon. When the Civil war broke out and the armored frigate "Merrimac," of the Confederate navy, sunk ship after ship of the Union's wooden fleet, the navy department called for designs for an armored ship, and Ericsson's "Monitor" plans were accepted. He built the ship in 100 days, and two days after completion, it met and whipped the "Merrimac." By that one invention of "a cheese box on a raft," as sailors dubbed it, he doomed wooden navies. The "Monitor" idea of a revolving turret mounting very heavy guns, was the father of the present battleships.

Having devised an apparatus that made wooden warships useless, Ericsson promptly set to work to perfect a ship

that could sink monitors. The result was a torpedo boat, which he named "Destroyer"—a name that has since been given to all of its class.

MYSTERY OF OCEAN CURRENTS SOLVED BY BOTTLES 206

The second mate fixes the steamer's position, writes down the bearings on a slip of paper and stuffs it into a bottle which is corked and thrown overboard. Nearly a year later, the bottle, covered with barnacles, is washed ashore 1,450 miles away, is found and returned to the navy department, increasing the navy's knowledge of the mysterious ways of the ocean. What is said to be the most remarkable trip of a bottle was started from the British steamship "Australplain" about 750 miles south and east of Africa. After three years, it was recovered off the coast of Chile, having traveled 8,800 miles.

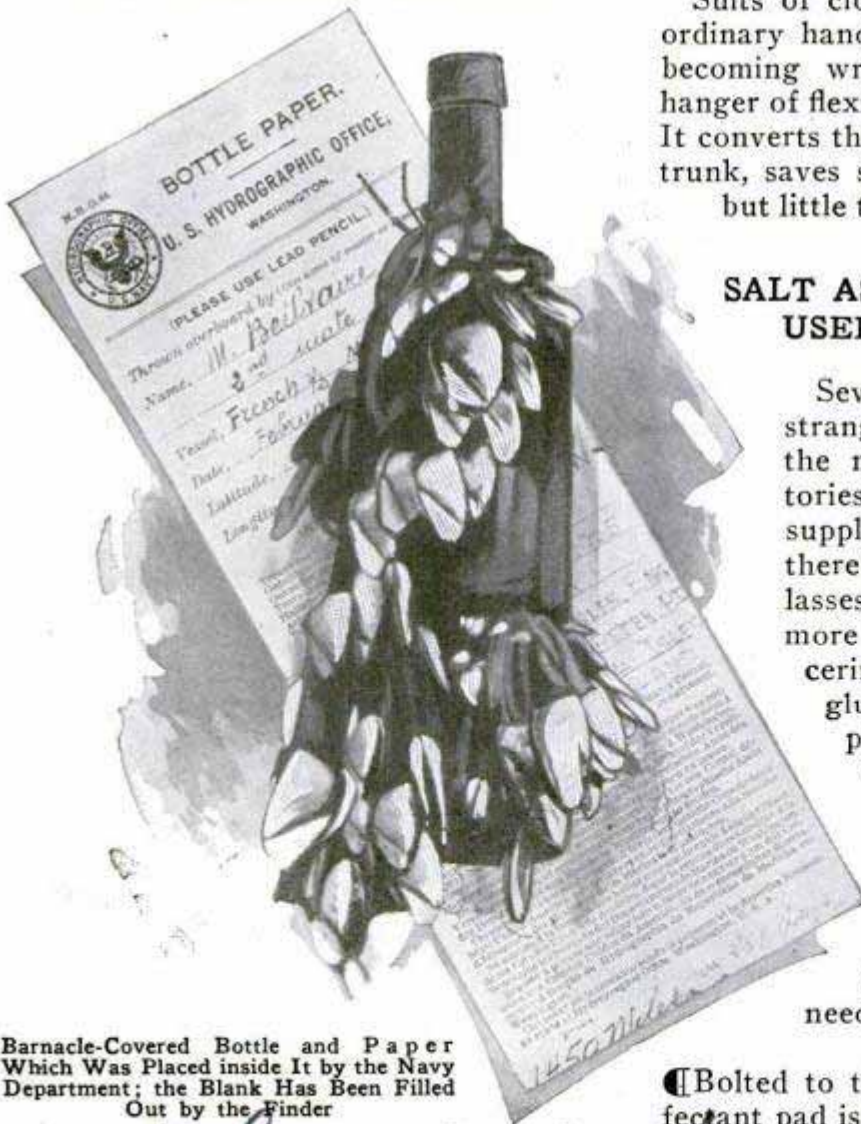

Barnacle-Covered Bottle and Paper Which Was Placed Inside It by the Navy Department; the Blank Has Been Filled Out by the Finder

*Com. Emmet Dougherty
514 Woodward Bldg
Washington D.C.*



Placing Suit on Hanger for Packing in Handbag; It Keeps the Garments Flat

CLOTHES HANGER FOR HANDBAG PREVENTS WRINKLES 1554

Suits of clothing can be carried in an ordinary handbag with less likelihood of becoming wrinkled with the aid of a hanger of flexible fiber now on the market. It converts the grip into a small wardrobe trunk, saves space and, being light, adds but little to the weight of the baggage.

SALT AS WELL AS MOLASSES USED IN PHONE BOOKS 2339

Several items that appear strange to the layman enter into the making of telephone directories. For instance, in last year's supply for the state of Illinois, there were 183 pounds of molasses, eighty-nine pounds of salt, more than 15,000 pounds of glycerin and over twice as much glue. The Illinois Bell Telephone company printed 2,654,112 books that, together, contained nearly 2,500,000,000 pages and required more than 6,000,000 pounds of paper. Some 114,000 pounds of ink and 537 pounds of staples were needed to finish the books.

*W. B. Alboth, Pres
Illinois Bell Tel. Co.*

Ⓢ Bolted to the garbage-can lid, a disinfectant pad is said to remove odors.

*San-O-Can
at Hardware
Stores 25¢*

*A. A. Zahner 812
Chil. St. St. Louis, Mo.*

Photos from Siemens Bros & Co. Ltd
 Woolwich, London, Eng.
Fastest Cable to Span Atlantic Will

Comb. Ernest Peterffy 354 Board Ave 53
 New York

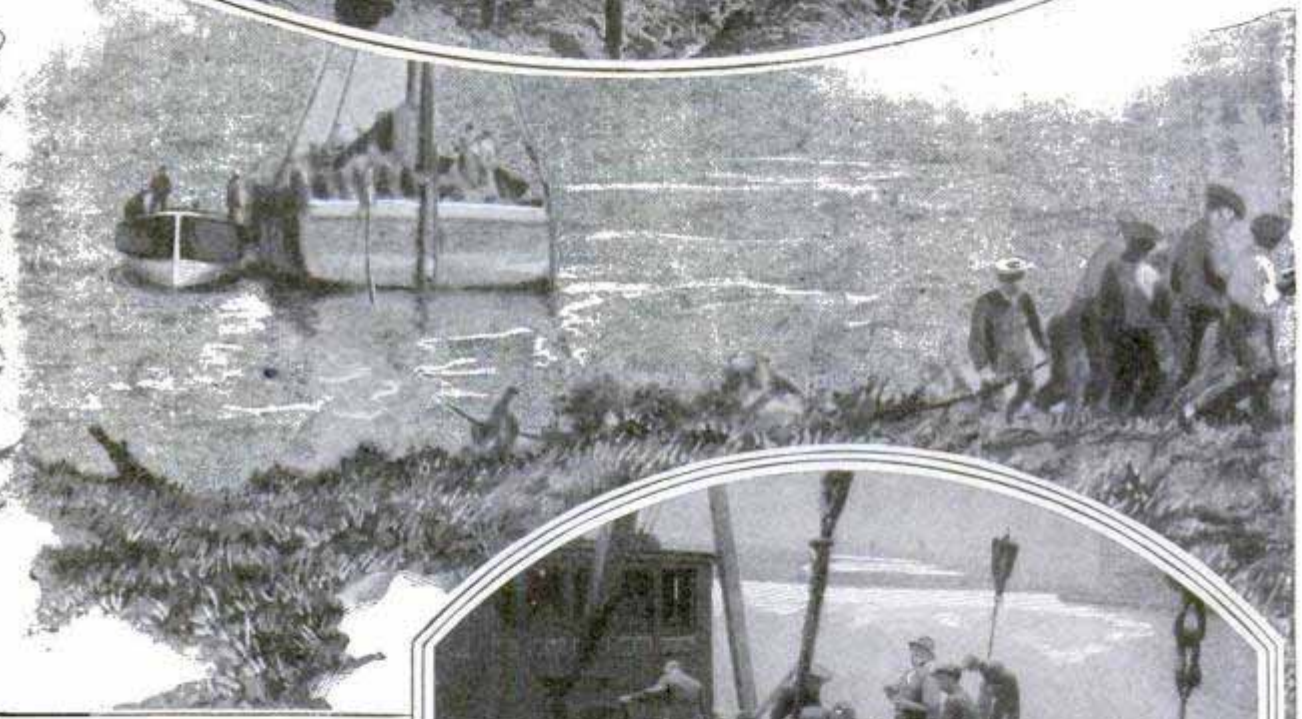
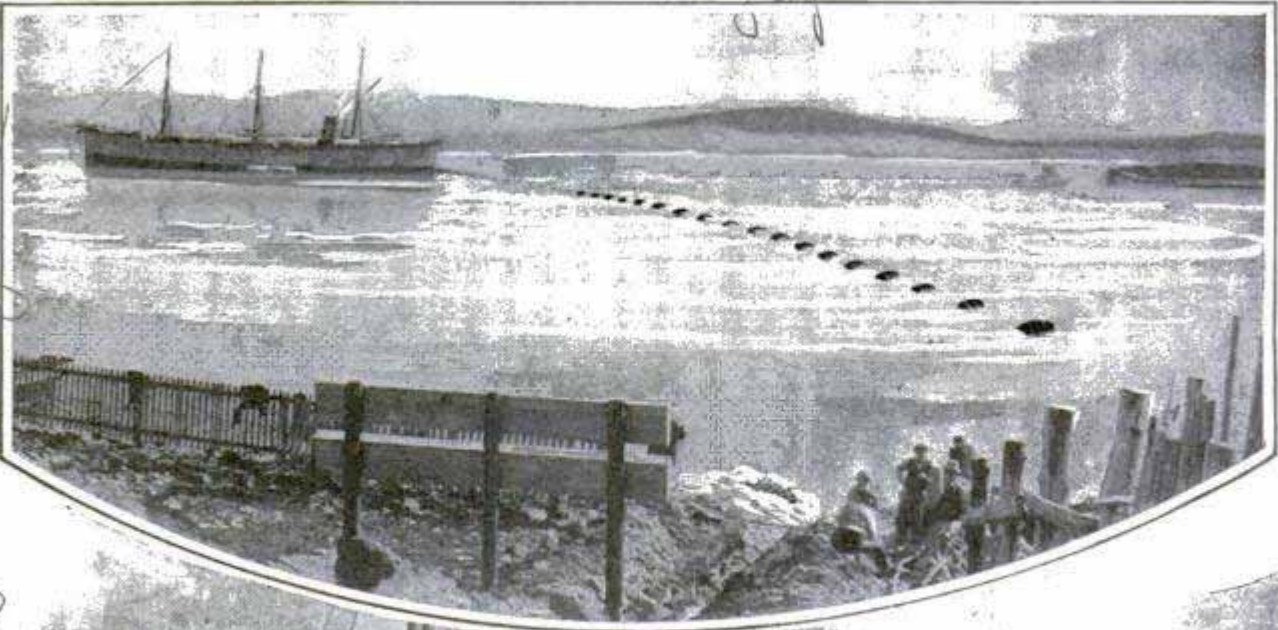

In Laying the Shore End, Barrel Buoys
 Temporarily Support the Line Until It Is
 Connected; a Coil Containing Seven and
 One-Half Nautical Miles of Cable; at
 Left, Buoy to Mark the Course; on Op-
 posite Page, Inset, Grapple to Hoist Cable
 and Cable Ship "Faraday"

New York and London Are to Be Brought Closer with the Laying of the Twentieth Transatlantic Cable, 3,800
 Nautical Miles Long, Affording Direct Communication between the Cities

Have Speed of 2,500 Words a Minute

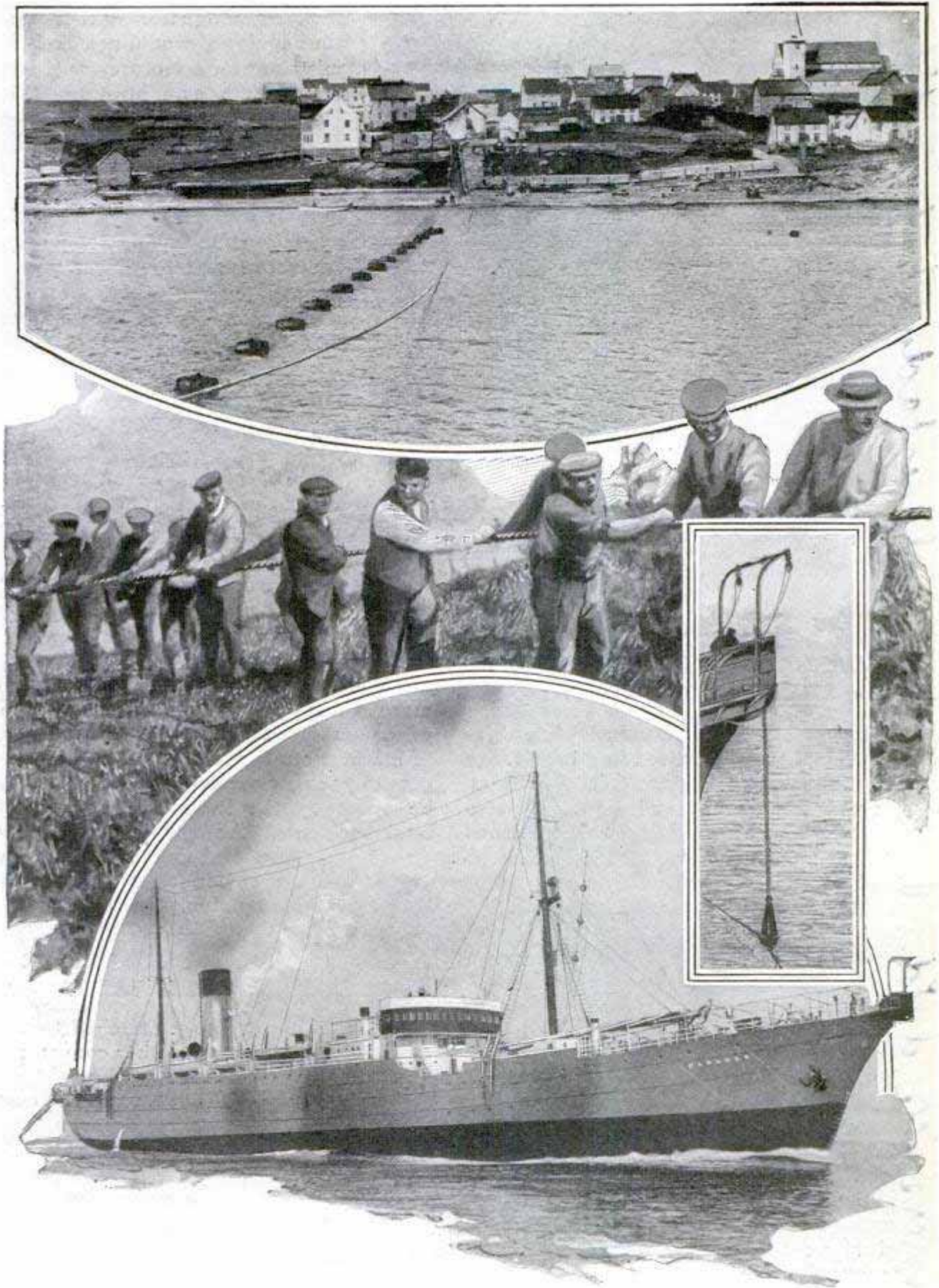

The Line Is Partly Made of Permalloy, a Composition of Iron and Nickel, Wrapped as a Thin Strip, One-Eighth of an Inch Wide, around a Copper Conductor

Director, General Electric & Illuminating Engineering Laboratory, Schenectady, N.Y.

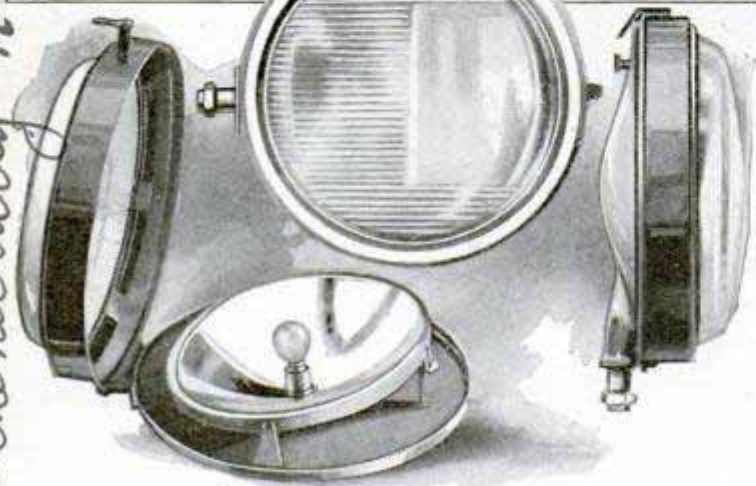

Upper Photo Shows Both Side and Front Illumination Afforded by the Headlight; Details of the Lamp Below

GLARELESS AUTO HEADLAMP LIGHTS SIDE OF ROAD

Greater safety and comfort while driving at night are promised in a long-range headlight that casts a powerful side beam, illuminating ditches and signs. It also projects a backward light so that persons in the car can easily read signs when the front end of the auto is several feet past such legends. Tests have shown that, when the beam is set at one degree above horizontal, at 100 feet there is no glare, unless the observer, stationed at that distance, places his head almost to the ground. It was further demonstrated that the lights appear to grow dimmer as persons walk toward them. They illuminate the radi-

ator, bumpers and front end of the forward mudguards so that a car thus equipped would not likely be mistaken for a motorcycle if only one light were burning. The lamps are only about three inches thick and new bulbs are easily installed. Reflector and lens are so adjusted that a double crescent of light is produced, rays from the upper portion having long range and those from the lower, superimposed on the other, spreading evenly over the entire road, ditches, telegraph poles and trees.

DEATHRATE OVER FORTY 222 VIS INCREASING

The gain in life expectancy is due largely to the saving of lives under thirty-five, according to Dr. J. Howard Beard, of the university of Illinois, because the death-rate over forty is increasing. There are four more deaths per thousand persons between forty-five and fifty than twenty years ago, six more between fifty and fifty-five, and eight more at fifty-five to sixty. Better control of communicable diseases and decrease of infant mortality have lessened the dangers to younger persons, but the gain may be offset by the increasing number of fatal accidents. An epidemic of contagion is being succeeded by an epidemic of injury, in his opinion.

SOAP PULVERIZER CUTS WASTE



Grinding Out Powdered Soap from the Cutter Box Which Preserves and Keeps the Cake Clean

Easily attached to the wall, or other convenient place, a small box-shaped grinder that cuts cakes of soap into powder, reduces waste and prevents clogging drain pipes with pieces of unused soap. It will shave bars of any shape or degree of hardness, and is operated by turning a small key.

U.S. Indiana Lamp Corp. Schenectady N.Y. 2077

Distributor Stover Signal Eng Co Racine Wis

Pulverizing Cake Soap Co, 412 Lyric Bldg. Richmond, Va.

Contains 2.00 each

Chelsea Clock Co.
10 State St.

POPULAR MECHANICS
Boston, Mass.

SHIPS' CLOCKS SOUNDING SEA
BELLS IN MANY HOMES

2165

Ships' clocks as the latest in home decoration have seized the fancy of thousands during recent months and caused a veritable run on supplies of the seagoing timepieces. Early last fall, for no apparent reason, orders for ship clocks began to pour in to the makers from all parts of the country. One company alone sold more than 13,000 during the winter. Clock makers attribute the sudden interest in the bell-striking clocks to the fad for ship models, old sea maps and other things nautical.

General

BICYCLE WITH JOINTED FRAME
REDUCES SHOCK

2071

Equipped with a strong spring action in the center sprocket-bearing joint, a bicycle can be ridden over objects of considerable size without throwing the entire frame off line, thus lessening the shock to the rider. If, for instance, the hind wheel passes over an obstruction, the spring per-



Spring in Socket Joint Keeps Bicycle Frame on Line While Going over Obstructions

mits the rear section of the bicycle to rise, absorbing the bump so that only a small portion of the shock is communicated to the operator.

When you want anything and do not know where to get it, write Bureau of Information, Popular Mechanics, Chicago.

Write Frederick M. Helano
22, Ave St. Augustin, 16, Ave la Paix.
Paris

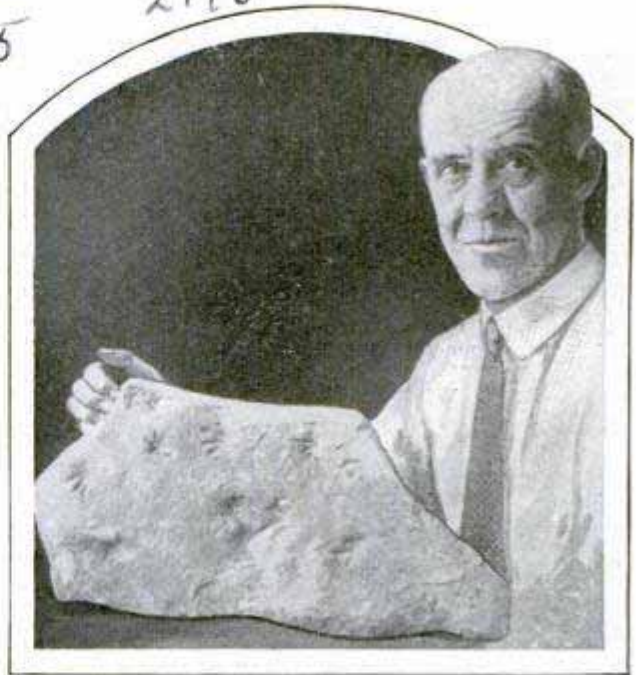

Fragment of Grand Canyon Rock Containing Several Footprints of Some Prehistoric Creature

FOSSIL FOOTPRINTS AGES OLD
FOUND IN GRAND CANYON

Evidence of animal life that roamed the Grand canyon, thousands of years ago, has been taken to the Smithsonian institution in the form of fossil footprints. A ton and a half of sandstone and shale, in which the prehistoric creatures left records of their roving, was gathered from three different levels of the canyon by Dr. Charles W. Gilmore of the National museum. The lowest was at 1,800 feet below the rim and 400 feet underneath any prints previously found. It is believed that the animals were early amphibians and reptiles belonging to the same families as those of which skeletons have been found in deposits of the Permian period in Texas, Oklahoma and New Mexico. The rock must have been soft sand when the tracks were made. The footprints were covered by successive layers of sediment. Other creatures crawled across this surface, some leaving deep impressions, close together, indicating heavy, squat-legged animals, and others the unbroken trail of a worm. The Colorado river, cutting through these accumulated strata, has exposed the ancient pages so that fragments of the story of life at those times can now be gathered. In all, the trails of some fourteen different kinds of animals were found.

1486

World's Queerest Race Track Built for Germs

Winners, Galloping Along under a Microscope, Prove to Doctors That Only Bacteria Charged with Electricity Are Harmful

THREE research workers, toiling in a laboratory at the university of Chicago, recently discovered that the deadly pneumonia germ became a harmless creature if an infinitesimal charge of electricity was removed from it; that it was turned again into a man destroyer when the charge was restored; and that past failures to perfect a serum to immunize against pneumonia were due to the fact that the pneumococci work just backward from germs which have already been conquered.

In those three discoveries—the result of two years of work by just one section of a vast scientific commission set up to rout influenza, pneumonia and all the pulmonary diseases—the research world has at last begun to penetrate the mystery of the life of the microscopic world which is inhabited by untold billions of germs.

Starting out to find the reason why germ cultures grown in the laboratory steadily lose their virulence with each succeeding generation, Dr. I. S. Falk and his

associates, H. A. Gussin and M. A. Jacobson, uncovered marvel after marvel. They found that each tiny germ—so small that it takes millions to form a cluster as big as the head of a pin—had a negative electrical charge, or potential difference, in direct proportion to its virulence. A fresh and deadly culture showed as much as twelve to fourteen-thousandths of a volt; and one that had lost its strength so far that no reasonable amount would kill even a mouse, showed the charge was almost gone, running as low as two or three-thousandths of a volt. They found harmful germs could be rendered harmless and harmless ones made virulent by simply adding to the food on which they were grown the necessary salt or acid or alkali to take away or put back the electricity. And then they found that the pneumonia germ is unlike any germ they had dealt with before, and, therefore, that all past attempts to make a serum to save people from the disease had been made with the wrong kind of culture.

When the laboratory wants to make a preparation to prevent typhoid fever, for example, the most deadly culture obtainable is used, the germs killed by heat, and then injected into the body of the person to be immunized—first a little to make him just a bit sick, then a bigger dose, and finally the biggest dose. The theory is that to protect from disease the worst germs available should be killed and used. But the thing that counts in making a serum is what the laboratory calls the antigens, and, unlike such diseases as typhoid, they discovered that pneumonia cultures contained more antigens when they were weak and harmless than when strong and virulent. So the next step in the experiments, which are to continue, may solve the serum problem.

The work started with a number of pneumonia cultures of various strengths. There was culture "A," which was so powerful that it would kill a mouse when

University of Chicago and City Health Service of Chicago

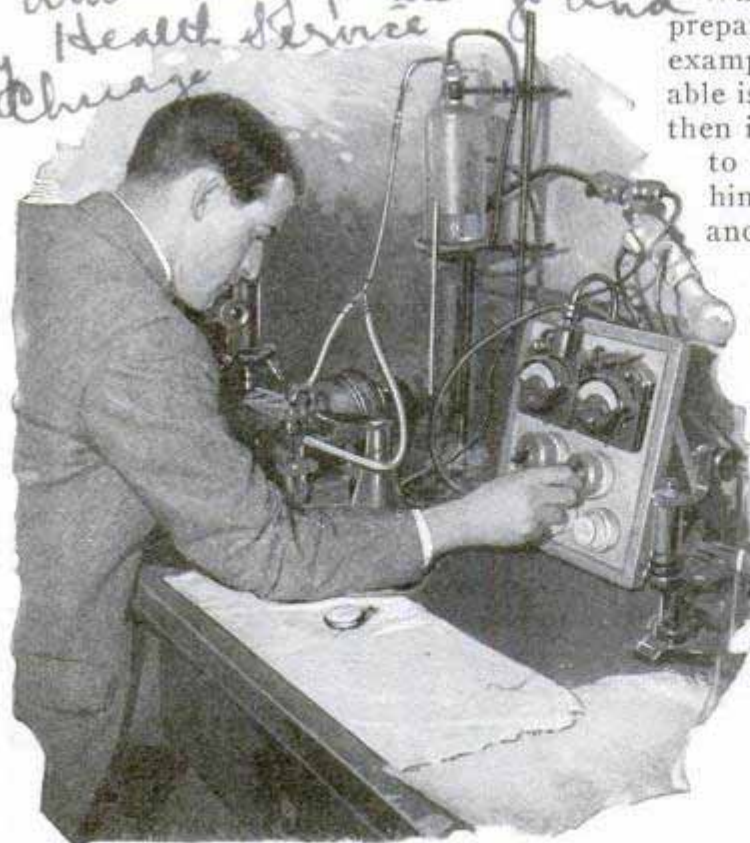

With One Eye on the Microscope and the Other on the Watch, Dr. Falk Turns the Switch That Starts the Germs down the Track

only one-millionth of a drop was used—this amount being so small that two or three individual germs were fatal; culture "B," which took as much as a thousandth of a cubic centimeter to produce fatal results, and others were non-fatal when as much as one-half of a cubic centimeter was injected.

A queer apparatus of glass tubes and valves and an electrical switchboard were built, with a glass funnel up at one side into which a mixture of fluid and germs could be poured. The whole thing was assembled around and over a microscope, and when the observer, with an eye at the microscope, a stop watch in one hand and the other hand on the electrical switch, turned the button that sent a current into the tubes of liquid, he saw one of the strangest races that was ever timed—dozens of disease spreaders galloping along, some fast, some slow, but all in one direction.

The germs all had negative potentials, and when the current was turned on they began moving toward the end of the tube where the positive wire led in, as electricity attracts opposites. But the speed at which they moved depended entirely on the amount of their negative potential—the greater the amount the greater the attraction, and so the faster they went. And the observer, with one eye at the eyepiece and the other on the stop watch, timed the galloping germs over a measured course, and by a system of involved figuring translated their speed back into terms of their electrical charge. Time after time, through hundreds of experiments, the figures were checked, always

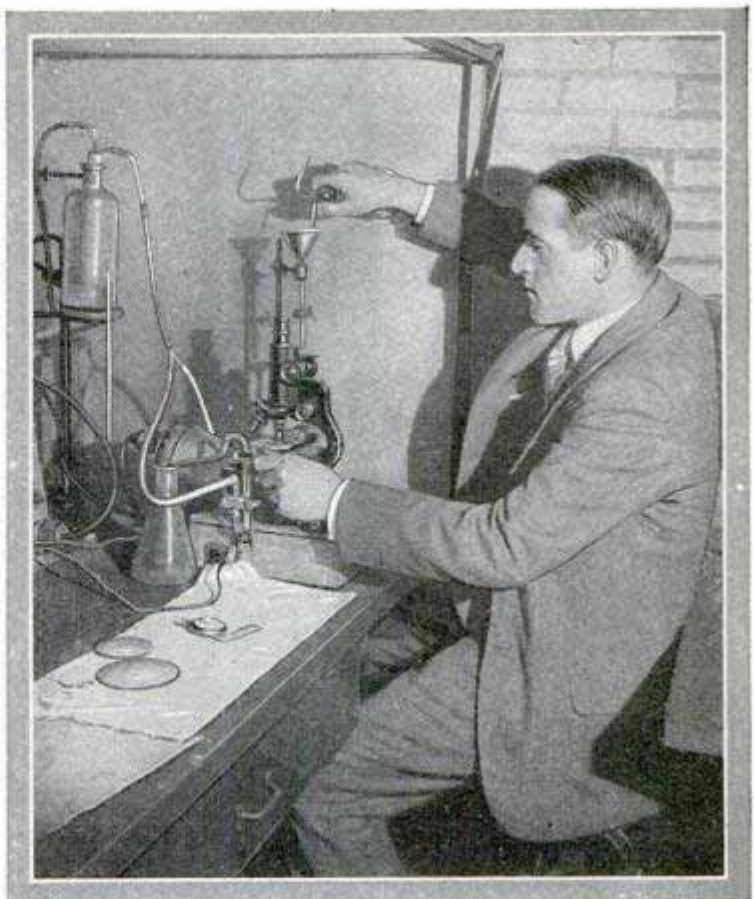

Pouring the Mixture of Pneumonia Germs and Liquid into the Tubing of the Electrical Race Track, Built under a Microscope

with the same result. Bad germs had a big charge, not so bad ones moved at medium speed, and the harmless brands sauntered along so slowly as to show their potential difference was approaching the zero point.

Then the watchers began juggling the pneumococci's electricity. They knew that potential differences could be altered by addition of various things, so they sent word to the germ-culture kitchen, where the cooks brew the broth on which the cultures feed, and had a bit of this and that added to various lots of the culture medium; prepared clean, fresh flasks; heated up their platinum rods over the gas burners to sterilize them; deftly lifted out a bit of this culture and that, and transferred the germs to the new food. Into the incubators the tubes went and new colonies of germs were raised, children of those that had already been clocked over the measured race course. But when the young colonies were poured down the funnel, the current turned on, and the race started, everything was changed. The children of the bad but speedy germs lagged

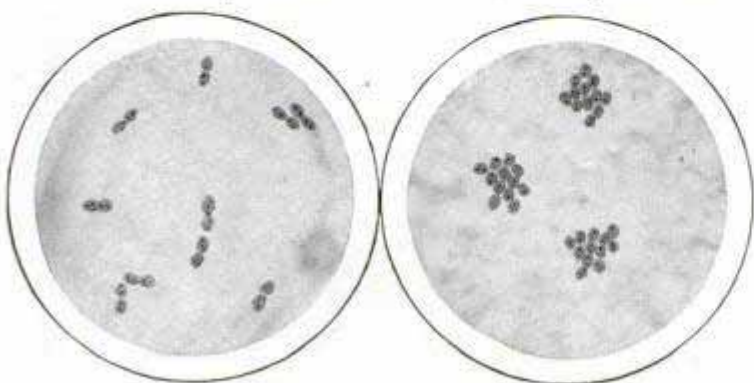

What Electricity Does to Germs; Negative Charge Keeps Them Apart, on Left, and Its Removal Unites Clusters, on Right

1486

behind—because the material added to their food had robbed them of their high negative charge. And the children of the poky but harmless germs sped across the field of the microscope propelled by the high potential which they had obtained from their food.

Then they grew a third generation, but switched the foods again, and in the third race, the grandchildren of the bad germs were bad again and the grandchildren of the harmless germs were harmless again.

The question arose whether a bit of salt or acid or alkali couldn't be injected into the veins of a pneumonia sufferer to take the charge off the germs in his system, and so save his life. A colony of rabbits was brought in, bad germs injected into them, and the experiment tried, with doubtful results. It may have worked, or it may not have—only further experiments can tell. But while that was going on another idea was tried, and with success. In the past, when the doctor wanted to know whether his patient had a mild or a virulent type of pneumonia, he took a culture and sent it to the laboratory, and the germs were tried out on a white mouse. If they were virulent, the mouse died and the doctor was advised accordingly, and if they were mild the mouse perhaps lived, and so did the patient. But if they were bad and the mouse died, it often happened that the

patient had died, too, before the information had been gained.

So Dr. Falk and his associates called for all the pneumonia cultures the hospitals of Chicago could provide. And they separated the germs in half, sent one-half through the mice in the usual way and put the other half through the microscope race course, clocked them over the measured course, and, as they moved fast or slow, advised the doctor that his patient had a good chance or a poor one. And usually the patient had the one or the other, just as the race track had indicated. So, right away, they cut many hours and days of delay from the analysis of the disease.

While the experiments were going on they found the answer to another puzzle that has perplexed the microbe hunters in the past. A mouse or a rabbit can be immunized against pneumonia by injecting freshly killed germs into its body, in increasing doses. Then it can be killed, a watery serum extracted from its blood and this serum mixed with pneumonia cultures. If the cultures were virulent, the observers had found, the serum did

not make much change; but if the germs were so weak as to be almost harmless there was a very noticeable shift. Ordinarily the pneumonia germ is found in scattered pairs, the

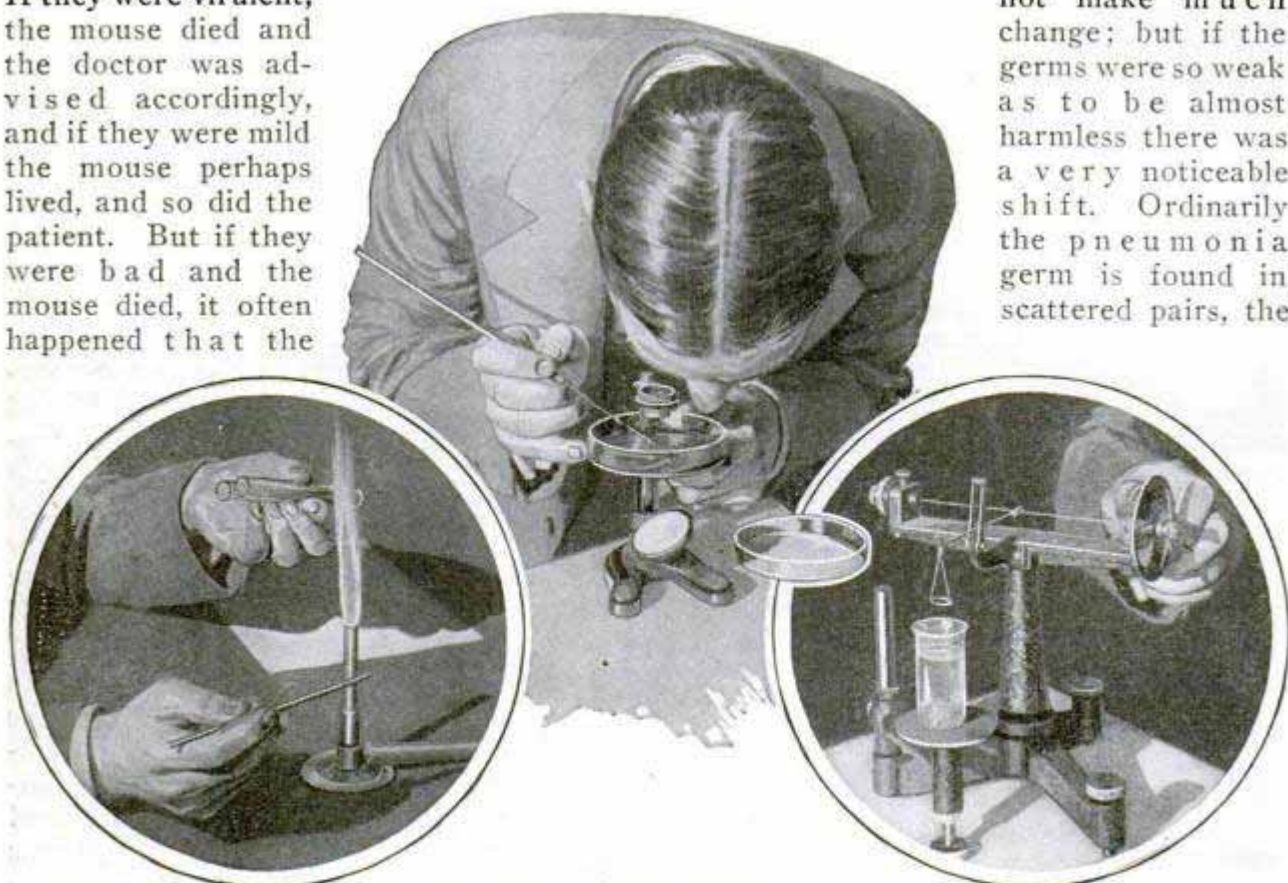

Handling Deadly Germs; at Left, Preparing to Transfer a Fresh Culture; Above, Seeking Germs Growing on Special Diet Kitchen Food, and at Right, a New Device That Measures the Surface Tension of Bacteria

two little round cells forming a sort of figure eight. But when the serum is added to the weakened, non-virulent strains, these scattered clusters begin to clump together.

The measure of the potential difference of the germs showed that it was probably the negative charge that held them apart—as like repels like in electricity; and that when the serum was added it neutralized the last of the charge, already weak on the nearly harmless germs, and permitted them to cluster together. The clustering was helped along because each germ is covered by a thin film of liquid which differs, owing to its contact with the germ, from the surrounding liquid. When two germs met, the bubble films had a tendency to combine in one bubble, and the process continued as more bubbles joined them.

So the research workers decided to study this film, which may be likened to a rubber balloon. Inside, instead of gas, was the germ, exuding something that was trying to get out and injure man, just as the gas tries to get out of the balloon. And outside was the surrounding liquid, trying to get in, so that between the two conflicting forces the bubble film was under constant stress. And just then a new instrument came along which is so delicate that it can actually measure the surface tension of the film on a germ so small that a pin point would be a mountain beside it.

The practical results have not begun to appear as yet, at least in their entirety. Further experiments, and additional research in other laboratories are necessary before pneumonia is actually conquered. But in the meantime the way, it is believed, has been paved toward an entirely new understanding of the whys and wherefores of a germ.

☐ In Chile, wild potatoes grow about as large as hazelnuts.

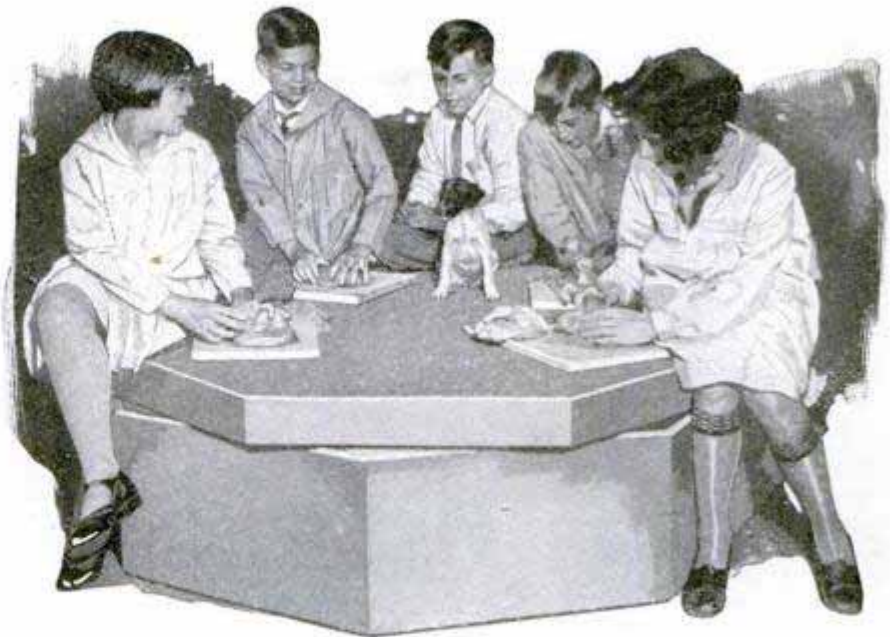

Members of Class at Art Institute of Chicago with Puppy Posing, to Aid the Young Sculptors in Rapid Clay Modeling

PUPPY MODEL FOR ART CLASS AIDS YOUNG SCULPTORS

Members of a juvenile class at the Art institute of Chicago receive instruction in rapid molding with clay by using puppies and other pets as models. Instructors have found that the children take added interest in molding from such subjects.

BULB WITH LUMINOUS CROSS FOR HOME RITES

For religious observances at home, a bulb with a luminous cross on the inside operates on either direct or alternating current. It burns for about 3,000 hours.

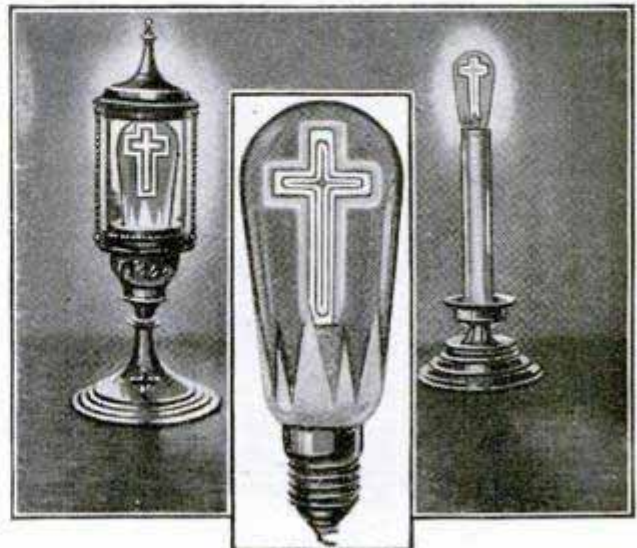

Close View of Bulb with Luminous Cross, and Two Adaptations of Its Use

*Commonwealth Edison Electric Shops.
72 W. Adams, Chicago*

2009

Builders and designers - C. W. Ruth Engineering Co, 8 S. Dearborn, Chicago

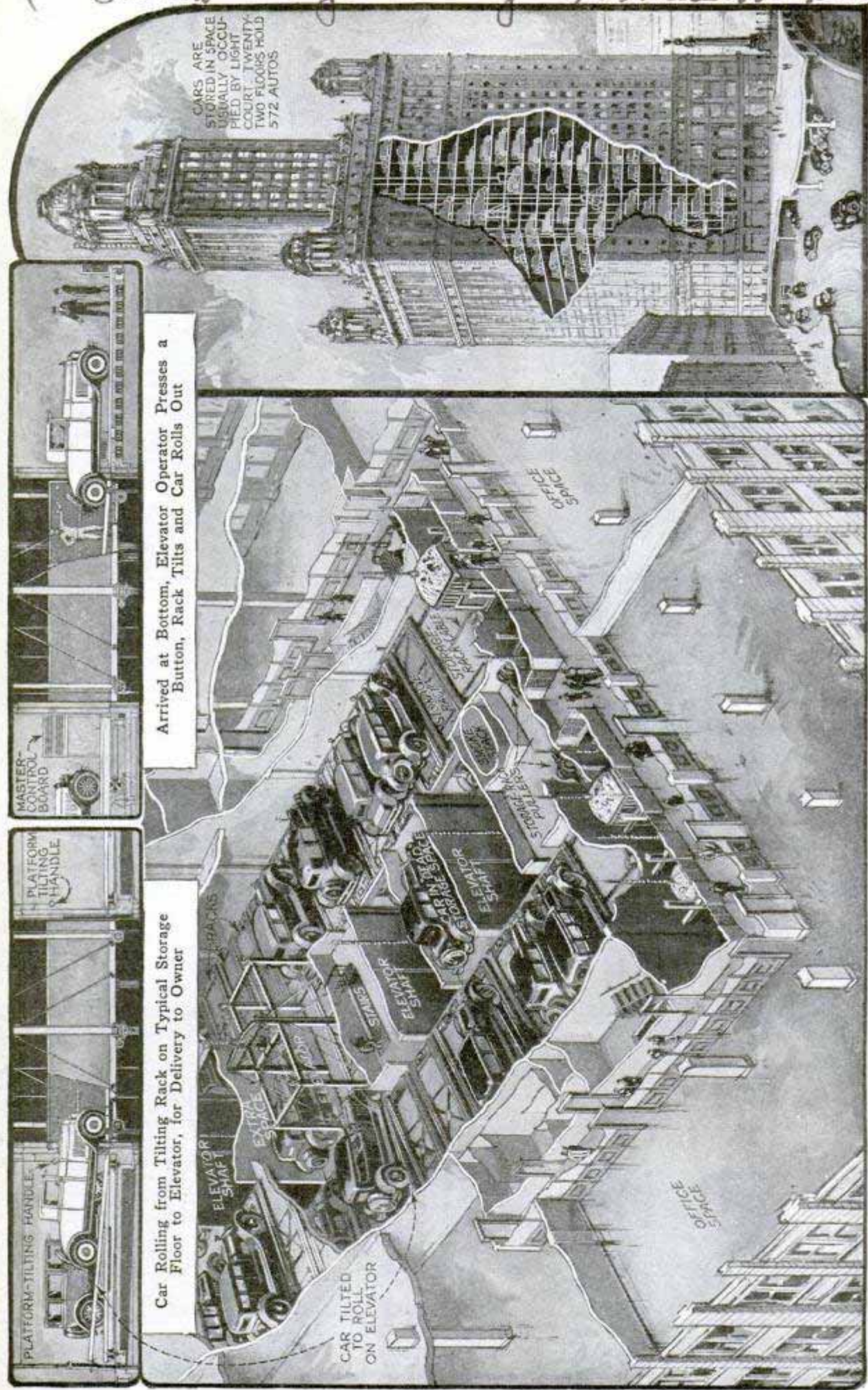

CARS ARE STORED IN SPACE USUALLY OCCUPIED BY LIGHT COURTY. TWENTY TWO FLOORS HOLD 572 AUTOS

Arrived at Bottom, Elevator Operator Presses a Button, Rack Tilts and Car Rolls Out

Car Rolling from Tilting Rack on Typical Storage Floor to Elevator, for Delivery to Owner

CAR TILTED TO ROLL ON ELEVATOR

Artist's Sketches of Garage System in Jeweler's Building at Chicago; Only Attendants Have Access to the Storage Floors, Cars Are Not Touched by Human Hand from Entrance to Departure, and as Motors Are Not Running, Fumes and Wasted Gasoline Are Eliminated

AUTOS PARKED IN SKYSCRAPER ON TWENTY-TWO FLOORS

Part of the space on twenty-two of the forty-four stories of a new Chicago skyscraper are used for a garage with a total capacity of 572 cars.

A feature of the installation is that, from the time the auto enters the building until the owner gets it back again, it is not touched by human hand. This has been accomplished by an arrangement of tilting racks on each of the four elevators used and on the storage floors. The driver runs his car upon a loading platform before one of the elevators. From a

master control board near by, an attendant determines what storage rack on a certain floor is vacant. He pulls a key from the lock bearing the designation of the stall assigned and gives it to the owner as his claim check. Pulling the key completes electrical connections that cause a storage rack on the specified floor to come to rest in front of the elevator. The car rolls upon the lift as the loading platform is tilted by pressing a button, the elevator operator dials an indicator, the car is raised to the floor selected, the elevator doors open automatically and, by again tilting the platform, the auto is rolled to the storage rack. To remove a car from storage, the owner receives a receipted bill from the cashier and presents the claim key to an attendant, who inserts it in the lock on the control board, according to symbols on the key. This causes connections to be made which set in motion a transfer car on the floor assigned and the storage rack automatically comes to rest in front of the elevator. The elevator operator, given a ticket to get the car, dials the indicator to the floor assigned and the lift stops at that floor, and again the doors automatically open. The operator pulls a handle which



Statue of Horse for English Church, to Commemorate Chargers That Served during War

causes the tilting platform on the storage rack to rise at the rear and the car rolls back upon the elevator from which it is discharged to the ground floor ready to be driven away. Advantages claimed for this system are that it eliminates practically all chance of damaging the car while taking it in or removing it from the building, gives protection against theft and eliminates gas fumes.

MONUMENT TO WAR HORSES IN CHURCH

In memory of the 375,000 horses killed in British units during the World war, a monument has been unveiled in an English church near London. It shows

the figure of a single charger and bears a suitable inscription in honor of the part played by the horse in battle.

FIFTY-TON TURBINE DOES WORK OF FOUR MILLION MEN

Power generated by a 50,000-kilowatt turbine constructed by an eastern company, will be sufficient to do the work of 4,000,000 men, it is estimated. The huge casting is nearly twenty-five feet high.

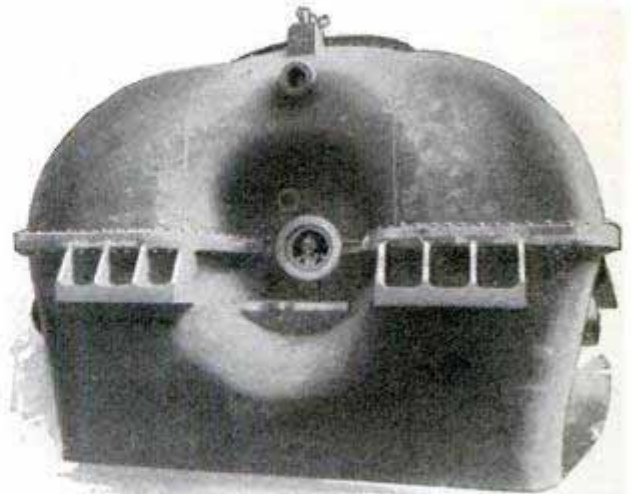

Head of Man Appearing in Center Opening Illustrates Size of Huge Turbine Casting

General Electric Co, Schenectady, N.Y.

*St. Gyles in the Hill
14th Hampstead Garden Suburb,
near London, England*

1869

1622

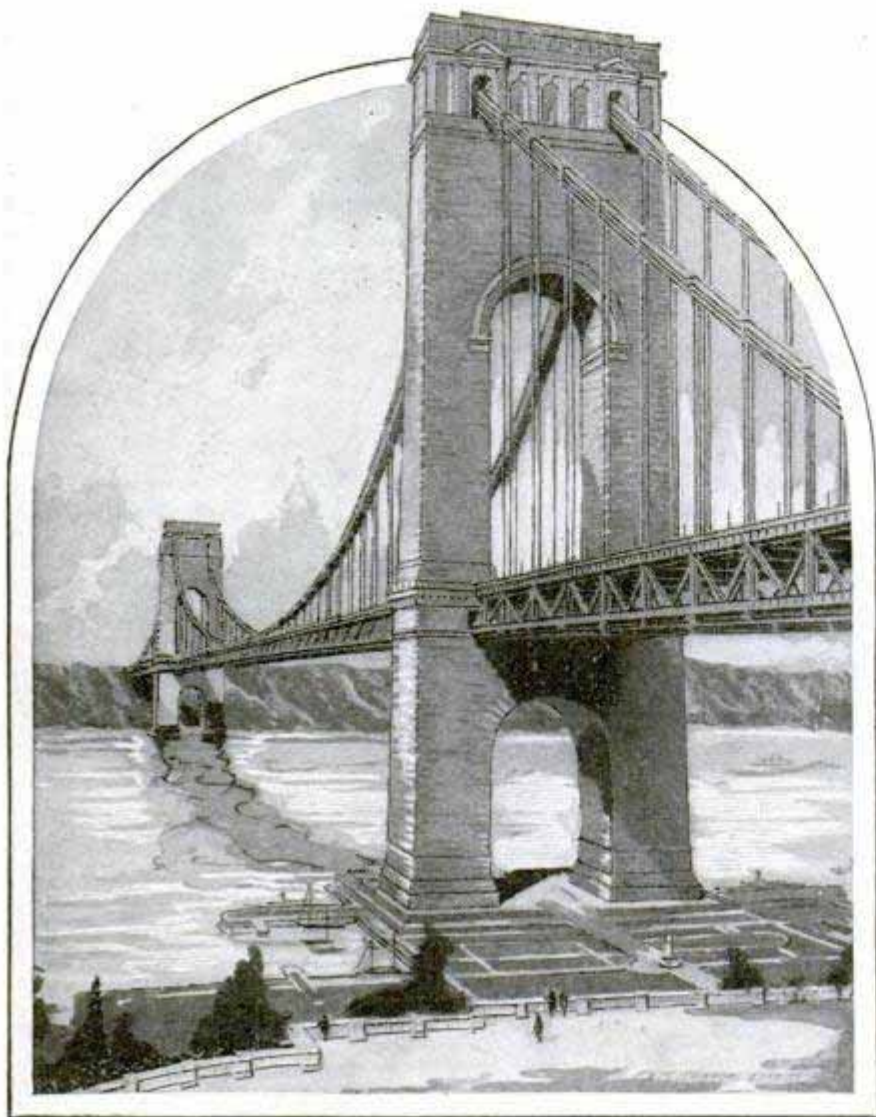

Architect's Sketch of the Hudson River Bridge, with Riverside Drive Passing beneath It in the Foreground and the Palisades across the River

only 380 feet. For another comparison, they will be just ninety-five feet higher than the Washington monument, with bases seventy-five by 220 feet, whereas the monument base is only fifty-five feet square. The great height of the bridge will not require particularly long approaches, as it springs from the Washington Heights above the river on the New York side and from the Fort Lee Palisades on the opposite shore. Riverside drive and Haven avenue will be crossed by great masonry arches, terminating in an anchor abutment between the drive and railroad cut. The anchor span from the main tower to this abutment and the similar span from the New Jersey tower to the Palisades will each measure 650 feet. The actual roadway will be 235 feet above high-water level and will pass through the towers in arches

BIGGEST BRIDGE IS PLANNED TO SPAN HUDSON

Plans for the New York-New Jersey bridge across the Hudson river, recently completed by Cass Gilbert, architect, call for the longest suspension span in the world, carried by the highest towers, and with record-breaking clearance beneath it for ships. The single river span will be 3,500 feet in length, as compared with the 1,750-foot span of the big Philadelphia-Camden bridge, recently completed. The bridge floor will be 200 feet above the water, and the towers at either end 650 feet high, while those of the Delaware river structure are

ninety-five feet wide and 230 feet high. On the New Jersey side the road, high as it is, will be below the top of the Palisades and will emerge through a deep cut, topped by an arch carrying a footwalk along the river heights.

SLIDING METAL BACK ON COMB KEEPS OUT DIRT

Provided with a sliding metal back, a comb introduced in England is easily kept clean, as the metal strip, fitting close against the comb, keeps dirt from lodging between the teeth at their base. The sliding back is easily removed for washing.



Metal Back Partly Removed from Comb; It Fits Snugly at Base of Teeth

1939
new hygiene
about 60c
© C. A. Oldroyd
Scott Morgan Co. St. Andrews House, Holborn London, E.C. 1, Eng.

*Air Ministry
Medical Board. London Eng*
POPULAR MECHANICS

1952

441

THESE TESTS FOR AIR PILOTS
MAY BE TRIED AT HOME

War-time tests for flyers, which centered around a whirling chair in which the prospective pilot could be strapped and then revolved head over heels, have been refined recently to the point where many of them can be tried out by the candidate at home. Among the tests standardized for British pilots are standing on one foot with the eyes shut, holding the breath as long as possible, lifting a balanced rod without upsetting it, and a series of lung-capacity measurements.

The candidate for flying papers is required to take a deep breath and hold it for more than 45 seconds—most of them achieve a minute or more, and 69 seconds is considered exceptionally good, though some pass even that mark. Next he is required to shut his eyes and then balance on one foot for fifteen seconds, without moving. It is easy to balance with the eyes open, and fairly simple to lift one foot first and then close the eyes, but much harder to close the eyes first and then lift the foot.

The next stunt is to lift a board from the table with one hand, raise it shoulder-high, lower it to the table again, and then repeat with the other hand; all this without upsetting a small metal rod standing upright on the other end of the board. The test is designed to measure the co-ordination between mind and muscle and determine whether the pilot's muscles respond quickly enough to make instantaneous adjustment of his flight controls.

Other tests include pulse fluctuations caused by sitting down and getting up several times, and one of the hearing, in which he must repeat whispered sentences.



Golf Putter Here Is Adjusted Short; the Handle Is Collapsible

GOLF PUTTER IS ADJUSTABLE
TO SHORT OR LONG SHOTS

With an extension handle, a golf putter now on the market can be made short or long to suit the player on shots of varying distance. The adjustment is quickly accomplished, a turn of the club's head and a push or pull on the handle, the lower part of which telescopes into the upper, being sufficient to give the desired length.

EIGHT-WHEELED MOTOR COACH
RUN BY RAILROAD

To meet competition from bus lines, a mid-western railroad has inaugurated passenger service in an eight-wheeled motor coach equipped with air brakes to supplement steam-train schedules. The bus has seats for thirty-five persons, is said to be the largest in the world, and its wheels are on two separate trucks.



Railroad's Answer to Motor-Bus Competition; Huge Thirty-Five-Passenger Coach with Eight Wheels and Air Brakes Operated on Regular Schedules to Supplement Train Service

Chicago & Alton R.R.
Chicago

Airways, June 1926.

*Distributor - Nieblo Mfg Co
38 E 23rd St
New York*

*William Lowell c/o Hermann
Fr. County, 7 E. 42nd, New York*

*Distributor Nieblo Mfg Co
38 E 23rd St
New York*

*Built by Alton Corp
Albany, N.Y.*

551 442

Brown Brothers, 1482 Broadway,
new York.

POPULAR MECHANICS

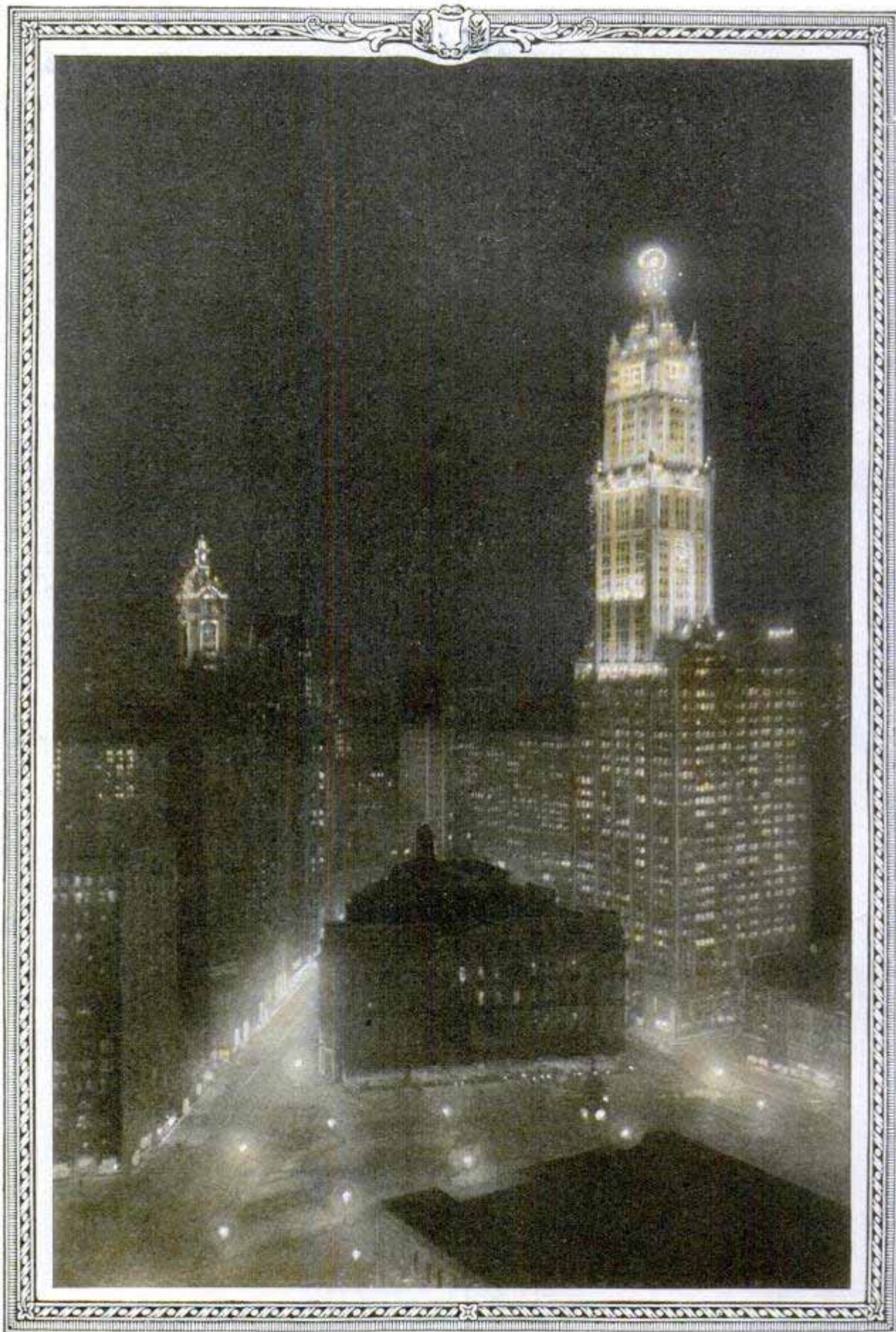

Two of the Gleaming Architectural Jewels of Night-Time Manhattan, the Woolworth Building, Tallest in the World, at the Right, and the Singer Building, on the Left

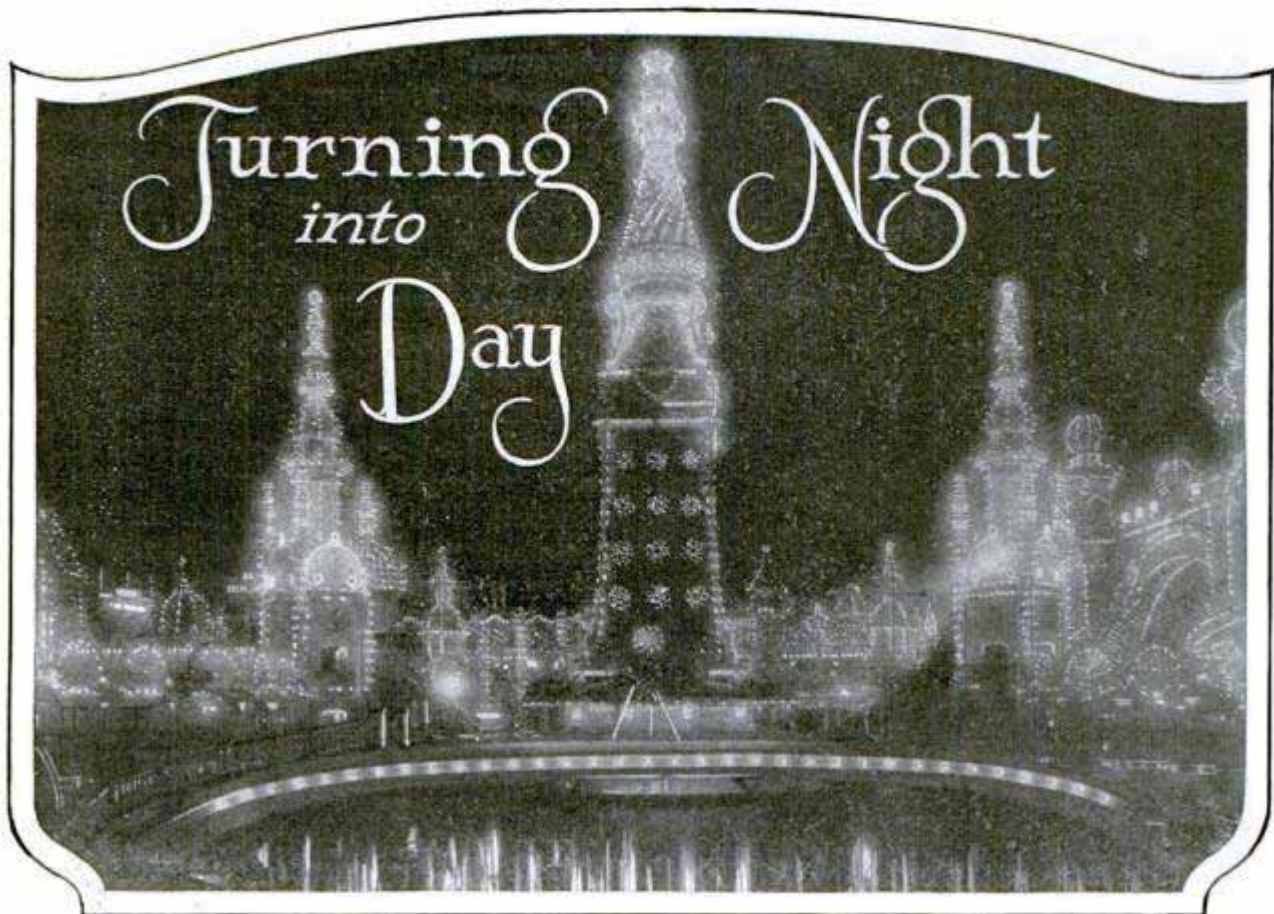

Part of the Fairy Tracery of Coney Island, Rising above the Sea with All the Gay Unreality of Some Strange Phantom Picked Bodily Out of a Tale of Gilded Nights in Arabia

Millions of Lights in Huge Signs Transform Cities and Turn Skyscrapers and Public Buildings into Scintillating Jewels

FLASHING 25,000,000 candlepower of light against the sky each night, New York's "great white way" lays claim to being literally the brightest spot on earth. The revolution that electric signs have wrought in the night-time appearance of a city within a few years is shown by the fact that the first electric sign on Broadway, which startled New Yorkers of thirty years ago, had but 200 lights, and their carbon filaments shed a yellowish glow that would pale into insignificance beside the modern white and colored lights.

Compared to this pioneer sign, the largest one in the world, re-



Welcoming the Newcomer, the Statue of Liberty Is Lighted by Night

cently removed to make way for another skyscraper, carried 19,000 lamps and required 21 miles of wire to connect them all. The first sign cost less than \$200 to build, while now one company spends \$600,000 annually for rental of sign space alone. Night illumination of cities has grown so rapidly and become such a recognized sight that it is hard to hark back to the latter years of the last century, when an electric display was a novelty.

The theaters, which paved the way and fixed Broadway in the public mind as a street illuminated by theatrical advertising, have become lost in the maze



The Making of Electric Signs Is a Highly Skilled Profession; Center Shows a "Flasher" Assembly for an Animated Advertisement

of other signs, until today they rank seventh on the list. Of the 17,000 electric signs on Manhattan island below 135th street, restaurants lead the way with more than 2,000, barber shops boast in excess of 1,300, tobacco advertisers alone have 1,100; 867 advertise various kinds of clothing, and 763 are devoted to automobiles and accessories, while the theaters have but 706. Even the churches have turned to electricity to spread their call, using illuminated crosses, as well as words, and today they stand halfway up on the list of eighty different kinds of electrical advertisers.

The glow of Manhattan island, visible far out at sea on a clear night, has become one of the wonders of the world. Artists, poets and writers have been enthralled by it, and in paint and print have tried to depict its glory. Picked out at night by floodlights and glowing windows, the sky-

scrapers are pictured as "cathedrals of commerce." The tallest building in the world, the Woolworth tower, the Bush Terminal building and the black-and-gold American Radiator building have become famous over two continents because of their night lighting, but it is the huge signs in the theatrical district that impress the visitor most. New York leads in electricity consumed, but other cities have done as much or more in ornamental floodlighting. The electrification of the Niagara Falls recently stands out as the finest example of beautiful effects yet achieved. In Washington, the capitol dome and the upper portion of the Washington monument are flooded each night with light so that they may be seen for miles. The capitol of Texas has a lighted dome which may be seen for

fifty miles, a glowing counterpart of the lone star from which the state takes its name.

A Chicago church, which owns a loop skyscraper surmounted by the

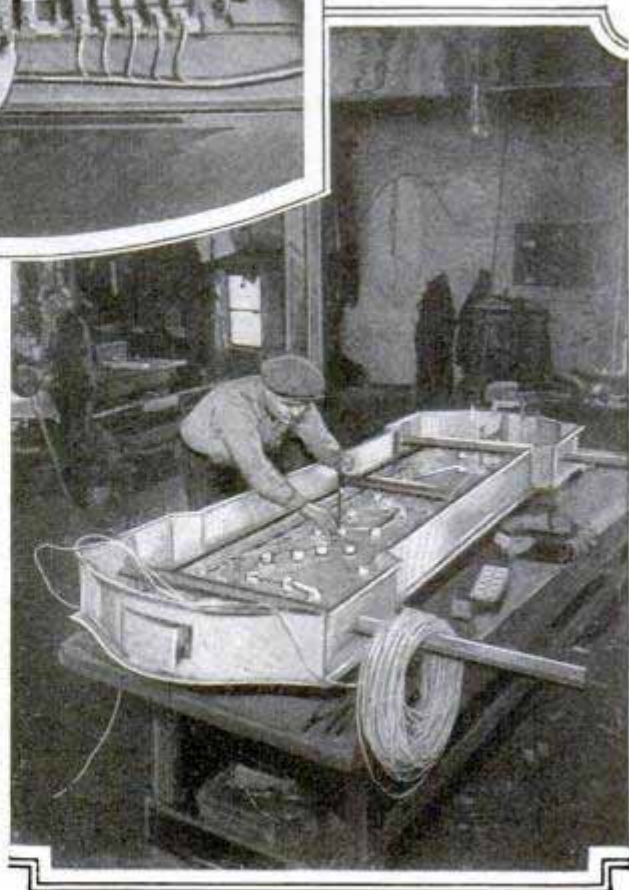
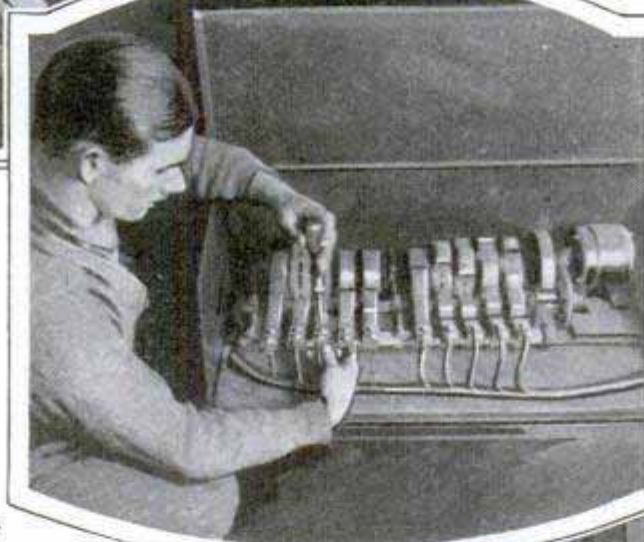

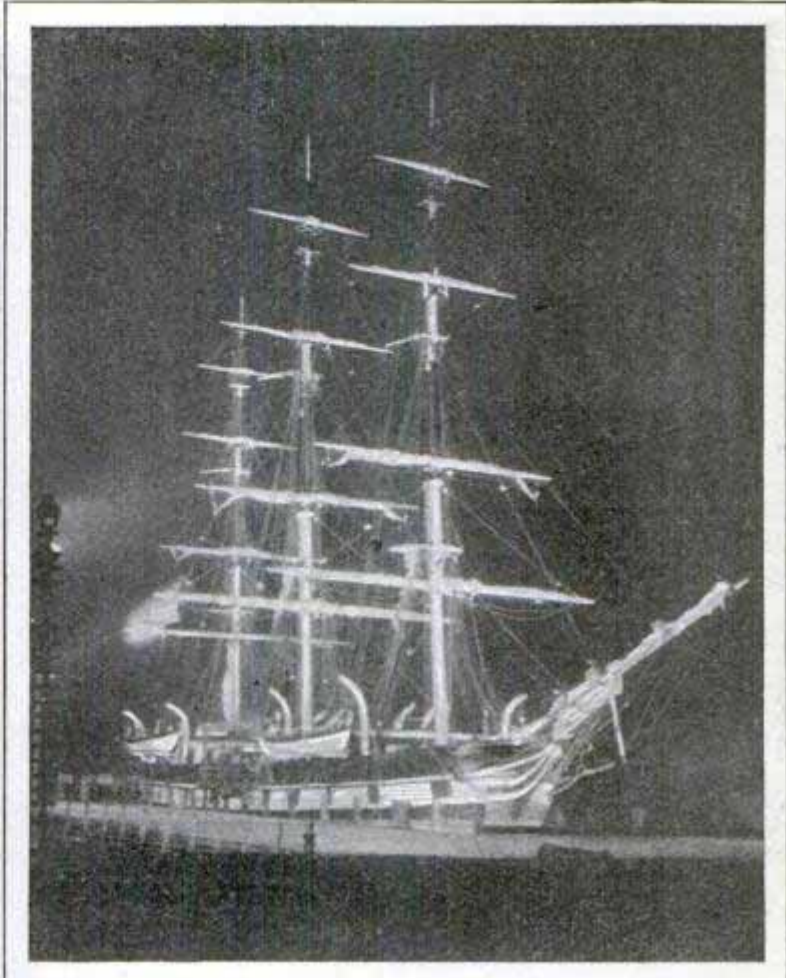
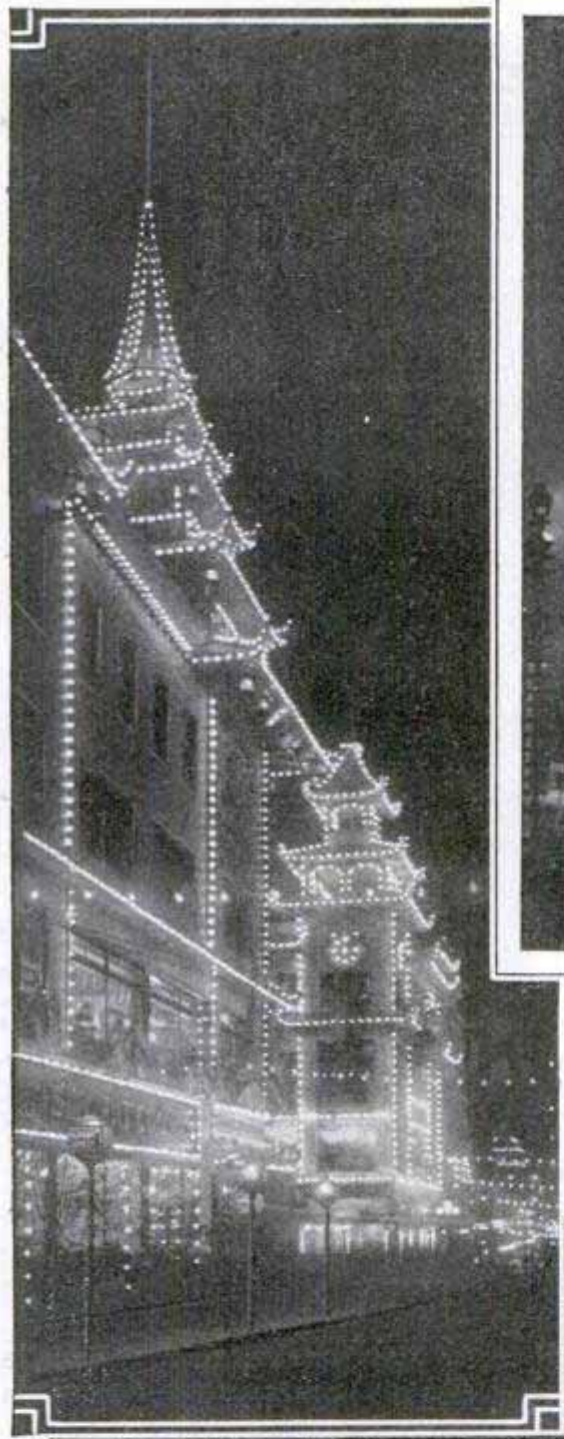

An Ancient Whaling Ship, Illuminated by Night, Is a Famous Sight on the Massachusetts Coast; at Left, Chinatown, San Francisco, Picked Out at Night by Myriads of Colored Globes



The "Flying Boat" at an English Amusement Park, Gives a Weird Effect When Its Hundreds of Rapidly Revolving Lights Are Caught by the Camera; the Amusement Parks, like the Theaters, Were among the First to Seize on Electric Lights as a Means of Popularizing Night-Time Play by Turning the Dark Hours into Day

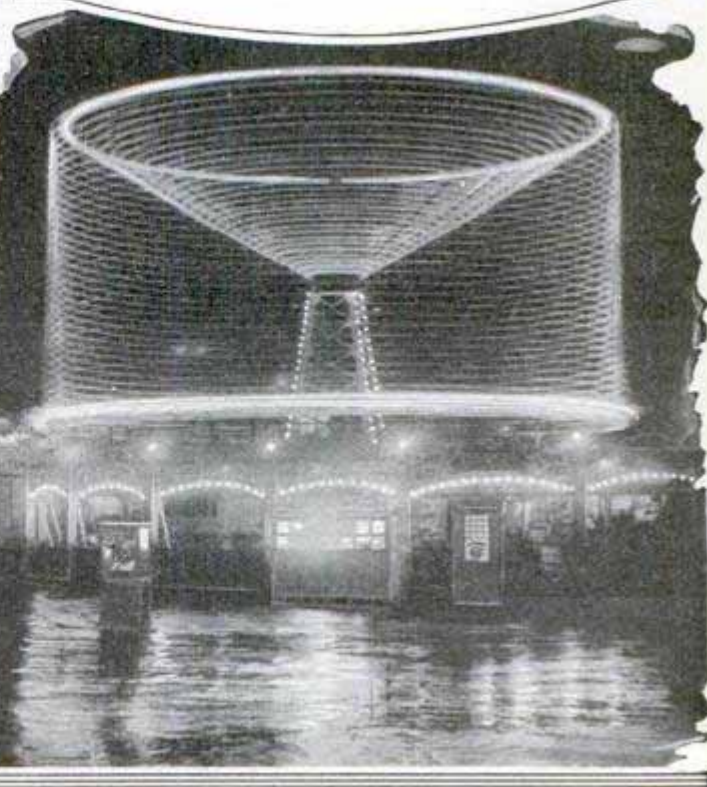

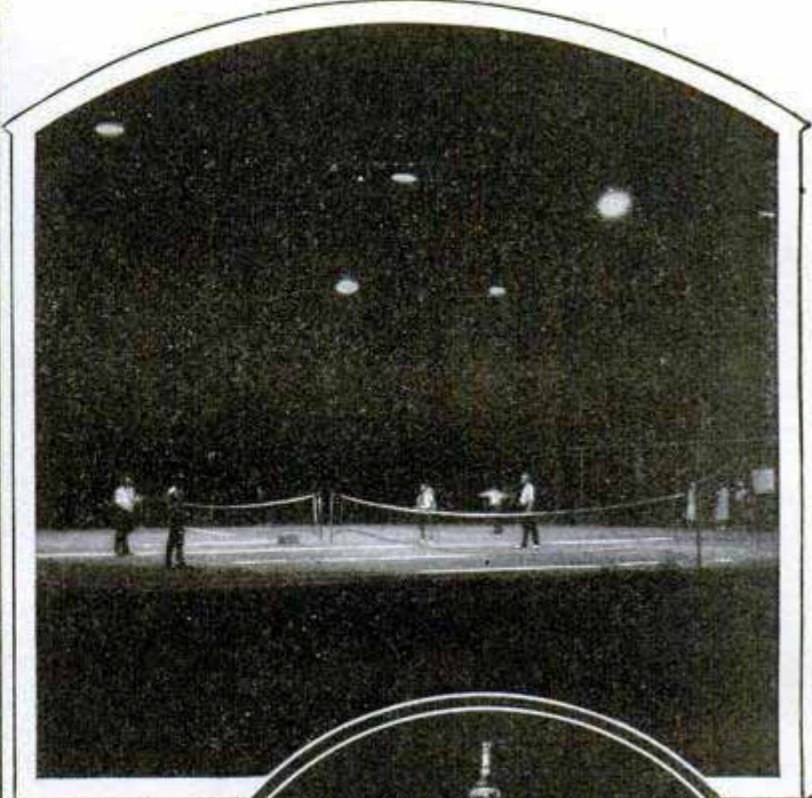
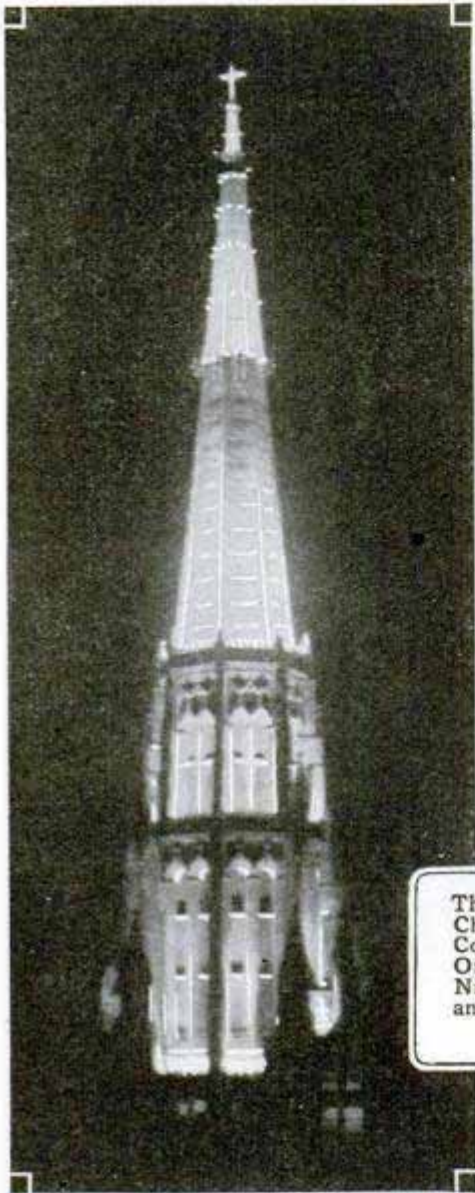

The Glowing Steeple of Chicago Temple, a Combined Church and Office Skyscraper; a Night Tennis Court and Dome of Texas Capitol

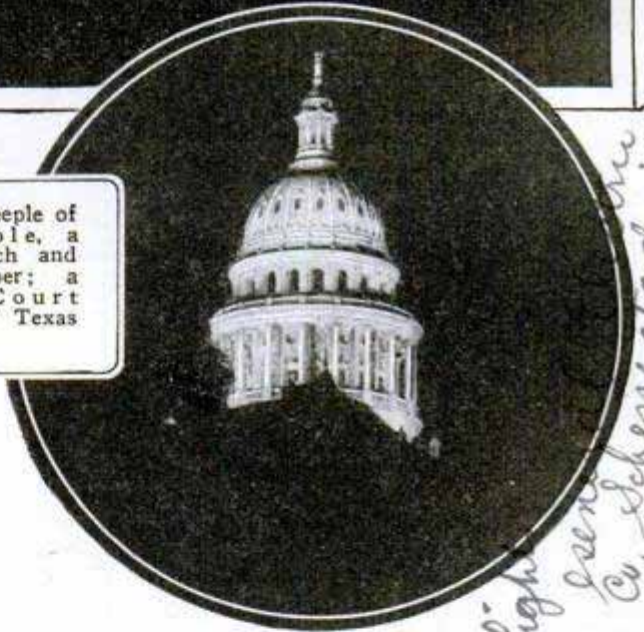

*Light
Sunt
Co., Schenectady NY*

highest steeple in the country, illuminates the white concrete sides, and tops it with a brilliant cross that is visible far across the lake on the Michigan shore.

How much electricity has done to

lengthen the play hours of the day is little realized. Tennis courts, croquet grounds



Illuminated by Floodlights, Soldiers' Field, Chicago's New Stadium, Becomes a Place for Night Play and Pageantry, Doubling Its Usefulness to the Millions of City Dwellers

*2/16! Built by Scott
Sidney
California sportsman*

and other outdoor athletic fields are made possible by night illumination. At Springfield, Ill., several successful tennis tournaments have been played at night on open-air courts.

Despite the vast increase in lighting, only half the homes in the United States had electric lights at the end of 1924. The other half, however, included several million farm houses. Salt Lake City, at last reports, was the most perfectly lighted city in the country, with fewer than seventy-five homes unconnected in its area.

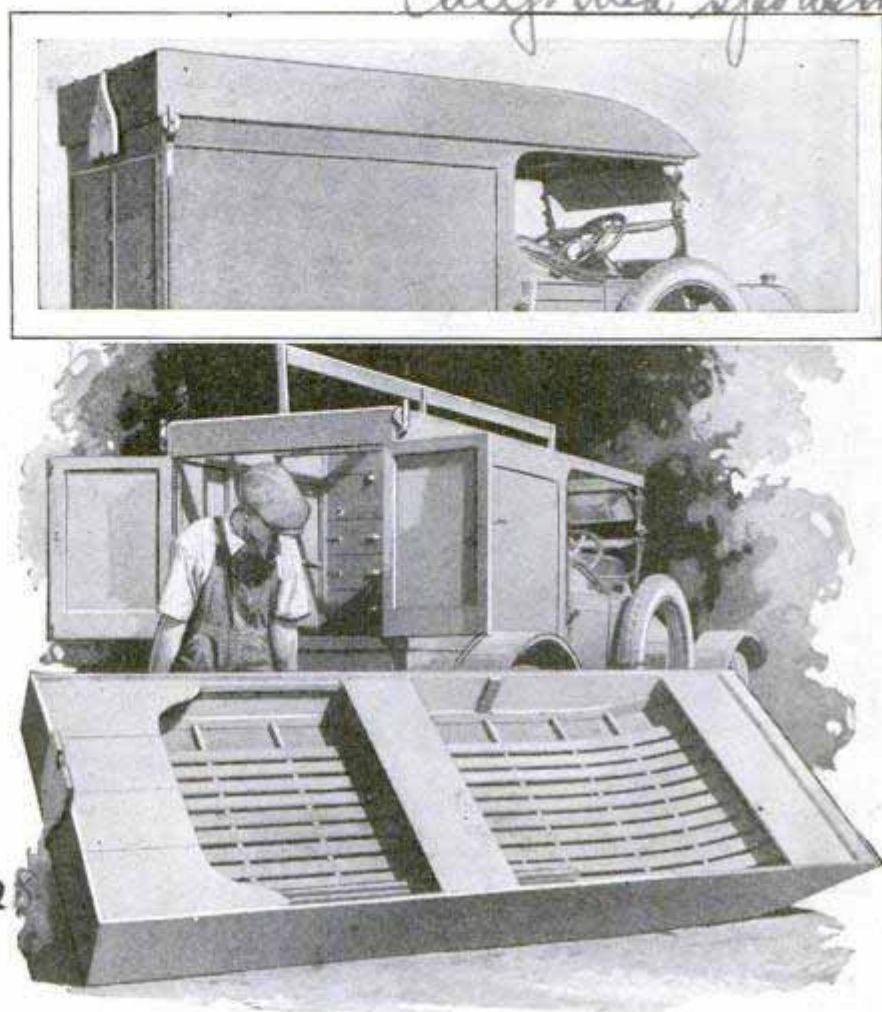

Upper Photograph Shows Top on Auto, and Lower, Removed, Turned Over and Ready for Service as a Duck Boat

WHALE HUNTERS USE AIRPLANE AND RADIO

222

For the first time in the history of the whaling industry, airplanes are being used in the north Pacific to sight the herds. The hunters are also adapting another modern invention to their work, the radio. When the whales are sighted, communication is established by wireless from the plane to the fleet, which may be several miles away. These more efficient methods of capture have been employed in an effort to make up for the scarcity of the animals. For a number of years, results of the whaling operations off this coast have been unsatisfactory. It is believed that migrations to southern waters may possibly be responsible for the shortage. To determine this, whales are being tagged with bright metal disks in an effort to trace their wanderings.

Six weeks is the average span of life of the honey bee.

AUTO TOP IS ROLLED OFF CAR FOR USE AS DUCK BOAT

2/16/

Resting on rollers so that it can be removed easily, the top of a special auto for sportsmen, serves as a flat-bottomed duck boat. It may be propelled by oars or with a small motor and is said to be seaworthy.

BOUQUET MODELED IN DOUGH BY PRISON COOK

165 O.



Prison Pastry Chef's Creation in Dough; the Bouquet Represents Products of the Institution's Farm

Fashioned entirely of bread dough, a bouquet of lilies, roses, leaves and fruits of various sorts, molded by the cook of an Ohio prison, was considered an excellent illustration of the pastry chef's art. The assembly was realistically tinted.

Chicago Daily News 6/1/1926

*London, Ohio
Prison Farm*

2158

Anna Case soprano and Frank La Forge pianist - composer in photo



"Footlights" for the Piano Music Rack; a Soft Glareless Glow Radiates from the Holder

MUSIC LIGHT RACK FOR PIANO PREVENTS GLARE

2158

Light is said to be evenly diffused upon the music, without injurious glare, from a special extension for the piano rack. It is constructed of corrugated wood and the electric lights, under glass, are so arranged that their rays are projected upward on the sheet in the manner of stage footlights. Asbestos lining prevents overheating and damage to the wood, and a button at one end of the fixture controls the current. The rack is furnished in various styles to harmonize with different pianos and may also be used on music stands, desks, pulpits and elsewhere in place of overhead fixtures.

ELECTRIC CURRENT IN NERVES DETECTED BY RADIO

2199

By means of a three-tube radio apparatus, Dr. E. D. Adrian of Cambridge university is reported to have detected the electric current that shoots along a single nerve fiber of a frog's leg under the stimulus of a message to the brain. This is said to be the first time that such a record has been obtained from just one fiber and the experiment is regarded as opening up a new field of research, one in which it may

England

World 6/10/26

be possible to read the main types of messages entering and leaving the nervous system and record the actual events in the brain by means of photographic impressions of the electric impulses that pass along the nerves. For some time, it has been known that messages are attended with electrical disturbances in the nervous system but it has been possible to record the effects only from large groups.

BIG WIND TUNNEL TESTS FULL-SIZE PLANES

2171

Big enough to hold within it a full-size airplane, a new wind tunnel built at Langley field, Va., for the national advisory committee on aeronautics, a government organization, will take airplane design and testing out of the model class and permit experts to study real planes under actual flying conditions. Two 3,000-horsepower Diesel engines, taken from an old submarine, furnish motive power for the huge propellers which will drive wind currents through the tunnels at speeds of 100 miles an hour or more, giving the same effect on the plane suspended in the tunnel as a free flight at that rate through still air. Thousands of curved vanes guide the air as it is sucked into the building and drawn past the full-sized models.

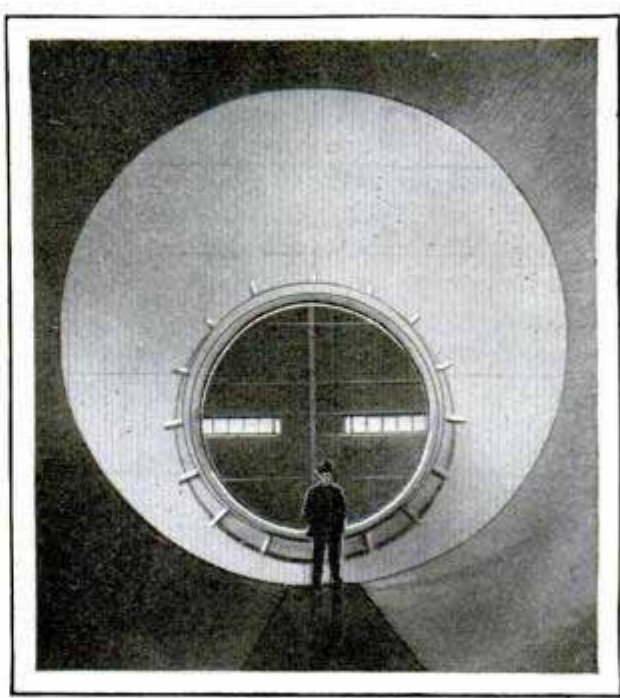

Interior of New Wind Tunnel for Testing Full-Sized Airplanes; Note Size in Comparison to Man

**NIAGARA RECEDES
 TWO FEET
 A YEAR** 2315

Besides being the source of tremendous amounts of power, Niagara Falls is a sort of gigantic clock by which scientists estimate time. From repeated annual measurements it has been found that the cataract is cutting back at the rate of two feet a year. At this rate, it has taken it at least 30,000 years to recede from its original site at Queenstown, 60,000 feet from the present location. Another check on time is afforded at the Mississippi delta. By measuring the sediment in a quart of the water at different seasons of the year and figuring the total volume, an estimate is made possible as to how fast the land is wearing away.



© Henry Miller

Safe and Dry in His Life-Preserver Canoe, the Fisherman Ventures into Deep Water Away from the Brush

name of maker unknown

**LIFE PRESERVER USED AS BOAT
 KEEPS FISHERMAN DRY**

Fishermen and hunters are protected from dampness and cold and can venture safely into deep water with a combination life preserver and canoe introduced in Germany. It is made of a strong rubberized fabric that will endure heavy wear and exposure and is not torn by projecting branches. The wearer stands in an upright position within it, so that he is partly concealed, an advantage in hunting.

**TESTER FOR AUTO BATTERIES
 SAVES REMOVAL FROM CAR** 18/16

All three cells of an automobile battery can be tested at one time without removing it, under discharge conditions such as exist when the car is actually in use. This is done by a tester with a carbon-pile rheostat, properly calibrated ammeter and three voltmeters. A supplementary jack is provided which eliminates the rheostat from the circuit for measuring the amount of current used by the starting motor. The outfit is inclosed in a compact aluminum case with a handle, and has bakelite instrument board arranged for easy reading.



*Harbort Bros. Co. Troy, Ohio.
 248.00 20.00*

**ELECTRIC BELL TRANSFORMER
 FITS CONDUIT BOX COVER**

Fastened directly to the cover of the conduit box, a small transformer for use with an electric bell is easily adjusted and is said to have met the approval of inspectors and fire underwriters. It takes up but little space, projecting only a trifle over two inches from the cover. The input wires are suitably marked so that the polarities may be recognized.

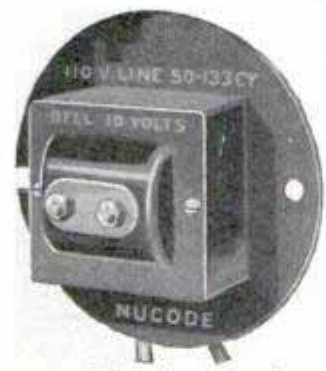

Jefferson Electric Mfg. Co.
 A CORRECTION 2258

In an article in the June issue, describing the bursting of a tile grain tank, no explanation was given as to the cause of the accident. According to a structural engineer, imperfect reinforcing and not the tile, was responsible for the break.

*Jefferson Electric Mfg. Co. Chicago
 501 S. LaSalle*

*501 S. LaSalle St. Chicago
 H. Ray Kingsley, Hollow Tile Advertiser
 Esplanade 40 Rectory St New York City*

18 26

HOW AN ENGINE "BREATHES"



²¹⁴¹ A railroad locomotive puffs approximately four times to each revolution of the driving wheels, regardless of their circumference. The sound is caused by the exhaust steam at the end of each stroke of the pistons, passing up through the smokestack where it aids the fire draft. It has been figured that an engine with drivers twenty feet in circumference and going fifty miles an hour will give 880 puffs a minute, or 52,800 an hour, the drivers making 13,200 complete revolutions in the sixty minutes.

HIGH-SPEED AUTO CARRIES MOTOR IN REAR

On Top of the High Tower; a Sturdy Japanese Directs the Water Gun during a Test of Nippon's Latest Fire Equipment

LOFTY LADDER FOR WATER GUN AIDS JAP FIRE FIGHTERS

Modern high buildings in Japan have necessitated the adoption of fire ladders for added protection against flames in that country. The nimble native firemen have shown, in tests and at actual fires, that they are specially suited to scaling the highest rungs of the extension ladder and directing the bucking nozzle where it will best strike the fire. Guy ropes are attached to the top of the ladders and are held at the bottom by other firemen, or may be tied to any solid object.

☐ Air forms from forty to fifty per cent of the content of ice cream.

ed view of the road and in warm weather contributes somewhat to his comfort, as he is not exposed to the heat of the engine. Although the motor is only sixteen horsepower, it develops high speed and consumes relatively little gasoline.

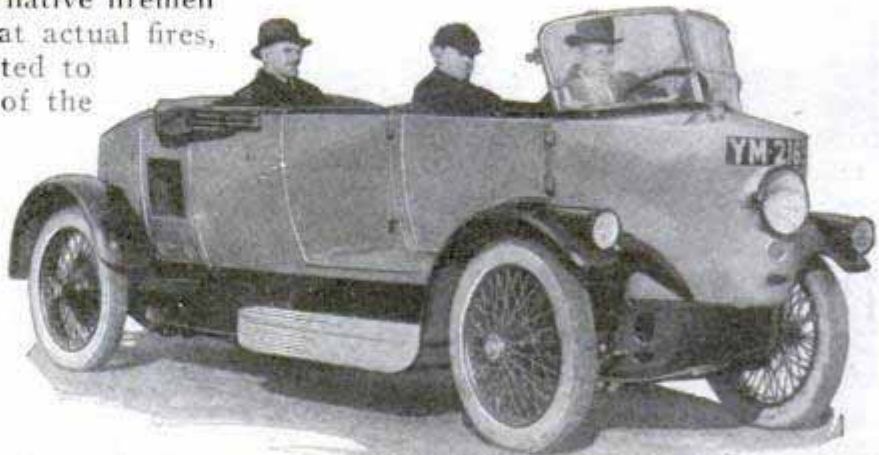

Engine Heat Does Not Bother the Driver of This German Car, For Motor Is Placed at the Rear

*Prumpfer-Motoren-Iserelebachs
Berlin, N.W. 7, Friedrichstr
100, Germany.*

Vertical handwritten text on the right margin, possibly a date or page number.

San Francisco, Calif

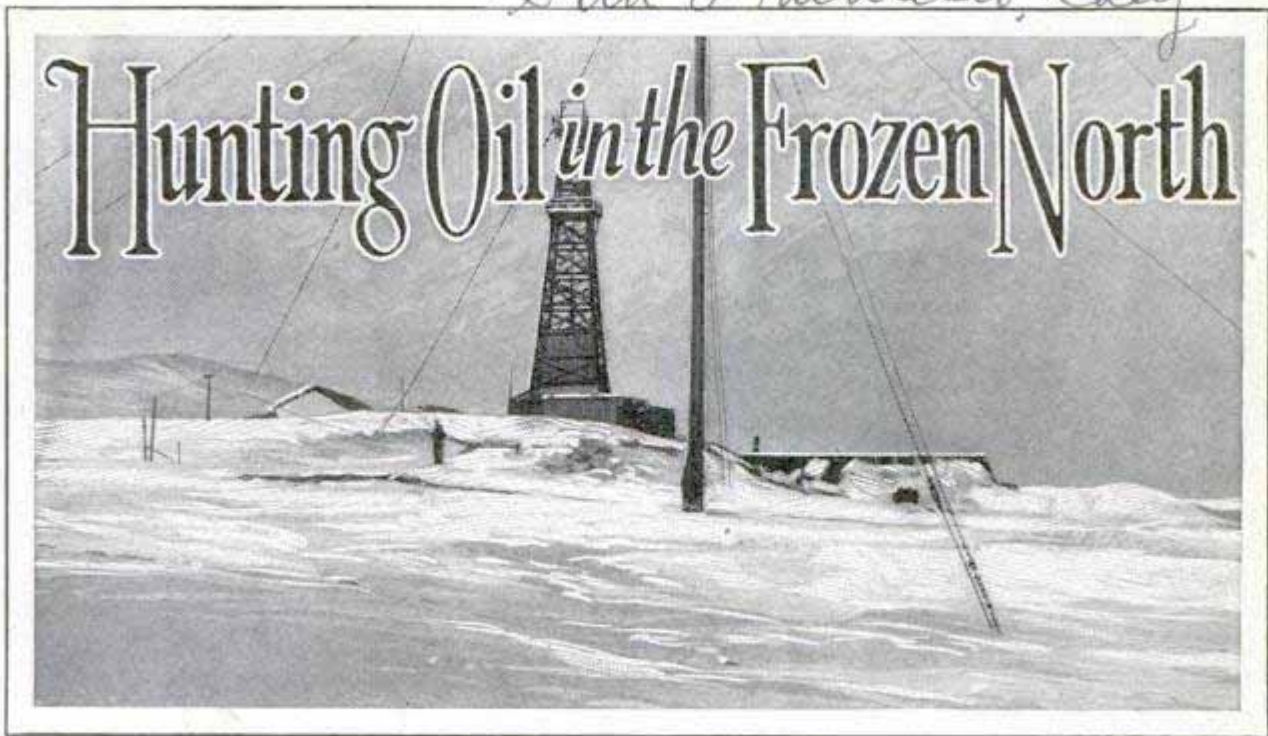

An Expensive Investment in Dry Hole; Lee No. 1, an Oilless Well Sunk in the Arctic Wilderness, with the Mast of the Radio Station Visible in the Foreground

Three-Year Fight against Gales, Blizzards, Raging Seas, Earthquakes and Volcanoes Ends in a Dry Hole, a Mile Deep

ABANDONING a three-year fight against every element that nature could bring to bear against them, an American oil company recently gave up one of the hardest-fought battles in oil-drilling history, when a "wildcat" well sunk in Alaska brought only a "duster," or dry hole, at a depth of nearly a mile.

For three years a crew of sixteen men, cut off from civilization most of the time, and with only a radio set to keep in touch with the outside world, drove steel tools down through the deepest hard-rock strata ever encountered in oil drilling. While they worked, gales blew their supply ship ashore, lifted the lighters up on the beach, and whirled the camp stable away with the horses inside; blizzards buried the roofs under snow; volcanoes turned the snow black and blinded the workers with fine sand and powdered lava; spring rains made roads impassable and floods washed their bridges away.

And after more than three years' work, that cost countless thousands, they ended up with a dry hole, 5,034 feet deep!

The story of the search in Alaska for more oil to keep America's automobiles running goes back to August, 1922, when

the crew of sixteen sailed out of Seattle harbor on a chartered ship with a complete outfit for drilling one well. The equipment included lumber for the derrick, machinery, drilling tools, a mile or more of well casing, two ten-ton tractors, supplies for the men and fuel for the equipment, and the wireless outfit. Their destination was a spot on the Alaskan peninsula, that long arm that stretches westward toward Asia, and seventeen miles inland, across two mountain ranges, from Portage Bay.

It took nine days' sailing to reach the bay, and then seventeen more just to lighter the cargo to the beach, swept day after day by the williwaws—the fierce and sudden storms that later brought one of the round-the-world flyers to grief not far away and sent the well drillers out to aid in the hunt for him.

Once on the beach, they had to build a road to the drilling site, over the two ranges of mountains and across several miles of swamp. Working through the winter blizzards, they built the road, moved the equipment to the site, erected it and, in March, 1923, the well was spudded in. It was just three years later, al-

most to a day, that work was abandoned. "The outstanding feature of this wildcat well," says the final report, "was the amount of hole made in hard formations. Very often no more than a foot of hole per day was made during the first 1,600 feet of drilling. Deeper wells than this have been drilled and harder formations encountered, but it is believed that, in all the annals of well drilling, there is not another instance where bits were called upon to penetrate to the depth attained through formation of equal hardness."

The best story of the three-year fight, however, is told by excerpts from the radio reports of the drilling crew:

"Nov. 5, 1922. Our mechanic thinks this is the hardest test tractors ever were subjected to. It keeps two men employed at repair work most of the time. Average time of the trip from Lake Becharof to location with a load of three tons is about ten hours. The latter part of the week we

went through one of the worst blizzards to date. We had a storm no one could face and live long. Our men were driven into camp at Lake Becharof.

"Nov. 26. On the night of Nov. 25, we sent the 'Pilgrim' [their supply boat] to rescue the crew of the 'Grizzly,' a gas-boat freighter. They had been nine days on Jute island and were seen from the mainland by a native trapper, who informed us. Enough food and blankets had been salvaged before the boat broke up to keep them alive.

"Jan. 1, 1923. Conditions have changed entirely this week, due to the cold north wind. We have had some snow and cold weather which froze the ground and streams, making it difficult to get down to Ugashik creek. Both of our tractors broke through the ice, damaging the radiators. On Dec. 24, Mt. Pavalo and Mt. Moses broke loose on the peninsula, some distance west of us, and threw enough

ashes and sand on the mountains around our camp to darken the snow. The fine sand was painful to the eyes of those out in the wind.

"Jan. 14. The latter part of the week has been one of very severe weather, accompanied by N.W. wind which drifted the snow so as to bury our road. Some idea of the fierceness of the wind may be had from the fact that it blew down a part of our warehouse, carried three-inch planks for a distance of fifty yards and tore strips of corrugated iron in two pieces.

"Feb. 11. The ice commenced to drift out to Lake Ruth and was the cause of washing a part of our bridge away. The lumber was recovered and the bridge replacement begun.

"March 4. March entered in true form with a severe blizzard, but soon

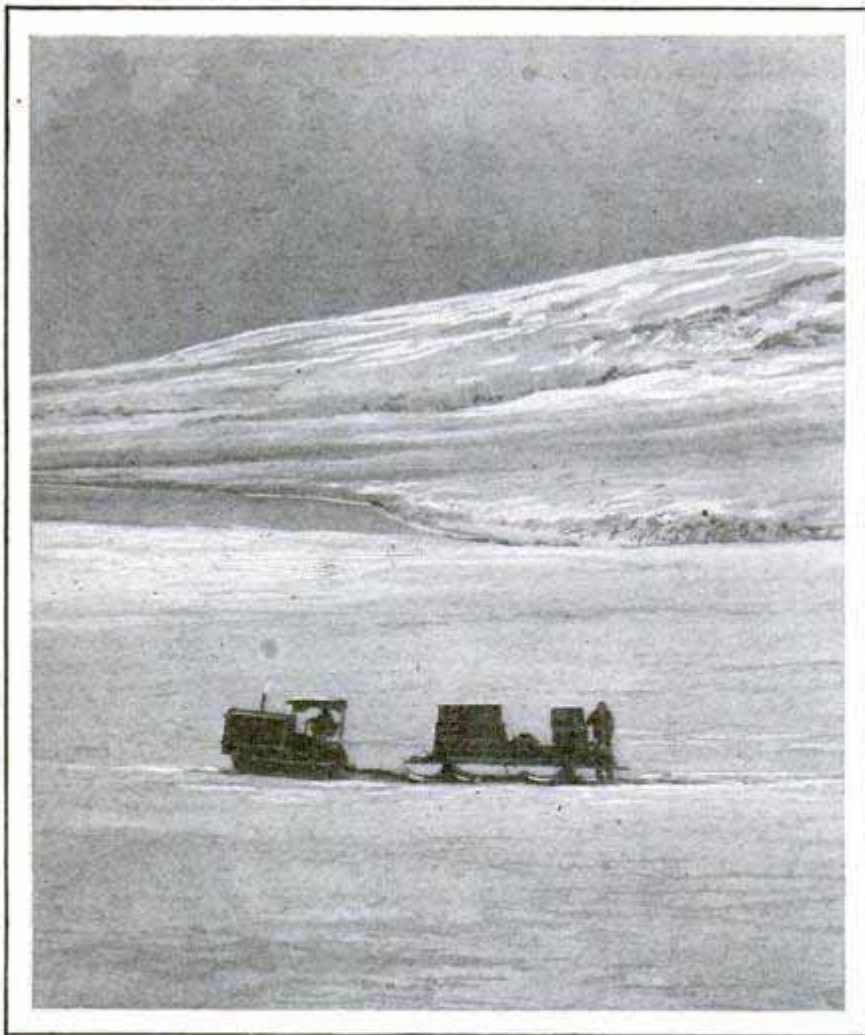

Sledding In the Supplies with a Tractor-Drawn Sledge, Battling Along over Windswept Ice of Lake Becharof

2129

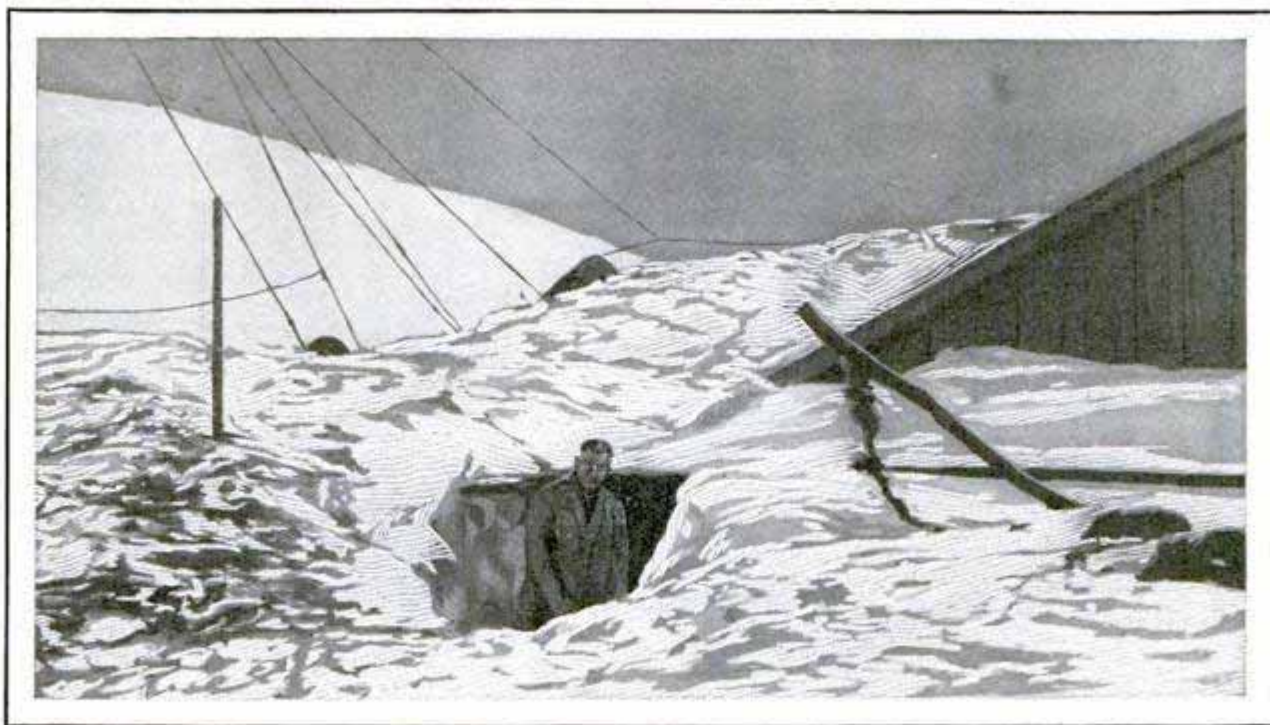

Frequently Howling Blizzards Covered the Camp with Snow, Requiring Tunnels to Reach the Doors, and Then Spouting Volcanoes Flecked the White Waste with Sand and Powdered Lava

changed to milder weather, and we were able to get through the pass with a tractor and four horse loads of provisions. We started over with a load of drilling tools; the stem broke down the sled on Becharof hill, and we were obliged to go to camp for another.

"April 7. The latter part of the week we have been compelled to use the trailers on account of the lack of snow on a great part of the road. The south winds have started melting the snow and thawing the ground so as to make our roads swampy and more difficult traveling in places.

"May 5. The roads have become almost impassable on account of the water from the melting snow.

"Oct. 20. Kanatak was badly damaged by the high tide and storm on Oct. 12 and 13. There was no loss of life. Buildings were washed away and boats and barges washed into the center of the town.

"Dec. 30. Very severe weather during the month, necessitating a twenty-four-hour shut-down. One can readily believe that the wind blows in Alaska, as our barn at the camp, which is fourteen by sixteen feet with two-inch plank floor, and with a horse inside, was carried (horse and all) a distance of forty feet during one of the storms. On Sunday night, Dec. 9, in a blizzard and rough sea, the S. S. 'Starr' went on the rocks on Raspberry island,

coming from Kodiak. Mr. Wright (our wireless operator) was trying to connect with the 'Starr' when, about 7:25, he heard their SOS calls for help. No help was near. Their lifeboats, covered with ice, sank as soon as lowered. We heard all messages asking if help were coming; that they were sinking, and the operator's farewell message to his wife. At 11:30 p.m., the boat slipped off the rocks, righted herself and floated, and they were able to anchor and keep afloat until towed to Kodiak.

"Jan. 15, 1924. Mt. Ravalof erupted today, throwing out ashes and clouds of black smoke. A series of earth tremors occurred, lasting about seven minutes.

"Jan. 30. The 'Starr' arrived today and attempted to discharge freight. In landing the mail and passengers, one man's face was frozen and another man's fingers.

"Feb. The first week in February was one of the worst continued spells of cold weather we have experienced. It has been from ten to twenty-two degrees below zero, with a north wind. Many days a dog team could not travel. Our water lines, although well covered, have frozen and our cookhouse is entirely covered with snow. On Dec. 2 the 'Viking,' one of the best equipped gas boats on this coast, was obliged to come into Portage Bay on account of bad weather. The 'Viking' carried a party of San Francis-

cans who had been hunting bear along the coast. All of the party and crew, except one, came ashore. At 5:00 a.m. the boat broke anchor and drifted out to sea. No hope was held for the safety of the man, as the worst of the storm followed his disappearance. We notified all stations of the boat being adrift, but nothing has been heard or seen of man or boat since. (In a later report it was announced that, two months after the incident, the man was found living on a small island near Kodiak, having salvaged enough material from the wreck to keep alive.)

"March. As usual, experiencing bad weather and the road through Ugashik was completely obliterated during the last week in February. It was necessary for the tractors to pass over drifts eight to ten feet deep.

"June. The snow is melting and the bunkhouse is now in sight.

"April, 1925. We have had the heaviest snowfall of the season, and it has drifted badly. Guide stakes, four and five feet high, along the trail are entirely covered. We came near having to make a survey to locate our horses one morning this week. A hole, five feet deep, was dug before striking the highest part of the barn.

"July. We have experienced no such rainfall and high water as we are having this week. Considerable damage is being done to roads, and transportation is difficult. The barge was blown loose from moorings and carried high and dry on the beach."

And so it went on until March of this year, when work was finally stopped, the tools pulled from the dry hole, and the entire investment written down as another loss in the hunt for oil.

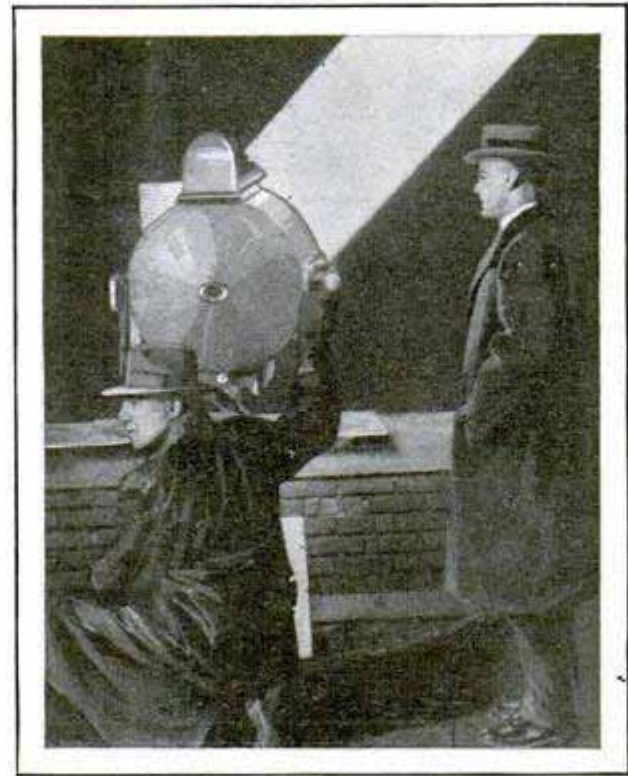

Measuring Altitude of Clouds with Powerful Searchlight; Observer Is at a Known Distance from Beam

2241
LIGHT TELLS HEIGHT OF CLOUDS

With the aid of a 42,000,000 - candle-power searchlight, attaches of the weather bureau at the Pittsburgh station are quickly able to measure the altitude of clouds. The beam is usually directed vertically upward, while an observer, at a known distance from the searchlight, focuses a theodolite on the illuminated spot to note the angular elevation from his position. He thus

has the base and an acute angle of a right-angled triangle. From these data, it is easy to compute the length of the light shaft to the cloud, its elevation.

2089
WIRE CUTTER ON AUTO FRONT HELPS FOIL BANDITS

Wire barriers stretched by bandits to obstruct pursuit are quickly removed with a powerful cutter a German has devised for attachment to the front of the auto. It does not interfere with the steering, is quickly fastened to the car and may be taken off easily when not needed.

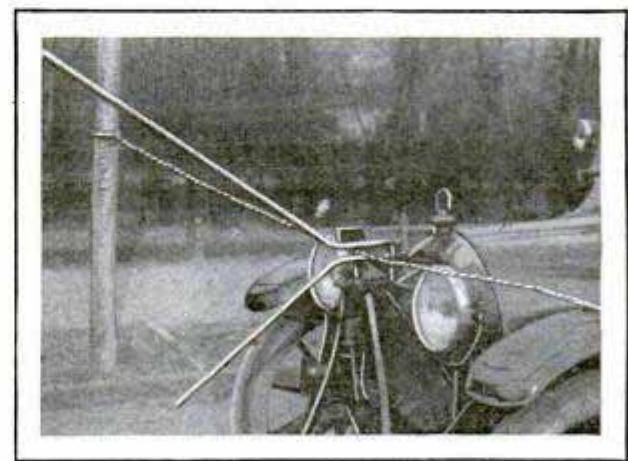

© Henry Miller
Wire Barriers Have Little Effect against This Auto Equipped with Powerful Cutter in Front

STEAMER DODGES HURRICANES WITH STORM FINDER

Radio, barometric-pressure charts and weather maps were used successfully by navigators on the cargo ship "Kittery" recently in sidestepping disastrous storms on the run between Hampton Roads and the West Indies. With the aid of data furnished them, observers were able to plot lines of equal pressure and thus calculate the rate of speed and the direction of travel of the hurricane or storm areas which are unfailingly indicated by troughs of low barometric pressure. The ship was either put back into port before the winds arrived or was steered out of their course. It is predicted that this system will come into general use.

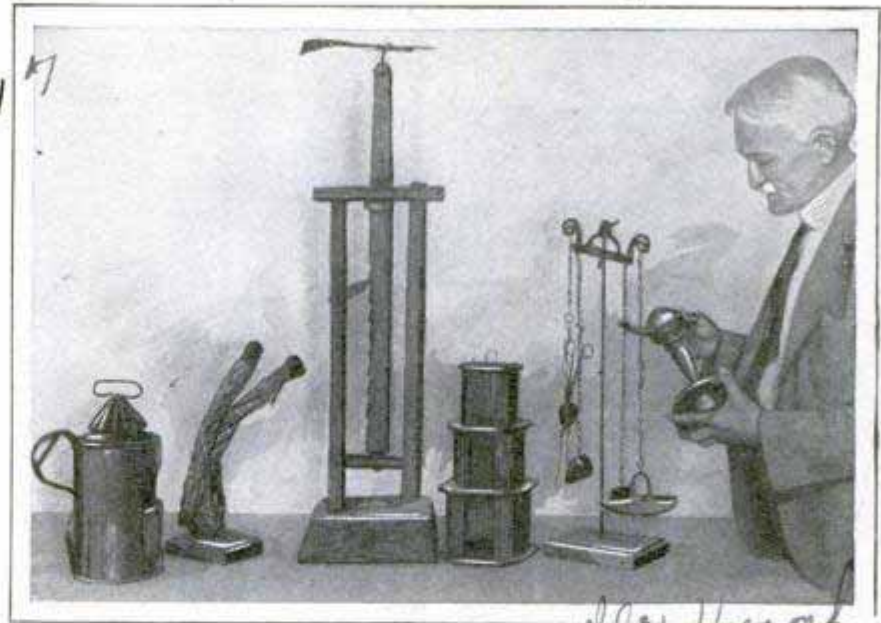

Part of Odd Collection of Lamps at Smithsonian Institution; Tall Object in Center Is a Finnish Pine-Splint Holder

QUAINT COLLECTION OF LAMPS TELLS STORY OF LIGHTING

Development of artificial illumination through the centuries is seen at a glance in an odd collection of lamps at the Smithsonian institution. Among them is a firefly lantern used by natives of the West Indies a century ago, a crude boat-shaped beam lamp, commonly seen in the fourteenth century, and a horn dark lantern with which households of Revolutionary days were familiar. A Spanish rosin torch shows how men found their way at night during the Middle Ages.

TIRE IS LOCKED WITHOUT KEY AT PRESS OF FINGER

To guard the spare tire, a lock that fits the carriers on most of the popular cars has an elongated nut which is attached in place of the regular unit and is equipped with a hardened-steel housing. This is fitted with a pin-tumbler locking cylinder which is secured with the fingers, no key being needed. The cylinder is provided with a cap to protect it from dust and weather.



Chicago Mingo Sales Co
1509 Michigan
HOSE CLAMP WITHOUT SCREWS
IS QUICKLY APPLIED
Victory 6740
1960
Held in position by spring tension, a hose clamp without screws is easily adjusted. A series of notches, raised on one side of the clamp, provides a hold for the spring fastener, which is tightened by a finger lever.

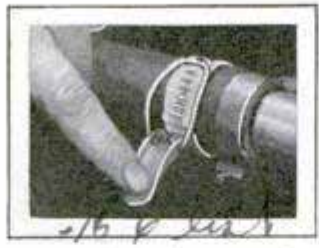

ANTS LIVE FIFTEEN YEARS

Long life as well as great strength is a distinguishing characteristic of the ant. The queens of some species live fifteen years and longer. The workers, which are undeveloped females, live four or five years, while the male ants are short-lived, like the drones in the bee colony.

Phila. Inquirer
2166
Snap-Lite Clamp Co. Inc.
110 W. 14th St. New York

Phila
St. P. Phila
Products Corp
Automotive
4647 1/4 St. 18th
45.00
44.50

AUTO DRIVERS' SKILL IS TESTED IN STRANGE RACES

2084

in Germany.



Tests of Steady Driving; in a German Contest, a Motorcycle Rider Guided His Machine between Traps That Fired Shots, if They Were Struck, and, at Upper Right, an Autoist Trying to Halt His Car Exactly at the Barrier Connected to a Horn Which Sounded if Board Was Pushed beyond the Mark

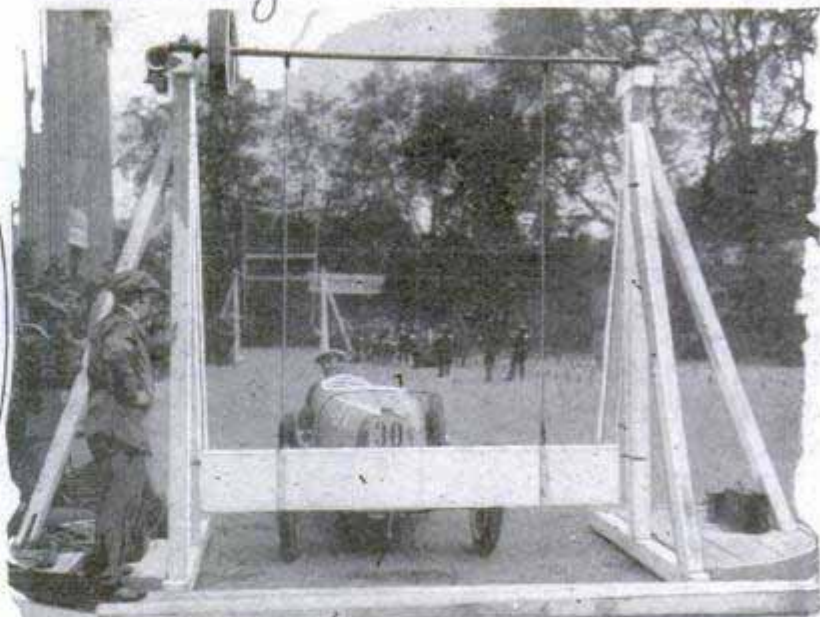

A German Run between Wine Bottles, and Below, a Similar Test on Curved Roadway at a Denver, Colo., Trial; in This Test, 314 Women Attempted the Feat, but Only One, a Sixteen-Year-Old Girl, Made a Perfect Score



German Air Service *And. Norman Perrigo*
Aere POPULAR MECHANICS *Regina Hotel 457*
Los Angeles, Calif.

WIRELESS PHONES ON AIRSHIPS
LATEST TRAVEL LUXURY 2316

Experiments with wireless telephony from moving airplanes have proved successful in Germany and it is reported that the equipment soon will be added to other conveniences on several of the big liners of the air. A passenger thus will be able to talk with any subscriber in any large city in Germany while speeding on his journey. Motion pictures and phonograph music already have been furnished for patrons. One of the features of the wireless-telephone system is the overcoming of the noise from the three 120-horsepower motors. *NY Herald 6/27/26*



Sample of Sidewalk Street Numbers for Houses; the Numerals Glow in the Dark

2128
ELECTRIC HANDSAW OUTFIT
PERFORMS MANY TASKS 2128

Driven by a 110-volt motor, an electric handsaw is like a portable woodworking plant, for it can be used with a straight blade, a table saw for cutting at angles up to forty-five degrees or cross or ripping, and is provided with attachments for dadoing, fluting, boring and other operations. As a circular handsaw, it weighs but sixteen pounds, ready to run, and the seven-inch blade develops a speed of 4,737 feet a minute at the teeth. A miter square and ripping guide, miter box for cutting at any desired bevel and angle are furnished and the straight-blade reciprocating saw attachment will take material up to eight inches in thickness. The borer operates at any angle in an arc of ninety degrees relative to the saw frame. On electric wiring jobs, for instance, it can be used between fourteen-inch joists and will bore within an inch of the underside of flooring.

HOUSE NUMBERS ON SIDEWALK GLOW IN DARK

House numbers in paint containing a radium substance and placed on the sidewalk where they can easily be seen at night, have been devised by a western inventor. They are said to glow with sufficient light to be plainly legible in darkness and are readily seen by day. Inclosed in a neat holder, they present an attractive appearance.

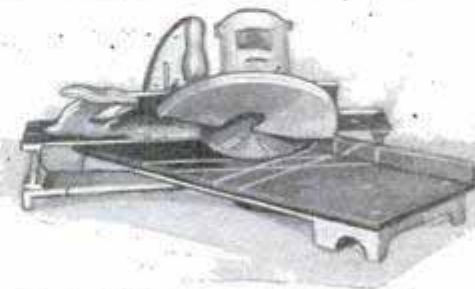
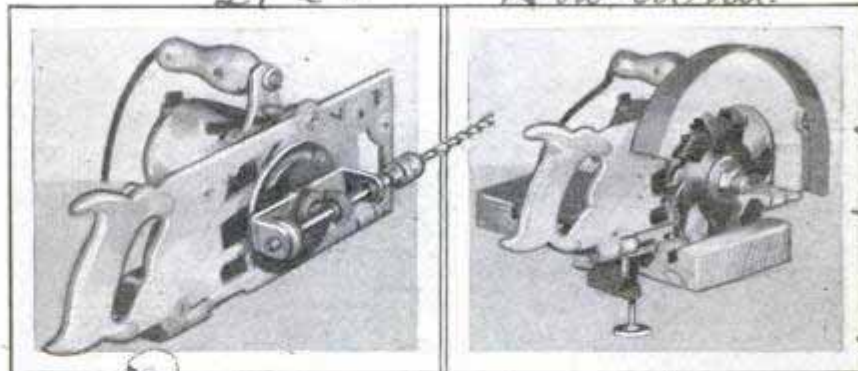

Illustrating Four Uses of the Outfit; Driving a Bit, Cutting a Groove, Operating Straight-Blade Saw, and in Miter Box

☐The Popular Mechanics' Bureau of Information offers its free service to all our readers. Names and addresses of manufacturers will be promptly furnished.

Pat. applied for by H. W. Howland
made by Torha Bros.

Distributed by Murray Jacobs
Electric Hand Saw Co 69 Columbia St
Seattle Wash

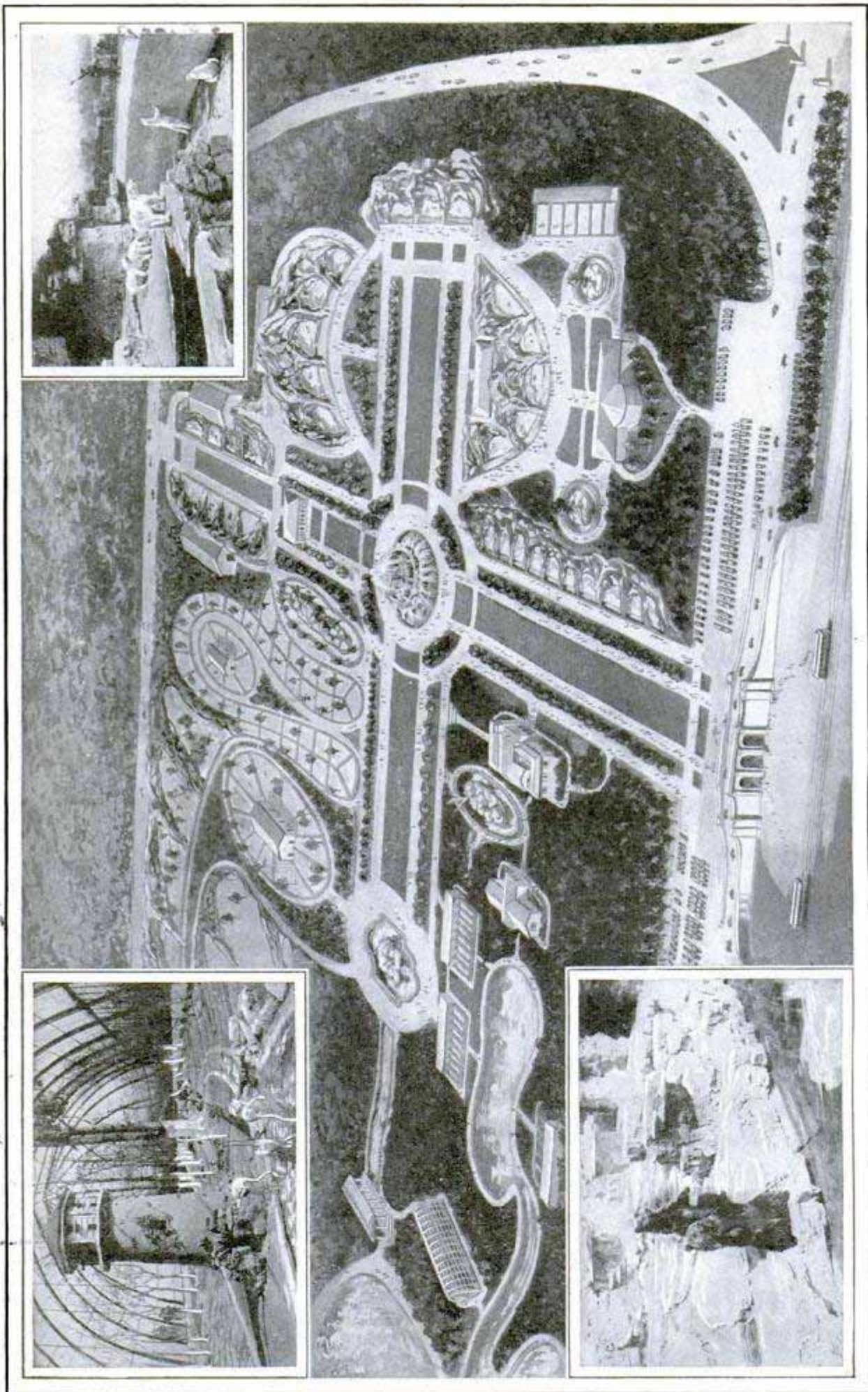

Architect's Plan for New Open-Air Zoo, Where Animals Will Roam in Barless Freedom; in the Inserts, Rock Dens of the Type to Be Used to House the Chief Exhibits, and, in Top Left Corner, Picture of a Flying Cage for Rare Birds

International

GREAT CAGELESS ZOO TO COST FOUR MILLION DOLLARS

2016

A vast open-air zoo, in which lions, tigers, bears and other animals will roam about in barless freedom, separated from the spectators only by moats and running water, is to be built in the forest preserves just outside of Chicago as result of approval by the voters of a \$4,000,000 bond issue for the project. Work is to start this year and about two years will be required to complete the project.

Plans for the zoo, prepared after study not only of similar institutions in America, but also of the big open-air zoos of Rome and London, and the Hagenbecks, at Hamburg, Germany, provide for groups of animal dens built up of cement to imitate natural rock fastnesses. The imitation walls will be carefully undercut just enough to prevent the animals from climbing into the neighboring pits, while across the front a deep moat will make it impossible for them to reach visitors. In addition to the open dens there will be permanent winter homes for the more delicate animals; year-round buildings for those from tropical climes; an insect house modeled after the one at the London zoo; an indoor bird house and a vast flying cage for the birds that can be exhibited in the open.

The zoo will occupy one end of a big tract of land donated for the purpose by the daughter of John D. Rockefeller, and the remaining part will be prepared as a picnic ground. An automobile drive will circle the entire plot, and, by passing over the roof of the main gate, will be so arranged that visitors on foot will not have to cross the drive at any point, protecting them against accidents. A creek winding through the grounds is to be dammed to provide canoeing, while its waters also will fill a series of artificial lakes and the moats. When completed, the zoo will be one of the largest in the world and will include features not seen in the United States before.



Rear View Showing Folded Cords of Parachute, Which Is Worn as a Coat

PARACHUTE AS BACK OF COAT INCREASES FLYER'S COMFORT

Fashioned so that it can be worn as a coat instead of being strapped on as a separate and cumbersome article, a parachute devised by a western aviator is said to have withstood actual tests successfully. It is constructed as part of the coat itself, being built into the back of the garment, and is opened by pulling a ring under the left shoulder.

DEEP-SEA FISH CAN WHISTLE

One of the strangest species of ocean fish yet discovered makes a whistling sound, and while edible at certain seasons, it is poisonous at others. Its body is illuminated by a row of phosphorescent spots along both sides.

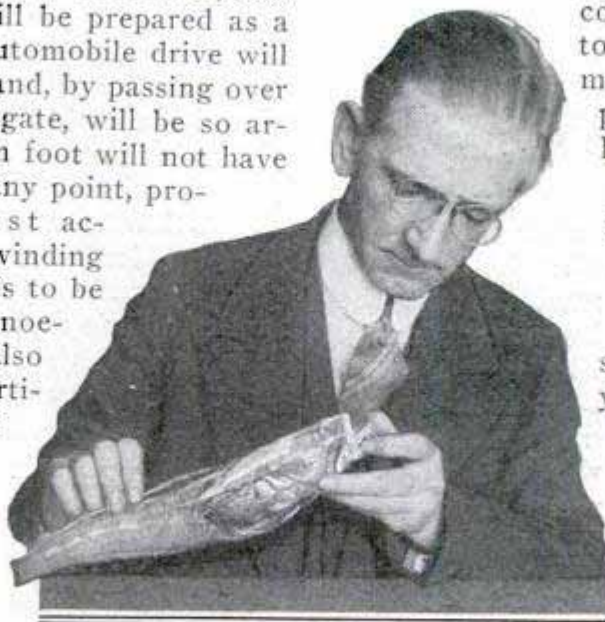

Examining Mouth of Curious Deep-Sea Fish Which Makes a Whistling Sound

E. S. Reid, Smithsonian Institution

1925

Hand Mc Clellan St. 538 Fremont Los Angeles, Calif.

International

1811

Edw. J. W. Coons of Pacific Gas & Electric Co., Woodland, Calif.

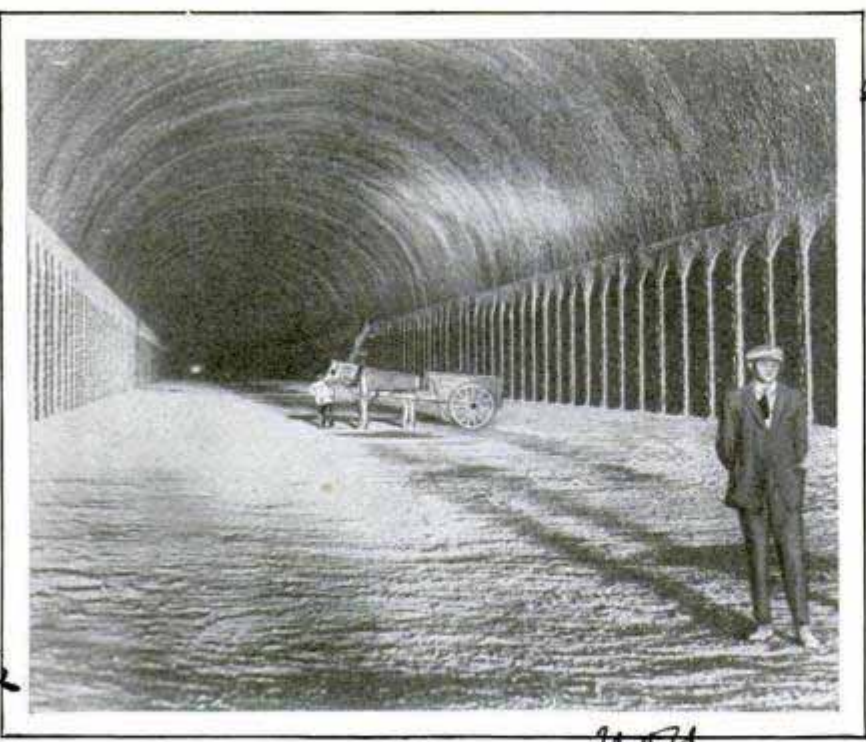

Where Ships Run through a Mountain; Section of Subterranean Canal near Marseilles, France, Before Water Was Turned In

SHIP CANAL RUNS UNDER HILLS THROUGH FOUR-MILE TUNNEL

What is said to be the longest subterranean canal in the world has been constructed near Marseilles, France, as part of a ship passage to link that port with a smaller one inland. For four miles, the canal runs under a chain of hills. In this section, it is nearly fifty feet high and seventy feet wide. Building it required an expenditure of more than half the total cost of the canal.

RAZOR DRIER ON LAMP SHADE SAVES TIME AND TROUBLE

Heat from the bathroom electric-light bulb is utilized by a California inventor to dry his safety razor so that he does not need to take the instrument apart. The light's shade is molded with a depression in which is fitted a metal box large enough to contain the razor. Its top is flush with the top edge of the globe so that it is not conspicuous. After rinsing, the razor is placed in this holder where it dries thoroughly before it is needed again.



POWDERING FOOD TO SAVE CROPS

2281 Pulverizing fruits and other crops in order to preserve them and keep their nutritive properties in concentrated form, has been the object of experiments by Prof. G. W. Cavanaugh of Cornell university. He believes that a reduction of waste can be effected by this method which has practically the same purpose as has been achieved with milk, which is now put up in powdered form that retains all its original substances and is shipped to great distances without spoiling. Should the pulverization

treatment prove successful with fruits and grains, farmers would be assured of a market for all their crops, Prof. Cavanaugh points out.

FOUNTAIN BRUSH FOR CLEANING HOLDS LIQUID IN HANDLE

1794 Cleaning liquids are carried in the handle of a brush now on the market so that the solvent may be supplied as needed and the bother of dipping into a basin is eliminated. A thumb valve and plunger are provided to feed the liquid to the brush, which is made up of alternate layers of bristles and felt and may be removed for cleaning. A tight-fitting brass cap for the handle prevents spilling the contents.



FOOT TRAFFIC PAST STORES HELPS FIX RENTS

2308 The relation of pedestrian traffic to rental values is being investigated by an association of building owners. Reports from several cities indicated that a traffic

L. B. Ermeling, Chicago, Executive Secretary, National Assn. Building Owners and Managers

Green & Smith Co., Boston, Mass. Bayleton St.

821

of 500 persons per hour means a revenue of \$100 a month for each front foot for the retail-store proprietor. On the same basis of calculation, the property owner generally figures that he can ask a rental of \$2 per front foot for each 100 persons passing each hour. From actual counts made in more than a dozen large cities, it was found that the south and west sides of the streets generally have the largest volume of foot traffic, although there are notable exceptions to the condition. One explanation of this is believed to lie in the fact that women shoppers, appearing in larger numbers in the afternoons than in the mornings, prefer the shady sides of the streets, while men are more numerous on the sidewalks in the mornings.

PHONOGRAPH RECORDS ON FILM TO REPLACE DISKS? 2072

Phonograph records are made on motion-picture film by a process developed in France. A comparatively short length will hold impressions that would require forty large-sized disks, it is said, and long speeches and musical selections may be reproduced without interruption. In making the record, a heated needle and a special solution are used to facilitate registering the variable sound waves on the film. Simplification of "speaking movies" is suggested and experts say that it may be adapted to "talking" dolls.

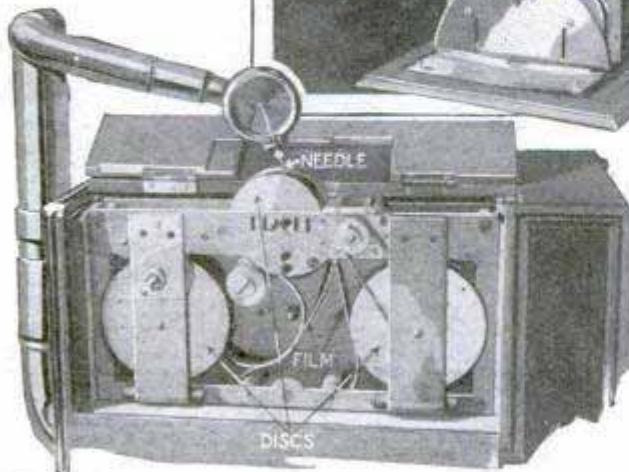

Views of the Film-Record Phonograph Showing the Winding Reels and Position of Needle

Inquiries to Frederic M. Deland,
22, Rue St. Augustin,
Paris France



Successively Flashing Lights Lead from Imitation Pump to "Tank" on Auto, Part of Filling-Station Sign

UNUSUAL GAS STATION SIGN SHOWS CAR BEING FILLED

Replenishing the auto gasoline tank is represented in a lifelike manner by a huge flashing electric sign at a mid-western filling station. Nearly 2,000 lights are used, some of them arranged to go on and off in series to imitate the flow of the liquid from and into the replica of a pump and others set to outline a reproduction of an auto as it appears at night.

Wellington, Ohio

WASHED SMOKE YIELDS FUEL

Most of the dirt is removed from smoke and saved for fuel by a washing system devised by an English engineer, it is reported. Fumes from the chimney are passed through a box in which a bladed wheel revolves and casts a fine spray as water is played on the spokes. This robs the smoke of its gases and fine particles of soot. The water is filtered, leaving a black residue, much of which is unburned carbon, and this is collected, dried and used as fuel.

Dr. H. M. Suddleton, Engineer, Manchester, England.

1821

Time and Money for Your



When There Is Ironing to Do, the Back of This Chair Is Converted into a Handy Board



Unightly Marks Are Kept from Carpets, Table Tops and Tile by Means of This Rubber Rim That Fits Bottom of Pails and Jugs



Electric Iron with Water Reservoir Eliminates Sprinkling

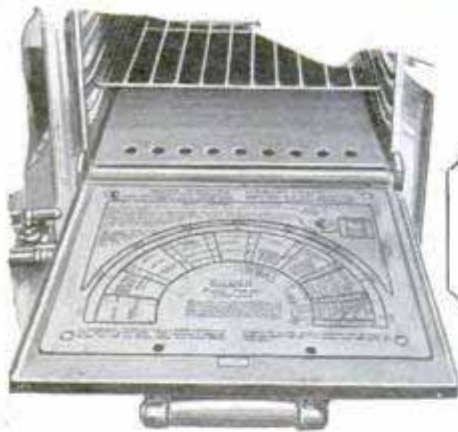

Burned to the Oven-Door Lining, This Cooking Chart Cannot Get Torn and Is Always Accessible



Electric Ironer Run from Light Socket Has Switch Giving Three Degrees of Heat

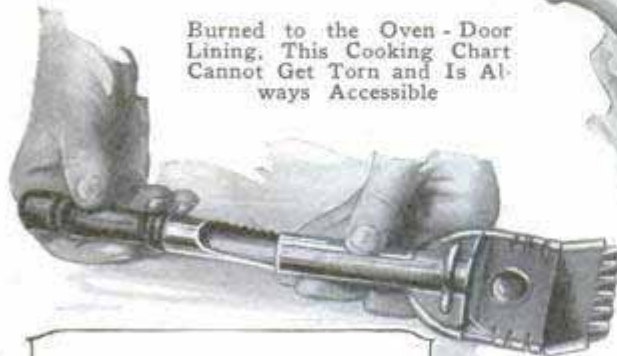

Handle of Cabbage Slicer Serves as Apple Corer

Anyone wishing further information on devices described in the editorial pages can

Saving Things Home

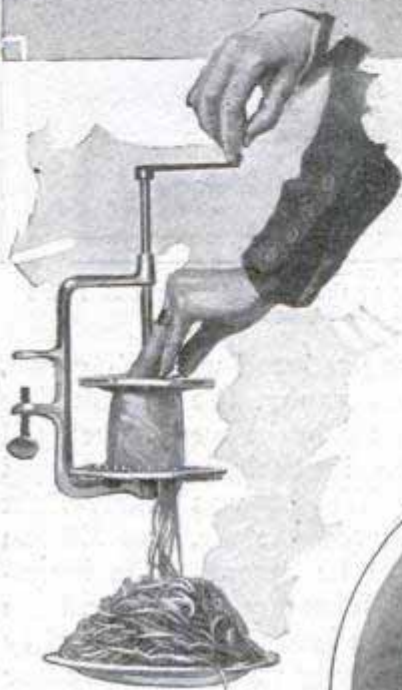

To Save the Hands,
This Rapid Fruit or
Vegetable Slicer and
Shredder Prepares
Foods in a Number of
Different Ways

Fur Coats and
Other Garments Are
Protected from
Moths, Dust and
Dampness in Metal
Vault Which May
Be Built into the
Wall or Used as
Separate Article of
Furniture; the Cab-
inets Are Air-Tight
and Permit Thor-
ough Fumigation



Marcel Waves at
Home with Electrically
Heated Iron



Fruit-Jar Sealer and Open-
er Smooths Kinks in Old
Caps



Trousers Press
in Back of
Chair Opens
like a Door

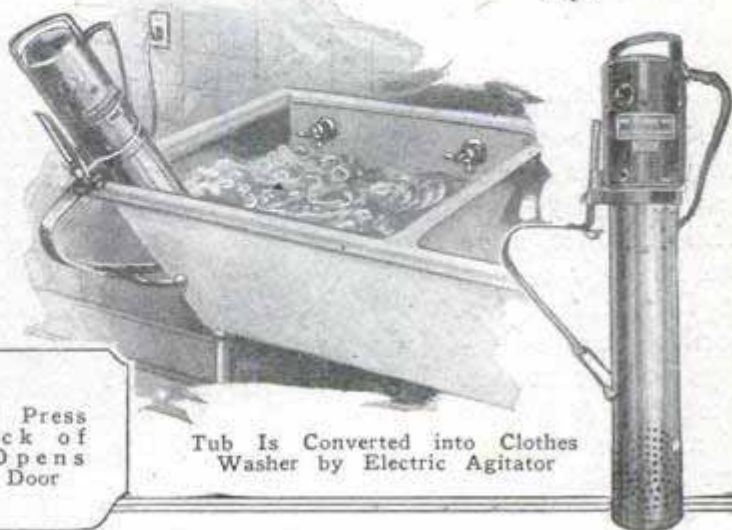

Tub Is Converted into Clothes
Washer by Electric Agitator

obtain it by addressing Bureau of Information, Popular Mechanics Magazine, Chicago.

1965

Cook - John Schumann, Box 1061,

St. Augustine, Fla.

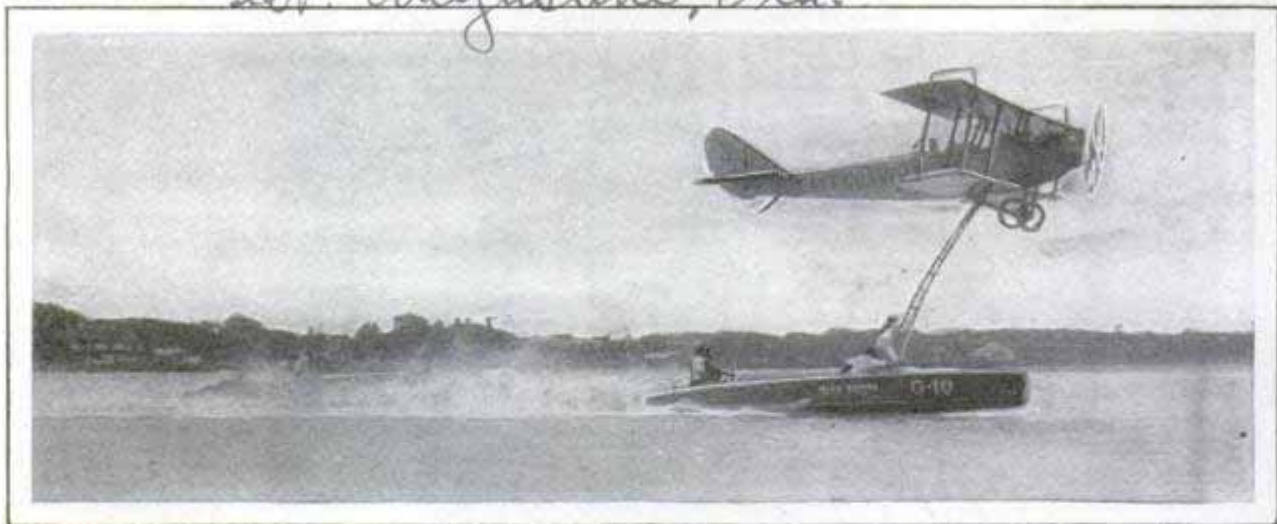

Miss Cody About to Leave the Speeding Motorboat and Climb the Ladder to the Airplane; Several Trials Were Necessary Before Success Rewarded Performers and Photographer

**GIRL IN THRILLING MOVIE STUNT
LEAPS OFF BOAT TO PLANE**

1965

While the boat was traveling at high speed, Miss Mable Cody, niece of the late Buffalo Bill, stepped from its deck, caught a ladder swaying from an airplane roaring above her and climbed up safely while a motion-picture camera recorded her daring deed. The stunt was done near St. Augustine, Fla., and required four days for successful completion. In one trial, spray from the speeding boat fogged the camera lens; in another, the photographer was too far from the boat and in a third attempt, the plane crashed and the boat caught fire.

inventions were produced was thirty-two, but wireless telegraphy, the self-binding reaper and the air brake were developed largely by men in their twenty-second year. Wilbur Wright was thirty-eight when he conquered the air, and Edison was thirty when he invented the incandescent light. The steam turbine and the steam engine were invented by men thirty years old, the sewing machine's inventor was twenty-six, and the discoverer of the process for the cheap production of aluminum was only twenty-three. Some statesmen and generals do not reach their peak of power until past seventy.

2065

**LAWN SHEARS ON
STICK HANDLE SAVE
KNEES AND BACK**

**YOUR BRAINIEST
PERIOD OF LIFE**

2/6

Inventors seem to produce their best work between the ages of twenty and thirty-five, and military genius develops at fifty-five, while business men are in their zenith at fifty-three, according to the findings of scientists. Research shows that the average age at which twenty of the greatest



Trimming the lawn edges without kneeling, crawling or soiling the hands or clothing can be done quickly and easily with shears fixed to a swivel at the end of a hardwood standard and operated by a pair of handles, waist-high. The blades can be adjusted to different angles for cutting around shrubbery or hedges.

Trimming Lawn Edges near Sidewalk without Having to Stoop; Shears Also Cut and Trim Shrubby

Perfection Store Co.,
7609 Platte Ave
Cleveland, Ohio.

Int Bits
6/6/6

Kans. City Star
6/8/26

Lectro - Shine.

Drum Boygia

OLD FALLACIES ABOUT FOOD
REFUTED BY DOCTORS 178

Like heirlooms, superstitions are handed down from generation to generation and some of them which have gathered about food and eating habits often have been detrimental to health, physicians assert. As an example, they cite the widespread belief that tomatoes thin the blood. This mistaken idea probably is the result of a queer mental twist. Tomatoes are red like blood and juicy, but thinner than blood, therefore they must thin the blood. But doctors declare that the fact is that the vegetables are exceedingly healthful and their juice is widely fed to babies, as a substitute for that of the orange, to promote growth. The belief that milk and acid fruits eaten together curdle in the stomach and therefore produce ill effects is also widely held. If they do curdle, doctors see no cause for alarm, because milk goes through this reaction with the gastric juice as soon as it reaches the stomach. Many women spend hours soaking cucumbers "to draw off the poison" without stopping to think that if the peel really were poisonous, the injurious substances would soak all the way through the cucumber. Special foods are in wide demand in some parts because they are said to be rich in helpful iron content. Ordinary lean meat, spinach, carrots, lettuce and egg yolk are considered sufficiently filled with iron to supply the normal body needs. That fish is a brain food is another common cookery delusion.

BOYS IN RAT AND INSECT GARB
WARN AGAINST PESTS 1679

Boys dressed like rats and mosquitoes learned to imitate the movements of the pests as a means of warning persons attending the exhibits shown during baby week in Bombay, India. The costumes all but concealed the actors, who illustrated by pantomime how the mosquito inflicts its poisonous bite and how the rat carries disease and destroys food as well as other things.

Electric Shiner in Operation; Extra Brushes Are Kept in Rack; Footrests Fold Back and Current Is Shut Off Automatically



ELECTRIC SHOE-SHINING STAND
SAVES TIME AND WORK

A motor-driven set of brushes and folding footrests are features of an electric shoe-shining outfit to replace old-fashioned hand methods. Brushes can be changed while the motor is running, three being used generally for one shine, a cleaning brush, the polisher and then a finish rub with a yarn brush. Lifting a lever when the shine is done, automatically folds the footrests back and stops the motor. Each shine is registered on a counter. It is said that patrons do not have to brace their feet when the brushes are used and the movement of the polishers imparts a pleasing sensation.

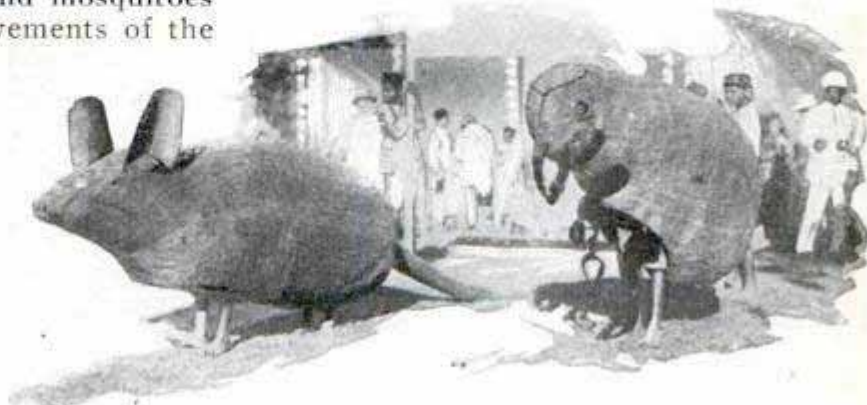

Indian Boy Actors in Their Pest-Masquerade Costumes during a Health-Education Exhibit in Bombay

Keystone View Co.

211

Johnson Elgin Ill. not being made. 1/3/26
Hasty

593

Carl L. W. Pedrose
617 Pacific Block
FIRST MODELS OF NOW FAMOUS INVENTIONS
Seattle Wash.



One of the First Vacuum Tubes Invented; It Is Seven Feet Long

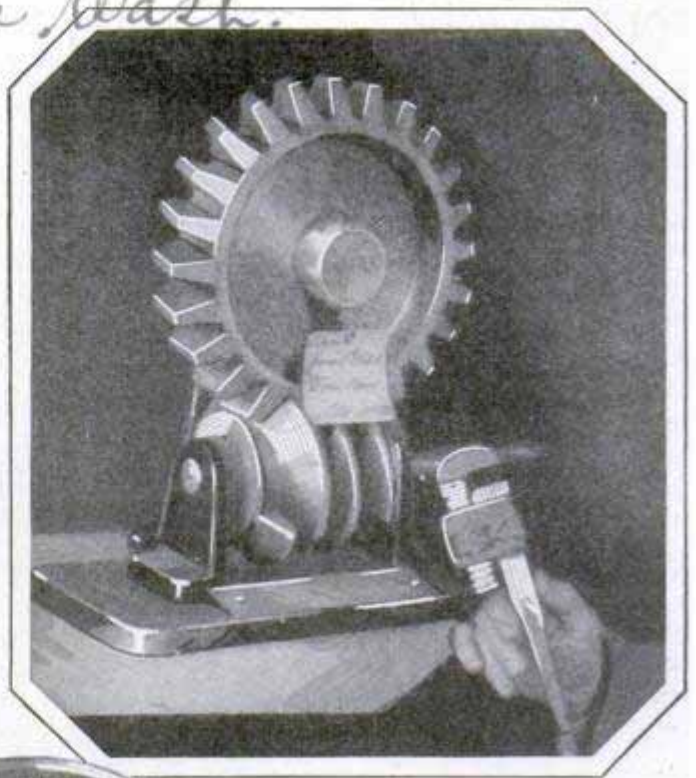

Original Model of Stillson Wrench and a Driving Gear, Early Patent-Office Relics

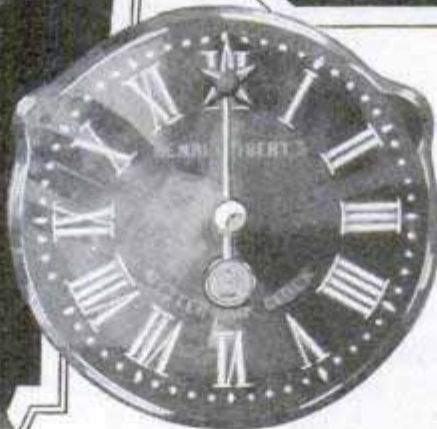

Famous Mystery Clock of 1879; the Mechanism Was Hidden in the Counterweight

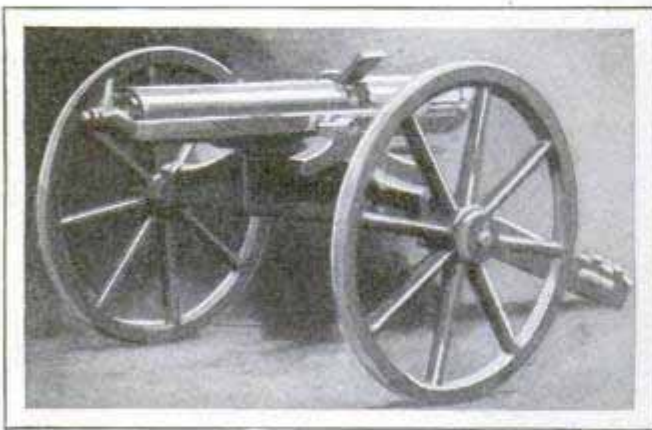

Above, Model of Rapid-Firing Gun and, at Right, Disappearing-Gun Model Devised by James B. Eads, Famous Bridge Builder



SIGN CONVERTED INTO MOVIE BY COLORED LIGHTS *219800*

By means of changing colored lights, the illusion of moving signs is produced on a patented billboard. Red, orange, magenta, pink and yellow lettering against a white background, appear to vanish when a red light is turned on but stand out in bold relief against black when the same color of illumination is used. With blue-green and other shades of light, similar quick changes are produced.

new York Edison Co.

IMPROVED AUTO-OIL FILTERS TO REDUCE WASTE *2146*

Crankcase oil is said to be thoroughly reclaimed at the rate of two and one-half gallons an hour and at a cost of less than nine cents a gallon in an apparatus a mid-western firm has introduced. One of its special features is the use of secret chemical preparations in the filters. They are said to remove floating carbon for which they have an affinity. Oils of little or no lubricating value are driven off by electric heat while water and sludge are removed by gravity. During the reclaiming process, a high-grade light oil is extracted which may be used as a lubricant for typewriters and fire-arms, or for fuel. It is estimated that American motorists throw away at least 200,000,000 gallons of old oil every year. Reduction of this waste and increase of the length of service, are regarded as important next steps in automotive economy. Bureau of standards tests have shown that lubricating oil does not wear out, while some experts declare that oil which has been reclaimed thoroughly is better than the original.

Ans Peter Wiederhold

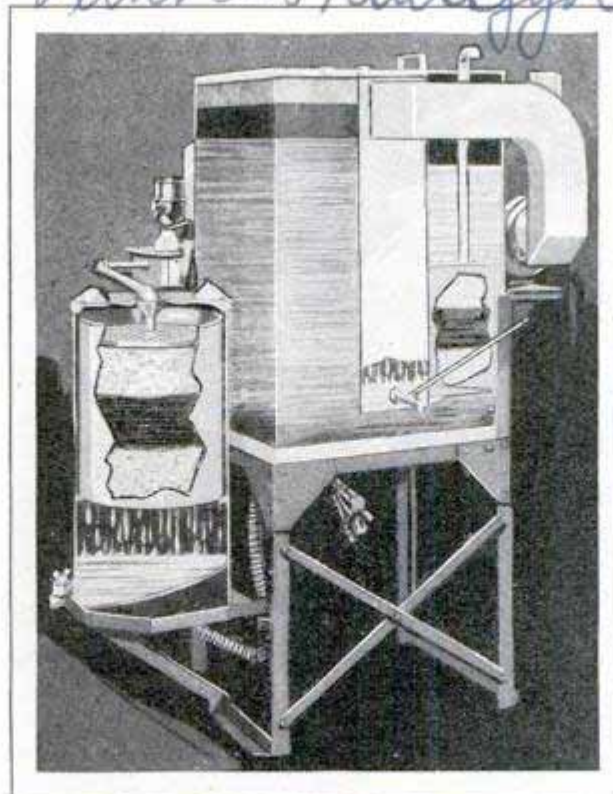

Sectional Sketch of Filter; Reclaimed Oil Is Dripping into Bottom of Tank at Left



Embalming a Gas Main; This Expert Taper Can Cover a Twenty-Foot Length in Two Minutes

GAS PIPE EMBALMED IN TAPE TO PROLONG LIFE

Several miles of gas main laid in southern Illinois were coated with tar and other ingredients, wrapped in linen tape, and then covered with a special paint. It is believed that this treatment not only will prevent leaks but possibly prolong the life of the pipe from an average of about twenty years to more than a hundred. The "embalming" was applied after the lengths had been welded and tested under high air pressure. Some of the wrappers became so expert that they could tape a twenty-foot length of pipe in two minutes.

*Plan of Illinois Paper and Light Corporation
 231 St. Charles Chicago*

☐ In its brief lifetime, a silkworm spins about 4,000 yards of thread.

*The Wiederhold Co.,
 5126/3-3947 Bellevue Ave.*

Detroit Mich

Things To Avoid in Buying a

By A DEALER

THERE are two vital facts necessary to know in order to obtain a bargain in a used car—when the car was built and how far it has been driven.

Another thing which must not be overlooked is the personality of the owner and his reason for selling. Many owners are good salesmen and have an inflated idea of the value of their old cars.

When I deal with such a man, I listen patiently while he tells me how good his car is, and when he is finished, I ask him to give me a ride. I make him do the driving and select the roughest and most crowded streets I can find.

Then I keep my mouth shut and my eyes on his feet. Almost invariably this greatly embarrasses the seller and he stalls his engine, clashes his gears and generally becomes so self-conscious that he makes a very poor demonstration. The result is to deflate his idea of his car's value and make him more ready to accept a fair price. I have saved thousands of dollars by this one trick.

Don't forget that there is a wide variation in cars even of the same make and

model. A cylinder block may be properly aged for months in the open before it is machined, or it may be pickled in an acid bath to hurry production. There is no way for the buyer to tell the difference. But it is a pretty safe rule to figure the life of the average car at 30,000 miles. There are exceptions, of course, but usually this is the point where the cost of the repairs, such as cylinder grinding, taking up main engine bearings and fitting new pistons, become prohibitive. So the first point is not to buy a car that has gone more than this distance and to figure the transportation you are getting as the difference between 30,000 miles and the number covered by the car.

Obviously the real value of a car is represented by the miles of service remaining in it, but the depreciation is figured almost entirely on its age. Thus depreciation of the average new car is figured at thirty per cent in three months, forty-two per cent in a year, sixty-four per cent in two years, and at the end of three years it is worth

Smoke from the Exhaust May Indicate Worn Cylinders, Which Would Make Necessary a Costly Regrinding Job

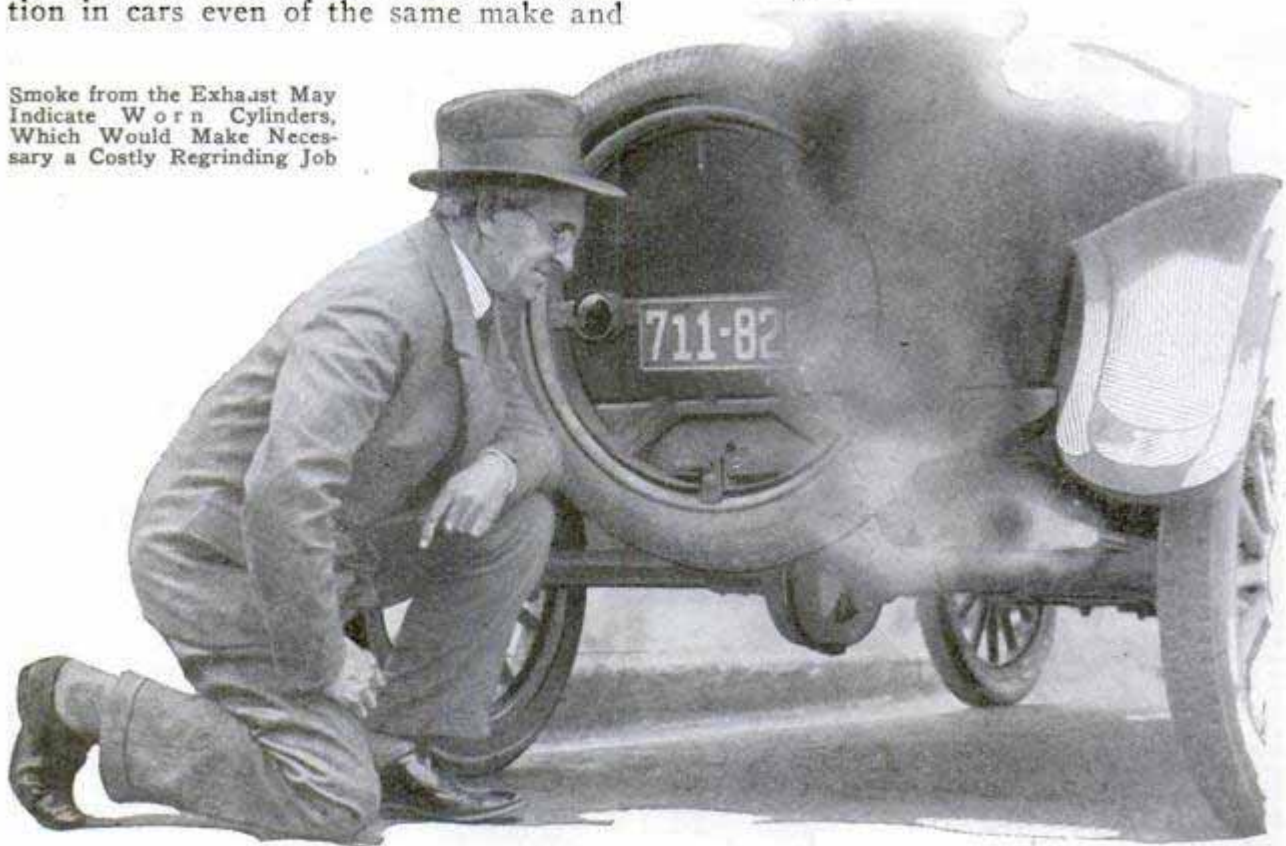

Used Car

only twenty-seven per cent of its purchase price. Therefore, be sure of the exact age of the car you are thinking of buying. Don't take the owner's word for it, but check the model number with the dealer.

Although it may only have been driven a few hundred miles, the value of a \$1,000 automobile at the end of three months is estimated at \$700, after a year at \$580, and when three years old at \$270. Suppose it has lain in storage most of this time and the speedometer only shows 2,000 miles. Obviously it is a bargain, for you are getting 28,000 miles of transportation for \$270.

Again, suppose this same car was run 10,000 miles the first year and received good care. In buying it you would be paying \$580 for 20,000 miles of transportation. In this case you could use it for two years and then sell it for about \$270.

Of course, the first instance would have been the best buy, although you would have received little or nothing for the car after it had reached the 30,000-mile mark.

Next you must consider the condition of the car. Contrary to popular belief, the first thing that wears out in an automobile is the frame, the body comes next and then the clutch, differential and transmission, in the order named. The motor usually is the last unit to go. The frame is the foundation of the car and is called upon to absorb all of the road shocks. As a result, the rivets work loose, causing "weave," which in turn ruins the body. In such cases they must be replaced with taper bolts.

Of course, it is impossible to go over the frame without disassembling the car, but there is an easy test of its condition.

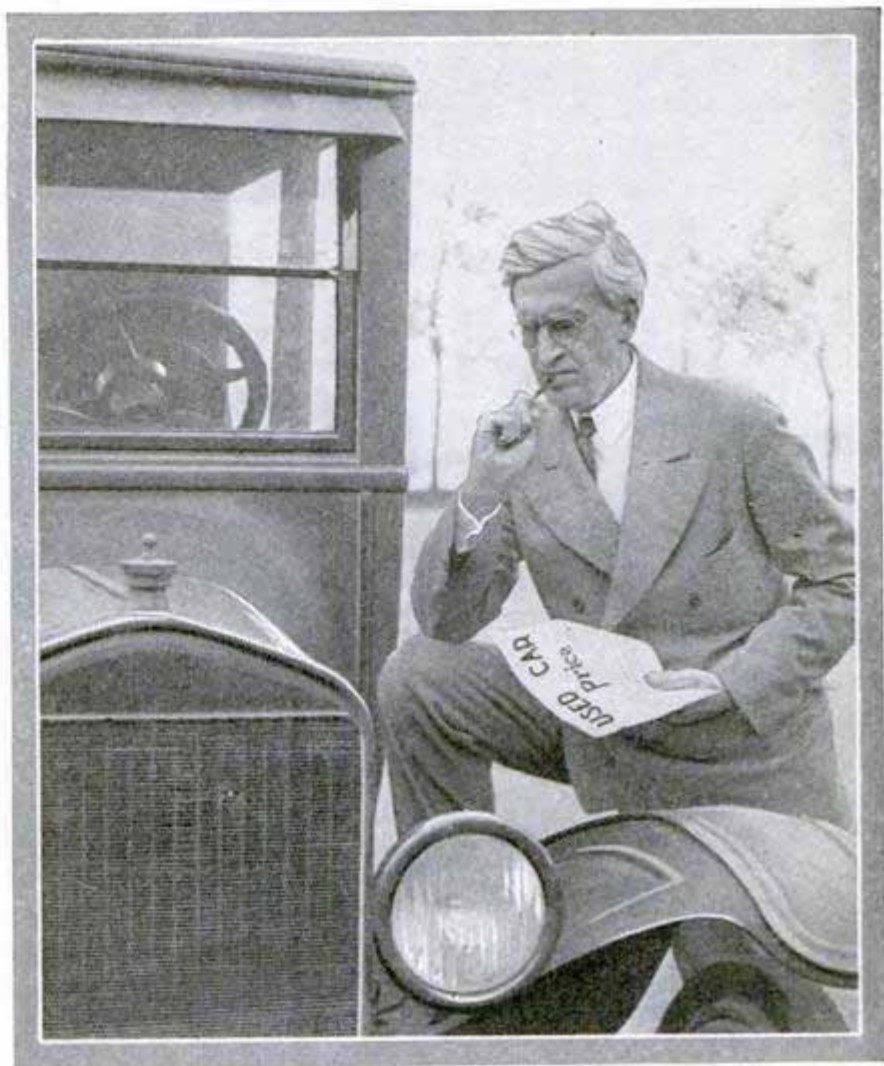

Drive one front wheel up on the curbing, stop the motor and then try to open the doors of the body. If they jam or bind when the car is in this position, don't buy it at any price. Also, make sure of the condition of the tires, as their replacement is costly. Standard tires, if properly cared for, should be good for from 10,000 to 18,000 miles or even more.

Then try the motor at various speeds, watching the exhaust. If it is smoky, that is a sign of oil pumping due either to scored cylinders or wear on the walls. If the car has gone under 15,000 miles and smokes, don't buy it, as this trouble is not normal and probably is due to scored cylinder walls, which will have to be rebored, or to badly fitted pistons. If, however, it has gone from 18,000 to 20,000 miles, some smoke may be expected and a new set of patent rings will give 10,000 more miles of service without regrinding and at small cost.

Some idea of the internal condition of the motor may be obtained easily, without removing the head, by taking out all

of the spark plugs. In the average four, the first and second cylinders, counting from the radiator, should show the most carbon. In sixes, numbers one and six

20,000 miles. The average car is at its best at from 12,000 to 20,000 miles, after which replacements are needed.

American manufacturers are building

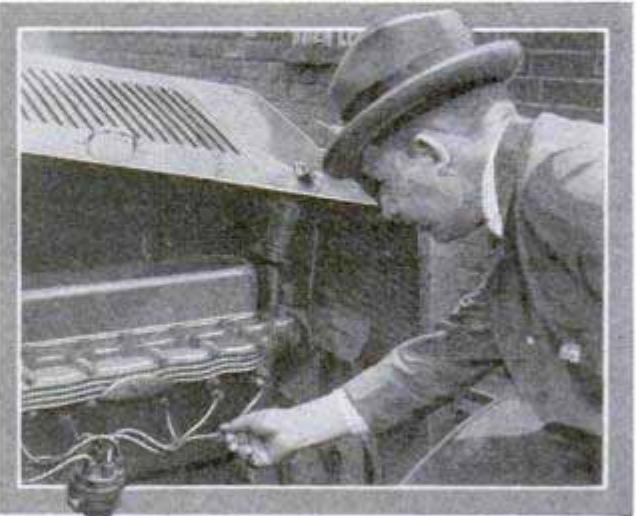

Put One Wheel on the Curb and Try Doors to See If They Bind; Also Inspect the Spark Plugs for the Uneven Formation of Carbon

have the greatest tendency to foul. If, then, in the four, more carbon is found in either number three or four than in one and two, this may indicate scored cylinders calling for a costly regrind job and new pistons and rings. The same is true of sixes. If more carbon is found in numbers two, three, four and five than in one and six, insist on removing the head to be sure none of the cylinders are scored.

If the average car has been properly cared for, the carbon will have to be removed at about 4,000 miles, the lower rods taken up at 7,000 to 12,000 miles, and new pistons or rings fitted at about 18,000 to

better and more sturdy cars than ever before. The days when some models developed weakness in certain parts are over, so that almost any good used car can be purchased on a mileage basis with the certainty of profit and pleasure.

In buying a used car, you eliminate the factory profit, dealer's commission and freight charges, and the market is filled with bargains capable of providing the most economical transportation available.

Above all things, make sure that the owner from whom you purchase has a clean bill of sale. Failure to do this may cost you the car and the sum you paid.

TINY THREE-INCH TYPEWRITER WEIGHS ONE OUNCE

What is believed to be the smallest typewriter in the world has been constructed by a Pennsylvania inventor after some fourteen years of work. Although but three inches in diameter and weighing only one ounce, it contains all the letters of the alphabet and has been used by the inventor in an-

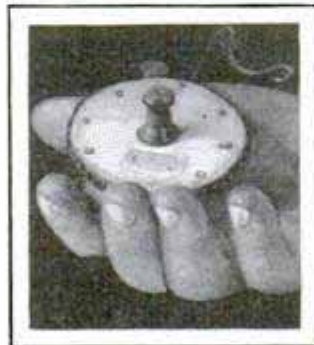

swering the many letters of inquiry he has received concerning the tiny machine. A central knob turns the disk to print the proper characters.

RANGE OF TREE SEEDS' FLIGHT TESTED IN DEEP SHAFT

To find out how far the wind carries seeds from trees, a series of interesting experiments were conducted by the forestry department in the 160-foot elevator shaft of the Campanile at the University of California. Twenty-seven lots of seeds were dropped from the top of the shaft and the time it took them to reach the cloth screens spread at the bottom was

1754

2143

d no. Mrs. Wetherill
3734 Walnut
Phila.

*U. S. Agent - Oliver's Holaprint
 Inc, Suite 1106, 1 Park
 Ave. New York City 471
 1568*

POPULAR MECHANICS

measured by a stop watch. Absence of appreciable air currents aided accurate timing. After the rate of fall per second was calculated, the approximate distance a seed would travel from a parent tree when exposed to winds of various speeds before striking the ground was estimated. It was found that many seeds journey farther than had been supposed. Seeds of the Sitka spruce, for instance, drifted down so slowly that even slight stirrings of air carried them temporarily out of sight.

COMPACT HOME WORKSHOP *1958*

Including a motor, jig and circular saw with special beveling attachment, wood or metal lathe, a drill and several other tools, a compact home workshop outfit now on the market can be assembled in a space no larger than that of the kitchen-table top. The instruments are not toys but real tools similar to those various manufacturing plants are using for lighter tasks and they are accurately made. The motor is run from the house-lighting circuit and arrangements are made for operating more than one machine at a time.

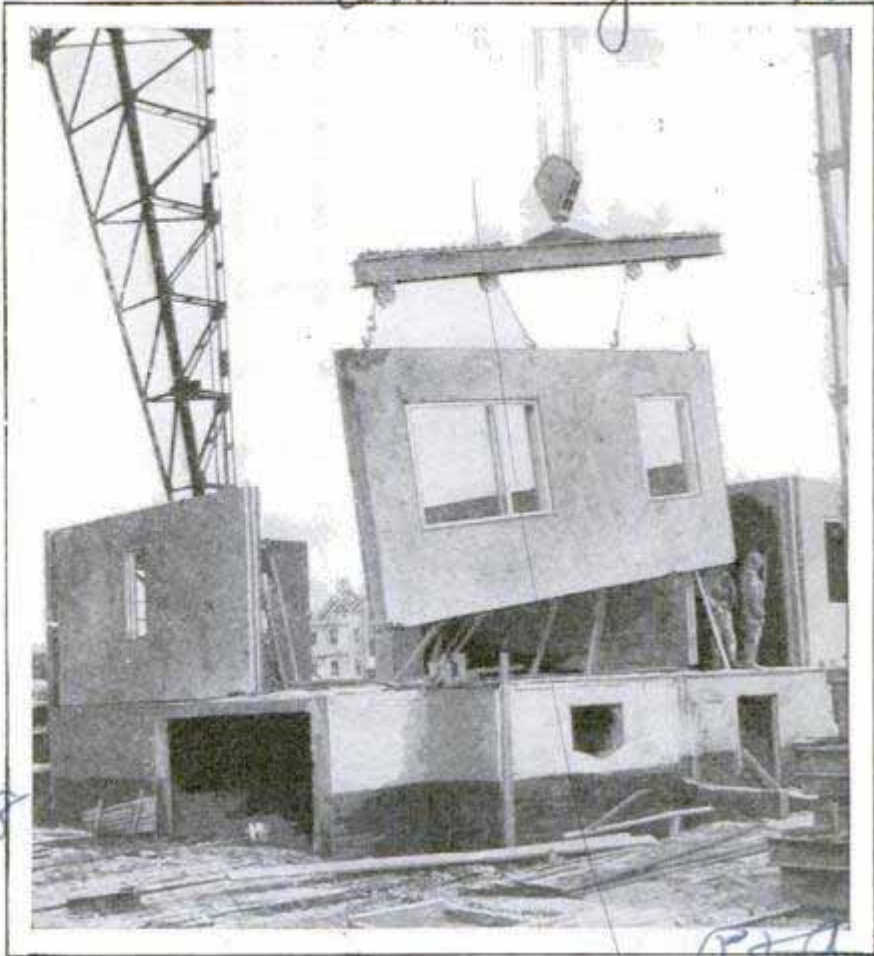

Where Derricks Serve as Masons: Lowering Side of Concrete House as Unit to Foundation during Rapid Construction

HOUSES ARE BUILT IN ONE DAY OF CONCRETE SLABS

Builders are seeking a solution of the shortage of houses near Berlin, Germany, by erecting small cottages of concrete that can be put together and made ready for occupancy in twenty-four hours. The walls are constructed as units, then raised one at a time and secured on the foundation and to each other. This method of building is said to be from thirty to forty per cent cheaper than others, each house costing only slightly more than \$2,000.

METAL SHEET PRINTS COPIES FROM TYPEWRITING

As many as 6,000 copies an hour can be made from a thin sheet of metal, according to reports of the substance which is of German origin. The material is so flexible that it will easily work in the typewriter or register impressions from handwriting. A special duplicating press is used with the metal.

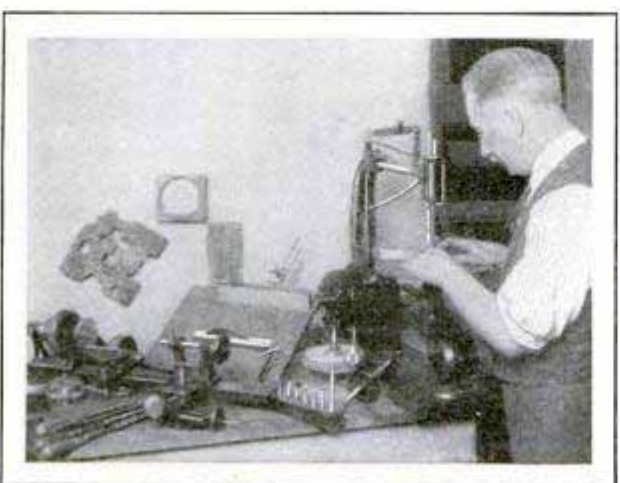

Using Jigsaw of Set; Other Tools Grouped on Table to Show Variety and Convenient Size

2122
U. S. Robert Reiner, Inc. Weehawken, N. J.
210 All Mfg. Co., Whiteas St. Chicago

*Deutsche Maschinenbau-AG
 Vertriebss Gesellschaft
 Berlin, N. 4. German*

Cont. Lloyd Taylor, City Room.

789/472

POPULAR MECHANICS

Herald-Tribune, New York

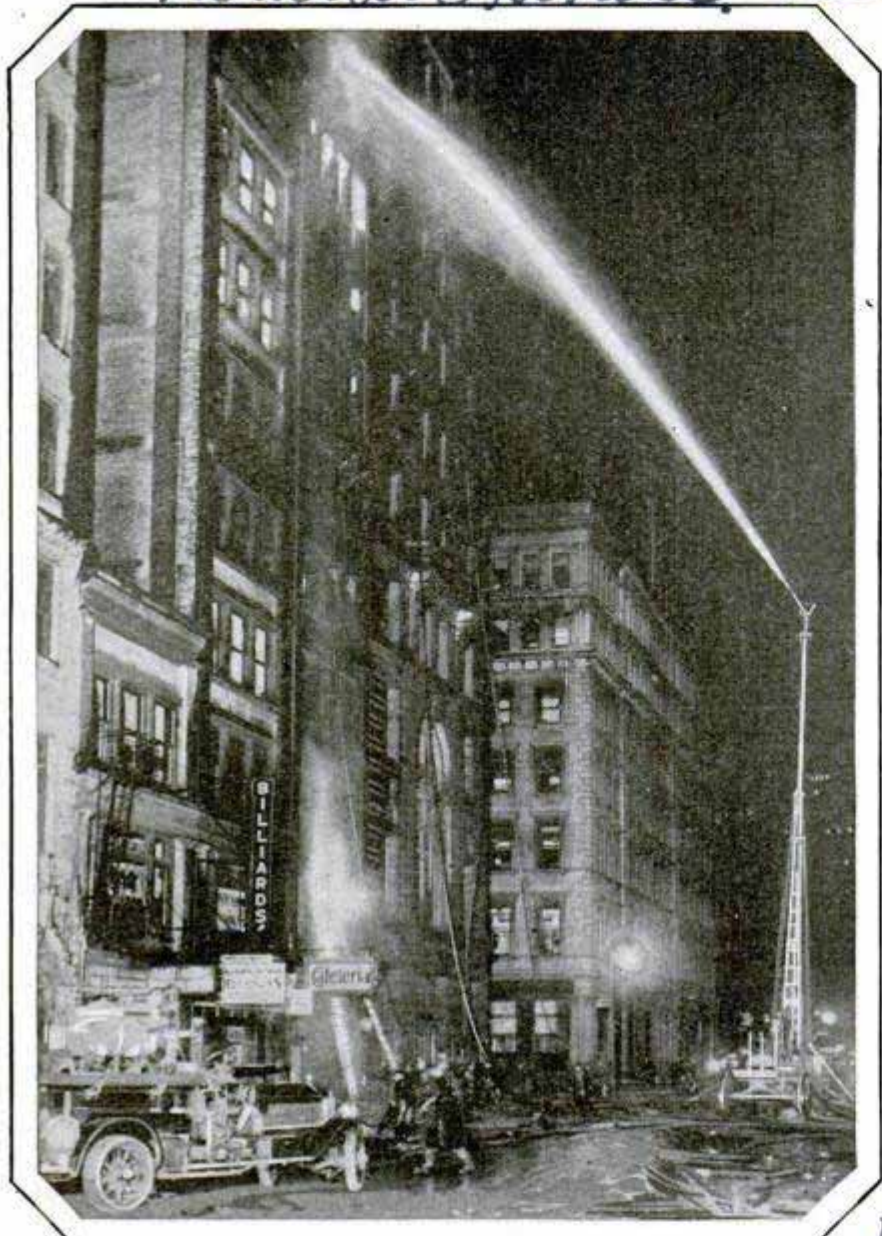

rowness and the right-angle turn, seemed an impossible place for a water tower, but one of the fireman chauffeurs volunteered to try to place his machine there, and succeeded in doing it. Caught between streams from two towers, the flames were snuffed out as neatly and almost as quickly as one snuffs out a candle. While the water tower was maneuvering into position, firemen climbed to the roof of the fifteen-story building, carrying reels of hose, attached the lines to standpipes and, lying along the cornice, lowered the nozzles with ropes until they came opposite the windows where the fire was located, and thus directed streams into the interior, breaking out the window panes by swinging the heavy nozzles against them.

Fire Tower in Action from Front at New York Night Blaze, While Mate, Driven down Narrow Alley, Attacks the Fire from the Rear

SKILL OF CHAUFFEUR ENABLES FIREMEN TO BEAT BLAZE

The skill of a chauffeur, who piloted a huge water tower down a fifteen-foot alley and around a right-angle turn, enabled New York firemen recently to conquer a stubborn fire which had started in a ten-story building, broken through the roof and jumped to a fifteen-story skyscraper alongside. At the back, across a narrow alley, was a row of old five-story paper warehouses, and the firemen did not dare attack the flames from the front with high-pressure streams for fear of driving the fire through the building and across the alley. The latter, because of its nar-

AUTO LIGHT SHIELD STOPS GLARE

Easily attached to any automobile headlight without the use of tools,

deflectors now on the market are intended to remove the objectionable glare of the lamps and make it unnecessary to touch the dimming switch while driving. They

are installed by opening the headlight, removing the bulb and inserting it within the deflector, which consists of a double-wing arrangement with a central barrel that fits over the bulb and a reflector band held in



place by two small vacuum cups and extending horizontally across it.

2 Airchild Reflector Corp. Clinton, Iowa

St. Louis, Mo. 3007
D. S. Taylor, City Room, N. Y. Herald-Tribune

*Stevens & Co.
46 E. Houston
New York City*

Finishing Radio Cabinet

Many radio fans can boast of as fine a homemade set as can be bought anywhere, but most of us are not well satisfied with the appearance of the homemade radio cabinet. Of course, we have sanded and finished it with care, but it does not quite come up to the manufactured product, especially of the two-tone type. The two-tone effect can be obtained easily and at little cost as follows: If the cabinet has already been finished take off the finish with varnish remover. Then sand the cabinet well and, with a small brush, paint the parts you wish to be lighter-colored with white shellac. Sand again after the shellac has dried, until the treated parts are level with the rest of the surface and smooth. Finish with a coat or two of some good varnish stain and the pleasing result will more than repay you for the trouble. If a piano finish is desired afterward, it is advisable to add a coat of clear varnish and allow it to stand six days, then rub down with rottenstone and oil to the required brilliancy.

965-R

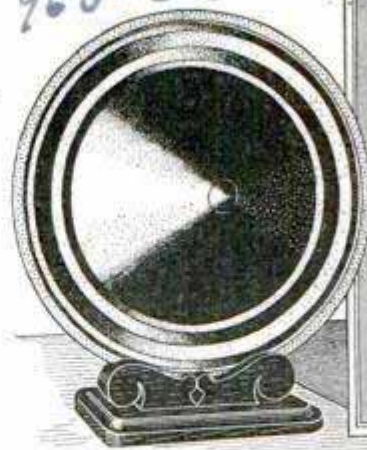

Cone-Type Loud Speaker Showing Method of Easel Mounting; Insert, Speaker Hung on Wall

Cone Speaker for Wall or Easel

The cone speaker shown in the illustration is one of the late arrivals on the market, and is featured by its adaptability for mounting on an easel base or hanging on the wall, to which end it is provided with a detachable base and a silk hanging cord. When suspended on the wall, it decorates the room and is less subject to the vibrations encountered by the table type of speaker. The seamless diaphragm is replaceable at small cost, and is claimed to be immune to atmospheric effects. It has a mahogany back which acts as a sounding board, increasing the volume.

Variable Condenser Has Plates That Are Wedge-Shaped

906-R

A new straight-line-frequency condenser differs from the usual design in that the plates are wedge-shaped. The mechanical strength of the old-type condenser is retained with the added ad-

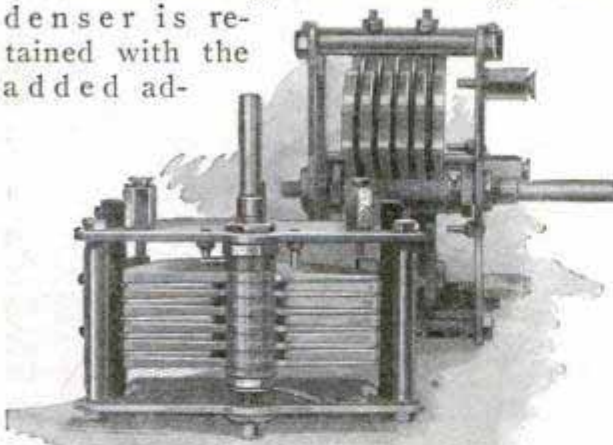

Side View Showing Wedge-Shaped Rotor and Stationary Plates

vantage that there are no widely extended rotor plates to cause crowding of parts on the usual 7-in. panel.

☐ A moist ground is the best as it offers the least resistance.

Hints on Connecting Aerials

When building the aerial keep the connections as few as possible. Try to have the aerial wire in one piece; this can be done by threading the wire through the end of the insulator at the lead-in end, taking two turns around the horizontal wire and continuing on down with the same wire for the lead-in. Keep the horizontal part of the aerial as straight as possible, without bends. This also applies to the lead-in wire; do not try to fit it around corners. When planning the aerial, see that the lead-in wire will reach the set by the shortest way. The ground wire should also be as short as possible. For these short connections it is necessary to carefully consider the location of the set in the building and of the aerial on the roof.

*Allen S. Cardwell Mfg. Co.
81 Prospect St. Brooklyn, N.Y.*

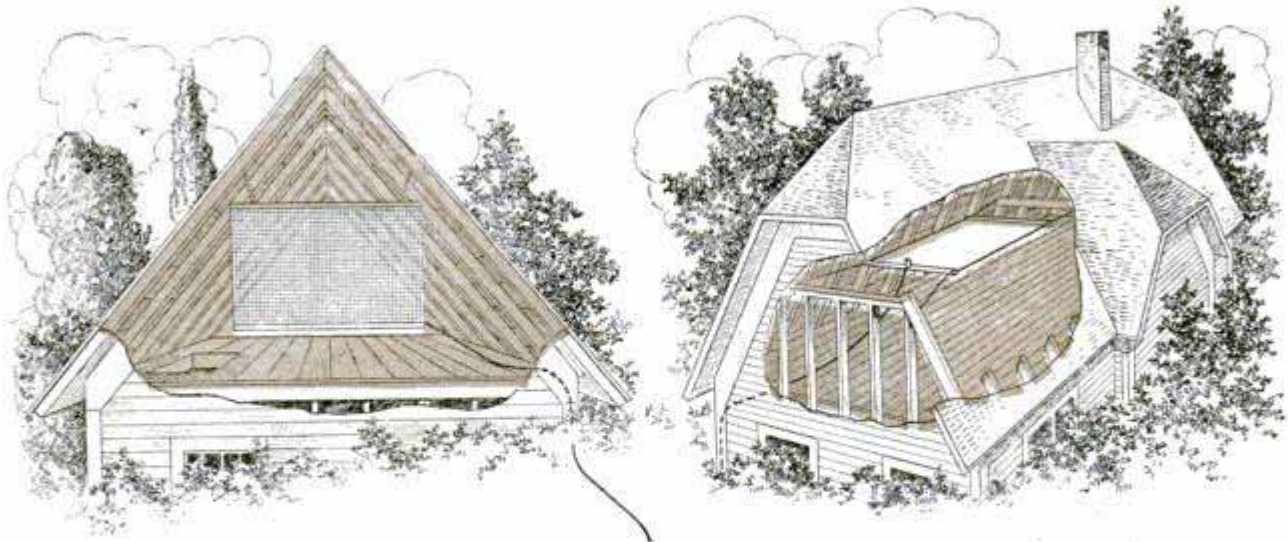

Installing an Aerial in Your Attic

By F. L. BRITTIN

ATTIC aerials, if properly constructed, give almost as good results as the elaborate outdoor types and are easier to build. No lightning arrester is required for them and another advantage is that they are protected from soot and corrosion due to smoke and weather conditions.

When selecting the type of attic aerial to use, it is necessary to take into consideration the size and shape of the attic. The illustrations give the builder a number of different types and methods of installation, all of which are good. We will first consider the end-to-end type, shown in the lower illustration on next page. It consists of four wires run the full length of the attic and connected to insulators at each end. Jumper wires are then soldered across, as shown, so as to make one continuous wire. The lead-in wire is soldered to the end indicated by the worker's hand, and is connected just inside of the insulator; from this point it is taken down to the set. The lead should be of insulated No. 14 wire and can be run down between the partitions and brought out to a wall plate in the room where the set is to be

located. Brass wall plates are now available for this purpose, and some are equipped for both the aerial and ground connections. The aerial and ground leads from the set are then provided with small plugs which are inserted in the wall plate, making simple and efficient connections that eliminate long unsightly wires running around the room.

At the upper left in the same illustration is shown a similar type of aerial consisting of one continuous wire fastened to the rafters with porcelain insulators of the split-unit type. This aerial is recommended where space is limited, as in hip-roofed attics. One length of No. 14 wire, 150 to 200 ft. long, will give excellent results. It will be noted in each of these aerials, the far end of the wire is left dead.

The flat-loop aerial, shown at the upper right, is preferred by some experimenters as it is especially useful where space is at a premium. Two lengths of clothesline or light rope are strung across the attic from corner to corner, and are tied together at the crossing point. The aerial wire is fastened to the ropes, as shown, and is

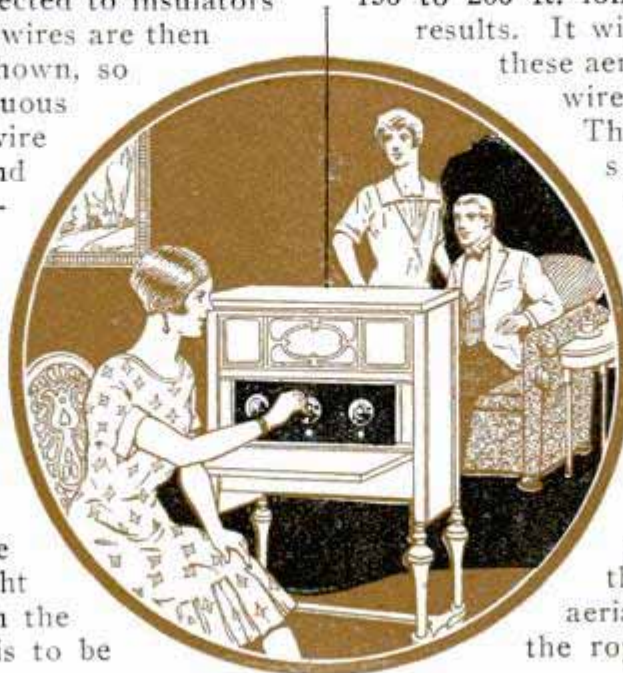

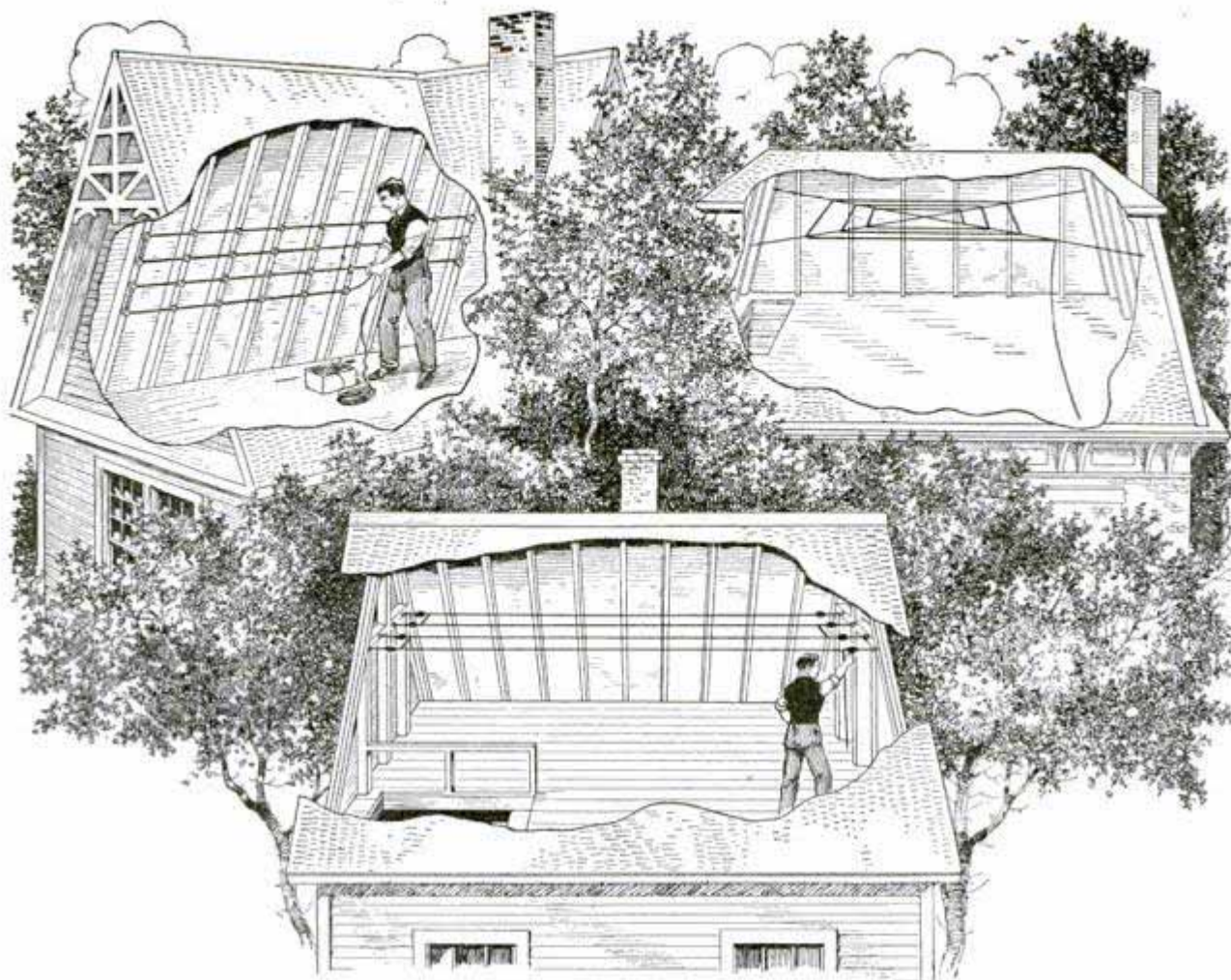

tied firmly at every point where it touches the rope. The inner end is the dead one and the outer end is connected to the lead wire to the set. The turns should be spaced about 1 ft. apart.

The curtain and mat types of aerial, shown in the colored illustration, are very popular. The one at the upper right is a manufactured type built in the shape of a large mat, and consists of numerous small wires between two thicknesses of heavy paper. The wires are bound with metal strips at each end and the lead wire is taken from one of these strips. The mat is suspended from the rafters by means of short ropes. The aerial at the left is homemade and of the curtain type. It consists of a section of copper screen with wood strips at top and bottom. The lead-in wire is soldered directly to the copper screen.

Do not neglect a good ground for the set; this is fully as important as a good aerial, and one of the best grounds obtainable is a cold-water pipe located as near the set as possible. Use a ground clamp

and see that the pipe is free from rust or paint at the point where the clamp is to be fastened to it.

Tube Rejuvenator Operates from Radio Batteries

797R

A tube booster, or rejuvenator, that operates from the batteries of the radio set instead of the lighting socket, is now available. This makes tube boosting instantly possible wherever the set may be, at the summer camp, on a farm or in the city. The direct current from the batteries is claimed to have greater efficiency, due to the absence of periods that tend to cool the filament



mu. life \$1.59 each

between the "flashing" of the tubes at the high voltage.

Mutual Radio Corp.
36 S. State, Chicago

796 R.
Compact Variable Condenser
Has Triple Range

Three capacity ranges feature a new and compact variable condenser. This

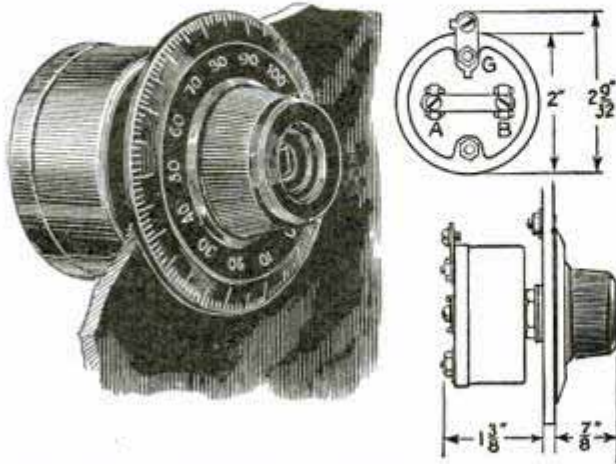

Triple-Range Condenser and Details Showing Method of Mounting, and Small Space Required

low-loss instrument is thoroughly shielded and is adapted for convenient mounting without special drilling jigs. It meets the demand for a condenser unit of small size which covers a wider field of usefulness than the ordinary type. The method of mounting the unit is shown in the illustration. It will be noticed that the unit extends only $1\frac{3}{8}$ in. back of the panel. The end view shows three terminals, A, G and B; connections to terminals G and B give a range equivalent to an ordinary 11-plate condenser, to terminals G and A, the equivalent of the ordinary 23-plate condenser, and to terminals G and AB (using busbar), the equivalent of the ordinary 43-plate condenser. Terminal G is in contact with the condenser case or "shield," and may be grounded to eliminate body capacity.

Position of Loud Speaker Important

A number of tests have shown that the position of the loud speaker in any particular room or apartment has a very decided influence on its acoustical performance. In several cases where results were not satisfactory and the difficulty had been blamed on the set, the trouble was discovered to lie not in the set, but in the location of the loud speaker relative to the listeners. A common mistake is sitting too near the speaker, or placing the horn too near the set or on top of it, with

the result that voice or music is blasted into the ears of the listeners, because no chance is given the mellowing effect of distance to filter out the background of undesirable noises. To get the best effect, place the speaker in a corner opposite the set. Curtains, tapestries, rugs and thick draperies are detrimental to good reproduction. A lightly furnished room invariably gives better results, although echoes are likely to develop in it. In that case certain draperies may be necessary. No definite rules can be laid down, however, and a little experimenting will be necessary to obtain best reception. Sometimes the mere parting of curtains between rooms will give the desired result. Never place a loud speaker where vibrations from it can be transmitted to the set; this applies to both the horn and cone-type of speaker. The latter is especially effective if suspended from the ceiling or picture molding, or placed in a corner so as to throw the sound across the room. Try several positions for the horn and, after the best place has been found, fasten an extension cord around the room and connect the horn permanently. Take the wire along the junction of the floor and wall, or run it behind the picture molding where it is hidden.

Permanent Hydrometers Simplify
929 R. Battery Testing

A hydrometer mounted permanently in each battery cap takes the danger to rugs and floors out of this method of battery testing and is always ready for use. The

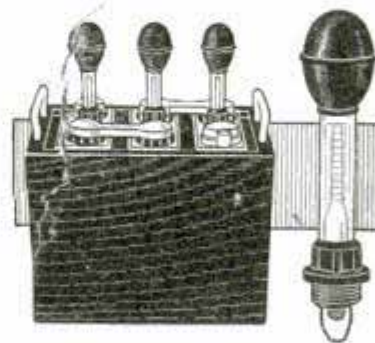

units are available in sets of three and can be adjusted to fit in any battery. The reading of each cell may be taken by compress-

ing each bulb in turn and returning the electrolyte to the cell after the reading has been taken. As the instruments are not withdrawn from the cells, there is no danger of spilling the corrosive solution, as with the common type.

A. N. A. Cap Hydrometer
Co., 1343 W. 4th Place

No further data

*Chas. Dr. A. J. Lucia
Asst. Prof. of Physics*

HERE IS A RADIO TUBE THAT WON'T BURN OUT

894-R

753-R

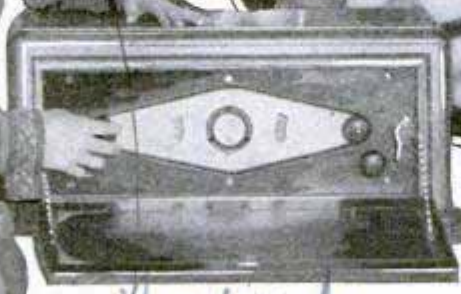

New Tube with Parts; It Uses 110-Volt Alternating Current and, Having No Filament, It Cannot Be Burned Out

Herbert
One of the Latest Developments of Radio is the Waterproof Cabinet for Use on Boats; the Five-Tube Set in the Photo, Ready for Operation, is of This Type

944-R



University of Pennsylvania

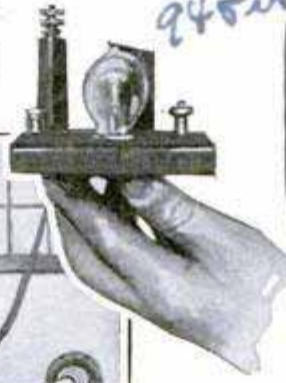
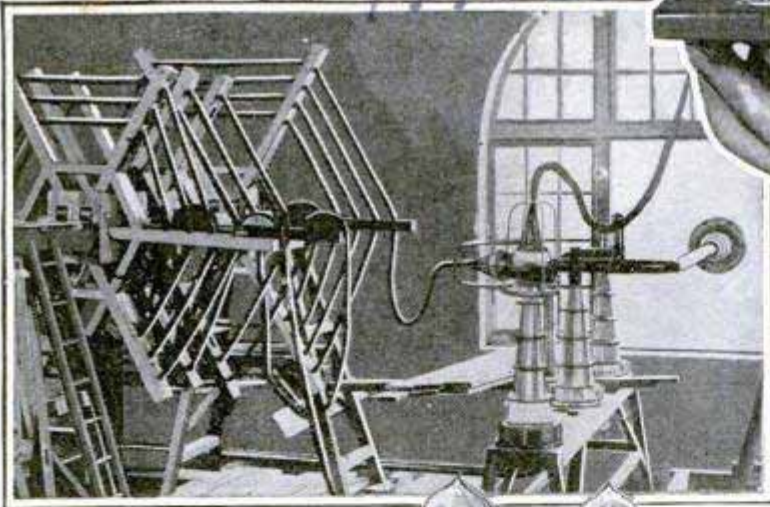

First and Latest Types of Radio Tubes; Left, Fleming's First Valve Used for Receiving, and, Right, the Latest Type of Transmitter

8860R

Above, the Huge Induction Coil and Lead-In at the GPO Wireless Station, near Rugby, England; This is the Largest Station in England and is Now in Touch with the United States; Right, the Automatic Device Used to Send Out Calls to Be Checked by the Byrd Arctic Expedition; the Calls were Received by the Powerful Sets with which Byrd's Plane was Equipped

at Helmsport Eng.

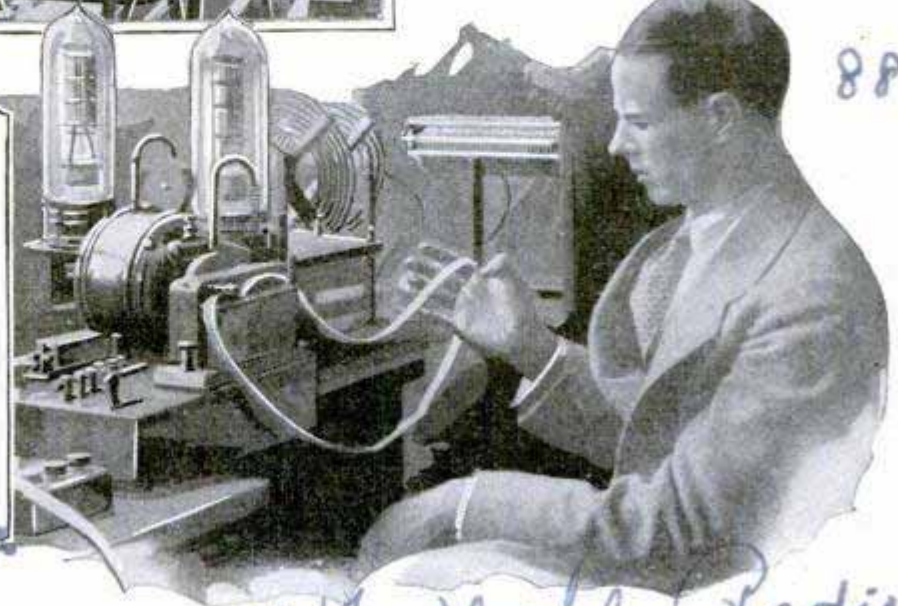

W. J. Lechl, Radio Engineer

Newark N.J.
Power Control Simplifies Set Wiring

A simple device for controlling the power supply to the A-battery charger and B-eliminator is now on the market.

Price - \$3.50.

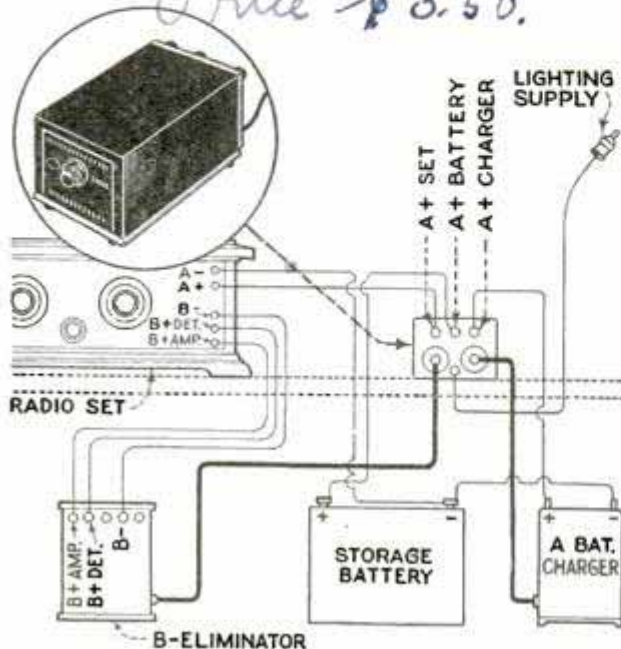

Insert Shows Compact Form of Power-Control Unit; Below, Rear View and Detailed Wiring Diagram

The device, shown in the illustration, eliminates much of the intricate wiring used in the modern set employing a battery charger and B-eliminator. It is operated by turning the small knob on the front. A cord and plug are provided for connection to a wall socket and the A-battery charger and B-eliminator are then plugged into the switching device. The other connections are made to the three terminal posts on the rear of the unit.

In one position (the arrow on the knob pointing to the left) the switch turns the lighting current on the B-battery eliminator, so that the set receives the B-battery current. It also connects the storage or A-battery on the set and enables the receiver to operate. It is not necessary to use any other A-battery switches or rheostats to turn the set on or off; if such a switch is provided it should be left on at all times, and the rheostats left at their proper positions for best operation. Turning the switch knob to the right, the device performs the following functions in the order given: disconnects the power supply from the B-eliminator and opens the A-battery circuit to the set; connects the charger to the storage battery and turns on the power supply to the charging

unit. The switch is so designed that, when opening circuits, it breaks connections on both lines, and will handle safely a lighting supply of 115 volts.

Advantages of Variable Gridleak

For distance, volume and tone quality, the grid circuit of the set must be "tuned" to the particular transmitting station desired. This is not practical in general use, so a compromise of some fixed gridleak value is made. However, for those who wish to go to extremes for added efficiency, a gridleak of the variable type that can be adjusted with a front-panel control is desirable. If the value of leakage is too high or too low for the station sending, the set will be out of tune or pitch with the sender. The gridleak of the fixed type will, of course, get a few stations with perfect volume and clarity, but will be limited to these few. With the adjustable gridleak all stations will come in with full volume and clearness.

Holder Keeps Hydrometer Safe

After breaking several hydrometers and laying several more down carelessly where the electrolyte damaged rugs and furniture, I made the little holder shown in the illustration. The back may be a

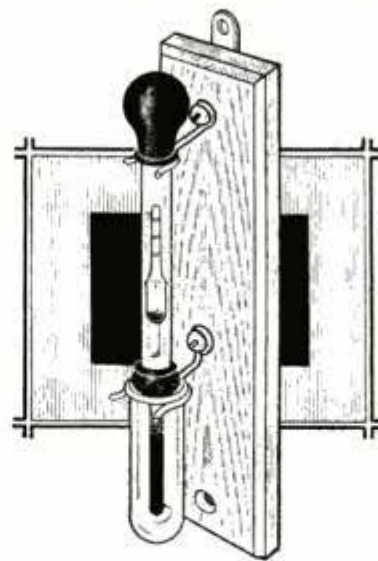

piece of wood or scrap bakelite. The brackets holding the hydrometer and test tube are fashioned from short pieces of bus-bar wire. About the only part that will have to be purchased is the test tube, and this

can be obtained from any drug store for about five cents. Fifteen minutes' work is all that is required to complete the device and you will always know where to look for the battery tester.—W. J. Langan, Freeport, Ill.

Tool Kinks for Radio Builders

By ROBERT S. KRUSE

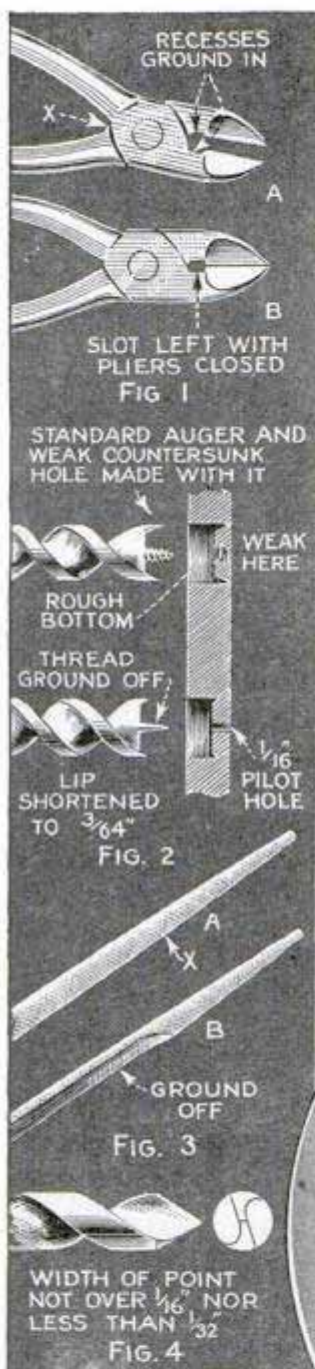

THE kinks and suggestions given in this article are not intended to be strikingly novel but simply to point out to the radio builder some handy ways of making the tool fit the job.

When wiring radio receivers, or anything else, wherein "annunciator" wire is used, there isn't a doubt that the handiest cutting pliers are the so-called "diagonals," which have a very pleasing way of reaching into close corners and making the cut at exactly the right place after the wire is in position. Unfortunately these pliers have no convenient place in which the rubber-wound wire can be squeezed to break the insulation before stripping it from the wire. A simple way to provide such a surface is shown in Fig. 1, $\frac{3}{16}$ in. of the cutting edge nearest the hinge being sacrificed. The flats are formed by grinding, as shown at A. When the pliers are closed, as at B, the slot should just allow the smallest size of wire to

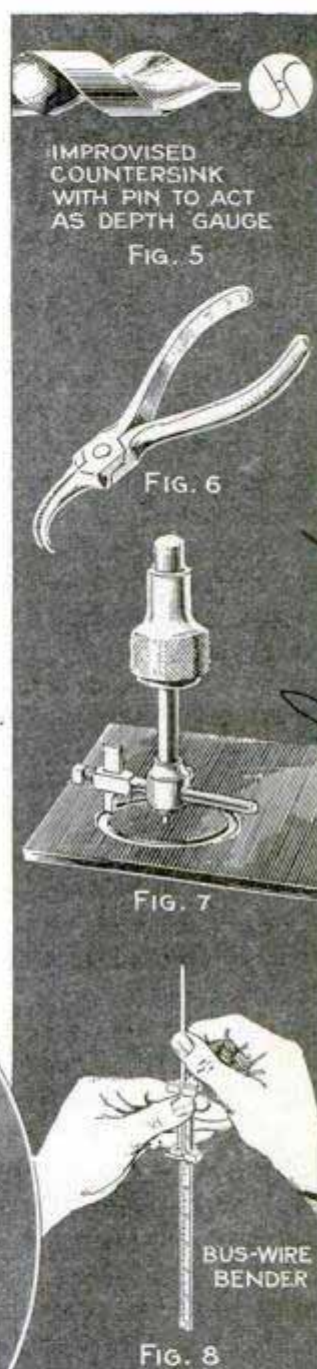

slide through after the insulation has been stripped. Usually the smallest wire is No. 22. Since the recesses should be reasonably square-cornered and the steel is usually too hard to file, it is convenient to finish the cut with a small slip of carborundum stone. If this is not available, it can be done with a small file plus oil and carborundum powder; this may ruin the file, so if a worn-out file can be used so much the better.

When assembling radio sets or other light devices on a wooden baseboard, it is frequently necessary to countersink a round-headed machine screw in it, usually with a washer under the head. The hurry-up amateur way of doing this is to use an auger, with the result shown in Fig. 2, a weak uneven bottom being obtained that will not support the machine screw and washer because the edges are almost cut through.

Wahem & McLaughlin, 205 E. Illinois, Chicago

A bit can be prepared for this work by grinding off the threads of the lead screw and shortening the lips to $\frac{3}{64}$ in., as shown in the lower sketch. Care should be taken to leave the guiding spur true. In using a bit of this type, a $\frac{1}{16}$ -in. pilot hole is first made with any type of drill, after which the auger will follow exactly. When the hole has reached the right depth, take one turn without feeding, and the bottom of the hole will be made smooth.

Sooner or later one has to ream holes in insulating material; some of this will not stand up under the reamer and the only remedy seems to be to work with a tapering round file, which, however, persists in jamming in the hole. Fig. 3 shows a way of grinding such a file so that it will be more easily handled. The first third of the file is left round and the rest ground off on one side. This may sound foolish, but is a great help.

A good countersink tool for insulating materials is shown in Fig. 4, and is made by grinding an ordinary twist drill to a long point. Flat-head screws are supposed to have their heads made to a standard angle, but this is not true with the smaller brass screws. It is best to make the point of the drill a little too sharp; very little clearance should be ground off to prevent hogging. This sort of counter-

sink keeps the chuck far enough from the work to permit a clear view which is important because a single hole countersink too far will often spoil the job.

The difficulty of judging the proper depth of the countersink can often be avoided by the kink shown in Fig. 5, although it is good only when the insulating parts are of uniform thickness, the pin acting as a depth guide. If the panel is of rubber, the pin must be a bit undersized to prevent seizing. A countersink of this type can be ground from an ordinary twist drill.

When drilling or countersinking holes, stand directly above the work in the position shown in the photograph. Keep the drill straight up and down and apply only sufficient pressure to insure a good cutting action. Excessive pressure will break out the underside of the material; a block of wood under it will prevent this and insure a clean hole. Large holes for voltmeters often try the patience of the amateur, but by using an expanding bit of the type shown in Fig. 7, this part of the work will be found very simple. The bus-wire bender shown in Fig. 8 is a new and useful tool, saving time and wire, as it measures the wire to the length of each bend, and after a little practice surprisingly quick and accurate work may be done with it.

Neighboring Aerial Installation

The aerial installation shown in the illustration has several advantages where two neighbors have the same problem to solve. In suburban localities difficulties sometimes arise preventing a de-

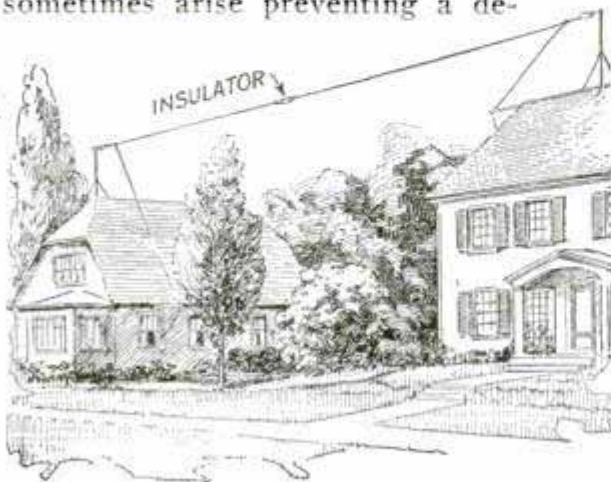

Divided Aerial Showing the Position of the Insulator Midway between the Two Houses

sirable location of the aerial for best results. Everyone wishes to run his aerial in the direction best suited for the greatest number of broadcasting stations, and if the houses are facing north or south, for instance, the limited width of the average lot will not permit a very long east-and-west aerial. With a little co-operation this difficulty can be overcome, the single-wire aerial being divided in the exact center by an insulator.

Ten-Tube, Six-Condenser Set

919-R. Has Single Control

We are familiar with single-control sets of the five-tube variety, but when ten tubes are placed under a single control our curiosity is aroused. The photos show the arrangement of a well-designed receiver of this type. Five stages of tuned r.f. amplification, a tuned detector, and

*Genial Radio Corp.
Strauss Bldg. Chicago*

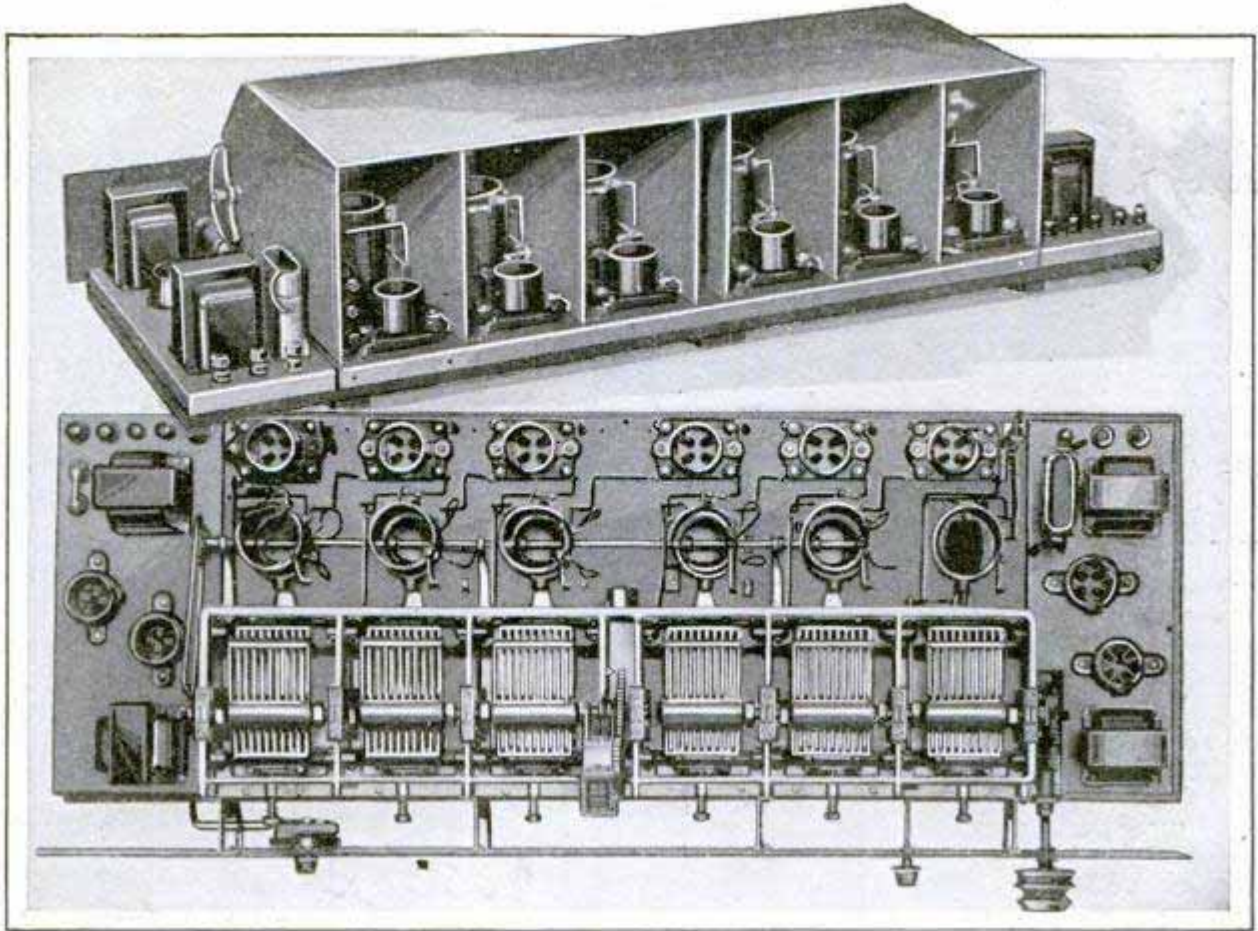

Above, Rear View Showing Method of Shielding; Below, Shield Removed Showing Gauged Condensers and Rotating Mechanism

four stages of low-ratio a.f. transformer-coupled amplification are used.

The five tuned r.f. stages and the detector stage are well shielded and are all tuned by variable condensers operated from a single shaft. A small coil in the plate circuit of each stage, coupled with the succeeding grid circuit, is rotated whenever the main tuning control shaft is turned, and automatically maintains each stage of the amplifier at the best coupling point as the wavelength is varied. All of the rotor coils are mounted on one shaft, which is in turn driven from the main condenser shaft by a link mechanism. Special one-to-one ratio a.f. transformers, with unusually large iron section and winding space, are used. An output transformer to match the loud-speaker units, which are supplied with the set, is incorporated in the receiver.

With the one tuning dial it is possible to run over the entire broadcast range of the receiver in less than a minute, and to note the nature of the program from every station within range at the moment.

The frame of the six-unit variable condenser serves as the chassis of the set it-

self and within this frame are mounted the die-cast stators of the six condensers.

The set is available in several antique models of period type, each cabinet containing a battery compartment, and is equipped with dual loud speakers covering the entire musical range. A pilot light is mounted within the cabinet to illuminate the dial, and this light is controlled by the switch on the panel which places the set in operation.

8992R

Dustproof Case on Rheostat

\$ 3.50

Soft Head

A bakelite and polished-nickel case completely incloses this new rheostat. Its moving parts are thoroughly protected from

mechanical injury or accumulation of dust and the instrument takes up very little room behind the panel. Mounting requires the drilling of only one hole for the center bushing and locking nut.

Starling Mfg. Co.
 2831 Prospect Ave
 Chicago, Ill.

Webbing for Loop Connections

The usual loose and haphazard way of connecting loop aerials to sets has been the cause of considerable annoyance due to the inductive effect of

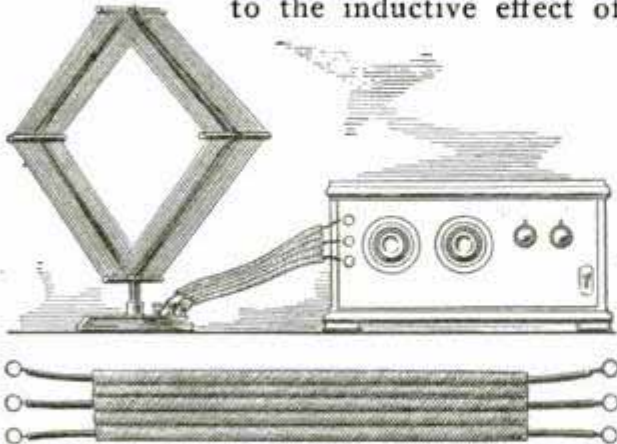

Loop Leads Are Threaded through Webbing to Prevent Induction and Improve Appearance

the varying distances between the lead wires. This condition has been especially noticeable when turning the loop to obtain directional effects, the changing position of the leads making distant reception difficult. One of the best ways to overcome this inductive disturbance is to obtain a piece of cotton webbing similar to that used in trunk straps. Remove the two outside cords and, if the loop is of the three-tap type, also the center cord. The loop leads of No. 22 copper wire are then threaded through the conduits thus formed. For best results the terminals should be connected to a binding-post strip fastened to the base of the loop, leaving enough slack in the flexible wires so that the loop can be rotated.

Preventing Interference in Congested Districts

Interference from the multitude of causes present in the crowded localities of large cities has for some time been the main topic of conversation in radio-engineering circles. Motors used for operating the blowers of home oil burners cause quite a bit of this interference. The trouble is usually caused by sparking at the commutator brushes; if the commutator is rough, it should be smoothed with a piece of fine sandpaper and the brushes reset correctly. A large by-pass condenser across the brushes will do no harm to the machine, and will help to

stop this sparking, as well as increase the efficiency of the brushes and commutator. If the aerial is paralleling a high-tension line, it should be changed so as to run at right angles to the line; this also applies to street-car and elevated lines. Often humming sounds that are difficult to locate, are found to be caused by the d.c. lighting circuit. If the building is supplied with a d.c. source, try putting a large by-pass condenser across the line at the main switch. Disconnect the ground wire from the receiver, and, if the hum has disappeared, it is an indication that the interference is coming in over the ground wire. The best remedy in this case is to use a counterpoise instead of a ground wire. An effective counterpoise can be made by running the same amount of wire you now have in your aerial around behind the picture molding of the room. The lead from the counterpoise is then connected to the ground post of the set instead of the usual ground.

New Power Tube Has External Posts

Power tubes having external binding posts for the necessary battery connections, eliminating wiring changes in the set, have now appeared on the market. These tubes fit in the standard sockets and the extra C and B-battery connections greatly simplify the installation. The two binding posts are connected if the proper C and B-batteries are already in the set. Power tubes, when used in the last stage of a.f. amplification, prevent overloading and distortion.

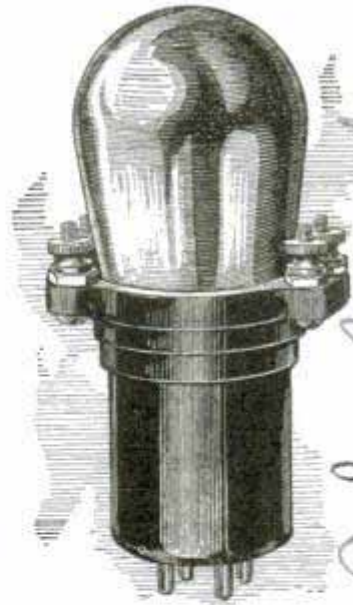

When several low-powered stations are difficult to separate and bring in clearly, increase the detector and amplifier filament voltage slightly.

767-R

A. J. Musselman Co., Chicago, Washburn, Chicago



By ROBERT H. KIRBY

THE thrill of bringing in a really distant station comes only to those who make possible the conditions favorable to long-distance reception. Now that the ideal radio weather will soon be with us, it is high time to look over the radio set, aerial and ground connections and see what can be done to obtain the very best results.

We will assume that the receiving set is a good one, not necessarily a large set, but one that is well designed and carefully built. A well-built 'three-tube set will often step out and bring in surprisingly distant stations if given a chance; however, the larger sets have a decided advantage, enabling them to overcome conditions smaller sets cannot cope with. Good tubes and fresh batteries are, of course, of first importance; if the tubes have been in use for some time, they may need rejuvenating or, if beyond such help, must be replaced with new ones.

Short battery leads are important; photos are shown of typical installations to give the reader an idea of the right and wrong way of placing the batteries. The switchboard on the door of the console cabinet is a good idea for an elaborate installation

when A and B-batteries and charger are combined in one compartment. However, there are several compact power-control devices now on the market that take up less space. The main idea is to keep all batteries close to the set, and at the same time out of sight or as nearly so as possible. Note the untidy arrangement in the photo showing the batteries on the floor with long straggling leads running to the set; an installation of this kind cannot be expected to give maximum results. The same set is shown at the right with the batteries placed on a shelf under the table, making possible short battery leads and certainly a neater appearance.

Proper placing of the set in the room, so as to obtain short aerial and ground leads, as shown in the illustrations, often results in greater efficiency, and eliminates long unsightly wires running around the room. Distance can only be obtained by close attention to details. If you live

in a city, there are many obstacles to be overcome and sometimes they make distant reception impossible; however, these conditions are not common and only exist in certain localities. One sketch shows a busy city street and the various points from which interference may come. City and pow-

er lines are also shown. City and power lines are also shown.

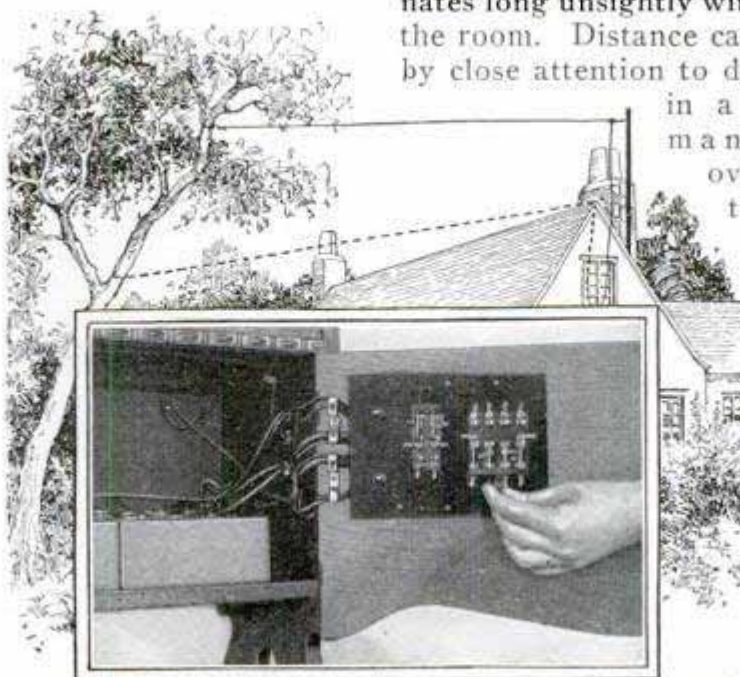

Battery Compartment of Console Set, Showing Switch Panel; Aerial Suggestions Above

er-plant officials are co-operating to minimize these sources of interference and much improvement is already in evidence. The radio listener can help

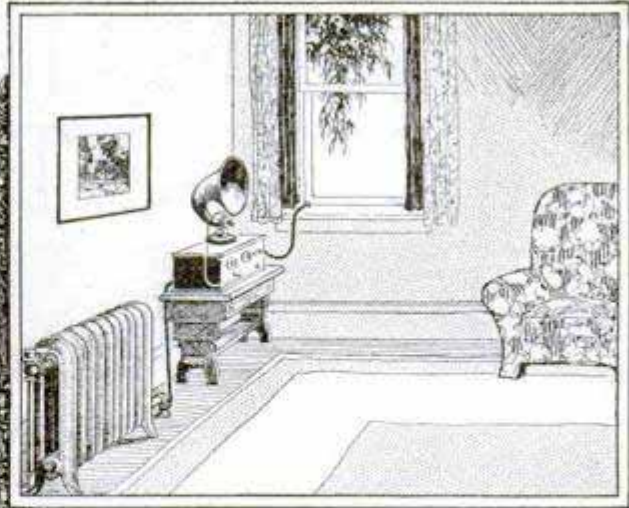

Left, Inefficient Arrangement of the Set, Making Long Aerial and Ground Leads Necessary; Above, Efficient Arrangement Showing Short Aerial and Ground Connections

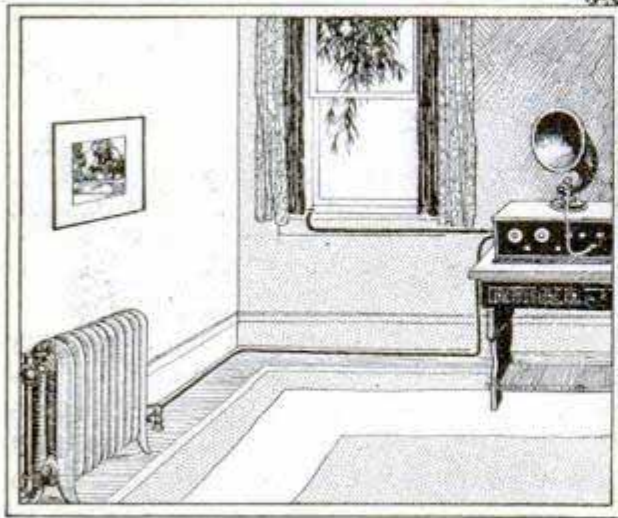

himself under these conditions by making sure his aerial does not parallel any such power lines, and notifying the officials when any particularly annoying interference is present in the neighborhood.

Atmospheric disturbances, known as static, are nature's great obstacle to long-

distance reception, and, as yet, little has been accomplished in the way of a remedy. Static is present the greater part of the year, and is at its lowest ebb during the winter months. It knows no wavelength and when the so-called static-interference level is above the signal strength of the transmitting station, the receiver is cut off completely. This effect is illustrated by the beam of light cut off by the intervening wave in one of the drawings; the static waves offer the

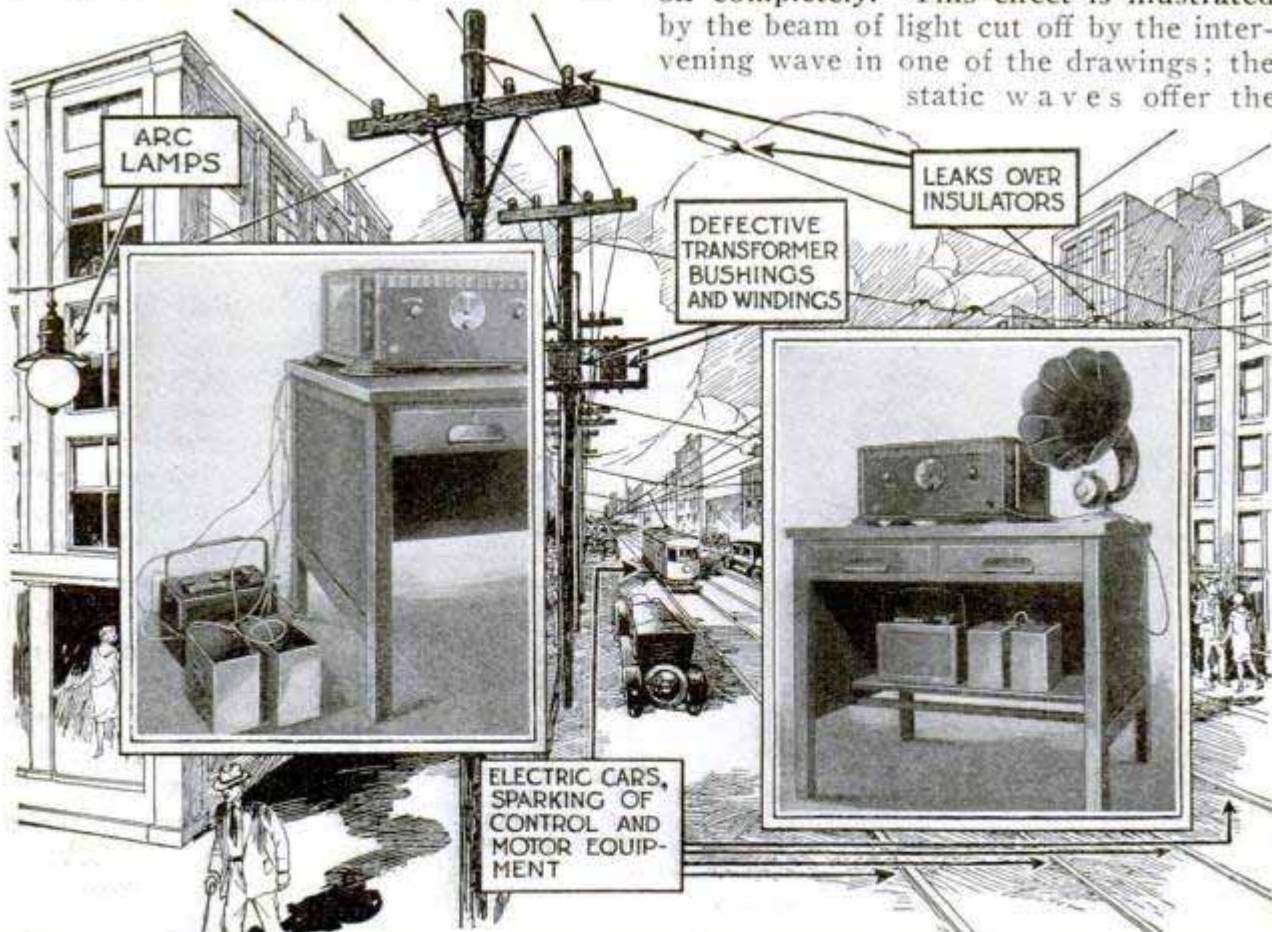
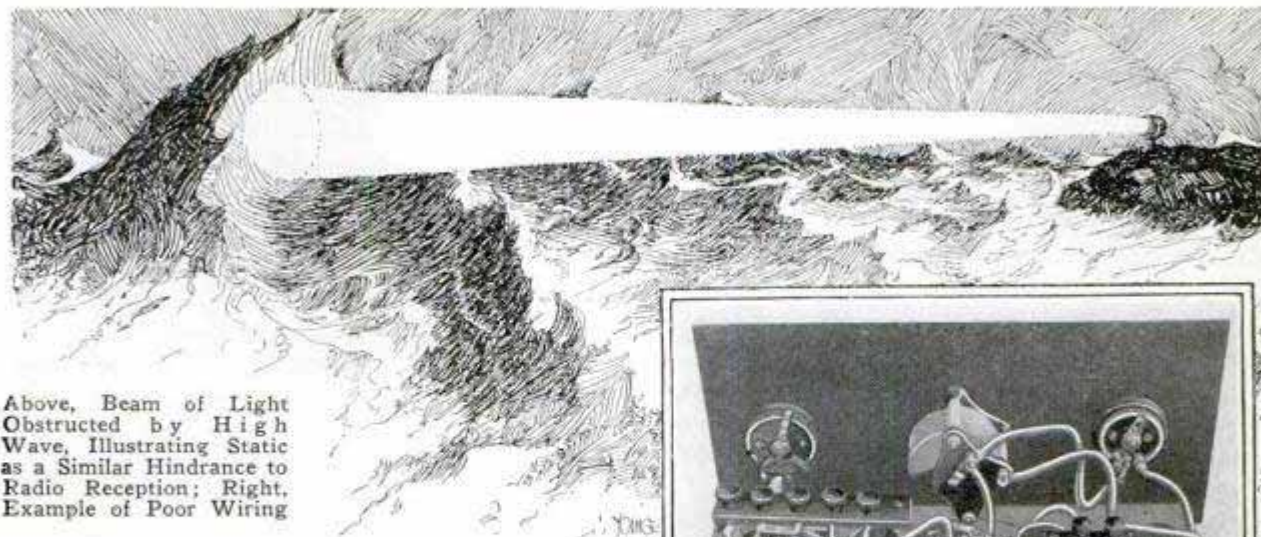
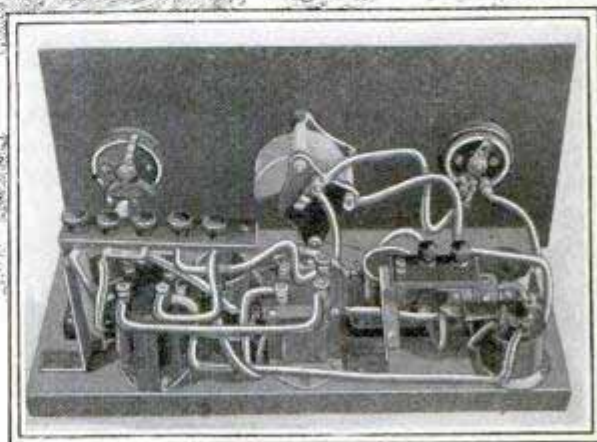

Photo at Left Shows Poor Battery Arrangement and Careless Wiring; Correct Method Shown at Right; Sketch Indicates Sources of Interference in the Average City



Above, Beam of Light Obstructed by High Wave, Illustrating Static as a Similar Hindrance to Radio Reception; Right, Example of Poor Wiring



same interference to the signal. Static interference can be minimized by the use of sets employing loop aerials, and one of the best methods yet found for sets of the aerial type is the underground or sub-antenna. This type of antenna is now available and comes ready to install, either in the yard or under the building. The results are much better during the static season with this subantenna, and the signal strength is about the same as that obtained with an outdoor aerial. The illustration shows the method of installation in a hole 3 ft. in diameter and about 4 ft. deep. The antenna is coiled in layers and the earth filled in between the coils up to the surface level.

The rear view of a set showing the terrible example of bad wiring, is an actual photo; indeed, the photo flatters it. No one can expect to get distant stations with a receiver of this kind; it is a marvel that it works at all. Some radio builders are apparently satisfied if the set brings in signals, but there is little gained by buying good parts and then throwing a bunch of wire around them. Anyone can build a neat and efficient radio set without even soldering a joint if a little pains is taken. If a soldering iron is not available, neat and good work can be done with busbar wire and a pair of long-nosed pliers, or special wire-bending pliers. Loops may be made over the various terminals, good electrical connections obtained and the wiring run direct to each instrument.

For the distance or DX fan, there are several ways by which he can extend his range and bring in stations he has not heard before. The addition of a stage

of tuned radio frequency will often give surprising results in better selectivity, range and volume. There has long been a demand for a self-contained independent unit of this type and several such units have lately appeared on the market. The one shown in connection with this article may be obtained either as a finished unit, as shown, in a case, or as a knockdown kit

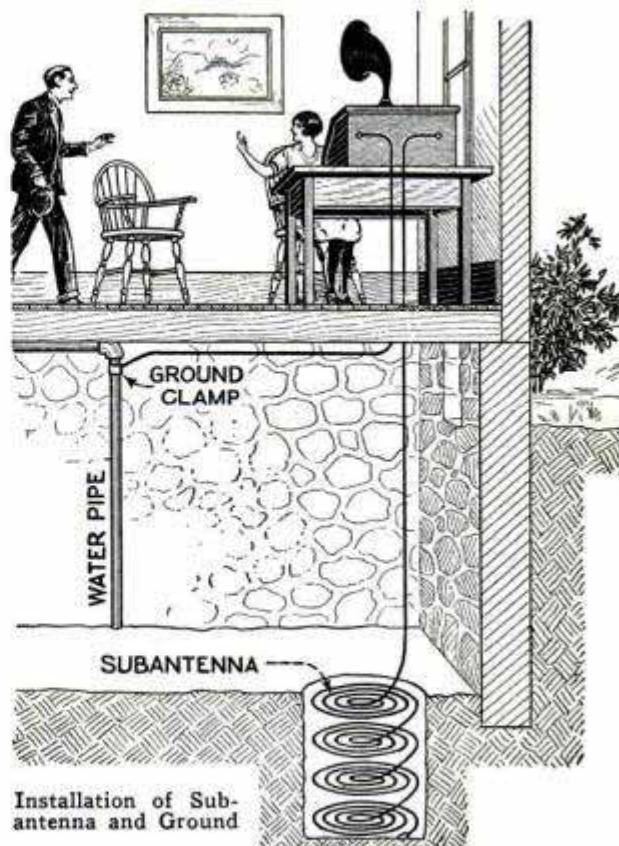

Installation of Sub-antenna and Ground

Chicago

*Sub Antenna - Cloverleaf
Mfg. Co., 2714 S. Canal*

that can be built up as shown at the left. This instrument is simply connected between the aerial and the set; it takes the impulses from the desired station and delivers them to the receiver in a highly amplified form. In effect, the station selected is brought closer to the exclusion of all others. All connecting wires are furnished and the battery connections are given; no alterations are necessary in the set, and the unit can be placed on top of the receiver. No additional batteries are required, as the instrument is operated from the same batteries as the set.

After the set and installation have been carefully checked and everything done to insure maximum results, there is one remaining factor to be considered before a far-distant station can be brought in; this is the personal factor, and everyone has the same problem.

You must learn to tune your set; this comes more quickly to some than to

others. Patience is necessary in learning to tune a receiver and practice makes perfect. Do not twirl the dials and turn up the rheostats aimlessly; begin with local stations and log them carefully, noting the position of the rheostats for best results. The same relative positions will be best for the far-away stations, and the delicate balance maintained between the tuning and filament controls will bring the reward of distant reception. Vernier controls add much to delicate tuning, as often a very slight movement of a dial will tune in several different stations. After the desired station has been located, it is easy to readjust the controls so as to get it at maximum strength.

Terminal Clips for A.C. Tubes

The new a.c. tubes are provided with two heater terminals; these are placed at the top of the tube, protruding from a small bakelite connection block, and do not offer a very handy connection. The manufacturers have now placed on the market a small clip that fits on the tube connections and is equipped with small binding-post terminals for holding the connecting wires.

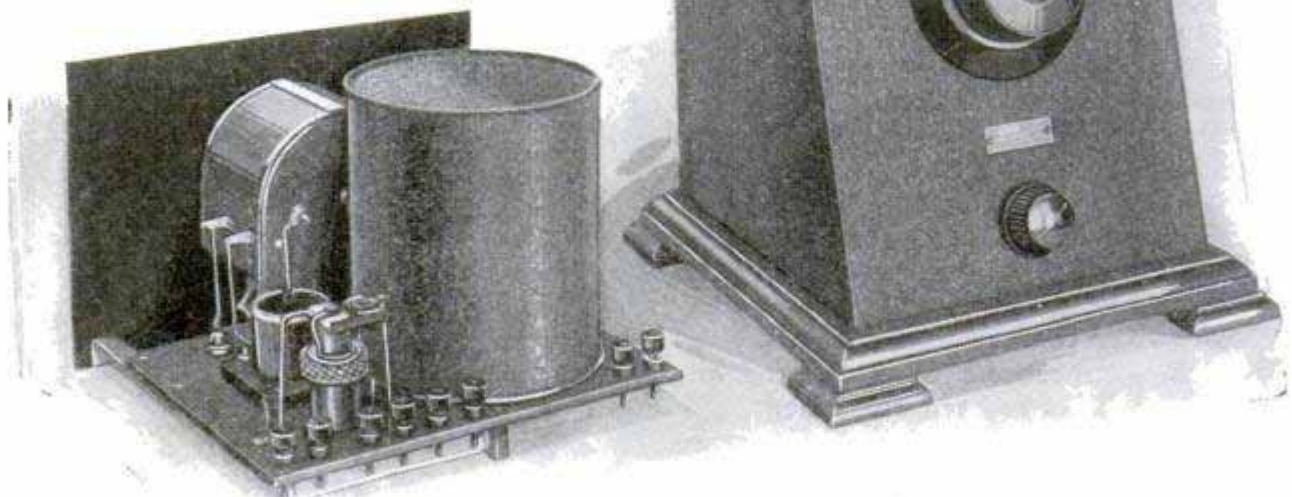
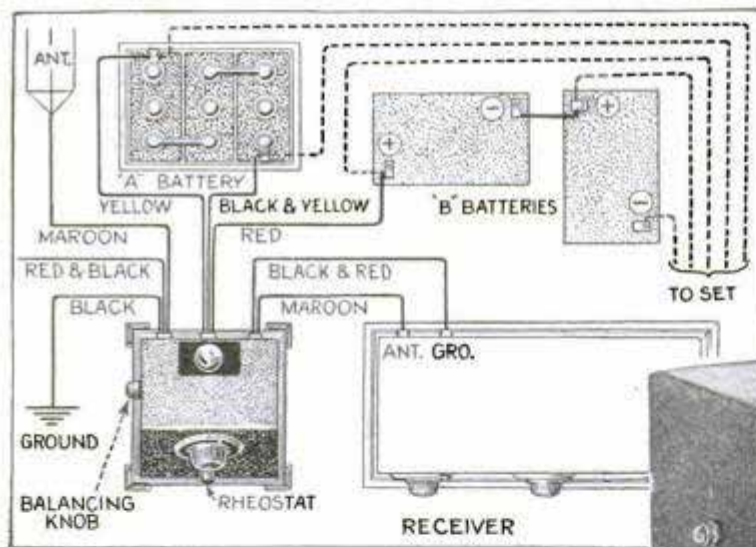

Left, Tuned Radio-Frequency Unit Made Up from Knock-Down Kit; Right, Ready-Built Unit of the Same Type; Above, Unit in Position with Battery Connections



Build Yourself a "Water Sprite"

By R. L. SIMONS

A SPORT that has, during recent seasons, experienced a great wave of popularity at lake and ocean resorts is

afforded so much pleasure that he made several others for friends. After some experimentation, two sizes were decided up-

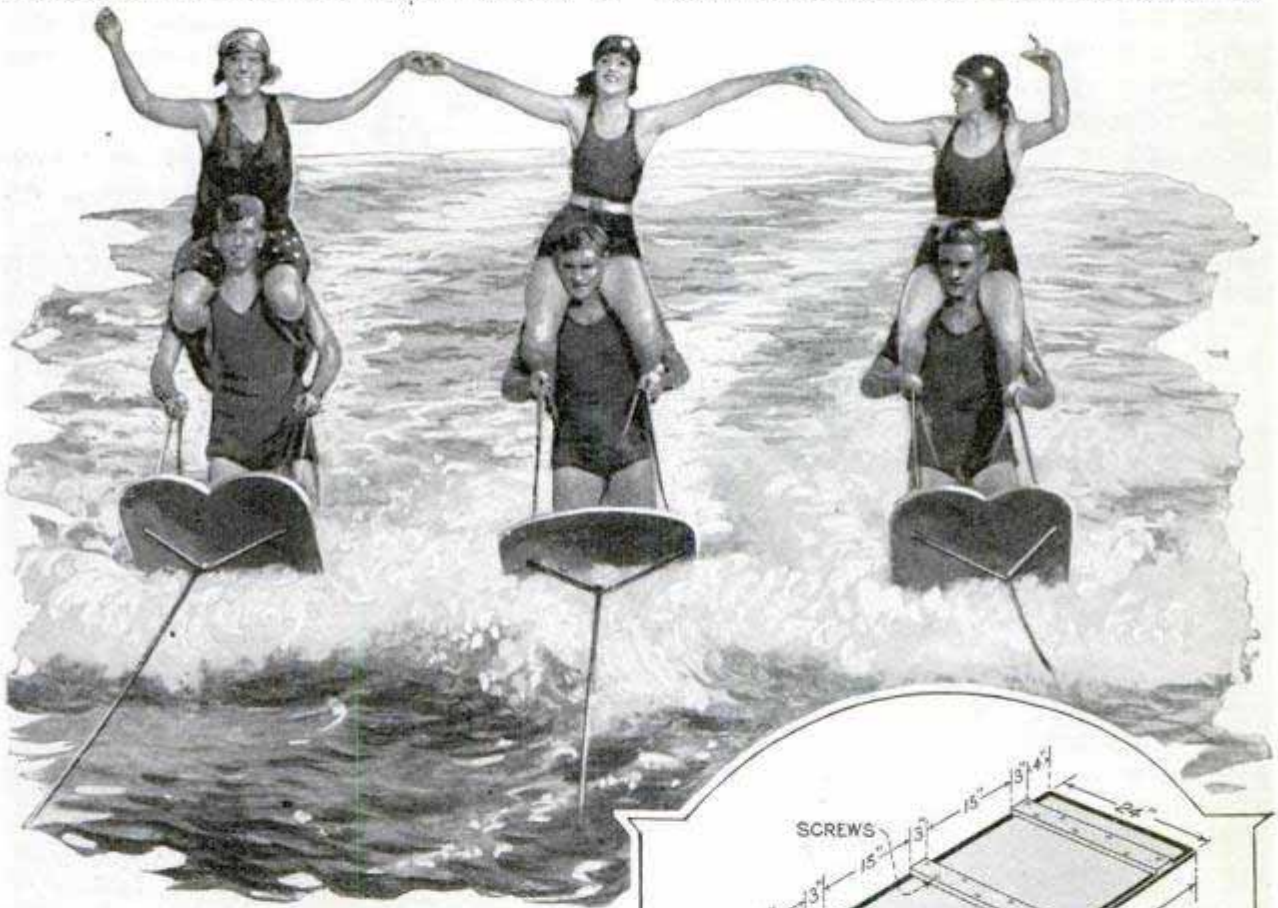

Right. Constructional Details of the "Water Sprites" or Aquaplanes; Above, Aquaplanes in Action.

that of aquaplaning; riding on a board towed by a motorboat. One ride is sufficient to convert any normal citizen into an enthusiastic fan.

Anyone with the usual household equipment of tools can with ease and pleasure make a "water sprite," as the aquaplanes have been nicknamed, and if reasonable care is exercised it will be quite as good as a commercial board.

During the summer season of 1925, the writer made his first water sprite, and it

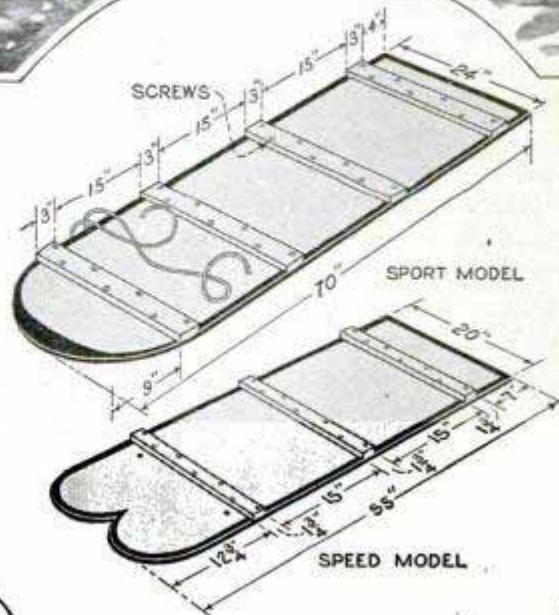

on as most satisfactory, the sport model and the speed model. The former is a larger plane, capable of being towed by a slower boat and carrying as many as three passengers. The latter is a smaller board which, having less area exposed to the water, must be drawn faster in order to plane with its single passenger. It offers the greater kick of the two styles, for it travels faster and requires greater skill in balancing and riding. The larger or sport model—family model one spectator called it—will plane with one passenger at a speed of six miles an hour, though the real thrill comes at higher speeds. The speed model, and the sport type when it is carrying two passengers, require about double this speed.

Dimensions for both types are given in the drawing. There is nothing arbitrary about these sizes, and they may be varied at will, but as they have been found satisfactory there would be no point in departing too far from them, unless the material available made this necessary. If the sprite is too narrow it will be very nearly impossible to stay on it; on the other hand, it should not be too wide. Any smooth, unsplintered wood may be used for the board part, on which the rider stands, or tries to stand. In the case of the writer, the board was made of tongued-and-grooved white-pine stock, clamped up with marine glue in the joints and strengthened by cleats, but such elaborate joints are an entirely unnecessary refinement, and were used only to improve the looks of the finished sprite.

It will be quite satisfactory to hold the boards together by three or four cleats running across. These should be held firmly in place by flat-head countersunk wood screws, staggered to distribute the strain, as the water sprite receives a great

deal of pounding while in use, and all precautions should be taken to have it strong enough. The edges of the cleats should be beveled, as the rider braces his feet against them. Similarly, the edges of the

board should be beveled, as the rider will find himself grasping at the side to climb back on, after inevitably losing his balance. The towrope should be passed through holes bored into the forward cleat and under part, for greater strength, in the speed model, and the second cleat in the sport model. The rope to which the rider holds should be put through holes in front of the towline. Each rope is held by a knot on the end. The towline is led out

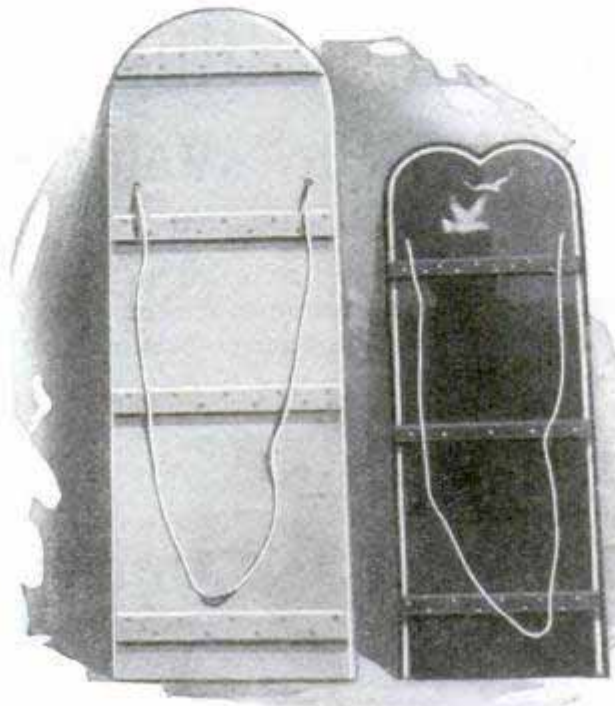

Left, the Sport Model, for One or More Persons;
Right, the Speed Model for One

of the board, and knotted on top. The sprite may be finished with clear varnish or painted in color. The writer has tried both and favors the natural wood, varnished, as presenting the more professional-looking job. However; the board, while in use, has the appearance of snap and life if painted in brilliant colors. The writer further embellished his boards with seagulls on one, a diving girl on another, and other marine suggestions, the decoration being on the forward part. A stripe of color around it, near the rim, also looks well.

In use the water sprite runs 15 or 20 ft. astern of the towing boat. Very little in the way of instructions can be offered for riding the board, as it is largely a matter of experience. The writer's practice is to lie flat on the board, taking a short hold on the hand rope and allowing plenty of slack cord, between the stomach and the sprite. As it gains speed I slide back, keeping the weight well aft, for if the weight is too far forward, the stern will tip up, the bow will dive and the entire board will spin around. As the sprite attains

full speed I assume a squatting, then a standing, position. Practice will enable the rider to do various stunts. A friend of the writer can carry another person on his shoulders, can stand on his head and hands on the fast-moving board, and can ride without the use of the hand rope.

Raising a Sagging Door

When a door sags and the bottom scrapes on the floor, it may be raised to clear the threshold by slipping a hairpin, or other similarly bent wire, under the upper half of one of the hinges around the pin and then twisting it. This will serve as well as an extra washer. In replacing a door which has been removed, the hinges can more easily be brought into alinement if the bottom of the door is rested on the toe of the boot and steadied while the hinge pins are guided into the holes.—Dexter W. Allis, Everett, Mass.

Combination Steps and Driveway

A novel method of combining steps and an automobile driveway, where the house is built on a terrace, is shown in the photo. The steps are built inside of the concrete strips which form the roadway and curbs are laid on the outside of these. By this method of construction a passage is provided for deliveries to the rear of the house without taking up additional room, which is a feature worth considering where the house is built on a narrow lot. In order to make steps easy for ascent and descent they should be proportioned so that the height of two risers plus the width of one tread will be about 24 in. Thus steps 6 in. high should be 12 in. wide. A wooden float should be used in finishing.

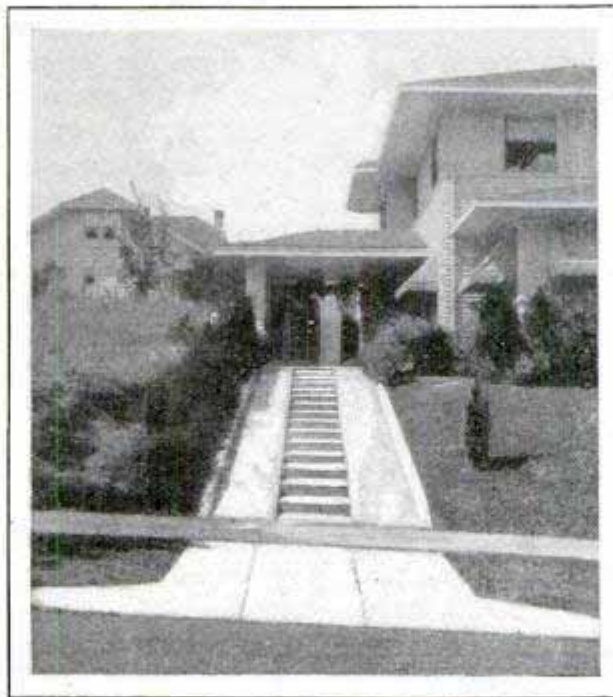

Combination Steps and Auto Drive on Terraced Lawns Found Convenient and Space-Saving

Lens Mounted on Sewing Table



Magnifying Lens Mounted on Edge of Sewing Machine or Table Eliminates Eye Strain

Eye strain can be eliminated to some extent by attaching a reading glass to the sewing table. A spring and washer on a pivot screw serve to hold the handle of the glass against a beveled block and a small collar on the pivot screw enters a recess in the handle, as shown. The glass is removed by pressing it down from the catch and pulling it away from the pivot. When not in use, the glass is swung under the table top where it is safe. The beveled block should have such a slant that the lens will be held at an angle convenient for threading needles. Cloth, held on the knees, can be cut along a thread without strain, and certain knots in embroidery may be tied much more quickly. — Harold E. Benson, Boulder, Colorado.

Chair-Arm Ash Trays

Individual ash trays for use on the arms of overstuffed chairs can easily be made



CLOTH WITH WEIGHTED ENDS

ASH TRAY

in a few moments. Obtain a piece of silk velvet, about 2 in. wide by 1 ft. long, of a color to harmonize with the chair. Get a little tray, and two small strips of lead or iron to weight the ends of the piece of velvet. The strips

should not be over 2 in. wide, and should be of sufficient weight to hold the tray in place. Punch a small hole in the bottom of the tray and attach it to the center of the cloth by using a small split brake-band rivet, or else punch two small holes in it and sew the tray to the cloth. The weights are attached by folding the ends of the cloth over them, and sewing them in place as shown in the drawing.—Glen F. Stillwell, Collinsville, Ill.

Cutting Large Branches

When large tree branches are to be removed, care must be taken in cutting them off so that the tree trunk will not be torn. If the limb is sawed off in the ordinary manner, the result will be



FIG. 1

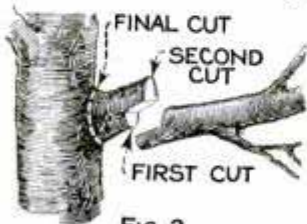

FIG. 2

somewhat similar to that shown in Fig. 1. If, however, three cuts are made as shown in Fig. 2, the branch may be removed in a workmanlike manner without any damage. The first cut should be made by sawing into the underside of the limb until the weight of the limb pinches the tool. Then the upper cut is made,

deep enough to cause the limb to break off and fall. The remaining stub may then be cut off close to the trunk so that the wound will heal over without decay.—G. E. Hendrickson, Argyle, Wis.

Guide for Tapping Holes

When tapping a hole in a steel or metal block, it is difficult to keep the tap vertical while cutting the first few threads. Unless started right the threads will have the wrong pitch and make a poor fit for the screw or bolt. One way to overcome this trouble is to bore several hardwood blocks with exactly vertical holes of sizes to fit the taps. One of the wood blocks is placed over the hole to be tapped and the tap is started through the hole in the block. This will keep it plumb or at right angles to the work and insure a good job without breaking the tap.

Lock for Box-Camera Shutter

Nearly everyone owning a box camera has at some time or other found that the shutter was accidentally snapped and a section of film spoiled. This can be prevented by means of a simple lock as shown in the drawing. It costs practically nothing for material. First cut out a bar of stiff brass, 1 in. long and as wide as the space crossed by the shutter when it is pushed to each end of the slot. Turn up one end of the bar for a finger pull, polish it and smooth off the edges. Make a pair of slides from the same material. One is $\frac{1}{2}$ in. square and the other $\frac{1}{2}$ in. long and $\frac{1}{4}$ in. wide. Bend them so that the bar will slide under them. Drill small holes in the flanges for fastening, and polish them. The lock is assembled as indicated. The bar crosses the slot in the middle and the slides are screwed to the camera box, the large slide to the left and the small one to the right. Be sure that the finger pull

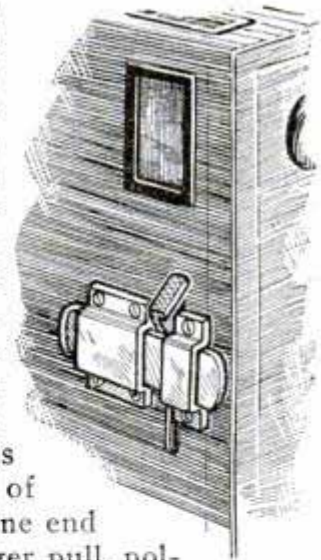

is to the left. To lock the shutter, push the bar across the slot. To snap a picture, pull the bar back across the slot until the finger pull hits a stop pin placed behind it at the left. This pin can be made from a phonograph needle driven into the wood and snipped off where desired.—L. B. Robbins, Harwich, Mass.

How to Wash the Car

Cold or luke-warm water should always be used for washing a car. Hot water is injurious. If you use a hose, let the water run out slowly. If it comes out with force, the finish of the car will be ruined as the dirt will be driven into the varnish. Grease and oil should be removed with gasoline. After most of the dirt has been washed off, clean the surface with luke-warm water and a mild grade of laundry soap or linseed-oil soap. Rinse with cold water, rub dry and polish with chamois skin. To add to the luster of the finish you can use a good grade of automobile or furniture polish. The nickel parts of the car can be polished with any good metal polish, which does not contain too much abrasive matter, and a soft cloth, which will not scratch, should be used for this purpose.

Cleaning Straw Hats

In cleaning straw or panama hats, considerable inconvenience is usually experienced on account of the necessity of removing the band and bow to prevent the cleaning and bleaching liquid from staining them. This difficulty can readily be overcome by placing two wide rubber bands around the hat, as shown, one to cover the upper edge of the ribbon and one the lower, and the cleaning can then be done without soiling them.



RUBBER BANDS.

Clothes Hangers Keep Children's Room Tidy

Clothes hangers of the kind shown in the drawing are quite novel and aid in teaching children to hang their clothes neatly when going to bed. The figure can be



Ornamental Figures in Child's Bedroom Hold Clothes Neatly at Night

made of wood, painted in appropriate colors. The desired pattern, which may represent a French maid, a brownie, an elf, clown, pierrot, dancing Indian warrior, or any other thing interesting to a child, is first drawn on a large sheet of paper. It should be from 30 to 36 in. high. After cutting it out, it is traced on a 1/2-in. board and the outer parts of the wood saved off with a band or jigsaw. The arms, which are separate pieces, are nailed on and the figure is mounted on a base.—Mrs. E. W. DeHuff, Santa Fe, N. Mex.

do U. S. Indian School.

Bath-Spray Nozzle Made from Oilcan

Desiring to have a spray attachment for his bathtub, one man punched holes in the bottom of a cheap oilcan, cut off most of the spout and stuck the remainder into the end of a rubber gas tube. This outfit was connected to the hot-and-cold combination faucet provided on the tub and made an excellent spray nozzle.



Toy Flipper Easily Made of Thermostatic Metal Amuses Everyone

Jumping Disk Proves Amusing

There are available on the market several so-called thermostatic metals, consisting of two layers of different kinds welded together. From this material an amusing toy can be made. It is simply a 1 1/4-in. disk, dished in the center by means of a ball-peen hammer. If the disk is heated and placed on a table, it will jump suddenly upon cooling. In making the disk, carefully notice the difference of the two sides. One is usually yellowish in color and the other bluish-white. The former is the one to be dished until its center is about 1/16 in. below the edge. File the edge smooth. To use the toy, heat the disk carefully until the yellow side bulges outward, making the disk the reverse of what it was before heating. Then place the disk with the yellow side on a cool surface, so that it will contract. When the contraction reaches a certain point, the disk will reverse again and jump up suddenly, perhaps about 6 ft. or more. Other ways to make such a toy are to cut two strips of the same material, dishing both and riveting them together to form a cross, as shown in Fig. 3, or fastening the ends to a ring, as shown in Fig. 4. These do not require the careful dishing that is necessary in the case of the disk, and will not jump so suddenly nor so high.

The explanation of the action lies in the fact that the two layers of metal expand and contract at different rates, when being heated or cooled, the yellow one usually having the higher rate.—James G. Zimmerman, Madison, Wis.

Anchors Made of Concrete

A traveler recently returned from Europe brought an interesting picture of concrete anchors used extensively by the fishermen along the Danish coast and also, to some extent, for mooring yachts and other pleasure and commercial craft. The concrete block is 18 in. square at the bottom, 12 in. square at the top and about 5 ft. high. To increase the holding power protruding arms of 3-in. T-irons, bent up to form hooks, are imbedded in the concrete. A simple square wooden box form is used for molding the anchors, fillet strips are used to cut off the corners, the sides being mortised so that the T-irons can project. The top form is similarly mortised to accommodate the lifting hook, which is a length of 1/2-in. round steel bar, bent to a U-shape and extend-

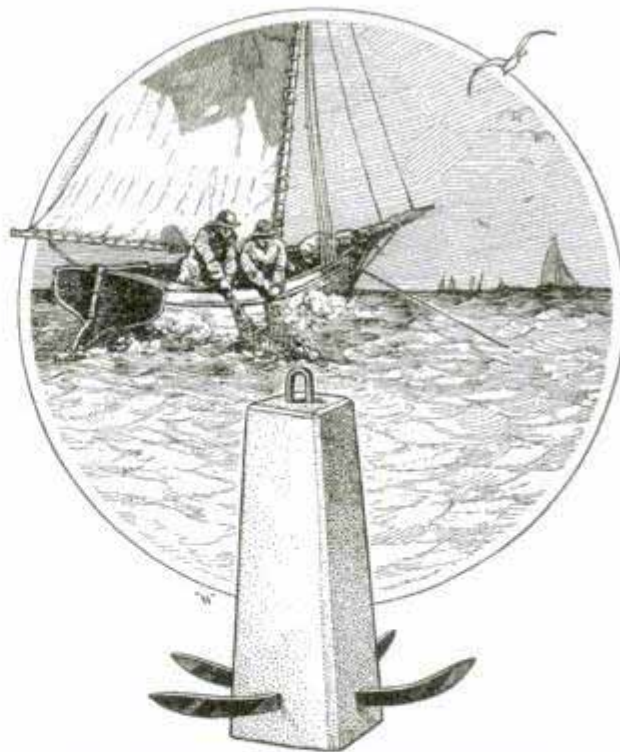

Concrete Anchors, Used by Danish Fishermen, Are Cheap and Have Great Holding Power

ing into the concrete about 10 or 12 in. The anchors cost very little to make.—A. J. R. Curtis, Chicago, Ill.

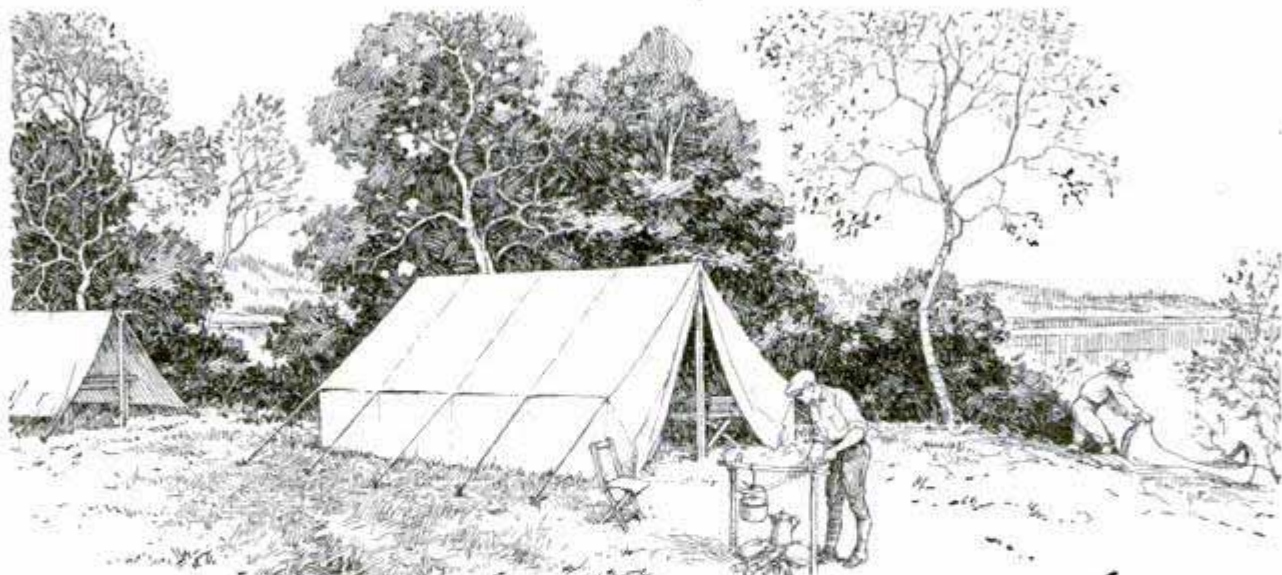

The TRICKS of *by* Bob Becker CAMPING OUT *Becker*

WHEN summer comes thousands of city dwellers feel the call of the outdoors and the lure of camp life, which means a restful, gypsylike existence far from crowds and noisy streets. To the man who knows the tricks or the "art" of camping, several weeks in a tent is a restful, carefree experience, as a knowledge of how to live in the woods means the difference between comfort and discomfort after leaving behind the world of gas stoves, spring beds and refrigerators.

The outdoor fan who chooses to put a canvas roof over his head on the bank of a stream or lake is on "his own." He must know a few things about choosing a camp site. He should know how to fix up his camp for comfort, keep perishable foods, make a bough bed and other things which contribute to the success of his "back-to-nature" existence.

The first problem that confronts the tent dweller when he arrives in vacationland is the choice of a camp site. Where the tent shall be pitched is an important matter. Briefly, the trick of "getting set" in a tent home involves the following:

Pure drinking water, a fairly level spot for the tent, an ample supply of firewood, exposure that insures sunlight part of the day, and drainage. The inexperienced camper may dream about his ideal camp

buried in the heart of the forest primeval, but the experienced outdoorsman shuns such a site in the summertime, as he wants his camp to be bathed with sunshine part of the day and also swept by breezes. Therefore, a high, well-drained spot on a river or one jutting out in a lake or stream and not too densely covered with trees is an ideal location for the permanent camp.

And which way shall the tent be faced? As a rule an easterly exposure is best. Next comes the southeasterly exposure. In any event, face your tent away from that point of the compass which is apt to produce heavy blows and squalls. After the camper has scanned the landscape for the best site, found the high ground and is ready to make his decision, the common blunder usually made is to pitch the tent under a big tree. The big tree may be all right when there's blue sky overhead but during a storm it's another story. Avoid the big ones, especially those with dead limbs which may come hurtling down upon you some night.

If you are in a country that offers few fairly level spots, smooth off the floor area of your future outdoor home and cut a narrow trench around the outside of it. This should be close to the wall of the tent, about 3 in. deep and 3 or 4 in. wide.



In case of a heavy rain any water having an inclination to drain down the slope into your

drive the tent pegs into the ground, presents a problem that can be solved by using large logs over the guy ropes. Drive in the pegs as far as possible and then swing the ax on a log to cut a chunk to fit your needs. Roll this wood over the guy ropes next to the pegs, and it will back up the stakes in their work of holding your tent against wind. If a wall tent is used, one can dispense with the small pegs commonly used to hold the walls to the ground by having more logs or big boulders. Allow several inches of the wall to rest on the ground. Over this place your logs or boulders, and no pegs will be needed.

The camper needs a tool kit in order to make himself comfortable in the woods. To make rough camp furniture, cut wood, and repair equipment the following items should be taken into the woods: a good ax, hatchet, a spade (for trenching the tent, digging a refuse pit, etc.), a hammer,

an assortment of nails, a ball of heavy twine, about 20 ft. of heavy wire for hooks, 1 spool of annealed wire, a small saw (if you wish to make your camp table and other furniture) and a coil of heavy sash cord or 1/4-in. rope. With these tools one can play carpenter and in a

quarters will be caught by this "trough" and diverted.

For a permanent camp a site in dense timber into which the sunlight can hardly penetrate is to be avoided. The average city dweller who goes into the woods for his first camping experience is apt to think of shade first of all as he selects a spot for his tent.

All shade and no sunlight means damp food, damp blankets or sleeping bag, unhealthy sleeping conditions and eventually mildewed equipment. Unobstructed sunlight upon your tent for several hours every day is almost a necessity if one is to be comfortable and healthy during the period spent in the woods.

Anchoring a tent in a country that has little top soil, thus making it difficult to

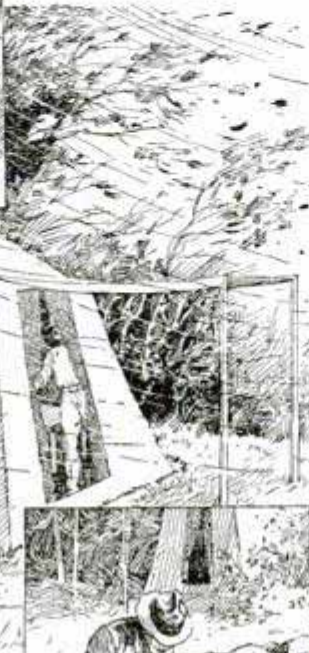

FACE TENT AWAY FROM WIND



TRENCHING



KEEP AWAY FROM EXCESSIVE SHADE

few hours have an array of equipment that will make for orderliness, comfort and health. For example, it is uncomfortable to eat while sitting on the ground, so the first job is to build a table if a folding dining table is not included in the camp equipment. Here is where the man handy with tools earns his salt the very first day in camp. He can drive four stakes into the ground for legs, nail cleats across the ends and then proceed with the top. If one has a few packing cases in camp, the top of the table can be made from them. If boards are not available, straight sticks will do. When finished the table should be about 30 in. high. Benches for it can be made in the same manner. A tent fly, tarpaulin or other fabric spread over this table completes the job.

The disorderly camper strews his equipment around, can never find anything, ignores his food supplies and then wonders why camping is more work than play. The orderly tent dweller spends several hours the first day getting things shipshape and making some of the following things for his outdoor home. First, a rack for the cooking utensils which can be made as follows: Drive two forked sticks into the ground until they are about 30 in. high. Lay a pole, 4 or 5 ft. long and 2 or 3 in. in diameter, across these. Wire or nail the ends of the pole

coffee pot and other cooking utensils. If there is a tree close to the "kitchen," it can be converted into a rack by nailing to the trunk inverted crotches. In the commissary tent (and every camp-



to the supports. Then dig up that coil of heavy wire and make five or six S-hooks to be hung on the pole. With these in place you have a rack for the skillets, cooking pots,

your ax, go into the woods, find a bush with a number of branches and cut it down. Then trim it so that the stubs of the branches will remain. Drive this skeleton into the ground where you want it, and you have an excellent rack for the dish towels.

A camping party that stays more than one or two nights in one place should fit up the sleeping tent with a little rustic

ing party should have a small tent for this purpose, with an awning to work and cook under in wet weather) we used a trimmed bush as a rack for the dish towels, etc. Ten minutes do the trick. Take



CLOTHES RACK



KEEPING FOOD COOL



CANDLESTICK

equipment which can be made quite easily. Where to hang things is always a problem for the city man who comes fresh from a world of closets, coat hangers and furniture with capacious drawers.

Here is the way to take care of the clothes, guns, tackle and other things in the sleeping tent so that they won't be cluttering up the quarters: If you are using a wall tent, sink a forked stick in each corner and then lay poles on them. Drive nails in these poles six, eight or ten inches apart or make some more wire hooks for them, and you have hooks aplenty on which to hang things. The advantage of this arrangement is apparent when bedtime comes around. One can undress, hang his clothes high and dry and in the morning simply reach up for his outfit, which has been kept out of the dirt and dampness. Guns and fishing rods can be cared for in much the same manner by forked sticks and poles placed closer to the ground. These articles may be ruined if left to lie on the floor of the tent. A rack built outside of the tent is a handy thing for fishing rods during the day, but these delicate accessories should not be left out overnight.

Although manufacturers have devised many ingenious types of lanterns and other lighting equipment for the camper, usually there comes a time when the old candle must serve after the sun goes down. They are a nuisance and a menace

unless fitted into a candle holder which keeps them standing straight up. A tin can makes a serviceable candle holder if it is filled with moist earth. Tamp it down around the candle and you will have

a lighting equipment fit to be used.

Although it is thrilling to read about the woodsman who rises with the sun, strides down to the crystal brook and plunges his face into the water to perform his morning ablutions, the average camper prefers a more convenient set-up, which involves a wash stand. If two trees are standing fairly close together, one can make a shelf out of sticks and a few nails on which the wash basin can be placed; if a small box is available this is still better. If the back-to-nature method of washing in the lake or stream is preferred, better give the bar of soap a fair shake by at least making a soap container as follows: Drive a stake into the ground near the water and nail into its top a small piece of birch bark, the top of a tin box or a flattened tin can which will serve as a soap dish.

In tackling the problems of keeping perishable food fresh in camp or sleeping comfortably, the city dweller camping for the first time is apt to be stumped. Food especially is a stickler. Here are some tricks that can be worked to keep such articles as butter, milk or fresh meat cool without the use of ice. In the first place use friction-top tins for butter, lard and





CAMP STOVE



WASH STAND

similar food articles. These can be purchased at any sporting-goods store. Secondly, make a sort of an "icebox" for your perishables. If you have a spring near camp your cooling box can be placed in it. Take an ordinary packing box such as the grocer will use to pack your supplies and put it down two, three or four inches in the spring or in the rivulet which flows from a spring. There should be two or more holes in each end of the box near the bottom of it so that the cool water can flow through. Place the tin of butter, the can of lard or other foodstuffs on flat rocks inside of the box, and even in the warmest weather things will keep cool. This back-to-nature type of icebox has only one drawback. It may be a lure for prowling mammals, so it is well to keep the top fastened down. A big rock will do the trick. Although this spring box will keep milk, butter and other things cool and sweet, it won't keep them from being tainted if you put fish in the cooler as the former pick up odors from other foods. If you are not near a spring, dig a hole in the moist earth for the box.

If you should be one of those fortunate campers in a not too remote area where ice can be had, you'll have to go to the nearest town for a barrel before you start to work on your icebox. A good-sized barrel is the simplest ice chest that can be devised for camp. Provide a couple of holes in the bottom of it for drainage, put the ice in the bottom and you're prepared for any temperature.

To hold such foodstuffs as beans, rice, flour, sugar, salt and similar items there is nothing like the waterproofed bags which can be purchased in nearly any sporting-goods store. They are tough, will

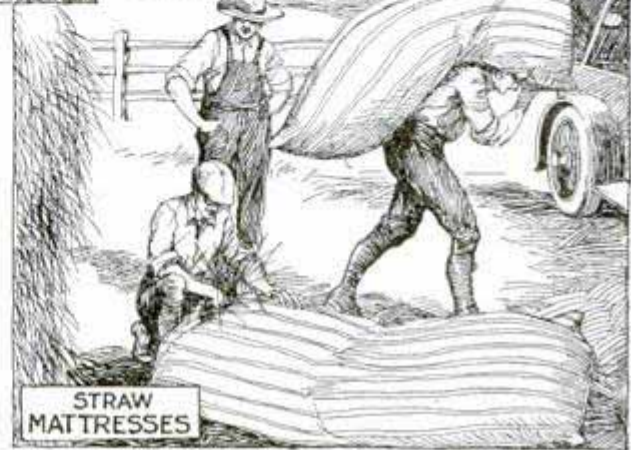

STRAW MATTRESSES

stand punishment, do not absorb moisture and can be obtained in any size. When labeled they are ideal for carrying foodstuffs.

At least one-third of a camper's time is spent in bed, so the matter of sleeping arrangements in camp cannot be overlooked. One can stand most any kind of a hardship during the day, but when night comes there is just one thing that will keep a man going and that is restful sleep on a good bed. The camper has a wide range of bedding materials and outfits to choose from, including folding camp cots, sleeping bags, bough beds and air mattresses, all of which are recommended. The trick of keeping warm on a camp cot is in having more blankets under you than over you, as there is a big circulating air space between you and the floor of the tent which "draws" the body heat. Air mattresses make soft beds, but they need several layers of woolen-blanket insulation. While on an Alaskan big-game hunt we carried air mattresses on the entire trip, but with plenty of spruce boughs available for beds, we stuck to the latter and with a sleeping bag for warmth our sleeping facilities were top-notch.

Every camper should know how to make a browse bed even though he is in a permanent camp with cots, springs or other appurtenances of civilization. Here is



the method and, if followed, it will produce a springy, fragrant bed. First the material. Let the poet sing of his "bed of pine boughs," but when you select material for your browse bed look for hemlock or balsam trees as your sources of material. Cedar and spruce will serve very well, but pine-tree branches are quite hopeless as they haven't the bulk. With an ample supply of short twigs start at the foot or the head of your bed where short logs staked down will help to keep the boughs in place. Stick the twigs in the ground so that the tips will be exposed and lay a row across the bed. Then lay down row after row of the boughs so that only the tips will be in the air while the hard stems will be burrowing underneath. After covering the ground with a mat of this sort you're ready for the second operation. With the hatchet cut a plentiful supply of smaller branches, just long enough to keep their heads above the first layer when stuck through it. Pad the bed from one end to the other with these. If time permits, go over the bed with another layer of small twigs as a browse bed is soft and springy in proportion to the time and material used on it. Throw your blankets on this mattress, or your sleeping bag, and you needn't worry about a restful night's sleep. Another good kink is to make up mattresses from ticking; just a simple bag that will fit a camp cot. Fold them up and pack them among the

dunnage. When camped, fill the mattresses with hay, straw, or even dry long grass, and you will have comfortable, warm beds.

A Wallpapering Kink

Amateurs who do small jobs of papering in their homes will find the labor simplified considerably if the paste is applied to the wall instead of the paper. This makes the handling and trimming of the strips on the table much easier, and there is less danger of soiling or tearing.

Effective Crow Trap

Traps of the kind shown in the drawing have been found very effective for catching crows. It is an easy matter for the bird to get inside from the top but impossible for it to get out again. Four light wooden posts, about 6 ft. long; two stakes, about 3½ ft.; eight poles, varying in length from 4 to 5½ ft., and some wire poultry mesh are all the materials required. The trap is located at any desirable spot, which is usually along marshes or lakes, near woods or around outlying buildings. The posts are driven into the ground, and the crosspieces and

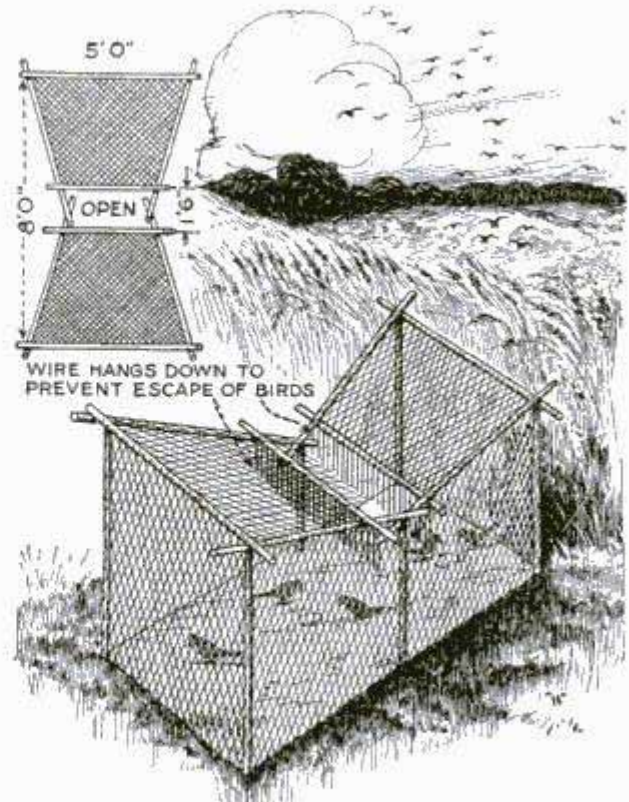

An Effective Crow Trap Which Can Be Made of Old Poles and Poultry Mesh

wire mesh are attached as shown in the illustration. Old weather-beaten material is preferable to new, and chipping marks on the surfaces of the poles should be avoided, as the crow is a wary bird. Do not go near the trap during the day, but visit it after dark.

Efficient Honey Reservoirs

Liquid honey is usually obtained by separating it from the wax comb, either by the modern centrifugal extractor or by the older method of crushing the comb and straining out

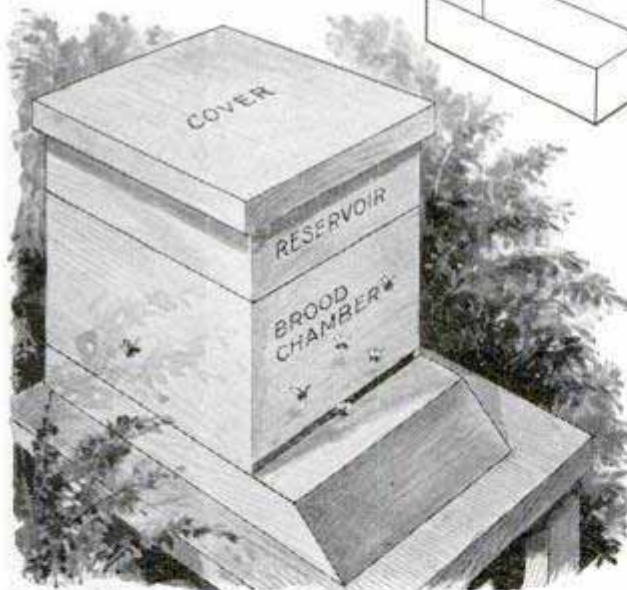
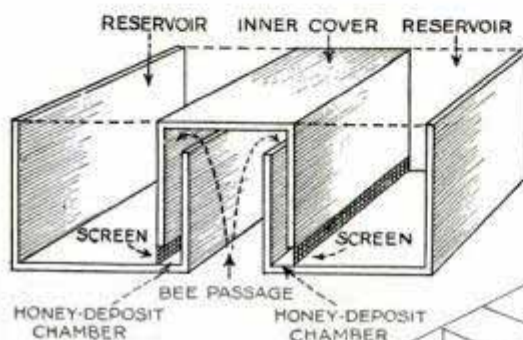

the honey. I tried to have bees store honey directly in a reservoir instead of in combs and found this method highly successful. The construction of the reservoir is shown in the drawing. It is made of $\frac{3}{8}$ -in. dressed boards, leak-proofed at the joints with beeswax or paraffin wax. The reservoir does not interfere with the brood nest at all. The brood is reared as usual. Small quantities of honey and pollen are carried up and deposited in the reservoirs at either side

of the hive. During the gathering season the bee master may go each evening and dip the honey, without interference from flying bees, into pails for marketing. I

have 34 colonies of bees and, at present, 15 colonies are using these reser-

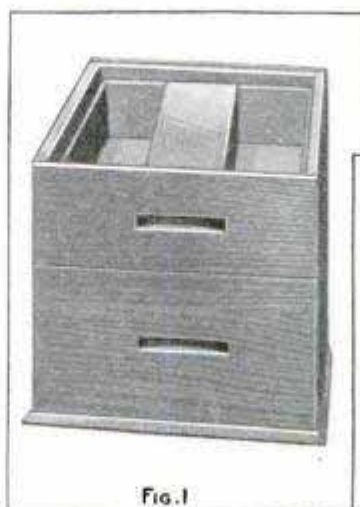

Fig. 1

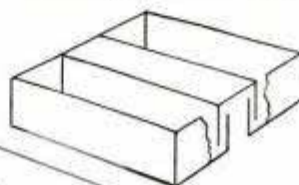

Fig. 2

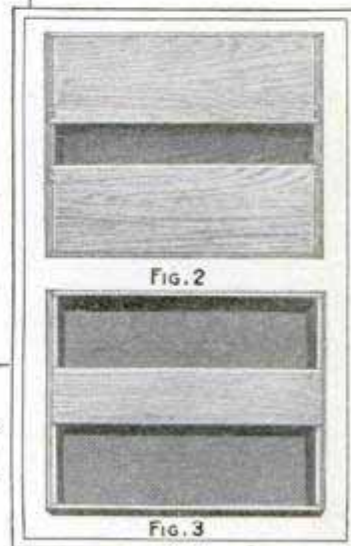

Fig. 3

Honey Reservoir Which Is Placed on the Brood Chamber. Bees Deposit Honey in It without Making Combs

voirs and I expect to equip all my colonies with them. — L. Wilson, Ottawa, Canada.

409 Connaught Bldg.

Reassembling Furnace-Pipe Sections

When long runs of furnace pipes are dismantled it is often difficult to get the sections together again in their proper places. This is important in order to have the joints tight, and applies particularly to sections that have been keyed together to prevent sagging. The trouble may be overcome by numbering each section with black stovepipe paint and drawing a line across the union of adjoining sections. When the pipe line was to be reassembled the sections were joined in numerical order with the marks meeting, and then the keys or pins could be inserted without difficulty or loss of time.

☞ To avoid brush marks when painting glass, clean the glass with alcohol; use thin colors ground in japan, with flattening oil to which a small amount of varnish is added, then stipple the colors on the glass.

Grass Catcher for the Lawn Mower

When you need a new grass catcher on the lawn mower, try using an ordinary basket, attached as shown in the drawing,

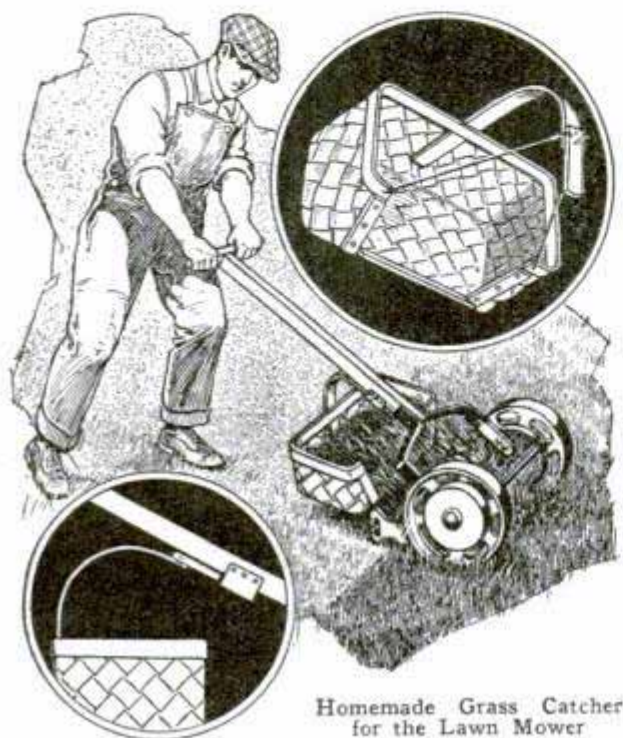

Homemade Grass Catcher for the Lawn Mower

and you may find this improvised catcher just as good as the commercial kind. Cut out one side of the basket and the handle, and tack short lengths of lath on the cut edges. Run two lengths of wire from the handle to the corners of the basket. The handle is fastened to the lawn mower as indicated in the lower insert.—Wilson G. Walters, Rochester, N. Y.

Improving Appearance of Bell Wiring

Wires leading to electric bells in houses are usually allowed to look untidy by sagging and collecting dust. In most cases the wires are coiled about a pencil and attached to the bell in a careless manner, and the insulation at the ends is allowed to fray. A couple of lengths of spaghetti tubing, such as is used in radio work, will make a much neater-appearing job. Scrape the insulation from the wire clear down to the wall. Then slip a length of spaghetti over the bared wire so that it is completely covered and the spaghetti enters the hole in the plaster. If the spaghetti is selected to match the walls, neatness is even more assured. Wrap the bot-

tom ends of the spaghetti with a short strip of friction or adhesive tape and stick the torn wallpaper down, and you will be surprised at the improvement.—L. B. Robbins, Harwich, Mass.

Veneering Old Steps

Not so long ago my attention was called to a simple method of veneering old stair steps. At first, I was a little skeptical, but after the method had been thoroughly explained I was satisfied that it was really a successful method of repair.

The veneering used in the case illustrated in the drawing is $2\frac{1}{4}$ -in. oak flooring. The nosing of the old treads is to be cut off before the veneering is put in place. The last board of the riser is ripped off in such a manner that the nosing piece will rest tightly onto it, as shown by the drawing. Then the nosing piece is nailed into place and the tread covered with flooring.

The inset detail shows how the nosing can be made out of a piece of flooring, by placing a fillet between the nosing board and the cove. It is shown with square corners, but if round ones are desired, they can easily be cut down.—H. H. Siegele, Emporia, Kans.

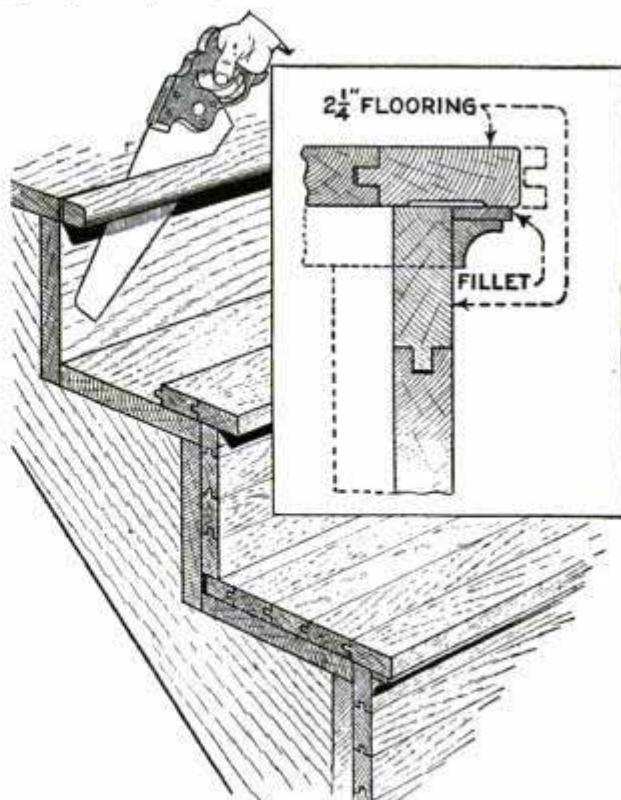

Simple Method of Veneering Old Steps, Using Common Oak Flooring

These Will Puzzle Your Friends

WIRE puzzles, while they are very easy to make, and very easy to solve (when you know how), may be made to provide a lot of amusement. Any boy, with the aid of a pair of pliers, can make

out of joint; on the other hand, it need not be too heavy and stiff, or it will be difficult to form.

The solution is simplicity itself. The open ring is folded back against its hair-

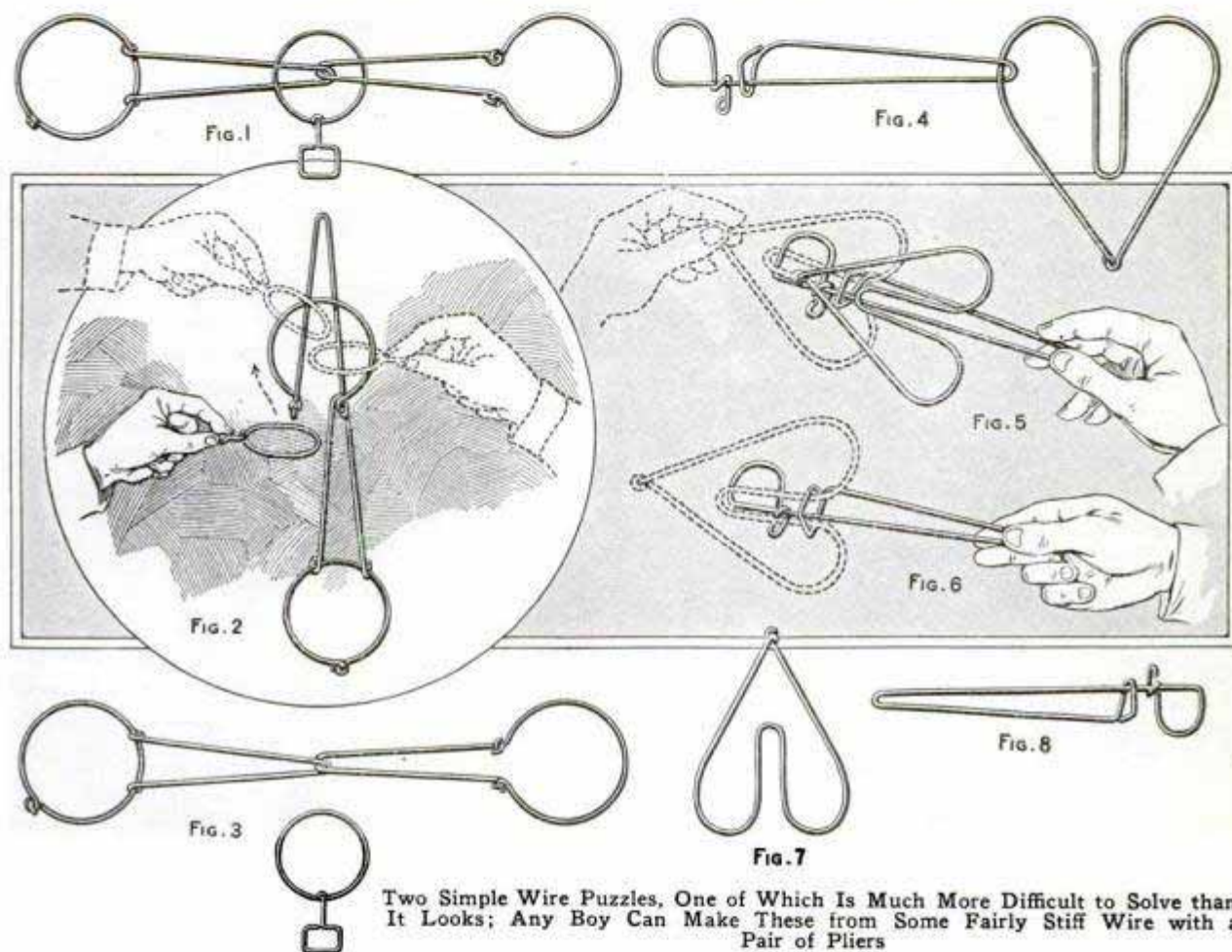

Two Simple Wire Puzzles, One of Which Is Much More Difficult to Solve than It Looks; Any Boy Can Make These from Some Fairly Stiff Wire with a Pair of Pliers

the two shown in the illustration, which, simple as they seem, will make even his elders spend many minutes in trying to solve them.

The puzzle shown in Fig. 1, while it looks the simpler of the two, has been found the more difficult. It consists of two hairpin-shaped pieces of wire linked together and to two rings, one of which is open and the other closed. The hairpins are each $1\frac{1}{2}$ in. long and the rings at each end are 1 in. in diameter. Assembled, the puzzle looks as in Fig. 1, the central ring being about $\frac{3}{4}$ in. in diameter. The problem is to get the central ring off. The wire chosen to make puzzles of this character should be so stiff that it cannot be sprung or forced easily when the puzzle is made up, otherwise too enthusiastic solvers will quickly knock it

pin, as shown in Fig. 2, when the loose ring can be passed around both and off. This may seem almost too simple, but that is the beauty of this puzzle. It is the exception rather than the rule to find anyone who can take the ring off in less than twenty minutes, and many give it up entirely. With a little practice, the owner of the puzzle can hold it behind his back for a second and—presto!—the ring is off, thus adding to the mystification of the person who gave it up.

The second puzzle, shown in Figs. 4 to 8, is simpler to solve, but even this keeps many people occupied for a considerable time. The left-hand piece in Fig. 4 is sword-shaped, and is 3 in. long over all. The handle of the "sword" is about $\frac{1}{2}$ in. long and $\frac{5}{8}$ in. wide, and the lower loop is $2\frac{1}{4}$ in. long. The heart is $2\frac{1}{2}$ in. long and

$1\frac{3}{4}$ in. wide at the top. The loop in the center of the heart must be narrow enough to pass through the closed hook at the top of the lower loop of the sword. The solution is shown in Figs. 5 and 6. The point of the heart is grasped and the loop in its center drawn through the hook in the sword, then over the handle and down through the hook again, the hook being sprung inward slightly to enable this last operation to be performed easily. The whole thing can be done quicker than it can be described, and a minute's practice with the puzzle will show the method.

Tailless "Wise-Owl" Kite

Boys who are looking for something new in kite construction will find the wise-owl kite an easy one to make and quite novel. The frame is made of lightweight reed or bamboo and is covered with light but stiff paper. The paper is cupped, lapped over and pasted, and attached to the frame by several narrow strips of paper on the back side. An opening is left in the end of each wing, as shown in the detail, so that the

the top, and experiment will show the correct place at which the flying string should be permanently fastened to the bridle. Starting at the lines where they join the body, the wings slope back in the cupped surface mentioned above until at the tip they have receded a distance of $1\frac{1}{4}$ in. If properly made and balanced this kite will need no tail.

Removing Broken Transmission Key

Several manufacturers of automobiles equip them with transmission locks. This lock is an excellent feature, but it has the disadvantage that the key is easily broken in the lock by someone striking against it with the foot. In several makes, it is necessary to saw the lock off the transmission in order to remove the broken key. However, it is sometimes possible to get the key out in the following way: Scrape the visible portion of the key near the top of the slot with the tang of a small file, and, with a toothpick or other small piece of wood, rub some soldering flux on it. Get a strip of copper, about $\frac{1}{4}$ in. wide and 6 in. long. The thickness does not matter so much provided it is not so thick as the

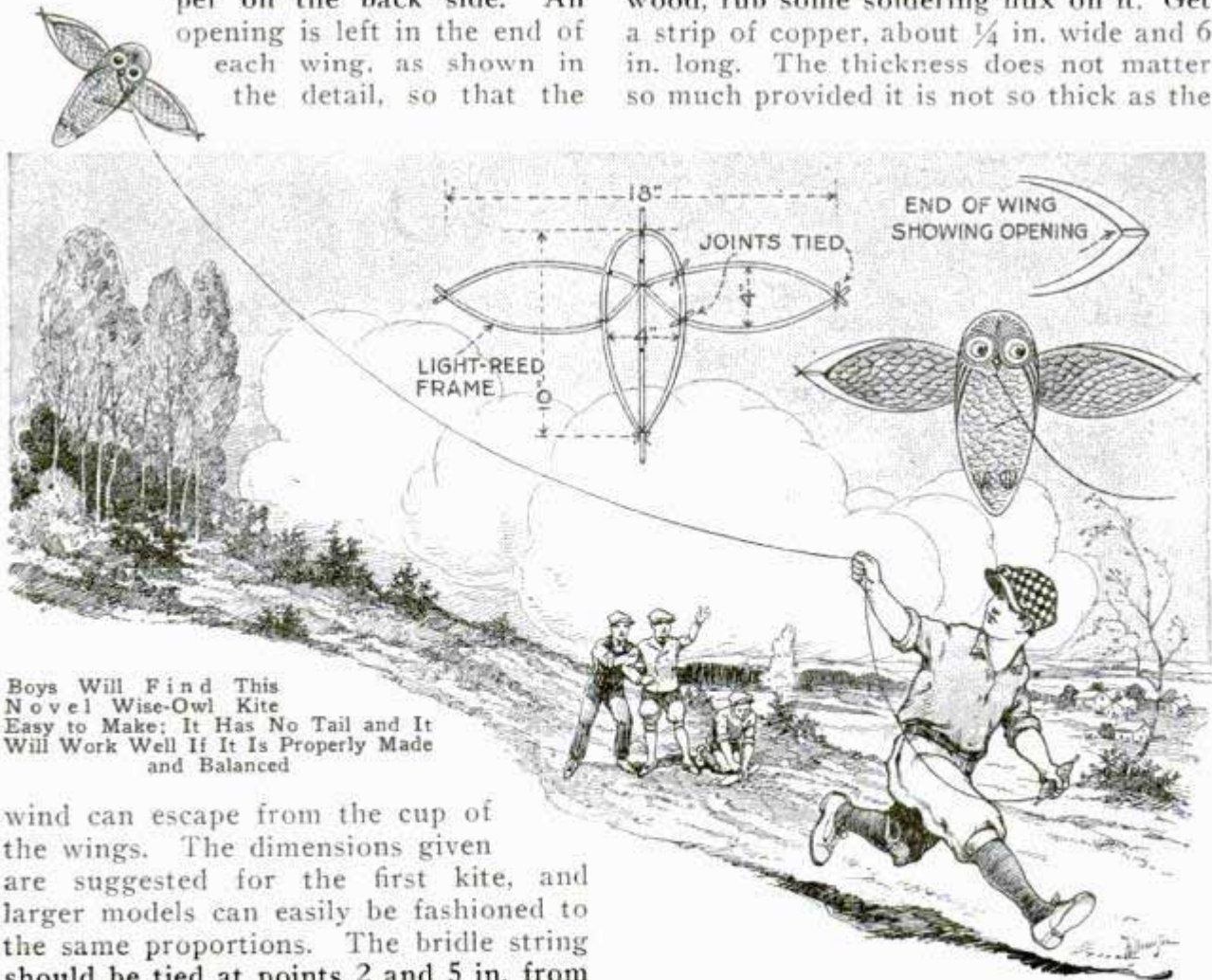

Boys Will Find This Novel Wise-Owl Kite Easy to Make; It Has No Tail and It Will Work Well If It Is Properly Made and Balanced

wind can escape from the cup of the wings. The dimensions given are suggested for the first kite, and larger models can easily be fashioned to the same proportions. The bridle string should be tied at points 2 and 5 in. from

broken key in the lock. Clean the end of this strip, put soldering flux on it and heat it sufficiently to pick up a small drop of solder. Now set the strip above the broken key with the soldered end touching the end of the key. With a small portable blowtorch, or blowpipe of some sort, heat the copper strip as close to the end as is possible without setting anything on fire. As soon as the drop of solder starts to melt and run onto the key, remove the torch, taking care not to jar the copper strip, and when the solder is cooled, it should have made a joint between the copper strip and the broken key; then, all that remains to be done is to put a few drops of oil around the key and carefully pull it out with the copper strip.

Quickly Detachable Lawn Hose

To add to the convenience of the lawn hose and the outdoor hydrant, the method of attaching the hose can be simplified so that it can be done almost instantly. Two gaspipe nipples, a tee, a suitable length of discarded shovel handle and a stout coil spring are assembled as shown in the drawing. The upper threads of the top nipple are filed down so that it can be easily inserted into the outlet of the hydrant. When the assembly is completed, the hose is permanently attached to the nipple, screwed into the tee and the device is ready for use. To attach it to the hydrant, a rubber washer is slipped over the smooth nipple, and the supporting spring at the lower end of the device is pressed down against the ground so that the nipple may be inserted into the hydrant opening. The tension of the spring compresses the rubber washer between the mouth of the hydrant and the shoulder of the tee so that a watertight connection is made.

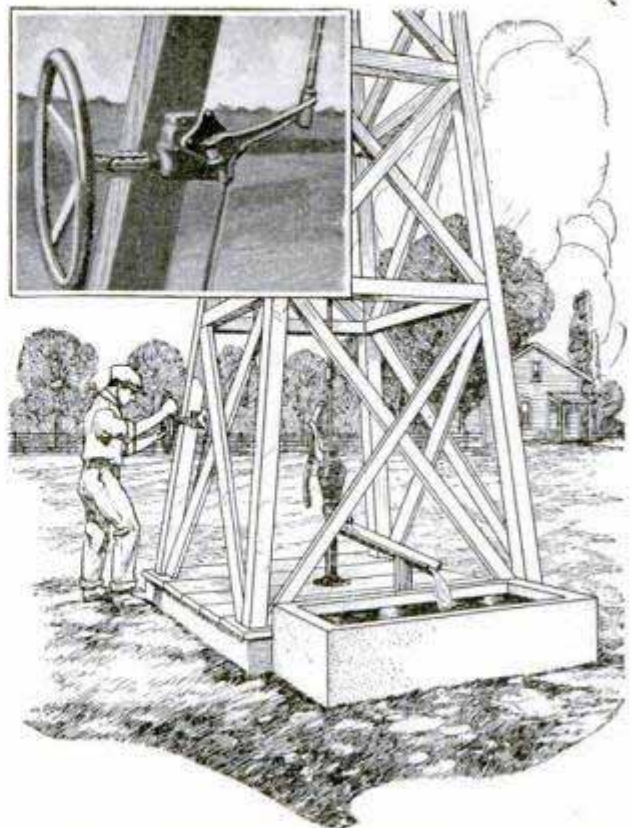
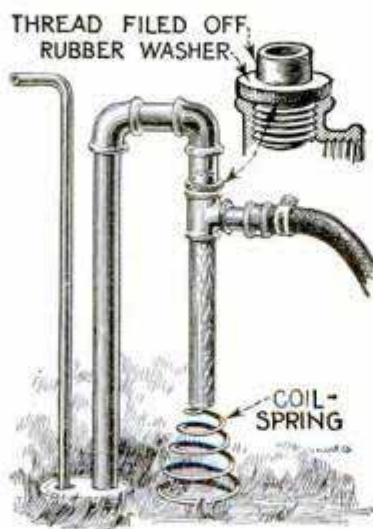

Old Auto Steering Device Attached to Windmill Frame for Controlling the Fan

Control for Windmill Rotor

Frequently the lever used to control the rotor on a windmill becomes loose so that the mill runs wild if no one is around, and besides, the usual lever is rather hard to operate. A decided improvement in the fan control is shown in the accompanying illustration. It consists of the steering device of a discarded auto. The arm is turned by the worm gear and will stay where it is set, no matter how hard the wind blows.

High-Speed Commutator Needs Plenty of Oil

Due to its high speed, the Ford commutator will soon become badly worn unless its parts are lubricated sufficiently, which most owners forget to do. Keeping the commutator in good condition by oiling it properly is necessary to keep the engine in good firing condition. If the contact points do not make perfect contact with the roller, the engine will misfire at fair speed. Put a little good, light oil into the commutator every day if you use the car considerably, or after every 200 miles of driving.

Outboard Motor Doubles as Wash Machine

Not feeling inclined at the time, to spend the money for a washing machine, and facing an accumulation of soiled clothing that would have cost at least \$10 if done

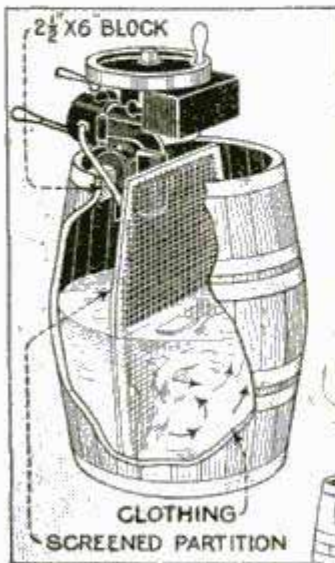

Outboard Motor Fitted on Barrel Is a Good Substitute for Washing Machine



at the laundry, I decided to do a little experimenting. I had a perfectly good outboard boat motor, and reasoned that it could be made to wash clothes quite as effectively as it drives a boat. The whole principle of a power washing machine seems to be that of stirring the clothes around in the water and suds until the dirt is worked out of them, and it seemed that an outboard motor could be made to do the job. I mounted the motor in a barrel as indicated in the drawing, and built a grating of slats and wire screen to keep the clothing away from the propeller. After the clothes, water and soap were placed in the barrel, I started the motor, and soon discovered that I had all the motion that any washing machine could produce. The clothes, suds and water tumbled around at a lively clip. Thirty minutes later I drained off the water and removed the clothes and found them just as clean as if washed in a regular washing machine. By draining the water off and refilling the barrel with a hose, I also made the motor supply the power for rinsing. This use of an outboard motor will not injure it in any way. The same water in which the washing is

done is, of course, pumped through the cylinder jackets to cool the motor, but the soap that is in it is in no way injurious to the motor. Any owner of an outboard motor can rig up a washing machine in this way at almost no expense whatever. It will do the family washing every week for about ten cents, and give just the same service as before when its use is desired for driving a boat.—John Edwin Hoag, Los Angeles, Calif.

Stopping Crankcase Leaks

Frequently leaks around the flange of the auto crankcase, where it is bolted to the engine block or transmission cover, are hard to repair. This is especially true of Fords. The transmission cover may have to be lifted and additional gaskets inserted before the leak can be stopped. However, if it occurs between two bolts or capscrews holding the pan, it can easily be stopped by simply driving upward on the crankcase flange at the point it is leaking with light blows of a hammer and a blunt punch. The operator should not hammer on the lip of the flange but between the two bolts on its flat part. These leaks are usually caused by the crankcase flange being drawn out of line through frequent removal and replacement of the crankcase, the drawing down of the bolts being responsible for the uneven flange.

Corrected Wiring Diagram

In the June, 1926, issue of Popular Mechanics Magazine, on page 1025, was published a wiring diagram for a lamp to be

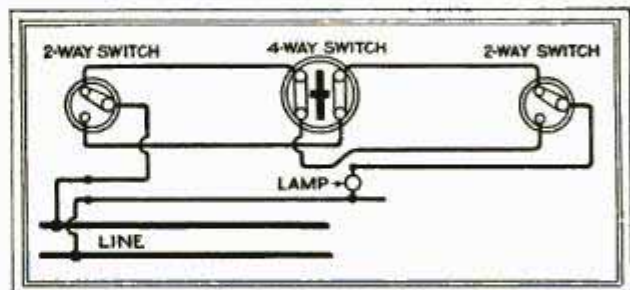

controlled from three points. Unfortunately an error was discovered in it and a corrected diagram therefore is given here.

☛ Broody hens which are not wanted for hatching purposes should be broken up as soon as detected.

Make this Amusing Crazy Clown

BY E·R·HAAN

EXCEPTIONALLY odd in appearance and action, this clown will prove popular with children and will also provide amusement for their elders. If placed on an inclined board, the toy will creep down of its own accord in a peculiar way. It is operated by

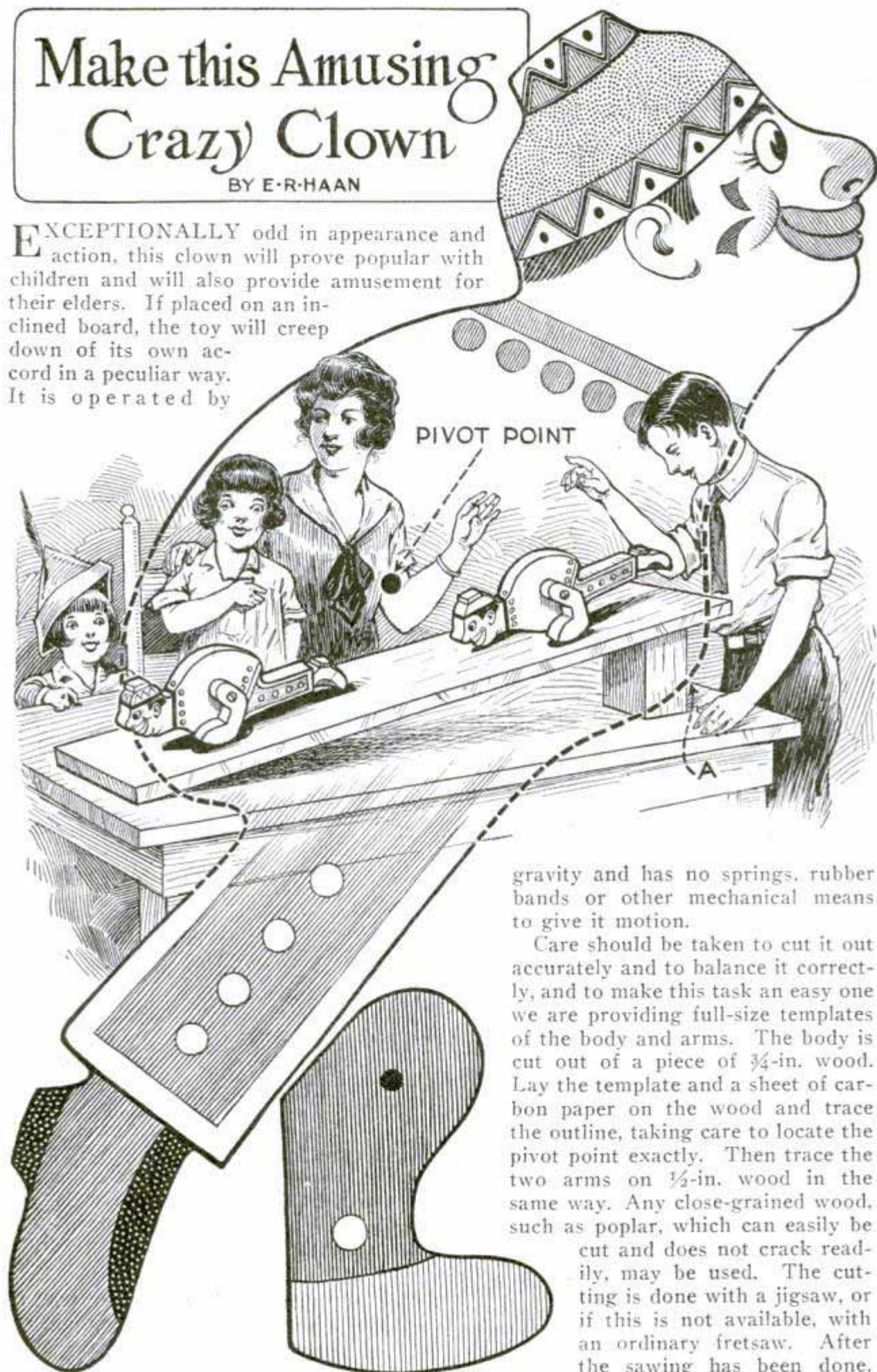

gravity and has no springs, rubber bands or other mechanical means to give it motion.

Care should be taken to cut it out accurately and to balance it correctly, and to make this task an easy one we are providing full-size templates of the body and arms. The body is cut out of a piece of $\frac{3}{4}$ -in. wood. Lay the template and a sheet of carbon paper on the wood and trace the outline, taking care to locate the pivot point exactly. Then trace the two arms on $\frac{1}{2}$ -in. wood in the same way. Any close-grained wood, such as poplar, which can easily be cut and does not crack readily, may be used. The cutting is done with a jigsaw, or if this is not available, with an ordinary fretsaw. After the sawing has been done,

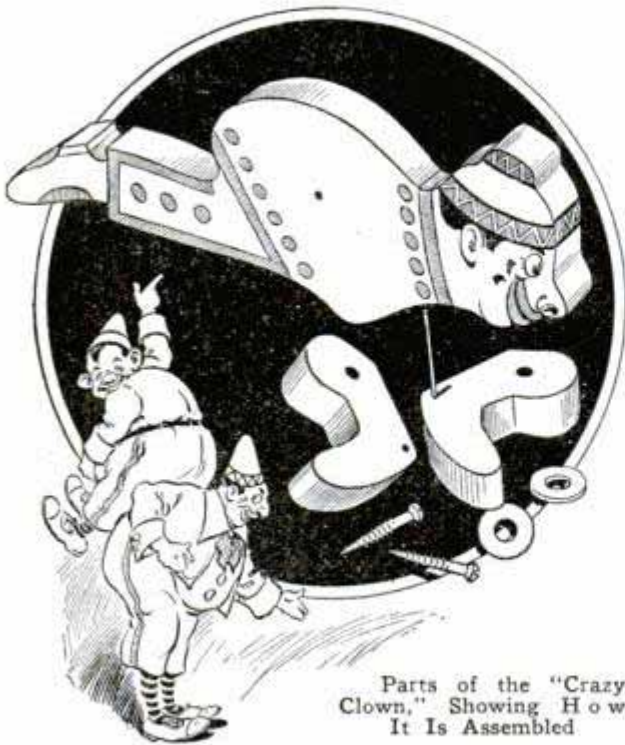

Parts of the "Crazy Clown," Showing How It Is Assembled

sandpaper the edges and sides and drill a hole through the pivot point on the arms to take a 1-in. round-head wood screw loosely. Drill two smaller holes in the "elbows" to receive a short length of wire. This connects the arms so that they move together and also limits their swing. The holes should not be drilled entirely through the arms but only deep enough to hold the wire snugly.

After boring a small hole at the pivot point screw the arms to the body and slip a washer over the end of the screw before driving it in, to reduce friction between the arms and the body. Allow the arms to swing freely. The toy is then ready to be tested.

Hold the figure down so that the chin and the point A touch the inclined board. In this position, the arms should swing freely and just clear the board underneath. In some cases there may be too much space between the legs and the board so that it is necessary to reduce the bulge at A by sandpapering slightly. However, if the body and legs are exactly made according to the template there will be no trouble. After the test the toy is taken apart and painted, care being observed not to get paint in the holes in the arms. If this happens the holes should be thoroughly cleaned out before reassembling. Lacquer is recommended for painting, as it dries quickly. The toy, due to irregulari-

ties in the cutting, may not operate well on the first trial, but a little experimental work with sandpaper on the bulge A, or the bottom surfaces of the arms, will usually remedy this.

Watering Bees

Few bee keepers who have a small apiary know that it is essential to keep water for their bees. A bee will hunt the well and the watering trough to quench its thirst just as a dog or cat, but the bee is not so lucky when it falls in. It cannot get out of water easily. Therefore, a way should be provided for the bee to get its drink without effort or danger of drowning. To do this, keep fresh water in a pail or other vessel and put ground cork, which can be had at any fruit store, on the surface of the water. Keep quite a thick layer of the cork on the water and change it to keep the cork fresh. The cork will float the bees so they cannot fall in.

Ratrap for Scaling Fish

For cleaning and scaling of fish a novel and convenient device is shown in the accompanying illustration. It consists of



a ratrap with the bait pan removed and several steel nails driven into the wooden base near the edge. The points are left projecting about $\frac{1}{2}$ in. and are filed sharp. The trap is fastened to a post at a convenient height, and in use, the trap jaw is raised and the tail of the fish placed upon the projecting brads. Releasing the jaw presses the brads into the tail, so that the fish will hang head downward at a convenient height for scaling.

Many chickens are killed by feeding them too much grain; this is not seldom the cause when they die suddenly.

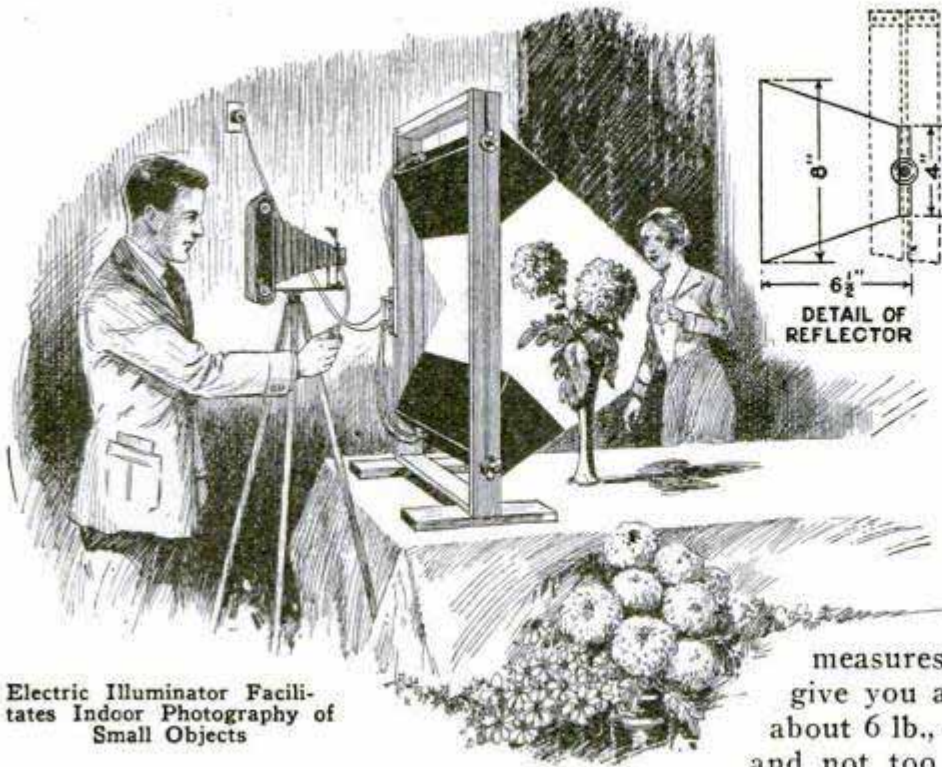

Electric Illuminator Facilitates Indoor Photography of Small Objects

Illuminator for the Amateur Photographer

This simple, homemade illuminator comes in very handy for photographing small objects indoors. Copying and photographing objects, such as flowers, that might be moved by the slightest breeze if taken outdoors, may be done with this outfit indoors under absolute time and light control. The arrangement of the four lamps insures the additional advantage of eliminating all shadows on the object if desired. Two reflectors are attached on a wooden frame and these can be moved up or down and adjusted to any angle desired to suit the work at hand. The bottom and narrow sides of the reflectors are made of wood, while the long sides are of thin sheet metal. The inner sides of the reflectors are painted white. Four 75-watt lamps, connected in parallel, furnish the illumination.—Ernst Keil, Dayton, Ohio.

How to Make a Lead Mallet

One of the handiest tools for the man who works around his car is a lead mallet. With it he can drive out the most obstinate bolts, without injury to the threads, or do almost any job that requires a heavy, solid hammer. A mallet of this kind is very easily made. First, get a small tin can, without wrinkles or dents; one that

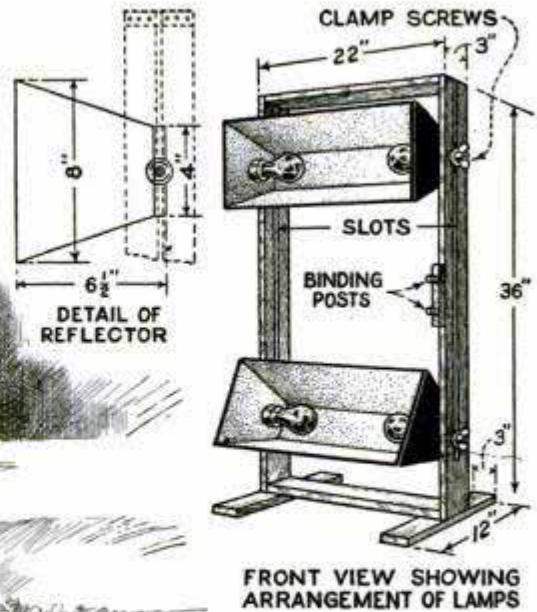

measures about 2 by 3 in. will give you a mallet head weighing about 6 lb., which is heavy enough and not too large to be unwieldy.

Cut a round hole in the center of the side of the can and insert a piece of 1/2-in. pipe for a handle, allowing it to project almost through the can. After warming the tin so that it is perfectly dry, quickly fill it with molten lead. Let the job cool and then tear off the can with a pair of pliers. When, after long usage, the mallet becomes too battered and rough for service, repeat the process.

Wooden Lawn Chain

Ornamental wooden chains for the garden or yard can be made by nailing together 1-in. strips to form links. The usual way is to cut some of the strips 6 in. and an equal number 1 1/2 in. long, assembling them as shown in the photo.

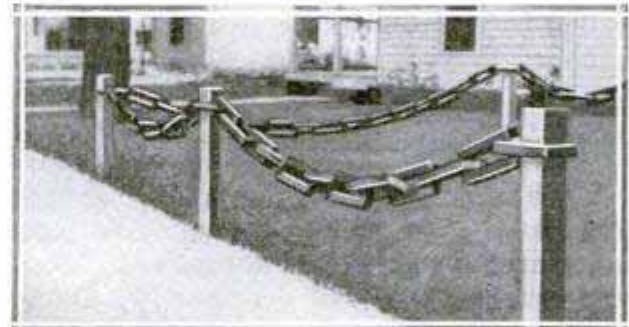

Ornamental Wooden Chain Improves Appearance of Yards and Gardens

This gives a symmetry that is pleasing to the eye and prevents stiffness in the chain.

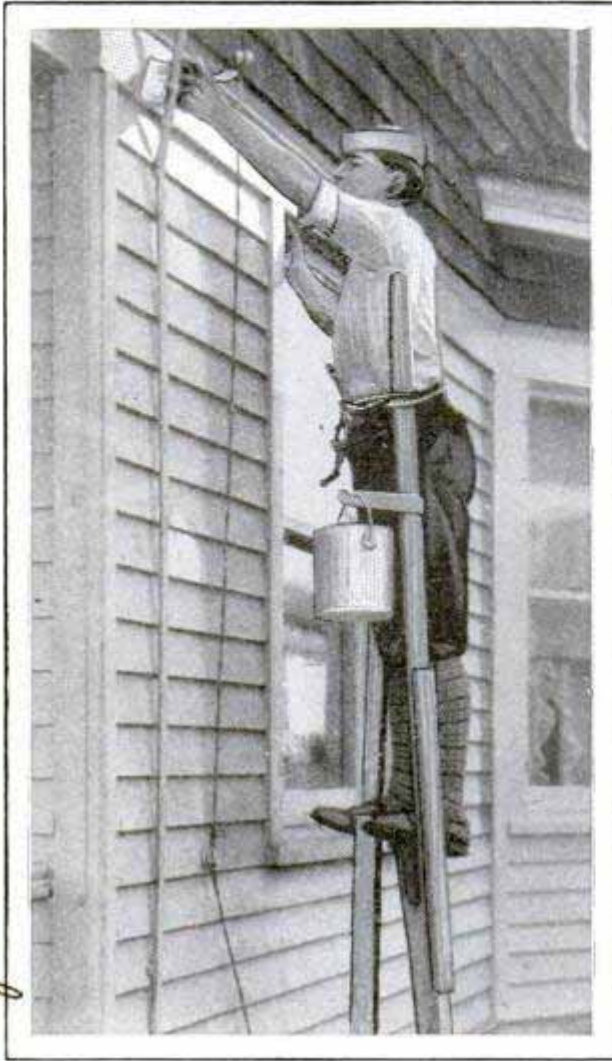

Stilts Help Home Owner to Paint House When Only a Short Ladder Is Available

He Paints on Stilts

Finding that his stepladder was too short to paint the siding of the house up to the top of the first-floor windows, one house owner made a pair of stilts which he used for the work and found them very convenient for this purpose. A short length of wood, notched at one end and nailed to the top of one stilt at the other end, serves as a pail hanger.

Cut Filler for Tires

Tires rapidly deteriorate because gravel and sand enter them if small cuts and holes are allowed to go unrepaired. Here is a simple method of permanently filling tire cuts or actually vulcanizing them without heat. Make a thick paste of live rubber, such as scrap rubber or rubber bands, dissolving it in acetone or other solvent. Then clean the cut with gaso-

For solution - dissolve 60 gr. india rubber in 2 oz. benzoline and 1 oz. sulphuric acid

Best and most rapid methylated ether and petroleum spirit

line, and apply the paste. Mold the composition over the outside of the tire for an inch around the cut and allow it to dry overnight. The composition becomes a part of the tire and wears equally well. The same compound can be used to repair worn places in tires. Spread the composition over the worn places and smooth out with the moistened hand. A tread nearly as good as new, and that will give satisfactory service, will be the result.—Kenneth B. Murray, Sturgis, Mich.

Sawing Soft Metals

When sawing soft metals with a hacksaw, use two blades instead of one, and you will find that the cutting can be done much easier. One of the blades is inserted in the frame in the usual manner, while the other blade is reversed so that cutting takes place on both the forward and backward stroke. The sliding movement of one of the blades at all times will prevent the other blade from making too deep a cut.—W. Edmonds, Whitehall, N. Y.

Screen-Wire Crayon Sharpener

Woodworkers, shipping clerks and others who use marking crayons in their work are often inconvenienced by the necessity of sharpening them with a pocket-knife so that they will serve for finer marking or lettering. However, a simple sharpener that will do the work very quickly and efficiently is shown in the illustration.



Just above the workbench next to the receptacle containing the crayons, an 8 by 10-in. wood frame is hung, the front of which is covered with screen wire and the back with a door, hinged to the frame.

A dull crayon needs merely to be drawn across the screen a few times to be sharpened. The shavings are caught and retained between the screen and the door of the frame and are easily removed at any time.—G. E. Hendrickson, Argyle, Wis.



All Shop Notes published in 1925, in book form—Fifty Cents—from our Book Department

Shop Power Plant Has Many Uses

By D. R. VAN HORN

THERE are many small garages and repair shops where the volume of work does not warrant the installation of a regular automatic air-compressor system, but where the necessity for pumping up heavy tires arises often enough to make the hand-pump method a nuisance. One small shop, where this was the case, solved the problem in the manner shown in the illustration. A $\frac{1}{4}$ -hp. electric motor was

obtained and attached to the top of a tool box.

tor, of course, is belted to the compressor. The box, being full of tools, is heavy enough to permit the motor to be belted to any other small machine within its capacity and to serve as a power plant. The upper left-hand photo shows the compressor belted to the motor, and also the large pulley on the former. This was made of wood, and is necessary to reduce the speed of the motor to one suitable for the compressor. A slot is cut in the top of the tool box to accommodate the pulley and belt. The other photo shows the compressor pumping up a truck tire 8 in. in diameter; it will inflate these tires to a pressure of 105 lb. per sq. in. without any difficulty, and those who have attempted

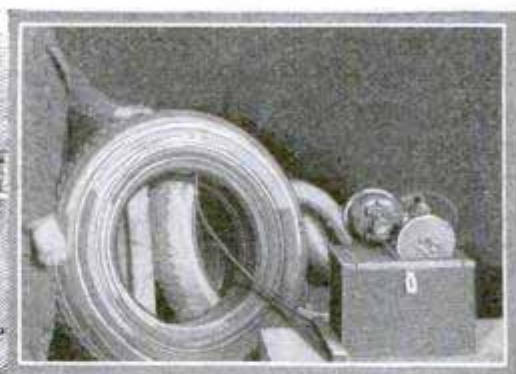
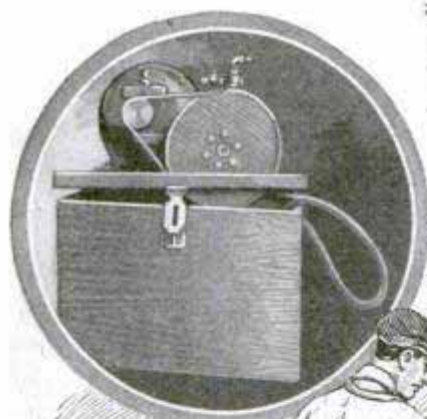

For All-Around Use in the Small Shop with No Power, This Portable Unit Will Pay for Itself in a Day

In line with it, on the box top, was bolted a small air compressor or tire pump of the type fitted to many automobiles several years ago, and which can often be picked up at a wrecker's for next to nothing. The mo-

tor is pressed into service for doing other work around the shop. One use to which it is adapted is shown in the sketch. The forge in the shop is of the hand-drive type, but the

to pump up a tire of this size by hand will appreciate the advantages of the outfit.

Besides doing the chores of pumping tires, the motor is pressed

motor is now used, permitting the workmen to handle the work to better advantage. To reduce the excessive draft caused by the motor drive, pieces of cardboard are set on each side of the forge air inlet to restrict the opening. The motor may also be used for driving scratch

brushes and tire buffers by means of a flexible shaft, or operate a small sensitive drill or a bench grinder. In fact, any tool in the shop that is within the capacity of the motor can be made into a power tool by simply setting the motor and box in position and belting it to the drive pulley.

Rig for Rolling Veneer Blocks

Rolling huge veneer blocks, by means of a cleverly contrived rig, is the novel method used by a western factory to get



Rolling Huge Blocks from Forest to Mill with a Tractor Linked to Their Centers

its raw material from forest to plant. Although logs of great diameter are well suited for conversion into veneer, they are difficult to load onto flat cars, motor trucks or wagons. But by driving axles into the big blocks at their centers, the cut logs, like mammoth cheeses, are readily rolled to the mill with a tractor. The system operates independently of roads and one man and one tractor have demonstrated ability to transport more veneer blocks than two men and two teams of horses.

Cutting Off Piston Rings

After turning and boring a piece of cast iron to make a few piston rings for a repair job, I found that I did not

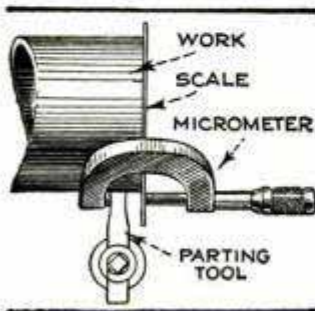

have the proper tool to measure the width before cutting them off. However, the following plan proved very successful: The width of the parting tool and the thickness of the scale were first measured care-

fully, and the parting tool was then set approximately in the position for cutting, with the scale held across the open end of the work in line with the parting tool. The micrometer was placed in the position indicated, over the tool and the scale, and the parting tool shifted around until the micrometer reading corresponded to the total width of the parting tool and the thickness of the scale. The parting tool was then tightened and the ring cut off. —L. Christensen, Hoboken, N. J.

Stand for Tailors' Goose

In most tailor shops where pressing is done by hand considerable space is taken up on the work table by the pressing iron or goose. To make the handling of the heavy iron more convenient and at the same time keep the pressing board free of the iron, one tailor devised the holder shown in the drawing, which is set up a short distance from the end of the board. The legs of the holder are lengths of pipe of the proper height, so spaced that the feet on the cast-iron plate, furnished with the iron, can be inserted in their upper ends. The lower ends are fitted with flanges screwed to the floor.

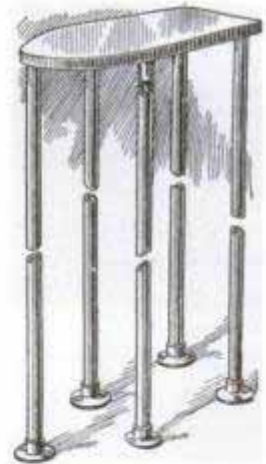

Quick Way of Lapping Bushings

A few days ago I made a bushing for a boring-bar guide that had to be a running fit without shake, to avoid chatter. In taking my measurements I found that I had a tight fit when the bushing was tried. I was going to chuck it over and scrape it slightly, but my foreman said he would

take care of it. He took a piece of emery cloth, wrapped it around a length of broom handle, slipped the bushing over the emery cloth and forced the bushing against a belt running perpendicularly so that the bushing would revolve several hundred times faster per minute than any lathe spindle in the shop. The bushing was lapped out in a few moments, with a high polish, and it was more accurate than could be done in a lathe. The closer the polishing stick fits the hole, the better the work will be.—F. W. Schrader, Woodstock, Ont., Can.

Electroplating Lead

Before plating lead, it is advisable to give it a coating of copper as other metals adhere more readily to the copper. The surface of the lead is scrubbed thoroughly with a hot solution of potash and water, using a coarse brush, then rinsed and dried with a clean rag. It will then take a coating of copper by electroplating, and another metal can be applied later.

Knob Makes Acetylene-Tank Wrench

It seems that no matter how many acetylene-tank wrenches are around the welding plant, there will be some operator who cannot find his wrench. Recently we missed a door knob from one of the inner doors of the welding room; the knob was replaced, but disappeared again in the course of a few days. This occurred several times and finally the foreman saw one of the missing knobs lying on the top of an acetylene tank. He picked it up, and in doing so noticed that the square hole in the knob was just about the size of the stem on the acetylene tank. He tried it—it was a perfect fit. All the operators are now equipped with "wrenches" of this type.—A. S. Jamieson, Springfield, Mass.

Roof Protects Outdoor Air Press

This 15-ton air press, used to shape steel of various sizes and contours, was con-

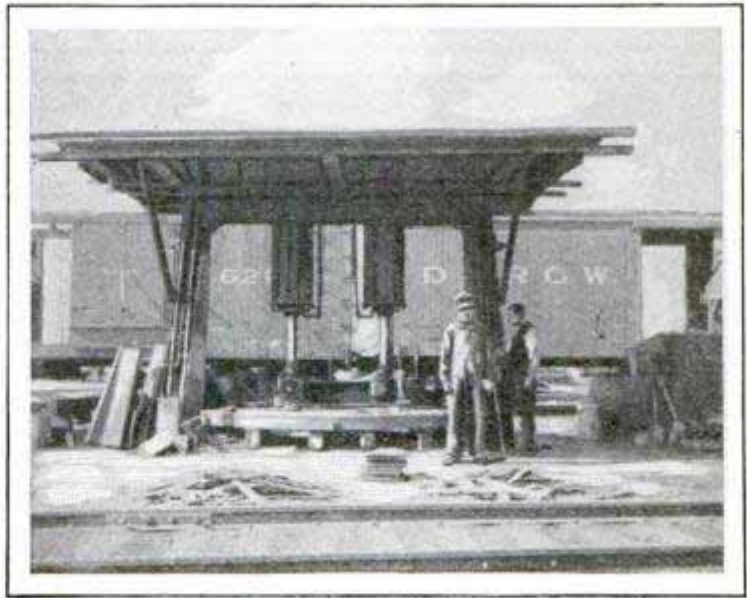

Roof Attached to Framework of 15-Ton Press Protects It from Elements and Reduces Repairs

tinually getting out of order, because snow penetrated into its moving parts and froze. To house it would have caused serious difficulty in getting long and heavy steel to the press and was, therefore, out of the question. The problem was solved by bolting the framework for a shed to the upper portion of the heavy steel columns of the press, so that nothing would be in the way of the workmen on the ground.

Fixed Line Gauge

One inconvenience frequently experienced when operating a linotype is the absence of a line gauge at the moment when it is urgently needed. To be sure to have one handy at all times, one may be made of brass and graduated in picas and half picas along one edge, the opposite edge being drilled for screws, which hold the strip on the keyboard, as shown in the illustration. A small stop should be fixed at the zero graduation in order to facilitate the measurement of the slugs still further.



Line Gauge for the Linotype Operator Is Handier When Fixed on Keyboard

Fixture for Lathe Refaces Brake Drums

In a western auto-repair shop the foreman has rigged up a lathe attachment for

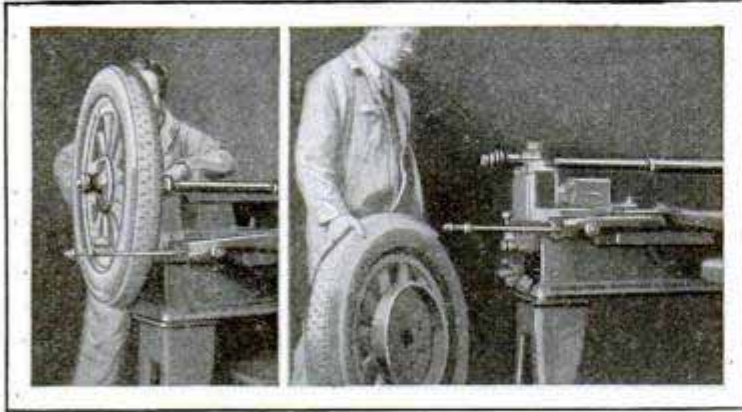

Lathe Attachment Trues Up Automobile Brake Drums without Removing from Wheels

truing up and refacing brake drums on auto wheels, which does the work as well as a special machine made for this purpose. There are three attachments for different models of cars, consisting of duplicates of the axle shafts of the cars, on one end of which the wheel may be mounted, while the other is held in the lathe chuck. The axle is supported at the outward end by a special bearing on the lathe ways. The auto wheel is fastened to the end of the attachment as shown in the left-hand photo, and the machinist then refaces the brake drum. The right-hand photo shows the attachment, the bearing and a brake drum which has just been refaced.—Charles W. Geiger, San Francisco, Calif.

Tile Trenches Dug with Tractor and Plow

We were tiling 40 acres this spring and instead of digging the trenches by hand we used a tractor to remove most of the dirt. First a walking plow was run just as deep as possible, that is about 10 in., and with it a furrow was thrown each way. A lister with long extension moldboards on each side was hitched to the tractor. The latter straddled the trench and the lister was run about 12 in. deep. A long hitch was made with a chain and a guide wheel was attached to the front end of the beam. As the soil was heavy and wet at this depth, it was pushed out along the extensions of the moldboards far enough

so that it would not roll back into the trench. The rest of the depth and the leveling were done by hand, which was not more than one-fourth of the digging. Where the trenches are to be extra-wide, the plow is again run along one side, throwing the dirt into the trench made by the lister. This leaves it loose and it can then be easily thrown out by hand.—Geo. G. McVicker, North Bend, Nebr.

Saving Cement

When a bag of cement is dumped out, a good deal of the material is left in the bag fibers. A simple and effective method of removing this is to put a few stones in the bag and then shake it vigorously. The amount of cement thus shaken loose from the fibers is surprising. This method is better than beating the bags, as, in the latter case, the wind carries off a good deal of the cement.

Attachment on Ferryboat Holds It to Dock

Designed to hold the boat to the dock without the aid of ropes, the ferry attachment shown in the photo has been found extremely satisfactory. One man can run the boat and make a landing, whereas otherwise two men would be required, one

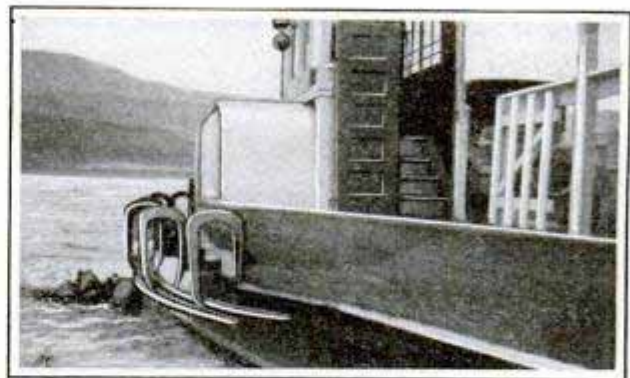

Attachment on Ferryboat Permits It to Be Moored to Dock without Ropes

to steer and the other to tie it to the dock. The attachment consists of two iron rails fastened to the side of the boat by means of heavy supports, as shown. The boat is steered so that the rails catch the mooring post on the dock.—Carlton Groat, The Dalles, Oreg.

Shortening Ford Valve Stems

After grinding Ford valves or installing new ones, one is usually found too long, and it is then necessary to file it down or shorten it in some other way to get the required minimum of $\frac{1}{64}$ -in. clearance between the end of the stem and the top of the push rod at its lowest point. But filing the end of the stem by hand, even when the valve is held in a vise, is a somewhat troublesome process. An easier method is to place a sharp file, flat side down, on the top of the push rod and insert the valve in its correct position in the cylinder block, allowing the end of the valve stem to come in contact with the file as it rests on the push rod. The end of the stem is rotated on the file by turning it with a valve grinder and the stem will be shortened as desired, the speed depending on the pressure exerted upon it and the number of revolutions given to the stem. Removing the file from the push-rod top allows measurement of the clearance without the necessity of withdrawing the valve stem. After grinding the stem in this manner, care should be taken to wipe away all the filings that have dropped into the valve chamber.

Double Track for Narrow Bridge

On a two-track electric line there are a number of viaducts which it was not deemed advisable to build to double-track width. Instead the two tracks were run over the bridge in the manner shown in the illustration. With this arrangement one track forms the guard rail for the train on the opposite track. Automatic signals on each side of the bridge were provided. In addition to saving in first cost, this construction permits the trains to cross without stopping while a switch is thrown, which could not be done if a single track were used to cross the bridge.



Convenient Method of Turning Coil Springs by Hand

Spring-Wire Coils Wound by Hand

An easy method of winding a coil spring is shown in the drawing. Bend a length of steel rod, equal in diameter to the inside diameter of the coil spring, to a crank shape and drill a hole through it for the end of the wire. Take two blocks of wood and set them up in the vise with the crank between as indicated. Set the wire so that it will make a thread in the wood when you start winding. The wire will then follow this thread as it is fed from the top. A little oil may be used to avoid excessive friction.—C. D. Fredericksen, Detroit, Mich.

New Use for Large Clips

A large office that sends a number of telegrams every day has worked out a new use for large 2-in. clips. Just to one side of the door that leads into this office from the corridor, one of these large clips is attached to the wall, the flat piece at the top of the clip being fastened to the jamb. Whenever a telegram is ready the telegraph signal is rung and the message put in the clip. There it is safe until the boy comes around, and he knows just where to look for it.—Russell Raymond Voorhees, Jacksonville, Fla.

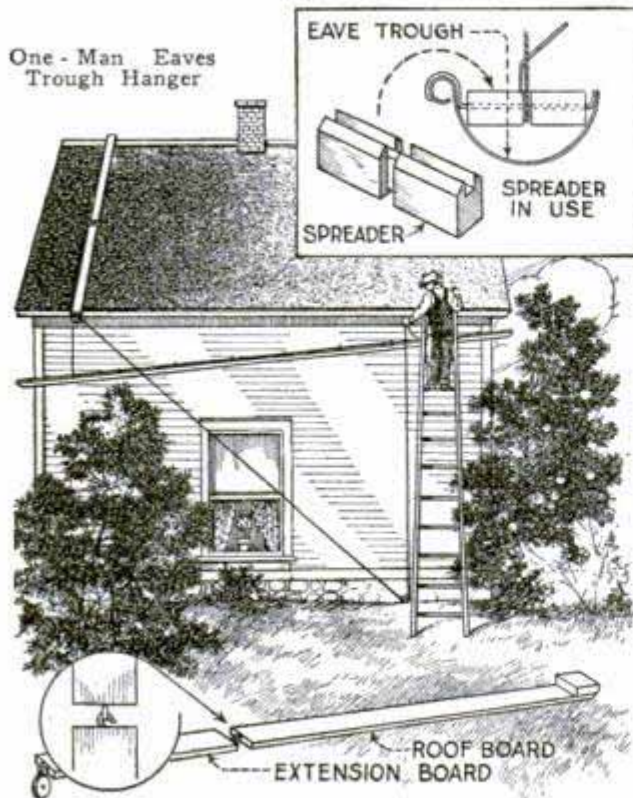

Hanging Eaves Troughs

Hanging eaves troughs is generally considered a two-man job, but with the arrangement shown in the drawing one man can easily do the work. In addition to a ladder, a $\frac{3}{4}$ by 6-in. board of convenient length is used. It is rounded at the top edge so that it can be pushed over the shingles easily, and has a 2 by 4-in. cleat nailed on one end, which is hooked over the ridge, and a screw-eye in the other. If a board of sufficient length to reach from ridge to eave is not available, an extension board can be hooked to the first, as shown, and a screw-eye driven into its lower end. The little wooden spreader shown in the insert is also required. The device is used in the following way: The board is hooked over the ridge of the roof so as to project a little over the drip edge. A pulley is attached to the screw-eye for a rope, as shown. The spreader is placed in position under a trough hanger, and one end of the rope is attached to it. The rope is threaded through the pulley, then through another pulley at the side of the ladder, which is then set up at the other end of the house. The worker now attaches the free end of the rope to the trough and climbs the ladder, taking the trough with him, and, in doing so, also lifts its other end. After fixing a hanger

at his end, he raises the trough to the proper slope and sets the remaining hangers.—H. A. Freeman, Willimantic, Conn.

Stamp for Dimension-Line Points

When inking in a drawing, I found that much time could be saved and a neater job done, if the dimension-line arrow-heads were put in at one time with a rubber stamp. I cut it on the end of an eraser with a very sharp knife. The inside of the V was cut out first, and then the outsides. For an ink pad I used a small piece of blotter saturated with ink. After I had marked all the ends of the pencil lines, the latter were inked in.—Dexter W. Allis, Everett, Mass.

Attachment for Calipers Makes Precision Tool

Any mechanic can make a precision tool of his inside caliper by fitting it with the attachment illustrated. The indicating arm can be long enough so that accurate measurements can be obtained. The leg of the caliper is upset to make it thick enough for a slot to be cut in it for the indicator arm. The plunger comes in contact with the work and exerts pressure on this arm, and the spring keeps it tight against the plunger. For making shrink and forced fits the caliper is set at zero and the allowance can then be read on the scale. As this tool does not depend on the sense of touch of the operator, the human element is eliminated and accurate results are assured. The scale should be made accurately, which can readily be done with a dividing head.—Charles Kugler, Philadelphia, Pa.

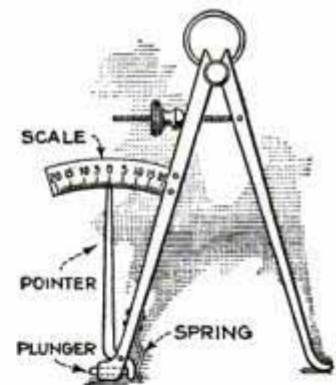

Using Lacquer

Never apply lacquer over a coat of ordinary paint as the ingredients of the two are so different that the finish may be ruined due to chemical interaction. The

solvent in the lacquer attacks the paint and causes bad checks which make the surface very rough, necessitating the removal of the paint, and resanding. If the lacquer is too thick to use, and no thinner is available, use wood alcohol. This should also be used to clean the brushes. Lacquers made by different concerns can sometimes be mixed if they have similar solvents, but ordinary paint and lacquer cannot be mixed. Turpentine should never be used to thin lacquer. After lacquer has dried thoroughly a coat of varnish can be applied if necessary, but usually lacquer has a gloss finish and the more it is rubbed the more it will shine. It is unnecessary to use a wood filler before applying lacquer as it fills the wood and gives a nice, even finish if put on properly. Do not use too much lacquer or the surface will be uneven and it will run. Apply it quickly and evenly and do not attempt to brush it out for the reason that it sets in a very few moments and gets tacky at once.—E. R. Haan, Chicago, Ill.

Magnet for Removing Chips

Having a number of holes to drill and tap in a solid block, which could not be turned over easily to remove the chips, I found the magnet a very handy tool. After drilling the hole to the required depth I took the magnet and a capscrew that would slip into the hole easily. After letting the screw to the bottom of the hole, I applied the magnet to the head, which caused the chips to cling to the end of the screw so that they could be removed easily.—Ralph Hanenkratt, Albany, N. Y.

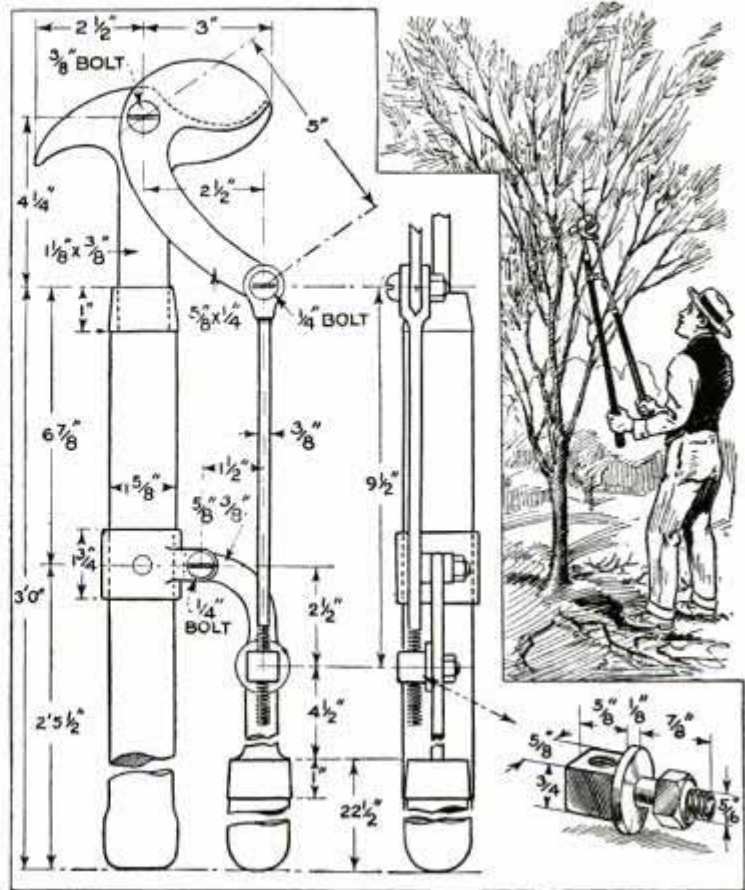
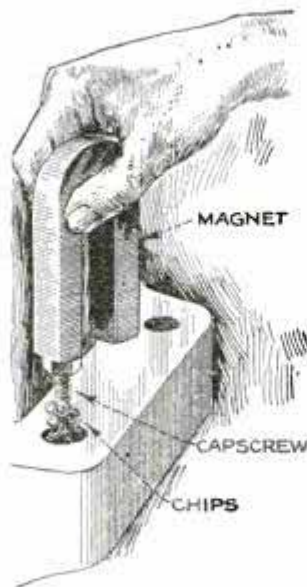

Handy Pruning Shears for the Gardener and Orchardist Can Be Made by Any Blacksmith

Effective Pruning Shears

An almost indispensable tool for horticulturists and gardeners, is a pair of pruning shears. A good one, which can be made in any blacksmith shop, is shown in the illustration. The constructional details of the shears and the dimensions are clearly given. One particular advantage of this style is the hook part of the shear blade, which enables the user to pull the pruned limb or vine down without touching it with his hands. The shearing blades are forged from 60-point carbon steel, hardened in water and drawn to a dark blue, while the other parts are forged of ordinary machine steel. The handles are turned of ash.

Cleaning Files

One of the best methods of cleaning files, whether fine or coarse, is to rub them with a piece of coke. If the coke becomes full of grease when used on fine files, rub it on a rough file. This will make the coke clean again and the file will be cleaned at the same time.

Forming Corn Stacks

One man can stack corn with the simple "horse" shown in the drawing. The center pole is light enough to be dragged

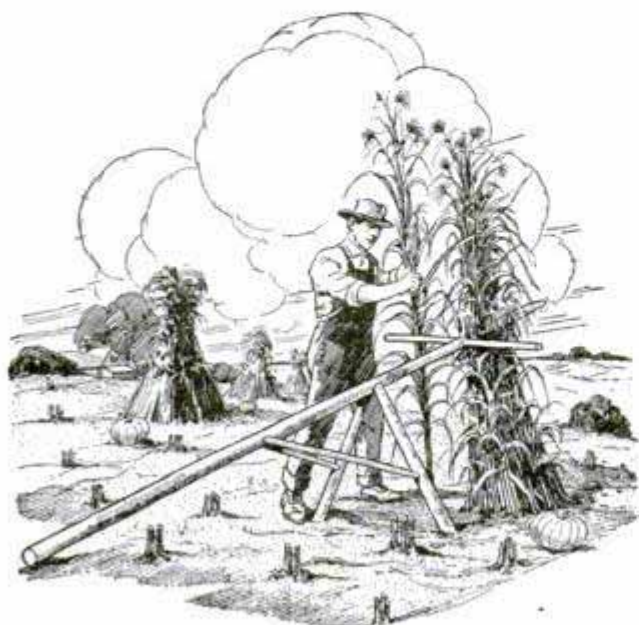

With This Wooden "Horse" One Man Can Stack Corn Easily and Quickly

around with ease. It has two legs, preferably braced, near one end. A hole, large enough to allow a broom handle to pass in and out freely, is drilled at the point indicated. The stack is built up, tepee-fashion, by standing the stalks in the four corners of the crosspiece. When the stack is finished the broom handle is pulled out, which permits the horse to be removed easily.—H. Faller, New York City.

Removing Steel-Wool Shreds from Crevices

Steel wool is an excellent substitute for sandpaper in many cases, particularly on paint jobs between coats. It has the disadvantage, however, that small shreds of the wool break off and lodge in cracks, corners and crevices, from which it is hard to remove them with the dust brush, yet they will often be dragged out of these places by the bristles of the paint brush and disfigure the work, especially on white or other light-colored jobs. As a help to the dust brush, a horseshoe magnet, such as a magneto magnet, solves the difficulty, for it pulls out the bits of wool easily. As the shreds are so light in relation to the strength of the ordinary horseshoe mag-

net, just a sweep along the cracks and in the corners will remove all the steel-wool shreds.—L. I. Thomas. Oak Park, Ill.

Rotary Punch for Felt

In an attempt to punch 2-in. blanks from $\frac{1}{2}$ -in. felt, I found that an ordinary arch punch had a tendency to cut through the felt obliquely, even though the punch was held vertically. There being a large number of punchings to do, I turned down the shank of the punch to fit the chuck of a drill press, and used it in the press in the manner of a drill, bringing it down onto the felt while revolving at moderate speed. A board was first placed on the drill table to save the edge of the punch. I found there was now no spoilage, and the work could be done faster than when using the punch with a mallet.—Dexter W. Allis, Everett, Mass.

Automatic Oiler for Line Shaft

Frequently an engineer or oiler will come across a bearing that never gets enough oil. This trouble can be remedied by providing an oil pump that will take care of three or four bearings. A cam is made with a 1 or $1\frac{1}{2}$ -in. throw, depending on the stroke one wants to give the pump. A lever, having a small roller in contact with the cam, is pivoted to a bracket at one end, and the other end is attached to the pump piston. A strong compression spring is placed under the piston to make the return stroke. The cylinder is made from a length of brass tubing. Two holes are provided for the inlet and outlet, and check valves placed in the pipe run to the bearings and from the source of supply.

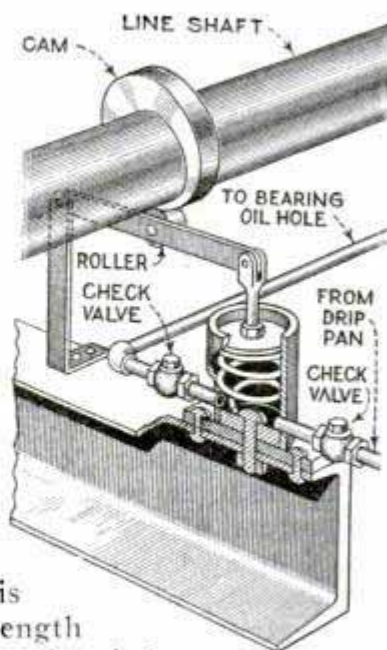

You Can Fix That Dripping Faucet

Worn-Out Washers and Fuller Balls Can Be Replaced in Five Minutes When You Know How the Faucet Comes Apart

THERE is nothing more annoying around the home than a dripping faucet, and yet the trouble can be cured in five minutes with the aid of a monkey wrench and a new washer or ball, which costs about a cent. Faucets are common-

will be found fastened to the bottom of the spindle by means of a round-head screw, and it is only necessary to remove this screw and the small iron washer under it to replace the seat washer. Be sure to use the proper size of seat washer for the faucet. If the screw has rusted in place and is difficult to start with the screwdriver, place a drop or two of kerosene on it and allow the liquid to soak in for a few minutes before trying again. The screwdriver blade should be square across and a

square across and a

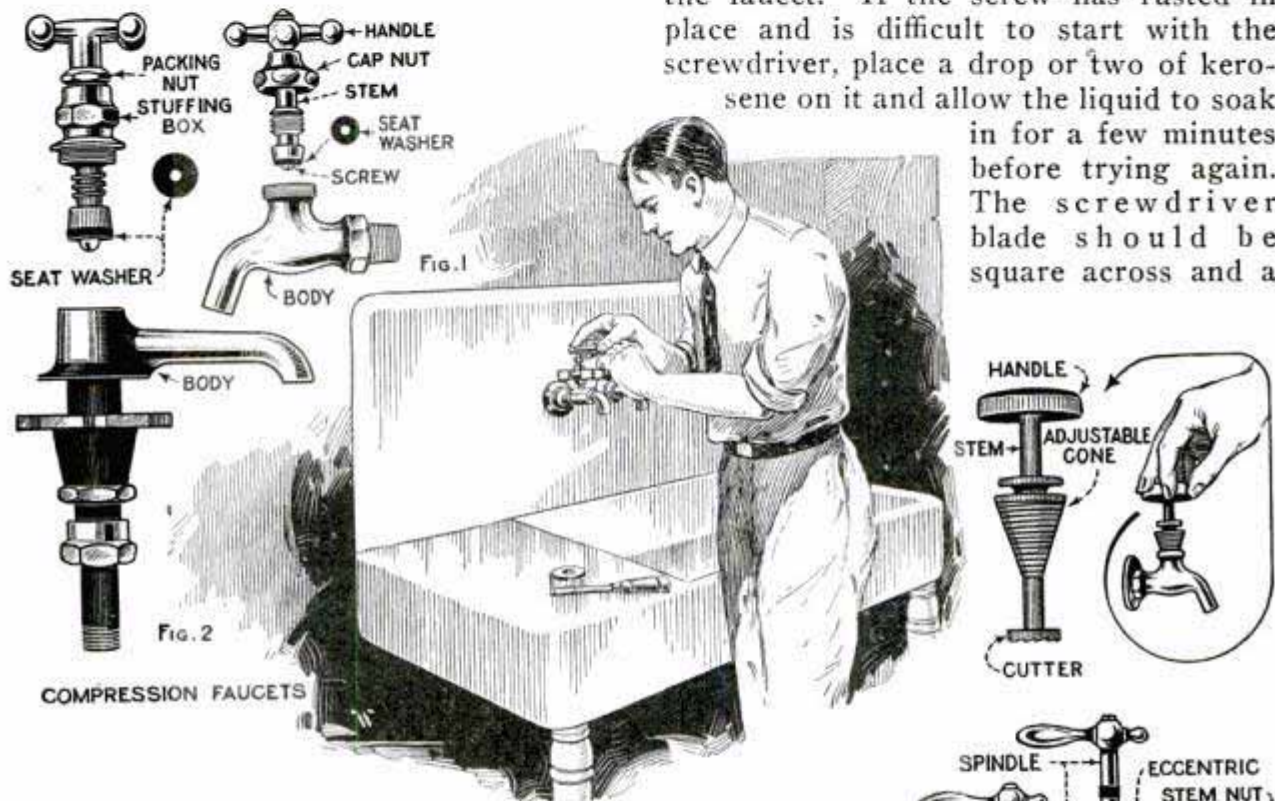

How Common Compression and Fuller Faucets Are Taken Apart for Renewal of Balls and Washers or Redressing the Seat

ly of two kinds, the compression and the fuller type. In the first the stem of the faucet, carrying a composition washer at the bottom, is screwed down against a seat in the body of the faucet to stop the flow of water. In the fuller type the seat is horizontal, and the flow of water is controlled by a rubber "ball" which is moved toward and away from the seat by a small crank or eccentric on the end of the spindle.

To replace the seat washer on a compression faucet, shut off the water in the basement, or under the sink if there is a cock or valve there, then unscrew the cap nut on the faucet (see Fig. 1). A piece of heavy paper between the jaws of the wrench and the nut will prevent scoring or otherwise marring the nut. The washer

good fit in the slot of the screw head. If no regular composition washer is at hand, cut a new one of the same size and thickness as the old, from rubber, if the faucet is used for hot water, and from leather if it is for cold water. When replacing the spindle, be sure that it has not been screwed down hard on the seat before the cap nut is tightened. Screw the spindle in, down to the seat, then back it off the seat a full turn and screw down the cap nut.

Compression faucets used on washstands are often slightly different in construction from the regular sink compression faucets, although the mechanism is the same. If the top of the spindle looks

as shown in Fig. 2, and there seems to be two cap nuts, then the upper, smaller one is a packing nut, and the lower one (marked stuffing box) is the one that must be turned with the wrench to remove the faucet. If, in a faucet of this type, any leakage is found to occur around the upper small nut, tightening this will usually remedy the trouble. If it persists, unscrew the packing nut and wrap a turn or two of asbestos cord, candle wicking or even common string rubbed with soap, around the spindle, then screw down the packing nut again.

The seat of a compression faucet often becomes nicked, scored or worn, and new washers will not stop the leakage. When this happens, the seat can be made as good as new again by means of a seat-dressing tool, shown in Fig. 3. To use this, the stem of the faucet is removed as described before, and the threaded cone of the tool screwed down into the body of the faucet to center it. The handle at the top of the tool is then revolved several times and the cutter on the bottom of the tool spindle squares the seat. The cuttings are then washed out of the faucet and the stem replaced. These tools come with several cutters for faucets of different sizes.

The method of removing a fuller faucet for renewal of the ball is shown in Fig. 3, the wrench being applied to the hexagonal part of the faucet body. It is not necessary to remove the spindle, as the ball is exposed when the front part of the faucet is unscrewed. Use one wrench on the body of the faucet and another, pressing in the opposite direction, on the tailpiece of the faucet, to prevent unscrewing the latter. The ball is held on the stem by a nut and cup-shaped washer. Re-

move the nut and washer, replace the ball, put back the nut and washer, screw the faucet body back into the tailpiece, and the job is done. Be sure to use the same size ball as the one removed. If, when tightening the faucet back into place, it turns over too far, or if the joint leaks when the water is turned on, screw the body back half a turn and wrap one turn of string around the joint, between the body shoulder and the shoulder on the tailpiece; then tighten.

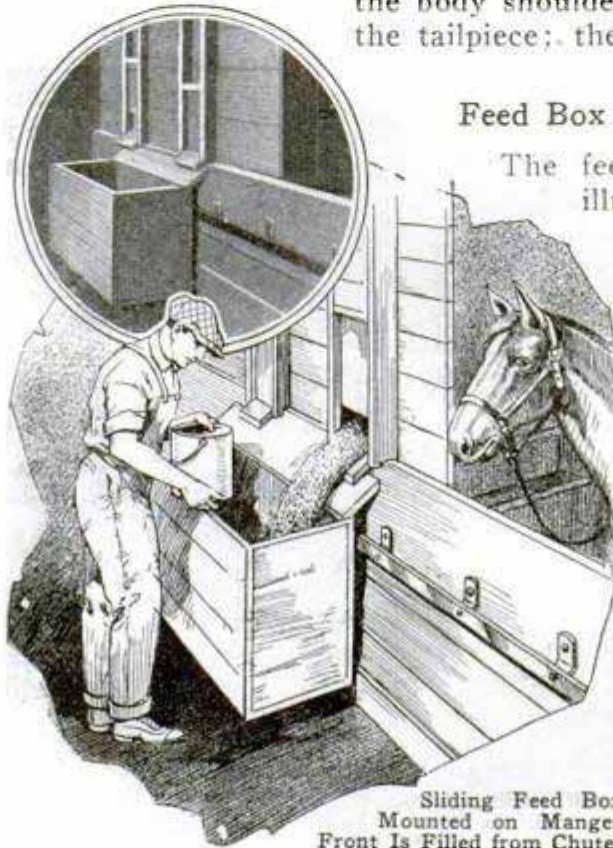

Sliding Feed Box Mounted on Manger Front Is Filled from Chutes

Feed Box on Manger Front

The feed box shown in the illustration is mounted on a barn-door carrier track in front of the horse mangers. The carrier cars are bolted to the back side of the box, while two flat-faced wheels are mounted on the same side but below, to take the side draft of the box. They roll along the front of the mangers. The box is shown in position receiving grain from one of the two overhead chutes, sliding doors being provided on the spouts to control the flow. The wooden flange on the top of the box prevents wasting any of the grain.—Dale R. Van Horn, Walton, Nebr.

Ball Punches Spring Steel

I often have occasion to punch strips of $\frac{1}{16}$ -in. Swedish blue-tempered steel with a $\frac{1}{8}$ -in. hole in each. These holes must be absolutely uniform in size, and must be put through with little expense as to time and tools. After unsuccessfully trying all ordinary methods, including use of the mercury-hardened drill, I hit upon the following plan which proved successful: On an anvil I placed a flat piece of steel having a $\frac{1}{4}$ -in. hole through it. Over this I placed the strip to be punched, and with a round-end prick punch made a depres-

sion in the strip directly over the hole, using a heavy hammer. Then I dropped a $\frac{1}{8}$ -in. bicycle ball into the depression, and over that placed a strip of soft steel, that held it in place while I pounded on top of the soft strip. Three or four blows forced the ball through, making a clean hole.—D. W. Allis, Everett, Mass.

Electric Knife for Opening Storage Batteries

The novel electric knife described in this article consists essentially of an old spatula blade slotted to within $\frac{3}{4}$ in. of the end, as shown in the drawing, the slot being $\frac{1}{8}$ in. wide. The blade is fitted with a fiber handle, made in two pieces. Between the blade and the fiber block on each side, are four brass terminal plates, made as shown in the lower detail, and rounded on the projecting portions to fit in the tubes of the plug connector. The latter consists simply of a fiber block drilled for two brass tubes, which should be a tight fit in the block and are drilled and tapped for small round-head screws to fasten the ends of the line wires.

About 2 volts are sufficient for most purposes, although for very rapid heating from 4 to 6 volts may be employed. Number 10 wire, rubber-covered, is used for the leads. The knife can also be used on a.c. current by using a step-down transformer, 3 volts being about right.—Arthman C. Capron, Athelstan, Can.

Self-Measuring Wood-Turning Tool

Many wood-turning jobs can be done more quickly with the aid of the novel turning tool shown in the drawing. It is used for finishing wood plugs and, by its shape, renders unnecessary any measuring tools. To make it, a steel ring is bored to the finished size of the work. The ring is split eccentrically and a hole drilled through the center of the smaller part to take a handle. After roughing, the tool is used until it cuts no more.

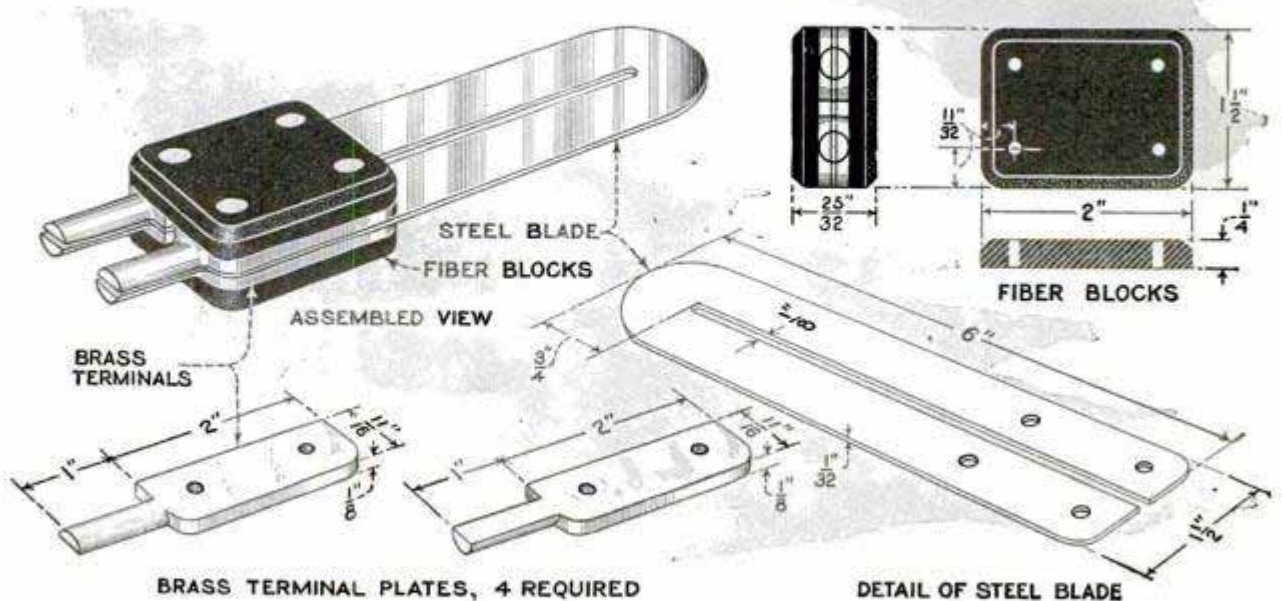
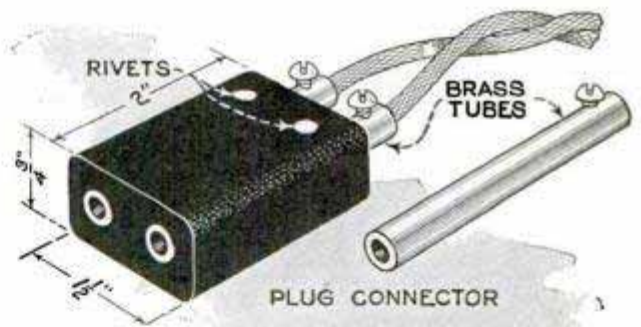

A Knife for Use in Opening Storage Batteries That May Be Heated from Another Battery or from an A.C. Line; About Two Volts' Pressure Is Sufficient

Knurling in the Vise



In the home workshop or garage, where one has only a few hand tools and a vise, a good knurling job can be done the following way: The work is pinched between two mill files, placed in the jaws of the vise as shown in the illustration. The files must be parallel and the work set perfectly vertical. A moderate pressure should be applied, and the end of one of the files is carefully tapped with a hammer so that the work rolls between them.—Allan B. Shaw, Prescott, Ariz.

Homemade Milk-Bottle Washer

Washing milk bottles by hand is out of date and the small dairy, which cannot afford a commercial machine, will welcome the washer shown in the illustration. Its construction is simple, only one casting being required and that for the mouthpiece, which should be of some non-corrosive metal, such as brass. This piece is drilled a sliding fit over a $\frac{1}{2}$ -in. pipe and is fitted with a rubber washer, as shown. Use soft rubber, which will conform to the shape of the mouth of the bottles. A push-pin bracket is screwed on the bottom. A piece of $\frac{1}{2}$ -in. pipe is screwed into a $\frac{1}{2}$ -in. tee, and in the bottom of this tee, is screwed a brass plug, made as shown, while into the outgoing hole of this plug is screwed a short length of $\frac{1}{4}$ -in. pipe, connecting with the two small water-inlet holes, drilled into the sides of the plug. A $\frac{3}{8}$ -in. button-head steam valve is fitted into the side branch of the tee and is operated by the push pin, which is carried in alignment by the bracket and a hole drilled in the tank cover. The top

plate is made of $\frac{1}{8}$ -in. sheet metal and should be drilled with small $\frac{1}{4}$ -in. holes to allow the water to drain back into the tank. The whole outfit rests on a $\frac{1}{2}$ -in. flange screwed to the bottom of the tank. A coil spring lifts the mouthpiece and supports its weight when empty. When a bottle is set into the mouthpiece and a weight is put on the bottom of the bottle, the mouthpiece descends and the pin pushes the valve open. Live steam shoots up through the $\frac{1}{2}$ -in. pipe sucking up a quantity of water by its whirling action, which cleanses the bottle. For the first washing a quantity of caustic or cleaning powder is added to the water in the tank, which is heated by the condensing steam. In rinsing, only clean water and steam are used. Control of the steam jet is made possible by placing a shut-off valve in the ascending line against the wall. A washer of this type will pay for

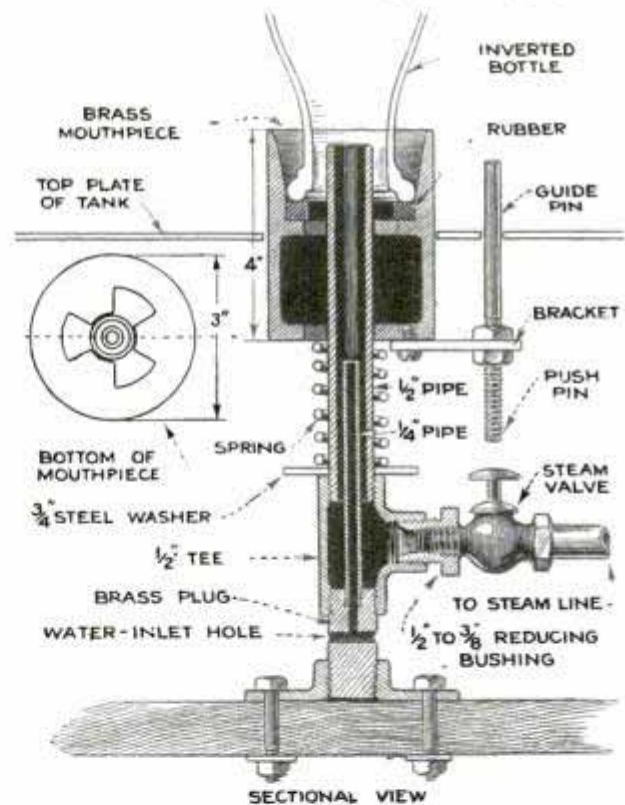

SECTIONAL VIEW
Inexpensive Milk-Bottle Washer Lightens Labor on Small Dairy Farm

its cost in a few days and will speed up the cleaning considerably.

☐ A piece of canvas, cloth or light leather, about 12 by 24 in., with the apron string along the longer edge, makes a good protection for the clothes when leaning against the drafting table for long periods.

*Open top holster Alward
Anderson-Southard Co.*

Filing Piston Rings

When filing piston rings it is not necessary to use a vise. The rings can be filed more easily and quickly in the following way: A hole is drilled horizontally at a convenient height in the bench or stand close to the work, and the shank of the file is inserted in the hole as far as it will go, which will leave its cutting surface projecting horizontally. The operator should stand in front of this and bear down sufficiently on the projecting end to hold it firmly while filing the ring, which is done with both hands, moving the ring back and forth with the file between its ends. A neater and quicker job of filing can be done in this way and if the motor block is out and lying on its side on the bench, a hole for the file need not be drilled, as it can be stuck in a capscrew hole and, of course, much time will be saved in doing the job, for there will be no running back and forth to the vise, as is necessary with the common method.—Glen F. Stillwell, Collinsville, Ill.



Convenient Method of Carrying Revolver on Gear-Shift Lever of Car

Handy Holster for Revolver in Auto

When a revolver is needed while driving, it will be found very convenient to have the holster attached to the gear-shift lever for quick action. A western fish and game warden carries his revolver here while traveling in his car. The method of mounting it is clearly shown in the photo.

9250. Chicago Car Chicago

Test Distinguishes Steel from Iron

A few years ago I was employed by a large manufacturing concern that purchased a quantity of surface-rusted large-diameter shafting which was supposed to be cold-rolled steel but later was found to be only iron. If a simple test had been made of this material previous to purchase, this error could have been avoided. Such a test, which can be performed by anyone, is the following: A spot on the material to be tested is ground or filed bright and then brought to a polish. On to this spot diluted nitric acid is placed and allowed to remain until the surface is well etched. The acid solution is then washed off and the surface dried. If iron, the surface will have a fibrous appearance, but if cold-rolled or other ordinary steel, it will appear honeycombed.

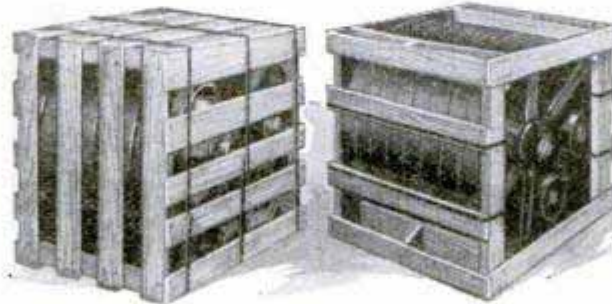

Left, Old Crate for Holding Heavy Iron Castings; Right, Improved Crate

If the spot shows a fine, frosted surface, the metal is a high-grade steel.—W. J. Edmonds, Jr., Whitehall, N. Y.

Improved Crates Cost Less

The crate on the left in the accompanying photo was used by a manufacturer of steel pulleys for the export shipment of his product. The crate on the right is an improved type designed for the shipper by the U. S. forest products laboratory. Some crates carry a load of four 36-in. and twelve 8-in. pulleys. The improved crate occupies a trifle less shipping space than the other one. It requires 13.5 per cent less lumber for its construction, 33 1/3 per cent less strapping and weighs 5 per cent less. One drop in the tumbling drum used to test boxes was sufficient to bring about the failure of the original crate. The improved crate withstood 100 drops before breaking.

Compact Sling Loads
Broken and Spread
Evenly in Loft by
Suspended Chain

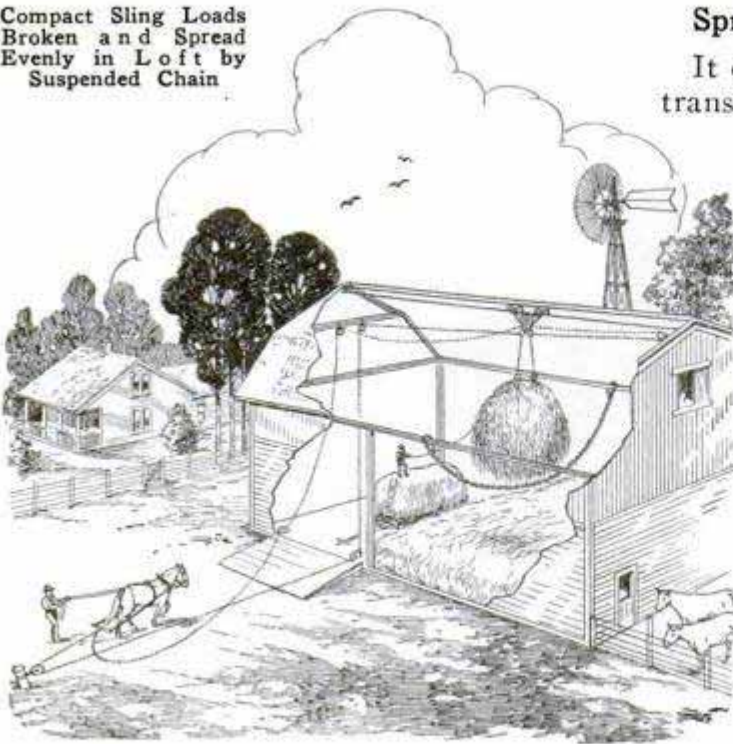

Chain Scatters Hay in Mow

An objectionable feature of the ordinary hay carrier is that the fork or sling load is so large that the hay becomes too compact in the mow, which necessitates the use of a hay knife to get the hay out for feeding purposes. This difficulty can be prevented by suspending a chain between plates or studdings in the hayloft, as shown in the drawing. The sling load is tripped over the chain so that the hay is scattered loosely and can later be pitched out with an ordinary fork.—Tud Garver, Huntingdon, Tenn.

Cutting Off Spiral Springs

In an attempt to cut to length a quantity of $\frac{1}{4}$ -in. diameter spiral springs, made of No. 20 gauge piano wire, I found the use of cutting pliers out of the question and the cold-chisel, hammer and anvil method inconvenient, because the lengths of spring would fly away and be lost as I cut them off. I did the job by clamping the cold chisel, edge up, in a vise, placing the spring on the edge and using the hammer to cut it. A gauge was set up on the bench to make the pieces of spring equal in length. With this method of cutting I had one hand free to hold the spiral and prevent the cut-off ends from flying away.—Dexter W. Allis, Everett, Mass.

Spring Compressor for Ford Clutch

It often happens, in overhauling a Ford transmission, that it is necessary to remove the clutch spring. While this is not difficult to do, with the proper equipment, the task may become burdensome with makeshift apparatus. The job can be performed on the arbor press or on the garage press, but the spring compressor shown in the photo makes it still easier. A ring or collar, large enough to clear the spindle of the driving plate, is turned out of $\frac{1}{8}$ -in. stock. Two holes are drilled into the rim, just far enough apart to allow the side members of the puller to pass over the spring and through them. A discarded transmission throw-out collar yoke is used for the grip, which enters the clutch throw-out collar. This is its normal position so that it is a nice fit. The side members of the studs are made from $\frac{7}{16}$ -in. cold-rolled steel. One end of each is heated and forged flat. Holes are drilled in this flat portion to receive the lugs on the collar yoke. With the side members in place, the lugs are then riveted over. The upper ends of the studs should be threaded for a distance of about 5 in. and nuts and washers supplied. The spring is readily compressed and held while the parts are moved about and the pinholes lined and

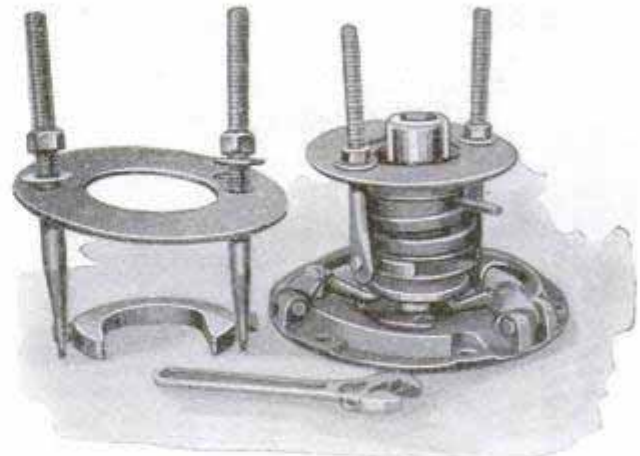

Spring Compressor for Ford Clutch Simplifies Task of Removing Spring

the pin driven out or in, as the case may be, without any awkward manipulation of punch and hammer.—Ray F. Kuns, Cincinnati, Ohio.

Leaks—in Walls, Pipes and Purses

By ROBERT TAYLOR JONES

MOST of our home-building efforts are directed toward the prevention of leaks. The walls we build must not leak heat, cold, wind or rain. The roofs we place over our heads—if they leak, then malediction on the roofer! Then there are the pipes that the plumber puts in. He is supposed to do work of such quality that we never again shall be reminded of him, and if the plumbing leaks, it violates our confidence—besides ruining the plas-

a crack so large that through it we could actually read the numbers on the license plates of passing automobiles. No wonder the basement was cold and the cost of heating the house high! The easiest way for the home owner to remedy a condition like that is to get a bucket of damp clay and mix with it a small quantity of hair, which can be obtained from any dealer in supplies for plasterers.

Left, Applying Weather Stripping Is a Simple Method of Saving Heat; Lower Right, an Effective Metal Strip

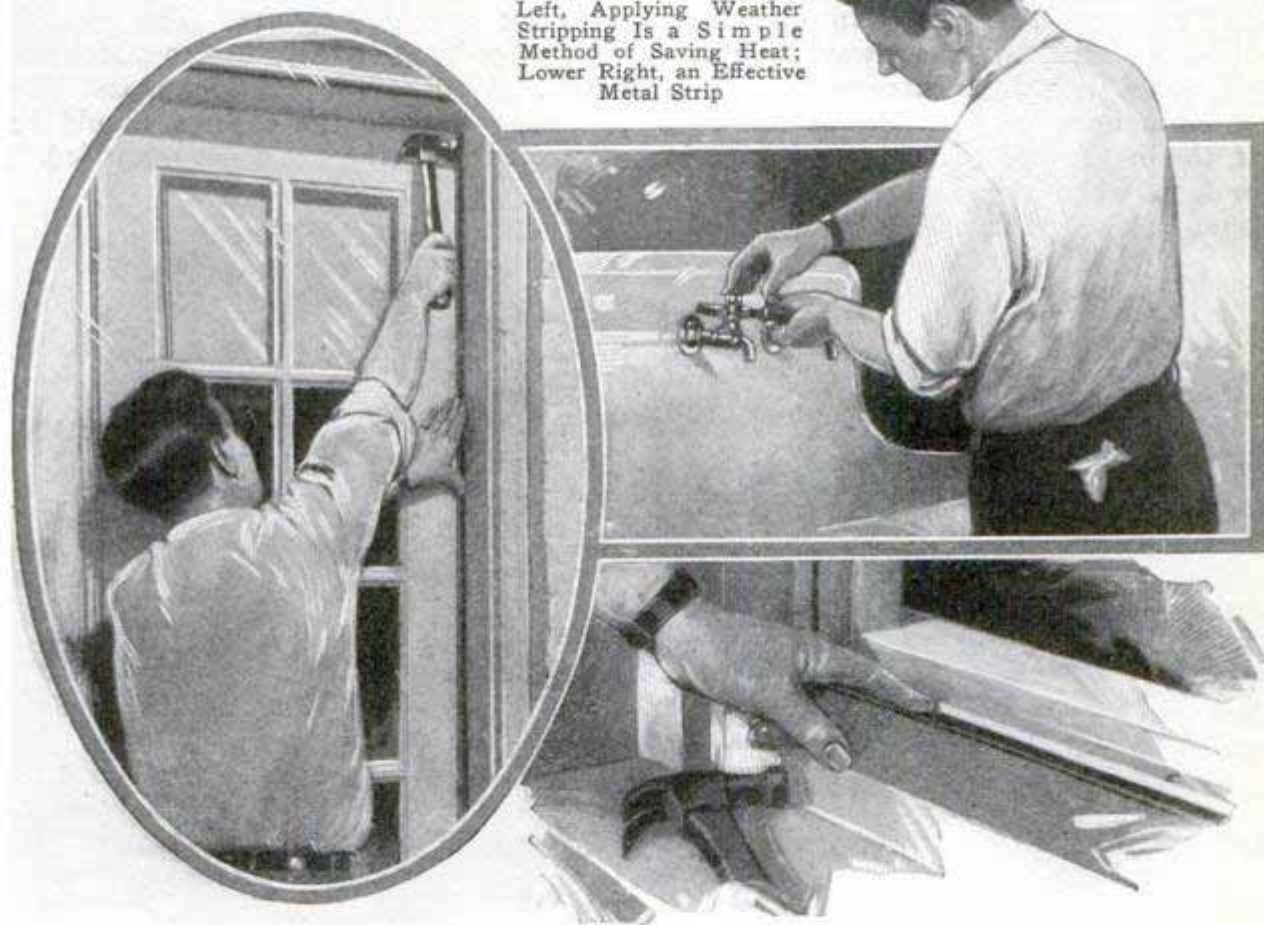

ter. There are smoke leaks, spark leaks, leaky flues, leaky cellars, leaks in electric wires and heat leaks from uncovered piping, all leading directly to a large leak in the pocketbook. All of these can be stopped, however, with a little work and a little horse sense. Perhaps not everyone can tell what causes a leak, but certainly everyone can find it after it starts. Sometimes they exist from the time the house was built, sometimes they grow up as the house wears down. The other day a friend took me into his basement, and there, between the sill and the foundation wall was

Then fill in the cracks in the walls of the basement and joints with the mixture. Chink up every place where a ray of light can be seen, and then, on the first cold, windy day, see if any cold air can be felt coming in around these places. If so, fill in with some more of the homemade plaster. In many houses, warm air can pass up from the basement between the studs of the walls. If such is the case, it is advisable to close the openings between the joists with old brick, tile or other suitable material. Also, in houses where there is no fire stopping between the studs, cold

air can pass freely from the attic to the basement. In such cases, if the plaster goes down only a little below the top of the baseboards in the rooms, much air enters the rooms under the baseboards, where they do not fit closely. Such cracks should be closed. Basement doors and windows should be examined and made as wind-tight as those in the other parts of the house, as cold air entering the cellar cools off the furnace pipes and the floor above.

The covering of the furnace and the heating pipes in the basement is usually advisable, although a little judgment should be applied here. In one case, where the basement was always comfortably warm, with the furnace and the heating pipes uncovered, it became too cool for the housewife to wash and iron in comfort, when the job was done. This was remedied by

Look to the outside doors. These are often poorly fitted, and cold air can pass easily above and below them. The crack below the door is often so large that cold air sweeps across the floor, keeping the room cold. Good weather stripping, applied all around the door, will remedy this, of course, but a better job, and a permanent one, may be had by the use of metal weather strips on all doors and windows. This is more expensive than the wood-and-felt type, but it pays in the long run. Leaks around window casings and baseboards can be stopped with strips of paper, soaked in water overnight and then driven into the openings tightly. This can be stained, painted or varnished to match the trim, and will stay in place for years. The wallpaper around the casings should be protected while the wet paper is applied.

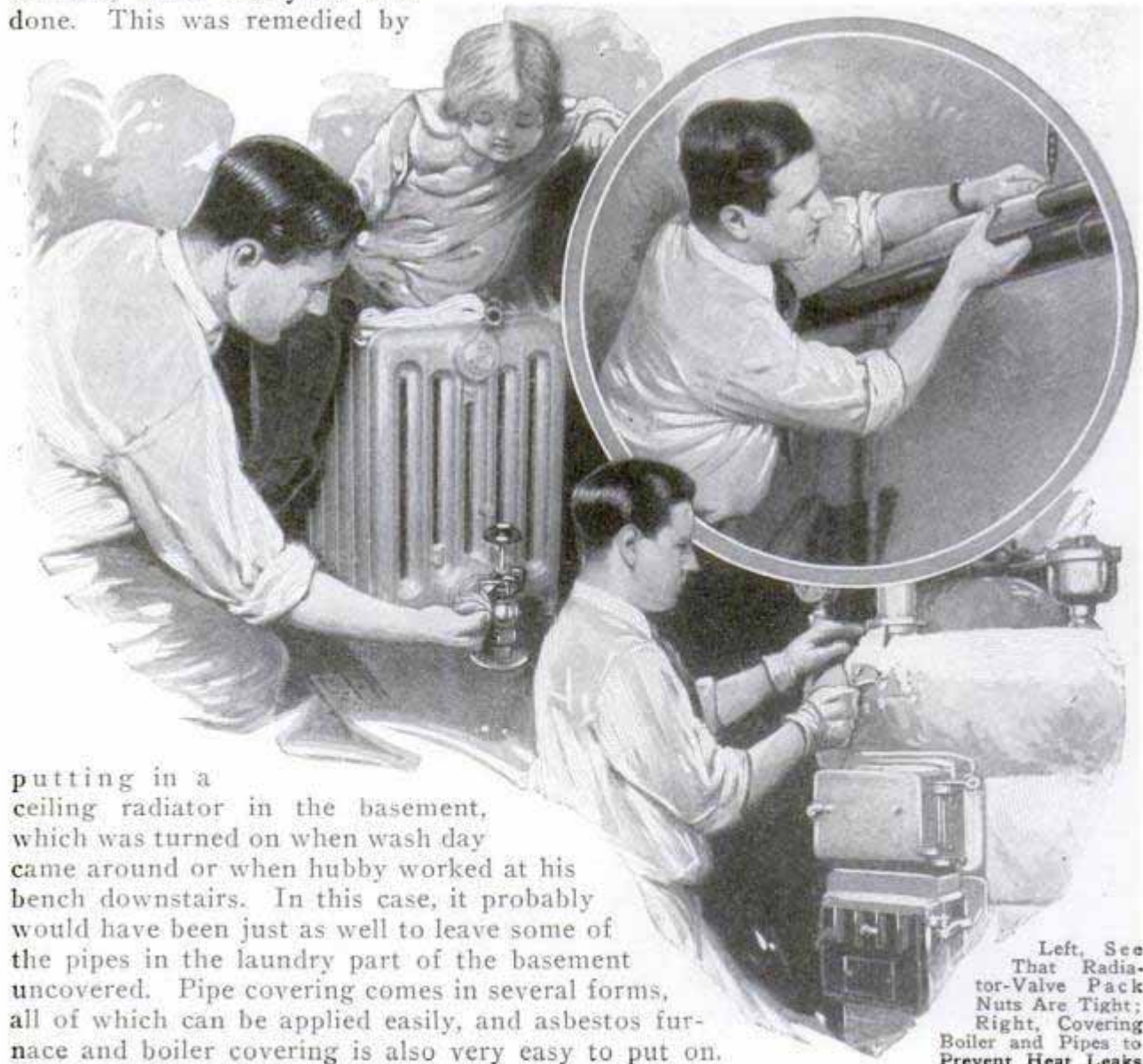

putting in a ceiling radiator in the basement, which was turned on when wash day came around or when hubby worked at his bench downstairs. In this case, it probably would have been just as well to leave some of the pipes in the laundry part of the basement uncovered. Pipe covering comes in several forms, all of which can be applied easily, and asbestos furnace and boiler covering is also very easy to put on.

Left, See That Radiator-Valve Pack Nuts Are Tight; Right, Covering Boiler and Pipes to Prevent Heat Leaks

There are some things that will save heat that cost no money at all, only a little time. Locking the windows when closed, drawing down shades all the way so as to provide an air space between the shade

linings cost so little that they can scarcely be found in the masonry bill, yet they pay dividends year after year in protection.

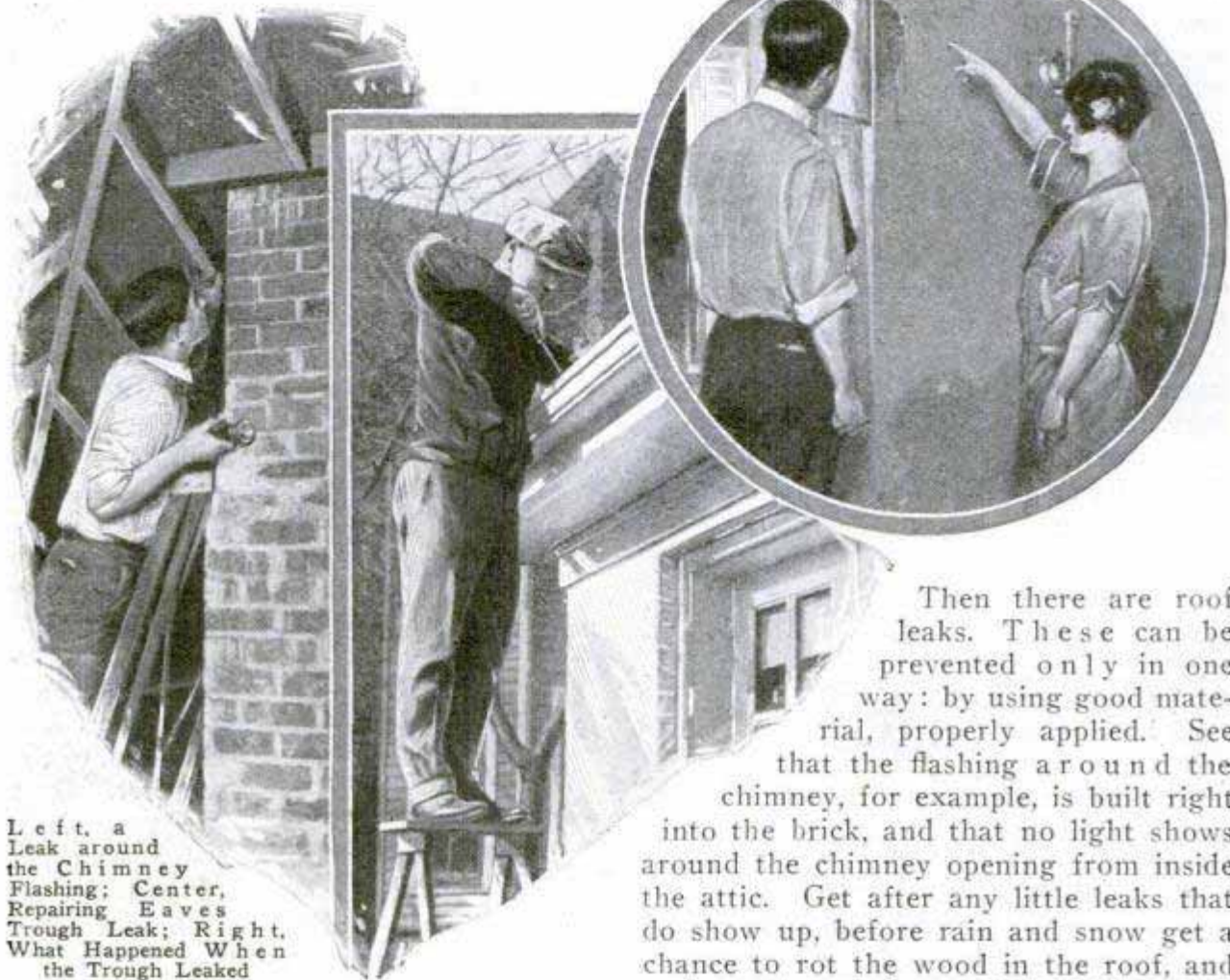

Left, a Leak around the Chimney Flashing; Center, Repairing Eaves Trough Leak; Right, What Happened When the Trough Leaked

and the glass, turning off heat in an unused room, or at night when the windows are open, periodical care of the heating equipment, all take but a little time, but will save a lot of heat.

Another part of the heating plant, the flue, is a prolific source of leaks. There should be two openings in a flue and no more. The flue should be lined with tile from the point where the furnace or stove-pipe or fireplace throat joins it to the top of the chimney stack. Think what happens in that flue when the soot accumulates and takes fire, as it often does. If there is an opening somewhere along the stack between the bricks, due to mortar falling out, what is to prevent the blazing soot from going through this opening rather than out of the chimney top? Fire starts and the house is ruined. Flue

Then there are roof leaks. These can be prevented only in one way: by using good material, properly applied. See that the flashing around the chimney, for example, is built right into the brick, and that no light shows around the chimney opening from inside the attic. Get after any little leaks that do show up, before rain and snow get a chance to rot the wood in the roof, and perhaps the attic floor and the ceiling plaster. Watch the gutters on the eaves and repair any small holes that develop in them before they make rusty marks on the sides of the house, or allow water to seep in around the window casings.

Learn to fix the small leaks in the plumbing equipment of the house. Faucets and toilet flushes are easy to fix when they go wrong, and many a plumber's bill will be saved by a stitch in time. A can of "smooth-on" cement will fix the majority of piping leaks. If the pipes can be unscrewed and the new joint made up with this cement, the repair will be permanent. If not, one or two applications of the cement to the outside of the joint will make a repair that will last for a long time.

Plenty of exercise in deep-litter scratching keeps hens in a healthy laying state.

Water-Cooled Meat House

The claim is made by the owner and builder of the water-cooled meat house shown in the illustration that the meat

chilled in it will keep from two to three times as long as meat chilled in an ice house. The owner of the house is a cattle trader and butcher of Princeton, B. C., who operates his own slaughter house in connection. After being killed and dressed the carcasses are taken to the meat house for chilling, cutting and weighing. They are kept there from 24 to 48 hours and sold. The house consists

of a 30 by 12-ft. frame building with two rooms and a porch. It is built in an excavation in a hillside, placing it partly below the level of the ground, and a V-trough is built over the ridge of the roof as shown. The trough has holes drilled in the sides to allow a steady flow of water to pass over the roof and down off the eaves. The building is shaded by close-growing cottonwoods and alders, although this detail was intentionally omitted in the drawing. Of the two rooms back of the porch, the rear one is used for a sausage room, and the front one for meat storage. The weighing, cutting and wrapping of meat for delivery are done on the porch, which is fitted up with tables, scales, chopping blocks, etc., in true butcher-shop style. Excellent insulation against the heat is obtained by air spaces in the walls and ceiling, as shown in the end view, and a double floor with building paper between the boards. The walls

are built of 1-in. ship-lap lumber nailed to 2 by 4-in. studdings with building paper on the inside. The inner walls are of 1-in. sheathing nailed to the inner face of the studding, leaving an air space for in-

sulation between the inner wall and the building paper. The cross beams between the walls are covered with a ceiling of 1-in. sheathing, making an air space between the roof and the ceiling. The roof rests on 2 by 4-in. rafters over which 1-in. sheathing is nailed; and over this, in turn, red cedar shingles are laid, 4 in. to the weather. Over the peak is a V-trough made of 1-in. fir. A

4-in. insulated door, in which is a small trap window, separates the porch from the chilling room, while an ordinary door of 1-in. lumber separates the two inner rooms. At the back of the building, near the floor level, is another trap window, 12 by 20 in., leading to the space between the building and the earth bank at the rear. Two sets of horizontal bars serve as racks for hanging the meat in the chilling room. The sausage room is fitted up with tables, choppers, sausage machine, etc. Back on the hillside, about 50 ft. distant and about 10 ft. above the level of the roof of the meat house, there rises a small spring of ice-cold water which has an even, year-long flow. This has been dammed and the water led to the roof of the meat house in a V-flume. The flume is directly over the peak of the roof and runs to within 4 ft. of the front. Small holes are drilled about 4 in. apart in the sides of the flume to allow the water to

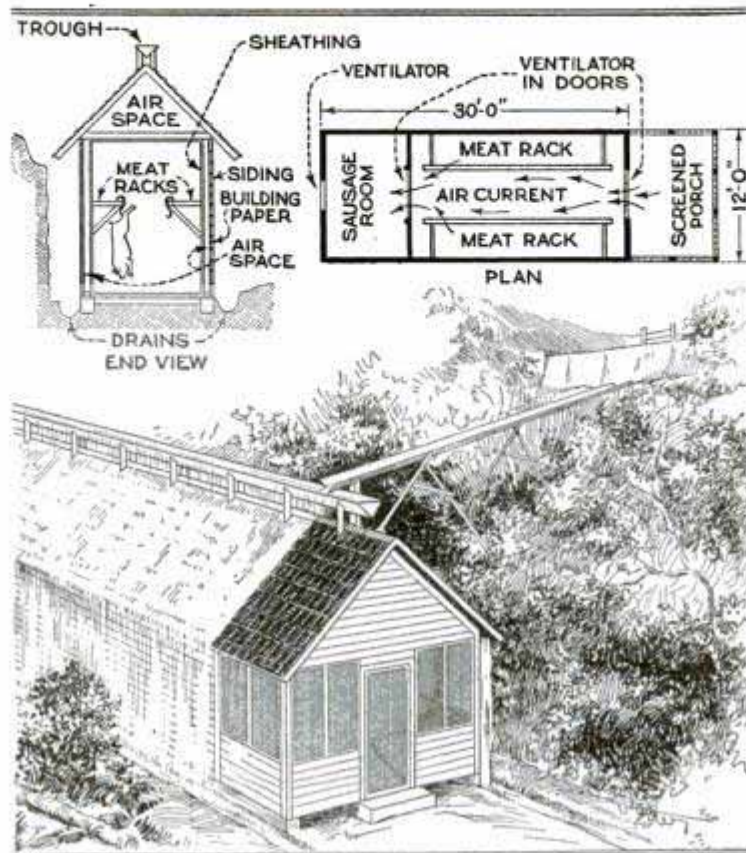

Thin Sheet of Cold Spring Water from Near-By Hillside Flowing over Roof Keeps Meat House Cool

run down over the roof. They are close enough together to make a solid sheet of water over the whole roof. The water drips off the eaves into the space between the building and the earth bank and is carried away in drains. The coolness of the water, as well as its evaporation, keep the building exceptionally cool. The flow of water in the flume is controlled by a slide gate in the dam. Dirt and leaves are kept out by screening in the outlet gate. A current of cool air is arranged for by small trap windows in the front door and rear of the building. This is a very important part of the chilling process.

Lathing Hints

Lath shrink most when they first dry out, and therefore only well-seasoned, clean lath should be used. Less contraction, however, takes place when the lath are wet on installation. Hence, they should be thoroughly soaked before they are nailed on to prevent cracking of the plaster. To make this wetting most effective, the plaster should be put on as soon as possible after the lath are placed. They should be spaced about $\frac{3}{8}$ in. apart and a space of $\frac{1}{4}$ in. left at the joints. Regular lathing nails should be used, and the lath should be nailed to every stud, breaking joints every six or eight laths. It is objectionable practice to allow lath to run in behind partitions, and ends in corners should always be supported.

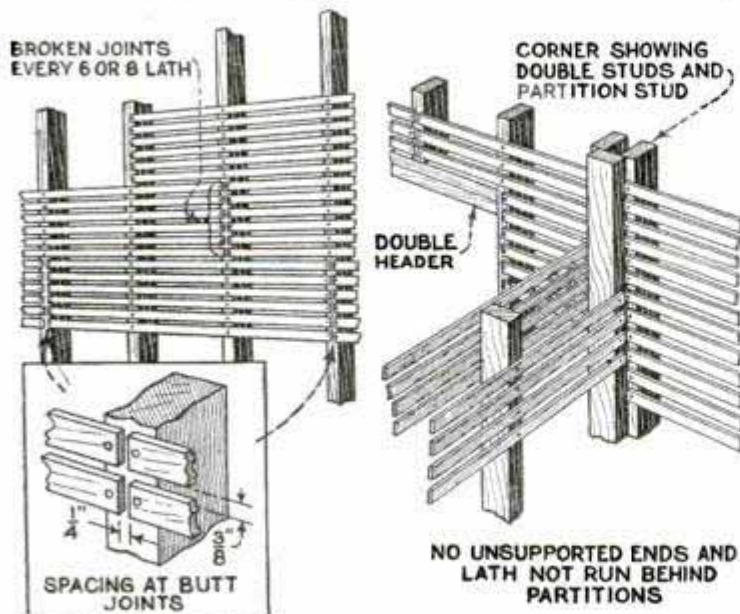

Proper Method of Applying Lath and Supporting It at Corners

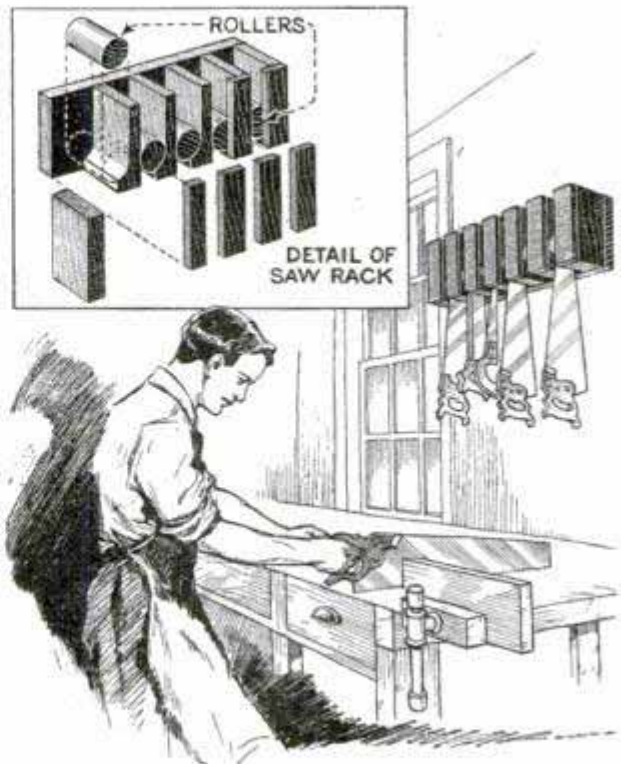

Convenient Rack for Holding Saws on Wall above Workbench

Handy Saw Rack

To have your saws out of the way and handy at all times you will find the illustrated saw rack of considerable convenience. It consists of a 1-in. board, about 6 or 8 in. wide, the length depending on the number of saws. A space of $3\frac{1}{2}$ in. is allowed for each with an inch extra at each end. Shape a number of pieces of 2 by 4-in. stock as shown in the illustration, and nail them to the board on $3\frac{1}{2}$ in. centers. Place a 2-in. roller in each space and nail on a 2-in. strip, as indicated, to prevent the roller from coming out.

Substitute for Dry Cells for Ignition

Dry cells used on a gasoline engine running a concrete mixer were worn out, and to replace them meant a trip to town, which would delay the work considerably. Electric-light lines were near by and a toy transformer was obtained as a substitute for the dry cells. This was hooked up, and the engine started with a bang and kept on running in a satisfactory manner.

2020

This May Be Your Home

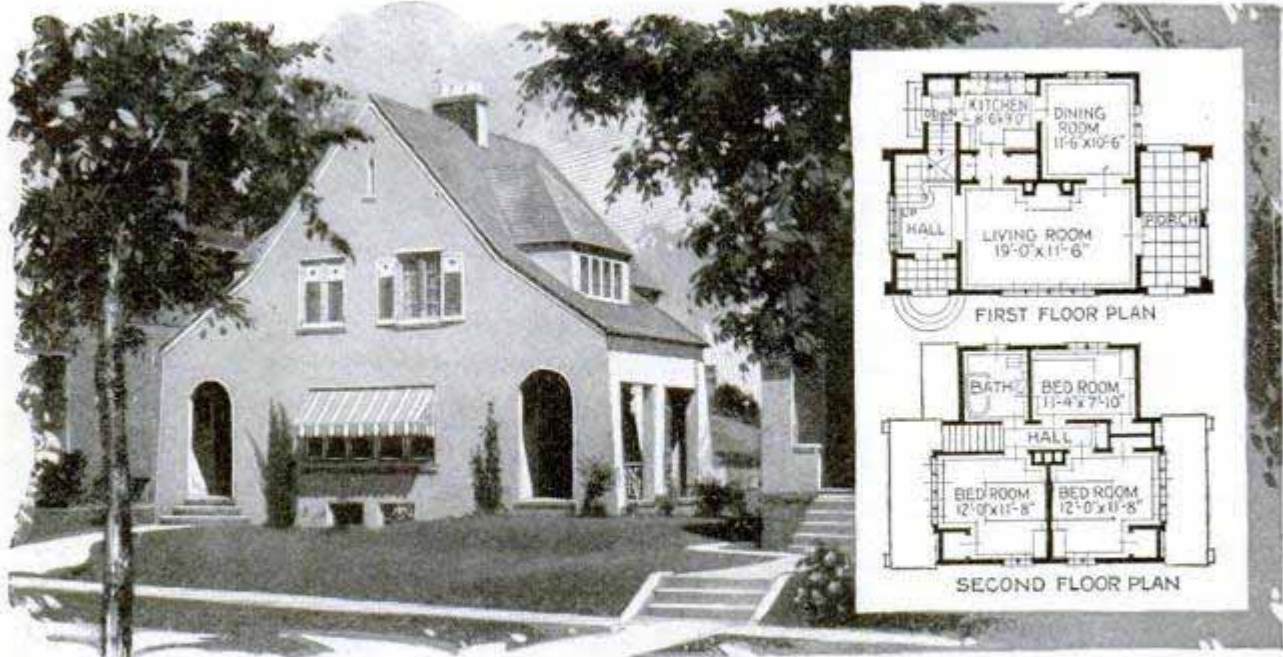

Copyright, Architects' Small House Service Bureau

Plan No. 6B4

QUESTIONS regarding home building addressed to this magazine will be answered by The Architects' Small House Service Bureau of the United States, Inc., controlled by the American Institute of Architects and endorsed by the United States department of commerce. Inclose 10c and self-addressed envelope. Blueprints, specifications and material list for the house shown here may be obtained at nominal cost. Inclose self-addressed stamped envelope for reply. If further information is desired, send 5c and stamped envelope for a 24-page booklet explaining how the Small House Service Bureau functions and showing 12 sample plans. A new booklet, entitled "Fifty Ways to Lower Home Building Costs," illustrated by ten bureau houses actually lived in, and showing how as much as \$1,000 can be saved on a home, may be obtained for 20 cents.

THIS house shows the modern trend in building small homes of individuality and distinction. It is an ideal combination of features that make for convenience and comfort with unusual design. Graceful well-balanced arches form the entrance to the front hall and to the comfortable porch. Every room is of good size, well lighted and livable.

In this design, even the hall has individuality. It is ample in size, with beautifully arranged open stairway and large triple window. The large opening from the hall to the living room permits a delightful view across the living room into the cool, shadowed porch. A fireplace, and a group of wide windows in front, add greatly to the distinction of the good-sized living room. In the side entry there is both a broom closet and a coat closet.

On the second floor there are three good-sized bedrooms, bath and five closets.

Two of the bedrooms are exceptionally pleasant.

Counting over the advantages of this plan one cannot fail to see that they mount up high. A paved porch, a grade entrance, a vestibule, stair hall, fireplace, plenty of closet space and many windows—and above all a plan well thought out for convenience and beauty. The exterior does not suffer by comparison, for its well-balanced walls and roof lines show the hand of the expert.

Materials used: Frame construction, with stucco finish on metal lath. Trim, hardburned flash brick; shingle roof.

Width over all: Thirty-five feet.

Depth: Twenty-four feet three inches.

Approximate size of lot: Fifty feet.

Facing: The plan, as shown, is designed to face south or west, but can be reversed.

Basement: Under entire house, except the porch. Contains a well-lighted laundry.

IN accordance with the editorial policy of this magazine never to accept compensation in any form for what appears in our reading pages and also to avoid the appearance of doing so, we are obliged to omit the name of the maker or the seller of any article described. This information, however, is kept on file and will be furnished free, by addressing Bureau of Information, Popular Mechanics Magazine, Chicago.

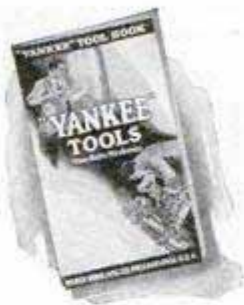
**FREE****New "Yankee" Tool Book**

This interesting little book is for all lovers of fine tools. It tells just what you want to know about all the famous "Yankee" Tools. Write for your copy today.

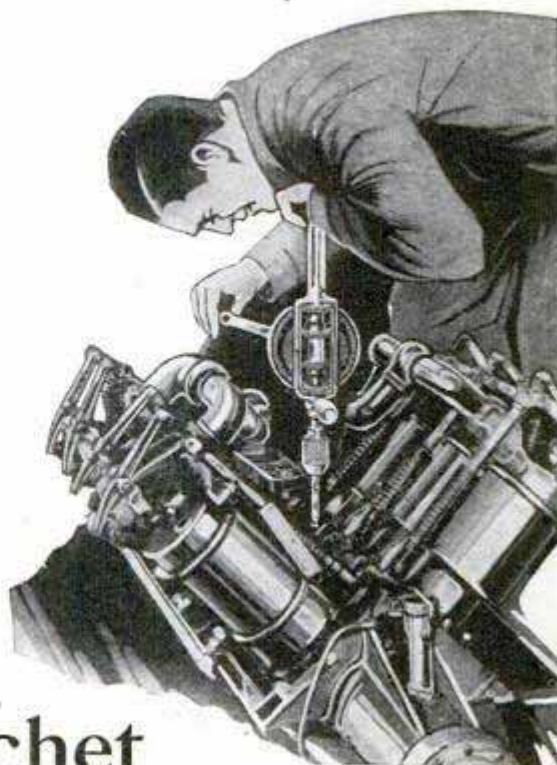

The "YANKEE" Ratchet makes hard jobs *easy*

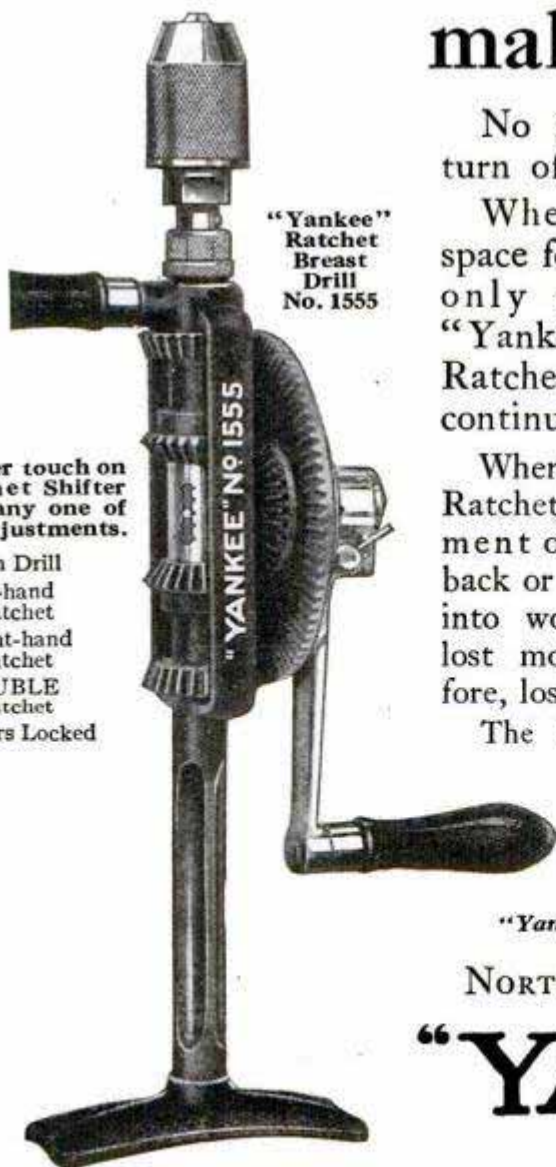

"Yankee"
Ratchet
Breast
Drill
No. 1555

A finger touch on Ratchet Shifter gives any one of five adjustments.

1. Plain Drill
2. Left-hand Ratchet
3. Right-hand Ratchet
4. DOUBLE Ratchet
5. Gears Locked

No need for a full turn of the crank.

Whether you have space for a half turn or only an inch, the "Yankee" DOUBLE Ratchet lets you drill continuously.

When set on DOUBLE Ratchet, any slight movement of crank, either back or forth, sends drill into work. This saves lost motion and, therefore, lost time.

The four other ratchet

adjustments shown, and two speeds, make this "Yankee" Drill the handiest and fastest ever designed.

You can change speeds instantly without removing drill from work. Just shift lever at base of hub.

No. 1555 (Illustrated) 3-jaw; No. 555, 2-jaw. Hold $\frac{1}{2}$ in. Drills. No. 1545, 3-jaw; No. 545, 2-jaw. Hold $\frac{3}{8}$ in.

For smaller drilling jobs use "Yankee" Ratchet Hand Drill No. 1530, with five ratchet adjustments. Holds $\frac{1}{4}$ in.

Some other "Yankee" Tools

Ratchet Screw-drivers
Ratchet Bit Braces
Automatic Push Drills

Automatic Feed Bench Drills
Ratchet Tap Wrenches
Vises, Removable Base

Dealers Everywhere Sell "Yankee" Tools

"Yankee" on the tool you buy means the utmost in quality, efficiency and durability.

NORTH BROS. MFG. Co., Philadelphia, U. S. A.

"YANKEE" TOOLS

Make Better mechanics



The Telephone and the Farm

THERE was not a farmer in the world fifty years ago, who could talk even to his nearest neighbor by telephone. Not one who could telephone to the doctor in case of sickness or accident. Not one who could telephone for the weather report or call the city for the latest quotations on his crops. Not one who could sell what he raised or buy what he needed by telephone. A neighborly chat over the wire was an impossibility for the farmer's wife or children.

In this country the telephone has transformed the life of the farm.

It has banished the loneliness which in the past so discouraged

the rural population and drove many from the large and solitary areas of farms and ranches.

It is a farm hand who stays on the job and is ready to work twenty-four hours every day.

The telephone has become the farmer's watchman in times of emergency.

It outruns the fastest forest or prairie fires and warns of their approach. It has saved rural communities from untold loss of lives and property by giving ample notice of devastating floods. Three million telephones are now in service on the farms, ranches and plantations of the United States.

AMERICAN TELEPHONE AND TELEGRAPH COMPANY
AND ASSOCIATED COMPANIES

BELL



SYSTEM

IN ITS SEMI-CENTENNIAL YEAR THE BELL SYSTEM LOOKS FORWARD
TO CONTINUED PROGRESS IN TELEPHONE COMMUNICATION

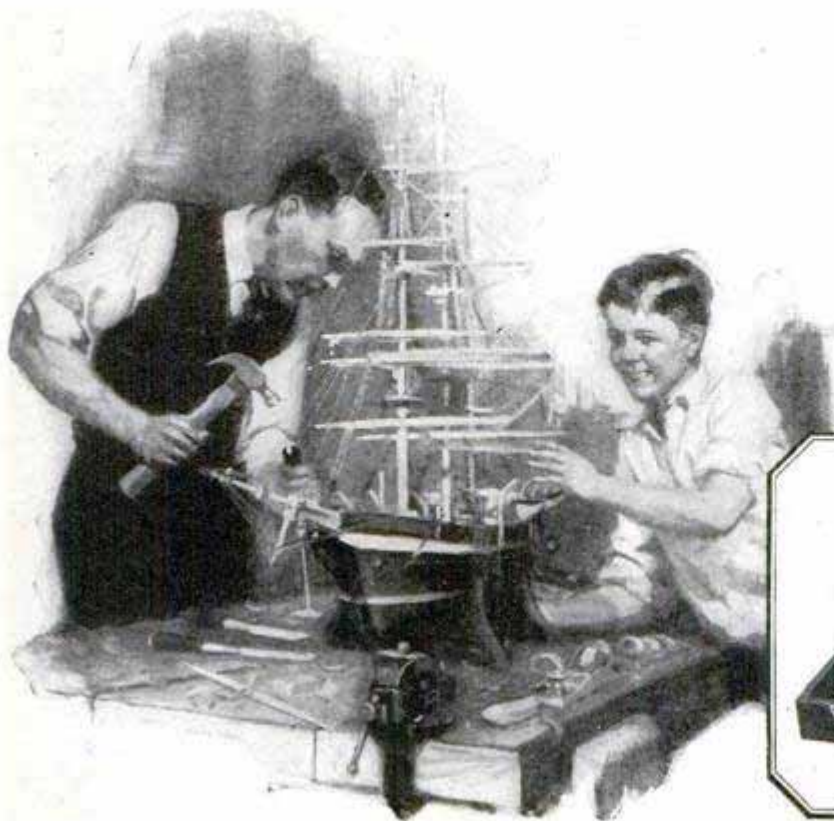

*Buy separately
or in assortments*



Father & Son—Partners!

S AID a happy father recently, "I can't think of anything I ever bought for my boy that worked out better than our Stanley Tool Set. We've had a lot of fun working together. We started with a few simple repairs about the house. Then we made our own work bench; after that a table. Now we have just started on our most ambitious effort—a model of an old galleon—and already it looks like a success."

Such work requires good tools. Stanley Tools have been standard for more than a half century. You'll find them in most carpenters' kits and in

manual training classes throughout the country.

You can buy Stanley Tools separately and gradually accumulate your set. For your convenience in buying, there are also sets in fine oak chests from \$15 to \$95. Or there are assortments of the same good tools in strong cardboard boxes containing simple directions for making your own chest. Prices \$5 to \$20.

Ask your hardware dealer to show you the line of Stanley Tools. And send for our Catalogue No. 34 which describes Stanley Tools both separately and in assortments. Address: The Stanley Works, New Britain, Conn.

The best tools are the cheapest to use
Ask your hardware dealer

STANLEY TOOLS

THE MOST COMPLETE LINE

P-rrrrrt!! and flash, a car sweeps by—a race is won!—and Good Tools Play Their Part

ALMOST invariably, the outcome of a race depends upon the mechanical superiority of the winning car. Its mechanical superiority may depend upon the use of more care in its original construction or more accurate adjustment in tuning up immediately before taking to the track. In either case, however, to gain the victory, good tools are necessary—tools of Brown & Sharpe Quality.

You may not be called upon to adjust a racing car for its breath-taking whirl around the track, but no matter whether you work in shop, garage or at home, you know there's no more certain way to be sure your work is right than to use tools of Brown & Sharpe Quality.

Send for the Brown & Sharpe Small Tool Catalog No. 30. It contains 448 pages, each one of which holds something of interest for you. Write for your copy today.

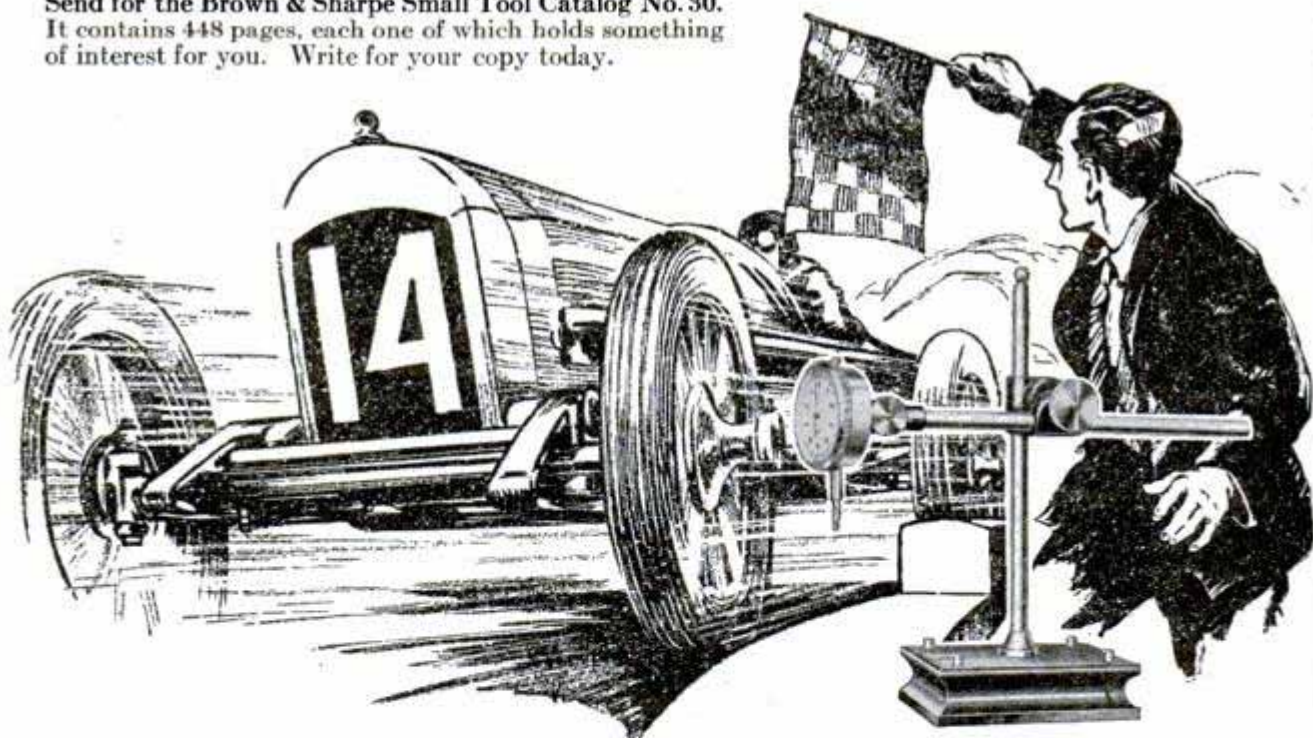

Dial Test Indicator No. 733 is a handy tool for motor machinists. It is but one of the hundreds of Brown & Sharpe Tools in daily use in the manufacture of automobiles.

BROWN & SHARPE TOOLS

BROWN & SHARPE MFG. CO., Providence, R. I., U. S. A.

Remington Portable

Lightest

Fastest

*Most
Compact*

*Most
Dependable*



REMINGTON Portable is the recognized leader in sales and popularity. It enjoys this distinction for common-sense reasons.

It is the *lightest* standard keyboard portable—weighs 8½ pounds net. It is the *fastest*, turning out neat and accurate work at any speed you demand. It is the *most compact* of all writing machines—the carrying case is only 4 inches high. Years of service everywhere have proved its outstanding dependability under any and every con-

dition of service. All these advantages plus the standard keyboard!

Remington Portable is sold by our branches and dealers everywhere on terms as low as \$10 down and \$5 monthly. Write to Dept. 12 for our booklet, "For You—For Everybody."

REMINGTON TYPEWRITER COMPANY
374 Broadway *Branches Everywhere* New York
Remington Typewriter Company of Canada, Ltd.
68 King Street, West, Toronto



Remington

TYPEWRITERS

**A MACHINE FOR
EVERY PURPOSE**



**STANDARD
TYPEWRITERS**



**NOISELESS
TYPEWRITERS**



**ELECTRIC
TYPEWRITERS**



**PORTABLE
TYPEWRITERS**



**TABULATING
TYPEWRITERS**



**ACCOUNTING
MACHINES**

REMINGTON-MADE PARAGON RIBBONS AND
RED SEAL CARBON PAPERS ALWAYS MAKE GOOD IMPRESSIONS

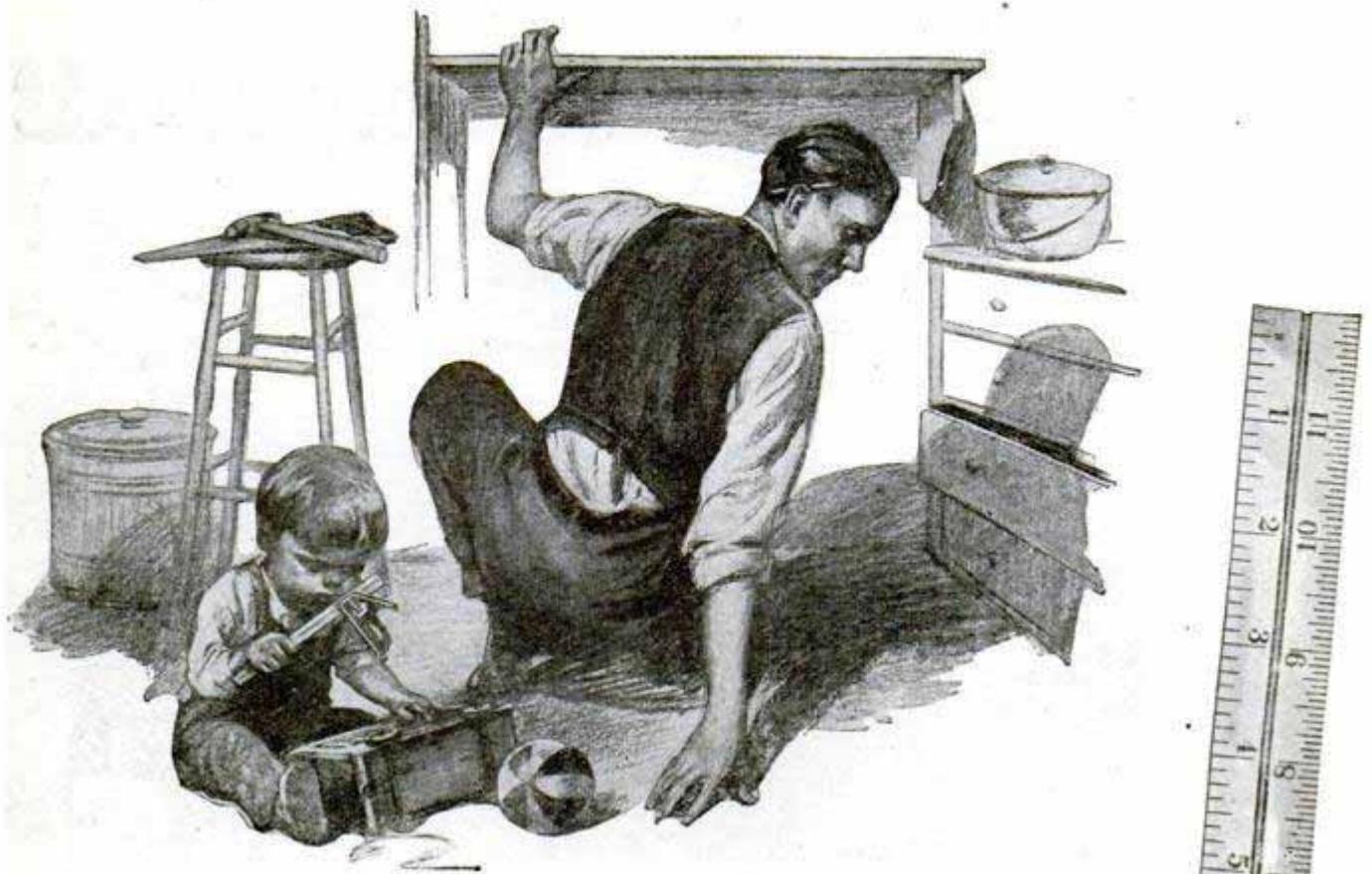

S'matter, Pop?

'S funny, once you've formed the habit of working with a Starrett Combination Square, you're absolutely lost when somebody gets away with it.

That's because of its great convenience, the number of different tools it replaces and the tremendous number of uses it can be put to.

When you stop to think that 7 distinct tools are replaced by the No. 94—a marking gage, a rule, a square, a miter, a depth gage, a height gage, and a level and plumb—it's easy to see what a hole its loss leaves in most men's kits.

And when you start to figure up the number of uses for this one tool—well, as one practical carpenter put it, "Every day and every job brings a wholly new use for this Combination Square."

Ask your hardware dealer to show you one—and also write us for a free copy of Catalog No. 23 "A.P."

THE L. S. STARRETT CO.
World's Greatest Toolmakers
Manufacturers of Hacksaws Unexcelled
Steel Tapes—Standard for Accuracy
 ATHOL, MASS.

Starrett Combination Square No. 94—the tool with more uses than a dog has fleas.

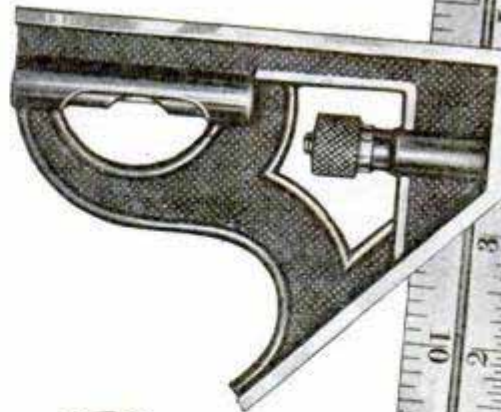

9307

Use Starrett Tools

Announcing the new Balkite Light Socket Radio Power Units



The New Balkite Charger

MODEL J. has two charging rates. A low trickle charge rate and a high rate for rapid charging. Can thus be used either as a trickle or as a high rate charger. Noiseless. Large water capacity. Rates: with 6-volt battery, 2.5 and .5 amperes; with 4-volt battery, .8 and .2 amperes. Special model for 25-40 cycles. Price \$19.50. West of Rockies \$20.



Balkite Trickle Charger

MODEL K. With 6-volt "A" batteries can be left on continuous or trickle charge thus automatically keeping the battery at full power. Converts your "A" battery into a light socket "A" power supply. With 4-volt batteries can be used as an intermittent charger. Or as a trickle charger if a resistance is added. Charging rate about .5 amperes. Over 200,000 in use. Price \$10. West of Rockies \$10.50.

All Balkite Radio Power Units operate from 110-120 volt AC current with models for both 60 and 50 cycles. Prices are higher in Canada.

A new Balkite Charger with both trickle and high charging rates. Three new Balkite "B's," including the new popular priced Balkite "B"-W at \$27.50. The new Balkite Combination — with your "A" battery it furnishes automatic power to both circuits.

Now you can operate your radio set from the light socket. Either by adding a Balkite Charger and Balkite "B," or by adding the new Balkite Combination Radio Power Unit.

In either case the result is the same — smooth, silent light socket power and maximum convenience. Balkite Light Socket Power is noiseless. There is no hum. It is never low or run down, but is always exactly what is required by the set.

Balkite Radio Power Units are permanent pieces of equipment. They have no bulbs, and nothing to replace or renew. They cannot deteriorate from use or disuse. Other than a negligible amount of household current their first cost is the last. With sets of high current requirements they effect a decided saving. They require no changes in your set.

Over 600,000 radio receivers — one of every ten — are already Balkite equipped. Equip yours with Balkite and convert it into a light socket receiver. Know the pleasure of owning a set always ready to operate at full power.

FANSTEEL PRODUCTS COMPANY, Inc.,
North Chicago, Illinois

FANSTEEL
Balkite
Radio Power Units



A New Balkite "B" at \$27.50

Balkite "B" eliminates "B" batteries and supplies "B" current from the light socket. Noiseless. Permanent. Employs no tubes and requires no replacements. Three new models. Balkite "B"-W at \$27.50 for sets of 5 tubes or less requiring 67 to 90 volts. Balkite "B"-X, for sets of 8 tubes or less; capacity 30 milliamperes at 135 volts — \$42. Balkite "B"-Y, for any radio set; capacity 40 milliamperes at 150 volts — \$69.



Balkite Combination

When connected to your "A" battery supplies automatic power to both "A" and "B" circuits. Controlled by the filament switch on your set — entirely automatic in operation. Can be put either near the set or in a remote location. Will serve any set now using either 4 or 6-volt "A" batteries and requiring not more than 30 milliamperes at 135 volts of "B" current — practically all sets of up to 8 tubes. Price \$59.50.

No. **125**

Bench Lathe
Complete as
Illustrated
Price \$40



This bench lathe
makes your home shop
a real workshop

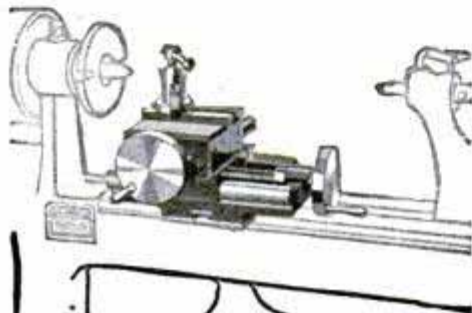

No. **132** Slide Rest
Price \$17.50

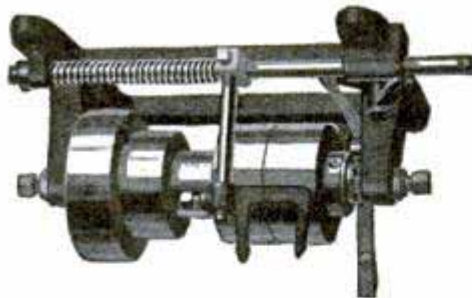

No. **130** Counter Shaft
Price \$12

Bench Lathe No. 494

This lathe has the same construction as the No. 125 above, but is slightly larger. Length over all, 31 inches; height, 11½ inches; swing, 7 inches; extreme distance between centers, 18 inches. Net weight, 36 pounds. Price, \$44.00.

THERE are many turning and boring jobs you could do yourself if you had a bench lathe. Make your workshop more complete by adding to it this Goodell-Pratt Lathe. It enables you to do professional-looking work. Over-all length of this bench lathe is 25 inches; height, 11½ inches; swing, 7 inches; extreme distance between centers, 12 inches. It weighs only 30 pounds. Price, \$40.

This lathe has a milled bed and a tail stock with milled base. Live spindle has a cone bearing to take up wear. The tail stock has both screw and lever feed. Cone pulley has 3 steps—1½, 2½, 3½ inches in diameter. The lathe is finished with black and red enamel. All working parts are beautifully polished.

A complete line of attachments is available to fit this lathe. Among them are a slide rest, lathe tools, compression check and collets, milling attachments, turret attachments.

400-page book of tools FREE

A postcard will bring you the 400-page pocket-size book of all the famous 1500 Goodell-Pratt tools. In this book are shown and described many tools you will want to outfit your workshops completely. Every tool shown is beautifully made and finished by skilled toolmakers. Just let us know where to send your copy of the book. It is FREE.

GOODELL-PRATT COMPANY
GREENFIELD, MASS., U. S. A.

Toolsmiths

Makers of Mr. Punch

GOODELL-PRATT
1500 GOOD TOOLS

Auto

7¢
per
mile

Down Comes the Cost of Travel

Rail
Road3¢
per
mileStreet
Car2¢
per
mile1¢ per
mileThe
Single

Ride the New Way! at 1¢ per Mile!

Safe

Almost self-balancing. Steering is instinctive. Simple controls—throttle and spark are in your hands all the time.

YOU save money every mile when you ride a Harley-Davidson Single—the new-type motorcycle that travels 80 miles on every gallon of gasoline.

Safe, comfortable traveling, too—and delightfully enjoyable. The Single is nearly self-balancing, with simple controls, responsive, powerful motor and 3-speed transmission.

Easier to ride and control than a bicycle—safe. Easy to park and house—any 2x8 ft. space will do. Easy to buy—your Dealer offers a convenient Pay-As-You-Ride Plan, and the price is low—complete with built-in electric equipment, f. o. b. Milwaukee, only \$235

See your Dealer—and mail us the Coupon.

HARLEY-DAVIDSON MOTOR COMPANY
Department P Milwaukee, Wis.

The HARLEY-DAVIDSON [New-Type Motorcycle] Single

80 miles
per gallon

HARLEY-DAVIDSON MOTOR CO.
Dept. P. Milwaukee, Wis.

- Interested in your Single; send catalog and Dealer's Name.
 Interested in your Dealer proposition. Is my territory open?

Name

Address

**Double Keen
Double Clean**



Make The Twice-Over A Once-Over

THE Gem Double Life Blade gives a double-clean shave in half time! Its double-keen shaving edge gets the hair at the dermal line the first stroke! Double-heavy, double-reinforced, double-durable—it keeps giving brand-new shaves long after other blades have expired! Made of better tempered steel, it leaves you in a better temper after the shave! Sold everywhere.

P.S.—Your money does double-duty when it buys the Gem de Luxe Razor. And to make sure that every Gem owner is double-happy, our service department will make good for any frame that isn't 100% perfect—no matter how long it's been in use. Send it to

GEM SAFETY RAZOR CORPORATION
Brooklyn, N. Y.

GEM

Double Life
BLADES

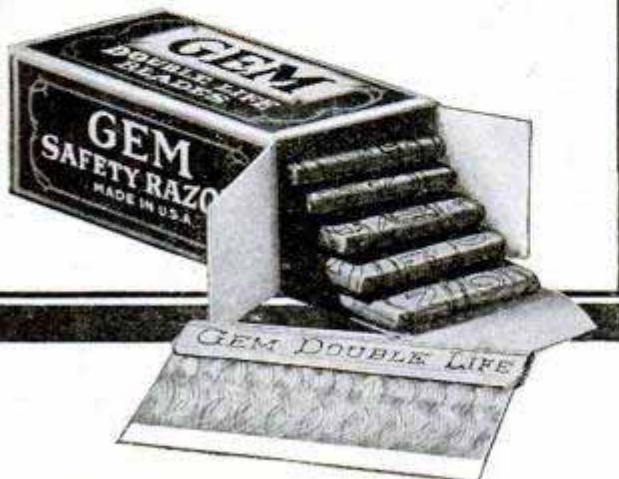

Please Mention Popular Mechanics

500 Quarts of Fire Quenching Gas from 1 Quart of Liquid

At last the ideal way to put out fires quick has been discovered. This is a new fire gun that shoots a chemical more than 25 feet without pumping. And this chemical coming in contact with fire creates a gas of more than 500 times the original volume. This gas smothers out fires instantly by shutting off the air. It puts out celluloid, gasoline, kerosene fires that water only makes worse. Absolutely stainless to clothes, harmless to people. Inexpensive. Always ready. Absolutely necessary for cars and homes, farms, garages, factories, schools, etc. Write at once for low price introductory offer to the Weldon Manufacturing Company, Dept. 7-K, Grand Rapids, Michigan. Agents or spare-time workers interested in making up to \$25 a day should write immediately for sales plan.—Adv.

Just Out!

World's Greatest Utility Light

300 CANDLE POWER—with new built-in Utility Pump. Handiest, most practical light invented. Storm-proof, rain-proof, bug-proof. Ideal for farmers, campers, tourist, sportsmen.

Bright, white light—20 times brighter than wick lanterns on half the cost. Burns 26 per cent air—4 per cent fuel, gasoline or kerosene. Lights with match. Clean, odorless, safe, Guaranteed.

AGENTS!

Make \$60 to \$100 a week. No experience or capital required. Outfit Free to workers. Exclusive Territory. Write quick!

FREE TRIAL

Try 30 days at our risk. Send for special money-saving offer and catalog giving all details FREE. Write now.

THE AKRON LAMP CO.
109 Lamp Bldg., Akron, Ohio



Learn How to WRESTLE

In Your Own Home
By Mail



Yes, learn to become an expert wrestler right in your own home, by mail. He will now teach you Scientific Wrestling—Physical Culture—Jiu-Jitsu—Self Defense. Every man and boy in America, no difference what age, needs this wonderful course of lessons. Write today—your name, age and address on a postcard or letter brings you our fine book absolutely free, no obligation of any kind. A splendid book on wrestling and physical culture. Write today staking your age.

Farmer Burns and Frank Gotch

Farmer Burns, "the grand old man of the mat," taught Frank Gotch, the World's Champion, all he knew about wrestling, so Gotch said. He will now teach you Scientific Wrestling—Physical Culture—Jiu-Jitsu—Self Defense. Every man and boy in America, no difference what age, needs this wonderful course of lessons. Write today—your name, age and address on a postcard or letter brings you our fine book absolutely free, no obligation of any kind. A splendid book on wrestling and physical culture. Write today staking your age.

Farmer Burns School of Wrestling 9776 Range Bldg., Omaha

This
Wrestling
Book
FREE

WURLITZER
TRADE MARK REGISTERED
 THE WORLD'S LARGEST MUSIC HOUSE



Try Any Wurlitzer Instrument in Your Own Home

EXAMINE IT, show it to your friends, play it as much as you wish. An ample free trial—no obligation to buy. We make this liberal offer because we want you to see for yourself this superior quality of Wurlitzer instruments, the result of 200 years' experience. Noted musicians praise them for unusual tone quality, artistic workmanship and ease of playing. They are used in the finest bands and orchestras throughout the country.

Easy Payments

If you decide to buy, payments are arranged in small monthly sums. A few cents a day pays for your instrument. Special offers on complete musical outfits.

SEND FOR New Catalog

The greatest musical catalog ever published! Over 3,000 articles—every known instrument described and illustrated; many of them shown in full colors. Gives you lowest prices and all details of Free Trial, Easy Payment plan. All sent FREE—no obligation. Send coupon below.

Clip and Mail

THE RUDOLPH WURLITZER CO., Dept. 1776

120 W. 42nd St., New York 117 E. 4th St., Cincinnati
 329 S. Wabash Ave., Chicago 250 Stockton St., San Francisco

Send me, absolutely free, new illustrated catalog, with prices and details of Free Trial Easy Payment plan. No obligation.

Name _____

Address _____

City _____ State _____

Instrument _____
 (State instrument in which you are interested)

Aching Feet

Quick relief

At all druggists \$1.25

Send for free trial bottle
W. F. Young, Inc.
Springfield, Mass.

SIMPLY rub in a few drops of Absorbine, Jr. A soothing, cooling, and comforting feeling follows the relaxed tension of the muscles and nerves.

After a warm foot bath, Absorbine, Jr. is delightfully invigorating—or if preferred, shake a few drops in the bath.

Absorbine Jr!

THE ANTISEPTIC LINIMENT

Shoot the Best Gun

The NEW BENJAMIN is the finest air rifle ever made. Unlike all others. Has amazing accuracy—shoots hard and far. It's the original American genuine AIR operated rifle. One to six pump strokes compress air to any desired degree of power. Same force as in air drills and air hammers except you control the shooting force. Never loses force—no springs or levers to get out of order. Makes crack shots quickly, inexpensively. Gives years of delightful recreation with utmost safety. At your dealer's, or sent postpaid for \$5.00.

Shoot 5 Days FREE

We give you five days, ammunition supplied, to test the NEW BENJAMIN. If in this time you don't believe it to be the finest air rifle you've ever seen or used, and if you don't believe it is the one and only air rifle for you, return it, postpaid, and your money will be refunded at once.

The NEW BENJAMIN AIR RIFLE

America's Original Air Rifle

\$5 at your dealer's or sent postpaid direct from factory on FREE Trial as above if dealer does not handle it—write for our wonderful offer.

Get This Book and Details FREE

BENJAMIN AIR RIFLE & MFG. CO.
635 N. Broadway, St. Louis, Mo.

Please send your amazing offer and free copy of "The Shooter's Art," telling how to become a crack shot, how to hold, aim, and handle guns and guide others in use of guns.

Name _____

Address _____



SENSATIONAL \$3 Typewriter Offer

3

AFTER 10 DAY FREE TRIAL

DON'T SEND US A CENT—we'll ship you a genuine L. C. Smith for a 10-Day Free Trial. Put it to any test in your home or office—no one will urge you to buy. Compare it with any machine made. Then, if you decide to keep it, we'll make you the LOWEST PRICE EVER OFFERED and give you EASY MONTHLY PAYMENTS so small you'll never miss them.

The ONLY Ball-Bearing Typewriter

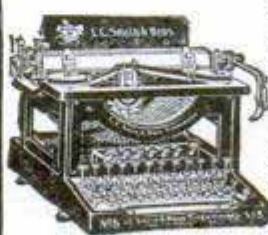

Because of its ball-bearing construction, the L. C. Smith is the easiest running and longest wearing typewriter made. ALL THE 1926 ATTACHMENTS.

Guaranteed for 5 Years HIGHEST QUALITY re-newed. Don't buy any typewriter until you have tried an L. C. Smith. For the sake of your future satisfaction, accept our FREE TRIAL OFFER.

\$3 Worth Extras FREE

By acting now, you get Tools, Waterproof Cover, valuable Home Study Course in Touch Typewriter Free. Play safe. Use the ball-bearing L. C. Smith 10 days before deciding on any machine. Write TODAY for details of our Special Offer and manual of typewriter information.

Smith Typewriter Sales Corp.

119-360 East Grand Avenue, Chicago

Light Weight Marvel

Power 1/2 to over 1 H. P.—Air cooled—Rated 3/4 H. P. normal. Used for a multitude of power services for practical uses of individual or manufacturer in place of electric motor. Power from crankshaft at full speed—jack shaft at quarter speed. Spark feed control with simple make-and-break ignition or magneto.

WEIGHS ONLY 22 POUNDS
With carburetor, gas tank and base, complete, weighs 28 pounds. Furnish V or flat belt type pulley for crank or jack shaft. Power take-off pulley, 4 to 1 reduction. Ideal for applied power. Tell us your needs.

Write—CUSHMAN MOTOR WORKS
Builders of High-Grade, Light-Weight Engines
882 No. 21st Street, LINCOLN, NEBRASKA

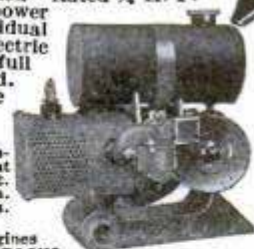

FREE 1000 Illustrations ELECTRIC FIXTURE CATALOG!



Write today for your copy. Save 50% direct from Manufacturer. No Middleman's Profit. OUR SPECIAL: 8 Room Electric Set, ready to hang, \$24.50—Other bargains.

UNITED LIGHTING FIXTURE CO.
83 Flatbush Ave. Dept. P, Brooklyn, N. Y.



Great New Invention

For Better Health—More Power—Greater Vitality to Enjoy Life's Pleasures.

ELCO Health Generators generate Nature's Four Greatest Curative Powers—Violet Ray, Vibration, Ozone, Medical Electricity. Leave Bad Health and Weakness Behind Forever—Revitalize Yourself—Bring Back Lost Energy—Be Wholly Alive. 20 Home Trial Treatments with Physician's Directions FREE. Quick Results—No Medicine—No Dieting—No Exercise—No Drugs. AGENTS WANTED. Lindstrom & Co., 30 W. Lake St., Dept. 13-56, Chicago



Write For Free Book



This is the new Burgess Radio "A" Battery

A SPECIALLY designed "A" battery for radio service. There is nothing like it in its field.

Proportioned to permit ease of handling and convenience of cabinet assembly and storage, you may expect this new Burgess creation to give you the length of service and dependability under all conditions for which all products of Burgess are noted.

If you are using the ordinary type of No. 6 "A" battery, we suggest that you learn for yourself from the Burgess Radio "A" the measure of service you have a right to expect.

Ask Any Radio Engineer

BURGESS BATTERY COMPANY

GENERAL SALES OFFICES: CHICAGO

Canadian Factories Sales Offices: Niagara Falls and Winnipeg



BURGESS RADIO BATTERIES

*The dawn of a new day
in Radio Speakers*

The Tower Cone



THE most beautiful Cone in America!
With those mechanical niceties that insure finer tone and volume, this Tower Speaker virtually revolutionizes present day conceptions. The double-drive unit, the acoustically perfect non-warping Cone, the eight connections from unit to Cone, the free-edge construction — these basic features establish Tower Supremacy.

Price
\$9.50

On Sale from Coast to Coast.

TOWER MFG. CORP. BOSTON, MASS.

OIL HEAT

**Astonishing Simplicity
Marks an Epoch in Oil Burner
Construction and Efficiency**

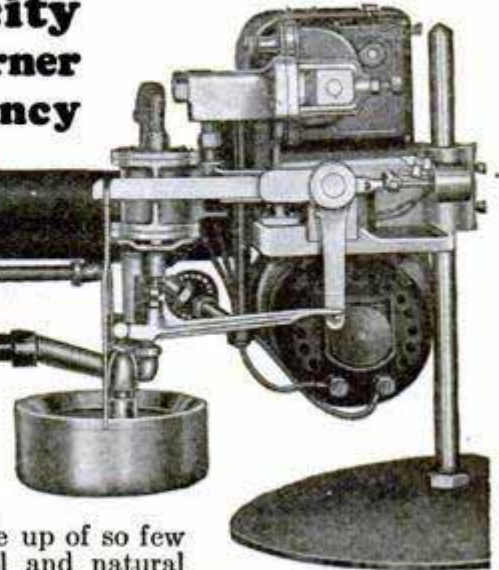

The HI-LO OIL VAPOR BURNER operates with absolute certainty, without intricate machinery and embodies simplicity of construction that makes it thoroughly understandable to any one in ten minutes' time.

The HI-LO Oil Vapor Burner is made up of so few parts that by very simple mechanical and natural laws, it will accomplish all that the complicated high priced oil burner does—and then some.

The HI-LO feature increases or diminishes the heat automatically as required without nerve racking ignition explosions or ignition failures. It always produces perfectly regulated heat in accordance with weather conditions.

*Desirable territory open to responsible dealers.
Send for catalog and dealers' plan.*

Mr. Arthur Crist, Ithaca, N. Y., a dealer for four years, has just placed an order for two car loads—over \$70,000. Other dealers' records accordingly.

GLORIA LIGHT COMPANY 111-9 N. MAY STREET CHICAGO, ILLINOIS

Here Men!

A CHANCE FOR QUICK SUCCESS

No fancy selling to make big money with the new Fall line of Wright tailored to measure clothes. Two prices—\$23.50 and \$31.50. Suits every taste. All wool fabrics. Guaranteed fit and tailoring. Orders come easy—you just take measures and pocket \$3.00 to \$7.00 profit on the spot. We attend to everything else. Complete outfit furnished you to do big business. **130 all wool 9x13 samples.** Advertising helps and complete instructions so clear you can't fail—all FREE. No deposit. Exclusive territory given. Rush application today. Tell us your past experience.

**ALL WOOL
MADE TO
MEASURE
SUITS**

\$23.50

WRIGHT & COMPANY, Dept. 28, 2226 to 2302 Wabasha Ave., Chicago, Ill.

\$25.00 a DAY CLEAR



Write Quick for Details

SURFACING FLOORS

Scores of inexperienced men whom we started as American Universal Floor Surfacing Contractors are making up to \$10,000 a year in this wonderful, new, uncrowded field. Electrically driven American Universal Machines do 500% more work and 100% better work than most expert hand scraper, and earn six men's pay. Work is plentiful, fascinating, immensely profitable. Experience unnecessary. Small amount starts you. We furnish everything, teach you, help you succeed. Opportunity of lifetime to be your own boss and make big money.

AMERICAN FLOOR SURFACING MACHINE CO. 523 So. St. Clair St. TOLEDO, OHIO



\$35 Complete Outfit as Illustrated

Delivery Paid East of the Mississippi

\$38 Delivery Paid West of Miss.

Saw Table Can be purchased with 6-inch saw for **\$22.50** Delivery paid East of Mississippi. **\$24.50** Delivery paid West of Mississippi.

Motor This heavy duty motor can be furnished separately for **\$12.90** delivery paid East of Mississippi. **\$13.90** Delivery paid West of Mississippi. Complete with Cord, Plug and flat or grooved Pulley. Guaranteed 50% Overload. Special Prices on Quantities of 10 or Over.

PAUL J. DEVITT, 1101-1107 So. 2nd St., Phila., Pa.

MECHANICS BENCH SAW

With this saw you can make your own repairs in shop, home, farm or garage. Makes a clean edge on the toughest wood—no planing necessary. Rips, cross-cuts, bevels, miters, mortises, tenons, or grooves. Attach to any lamp socket. Weight only 61 lbs. Will cut up to 1 1/4. All metal. Saw size 6 in. Table 10x13, base 7x11 height 7 in. Table tilts for beveling 5 degrees left 10 degrees right.

WRITE FOR OUR NET PRICE BUILDERS' HARDWARE CATALOG

Buy Direct From Mill!

You can buy at **wholesale prices** just the home you want, and save \$200 to \$2,000. Materials shipped direct from mill to your station.

Ready-Cut Enables You to Do Own Building

Studs, joists, rafters and sheathing cut and fitted at mill. Plans so easy to follow and material so accurately cut, many buyers put up houses themselves. Save in both labor and lumber.



Gordon-Van Tine Home No. 623

5 rooms and bath—
Materials—

\$1201

Build Your Own Home!

Highest Quality Guaranteed

Everything top quality, backed by guarantee of "Satisfaction or Money Back." 200,000 customers.

Free Estimates On Any Job

We carry largest stocks of lumber, millwork and building material in the country. Send us your bills and we will figure them free.

Garages \$69 up
Build it yourself.
Material Ready-Cut. Easy to put up.

Send for Book Today!

Shows photos, floor-plans, descriptions, 3 to 9 room town and country homes, bungalows, cottages, Colonial, color illustrations, full specifications; describes our famous Ready-Cut system. 132 pages. Clip coupon or mail post-card for Book today.



Gordon-Van Tine Co.

ESTABLISHED 1865

Satisfaction Guaranteed or Money Back
819 Case Street DAVENPORT, IOWA

GORDON VAN-TINE CO.,
819 Case St., Davenport, Iowa

I expect to
 Build a
 Repair a
 Please send proper catalog.
 Name
 Address

SARGENT PLANES

See them at your hardware store.

Write for booklet.

SARGENT & CO., 49 Water Street, New Haven, Conn.



New Plan! makes it easy

\$50⁰⁰ to \$100⁰⁰ Weekly

Selling Shirts Direct to Wearer.
No capital or experience needed.
Spare or full time. Established 1885.
Represent a real manufacturer.

WRITE FOR FREE SAMPLES
MADISON SHIRT MILLS, 562 BROADWAY, NEW YORK

Do Wonderful Chemical Tricks and Experiments with CHEMCRAFT Junior!



Make your own ink, dye cloth, test water and soil, and learn about Chemistry. Surprise and puzzle your friends with Magic Chemical tricks; write secret letters with invisible ink; pour blue, brown and black liquid from a glass of water; make a magic pitcher of blueing; make your own magic writing paper. It's all easy if you have CHEMCRAFT JUNIOR. Order right away and get a FREE copy of The Chemcraft Chemist magazine; full of interesting chemical information, experiments, pictures and news from club members. You'll like it. Be sure to send today.

ONLY 50¢ POSTPAID

The Porter Chemical Co.
113 Summit Ave. Hagerstown, Md.

A Permanent Vacation

AND THEY SURE GET BIG PAY FOR IT



At the Beach, playing nights, with all day to themselves. The most pleasant vacation imaginable. Musicians are in big demand.

Whether you are just learning to play or are a finished musician you will find King Band Instruments easiest to play.

It is easy to own a King Instrument. They are sent on 10 days free trial and sold on convenient payment terms. Send for free copy of latest catalog.

THE H. N. WHITE CO., Cleveland, Ohio
5211-79 Superior Ave.
Makers of **KING** Band Instruments and Saxophones

The H. N. White Co., 5211-79 Superior Ave., Cleveland, O.
Kindly send me free your latest catalog on KING

(Instrument)
 Name
 Address
 City State

Millions of Motorists Now Fix Punctures This New Simple Way

Nothing Else Like It

Times have changed. So have the ways of fixing punctures. Motorists by the millions are discarding the old-fashioned way of fixing punctures for a newer, simpler way.

It is called the Shaler 5-Minute Vulcanizer. This handy little outfit comes packed in a small box to carry under the car seat. It makes permanent, heat-welded (VULCANIZED) tube repairs in just a few minutes.

Motorists use it, not because they like to fix punctures, but because it's the easy, quick way in an emergency.

Anyone Can Do It

When you get stalled anywhere on the road with a "flat," simply clamp a Shaler Patch-&-Heat Unit over the puncture and light the prepared solid fuel it contains.

In five minutes take off the pan and throw it away. That's all there's to it. The repair is permanent because it's heat-welded (VULCANIZED) to the tube.

Get this handy little Shaler vulcanizing outfit today wherever auto supplies are sold, for only \$1.50. Slightly higher in Canada and far West.

C. A. SHALER CO., Waupun, Wis., U.S.A.

Branch
Factories:

Beeston, England
and Montreal



PLAY THIS HAUNTING "JAZZITHA" The one string Hawaiian Guitar

Have you seen the latest Jazz instrument? Everybody is talking about the curious, unusual "Jazzitha." If you hear it you will want to own one.

The simplest instrument in the world to play. Absolutely no instructions or lessons necessary. Music is written in numbers. The numbers on finger board correspond with Music numerals. "Boy"—what Music! In ten minutes you'll have everybody stepping. If you want your friends to sit up and take notice get yourself a "Jazzitha." Take it wherever you go. You're sure to have the time of your life. Be original—be the first one in your "crowd" to introduce this weird Jazzitha. Play all the latest song hits.

The Jazzitha is made of fine grained hard wood with specially designed metal sound box. Handsomely decorated and beautifully finished in lacquer—19 inches in length—played with bar and pick.

Send No Money

Just your name and address when Jazzitha and sheet music arrive, pay postman only \$1.47—plus a few cents extra for postage.

FREE—with every instrument we will include 3 extra Jazzitha strings worth 25c.
JUST OUT Book of 5 Latest Song Hits, written in numbers... 25c

THE JAZZ STUDIOS

2512 41st Ave., Dept. 125, LONG ISLAND CITY, N. Y.

\$1.47



"Independent" GOLD POINT

Lever, Self-Filler Stylopen

"Makes Writing a Pleasure"

Jumbo, \$3.50; Red, \$3.00; Black

\$2

J. C. ULLRICH & CO., 161 Washington St., N. Y. Est. 1884 Agents Wanted



Real MOVIES

—Make them yourself with

VICAM Standard MOVIE CAMERA

Camera, Tripod, Projector and 2 Magazines Complete outfit for taking and showing standard size pictures. Equal to biggest cameras. Loads in daylight. Projects on wall or sheet.

\$37

Send 10c in Stamps for illustrated BOOKLET

VICAM PHOTO APPLIANCE CORPORATION

1224 Belmont Avenue, PHILADELPHIA

AGENTS \$65.00 and FREE SUIT a Week

Write Today
Outfit FREE

No question about it, any man can easily earn \$65 a week just showing our wonderful outfit and taking orders for our high-grade tailoring—lower prices—better clothes—bigger cash profits.

SUIT FREE—SEND NO MONEY

To introduce unbeatable values, classy styles and perfect tailoring, we make this introductory free suit offer for taking a few orders—something different, better, bigger, more liberal than any offer ever made.

Handsome complete outfit of 2001 arge real cloth samples—everything furnished. Just drop us a line today for free suit and sample outfit offer.

SPENCER MEAD COMPANY
Wholesale Tailors Dept. W-516

CHICAGO





Going to Rain to-morrow? Consult a

Tycos Stormoguide

If your Dealer cannot supply You, write
Taylor Instrument Companies
 ROCHESTER N.Y.
 Canadian Plant, Tycos Bldg. Toronto
 There's a Tycos or Taylor Thermometer for Every Purpose

Own a CORONA

The portable typewriter built like an office machine. Has four-row keyboard and big-machine features throughout. Write to

Corona Typewriter Co., Inc.,
 108 Main Street, Groton, New York



Beautiful HOUSES \$900 and BUNGALOWS

CAN BE BUILT FOR AND UP

This and many others in my new book, Building Plans for Modern Homes, will save you hundreds of dollars. One of the most complete and comprehensive books of plans ever published by any architect. New edition just off the press. Nearly 600 floor plans and photographs of Colonial houses, bungalows, etc., costing from \$200 up; gives sizes and cost to build. Sent postpaid for \$3.00.



FREDERICK H. GOWING
 ARCHITECT
 101 Tremont St., BOSTON, MASS.



Only 3 1/4 in. long!

THIS CLEAR, POWERFUL 6 POWER VEST POCKET TELESCOPE
 with glove leather case \$2

Easily slips in vest pocket, powerful, precise, adjustable to either eye, 6 full magnifications bring distant objects close in full detail. Thorough satisfaction or money back.

BOSTON SPORTING GOODS CO. Dept. P., 80 Boylston St. BOSTON, MASS.

This Year—make it a Real Vacation!

Thrilling, foaming speed with the Super Elto outboard motor! Instantly attached to any rowboat. Easily portable. World famous for easy starting. Multiplies the pleasures of fishing, racing, vacationing. Write today for new catalog—beautifully illustrated—intensely interesting.

Elto Outboard Motor Co.
 Ole Evinrude, Pres.
 Dept. ad, Mfrs. Home Bldg.
 Milwaukee, Wis.

The Super Elto

"Starts With a Quarter Turn"



Keds—I win!

Trademark Reg. U. S. Pat. Off.

IN the rough and tumble contests at school — quick, sure footing most often decides the winner. That's when you want Keds!

Keds soles are tough, full of life and spring — give a sure grip. The uppers are made of canvas that is light, yet strong enough to support the ankles. There's a special Feltex innersole to keep your feet always cool. And Keds fit snugly.

That's why nearly all the great athletes wear Keds in their championship games. And that's why millions of boys all over the country wear Keds to school as well as all summer long for hiking, camping, and games of all sorts.

Keds come in all popular styles, at prices from \$1.25 to \$4.50. Your dealer either has genuine Keds or can get them for you.

Our 1926 Keds Hand-book of Sports sent free if you address Dept. 1670, 1790 Broadway, New York City.

United States Rubber Company

They are not Keds unless the name Keds is on the shoe

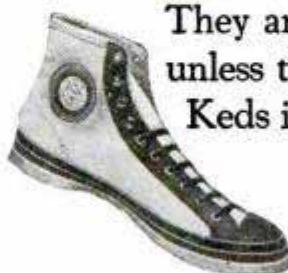

"CONQUEST"
 A Keds model made in white with black trim or brown with gray trim, both with vulcanized creperubber soles

"SPORTSTER"
 A sturdy athletic-trim Keds model. Comes in white with black trim or brown with gray trim—gray corrugated soles



Please Mention Popular Mechanics

FINEST QUALITY GENUINE DIAMONDS

CASH OR CREDIT
SATISFACTION GUARANTEED OR MONEY REFUNDED

Our values are unexcelled—prove it for yourself by investigation and comparison. Blue-white Diamonds of dazzling brilliance and colorful fire, in latest style ring mountings. Priced especially low for quick selling—order now!
Every ring sent in handsome gift box.

No. 841 \$143.75 per wk. \$3.25 per week
No. 27 \$97.50 per wk. \$2.50 per week
No. 831 \$97.50 per wk. \$2.50 per week
No. 28 \$37.50 per wk. \$1.00 per week
No. 12 \$48.75 per wk. \$1.25 per week

Send for Free Catalog

Write now for our big Diamond Book—absolutely free! Fully illustrates Diamonds, Watches, Silverware, Toilet Sets and Gift Novelties.

All goods delivered on payment of one-tenth purchase price. Balance weekly, semi-monthly, or monthly as convenient.

WEDDING RINGS

No. 824—The "Elite" 18-K white gold, \$7.50, Set with 3 Diamonds, \$22.50; 5 Diamonds, \$32.50; 7 Diamonds, \$42.50; 9 Diamonds, \$52.50; 12 Diamonds, \$67.50. All Platinum, \$25 up. With 3 Diamonds, \$50; 5 Diamonds, \$70; 7 Diamonds, \$80; 9 Diamonds, \$100; surrounded by Diamonds, \$200.



WRIST WATCH No. 839 14-K white gold band engraved case, Fancy wing ends, Silver dial, High grade 15-Jewel movement, \$25. \$2.50 down and \$1.00 a week.

Railroad Watches—Guaranteed to Pass Inspection

HAMILTON No. 992. 21 Jewels, Adjusted to 5 Positions. Gold filled 26-Year Case. \$55
ELGIN'S LATEST RAYMOND. 21 Jewels, 8 Adjustments. Runs 40 hours one winding. Gold filled 20-Year Case. \$55
ILLINOIS "BUNN SPECIAL." 21 Jewels, Adjusted to 6 Positions. Gold filled 25-Year Case. \$50
HOWARD RAILROAD WATCH. 21 Jewels, 8 Adjustments, 20-Year Gold filled Case. \$80



LOFTIS The National BROS. & CO. EST'D 1858 Jewelers DEPT. D-894

108 N. State Street, Chicago, Ill. Stores in Leading Cities

17-Jewel ELGIN No. 15 Green gold, Elgin Watch; 25-year quality case; 12 size; gift dial; \$30. \$3 down \$1 a week

FISHERMEN

You don't need to worry about carrying a cumbersome minnow pail on your fishing trip; just pack the new patented WALLACE minnow bucket cover in your kit, borrow a pail, snap on the cover and you have a minnow pail that will keep minnows alive longer than any other bucket on the market. Will last a lifetime.

Sent postpaid for \$1 if your dealer cannot supply. Money cheerfully refunded if you are not satisfied. Send today to:
Wallace Specialty Mfr's. P. O. Box 367, ALGONAC, MICH.

RAISE BELGIAN HARES

NEW ZEALAND REDS—Chinchillas—Flemish Giants
MAKE BIG MONEY—We supply stock and pay you following prices for all you raise: Belgian Hares \$2 each—New Zealand \$3 each—Chinchillas \$4 each—Flemish Giants \$5 each. 32-page illustrated book, catalog and contract, also copy of *Fur Farming* magazine, tells how to raise skunk, mink, fox, etc., for big profits, all for 10c. Address
OUTDOOR ENTERPRISE CO., Box 25, Holmes Park, Mo.

PIMPLES

Cleared up—often in 24 hours. To prove you can be rid of Pimples, Blackheads, Acne Eruptions on the face or body, Barber's Itch, Eczema, Enlarged Pores, Oily or Shiny Skin, simply send me your name and address today—no cost—no obligation. **CLEAR-TONE** tried and tested in over 100,000 cases—used like toilet water—is simply magical in prompt results. You can repay the favor by telling your friends; if not, the loss is mine. **WRITE TODAY.**
E. S. GIVENS, 429 Chemical Bldg., Kansas City, Mo.

You can play

TOM BROWN
World's Finest Saxophone Comedian in Vaudeville

this easy fingering Buescher Saxophone. Most wonderful music. 3 lessons given on request with each new Buescher True-Tone. Teach yourself. Many play scales right off—easy tunes first week. You can.

Easy to Play, Easy to Pay

Try any Buescher instrument for 6 days. Satisfaction or no sale. Easy terms arranged. Send postal for catalog and details of trial and payment plans. Mention instrument preferred. No obligation. Send today.

BUESCHER BAND INSTRUMENT CO.
1729 Buescher Block Elkhart, Indiana

AGENTS 500% PROFIT

GENUINE GOLD LEAF LETTERS

guaranteed to never tarnish. Anyone can put them on stores and office windows. Enormous demand, large profits. Paul Clark says: Smallest day \$28.70. R. L. Reel made \$920 in two months. Write today for free sample and liberal offer to general agents.
METALLIC LETTER CO., 433-B N. Clark St., CHICAGO

Do Your PRINTING

Cards, stationery, circulars, tag, labels, paper. Complete Outfits, \$8.85 up, Job Presses \$11 up, Rotary \$149. Card Cutters, \$3. Save money. Print for others, big profits. All easy rules sent. Write for catalog presses, type, paper cards, ink etc. **THE KELSEY CO.,** P-37, Meriden, Conn.

KRAG CARBINE STYLE

The famous all-around rifle suitable for hunting or target practice. Serviceable condition. Shipping weight 12 lbs. **Price F.O.B. \$15**

Krag Rifles \$12.50 Krag Sporting Rifles \$14.00
Krag Bayonets — 40c ea., Postage extra, (2½ lbs.)

Catalog Free on Request Army—Navy—and Sporting Goods
W. STOKES KIRK, 1627 P.M. North 10th St., Phila., Pa.

Earn \$100 a Week Profits in Advance

Sell Gibson extra fine men's made-to-order all-wool suits at \$31.50, direct to wearer. Regular \$55 values. **Biggest commissions paid in advance.** We deliver and collect. 6 x 9 cloth samples (over 100 styles—all one price) and complete outfit in handsome carrying case, furnished to ambitious men who are willing to hustle and earn \$100 weekly. Write today.
W. Z. GIBSON, Inc., 161 W. Harrison St., Dept. W-516, Chicago

\$351⁰⁰ CLEARED ~ IN ONE DAY

So writes W. H. Adams of Ohio in August 1925. V. A. Marini of California reports \$11275 sales in three months. Jacob Gordon of New Jersey \$4000 profits in two months." Alexander of Pennsylvania "\$3000 profits in four months." Ira Shook \$365 sales in one day. Bram bought one outfit April 5 and 7 more by August 28. Iwata, bought one outfit and 10 more within a year. Mrs. Lane of Pittsburg says "sold 8090 packages in one day. J. R. Bert says "only thing I ever bought that equaled advertisement." John Culp says:

"Everything going lovely. Crispette wrappers scattered all over town. It's good old world after all." Kellog, \$700 ahead end of second week.



WE START YOU IN BUSINESS

Furnish secret formulas, raw material, and equipment. Little capital required; no experience needed.

Build a Business of Your Own

No limit to the sale of Crispettes. Everybody likes them. It's a delicious food confection. Write for facts about a business that will make you independent. Start now, in your own town.

Profits \$1000 a Month Easily Possible

Send postal for illustrated book of facts. It contains enthusiastic letters from others—shows their places of business, tells how and when to start, and all information needed. Free. Write now!

LONG-EAKINS COMPANY

928 High Street

Springfield, Ohio

FREE FOR TEN DAYS TRIAL

Special Reduced Prices

Real Bargains. All standard makes—Young Process re-manufactured, like new—good as new—without a flaw. Guaranteed 5 years—no money down—easy terms. Extra for beginners

Complete Course in FREE

tough typewriting

Write for illustrated catalog, free trial offer, low reduced prices now.

Young Typewriter Co., 654 W. Randolph St., Dept. 1109, Chicago



Big Saving

MEN \$75 Every Week

I Show You How Send For Samples

Yes, hundreds make more. But no wonder Fashion Wear Shirts take prospects "off their feet" when you tell them the amazing low prices for these fashionable, smart shirts. You can earn \$10 to \$15 every day just calling at factories, offices, garages, etc.

Every Man Wants These Shirts At 3 for \$4.95

Big profits for you. Satisfaction guaranteed or money back quick. You don't need experience. Samples sent absolutely free. Just send name on postcard. Make \$10 to \$15 the day samples arrive. But you must act quick on this unusual offer. Address Charles Hope,

FASHION WEAR SHIRT COMPANY

1200-20 Jackson Street, Dept. L-352, Cincinnati, Ohio

Magic

Learned Easily At Home

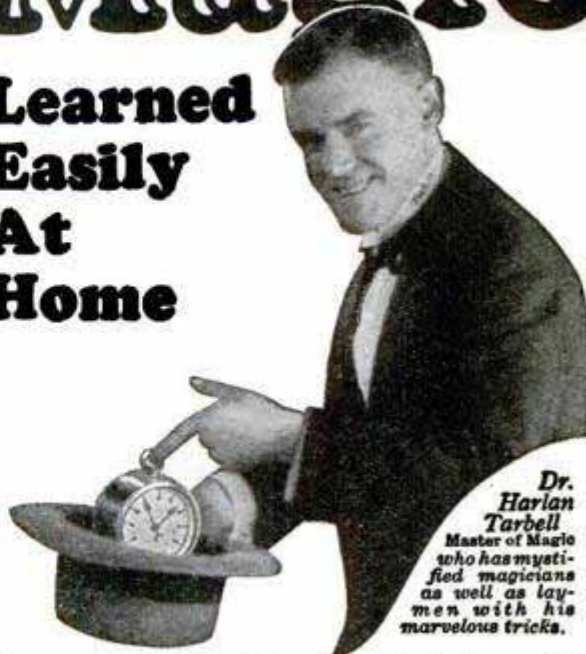

Dr. Harlan Tarbell
Master of Magic
who has mystified magicians as well as laymen with his marvelous tricks.

Astonish Your Friends

Gain that magnetic popularity that makes you the center of any crowd. Business and social success is assured the man who can perform mystifying tricks. You can earn big money either on the side or as a professional, as well as being the most popular person in your crowd. Why envy others' skill? You can learn Magic yourself, quick and easy.

Earn \$250 to \$1000 a Month

Even sleight-of-hand, generally supposed to require long practice, is NOW made simple to learn. For Dr. Harlan Tarbell, one of the really Great Magicians, has finally opened up the secrets of his profession in a completely illustrated course offered at a merely nominal cost. Through the wonderful Tarbell System you will be able to mystify and entertain your friends with simple tricks taught in your very first lesson. After that Dr. Harlan Tarbell takes you through the entire maze of sleight-of-hand, card tricks and elaborate stage diversions. The apparently superhuman doings of the accomplished magician become as simple as ABC when you just know how.

Mail Coupon for Special Offer

There is a tremendous demand for magic entertainment. Clubs, Lodges, Charity and Social affairs—all will pay high fees to the man who knows Magic. Dr. Harlan Tarbell really gets as high as \$250 for an half hours work right now. Opportunity everywhere to make money aside from your regular occupation. Salesmen find it a tremendous asset. Find out all about this unprecedented opportunity to learn Magic. The coupon brings full details without any obligation. Mail it TODAY.

Tarbell System, Inc.

1926 Sunnyside Ave., Studio 13-56 Chicago

Tarbell System, Inc.

1926 Sunnyside Ave., Studio 13-56 Chicago

Tell me all about Dr. Tarbell's new and simple system by which I can learn the secrets of MAGIC. No obligation on my part.

Name.....

Address.....

It will pay you to look into this heating outfit



Convenient canvas roll case

GARAGE men everywhere tell us that the Prest-O-Lite 5-in-1 Heating Outfit is one of the greatest time and money savers in their shops. And one of the tools most frequently in use.

It produces instant, intense heat, anywhere. Carry it right to the job, turn on the gas and there's exactly the right heat for every job of soldering, brazing, melting or fusing.

The outfit is complete with four torch heads, handy soldering iron that stays hot until the job is done, rubber hose and wrench. Nothing complicated about it.

It operates on Prest-O-Lite Gas in convenient tanks. You merely exchange an empty tank for a full one at any one of the thousands of Prest-O-Lite Service Stations located all over the country. You pay a small amount for the gas only.

Ask about this equipment at any Prest-O-Lite Service Station or write us direct for detailed information. The price is only \$7.50 complete.

THE PREST-O-LITE CO., INC.

INDIANAPOLIS, IND. Dept. L-9

New York San Francisco

In Canada: Prest-O-Lite Company of Canada, Ltd.
Toronto, Ontario

\$7.50

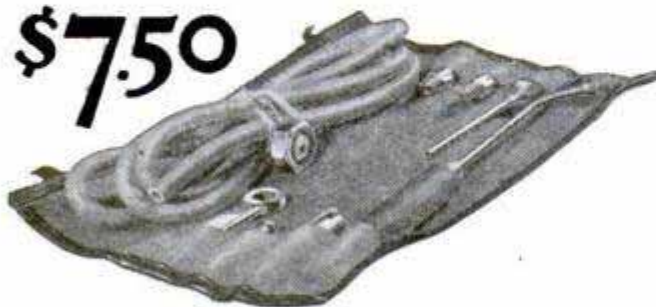

Prest-O-Lite Gas

"The gas of a thousand uses"

EDWARDS WILL SAVE YOU MONEY ON METAL ROOFS

We own our own steel mills, roll our own sheets, make them into high-grade REO METAL SHINGLES, Sidings, Ceilings and Roofings of every type and style for every kind of building. We control every operation from the raw material to the finished roof and we sell direct from our factories to the user. Not a dollar to divide with anybody but the customer! You get better value for less money.

OUTLAST THREE ORDINARY ROOFS

EDWARDS METAL ROOFS are weather-proof, lightning-proof, fire-proof! The galvanizing bends with the metal. No tools required.



LOW-COST ALL-METAL GARAGES

Any size. Any style. Portable. Ready to erect. Complete with frames, doors, sash and hardware. Ornamental, durable, economical. Blue-prints and complete instructions FREE. Write today. Get our low prices and Free Samples. Ask for Roofing Book No. 150 or for Garage Book No. 150

THE EDWARDS MFG. CO.
900-950 Butler St. Cincinnati, O.



Tire AGENTS WANTED

Use and Introduce MELLINGER CORD TIRES

15,000 MILES GUARANTEED

Lowest Wholesale Prices in America. Shipped prepaid on approval. Make big money all or part time. No capital or experience. Sample sections furnished.

YOUR TIRES FREE! Simply send name today for valuable FREE BOOK; tells how thousands have gone into big business. SPECIAL AGENTS' OFFER. Wholesale Prices and FREE SAMPLE KIT. Write nearest address.

MELLINGER TIRE & RUBBER CO.
Dept. 415, Kansas City, Mo. Dept. 415, Philadelphia, Pa.
Dept. 415, Oakland, Calif. WRITE NEAREST OFFICE



Fits Hand Like a Glove

AGENTS' AUTOIST WILL BUY

AUTOMITTEN DUSTER

Chemically treated yarn MITTEN DUSTER, for auto and home use. Dusts, Cleans and Polishes. Agents are Cleaning Up Big. Costs you 25c each, less in gross lots, sells for 75c. Sample and Selling instructions 25c Postpaid. Send for Free Details and Sample Case Offer.

NATIONAL FIBRE BROOM CO., St. Louis, Mo.

You and This New Machine Can Earn \$500 a Month



Operate a Tire Repair Shop 70,000,000 Tires in use. America's greatest opportunity for men with small capital. We furnish everything—\$100 and up. Easy payments. We train you FREE right at home. Start making money at once. Write today for Free Book of Opportunity.

Haywood Tire Equipment Co. 1344 S. Oakley, Chicago

FREE Kalamazoo Book of Factory Prices

NOW READY

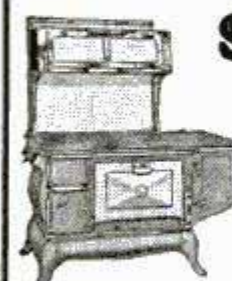

Save 1/3 to 1/2

New FREE book quotes **Reduced Factory Prices**. Introduces sensational **5-Year Guaranteed Bond** on Stoves, Ranges, Furnaces. 200 styles and sizes. Beautiful porcelain ranges and combination gas and coal ranges in soft grey and delft blue. Mahogany porcelain enamel heating stoves. Cash or easy terms—as low as \$3 down, \$3 monthly. 24 hour shipments. 30 day **free** trial. 360 day approval test. Satisfaction guaranteed. 26 years in business, 600,000 customers. Write today for your copy of this FREE book.

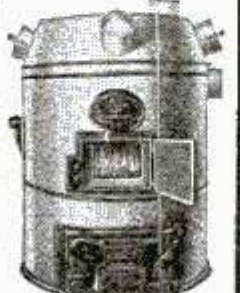

Ranges \$37⁷⁵ up

Pipe or Pipeless Furnaces \$59⁹⁵ up

KALAMAZOO STOVE CO., Mfrs.
391 Rochester Ave.
KALAMAZOO MICH.

"A Kalamazoo Direct to You"
Trade Mark Registered

SEND FOR THE INTERNATIONAL CATALOG



Our net price list. Full line of auto bodies and accessories for Fords at Wholesale Prices. Save big money on bodies by buying Direct from Factory.

FOR FORD—Prices from \$27.85 up. Factory to consumer direct—Pay Only One Profit.
International Body Works, 914 W. Ohio Street, Dept. 7, Chicago, Illinois

INSTANT WELD RUBBER INSTANTLY

Make \$200. to \$500.00 Per Month

A New Scientific Principle without heat or cement. Instantly repairs punctures or blow-outs. Better—Quicker—Easier than vulcanizing. **ONCE ON—ALWAYS ON.** Every auto owner is a prospect. Repeat orders sure. Big profits. Appoint sub-agents.



Write for Free Sample Today.
TOURISTS PRIDE MANUFACTURING CO.
Desk 50-1 MINNEAPOLIS, MINN.

STOP FORD CRANKSHAFT END-PLAY!

C-A ADJUSTABLE BEARING corrects and prevents end-play without removing motor. Eliminates many troubles. Easy to install—simply drop pan. Only \$3.75. Ask your dealer or sent prepaid by **ADJUSTABLE BEARING CO.** Dept. P **BRAZIL, IND.**

MOTORCYCLES

LESS THAN HALF COST
Ace, Indian, Cleveland, Harley-Davidson, Henderson Motorcycles and Sidecars, new, used and rebuilt. **Rider Agents Wanted.** Write for **FREE** trial offer, agent's free outfit and big bargain bulletin. **New American Bicycles** in different styles and colors. Write for illustrated catalog giving our money saving prices.
AMERICAN MOTOR CYCLE CO.
2047 W. Chicago Ave., Dept. 935, Chicago

Every Handy Man needs SMOOTH-ON NO. 1



SMOOTH-ON No. 1 hardens like iron and expands in doing so to make cracked, open or loose parts everlastingly tight.

Don't pay any professional fixer a big price to make such repairs. With Smooth-On No. 1, you yourself can do a perfect job for a few cents and usually in a few minutes.

Get the Smooth-On habit and you will quickly find that it keeps many dollars in your own pocket. Try it on the following and see for yourself:

In the Home

Stopping leaks in steam, water, gas, oil or stove pipes, mending cracks, breaks or leaks in furnaces and boilers, radiators, tanks, sinks, pots and pails, making loose handles tight on umbrellas, knives, hammers, brushes, drawers, etc., tightening loose screws, hooks, locks, door knobs, etc.



On the Automobile

Making bursted water jackets and pumps good as new, stopping leaks in radiator, hose connections, gas tank and gas, oil and exhaust lines, making a fume-proof joint between exhaust pipe and tonneau heater, tightening loose headlight posts, keeping grease cups, hub caps and nuts from loosening and falling off, etc.

To get perfect results, write to us for and use the Smooth-On Repair Book. Free if you return the coupon.

Write for **FREE BOOK**

Get Smooth-On No. 1 in 7-oz., 1-lb. or 5-lb. cans at any hardware store, or if you want us to send sample 7-oz. can, enclose 35 cents in stamps when returning coupon



SMOOTH-ON MFG. CO.
Dept. 37, 574 Communipaw Ave.
JERSEY CITY, N. J.

Do it with SMOOTH-ON

SMOOTH-ON MFG. CO., Dept. 37,
574 Communipaw Ave., Jersey City, N. J.

Please send the free Smooth-On Repair Book.

Name.....

Address.....

A FULL YEAR TO PAY *Charge it!*

Wear While Paying

PA3— Lady's wrist watch latest style solid 14 Kt. gold, highest grade 17 ruby and sapphire jewel movement, life-time guarantee. Featured at **\$22**

PA4— Fiery blue white diamond—best quality 18 Kt. white gold—artistically carved, hand pierced, lady's mounting. Featured at **\$49.50**

PA7— Three large perfectly matched genuine blue white diamonds, two French blue sapphires, 18Kt. white gold dinner ring, exquisite design. Price **\$42.50**

PA5— Three perfectly matched blue white diamonds set in a beautifully hand pierced mounting—18Kt. white gold—latest creation. Featured at **\$36.75**

ROYAL DIAMOND & WATCH CO.
ESTABLISHED 1895
ADDRESS DEPT. 1650 170 BROADWAY, N.Y.

AGENTS \$75⁰⁰A Week SURE

Make \$75 a week and liberal bonus selling famous Pioneer tailored-to-measure, all-wool suits at \$23.50. Striking leather brief case containing nearly 100 large swatch samples furnished—other equally remarkable values at \$29.50 and \$34.50. We train the inexperienced. Men with determination and willingness to work for success, write for this big money-making opportunity.

PIONEER TAILORING CO.
159 W. Harrison St., Dept. W-1118 Chicago



MOTORCYCLES

RELIABLE STANDARD MAKES that you can **DEPEND** on. Enjoy the glorious experience of going wherever you like—when-ever you like. The price is within your means—25% to 50% less than others. These machines are slightly used, thoroughly overhauled or rebuilt. Send for catalogue.

MYEROW BROS.,
15 Berkeley St. Boston, Mass.



SHAW MOTOR ATTACHMENT
MAKES YOUR BIKE A MOTORCYCLE!

A high grade 2 1/2 H. P. motor attachment quickly clamped on any bike frame. Speed 4 to 40 miles an hour. 90 to 125 miles per gallon of gas. **Special Low Price Now!** Write today for Complete Description and Special Low Prices on SHAW Motor Attachments and the SHAW Complete Motorbicycle.

SHAW MANUFACTURING COMPANY
Dept. 37
Galesburg, Kansas



Delivered to You Free

for 30 days trial on approval. You can have your choice of **44 Styles**, colors and sizes of the famous **RANGER** Bicycles. **Express prepaid. Factory-to-Rider** Prices save you \$10 to \$25 on your bicycle.

\$5 a Month if desired. Many boys and girls easily save the small monthly payments. Parents often advance first payment.

best quality, at factory prices, **express prepaid.** Lamps, wheels and equipment, low prices. **Send No Money, do business direct with makers.**

Mead CYCLE COMPANY
DEPT. 109 CHICAGO

Write today for free Ranger Catalogue, factory prices and marvelous easy payment terms.



When it's 23 Below Zero

The EVERBRITE
Radiant Oil Heater

will keep you comfortable. Mrs. Senften, Nebr., writes: "Last Sunday it was 23 below zero but The Everbrite kept us warm and burned 2 1/2 hours on one filling."

Every home, store, church, can now have all the advantages of natural gas heat at a cost of 1 cent an hour. Burns 8 to 10 hours on gallon of Coal Oil. Cheaper—cleaner—more comfortable than coal or wood fire. No wick—no smoke—no odor. Will heat the whole house in coldest weather. May be moved from room to room. Simple; turns up and down—off and on like city gas. Absolutely safe. Thousands in Happy Homes everywhere. Built of steel and nickel—weighs 44 lbs.—height 22 inches. Simply send name today for circular. full details how it works and amazing free home test offer.

EVERBRITE STOVE CO. 1212 Gateway Station, Kansas City, Mo.

\$1465.50 earned one month by Agent Resing, of Texas, \$200 a week by Agent Meeks, of Mississippi. If interested in Agency write today. Good territory open. Big Money.

Your OWN GROCERY STORE

WITHOUT CAPITAL
I'll Start You NOW.
Represent **E. C. Harley** Company, 34 years leading distributor of purity products. Take orders and deliver. You need no investment. Earn \$50 to \$150 a week. Write for **FREE** portfolio. **E. C. Harley, President, E. C. HARLEY CO.,** K-392, Harley Bldg., Dayton, O.

\$100 to \$125 PROFITS WEEKLY

New line of quality toilet goods sells like wildfire. No experience required. All you do is take orders from this beautiful sample case. Finest perfumes, soaps, facial creams, bath salts, face powders—wonderful products at prices that appeal to all women. Just send name and address for **FREE CATALOGUE.**

NATIONAL SOAP & PERFUME CO.
512 W. Huron St. Dept. A-9 CHICAGO



"Best Pen I Ever Had—and costs less!"

That's what users of the Postal say. New filling method—easiest ever devised. Holds 4 times usual amount of ink. Transparent (always know how much ink you've got!). Unbreakable. Only \$2.50! Sent C. O. D. Order now and try it! Money back if you don't like it.

Postal Pen Co., Inc., Dept. P. M. 9, 25 W. 43rd St., New York City

MAKE YOUR Ford INTO THIS Sport Car—Save \$50 to \$150 with Red-i-Kut Life-Size Patterns \$5⁰⁰

Famous sure-fit **RED-I-KUT** life-size patterns and picture instructions show how you can easily convert your Ford into this **Fast, Snappy, Sport Car** as thousands have done, with easily obtained materials. No need to lay up the car. Rear seat folds, making 4-passenger car. Look at **Willard Eno's**.

Eno says: "It took me 3 Sundays to build it and I sure am proud to hear them say, 'He built that snappy sport car.' I never cut any steel or did any wood-work before, but one can't go wrong with **Kumpel** patterns." **St. Louis, Mo.**

The **Lark** life-size patterns for each part of the body so you can't go wrong. picture instructions and **CONICAL DISK WHEEL PATTERNS.** Only \$5.00 delivered. 34 extra brings patterns for **Jiffy Top** and **Gesum** windshield. **RKO Steel** for **Lark 310** complete. Extreme West \$13. Order now while we can make a good delivery, and really enjoy the wonderful spring days in your **Lark, Kean, Classy, Up-to-the-minute.** You can build it. Over 11,000 in use. Don't hesitate. "Bring Lo!" Underling frame, no frame cutting kind, \$5.99. Only \$4.99 when ordered with **Lark** patterns. Send 10c coin for actual body photo and new manual of other distinctive sport body patterns from \$5.00 up—"RKO Steel" **"Spring-La"** Irens, Tenz and **Windshields.** **ORDER RIGHT NOW.**

KUMPEL CO., 76 Kumpel Bldg., Guttenberg, Iowa

Easy-to-Understand Instructions

The "Lark" Class—Snap

38-inch Easy Riding Seat



\$5 DOWN Buys Any WITTE STATIONARY ENGINE

FROM 1½ TO 7 HORSE POWER

The One Profit Engine

NO INTEREST CHARGES

NOW, more than ever, the need for economical, dependable power is felt by the producer who is faced with ever-increasing labor costs. WITTE Throttling Governor ENGINES answer this important question perfectly—now an economical, dependable power plant is within the reach of everyone.

To-day the WITTE ENGINE sells at the lowest price in history. Into this WITTE has gone the ripe experience of more than 42 years of engine building—over 150,000 users all over the world have placed upon it their stamp of approval. You, too, can put a WITTE on your place, secure in the knowledge that it represents the Standard of Power.

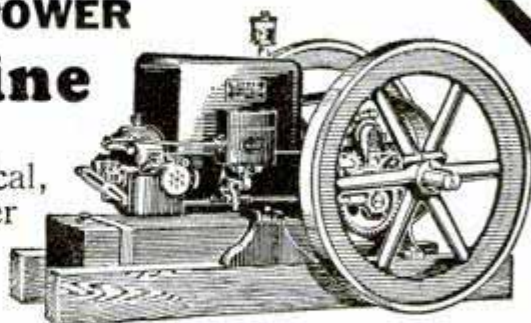

The Most Modern Engine

The Witte Throttling Governor

the original and leader of the throttling-governor type. An even, steady speed with a big surplus of power for the heavy loads.

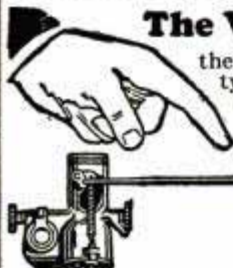

The minimum in fuel consumption—the WITTE ENGINE burns kerosene, gasoline, gas-oil, distillate or gas at a

fuel cost of less than 2c an hour per H. P. Simple, trouble-proof and guaranteed for a life-time of hard work. Completely equipped with WICO Magneto, speed and power regulator and throttling governor, square, protected tank and die-cast removable bearings.

WITTE ENGINE WORKS

(FOUNDED IN 1870)

1747 Witte Bldg., Kansas City, Mo.

1747 Empire Bldg., Pittsburg, Pa.

1747 Witte Bldg., San Francisco, Cal.

Quick shipments also made from nearest of these warehouses: Minneapolis, Minn.; Atlanta, Ga.; Trenton, N. J.; Richmond, Va.; Tampa, Fla.; New Orleans, La.; Dallas, Tex.; Laredo, Tex.; Denver, Colo.; Billings, Mont.; New York, N. Y.; Albany, N. Y.; Bangor, Me.; Portland, Ore., and Los Angeles, Calif.

The WICO Magneto

—the most perfect system of high tension ignition known. Makes starting easy, even at 40 below zero.



Sure performance in any climate or temperature. Not affected by rain, hail, snow or sleet. The perfect replacement for old style battery-equipped engine.



Makes All Jobs Easy and Cheap

No need to do the hard, back-breaking work—no need to pay high prices for poor labor—you can show \$1,000 more profit every year you have a WITTE working on your place. Investigate now!

All sizes 1½ to 30 H.P. Easy Terms. Scrap the Old One—Pay a Little of It Down on the New WITTE.

Ask for FREE Catalogue

Our Big FREE Catalogue or if interested, ask about Log and Tree Saws, 3 in 1 Saw Rigs, or Pump Outfits.

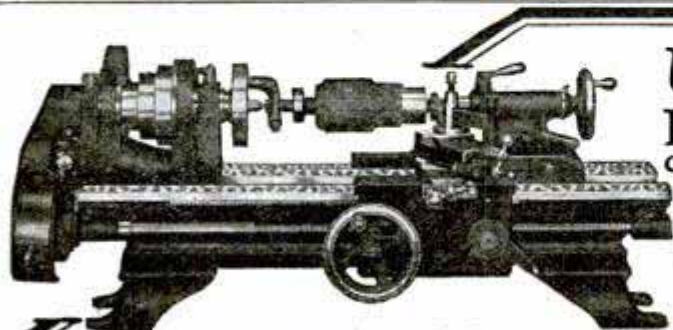

The 9-Inch South Bend Junior

A Practical Back Geared Screw Cutting Bench Lathe

Shipping weight, 350 lbs.; distance between centers, 18 ins.; width of cone belt, 1 in.; length of bed, 3 ft.; power required, ¼ H. P.

SOUTH BEND LATHE WORKS, 813 East Madison Street, South Bend, Indiana

Unusual Value In 9-Inch LATHE

\$150

Complete with Countershaft and Equipment

Here is a Back Geared Screw Cutting Bench Lathe that will meet practically every need in your shop. It is a quality Lathe throughout. In fact, the Compound Rest, Back Gearing, Lead Screw, Head Stock and Tail Stock are exactly the same in design, quality and workmanship as on our finest

SOUTH BEND LATHES

With this one tool you can turn Commutators, undercut Mics, make bronze Bushings, reface Valves, finish semi-machined or oversize Pistons, cut Threads, do turning, boring, drilling, polishing, filing and hundreds of other jobs. Why not put in the one tool that does all? Write for Folder No. 22-J on the South Bend 9-inch Junior Special. Easy Payments if Desired.

GOOD TOOLS STOP WASTE

SIMONDS CIRCULAR SAWS

BY specifying SIMONDS, in buying tools, you are assured of speedy, economical production and the finest cutting quality—quality born of Simonds near-century of experience in making tempered steel cutting edges. Whatever YOUR cutting problem may be, put it up to Simonds. Ask your supply house or dealer, or write direct.

SIMONDS SAW AND STEEL COMPANY
 "The Saw Makers" Fitchburg, Mass. Established 1832
 Branch Stores and Service Shops in Principal Cities

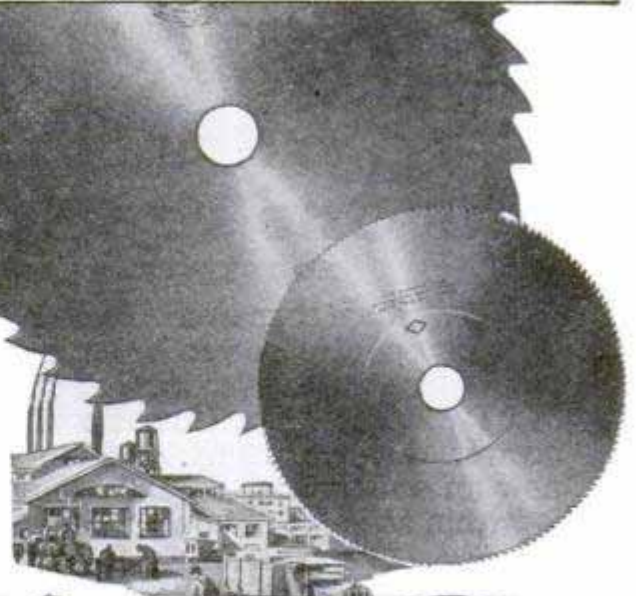

SIMONDS

Pronounced SI-MONDS
 SAWS FILES KNIVES STEEL

DISCO Automatic Screw-Gripping
Screw Driver

Holds screws rigid for insertion or withdrawal—A REAL Tool—Not a toy!

Fits any round, flat or hex head screw, from 9-32" to 3-8" head. Is also used as socket wrench for hex head nuts, on electrical or radio work.

Order NOW and pay postman \$1.50 only, on receipt \$1.50 Post-paid

AGENTS WANTED EVERYWHERE

Agent's Demonstration sample \$1—Send Money Order.
 DIVERSIFIED SALES CO., 577 Jackson Ave., Jersey City, N. J.

Makes Old Ford a Tractor

We furnish everything for converting Ford Auto Chassis with Engine into a handy Farm Tractor. Just right for truck growers, small farms, nurseries, etc. Pulls 16' Plow, Discs, Seeds, Cultivates; Runs Belt Machinery. We also build Garden Tractors and Cutter Bar Mower Attachments.

Handles Easily Turns in 18' Circle

Write for Free Particulars.
 SHAW MFG. CO., Dept. F, Galesburg, Kan.

Free! DISSTON SAW CHART

Gives facts about sawing and saws. Helps you do better, faster work. Write for it.

Henry Disston & Sons, Philadelphia, U. S. A.

Efficient Speed Reduction

Use IXL Speed Reducers

write for free book on your letterhead

FOOTE BROS. GEAR & MACHINE CO.
 316 N. Curtis Street CHICAGO, ILL.

Buy Now Pay Later

Let Boice Help You Build It!

Send now for 64-page catalog and learn what you can do with Boice's low-cost machines. With our easy pay plan you can equip your shop now and profit as you pay.

Boice-Crane Bench Machines

includes a complete line of circular, band and jig saws, mortisers, jointers, lathes and drills. **Handisaw** shown does ripping, mitering, grooving, sanding, drilling, moulding. Does 3/8" x 3/8" 8" Bench Lathe does turning, drilling, sanding, grinding and jig sawing in wood or soft metal. Compound slide rest furnished with metal-working model. Boice machines driven by 1/2 to 3/4 h. p. motor attached to light socket. Machines sold with or without motor.

8" Bench Lathe

W. B. & J. E. BOICE, Dept. P. M. 9-B, Toledo, Ohio

MEN *This NEW MONEY* MAKER PAYS YOU \$90 A WEEK



Hundreds making big money showing famous Hutchins tailored pants and knickers. Every man eager to buy. Sensational values. Finest materials and workmanship. Greatest bargain in years, and you collect a big commission in advance. No experience needed. You merely take orders. We deliver.

SEND NO MONEY

Just rush name and address for beautiful FREE samples. Start right out earning \$15 or \$20 a day. I'll show you how. Wonderful opportunity to build up big profit, steady business. Also get your own tailored pants or knickers free. A post card will do. Address

The HUTCHINS PANTS CO., L-19, 316 E. Fifth St., Cincinnati, Ohio

Interlox MASTER SLIDE RULE

Takes accurate inside or outside measurements

MASTER RULE MFG. CO., 813 E. 136th St., NEW YORK

Works fast. Slides in and out quickly. Durable made of brass trimmed boxwood. Any length 2 to 8 feet, 20 cents per lineal foot. If not at dealer's, send postpaid.

Dealers and Agents: request attractive proposition



A Gerstner CHEST

is the right Chest for your needs. Toolmakers and Machinists—select your Cases and Chests from our free catalog.

Gerstner Sons

433 Columbia St., DAYTON, OHIO.

CALCULATIONS

in Office, School, Store and Shop can be instantly made with the Midget Slide Rule. It gives the answer to any problem involving fractions, mixed-numbers, decimals, whole-numbers, roots, powers, Logs, and Trig. Functions. Thousands of these rules are used by Accountants, Engineers, Clerks, Students, etc. It is the most versatile calculator ever invented. If you have any figuring to do, order a Midget Slide Rule on trial. Made of aluminum with figures on white celluloid. Size 4". Price with Instruction Book \$1.50. Leather Case, 50c extra. Catalogue Free. Sent C. O. D. if desired. Your money back if you are not satisfied.

GILSON SLIDE RULE CO., Niles, Mich.

BURN YOUR NAME ON TOOLS
WITH THE
ARKOGRAF

PROTECT YOUR TOOLS FROM THEFT
Write with electricity any name or design on the hardest and finest tools and instruments, or any metal, like writing on paper with pen or pencil. Complete Outfit \$3.50—Prepaid Anywhere. Interesting illustrated circular free. Write today. Agents wanted.
ARKOGRAF PEN CO., 1171 E. Stark St., Portland, Oregon



HOW A BOY BUILT UP A GREAT SQUAB FARM



Started small in backyard when at school with no money, now has \$30,000 plant, ships to New York 150 bbls. squabs yearly, receiving \$75 to \$100 a barrel. You can do the same. Send for this book. Price is fifty cents but we will mail it to you for the names and addresses of four of your friends and your own name and address. Write today to

Plymouth Rock Squab Co., 634 A St., Melrose High., Mass.



SAY! LISTEN!

A New Pair of Pants Matched to Your Coat and Vest

Just doubles the life of your suit. We can match almost any suit. 70,000 patterns. Sample is sent for your O. K. before making. All made to measure. Send piece of cloth or vest for matching.

ACME PANTS MATCHERS
Dept. R 20 W. Jackson CHICAGO
Enclose return postage if vest is sent

PARKS

WOODWORKING MACHINES

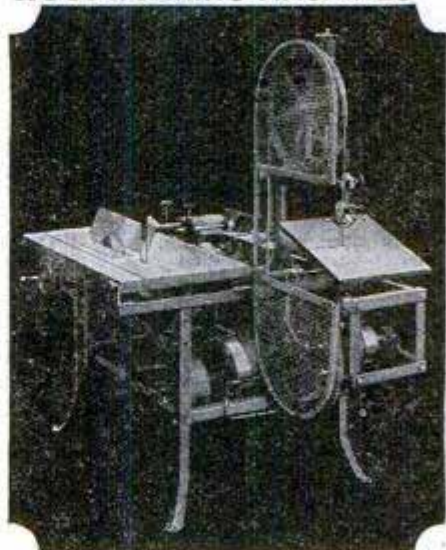

Cabinet Shop
Special

\$290

with motor

See this Parks this month!

September and October are "Parks Cabinet Shop Special months" with Parks dealers everywhere. In their showrooms this wonderfully popular woodworker will be on display and in many instances in actual operation.

Parks Cabinet Shop Special No. 10 at \$290.00 is the handiest machine Parks ever built! Big enough to turn out first-class work—small enough to fit in a small shop or basement—a real machine built for real work without freakish "stunt" designing. It makes practically any cut and includes rip and cut-off circular saw, jointer, and band saw. Lathe and shaper may be added at small extra cost. Every man who does cabinet making or woodworking of any kind wants this splendid machine. It is the biggest woodworking machinery value on the market today. Be sure to see this Parks this month

in these dealers' showrooms

ALA.: Moore, Handley & Hwde. Co., Birmingham; McGowin-Lyons Hwde. & Supply Co., Mobile; Alabama Mch. & Supply Co., Montgomery; ARK.: Ben D. Schaad Mch. Co., Little Rock; CAL.: Shaw-Palmer & Bakewell Co., Los Angeles; Harron-Rickard & McCone Co., San Francisco; COLO.: H. W. Moore Equipment Co., Denver; CONN.: Lunt, Jillson Co., Manchester; FLA.: Cameron & Barkley Co., Jacksonville; Cameron & Barkley, Miami; Cameron & Barkley Co., Tampa; GA.: R. S. Armstrong & Bro. Co., Atlanta; ILL.: Woodworkers' Tool Works, Chicago; KY.: Roy C. Wayne Supply Co., Louisville; LA.: Clark D. Shaughnessy Co., New Orleans; MASS.: Lunt, Jillson Co., Boston; MICH.: Riverside Mch. Depot, Detroit; McMullen Mch. Co., Grand Rapids; MINN.: Raymer Hwde. Co., St. Paul; MO.: Standard Tool & Supply Co., Kansas City; S. T. Hatcher & Co., St. Louis; NEB.: Diehl Mch. & Supply Co., Omaha; N. Y.: Interstate Mch. Co., Troy; Chas. E. Mapps, 178 Lafayette St., New York City; N. H.: Brackett & Shaw Co., Somersworth; N. CAR.: Amer. Hwde. & Equip. Co., Charlotte; Raleigh Iron Works Co., Raleigh; OHIO: J. C. Baker, Columbus; OKLA.: Universal Supply & Mch. Co., Tulsa; ORE.: Portland Machy. Co., Portland; PA.: K. O. Dittmars, Bourse Bldg., Philadelphia; Coblenz Tool & Supply Co., Erie; S. CAR.: Cameron & Barkley Co., Charleston; TENN.: Peglar Mch. Co., Chattanooga; Iddins Mch. Co., Knoxville; Harvill Supply Co., Nashville; Carriage & Wagon Supply Co., Memphis; TEX.: Universal Supply & Mch. Co., Amarillo; Southern Implement Supply Co., Dallas; Don A. Carpenter & Co., El Paso; Peden Iron & Steel Co., Houston; Peden Iron & Steel Co., San Antonio; UTAH: Salt Lake Hwde. Co., Salt Lake; VA.: James McGraw, Inc., Richmond; W. VA.: LaLance Equip. Co., Huntington; WIS.: Shadbolt & Boyd Co., Milwaukee; WASH.: Union Mch. & Supply Co., Seattle; FOREIGN: Sipe Mch. Agency, San Jose, Costa Rica; P. I.: Zayas, Havana, Cuba; Weir Mch. Co., Vancouver, B. C.; Morris, Black & Matheson, Ltd., Auckland, N. Z.; West India Mch. & Supply Co., San Juan, P. R.; Bournival & Co., Montreal, Can.; Engineering Supply Co. of Australia, Ltd., Brisbane, Australia.

See this Parks by all means! If you can't, then write us for circular No. 10 and the new Parks catalog.

THE PARKS BALL BEARING MACHINE CO.
1500-40 Knowlton Street CINCINNATI, OHIO
Canadian Factory: 200 Notre Dame East, Montreal, Canada



Amazing Tests

Hard to Believe

5/8" Cornwell flat chisel can be driven clear through 1 1/2" cold-rolled machinery steel without damaging blade. Plain or drift punches can be driven through steel 1 1/2 times as thick as their face. Pin punches can be driven through steel as thick as their face. Screw drivers will twist off heads of screws without injuring tool. Bearing scrapers will cut shavings off vise handles without injuring the cutting edge. Wrenches will break any other wrench when locked size for size. These tests show amazing strength of Cornwell Tools.

Cornwell Hand-Made Tools

Cornwell Tools made of finest Swedish Charcoal Process Molybdenum Steel, from our famous Cornwell secret formula. Forged, heat treated, and hardened and tempered in oil. All tools made by hand, NOT drop forged and case hardened.

MONEY-BACK GUARANTEE

If you ever saw tools as good as these, return your order and get your money back. Guaranteed superior to any tools made anywhere in the world. Any tools that do not stand amazing tests described, instantly replaced or money refunded.

FREE BOOKLET—Mail the Coupon
Get wonderful booklet, illustrating and describing tests which no other tools in the world will stand.



CORNWELL QUALITY TOOLS CO.
Dept. E, Cuyahoga Falls, Ohio

Send me illustrated booklet with prices on full line of Cornwell Secret Formula Hand-Made Tools.

..... Occupation
Name.....
Address.....
City..... State.....

\$10 to \$20 A DAY!

MEN

If you want to make \$10 to \$20 a day, write at once. We need representatives everywhere for Mason Shoes. Neither experience nor capital required. Just take orders. Many Mason Salesmen make \$100 to \$150 weekly.

Get FREE Sales Outfit

Mason Shoes for men, women and children are sold direct from factory. Amazing values. Finest leather throughout. Expert workmanship. Several exclusive features insure styles, better fit, comfort and longer wear. Prices half of what customers pay at stores. That's why orders come quickly—why Smith cleared \$60 in a day, and St. Amour made \$600 in one month. Send for FREE outfit and begin to make the same big money. Dept. A-9, 112 Mason Ave. CHIPPEWA FALLS, WISC.

MASON SHOE MFG. CO.

CRESCENT WOODWORKING MACHINERY

High in quality, moderate in price. Ask for circulars describing bench machines for the small shop.

If you are interested in the larger machines we can supply you with Band Saws, Saw Tables, Self Feed Rip Saw, Shapers, Jointers, Variety Wood Workers, Planers, Planers and Matchers, Disk Grinders, Cut Off Table, Swing Cut Off Saws, Borers, Hollow Chisel Mortisers, Tenoner, Universal Wood Workers. Ask for circulars.

The Crescent Machine Co.,
93 Columbia St., Lestonia, Ohio

MOVIES IN YOUR HOME

Practical Movie Machines in many wonderful models, some as low as \$3.75 and use same size film as big theatres. Fine films at lowest prices with a film exchange service. Many biblical films. Write for free illustrated catalog.

PARAMOUNT MFG. CO.
Dept. MB, 120 High Street, Boston, Mass.

WADE AMATEUR MECHANICS, REPAIR SHOPS, INVENTORS, STUDENTS

BENCH LATHE

A real machine tool for the home work bench—capacity 4" dia. x 12" length. For Metal—Wood—Composition Materials. Turning—Facing—Boring—Drilling—Winding—Thread Cutting. Accurate—Strong—Quiet—Compact. Slide-rest has travel entire length of bed. Leadscrew inside bed. No. 1 Lathe, plain headstock, \$28.00. No. 2 Lathe, back-gear headstock, \$58.00. Extra for lathes with 18 inches between centers, \$7.00. Complete line of accessories at equally low prices. Write for free catalog.

THE GEROLD CO., Dept. P-26, 120 Liberty St., New York

Gas Blow Torch and Solder Iron Heater

Connects to any gas jet or gas connection. No air attachment necessary. Heats solder iron in less than a minute. For home use, repair shops, laboratories, manufacturing plants, and foundries. A wonder for the mechanic's work bench.

A Blast 8" long, 1" in diameter—Intense Heat.
Postpaid \$1.00; Canada \$1.40

Tri-une Company, Dept. 802, 215 S. 15th Ave., Maywood, Ill.

MOTORCYCLES

Used and Rebuilt Indian, Harley-Davidson, Ace, Henderson and Cleveland motorcycles at a saving of 50%. Send for our latest list.

"Motorcycles shipped to all parts of the world."

WALKER-INDIAN CO., 188 Mass. Ave., BOSTON

NOW—GET MY GREATEST Log Saw Offer

Fastest Cutting

Saws 15 Cords a Day

ONLY \$39

Used by The United States Government

It's easier, now, than ever before to own this fastest-cutting, easiest-moved, most powerful Log Saw. Now, you can make big money sawing firewood, stove-bolts, ice, shingle timber, etc. WRITE TODAY FOR FULL DETAILS.

Try 30 Days **OTTAWA** **Make Big Money**—Wood selling at \$3 a cord brings owner \$45.00 a day. Go into the wood business. Don't let the lack of ready money stop you! Remember, we sell on very easy terms.

To Save You Freight—and get your machine to you a few days after you order, I ship from factory or nearest to you of NINE BRANCH HOUSES.

ONE WHOLE MONTH to use the OTTAWA at your own sawing. Every saw shipped on trial only—**Backed by 10-Year Guarantee**

FREE Send me your name and address on a postcard today for my wonderful new edition of the "Wood Sawing Encyclopedia." Be sure to investigate—it will help you to make big money.

HARRY OVERMAN, Pres., OTTAWA MFG. COMPANY
1745-L Wood St., Ottawa, Kans. 1745-L Magee Bldg., Pittsburgh, Penna.

Puts the OTTAWA Working For You!

350 Cuts a Minute! Now you have a log—in a few seconds it's all sawed up—without any hard work!

FREE Wood Sawing Encyclopedia

UNIFORM CUTTING CONSISTENCY

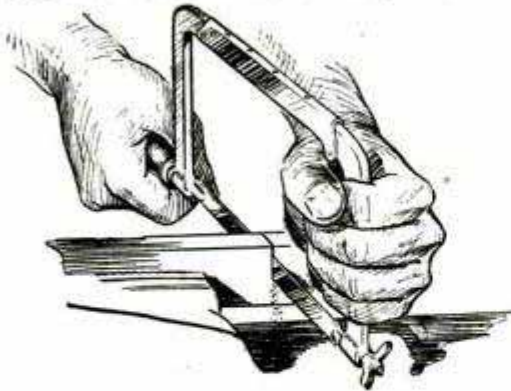

Star Hack Saw Blades

have proved their cutting qualities during the last half century and the users of these blades know they buy in each blade an even, uniform cutting consistency.

The Star Special Flexible Blade combines this cutting efficiency with the flexible qualities you have never experienced in any other blade.

Let us send you samples of this blade free
CLEMSON BROS., Inc., Middletown, N. Y.

WHAT EVERY MASON WANTS



We have Masonic books and lodge supplies for Blue Lodge, Chapter, Commandery, Scottish Rite, and Shrine.

Our Rituals Are Used the World Over
 Send for free catalog of books and rituals for Masons, Odd Fellows, Knights of Pythias, Knights of Columbus, Elks, etc.

EZRA A. COOK, Publisher, Inc.
 1350 N. Clark St., Dept. M, Chicago, Ill.



Be a Taxidermy Artist

Marvelous Book Sent FREE

You can now learn **Taxidermy**, the wonderful art of mounting birds, animals, tanning skins, etc. Learn at home, by mail. The free book tells how. Mount your own trophies. Decorate home and den. Hunters, trappers, nature lovers, you need taxidermy. Interesting, fascinating, big profits. Join our school. 55,000 students. Success guaranteed. Get our free book without delay. Send right now—today.

N. W. School of Taxidermy, 9776 Elwood Bldg., Omaha, Neb.



Big Money

Made by agents selling our wonderful Facial Soap, Perfumes, Toilet Articles, Spices, Extracts, etc. Free cake of soap and agents' terms mailed to any address.

LACASSIAN CO. Dept. 455 ST. LOUIS, MO.



If your hair won't "lie down"

keep it in place with the dressing more fellows use than any other . . .

Almost every fellow uses something to keep his hair from getting out of place.

Maybe he plasters it down with water. In that case he is robbing his hair and scalp of their natural oils, making them an easy prey to dandruff.

Or perhaps he relies on sticky preparations that leave the hair matted and greasy-looking.

But that isn't necessary today! You can start now to use the hair dressing that is relied on by more fellows than any other! This dressing is *Stacomb*.

No matter how you wear your hair, *Stacomb* will keep it in place—smooth, slightly glossy—all day long.

Yet never gummy or greasy-looking. *Stacomb* is actually beneficial, because it helps to prevent dandruff.

And whether you prefer the combing cream (in jars and tubes) or the new Liquid *Stacomb*, you will find that both forms are equally pleasant to use and either one will really keep your hair in place. At all drug and department stores.

FREE OFFER—*Stacomb*

Standard Laboratories, Inc., Dept. BB-1, 113 W. 18th Street, New York

Send me free sample of *Stacomb* as checked:
 Original, cream form New liquid form

Name.....

Address.....

Bodies of Rare Beauty for Fords

At Factory Prices!

Write for circular A-2 showing this De-Luxe Model and others.

\$22.75 AND UP



SPORT FACTORIES, Aurora, Ill.

UNBREAKABLE TWO YEAR GUARANTEED TRIO PEN

SELLS FOR \$1.25

SAMPLE 67c

Writes like a \$7 Pen

"IT'S THE POINT" →



Pens finished in beautiful green, red, black, or purple, ladies' or men's style. Money refunded if not pleased. Write for wholesale prices and selling plans. \$15 Daily easily made.

F. SPORS & CO., 355 Main St., LESUEUR CENTER, MINN.



PA INVENTORS.

**JUST
ACROSS
STREET
FROM
U. S. PAT.
OFFICE.**

At the right is a view of my drafting and specification offices where a large staff of experienced experts are in my constant employ. All drawings and specifications are prepared under my personal supervision.



PROTECT YOUR IDEAS Take the First Step Today

If you have a useful, practical, novel idea for any new article or for an improvement on an old one, you should communicate with a competent Registered Patent Attorney AT ONCE. Every year thousands of applications for patents are filed in the U. S. Patent Office. Frequently two or more applications are made for the same or substantially the same idea (even though the inventors may live in different sections of the country and be entirely unknown to one another). In such a case, the burden of proof rests upon the last application filed. Delays of even a few days in filing the application sometimes mean the loss of a patent. So lose no time. Get in touch with me at once by mailing the coupon on the opposite page.

Prompt, Careful, Efficient Service

This large, experienced organization devotes its entire time and attention to patent and trademark cases. Our offices are directly across the street from the U. S. Patent Office. We understand the technicalities of patent law. We know the rules and requirements of the Patent Office. We can proceed in the quickest, safest and best ways in preparing an application for a patent covering your idea. Our success has been built on the strength of careful, efficient, satisfactory service to inventors and trademark owners located in every state in the Union.

Clip this Coupon and Mail

PATENTS

Write for these FREE BOOKS

NO CHARGE for Information On How to Proceed!

The booklet shown here contains valuable information relating to patent procedure that every inventor should have. And with it I will also send you my "Record of Invention" form on which you can sketch your idea and establish its date before a witness. Such evidence may later prove valuable to you. Simply mail the coupon and I will send you the booklet, and the "Record of Invention" form, together with detailed information on how to proceed and the costs involved. Do this NOW. No need to lose a minute's time. The coupon will bring you complete information entirely without charge or obligation.

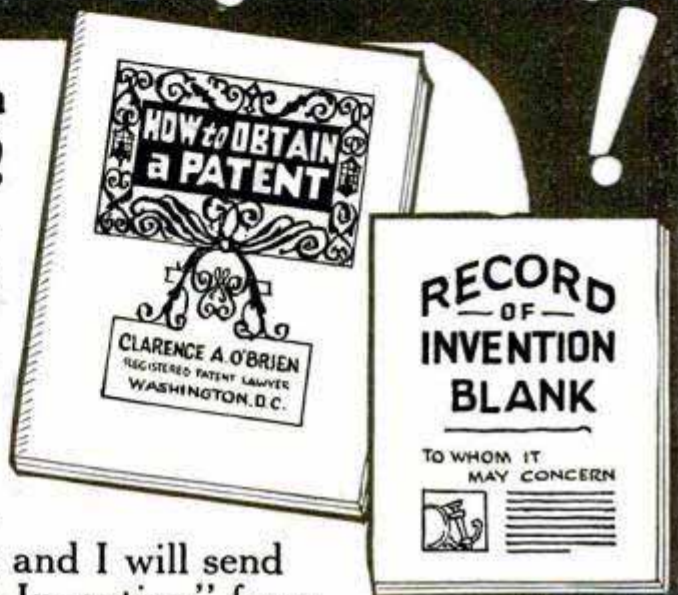

STRICT SECRECY PRESERVED

All communications, sketches, drawings, etc., are held in strictest confidence in strong, steel, fireproof files, which are accessible only to authorized members of my staff. Feel free to write me fully and frankly. Your case will have my personal attention. It is probable that I can help you. Highest references. But FIRST—clip the coupon and get my free book. Do THAT right now.

Clarence A. O'Brien

Registered Patent Attorney

Member of Bar of: Supreme Court of the United States; Court of Appeals, District of Columbia; Supreme Court, District of Columbia; United States Court of Claims

Practice confined exclusively to Patents,
Trademarks and Copyrights

FREE COUPON

CLARENCE
A. O'BRIEN

Registered
Patent Attorney

70-L Security Savings and
Commercial Bank Bldg.,
Washington, D. C.

Please send me your free book, "How to Obtain a Patent," and your "Record of Invention" form without any cost or obligation on my part.

Name.....

Address.....

It Now!

(Important: Write or Print name clearly)

PATENTS TRADE-MARKS AND COPYRIGHTS

Have You An Idea?

Our Offer: FOR THE PROTECTION OF YOUR INVENTION YOUR FIRST STEP

Before disclosing an invention the inventor should write for our blank form

"RECORD OF INVENTION"

This should be signed and witnessed and returned to us together with model or sketch and description of the invention for **INSPECTION and INSTRUCTIONS**

No Charge for the Above Information

**Our Four Books Mailed
Free to Inventors**

Our Illustrated Guide BOOK

How to Obtain a Patent

Contains full instructions regarding U. S. Patents. Our Methods, Terms, and 100 Mechanical Movements illustrated and described.

Our Trade Mark Book

Shows value and necessity of Trade Mark Protection. Information regarding *Trade Marks and unfair competition in trade.*

Our Foreign Book

We have Direct Agencies in Foreign Countries, and secure Foreign Patents in shortest time and lowest cost.

Progress of Invention

Description of World's Most Pressing Problems by Leading Scientists and Inventors.

We Regard a Satisfied Client as our best advertisement, and furnish anyone, upon request, lists of clients in any state for whom we have secured patents.

**Highest References—Prompt Attention
—Reasonable Terms**

VICTOR J. EVANS & CO.

PATENT ATTORNEYS

Main Offices: 956 9th St., N. W., Washington, D. C.

Opposite U. S. Patent Office

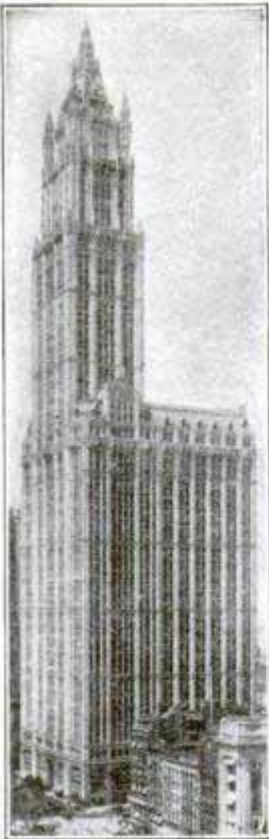

Our New York Office
Suite 1007 Woolworth Bldg.



Our Philadelphia Office
Suite 714-15 Liberty Bldg.



Our Washington Office
Victor Building

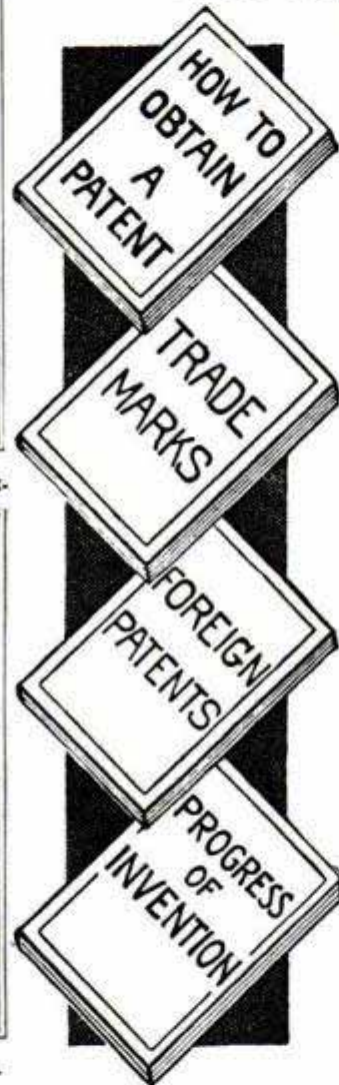

PATENTS TRADE-MARKS AND COPYRIGHTS

IMPORTANT

TO HAVE YOUR CASE MADE SPECIAL AND AVOID DELAY YOU SHOULD HAVE YOUR CASE MADE SPECIAL IN OUR OFFICE to secure protection, save correspondence and secure early filing date in Patent Office. To secure special preparation of your case send \$25.00 on account with model or sketch and description of invention.

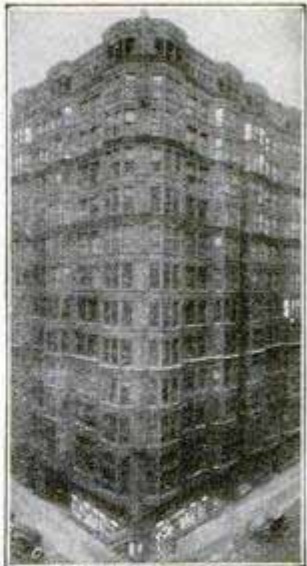

Our Chicago Office
Suite 1114 Tacoma Building



Our Pittsburgh Office
Suite 514 Empire Building



Our San Francisco Office
Suite 1010 Hobart Building



MAIN OFFICE, VICTOR J. EVANS & CO.—VICTOR BUILDING, WASHINGTON, D. C.

Our Lawyers Practice in all U. S. Courts and defend Clients in Suits involving Patents, Trademarks and Copyrights

All Communications and Data Strictly Confidential. Interference and Infringement Suits Prosecuted

OUR ORGANIZATION OFFERS PERSONAL SERVICE By Experienced Patent Lawyers, Solicitors and Draftsmen

**FREE
COUPON**

**VICTOR J. EVANS & CO.
PATENT ATTORNEYS**

NEW YORK OFFICES
1007 Woolworth Bldg.

CHICAGO OFFICES
1114 Tacoma Bldg.

PHILADELPHIA OFFICES
714-715 Liberty Bldg.

PITTSBURGH OFFICES
514 Empire Bldg.

SAN FRANCISCO OFFICES
Hobart Bldg.

MAIN OFFICES: 956 9th Street, N. W., WASHINGTON, D. C.

Gentlemen: Please send me *Free of Charge* your books as described on preceding page.

Name

Address

PATENTS

TRADE MARKS • DESIGNS • FOREIGN PATENTS

MUNN & CO. PATENT ATTORNEYS

Associated since 1846 with the Scientific American

1572 SCIENTIFIC AMERICAN BLDG.
New York City

523 SCIENTIFIC AMERICAN BLDG.
Washington, D. C.

1312 TOWER BUILDING
Chicago, Ill.

665 HOBART BUILDING
San Francisco, Cal.

520 VAN NUYS BUILDING
Los Angeles, Cal.



Books and Information on Patents and Trade Marks by Request. Associates in All Foreign Countries.

INVENTORS

who derive largest profits
know and heed certain
simple but vital facts be-
fore applying for Patents.
Our book *Patent-Sense*
gives those facts; sent
free. Write

LACEY & LACEY
Established 1869
704 F St., Washington, D. C.

C. L. PARKER

Ex-Examiner U. S. Patent Office

**ATTORNEY-AT-LAW and
SOLICITOR OF PATENTS**

McGILL BLDG. WASHINGTON, D. C.
Patent, Trade Mark and Copyright Law.

Have You An Invention?

If so the WORLD PROGRESS will send you upon re-
quest sample copy Free containing SUGGESTIONS TO
INVENTORS as to Inventions Needed. We invite manu-
facturers to address us regarding inventions they want.

Subscription for one year 60 cents

WORLD PROGRESS PUB. CO., Inc.
Room 203 Victor Bldg. WASHINGTON, D. C.

PATENTS

**Booklet Free Highest References
Promptness Assured Best Results**

Send drawing or model for preliminary
examination of Patent Office records.

ALL BUSINESS GIVEN PROMPT AND PROPER ATTENTION

Listed Patent Lawyer in the latest editions of the Rand-McNally Directory of Bank-
ers and Attorneys, of Chicago, Ill.; The Baggott & Ryall Directory of Attor-
neys, New York City; The Lawyers Guaranteed Directory, Detroit, Michigan;
The Lawyers and Bankers Quarterly, published by the Legal Directory Pub-
lishing Company of St. Louis, Mo.; the American Lawyers Annual, Cleveland, Ohio.

WATSON E. COLEMAN,
REGISTERED PATENT LAWYER

644 G Street, N. W., Opp. U. S. Pat. Office
WASHINGTON, D. C.

INVENTORS PROTECT YOUR IDEAS

Before disclosing your invention send for our Evidence of Invention Blank. This should be signed and witnessed and returned to us with a model or sketch and a description of your invention for our *Inspection and Instructions* which are free.

Also send for

Our guide book "How to Get Your Patent" which is sent free upon request. This book includes full instructions regarding U.S. Patents, Trade Marks, our Terms, Methods, etc.

WRITE TODAY

RANDOLPH & COMPANY
300 Victor Bldg., Washington, D. C.
Please send me FREE OF CHARGE your Evidence of Invention blank and your guide, "How to Get Your Patent."

Name.....

Street.....

City..... State.....



*Terms
Reasonable
Best
References*

RANDOLPH & CO.

300 Victor Bldg. Washington, D. C.

PATENTS

TradeMarks, Copyrights, Patent Litigation Handbook with illustrations, 100 mechanical movements. Sent free on request.

ALBERT E. DIETERICH
formerly member examining corps U. S. Patent Office
PATENT LAWYER and SOLICITOR

621-A, Ouray Bldg.
27 Years' Experience Washington, D. C.

PATENTS

REGISTERED ATTYS. U. S. AND CANADA

LANCASTER & ALLWINE

Send for our Original Form

EVIDENCE OF CONCEPTION

418 Ouray Bldg. WASHINGTON, D. C.

1000 NEEDED INVENTIONS!

Here is the most remarkable book ever offered to inventors. One Thousand needed inventions listed and described. Arranged as follows: General Problems; Automotive; Mechanical; Electrical; Chemical; Radio; Marine. Separate chapter on the Ten Most Needed Inventions. This book may give you one idea that will win you a fortune. Nothing else like it has ever been published. Compiled at enormous expense. Edited by Raymond Francis Yates, formerly Managing Editor of a leading scientific magazine. Over 100 pages, durably bound. Send no money. Pay postman only \$1.00 plus postage on arrival. Money back after 10 days' examination if desired. Limited edition. Write NOW.

BUREAU OF INVENTIVE SCIENCE

DEPT. 39

ROCHESTER, NEW YORK

PATENTS

To the Man with an Idea

I offer a comprehensive, experienced, efficient service for his prompt, legal protection and the development of his proposition.

Send sketch, or model and description, for advice as to cost, search through prior United States patents, etc. Preliminary advice gladly furnished without charge.

My experience and familiarity with various arts frequently enable me to accurately advise clients as to probable patentability before they go to any expense.

Booklet of valuable information and form for properly disclosing your idea free on request. Write today.

Richard B. Owen, Patent Lawyer
9-303 Owen Bldg., Washington, D.C.
41-E Park Row, New York City

**TRADE-MARKS
REGISTERED**



A Chorus with NO BASS Voices?

CAN you imagine that—a chorus without basses? ...What would it sound like?... What *does* it sound like? Anyone with an ordinary radio set can tell you.

The Daven Bass Note Circuit, which is creating such a sensation among the fans, embodies everything that a *good* circuit should have—Quality—Volume—Sensitivity—Selectivity and Ease of Tuning. The Daven Super Amplifier, assures perfect reproduction. The DRF Coils, designed as a companion of the Daven Super Amplifier, function as perfectly in the radio end as the Super Amplifier does in the Audio.

Six tubes, tuned radio frequency, volume controlled from the faintest whisper to enough to blast the speaker. Straight line construction, simple to build.

Any authorized Daven Service Dealer can supply you with all of the parts with full instructions. For full information and address of nearest Daven Dealer, write us direct.

DAVEN

Bass Note Circuit

Embodying These Standard Daven Radio Parts

- | | |
|---|-----------------------------|
| 1 Set D. R. F. Coils | 1 Daven Leakandenser No. 22 |
| 1 Daven Super-Amplifier with the new Glaptors | 1 Daven 1/4 Ampere Ballast |
| 3 Daven Mu-20 Tubes | 1 Daven 1/2 Ampere Ballast |
| 1 Daven Mu-6 Power Tube | 1 Daven Type "A" Condenser |



Daven Radio Frequency Coils combine extreme sensitivity with selectivity and ease of control

Daven Super Amplifier, combines with any circuit, giving pure tone, free from distortion

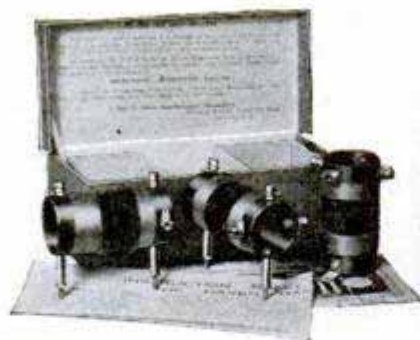

Write for Free Catalog

"The Sine of Merit"

DAVEN RADIO CORPORATION

TRADE MARK "Resistor Specialists" REGISTERED

169 Summit Street

NEWARK, N. J.



This book 25c at dealers, describes Daven Resistance Coupled Amplification in full detail. 30c by mail

"Can't beat them for convenience"

M. J. Lucas, a Chrysler dealer in Buffalo, N. Y., says, "I certainly recommend Crescent Tools to any Chrysler owner. You can't beat them for convenience and adaptability whenever there is a tightening or adjusting job to be done." Get Crescent Wrenches, Crescent Pliers, and Crescent all-steel screwdrivers from your hardware or accessory dealer.

CRESCENT TOOL CO.

210 Harrison Street
Jamestown, N. Y.

"Originators of the Crescent Wrench"



CRESCENT TOOLS



PATENTS

Send us sketch or model for advice and exact cost of patent. Our book "How to Obtain a Patent" sent free. It tells how to apply for Patents, Trade Marks, Foreign Patents, Copyrights, etc.; gives information on Patent Procedure; tells what every inventor should know. Thousands of inventors, who are our clients, are our reference.

CHANDLEE & CHANDLEE, 25 Years' Experience
473 7th St. Washington, D. C.

BLUE BOOK ON PATENTS

AND PRIORITY RECORD BLANK GRATIS.

MONROE E. MILLER, PATENT LAWYER
411-2 Ouray Building, WASHINGTON, D. C.
ELECTRICAL AND MECHANICAL EXPERT

RADIO LATEST CATALOG OF NEWEST PARTS AND KITS FREE

Send name and address, also name of friend. Send at once.
BARAWIK COMPANY, CHICAGO, ILL.

You—and This Machine Can Earn \$300 a Month



Charge batteries in 1-3 the usual time and at half the cost. Hundreds have built up profitable businesses with HB. Recommended by leading battery manufacturers and approved by U. S. Bureau of Standards. **Small space required**—start in your home or small corner or a shop. HB requires **practically no investment** on your part. **No special experience required.** Pays for itself on easy monthly payments with no expense

to you and yields a handsome profit besides.
30 Days Free Trial Find out about this wonderful moneymaker **NOW!** Built by Successful Manufacturers Since 1892. **Bulletin M** contains full particulars of the 30 Days Free Trial Plan. Write for it today!
HOBART BROS. CO. Box M99 Troy, Ohio



**A Professional
MOVIE CAMERA
for AMATEURS'
EASY USE**

**Experts at Last Perfect
Standard Film Camera
for Everybody**

De Vry

The De Vry Corporation announces a new movie camera! At last, a motion picture camera with STANDARD FILM for your own private use! Clear-cut motion pictures in the home. You, too, now can take professional pictures and show them anywhere—theatres, churches, school houses, every place you see regular motion pictures—your children, friends, picnics, games, travel, the family circle—cherished pictures you want to preserve—in full theatre size and clarity. Yet the price is lower than many motion cameras for amateur use that require "off-standard" narrow film which professionals do not use. Don't impair your negative by permitting it to be turned into a positive that you can't make clear prints from.

**Amazing
Low Price
Only
\$150**

Ask Your Dealer

This wonderful new De Vry weighs only 9 lbs. No tripod needed. Three view finders! Handsome, all metal grained leather finished case. Size 8 1/2 x 6 1/2 x 3 3/4. Accurate, automatic footage meter. Also an amazing exclusive feature—an action lock that actually lets you get into the scene yourself or direct the action while the camera goes on recording.

All other standard automatic film motion cameras sell for \$350.00 and up! Many owners of the new De Vry earn big money taking pictures for theatres and news reels. They cannot do this with "off-standard" cameras. Don't think of buying a motion camera without learning about this superior machine. If your dealer cannot give you this information, write us direct.

DE VRY CORPORATION

"Dept. 9-K" 1111 Center Street, Chicago, Ill.

**"Red Devil"
Glass Cutters**

EVERY handy man should own a Red Devil No. 48 Glass Cutter. Six hand honed wheels—one always ready—five in reserve. Sold by hardware and paint dealers.

LONDON P. SMITH, INC. "Its all in the Wheel"
106 Coit St., Irvington, N. J.



**Pocket \$110 A Week
With Amazing New Cap**

New adjustable feature makes Fits-U Caps fit any head instantly. A perfect fit always. 36 snappy style-color combinations. Finest hand tailored workmanship. Amazingly low price. Every man and young man wants one of these new stylish caps. All you do is take orders. No experience necessary. Big commissions daily in advance.

Selling Outfit FREE

You, too, can make \$110 a week showing this wonderful Fits-U Adjustable Cap. We furnish complete selling outfit FREE. Write immediately for it—also for full details about the FREE cap we give you.

FITS-U CAP CO., Dept. A-9, Cincinnati, O.



*This fun is for
You!* YOU'RE at the top o' the world socially when you play a Conn Saxophone. Popular?

Why, man, you're wanted everywhere! Entertain yourself and friends; play professionally if you choose, the demand for good players exceeds the supply.

And with a Conn you can do it easily. Does live music thrill you? Can you follow a tune, singing or whistling? Then you can learn to play a Conn; it will come naturally. Conn's exclusive features give you quick mastery.

The world's foremost artists in symphony, opera, concert and popular orchestras and bands choose Conn instruments for their superior quality. You can have the best at no greater cost.

FREE TRIAL, Easy Payments on any Conn saxophone, cornet, trumpet, clarinet, flute, Sousaphone—everything for band or orchestra. Now is the time to start. Send coupon for details.

**CONN
BAND
INSTRUMENTS**
WORLD'S LARGEST MANUFACTURERS

C. G. CONN, LTD., 931 Conn Bldg., Elkhart, Ind.
Please send literature and details of free trial, easy payment offer on

(Instrument)

Name _____

St. or R. F. D. _____

City, State _____

County _____

New! New! New!

If You Can Take Orders
Your Fortune is Made

Sells on Sight

Just What
Invalids
and sickly
people have
wanted for
years



FOLDED OPEN

Dr. Farrington's LAP-TABLE

For reading—writing—drawing
—typing—eating—drafting, etc.
ADJUSTABLE TO ANY POSITION OR ANGLE

Used and endorsed by Doctors, Students, Ministers, Lawyers, etc. Nothing like it in the world for old or young—all ages.

An order-taker can make \$10 every day with this latest and greatest of modern conveniences. A salesman can make from \$25 to \$50 a day! No competition. No prices to beat or talk about.

Act Quick—Get Our Plan

We want agents—honest-to-goodness, fast-moving responsible agents who will give themselves a chance to make a fortune. You've never had a gold mine like this offered you before. One agent sold 60 lap-tables in an hour in one school. That's more than \$100 net profit. Get our plan—writetoday. You want this.

Read
in Bed.

No More
Eye Strain.



The Farrington Co.
Dept. 1700
21 W. Elm St., Chicago, Ill.



*“Been on a
vacation
Bill?”*

“No, Jim—I’ve stopped smoking. Gained six pounds in a week. You know how I used to smoke—a package of cigarettes and a cigar or two a day—it sure had some hold on me. But I’m cured—

took a scientific home tobacco treatment—fixed me up in two weeks.

“Wasn’t hard on me at all—noticed improvement the first day—I feel like a new man. It didn’t interfere with my work—didn’t leave any druggish after-effects—the money I saved in the last two weeks has paid for the treatment alone.

“Why don’t you take it! It has cured men like you and me for over forty years—it is a doctor’s individual prescription that sure fixes you up. Just send the coupon for full information NOW. No obligation. All correspondence is strictly confidential.”



*“A Doctor’s
Prescription”*

The Keeley Institute, Dwight, Ill.

Please send me, without any obligation on my part, your free booklet which will tell me how to rid myself of the tobacco habit.

Name.....
Town.....
Street..... State..... PM-9

Easy to Solder This New Way

Indispensable for all soldering work. Simple—Speedy—Economical.

3.75

Complete

Press-to-Feed Electric Soldering Iron

One hand does the work of two. Speeds up radio set construction. Simplifies all kinds of soldering work. Far better than a blow torch. Solder will not melt until it reaches Soldering Point. Porcelain insulation prevents heat from entering handle.

AGENTS—DEALERS—JOBBER

This newly invented electric soldering iron offers big money making opportunity. Order a sample today \$3.75. Discounts in quantities on request. Write to

ILLINOIS STAMPING & MFG. CO.
220 N. Jefferson St., Dept. 16, CHICAGO

AGENTS—\$100 to \$200⁰⁰

can easily be made selling my **SUPER-BUILT SUITS** at remarkably low price of \$13.50. Rendell made 31 sales in five days. Profit \$111.00.

EASY TO DO—WE SHOW YOU HOW

You get your pay every day. Be independent. Get into business for yourself. We furnish you **FREE** samples. If you have an ounce of ambition and want to make **BIG MONEY** write us.

CHICAGO SUPER BUILT GARMENT CO., Inc.
Desk 1B, 416 So. Dearborn St. Chicago, Illinois

Pattern Makers—Carpenters—Cabinet Makers

This handy little tool is just what you need.

It will prove to be the last tool in your kit with which you would part. For putting Leather Flics on patterns it has no equal. Works in hard as well as soft wood, leather, etc. No nail set required, as Brad will be set beneath surface far enough to cover with putty or wax. A push with this handy little tool does the trick. The Magnetic Ram Flics 'Em up in a jiffy. Easily reaches most unhandy places. Ask for **FREE** catalog of complete line of tools for Pattern Makers, Cabinet Makers, and Wood Carvers. Enclose 10 cents in stamps to cover cost of mailing which will be refunded with first order.

MARKWELL MAGNETIC BRAD-SET at this remarkably low price **\$1.25**

ADAMS & NELSON CO., Dept. PM-9, 4125 Fullerton Ave., CHICAGO, ILLINOIS

BOW LEGS and KNOCK-KNEES UNSIGHTLY

Those afflicted with BOW LEGS should wear the “PERFECT LEG FORMS” and overcome this deformity. Trousers hang perfectly straight. Made of the highest grade Aluminum. Sanitary, Light and Durable. Easy to put on or off. Send for booklet showing photos of men with and without the “PERFECT LEG FORMS.”

PERFECT SALES CO.
140 N. Mayfield Ave. Dept. 5 Chicago, Ill.

A PERFECT LOOKING NOSE

Can Easily Be Yours

Trados Model No. 25 corrects now ill-shaped noses quickly, painlessly, permanently and comfortably at home (excepting cases caused by improper bone structure). It is the only adjustable, safe and guaranteed patent device that will actually give you a perfect looking nose. Over 90,000 satisfied users. For years recommended by physicians. 16 years of experience in manufacturing Nose Shapers is at your service. **Model 25 Junior** for children. Write for testimonials and free booklet, which tells you how to obtain a perfect looking nose.

M. TRILETY, Pioneer Noseshaping Specialist
Dept. 2668 Binghamton, N. Y.

\$10⁰⁰

33¢ a day
for ten months



Delivers this Wonderful New Burroughs

Portable Adding Machine To You

Here at last is a light-weight, handy, dependable, and yet speedy adding machine designed for the needs of wholesalers—retailers—professional men—secretaries of organizations, churches and clubs—and even your home! Yet the cost is amazingly low. It has the Burroughs standard keyboard; adds up to \$1,000,000.00; has one-hand control. It is so light it can be easily carried wherever needed.

Accurate Records Are Vital to the Intelligent Conduct of Any Business

Do you remember those many times you wished for a less irritating way of adding up columns of figures? Remember the countless times you made annoying mistakes—so often costly? You too, have struggled with pencil and paper, columns of figures before you, until your head swam with errors that seemed so absurdly easy to avoid! And yet your mistakes are the very same mistakes the most expert mathematicians make in hurriedly adding figures that mean actual dollars and cents in losses and profits. These mistakes are made every day.

This new Burroughs Portable was made for just this sort of work. Who can use it? You can, surely. Retailers in any line? Offices? Homes? Societies? YES! And thousands of others, too. We have proved it. Already, just through the astonishing results it has scored, over 35,000 are in use.

Now—An Adding Machine for Everybody

A long and extensive survey our experts conducted proved that the need for this machine actually was nationwide. We found that users of this machine could actually record a day-to-day saving. It was determined that the average small business man, through eliminating errors in addition, saved from 45 cents to \$2 a day, according to volume of receipts. That

shows how little mistakes pile up, how they reach an alarming total that you might not realize until it is actually brought home to you—that you cannot reliably figure considerable sums in your head, or hurriedly with pencil and paper.

Now this small, compact, but wonderfully efficient Burroughs Portable! So light you can tuck it under your arm and carry it home with you. So compact it covers scarcely the space of a letter-head. And so simple even a youngster might operate it to subtract, to multiply and to add the school sums. And above all, so sensibly priced that the smallest imaginable volume of figuring amply justifies its purchase. It's so sturdy and staunch it promises you years and years of faithful service. It's a real PROFIT MAKER.

Easy to Own

The price of this amazing Burroughs is only \$100. You advance but \$10. Then only 33 cents a day for ten months—

shows those few months all the savings this machine makes possible is clear profit—year after year. And think! No more slow, irritating figuring. No more time-wasting, labor-wasting calculation. No more old-fashioned, antiquated book-keeping. Instead the new Burroughs Portable quickly giving the accurate total to pleased customers—Saving you money every day.

We have made the purchase of this new Portable Adding Machine easy for you because we are certain you need it. It has the same durable work-capacity as other Burroughs machines. It carries exactly the same guarantee that all other Burroughs models carry. It has the same assurance of service satisfaction that the great Burroughs organization maintains throughout the nation. It is manufactured under precisely the same rigid standards of reliability and superior workmanship that have builded the Burroughs reputation throughout 40 successful years.

Pin a \$10 check or bill to the coupon and mail it in now. Have your new Burroughs Portable working for you, saving you money, and irritation and bother and time, at once. Your order will receive immediate attention. It will be the most profitable \$10 you have ever invested. Mail the coupon while it is before you.

BURROUGHS ADDING MACHINE COMPANY,
6556 Second Boulevard, Detroit, Michigan.

I would like a demonstration of the Burroughs Portable Adding Machine.

Here is my \$10. Send me your new Burroughs Portable Adding Machine, with the understanding that it carries the standard Burroughs guarantee and is protected by the Burroughs service organization. I will pay the balance in convenient monthly payments.

Name _____

Street _____

City _____ State _____

BURROUGHS ADDING MACHINE CO., DETROIT, MICHIGAN

How Good The Bristles Feel!

The first thing you notice about a WHITING-ADAMS BRUSH is how good the bristles feel. How strong and springy they are! Then you notice what a clean-cut, perfectly-balanced, and "usable" article the whole brush is. Ask your dealer to show you one.



WHITING-ADAMS BRUSHES

Send for Illustrated Literature

Making a Brush to Last a Lifetime is a Lifetime Job

JOHN L. WHITING-J. J. ADAMS CO.
Boston, U. S. A.

Brush Manufacturers for Over 116 Years and the Largest in the World

AGENTS! EXPERIENCE UNNECESSARY



Science has finally produced it. An instantaneous metal cleaner—neither sloppy liquid nor messy paste. Dry magic floss. Touch it to silver, nickel, copper or brass. The metal shines bright and clean instantly! No hard rubbing! Approved by Good Housekeeping Institute. Agents making up to \$30 a day!

Makes a Sensational Demonstration! Imagine! Touch tarnished articles with Lightning Polishing Floss and you make them bright as new. Demonstrations positively astonishing! Every one a sale! Agents collect real money on every call.

AMAZING DISCOVERY ABOLISHES METAL POLISH

HOUSEWIVES, AUTOISTS AND STORES

Everybody Buys These Products. Housewives buy the Lightning Polishing Cloth. Autoists buy Lightning Polishing Floss. Sell both to stores and offices in big quantities. Nothing else like them. Sure big, quick MONEY GETTERS. Sample Free! Exclusive territory. Real cooperation. Triple profit. Answer this ad at once. Make big money. Easy! Quick! Don't delay. Write NOW! FREE test sample and proposition by return mail.

A. U. LIGHTNING PRODUCTS CORP., 1773 Greenleaf Ave., Chicago

New ADDING SUBTRACTING Machine

New invention. Accurate adder and subtractor. Faster than fingers. Easy to operate. 8 banks. Does the work of high priced machines. Mechanically free from error. Fully guaranteed. Now being used by offices, cashiers, stores, banks, etc. No room here to tell our story. See it at your dealer's or write for complete details.

\$24.50

More Dealers and Representatives Wanted in territories not now covered. ADDAC demonstrates wonderfully. Easy to sell. Big market. Exclusive territories to producers.



ADDAC CO.
Sales Dept. 11
Grand Rapids - Michigan



CROSLEY Musicones

\$12.50 12 INCH CONE | 16 INCH CONE \$14.75

PRICES SLIGHTLY HIGHER ON WEST COAST

Already replacing hundreds of thousands of old-type loud speakers. Crosley patented actuating unit, not the cone shape, is the secret of unmatched tone.



MUSICONSOLE
28 inch solid mahogany chassis with built-in Musicone. Space for all accessories.
\$32.00

Other CROSLEY RADIOS - from 1 tube "Pup" at \$9.75 to R.F.L.-90 Console at \$90.

Write Dept 15 for Catalog
CROSLEY RADIO CORPORATION
CINCINNATI

GET YOUR SLICE OF BIG PROFITS

with this amazing new



DOUBLE EDGED RAZOR BLADE PARING KNIFE
The fastest selling home necessity ever offered. Sells for 25c. Your price \$1.50 dozen, prepaid. Guaranteed.
MORGAN MANUFACTURING CO., 440 S. Dearborn St., Dept. G, Chicago

Send 35c for an All-Work File to
FAYETTE R. PLUMB, Inc.
4817 James St. PHILADELPHIA

Books on all subjects are sold by Popular Mechanics Press, 200 East Ontario Street, Chicago, Illinois.

Make \$250 an Hour Your Profit in Advance



"Stay-Prest" Trouser Presser sells quick to every man—thousands in use. Men and women are cleaning up big profits with this fast seller. Sells on sight. Priced low. 40% clear profit for you. You take orders. We deliver. Your profit in advance.



Wonderful New Invention
Puts perfect creases in trousers. Takes out wrinkles and baggy knees. Easy to use—takes less than half a minute. Folds into small size. Saves clothes and tailor bills.

MAKE BIG PROFITS - Others Do
Jack Ames made \$24 in four hours. Randle sold 25 the first day. Mary Roberts made \$10 in one evening. Others making big profits in spare or full time. So can you. You risk nothing. We start you.

FREE Write quick for FREE selling outfit and full details of money-making selling plan.
THE GETGEY-JUNG CO., M-224, G-J Bldg., Cincinnati, O.

12,000,000 FORD OWNERS Need This NEW Timer!



Earn \$100. Weekly Selling Them!

You will never find such an opportunity to make big money as the "WEEKS

TIMER" offers you right now—

the Timer is the weak spot of the Ford car. Expert automotive engineers claim that the average Ford may wear out from 8 to 10 ordinary Timers.

Think of the sales possibilities when you offer the "WEEKS" with a guarantee for the life of the car. You don't have to be a salesman—this amazing Timer sells itself on sight—millions of Ford owners need it. 200 percent profit for you on every sale.

Makes Old Fords Run Like New

Once a Ford car is equipped with the "WEEKS", the Timer can be forgotten—the only thing that will prevent forgetting it will be the noticeable improvement in the running of the car. More power, more mileage, instant starting, amazing pick-up, are only a few of the features that will make any Ford owner a "WEEKS" booster after he once uses this new Timer.

Guaranteed for Life of Ford Car

Remember, every Ford owner in your territory sooner or later is going to have to buy a new Timer. Why not be the one to sell him a "WEEKS Timer," backed with our actual guarantee for the life of the car?

Get Territory Quickly

Territory is going fast. Our agents can easily make \$5,000, \$6,000, yes, even \$10,000 a year. Spare time workers make \$20 or even \$30 a day. If you want to get in on this big money, investigate NOW.

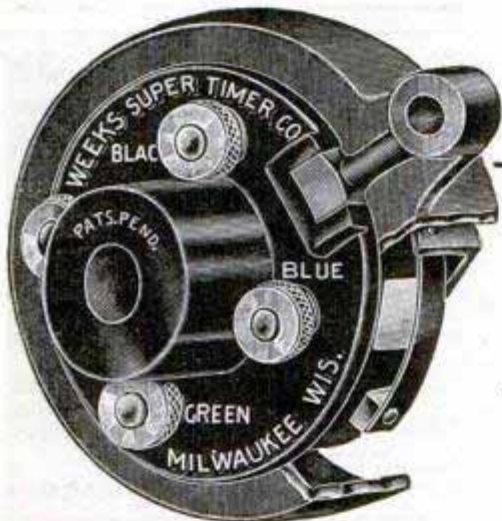

FREE SAMPLE

To aid our agents, we have arranged a plan that provides them with a Free Sample so they can equip their own car or carry it for demonstration purposes. The unique principles of this wonderful Timer will make themselves apparent to any Ford owner after a minute's examination.

Big Money For You!

The money-making possibilities of a WEEKS agent are absolutely unlimited, especially with the sales help and backing we give our men. JOHN KABLE made \$200 in less than 10 days. Many others are making big profits also. There is no reason why you, too, cannot get into the big-money class the same as John Kable and these others.

Now Is the Time to Act!

Don't let some friend or neighbor in your territory beat you to it. Send in the coupon TODAY for FREE SAMPLE offer and particulars of our big money-making proposition.

Weeks Super Timer Company

426-717 Eleventh Street

MILWAUKEE, WISCONSIN

RUSH COUPON TODAY

Weeks Super Timer Co.
426-717 Eleventh St., Milwaukee, Wis.

Gentlemen: I want to get in on the big money to be made with your new TIMER. Without obligation, rush me particulars of your territory plan and FREE SAMPLE offer.

Name
Local Address
City
State

What I Will Do!

Yes, only \$1 will bring your choice of these Big Bargains for your approval and 15 DAY TRIAL. Simply pin \$1 bill to this ad, indicate your selection and mail it TODAY. If you can duplicate your selection for less money elsewhere, send it back and your \$1 will be refunded. If satisfied, pay balance in 10 equal monthly payments. NO RED TAPE—PROMPT DELIVERY. DEALINGS CONFIDENTIAL.

B80—Ladies 18K White Gold Ring; beautifully designed. AA 1 Blue-white Diamond. \$50 \$4.90 a Month.

B81—Ladies hand-engraved 18K White Gold Birthstone Ring set with 2 Blue-white Diamonds. Any birthstone furnished. \$25. \$2.40 a Month.

B82—Ladies hand-carved 18K White Gold ring, with 2 Blue-white Diamonds. \$45. \$4.40 a Month.

B83—Gents 14K Solid Gold hand-engraved Ring with AA 1 Blue-white Diamond set in White Gold square top. \$42.50. \$4.15 a Month.

B84—14K White Gold Wrist Watch; 4 Blue; white Diamonds; 4 Blue Sapphires. Guaranteed 16 Jewel movement. \$42.50. \$4.15 a Month.

B85—Famous Bulova Gents Strap Watch 14K Gold filled case; guaranteed 16 Jewel movement. \$28.50. \$2.75 a Month.

B86—12 size 21 Jewel Illinois Victor Watch; 14K Green Gold filled case. Price \$45. \$4.40 a Month.



B85—\$28.50
It's a Bulova

3000 Big Bargains in Diamonds, Watches and Jewelry shown in the catalog. Send for it Today—it's FREE.

L.W. SWEET Inc.
DEPT. 66 1660 BROADWAY NEW YORK

\$25 to \$45



GET THE NEW IDEA BATES MOTOR SAW — 6 SAWS IN 1 —

Does the work of hand-saw, rip-saw, cross-cut, miter, bevel and scroll-saw. A wonder worker for the home shop. Direct drive! Can't stick! Cuts 2" wood. Most amazing variety saw ever invented. Does more, costs less! Write for circular.

BATES MOTORCRAFT COMPANY
Dept. M 28 N. Clinton CHICAGO, ILL.

SELECTIVITY! NEVER BEFORE EQUALLED IN ANY BREMER-TULLY CIRCUIT

FOUND IN THE

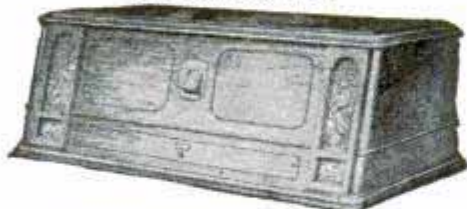

COUNTERPHASE-EIGHT

B-T'S latest contribution to Better Radio

You owe it to yourself to investigate the many features found in the new Counterphase Receivers. Any Authorized Dealer will gladly show you.

The 10th Edition "Better Tuning" gives full information on the new sets, B Power Unit and our views on the latest developments in Radio. Price 10c.



BREMER TULLY MANUFACTURING CO.
520-532 So. Canal Street
CHICAGO, ILL.

"Pioneers of Better Tuning"

HOTTER THAN COAL

—and no dirt



Do away forever with the drudgery of wood or coal. The most simple and economical invention on the market is now giving perfect satisfaction to enthusiastic users everywhere. The OKAY Oil Burner fits in the fire box of your furnace or stove. Installed in a few minutes. Burns 96% air and 4% cheap oil (Distillate). No noisy motor or complicated parts. Simply turn one valve and you have all the heat you want. Cleaner and better for heating and cooking.

30 Days FREE Trial Offer

Try this wonderful OKAY Oil Burner right in your own home at our risk. Act quick and get our special low introductory price. Sold under absolute money-back guarantee. Write at once for free booklet on home heating.

AGENTS—Our men are making big money introducing OKAY Oil Burners. The demand is enormous. We want spare or full time workers immediately. If \$500 a month and more

interests you, write or wire us for our protected territory offer.

OKAY MANUFACTURING COMPANY
Dept. 174 East St. Louis, Ill.

EVERY ELK WANTS ONE



You should have one of these handsome plaques which is an ornament to every home and office. It is an exact reproduction of the—Elks National Memorial, Chicago. Made of a special metal alloy—antique gold finish. Size 6 inches. Price \$1.50 postage paid.

**REPRESENTATIVES WANTED
BIG PROFITS
FULL OR PART TIME**

You have 900,000 Elks as prospects. 9 sales out of every 10 calls.

MID-CITY DEVICES CO.

1430 S. MICHIGAN AVE., Dept. N, CHICAGO, ILL.

Enjoy a Big-Powerful Radio: 30 Days FREE!



**MIRACO
Ultra 5**

27 in. Long

**MIRACO
RADIO
GETS 'EM
COAST &
COAST**

Users everywhere report it gets coast to coast, Canada to Mexico, loud and clear on speaker; outperforms \$100 to \$200 sets. Some hear Europe. Marvelous bargain! Don't buy unless 30 Days Trial proves it most Selective, Clearest and Most Powerful Distance-Getter among big, fine-tube radios. Retail LIST price, now \$49.75.

Factory Prices—SAVE UP TO 1/2

Every set completely assembled, rigidly tested, fully guaranteed. Single Dial Sets, Speakers, batteries, tubes, etc., at big savings.

Free literature, users' testimony and BIG SPECIAL OFFER

MIDWEST RADIO CORPORATION

Pioneer Builders of Sets

Send for Proof

407-B Miraco Bldg.,

Cincinnati, Ohio

**USER-
AGENTS
WANTED**
Write for
discounts



FREE Book on Deafness

Write today for 168 page FREE book giving full particulars and testimonials from hundreds of grateful users whose hearing has been restored by use of our "little wireless phones for the ears."

Wilson Common-Sense Ear Drums require no medicine but effectively replace what is lacking or defective in the natural ear drums. They are simple devices, which the wearer easily fits into the ears where they are invisible. Soft, safe and comfortable.

WILSON EAR DRUM CO., Incorporated
103 Todd Building LOUISVILLE, KY.

THIS WINTER
—more heat—more comfort
LESS COAL
LESS DIRT
and less expense, too

Winter is coming with its coal costs; its draughty rooms; its coal-shoveling; its ash-carrying. This winter why not get away from part of your coal costs; have healthy winter-warm rooms; and eliminate a great part of the drudgery of taking care of the furnace? Thousands have done it. Thousands are doing it with the scientific Crown Fuel Saver—

This Scientific Device is easily attached to Furnace Door



CROWN
FUEL SAVER
and SMOKE ABATER

Mix red hot oxygen with coal gases over furnace fire bed and

Save 20% on your Coal Bill

That is an unqualified guarantee. Either the Crown Fuel Saver makes a saving of at least 20% in your usual coal bill, or we will take it back and refund its purchase price. With coal at \$10 to \$18 a ton—figure your own saving at 20%—not taking into consideration the extra heat, comfort and convenience offered by the CROWN.

Write today for full details and special low price of Crown with money-back guarantee. Install it now before fall firing begins. The Crown has been in successful use 11 years in homes, stores, buildings and high pressure steam plants.

Distributors Wanted Men who seek a solid business connection of profitable stability—write or wire. Now is the time to get ready for the big fall season.

CROWN FUEL SAVER CO.
49 N. 10th Street RICHMOND, IND.

How I Saved Half My Coal

"I had a hot air furnace in our house before I got the Bulldog and our 7-room house was always cold. With the Bulldog it only takes half as much coal and we had weather below zero, and the house was nice and warm in the morning when we got up. We never have the draft on more than a half hour at a time and it has the place red hot." That's the marvelous record of the Bulldog Pipeless Furnace as told by Jess T. Conrad, 1211 W. Arch St., Shamokin, Pa.

Heats 7 Rooms Instead of One!

"With the Bulldog, we find it takes a little more coal to heat the whole seven room house than it did to heat one room with a stove using chestnut coal."—J. B. Smith, 19 Elm Street, Somerville, N. J.



If you are even thinking of a pipeless furnace, or any furnace, write for our free catalog. The Bulldog is one furnace you MUST investigate. Comes completely erected. Fits any height of basement and you install it yourself.

No Money Down

The Bulldog is sent for free inspection Then, if satisfied, you make only small monthly payments at our amazingly low price. Factory connections in both East and West. We ship from nearest point. Don't consider buying any furnace until you find out about the Bulldog. Write at once for our special offer and our free catalog together with the wonderful record of Bulldog success. Mail this coupon today.

Babson Bros.

19th and California Ave., Dept. 13-56 Chicago
 Without obligating me in any way please send me your free catalog and special offer on the Bulldog Pipeless Furnace.

Name.....

Address.....



KESTER
 READY TO USE
METAL MENDER
The Household Solder

Here's why thousands use Kester Metal Mender. **Simple**—Requires Only Heat! Anyone can use it. **Safe**—No messy pots or dangerous acids. **Sure**—Genuine Solder makes firm metal joints. **Satisfactory**—Works equally well on light or heavy, old or new work. **Economical**—Saves many times its price. **Your Dealer Can Supply You**

Soldering Booklet
"It's a Cinch to Solder"
 Upon Request



CHICAGO SOLDER COMPANY
 4201-334 Wrightwood Ave., Chicago, U.S.A.

Tires Hammered Full of NAILS LEAK NO AIR

AGENTS MAKE \$5,000 to \$10,000 A YEAR

MAKE YOUR TIRES PUNCTURE-PROOF In ONE Minute

Galacite

The new scientific invention—has the marvelous property of *sealing all punctures the moment they occur. ACTS INSTANTLY.* You can pick up any number of nails **WHILE RIDING** without the loss of a pound of air. One application, made in a minute, without taking tire off wheel or rim, *actually makes tire puncture-proof for life.* Guaranteed not to injure tire, tube or valve. On the contrary Galacite preserves rubber, lengthening the life of both tube and tire,—**Often Increasing Tire Mileage from 10,000 to 12,000 Miles**

MAKE THIS TEST Take a hammer and drive as many nails into a tire as you wish, 10, 50, 100, it makes no difference; all punctures are sealed instantly. Used in all kinds of tires including low pressure **BALLOONS.** Galacite is inexpensive and can be tried out at our risk. Warranted for one year but will last indefinitely.

GUARANTEED TO DO ALL WE CLAIM

Don't confuse Galacite with anything else ever intended for the same purpose; it is *new and different*—a revolutionary invention, the result of years of research and experiment. We are a long established highly rated concern. Galacite is backed by our Money Back Guarantee. It must make good—or we will. *You take no risk.*

AGENTS—Earn \$5,000 to \$10,000 a Year

TREMENDOUS PROFITS Galacite agents make almost unbelievable success. A **NAIL DRIVING** demonstration does the selling. No lengthy arguments. Demonstrate and sell to car owners, Garages, Filling Stations. Work all or spare time in your home town or travel. You can also manufacture and sell **GALACITE PUNCTURE PROOF** inner tubes. *The market for Galacite is inexhaustible.* **EXCLUSIVE** territory and splendid **FREE ADVERTISING HELPS** make your business permanent. **RUSH** your name to us for full particulars. **TERRITORY IS GOING FAST.** Delay may cost you the chance to make \$5,000 to \$10,000 a year. Send no money, just your name, but **WRITE TODAY.**

C. F. JOHNSON & CO. 19 W. Jackson Blvd., Dept. 341 CHICAGO



"GALACITE" Trade Mark Registered
Licensed under Folmer-Hewitt Process

BOW LEGS?

OUR GARTER (Pat'd) Makes Trousers Hang Straight

If Legs Bend In or Out. Self Adjustable.
Free Booklet — Plain Sealed Envelope

THE T. GARTER CO. Dept. 2, New London, New Hampshire



BUILD SHIP MODELS!

Easy to build and sell. Plans and instructions: "Santa Maria" \$1.02—Viking Galley, 42c—Magellan's "Victoria" 77c—Hudson's "Half Moon," 92c—Clipper Ship, 82c—or all for \$3.75.

SEA ARTS GUILD, 405A Eleventh Ave., Milwaukee, Wis.



NEW VEST POCKET ADDING MACHINE

BABY CALCULATOR
CHICAGO U.S.A. PATENT APPLIED FOR

ADDS, SUBTRACTS, MULTIPLIES, DIVIDES

Does work of \$300 machine. Guaranteed 5 years. NOT A TOY.

Made of steel and indestructible. Million dollar capacity. Fits in pocket. Will not make mistakes. So simple child can operate it. Everybody should carry one for figuring.

FREE TRIAL \$2.50 Total Cost

SEND NO MONEY—Just name and address. We will ship Calculator immediately. On delivery pay postman \$2.50 (Plus few cents Postage). (If outside U. S. send cash). If not satisfied after 10 day trial you get your money back. **THOUSANDS OF SATISFIED USERS.** This is lowest priced practical calculator made. "Why pay more for inferior imitations?" Order from this ad.

-----Mail Coupon Today-----
BABY CALCULATOR SALES COMPANY
Dept. 41, P. O. Box 1118, CHICAGO, ILL., U. S. A.

I am enclosing \$2.50—send adding machine prepaid.
 Send Adding Machine C. O. D. \$2.50 plus postage.

Name.....
Address.....
City..... State.....

AGENTS Write for big commission and territory proposition.

AGENTS AND SIGN MEN

Now Making \$50.00 to \$100.00 and Up Per Week Selling Our

R GOLD LEAF SIGN LETTERS

For store and office windows, board signs, trucks and glass signs. We also make to order script signs and business emblems singly or by the thousands. A permanent business. No capital or experience required. Big demand in every city. *Samples and Literature Free.*

CONSOLIDATED SIGN LETTER CO. 69X W. Van Buren CHICAGO, ILL.

30 Days' Free Trial

Start a **Big Profit Making Business** of your own—**"One Day Battery Charging."** Requires **small space and practically no investment.** Anyone can successfully operate. Charges batteries in $\frac{1}{2}$ the usual time at $\frac{1}{2}$ the cost. **Every car owner a customer.** Recommended by leading battery manufacturers and approved by U. S. Bureau of Standards. Try it out for thirty days at our risk, under absolute **money back guarantee.** The HB One Day Battery Charger will pay for itself on easy monthly payment plan with practically no expense to you—and bring you a handsome profit besides. Built by Successful Manufacturers Since 1893. **Write for full particulars in Bulletin M. NOW!**

HOBART BROS. CO., Box M9, Troy, Ohio



Please Mention Popular Mechanics

Don't Be A Slave

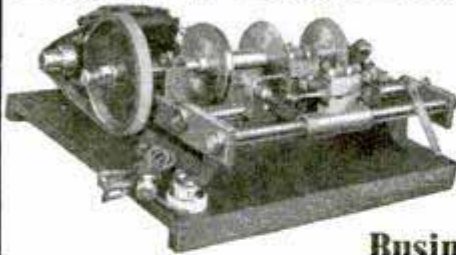

Be Independent,
Start Your Own
Business Now!

Make Big Profits with the
BEISSER KEY MACHINE
No Experience Necessary—Others Make
\$20 to \$50 a Day

You can do the same. Devote all or spare time. The only machine that will cut any type of Key—Bitted, Double Bitted, Yale and Flat Steel Keys—in one operation. The only machine that will make first Keys without taking lock apart. **MAKES A DOZEN DUPLICATE KEYS PER MINUTE.** Big demand for duplicate Keys for autos, apartments and residences. This is your money-making opportunity.

Write Today for Full Particulars.

BEISSER KEY MACHINE CO.
407 Fort Street E. DETROIT, MICH.

World's Greatest Screwdriver

\$1.50



Has power of 20'

UNIQUE OFFSET RATCHET

Works in close quarters where ordinary screwdrivers are useless. Two milled bits furnished. Satisfaction guaranteed or your money back. Ask for FREE catalogue of other Unique Tools. **Representatives Wanted Everywhere**

LANE UNIQUE TOOL CO., Dept. P.M.9, 422 S. Dearborn St., CHICAGO, ILL.

MAKES \$18.08
In Few Hours



Without experience E. Lube earned \$18.08 in one afternoon with our beautiful dress goods, silks and wash fabrics. No capital needed. We show you how to succeed. Write for samples and complete selling instructions.

The National Importing Company
Dept. J-6, 573 Broadway, New York City



ACME FOLDING BOATS

Make up or fold in 6 to 8 minutes. Toss onto shoulder with ease. Carry four grown men in perfect safety. Accommodate largest outboard motors. Made since 1890. Sold all over the world. Many models. Priced right. Guaranteed. Write for particulars.

ACME FOLDING BOAT CO., 917 Boat St., Miamisburg, Ohio

The Best Friend on the Road

A great traveling companion, this Barbasol. No tools to pack except the good old razor. No brush. No rub-in. And a real head-barber shave! 35c and 65c tubes.

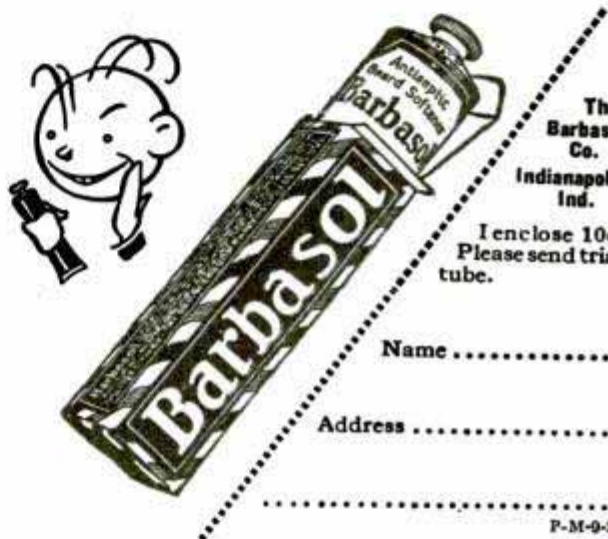

The Barbasol Co.
Indianapolis Ind.

I enclose 10c. Please send trial tube.

Name

Address

P-M-9-26

For Modern Shaving

FREE INSTRUCTIONS

We furnish complete blue prints and instructions for making the items shown, and dozens of other useful articles with



SpeedWay Shop

Enjoy the thrills of making countless things of wood and metal—make toys, furniture, repair the car, polish golf clubs, do radio jobs, etc.

SPEEDWAY SHOP AND TOOLS

Six motor-driven tools—Saw, Lathe, Grinder, Buffer, Cleaner, and Drill, making complete outfit for mechanics, householders, farmers, and "handy-men."

Only \$10 Down, Easy Payments

Pay as you enjoy it. Use the Shop for pleasure or profit.

Every tool in the "Shop" is high grade, for regular work.

A money maker for the small job man. Write today.

ELECTRO-MAGNETIC TOOL COMPANY
Dept. 29, 1830 S. 52nd Ave., Cicero, Ill. (Adjoining Chicago)



A Genuine \$2 Knife for \$1.18 Postpaid

Handy shaped blade makes this knife best for mechanics, sportsmen and farmers; light but strong; re-sharpened easily. Stag handle. German silver finish; blades file tested, hand forged from razor steel and warranted.

Direct at Factory Prices

Sample \$1.18 3 for \$3.00 Postpaid

Hand Forged Razor Steel Blades
Send for our 100-page FREE List and "HOW TO USE A RAZOR."

Maher & Grosh Co.
106 A St., Toledo, Ohio

Suppose You Were Offered Diamonds at 60% of Market Price



Suppose a reason you rarely think of makes possible here radically low prices, even for finest quality diamonds. Thousands of representative people, bankers, lawyers, merchants, others—continually reap this real advantage. Everything sent for Free Examination. This 3/4 century, oldest, largest diamond banking institution in the world, rated over \$1,000,000.00,—converts into cash the diamonds on which money was loaned and not repaid. Loan values, a fraction of market values, are the price basis. Diamonds too from big cash deals direct with European cutters. Must sell now

Why Pay Full Prices

When Much Less Buys the Same See this 3/4 less 1/16 ct., snappy solitaire for \$69.50. Try to match at \$115.00. Examine free any bargain at our risk. Startling, legitimate offers here of diamonds at 60% of market price. Send now for full details. Diamonds of unusual qualities (also watches) from unpaid loans, offered at radically low prices based on mere loan values. Then, too, we have hundreds of diamonds from big, cash, European deals with diamond cutters, who sacrificed these gems away under the market. Send now for our latest offers of this internationally known cash headquarters.



Unpaid Loan Listings Ready

As low as \$60 a Carat

Radically different from a catalog. List accurately describes every diamond in full detail with guaranteed exact weight, color, quality, etc. Explains Guaranteed Cash—like Insurance Policy Loan guarantee. Also Unlimited Exchange privilege at price paid us. Gives full details of free examination offers. Don't wait, the very diamond you want may be in this very list at a price that will amaze you. Costs nothing to see. Write today. A postal will do, or



Command Recognition a DIAMOND Does It

JOS. DE ROY & SONS
Only Opposite Postoffice
1948 De Roy Bldg., Pittsburgh, Pa.

Without obligation to buy, send me free, in plain envelope, your Latest Bargain List of Diamonds, Watches, and other Jewels.

Name _____
Address _____
City _____ State _____

References by Permission:—Bank of Pittsburgh, N. A.; Marine National Bank; Union Trust Co., Pittsburgh, Pa. Your bank can look us up in the mercantile agencies.

THE WOTEN GASOLINE ENGINE

Air-cooled—Water-cooled. One H. P. in 20 pounds. Handiest little engine ever made. Ideal wherever power is needed. Also the Metalumen Model Airplane Engine, one-half H. P. in 3 1/2 pounds. The market demands them in thousands. Generous agency propositions on request. Complete line of small gasoline and steam engines, battery chargers, etc. Catalogue Free.

DYNAMIC MANUFACTURING CO.
First Nat'l Bank Bldg., Dept. 7, CHICAGO



AGENTS Some Seller at \$1.50

Looks Like \$5.00 Worth Gives You 75c Profit!

PERFUMES, TOOTH PASTE, FACE POWDER, FACE CREAMS, SOAPS, EXTRACTS, &c.

YOU should see this "Super 8" Package. Also our 11 piece Assortment selling at \$2.00 with 2 piece Carving Set FREE to each Customer. No fancy talk—Experience Unnecessary. Harris in W. Va. sold 800 in 6 weeks. Profit over \$100 a Week.

MAKE BIG PROFITS right from the start. What more could you ask while introducing line of Soaps, Toilet Articles, Food Specialties, Polishes, Remedies, etc. at **ATTRACTIONAL PRICES?** 100% Profit. 250 Products—All Repeaters. 30 years on Market. Write today for Illustrated Circulars and **UNIQUE SALES PLANS.** Act NOW.

E. M. DAVIS COMPANY, DEPT. 5645, CHICAGO, ILL.

Big 3-ft. Telescope

Makes people and objects miles away seem close. Brings new pleasures to home, farm, camp, travel, sport. See moon and stars as never before. New Ferry "Wonder" telescope has 5 sections—over 3 ft. long open, 12 in. closed. Fully brass bound. Powerful lenses.

Only **\$1.85**

FREE! Yes, Absolutely FREE! Hand-some leatherette covered Carrying Case, light, strong, complete with strap. Handy for farmers, auto tourists and bikers.

5 Sections 8-Power Lenses Thousands Delighted!

"I am delighted with the 'Wonder' telescope. Today I have been watching submarines 3 miles off the coast."—Philip Brush. "I can see across the Mississippi 3 miles and see people fishing."—M. L. Thorn. "I am nearly 80 years old and if I could not get another would not take \$10.00 for it."—A. R. Walker. "I can tell time on the church clock 5 miles away."—Edward Foster. "Could tell color of aeroplane 4 miles away."—Mrs. L. M. Yarbrough. "I saw a Light House 18 miles away."—Clyde Scribner.

Send No Money

Send name and address and Ferry Wonder 3-ft. Telescope with free Carrying Case will come by return mail. Pay postman special bargain price of \$1.85 plus a few cents postage. Satisfaction guaranteed or your money back. Supply limited.

Order Today! **FERRY & CO., Dept. 1776, CHICAGO**

EASY \$100 a Week

FUGO FIRE EXTINGUISHER

Unusual opening for live agents in every locality. Make \$5000 or more a year—easily. Fugo—the instantaneous automatic fire extinguisher—is needed and wanted in every home, store, theatre, garage, shop, school, automobile, etc. Cheapest fire protection available today. Within reach of all.

1 Qt. Size \$5.00 2 Qt. Size \$7.50

Recharged in a fifth.

Amazing 30-second demonstration clinches sale—each one sold sells others. Territory going fast. Write at once for wonderful proposition that will **MAKE YOU BIG MONEY.**

THE NATIONAL FORMAL CO.
240 St. Clair Ave., N. E. Cleveland, Ohio

38,000 Candle Power—No Glare!

Agents cleaning up as high as \$100 daily on Trippe Reflectors, the latest and greatest auto sensation. Sells for a few dollars, fits all cars. Rush answer by mail or wire today—territory going fast.

AERIAL ELECTRIC CO., Mfrs., 128 1/2 W. Kinzie St., CHICAGO, ILL.

A Test Every Man Past 40 Should Make

Medical authorities agree that 65% of all men past middle age (many much younger) are afflicted with a disorder of the prostate gland. Aches in feet, legs and back, sciatic pains, are some of the signs—and now, a well known American scientist has written a remarkably interesting Free Book that tells of other symptoms and just what they mean. No longer should a man approaching or past the prime of life be content to regard these pains and conditions as inevitable signs of approaching age. Already more than 20,000 men have used the amazing method described in this book to restore their youthful health and vigor—and to restore the prostate gland to its proper functioning. Send immediately for this book. If you will mail your request to the Electro Thermal Company, 2161 Main Street, Steubenville, Ohio—the concern that is distributing this book for the author—it will be sent to you absolutely free, without obligation. Simply send name and address. But don't delay, for the edition of this book is limited. Western Office, Suite 21-D, 303 Van Nuys Bldg., Los Angeles, Calif.

FREE RADIO CATALOG



Special Summer Bargain Bulletin

HAVE you received a copy of our special Summer Bargain Bulletin? Pages of parts, accessories, kits and sets—all the best and the latest. A \$1,000,000.00 Radio Stock to choose from. A copy of this unusual catalog is yours for the asking. Just drop us a line—now.

DEPT. PM

CHICAGO SALVAGE STOCK STORES

509 S. State Street CHICAGO, U. S. A.

SOLDERALL

METAL IN PASTE FORM



The SOLDERALL CO., NEWARK, N.J.

NEW KIND OF RADIO!

GETS 40 TO 550 METERS—CIRCUIT INLAID

The Ambu-5 is the latest thing in radio. Gets all amateur, experimental and regular broadcasts between 40 to 550 meters—local and foreign. Circuit is imbedded in sub-panel.

Factory Representatives Wanted!

\$60 to \$100 a Week! We need men in every section to demonstrate and take orders. \$60 to \$100 a week easily made in spare time. Big demand. We put you in business. No investment. Mason made \$212 in few days. Write for special offer on Demonstrator Set.

AMBU ENGINEERING INSTITUTE 2631-R Prairie Ave., CHICAGO



Here It Is!
The **KODEX**
MICROPHONE
Loud Speaker

See Your Nearest Radio Dealer



Free Instructions

Mail us the coupon below and we will include FREE with your Saxophone the same Course of written Instruction which Richard Dix received, enabling you to learn quickly and easily.



"If you can whistle a tune you can play a Lyon & Healy Sax" —says Richard Dix

"YOU'RE missing half your life if you don't play a Lyon & Healy Sax. For winning you popularity it can't be beat. And it's surprisingly easy to learn to play one. If you've got two hands and can whistle a tune you can learn to play one of those new Lyon & Healy Saxophones!"

Richard Dix —

Richard Dix, popular screen star, hero in "The Quarterback" and other feature films, pictured above with his Lyon & Healy Saxophone—he certainly knows what he is talking about. Why should you envy the other fellow his popularity, good times, leisure, extra spending money, when you can enjoy the same things too?

Easy to Learn Our Way

You can quickly learn to play a Lyon & Healy Saxophone because—with our sixty years musical experience to guide us—we have simplified the fingering, made it easy for you to play, easy to produce full, rich tones. The Lyon & Healy is the choice not only of noted amateurs like Richard Dix, but of leading professional players as well, because of its extremely accurate adjustment, improvements in key action for hair-trigger finger work, perfection in pitch and resonant and mellow tones. Remember—it is made and guaranteed by America's leading musical house!

Pay as You Play

Now you can own one of these wonderful instruments and pay in small installments, at the rate of only a few cents a day. Many earn enough playing for dances and parties to meet their payments. Mail the coupon today for full details. Don't delay.



LYON & HEALY

"Everything Known in Music"

62 E. Jackson Blvd.
CHICAGO

FREE! A Picture of Richard Dix and a facsimile of his letter

Use This Coupon Today!



LYON & HEALY, Inc., Musical Headquarters
62 E. Jackson Blvd., Chicago

Please send me, full information regarding your liberal offer on the famous Lyon & Healy Saxophones and Richard Dix's autographed photograph and letter, FREE.

Name.....

Street.....

City..... State.....

Swear Off Tobacco



Tobacco Tells on
Nervous System



Tobacco Ruins
Digestion



Tobacco Stunts
Boy's Growth



Tobacco Robs
Man of Vitality



Tobacco Steals
from You the
Pleasures, Com-
forts, Luxuries
of Life

Tobacco Habit Banished Let Us Help You

Quick Results

Trying to quit the tobacco habit unaided is often a losing fight against heavy odds, and may mean a serious shock to your nervous system. So don't try it! Make the tobacco habit quit you. It will quit you if you will just take **Tobacco Redeemer** according to directions.

It doesn't make a particle of difference whether you've been a user of tobacco for a single month or 50 years, or how much you use, or in what form you use it. Whether you smoke cigars, cigarettes, pipe, chew plug or fine cut or use snuff—**Tobacco Redeemer** will positively remove all craving for tobacco in any form in a few days. Your tobacco craving will usually begin to decrease after the very first dose—there's no long waiting for results.

Tobacco Redeemer contains no habit-forming drugs of any kind and is marvelously quick, scientific and thoroughly reliable.

Not a Substitute

Tobacco Redeemer is in no sense a substitute for tobacco, but is a radical, efficient treatment. After finishing the treatment you have absolutely no desire to use tobacco again or to continue the use of the remedy. It helps to quiet the nerves, and will make you feel better in every way. If you really want to quit the tobacco habit—get rid of it so completely that when you see others using it, it will not awaken the slightest desire in you—you should at once begin a course of **Tobacco Redeemer** treatment for the habit.

Results Absolutely Guaranteed

A single trial will convince the most skeptical. Our legal, binding, money-back guarantee goes with each full treatment. If **Tobacco Redeemer** fails to banish the tobacco habit when taken according to the plain and easy directions, your money will be cheerfully refunded upon demand.

Let Us Send You Convincing Proof

If you are a slave of the tobacco habit and want to find a sure, quick way of quitting "for keeps" you owe it to yourself and to your family to mail the coupon below or send your name and address on a postal and receive our free booklet on the deadly effect of tobacco on the human system, and positive proof that **Tobacco Redeemer** will quickly free you from the habit.

Newell Pharmacal Company
Dept. 300, Clayton Station, St. Louis Mo.



Free Book Coupon

NEWELL PHARMACAL CO.,
Dept. 300, Clayton Station, St. Louis, Mo.

Please send, without obligating me in any way, your free booklet regarding the tobacco habit and proof that **Tobacco Redeemer** will positively free me from the tobacco habit or my money will be refunded.

Name.....

Street and No.....

Town..... State.....

Look ^{sent on} Approval

Adjusted to the Second
Adjusted to Temperature
Adjusted to Isochronism
Adjusted to Positions
21 Ruby and Sapphire Jewels
25 Year Gold Strata Case
Your choice of dials
(Including Montgomery R. R. Dial)
New Ideas in Thin Cases



Men in every walk of life
now wear Strap Watches

The 21 Jewel Santa Fe Special

We will send this famous watch, express prepaid, for you to examine, to inspect, to admire, to approve without one penny advance payment. Examine the watch and be convinced it's the best watch buy you ever saw. Just a small payment down, the balance in easy MONTHLY payments. You use the watch while paying for it.

Save 1/3 to 1/2 of Your Money

By purchasing this Famous Santa Fe Special Watch. Not only are you saving money from the present day prices of watches, but you can still secure the "Santa Fe Special" Watch, at the same low prices and terms that have made our watches famous.

Ladies' Wrist Watches

Artistic, dependable ladies' wrist watches—perfect timepieces, beautiful hand engraved cases in white or green gold. Send for New Watch Book and see the new shapes and designs. Sent on approval and sold on payments.

Write for "Santa Fe" Watch Book

Clip the coupon, fill out and receive the FREE WATCH BOOK just off the press. All the newest watch case designs in white or green gold, fancy shapes and thin models are shown. Read our easy payment offer. Wear the watch 30 days FREE. Watch sent for your examination and approval without a penny down. Nothing to risk. See the watch before you buy.

Write for New Book Today and Select Your Watch.
Mail Coupon.

SANTA FE WATCH COMPANY

96 Thomas Building, Topeka, Kansas
(Home of the Great Santa Fe Railway)

A Limited Offer!

With every Santa Fe Special, a beautiful gold chain or strand of exquisite pearls. Write while offer lasts.

FREE BOOK COUPON

Santa Fe Watch Company
96 Thomas Building,
Topeka, Kansas.

Please send prepaid and without obligation your New Watch Book Free, explaining your "No Money Down" Offer on the Santa Fe Special Watch.

Name.....

Address.....

State.....

LUMINOUS PAINT

Make Your Watches, Clocks, Etc., Visible by Night

The very latest discovery in the scientific world, hitherto, practically unobtainable, has succeeded in producing this remarkable LUMINOUS PAINT, which, applied to the surface of any article, emits rays of white light, rendering it perfectly visible in the dark. THE DARKER THE NIGHT, THE MORE BRILLIANT IT SHINES. Quite simple to use. Anyone—you can do it. A little applied to the dial of your watch or clock will enable you to tell the time by night. You can coat the push buttons or switch plates of your electric lights, match boxes, and innumerable other articles; make your own Luminous Crucifixes, Luminous Rosaries, etc. Small bottle, price 25c. Larger sizes, 50c and \$1 postpaid. **JOHNSON SMITH & CO., Dept. 573, RACINE, WIS.**

Serpent's Eggs

Box contains 12 eggs. When lit with a match, each one gradually hatches, itself into a snake several feet long, which curls and twists about in a most life-like manner. Price per box, 10c postpaid, 3 for 25c.

CIGARETTE MAKER



Roll your own and save money. Makes them better and quicker besides saving more than half. Use your favorite brand of tobacco. Neat, useful and handy. Pocket size, weighs 1/4 oz. Made entirely of metal, nickel-plated. Price 25c postpaid.

MIDGET BIBLE

GREAT CURIOSITY
Smallest Bible in the World. Size of a postage stamp. 200 Pages. Said to bring good luck to the owner. A genuine work of art. Must be seen to be appreciated. Many good days of selling them to friends, church acquaintances, etc. PRICE 15c each, 3 for 40c, 12 for \$1.35, 100 for \$7.50. Also obtainable in Leather Binding, with gold edges. Price 50c each, 3 for \$1.25, \$4.50 per doz. Magnifying Glass for use with Midget Bible, 15c.



STAGE MONEY

With a bunch of these bills, it is easy for each person of limited means to appear prosperous by flashing a roll of these bills at the proper time and peeling off a genuine bill or two from the outside of the roll, the effect created will be found to be all that can be desired. Prices, postpaid: 49 Bills 20c, 120 for 50c, or \$3.50 thousand postpaid.

Wonderful X-Ray Tube

A wonderful little instrument producing optical illusions both surprising and startling. With it you can see what is apparently the bones of your fingers, the leg in a lead pencil, the interior opening in a pipe stem, and many other similar illusions. A mystery that no one has been able to satisfactorily explain. Price 10c, 3 for 25c, 1 dozen 75c. **Johnson Smith & Co.**



Good Luck Ring
Quaint and Novel Design

A VERY striking and uncommon ring. Silver finish, skull and crossbones design, with two brilliant, flashing gems sparkling out of the eyes. Said by many to bring Good Luck to the wearer, hence its name, Good Luck Ring. Very unique ring that you will take a pride in wearing. ONLY 25 CENTS.

JOHNSON SMITH & CO.

Dept. 573 RACINE, WIS.

A De Luxe Edition of our new 1927 CATALOG mailed on receipt of 25c. Handsome binding. Bigger and better than ever. Only book of its kind in existence. 550 pages of all the latest tricks in magic, the newest novelties, puzzles, games, sporting goods, rubber stamps, interesting books, cuttables, and plaques, etc., unobtainable elsewhere. Remit by Stamps, Coin, Money Order, Check, etc. Unused Canadian and Foreign Stamps also accepted.

Exploding Cigarettes



JUST LIKE ORDINARY CIGARETTES. BUT SUCH REAL STARTLERS! The box contains ten genuine cigarettes of excellent quality. They appear so real, but when each cigarette is about one-third smoked, the victim gets a very great surprise as it goes off with a loud BANG! A great mirth provoker yet entirely harmless. Price 25c per box.

Popular Watch Charms

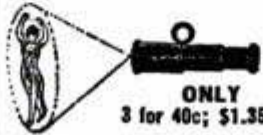

Very pretty little curiosities and decidedly novel. Fitted with Magnifying Lenses that enlarge the pictures to a very surprising degree; in fact, it seems almost incredible that a clear picture could be possible in such a small compass, and how sharp and distinct they show up when you look through. Come in assorted views—Actresses, views of Panama Canal, Lord's Prayer in type, etc.

Mystic Skeleton

A jointed figure of a skeleton 14 in. in height, will dance to music and perform various gyrations and movements while the operator may be some distance from it.



Novelty Badges



Kissing Permit 10c **Garter Inspector 10c**
Two very novel metal badges, nickel plated, that you can wear, giving you fun out of all proportion to their trifling cost. 10c, each badge, 3 for 25c, or 75c per doz. p.p.d.

MAGIC FLUTE

Wonderfully Sweet Toned and Musical



The Magic Flute, or Humanatone, is a unique and novel musical instrument that is played with nose and mouth combined. There is just a little knack in playing it which, when once acquired after a little practice will enable you to produce very sweet music that somewhat resembles a flute. There is no fingering, and once you have mastered it you can play all kinds of music with facility and ease. When played as an accompaniment to a piano or any other musical instrument, the effect is as charming as it is surprising.

BLANK CARTRIDGE PISTOL

Protection against Burglars, Tramps & Dogs

Prices
50c
\$1.00



Well made and effective; models in latest type of Revolver; appearance alone is enough to scare a burglar. When loaded it may be as effective as a real revolver without danger to life. It takes standard .32 Cal. Blank Cartridges obtainable everywhere. Price 50c, superior quality, \$1.00 postpaid. Blank Cartridges, by express, 50c per 100. Holster (Cowboy type) for Blank Cartridge Pistol, 50c. **Johnson Smith & Co., Dept. 573, Racine, Wis.**

BOYS! BOYS! BOYS!

THROW YOUR VOICE



Into a trunk, under the bed or anywhere. Lots of fun fooling the teacher, policeman or friends.



THE VENTRILLO

a little instrument, fits in the mouth out of sight, used with above for Bird Calls, etc. Anyone can use it.

Never Fails. A 32 page book on ventriloquism, the Ventrillo, ALL FOR 10 CENTS

K.K.K.



Everything about the Ku Klux Klan told in a clear, fearless manner. Book tells all—How it started and was oppressed in 1871—The New Ku Klux Klan—How Organized—How Members are Enrolled—Oath of the Klan—Questions for Candidates—Creed—Objects of the Order—Obedience—Fidelity—Pledge of Loyalty—Ku Klux Klan and the Masons—The Jews—The Masons—Real K. of C. Oath—The Negro Ku Klux Klan, etc., etc. Latest and most complete book on the Klan published. Price 35c, Postpaid. Stamps or Coin

PISTOL, OPERA & FIELD GLASS

PRICE POSTPAID \$1.00



LOOK!

It is made in the shape of and looks like a regular Automatic Pistol. No one is likely to stop and ask you whether it is real or not. Thus it is likely to prove itself very handy in an emergency. On pressing the trigger it opens up, as shown in the illustration at the right, revealing nine most useful articles—Opera and Field Glass, Telescope, Mirror, Magnifying Glass and Burning Lens, Reading Glass, Sun Dial, Sun Compass, etc. In the handle of the revolver there is a place for various pocket necessities, such as First Aid Articles, Buttons, Pins, etc. The Pistol is of sheet metal, blued finish, that can be carried comfortably in pocket. PRICE \$1.00.

HOT DOG! SENSATIONAL NEW NOVELTY



It is made of rubber like a small balloon. Contains a curious chemical that acts in a most remarkable way. Squeeze the deflated balloon with the hand and suddenly becomes quite warm and fills itself up with air. It is SELF-BLOWING. Play all sorts of jokes with it. Lay it on a chair; place it secretly underneath anyone; underneath anyone's pillow; drop it in someone's pocket, and after a short time, when friction causes the chemicals to act, a large and superbly colored balloon develops. Each Hot Dog in a small box. Quite harmless balloons of fun. 15c, each, 3 for 40c., \$1.35 doz. postpaid.



Female SEX Indicator 25c
Male Sex Indicator
Hold the MAGIC INDICATOR over a man's hand—instantly it moves in a straight line, backward and forward. Hold it over a woman's hand and it describes a complete and continuous circle. The same action can be obtained over a letter written by a man or woman, etc. It is fascinating; ha ha! We have never been able to figure out how it's done, but we've never seen it fail. Many novel and entertaining feats may be performed with the Sex Indicator. For example, similar results can be obtained with animals, cats, dogs, rabbits, over birds, chickens, canaries, etc. Also used to predetermine the sex of chickens and birds, etc., in fact it is sold as a patented sex tester in Europe. Price 25c, or 3 for 65c. p.d.

JOHNSON SMITH & CO., Dept. 573, RACINE, WIS.

A NEW BUSINESS —REAL MONEY!

Filing saws with the Foley Automatic Saw Filer pays as high as \$15 to \$20 a day. Practically no competition. One man using this machine can handle more saws than six hand filers—and do better work. Always plenty of business from carpenters, contractors, woodworking shops, meat markets, schools, machine shops and homes.

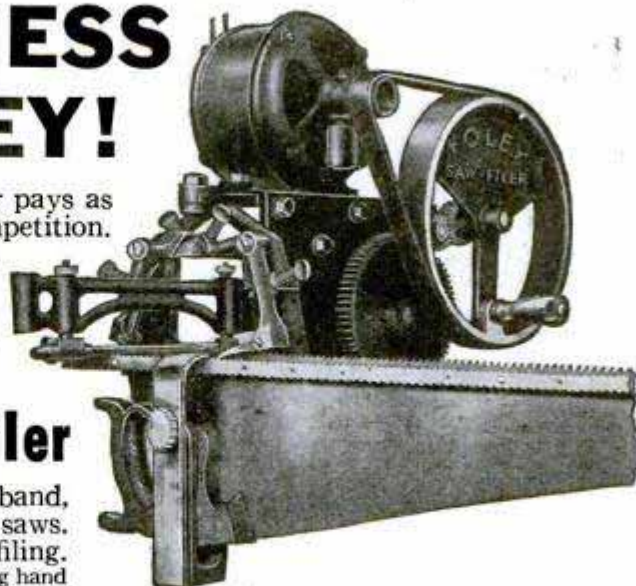

FOLEY Automatic Saw Filer

the only machine that sharpens hand, back, band, circular, and meat saws. Easily retoothes old saws. Does more perfect work than possible by hand filing. Motor and hand driven models. Get 50c or more for filing hand saws. \$1.25 to \$1.50 for retoothing. One machine files 6 to 8 saws per hour. Foley Rotary Saw Set gives a perfect set in *one minute*. Don't let anyone beat you to getting these easy profits and a business of your own. Mail the coupon *now* for complete information about Foley Saw Tools.

Foley Saw Tool Co.
Minneapolis, Minnesota

**\$10
BRINGS IT
TO YOU**

**Foley Saw Tool Co., 207 Foley Bldg.,
914 East Lake St., Minneapolis, Minn.**

Send complete information about Foley Saw Tools at once.

Name _____

Address _____



The New Sypher No. 10

Biggest lathe value on the market. Length over all 30 in.; between centers 14 in. Swing over bed 7 3/4 in. Includes counter shaft, bronze taper bearings. Weight 60 lbs. No. 11 Lathe, 40 in. over all; 24 in. centers, 7 1/4 in. swing. Price \$75.00. Time Payments if desired. Write today for circular.

\$60

The Sypher Mfg. Co. Dept. D Toledo, Ohio



Here's the Biggest Money Maker

It's Speed for Spots—the new Spot Cleaner, a self seller, 9 out of 10 buy. Just rubs the spots away—a cleaning plant in a bottle. Bank your profit every night—It's the sure road to independence. A 50c seller—everybody buys—send quarter for Sample and get our easy selling plan FREE.

SPEED SALES CO.

Dept. A, 1000 State Lake Bldg., Chicago, Ill.

\$ Profit by this Offer \$
You save 20 cents. Send us your dealer's name and 20c in stamps for one 40c sample of famous Valspar Varnish. You can get the clear varnish or in any color. State color desired. Valentine & Company, 452 Fourth Avenue, New York, N. Y.

Catch! Fish! Mink, Muskrats with our new foldin' galvanized **STEEL WIRE TRAP**. Write for our **FREE TRAP OFFER** and Bargain Catalog of Supplies. **\$1 Box** of our famous Fish Bait for 50c. **WALTON SUPPLY CO., 3505 JUNIATA AVE., ST. LOUIS, MO.**

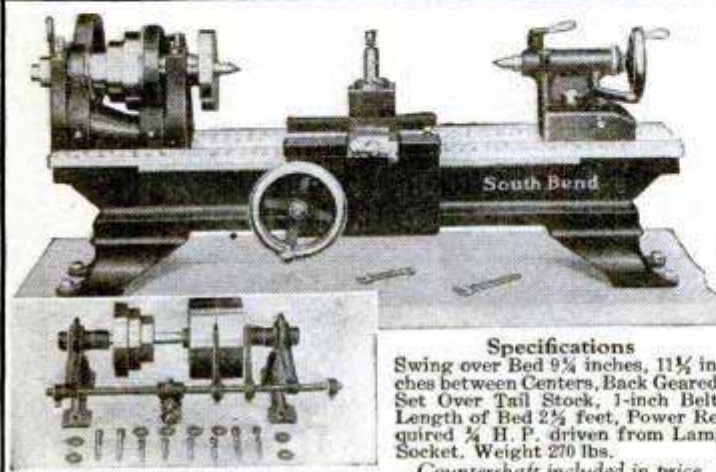

No. 20-B Special Lathe \$100

9-in. x 2 1/2-ft. 11 1/2-in. between Centers
No. 20-B is our regular Quick Change Gear Lathe stripped of all extras that are not needed in the small shop. Can be furnished with 3, 3 1/2 or 4-foot Bed—also Compound Rest and Long Legs at slightly extra prices.

Can Do All This Work

—turn Commutators, undercut Mica, turn Pistons, can be fitted with 6-in. Chuck, will bore, drill, etc., can also be fitted with our draw-in chuck attachment, capacity of Collets 0 to 1/2-inch. Write for Folder No. 20-S.

—Easy Payments if Desired—

South Bend Lathe Works
1813 E. Madison Street, South Bend, Indiana

Specifications
Swing over Bed 9 3/4 inches, 11 1/2 inches between Centers, Back Geared, Set Over Tail Stock, 1-inch Belt, Length of Bed 2 1/2 feet, Power Required 1/2 H. P. driven from Lamp Socket. Weight 270 lbs.
Countershaft included in price

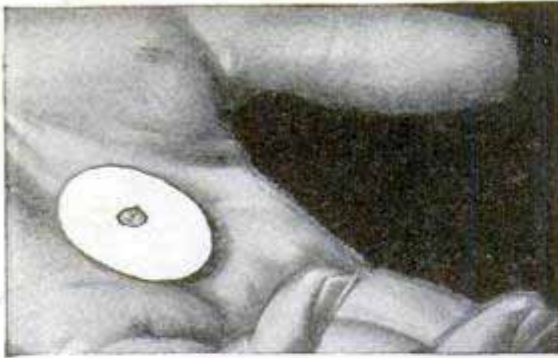

My Rupture Fear Vanished in 2 Seconds



In a flash I knew that at last science had given to rupture victims real, quick, positive relief. I knew that through the discovery of a well-known American Scientist my rupture suffering was over.

Tiny Magic Dot a Rupture Wonder

An extraordinary little device, weighing less than 1-25 of an ounce, now makes heavy, cumbersome, old fashioned devices, cruel springs, heavy straps and pads unnecessary. This new invention is called "Magic Dot," and by its use it is now possible to walk, run, jump, exercise, bend, etc., with perfect security—without cruel pressure or barbarously tight strapping. At last, here is a way to prevent coming down of rupture, and tiny Magic Dot is only a part of the wonderful New Science System.

Breathes Air

A wonderful new pad, light in weight, soft and pliable, actually breathes air. Smaller, much smaller, than you ever thought possible.

FREE Sample

The pad is made of an amazing new material called Airtex. A sample will be mailed absolutely free.

These two items are only a part of this new system that is said by doctors and rupture victims alike to be a thousand years ahead of all other methods.

FREE Inspection

We could never tell you all of the remarkable features of this modern, scientific rupture relief, but without risk you can have it for free inspection. Send no money. You can easily get full particulars and free illustrated material. Find out now how you can get New Science Rupture System for free inspection. Merely clip coupon, and mail it to

NEW SCIENCE INSTITUTE
2128 Clay Street Steubenville, Ohio, U. S. A.

NEW SCIENCE INSTITUTE
2128 Clay St., Steubenville, Ohio
Please send me at once full details of your free inspection offer. I am not obligated.

Name

Address

City.....State.....

Save On This Home
\$803

STERLING HOMES

This FREE BOOK Tells How!

\$1606 FREIGHT PAID

Just think! Through our amazing new plan you can get this \$2409 bungalow for only \$1606—a clear cut saving to you of \$803 or actually a third! We furnish you with the finest materials cut to fit direct from our mill—saving you big money on your lumber, mill work and labor. Satisfaction guaranteed or your money back.

Buy Direct from Mill—Save 4 Profits

You positively save four big profits by buying direct from our mill. We give you everything complete—all lumber cut-to-fit, windows, doors, flooring, shingles, lath, glass, paints, varnish, putty, hardware, nails, molding, cupboards—all plainly marked and easily assembled according to drawings and directions we furnish. We pay the freight. Write now for our beautiful book of homes which shows you a large number of lovely homes, priced from \$478 up. Send for it at once—no obligation.

INTERNATIONAL MILL AND TIMBER CO.
1-2 South Wenona Ave. BAY CITY, MICHIGAN

\$25.00 A DAY PROFIT

You and the wonderful new HB Paint Spray Outfit can do the work and get the wages of 5 men with brushes. Paint Houses, Barns, Factories, Furniture—do any paint job in 1/5th the usual time.

Painting by New, Quick Method!
No special experience necessary. Pays for itself on easy monthly payments with practically no expense to you. Full information in Bulletin P.

Write today to
HOBART BROS. CO., Box M-999, Troy, Ohio



A practical lathe for shop or home. Cone or Back Geared Head: 6" swing, 12" or 18" between centers; speed 130 to 1750 R. P. M. Will do wood or metal turning. Low price, high quality. Send for complete information on Baby Grand Lathe, Drill, Grinder, etc.

The Watson Mfg. Co., 199 Watson Bldg., Toledo, O., U.S.A.



DIVINE RED DEVIL Water Motors

Simple—strong—durable. Wonderful little workers for all sorts of household and shop uses. Thousands in use. For all light power purposes. Attaches to faucet.

Two sizes: 4"—\$4.25
6"—\$6.75

The higher the water pressure the more work they do.
Send today for catalogue.
Divine Water Motor Company
Utica, N. Y.

NEW DOUBLE-HEAD REVERSIBLE SPARK PLUG

ABSOLUTELY GUARANTEED FOR 2 YEARS

USERS "WILD OVER IT"

A New Spark Plug with increased value and efficiency—for all makes of cars, trucks and tractors. Double head means double service. Usable at both ends. Two plugs in one. Automatically cleans itself by running; without detaching wires. Color of spark, visible on top; shows how efficient they fire. Positively a sensation. Entirely new. Exclusive principle. In a class by itself. Everybody wild over it. All say it's a wonder.

MORE PROOF—G. Engessor of Iowa says:
"Your Double Head Reversible Spark Plug is the best I've ever used. I had to clean plugs daily before using yours."

EVERYBODY SATISFIED

There is nothing else like it—means unlimited spark plug service. Its life is perpetual. That's the reason we do not hesitate to guarantee it for two years.

NEW PRINCIPLE—SELLS ITSELF

Wherever demonstrated everyone is convinced of the increased value in this new principle and easily sells itself. Every user is a sales booster.

SPECIAL INTRODUCTORY OFFER

To the first person in each locality we are willing to send a set under a very special offer.

BE THE FIRST IN YOUR LOCALITY

CHICAGO TIRE LUG COMPANY, INC.,
SPARK PLUG SALES DIVISION
185-338 W. 47th St. CHICAGO, ILLS.



AGENTS "MAKE BIG MONEY"

This field is tremendous. The money-making possibilities are wonderful. Spare time or full time. They all make money. No experience necessary. Your profits are only limited by the number of automobiles in your locality. Every car owner that sees this new plug is interested and wants to buy.

VISIBLE CAP FITS EITHER END

\$60 TO \$120 PER WEEK

Ordinary profits do not belong in this class. Because the advertising value of each satisfied user creates a bigger demand and this demand must be supplied. That's why we want distributors everywhere. This means big money to each distributor. Irregardless of what you may have sold before, here is a real article, with a real proposition, in an unlimited field.

Agents Wanted Everywhere

The demand for territory will be big, so we advise you to act promptly. Remember, we want to be fair to everyone.

COSTS NO MORE Than Any Ordinary Spark Plug—Outlasts Them all



MAIL TODAY

CHICAGO TIRE LUG CO., Chicago, Ill.
185-338 W. 47th St.,
Gentlemen:—Kindly mail me free particulars about your latest invention and direct factory selling plan.

Name.....
St. or R. F. D.....
City..... State.....



Lighting Fixtures

READY TO HANG

(Direct from the Manufacturer)

Completely wired, including glassware. Send for New Catalogue No. 27. Just reduced prices.

Special proposition to DEALERS.

ERIE FIXTURE SUPPLY CO.
STA. A ERIE, PA.



\$100 a week Selling Shirts

Fred Frankel, Ills., writes: "I learned \$110 first week selling Carlton Shirts direct to consumer." You can too. No capital or experience required. We pay 25 per cent. cash commissions daily and big extra bonuses.

WRITE FOR FREE SAMPLES
CARLTON MILLS, Inc., Shirt Mfrs.
114 Fifth Ave., Dept. 106-A, New York

WILL YOUR FORD GO 66 MILES ON 1 GALLON?

Walter Critchlow, M-805 Street, Wheaton, Ill., has patented a new Vapor Humidifier and Gas Saver that beats anything ever gotten out. It causes autos to give amazing mileage and automatically frees them from hard carbon troubles. One Ford owner reported 66 miles on 1 gallon. It is for all makes. Mr. Critchlow offers 1 free to quickly advertise. Write him for one. He also wants county and state distributors who can make \$500 to \$2500 per month.

FOR HOTTER HEAT — Perfectly Controlled

When a man wants heat—for soldering a pan—for mending a waterpipe—for electric or phone line work—etc., etc.—when he wants real heat for any job, big or small, he wants that heat steady, dependable, and hot.

The man who knows—the skilled mechanic—asks for the

TURNER BLOTORCH
Safe as a Candle

MASTER No. 45

\$8.25
Post Paid

Gives 400° greater heat, with present day inferior gasoline or kerosene. Operates steadily in wind or coldest weather. Doublevalve system insures perfect flame control at all times. These are part of the 11 patented superior points of the Turner Master No. 45 Blotorch.

Ask Your Dealer

Ask for a Turner Master No. 45. If he hasn't it—don't let him substitute—he can get it if you insist. Or send direct to the factory—\$8.25 postpaid and "fearlessly guaranteed."



THE TURNER BRASS WORKS
Industry Ave., Sycamore, Ill.

OXO-GAS OIL BURNERS



OXO-GAS oil burner for ranges One of 20 types for all purposes.

For Furnaces, Ranges, Heating Stoves, Etc.
 OXO-GAS, the cheapest, cleanest, most efficient fuel known to science, is made from kerosene or distillate, and air, mostly air. Burns with a pure blue flame of high heating intensity, as silently as city gas. *Over a million in use.* Manufactured by the oldest (est. 1906), highest rated and most responsible corporation. *Ask any bank. Send for Catalog* illustrating and describing twenty different distinctive designs of oil burners for *Furnaces, Cook Stoves, Heating Stoves, Base Burners, Hot Water Heaters, etc.*

Agents Wanted Some choice territory for OXO-GAS agencies still open to thoroughly responsible parties. Your own locality may yet be unassigned.

GLORIA LIGHT COMPANY, 115-9 N. May St., Chicago, Ill.

Now You Can Play A Trumpet



You can play "the cat's meow," and all other barnyard "wows," stunts and crescendos. The TRUMPET is the star performer in every orchestra and band. It's the TRICK instrument, when one is needed, yet gives the piercing brilliancy and color range required for regular work. The ideal instrument for you to learn to play for home, church, school, orchestra or band. Here's a Trumpet at a remarkably low price that will appeal to you.

FREE TRIAL OFFER **Pan-American Trumpets**
 Easy to Learn - Easy to Play!

Own a PAN-AMERICAN Trumpet. Write today for our free trial offer and easy payment plan on PAN-AMERICAN'S. You can own a PAN-AMERICAN Trumpet and become a leader in any musical organization. The PAN-AMERICAN Trumpet is performed by great artists—yet it is medium priced. Send coupon below for beautifully illustrated booklet describing this wonderful music-maker—as well as our complete line of PAN-AMERICAN Band Instruments.



SEND NO MONEY JUST MAIL COUPON
 The Pan-American Band Instrument & Case Co.,
 Elkhart, Indiana—Dept. G-1

Send me complete information on Pan-American Trumpets and other band instruments.

Yes! Name _____
 Address _____
 City _____ State _____

The man who studies gets ahead. Popular Mechanics Press will advise you what books to read to advance in your trade, 200 East Ontario Street, Chicago, Illinois.

I Have a Product— that SELLS to 9 out of 10 Men or Women.

Ten calls a day nets you \$16.00 profit. Write me all about yourself and I'll send you an outfit that will start dollars rolling in.

**FORREST DUSTIN, 932 Wrightwood Ave.,
 Dept. F-179, Chicago**

21 Jewel Burlington



Only \$100 Down

The 21-Jewel Burlington is sold to you at a very low price and on the very special terms of \$1.00 down—free examination—small monthly payments after acceptance. Send today for information.

Free Book Send for the most complete watch book ever produced. 100 designs and engravings beautifully illustrated in colors. Write for it today, it is free. A letter or a postcard will do.

Burlington Watch Company 19th St. and Marshall Blvd.
 Dept. 13-56 Chicago, Ill.

Make \$100 Weekly—sell RADIO

Demonstrate Once—Results Mean Sure Sale

Sell what everybody wants—radio at low prices—easy sales—big profits—music from Coast to Coast—4, 5, 7 tube radio.

12 Selling Free Lessons

Establish a business of your own. Start in spare time—evenings. Sales course of 12 lessons and 10 radio service lessons teach you everything you need. Exclusive territory to proven men!

FREE Book! Tells how 3100 men have made big increase in their income under this unusual plan. Ask for Ozarka Plan No. 100 and don't fail to mention the name of your county.

**OZARKA, Inc. 120 Austin Avenue P,
 Chicago, Illinois**



DARGHE "CALL-ME" ELECTRIC ALARM AND LIGHT CLOCK



Will ring until you get up and STOP it. No home complete without one. Can be used as an "alarm clock" or "morning clock." With a little effort on your part you can get one.

FREE OUR OFFER TELLS YOU HOW

Agents, here is a big money-maker, no competition, sells on sight. A good punch board proposition. Write today for our descriptive literature. An ideal GIFT for any occasion. Mahogany finish. Size 10 1/4 x 8 1/4 x 4. This applies to U. S. only.

Darche Mfg. Co., 645 Washington Blvd., Chicago

500 Punctures Without Loss of Air

**OVER
1,000,000
SOLD**



**ILL PAY YOU BIG MONEY
To Demonstrate My Guaranteed
MILBURN PUNCTURE-PROOF TUBES**

20,000,000 CAR OWNERS

Are waiting for my amazing long-life, no trouble, air-filled, puncture-proof inner-tube—the *only* tube to successfully withstand the 500-nail-hole-plank-test without loss of air.

Costs no more than the ordinary tube and is sold under a *positive, money-back guarantee.*

WARNING
I am the originator of the air-filled puncture-proof tube. Beware of imitators. I have no other connection with any "so-called" puncture proof tube. —M. E. Milburn.

MAKES MOTORING A PLEASURE—DOUBLES TIRE MILEAGE

Users of *Milburn Puncture-Proof Tubes* everywhere are enjoying the easy riding performance of the air-filled tube *without the annoyance of punctures and slow leaks.* And a tire mileage increase from 12,000 to 15,000 miles. Many users report 30,000 miles (double mileage) without removing a tire from the wheel.

TEST THE MILBURN AT MY RISK

You'll be delighted. And you'll realize how easily orders are secured. Sales experience is not necessary to coin money selling the *Milburn. Positively the biggest tube value obtainable.* Absolutely non-competitive. I control all basic patents. Car owners buy on demonstration. It makes no difference what tires they use or what car they drive.

\$178.56 IN 6 DAYS

That's what A. Murphy made the first six days out with *Milburn Puncture-Proof Tubes.*

\$14.04 in 10 Minutes

"I made \$14.04 in ten minutes with your tubes."—Chas. Clayton.

\$58.50 in 3 Days

"The first three days out selling your tubes I cleaned up \$58.50.—J. C. Jerves.

MONEY BACK GUARANTEE

We hereby agree to refund to any purchaser the full amount paid for any *Milburn Puncture-Proof Tube* that leaks air when punctured by anything not larger than a twenty-penny spike. We also guarantee that casings will last much longer and give much greater mileage where *Milburn Puncture-Proof Tubes* are used.

Milburn Puncture-Proof Tube Co., Inc.

PROOF

J. D. Cooper—"I have made 30,000 miles with my *Milburn Puncture-Proof Tubes* and have not as yet removed a rim or casing and my casings are in excellent condition."

J. T. Berdahl—"Have been using *Milburn Tubes* since 1922, driving every day. Have pulled out any number of nails without loss of air."

S. C. Wintrey—"I have driven 500 miles in one of my *Milburn Puncture-Proof Tubes* without loss of air."

J. S. MacElroy—"Received the shipment of 200 *Milburn Puncture-Proof Tubes* and find them as represented. Hope to send you another 200 tube order soon."

W. H. Rodman—"I wish to praise your *Milburn Puncture-Proof Tubes.* They can't be beat. I drove 15 miles in one tube and I haven't put any air in it since. Everyone is wild over your tubes."

FREE TUBE OFFER

Stop working for others! Get into business for yourself selling *Milburn Puncture-Proof Tubes* and you, too, can make big money. My *No-Capital-Direct-From-Factory-Sales-Plan* makes it easily possible. Line up your territory rights on this whirlwind seller—full or part time—NOW. National advertising campaign just starting. Big season here. Act quick. Clip and mail the FREE TUBE COUPON—NOW.

References } Industrial State Bank, Chicago.
Baker State Bank, Chicago.

M. E. Milburn, Pres.

Milburn Puncture-Proof Tube Co., Inc.
178-336 W. 47th St., Chicago, Ill.

MAIL NOW

M. E. Milburn, President
Milburn Puncture-Proof Tube Co., Inc. FREE TUBE COUPON
178-336 W. 47th Street, Chicago, Ill.

If the money-making opportunity is as big as you claim, I am interested in receiving the facts so that I can enjoy a share of the profits selling *Milburn Puncture-Proof Tubes.* Without obligation, send me information about commission and Free Tube Offer to agents.

Name

Address

City State



We're Sending Men

10-day tubes of Palmolive Shaving Cream, free, to prove its case.

GENTLEMEN:—We have a shaving cream that softens the toughest beard in one minute—that does things, men tell us, no other shaving preparation before it has ever done.

Its success is a national sensation. Eight in ten who try it become enthusiastic. Now in courtesy to us, will you accept a 10-day tube to try?—give it a chance to prove its claims to you?

Now the best that we know, we've put in this new creation. There is no other like it. We made it to the expressed order of 1000 men who told us their supreme desires in a shaving cream, plus a fifth . . . strong bubbles . . . the supreme requirement of all. We made and tested 130 formulas before perfecting it.

Note these five

- 1—Multiplies itself in lather 250 times.
- 2—Softens the beard in one minute.
- 3—Maintains its creamy fullness for 10 minutes on the face.
- 4—Strong bubbles hold the hairs erect for cutting.
- 5—Fine after-effects due to palm and olive oil content.

Send the coupon

You may think your present cream is supreme. But you can't be sure without trying this new creation.

Let us send you a tube . . . both for your sake and for ours. We'll rest our case on what you find. Send the coupon. Mail it before you forget.

To add the final touch to shaving luxury, we have created Palmolive After Shaving Talc—especially for men. Doesn't show. Leaves the skin smooth and fresh, and gives that well-groomed look. Try the sample we are sending free with the tube of shaving cream. There are new delights here for every man who shaves. Please let us prove them to you. Clip coupon now.

THE PALMOLIVE COMPANY (Del. Corp.)
CHICAGO, ILLINOIS

10 SHAVES FREE

and a can of Palmolive After Shaving Talc

Simply insert your name and address and mail to Dept. B-1239, The Palmolive Company (Del. Corp.), 3702 Iron Street, Chicago, Ill.

Residents of Wisconsin should address The Palmolive Company (Wis. Corp.), Milwaukee, Wis.

PLEASE PRINT NAME CLEARLY

SM

Quality

— such as you've never heard. The Silver-Marshall 220 audio transformer compensates not only for short comings in modern broadcasting but it is the first transformer manufactured with a rising low note characteristic which compensates for conditions of a reverse nature in our speakers. Price \$6.00



The
220 & 221

Read more about it in the "Secret of Quality" which covers every practical phase of audio amplification. Get a copy of this 96 page book from your dealer. Price, 10c.

SILVER-MARSHALL, INC.

840 West Jackson Blvd.

Chicago, U. S. A.

FROST-RADIO

Type 880 Super Variable Resistance

These new non-inductive, variable high resistance units are precision instruments which operate smoothly and noiselessly from zero to maximum rating. Have low temperature coefficient. Lever makes positive rolling contact with resistance element with absolutely no wear. Designed for use as tone and volume control, for resistance coupled amplification, to control regeneration, and as a stabilizer. Furnished in following resistances: 50,000, 100,000, 200,000, and 500,000 ohms. List: \$1.25.



HERBERT H. FROST, Inc.
160 N. LaSalle St., Chicago New York City Los Angeles

Pin a Dollar Bill to This

and get this fine 5 card case. Genuine leather. Masonic or Shrine emblem stamped on in gold free. (No other emblem supplied on this case.) Your name or other stamping 35c extra per line.

Cash must accompany order



We carry
**EVERYTHING
MASONIC**

Send for free catalogue No. 3 of Books, Monitors, Jewelry; No. 4 of Lodge Supplies.

We have been in business 67 years!

REDDING & COMPANY

200 Fifth Ave., or 9 West 23 St.

New York



Tires Run 44,000 MILES

with this
Air Tight Cap
Constant
Pumping
Unnecessary



Actual photograph of a tire which, equipped with Hughes Valve Cap, has run over 44,000 miles

TIRE experts all agree that even pressure and proper inflation lengthens the life of tires. The Hughes Air-Tight Valve Cap acts as a seal on the valve, thus preventing leakage of air. This little cap does a big job perfectly. It eliminates the annoyance and bother of constant inflation, and most important of all, increases tire mileage.

Live agents are making big money distributing THE HUGHES VALVE CAP. Mr. O. S. Durr of Kansas City started selling Hughes Valve Caps in a small way. The first year he sold 14,910 sets, and his business has now reached the volume of 5,200 sets in a single month. Mr. J. A. Haines of Carey, Ohio, has sold over 12,000 sets in 5 months.

\$100 a Week and More

To live wire salesmen who want to get in the big money class, we will send our complete sales plan, explain our exclusive territory offer and send a

FREE SAMPLE

You can build a permanent, constantly increasing sales business introducing the Hughes Valve Cap. It has the endorsement of big leaders in the automobile industry such as Dodge Brothers, Goodyear Tire & Rubber Company, and Firestone Tire & Rubber Company. Sign and mail the coupon below TODAY.

Cross
Section
Hughes
VALVE
CAP

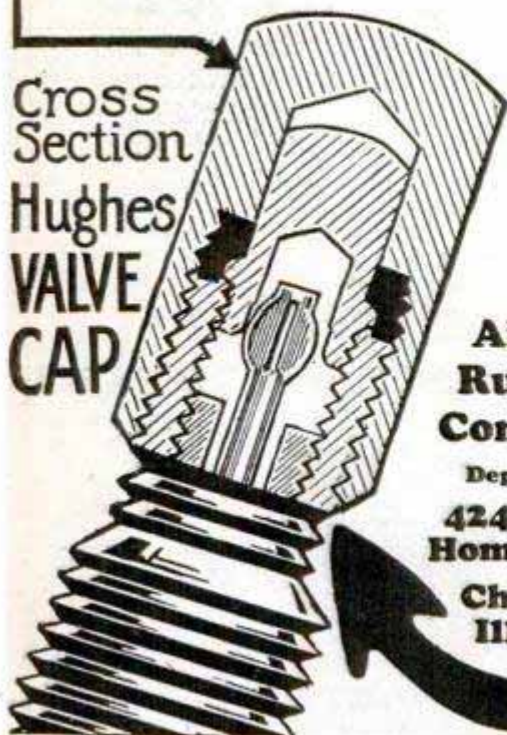

**Airlox
Rubber
Company**

Dept. 541-H

424 North
Homan Ave.

Chicago,
Illinois

AIRLOX RUBBER COMPANY, Dept. 541-H
424 N. Homan Ave., Chicago, Ill.

I want to know how I can make \$100.00 a week or more and build a permanent business for myself selling Hughes Valve Caps. Give me full particulars of your proposition and your exclusive territory offer, also send me a free sample.

Name _____

Street or R. F. D. _____

Town _____ State _____

LET AN EXPERT TELL YOU

all about wood finishing

HOW TO MAKE BIRCH
LOOK LIKE MAHOGANY

HOW TO RENEW OLD
SHABBY FURNITURE

HOW TO RENOVATE
2nd-HAND FURNITURE

ETC., ETC., ETC.

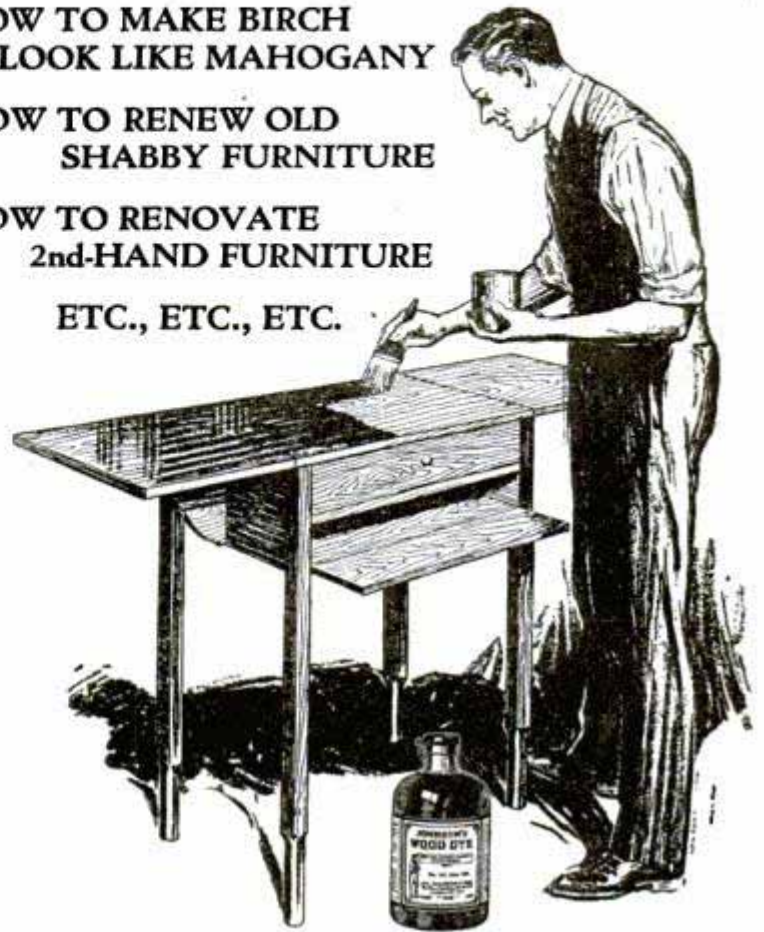

This free book we offer will teach you the methods by which professionals do the finest wood-finishing. You can soon master all the best ways to make inexpensive soft wood perfectly resemble rosewood, ebony, walnut, mahogany. You will know all the "tricks of the trade."

Save Yourself Money!

The book will show you how best to finish things you build at home. Or how to renovate shabby, worn furniture to look new again. These are profitable, practical things to know how to do right. The book will tell you. *Get it.*

JOHNSON'S WOOD DYE

PENETRATES DEEPLY—WILL NOT SMUDGE

This is the easiest of Wood Stains to apply, the finest in results. Dries in four hours, bringing out all the natural beauty of the grain without raising it. It never can rub off nor smudge at all. Color charts in the book show 17 handsome shades, which you can lighten, darken or mix to suit your wishes. Some reliable store near you sells Johnson's Wood Dyes, including these highly popular numbers:

131—Walnut
123—Dark Oak
127—Brown Mahogany

126—Light Oak
124—Golden Oak
129—Dark Mahogany

SEND IN THIS COUPON

Mail it to S. C. JOHNSON & SON Dept. P. A. 9 Racine, Wis.

First ask for a FREE copy of this 25c book at the hardware store or paint supply dealer in your neighborhood. If he cannot supply it, mail this coupon for one and we will send FREE AND POSTPAID.

Name

Address

City and State

Dealer You Asked

PRACTICAL! RELIABLE!
and

FREE
To YOU!



The last word on wood finishing as experts do it. Lavishly illustrated, talks plain English, tells all you want to know.

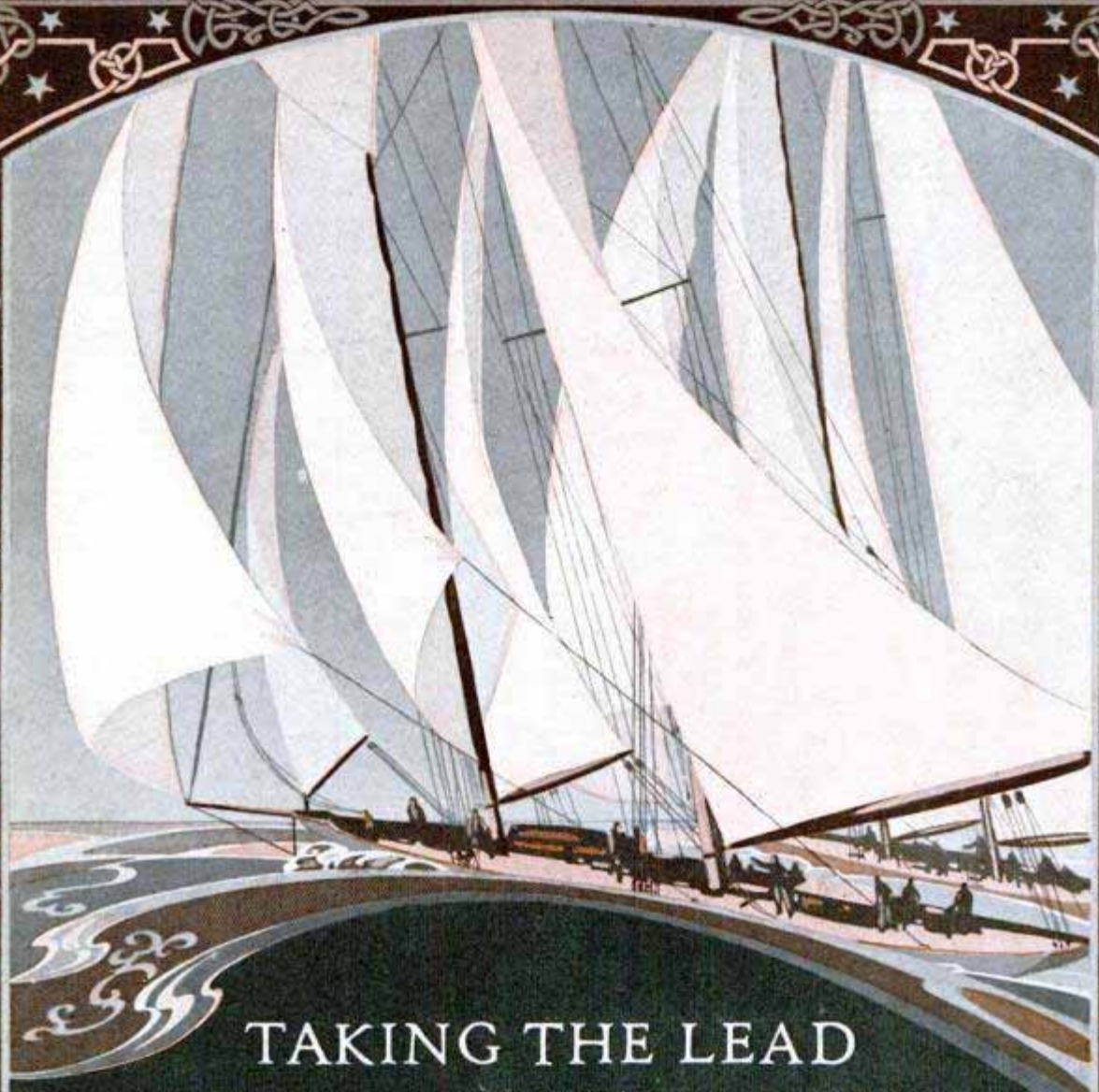

TAKING THE LEAD

For CHESTERFIELD'S swift gains, look to the cigarette itself, its unchanging good taste, and its unvarying high quality

Chesterfield



W
LIGGETT
& MYERS
TOBACCO
CO.

WDT

A WARM HOUSE
IN THE MORNING~

HARDIN-LAVIN
ALL-CAST

PIPELESS FURNACE

SAVE HALF-INSTALL YOUR OWN

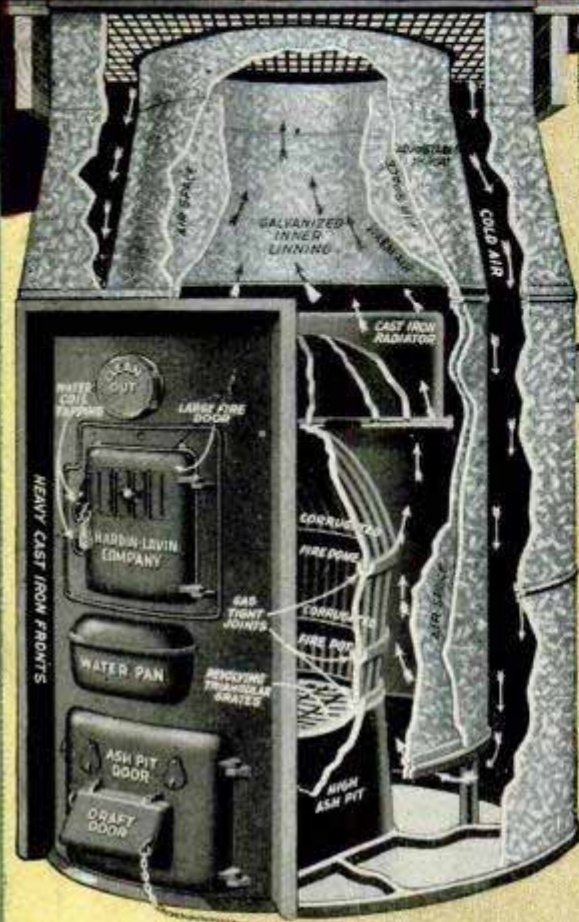

The Hardin-Lavin Company founded 50 years ago this year has specialized from the beginning in highest grade Plumbing and Heating. This reputation for square dealing over half a century is backed by our Million Dollar plants and Bonded Guarantee. As our 50th Anniversary Special, we now offer the new improved model, all-cast Pipeless Furnace at a remarkable low wholesale price.

Burns Any Fuel—Needs Less Attention

This superior, all-cast Pipeless Furnace burns any kind of fuel with equal satisfaction. Designed to give the utmost in heating results. No other Pipeless Furnace will give you more heat from the fuel used than will this new model, Hard n-Lavin.

Heats the Whole House.

The firepot that keeps the fire just as hot at the outside edges as at the center. Forever does away with the inconvenience of a stove and gives you a complete Pipeless Furnace heating plant at **less than the cost of the average heating stove.** You can do the installing yourself without previous experience. We send clear instructions that anyone can understand. A house equipped with this heating plant is comfortable in any weather, clean and attractive at all times and much more easily salable.

Special
at
\$62.95

For 5 Room
Size

Double Casing—No Heat Lost

A double air-and-asbestos-insulated heavy galvanized casing encloses the furnace. Ample air return insures good circulation. You get wholesale price and bonded guarantee. Order today and save.

Model	Firepot	Heat Capacity	Special Price
PM-88	18 in.	10,000 ft.	\$ 62.95
PM-89	20 in.	14,000 ft.	72.75
PM-90	22 in.	18,000 ft.	86.80
PM-91	24 in.	28,000 ft.	99.25
PM-92	28 in.	40,000 ft.	132.95

NOTE: For large houses with high ceilings and many partitions, we recommend our warm air pipe furnace. Send for catalog.

HARDIN—"Furnaceola"
LAVIN
SMALL—BEAUTIFUL—EFFICIENT
THE NEW HOME HEATER



More Heat—
Less Cost **\$67.50**

The Hardin-Lavin "Furnaceola" represents the latest development of a strictly high class furnace that can be set on the first floor and yet heat the whole house to a uniform temperature. Designed to take the place of old style, inefficient heaters in homes, stores, offices, churches, etc., where there is no basement.

Furnace Heat, Stove Economy

Constructed just like a high class furnace. Circulates moist air to the farthest corner of every room in any weather. The "Furnaceola" has heavy outer jacket, open bottom and top, for rapid air circulation. Holds fire full 24 hours under test. Burns any fuel. Can be equipped extra with magazine for burning only hard coal. Will heat 6 or 7 good-sized rooms with no more fuel than old style stove. Size: 47 inches high over all. Floor space occupies 22x22 inches. Takes 7-in. stove pipe.

PM-1061—Cast iron nickel trimmed	\$67.50
PM-1057—Grain mahogany enameled	74.50

Grade A Quality Guaranteed Plumbing Outfits

—at **WHOLESALE!** We help you plan and install. Send us your blue print or rough sketch of room arrangement and we will figure without obligation the exact cost of bathroom, kitchen and laundry plumbing; heating plant, water supply system or complete equipment.

HOT WATER HEATING PLANT CUT-TO-FIT GUARANTEED

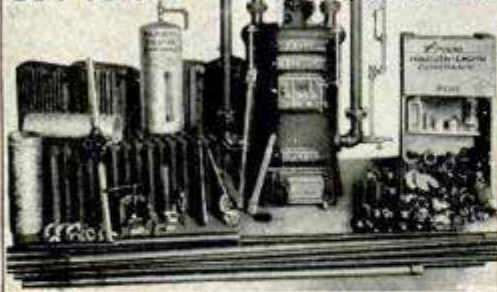

Hot Water Heating Plant as low as \$200.00 complete

MAIL COUPON FOR FREE BARGAIN CATALOG

We are helping thousands to save and make money. Our free Bargain catalog explains how. Send for your copy today. Our outfits are cut to fit the exact job. Installing plans, diagrams and complete instructions free so that any handy man can do the installing. All orders are shipped from our Chicago plant the day they are received. It means a lot to know that you will get prompt service and square dealing.

HARDIN-LAVIN COMPANY

When in Chicago visit our new plant at
107-17 W. PERSHING ROAD CHICAGO, ILL.

SPECIAL! Deferred Payments

In addition to highest grade goods at wholesale and the many other Hardin-Lavin advantages of easy installing features, free plans, etc., we have now also made arrangements so that you can **BUY ON EASY TERMS.** Nowhere else can you find this complete combination of quality goods, wholesale prices, exclusive features, and budget plan of payment.

Our Bonded Guarantee Protects You

Every system or fixture is backed by our bonded guarantee, million dollar plants and 50 years' reputation for highest quality goods at lowest possible prices.



Send for
Your
FREE
Copy
Today

Full of
Big Bargains

HARDIN-LAVIN CO., 107-17 W. Pershing Road, Chicago, Illinois

Gentlemen: Please send me your free bargain catalog with special wholesale prices and easy terms. I am interested in the articles checked below but this puts me under no obligation:

- | | | | |
|---|--|---|--|
| <input type="checkbox"/> H. W. Heating Plants | <input type="checkbox"/> Pipeless Furnace | <input type="checkbox"/> Water Supply System | <input type="checkbox"/> Bathroom Plumbing |
| <input type="checkbox"/> Steam Heating Plants | <input type="checkbox"/> Warm Air Pipe Furnace | <input type="checkbox"/> Kitchen & Laundry Plumbing | <input type="checkbox"/> Furnaceola |

Name..... Address.....