

FEBRUARY

Built-In Radio—Page 297

N.S.E.
25 CENTS

POPULAR MECHANICS

MAGAZINE

WRITTEN SO YOU CAN UNDERSTAND IT

REG'D. TRADE MARK GREAT BRITAIN, No. 410438

REG. U.S. PAT. OFF.

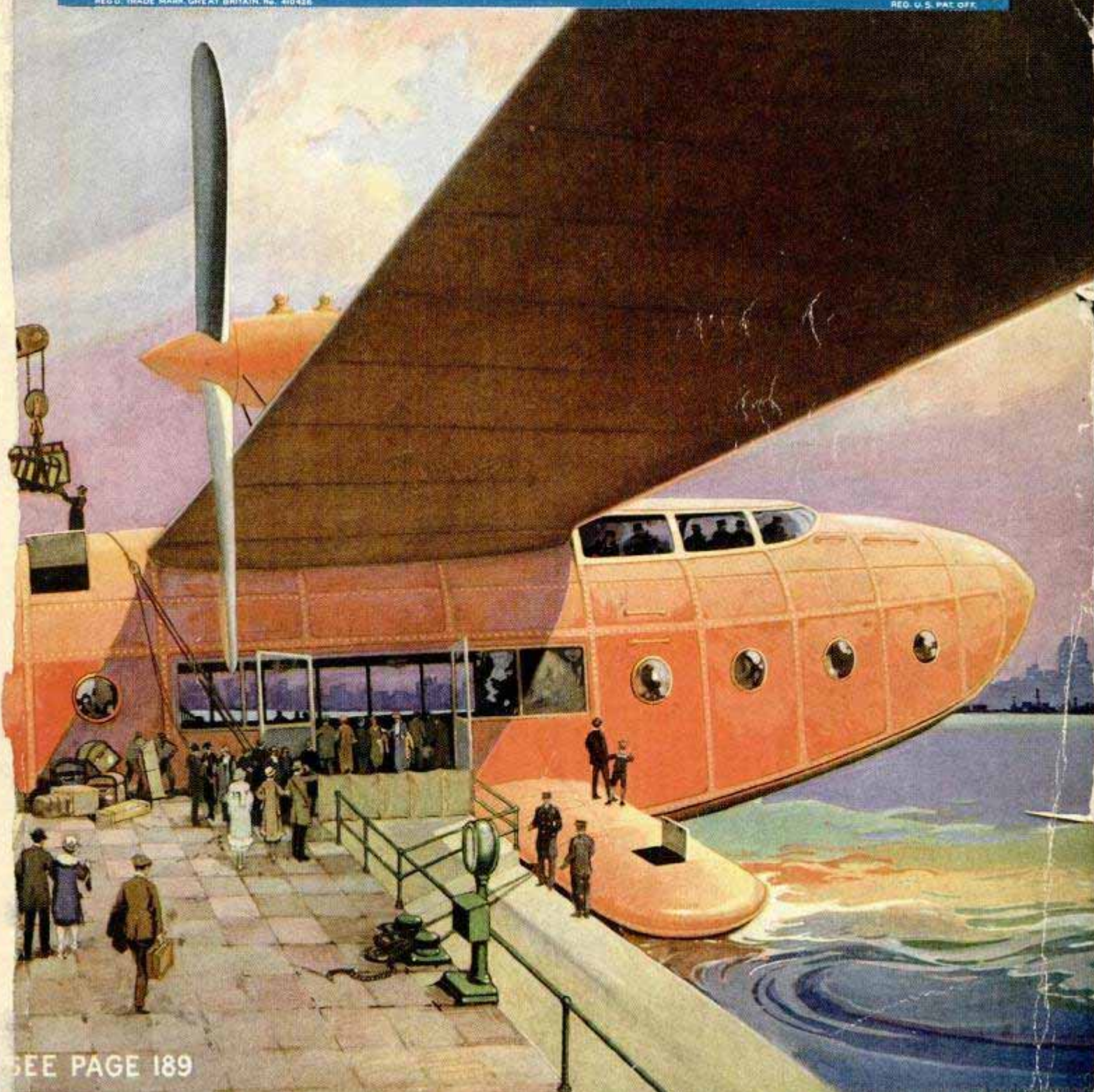

SEE PAGE 189

It takes *only* 8 weeks to get a big job



George W. Smith runs a big Ford Agency and Repair Shop at West Alexandria, Ohio. He says, "I am clearing over \$800 per month."



My method is the shortest successful system ever known for training Big Salary men.
J. H. MCSWEENEY,
President.

Read what these men are doing in the Auto, Tractor and Electrical Business. Here is your big chance to get "on easy street." Come to the great McSweeney Shops on the biggest Special Offer ever made.

Big Firms Need Trained Men

The Auto, Tractor and Electrical Business is on the boom. Thousands of trained men will be needed during the next few months. I get calls every day from Garages, Battery Stations, Auto Repair Shops and other **successful** concerns for McSweeney men. When the big fellows need high-grade men, they know where to come for them. **They want McSweeney-trained men.**

My Training Unusual

Scientific tool training—that's the secret. You do things here according to the latest engineering standards. Thousands of dollars have been spent in modern tools and equipment. That's why my men are at home in the biggest shops in the country. If you want to succeed the way Smith and Collins and the rest have—qualify by the same method.



C. E. Gillispie has charge of a fleet of trucks and tractors with the State Highway Commission, due to McSweeney training.

I'll Pay Your Railroad Fare and Board You

In order to fill the openings that now exist, I am making an offer no one has ever made before—**Free railroad fare, Free board.** But even that is not all. I'll tell you about the rest in my letter.



W. W. Peace gets \$250 a month and expenses operating a tractor in the oil fields.

Send for **FREE** Book

My big illustrated training book tells how others are succeeding. It tells many things you ought to know about Autos and Tractors. Write for it and my **short time** offer NOW. It soon expires.



D. M. Collins, Williamsville, West Virginia, writes, "Shortly after finishing McSweeney training, I started in as manager of a garage at \$300 per month."

McSweeney AUTO TRACTOR AND ELECTRICAL Shops

Dept. 147
CINCINNATI
9th and Walnut

Dept. 147
CHICAGO
517 So. Laflin

Dept. 147
CLEVELAND
1815 E. 24th St.



McSweeney Auto, Tractor and Electrical Training Shops,
Dept. 147 (Address shops nearest you)
Cincinnati, O., or Chicago, Ill., or Cleveland, O.

Without any obligation send me your big free book on Autos. Also information regarding special temporary offer.

Name.....

Street.....

City..... State.....

3 Big Training Shops
Cincinnati Chicago Cleveland

give your radio set more power with one new Radiotron

DRIVE a car uphill beyond its power—and the motor knocks. Drive a radio set beyond its power—and the last tube chokes. But change one single tube in the set—and you have the power you need for *greater volume* and *finer tone*.

The new RCA power tubes add about fifty per cent greater efficiency to any radio set. They cost but \$2.50, and need only an inexpensive adapter and a little extra current. Change the tube of the last audio stage to a new power tube, as any dealer will show you—and in ten minutes you have a new set.



Radiotron UX-112
\$6.50

RADIOTRON UX-112

The new storage battery power Radiotron UX-112 may be used in sets that use Radiotron UV-201-A.

RADIOTRON UX-120

The new dry battery power Radiotron UX-120 may be used in sets that use Radiotron UV-199.

You would not use any but a Mazda lamp in your lighting circuit. Why use any but an RCA Radiotron in your radio set? They are made by the same skilled workers, backed by the same research laboratories. But the Radiotron is far more delicate to make.



Radiotron
UX-120
\$2.50

RADIO CORPORATION OF AMERICA
NEW YORK · CHICAGO · SAN FRANCISCO

RCA Radiotron

MADE BY THE MAKERS OF RADIOLAS



BGG2-8NL-W4LK

Maybe his wife was right

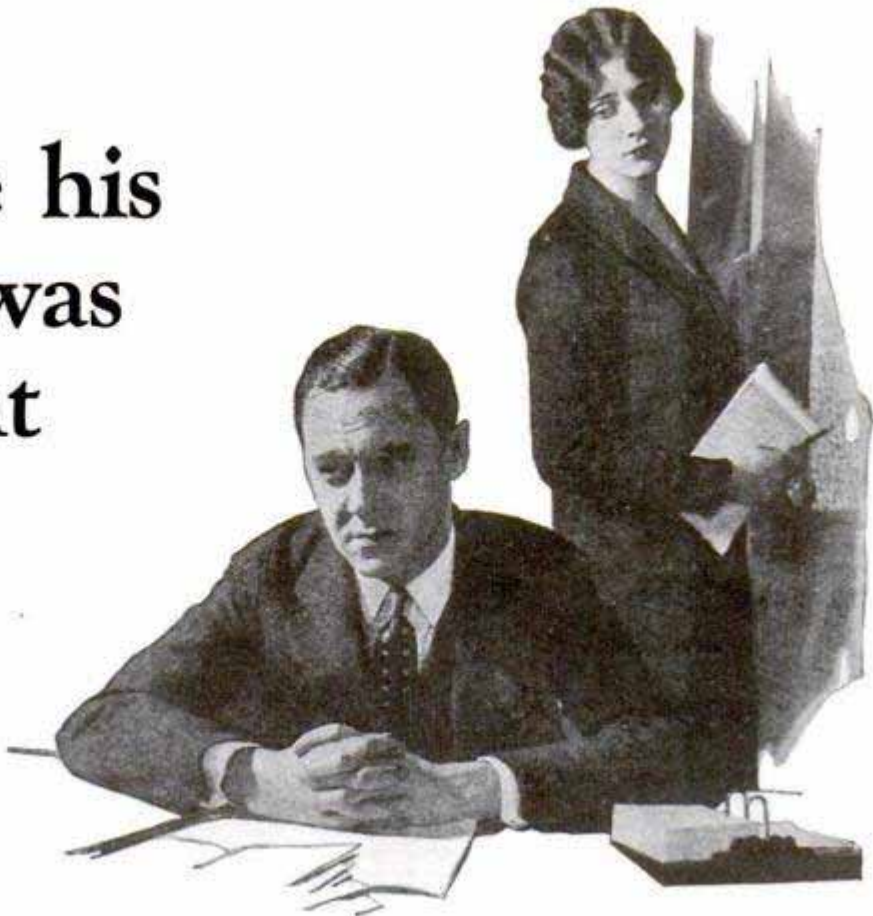

HE had ability, he dressed well—but several recent opportunities in the office had gone to other men. Maybe his wife was right. She had tried to be tactful when she told him—and now he was going to do something about it.

* * *

A great many men are inclined to have a grimy-looking skin, spotted with blackheads and dull in appearance. Few realize that this hinders their success in life. Pompeian Massage Cream helps you overcome this handicap by giving you a clean, ruddy complexion.

Clears the Skin: Pompeian Massage Cream thoroughly cleanses the pores. It helps clear up blackheads and pimples by stim-

ulating healthy circulation, and by keeping the skin clean and the pores open.

Easy to Use: After shaving or washing, rub it in gently. Continue rubbing and it rolls out, bringing with it all the dirt and skin impurities. Result—a clean, healthy skin with clear, glowing color.

Special Introductory Offer

$\frac{1}{3}$ of 60c jar for 10c

For 10c we send a special Trial Jar containing one-third of regular 60c contents. Contains sufficient Pompeian Massage Cream to test thoroughly its wonderful benefits. Positively only one jar to a family on this exceptional offer.

The Pompeian Co., Cleveland, O., Dept. 75
Gentlemen: I enclose a dime (10c) for $\frac{1}{3}$
of a 60c jar of Pompeian Massage Cream.

Name _____

Address _____

City _____ State _____



AT YOUR DRUGGIST

Use Pompeian
Massage Cream
regularly at home
—then you'll get
the full benefit.

DRAKE'S PRACTICAL MECHANICAL BOOKS

THEY WILL RAISE YOUR PAY—

ORDER ON 5-DAY TRIAL

The books listed below will perfect you in your chosen trade—pave the way to the big positions. Written in non-technical language—easy to read and understand. **Every book covers its subject completely. An entire course of instruction condensed into one volume.** Your choice sent postpaid—you benefit 5 days—money refunded in full if not entirely satisfactory. Order direct from this page.

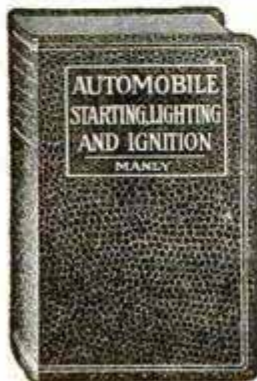

Automobile Books

Automobile Starting, Lighting and Ignition, by Manly... 700 pp. \$3.00
 Drake's Automobile Handbook, \$2.00
 Motor Car, Truck and Tractor, by Manly... Cloth \$1.50
 Automobile Battery, Care and Repair, by Manly... Leatherette \$2.00
 Motorcycle Handbook, by Manly \$1.50

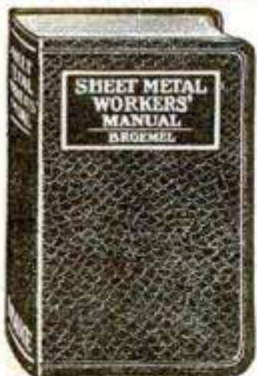

Shop Practice Books

Sheet Metal Workers' Manual... \$2.00
 Acetylene Welding and Cutting... Cloth \$1.25
 Slide Rule and Logarithmic Tables... \$2.00
 Handbook for Millwrights... Cloth \$2.00
 Machine Shop Practice... Cloth \$2.00
 Mechanical Drawing and Machine Design... Cloth \$2.00

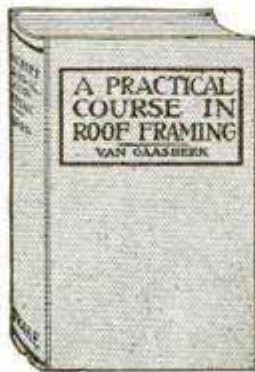

Carpentry Books

Cloth Binding
 Modern Carpentry, 2 vols. \$3.00
 The Steel Square, 2 vols. \$3.00
 Modern Estimator... \$1.50
 Timber Framing... \$2.00
 Builder's Architectural Drawing... \$2.00
 Concretes... \$1.50
 Practical Bungalows... \$1.00
 Roof Framing, by Van Gasbeek... \$1.50

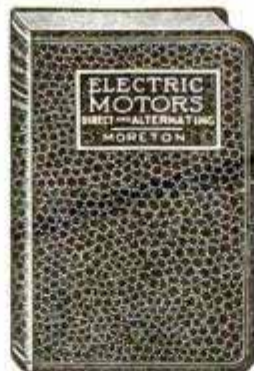

Electrical Books

Telephony, Including Automatic Switching, by Smith, 450 pp. Leatherette \$2.50
 Practical Applied Electricity... \$2.00
 Wiring Diagrams and Descriptions... \$1.50
 Armature and Magnet Winding... \$1.50
 Electric Motors, D. & A... \$1.50



Painting and Decorating

Ross Crane Book of Home Furnishing and Decoration... Cloth \$3.00
 House Painting Methods with the Brush and Spray Gun, by Vanderwalker... Cloth \$2.00
 Interior Wall Decoration, by Vanderwalker... Leatherette \$4.00
 The Mixing of Colors and Paints, by Vanderwalker... Cloth \$2.00
 A Show at Sho' Cards... Cloth \$4.00
 Sign Painting, by Atkinson... Cloth \$4.00
 Strong's Book of Designs, Leatherette \$4.00
 Modern Painter's Cyclopedia... Cloth \$2.00
 Automobile Painting... Cloth \$1.50
 New Hardwood Finishing... Cloth \$1.50
 Wood Finishing, Plain and Decorative... Cloth \$2.00

Steam Engineering

Swingle's Handbook for Steam Engineers and Electricians. Leatherette... \$4.00
 Examination Questions and Answers for Marine and Stationary Engineers. Leatherette... \$2.00
 Steam Boilers... Leatherette \$2.00
 Swingle's Catechism of Steam, Gas and Electrical Engineering. Leatherette \$1.50

Modern Languages

By Prof. P. S. Allen, U. of Chicago
 French without a Teacher... Cloth \$1.25
 Spanish without a Teacher... Cloth \$1.25
 German without a Teacher... Cloth \$1.25
 Everyday French... \$1.25
 Everyday Spanish... \$1.25

ORDER DIRECT FROM THIS PAGE ON OUR MONEY-BACK PLAN

The books listed above are only a few of the many in our catalogue, which you will receive promptly after filling out and mailing us the attached coupon. For quick action order direct from this page—cross name of each book wanted and send in with price quoted. We repay postage and send the books on our money-back plan.

FREDERICK J. DRAKE & CO.

PUBLISHERS

1008 Michigan Ave., Chicago

Drake Books Are For Sale at All Book Stores

FREDERICK J. DRAKE & CO.
 1008 Michigan Avenue
 Chicago, Ill.

GENTLEMEN:—Please send me free, postage paid, your illustrated catalogue which lists and describes 200 Practical Mechanical Books for Home Study.

My name is

and my address

Mail Coupon For Free Catalogue
 Your Guide to Home Study

Multiplies His Earnings by the Salary-Doubling Plan!

A. W. Weber was working in a grocery store when he took up home-study business training. Eighteen months later, he had earned for himself the position of Assistant Auditor of the Ohio Savings Bank and Trust Company, Toledo, at a salary-increase of 150 per cent.

More recently, he has been made Assistant Secretary and Assistant Trust Officer of the bank in which he started as a clerk. His salary-increases now exceed 200%.



LaSalle Made Possible the Opportunity

"My attention has been directed to our Mr. Weber, who is now in his second course of study with your institution. This is most interesting to us, as Mr. Weber's progress has been quite exceptional, he having advanced from a clerkship to Assistant Secretary and Assistant Trust Officer in our bank in the short period of five years.

"This attainment is most gratifying to us, and we are frank in giving expression to our belief that much credit is due to your splendid institution, through which medium opportunity was afforded in making it possible for him to accomplish the purpose.

"It has ever been our policy to be helpful and to encourage those of our employees in acquiring information and knowledge looking to their own betterment, and we are most anxious and willing to recognize and cooperate with those employees whose desires and ambitions are directed to greater achievements and further advancements." (Signed)

EDWARD KIRSCHNER,
Vice-Pres. Ohio Savings Bank
and Trust Company.

LaSalle Training Changes Opportunities Into Dividends

"Without the knowledge obtained from your course, I would not be able to fill the position I hold today. Monthly dividends are being paid me on my investment in LaSalle training, in the form of increased salary, at a rate in excess of 125 per cent." (Signed)

ARTHUR W. WEBER,
Asst. Sec'y Ohio Savings Bank
and Trust Company.



Ohio Savings Bank and Trust Co., Toledo
—one of the largest and best banks in Ohio

—How Home-Study Training Nets A. W. Weber 125% a Month

The prospect of working in a grocery store all his life did not satisfy A. W. Weber, a Toledo man. He resolved to make a new start—and to speed his progress he undertook LaSalle training in Higher Accountancy. He secured a job first as time-keeper in an automobile plant—then as clerk in the Ohio Savings Bank and Trust Co. Within 18 months his training had helped him to the position of Assistant Auditor.

Since that time, repeated promotions have advanced him to the position of Assistant Secretary and Assistant Trust Officer, and he writes that his monthly dividends on his investment are at a rate in excess of 125%. Read his letter, and the letter of his employer, in the column at the left.

Mr. Weber is now adding to his momentum by means of a second LaSalle course—home-study training in Law.

Will You be Selected for Promotion?

You have often wondered whether or not it would pay you to take up specialized business training with LaSalle.

But—can there be any question about its paying when so many thousands of LaSalle members are advancing—thru its aid—to positions of responsibility and influence?

In the very bank of which Mr. Weber is officer, thirty-eight other men and women have enrolled with LaSalle; in the Guaranty Trust Company, New York, LaSalle members number ninety-eight; in the Royal Bank of Canada two hundred and seventy-nine.

During only six months' time, as many 1,248 LaSalle members reported definite salary increases totalling \$1,399,507, an average increase per man of 89 per cent.

Send for Free Outline of LaSalle Salary-Doubling Plan

What would it be worth to you to increase your earnings 89 per cent—within a comparatively few months?

The LaSalle salary-doubling plan will show you how to do so. Simply fill out and mail coupon—and a 64-page book describing the salary-doubling plan will be sent you FREE. Whether you adopt the plan or not, the information it will place in your hands is of very real and definite value.

Balance the two minutes that it takes to cut the coupon against the rewards of a successful career—then clip and mail the coupon—

LASALLE EXTENSION UNIVERSITY

The World's Largest Business Training Institution

CLIP AND MAIL

LASALLE EXTENSION UNIVERSITY

Dept. 264-R

Chicago

I shall be glad to have details of your salary-doubling plan, together with complete information regarding the opportunities in the business field I have checked below. Also a copy of "Ten Years' Promotion in One," all without obligation.

- Business Management: Training for Official, Managerial, Sales and Departmental Executive positions.
- Modern Salesmanship: Training for position as Sales Executive, Salesman, Sales Coach or Trainer, Sales Promotion Manager, Manufacturer's Agent, Solicitor, and all positions in retail, wholesale, or specialty selling.
- Higher Accountancy: Training for position as Auditor, Comptroller, Certified Public Accountant, Cost Accountant, etc.
- Expert Bookkeeping: Training for position as Head Bookkeeper.
- C.P.A. Coaching for Advanced Accountants.

- Law: Training for Bar; LL.B. Degree.
- Commercial Law: Reading, Reference and Consultation Service for Business Men.
- Traffic Management—Foreign and Domestic: Training for position as Railroad or Industrial Traffic Manager, Rate Expert, Freight Solicitor, etc.
- Railway Station Management: Training for position of Station Accountant, Cashier and Agent, Division Agent, etc.
- Banking and Finance: Training for executive positions in Banks and Financial Institutions.

- Industrial Management: Factory Management: Training for positions in Works Management, Production Control, Industrial Engineering, etc.
- Modern Foremanship and Production Methods: Training for positions in Shop Management, such as that of Superintendent, General Foreman, Foreman, Sub-Foreman, etc.
- Personnel and Employment Management: Training in the position of Personnel Manager, Industrial Relations Manager, Employment Manager, and positions relating to Employee Service.

- Modern Business Correspondence and Practice: Training for position as Sales or Collection Correspondent, Sales Promotion Manager, Mail Sales Manager, Secretary, etc.
- Business English: Training for Business Correspondents and Copy Writers.
- Commercial Spanish: Training for position as Foreign Correspondent with Spanish-speaking countries.
- Effective Speaking: Training in the art of forceful, effective speech, for Ministers, Salesmen, Fraternal Leaders, Politicians, Clubmen, etc.

NAME..... PRESENT POSITION..... ADDRESS.....

Popular Mechanics Magazine

200 E. Ontario Street, Chicago, U. S. A.

H. H. WINDSOR, Founder

H. H. WINDSOR, Jr., Editor and Publisher

London: Hachette & Cie.,
16-17 King William Street, Charing Cross, W. C. 2

Paris: Hachette & Cie.,
111 Rue Reaumur

Melbourne: Gordon & Gotch
509-513 Little Collins St.

ISSUED MONTHLY

SUBSCRIPTION:

SINGLE COPY, 25 CENTS

In United States and its possessions, also Canada, Cuba, and Mexico, per year, postpaid - \$2.50

To all other countries in the Postal Union - 3.00

All subscriptions are discontinued at expiration. Please examine the date printed on your wrapper.

Entered as Second Class Matter Sept. 15, 1903, at the Post Office at Chicago, Illinois, under Act of March 3rd, 1879.

Entered as Second Class Matter at the Post Office Department, Canada.

Published monthly by POPULAR MECHANICS CO.

Copyright, 1926, by Popular Mechanics Co.

Copyright in Australia. Copyright in France

Vol. 45

Contents for February, 1926

No. 2

Duel from Waste Products
289

Agriculture	
school of horticulture for women	205
with Uncle Sam's plant hunters	259
Airplane	
cabins in wings for transatlantic flight	189
how tested	233
new instruments in	180
thirty-passenger, has restaurant	225
Airship— to use excess gas as fuel in engines	204
Archaeology—traces of Norse colonies found in Greenland	250
Architecture—arch made from one tree to shelter tourists	278
Automobile—every auto buyer given paint kit	290
Automobile Touring—war veterans tour country in imitation tank	279
Automobiles—Design	
taxi built like hansom cab	187
with expanding body serves as sales room	224
Automobiles—Equipment and Supplies—heater for auto serves as trouble light	208
Automobiles—Muffler—muffler stops auto smoke and absorbs poison fumes	204
Automobiles—Radiator	
condenser for car radiator	288
push cock for auto radiator	240
Automobiles—Repairing	
trouble finder for autos locates knocks	242
valve grinder driven by air	225
Automobiles—Safety Devices—hub light aids driver	296
Aviation—trenches of light aid flyers to land in fog	290
Bees—sent south for winter for two crops of honey	242
Belt—with concealed spring	235
Berries—grow strawberries in boxes	236
Bicycle—six-day bicycle races	251
Biology—tiny beings magnified	216
Birds	
made helpless by oil at sea	294
taught Eve to sew	236
Boats and Boating—motorboat garage in home	203
Botany—growth of plant in second measured by sound	215
Building Construction	
material made from waste to resist earthquakes	180
planting a forest under a skyscraper	274
wall's motion when pushed measured by light rays	249
Buildings—wind pressure on	177
Bullet-Proof—police shields	288
Cake—three-hundred-pound baked for children	241
Cathedral—at Reims restored	256
Clamp—for holding boards	236
Coal—washed down flume to save hauling	228
"Constitution"—figurehead of, preserved as relic	278
Cork—medicine dropper and cork combined	255
Diamonds—of world worth five billion	208
Divers—school for, teaches how to wear suit	187
Earthquake—safety in height of buildings	226
Eggs—bad ones used in tanning	285
Electric Power	
engineers risk lives to span narrows	190
heat stored nights to warm homes	217
Electricity	
course for girls teaches repairing	250
for finding ores supplants magic rod	231
progress to century shown at electric exhibit	256
Excavators—shaver cuts clay from hill	272
Fan—pocket size operated by flashlight battery	256

Fasting—forty-one days, man loses thirty pounds	266
Fertilizer—key to cheaper, found by chemists	295
Finger Nail—electric buffer for	240
Fire Alarms—purple lights on fireboxes to replace red	215
Fire Apparatus	
dry fire extinguisher uses powder to kill flames	283
fire put out by vibrations	295
Fire Protection—floating fire department propelled by poles	279
Fireboat—with six big pumps	258
Fireproof—test roofing by flame blast	266
Fireworks—red fire used in skyrockets produced from metal	255
Fishing—thermometer aids in fishing for cod and haddock	236
Floor Scraper—and sander combined	266
Florida—seas reclaimed for homes	193
Fogs—register own warning by ringing signal bell	273
Fountain Pen	
for lettering	182
stamps held in	209
Gas and Oil Engines—pygmy motor for airplanes	226
Gas Masks—guard workers repairing leaky mains	189
Germicide—new death ray kills germs in tenth of second	192
Glass—made fog-proof by paraffin	190
Gold—river drained for	278
Golf	
bag that stands erect	289
wrist pad for golf score	231
Heart—of dead chicken beats thirteen years	217
Horses—value of, measured by pull	235
Hose—automatic nozzle for hose	273
House Plans—story and one-half Dutch colonial	351
Household Devices	286
Hunting	
ancient weapons in big-game hunting	284
moving head for duck decoy	204
Iron—made without "pigs" by electric process	208
Jewelry	
diamond dart piercing arm latest fad	215
frame for jewels for ears	283
tests for jewel forgeries to guard buyers	182
Light	
beams produce music through whirling disks	295
plant that gives cold light shines in dark	278
that casts no shadow aids surgeons	289
Lighthouse—for airship line at Croydon, England	215
Linoleum—from earthen floors to linoleum	211
Milk—garlic flavors cow's milk in minute	224
Models	
flowers copied in rubber	265
shipyard in skyscraper	267
Monkeys—apes use reason to solve problems	296
Moths—cedar plaster for closets	273
Motor Truck—armored cage on mail truck protects driver	242
Motorcycle	
shield for motorcycle rider	192
side car with hinged front	182
Moving Picture Projector—run by phonograph	217
Musical Instrument—banjo, harp and guitar in one	273
Oars—with reversible locks	192
Oranges—electricity to ripen	187
Phosphorescence—glow of sea bright enough for reading	266

meter 14th Barre 308

Flowers Copied in Rubber 265

Lumber, Synthetic 180

[Continued on Page 4]

Paint Sprayer 249
Paint Sprayer 290

[Contents—Continued]

Plant Hunters

Model 207

Photography
aerial photos taken at night 203
camera ends drudgery in keeping records 237
triple spill in horse race tests speed of camera 209
Pictures—war scenes molded in sand by cripple 285
Pipe (Tobacco)—pipe with trap for nicotine 294
Propeller—pitch of, measured to avoid vibration 190
Playground Apparatus—slide and teeter combined 290
Police—signal lights to control police in Memphis 294
Poultry—shoeing roosters for fights 255
Printing—blind men devise printer for blind to operate 265
Projector—as sales aid 265
Purse—that sticks to pocket to prevent theft 254
Rabbit—pest in New Zealand yields profit in fur 241
Radio—vibrations on edge of disk improve tone 203
Radio Apparatus
ground clamp requires no screws 305
horn extension made from old appliance cord 306
paper sleeves for spiderweb coil forms 301
pilot light on panel saves tube and batteries 309
Radio Application
ends Arctic terrors 183
wireless phones for trains to replace arm signals 258
Radio Battery
bobber battery gauge gives voltage reading 301
connector made of machine screw and wingnut 309
disconnect A battery when set is not operating 309
Radio Broadcasting
men risk lives to broadcast chimes 241
nine hundred stations in four years 225
Radio Construction
battery panel 306
handy method of soldering leads to switch points 306
how to change sets to suit alternating current tubes 308
semi-automatic coil winder 310
spring connector eliminates soldering 301
Radio Crystal Set
moving metal shields tune 305
Radio Loop
double loop acts as booster for outside aerial 308
stable base for home built 307
Radio Questions and Answers 352
Radio Receiver
building in the radio set 297
set tunes by keyboard 242
six tube set is highly selective 303
success with new hookups depends on parts used 309
Radio Sockets—and adapters for use with UX and CX tubes 307
Radio Tools—adjustable meter hole borer 308
Rain—thirty-million-ton rainfall measured by glass 282
Roosevelt, Theodore—memorial to 234
Sandblast—cleaning auto by 264
Saws and Sawing Rigs—auto hauls saw as a trailer and runs it 289
Screwdriver—run by motor also sets nuts 290
Sculpture—soap for comic sculpture 258
Ships
voices of ships 243
Shoes—made from Panama hats 217
Silk—silkworm's secret applied in artificial product 255
Silkworm—solving their secrets 227
Skating Rink—electric dummy 225
Skyscraper—the world's biggest 240
Speech—students see selves talking in wavy lines 256
Speed—high speeds measured by notes in musical scale 265
Sphinx—beauty doctors treat 235
Stairs—ups and downs of stairways 291
Steamship—elevators run in stacks on steamless ship 282
Steel—tissuelike steel is transparent 258
Submarine—a dollar for every dive 219
Sun—lowers blood pressure in tests with animals 285
Tanks—bullet-proof for aviators 231
Telephone
replaces telegraph key on railways 241
Theater
like Italian garden 249
patrons paged with light in box 192
Totem Pole—bird with board wings guards village 208
Toys—box of games for children 203
Transportation
planes and waterways take place of roads in Siam 288
strange methods of, where machines are unknown 280
Truck—hand, to lift buckets 250
Tunnel—through rock to divert river 240
Vault—install hundred-ton, in Chicago bank 296
Violin—rich tone of ancient violins believed due to salt 283
Waste Products—fuel from refuse reduces cost of removal 289
Wireless—set is waterproof for lifeboat 180
Wrench—six socket ratchet wrench fits in pocket 272
X-Ray—to disclose faults in steel 231

AMATEUR MECHANICS

Archery—bamboo bow and arrow 326
Automobile—starting car in cold weather 323
Automobile Driving—adjustable arm support 320
Automobiles—Equipment and Supplies
mud attachment 332
semi-automatic windshield wiper 313
Automobiles—Muffler—choked mufflers cause trouble 318
Automobiles—Repairing—cleaning auto shackle pins 328
Boats and Boating—mooring the motorboat 319
Brushes
cleaning small paintbrushes 325
holder for home painter 327
Bulbs—case for tall light lamp 313
Cabinet—handy for toaster 315
Cans—old milk cans hold tractor oil and fuel 325
Casting—small pillow blocks 320
Cleaning—hints to home dry cleaners 322
Clothes Dryer—protecting clothes on line 322
Coal—burning soft coal or small anthracite sizes 330
Drainage—glazed tile as good as porous for drainage lines 328
Fish—how to smoke properly 314
Fountain Pens—remedy for leaky 331
Gate—automatic, for closed highways 319
Guns—improved cleaning rod for guns 318
Heating Plant—heating rooms with kitchen range 321
Ink—removing ink stains 316
Magic Lantern—screen for 318
Nail—puller for shingles 322
Needles—picking up phonograph 319
Oil
filter from old felt hat 330
reclaiming oil in small quantities 314
Paint
durable whitening 320
Photography
making direct photographic positives 326
novel photographic collection 332
Polish—wash furniture before polishing 332
Reed Furniture—repairing woven 327
Refuse Burner—homemade 311
Ribbon—replacing watch ribbons 312
Rust—protecting small articles against rust 313
Saws and Sawing Rigs—saw setting vise on sawbuck 325
See-Saws—hand grips make teeter safe 313
Smokers' Stands, Etc.—making an Egyptian ash tray 329
Snow—clearance on garage doors 331
Stencil—handy disk shaped 328
Tanks—oil drum makes water tank heater 332
Toys—novel toy boxers 321
Trolleys (Aerial)—emergency trolley for fording flood streams 324
Typewriters
convenient typewriter shelf 314
paper strip indicates bottom margin 326
Ventilation—gable ventilators for homes 331
Wells—adjustable well auger handle 315

SHOP NOTES

Automobile—Repairing—fitting piston rings 336
Bleachers—for small athletic field 339
Bumper—for lumber yard posts 337
Carpentry—hints on driving nails and screws 333
Compressed Air—wet air in compressed air hammer 338
Cupboard—built-in furniture—Part XV—kitchen cupboards that meet in corner 344
Cutters—operating snips by foot 350
Cylinder—repairing break in 349
Dams—spillway for bathing pools 340
Drawing—copying drawings and photos 343
Drawing Instruments—handling celluloid triangles 337
Gate—for stock corral 337
Holders—spring holder for metal plates 341
Jigs
T-handle tap wrench used for holding small drills 343
U-bolt makes good bending jig 343
Lantern—holder for signal lantern 338
Safety Devices and Measures—handle for chisel or punch 341
Slide Rule—protector 348
Solder and Soldering—removing soldering flux 338
Steps
concrete steps on high curb 338
permanent steps on truck aid loading 342
Tanks—chain block sling for tanks 350
Tiles
quadruple tile joint 342
unloading drain tile 349
Tires—rethreading tire valves 349

John

BUILDERS

TRADE GUIDES



4 Vols. \$6

AUDELS CARPENTERS AND BUILDERS GUIDES—4 VOLS. \$6

Inside Information for Carpenters, Builders, Joiners, Building Mechanics—all Woodworkers. **1600 pages; 3700 diagrams; flexible; pocket size.** Short-cut instructions, new methods, ideas, solutions, plans, systems—money saving suggestions. An easy progressive course for the apprentice. A practical daily helper and Quick Reference for the master worker. A Helping Hand to Easier and Better Work and Better Pay. To get this aid for yourself, simply fill in and mail the FREE COUPON below.

INSIDE TRADE INFORMATION ON:

How to use steel square; How to file and set saws; How to build furniture; How to use mitre box; How to use chalk line; How to use rules; How to make joints; Carpenters' arithmetic; Mensuration problems; Estimat-

ing strength of timbers; How to set girders and sills; How to frame houses and roofs; How to estimate costs; How to build houses, barns, garages, bungalows, etc.; How to read and draw plans; Drawing up specifications; How

to excavate; How to use settings 12, 13 and 17 on the steel square; How to build hoists and scaffolds—skylights; How to build stairs; How to put on interior trim; How to hang doors; How to lath—lay floors; How to paint.

"Audels Guides worth four times their price—handy too as I carry them in pocket for reference." W. J. Bates, Knoxville, Pa.



4 Vols. \$6

AUDELS PLUMBERS AND STEAMFITTERS GUIDES—4 VOLS. \$6

A new set—just out! A practical, illustrated, Reference Library and Study-Course for Master Plumbers, Journeymen and Apprentice Steamfitters, Gas Fitters and Helpers, Sheet Metal Workers, Draughtsmen, Master Builders, Engineers and all Building Trade Students. **1670 pages; 3642 diagrams; flexible; pocket size.** Guides explain all the principles, advances and short cuts of the Plumbing and Heating trade. Contains instructions on how to figure and estimate jobs. Use FREE COUPON below to examine, without obligation, this valuable work.

INSIDE TRADE INFORMATION ON:

Soldering, tinning. Joint wiping, bending, beating. Pipe—iron—steel, threading. Mathematics, tables, physics. Materials—iron, steel, copper, brass, lead, tin, antimony. Sheet metal—galvanized—plate. Sanita-

tion, syphonage, tanks. Drainage, sewage, purification. Fixtures—bath—kitchen. Pipe fittings, soil pipe, tools. Laying out work. Roughing. Screwed fittings, flanges, joints. Pipe bending, examples. Elbows. Heating, ven-

tilation, refrigeration. Water supply, mains, wells, tanks. Gas-fittings. Underwriters. Sheet metal work, problems, methods, brazing, heating, lead burning. Welding, various welds, methods. Blacksmithing, forges, tools.

"Audels Guides are practical, easy to understand, reliable. Cover the field in plain language." Arming, Annapolis, Md.



4 Vols. \$6

AUDELS MASONS AND BUILDERS GUIDES—4 VOLS. \$6

A new, complete, illustrated trade reference library, for Bricklayers, Cement Workers, Plasterers, Tile Setters and Stone Masons, including a practical outline of Steel Construction. **1100 pages; 2067 diagrams; flexible; pocket size.** A practical Trade Assistant explaining modern methods of masonry construction. Easy to understand and apply. A reliable and authentic reference work and study-course for Master Journeyman and Young Mechanic. Use FREE COUPON below and find out for yourself, without obligation, whether this set will benefit you.

INSIDE TRADE INFORMATION ON:

Bricklaying, tools, materials; Brick designs, patterns, bonds; Setting frames and foundations; Mortars, scaffolds, estimating; Mortars and mortar mixing; Tile setting, mosaic, hollow tile; Straight edge test, trow-

eling; How to figure brick work; Safe loads, piers, chimneys; Boiler settings, anchors, fire stops; Labor tables; Concrete, forms; How to figure concrete work; Stucco—on old and new buildings; Plastering—wood lath—metal;

Plasterers agreement; Plastering on various surfaces; Stonemasonry; Cutting, finishing, estimating stone; Derricks, rigging; Steel construction; Fire proof; How to read blue prints.

"Audels Masons Guides are the best books on the subject. Have laid brick 12 years and am able to judge." H. A. Sonnett, Corliss, Pa.



PRACTICAL ELECTRICITY — 1 VOL. \$4

Audels Handy Book of Practical Electricity is a simplified Ready Reference and Study Course in one pocket size, leather bound volume—for Engineers, Professional Electricians and Students. **1040 pages; 2600 diagrams; flexible red leather bound.** A reliable authority and handy helper for every electrical worker. Contains important and valuable wiring diagrams, calculations, machine sketches, helps on maintenance and repair. Use this FREE COUPON today and find out, without obligation, how this handy book will help you in your daily work.

Complete in one handy, red leather bound volume



1040 Pages 2600 Diagrams

INSIDE TRADE INFORMATION ON:

Electro-Therapeutics, X-Rays, Shocks, Welding, Brazing, Radio Hook-ups, Motion Pictures, Telephone, Telegraph, Cranes, Bells, Elevators, Pumps, Tools, Ship Drive, Railways, Vehicles, Automobile Electric Systems, Ignition, Generation, Lighting, Plant Management, Power Plans, Armature Winding, Repairing, A. C. Motors and Apparatus, D. C. Motors and Apparatus, Alternator Construction, Dynamos, Wiring Diagrams, Sign Flashers, Cable Splicing, Power Wiring, Outside Wiring, Switches, Lighting, Rectifiers, Converters, Transformers, Fuses, Circuit Breakers, Rheostats, Electro Plating, Electrolysis, Storage Batteries, Magnetism, Electrical Energy, Conductors, Insulators, Static, Dynamic, Radio Electricity, Applications, Ready Reference and Index Covering the entire field of Modern Electricity.

Learn More and You Will Earn More!

Know your job and you'll never be without one. The skilled man is always in demand. Knowledge is power. Learn your trade thoroughly by easy reading. This coupon is your opportunity for advancement and better pay. You risk nothing in sending for Audels Guides for free examination. Send it NOW!

FREE EXAMINATION COUPON

THEO. AUDEL & CO., 65 W. 23 ST., NEW YORK CITY

Please mail me for free examination the books marked (x) below. If I find them satisfactory, I agree to mail \$1 in 7 days, on each set ordered, and to further mail \$1 monthly on each set until I have paid the purchase price.

4 CARPENTERS GUIDES \$6 4 PLUMBERS GUIDES \$6

4 MASONS GUIDES \$6 1 ELECTRICIANS HANDY BOOK \$4

NAME

ADDRESS

OCCUPATION

EMPLOYED BY..... 2-T-30

B-W COOKE
Directing
Engineer

BE AN AUTO EXPERT

Clip coupon for Free Auto Book

I'll train you at Home

Get RESULTS Quick
The B.W. "COOKE-WAY!"

THE WORLD'S BIGGEST BUSINESS NEEDS YOU

\$30 or \$40 a week is terrible pay for any man, when Five Thousand Million Dollars are paid every year to Auto men for upkeep alone. Big Jobs and Big Raises come amazingly quick. Get my Free Book.

in ONLY 10 months

225 IN A WEEK FOR RUMPEL

Think of it— from \$35 a week to \$225 in a week quick! Pick the line and the training that brings results quick.

in ONLY 3 months

\$215 IN A WEEK FOR TUCKER

Just three months after enrolling—\$215 IN A WEEK! That's the kind of QUICK RESULTS YOU want!

in ONLY 2 months
The BEST training in the BEST line brings QUICKEST and BIGGEST RESULTS

200% INCREASE FOR SIEMENS

You TOO need "Job-Way" B-W COOKE AUTO TRAINING

Get my Free Book—I'll tell you about Mr. Rumpel—and Tucker—and Siemens—and hundreds of others—

I Guarantee—that nowhere else on earth can you get this training that shows such astonishing QUICK and TREMENDOUS RESULTS. For your Quick Success get this QUICK TRAINING in the Gigantic Auto Business, where tremendous sums are paid men, making such astonishing Quick and Big Results so plentiful.

4 BIG OUTFITS INCLUDED FREE of extra cost
Tools, Test Bench, Radio Receiving Set, All equipment included Free of extra charge. Also 293 wiring diagram charts. Act quick. Clip coupon for full details.

I GIVE YOU FACTS!

16 SMASHING GUARANTEES plus AMAZING PROOF are what I give you. Just read my book. There's a mighty REASON why I DO get such QUICK RESULTS for so many of my students. It is Practical Training from a practical Engineer. I know what training you need, no matter whether you are YOUNG or OLD, EDUCATED or POORLY EDUCATED, EXPERIENCED or WITHOUT A DAY'S AUTO EXPERIENCE—That Training I give you.

Get my FREE Book. I give you \$10,000 lesson on the word QUICK!

"Quick" IS THE VITAL WORD

To make \$1000 SLOW in say 5 years means FAILURE. To make \$1000 QUICK in a month means SUCCESS. QUICK is the dominating, all important word that is the Father of the word SUCCESS. Get My QUICK training. Of course my Training includes ALL ELECTRICAL, ALL MECHANICAL—WELDING, BRAZING, VULCANIZING—it's complete. Of course, I give you LIFE-TIME CONSULTATION SERVICE and my students say it's wonderful—but on top of all this, I give you a valuable Business Course—Salesmanship, Advertising, Book-keeping, Buying—everything. The best of Auto Engineers on my Pay Roll help me to help you, with backing of Auto Industry makes all this possible.

Go Into Business

My Free Book, AUTO FACTS, shows how I've put man after man in the Auto business for himself—QUICK—just a few weeks after enrolling! Amazing rewards are everywhere for men TRAINED MY WAY, to be their own Bosses—own their own Shops. Very little capital needed to start.

One Million Auto Experts BADLY NEEDED

Over a million trained men are needed it is rated to replace "tinkerers" and untrained "guessers." Farms, Villages, Cities offer BIG MONEY opportunities QUICK. Stay Home. Keep your job—I'll show you the way to fatten your present pay right away, in the earliest weeks of your training. Hundreds virtually get my training for nothing! See all this in my Big Book.

I Help You to GOOD JOBS

ALL YOUR LIFE, this Great Auto Institution, backs you up with Employment Service as often and as long as you want it absolutely at no extra cost. My fine Automotive Magazine "POPULAR AUTOMOTIVE NEWS" is also sent you free of extra cost. Free book tells all. Action makes dreams come true, QUICK!

Get My Free Book. I Train You in Your Spare Time, At Home

When you look at training—look for its Quick Results. Good training can show you QUICK RESULTS. Act quick and I'll send you Free my remarkable book, "Auto Facts." See how in 3, 6, 10 and 15 weeks many students' earnings jump. Judge as your good judgment tells you. BUT ACT!

Big Auto book Free! GET IT

MAIL THIS COUPON NOW!

B. W. COOKE, Directing Engineer
CHICAGO MOTOR TRAINING CORPORATION
1916 Sunnyside Avenue, Dept. 216, CHICAGO, ILL.
Send me FREE Auto Book and proof that you will show me the QUICK WAY toward a BIG JOB and a RAISE IN PAY. Also send your 4 Outfits Offer. It is understood that this obligates me in no way and no salesman is to call on me.

Name

Address

B. W. COOKE DIRECTING ENGINEER
CHICAGO MOTOR TRAINING CORPORATION
1916 Sunnyside Avenue Dept. 216 CHICAGO



“There’s the *new* Bill Tyson” He’s making \$6500 a year now

“SEE that man behind me—at the table on my right? That’s Bill Tyson—sales manager for Brooks & Watson.

“I used to know him when I was a kid—we went to grammar school together.

“Then his father died and he had to go to work. Got a job with Brooks & Watson as a shipping clerk, but couldn’t seem to get ahead. Finally grew discouraged and settled down into the rut—a typical office grind.

“Then overnight something seemed to wake him up. He began making suggestions to the firm—helped them to save a great deal of money.

“Then Old Man Brooks became interested—wanted to know how Bill happened to know so much about the business. Bill told him he’d been studying at home at nights through the International Correspondence Schools. ‘H’m,’ said Mr. Brooks, ‘I’ll remember that.’

“He did too. Put Bill out on the road as a salesman for a year or so and then brought him into the main office as sales manager.

“He’s getting \$6500 a year now and everybody calls him ‘the new Bill Tyson.’ It’s a good name too. I’ve never seen such a change in a man in my life. The I. C. S. deserves a lot of credit.”

An International Correspondence Schools course will help you just as it helped Bill Tyson. It will help you to have the happy home—the bigger salary—the comforts that you want for your wife and your family.

For spare-time study is that vital something which makes one man succeed where one hundred fail—that lifts a man out of the rut and makes him a trained worker instead of just a “hand.”

One hour a day, spent with the I. C. S. in the quiet of your own home, will prepare you for the position you want in the work you like best. Put it up to us to prove it!

Mail the Coupon for Free Booklet

INTERNATIONAL CORRESPONDENCE SCHOOLS
Box 5552-E, Scranton, Penna.

Without cost or obligation, please tell me how I can qualify for the position or in the subject before which I have marked an X:

BUSINESS TRAINING COURSES

- | | |
|--|---|
| <input type="checkbox"/> Business Management | <input type="checkbox"/> Salesmanship |
| <input type="checkbox"/> Industrial Management | <input type="checkbox"/> Advertising |
| <input type="checkbox"/> Personnel Organization | <input type="checkbox"/> Better Letters |
| <input type="checkbox"/> Traffic Management | <input type="checkbox"/> Show Card Lettering |
| <input type="checkbox"/> Business Law | <input type="checkbox"/> Stenography and Typing |
| <input type="checkbox"/> Banking and Banking Law | <input type="checkbox"/> Business English |
| <input type="checkbox"/> Accountancy (including C.P.A.) | <input type="checkbox"/> Civil Service |
| <input type="checkbox"/> Nicholson Cost Accounting | <input type="checkbox"/> Railway Mail Clerk |
| <input type="checkbox"/> Bookkeeping | <input type="checkbox"/> Common School Subjects |
| <input type="checkbox"/> Private Secretary | <input type="checkbox"/> High School Subjects |
| <input type="checkbox"/> Spanish <input type="checkbox"/> French | <input type="checkbox"/> Illustrating <input type="checkbox"/> Cartooning |

TECHNICAL AND INDUSTRIAL COURSES

- | | |
|---|--|
| <input type="checkbox"/> Electrical Engineering | <input type="checkbox"/> Architect |
| <input type="checkbox"/> Electric Lighting | <input type="checkbox"/> Architects' Blue Prints |
| <input type="checkbox"/> Mechanical Engineer | <input type="checkbox"/> Contractor and Builder |
| <input type="checkbox"/> Mechanical Draftsman | <input type="checkbox"/> Architectural Draftsman |
| <input type="checkbox"/> Machine Shop Practice | <input type="checkbox"/> Concrete Builder |
| <input type="checkbox"/> Railroad Positions | <input type="checkbox"/> Structural Engineer |
| <input type="checkbox"/> Gas Engine Operating | <input type="checkbox"/> Chemistry <input type="checkbox"/> Pharmacy |
| <input type="checkbox"/> Civil Engineer | <input type="checkbox"/> Automobile Work |
| <input type="checkbox"/> Surveying and Mapping | <input type="checkbox"/> Airplane Engines |
| <input type="checkbox"/> Metallurgy | <input type="checkbox"/> Navigation |
| <input type="checkbox"/> Steam Engineering | <input type="checkbox"/> Agriculture and Poultry |
| <input type="checkbox"/> Radio | <input type="checkbox"/> Mathematics |

Name.....

Street.....

Address..... 3-6-24

City..... State.....

Occupation.....

Persons residing in Canada should send this coupon to the International Correspondence Schools Canadian, Limited, Montreal, Canada.

**The International Correspondence Schools are the oldest and largest
correspondence schools in the world**

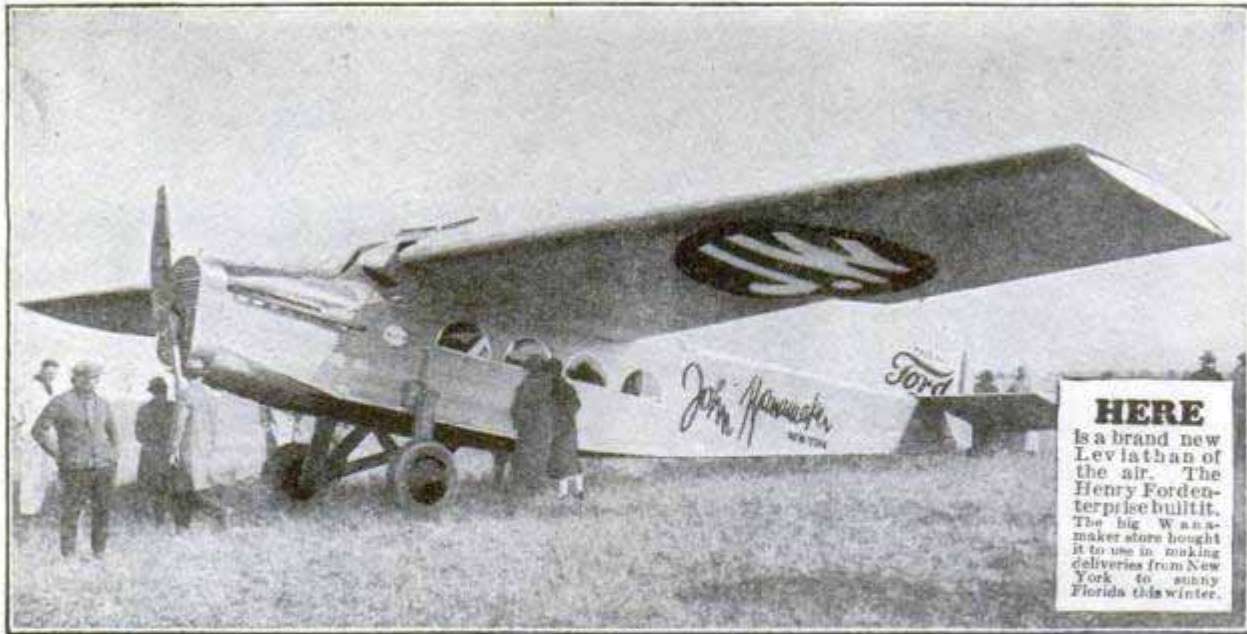

Aviation Demands Red-Blooded Young Men!

Amazing Aircraft Developments Are Taking Place Right Now! A Sudden New Demand for Daring Young Men Is Springing Up Almost Overnight! Qualify NOW for One of These Exciting Jobs That Pays \$4,000—\$10,000 a Year or More!

Thrills—Popularity—Big Pay!

AVIATION in America stands on the brink of an amazing new development. During the past two months, dozens of gigantic new aircraft enterprises have been established. Big men like Henry Ford have invested millions in commercial air lines and airplane factories. Even in the beginning, thousands of young men will be needed. Those who qualify will quickly find themselves on the road to undreamed-of money-success.



"Your lessons are as exciting as a romance—and so easy to understand! I never get tired of studying. Can hardly wait until I, too, am ready to jump into the airplane game as a real, qualified expert!" James Powers, Penn., writes: "I am indeed surprised that such a valuable course can be had from such practical men at so little cost." Hundreds of others are just as enthusiastic.

Easy to Become an Aviation Expert—\$75 to \$400 a Week

Today Aviation offers the same opportunities that the automobile and motion picture industries did 15 years ago. Men who got in on the ground floor of those industries made tremendous fortunes before the rest of the world woke up.

Get into this thrilling profession at once while the field is new and uncrowded. Now—by a unique new plan—you can quickly secure the basic training for one of these wonderful high salaried jobs, at home, in spare time. Experts will teach you the secrets—give you all the inside facts that are essential to your success. And, best of all, the study of Aviation is almost as fascinating as the actual work itself. Every Lesson is chock-full of interest—and so absorbing that you actually forget you are studying.

Students Learn Quickly

Only an hour a day will give you your basic training in a surprisingly short time. One student, G. H. Penton, Ill., says:

American School of Aviation

Dept. 1352, 3601 Michigan Ave., Chicago, Ill.

PREPARE For one of these Big Positions
 Aeronautical Instructor \$60 to \$150 per week
 Aeroplane Builder \$75 to \$200 per week
 Aeronautical Engineer \$100 to \$300 per week

Send for FREE Book

Send the coupon for our new, free book, just out—"Opportunities in the Airplane Industry." It is vitally interesting, reads like a romance and tells you things about this astonishing profession you never even dreamed of. This book is so fascinating it could easily sell for a dollar. We offer a limited number FREE. Write for yours today.

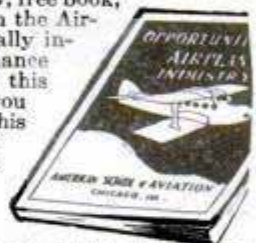

American School of Aviation,
 Dept. 1352, 3601 Michigan Ave.,
 Chicago, Ill.

Without any obligation please send me FREE book "Opportunities in the Airplane Industry," also information about your Course in Practical Aeronautics.

Name.....

Address.....

City..... State.....

**Learn In
12 Happy
Weeks
to Earn
\$60
to
\$200
per Week**

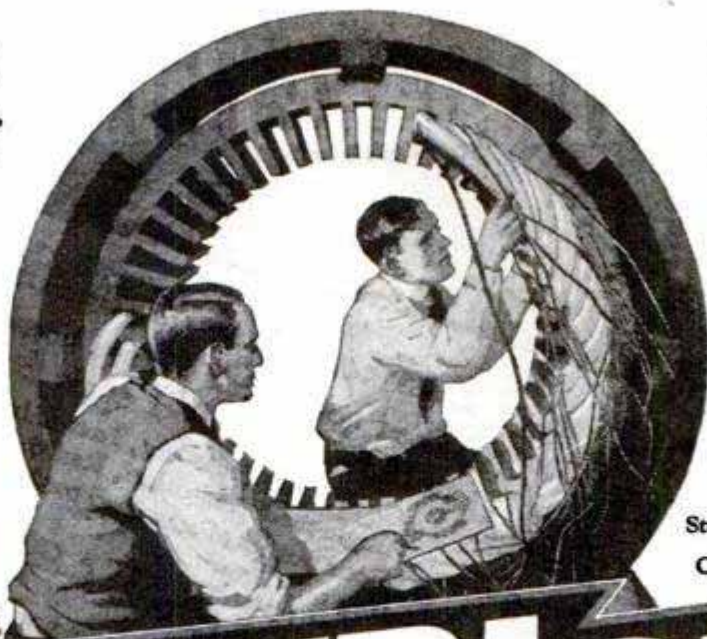

Student Winding
Stator in
COYNE Shops

**Get Real
Practical
Training
in Great
Shops of
COYNE**

ELECTRICITY

—as taught in the Great COYNE Shops

*It stands to reason:
There is no substitute for per-
sonal, practical training in great shops!*

Earn While You Learn at COYNE

My well-organized EMPLOYMENT DEPARTMENT helps you to get a job to earn part or all of your expenses while training at COYNE and assists you to a good job on graduation. Furthermore, it stands by you THROUGH LIFE without a penny of extra cost to you.

You Don't Need Advanced Education or Experience

Don't worry if you lack advanced education, knowledge of higher mathematics, or experience. My course is a *practical, LEARN-BY-DOING* Course. Every COYNE student receives *INDIVIDUAL and PERSONAL* instruction, on *COMPLETE* electrical apparatus, under *EXPERT INSTRUCTORS*, in the COYNE Shops at Chicago.

Men who never before had the slightest knowledge of *ELECTRICITY* have become *REAL ELECTRICAL EXPERTS* and stepped into *BIG PAY JOBS* because of our advanced simplified, practical, methods of training.

If you act NOW, I'll include with my course, without extra charge, my big Extra Courses in Radio Electricity and Auto, Truck and Tractor Electricity.

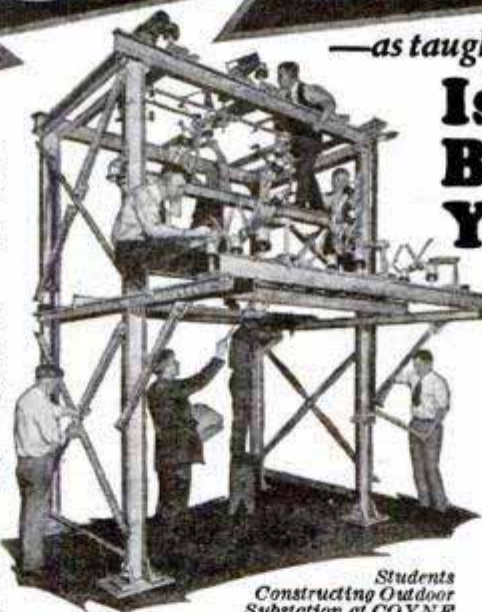

Students
Constructing Outdoor
Substation at COYNE

We Teach Electricity and Nothing Else

COYNE teaches only *ONE* thing—*ELECTRICITY*. We are *SPECIALISTS*. Our interests are not divided, nor is Electricity a sideline or merely an "additional" subject with us.

**You Can Start Any Day of
the Year at COYNE—No
Classes or Seasons**

Is the Key to Bigger Pay for You—Quickly!

If you are going to train for one of the thousands of *BIG-PAY* opportunities in the fascinating Electrical Field, why not train on real, gigantic electrical equipment such as you will find in the great Shops of COYNE at Chicago, the electrical center of the world?

Complete Electrical Training In 12 Happy Weeks at Coyne

My newly enlarged Electrical Course is the result of 27 years of experience, solving the needs of young men and of the Electrical Field. COYNE has been teaching Electricity in a *PRACTICAL* way since 1899. My course is thorough, easy to master, and fits men for *BIG* Electrical jobs, the *HIGH-SALARIED* thrilling jobs.



H. C. LEWIS
President, Coyne
Electrical School

Send for Big, FREE BOOK!

I want to send you a copy of my big, attractive Electrical Book. It is 12x15 in size and contains 151 photos of electrical scenes. Tells about dynamos, radios, autos, airplanes, farm lighting and power, etc. *Absolutely FREE, Remember.*

Be Sure to Get the Coupon in the Mail Today!

COYNE

ELECTRICAL SCHOOL

H. C. LEWIS, President

Established 1899

1300-10 W. Harrison St., Dept. 1352, Chicago, Ill.

*Not a Correspondence Course; All Practical,
Personal Training in Great Shops*

SEND THIS COUPON NOW

H. C. Lewis, President Coyne Electrical School,
1300-10 W. Harrison St., Dept. 1352, Chicago, Illinois

Dear H. C.—I'm an ambitious fellow and want to lead a happy, successful life. Send me one of the *FREE* copies of your Big Electrical Book which tells how others have made big money in Electricity. Also tell me about *Special Offer of Two Extra Courses*.

Name

Address

Chief Engineer Dunlap

I will make this contract with you

Your name here Wm. C. Campbell

When you enroll for my home-training in **ELECTRICITY** I agree to give you:

1. Complete training, including Electrical Engineering, Ignition, Radio, etc.
2. Four outfits of standard tools and materials, including a \$10 motor.
3. I WILL HELP YOU GET A GOOD JOB AND A RAISE IN PAY.
4. All these things I agree to give you or your money refunded.

AMERICAN SCHOOL
By Chief Engineer Dunlap

send you 4 Costly Electrical Outfits!



AMERICAN SCHOOL
— the Million Dollar Educational Institution



The third free outfit is a \$10 motor.



The first two free outfits prepare you to do Wiring Jobs like these.

The fourth outfit is a Radio Set.

Electrical Home-Training

now backed with **FREE JOB SERVICE**

I am pushing thousands of men ahead to success in Electricity by a wonderful new method of home-training. Now we announce a new feature for students and graduates of the American School—a nation-wide Employment Service under the direction of Mr. H. A. Burgkart, Job Expert. Burgkart is placing men in fine Electrical positions as fast as they qualify. The Electrical business needs more Experts. Go into Electricity and you're sure to find a good job when you're ready for it. **You can get ready with Dunlap Job-Method Training:**

1.—because it's complete Small Monthly Payments

We guarantee this training is both up-to-date and complete. Without extra charge I give you Electrical Engineering subjects, Electrical Drafting, Ignition, Radio, and many business subjects.

Our educational standards are high, tuition is within reach of the untrained man who needs this training, and small monthly payments accepted. So you need not face the world without training—let me show you how to get this million dollar No-Profit institution back of you in your fight for success and independence.

2.—because prepared by 23 noted Engineers

This is no one-man, one-idea school. America's greatest Electrical Engineers helped me prepare this training, and their work vouches for its high-standard and thoroughness.

Get My JOB AND RAISE Offer—Quick!

Now you can put your time and money into home-training with the positive knowledge that it will lead to a better job and increased pay. Get the facts about my amazing offer. Find out about the opportunities and jobs waiting for you in Electricity. Act quick and make the next few months the turning point in your life. Coupon brings complete information.

Instruction prepared by men from:

- | | |
|---------------------------------------|---------------------------|
| 1. General Electric Co. | 7. Western Electric Co. |
| 2. Commonwealth Edison | 8. Underwriters Lab. |
| 3. Crocker-Wheeler Co. | 9. Columbia University |
| 4. Cutler-Hammer Mfg. | 10. Dartmouth College |
| 5. American Telephone & Telegraph Co. | 11. Massachusetts Inst. |
| 6. Westinghouse Electric & Mfg. Co. | 12. Lehigh University |
| | 13. University of Vermont |
| | 14. Armour Institute |
| | 15. University of Kansas |

CHIEF ENGINEER DUNLAP, Electrical Division
AMERICAN SCHOOL, Dept. E-274
Drexel Ave. & 58th St., Chicago

3 because I train you by the Job-Method

These pictures show how my students learn Electricity by doing actual Electrical jobs with standard materials and tools which I supply without extra cost. Four costly outfits given! Students make fast progress by this wonderful Job-Method. Many do similar jobs for pay in their spare time and earn more than enough to pay for this training.

Send JOB and RAISE OFFER

to.....
St. No.....
City..... State.....

(Mail immediately to Chief Engineer Dunlap, American School, Dept. E-274, Drexel Ave. & 58th St., Chicago)

He: "I simply must make more money!"
 She: "Yes, but you never do anything about it."



HOW MANY WIVES have heard their husbands complain that they have hit a stone wall in business? How many wives have seen their husbands grow old waiting for "the big things" to come their way, while living expenses go steadily up and up and up?

The number must run into millions.

Yet we know, from our experience with 180,000 husbands, that in nine cases out of ten *something* can be done about it.

We have a little book which we have printed especially for dissatisfied men. It is called

"Forging Ahead in Business." It shows just what happens to a man's business worries when he broadens his knowledge of business principles; just why some men reach their limits young while others go to the top; just what the Institute's training can mean to your business career if you will follow it thru.

It is a helpful, *practical* little book. Among the men who have found it worth reading are 32,000 corporation presidents. If you want the big things of life *and are willing to work for them*, tear off the bottom of this page and mail it today.



To the ALEXANDER HAMILTON INSTITUTE

483 Astor Place, New York City

Send me, without cost or obligation, the new revised edition of the booklet, "Forging Ahead in Business."

Signature..... Business Position.....

Business Address.....

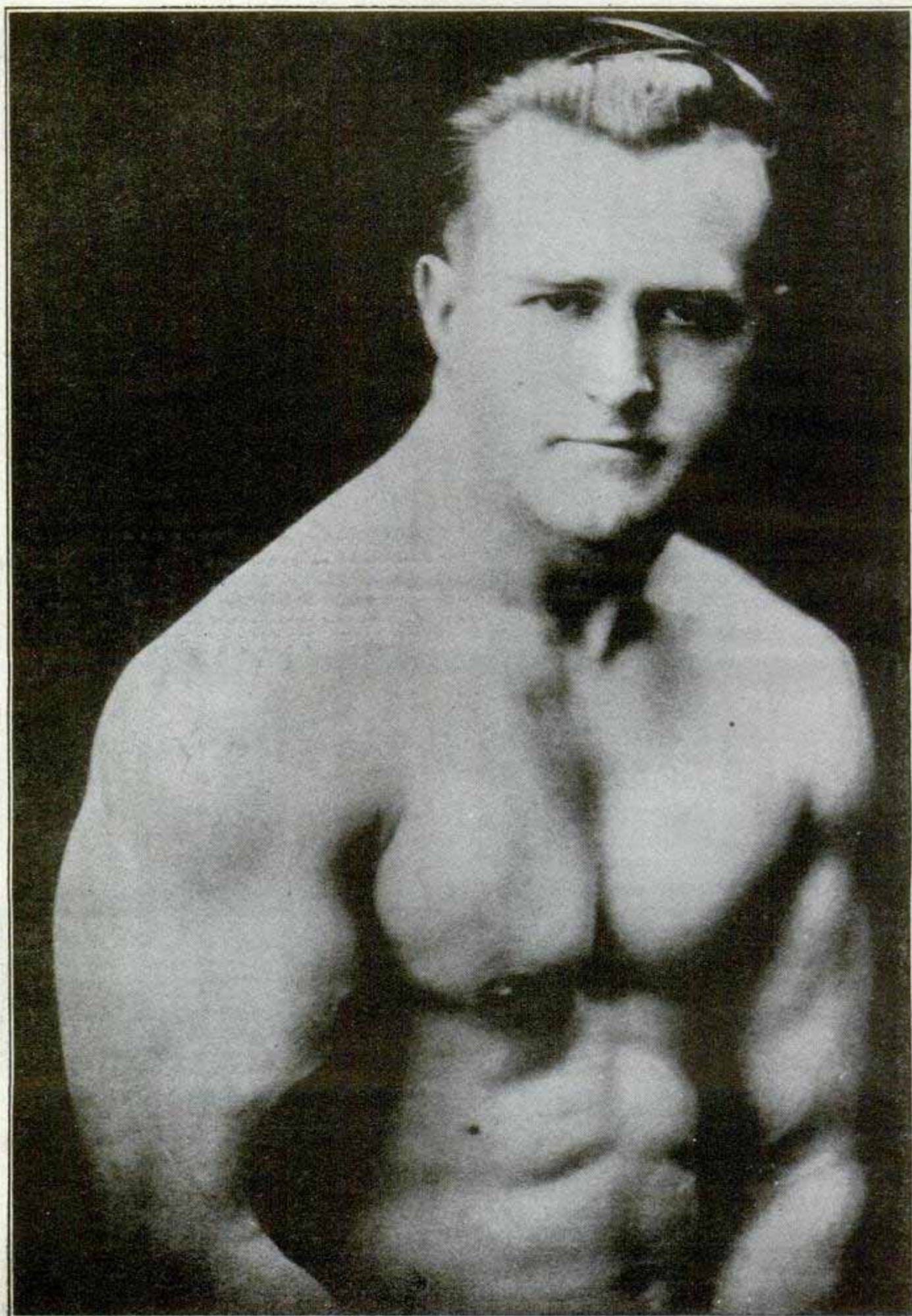

EARLE E. LIEDERMAN, *The Muscle Builder*

Author of "Science of Wrestling," "Muscle Building," "Secrets of Strength," and "Here's Health," etc.

If You Were Dying To-night

and I offered something that would give you ten years more to live, would you take it? You'd grab it. Well, fellows, I've got it, but don't wait till you're dying or it won't do you a bit of good. It will then be too late. Right now is the time. Tomorrow or any day, some disease will get you and if you have not equipped yourself to fight it off, you're gone. I don't claim to cure disease. I am not a medical doctor, but I'll put you in such condition that the doctor will starve to death waiting for you to take sick. Can you imagine a mosquito trying to bite a brick wall? A fine chance.

A RE-BUILT MAN

I like to get the weak ones. I delight in getting hold of a man who has been turned down as hopeless by others. It's easy enough to finish a task that's more than half done. But give me the weak, sickly chap and watch him grow stronger. That's what I like. It's fun to me because I know I can do it and I like to give the other fellow the laugh. I don't just give you a veneer of muscle that looks good to others. I work on you both inside and out. I not only put big, massive arms and legs on you, but I build up those inner muscles that surround your vital organs. The kind that give you real pep and energy, the kind that fire you with ambition and the courage to tackle anything set before you.

All I Ask Is Ninety Days

Who says it takes years to get in shape? Show me the man who makes any such claims and I'll make him eat his words. I'll put one full inch on your arm in just 30 days. Yes, and two full inches on your chest in the same length of time. Meanwhile, I'm putting life and pep into your old back-bone. And from then on, just watch 'em grow. At the end of thirty days you won't know yourself. Your whole body will take on an entirely different appearance. But you've only started. Now comes the real works. I've only built my foundation. I want just 60 days more (90 in all) and you'll make those friends of yours who think they're strong look like something the cat dragged in.

A Real Man

When I'm through with you you're a real man. The kind that can prove it. You will be able to do things you had thought impossible. And the beauty of it is you keep on going. Your deep, full chest breathes in rich, pure air, stimulating your blood and making you just bubble over with vim and vitality. Your huge square shoulders and your massive muscular arms have that craving for the exercise of a regular he-man. You have the flash to your eye and the pep to your step that will make you admired and sought after in both the business and social world.

This is no idle prattle, fellows. If you doubt me, make me prove it. Go ahead, I like it. I have already done this for thousands of others and my records are unchallenged. What I have done for them, I will do for you. Come then, for time flies and every day counts. Let this very day be the beginning of new life to you.

Send For My New
64 Page Book

"Muscular Development"

IT IS FREE

It contains over four dozen full-page photographs of myself and some of the many prize-winning pupils I have trained. Some of these came to me as pitiful weaklings, imploring me to help them. Look them over now and you will marvel at their present physiques. This book will prove an impetus and a real inspiration to you. It will thrill you through and through. And it's all yours, I don't ask a cent. This will not obligate you at all, but for the sake of your future health and happiness do not put it off. Send today—right now before you turn this page.

EARLE E. LIEDERMAN

Dept. 2002,

305 Broadway, New York City

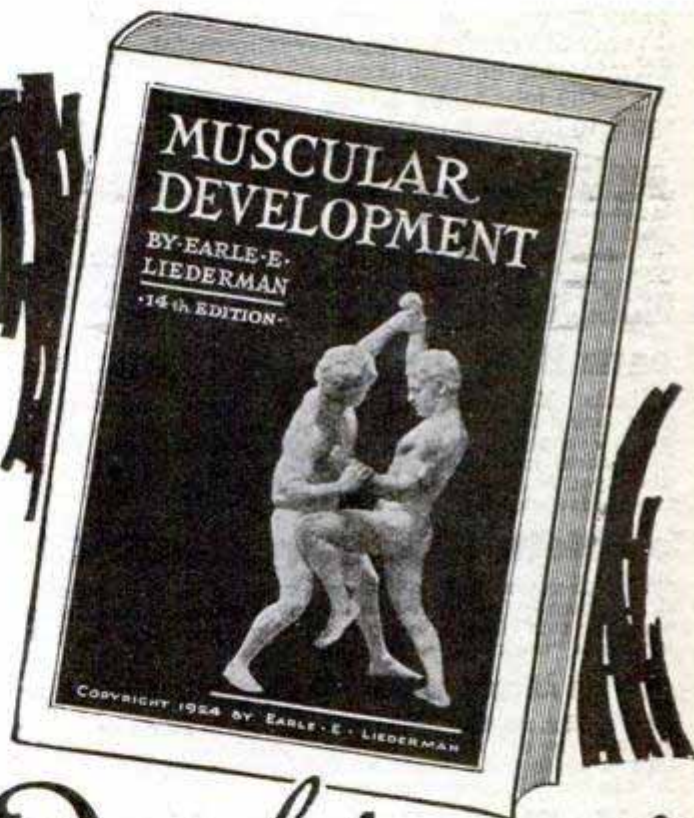

It
Is
F
R
E
E

DON'T
SEND ONE
PENNY
—
YOUR
NAME AND
ADDRESS
ON A
POSTAL
WILL DO

EARLE E. LIEDERMAN
Dept. 2002, 305 Broadway, New York City

Dear Sir: Please send me, without any obligation on my part whatever, a copy of your latest book, "Muscular Development." (Please write or print plainly.)

Name

Address

City..... State.....

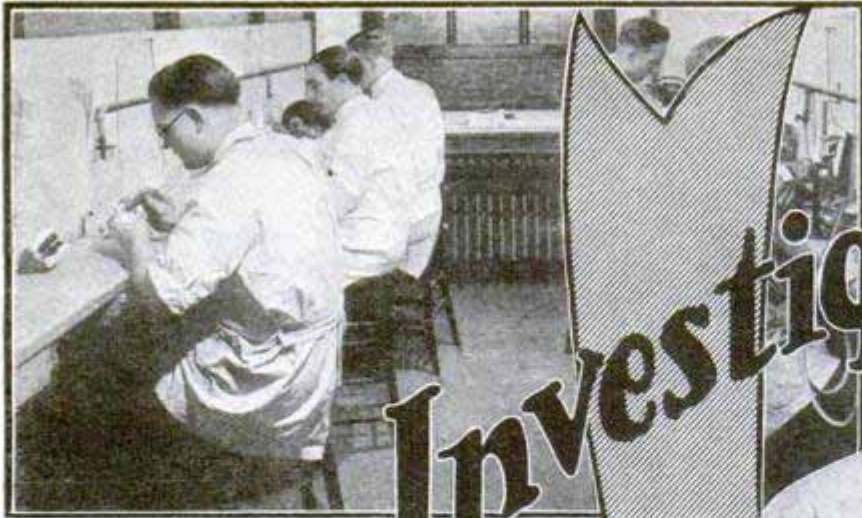

Mechanical Dentistry

70,000 Dentists Use Dental Laboratory Work



Investigate!

Be a "Mechanical Dentist!"

There is big money in Dental Laboratory work. Here's a rapidly growing, uncrowded field in which men with only 8th grade schooling are successful. Investigate your opportunities in "Mechanical" Dentistry—the jobs and salaries, the many openings to go into business for yourself with little capital.

Fascinating, Professional Work

It is not necessary to be mechanically inclined to be successful in this work. Short hours, pleasant surroundings, fine fellows to work with. And your business is entirely with DENTISTS. You work with gold, platinum, silver, rubber, plaster, porcelain, and composition. You make crowns, plates, and bridges from Dentists' "impressions."

Learn By Doing Actual Work

No text books in my schools. You learn by doing actual Dental Laboratory jobs for practicing Dentists. You use standard tools and materials—which I supply to every student without extra charge. Individual, practical instruction here—no books, no classes. By these methods you become skillful in all branches of Mechanical Dentistry in a few months.

Complete Laboratory Outfit Given

—new, high grade, the kind you will continue to use when employed. And it's actually FREE because I have not raised my tuition since announcing this offer. Easy terms. Day or evening instruction permits you to "work your way thru."

R. R. Fare Allowed to Chicago, Detroit, Cleveland, or Boston

—a big saving, as the tuition remains the same as before. A real inducement to get more men into "Mechanical Dentistry" quick—to wake you up to the money-making opportunities, the fine jobs and large salaries in Dental Laboratory work.

Get My Big FREE Book More Laboratories, more trained "Mechanical" Dentists are needed in a thousand cities. You need little capital to open a Laboratory of your own when you have real training, such as I guarantee to give you.

Get my Free Book. Investigate Mechanical Dentistry. Find out how I help ambitious men with little money become successful Dental Laboratory workers. Coupon brings complete information.

H. A. McCARRIE, Director

McCARRIE SCHOOLS OF MECHANICAL DENTISTRY
1338 S. Michigan Ave., Dept. 3101-B, CHICAGO

SALARIES
\$60 TO \$125
A WEEK!

4
BIG

Individual, personal instruction in my schools

Big Demand

H. A. McCARRIE
Director of the McCARRIE Schools is the pioneer in modern methods of training men for success in Mechanical Dentistry.



SCHOOLS NOW!

In great industrial centers where it's easy to find spare-time work while getting my training.

- CHICAGO**
10,000 square feet of daylight space, overlooking Lake Michigan and the new, great Stadium.
- DETROIT**
In great big modern office building on Detroit's principal thoroughfare—Woodward Ave.
- CLEVELAND**
Without a doubt the finest building in this city. Well located. Fine transportation.
- BOSTON**
In the heart of Boston, quick transportation facilities to all points. One block from new Statler Hotel.

Send me the facts!

H. A. McCARRIE, Director
McCARRIE Schools of Mechanical Dentistry
1338 S. Michigan Ave., Dept. 3101-B, Chicago.

Send me the facts about Mechanical Dentistry; free book, R. R. fare, and other offers.

Name

St. No.

City State



Lower removable bridge, needed where molars are missing on one side only.



Full upper plate, ordered by Dentist where patient has lost all upper teeth.



Lingual (Tongue) Bar Plate

Used where all the back (posterior) teeth are missing. The gold clasps help to hold the plate in place, and the gold bar provides additional strength and room for the tongue.

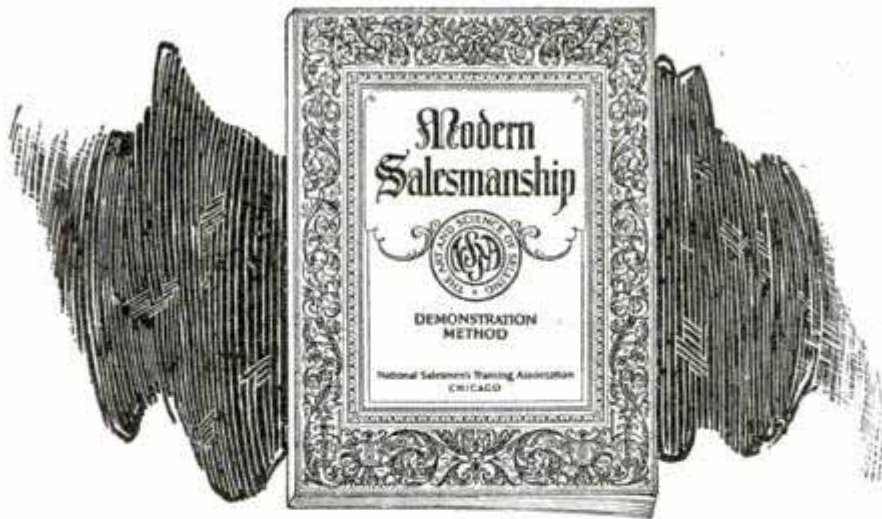

Where Shall We Mail Your Copy of this Book—FREE

Remarkable new book on Salesmanship just off the press will be mailed to you without cost or obligation

THE contents of this amazing new book—just published by the National Salesmen's Training Association—will prove a revelation to every man who is interested in making real money—and to those who realize the tremendous possibilities for high earnings in the selling field.

Thirty thousand copies of this book will be mailed free without cost or obligation to those who send for it while the supply lasts—and there is no time like the present for you to fill in the coupon below.

FULLY EXPLAINS NATIONAL DEMONSTRATION METHOD

Thousands have wondered why N. S. T. A. Members invariably make good, in a big way, right from the start, even though they have had no former selling experience, or why salesmen who have just plodded along with indifferent success quickly begin to outstrip their brother salesmen after becoming members of the Association.

Among other things, this remarkable free book explains just why success comes rapidly and surely to those who enroll for this amazing System of Salesmanship Training.

There are too many victims of that vicious superstition that "salesmen are born and not made," but after reading "Modern Salesmanship," you will realize the utter fallacy of that foolish notion.

QUICK SUCCESS THROUGH N. S. T. A. TRAINING

EMPLOYERS are invited to write to the Employment Dept. of the N. S. T. A. No charge for this service to you or our members. Employers are also cordially invited to request details about the N. S. T. A. Group Plan of instruction for entire sales forces. Synopsis and charts sent without obligation.

Whether you have had selling experience or not, it makes no difference. The N. S. T. A. System of Salesmanship Training will enable you to become a Master Salesman in an amazingly short period of time. It will teach you, in your spare time, at home, the fundamental rules and principles of selling—how to approach different types of prospects to get their undivided attention—certain ways to stimulate keen interest—ways to overcome objections, batter down prejudices, outwit competition, and make the prospect act.

Step by step this Training takes you through every phase of Salesmanship. Every underlying principle of sales strategy is made as simple as A B C. Through the National Demonstration Method, you get actual experience on practically every type of sales problem that may ever present itself. And through the instruction in Character Analysis, you will become an expert in reading character on sight—a valuable asset for any salesman.

JUST MAIL THE COUPON THE BOOK IS FREE

To fill in and mail the coupon will not obligate you in any way, but it, undoubtedly, will show you the way to be a "star" salesman. No matter what you may think now, it can only be a thought and it will pay you to let us send you this valuable and interesting book.

While this is before you, fill in and mail the coupon and get it into the mail some time today.



Dept. B-12

N. S. T. A. Building,
Chicago, Ill.

National Salesmen's Training Ass'n, Dept. B-12,
N. S. T. A. Building, Chicago, Ill.

Without cost or obligation you may send me your free book, "Modern Salesmanship," and all I promise to do is to read it through carefully.

Name.....

Address.....

City.....State.....

Age.....Occupation.....

There Ain't No Santa Claus



IF YOU were offered a job at a salary of one cool million a year, would you take it? You'd grab it. Well, fellows, don't be misled by any such big-salaried jobs, 'cause "there ain't no Santa Claus"; but—I can put you in line for one of the nicest little jobs you ever dared dream about. Big money? I'll say it is. And when it comes to steady work, there's no such thing as a day off. Business is always prosperous.



The Man You Work For

Did you ever listen in while some of these big bankers talked about investments? When they want to make a sure clincher, they say, "It's as sure and safe as a U. S. Government Bond;" and that's some sure—there isn't anything better. Well, how about getting on the inside with the crowd that make these bonds so sure that every other country in the world would like to get a hat full?

Did you ever check up on what these government employees get? I want to tell you it's worth looking into. It's big money, sure money, and in just about as pleasant surroundings as any fellow ever wished for.

When you work for Uncle Sam, your friends know you are a somebody. They respect you. And why shouldn't they? In almost every case you're holding down the job they would like to have, but don't know how to get it.

I Will Show You How

A lot of fellows think every good job in the government is secured by some kind of pull. And they're right. But it isn't the kind of pull they talk about. It's by doing just a little work and pulling yourself out of that rut you've been traveling in all these years.

Honest, fellows, you'd laugh if you knew how easy it is when the thing is explained to you by someone that knows. I tell you what you do. You just write a letter to Arthur R. Patterson, giving your name and address, and I'll tell you all about it. After completing your course with me and receiving your rating, if you are not offered a job within one year I will refund the small fee I charge for teaching you. You couldn't get a better break than that.

But let's not argue over this thing. Fill in the coupon below or drop me a line. This won't cost you a cent. I'm not going to bother you. I just want to tell you about it. If you don't like what I tell you, why, forget it. But if you do, you're going to write me another letter some day and thank me.

Let me hear from you—right away. Take my little tip. There's some good thing breaking. Mark your envelope **PERSONAL** and send it to

ARTHUR R. PATTERSON, Principal
PATTERSON CIVIL SERVICE SCHOOL

Approved as a correspondence school under the laws of the State of New York.

81 Wisner Bldg. Rochester, N. Y.

PATTERSON CIVIL SERVICE SCHOOL
81 Wisner Building, Rochester, New York

Send me your big **FREE BOOK** and tell me how I can secure a position with the U. S. Government paying from \$1140 to \$2700 a year to start, with excellent chances for advancement. This doesn't cost me a penny.

Name.....

Address.....

City.....State.....



Your Choice

\$20⁰⁰

Musical Instruments

FREE TO OUR STUDENTS

Your choice of a Violin, Tenor Banjo, Hawaiian Guitar, Banjo, Cornet, Ukulele, Banjo Ukulele, Guitar, Mandolin or Banjo Mandolin. You will be proud to own any one of these instruments and you can have one absolutely **free**. A few cents a day for lessons is your only expense. Our system of teaching is so easy that you can play several pieces by note with the first four lessons. We guarantee success or no charge. Instrument and lessons sent on **one week's free trial**. Write for booklet today, no obligation.

CHICAGO CORRESPONDENCE SCHOOL OF MUSIC
Orchard and Willow Streets • Dept. 70 • Chicago, Illinois

Learn to Mount Birds



Learn at home by mail, to mount birds, animals, game heads; tan furs, make rugs and robes. Complete lessons. Easily and quickly learned by men, boys and women.

FREE Write today for Free Taxidermy Book. Tells all about it. Every Sportsman, Hunter, Trapper and Nature lover should know this wonderful fascinating art. Save your trophies. Big profits. Success guaranteed. Our school is 20 years old - 75,000 graduates. Investigate today. Write for Free Book.

Northwestern School of Taxidermy 9772 Elwood Bldg., Omaha, Neb.

STUDY AT HOME

Directed by

The University of Chicago

Courses in English, History, Chemistry, Business, Education, Mathematics, Psychology, and 35 other subjects command credit toward a Bachelor degree. Begin any time. Address 15 Ellis Hall, University of Chicago, Chicago, Ill.



LEARN TO DRAW!

Remarkable book just off the press—"COMMERCIAL ART AND CARTOONING." Explains how to make illustrations for Books, Advertisements, etc. Also tells how to become a successful Cartoonist. **NO CORRESPONDENCE COURSE**—Everything complete in this book—14 chapters, over 125 illustrations. Tells about Elementary Drawing, Still Life; Pen, Ink, Charcoal and Crayon Work; Wash and Figure Drawing; Cartooning. Bound Flexible, Imitation Leather—Gold top.

Worth \$5.00. Sent postpaid for \$2.00 (C. O. D. 17c extra!)
OGILVIE PUB. CO., 57 Rose St., New York, Dept. 133



"STAMMERING Its Cause and Cure"

You can be quickly cured if you stammer. Send 10 cents, coin or stamps, for 288 page cloth bound book on Stammering and Stuttering. It tells how I cured myself after Stammering and Stuttering for 20 years. **BENJAMIN N. BOGUE**
6930 Beque Building, 1147 N. Ill. St. Indianapolis

WHY NOT spend Spring, Summer and Fall, gathering butterflies, insects? I buy hundreds of kinds for collections. Some worth \$1 to \$7 each. Simple outdoor work with my instructions, pictures, price-list. Send 10 cents (not stamp) for my illustrated Prospectus before sending butterflies.
MR. SINCLAIR, DEALER IN INSECTS,
Dept. 6, Box 1210, Victoria, B. C., Canada



Wonderful, new device, guides your hand; corrects your writing in few days. Big improvement in three hours. No failures. **Complete outline FREE.** Write C. J. Ozment, D-34, St. Louis, Mo.



Why Dance in the Old Fashioned Way —When It's So Easy to Be Up-to-Date?

Want to be truly popular? Want to be invited everywhere? Want to enjoy parties and get real joy out of dancing? Here's how! Learn to dance the new peppy way and see how you begin to be in demand as a partner!

NO one enjoys dancing with a "walk around" who thinks he's getting by because he knows a few old-fashioned steps. You simply can't dance that way to the new ballroom music. You must know the latest steps, the joyous modern steps that everyone is doing!

Those lumbering dances they used to do before jazz laughed its way into the ballroom—those awkward, old-fashioned steps—get rid of them! Learn to dance the new way and see what a difference it makes. Not only will you be more popular, not only will you be a favorite partner, not only will the girls like to dance with you, but—

You yourself will get more joy out of dancing!

No longer will dancing be a ballroom duty, but a pleasure! At the end of a dance you won't feel tired, but exhilarated. You can dance all night the new way and enjoy each dance more than the one before. It's great!

Arthur Murray's Famous At-Home Method

Of course you want to dance the new way! Why don't you let Arthur Murray teach you—his fascinating, quick, at-home way—without partner, without music, in the privacy of your home? You'll get real pleasure out of it. Quicker than you'd imagine possible you'll learn how to do all the modern jazz steps that make a dancer popular.

To prove it Mr. Murray is willing to send his new illustrated book, "The Short Cut to Popularity," to any one who requests it.

Send for this FREE book —TODAY!

This free book describes Mr. Murray's unique method of teaching in detail, and also includes a special test lesson from his famous course FREE. Just send the coupon (with 10c to cover cost of printing and mailing) and this in-



Posed by Edna Murphy, "Pathe Film Star," and Arthur Murray

teresting book with the free lesson will be forwarded at once.

No, don't wait—you may forget—Clip and mail this coupon NOW.

**Arthur Murray, Studio 585,
7 E. 43rd St., New York City**

Arthur Murray, Studio 585,
7 E. 43rd St., New York City

Please send me your 32-page book and Special Test Lesson. I enclose 10c to cover postage, printing and mailing.

Name.....

Address.....

City.....State.....



An Easy Way to Learn PHARMACY AT HOME

Graduate pharmacists are always in demand. The work is interesting and pleasant and salaries are good. Many young men open drug stores of their own and become independent.

There's an easy way to learn pharmacy right in your own home in spare time, without losing a day or a dollar from your present work.

The International Correspondence Schools course in Pharmacy supplies the knowledge which it will be necessary for you to have in order that you may pass your State Board Examination.

Just mark and mail the coupon printed below to the International Correspondence Schools, Box 5558-E, Scranton, Pa., and full particulars about the Pharmacy Course or any other work of your choice will come speeding to you by return mail.

INTERNATIONAL CORRESPONDENCE SCHOOLS
Box 5558-E, Scranton, Penna.

Without cost or obligation, please send me full information about the subject before which I have marked an X in the list below:

TECHNICAL AND INDUSTRIAL COURSES

- | | |
|--|---|
| <input type="checkbox"/> PHARMACY | <input type="checkbox"/> Civil Engineer |
| <input type="checkbox"/> Chemistry | <input type="checkbox"/> Surveying and Mapping |
| <input type="checkbox"/> Automobile Work | <input type="checkbox"/> Mine Foreman or Engineer |
| <input type="checkbox"/> Navigation | <input type="checkbox"/> Steam Engineer |
| <input type="checkbox"/> Agriculture and Poultry | <input type="checkbox"/> Gas Engine Operating |
| <input type="checkbox"/> Mathematics | <input type="checkbox"/> Wireless <input type="checkbox"/> Airplane Engines |
| <input type="checkbox"/> Electrical Engineering | <input type="checkbox"/> Architect |
| <input type="checkbox"/> Electrician | <input type="checkbox"/> Contractor and Builder |
| <input type="checkbox"/> Mechanical Engineer | <input type="checkbox"/> Architectural Draftsman |
| <input type="checkbox"/> Mechanical Draftsman | <input type="checkbox"/> Concrete Builder |
| <input type="checkbox"/> Machine Shop Practice | <input type="checkbox"/> Structural Engineer |
| <input type="checkbox"/> Railroad Positions | <input type="checkbox"/> Plumbing and Heating |

BUSINESS TRAINING COURSES

- | | |
|--|---|
| <input type="checkbox"/> Business Management | <input type="checkbox"/> Salesmanship |
| <input type="checkbox"/> Industrial Management | <input type="checkbox"/> Advertising |
| <input type="checkbox"/> Personnel Organization | <input type="checkbox"/> Better Letters |
| <input type="checkbox"/> Traffic Management | <input type="checkbox"/> Foreign Trade |
| <input type="checkbox"/> Business Law | <input type="checkbox"/> Stenography and Typing |
| <input type="checkbox"/> Banking and Banking Law | <input type="checkbox"/> Business English |
| <input type="checkbox"/> Accountancy (Including C.P.A.) | <input type="checkbox"/> Civil Service |
| <input type="checkbox"/> Nicholson Cost Accounting | <input type="checkbox"/> Railway Mail Clerk |
| <input type="checkbox"/> Bookkeeping | <input type="checkbox"/> Common School Subjects |
| <input type="checkbox"/> Private Secretary | <input type="checkbox"/> High School Subjects |
| <input type="checkbox"/> Spanish <input type="checkbox"/> French | <input type="checkbox"/> Illustrating <input type="checkbox"/> Cartooning |

Name.....
Street.....
Address.....
City..... State.....
Occupation.....

Persons residing in Canada should send this coupon to the International Correspondence Schools Canadian, Limited, Montreal, Canada

QUIT WISHING
AND WAITING

EARN

\$3500 to \$5000 a Yr.

LEARN

MECHANICAL DENTISTRY

Three Months' Training Will Qualify You for Success.

2500 More Dental Mechanics Needed Now and Demand Is Increasing.

YOU LEARN BY DOING

We train each student individually—no classes whatever—using the tools of the trade and you learn on regular dental work. But we do not make the serious mistake of depending on practical work alone. You are given definite theoretical training as well.

FREE PARTIAL SCHOLARSHIPS

Send today for Free Catalog No. 2, outlining Scholarship Offer, how students "Learn by Doing" actual work through practical, individual instruction, day or evening sessions, and how you can "Earn while Learning."

BODEE DENTAL INSTITUTE

Established 30 years.

New York	Philadelphia
136 W. 53d St.	1305 N. Broad St.
Buffalo	Brooklyn
501 Washington St.	85 Court St.

Anyone CAN LEARN

No talent or experience necessary. Fascinating work. Pays big money. Complete instruction book tells about: Alphabets, Colors, How to Mix Prints, Show Cards, Window Board and Wall Signs, Ready made letters, Gilding, Tricks of the Trade, also gives 100 Alphabets and Designs. Book bound in flexible imt. leather-gold edges, and four ball bearing Show Card Pens. Sent postpaid \$3.00. (C.O.D.) 10c ex. Ogilvie Pub. Co., 57 Rose St. Dept. 50. N.Y. City

\$3

EARN MONEY IMMEDIATELY—WE FURNISH EQUIPMENT TO START!!

Comedies, Dramas, Musical Comedies and Revues, Minstrel Choruses, Songs, Blackface Plays, Burnt Cork Shows and All Amateur Entertainments, Monologs, Dialogs, Speakers. **CATALOGUE FREE.**

T. S. DENISON & CO., 623 So. Wabash, Dept. 9, CHICAGO

Play the HAWAIIAN GUITAR

Just as the Natives Do

FREE when you enroll

\$15 HAWAIIAN GUITAR and Case

Only 4 Motions used in playing this fascinating instrument. Our native Hawaiian instructors teach you to master them quickly. Pictures show how. Everything explained clearly.

Play in Half Hour
After you get the four easy motions you play harmonious chords with very little practice. No previous musical knowledge necessary.

Free Guitar
and Outfit in Genuine Seal Grain Fabricoid Case as soon as you enroll. Nothing to buy—everything furnished. No delay.

Easy Lessons
[Even if you don't know one note from another, the 52 printed lessons and the clear pictures make it easy to learn quickly. Pay as you play.]

Write at Once
You'll never be lonesome with this beautiful Hawaiian Guitar. Write for Special Offer and easy terms. A postcard will do. ACT!

FIRST HAWAIIAN CONSERVATORY OF MUSIC, Inc.
9th Floor, Woolworth Bldg., Dept. 148 New York, N. Y.
Approved as a Correspondence School Under the Laws of the State of New York

ELECTRICITY

Complete Study Course and Pocket Library \$10

SHIPPED FREE



A set of **HAWKINS GUIDES** is a good friend to the electrical worker. It tells you how to do any job the right way—without guessing or taking chances.

Hawkins Guides put the facts about modern electrical engineering at your finger tips, making your chances for advancement in the electrical field unlimited.

HAWKINS GUIDES INCREASE YOUR PAY



Electricity is king! It is the great ruling force—transportation, communication, light, heat, power—almost every modern activity is dependent on electricity. Industry is demanding electrical men that know their jobs!

Hawkins Guides teach you all you need to know about electricity in easy, step-by-step lessons. Daily spare time reading of the Guides will greatly increase your value to yourself and your employer in a few weeks. Hundreds of our friends have written us and told us this!

READERS OF HAWKINS GUIDES KNOW HOW



"You can't stump him on an electrical job." "He certainly knows his business." "Certainly have to hand it to him for knowing how." —These are the things employers say about our friends who are readers of Hawkins Guides. No matter what question or problem comes up the Ready Reference Index enables you to give an expert answer at once.

HAWKINS STARTS YOU WHERE OTHERS LEAVE OFF

Don't work any longer at low wages when easy reading of **HAWKINS GUIDES** will give you the money-making knowledge of the expert! Easy daily reading of the Guides will teach you in a few months what it has taken the expert a lifetime to learn!

With **HAWKINS GUIDES** in hand you have a running start to success in the electrical field. You will actually begin where others left off!

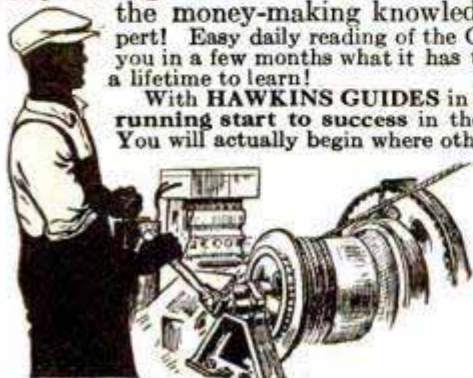

NOW!

This coupon is your golden opportunity. Tear it out—send it now!

FOR EXAMINATION!

REAL ELECTRICAL EDUCATORS

"Hawkins Guides at \$10 are the best investment I have ever made. Am able to take up almost any electrical job and have never gone to an electrical school."—B. Roessler, Oenaville, Texas.

AS EASY AS A. B. C.

"Everything in Hawkins Guides is very plain and anybody can read and understand them as easy as A. B. C."—J. Knight, Tobyhanna, Pa.

OTHER READERS SAY

"Worth ten times their price." "Helped me to two raises in four months." "Better than a school of instruction." "Studied them when I was laid up and got further ahead than if I had been on the job."

Hawkins Guides Explain These Points So You Can Easily Understand:—

Magnetism—Induction—Experiments—Dynamometers—Electric Machinery—Motors—Armatures—Armature Windings—Installing of Dynamometers—Electrical Instrument Testing—Practical Management of Dynamometers and Motors—Distribution Systems—Wiring—Wiring Diagrams—Sign Flashers—Storage Batteries—Principles of Alternating Currents and Alternators—Alternating Current Motors—Transformers—Converters—Rectifiers—Alternating Current Systems—Circuit Breakers—Measuring Instruments—Switch Boards—Wiring—Power Stations—Installing—Telephone—Telegraph—Wireless—Bells—Lighting—Railways. Also many Modern Practical Applications of Electricity and Ready Reference Index.

Hawkins Guides—10 POCKET SIZE NUMBERS

Each number easy to carry around and read in spare time. Big type and clear diagrams. Easy to study and learn. Durable, flexible binding—gold edges. 3,500 pages—4,700 illustrations. Shipped free for examination. Pay only \$1 a month if satisfied. Price of set, complete, \$10.

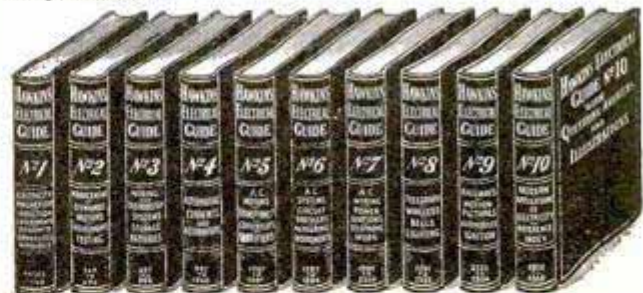

EXAMINE GUIDES FREE!

Let the Guides themselves demonstrate their practical value to you—as a study course, reference work and complete electrical library. You are the judge. Simply send this coupon. No obligation unless you are entirely satisfied. Tear out on dotted line—fill in—mail it NOW!



FREE EXAMINATION COUPON

Theo. Audel & Co., 65 W. 23rd St., New York City

Please send me (postpaid) for my approval **Hawkins Electrical Guides**, 10 numbers (price \$1 each). If satisfactory I will mail you \$1 in 7 days and further mail \$1 monthly until purchase price of \$10 is paid.

Name.....

Address.....

Occupation.....

Employed by.....

\$100 for One Good Commercial Drawing



Become An Artist This Quick Easy Way

Thousands who never dreamed they could draw can now easily become artists. **You** too—without any previous training—and no matter how little apparent talent you have—can now easily learn Illustrating, Designing and Cartooning through this amazingly easy method.

You learn at home, yet your work receives the personal attention and criticism of one of America's most successful artists. Many students actually sell enough work during their training to pay for it many times over.

Big Money in Commercial Art

Millions of dollars are being spent this year on advertising and story illustrations, commercial designs, and cartoons. And even more will be spent next year. Commercial art is a **tremendous** field—and a field where very big money is gladly paid anyone who can produce good art work. Advertisers, magazines, newspapers, printing houses, business concerns all need trained artists. Competent artists easily earn from \$50 to far over \$300 a week. And now you can easily enter this "world's most fascinating, best paid business."

Mail Coupon for Free Book

A new handsomely illustrated book has just been printed, which gives all the most up-to-date information on the thousands of wonderful opportunities in Commercial Art and shows how this startling short-cut method easily enables you to enter this field. It tells about our students—their success—what they say—actual reproductions of their work—how they made big money while studying. This attractive book will be sent without cost or obligation. Send for it. Mail coupon now. **Washington School of Art, Room 302-D, 1115-15th St., N. W., Washington, D. C.**

WASHINGTON SCHOOL OF ART
Room 302-D, 1115-15th St., N. W., Washington, D. C.

Please send me without cost or obligation your new book on art, "Quick Way to Become an Artist," and details of your special offer.

Name

Please write plainly Mr., Mrs. or Miss

Address

City..... State.....

Make Money Taking PICTURES



Tremendous, big-paying opportunities are open for ambitious men in Modern Photography. This is the picture age. Magazine and newspaper publishers buy thousands of photographs each year. Every manufacturer sends out high priced pictures of his products. Every home wants portraits. Photography is a business running into millions of dollars each year. And there is a great shortage of trained photographers.

Get \$100 for Flood Pictures

"I took pictures of a flood and sold them for \$100. I have been able to buy my house and lot from the sale of pictures."

C. M. COLE, Washington.

\$97 in Two Days!

"I made \$285 in December. Went out two days last week on home portrait work and made \$97."

A. G. HUGHES, Kentucky.

EARN \$3,000 TO \$10,000 A YEAR

Hundreds of men are earning big money and establishing their own businesses. **Even during spare time**, while training, you can make \$75 a week easily—no matter where you live!

AMAZING NEW EASY METHOD

I show you, at home, how to do the kind of work turned out by the big studios in New York and Chicago! I show you how to make big money **within 30 days!** C. M. Cole bought a home with money he had made when **only half way through** his training. So well do I know what I can do for you that I guarantee under bond to return every cent of your tuition if you are not thoroughly satisfied.



PROFESSIONAL VIEW CAMERA FREE!

Write at once for Free Camera Offer—I give you, free, a splendid professional view camera. You will be astonished and delighted. This offer open for short time only—so act quick! **No obligation.**

INTERNATIONAL STUDIOS, INC., Dept. 1352
3601 Michigan Ave. CHICAGO, U. S. A.

PIANO JAZZ

By Note or Ear. With or without music. Short Course. Adult beginners taught by mail. No teacher required. Self-instruction Course for Advanced Pianists. Learn 259 styles of Bass, 684 Syncopated Effects, Blue Harmony, Oriental, Chime, Movie and Cafe Jazz, Trick Endings, Clever Breaks, Space Fillers, Sax Sturs, Triple Bass, Wicked Harmony, Blue Obligato, and 247 other Subjects, including Ear Playing. 133 pages of REAL Jazz, 25,000 words. A Postal brings our FREE Special Offer.

Waterman Piano School, 1826 W. Adams St. Los Angeles, Cal.

Learn Advertising at HOME

The highest paid men in the world are advertising men. You can learn easily and quickly at home during your spare time. Bigger opportunities now in advertising than ever before. Tremendous demand for our graduates at big pay.

Send for **FREE Book**. Giving interesting information and vital facts—just what you want to know about advertising. Write today!

PAGE-DAVIS SCHOOL OF ADVERTISING
Dept. 1352 3601 Michigan Ave., Chicago, U. S. A.

LAW High-Grade Instruction

By Correspondence Prepares You for the Bar—Est. 1892 University Methods. Standard Text-Books. Approved by Bench and Bar. Graduates practicing in every state. Send today for Free Catalog and Rules for Admission to the Bar. **CHICAGO SCHOOL OF LAW, 802 Reaper Block, Chicago, Ill.**



LEARN WATCH REPAIRING

Be a watchmaker—you can learn this profitable trade by correspondence in a few weeks in your own home by the DeSelms Chart System. After you complete the course you will know a watch from A to Z. You will know just what the matter is and how to repair one. When you graduate you will be a practical watchmaker and repairer and competent to fill any position. Positions for our graduates. Ask for our Free Book. It explains our system and terms.

THE DeSELMS WATCH SCHOOL
LOGANSPORT, INDIANA



Easy as A-B-C!

**You Can Play Any Instrument
In a Few Months
This Delightful
New Easy Way!**

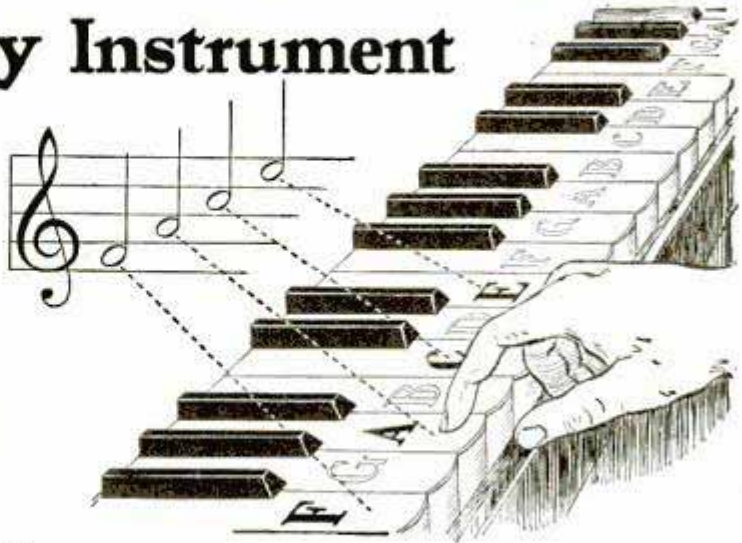

Quickest because natural and pleasant. Grateful students say they learn in a fraction of the time old dull methods required. You play direct from the notes. And the cost is only a few cents a lesson!

Learning music is no longer a difficult task. If you can read the alphabet, you can now quickly learn to play your favorite instrument! A delightful new method has made it positively easy to become a capable performer within just a few months. And the cost is only a *fraction* of what people used to spend on the old, slow methods!

You don't need a private teacher, this new way. You study entirely at home, in the privacy of your own room, with no one to interrupt or embarrass you. And, strange as it may seem, you'll enjoy every minute of it—because the new method is *agreeable* as well as *rapid*!

No Tricks or Stunts—You Learn from "Regular" Music

You don't have to know the first thing about music in order to begin. You learn to play from actual notes, just like the best musicians do. And almost before you realize your progress, you begin playing real tunes and melodies instead of just scales. There are no trick "numbers," no "memory stunts." When you finish the U. S. School of Music course, you can pick up any piece of regular printed music and understand it! You'll be able to read music, popular and classic, and play it from the notes. You'll acquire a life-long ability to please your friends, amuse yourself, and, if you like, make money (musicians are highly paid for their pleasant work).

Whether you like the piano, violin, 'cello, organ, saxophone, or any other instrument, you can now learn to play it in an amazingly short time. By means of this wonderful newly perfected method reading and playing music is made almost as simple as reading aloud from a book. You simply can't go wrong. First, you are told how a thing is done, then a picture shows you how, then you do it yourself and hear it. No private teacher could make it any clearer. The lessons come to you by mail at regular intervals. They consist of complete printed instructions, diagrams, all the music you need, and music paper for writing out test exercises. And if anything comes up which is not *entirely plain*, you can write to your instructor and get a full, prompt, personal reply!

The Surest Way To Be Popular and Have a Good Time

Do you sit "on the sidelines" at a party? Are you out of it because you can't play? Many, many people are! It's the musician who claims attention. If you play, you are always in demand. Many invitations come to you. Amateur orchestras offer you wonderful afternoons and evenings. And you meet the kind of people you have always wanted to know. So don't miss this exceptional opportunity.

Learn to Play by Note

Piano	'Cello
Organ	Harmony and
Violin	Composition
Drums and	Sight Singing
Traps	Guitar
Banjo	Ukulele
Tenor	Hawaiian
Banjo	Steel Guitar
Mandolin	Harp
Clarinet	Cornet
Flute	Piccolo
Saxophone	Trombone
Voice and Speech Culture	
Automatic Finger Control	
Piano Accordion	

Free Book Explains All Get This Special Offer

The whole interesting story about the U. S. School course can not be told on this page. So a booklet has been printed—"Music Lessons in Your Own Home." You can have a copy absolutely free by mailing the coupon below. In the booklet you will find a special offer that makes the U. S. course available to you at a very low price—if you act promptly. With it will be sent a demonstration lesson which shows better than words how delightfully quick and easy the wonderful Method is. If you are really anxious to become a good player on your favorite instrument, mail the coupon now—today. Instruments supplied when needed, cash or credit. U. S. School of Music, 72 Brunswick Bldg., New York City.

U. S. School of Music,
72 Brunswick Bldg., New York City.

Please send me your free book, "Music Lessons in Your Own Home," with introduction by Dr. Frank Crane, Demonstration Lesson, and particulars of your Special Offer. I am interested in the following course:

(Name of Instrument or Course)

Name.....

Address.....

City..... State.....

BOYS

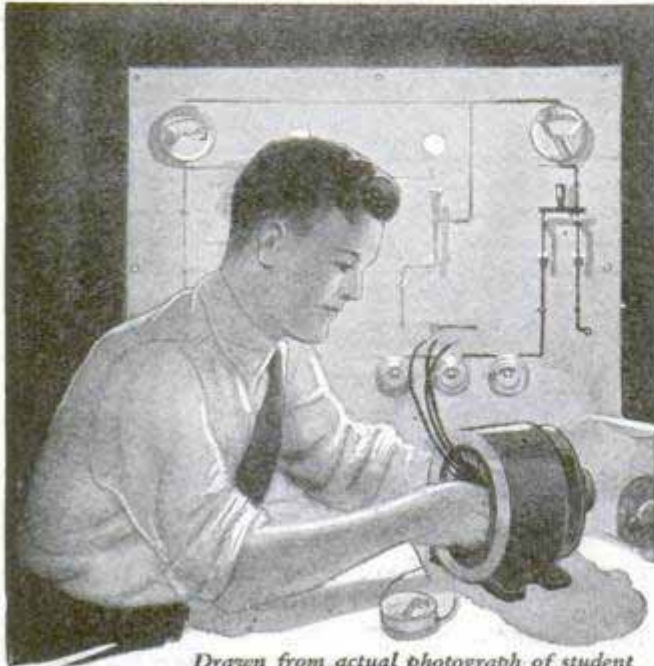

Drawn from actual photograph of student doing spare time electrical work

Learn Electricity Make Big Money

How would you like to earn two or three dollars every evening after school and prepare yourself for a fine big job at the same time? Here's the opportunity of a lifetime for you fellows who like Electricity. Begin right now to prepare yourself for a regular man's size job in this fascinating field. Your chances for a big success are simply wonderful—the pay is big (thousands of men earn \$70 to \$200 a week) and advancement comes swift and sure.

I Will Train You at Home

With my easily earned, spare time Electrical Course I will train you at home like I have trained hundreds of other boys who are now big successful men. It will not interfere with your school work and you can earn more than the small cost of the course doing odd electrical jobs in your spare time. The Course pays for itself. I will show you how to get this work and how to do it. Some of my boy students make \$10 to \$15 a week this way.

Tools, Apparatus and Radio Course—Given Without Extra Charge

Send me the coupon below and I will tell you all about the big outfit of tools, apparatus and instruments and a new Radio Course that I am giving to my students for a limited time. I will send you my big interesting Electrical Book and a sample lesson, too—all Free. You will be tickled with the things I will send you Free. Mail the coupon right now.

L. L. COOKE, Chief Engineer
Chicago Engineering Works
Dept. O-12 CHICAGO

Look What This Boy Is Doing

"Although the School term is coming to a close, and I am pretty busy with my examinations, I manage to keep up with my electrical studies and work."

"I guess I forgot to tell you I am now in business for myself. Am doing fine, but owe it all to you. If it had not been for your Course, I, being under age, could not have secured my license in this town. But I got it, and now have all the work I can do, averaging \$20 to \$30 a week, thru spare time work."

"I went out on a job tonight after school, on which I made \$3 and brought home another on which I made \$2.50—\$5.50 for 4 hours' work and no material furnished by me."

ROGERS SMITH,
1215 Chestnut St.,
Greenville, N. C.

Use This "FREE BOOK" Coupon

L. L. COOKE, Chief Engineer,
Chicago Engineering Works,
Dept. O-12 2150 Lawrence Avenue, Chicago
Send me your Big Outfit Offer, your big Electrical Book, Sample Lesson and particulars of your Electrical Course and Extra Radio Course. This will not obligate me in any way.

Name.....
Address.....
This Coupon only for use of boys 15 years old or more.

\$25⁰⁰ DRAWING COURSE for \$2⁹⁸



Haven't you often wished that you could draw cartoons, illustrate some idea, sketch some pretty face, etc.? You can do all of these things. One of America's most famous Cartoonists and illustrators has developed a great, simple system for success in all branches of Commercial Art. This system has revolutionized the entire theory of drawing. It means that drawing can be as easy for you as writing—much simpler than learning shorthand, bookkeeping or typewriting. We are now placing this original system for learning Drawing, Art and Cartooning, consisting of 34 lessons with over 500 illustrations, within reach of every one. If you will devote a few hours each week to the Course WE ABSOLUTELY GUARANTEE that you will learn to draw and draw well before you have half finished the Course. If we fail to make this claim good, we will refund every cent paid us. By eliminating a large office force for answering correspondence, expensive catalogs, etc., we are enabled to make a price of \$2.98, the cheapest price ever known for a high-grade, home study course. Many have sent us letters similar to that of Rob't P. Davis of Detroit, who wrote: "I can't see how you ask so little, when others with inferior Courses get from \$20 to \$60 for theirs. It is more than I expected." Learn to draw. It is a big asset, no matter what field you are in.

Send No Money

Just order the Course, and on arrival pay postman **\$2.98** plus a few cents postage, payment in full for the entire Course and Free Drawing Outfit. If not entirely satisfied, return within five days and we will REFUND MONEY. Address:

FREE: If you order the course at once, we will include a drawing outfit, consisting of artist's pencils, pens, paper, erasers, thumb tacks, etc., enabling you to go to work without any additional cost.

LEDERER SCHOOL of DRAWING, Dept. 725-H, Chattanooga, Tenn. Orders from outside the U.S.A. are payable \$3.28 cash with order.



easily, permanently corrected. Win happiness and success. Ask for full information and special phonograph record. Send dime for postage 153 Simson Ave., The LEWIS INSTITUTE, Detroit

Here's the Career for YOU



Get into Motion Picture Camera Work, Portrait and Commercial Photography. Learn at home. Big money while learning.

Earn up to \$250 a week

Hundreds of positions pay \$75 to \$250 a week. Or open your own studio. Easy, fascinating work.



CAMERA FREE

to students. Your choice of real Motion Picture Camera using professional film or 5 x 7 View Camera, anastigmat lens.

Write for big Free Book on Professional Photography. Explains amazing opportunities.

NEW YORK INSTITUTE OF PHOTOGRAPHY
Dept. 49, 143 W. 36th St., New York, N. Y.

Note: If you prefer to come to our studios for instruction, write for Catalog R-49 to nearest address: 141 W. 36th St., New York, or 630 So. Wabash Ave., Chicago.



& Music Lessons

WITH AN ACCREDITED SCHOOL

At Home

A Complete Conservatory Course By Mail
Wonderful home study music lessons under great American and European teachers. Endorsed by Paderewski. Master teachers guide and coach you. Lessons a marvel of simplicity and completeness.
Any Instrument Write telling us course you are interested in—Piano, Harmony, Voice, Public School Music, Violin, Cornet, Mandolin, Guitar, Banjo or Reed Organ—and we will send our FREE CATALOG with details of course you want. Send NOW.
University Extension Conservatory, 247 Siegel-Myers Bldg., Chicago, Ill.



Read this Boy's letter

"I am a boy twelve years old, in the 7th Grade. We had a lot of home work and I used to ask Dad about Geography, History and other subjects. Dad said, the subjects change so often, that he couldn't remember, so he helped me to look up the different subjects in our Nelson's Loose-Leaf Encyclopaedia. Now, I have the habit of looking things up for myself.

"Teacher noticed my answers were always correct and asked me who helped me. I told her Nelson's Encyclopaedia and she gave me an extra credit for looking up my own subjects.

"I also get a lot of information from Nelson's about Sports, Radio, Automobiles, and other things not in my home lessons."

FRED LEISSING, Milwaukee, Wisconsin.

The BEST Encyclopaedia in the English Language

BECAUSE:—it is 10 Years Later Than Any Other—

— it is ALWAYS NEW.

Nelson's Loose-Leaf
Encyclopaedia Is the Standard
Encyclopaedia of the World

BECAUSE—

Nelson's patented Loose-Leaf Binding Device keeps it always new—it cannot grow old. Each six months subscribers receive 250 or more new, rewritten pages to insert in the volumes in place of the pages that, because of the march of the world's progress and activities have become out of date. With this new Loose-Leaf Method you can always be sure of your facts. Never was there so much need for a complete and up to date fund of world knowledge as today.

Nelson's Reader's Guide— A College Education

It is not necessary to go to a university to get an education. A splendid education can be had on every subject taught in colleges and is within your grasp if you know how to obtain it. The Nelson Reader's Guide consists of 33 full study courses based on the Encyclopaedia.

Nelson's Free Research Bureau

FOR SCIENTIFIC REPORTS AND SPECIAL INFORMATION AND CORRESPONDENCE. Every purchaser of Nelson's is entitled to free membership in this Bureau. If at any time you are in doubt on any subject, old or new, write to this Bureau with the positive assurance that you will promptly receive the latest obtainable and most dependable information.

THOMAS NELSON & SONS

Edinburgh Toronto London Paris
Melbourne Bombay

It provides a course of reading, for every one, whatever his interests, from Aeronautics to Zoology. It is written in a human and absorbing style, compelling the reader's interest and making him eager to supplement his reading in the Encyclopaedia.

The Reader's Guide demonstrates the practical value of the Encyclopaedia to every member of the family—to the child or student in school—to the parent who would follow his child's interests and keep pace with his educational progress—to the man or woman in business or professional life—to every one who desires to be well informed in the subjects that go to make up a liberal education.

Fifteen minutes a day spent in reading the Loose-Leaf Encyclopaedia—with the aid of Nelson's Reader's Guide—will supply you with an education a college graduate could be proud of. Nelson's Encyclopaedia is a college education in twelve volumes—twelve volumes containing over 7,000 illustrations and overflowing with facts, knowledge and authoritative information on upwards of one million (1,000,000) topics.

Why Pay for Old, Obsolete Bound Volumes?

By the time an encyclopaedia composed of permanently bound volumes is delivered to you, it is anywhere from five to fifteen years out of date! And trying to bring it up to date by issuing supplementary volumes now and then is simply a makeshift, and a confusing one. The reader, struggling through several volumes and supplements, finds an uncorrelated mass of material and conflicting statements from which he must disentangle, as best he may, the information he requires. This old cumbersome method has given so much dissatisfaction that frequently two volumes are bound into one, but this only adds to the complexity. Why pay for a large percentage of out of date misinformation? The New Way—Nelson's Loose-Leaf Encyclopaedia—with no dead wood, brought up to date every six months—saves you money, time, patience. It is the only really new and up to date Encyclopaedia obtainable at any price.

Published in 12 Royal Octavo Volumes and Index Volume

Mail the FREE Examination Coupon TODAY

PM-2 THOMAS NELSON & SONS
381 Fourth Avenue, New York City

Send me your portfolio of sample pages, beautifully illustrated, containing color maps, plates and photographs, and full information how, by easy monthly payments, I can own Nelson's Perpetual Loose-Leaf Encyclopaedia and receive FREE membership in Nelson's Research Service Bureau for special information. This must incur no obligation whatever on my part.

Name.....
Address.....
City.....State.....

FASCINATING

... and perhaps you, like other ambitious men, due to the lack of money, time and education necessary to master *difficult* mechanical trades, wonder what *you* can get into *quickly* and make the most out of, *now!* Haven't you *overlooked* the very thing you are looking for?

For *there is* a profession begging for clean-cut, *earnest* men, like yourself! *Look into it!* 60,000 Moler graduates *know* Modern Barbering is easy to learn, inexpensive, *quicker* to earn, *clean* and FASCINATING! It pays *better* than you think! FIND OUT! Write for catalog B.2.

Address the branch of the **MOLER SYSTEM OF COLLEGES** nearest you
(Street address not needed)

Chicago, Ill.
New York, N. Y.
St. Louis, Mo.
Kansas City, Mo.
Cincinnati, Ohio
Cleveland, Ohio

Detroit, Mich.
Denver, Colo.
New Orleans, La.
Omaha, Nebr.
Milwaukee, Wisc.
Atlanta, Ga.

Memphis, Tenn.
Dallas, Tex.
Houston, Tex.
San Antonio, Tex.
Minneapolis, Minn.
Seattle, Wash.
Portland, Oregon

Los Angeles, Calif.
Salt Lake City, Utah
San Francisco, Calif.
Tacoma, Wash.
Fargo, No. Dak.
Winnipeg, Man., Can.
Toronto, Ont., Can.

STRUCTURAL DRAFTSMEN
 First class drafters and checkers wanted.
E. MOSS IRON WORKS.
 414 Bessner Bldg.
 10-25

DRAFTSMAN.
 Experienced in iron and steel work, line cabinetry, fixtures, and interior trim. Steady position for good man. State experience and salary. Reply confidential.
WLS WOODWORKING CO.
 310 N. Ada-st.

DRAFTSMAN
 Experienced of iron stairs and ornamental iron.
DUFAN IRON CO.
 487 S. Karle.

DRAFTSMAN
 Experienced on ornamental iron. Give experience and first letter. Address M C 291.
WLS WOODWORKING CO.

DRAFTSMEN WITH AUTOMOBILE BODY EXPERIENCE.
 Take Harbor car west on Grand to 5800
YELLOW TRUCK & COACH MFG. CO.
 559 W. DICKENS-AV.

DRAFTSMAN—ORNAMENTAL IRON Experienced in cast iron stove front, mantels and stair work. State and experience and salary. Reply confidential.
PRICE-EVANS LUNDRY CO.
 Chicago, Ill.

DRAFTSMAN AND ESTIMATORS Experienced. Apply Chief Engineer
STEEL & PIPE CO. Pittsburgh, Pa.

STRUCTURAL
 Experienced in structural and miscellaneous work. Give experience and first letter.
 Address M K 3.

DR
 Constantly available. Salary \$60 to \$125 a week. More than 70,000 fine Drafting jobs advertised this year. Why not prepare for one of these jobs? I will show you how to get into this important work under a positive agreement to fit you for a good job and a big increase in pay, or your money refunded.

Draftsmen WANTED



Get ready for a fine JOB!

Salaries \$60 to \$125 a week. Short hours. Fascinating, easy work. Pleasant surroundings and a fine bunch of fellows to work with. And unlimited opportunities for advancement to Executive positions.

FREE JOB SERVICE for Students and Graduates
 This course has accomplished such miracles in the past, in pushing men ahead to fine jobs and bigger pay as real Draftsmen, that now we back it with a nation-wide free JOB-SERVICE under the direction of an Employment Expert. This training is right and the fine jobs are there. Look into this wonderful opportunity—coupon brings my sensational offer. Mail it today!

New, Easy Way to Learn AT HOME!
 —by a simplified one step at a time method, combined with actual Drafting room practice. Men with no previous Drafting experience, many with only common schooling, make rapid progress with this new, easy instruction. For the first time in home-study instruction, we have eliminated copying and tracing—the new system makes you a real Draftsman quick, capable of doing original, professional work.



Professional Outfit GIVEN
 to every student without extra charge. Includes high-grade imported Instruments, table and board, Mahogany-bound T square, triangles, paper, ink, thumb tacks, scale, protractor, etc. We purposely send you an outfit of the best grade, because you learn easier and faster with good tools.



Interesting, Easy Work!

All the great world of machinery about you, starts on the Draftsman's table. Draftsmen draw the plans for Radio and other Electrical products, for Automobiles, for great buildings and public works. There's a fascination to Drafting you cannot find in any other line of work. Salaries are large; with frequent advancement to positions as Chief Draftsman, Superintendent and Manager.

5 Roads to Success

General instruction in Drafting leads only to ordinary jobs. The big jobs and the largest salaries are paid to Draftsmen who SPECIALIZE in some one branch of the work. So after you have mastered the general practice at the beginning of your training, you choose one of five great branches—1. Mechanical Drafting, 2. Electrical Drafting, 3. Architectural Drafting, 4. Automotive Drafting, 5. Structural Drafting. And we give you Engineering subjects, advanced practice and specialized training in the branch you select, so when you finish you can take a good job and make some real money.

Read the Ads

—every one seeking a SPECIALIST. At large salaries. Mail coupon, and I will tell you how to prepare for these fine jobs at home in spare time.

Write to Chief Drafting Engineer

American School Drexel Avenue and 58th Street, Dept. D-274 CHICAGO

Chief Drafting Engineer, AMERICAN SCHOOL
 Dept. D-274 Drexel Ave. & 58th St., CHICAGO

Those Drafting opportunities look good. Tell me how I can prepare for a fine job as a real Draftsman.

Name

St. No.

City..... State

Learn to Write

GOOD hand-writing has been truly called the "Bread and butter of a business education." It should be the determination of every body to learn to write at least a good business hand. **Good writing is the very foundation of business success.**

Easy to Learn By my system you can become a good penman at home, in your own room during spare time. Don't be content with the notion that good penmen "are born" such. Because one's ancestors may have been noted for poor penmanship, is no excuse for him to remain an illegible scribbler. My system is original, unique, and highly successful—the result of 25 years' experience.

Your Spare Time Just your spare moments—that's all I ask. If you follow my instructions you will soon be able to write a beautiful hand that will be a source of pride to yourself and envy to your friends. Notice the improvement shown in Mr. Campbell's writing below.

Leland M. Campbell

"I am astonished at the improvement I've made by means of The Tamblin System in so short time."
LELAND M. CAMPBELL,
Campbelltown, Ohio.

Leland M. Campbell

Mr. Campbell wrote his upper signature July 20, and the lower one November 10—a little less than 4 months apart. Hundreds and hundreds of others in all parts of the world are doing as well with my system.

I have had unbounded success in making poor writers good ones and good writers better penmen than they thought possible.

NOW TO
Become
a
Good Penman

FREE BOOK WRITE FOR IT TODAY

32 PAGES
HIGHLY ILLUSTRATED.

Penmanship is particularly adapted to correspondence instruction, and I absolutely guarantee satisfactory improvement. Distance no barrier. Ladies taught just as successfully as men.



Don't wait, don't delay, begin now to prepare for that position where good penmanship will be required. Send today for my Free Book, "How to Become a Good Penman," which contains copies and beautiful specimens and tells how others have become good penmen by means of the Tamblin System. Your name will be beautifully written on a card with white ink if you enclose stamp.

F. W. TAMBLIN,
418 Ridge Building
Kansas City, Mo., U.S.A.

FREE BOOK COUPON

F. W. TAMBLIN, 418 Ridge Bldg., Kansas City, Mo., U. S. A.
I am interested in improving my penmanship. Please send me free your Book "How to Become a Good Penman."

Name

Address

Sign and mail this today, before you forget it.

ART

We Teach COMMERCIAL ART

Meyer Both Company, maintaining the most widely known Commercial Art Studios in the World, offers you a practical training based upon 25 years' success in producing over a quarter million drawings for leading advertisers. This attractive profession equally open to men and women. Home study instruction.

Get Facts Before You Enroll in Any School

Send 4c in stamps for illustrated booklet telling of the success of our students.

MEYER BOTH COMPANY
Dept. 16
Michigan Ave at 20th St
CHICAGO, ILL.

ELECTRICAL ENGINEERING

Course for men of ambition and limited time. Over 4000 men trained. Condensed course in Theoretical and Practical Electrical Engineering including the closely related subjects of Mathematics and Mechanical Drawing taught by experts. Students construct motors, install wiring, test electrical machinery. Course complete

IN ONE YEAR

Prepare for your profession in the most interesting city in the world. Established in 1893. Free catalog.

BLISS ELECTRICAL SCHOOL
232 Takoma Ave. WASHINGTON, D. C.

Learn Watchwork, Jewelrywork and Engraving A fine trade commanding a good salary, and your services always in demand. Address **Horological, Dept. P, Bradley Institute, PEORIA, ILLINOIS,** for our latest catalog.

WANT GOV'T JOB?

All men-women, 18-65, wanting to qualify for Government Positions, \$140-\$300 monthly, local or traveling—**Write Mr. Ozment, 111, St. Louis, Mo.**

TELEGRAPHY

(Morse and Wireless) and RAILWAY ACCOUNTING taught thoroughly. Big salaries; great opportunities. Oldest, largest school. Endorsed by Telegraph, Railway, Radio, and Government officials. Expenses low—opportunities to earn large portion. Catalog free. **DODGE'S INSTITUTE, Jones St., Valparaiso, Ind.**

MINSTRELS

Musical Comedies and Revues, with full instructions for staging. You can stage your own show with our books. Full line of plays, stage songs, crossfire, monologues, afterpieces, vaudeville acts and make-up. **CATALOGUE FREE. T. S. Denison & Co., 623 S. Wabash Ave., Dept. 19, Chicago**

BIG VALUE FOR 10 CTS.

6 songs, words and music; 25 Pictures Pretty Girls; 40 Ways to Make Money; 1 Joke Book; 1 Book on Love; 1 Magic Book; 1 Book Letter Writing; 1 Dream Book and Fortune Teller; 1 Cook Book; 1 Base Ball Book, gives rules for games; 1 Toy Maker Book; Language of Flowers; 1 Morse Telegraph Alphabet; 12 Chemical Experiments; Magic Age Table; Great North Pole Game; 100 Conundrums; 3 Puzzles; 12 Games; 30 Verses for Autograph Albums. All the above by mail for **10 cents, and 2 cents postage.**

ROYAL SALES CO., Desk 147, Norwalk, Conn.



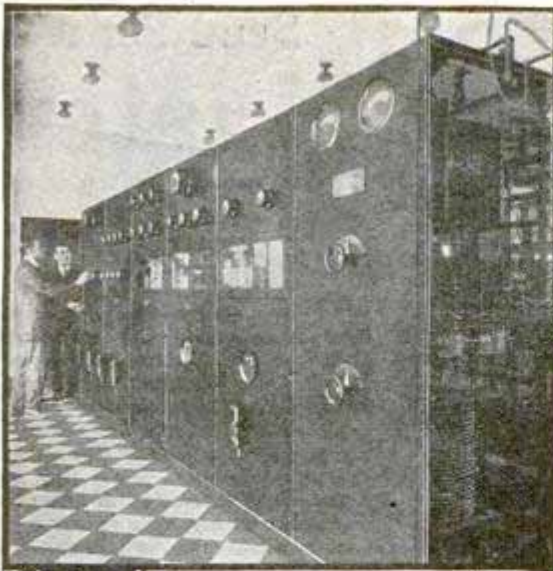

**\$50. to \$250 a week
IN WORK THAT IS
ALMOST ROMANCE**

Be a Radio Expert

Get into the great new Big-Pay Industry—Radio. If you're earning a penny less than \$50 a week, **clip coupon now.** Send for AMAZING FREE BOOK. Be a Radio Expert, and draw down big money for the easiest and most fascinating work in the world. Positions everywhere. Thoroughly-trained men are in big demand. Need for Radio Experts in every community. Short hours. **BIG PAY. Free book gives all the facts.** Astonishing opportunities—thousands of them! Every day N. R. I. trained men are taking good places in the Radio field. Free book tells all about their success. Send for it now!



**Learn Quickly and Easily
AT HOME**

Master Radio Engineers will show you how to qualify quickly and easily at home, for Radio's fine jobs. We **guarantee** to train you successfully. Lack of experience no drawback—common schooling all you need. Our tested, clear methods make it easy for you. Send coupon now for free proof.

**Instruments Given
with Course**

All instruments shown here and many others given to students for practice work while learning. Receiving sets, from simplest kind to thousand mile receiver. An **UNEQUALLED OFFER.** Many other big features for limited time only.

**Famous Training
That "Pays for
Itself"**

Spare time earnings are easy in Radio. Increase your income almost from the start through practical knowledge we give you. This is the famous practical training that pays its own way.

PROOF



Operates WMAQ
"Accepted a position with Chicago Daily News—Station WMAQ. My income practically doubled, thanks to your fine course."
KEITH KIMBALL, Chicago.



Gets Big Job
"Just been made Sales Manager of this Radio concern—a big raise in pay. Regret I did not take course sooner."
R. E. JONES, Bay City.



Get this Amazing Book

Most amazing book on Radio ever written—full, interesting facts about this great field and how we prepare you and help you start. You can do what others have done. GET THIS BOOK.

Send Coupon

Send coupon today for special limited offer, including all instruments—you'll get full particulars by return mail.

National Radio Institute

Dept. BT7, Washington, D. C.

You get all of these

MAIL THIS NOW

**NATIONAL RADIO INSTITUTE
Dept. BT7, Washington, D. C.**

Without obligating me in any way, send me your free book, "Rich Rewards in Radio," and all information about your practical, home-study Radio course.

Name.....
Address.....
Town.....State.....



ORIGINATORS OF RADIO HOME-STUDY TRAINING
ESTABLISHED 1914



“There’s One Man We’re Going to Keep”

“Ed Wilson, there, is one of the most ambitious men in the plant. I notice that he never fools away his spare time. He studies his International Correspondence Schools Course every chance he gets.

“It’s been the making of him, too. He hasn’t been here nearly so long as Tom Downey, who was laid off yesterday, but he knows ten times as much about this business.

“I’m going to give him Tom’s job at a raise in salary. He’s the kind of man we want around here.”

HOW do you stand in your shop or office? Are you an Ed Wilson or a Tom Downey? Are you going up? Or down?

No matter where you live, the International Correspondence Schools will come to you. No matter what your handicaps or how small your means, we have a plan to meet your circumstances. No matter how limited your previous education, the simply-written, wonderfully-illustrated I. C. S. textbooks make it easy to learn.

This is all we ask: Without cost, without obligating yourself in any way, put it up to us to prove how we can help you. Just mark and mail this coupon.

TEAR OUT HERE
INTERNATIONAL CORRESPONDENCE SCHOOLS
Box 5353-E, Scranton, Penna.

Without cost or obligation, please tell me how I can qualify for the position or in the subject before which I have marked an X:

BUSINESS TRAINING COURSES

- | | |
|---|---|
| <input type="checkbox"/> Business Management | <input type="checkbox"/> Salesmanship |
| <input type="checkbox"/> Industrial Management | <input type="checkbox"/> Advertising |
| <input type="checkbox"/> Personnel Organization | <input type="checkbox"/> Better Letters |
| <input type="checkbox"/> Traffic Management | <input type="checkbox"/> Show Card Lettering |
| <input type="checkbox"/> Business Law | <input type="checkbox"/> Stenography and Typing |
| <input type="checkbox"/> Banking and Banking Law | <input type="checkbox"/> Business English |
| <input type="checkbox"/> Accountancy (including C.P.A.) | <input type="checkbox"/> Civil Service |
| <input type="checkbox"/> Nicholson Cost Accounting | <input type="checkbox"/> Railway Mail Clerk |
| <input type="checkbox"/> Bookkeeping | <input type="checkbox"/> Common School Subjects |
| <input type="checkbox"/> Private Secretary | <input type="checkbox"/> High School Subjects |
| <input type="checkbox"/> Spanish | <input type="checkbox"/> Illustrating |
| <input type="checkbox"/> French | <input type="checkbox"/> Cartooning |

TECHNICAL AND INDUSTRIAL COURSES

- | | |
|---|--|
| <input type="checkbox"/> Electrical Engineering | <input type="checkbox"/> Architect |
| <input type="checkbox"/> Electric Lighting | <input type="checkbox"/> Architects' Blue Prints |
| <input type="checkbox"/> Mechanical Engineer | <input type="checkbox"/> Contractor and Builder |
| <input type="checkbox"/> Mechanical Draftsman | <input type="checkbox"/> Architectural Draftsman |
| <input type="checkbox"/> Machine Shop Practice | <input type="checkbox"/> Concrete Builder |
| <input type="checkbox"/> Railroad Positions | <input type="checkbox"/> Structural Engineer |
| <input type="checkbox"/> Gas Engine Operating | <input type="checkbox"/> Chemistry |
| <input type="checkbox"/> Civil Engineer | <input type="checkbox"/> Automobile Work |
| <input type="checkbox"/> Surveying and Mapping | <input type="checkbox"/> Airplane Engines |
| <input type="checkbox"/> Metallurgy | <input type="checkbox"/> Navigation |
| <input type="checkbox"/> Steam Engineering | <input type="checkbox"/> Agriculture and Poultry |
| <input type="checkbox"/> Radio | <input type="checkbox"/> Mathematics |

Name.....
 Street.....
 Address..... 3-6-24
 City..... State.....

Occupation.....
 Persons residing in Canada should send this coupon to the International Correspondence Schools Canadian, Limited, Montreal, Canada



Send For a Master Key

It tells how environment is created. How circumstances may be controlled. How lines of least resistance are formed. Why some persons attract success, power and wealth. Why others seem to fail. It explains the effect of concentration. It explains the Law of Abundance. It tells of a simple but infallible test by which anyone may determine whether he is destined to be a success in life or not. Over a million copies printed during the last ten years. A record of accomplishment seldom equalled. Sent postpaid for only 10c, money refunded if not satisfied.

MASTER KEY SYSTEM
714 N. 9th St. St. Louis, Mo.

BE A JAZZ MUSIC MASTER



PLAY PIANO BY EAR

Play popular song hits perfectly. Hum the tune, play it by ear. No teacher--self-instruction. No tedious ding-dong daily practice--just 20 brief, entertaining lessons, easily mastered.

At Home in Your Spare Time

Send for FREE BOOK. Learn many styles of bass and syncopation--trick endings. If 10c (coin or stamps) is enclosed, you also receive wonderful booklet "How to Entertain at Piano"--and many new tricks, stunts, etc. NIAGARA SCHOOL OF MUSIC, Dept. 823 Niagara Falls, N. Y.

Send for this Free Book

A FILE

Stop Forgetting

Make Your Mind an index from which you select facts, figures, names, faces. Develop concentration, self-control; overcome bashfulness, forgetfulness. Write today for FREE memory and concentration test and illustrated booklet, "How to Remember."

PROF. HENRY DICKSON
Dept. 7052 Evanston, Ill.

NOT A PILE

LEARN TO BE A CHALK TALK CARTOONIST

Each money drawing pictures. "Novel Way"--easy to learn. Program and instructions by professional cartoonist. Send \$1.00 for copy or stamp for particulars. Money back if not satisfied. NOVEL ART STUDIOS, Dept. P2, 7 East 42nd Street, N. Y. C.

Clear-Tone TO Clear Your Skin

Your skin can be quickly cleared of Pimples, Blackheads, Acne or any Eruptions on the face or body, Barbers Itch and Eczema, Enlarged Pores, Oily or Shiny Skin. CLEAR-TONE has been Tried, Tested and Proven its merits in over 100,000 test cases.

FREE

WRITE TODAY for my FREE Booklet --"A CLEAR-TONE SKIN" telling how I cured myself after being afflicted for fifteen years.

E. S. GIVENS 128 Chemical Bldg. Kansas City, Mo.

Make Yourself a Popular Favorite with the TENOR BANJO

Play for Fun or Money

Don't be a wallflower. Get in on parties. Entertain your friends. *Be popular.* Play at dances, etc. Form an orchestra. Earn Money in spare time or become a professional. Our 52-lesson course will make you an accomplished player.



\$18 TENOR BANJO
FREE when you enroll
 In Genuine Seal Grain Fabrikoid Case

This beautifully made, sweet-toned, mellow Tenor Banjo is given to you, **Free**, in a **Genuine Seal Grain Fabrikoid Case**, as soon as you enroll. In a music store it would cost you \$18 to \$20. We can only afford to give you this splendid instrument because it is made in our own big factory. We also give you 52 pieces of music and everything necessary to play your Tenor Banjo. **There are positively no extras.**

Complete 52-Lesson Course

Our method is so interesting, simple and practical you will not only be pleased but astonished at the rapid progress you make. Even if you are an absolute beginner in music, even if you can't tell one note from another, by means of our complete 52-lesson Conservatory Course, directed by expert instructors, you can soon realize your ambition to become a skilled Tenor Banjo player.

You Can Play in 30 Minutes

45,000 successful students back up our claim that you can play a piece in 30 minutes by following our printed, illustrated instructions. Right from your very first lesson you are playing real pieces. No tedious practicing—no irksome scales—music from the very start!

Pay as You Play
 Low Price! Easy Terms! A small first payment starts you. And the entire 52-lesson course comes to just a few cents a lesson!

Learn in Spare Time at Home

Study at your leisure. Select your own lesson time—practice whenever you find it most convenient. No waiting for a teacher—no appointments to keep—and your lessons are always at hand, to refer to whenever necessary. You are never hurried, never forced—but you can go ahead as fast as you like. And—no waiting for a class to form—you can begin now.

Picture Lessons Make it Easy

You can't fail to learn because clear, distinct pictures explain every move. Everything is concise and easy to grasp. And with each succeeding lesson you will become more and more interested, more and more fascinated, by the wonderful music you find yourself able to produce!

Send this Popularity Coupon ~ **NOW!**

Interested in Other Courses?

Famous teachers conduct our courses in Hawaiian Guitar, Violin, Mandolin, Banjo, Ukulele and Ukulele. Write for literature.

FIRST HAWAIIAN CONSERVATORY OF MUSIC, INC.

9th Floor, Woolworth Building

Department 160, New York

Approved as a Correspondence School under the Laws of the State of New York

Our Written Guarantee

We guarantee in writing to teach you to play the Tenor Banjo. This guarantee protects you from every standpoint. In addition, after you graduate, we coach and advise you—at no extra expense. Bear in mind the success of 45,000 students—most of them without musical training when they enrolled. You can do as well as they have done. Get your enrollment in at once and get started on the great popularity-building career—music!

FIRST HAWAIIAN CONSERVATORY OF MUSIC, Inc.
 9th Fl., Woolworth Bldg., New York, N. Y., Dept. 160
 Please mail full information about your complete 52-lesson Conservatory Course on the Tenor Banjo, and free offer. I understand this does not bind me to enroll.
 Name _____
 Address _____
 City _____ State _____



High School Course in Two Years!

You Want to Earn Big Money!

And you will not be satisfied unless you earn steady promotion. But are you prepared for the job ahead of you? Do you measure up to the standard that insures success? For a more responsible position a fairly good education is necessary. To write a sensible business letter, to prepare estimates, to figure cost and to compute interest, you must have a certain amount of preparation. All this you must be able to do before you will earn promotion. Many business houses hire no men whose general knowledge is not equal to a high school course. Why? Because big business refuses to burden itself with men who are barred from promotion by the lack of elementary education.

Can You Qualify for a Better Position

We have a plan whereby you can. We can give you a complete but simplified high school course in two years, giving you all the essentials that form the foundation of practical business. It will prepare you to hold your own where competition is keen and exacting. Do not doubt your ability, but make up your mind to it and you will soon have the requirements that will bring you success and big money. YOU CAN DO IT.

Let us show you how to get on the road to success. It will not cost you a single working hour. Write today. It costs you nothing but a stamp.

American School

Dept. H-274, Drexel Ave. and 58th St., Chicago

American School

Dept. H-274, Drexel Ave. and 58th St., Chicago

Send me full information on the subject checked and how you will help me win success.

- | | |
|------------------------------|----------------------------|
| Architect | Business Law |
| Building Contractor | Lawyer |
| Automobile Engineer | Machine Shop Practice |
| Automobile Repairman | Mechanical Engineer |
| Civil Engineer | Shop Superintendent |
| Structural Engineer | Employment Manager |
| Business Manager | Steam Engineer |
| Cert. Public Accountant | Foremanship |
| Accountant and Auditor | Sanitary Engineer |
| Bookkeeper | Surveyor (& Mapping) |
| Draftsman and Designer | Telephone Engineer |
| Electrical Engineer | Telegraph Engineer |
| Electric Light & Power | High School Graduate |
| General Education | Wireless Radio |
| Vocational Guidance | Undecided |

Name.....

Address.....



Will You Wear This Suit?

Show it to your friends and neighbors as a sample of our fine quality, hand-tailored, **All-Wool Suits**, guaranteed \$40 values, at amazing low price of \$23.50, take their orders, keep handsome profit for yourself and send orders to us.

Agents Making BIG MONEY

\$3.00 to \$5.00 an hour in spare time, \$75 to \$150 a week for full time. We supply handsome Swatch Line Outfit, large size samples and all latest styles in elegant Leather Case. Positively finest selling outfit ever furnished salesmen. Write for yours at once, pick out your suit and get started making the Big Money right away. Address Dept. 346.

JAMES OLIVER, Inc., 848 W. Adams St., Chicago

Write name and address below and mail at once.

Name.....

St. and No..... R. F. D..... Box.....

Town..... State.....

Learn Furcraft

Learn by mail, evenings at home, to Renew, Repair and Make-up all kinds of fur garments. Learn glazing, ironing and storage. Big demand, big need for your service in every neighborhood. **\$3 an hour in your spare time** or a real business now and a fur shop later. We teach you secret processes. Earnings start in 30 days. Uncrowded field for men and women. **FREE BOOK**—send now for free book giving details. No obligation.

Northwestern Fur Co. 1772 Sunderland Bldg. OMAHA, NEBRASKA



BECOME A LANDSCAPE ARCHITECT

Established 1918.

Dignified, exclusive profession. Little competition. \$5,000 to \$10,000 incomes for experts. Easy to master under our correspondence methods. Assistance extended to students and graduates. Write **AMERICAN LANDSCAPE SCHOOL, 107-NA NEWARK, NEW YORK**



FLY

Young man learn aviation. Build this classy plane and learn to construct and operate aircraft. Use your motorcycle engine or our "Meteor" 20 h. p. motor. We furnish parts very reasonable to build this wonderful little "Meteorplane," the World's first successful motorcycle engined aeroplane. Send \$3.50 for complete set of blue prints and parts price list of this latest Model M-T-2: **IRWIN AIRCRAFT CO. 126 O Street, Sacramento, Cal.**

BE AN ARTIST

WE CAN TEACH YOU DRAWING in your own home during your spare time. Twenty-five years of successful teaching proves our ability. Artists receive large salaries.

Write Today for Art Year Book

SCHOOL OF APPLIED ART ROOM NO. 2 BATTLE CREEK MICH.



LEARN PHOTOGRAPHY!

Earn \$200 to \$500 monthly. Or start your own business. Photography and Photo-Engraving taught by largest college of its kind in world. Established 1893. Big demand for graduates. Write for free book. **Illinois College of Photography, Box 426, Effingham, Ill.**



Buchstein's Fibre Limb

is soothing to your stump—strong, cool, neat, light. Easy payments. Braces for all deformities. **D. BUCHSTEIN CO.**

Send for Catalog Today

610 3rd Ave., So., MINNEAPOLIS, MINN.

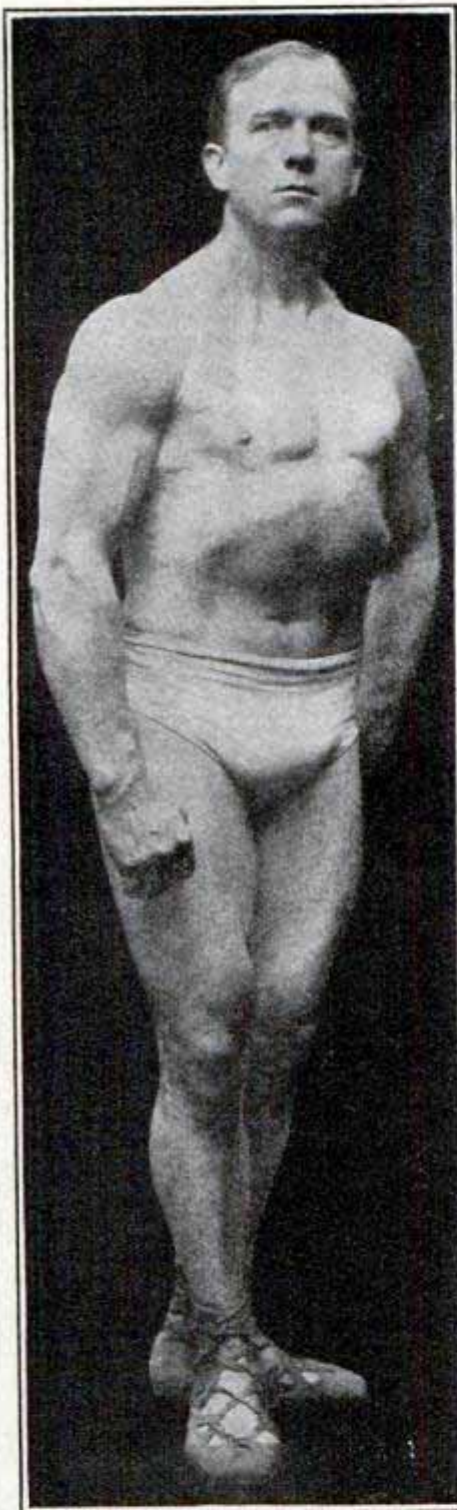

LIONEL STRONGFORT

Dr. Sargent, of Harvard, declared that "Strongfort is unquestionably the finest specimen of physical development I have ever seen."

It will not cost you anything and it will surely help you to broader, bigger, better things and a great deal more happiness.

SEND FOR MY FREE BOOK

To know what Strongfortism can do for you, send for a FREE copy of my book, "Promotion and Conservation of Health, Strength and Mental Energy."

USE THE COUPON. CLIP IT TODAY.

LIONEL STRONGFORT
Physical and Health Specialist for over 25 Years

Dept. 98

Newark, N. J.

Oh! You Misfit

Sailing under the name of man. You know the truth if no one else does—you know what you lack—what you need. You may hide it from others in a way, but you can't hide it from yourself. Are you a victim of any pernicious habit that you want to get rid of? Have you a spark of ambition left to be the man you once were, to be the man you ought to be? Are you an easy victim to every little ailment that comes along, going around without snap or ginger, losing ground when you ought to gain it? Then wake up and be a man, not a misfit. Deserve the name of man; be vigorous. It makes no difference if you are a physical wreck, if you join hands with me, I'll make you the kind of man that's wanted, the kind of man needed, the kind of man looked for, sought for, bid for all the time, and it will be done without drugs, or tonics or stimulants.

You will gain in vim and vigor; your muscular power will increase in flexibility and strength, your nervous system fortified to renew its energy, not bolstered up for the time being, to fall back below the level it was, as it does when you resort to drugs or medicine.

You Young Man think of your future—how about it—are you fit—are you qualified—do you feel it in your soul—are others sliding by you doing more—getting more than you are? I know what is dragging you down, what is keeping you down. Come to me, I have helped thousands; physically, mentally, morally. I will help you; will make you the kind of young man that is a credit to any community—I will make you so that your progress in any undertaking will be easier. Just be frank and above board—tell me your troubles. I will guide, direct and point the way; the natural way for you to achieve what I have said—Nature's way. You can gain muscular tissues, be strong, erect in carriage, courageous, and likable to all you meet.

You Business Man overworked did you say? You are not doing half as much as you ought with your experience. Never mind, there is a way to get back your aggressiveness, to be right in the fight and enjoy it. You can double your percentage of real worth as a man, and enjoy life as you ought to be able to do. Let me be your guide, your teacher. I have pupils all over the world, learning a system of Health, Strength, moral courage building known as

STRONGFORTISM

Under my system of practicing **Strongfortism**, you men can build your body up in symmetrical proportions, as nature intended you to be. You will gain greater confidence in yourself; and that will bring you success—capped with the glow of health and the supreme joy of living. You can keep your youth no matter what mistakes you have made, or what your present physical condition is, or what ailment or disorder you have—constipation, rheumatism—no matter what. See that coupon, check what interests you, mail it, and I will send you helpful personal information.

FREE CONSULTATION COUPON

Mr. Lionel Strongfort, Lionel Strongfort Institute, Dept. 98, Newark, N. J.

Please send me ABSOLUTELY FREE my copy of your book "PROMOTION AND CONSERVATION OF HEALTH, STRENGTH AND MENTAL ENERGY." I have marked (x) before the subjects in which I am most interested.

- | | | |
|---------------|---------------------|-------------------------|
| .. Colds | .. Increased Height | .. Weak Eyes |
| .. Catarrh | .. Pimples | .. Weak Heart |
| .. Asthma | .. Insomnia | .. Poor Circulation |
| .. Hay Fever | .. Short Wind | .. Round Shoulders |
| .. Headache | .. Constipation | .. Lung Troubles |
| .. Thinness | .. Indigestion | .. Muscular Development |
| .. Rupture | .. Nervousness | .. Great Strength |
| .. Lumbago | .. Rheumatism | |
| .. Flat Chest | | |

Name

Age..... Occupation.....

Street

City..... State

Quickly Learn to Play Hawaiian Guitar

Play Like This Native

Bring the romantic, enchanting, entrancing and melodious strains of the great instrument of the Hawaiian Islands into your soul. Become popular and successful. This **short cut method** of home instruction enables you to quickly master Hawaiian Guitar so you will play as well as Native Hawaiians.

Our staff of Hawaiian instructors have perfected a method of teaching, so simple, that without musical knowledge, you quickly learn to play real music from notes. Simple as learning your A, B, C's and it will not be long before you will play latest Broadway hits.

Only four simple motions to learn. You will then play any music, whether it be popular, dance or classical. Almost from first lesson, you play love songs like Aloha Oe.

To help you get started, we furnish free when you enroll as a student, a beautiful, full tone, genuine, \$18.00 Hawaiian Guitar. Only 1,000 free instruments given away; if you want to get in on free offer, write for particulars at once—you must act quickly.



New Invention—Kno-All-Chart QUICKLY TEACHES YOU HOW TO PLAY

The newest invention of our Hawaiian instructor, which is exclusively used by us and which we call the "Kno-All-Chart," quickly teaches you how to play and read notes. So simple is this device that any one can understand it and begin to play immediately.

Picture Method Easy

We do not depend upon our printed instructions alone for your success as a student, but we also supply you with many pictures of our professors' playing. This enables you to imitate the pictures. Isn't this easy?



Free \$18 Hawaiian Guitar when you enroll

Phonograph Records FREE

As an additional guide, we also furnish you with phonograph records of our Hawaiian instructor's own playing of the pieces you are learning. This practically brings our professors from our studio to your own home and enables you to listen to their playing just as if they were actually in front of you.

Genuine \$18.00 Hawaiian Guitar Free

Enroll as a student, and secure free, a beautiful, full tone, genuine \$18.00 Hawaiian Guitar.

We also furnish every bit of equipment so it is never necessary for you to spend an extra penny. When you graduate, you get a beautifully engraved diploma and after graduation, we also give you six months' free service and consultation. Send for free particulars now.

JAZZ

Your Way to Popularity and Success

No forming class to wait for. Start at once and join band wagon of success and popularity. Do it through Hawaiian Guitar.

Send for free First Lesson and Book. So positive are we you will become one of our students, that if you write at once, we will send you free, our first lesson which will enable you to see just what you can expect when you enroll. You will also receive our big book of full particulars. Write for your copy and free lesson today.

Write at **Hawaiian Studio No. 522** of New York Academy of Music 100 Fifth Ave., New York, N. Y.

HAWAIIAN STUDIO No. 522 of New York Academy of Music 100 Fifth Avenue, New York, N. Y.

Please rush your book, "How to Learn Hawaiian Guitar" and my first free lesson. Also reserve a gift Hawaiian Guitar for me. This obligates me in no way whatever.

Name

Address

City..... State.....

Don't Wear A Truss

FREE TRIAL

NO MORE STEEL OR RUBBER BANDS



YOU know by your own experience the truss is a mere make-shift—a false prop against a collapsing wall, and is undermining your health. Why, then, continue to wear them?

STUART'S PLAPAO-PADS are entirely different—being medicine applicators, made self-adhesive purposely to prevent slipping, and to hold the distended muscles securely in place. No metal parts; no straps, buckles or springs attached; no "digging-in" or grinding pressure. Soft as Velvet—Flexible—Easy to Apply—Inexpensive. Continuous day and night treatment at home. No bothersome taking off every night, no delay from work. Hundreds have testified under oath that Plapao-Pads positively and permanently cured their Rupture—some, most aggravated cases.

FREE TO THE RUPTURED
TRIAL OF PLAPAO and interesting, instructive 48-page book on Rupture, both Absolutely FREE. Nothing to pay—now or ever nothing to be returned. Write today, 'tis madness to defer. Address, **PLAPAO LABORATORIES, Block 1762 St. Louis, Missouri.**

SOFT AS VELVET—EASY TO APPLY

EQUALLY GOOD FOR YOUNG AND OLD

Beautiful Complexion in 15 Days



Clear your complexion of pimples, blackheads, whiteheads, red spots, enlarged pores, oily skin and other blemishes. I can give you a complexion soft, rosy, clear, velvety beyond your fondest dream. And I do it in a few days. My method is different. No cosmetics, lotions, salves, soaps, ointments, plasters, bandages, masks, vapor sprays, massage, rollers, or other implements. No diet, no fasting. Nothing to take. Cannot injure the most delicate skin. Send for my Free Booklet. You are not obligated. Send no money. Just get the facts.

DOROTHY RAY, 646 N. Michigan Blvd., Suite 122, Chicago

NO JOKE TO BE DEAF

—EVERY DEAF PERSON KNOWS THAT



I make myself hear, after being deaf for 25 years, with these Artificial Ear Drums. I wear them day and night. They stop head noises and ringing ears. They are perfectly comfortable and I no one sees them. Write me and I will tell you a true story how I got deaf and how I make you hear. Address **Medicated Ear Drum**



GEO. P. WAY, Artificial Ear Drum Co. (Inc.) 80 Hoffman Bldg., 2539 Woodward, Detroit, Mich.

How to Straighten Bow and Knock-kneed Legs!

Improve your personal appearance by using the new patent "Lim-Straitner," Model 18. Corrects now Bow and Knock-kneed legs safely, quickly and permanently at home. No costly operation or discomfort. Is worn at night. Easy to adjust; its result will save you soon from further humiliation and will improve your personal appearance 100 per cent. Write today for copyrighted Physiological and Anatomical book and experience of others without obligation. Enclose a dime for postage.

M. TRILETY, Specialist Dept. 1308 BINGHAMTON, N. Y.

NO MORE BALD HEADS



WHEN our VACUUM CAP is used a few minutes daily. We accept no pay until you have tried the Cap 60 days and are satisfied. The Vacuum Cap is an appliance that draws the blood to the Hair Roots and starts a new healthy crop of hair. It stops Dandruff, stops the hair from falling out.

Bought by Doctors and men who know that it is the only reasonable HAIR GROWER known to science. No Drugs Used. Write for application blank, testimonials and booklet on "HAIR," sent sealed in plain envelope, FREE.

THE MODERN VACUUM CAP CO. Q-559 BARCLAY, DENVER, COLO.

How a Strange Accident Saved Me From Baldness-

Sixty days ago it made me boiling mad. Today I look back and laugh at the incident for it brought me a marvelous new growth of hair.

WHEN my wife began to look sorrowfully at my thinning hair I smiled regretfully. When my friends began to call me "baldy" I felt annoyed. But when my secretary began to look at my glistening scalp and snicker—well it made me mad!

But the worst was yet to come. About sixty days ago I saw a tooth paste advertisement that offered to send a free booklet. I clipped the coupon and gave it to my secretary to fill in and mail.

Well, a few days later, to my utter surprise I found on my desk—not a booklet on toothpaste—but a booklet telling how to grow hair in 30 days!

I glanced from the booklet to my secretary. I felt my blood boiling.

"Miss Harris," I said to her, "I can't say that I appreciate your sense of humor. Just what is your idea?"

She paled. "Why, Mr. Burns—what's wrong?"

"Wrong?" I shouted, "what's the idea of sending me this hint about my hair?"

Tears came into her eyes. And between sobs she explained why it wasn't her fault.

She said the coupon I asked her to mail had another coupon printed on the back—and the other coupon offered to send a free book about baldness. Well, she simply used her own judgment!

"Hm," was all I could say.

That night on my way home I read the book about baldness. It described an entirely new method of making hair grow—perfected by Alois Merke, founder of the Merke Institute, Fifth Avenue, New York. It is the only treatment I ever heard of that reached right down to the hair roots and awakened them.

As I read on I felt myself weakening in my resolve not to try another hair treatment. And then when I read that Merke actually guaranteed a new growth of hair in 30 days or no cost—well, I sent for the treatment.

Read This!

"My hair was coming out at an alarming rate, but after four or five treatments I noticed this was checked. My hair is coming in thicker and looks and feels full of life and vigor."—W. C., Great Neck, N. Y.

"I have used your system for eight weeks and although the top of my head has been entirely bald for six years, the results up to the present are gratifying. In fact, the entire bald spot is covered with a fine growth of hair."—W. B., Kenmore, Ohio.

(Original of above letters on file at the Institute.)

The first two or three days, nothing happened. But a week or so later when I looked in the mirror I saw something that almost bowled me over! For there, just breaking through, was a fine downy fuzz all over my head.

Every day this young hair kept getting stronger. At the end of a month you could hardly see a bald spot. And at the end of sixty days—well, my worries were ended. For I had regained an entirely new growth of hair.

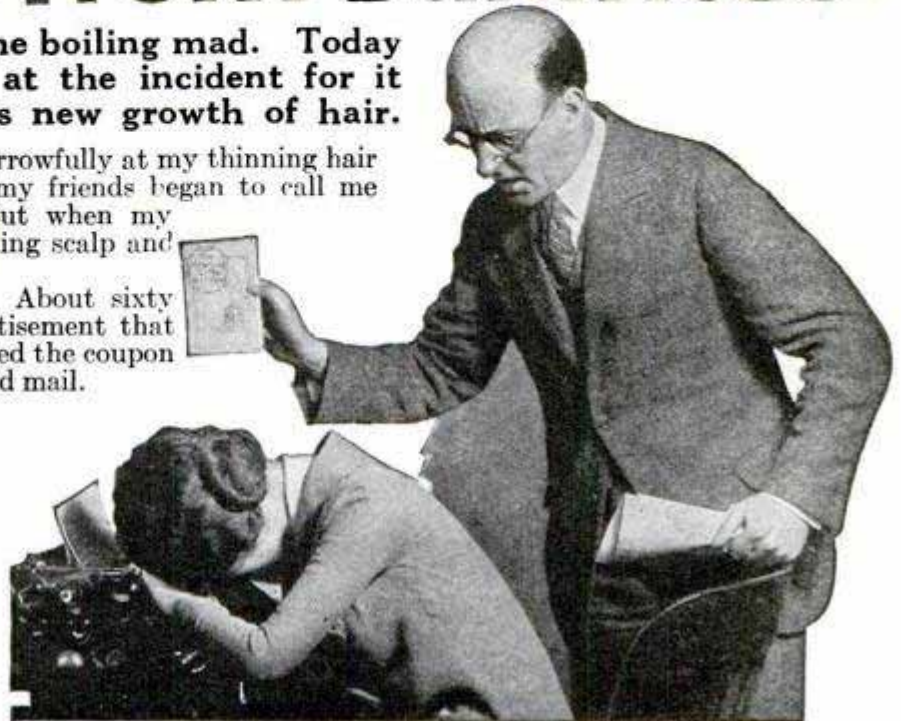

Here's the Secret

According to Alois Merke, in most baldness the hair roots are not dead, but merely *dormant*. Now to make a sickly tree grow you would not rub "growing fluid" on the leaves. Yet that is what I had been doing, when I used to douse my head with ordinary tonics, salves, etc. To make a tree grow you must nourish the *roots*. That's exactly what the Merke treatment does.

At the Merke Institute many have paid as high as \$500 for results secured. Now these same results may be secured in any home where there is electricity—for a few cents a day.

Merke admits that his treatment will not grow hair in every case. There are some cases of baldness that nothing can help. But so many have regained hair this new way, that Merke invites you to try the treatment 30 days at his risk, and if it fails to grow hair then the trial is free. Your money is instantly refunded. You are the sole judge.

Coupon Brings You Full Details

This story is typical of the results that people are securing with the Merke Treatment.

"The New Way to Make Hair Grow," is a 34-page book which will be sent you entirely free if you mail the coupon below. This book tells all about the new treatment, shows what it has done for others, and contains much valuable information on the care of the hair. Remember, this book is yours free. And if you decide to take the treatment, you don't risk a penny. So mail coupon now. Address Allied Merke Institute, Inc., Dept. 162, 512 Fifth Ave., New York.

Get This Free Book



Allied Merke Institute, Inc.
Dept. 162, 512 Fifth Avenue, New York City.

Please send me—without cost or obligation, in a plain wrapper, a copy of your book describing the Merke system.

Name.....
(State whether Mr., Mrs., or Miss)

Address.....

City.....State.....

Learn Autos In Detroit

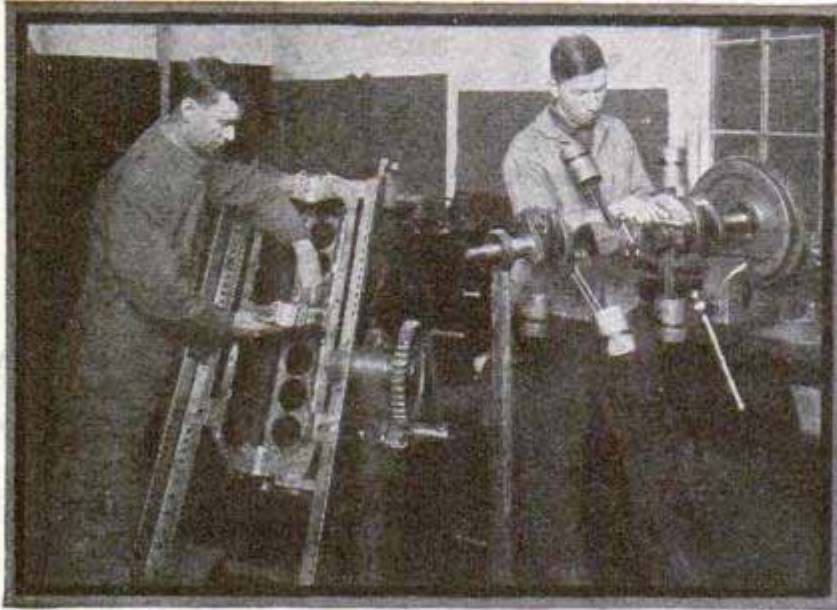

An example of the kind of practical shop training you get at the "Michigan State," in Detroit, the Auto Center. The knowledge we put in your head guides the skill we put in your hands. Howard (New York) says: "The foundation you gave me enabled me to jump ahead of men who had 12 to 15 years' experience."

**By Practical
Factory Approved
Shop Methods**

You can start right now to get ahead in the world! The great success-training of this world-famous "Michigan State Automobile School" can be brought to you at home if you are not ready to come to Detroit now. Read all about it in this announcement. And send the coupon on the opposite page for full detailed outlines of the Courses.

Thomas (Pa.) became foreman of Dodge garage at \$200 a month, three months after graduating.

No Experience Required

Whether you have auto experience or not, makes no difference. Green men get this training and start at once in better jobs, soon advance to have their own business, make big money. Men who have experience also say this training puts them way ahead of other men, into the big pay class at once, saves them years of dirty work. In just a few weeks, if you start now, you can be earning this bigger pay!

No Education Needed Either

It just takes common sense, to learn by the practical methods we teach you. Mathews (Detroit) was a professional musician, getting nowhere. Now earning \$50 to \$60 a week and advancing fast.

100,000 Trained Auto Men Needed Yearly

Where can you find such an opportunity as this? The Auto Business has grown in a short period to be the biggest business in the world. Its volume is above that of the steel or railroad industries. And it has more individual opportunities than any other business. A hundred thousand more trained men are needed every year, but they are not produced. So the field is getting bigger all the time. Green men can't draw the good pay. But trained men can. McMannis (Quebec) writes: "M. S. A. S. training doubled my salary. I specialize in auto-electricity and welding."

Come to Detroit the Auto Center

Of course Detroit is the place to learn autos. Over three-fourths of all cars come from here. Detroit training is practical training. Stick this in your memory,—the Detroit Trained man has an immense advantage over all others. So come here as soon as you can. Come now if possible. If you can't come now, start to learn under our Home Study Plan. (This does not cost anything extra.) Then plan to come here to School later to finish in thorough "Detroit training." Hill (Mich.) writes: "I doubled the money many times that I spent at your great School."

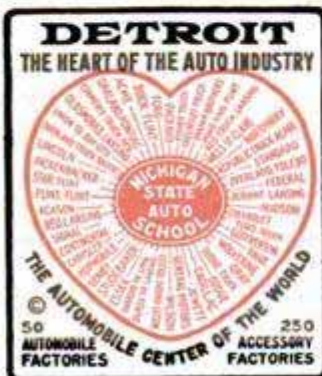

Factories Endorse These Courses

Auto factories endorse "Michigan State" training methods. Because they are thorough, practical. Because they put knowledge in your head and skill in your hands. Because they really fit you to make good. Greve (Calif.) paid for a home his first year in business for himself.

Help to Get Jobs

"Michigan State" trained men are wanted, in Detroit, in your home town, in garages throughout the country. We place many of our graduates directly. This Employment Service is absolutely free. Kelly (Ohio) writes: "I get \$1.00 per hour now for truck repair work."

No Exaggeration

Note that we don't promise to put you on top of the world in a few weeks. We know the great need for skilled men, and the wonderful future ahead of you if you get started now. But we know it takes work. It takes real knowledge. And that we can give you. Then start in a good job and advance to big money. Auto knowledge means steady work, wherever you want to go, at good pay, and a certain future.

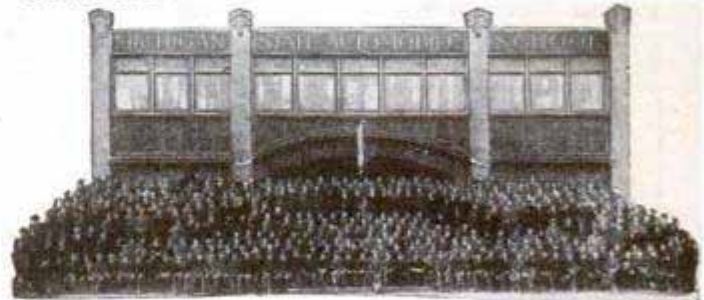

A class of 600 students in front of the M. S. A. S. Main Building

MICHIGAN STATE
302 Auto Bldg. Detroit, Mich.

100,000 Trained Auto Men Wanted This Year

60 MILES ON A GALLON OF GASOLINE

TESTS SHOW FORD CAN RUN 60 MILES ON A GALLON

The amazing fact that a Ford can run 60 miles on 1 gallon of gasoline was recently brought to light through tests conducted by America's foremost engineers, where it was shown that a gallon of gasoline contains sufficient heat units which if properly atomized and mixed with air would give this additional mileage. Great strides have already been made in this direction by the recent invention of a simple attachment which can be installed in a few minutes without any alterations to the motor. It is common for Ford Owners to make from 40 to 44 miles per gallon after this marvelous device is attached.

MOST WONDERFUL INVENTION TODAY BRINGS JOY TO FORD OWNERS

Starts Ford Instantly

Starting a Ford Car in cold or zero weather is something every Ford Owner dreads—everybody realizes that difficult starting is an abuse on the starter and battery. Thousands of Ford Cars are "laid up" during the Winter just for these reasons. This great difficulty has been overcome. "The SUPER positively starts a Ford Car instantly in the coldest weather."

Marvelous Device

The SUPER is no trick affair—requires no mechanical adjustments and contains all the scientific principles of carburetors costing \$20 to \$35 and in its natural action uses up every particle of unused gasoline and breaks it up into a perfect vapor. The hitherto impossible is now realized by the SUPER.

Everybody Satisfied

Saves 3 to 7 Dollars Per Month

The best investment I ever made. The SUPER is saving me from three to seven dollars each month, besides putting new life into my motor.

A. H. WORRA, Iowa.

Makes 44 Miles Per Gallon

I have tried the SUPER and the results of the experiment are satisfactory. One quart of gasoline run my Ford 11 miles over improved roads which is just about again as far as I could run with the plain Ford Carburetor.

G. E. YODER, Penn.

Finds That Our Claims Are Correct

I find that your claims for increased mileage are correct and that a big saving is made by your SUPER, in fact, the best device I have met with in that line. M. J. VAN LEEUWEN, Mass.



The
Heart
of the
Motor

Eliminates Oil Pumping in Front Cylinder

What a wonderful relief to Mr. Ford Owner when he realizes that he can run his car without the motor pumping oil in the front cylinder. Sounds like an awful lot to expect of any device, but that is what the SUPER does and this is only one of its many advantages because it puts real efficiency into any Ford Car.

Complete Combustion

The SUPER is so designed that it takes advantage of the present Ford Carburetor and properly atomizes the light as well as the heavy elements of the fuel, converting every atom of gasoline and kerosene into power preventing liquid fuel from passing into the cylinders, thus avoiding carbon formation and oil dilution.

Easy to Sell

Sells Like Hot Cakes

This is a recent letter from one of our distributors: "Enclosed find draft for 200 more SUPERS, rush as I need them badly. I sold and banked \$104.00 in one day. Hope to sell 1000 SUPERS next month."

A. W. LEONARD, Penn.

Making Big Profits Every Noon

I have been working the SUPER at noon only. Yesterday noon I made more money with the SUPER than I did at my 11 hours' hard work in the factory all day.

J. L. LEHNER, Wis.

Had No Previous Selling Experience

This letter shows what ambition does: "I sold six SUPERS in less than 2 hours tonight. I think it's a pretty good start—for it's the first thing I ever sold."

E. MANGOLD, Ind.

\$60.00 TO \$150.00 PER WEEK EASY

You just can't help making Big Money selling the SUPER because a trial sells itself and soon everyone in the neighborhood get talking about this marvelous device. Men like Leonard, Shaw, Manner, Kinsley, Peters, Sands, Beck and Hall are not exceptional salesmen, but just the type of men that saw an opportunity and were quick to grasp it when within reach. No previous selling experience is necessary, just a little ambition on your part to make money is all we ask and we will extend the same opportunity to you. Spare time will pay you well. If you can devote your entire time so much the better, because the SUPER is a whirl-wind seller and takes hold in a locality like wildfire.

Men Wanted Everywhere To Introduce

We want distributors in all parts of the country to take orders and deliver the SUPER and to look after the repeat business that is bound to follow and to such distributors we are willing to assign territory. You do not have to own a Ford to take up this proposition but if you have a Ford it is easier to explain its many advantages. However a Trial of the SUPER convinces the most doubtful person and tells a wonderful story.

➔ **A REAL FUTURE HERE**

WEEKS SUPER CARBURETOR CO.

426-1616 Eleventh St., Milwaukee, Wis.

MAIL TODAY

WEEKS SUPER CARBURETOR CO.
426-1616 Eleventh Street, Milwaukee, Wis.

GENTLEMEN: Please mail me full free particulars about your wonderful invention.

Name

St. or R.F.D.

Town

County

State

PLAY A SAW!

I'll Teach You in 24 Hours

Be Popular! Amaze Everybody— Play for Fun or Money

Wonderful music from a saw—sweet and mellow like a rare old violin. Tone effects that are positively startling—all so unexpected that nothing compares with it in winning instant popularity in your social group or as a salaried entertainer. *And it's so easy!*

Just to prove how quickly you can learn, I'll send you a genuine "Musical Saw" (special temper, process patented) for FIVE DAYS' TRIAL. I guarantee that in 24 hours you can play tunes like "Old Black Joe" and "Home, Sweet Home." Then the latest jazz and song hits, operatic and classical music. Amazingly simple—no notes to read, no dreary practice.

Thousands Successful by My Method

Just three short, simple lessons reveal every secret of my 12 years' success as a professional saw musician—secrets with which I have taught thousands. Many of my pupils are on the vaudeville stage, playing in dance orchestras, making big money as entertainers. Let me prove that you, too, can quickly play like a professional—amaze your friends and always be in demand at parties and entertainments.

PHONOGRAPH RECORD FREE! of Saw Solo and Duet

Two beautiful selections. You'll wonder that a saw can produce such marvelous music. But the FREE phonograph record proves it. Send for it today. Mail coupon for free record and big free trial offer. Let me show you letters from pupils who are now stage celebrities.

C. J. MUSSEHL
Pioneer Artist on the Musical Saw, has taught thousands to become Experts, Vaudeville Stars and High-Priced Entertainers.



I'll Loan You The Saw 5 Days Free!



Harland Merrill secures contract for Musical Saw broadcasting from Chicago station.



"Bud" Gamble is paying his way around the world with the Musical Saw. Is now in Europe.



Charles Guglieri booked to play saw solos in Broadway (New York) motion picture theatre.

Mail Coupon

C. J. Mussehl, Pres. Mussehl & Westphal 254 W. Water Street FORT ATKINSON, WIS.

Without obligation to me, send me, postpaid, the Free Phonograph Record of Saw Solo and Duet; also full particulars about your big, Free Trial Offer.

Name.....

Address.....

Town and State.....

Mussehl & Westphal Fort Atkinson, Wis.



What Are YOUR Mistakes in English?

They may offend others as much as these offend you

IF some one you met for the first time made the mistakes in English shown above, what would you think of him? Would he inspire your respect? Would you be inclined to make a friend of him? Would you care to introduce him to others as a close friend of yours?

These errors are easy for you to see. Perhaps, however, you make other mistakes which offend other persons as much as these would offend you. How do you know that you do not mispronounce certain words; are you always sure that the things you say and write are grammatically correct? To you they may seem correct; but others may know they are wrong.

Unfortunately, people will not correct you when you make mistakes; all they do is to make a mental reservation about you. "He is ignorant and uncultured," they think. So you really have no way of telling when your English offends others.

FREE Book on English and 15-Minute Test

Sherwin Cody, perhaps the foremost teacher of English in the country, has prepared a simple 15-minute English test which you can take in your own home. This test, with the answers which will also be sent, tells you at once just where you stand. You can discover at a glance whether you make even slight errors. Give yourself this test. If you are efficient in English, it will give you greater confidence; if you are deficient, you surely want to know it, so that you can correct your mistakes.

Mr. Cody's remarkable new invention, the 100% Self-Correcting Method, has already improved the English of more than 41,000 people. No useless rules, no tedious copying, no hard study. Only 15 minutes a day required. You learn by creating the HABIT of using correct English. Nothing like Mr. Cody's method has ever been used before!

You do not want others to judge you unfairly. Write today for this test—it is free. We will also gladly mail you our new free book, "How to Speak and Write Masterly English." Merely mail the coupon or a postal card.

Sherwin Cody School of English

52 Searle Building Rochester, N. Y.

SHERWIN CODY SCHOOL OF ENGLISH
52 Searle Building, Rochester, N. Y.

Please send me your free book, "How to Speak and Write Masterly English," and also Mr. Cody's 15-minute test in English.

Name

Address

City.....State.....

Real Music TAUGHT FREE IN YOUR OWN HOME

Piano, Organ, Violin, Guitar, Mandolin, Banjo, Cornet, etc.

By one of the oldest and most Reliable Schools of Music in America—Established 1895



IN order to introduce our Home Study Music Course in your locality, we offer you, absolutely free, a course of lessons. After you have learned to play we are positive that you will recommend the lessons of the **American School of Music** for either beginners or advanced pupils. Our lessons are suited to your needs. It matters not if you do not know one note from another, our lessons are so simple and easy that any person who can read English can learn to play. We send out lessons to you weekly, and with our free tuition offer, your only expense is for postage and music you use, which averages about 2 cents a day. Thousands of pupils all over the world write—"Wish I had known of your wonderful school before." Write to-day for our convincing free booklet which explains everything in full. Write now to the

AMERICAN SCHOOL OF MUSIC
52 Lakeside Bldg. Chicago, Illinois

FREE Electrical Training Book

Mail postcard for amazing FREE book on electricity. Shows you how to earn \$150 to \$600 a month in this immense field. Famous S & H shop-type training fits you quick at home for big jobs. Exclusive system. Lack of experience or education no bar. Write **S & H Engineering Co., 1422 W. Monroe St., Dept. B-1, Chicago, Ill.**

LAW STUDY AT HOME

Become a lawyer. Legally trained men win high positions and big success in business and public life. Be independent. Greater opportunities now than ever before. Big corporations are headed by men with legal training. Earn \$5,000 to \$10,000 Annually.

We guide you step by step. You can train at home during spare time. Degree of LL.B. conferred. LaSalle students found among practicing attorneys of every state. We furnish all text material, including fourteen-volume Law Library. Low cost, easy terms. Get our valuable 168-page "Law Guide" and "Evidence" books FREE. Send for them NOW. **LaSalle Extension University, Dept. 264-L, Chicago**
The World's Largest Business Training Institution

LEARN PIANO TUNING AT HOME

Send for FREE copy of the 28th ANNIVERSARY EDITION of our book "Winning Independence." Read how students master TUNING with our Tune-A-Phone, and WHY our graduates head the profession in all parts of the world. With Bryant's patented devices, tools, charts, and lessons, one learns quickly and easily. Low tuition, easy terms. Diploma granted. MONEY-BACK GUARANTY. \$10 to \$25 a day, exceptional opportunities, and an ideal profession await you. **BRYANT SCHOOL OF TUNING, (71) Bryant Bldg., Augusta, Michigan**

Factory to Rider

Saves \$10 to \$25 on the **Ranger** Bicycle you select. You can have your choice of 44 Styles, colors and sizes. Delivered free on approval, *express prepaid*, for 30 DAYS' FREE TRIAL. Bicycles, \$21.50 up. \$5 a Month if desired. Possession and use at once on our Liberal Easy Payment plan. Parents often advance first payment.



best quality, at factory prices, *express prepaid*. Tires, lamps, wheels and equipment, low prices. Send No Money, do business direct with makers. **Mead CYCLE COMPANY**
DEPT. C, CHICAGO 109

Write today for free Ranger Catalog, factory prices and marvelous easy payment terms



Clip Coupon for Free Auto Book

BE AN AUTO EXPERT

Earn up to \$10,000 a year

Go to School AT HOME the Cooke "JOB-WAY"

FREE Auto Book

PROOF!
See What I Can Do For YOU!

Send coupon for this amazing **FREE BOOK** right now. See what it has done for others. See what it can do for you! Just think of this! —Walter Mayville, Harold Lester, M. J. Morrision, Herbert Trask, Allen Pomeroy and dozens of others without previous auto experience—In only a few months after enrolling—were in business for themselves, making real money. My Free Book tells you all about their wonderful successes. Send for it.



GET Results QUICK

The World's Biggest Business Needs You!

If you're earning a cent less than \$50 a week, **clip coupon now.** Get my Free Book. Let me show you how Five Thousand Million Dollars are spent every year for **Auto Upkeep alone.** From \$33 a week to **\$225 IN A SINGLE WEEK** is what Cooke "Job-Way" did for Bernard Rumpel, 365 Edison Place, Glendale, N. Y., in a few short months. This tremendous Field offers you most amazing opportunities. Positions Everywhere. THOUSANDS OF BIG PAY OPPORTUNITIES for Cooke "Job-Way" trained men to Boss Jobs or start Your Own Business and make up to \$10,000 a year and more. Find out now about Cooke "Job-Way" Auto-Training—the exclusive, genuine "Job-Way" Training.

Earn Up to \$150 a Week!

Don't sell your time for low pay. You don't need to with my "Job-Way" Training. Be a Big Pay man. My book will show you the way.

Learn Right at Home!

Keep your present job. Get started on the way to Big Pay as an Auto Expert, through Cooke "Job-Way," quickly, easily, right in your own home. Send for my free book: It shows you how successful I've been and how successful I am. Being a practical Directing Engineer, Owner and Head of this Institution, I know what practical money making training you need to become a BIG PAY MAN—and that training I give you.

GET THE FACTS!

Send for this remarkable FREE Auto Book. Get all the facts about this amazing "quick results" Training Method. See what others did. Find out what you can do. **ACT NOW!**

MAIL THIS "JOB-WAY" COUPON

B. W. COOKE, Directing Engineer CHICAGO MOTOR TRAINING CORPORATION 1916 Sunnyside Avenue, Dept. 216A, CHICAGO, ILL.

Send me FREE Auto Book and proof that you will show me the QUICK WAY towards a BIG JOB and a RAISE IN PAY. Also send your 4 Outfits Offer. It is understood that this obligates me in no way and no salesman is to call on me.

Name
Address

Start to Make Money Quick!

You don't have to wait to finish to make real money with Cooke "Job-Way" training. Many of my students make money right in the very first few weeks.

\$215 in a Single Week!
Only 15 weeks after enrolling, Ernest B. Tucker, Cotton, Minn., wrote me he was making as much as \$215 in a single week! That's the kind of QUICK RESULTS you want! Find out what you can do today!

Raises His Salary Almost 300% In 7 Short Months

Cooke "Job-Way" boosted the salary of Gust Alvaras, Box 172, Parkerton, Wyo., a foreigner with little education, from \$18 a week to \$50 a week in only 7 months and he gives my training full credit.

The Only "Job-Way" Training on Earth!

My training includes ALL Electrical work—Ignition, Starting, Lighting—All Mechanical and Welding, Brazing, Vulcanizing—also Business Course, Salesmanship, Advertising, How to Keep Simple Books—Also Auto Magazine, also 4 Outfits.

4 BIG OUTFITS INCLUDED Free of Extra Cost

Tools, Test Bench, Radio Receiving Set. All equipment included Free of extra charge.

Also 293 wiring diagram charts. Wonderful Offer Now. Act quick. Clip coupon for full details.
B. W. Cooke is in no way connected with any other person or training of similar name. Nowhere else can you get the original, genuine copyrighted Cooke "JOB-WAY" training. I train you with Tools which I give you and illustrated JOBS—not books. Learn what I have done for others, see what I can do for you. **Mail coupon right now!**

Common Schooling All You Need Men between 15 and 60 and easily finish my training. Many become Garage Owners, Managers, Superintendents, Foremen, Auto Experts, in the class with BIG PAY executives. I back you up with the entire resources of this great Institution. Employment service for your whole life. Also Lifetime Consultation service.

Notice on this page what a few of my students have done—then send for my Free Auto Book right away! Address me personally.

B. W. COOKE DIRECTING ENGINEER
CHICAGO MOTOR TRAINING CORPORATION
1916 Sunnyside Avenue Dept. 216A CHICAGO

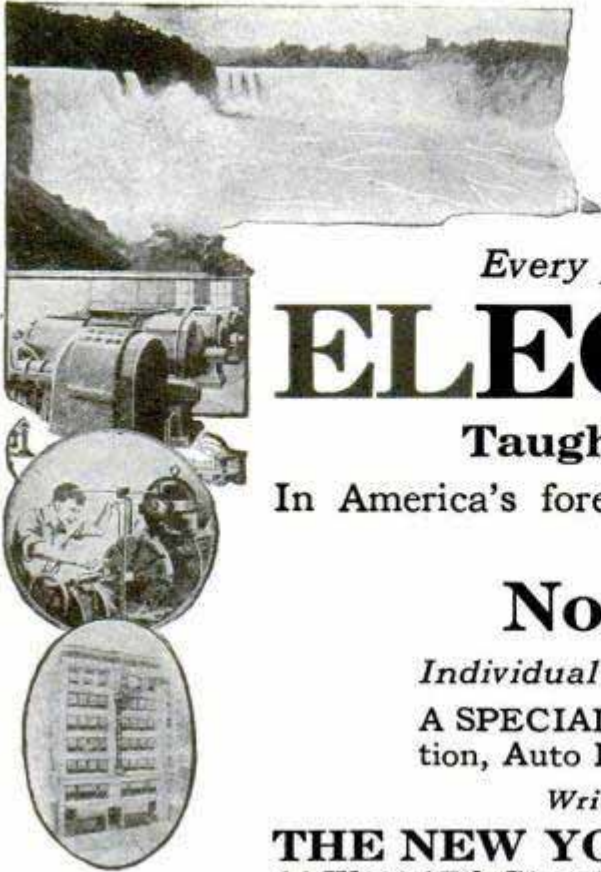

Learn By Doing!

Every phase of all branches of **ELECTRICITY**

Taught By Actual Practice

In America's foremost institution for trade training.

Established 1902

No Books Used

Individual Instruction. Start Any Day.

A SPECIAL and SEPARATE Course in Ignition, Auto Lighting and STARTER Systems.

Write for FREE 64-Page Catalog

THE NEW YORK ELECTRICAL SCHOOL
44 West 17th Street NEW YORK CITY

DO YOU LIKE TO DRAW?

It's Easy To Learn When Shown In The Right Way

Some of the cleverest cartoonists and comic artists in America today learned how to draw quickly—by following **CARTOONIST EVANS' SIMPLE AND EASY METHOD**. This school is recommended by foremost cartoonists because they know the students are handled right. If you like to draw, send 6c in stamps for **portfolio of cartoons and full details**. The course is **NOT EXPENSIVE**.

The W. L. Evans School of Cartooning 821 Leader Building CLEVELAND, OHIO



"THERE'S MONEY IN IT"

AT HOME LEARN TELEGRAPHY AT HOME

MORSE AND WIRELESS

TEACH YOURSELF in half usual time, at trifling cost, with the wonderful Automatic Transmitter, **THE OMNIGRAPH**. Sends unlimited Morse or Continental messages, at any speed, just as an expert operator would. **Adopted by U. S. Government, and leading Universities, Colleges and Telegraph Schools. 3 Styles. Catalog free.** **OMNIGRAPH MFG. CO., 13-19 Hudson St., NEW YORK**

If you own a Radio Phone Set—and don't know the code—you are missing most of the fun.

WANTED—RAILWAY MAIL CLERKS

\$158.00 to \$225.00 a Month for Life
(ALL POSTAL SALARIES JUST RAISED)

Every second week off with full pay—no "lay-offs" because of strikes, poor business, etc.—sure pay—rapid advancement to higher positions. City and country residents stand same chance. Common sense education sufficient—no political influence.

TRAVEL—SEE YOUR COUNTRY

Mail Coupon today—sure. Every day's delay means so much less chance of appointment from the next examinations—so do it at once.

Take this First Step for a U. S. Government Job

Use Coupon Before You Lose It

COUPON

FRANKLIN INSTITUTE, Dept. M-179, Rochester, N. Y.

Kindly send me, entirely free of charge, (1) A full description of the position checked below; (2) Sample examination questions; (3) A list of U. S. Government Jobs now obtainable; (4) Tell me how I can get the position here checked.

... Railway Mail Clerk (\$1900 to \$2700) ... Customs Positions (\$1140 to \$1860)
 ... Postoffice Clerk (\$1700 to \$2300) ... Internal Revenue (\$1140 to \$1860)
 ... City Mail Carrier (\$1700 to \$2100) ... Rural Mail Carrier (\$2100 to \$3300)
 ... Income Tax Auditors (\$2040 to \$3000)

Name

Address

AUDELS ENGINEERS & MECHANICS GUIDES

Salary Increased 100 Percent

"Aude's Guides gave me information I was unable to get from much higher priced works. By their use I have increased my salary 100 per cent."

C. Pelsor, Lic. Engineer, Springfield, Mass.

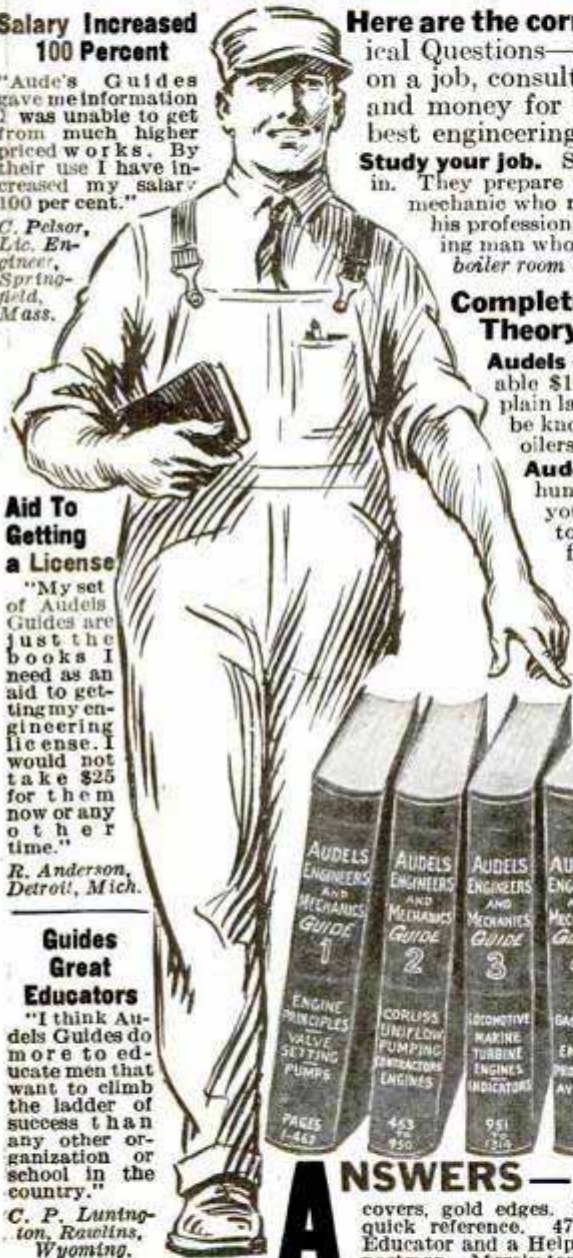

Aid To Getting a License

"My set of Audels Guides are just the books I need as an aid to getting my engineering license. I would not take \$25 for them now or any other time."

R. Anderson, Detroit, Mich.

Guides Great Educators

"I think Audels Guides do more to educate men that want to climb the ladder of success than any other organization of school in the country."

C. P. Luntington, Rawlins, Wyoming.

Here are the correct answers to Engineering and Mechanical Questions—in a handy form. When you are stuck on a job, consult Audels Guides. It will save time, labor and money for you. These authentic guides teach the best engineering practice. Don't guess or take chances. Study your job. Study Audels Guides on subjects you are interested in. They prepare you for the job higher up. The engineer and mechanic who reads and thinks as he works puts character into his profession. He is the master of his job. He is the outstanding man who is in demand in these days when power plant and boiler room economy is so important.

Complete Engineering Taught in Practice and Theory in These Practical Pocket-Educators

Audels Guides are 8 handy pocket books—price \$12, payable \$1 a month. These up-to-date educators explain in plain language the theory, practice and rules that have to be known by engineers, mechanics, machinists, firemen, oilers, draughtsmen and engineering students.

Audels Guides are Good Helpful Counselors, worth hundreds of dollars to any mechanic. By learning more you earn more. Read list of subjects covered—all easy to understand and apply. Engineering calculations figured out in simple arithmetic with sketches and examples.

Judge the value for yourself. Examine Guides Free! Send coupon NOW. Make up your mind about keeping these educators after a week's trial.

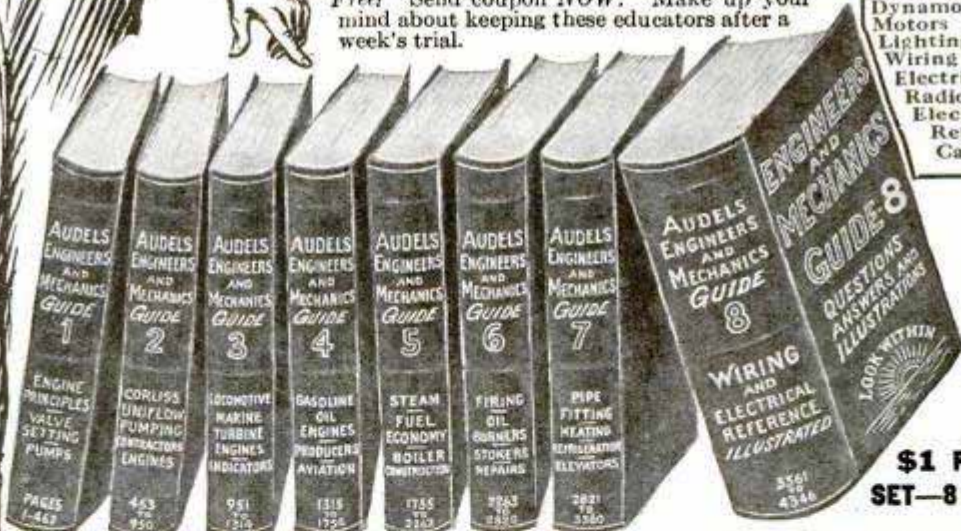

INFORMATION Answers On:

Engine Principles
Valve Setting
Pumps,
Engines—
Corliss Engines
Uniflow Engines
Pumping Engines
Contractors Engines
Locomotives Engines
Marine Engines
Turbine Engines
Gas and Oil Engines

Indicators
Producers
Aviation
Steam
Fuel Economy
Boiler Construction
Firing
Oil Burners
Stokers
Boiler Repairs
Pipe Fitting
Heating
Refrigeration
Elevators
Dynamometers
Motors
Lighting
Wiring
Electrical Diagrams
Radio
Electrical Reference and Calculations

\$1

\$1 PER MONTH SET—8 GUIDES \$12

ANSWERS—In A Handy Form

covers, gold edges. Easy to carry in pocket for daily reading. Handy to keep on table or shelf for quick reference. 4750 pages, 8754 illustrations. Highly endorsed by engineers everywhere as an Educator and a Helper to Better Pay. Examine the set free! Send no money. Pay nothing to postman. Merely tear out and mail this coupon today!

These 8 beautiful books are printed in big type, on strong paper. Flexible

flexible to keep on table or shelf for quick reference. Highly endorsed by engineers everywhere as an Educator and a Helper to Better Pay. Examine the set free! Send no money. Pay nothing to postman. Merely tear out and mail this coupon today!

Our Guarantee

Examine Audels Engineers & Mechanics Guides without charge. If you like this Master Set, keep it. If not, send it back. Pay us only if you are satisfied. No charge if you are not. This is the fair play plan on which we have distributed educational books for nearly 50 years.

NOW!

The foreman, superintendent, chief of today is the man that yesterday STOPPED EVERYTHING until he got this coupon into the mail! Send this coupon now. Learn more so you can earn more!

FREE THEO. AUDEL & CO.

EXAMINATION COUPON 65 West 23rd St. NEW YORK CITY

Please send me postpaid, for free examination AUDELS ENGINEERS & MECHANICS GUIDES—8 numbers, \$12. If satisfied, I agree to send \$1 in 7 days and \$1 monthly until paid.

Name.....

Address.....

Occupation.....

Employed by..... 2-T-30

Shake off your

THERE ARE THOUSANDS UPON THOUSANDS OF BIG, IMPORTANT OPPORTUNITIES IN THE GREAT FIELD OF ELECTRICITY

Don't envy the other fellow because he is getting the big things out of life! Chances are he had just as many, if not more, obstacles to overcome before he got on the road to Prosperity, Independence and Happiness. One thing is certain! He didn't get anywhere until he MADE UP HIS MIND to be a real success, and then ACTED! ACTION, applied in the RIGHT DIRECTION, will work wonders, and will surprise you with what it accomplishes for you. The Electrical Field is the ideal field today. It offers big pay, a steady income and fascinating work. Big as it is, it will grow bigger and bigger and offer more amazing opportunities each year. Don't let Lack of Training or Lack of Decision keep YOU forever in the poor, unhappy, unsuccessful class. SHAKE OFF THOSE SHACKLES—NOW!

COMPLETE ELECTRICAL TRAINING In 12 Happy Weeks at COYNE

Only three short months—think of it! Then on to Independence and Happiness in the most interesting of professions. No one can hold you back once you get the thorough knowledge of Electricity that my course provides. I and my big staff of Expert Instructors take you step by step over the whole ground until everything about Electricity has been explained to you, and you yourself know what's what about Dynamos, Generators, Motors, Wiring, Lighting, Batteries, Currents, Circuits and thousands of other things that you couldn't very well get for yourself out of books. Remember, when you study at COYNE you work with your own hands on giant electrical apparatus in COYNE'S Great Shops, right in the electrical center of the world. My newly-enlarged and simplified course is the result of 27 years' experience.

You Don't Need Advanced Education or Experience to Learn at COYNE

My course in Electricity is a practical, LEARN-BY-DOING Course. Every COYNE student receives INDIVIDUAL and PERSONAL instruction, on COMPLETE electrical apparatus, under EXPERT INSTRUCTORS. Therefore, it doesn't matter what kind of work you've done in the past. It doesn't matter if you've never spent a day at high school or college. You don't need advanced education or experience to learn at COYNE.

Make Up Your Mind—ACT AT ONCE!

Decide RIGHT NOW that you'll get ahead. I want to send you my Big FREE Book which tells all about my great, long established school. It also tells how thousands of fellows have pulled out of the rut and become well-fixed for life. For your own sake, use that "Better Times Coupon" on the opposite page, TODAY!

**HUNDREDS OF COYNE-TRAINED MEN
EARN \$60 TO \$200 A WEEK**

It stands to reason: There is no substitute for personal, practical training in great shops.

Tune in on COYNE
Radio Station WGES

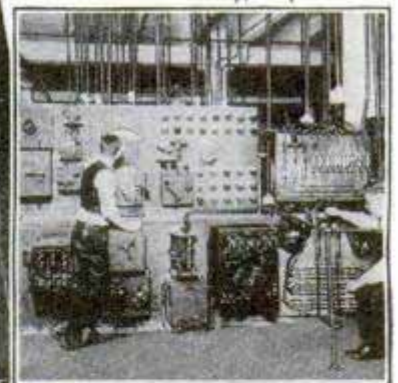

Every COYNE Student receives individual and personal instruction on complete electrical apparatus.

COYNE

1300 West Harrison Street

**H. C. LEWIS, President
Department 9352**

shackles!



ELECTRICITY

— Provides Bigger Pay, Steadier Jobs and More Thrilling Work!

EARN

While You Learn at COYNE

My wonderfully-organized EMPLOYMENT DEPARTMENT helps you to get a job to earn part or all of your expenses while training at COYNE, and assists you to a good job on graduation. Furthermore, it stands by you *through life*, without a penny of extra cost to you!

WE ARE SPECIALISTS

COYNE teaches only one thing—ELECTRICITY. Our interests are not divided, nor is Electricity a sideline with us. We have SPECIALIZED in the teaching of ELECTRICITY for more than a quarter of a century.

Men who never before had the slightest knowledge of ELECTRICITY have become REAL ELECTRICAL EXPERTS and stepped into BIG PAY JOBS because of our advanced, simple, practical methods of training.

2 BIG COURSES WITHOUT EXTRA COST IF YOU ACT AT ONCE

If you send the Better Times Coupon right away, I'll give you, without a penny of extra cost, complete courses in Radio Electricity and Auto Truck and Tractor Electricity.

There's no field like the Electrical Field. Fortunes have been made in it. Millions of people have gotten happiness and comfort from it. The properly-trained man is sure of both a PRESENT and a FUTURE in it. COYNE students are *thoroughly* trained. That's why they can pick their own jobs. That's why they get ahead of some of the "old timers" who know only one or two branches of Electricity.

IT STANDS TO REASON: THERE IS NO SUBSTITUTE FOR PERSONAL, PRACTICAL TRAINING IN GREAT SHOPS



H. C. LEWIS, President
Coyne Electrical School



Student Winding a Stator

Get My Big FREE Book and Special Offer NOW!

Be sure to send at once for my big FREE BOOK containing 151 actual photos of electrical operations and methods; also my special offer of 2 Big Courses without extra cost. Write today, sure, before this offer is withdrawn.



Better Times Coupon

H. C. LEWIS, President
COYNE ELECTRICAL SCHOOL
1300-10 W. Harrison Street
Dept. 9352, Chicago, Ill.

Dear H. C.—You can just bet I want one of those big, handsome FREE 12x15 books, with 151 actual photographs printed in two colors. Send it quick, before the supply is exhausted. Be sure to tell me all about 2 Big Special Courses without extra cost.

Name.....

Address.....

Town.....State.....

Electrical School

ESTABLISHED 1879
CHICAGO, ILLINOIS

This Tenor Banjo

FREE

WHEN YOU ENROLL -
Worth \$18.00



Thousands Enjoy Popularity!!

Popularity can be yours. We start you by presenting this handsome, full size professional tenor banjo. We want to present one of these wonderful, delightful instruments as a gift to each of 1,000 readers of this magazine. We want every music-lover to attain success and this gift offer is made to pave the way. No previous musical knowledge is necessary. Under personal supervision you will be given, by mail, the benefit of Prof. Harry Six's 22 years as director of Glee and Instrumental Clubs of N. Y. University. Our method is different and the simplest devised by man.

Learn in 30 Minutes

We furnish pictures and, as an additional guide, phonograph records of the professor playing the pieces you are learning, along with our thorough, printed and illustrated, easy-to-learn course. It is easy. If you could sit at our desk and see letters from students, you would be convinced that we have perfected the simplest course to insure your mastering tenor banjo.

Don't Send a Single Cent

Investigate today. Don't put off until tomorrow, because you might forget. It might be the turning point in your career. Don't send a single cent. Just drop a line—use coupon, or postal card will do—telling you are interested in receiving full particulars about course, and to reserve one regular eighteen dollar, full size professional tenor banjo for you, which is offered as a gift. Act Now!

EARN BIG MONEY

HUNDREDS HAVE STARTED ORCHESTRAS AND ARE MAKING BIG MONEY

FREE BANJO COUPON

New York Academy of Music
Studio 12, 100 Fifth Avenue, New York

Please rush all free information relative to your Tenor Banjo Course, sample lesson and reserve a gift tenor banjo for me. This obligates me in no way whatever.

Name

Address

City State



Don't Risk a Truss!

Now you can throw away forever steel bands, chafing leg straps and other heavy makeshift devices. For a well known American Scientist has found a new easy way to support rupture assisted by means of a wonderful little invention weighing less than 1-25 of an ounce. Not only do you do away with the objectionable pressure and tight strapping, but you eliminate the "coming down" of rupture—when running, straining, exercising, sneezing, etc.—which too frequently leads to strangulation. So great has been the success of this wonderful device that it is being offered to ruptured people on an absolute guarantee of instant satisfaction or no cost. Simply drop a postcard or letter requesting free literature to **NEW SCIENCE INSTITUTE, 2121 Clay St., Steubenville, O.**



FREE Book on Deafness

Write today for 168 page FREE book giving full particulars and testimonials from hundreds of grateful users whose hearing has been restored by use of our "little wireless phones for the ears."

Wilson Common-Sense Ear Drums require no medicine but effectively replace what is lacking or defective in the natural ear drums. They are simple devices, which the wearer easily fits into the ears where they are invisible. Soft, safe and comfortable.

WILSON EAR DRUM CO., Incorporated
386 Todd Building LOUISVILLE, KY.



A PERFECT LOOKING NOSE

Can Easily Be Yours

Tradex Model No. 25 corrects now ill-shaped noses quickly, painlessly, permanently and comfortably at home (excepting cases caused by improper bone structure). It is the only adjustable, safe and guaranteed patent device that will actually give you a perfect looking nose. Over 90,000 satisfied users. For years recommended by physicians. 16 years of experience in manufacturing Nose Shapers is at your service. **Model 25 Junior for children.** Write for testimonials and free booklet, which tells you how to obtain a perfect looking nose.

M. TRILETY, Pioneer Noseshaping Specialist
Dept. 2476 Binghamton, N. Y.



Bow Legs and Knock Knees Unsightly!

Send for booklet showing photos of men with and without **THE PERFECT LEG FORMS.**

PERFECT SALES CO. 140 N. Mayfield Ave. Dept. S, Chicago, Ill.

Clear Your Skin

If you suffer from pimples, acne, blackheads, oily skin, or eruptions, simply send me your name and address, and I will tell you about a simple home remedy that often cures pimples in one day after everything else has failed. No obligation—just send your name.

W. H. WARREN, 451 Gateway Sta., KANSAS CITY, MO.



Wide World Photo

Sudden New Demand for Daring Young Men!

AVIATION in America is on the threshold of an amazing new development. For in the past few months gigantic commercial air lines have been established. The biggest capital and business forces in the world are behind this enterprise. Even in the beginning, thousands of young men are needed. For those who can qualify there will be highly paid jobs which will lead quickly and surely to advancement and success.

Big Opportunities Await the Trained Man

Look over the fields of work which are open to the young man today. You will find that Aviation is the ONE FIELD that is not overcrowded—the ONE FIELD in which there is plenty of room at the top. Think of it! Only 21 years ago Orville and Wilbur Wright made the world's first airplane flight. Now airplanes fly around the world. Yes, Aviation offers the same wonderful opportunities today that the automobile and motion picture industries did 15 and 20 years ago. Men who got in on the ground floor of those industries made fortunes before others woke up.

Easy to Become an Aviation Expert—\$50 to \$100 a Week

You can qualify now quickly for one of these exciting highly paid jobs through a new, sure, easy method of training. The study of Aviation is almost as interesting as the work itself. Every lesson is fascinating and packed full of interest. That's why Aviation is so easy to learn—you don't have to force

yourself to study. Only one hour of spare time a day will give you the basic training in an amazingly short time.

One student, S. F. McNaughton, Chicago, says: "Your lessons are like a romance, and what is more, after one reading, the student gets a thorough understanding. One never tires of reading them." James Powers, Pa., another student, says: "I am indeed surprised that such a valuable course can be had from such practical men for so little cost."

Men who have had actual experience in Aviation give you personal attention and guide you carefully through your training. They select the lessons, lectures, blueprints and bulletins. They tell you the things that are essential to your success. Every lesson is easy to read and quickly understood.

PREPARE FOR ONE OF THESE POSITIONS

Aeronautical Instructor
\$60 to \$150 per week
Aeronautical Engineer
\$100 to \$300 per week
Aeronautical Contractor
Enormous Profits
Aeroplane Repairman
\$60 to \$75 per week
Aeroplane Mechanician
\$40 to \$60 per week
Aeroplane Inspector
\$50 to \$70 per week
Aeroplane Salesman
\$5,000 per week and up
Aeroplane Assembler
\$40 to \$65 per week
Aeroplane Builder
\$75 to \$200 per week



Big Book on Aviation FREE

Send coupon below for New Free Book, just out, "Opportunities in the Airplane Industry." It is interesting and instructive and will show you many things about Aviation which you never knew before. Only a limited number offered—get yours before the edition is exhausted.

AMERICAN SCHOOL OF AVIATION Dept. 1312, 3601 Michigan Ave., Chicago, Ill.

American School of Aviation,
3601 Michigan Ave., Dept. 1312, Chicago, Ill.

Without any obligation, send me your Free Book, "Opportunities in the Airplane Industry," also information about your Course in Practical Aeronautics.

Name.....
Street.....
City..... State.....

This New Book Tells You

the Quick Way to Big Pay

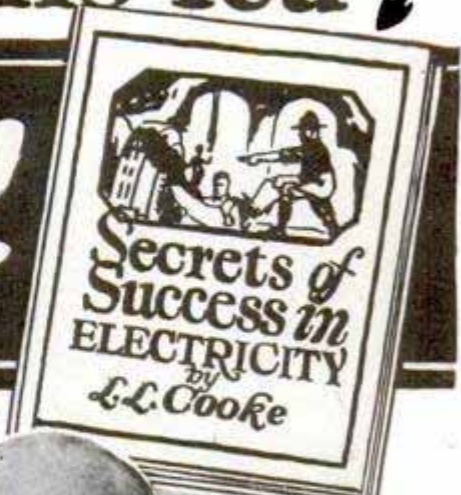

And it's yours for the asking!

Get this big illustrated book on Electricity FREE! Simply send the coupon below to Chief Engineer Cooke and you will receive, absolutely without cost, this great big book of facts, figures and pictures of the world's greatest business—Electricity.

Learn how easy it is to get into Big-Pay electrical work—how quickly you can learn to earn \$70 to \$200 a week—how thousands of others have won success. It's all in "The Secrets of Success in Electricity."



Who is L. L. Cooke?

He is Chief Engineer of the Chicago Engineering Works, Inc., a two million dollar institution. A college trained engineer with 20 years of practical experience, and an amazing record of success as a maker of Big-Pay Men in Electricity.

1926 Edition—Just off the press! 150 Electrical Pictures—100 Success Stories

Chief Engineer Cooke has a world wide reputation as the amazingly successful teacher of Electricity. His practical, simple, quick training is endorsed by employers, by thousands of Cooke Trained Men, and by great organizations like the American Association of Engineers. His new book tells all about it. Every man making less than \$75 a week—every man who is dissatisfied with his job and his future—should have a copy. It will tell you things about the wonderful Electrical profession that you never knew before. It will open your eyes to the startling possibilities of this sixteen-billion dollar business. It may be the turning point of your life—the first step on the road to a \$10,000 a year income. Send for this great book today.

A Practical Engineer Tells the Practical Way to Win Success!

Don't keep on blindly hoping that some day big money will come to you. Don't be a "wisher"—don't trust to luck. Get Chief Engineer Cooke's book and find out for yourself what your opportunities are. Here's the chance you've been looking for—the open door to success. Get the facts on Cooke Training—the practical, proven way to success in Electricity.

47 Electrical Jobs Pictured and Described

Maybe you thought there was only one sort of electrical work. Then you're in for a big surprise. Forty-seven separate

kinds of electrical positions—Radio, Auto Electricity, Armature Winding, Wiring, etc.—are pictured and described in L. L. Cooke's new book. And there are hundreds and hundreds of openings in every one of these lines.

Thousands of Big-Pay Men Started With This Book!

You don't need high school or college education to make good money in Electricity. You don't need previous experience. Cooke Training alone is enough. Thousands of Cooke Trained men who have become Electrical Experts didn't know a thing about Electricity before enrolling. The Chief's big book started them. Now they make \$3,500 to \$10,000 a year—\$70 to \$200 a week—and don't work half as hard as they used to when they earned only \$30 or \$40 a week. What this great book did for them, it may do for you. Send coupon for your FREE copy and find out.

"Boosted My Pay to \$400 a Month," says Moeschler

"Mr. Cooke, your book opened my eyes to the future in Electricity. With your Training my pay jumped from \$50 to \$400 a month," writes 21-year-old Carroll Moeschler, Chaska, Minn.

"I used to get \$1,800 a year—now I make \$8,700 and expect to go over

\$10,000 this year," writes E. M. Hughes, Terre Haute, Ind. "I would still be working at low wages if your book on Electricity hadn't shown me what I could do."

The Chief's book contains dozens of letters and photos of men who have made good in Electricity, telling how they started and what Cooke Training did for them. It will show you how you, too, can win the same success as others. You won't want to miss these absorbing success stories of men just like yourself.

Send the Coupon for Your Copy of This Book—It's FREE!

Send for "The Secrets of Success in Electricity"—NOW—TODAY. Don't put it off—don't let this opportunity slip. Fill in and mail the coupon below, or a postcard. You won't be under any obligation. No salesman or agent will call. Get this great book and see for yourself the tremendous opportunities Electricity offers to you. Address—

L. L. Cooke, Chief Engineer
Chicago Engineering Works, Inc.
Dept. 12, 2150 Lawrence Ave., Chicago

L. L. Cooke, Chief Engineer,
Chicago Engineering Works, Inc.,
Dept. 12, 2150 Lawrence Ave., Chicago.

Dear Chief: Please send me at once your big illustrated FREE BOOK on "The Secrets of Success in Electricity." This does not obligate me in any way. It is understood that no salesman will call.

Name.....
Address.....
City..... State.....

The Cooke Trained Man is the "Big Pay" Man

Classified Advertisements

WORLD'S BEST WANT AD MEDIUM

Advertisements in this section, 25 cents per word, each insertion, minimum 10 words, payable in advance.
To be inserted under proper classification in March issue, copy should be in our office January 18th.

ADVERTISING AGENCIES

TO secure agents or salesmen or for selling farms and reaching investors, use classified (want) ads in largest newspapers and magazines. Price list No. 30 sent free. Ankrum Advertising Agency, 20 W. Jackson Blvd., Chicago, Ill. The largest classified advertising agency in the U. S.

ADVERTISE in 24 Big Sunday Newspapers, 24 words \$15.00. Catalog listing 1,000 leading Dailies, Weeklies, Magazines, 4c stamps. Union Advertising, Baltimore Bldg., Chicago.

ADVERTISE in 24 big Sunday Newspapers, 24 words \$15.00. 300 Rural Newspapers 28 words \$10.00. 100 Big weekly newspapers 24 words \$5.00. Service 100%. Consultation Free. National Advertising Service, Richmond Hill, New York.

LEGITIMATE Advertising. All Publications, Latin America, United States, Country papers. Catalog free. Owl Agency, Times Building, New York.

25 WORDS—355 Rural Weeklies, \$14.20. Ad-Meyer Agency, 4112-M Hartford, St. Louis.

ADVERTISE—25 words in 75 weekly newspapers \$3.40. Shaw Company, Box 1373, Washington, D. C.

FREE. Advertising rates. Newspapers, magazines. Guaranteed agents' names, \$5.00, 1,000. Pennell, Covington, Ky.

ADVERTISING 222 Magazines .98c word, \$6.00 Inch, \$45.00 page. Sample 10c. Diamond Advertiser, Norton, Mass.

ADVERTISE—335 weeklies, \$3.55 line. Cope Agency, 233P, Champaign, Ill.

FOR ADVERTISERS

ADVERTISING Novelty Unusual. Your advertisement on Seven-in-One Vest-Pocket-Wonder Tool. For Radio, Automobile, Electrical or Home Use. Each in leather case. Price next to nothing. Desired on sight. Write for Free Sample. G.M.Z. Company, 309 Sixth Avenue, New York.

CATALOGUES—Booklets—folders—sales literature—planned—written—printed. Complete service at cost of printing alone. Binding—electrotyping. National Merchants Company, 4342 North Robey, Chicago.

CIRCULAR Mailing 25c per 100. Alderson, Box 167, South Bend, Ind.

YOUR Advertisement—3 weeks free. 22 leading newspapers. Pay one week regular rate 4c word. Affiliated Newspapers, Bedford Building, Chicago.

ADVERTISE in "Mail Order Opportunities" for Agents, Business Opportunities, Formulas, Stamps, Coins, etc. Good medium. Sample copy 10c. Field, 246 Fifth Avenue, New York.

ADVERTISE in 300 country newspapers, 28 words \$10. Keator, Hartford Bldg., Chicago.

25 WORDS, 88 magazines, \$1.00; Thrice \$2.00. Inch display \$2.00; Thrice \$5.40. Smith's Service, 1194, Wenatchee, Wash.

CIRCULARS Mailed—25c, 100; \$2.00, 1,000. Universal Mailers, 650 Center, Waukegan, Ill.

GET "Successful Retail Advertising" postpaid \$1.00. Quinan, 5404 Lansdowne, Philadelphia.

INCH Display 100 monthlies \$4. Cooe Agency, 233P, Champaign, Ill.

SALES PROMOTION

\$50 TO \$50,000 Daily Sales developed during 36 years for clients by my direct-mail plans, copy, campaigns. A \$25,000 annual volume increased ten-fold in twelve months. Another, from an initial expenditure of \$720 developed in four years sales by mail of half million yearly. Ten years Sales Promotion Manager Larkin Co. Submit sales problems for Free diagnosis. James C. Johnson, 118A Woodbridge Ave., Buffalo.

AUTOMOBILE SUPPLIES

USED Auto Parts for Any Car. Allen's Parts Co., 2091 So. 9th, St. Louis, Mo.

TIME before You, as You Drive: Watch and Holder on your steering wheel. Complete postpaid, \$1.60. Or free circular. See article page 727, November issue. Coffee Mfg. Co., Centralia, Ill.

VULCANIZING Auto Tires is a Paying Business on account of new tires advancing. We have Plants near you from \$100 up. We save you 50%. Catalog Free. Instruction Book \$1. Equipment Exchange, 108 East 11, Los Angeles, Calif.

BARGAINS on Radiators. All standard makes radiators furnished at bargain prices. State Make and model. We guarantee satisfaction. Independent Radiator Co., 1119 Wabash Ave., Chicago.

LIGHT weight white bronze pistons for all cars and trucks; low prices; get circular. Egge, 7704 South Main St., Los Angeles, Calif.

66 MILES on 1 Gallon. Wonderful Scientific Gas Saver. All autos. 1 free, demonstrator. Critchlow, O-124, Wheaton, Ill.

AUTOMOBILES

PATENTS. Time counts in applying for patents. Don't risk delay in protecting your ideas. Send sketch or model for instructions or write for Free Book "How to Obtain a Patent" and "Record of Invention" form. No charge for information on how to proceed. Communications strictly confidential. Prompt, careful, efficient service. Clarence A. O'Brien, Registered Patent Attorney, 58D Security Bank Building (directly across street from Patent Office), Washington, D. C. See pages 140 and 141.

FORD Chassis made dependable tractor by using Shaw Equipment. Pulls 16" plow, etc. Particulars Free. Shaw Manufacturing Company, Dept. R-1, Galesburg, Kans.

PATENTS: My fee in installments. Free personal advice. Frank T. Fuller, Washington, D. C.

MOTORCAMPERS! We supply camp car plans for the amateur builder. Pacific Vehicle Works, Box 574, Los Angeles.

SNAPPY Slogans and Comic Names for autos. New list, 1,000, 25c. Nichols, 1014 Thatcher, Boise, Idaho.

AUTOMOBILES: 753 Ideas on repairing and improving, in Popular Mechanics three new books: Auto Repairman's Handbook, Auto Owner's Handbook, Auto Tourist's Handbook. Send No Money. Just write a postal. Pay postman the postage and \$1.50. Popular Mechanics Press, Room 802, 200 E. Ontario St., Chicago, Ill.

AUTOMOBILE SUPPLIES, ACCESSORIES AND HOUSEHOLD GOODS WANTED

100,000 REPRESENTATIVES Wanted! Sell by mail through Agents, or Direct! Detailed Information—25c! None free. Surety Service, Importers and Exporters, Desk A, 551 Harvard St., Rochester, N. Y.

FOR FORD OWNERS

MARVELOUS Simple, Automatic, Everlasting Ford Ignition accessory. Two minute installation. Insures uniform spark, quick start, smoother running, less jerking. Sample 50c. Gold mine for Agents. Harry Iour, 891 State Life Bldg., Indianapolis, Ind.

HOT-SHOT Sight-Gap, Spark Plug. Amazing new invention. Visible intensified spark. Solves ignition troubles. Money back if not satisfactory. Price \$1.25 each. Order today. Latshaw Manufacturing Co., Clinton, Mich.

COMBINATION Bumpers and Fender Braces for 1925 Fords and earlier. 95c each for front or rear. Formerly cost \$6.00; no fake or graft; sacrifice sale; only 3,000 left. Steckel Mfg. Co., Inc., Pawbuska, Okla.

66 MILES on 1 Gallon. Wonderful Scientific Gas Saver. All Autos. 1 free, demonstrator. Critchlow, P-121, Wheaton, Ill.

DIRECT Engine Driven Tire Pumps for Ford Cars. Clagett Mfg. Co., Upper Marlboro, Md.

FORD propelled speedboat, easily built; blue print and directions, sixty cents. Hubbell, 4B East Ave., Newark, Conn.

UNDERSLING with "RKO" Swing Lo Irons. See "Red-I-Kut" ad page 148.

MOST valuable tool, removes cylinder head with one hand; saves your gasket. Nothing like it on the market. Price 25c. Agents write for proposition. Remco Mfg. Co., Kalamazoo, Mich.

MOTORCYCLES, BICYCLES AND SUPPLIES

1923 HARLEY-DAVIDSONS, \$168; 1922, \$118; 1921, \$111; 1920, \$85; 1919, \$67; 1917, \$50; 1916, \$45; 1915, \$40; 1914, \$35. Guaranteed. Money refunded if not satisfied. Circular free. Wisconsin Cycle Sales Co., 726 National Ave., Milwaukee, Wis.

OVERSTOCKED Used Motorcycles, 1923 Indian Chief \$95.00, 1923 Harley Davidson \$95.00, 1923 Henderson DeLuxe \$120.00. Two hundred others; write for free list. Myerow Brothers Co., 15 Berkeley St., Boston, Mass.

INDIAN Chief, 74 cubic inch motor, mechanically perfect, \$180.00. Ray Hummel, 30 W. Twelfth St., Cincinnati, Ohio.

DON'T buy a Bicycle Motor Attachment until you get our prices. Shaw Mfg. Co., Dept. 27, Galesburg, Kans.

AVIATION

AEROPLANE Motors, New complete Army \$2,000.00, 165 horsepower 9 cylinder Gnome air-cooled engines \$25.00 F.O.B. Dayton, Ohio. 1,100 engines purchased; need storage space, reason selling so cheaply. Hundreds sold delivered satisfied purchasers. Names furnished. Ideal for iceboats snowsleds, motor boats and wind wagons. Aeroplanes and parts. Reading course aerodynamics \$5.00 with text book. Ford propellers, \$5.00 up. Blue prints successful snowsled and lested \$1.00. Write for booklet. Marvin A. Northrop, 200 Builders Exchange, Minneapolis, Minn.

PATENTS. Time counts in applying for patents. Don't risk delay in protecting your ideas. Send sketch or model for instruction or write for Free Book "How to Obtain a Patent" and "Record of Invention" form. No charge for information on how to proceed. Communications strictly confidential. Prompt, careful, efficient service. Clarence A. O'Brien, Registered Patent Attorney, 58D Security Bank Building (directly across street from Patent Office), Washington, D. C. See pages 140 and 141.

HEATH propellers represent the most efficient method of aerial drive. Each propeller individually designed for the particular work to be done, as laid out by America's oldest aeronautical engineers. Propeller catalog 4c; Motorcycle Biplane circular 4c; Ford or Motorcycle sled blueprints \$2.00 each. Resistal goggles \$2.99. Wool Jersey helmets 95c. Heath Airplane Company, Chicago, Ill.

COMPLETE Scale Plans, with Building-Flying Instructions for following 3-R. Model Aeroplanes, 24c each postpaid: JN4D-2; DeHavilland; NC-1; Bleriot, Neuport or Taube Monoplanes; Cecil Peoff Racer. Complete 48-pp. catalog 5c; listing hundreds of parts and supplies for experimenters. Ideal Aeroplane Co., 163 1/2 Spring St., New York.

EARN \$3,500 to \$10,000 a year. Learn Airplane Engineering Now at Home. The World Flyers were Airplane Engineers. Write for free catalog. Western Airplane Corporation, Desk K-2, Monadnock Block, Chicago.

FOR Sale—260 H.P. Mercedes, 6-cylinder aircraft motor, complete \$295.00; 100 H.P. Anzani, 10 cylinder radial brand new \$175.00. Air Transport, Carl Place, New York.

SPECIAL Winter Flying Course \$100.00. Write for particulars. All types of ships, San Antonio Aviation & Motor School, 599 Navarro, San Antonio, Tex.

AIRPLANES, Motors, Supplies; New 100 H.P. Gnome Rotary Motor \$150; new 28 H.P. Lawrence \$100; Sheepskin-lined leather helmets \$5; non-shatterable Goggles, wide-vision, \$4.50; oval \$3.25. Logan Aviation, 715 W. Superior, Cleveland.

LEARN to Fly! Write for booklet. Robertson Aircraft Corp., Anglum, Mo.

I WANT Aviation training. Service in return. Harold Peters, Rudolph, Wis.

"TEN lessons in the air of twenty minutes each will make you a pilot by our advanced method of training. This together with our five weeks shop course at \$100.00 makes America's oldest aircraft factory the most popular flying school. Work after class hours guaranteed. Heath Airplane Company, Chicago, Ill.

BLUEPRINTS "Aerodrive" Ford Motor Conversion and Boat \$1.25. Ice Coach and Scooter Blueprints, \$1.25. Speedy Sled Blueprints \$1.00. Beautiful 16" Four blade Propellers \$2.25. Everything Aeronautical. Price list 5c. Ostergaard Aircraft, Dunning Station, Chicago.

MOTORS: Curtiss OX-6 Class A (under Fifty Hours) for Plane, Sea-Sled, Motor boat, etc., \$200.00. All Motor and Plane Spares at Best Prices. Send for Catalogue. Monumental Aircraft Co., 359 N. St. Paul Place, Baltimore, Md.

LEARN to Fly! Write for booklet. Robertson Aircraft Corp., Anglum, Mo.

THE American School of Aviation announces a new correspondence course in Mechanics of Aviation. A thorough training in Practical Aeronautics. American School of Aviation, Dept. 1861, 3601 Michigan Ave., Chicago, Ill.

AVIATION Fans: Send one dollar for beautiful pair sterling silver wings, mounted on bar pins with safety catch, and identification card issued by National Flyers' Association. Thousands being worn by pilots' aviation mechanics, and aero enthusiasts. Wallace Aero Company, Bettendorf, Iowa.

REMANUFACTURED Curtiss OX 90 H.P. airplane motors. Better than new and fully guaranteed and tested. \$225.00 white they last including propeller. Send 2c for our circular. Heath Airplane Company, Chicago, Ill.

FOR snow sleds and airplanes. 28 H.P. motor weighing 135 pounds, New, \$125. Others to 200 H.P. Propellers \$3 to \$25. Used aviators leather coats, mighty warm \$10. Smith Machinery Co., P. O. Box 153, Houston, Texas.

PATENTS: My fee in installments. Free personal advice. Frank T. Fuller, Washington, D. C.

WANTED Ten Men, interested in earning way through flying school. Send 25c for booklet and details. Flying Dept., Box 502, Peoria, Ill.

DICTIONARY of Aviation, \$3.90. Languages Publishing Company, 8 West 40th Street, New York.

BOYS, get a three-foot model aeroplane free. Nothing to sell. Write to Aero Shop, 3050 Hurlbut Ave., Detroit, Mich.

ENGINES for airplanes fully described in "Aeroplane Engines in Theory and Practice" by John B. Bathum. A book used by the government. Includes all makes of engines. For mechanic, builder, and flyer. Send No Money. Just order on a postal. When postman hands you book, pay him \$2.50 and postal charges. Popular Mechanics Press, Room 802, 200 E. Ontario St., Chicago, Ill.

WELDING AND SOLDERING

ALUMINUM Solder—Applied with soldering iron same as soldering brass. Sample 25c. Large bar \$1.00. Modern Machine & Pattern Co., Terre Haute, Ind.

ACETYLENE Brazing and Soldering Torches, \$2.00. Light welding and lead burning torches, \$7.00. Postage prepaid upon receipt of price. Marshall Mfg. Co., Kansas City, Mo.

BOOKS AND PERIODICALS

ELECTRICAL Dictionary—Cloth Binding—20c. 2,400 terms—67 Electrical Diagrams—Compiled by chief-engineer Cooke. Every Electrical man needs this handy vest-pocket dictionary to carry with him on the job. It's a wonder! Electrical Terms fully explained in simple words. Wiring and radio diagrams included. Nearly 200 pages of valuable "dope." Get this little book today—send 20c—two dimes—for your copy. We pay postage. Money refunded if you want it. Chicago Engineering Works, Dept. D-512, 2154 Lawrence Ave., Chicago, Ill.

ELECTRICAL Ideas on all phases of practical electricity are to be found in Popular Mechanics new book, "Electrical Kinks." 47 ideas on wiring, 45 on making electrical devices, 19 on lighting, 5 on transformers, 5 on motors, 8 on generators, 11 on switches, 22 on testing, 12 on repairing, 11 on battery manufacture and repair, 5 on telephones, and 9 on electricians tools, 214 articles, 162 pictures. Send No Money. Just write a postal. Pay postman postage and \$1.50. Popular Mechanics Press, Room 802, 200 E. Ontario St., Chicago, Ill.

STOP "Drifting"! Start now to attain that priceless independence which comes only to the man who has a profitable business of his own. Our "Collection of Business Plans" tells how to build big-paying businesses, many of which require no investment at all. Thousands of dollars could not otherwise secure the information contained in this book. Thousands of dollars may be made by those who heed the advice contained in it. Send no money. When Postman hands you the book, pay \$2.00. L. Randis & Co., Suites 404-405, 200 Broadway, New York.

CLASS, Trade Magazines. List free! Tepp Magazine Agency, Middletown, N. Y.

TRUE-BLUE friends everywhere. Exchange cards, letters, stamps. Movie fans. Leading club—17 years. Hundreds listless, dime. Year, \$1; half, 50c; quarter, 25c. Ed Erlerson, 226, Elroy, Wis.

FREE—Send for my Newthought, Sci-culture, Occult, Mystic and Scientific book literature. Martens Publisher, Burlington, Iowa.

FREE Book, "Elijah Coming Before Christ." Megiddo Department, Rochester, New York.

START a mail order business. Reliable, practical plan 25 cents. A winner. Morris Specialty Co., 2067 Park, St. Louis, Mo.

ART, Tattooing in Ancient and Modern Times. 25c. Catalog Free. Fowkes, 8430 John R., Detroit, Mich.

INDUSTRIAL Alcohol. Wright's book. Full directions for making, fully illustrated. \$2.50. Spon & Chamberlain, 120 P. M. Liberty Street, New York, N. Y.

FINANCING Your Business. Valuable booklet 25 cents. Financial Printing Company, 96 Wall Street, New York.

OUTDOOR Sports. Make a windwagon and convert this into an ice boat. Make a Ski glider. Build your own motor sled, or ice yacht. Make a small electric automobile. 226 articles in this wonderful book, and 317 illustrations. Send No Money. Just write a postal and ask for "Outdoor Sports The Year Round." Pay postage and \$1.50. Popular Mechanics Press, Room 802, 200 E. Ontario St., Chicago, Ill.

ANSWERS to all mathematical problems likely to occur in the office, store, shop, bank, farm, or factory. Explains and simplifies every principle of arithmetic, mechanics and mensuration. Over 2,000,000 sold. Send No Money. Just write a postal and ask for Ropp's Calculator. When the postman hands you the book, pay \$1.00 and the postage. Popular Mechanics Press, 200 E. Ontario St., Room 802, Chicago, Ill.

SHOP NOTES for 1926 now ready. Get your copy from this announcement. Only a limited edition. Contains all the articles published in the Shop Notes department of Popular Mechanics Magazine during 1925. Send No Money. Just write a postal and we'll send 1925 Shop Notes and Auto Tourist's Handbook. Pay the postman 98 cents when he hands you the two books. Popular Mechanics Press, 200 E. Ontario St., Room 802, Chicago, Ill.

PICTURES AND POSTCARDS

FAMOUS Pictures. Reproduced from renowned paintings by World's greatest Artists. 300 full-page half-tone reproductions. Intended for the true pure-minded lover of art. The various pictures, nude, semi-nude, sacred scenes, etc., are printed double-toned tinted ink, making the pictures look most life-like. \$3.00 postpaid. Art Publishing Co., 222 W. Madison St., Chicago, Ill.

EXCHANGE Postcards! Very interesting. Educational. Fascinating. Instructive. Pastime. Membership and List. 10c. Popular Exchange, Windsor, N. C.

75 BEAUTIFUL Art Pictures and Bathing Beauties 25c (coin). Photo Sales Co., 3242 Richter, Suite 400, Detroit, Mich.

PICTURES, Books and Novelties. Particulars Free. Howard Sales Co., Dent. 15, 1188 Folsom St., San Francisco, Calif.

JOIN Live Postcard Club; Membership lists including Catalog, 10c. Harvey Teeple, Decatur, Ind.

ART Photos—1—\$1.00. Ben Meyer, 35 West 31st, New York.

GAMES, ENTERTAINMENTS AND PLAYS

PLAYS, musical comedies and revues, minstrel music, blackface skits, vaudeville acts, monologs, dialogues, recitations, entertainments, musical readings, stage handbooks, make-up goods. Big catalog free. T. S. Denison & Co., 623 So. Wabash, Dent. 11, Chicago.

PLAYS, Minstrel Shows, Musical Comedies. Send for catalogue. Old Tower Press, 59 E. Adams St., Chicago.

VENTRILOQUISM taught almost anyone at home. Small cost. Send 2c stamp today for particulars and proof. George W. Smith, Room 8-52, 125 N. Jefferson Ave., Peoria, Ill.

MYSTIFY your friends and be immensely popular. Ventriloquism made easy by new Scientific Method. Great fun. Send only \$1 for complete professional course. Guaranteed. Whittle Institute Ventriloquism, Bloomfield, N. J.

100 LIGHTNING Chalk Talk Stunts \$2.00. Cartoonist, 2925 Euclid, Kansas City, Mo.

CHALK-TALK your way to popularity. Audiences will be at your feet if you learn how to entertain them with a few simple pictures. Little artistic ability needed. Our book, "How to Chalk Talk" tells what to say and what to draw. Profusely illustrated. Make \$10 and more a night giving these fascinating entertainments. Send No Money. Just order on a postal. When postman hands you the book, pay him \$1.00 and the few cents postage. Popular Mechanics Press, Room 802, 200 East Ontario St., Chicago, Ill.

NOVELTIES, CURIOS, ETC.

ECONOMY Cigarette Making Machine. 40 cigarettes made for ten cents. Rolls and glues cigarettes for future use. Select your own brand of tobacco. Postpaid on receipt of \$2.50. Economy Machine Works, 4816 Kenmore Ave., Chicago, Ill.

FASCINATING Novelties, Books. Big Catalog—3c. Supreme, 3246 Normal, Chicago.

MAGIC TRICKS, BOOKS AND JOKER NOVELTIES

MAGIC—Tricks, Books and Supplies. For Amateurs as well as the great professionals. Anyone can learn through our instructions. Feature Acts in Mind Reading, Spiritualism, Rope Ties, etc. Large illustrated Professional Catalog, 20c. Chicago Magic Co., 110 S. Dearborn St., Dent. B, Chicago, Ill.

MAGIC tricks, book containing many mystifying tricks, 10c. Book of card tricks by celebrated magicians 10c. Book of coin tricks by expert manipulators 10c. Ventriloquism 10c. Hypnotism 10c. Princess Yogi, wonderful card trick, creates sensation, 10c. Geo. Fenner, Louisville, Ky.

FREE Magic Book, 500 Tricks, Puzzles, Jokes and European Novelties. Explains 33 Tricks you can do. Amaze and mystify your friends. Easy to learn. Prices very low. Write today, enclosing 4c postage. Lyle Douglas, Station A, Dallas, Texas.

FREE with \$25 order die box. Send 20c for our large catalogue of tricks, wigs, sensational escapes. Oaks Magical Co., Dent. 518 Oshkosh, Wis.

200 KINDS of Iron, Wood and Wire Mechanical Puzzles. Leader with Illustrated Folders 10c. Western Puzzle Works, St. Paul, Minn.

BOOKS, Magic, Mysteries, Magic Tricks, Novelties, Catalogue Free. Singer, 555 Hancock, Wis.

ILLUSTRATED Magic Catalog 5c. Lynns, 105 Beach, Jersey City, N. J.

SURPRISE your friends with a Novelty Bootleg Cigar. AJM writes "It's a Riot! Everybody that sees it wants one." Sample only 35c. Le and Company, Fruitvale, Calif.

SPIRIT Writing on Arm 25c; Chemical Slate Trick 25c; Sealed Letter Test 25c; Catalogues Free! Lonergan, 431 North Clark, Chicago.

BOOK of Magic, Set Trick Cards, and Illustrated Catalog, 10c. Piedmont Novelty Shop, Box 631, Danville, Va.

CRYSTAL Gazing Globes, Magic, Catalogue for stamp. Waldmann, 1450 First Ave. New York.

MIND-READING Trick cards—Amusing, Mystifying. Set, postpaid 12c. G. Elsea, Bowling Green, Ohio.

WIZARD'S Manual; magic, mindreading, ventriloquism, 25 cents coin. Catalogue. Robert Neater, R. 11, York, Pa.

SEVEN Magical Delusions and Catalogs—25c. Gilmartin, Morgan Park, Ill.

READ sealed messages in the dark. Read messages retained by audience. Make burned messages appear on blank slate. Make spirit messages appear on slate in sitter's presence. Produce spirit rappings. Make spirits appear in the dark. Answer questions written on folded papers while blindfolded. All this you can do if you have the directions contained in our book, "Behind The Scenes With The Mediums." 69 of the best secrets of mediums fully exposed. These are the best because most baffling, and yet all are very easy to do. Send No Money. Just write a postal for this marvelous book. When postman hands you book, pay him \$1.50 and postal charges. Popular Mechanics Press, Room 802, 200 E. Ontario St., Chicago, Ill.

STAMP COLLECTING

BARGAIN Stamp Sets; No two stamps alike in any set. 50 Asia and Africa 11c; 14 Australia 6c; 29 Australia 14c; 100 Austria 10c; 200 Austria 33c; 300 Austria 58c; 50 Bavaria 9c; 100 Bavaria 23c; 7 Borneo 16c; 11 Bosnia 11c; 25 Bosnia 24c; 50 Bosnia 68c; 26 Bulgaria 12c; 50 Bulgaria 42c; 26 Canada 11c; 14 Cuba 9c; 23 Cuba 16c; 50 Czechoslovakia 16c; 80 Czechoslovakia 39c; 100 Czechoslovakia 78c; 11 Costa Rica 11c; 15 Chile 10c; 22 Chile 22c; 5 Congo 16c; 15 China 10c; 5 Crete 11c; 10 Crete 22c; 10 Ceylon 10c; 5 Cyprus 11c; 10 Danzig 6c; 21 Danzig 11c; 50 Danzig 26c; 200 Danzig \$3.15; 6 Estonia 7c; 9 Ecuador 9c; 15 Ecuador 16c; 14 Egypt 11c; 20 Egypt 16c; 9 Epirus 12c; 5 Fiji 16c; 5 Flume 6c; 11 Flume 17c; 3 Gabon 5c; 5 Gabon 10c; 4 Gold Coast 11c; 5 Guinea 5c; 5 German Air Mail 6c; 15 Greece 9c; 25 Greece 16c; 50 Greece 29c; 9 Hayti 15c; 5 Hong Kong 5c; 9 Gwallor 11c; 50 Hungary 10c; 100 Hungary 16c; 9 Hyderabad 11c; 5 Ivory Coast 11c; 15 India States 11c; 19 Italy 5c; 24 Italy 9c; 48 Italy 21c; 23 Japan 6c; 41 Japan 12c; 20 Lichtenstein 11c; 4 Liberia 11c; 5 Madagascar 5c; 8 Malta 11c; 8 Malay 11c; 6 Mozambique 6c; 8 Morocco 13c; 11 Mexico 7c; 19 Mexico 13c; 25 Mexico 16c; 5 Middle Congo 11c; 7 Nyassa 11c; 10 Martinique 16c; 11 Philippines 11c; 14 Portuguese Col. 6c; 26 Port. Col. 12c; 32 Port. Col. 17c; 100 Port. Col. 48c; 200 Port. Col. \$1.35; 30 Poland 11c; 25 Russia 11c; 25 Roumania 10c; 39 Russia 22c; 5 Rhodesia 11c; 10 Serbia 9c; 15 Serbia 16c; 21 Sweden 11c; 26 Switzerland 11c; 25 Spain 5c; 50 Spain 18c; 9 Salvador 10c; 15 Salvador 16c; 5 Senegal 5c; 5 Sudan 10c; 5 Siam 5c; 11 Siam 13c; 9 Travancore 11c; 10 Tunis 9c; 10 Turkey 5c; 23 Turkey 12c; 4 Tozo 6c; 5 Ubangi 11c; 5 Upper Senegal 9c; 10 Upper Silesia 11c; 20 Venezuela 16c; 23 Wurtemberg 10c; 39 Wurtemberg 17c; 500 All different stamps 35c; 1,000 all different 98c; Postage 3c extra all orders. Fine big set pictorial unused White Russia Stamps to Approval Applicants only for 9 cents. C. D. Reimers Company, 411 Flatiron Bldg., Fort Worth, Tex.

WORLDWIDE Packet. Have you a hundred different countries represented in your album. If not here's a packet you want—100 different stamps from 100 different countries. It's Scott Seald Packet No. 329, and only 75c. Also the following, specially selected from the Scott-Seald Packet List of guaranteed genuine, low priced, high value packets. No. 60, 150 all diff., .10; No. 279, 25 diff. Egypt, .30; No. 85, 20 diff. Madagascar, .50; No. 211, Honduras, 40 diff., .50; No. 72, 100 diff. Portuguese Colonies, .50; No. 266 Extra Quality) Austria, Czechoslovakia, Hungary, Italy and Switzerland, 75 diff., .50; No. 202, Wurtemberg, 50 diff., .25; No. 181, Iceland, 20 diff., .35; No. 238, Persia, 60 diff., only \$1.00. The new Scott Free Price List is out with hundreds of packets, set and dime set bargains. Send for it now. Scott Stamp & Coin Co., 1W-47th Street, New York, N. Y.

ARABS! Bandits! Head-Hunters! Egypt (sphinx); Malay (tiger); Benadir (elephant); Tunis (arab); Turkey (sacred mosque); Belgium (showing battle between angel and "old horns"); Congo (head hunter)—All of these mysterious and remarkable stamps are contained in our Famous Phantom Packet—55 fine varieties (to approval applicants only) for eight cents. Nothing like it; order at once! Pacific Stamp Co., Box 138, Helena, Mont. Extra! Send us with your order for the Phantom Packet at 8c, the names of three of your friends who collect stamps; and we will give you, free of charge, a scarce set of 11 diff. Albania—bandit land!—cataloguing over \$1.50. Supply limited; write immediately!

BIG Commission to Agents for the Best approval sheets of stamps ever offered. Write for sample outfit. Pioneer Stamp Album with 500 stamp illustrations, 500 mixed stamps over 40 countries, 500 hinges. All for 25c. Bargain Packets, 100 British Colonies 35c.—100 French Colonies 20c.—100 Portuguese Colonies 40c.—100 New Europe 10c.—50 Asiatic 15c.—50 African 25c.—50 Australian 25c.—500 all different 35c.—1,000 all different 95c. Hussman Stamp Co., Dept. P., 620 Olive St., St. Louis, Mo.

O-O-O-O-H, Boys! What a Thrill! The Fenway "Jungle" Packet!—Contains scarce stamps from jungle and cannibal-land! Included are: Abyssinia, Congo head hunters, Kenya and Uganda, Nyassa camels, Mozambique, Ivory Coast, Upper Volta, Tozo, Ubangi, Tanganyika, Fiji Islands (cannibals) and other savage lands. This wonderful packet from far-away countries to new approval applicants for only ten cents! Fenway Stamp Co., 161 Massachusetts Ave., Boston, Mass.

THE "Magnificarocious" 8c Snap, Snakes Alive! Here's your Liberia Triangle, African Congo, Cape of Good Hope, Abyssinia, Iceland, Hindustan and Collection of over 100 different stamps, including many unused; also Largest Stamp in the World, Jumbo Catalog, Perforation Gauge and Millimetre Scale. Only one packet to each applicant for our "Superstopgobious" Approvals. Collections Bought, Payn Stamp Co., 945 Vista Drive, Los Angeles, Calif.

START a Stamp Collection—70 different stamps from 70 different foreign countries, including Africa, Asia, Australia, Europe, West Indies, etc. Our pamphlet which tells "How to make a collection properly," and price list of albums, packets and sets all for only 16 cents. Queen City Stamp Co., Room 36, 604 Race St., Cincinnati, Ohio.

MYSTIC'S "Mysterious" Packet! Contains stamps from the lands of cannibals, heathens, sun worshipers, and wild savages. Included are Kenya and Uganda, Persia, Africa, Dutch Indies, Gold Coast, Federated Malay States, Eritrea, Nyassa, Travancore, Siam, Congo, etc. This wonderful packet containing 165 all different (mostly unused) for only 8 cents to approval applicants. Mystic Stamp Co., Dept. 8, Camden, New York

STAMP Collectors Outfit only 25c. includes 32-page book "How to Collect Stamps," Album (illustrated), 100 Hinges, 110 different stamps from Comoro, Guinea, Hejaz, Iraq, Sudan, Zanzibar, etc.; also "free stamps" coupon. For new customers only. Harry Ioor, 801 State Life Bldg., Indianapolis, Ind.

ANCHERS \$\$\$ Outfit—only 12c! Fine triangle stamp; set German stamps with (pre-war) value forty million dollars (interesting!); perforation gauge, mme. scale; small album; 2 approval sheets; airmail set; scarce stamp from smallest republic on earth; newspaper set; packet good stamps from Travancore, Johore, Dutch Indies, etc. Entire outfit for 12c to approval applicants! (Nice pocket stock book, value 25c, with every order!) Ancher Stamp Co., 148 1/2 Clerk St., Jersey City, N. J.

OLD Colony Packets—2,000, all different, \$3.00; 1,000 varieties 85c; 500 varieties 30c; 300 varieties 20c; 100 varieties 6c. Our approvals at 50% discount contain many unusual stamps. Imperial albums \$2.00; International Junior albums \$3.50; all albums sent postpaid on receipt of price. Want lists filled from a stock of 40,000 varieties to those sending satisfactory references. Approval Department, Old Colony Stamp Co., 333 Washington St., Boston, Mass.

55 DIFFERENT British Colonies 15c. 50 different Portuguese Colonies 20c. 50 different French Colonies 18c. 100 foreign 3c to approval applicants. Glen R. Knight, Box 3, Sausalito, Calif.

NET Approvals. Premium to new applicants sending reference. Tower Stamp Co., 42 Westville St., Dorchester, Mass.

FREE, 25 Varieties with 50% Approvals. Norman Rivkin, 2910 James St., Minneapolis, Minn.

FREE—3 Abyssinia to Approval Applicants sending 2c postage and reference. F. H. Marsh, 324 Hamilton Ave., Indianapolis, Ind.

TRY my one, two three, and four cent approvals. J. P. Scott, P.O. Box 33, Barrington, R. I.

100 DIFFERENT stamps, including old Canadian, Newfoundland, New Brunswick and foreign; perforation gauge and millimetre scale, 250 hinges, pocket duplicate case, forty-page memorandum book and list of packets, sets, etc. All for 25 cents to approval applicants. Prospect Stamp Co., 185 Annette St., Toronto.

20 DIFFERENT, Turkey 8c. Approvals. Fryrear, 1411 4th Ave., Cedar Rapids, Iowa.

FRENCH Colonies Free—Jungles, Tigers, Native Chiefs, 2c postage. Empire Stamp Company, Toronto, Canada.

500 DIFFERENT only 25c (regular price 50c), many unused, from British, French, Italian and Portuguese Colonies, Chile, Fiume, Guatemala, Persia, Siam, etc., to all approval applicants. Big bargain lists free. Victoria Stamp Co., London, Can.

AIRSTAMP—Canada, Laurentide green Cat. \$9.60, by Turton. Only 35c to applicants for our approvals. We handle only high grade stamps at low prices. Airstamp our specialty. Arthur Barger & Company, Barger Building, Framingham, Mass.

FREE—50 varieties to approval applicants sending 2c. Richard P. Lamprecht, Valparaiso, Ind.

PREMIUM 25 U. S. with Approvals. Postage 3c. Reference Please. St. Elmo Stamp Company, 4814 Claremont Ave., Chicago, Ill.

PORTUGAL—50 varieties 20c postpaid. Big value. Allion, Angola, Indc.

TRIANGLE Stamps! We offer to approval applicants: 100 all different fine stamps from far-off countries: Travancore, Upper Volta, Tchad, Madagascar, Malay, etc. Also three triangle stamps, including scarce Liberia—all for 7c. Order Now! C. D. Reimers Co., Flatiron Bldg., Fort Worth, Tex.

BEST one cent approvals in America. F. P. Hand, 1117 So. 60th St., Philadelphia, Pa.

WRITE for approvals, enclosing 36c, and receive packet of stamps cataloguing over \$10.00. Cedric W. Lemon, Delaware, Ohio.

STAMP Album Free; spaces for 1,200 stamps, with purchase of 100 different Unused stamps for 25 cents. B. Nagle, 1101 Marion, Reading, Pa.

109 DIFFERENT Including set "War Prisoners," Bulgaria and Turkey Picture Stamps, 10 cents. Sonnee Stamp Company, 675 Ivy, St. Paul, Minn.

HONORBILT Packets. List free. C. W. Ritchie, Watertown, So. Dak.

"EXHIBITION" "War Prisoners," "Airmail," "Pictures," "Eagles," "Charity"; six sets unused, different countries, five French, five British, five Portuguese Colonies. Packet Dutch Indies, 100 different foreign, 15c to approval applicants. Deering, 38 Fairmount, Marlborough, Mass.

FREE Unused Set—14 varieties, to applicants, 1c approvals—Postage, 2c. Elmer, 15 School Street, Boston.

BAVARIA—50 Different 10c. Browne, 90 Kemper St., Wollaston, Mass.

UNITED STATES Stamps. Complete stock priced reasonable. Selections sent. Price Lists Free. 500 General, 100 British Colonies, 100 Fr.-Port. Colonies, 100 Poland, 100 United States, 50 Greece, 25c each. Midwest Stamp Co., 720 Delaware St., Kansas City, Mo.

MAGNICAROCIOUS Packet Foreign Stamps, Beauties from Distant Lands, Many Richly Colored unusual designs, free for 2c. Gray Stamp Company, Toronto, Can.

100 STAMPS to approval applicants. Postage, Bedell, Branchville, N. J.

FREE, 25 different stamps to purchasers, 25 unused for 10c, and approval applicants enclosing reference. Emery, 590 Northcliffe Blvd., Toronto, Can.

COVERTCO Packet, 250 varieties unused and used stamps 15 cents. Covert Stamp, 39 State, Rochester, N. Y.

1,000 DIFFERENT 90c. Setlist free. Approvals against references. A. Goetz, 7 West 42nd St., New York.

FREE Premium with Approvals. Net prices. Reference, 150 different U. S. 50c. Clarkson, Ridgewood, N. J.

ELEPHANT Tusk Hunters, Cannibals, sugar gatherers, famous bicolored Mozambique picture set (10 beautiful stamps), only 3c to approval applicants. 1,000 Hinges 10c; 1,000 different foreign \$1. Big Album 75c. Sunflower Stamp Co., Hutchinson, Kans.

16 VAR. Armenian pictorials, cat. \$1.04, only 16c to approval applicants. Flower City Stamp Co., St. Thomas, Ontario.

6 HAITI 7c; 7 Lithuania Airstop 32c; 16 Armenia 16c; 6 Mozambique Free. Fred Jackson, Montara, Calif.

FREE—Ten "Buck" Bill (Polish) and 100 Stamps to approval applicants sending postage. Tell your friends. Pettet Co., 690 So. Boulevard, Atlanta, Ga.

UNITED STATES, 100 different 20c. Tausig, 2701 Ave. J, Brooklyn.

\$1.00 WORTH of Stamps for 3c. Hull, 14 West 101st, New York.

FINEST one-cent approvals. Boehm, 413 No. Church St., Allentown, Pa.

100 BRITISH Colonies 30c. 100 Portuguese Colonies 35c. 100 Central Americans 40c. 100 all different 15c. 25 Bosnia 25c. Advance Stamp Co., 26 E. 23rd St., New York, N. Y.

LIBERIA, Triangular Snakes, 5 varieties complete 30c. 1923 Commemoratives, 5 varieties complete 25c. Ireland, 10 different 12c. Armenia Pictorials, 16 varieties 18c. Send for bargain lists. Miller Company, Chatham, N. Y.

50 VAR. Scandinavians 10c. Gronberg, Box 341, Philadelphia, Pa.

FREE—15 all different Chile to approval applicants giving reference. F. L. Miller, 1009 S. Salina, Syracuse, N. Y.

FIFTY different Canada and United States fifteen cents. Good, clean stamps. Canada Stamp Company, Toronto, Canada, Station F.

200—200—200—200 ALL different stamps; 200 hinges; approval sheets to hold 200 stamps; perforation gauge, millimeter scale and ruler; duplicate stamp container—all for only 15c to approval applicants. Edgewood Stamp Company, Milford, Conn.

110 NEW Europe All Different, a wonderful collection cataloging several dollars, free to collectors requesting our Net Approvals. Postage 2 cents. Badger Stamp Co., Milwaukee, Wis.

STAMPS, 100 varieties, Africa, Brazil, Peru, Cuba, Mexico, etc., 10c, 50 different U. S. 25c; 1,000 mixed, 40c; 1,000 hinges, 10c. List free. C. Stegman, 5948 Cote Brillante, St. Louis, Mo.

FREE! 12 scarce Azerbaijan to approval applicants. Pennsylvania Stamp Co., Manor, Pa.

STAMPS 1c each. Cheapest and Best. 50¢ Free for 5c postage. C. H. Hollister, Mukwonago, Wis.

100 DIFFERENT South and Central American 45c; 200, \$1.10; 300, \$2.50; 500, \$4.50. Fred Onken, 630 79th Street, Brooklyn.

50 DIFF. stamps for Approval Applicants sending 2c postage. Rubin Hoffman, 405 Pennsylvania Ave., Brooklyn, N. Y.

STAMPS on approval 1/4c up. Free premium. References required. Herbert Keigwin, Middletown, N. Y.

AIRMAIL—29 different—15c. F. Buffham, Lake Ave., Racine, Wis.

500 MIXED U. S. and Foreign stamps 12c. R. H. Carlton, 380 W. So. Tennie, Salt Lake, Utah.

CURIOSITY Packet, 104 unused in blocks 12c. Big 20-page list, set Air Mails Free. Rueger, 31 Cambridge, Dayton, Ohio.

1,000 MIXED U. S. and Foreign Stamps 25c. Phil. Lundsted, Cape Cottage, Maine.

STAMPS Free—Ask for money-saving approvals. John P. Borresen, Cedar Falls, Ia.

ZAMBESIA, Zanzibar, Abyssinia, Herzegovina, Travancore stamps, menagerie collection, album, 10c. Liberty, 3974 Arsenal, St. Louis, Mo.

200 DIFFERENT stamps, set triangles, set animal stamps, other sets, U. S. Packet, blank approval book, 40 pages stamp bargains, \$6.00 value for only 25c to applicants. 1,000 Hinges, 9c; 100 U. S., 25c; 500 diff., 45c. Hawkeye Stamp Co., Cedar Rapids, 39, Iowa.

24 VARIETIES Cuban stamps, 10 cents. List of 6,000 low-priced stamps free. Address Chambers Stamp Co., 111P, Nassau St., New York City, N. Y.

STAMPS, 100 all different. Postage 2c. Lists free. P. M. Quaker Stamp Co., Toledo, Ohio.

110 DIFFERENT Stamps, many unused, high values, free to collectors requesting our Net Approvals. Postage 2 cents. Christensen, Milwaukee, Wis.

PACKET of 23 stamps, no two countries alike. Packet hinges. Set of \$1 and \$2 U. S. Rev., all for 5c. P. M. Miami Stamp Co., Toledo, Ohio.

FREE. "Liberty" packet to approval applicants sending 2 cent stamp. P. Earl Stamp Co., 1811 26th Av. North, Minneapolis, Minn.

25 PRECANCELS—and copy "Badger's Precancel Partner." 4c to approval applicants. Badger's Partner, Brookville, Fla.

FREE! Loose Leaf Postage Stamp Album at rate of 8 pages each month given with subscription to monthly Journal. Send 2c stamp for prospectus. United Stamp Co., Marquette Bldg., Chicago, Ill.

20 UNUSED stamps free. All different. Postage, 2c. P. M. Fisk Stamp Co., Toledo, Ohio.

FOREIGN Stamp Collection Sent Free. Cornish Co., Schenectady, N. Y.

FREE, Hungary Charity No. 565 to 567 and a surprise packet given to those requesting for my 1, 2 and 3c approvals and also my 50% discount and better. Chas. W. Schmidt, 3227 Benner St., Wisconsin, Philadelphia, Pa.

STAMPS sent on approval at 70% discount. Reference required. Emory Renoll, Hanover, Pa.

105 CHINA, etc., 2c. Album (500 illustrations) 3c. Bullard, Sta. A, Boston.

RARE COINS

GET Profit and Pleasure in collecting Old Coins. Send 10c for Sample Old Coin, together with my Large Illustrated Coin Catalogue. You'll be delighted with it. Send for it right now. B. Max Mehl, Professional Numismatist, Mehl Bldg., Dept. P, Fort Worth, Texas. Largest Rare Coin Firm in U. S.

CALIFORNIA gold, \$1/4 size, 27c; \$1/2 size, 53c; three-cent-piece and catalogue, 10c. Norman Shultz, Colorado Springs, Colo.

\$2 TO \$500 Each Paid for hundreds of Old or Odd Coins. Keep All Old Money. It may be very valuable. Send 10 cents for Illustrated Coin Value Book, 4x6. Get Posted. Guaranteed Prices. We Buy and Sell. Clarke Coin Office, LeRoy, N. Y.

50,000 GERMAN mark 5c. List free. American Exchange, 102 Poncejoy, Iowa.

UNITED STATES White cent and bargain Price List 10c. Aray, Box 483, Muskogee, Okla.

UNITED STATES, Large Cent, two-cent bronze, three-cent nickel and Bargain List, 25c. Fifteen dates large cents, \$1.00, George Coffin, Greenwood Mountain, Me.

SELL by mail European Bonds, Money, Foreign Coins. Profitable Business. Literature free. Giant beginner's outfit \$1.00. Hirschex, 70 Wall St., New York.

CALIFORNIA gold Quarter 27c. Half 52c; Confederate \$1.00, 20c; \$1.00, 10c; Washington token 20c. A. Welle, Wheaton, Ill.

5 DIFFERENT foreign coins 10c. 44 different \$1.00. Otto Oudehohn, Independence, Mo.

CALIFORNIA Gold 1/4 27c; 1/2 53c. 100,000 German Mark 10c; Nickel 3c and 2c 15; Wild Cat Bill and Price Lists 6c; 10 Foreign Copper Coins and German Scrip 25c. Al. E. Bousall, Richmond, Ind.

40 OLD coins, all different \$1.00. Alabama Half-Dollar, Uncirculated, \$1.00. Monroe Half-Dollar Uncirculated, \$1.00. List free. Claud Denney, Box 315, Dallas, Texas.

100 WAR coins 15c, 40 different coins 50c, 25 different 30c, 10 Confederate bills 35c, Revolutionary War bills 1776 30c, 10 Civil War cents 60c, 5 Roman coins 1500 years old 50c. Retail catalogue free. Naay, 8P South 18th, Philadelphia.

OLD Coins, Large Spring Selling catalogue of coins for sale free. Catalogue quoting prices paid for coins, ten cents. William Hesslein, 101A Tremont Street, Boston, Mass.

COIN and stamp dealers write for our dealers' list on foreign currencies and bonds. 50,000,000,000 mark note 15c; 10,000 Austrian kronen 35c; 1,000,000 mark treasury coupon bond 50c. Arrow C. Service, 1748 North Park Ave., Chicago.

FOR BOYS

BOYS! Look! Movie Machines for the family sell as low as \$7.00. We carry Westerns and Comedy Films only. Write now for free catalogue on Machines and Films. Globe Supply Co., P. O. Box 2722, Dent, Mass., Boston, Mass.

AUTOMOBILE—Make your own motor car, toy size, operated with motorcycle engine. Any boy can make it. Costs little aside from engine. Full directions with drawings and dimensions in the Boy Mechanic, Book 3. Send No Money, just write a postal. Pay postman postage and \$2. Popular Mechanics Press, Room 802, 200 E. Ontario St., Chicago, Ill.

BOYS! "25 Money-Making Plans" only quarter. Postpaid. Wisbey, Walton, Nebr.

25 EASY Money-Making Plans. Quarter. Press Studios, Walton, Nebr.

CARD tricks that will mystify any audience. Wrap pack in newspaper. Let someone insert knife dividing pack, you tell audience card above knife and card below, before pack is examined. Let spectator tear a secretly chosen card. Pieces of torn card placed in box which he keeps. Unprepared egg is broken open and card is found restored inside egg except for one corner which is in box. These and 50 other marvelous card effects fully explained in "Modern Card Effects." Send No Money. Just write a postal. Pay postman \$1.50 and postage when he delivers book. Popular Mechanics Press, Room 802, 200 East Ontario St., Chicago, Ill.

ESCAPE from any rope tie and mystify your friends. You can easily make \$10 a night giving escape entertainments in Churches, Clubs and country schools. The book, "33 Rope Ties and Chain Releases" tells how to conduct an entire entertainment. It tells how to escape when someone plays a trick on you and ties you more securely than you expected. Tells how to escape from the famous mummy tie in which you are bound from head to foot with 75 feet of strong rope. No knife or other instrument is needed. Send No Money. Just write a postal and ask for "Rope Ties." When the postman hands you this wonder book, pay 98 cents and the postage. Popular Mechanics Press, 200 E. Ontario St., Room 802, Chicago, Ill.

CAMERAS AND PHOTO SUPPLIES

KODAK Films—Special trial offer; your next kodak film developed, 5c—prints, 2c each. Moser & Son, 1917 St. James Ave., Cincinnati.

SIX Translucent Skyline pictures of Dallas. Wonderful Joint Metropolis of Northwest 35c. Kodak Roll and Six highest class glossy pictures finished 25c. Reprints 3c. Finest Kodak Finishers, Art Studio, Dallas, Tex.

SEND us your Films. We develop, print, enlarge. Careful attention to details that make superior quality pictures. Rolls developed 9c, prints 3c each; trial 8x10 enlargement in folder 40c. Wellington Photo Services, Riverdale, Md.

PICTORIAL Photo Service, 918 Melrose Avenue, New York. Films developed, printed; roll 35c. Enlargements 8x10, framed \$1.00. Send negatives. Special Department: 1,000 Cards printed, private or business, \$3.25.

PHOTOGRAPHIC equipment and accessories of every description are listed and illustrated in our 228-page catalogue. It will pay you to secure a copy which is issued free, as our prices are low. We also deal in used goods which are sold under the same guarantee as new goods. Ask for our Bargain Book. Central Camera Co., Dept. E-102, 112 S. Wabash Ave., Chicago, Ill.

MODERN Photography in all its branches now taught by mail. New Successful Method. Students earning \$300.00 while learning. Big opportunity. Write for particulars and unusual offer open for short time. Dept. 3431, International Studios, Inc., 3691 Michigan Ave., Chicago.

HAVE You a Camera? Write for Free sample of our big magazine, showing how to make better pictures and earn money. American Photography, 116 Camera House, Boston, 17, Mass.

FILMS Developed. Special Trial Offer. Any Size Kodak film developed 5c, prints 3c each. Trial 6x10 Enlargement in handsome folder 40c. Overnight Service. Roanoke Photo Finishing Co., 209 Bell Ave., Roanoke, Va.

UNEXCELLED Gloss Prints. Trial Offer. Your Kodak Film Developed and printed only 10c. F R B Photographers, Dept. "C," 1503 Lincoln Ave., Cincinnati, Ohio.

PRIZE-WINNING pictures, and how to make them. Learn how to put the final touch on your photographs that makes them stand out above others. Complete instructions for all features of successful photography fully treated in "Practical Amateur Photography," a 245-page illustrated book. Send No Money. Just order on a postal. When postman hands you book, pay him \$2 and the postal charges. Popular Mechanics Press, Room 802, 200 East Ontario St., Chicago, Ill.

MOTION PICTURES

SEND 10c for the latest and greatest Bass Book of Cinema Apparatus; gives full description of all types of instruments as well as the list price. Or, send \$3.00 for a 500-page Cinema Hand Book containing full instructions of the making and taking of films. Bass Camera Company, 105 N. Dearborn St., Chicago, Ill.

FILM—Million Feet for Sale. Cowboy—Drama—Comedy and Feature Specials. Mix—Hart—Chaplin and best Movie Stars. \$3.00 per reel up. Genuine List Free. We Supply the World. Dept. G, Monarch Films, Memphis, Tenn.

\$35.00 PROFIT nightly. Small capital starts you. No experience needed. Our machines are used and endorsed by government institutions. Catalog free. Atlas Moving Picture Company, 482 Morton Bldg., Chicago.

MOVIE films, 1,000 ft. reels. Complete stories, \$2.50 each; shipped anywhere on receipt of remittance with order. Independent Films, 177 Golden Gate Ave., San Francisco, Calif.

FILMS of every kind and character. Comedies—Westerns—Andy Gump Cartoons—Educational and Special Feature Subjects. Rock Bottom Prices. Wonderful Guaranteed List Free. Dixie Film Co., P. O. Box 407, Memphis, Tenn.

NEW and Rebuilt Machines for Big Theatres—Schools—Churches—Traveling Shows. Also Films—Supplies and Complete Theatre Equipments. Bargain List Free. Monarch Theatre Supply Co., Dept. P, Memphis, Tenn.

MAKE money writing photoplays; details free to beginners. No correspondence course. Producers League, 230 Wainwright, St. Louis.

MOVIE Films 1c Ft. 150 \$1. Reels \$3. Send Stamp for List. X. Sales Company, Box 1506, New Haven, Conn.

STILL Alarm, six reels, two prints. Plenty advertising. Price \$100. Rector Advertising service, Marshall, Ill.

FILMS 16 foot. Searles, 130 Fisk St., Providence, R. I.

\$\$\$ FOR Photoplay Ideas. Let us help you market your story. Write for particulars. Universal Scenario Corporation, 206 Security Bldg., Western and Santa Monica Blvd., Hollywood, Calif.

MOVING Pictures 1,000 feet only \$3.00; send cash with order. No lists. La Vere Film Exchange, 806 So. Wabash Ave., Chicago, Ill.

MOVIE Films Price List free. Donald Elder, 589 Broadway, Chelsea, Mass.

NEW \$150 Spring-Operated Movie Camera, standard size, finest lens; leather case, \$39. New Home Projector, 1,000 foot reels—\$35. New \$225 motor driven Projector \$85. Films, 5 reel Dramas \$10. Comedy \$5. Ray, 296 5th Avenue, New York.

BOYS, brand new movie films showing football games. Sample free. Rector Advertising Service, Marshall, Ill.

MACHINES, Films, Supplies, Bargain lists. National Equipment Company, Duluth, Minn.

SCENERY TO RENT

SETTINGS for Opera, Plays, Minstrels. Plush drops. Address Amelia Grain, Philadelphia.

ARTISTIC Scenery for amateurs. Sale or rent. Easy to hang. Low cost. Enkeboll Studios, Omaha, Nebr.

EDUCATIONAL AND INSTRUCTION

YOU can have a business profession of your own and earn big income in service fees. A new system of foot correction; readily learned by anyone at home in a few weeks. Easy terms for training; openings everywhere with all the trade you can attend to. No capital required or goods to buy, no agency or soliciting. Address Stephenson Laboratory, 1 Back Bay, Boston, Mass.

ARTIFICIAL Marble sanitary flooring instructions, ornamental casting, concrete, plaster, papier-mache decorations, garden furniture, statuary. Rubber-moulds. 18 years' instructing the public, particulars and 200 illustrations free. Chris Mahler, Huntington, N. Y.

BE a Handwriting Expert. A practical course by John S. Oglesby, Dallas, Texas, Examiner of Disputed Writing. Also photographs of writing, finger prints.

USED Books and Educational matter. Bargain prices. Bulletin free. Write. Instruction Correspondence Exchange, 1968 Broadway, New York.

SHOARD Writers, Decorators, Artists—Mixing proportions 500 beautiful (oil, water) colors. Nontechnical. Prepaid immediately \$1.00. Art Book Publishers, 2035-37 College, Indianapolis, Ind.

SHORTHAND in 30 days; written with ABC's; sample lesson free. Dickinson, 321-A Broadway, New York City.

LOOK! Improve your handwriting! Instructions 25c (silver). Prince, 130 W. 104th, New York.

BILLIARD Players masse and draw shots—Learn to master these in a few minutes—Sample Ivoire 25c. Ivoire Co., 4530, Blaisdell Ave., Minneapolis, Minn.

SHALL I Study Drafting? My pamphlet tells you. Price 25c. Robert W. Sheinre, 1417 Bordeaux St., New Orleans.

CAN You Add? Substantial award for correctly adding dividends of 310 companies. List free. Kerr & Co., Monadnock Building, San Francisco, Calif.

REAL ESTATE in All Its Branches. Complete course taught by mail. Booklet free. Penn Realty School, 1131 S. 19th St., Philadelphia, Pa.

BE Successful. Course in Scientific Thinking and Psychology \$2. R. E. Lee, Box 191, Highland Park Station, Los Angeles, Calif.

LEARN bricklaying in School run by 600 building contractors. No apprenticeship or age limit. Good demand for our graduates. Qualifies you to work anywhere. Associated Building Employers, 400 A. B. E. Building, Grand Rapids, Mich.

ELECTRICITY Made Simple; 233 pages, 108 illustrations, cloth. Reduced \$1.25. Ask catalog for home study. F. & R. Co., Hoboken, N. J., Dept. F.

BECOME Patent Lawyer. Full particulars. Patent Law, 301 Hennepin Ave., Minneapolis, Minn.

MARR'S Practical Bookkeeping or Simplified Shorthand, 25c. B605, Nashville, Tenn.

WORLD-ROMIC System, Masterkey 5,000 languages. Primers \$1.98. Chinese, French, Spanish—Languages, 8 West 40th, New York.

USED educational matter of all kinds. Sold on repurchase basis. Big saving. Money-back guarantee. List free. (Courses bought.) Lee Mountain, Pisgah, Ala.

USED educational matter bought, sold, exchanged. Handling, 799 Broadway, New York.

USED educational matter. Lowest prices; terms. Catalog free. Mention Subject. Economy Educator, 440-A Sansome, San Francisco.

DOUBLE Entry Bookkeeping mastered in 60 hours with 8 keys; guaranteed; diplomas. International Bookkeeping Institute, Dent, S. Springfield, Mo.

SHORTHAND in four evenings. Arthol course seven dollars. Sent approval. Particulars. Hollefreund's College, Stratford, Ontario, Canada.

OUTDOOR Opportunities for everyone. Complete instructions for raising and selling rabbits, guinea pigs, milch goats, silver foxes, ferrets, white rats, white mice, dogs, cats, pigeons, pheasants, bantams, canaries, bees, frogs, mushrooms, ginseng, and Golden Seal. These are all profitable and can be raised on a town lot. The same book gives instructions for all. Send No Money. Simply write a postal and say: "Send me Outdoor Opportunities." When postman hands you this illustrated book, pay him \$1.50 and the postal charges. Popular Mechanics Press, Room 802, 200 Ontario St., Chicago, Ill.

RADIO OUTFITS AND SUPPLIES

JOIN Radio University. Free. This department in Radio World, first illustrated weekly, solves your radio troubles. See current issue and join free. Many booklets, other great features. 15c copy. Newsdealers. Special: 50c for trial subscription 4 issues, or \$1 nine issues. Radio World, 145 W. 45th St., New York.

LONG distance radio \$2.95. Lambert's newest crystal success. No tubes. No batteries. No grief. Always ready. Works 600 miles. Fully guaranteed. We pay postage. Order direct from this add. Leon Lambert, Wichita, Kans.

DON'T buy tubes! You can build a crystal set for less than \$1 that will receive distant stations. Complete plans, with lifesize drawings, \$1. Particulars and picture of my set free. Amos Carr, 1507 West 58th Street, Chicago.

BY selling five beautiful five-tube radio frequency receiving sets, the first man in each community receives one set absolutely free of charge. Write today for full particulars. E. W. Parker, Putnam St., Peabody, Mass.

ATWATER Kent, Crosley Receivers—Speakers, Bargains. Write Simms, Lake, New York.

SAVE 50%. 5 Tube coast to coast Radio complete ready to listen in. \$62.50; send today for particulars. Ridgway Radio Co., 1620 Lister Ave., Kansas City, Mo.

BUILD your own radio. Complete set of plans 50c. Bottum Bros., Tulare, S. Dak.

2,650 MILES Distance with one tube. Any novice understands our simplified instructions. 25c. Big Booklet Free. Vesco Radio Co., Oakland, Calif.

CROSLY Musicone Loudspeakers \$12.00 list \$14.75. Crosley Receiving Sets at greatly reduced prices. J. Mold, 27 Chestnut St., Schenectady, N. Y.

FOR Sale: 5 tube Radios with accessories \$90. Herbert Clefsch, Garber, Iowa.

TRADE AND TECHNICAL SCHOOLS

LEARN Photo-Retouching. One of the most profitable fields of commercial art. Positions always open. Earnings \$50 to \$100 a week. We offer a thoroughly practical and easily mastered course of twenty-five lessons. No special ability required. Write at once for full particulars. School of Commercial Illustrating, 581 Century Bldg., Indianapolis, Ind.

LEARN bricklaying in School run by 600 building contractors. No apprenticeship or age limit. Good demand for our graduates. Qualifies you to work anywhere. Associated Building Employers, 400 A. B. E. Building, Grand Rapids, Mich.

DO you want \$12 to \$20 per day? Learn now Sign Painting—Decorating Paper Hanging—Auto Painting. Show Card Writing. Catalog Free. Chicago Painting School, 148 W. Austin Ave., Chicago.

DOUBLE your earning power. You can quickly become a foreman under my training. I teach you to read blue prints and take charge of work. Trained men are in demand. Write today—tell me your trade—I will show you how to succeed. Carroll Rumsey, 167 Drexel Building, Philadelphia.

TELEGRAPHY—Both Morse and Wireless—taught thoroughly and quickly. Tremendous demand. Big salaries. Wonderful opportunities. Expenses low; chance to earn part. School established fifty years. Catalog free. Dodge's Institute, Fern St., Valparaiso, Ind.

BUSINESS OPPORTUNITIES

PATENTS. Time counts in applying for patents. Don't risk delay in protecting your ideas. Send sketch or model for instructions or write for Free book, "How to Obtain a Patent" and "Record of Invention" form. No charge for information on how to proceed. Communications strictly confidential. Prompt, careful, efficient service. Clarence A. O'Brien, Registered Patent Attorney, 58D Security Bank Building (directly across street from Patent Office), Washington, D. C. See pages 140 and 141.

ENGAGE in proven, profitable Soldering Contract Business dealing with Ice Mfg. Plants, Dairies and Packers. Patented Process and equipment with special solder, chemical, license and instructions complete. Royalty basis. Small cash payment required. Callender Soldering Process Co., 2529 West 48th St., Chicago.

501 WAYS to make money. Free circular. B. French, 1903 E. Chase, Baltimore, Md.

START tiny factory, grow big. No competition. Or sell Mexican confections (candied fruits). Or make money by giving addresses. Hansen, Spartado 62, Nogales, Sonora, Mex.

CEMENT Masons, Plasterers, Contractors. Build successful business, stuccoing old and new buildings with Everlastone Indestructible Stucco; also installing Corkstone Floors over worn-out flooring. Write immediately for agency proposition. Everlastone Products Corporation, 828 W. Pratt St., Baltimore, Md.

INCREASE your income! The "Gateway To Independence" shows how. Particulars free. J. Englund, Box 267A, Ontonagon, Mich.

RUN a Profitable Mail Order Business in Your Spare Time. Sample and Particulars 25c. Satisfaction Guaranteed. United Specialty Co., Smithboro, N. Y.

GO into business for yourself. Make your own products. Formulas, toilet articles, perfumes, extracts. 500% Profit. Big Catalog Free. National Scientific Laboratories, 1920W Broad, Richmond, Va.

MAKE \$10 A Day cleaning clocks without taking apart. Copyrighted instruction \$1. Deselms Watch School, Longansport, Ind.

WANT More Money? Start Little Mail Order Business. Samples and Plan Free. Mailing Charges 10c. Snyder 10748 112th St., Richmond Hill, N. Y.

MAKE Money, silvering mirrors, refinishing auto headlights, tableware; metal plating, bedsteads, chandeliers. Outfits furnished. International Laboratories, Dept. 71, 309 Fifth Ave., New York.

BUILD splendid business making chipped glass number and name plates, signs, check-boards. Write for particulars. Simplex Utility Co., 1133 Broadway, New York.

LEARN Successful Mechanical business. Full instructions 10c. Schultz, Noel, Mo.

\$50 WEEKLY up made by men, women, giving lessons in popular subject; home, office, all (spare) time. Short, easy preparation. Instructions free. Dickinson, 321-M Broadway, New York.

SELL Copyrighted Business Plans by Mail. Enormous Profits, Particulars Free. Jerold Hinds, Monticello, Ill.

SHERIDAN'S Directory. Supply source and lowest wholesale prices on 250,000 articles. Biggest and best buyers' guide, \$1.00. Circulars free. S. Van Auken, 31 Righton Ave., Detroit, Mich.

CLEARANCE Sale on Mail Order merchandise. Price list for stamp. Field, 246 Fifth Avenue, New York.

START Home Mail Order Business. Circular Free. Neuroh, Box 249, Meadville, Pa.

EARN \$40 weekly at home silvering mirrors. Formula \$1. P. J. Brady, Aberdeen, S. Dak.

\$50 A WEEK. Mail Order Business. Free Booklet Tells How. Sample and Plans 25c. Free—\$3 worth of articles. E. B. Meadow, Box 1509-B, Lakeland, Fla.

YOUR own business. Mail or local. Spare full time. Many Opportunities. Details free. Walter Anderson, Dept. A, Villa Park, Ill.

QUICK Profit, Honest, Guaranteed workable Mail Order Plans and complete instructions including detailed working specifications of plans that have made fortunes. Written by a fully competent and reliable authority under bond. Mail Order Service, Box 93, Omaha, Nebr.

ONLY \$2.00 for 100,000 mark German coupon bond, for 100,000 kronen Austrian gov. coupon bond. Dealers wanted. Write for wholesale list. Arrow Sales, 1748 North Park Ave., Chicago.

BE the Boss Yourself. Have others working for you. Unlimited possibilities. Valuable information. Write quick. Regal Service, 305-J 43rd, Kansas City, Mo.

ARE you old at forty? See our advertisement on page 175 of this issue. The Electro Thermal Company, 2137 Main St., Steubenville, Ohio.

PUBLISH a magazine for \$2.50. Sample, particulars, 25c. Cope, 253P, Champaign, Ill.

FREE Copy. Greatest Money-Making Magazine Published. Subscription 25c per year. 3 months 10c. Make Money Pub. Co., 1043 Washington, Boston, Mass.

MIRRORS Re-Silvered at Home. Costs Less 5 cents per square foot; you charge 75 cents. Immense profits, plating auto-parts, reflectors, tableware, stoves. Refinishing metalware, etc. Outfits furnished. Write for information. Sprinkle, Plater 127, Marion, Ind.

25 WORD ad in "Make Money Magazine" six months, \$1.00. 10 word ad one month 10c. Free copies. Make Money Publishing Co., 1043 Washington, Boston, Mass.

20,000 MARK German Government Bonds only one dollar; remit money order. Julius Lowitz, 312 S. Clark, Chicago, Ill. Established thirty-one years.

DON'T Look for a Job, Make One. Selected Opportunities. 50c Tells How. Sharples, Souris, Manitoba.

SUCCEED With Your Own Products—Make them yourself. Formulas, Processes, Trade-Secrets. Modern master methods. Catalog free. B. Thaxly Co., Washington, D. C.

GUARANTEED profits, \$10 to \$25 weekly. I start you in a spare-time Mail Order Business furnishing everything. Write for particulars, Lee, 145 East 23rd St., New York.

MECHANICS, carpenters, painters, start furniture refinishing and handyman shop on nearly nothing; winning plan brings customers quickly. John Braceland, 1439 So. Ninth, Philadelphia, Pa.

ONE Inch Display Ad, 355 rural weeklies, \$45.00. Admeyer, 4112D Hartford, St. Louis.

GOOD Money easily earned at home spare time Silvering Mirrors, Glass Embossing, Chipping, Frosting, Gold Leafing, etc. Paterson & Co., Brooksville, Ky.

SCHEMER Magazine, Alliance, Ohio, 28th year, prints big profit Schemes, Ideas, Formulas. Subscriber made \$25,000; another \$10,000. Try your luck. Year \$1.00; three months, 30c. None free.

MANUFACTURER of useful Specialties wishes to give manufacturing secrets to party looking for good selling Specialties. Sample, particulars, 25c. Presto Manufacturing, 7 Fairmount, East, M. Trent.

EARN Big Money with Merrygoround, Ferris Wheels, Novelty Riding Devices, Everywhere. "MooreMade" LaPeer, Mich.

\$5 TO \$15 daily to introduce New Style Guaranteed Hosiery for men, women, children. No capital or experience required. Premium offer to every new customer. Pay You Daily. You simply write orders. We deliver and collect. Samples furnished. 57 styles, 40 colors. Macehee Textile Company, Card 2582, Cincinnati, Ohio.

GO in the Mail-Order Business; Start a Beauty Parlor, or a Child Shop. Others are achieving independence. You can too. Full particulars free. Scott Service, 3319 Forrest Bldg., Philadelphia.

SIGNS and Showcards Easily painted with Letter Patterns. Large variety of Styles and Sizes. Sample for stamp. John Rahn, 2120 Neva Ave., Chicago.

500% PROFIT and Up. Make and sell your own goods. Formulas, toilet articles, perfumes, extracts. Big catalog free. National Scientific Laboratories, 1920W Broad, Richmond, Va.

EARN \$12.00 Daily—Start your own Business; Repaint, Redecorate Homes, Automobiles; Retrim, Clean Cars. Easily Learned at Home. Modern trade instructions sent upon approval. Pay when satisfied. DeWilde, Sheboygan, Wis.

ELECTRICAL manufacturing business at home. Particulars One Dollar. Millar, Station C, Atlanta, Ga.

668 WAYS to Make Money—2,716 formulas "Encyclopedia Business Opportunities." 3 volumes, \$1. Ideal Book Shop, (EBO), Park Ridge, Ill.

\$50 A WEEK. Mail Order business. Booklet tells how. Sample and plan 25c. Complete outfit free. Omaska Sales Service, Box A623, Omaha, Nebr.

100 MONEY Making Opportunities. Particulars Free. Julius Wandor, Wyandotte, Mich.

60 MILES on 1 Gallon. Wonderful Scientific Gas Saver. All autos. 1 free. demonstrator. Critchlow, Q-124, Wheaton, Ill.

MAKE These Big-selling Specialties Yourself! Free Interesting Literature explains how others will sell your goods. Chemist's Lists Guaranteed Reliable Money-making Formulas. All lines. No "Master Formula" Junk. Miller, Chemist, 1706-H Jetton, Tampa, Fla.

PATENTS Procured; Trade Marks Registered—A comprehensive, experienced, prompt service for the protection and development of your ideas. Preliminary advice gladly furnished without charge. Booklet of information and form for disclosing idea free on request. Richard B. Owen, 30-Owen Bldg., Washington, D. C., or 41-R Park Row, New York.

MAIL Order News contains latest money-making schemes, opportunities and suggestions showing big profits. Complete instructions how to start profitable Mail Order Business of your own. Everything explained. Sample copy of this big magazine 25c. None Free. Established 23 years. Mail Order News, 360 Bristol Bldg., New York.

MAKE big money. Safe and Lock Expert. Wayne Strong, 3706 1/2 Lan Franco St., Los Angeles, Calif.

MAKE \$20 per 100, Stamping names on Keychecks. Send 25c for sample and instructions. J. Keytag Co., Cohoes, N. Y.

ENTER a new business. Earn \$3,000 to \$8,000 yearly in professional fees making and fitting a foot specialty, openings everywhere, with all the trade you can attend to; easily learned by anyone at home in a few weeks, at small expense; no further capital required, no goods to buy, job hunting, soliciting or agency. Address Stephenson Laboratory, (1) Back Bay, Boston, Mass.

MAIL Order Business is your opportunity. Breniser's Famous Handbooks teach how to start small, grow big. Sell merchandise, service, ideas; enormous profits. Spare time to begin. Get complete set, 11 books, \$3.00, and be posted. Breniser, 335 Walnut, Philadelphia. Descriptive Catalog and big batch interesting mail order information, 25c. None free.

\$3,000 TO \$6,000 Yearly. Want it? Others are making it. Send check or money order today for our invaluable books "How to Sell Real Estate," \$3.00—and "How to Conduct Real Estate and Insurance Business," \$1.50. Absolute satisfaction guaranteed. Free circulars. Realty Book Co., Dept. 52, Cleveland, Ohio.

UNPATENTED Ideas Can Be Sold. I tell you how and help you make the sale. Free particulars (Copyrighted). Write W. T. Greene, 810 Jenifer Building, Washington, D. C.

INVENTORS—Write for our Guide Book, "How to Get Your Patent" and Evidence of Invention Blank. Send model or sketch of your invention for our free Examination and Instructions. Randolph & Co., Dept. 435, Washington, D. C.

EARN \$10 daily silvering mirrors, plating and refinishing metalware, autos, chandeliers, bedsteads, headlights. Outfits furnished. E. DeCle Laboratories, 1133 Broadway, New York.

WE Start You in Business, furnishing everything; men and women, \$30.00 to \$100.00 weekly operating our "New System Specialty Candy Factories" anywhere. Opportunity lifetime; booklet free. W. Hillier Ragsdale, Drawer 4, East Orange, N. J.

ATTENTION! You can have a business of your own. Establish and operate New System Real Estate Business, brokerage and insurance agency in your community. Office at home. Earn \$5,000 year. Representatives wanted everywhere. Send stamp free booklet. Hayes Realty Association, Cincinnati, Ohio.

RESPONSIBLE manufacturer wants competent men to manage office and salesmen. \$300 to \$1,500 necessary; will allow expenses to Trenton if you qualify. Address Manager, 536 Forst Richey Bldg., Trenton, N. J.

MARBLE mixing instructions, covering wood or cement flooring 1/2 in. thick, fire-proof, waterproof, low cost, sanitary, all colors. Particulars, 200 illustrations free. Chris. Mahler, Box 122, Huntington, N. Y.

COST \$5.00, your profit \$104.75. Transferring Decalcomania letters on autos, trunks, bags etc. Send today for outfit or free samples. World Monogram, Dept. 73, Newark, N. J.

I MADE \$30 a Week Home. French Breadmaking. 15 years' experience; Free Booklet tells. Ashbrook 67, Marengo, Ohio.

GET Money in Your Mail. "Lambert's Mail Order Secrets" contains successful methods never before published. \$1.00 postpaid. Particulars free. Leon Lambert, Wichita, Kans.

LEARN the collection business. Good income, quick results. Interesting booklet, "Skillful Collecting" free. National Collectors Assn., Long St., Newark, Ohio.

MAKE toys and novelties at home. Big profits. Instructions and illustrations, 25c. Astrolite Company, Sharpsburg, Pa.

CHEMICAL Expert will furnish Formulas and Trade Secrets. All lines, Lists Free. W. L. Cummings, Ph. D., 228 Gordon Ave., Syracuse, N. Y.

PATENTBOOK, 139 mechanical movements and illustrations, sent free. Labinere, 3 Parkrow, New York.

BATTERY Shop Equipment and Supplies at Wholesale. Adams-Barr, Columbus, Ohio.

CORN Poppers—Money makers. Lowest priced small machines. Northsides Co., 1306 Fifth, Des Moines, Iowa.

START Your Business, Home Evenings. 24 Money-making Plans, 10c. De Luxe Chemical Service, Drawer D, Park Ridge, Ill.

START Candy Kitchen—Big Money. \$15.00 Course \$1.00. De Luxe Candy Shop, "Drawer D," Park Ridge, Ill.

COMPANIES organized. Financing. Write, Box 8-209, 311 Fifth Avenue, New York.

MAIL Order Booklet, where to buy Books, Novelties, Specialties, 10c. Harvey Teeple, Decatur, Ind.

66 MILES on 1 Gallon. Wonderful Scientific Gas Saver. All autos. 1 free. demonstrator. Critchlow, R-124, Wheaton, Ill.

TELEGRAPHY

TELEGRAPHY—Both Morse and Wireless—taught thoroughly and quickly. Tremendous demand. Big salaries. Wonderful opportunities. Expenses low; chance to earn part. School established fifty years. Catalog free. Dodge's Institute, H St., Valparaiso, Ind.

WANTED—BUSINESSES FOR SALE

IF You Want to Sell Your Business for Cash quickly and privately, we take the prospective buyer directly to you at our expense, no matter where located. We specialize in selling out-of-town businesses. If your business is worth \$5,000 or more, write us. The Mutual Security System, 68 W. Washington St., Chicago.

CHEMISTRY

CHEMICAL Technical Engineering Problems Solved. Analysis processes furnished. Five Dollars. Ferguson and Timpson, Spring Valley, N. Y.

YOUR chemical problem solved and working process furnished Five Dollars. Write me. W. Stedman Richards, Consulting Chemist, address, Box 2402, Boston, Mass.

TECHNICAL information, analysis, formulas, trade secrets. Jacob Sluyter, Chemist, 313 East Second St., Davenport, Iowa.

EXPERIMENTERS laboratory apparatus. Chemicals, Radio. Catalog 5c. Chemical Apparatus Co., 4402 West End, Chicago.

FORMULAS AND TRADE SECRETS

MILLER, "Formula King," 526 Main, Norfolk, Virginia, supplies any formula.

MAKE and Sell Never Freeze Radiator Solution. Costs few cents gallon. Formula \$1.00. Homer Dunn, 2125 Summer Street, Waco, Texas.

CONCRETE Waterproofing Processes, making Hard, Light Colored, Dampproof concrete building blocks. Concrete Machine Co., 5 Main St., St. Louis, Mo.

3,000,000 FORMULAS, 1,016 pages, \$1.98. 500 Formulas Free if you order quick. Ideal Book Shop, Drawer "D," Park Ridge, Ill.

500 FORMULAS—Including Resilvering Mirrors, Luminous Paint—Renewing Dry Batteries—Mechanics' Soap—Gas Tonic—25c. Catalog Free. Ideal Book Shop, Drawer "D," Park Ridge, Ill.

SUCCEED With Your Own Products— Make them yourself. Formulas, Processes, Trade-Secrets. Modern master methods. Catalog free. B. Thaxly Co., Washington, D. C.

750 GOOD formulas 35c. 200 10c. Rodgers Company, 843 Locust, Cincinnati.

SAWDUST and Chemicals makes Sanitary flooring. Directions \$1.00. Universal Supply Co., Auburn, N. Y.

500% PROFIT and Up. In business for yourself. Make your own products. Formulas, toilet articles, perfumes, extracts. Experience unnecessary. Big Catalog Free. National Scientific Laboratories, 1920W Broad, Richmond, Va.

FORMULAS, Best Chemical Science can devise. Stamp brings big bunch valuable literature describing Guaranteed Reliable Processes for manufacturing all lines. Don't buy till you've seen these valuable lists. 28 years supplying the Best. Miller, Chemist, 1706-F Jetton, Tampa, Fla.

RESILVERING Mirrors—100 Money-making Formulas 20c. Catalog free with order. De Luxe Chemical Service, Drawer D, Park Ridge, Ill.

FORMULAS; Beverages, Syrups, extracts, flavors and other manufacturing specialties. Free information. The Formula Co., 1613 Queen Anne Ave., Seattle, Wash.

WONDERFUL money-making formulas 25c. No Stamps. Mazza, VanBuren, Ark.

3,000 VALUABLE Formulas and Recipes, for \$1.00. E. Kephart, Box 34, Station Y, New York City.

500 VALUABLE Formulas, 25c. Circular Free. Harvey Teeple, Decatur, Ind.

15,000 FORMULAS in "Scientific American Cyclopedia of Formulas." Includes following and many others: accidents and emergencies, agriculture, alloys and amalgams, artist's materials, beverages, cements, glues, pastes, mullages, bleaching, renovating, coloring metals, dyeing, glass, heat treatment of metals, household formulas, ice cream, confectionery, chewing gum, lapidary work, exterminating vermin, lubricants, paints, varnishes, photography, condiments, canning formulas, rubber, soap, candles, soldering, toilet preparations, perfumes, waterproofing, fireproofing, writing materials. Send No Money. Just write a postal. When postman hands you book, pay \$5.50 and postal charges. Popular Mechanics Press, Room 802, 200 East Ontario St., Chicago, Ill.

10,000 FORMULAS. A real Gold Mine of money-making ideas. Tells how to make almost everything under the sun. You can make and sell cosmetics, mullage, anti-freeze solutions, battery solutions, beverages, cheese, chewing gum, cleaning preparations, extracts, hair preparations, inks, blueing, leather polish, mirrors, perfumes, polishes, typewriter ribbons, carbon paper, washing powders, liquid soap, and hundreds of other profitable articles. Send No Money. Just write a postal for "Henley's 20th Century Book of Formulas." Pay postman postage and \$4. Popular Mechanics Press, 200 E. Ontario St., Room 802, Chicago, Ill.

AGENTS WANTED

NO Dull Times in the Food Business. Selling Federal Pure Food Products is the greatest, surest and safest business in the world today, and here is your opportunity to get into it. You can make \$3,000, \$5,000, \$10,000, or more per year—the only limit is your ability to take care of the business. You will need no experience or money to get into this business. Your \$20.00 starting order sent on trust. We teach you everything you need to know. We furnish you with license. No Dull Times, for the People Must Eat, and our food products are the fastest selling, surest and quickest repeat order goods in the world. Sell on sight in every home where food is used—repeat orders immediately and every week thereafter. A real big business all your own. Every new customer adds a great deal to your weekly income. Your business once established, has a market value just like a store and can be easily sold. The greatest money-making opportunity of your lifetime because you risk absolutely nothing, as we guarantee your sales, and we will not let you fail. Remember! Guaranteed! Best products, biggest sellers, surest repeat orders. No capital or experience is required. We furnish capital and everything necessary for you to become a Federal Distributor. Exclusive territory will be given honest men or women who write at once, Federal Pure Food Company, 2309 Archer Avenue, Dept. A, Chicago, Ill. Largest packers of Pure Food specialties in the world. Reference, any bank, Dun or Bradstreet rating agency, Express or Railway Company in America.

DISTRICT Agents—For Union Made pure wool suits and topcoats retailing at \$23.50, none higher. A remarkable line of 45 beautiful fabrics tailored by a large and well known old established firm, sold only thru our own stores and district agents. A real opportunity for any good man. Big money to start and chance for advancement. We furnish large sales outfit, 9x13 cloth samples. Men over 30 years of age with tailoring or clothing experience preferred. Can use ambitious spare time men in smaller towns. Interested only in serious men who seek a future. Write for free sample and full information. Address: M. T. Harvey, Mur., Box 90, Chicago.

AGENTS: I'll send you complete line Jennings Guaranteed Hosiery. Every style, for every member of the family. Written guarantee with each pair, the kind that must wear or new hose free. Our Silk Hosiery can't be beat. Highest quality. Low priced. Sell 8 to 12 pairs day. Often that many in one family. Repeat business every month will make you \$45 week. Even spare time workers, many in small towns, make \$12 to \$18 week. Try it for 30 days. You can't lose. Send for samples today. Jennings Co., Dept. 231, Dayton, Ohio.

\$8.50 TO \$20.00 daily easy. Introducing New Insured Hosiery for men, women, children. 57 styles, 40 colors. Must wear or replaced free. Repeat orders sure. Nyland made \$395 one month. Edwards, \$460.60. Mrs. Bone, \$445.25. Why not you? Even spare time work should pay you \$3 per hour. Your Pay Daily in Advance. We deliver and collect. You spend all your time writing orders. No experience or capital needed. We furnish samples. All grades, colors including silks. No matter what you are now selling. It will pay you to get our offer. Macoshee Textile Company, Card 2562, Cincinnati, Ohio.

AGENTS: \$11.80 daily in advance (Send for sworn proof) Introducing New Insured Hosiery. 57 styles, 40 colors, guaranteed seven months. No capital or experience required. You simply take orders. We deliver and collect (or you can deliver, suit yourself). Credit given. Pay You Daily, monthly bonus besides. Spring line now ready. We furnish samples. Spare time will do. M. H. Mathews, Card 5862, Cincinnati, Ohio.

FREE Sample—"Rain Shield Wiper" Retail \$1.00—cost 25c. Just invented. No Cloth—No Paste—No Attachment. Sold Clear and Rainy Days—(1) Rub keeps windshield clear 24 hours. Automobileists buy quickly. Riley made \$198—three days. Experience Unnecessary. Wonderful Side-Line. Nulife Corporation, Hartford, Conn.

SUCCEED With Your Own Products— Make them yourself. Formulas, Processes, Trade-Secrets. Modern master methods. Catalog free. B. Thaxly Co., Washington, D. C.

THE Paying Business Today Is Selling oils and paints direct to consumer. We put you in this business. Todd Oil & Paint Co., Cleveland, Ohio.

FURNITURE refinishing, polishing, painting, handyman shop; wonderful profits; start yours on nearly nothing. John Braceland, 1457 So. Ninth, Philadelphia, Pa.

WORLD'S Largest Neckwear Manufacturer wants Agents. Remarkable opportunity. Immediate commissions 32½%. Advance styles, complete line. Greatest values. Beacon, 1483 Beaconwear Bldg., Boston, Mass.

THE simplest and best Oil Burner on the market for cook stoves and ranges. Retail at fifteen dollars. Samples sent to agents for five dollars. Rockport Mfg. Co., Rockport, Ind.

MEN'S Neckwear. New Spring patterns. Sample dozen \$3.00 C.O.D. Quick selling, extra wearing line of Work Pants. Samples and particulars free. Continental Mefac-tille, 51-R, Allen Street, New York.

AGENTS' Protector—Book every agent should have. Particulars Stamp. "Moore-Made," LaPeer, Mich.

MAKE big money selling Roadside Soap. Sample 25c. Particulars free. Write today. Farrington-Messenger, Stillwater, N. Y.

AGENTS. Mail dealers, write for sample 74-page jewelry catalogue. Address James Northern & Co., Harmon, La.

AGENTS: It's a winner. Combined cigarette and match case. 100 per cent profit. Write for particulars. All-In-One, 1931 Park Avenue, Minneapolis, Minn.

AGENTS—Mescro Corn and Callous Remover will build you a steady repeat business. Send today for pocket-size trial outfit. The Moss Co., 265 Searle Bldg., Rochester, N. Y.

AGENTS Wanted—Something new—Fyr-Fyter sells easily. Makes a spectacular demonstration; car owners, homes, factories, stores, practically buy on sight. Our men make \$10 to \$50 a day. Exclusive territory to producers. If you wish to establish a business of your own with unlimited possibilities for making big money, write us today. Fyr-Fyter Co., 998 Fyr-Fyter Bldg., Dayton, Ohio.

IF You Are Looking for a Money-Making Proposition, I have it; particulars 2 cents. W. P. Stamp, Hemet, Calif.

AGENTS. Big profits. Best and cheapest window letters made. Easily applied. Dime brings five samples. Particulars free. Stahlrite Co., 1115 Second Ave., New York.

MAKE \$3.00 an hour taking orders for Pie Crimpers, Egg Boilers, Wonder Wrenches, Knife Sharpeners, Polishing Cloths and 40 other wonderful sellers. New selling plan with free premiums brings astonishing cash profits daily. Agent's Outfit Free. Write quick. General Products Co., Dept. 7J, Newark, N. J.

EASY to Earn \$10 Daily selling our Seven-in-One Vest Pocket Wonder-Tool for Radio, Automobile, Electrical or Home use. Sells on sight. 25c. your profit 150%. Write today. Sample 15c. G.M.Z. Company, 309 Sixth Avenue, New York.

WE pay \$200 Monthly Salary, furnish car and expenses to introduce our guaranteed poultry and stock powders, cleaner, etc. Bigler Company, X 368, Springfield, Ill.

SELL Dry Goods Remnants. Wonderful bargains in dress lengths. Fine silks, woolsens, etc. Agents wanted. Dealers supplied. Remnant Store, 1707 Race Street, Cincinnati, Ohio.

AGENTS—Best seller; Jem Rubber Repair for tires and tubes; superseded vulcanization at a saving of over 800 per cent; out it on cold. It vulcanizes itself in two minutes, and is guaranteed to last the life of the tire or tube; sells to every auto owner and accessory dealer. For particulars how to make big money and free sample, address Amazon Rubber Co., Philadelphia, Pa., Dept. 595.

AGENT'S Opportunity. Hawkins complete line Toilet and Household preparations. Highest quality. Lowest prices. Every woman buys. Colonial Chemical Company, 711 Penn Avenue, Pittsburgh, Pa.

\$20 DAILY Selling Ver-I-Ezy Men's Shoes direct. Sell relatives, friends, neighbors first. Low priced. Give real comfort, long service. You take orders, keep big commission. We ship and collect. Full or part time. Write Now. Easy-wear Shoe Company, Dept. 229, Indianapolis, Ind.

NEW camera takes and finishes photos in one minute. Make money selling cameras or taking photos. Exclusive territory. Crown Co., Dept. 931, Norwalk, Conn.

HERE'S The Line That Satisfies—You'll sell yourself on first sight. New Rubber Specialties for every purpose. Over fifty fast sellers needed in every home; honest goods that we guarantee and the profits are large enough to give you a steady income and make you stick the year round. Write Dept. 805, B. & G. Rubber Co., Pittsburgh, Pa.

\$100 A WEEK Line. If you can't make your present line pay you more than \$35—\$40 a week, don't blame yourself! Chances are you're as good a salesman as those who earn \$100 a week taking orders for Carlton Stylish Dresses—prize-winners from New York and Paris. Investigate this opportunity quick. No charge or deposit for Sample Outfit. Carlton, Inc., 337 S. Franklin St., Dept. 453-A, Chicago.

\$100 WEEKLY — Pleasant Work; Apportioning local agents to introduce Mother Hubbard Foods; no canvassing; no delivering; no money invested. Mother Hubbard, 558 Congress, Chicago.

DIRECT factory representative to sell changeable letter signs to merchants. Excellent opportunity. Good income assured right men. Address, Maze Manufacturing Co., Norwood Station, Chicago.

SALESMEN: Write your name and address on a card and mail to us. We'll show you sure earnings of \$20.00 a day. Will you risk one minute and a one-cent stamp against \$20.00? Mind you, we say we'll show you. Address Sales Manager, Dept. 754, 850 West Adams Street, Chicago.

500% PROFIT and Up—in business for yourself. Make your own products. Formulas, toilet articles, perfumes, extracts. Experience unnecessary. Big Catalog Free. National Scientific Laboratories, 1920W Broad, Richmond, Va.

\$50,000. **PICTURE Man Friedman** made canvassing. Beginners can make \$100.00 weekly with my sales talk. Experienced men make more. Free book "Profits in Portraits" explains. Samples Free. Picture Man Friedman, Dept. 8-D, 541 W. Lake, Chicago.

AGENTS. Salesmen—Sell New Thermo-static Automatic Carburetor Control Attachment for Fords. Big profit, full or part time. Burns 95% air. Doubles Mileage. Attached in 2 minutes. No drilling. Does automatically exactly what Ford manual says do by hand. Cadillac now using Thermo-static Carburetor Control under Blanche license. Write today. A. C. Blanche & Co., Dent, 805BX, 602 Lake St., Chicago.

IF We Give You shoes made-to-your measure in any one 60 leathers, 50 different styles, will you keep them, wear them, show them to your friends as sample of our \$10 Made-To-Order shoes to sell at \$6.85? Advise us today. Your complete outfit will go forward absolutely free at once. Dept. 2000, Tailor-Made Shoe System, 932 Wrightwood, Chicago.

AGENTS—Three big lines hosiery, silk underwear, men's shirts. Liberal commissions. Send for free illustrated catalogs. Helix Co., 213ta Fourth Ave., New York.

AWAY Ahead of Every Thing Else! That's "Zippo" as a seller. Show your sample, talk a minute and pocket your profit. A real Sure-Fire, He-Man Money-Getter that repeats—and say, Boy, it actually sells on a ten second Show-Down. If we didn't know we had a proposition that any man could sell eight out of every ten calls, you can bet your sweet life we wouldn't spend money telling you about it. Karam-Smith, 602 F Street, Ft. Wayne, Ind.

AGENTS—\$90 a Week—\$2 to \$5 an hour spare time. Make this with the celebrated line of Ho-Ro-Co Soaps, perfumes, toilet articles and specialties; over 200 items. Big profit makers. La-Em-Strait Hair Dressing selling like hot cakes. Write for Free Sample Case offer. Ho-Ro-Co Mfg. Co., 782 Ho-Ro-Co Bldg., St. Louis, Mo.

AGENTS: \$100 week. No experience; genuine gold leaf sign letters and script. Consolidated Co., 638 S. Dearborn, Chicago.

AGENTS—\$14.50 Daily Easy—Your Pay Daily. Monthly bonus besides. Introducing Chieftain Guaranteed Shirts 3 for \$4.95. No experience or capital needed. Just write orders. We deliver and collect. Full working outfit free. Cincinnati Shirt Company, Secy. 1582, Cincinnati, Ohio.

FREE—Get This Quick! Chicago's Wonder Shirt line. Sell newest, stylish, snappy, Stylenor Shirts. Amazing values at low prices. Make \$100.00 weekly easy. Complete assortment of large swatches makes selling Stylenor Shirts a cinch. Experience or capital unnecessary. Be your own boss. We will show you how to build a big business of your own. We will deliver and collect. Exclusive territory open. Write today, for big free outfit. Stylenor, 81 W. Van Buren, Chicago, Ill. Dept. 1001.

AGENTS: Big money selling Great household necessities; sample 25c. Webster Co., 522 Wrightwood Ave., Chicago, Ill.

500% PROFIT and Up. Make and sell your own goods. Formulas, toilet articles, perfumes, extracts. Big catalog free. National Scientific Laboratories, 1920W Broad, Richmond, Va.

AGENTS—Big money, Handiest and Best Clothes Line Holders. Send for Sample 20c. H. & B. Mfg. & Supply Co., 1014 Raspberry St., Erie, Pa.

MAKE big money selling Eureka Patching Paste. Patches fabric and rubber. Eureka Cement Co., 208 E. 53rd St., Chicago, Ill.

65 MILES on 1 Gallon. Wonderful Scientific Gas Saver. All autos. 1 free, demonstrator. Critchlow, T-124, Wheaton, Ill.

DISTRICT Salesman: Must be reliable. Prefer married man, 30 years old or over and permanent resident in his community. Exceptional opportunity for good man. Address Sales Manager, 814 West Adams Street, Dept. 152, Chicago.

MIRRORS Re-Silvered at Home. Costs Less 5 cents per square foot; you charge 75 cents. Immense profits, plating autoparts, reflectors, tableware, stoves. Refinishing metalware, etc. Outfits furnished. Write for information. Sprinkle, Plater 128, Marion, Ind.

\$110 WEEKLY selling finest guaranteed union made to measure men's suits only \$12.50, boys' two-pants suits \$10.95. Six Latest Patterns that sell on sight. Also all-wool overcoats, vests, caps, riding breeches. Big commissions advanced. Free attractive outfit. Double Service Manufacturers, 1327-35 AF Washington, Chicago.

START in a permanent business of your own selling guaranteed Hosiery and Underwear worn all over the world. No capital or experience needed; many representatives make \$3,000 to \$5,000 per year. Become our district manager—get others working for you. Write for details to Malloch Knitting Mills, 562 Grant St., Grand Rapids, Mich.

TAILORING Salesmen: Our guaranteed \$23.50 and \$31.50 tailored to order suits are \$10 to \$20 dollars cheaper than store prices; commission in advance; monthly bonus; protected territory; beautiful assortment 6x9 swatches free. Our national advertising campaign makes selling easy—big repeat business. DeLonge's record \$343 in one week. In one state alone 47 men average \$57.18 weekly. J. B. Simpson, Dept. 1182, 843 Adams, Chicago.

BRING Home the Bacon—selling Stuart's famous Food Flavors. Quick sellers. Big profits. Write for free sample and terms. C. H. Stuart & Co., 6367 Main, Newark, New York.

CREATE Mail order or Local Business. New simple plan gets money. Easily, Quickly, Steadily. Particulars Free. Edw. Burke, 733 Nineteen, Oakland, Calif.

IMPORTED—Patented—5-color pencil, writes red, blue, black, green, indelible; sells on sight; everyone a prospect; no competition. Sample \$1.50. Square Deal Co., P-236 West 5th St., New York.

AGENTS: New Selling Plan! \$1.25 premium free to every customer on a \$2.00 sale, consisting of 8-oz. Vanilla, 6-oz. Shampoo, 4-oz. Lemon Lotion. A big hit everywhere. Complete details free. Territory going fast. Write today. The C. I. Togstad Company, Dept. 18-B, 29 South Clinton St., Chicago, Ill.

NUVALU Long Filled Sumatra Wrapper Cigars produce more money with less effort for salesmen. Biggest value, fastest selling cigar on the market. Write at once for details. The Nuvalu Cigar Co., Dept. 3, Daston, O.

WE pay \$48 a week, furnish auto and expenses to introduce our Soap and Washing Powder. Buss-Beach Company, Dept. A42, Chippewa Falls, Wis.

I PAY you \$60 a Week. Take orders every day for our famous shirts—lowest factory prices—biggest commission—complete sample outfit absolutely free. Write quick. Fashion Wear Shirt Co., Dept. B-941, Cincinnati, Ohio.

\$2.00 AN Hour for pleasant introductory work among local families. Pay starts immediately. Write American Products Company, 5782 American Bldg., Cincinnati, Ohio.

MOST Wonderful Seller. 96c Profit every dollar. No stock to carry. License unnecessary. Sample free. Mission Factory PM, 519 No. Halsted, Chicago, Ill.

EVERYBODY uses Extracts. Sell Duo Double Strength Extracts. Complete line of household necessities. Big repeaters. Write today. Duo Co., Dept. E-1, Attica, N. Y.

GIVE Away Best laundry soap Free. You'll make \$10 daily easy by new selling plan. Big repeat business. Write quick. Wolverine Soap Co., 28 Wolverine Bldg., Grand Rapids, Mich.

SELL Fine Made-to-Order All Wool Suits at \$31.50. Regular \$55 Values. Over 100 6x9 Cloth Samples. All One Price. Furnished. Hustlers Earn \$100 Weekly. Write W. Z. Gibson, Inc., 161 W. Harrison St., Dept. P-517, Chicago, Ill.

AGENTS: Free, large wholesale specialty catalogue, showing best sellers from all parts of the world. Write quick, no obligations. Spors Co., Lesueur Center, Minn.

AGENTS, \$14.85 daily in advance. Send for sworn proof. Introduce finest line guaranteed hosiery you ever saw. 106 styles and colors. Beats store prices. Best selling plan known. Auto furnished. Spare time satisfactory. No capital or experience necessary. Samples furnished. Wilkint Hosiery Co., Dept. 2078, Greenfield, Ohio.

AGENTS: \$65 to \$100 a week. High grade all wool suits made to measure. \$25 and \$30. Biggest commission in advance. Money-back guarantee. Free sample outfit. Write C. G. Ferrin, Mgr., Box 1997, Chicago.

WONDERFUL! Starting! Amazing! Our Ex-Cel Luminous Crucifix and Magical (Luminous) Necklace shine brilliantly in the dark. Sell on first demonstration. Big profits to you. Write for further particulars, or better still, send for sample and territory protection immediately. Crucifix \$1.50, Necklace \$1.00, postpaid. W. G. Hannan Co., Dept. B, 2539 So. State St., Chicago.

500% PROFIT and Up—in business for yourself. Make your own products. Formulas, toilet articles, perfumes, extracts. Experience unnecessary. Big Catalog Free. National Scientific Laboratories, 1920W Broad, Richmond, Va.

\$100 To \$150 Weekly. Wonder-Automatic Washer. Patented. Does large family washing spotlessly clean in 30 minutes. Creates its own power. Will last a lifetime. Sells for \$7.50. Unusually large commissions. Eureka Supply Co., Dept. 6, Sedalia, Mo.

WE'LL make a classy suit for well-dressed man over 25 who will wear and show to friends and help us introduce. Write for order blanks, etc. Chicago Tailors Ass'n, Dept 729, Sta. C, Chicago.

AGENTS: Sell suits on new plan; 9 weeks to pay—commission in advance—we collect payments. \$30 sample suit free to agent. Send postal to American Woolen Mills, Dept. 7009, Chicago.

AGENTS—90c an hour to advertise and distribute samples to consumer. Write quick for territory and particulars. American Products Co., 5781 American Bldg., Cincinnati, Ohio.

BLICE Flame Burner. Cooking and heating. Tested two years. Territory going. Wise salesmen Tri-Won. F. E. Bennett, Room 600, 17 N. LaSalle St., Chicago, Ill.

BUILD splendid business making chloped glass number and name plates, signs, check-boards. Write for particulars. Simplex Utility Co., 1133 Broadway, New York.

MAKE Money. Silvering mirrors, refinishing auto headlights, tableware; metal plating, bedsteads, chandeliers. Outfits furnished. International Laboratories, Dept. 71, 309 Fifth Ave., New York.

\$1,000.00 MONTHLY nothing unusual with my system. K. Home, 3949 Metropolitan, Chicago.

AGENTS—Why peddle? I made \$800 monthly; no soliciting, no goods to buy. Why not you? Details free. R. McNown, 303 Wilkinson, Omaha, Nebr.

AGENTS, both sexes, we manufacture and control new household article. Fast seller. Big profits. Exclusive territory. Write now. Connolly, 123 Liberty St., New York.

NO More Glare; night driving safe. No more dimmers; plain glass best. New device, better lights. Agents wanted. W. R. Reynolds, Madison, S. Dak.

AUTOMOBILE Specialties. Guaranteed formulas for all latest money makers. Lowest prices. Write for free lists. Murnby, Chemist, Tulunga, Calif.

AGENTS—Comb cleaners, self-threading needles and other good sellers to housewives get the money. Particulars, L. Miller, Box 3, Tremont Station, New York.

"MAKE and Sell Your Own Goods." Guaranteed Formulas. Catalog Free. Clover Laboratories, Park Ridge, Ill.

FREE Booklet Tells how to make big money in your home community. 42-year-old firm. New selling plan. 175 products. Credit given. Auto to hustlers. Write for best proposition in ten years. Anole Company, 105 First St., Tippecanoe City, Ohio.

WONDERFUL invention. Eliminates phonograph needles. Preserves records. Abolishes scratching. 14,000,000 prospects. \$20 daily. Supply in pocket. Sample on approval if requested. Everplay, Desk B-2, McClurg Bldg., Chicago.

AGENTS! Make \$30.00 weekly. Distribute quality food and toilet preparations among friends and neighbors. No money or experience necessary. Free automobile. Desk AK2. Healtho Products Co., Cincinnati, Ohio.

RARE Opportunity. Men and Women make enormous profits. Articles cost 5c sell quickly for \$1.00. Make \$15 to \$30 daily. Particulars Free. Baggs, 3239 Archer, Chicago, Ill.

AGENTS—Big profits selling Veripure Vegetable Soap for Toilet, Bath, Etc. Write for Territory. Veripure Laboratories, Box 999, Chicago.

AGENTS—Our newly assembled 1926 Spring line of silks, dress goods, wash goods, curtain materials and drapery fabrics is larger and more complete than ever. No investment or experience required. Collect liberal commission in cash as you go along. Write for details. International Home Fabrics Co., 235 Fourth Avenue, New York.

REPLATE brassy worn-off Automobile parts, Reflectors, Bath Room Fixtures, Worn Spoons, Forks, etc., with pure silver. Looks like new. Use U-Kan-Plate Polish. Positively no mercury. \$1.00 half pints postpaid. Satisfaction Guaranteed. Agents wanted. Dept. A, U-Kan-Plate Co., Philadelphia.

300% PROFIT—Quick Seller—Fast repeater. Sample Free. Bestever Products Co., 1941-PM Irving Park, Chicago.

NEW useful articles. Big repeats. Handsome profits. Kleiner Specialty Co., 141 New St., Newark, N. J.

AN Unusual Opportunity—Earn \$75.00 weekly and bonus taking orders for Nustile guaranteed hosiery. Sample outfit furnished. Full or spare time. Write now. The Nustile Company, Dept. 1-2, Philadelphia, Pa.

PATENTS. Time counts in applying for patents. Don't risk delay in protecting your ideas. Send sketch or model for instructions or write for Free book "How to Obtain a Patent" and Record of Invention" form. No charge for information on how to proceed. Communications strictly confidential. Prompt, careful, efficient service. Clarence A. O'Brien, Registered Patent Attorney, 58D Security Bank Building (directly across street from Patent Office), Washington, D. C. See pages 140 and 141.

ARE You Old at Forty? See our advertisement on page 175 of this issue. The Electro Thermal Company, 2137 Main Street, Steubenville, Ohio.

GET posted—Good prices paid for butterflies, insects. See Sinclair display advertisement, page 18.

GENERAL Distributors, Agents, Salesmen—Send for our live wire proposition and sample. Exclusive territory to workers. See our display ad on page 154. Wallace Rin Tool Mfg. Co.

42 YEAR old House wants representatives. Big pay by hour or day selling our line of 175 home necessities, big future business. Auto furnished hustlers. Credit given; Expense unnecessary. Amole Co., Dent. 19, Tippecanoe City, Ind.

EARN \$10,000—be financially independent—with fastest selling auto devices on market. Mashken, Indiana Harbor, Ind.

AGENTS—30% commission. Full line glove silk lingerie and guaranteed hosiery, mill to wearer; lowest prices. Get particulars. Wright Hosiery Mills, Philadelphia, Pa.

AGENTS wanted—Men and Women to sell our vanilla extract, 100% profit. Every housewife buys! Central Extract Co., Dent. V. Far Rockaway, N. Y.

AGENTS—49% profit every 50c sale; amazing; \$6.00 worth free. Hardy, Freeman Building, Atlantic City, N. J.

AGENTS wanted to Mail Circulars. Fast Selling Goods. New Methods. Big Profits. Particulars Free. Precise Service. Waterville, Me.

SHOW Us the Housekeeper Who Likes to clean stair corners. Ideal Dust Shields keep corners clean. Agents wanted. Ideal Stairway Equipment Co., Canton, Ohio.

500% PROFIT and Up. Make and sell your own goods. Formulas, toilet articles, perfumes, extracts. Big catalog free. National Scientific Laboratories, 1920W Broad, Richmond, Va.

TEN Million Customers eager for new 50c household necessity. Cash in big with exclusive virgin territory. Write today. Manufacturers Consolidated Co., Dent. 102, Grand Rapids, Mich.

MARVELOUS New Invention 400% Profit. Liquid Quick Mend for hosiery and fabrics. Tremendous demand. Over hundred other fast sellers. Local and General Agents. J. E. Johnson Co., Dept. 438, 69 E. South Water St., Chicago.

AGENTS—Make a dollar an hour. Sell new kind of sharpeners. Sharpens all knives and tools quickly. Demonstrating sample free. Premier Mfg. Company, Dent. 52, Detroit, Mich.

66 MILES on 1 Gallon. Wonderful Scientific Gas Saver. All autos. 1 free demonstrator. Critchlow, S-124, Wheaton, Ill.

AGENTS—No canvassing, No delivering, No Money Invested, Pleasant Work. Big Money, Appointing Local Agents to Introduce Welcome Foods. Welcome Products, 326 Harvey, Ill.

START Business of Your Own. Increase your income. Catalogue dependable formulas free. S. and L. Laboratory, 321 Larimer, Pittsburgh, Pa.

AGENTS: 500% profit. "Happy Home Maker Shampoo" builds your own big business. Martin of Indiana made \$75.00 in one day. Missouri man made \$750.00 one month. Exclusive territory. Geo. A. Schmidt & Co., Dept. P, 236 W. North Ave., Chicago.

ROLLOFF. Nothing like it. Makes chapped, rough skin like velvet. Cleans and softens. Quick seller. Startling demonstrator. Sure repeater. Rolloff Co., Deposit, N. Y.

GOLD-LEAF Sign Letters; make and sell; 1,000% profits. Particulars, Johnston Co., Quincy, Ill.

REPRESENT big manufacturer. Sell men's wool suits \$21.75. Students' and boys' suits. Collegiate trousers. Liberal commissions. Beautiful outfit free. Write today. Lincoln Tailoring Co., 138a West 17th Street, New York.

PORTRAITS, photo pillow tops, frames, sheet pictures, medallions, merchant's signs, food products, photo jewelry, guaranteed hose, toilet requisites, luminous crucifixes. Catalog 50 specialties free. 30 days' credit. Jas. C. Bailey Co., Sta. C, Chicago.

ONLY one sale a day means \$200 per month! Marvelous new adding machine. Retail \$15.00. Work equals \$3.50 machine. Add, subtracts, multiplies, divides, automatically. Computes feet and inches. Speedy, accurate, durable, handsome. Five-year guarantee. Offices, Stores, factories, garages, lumbermen buy one to dozen. A fortune for live agents. Write quick for protected territory and free trial. Lightning Calculator Co., Dept. F, Grand Rapids, Mich.

BIG Money Selling "Jiffy Tire & Tube Repair Kit." Contains 3 Self-vulcanizing Tire Shoes; Large Outfit Tube Patch; 3 Puncture sealers, everything complete. Sells to every auto owner and Accessory Dealer. Agents average \$80 to \$100 weekly. We also manufacture Nationally known "Jiffy Tire-Doh." Exclusive territory and free samples. Chicago Tire Patch Co., 347-65 E. 55th St., Chicago, Ill.

TAKE orders for Shirts and Overall. Big profits. Work full or spare time. No experience required. Big variety dress shirts with splendid line Union-made work and bannel shirts, overalls, coveralls, work pants, sheep-lined coats, leather coats and vests. Write today for free selling outfit. The Ninard Shirt Co., Dept. 8, 4922-24-26-28 Lincoln Ave., Chicago.

BIG Money monogramming autos, trunks, bags, etc. Make \$20 to \$25 daily. No experience needed. Samples, information free. Acme Products, 905 Broad, Newark, N. J.

AGENTS—Can earn \$100.00 and upwards weekly, selling the Gold Medal five-tube Tuned Radio Frequency set at \$25.00. "The Set that stormed the country," built for the home of moderate means. The Farmer, Clerk, Laborer and Lady of the home ought to buy it on sight. Write today for proposition and exclusive territory. Eureka Outlet Corp., Desk PM, 798 Southern Blvd., New York City.

MAN in each town to plate auto parts, reflectors, bathroom fixtures, refinish beds, mirrors, chandeliers; by new method. No capital or experience required. Simple plan of manufacturing at home starts you in big money-making business. Outfit furnished. Free particulars and proofs. Gun Metal Co., Ave. H, Decatur, Ill.

BE independent. Make—Sell your own specialties. Immense profits. Catalog dependable Formulas, special selected. Agent's best sellers Free. M. Lustru, 832 East Pershing, Chicago.

AGENTS—Shine-Brite Polishing Cloth polishes all metals. Sample free. Knoll Products, Box 532, Kankakee, Ill.

AGENTS—Men and Women—send for particulars. J. W. Danielski, P. O. Box 2163, Manila, P. I.

AGENTS make 500% profit handling auto monograms, sign letters, Novelty signs, etc. Catalog free. Hinton Co., 122 E. 58th St., Chicago, Ill.

MAKE \$75—\$100 Weekly. Famous Sun-lite household products; Big Quantity Seller; You risk nothing. Your money back for every unsold item. Amazing offer free. Summit Specialty, Union City, N. J.

\$100 TO \$500 a month easily earned selling New Guaranteed Auto Discovery. Nothing else like it. Big demand; sure repeater. Free folder explains; get it today. Boone Specialty Co., Dept. 327a, Boone, Iowa.

RADIO Gas Lighters are biggest 25c sellers in country. Every gas user buys one or more instantly; 300% profit. Enclose \$1.00 sample dozen or \$10 gross, including selling plans. M. Masterlite Co., 110 East 23rd St., New York. (Manufacturers famous Masterlite Pocket Clear Lighter.)

AGENTS wanted to sell to Retail Stores our fancy signs; three colors, shaded with airbrush, great variety. C. Pohmann, 929 Second Avenue, New York.

WHY Buy Other's Goods? Start your own profitable business, making them. Free valuable literature tells how, including Chemist's Interesting Lists Guaranteed Reliable Formulas for Latest Specialties. Miller, Chemist, 1706-K Jetton, Tampa, Fla.

DON'T Buy so-called "Master Formulas" (old recipe-book-stock-formulas). Get this Free, interesting, valuable literature describing Latest, Guaranteed, Special Manufacturer's Formulas for all lines latest specialties. Miller, Chemist, 1706-K Jetton-G, Tampa, Fla.

IF you want good live agents—fellows who can get the business—ask me how others are doing it. I'll gladly render the necessary assistance. M. L. Rund, Mgr. Classified Advertising, Popular Mechanics Magazine, Chicago.

USE No Liquid, Paste, Powder, New. Prepared Cloth Cleans all metals—Just (1) Rub. Retail 25c, cost 10c (Dozen in Display Carton). "Sample Free." NuLife Metal, Hartford, Conn.

WHY work for others? Make and sell your own goods. Formulas, toilet articles, perfumes, extracts. 500% Profit. Big catalog free. National Scientific Laboratories, 1920W Broad, Richmond, Va.

66 MILES on 1 Gallon. Wonderful Scientific Gas Saver. All autos, 1 free demonstrator. Critchlow, U-124, Wheaton, Ill.

LAMB Wool Polishers, Cleaners, Dust-ers. Newhall, 358 Broad, Lynn, Mass.

ATTABOY—Pung Chow and Joker. Great-est Amusement games ever played on Billiard or Pool Table. Brooks Mfg. Co., 1185 44th Street, Brooklyn, N. Y.

OVER 100% Profit, Self-Lighting Gas and Cigar Lighters. Everybody interested; repeat business. Sell individuals, dealers, subagents. Particulars Free. P. Bernhard, 148 Chambers St., New York.

AGENTS: Full or spare time—to sell hand painted scarfs, dollies, pillows. Extremely low priced. A wonderful new process. Our agents are cleaning up. Paintographs practically sell themselves. Write for full particulars of liberal agency offer and circulars describing Paintographs today. Bradford's Paintographs, Inc., St. Joseph, Mich.

300% PROFIT; Sells Like Wildfire. "Solidified Coconut Oil Shampoo." Gross weighs 10 pounds. All shipments prepaid. Distributing Samples Free. Write Quick. Bestever Products Co., 1941-KS Irving Park, Chicago.

TURN your spare time into dollars selling Polmet Polishing Cloth that cleans all metals without liquid, paste or powder. Retail 25c. Our agents say it sells like "hot-cakes." Prove it yourself with free sample sent on request. F. C. Gale Co., 122 Edinboro St., Boston.

WHY work for others? Make and sell your own goods. Formulas, toilet articles, perfumes, extracts. 500% Profit. Big catalog free. National Scientific Laboratories, 1920W Broad, Richmond, Va.

LIVE wires, are you looking for big money? Steam-No-More for Rain, Sleet, Steam, etc., on Automobiles, Windows; repeater; send 10c for 25c tube. Grayco, Box 535E, Port Huron, Mich.

AUTO owner tire agent wanted each locality to use and take orders for handmade Mellinger fabric and cord tires; guarantee bond 8,000 and 12,000 miles (no seconds); shipped prepaid on approval; get your tires free; no capital or experience required; make \$100 to \$300 weekly. Write for wholesale prices and sample kit. Address, Mellinger Tire Co., Dept. 300, Kansas City, Mo. or Dept. 300, Philadelphia, Pa.

LIVE Agents Make \$10 Day selling Eureka Strainer and Splash Preventer for every water faucet. Takes on sight. Widely advertised and known. Get details today. A. B. Seed Filter & Mfg. Company, 73 Franklin, New York.

SELF-THREADING Needles, Needle Books, Machine needles, find sales in every home. Fine side lines, easily carried, big profits, sample and catalogues free. Prentice Lee, 145 East 23rd St., New York.

AT Last! Diamond Rival Discovered! Amazing blue white Rajah Gem astounds jewelry world and deceives experts! Beautiful Sample case Free! \$100 weekly! Write Quick! Rajah Diamond Co., Dept. F-7, Salisbury, N. C.

WILLIAMS' No-Water Hand Soap. In tubes, has taken Auto owners by storm; washes dirtiest hands perfectly clean without water; easy demonstration makes quick sale. 150% profit. Williams Co., Dept. 265, Montclair, N. J.

BIG Money and Fast Sales. Every owner buys Gold Initials for his auto. You charge \$1.50; make \$1.35. Ten orders a day easy. Write for particulars and free samples. American Monogram Co., Dept. 40, East Orange, N. J.

AGENTS: Big Money Monogramming by Transfer Method. Catalog Showing Over 50 Styles and Particulars Free. Motorists' Accessories Co., Mansfield, Ohio.

INSTANT Weld. Repairs largest punctures without cement or heat. Lenn's profit one day, \$56. Write quick. Free sample; territory going fast. Tourists' Pride Mfg. Co., Desk T, Minneapolis, Minn.

DON'T sell for others. Employ agents yourself. Make your own products. Formulas, toilet articles, perfumes, extracts. 500% Profit. Big Catalog Free. National Scientific Laboratories, 1920W Broad, Richmond, Va.

WE Pay \$50 a Week and expenses and give a Ford Auto to men to introduce poultry and stock compounds. Imperial Co., D. 23, Parsons, Kans.

AGENTS—Make a dollar an hour. Sell Mendets, a patent patch for instantly mending leaks in all utensils. Sample package free. Collette Mfg. Co., Dept. 404, Amsterdam, N. Y.

\$60-\$200 A WEEK. Genuine Gold Letters for store windows. Easily applied. Free samples. Liberal offer to general agents. Metallic Letter Co., 438-D North Clark, Chicago.

AGENTS—Clever Invention! Inkspoon makes every pen a fountain pen. Fast office seller; big profit, demand increasing everywhere. Exclusive territory offered. Sample free. H. Marul Company, Tribune Bldg., New York, N. Y.

POLMET—The Wonderful Polishing Cloth that cleans all metals without liquid, paste or powder. Approved by "Good Housekeeping" and "Modern Priscilla"—sells fast at 25c. Sample free. Gais & Co., Inc., 15 Edinboro St., Boston.

WASH Clothes the new way. Use the Torrent Automatic Washer. You will be delighted. Special offer to one in each locality. Storm Royalty Co., 3810 Enright Ave., St. Louis, Mo.

WE Start You Without a Dollar. Soaps, Extracts, Perfumes, Toilet Goods. Experience unnecessary. Carnation Co., Dept. 201, St. Louis.

GET Our Free Sample Case—Toilet articles, perfumes and specialties. Wonder fully profitable. La Derma Co., Dept. A, St. Louis, Mo.

IMMEDIATE Profits in advance selling Vitalized Heat Pads, made in the Land of Sunshine. Replace hot water bottles and electric pads. Sell on sight. Write for proposition. Dept. PM, Radiant Mfg. Co., San Antonio, Texas.

BUILD your own Business! Free Valuable Literature explains how you can easily make your own Goods—have others selling them. Miller, Chemist, 1706-A Jetton, Tampa, Fla.

AGENTS—\$240 a month. Take orders for well known line of household specialties, food flavors, toilet preparations, etc. Full or spare time. Build a big permanent business. Must satisfy or money back. Write for free sample outfit and offer. C. H. Stuart & Co., 5507 Main, Newark, N. Y.

LEARN while earning \$10,000 with fast-selling auto devices on market. Be financially independent. Mashken, Indiana Harbor, Ind.

EVERYBODY buys from Gibraltar representatives all over country taking orders for famous Gibraltar line consisting of shirts, overcoats, raincoats, pants, hosiery, neckwear and other articles. Outfit representing full line free. Gibraltar Fashion Shop, 724 Roosevelt, Chicago.

STREETMEN. Big Money, Selling Intensifiers. Reliable Mfg. Co., Utica, N. Y.

MAIL-ORDER Houses and Distributors: We pack French made beauty creams, face powders, perfumes, toilet preparations with your label. Chemist, A2700 Wabash Ave., Chicago.

YOU Can Earn \$1,000 a month or more with an Everett Agency. Write for proof. Everett Company, Soc., Mich.

FAST Money-Maker. Greatest Polishing Cloth on Market. Big Profits. Sample Free. Wonderful Repeater. Keystone Specialty Company, Dept. B, Altoona, Pa. Established 1906.

AGENTS—Here's a New One. "Best-ever Powdered Hand Soap." Sells like wildfire. Marvelous Discovery. Removes grease, paint, ink, oil, in fact anything from the hands. Cannot harm skin. 150% Profit. Great Repeater. Agents simply coin money. "Free Samples Get the Business." Write immediately. Bestever Products Co., 1945 E. Irving Park, Chicago.

WINDOW Sign Letters. One Thousand for \$9.75 Beautiful design. Perfect cut. Free samples, catalogue. Foil Sign Works, 832 W. 11th Street, Oakland, Calif.

AGENTS—Write for Free Samples. Sell Madison "Better-Made" Shirts for large Manufacturer direct to wearer. No capital or experience required. Many earn \$100 weekly and bonus. Madison Co., 566 Broadway, New York.

SOMETHING new—Presto Rubber Repair for tires, tubes; all rubber goods put on cold, no heat, acid or tools; vulcanizes itself in few minutes. Sells to auto owners and dealers, sample free. Pioneer Products Co., Dept. A, Reobling, N. J.

AGENTS—Stamping names on Pocket Key Protectors; sample Check with your name and address, 25c. Stamping Outfits, Emblem Checks, Check Fobs, Name Plates. Hart Mfg. Co., Desk 2, 303 Degraw St., Brooklyn, N. Y.

ORIENTAL Perfumes bring 100% net profit. Good sellers and better repeaters. Romola Parfumerie, Inc., Woodlawn 10, Chicago.

NEW Marvelous Self-Lighting Pocket Cigar and Gas Lighters. No Friction. Sells on Demonstration. Sample 25 cents. Rapid Mfg. Co., 799 Broadway, New York.

EVERYBODY Buys Davis' Nifty Toilet Goods Assortments. Useful, handsome gifts free to our customers. Over 250 high quality products. All repeaters. 100% profit. 25 years of success. Write! Davis Products Co., Dept. 56, Chicago.

AGENTS—\$60 to \$200 weekly putting up our Burnished Genuine Gold window letters; scripts. Experience unnecessary. Free samples. Premier Letter Co., 121 N. Francisco, Chicago.

EASY, pleasant work for Mechanics, Shop Men, Clerks, during spare hours; will add many dollars to their salaries. Also want persons who can give full time. Big wages assured. Novelty Cutlery Co., 67 Bar St., Canton, Ohio.

AGENTS \$1. Retail \$3. Your Profit \$2. Wonderful, pocket Adding Machine with Magic Writing Pad. Particulars Free. Typewriter Supply, 905 Hensch Bldg., Pittsburgh, Pa.

DON'T sell for others. Employ agents yourself. Make your own products. Formulas, toilet articles, perfumes, extracts. 500% Profit. Big Catalog Free. National Scientific Laboratories, 1920W Broad, Richmond, Va.

\$31.00 PROFIT—with \$1.50 Outfit—Big Money—Easy Work. Selling Gold Monograms for Automobiles, Luggage, Windows, Wagons. No Experience. No License. "Samples Free." NuLife Monograms, Hartford, Conn.

LARGE Manufacturer Wants agents. Make \$100 weekly. Outfit free. Sell made-to-measure genuine Cravenette Gabardines, \$14.50. Whipcoats, \$12.50. Reversible Raincoats, \$9.75. Standard Raincoat Co., 131 W. 17th St., New York.

BUSINESS Guide with Free Legal Service Sells everywhere; Wells cleared \$1,185 in 35 days. Write for free outfit. Nichols Co., Nanerville, Ill., Dept. 4B.

AGENTS make \$100 week placing advertising Cigar Lighters with glass front. Every dealer wants one. Write for free plan. Drake Mfg. Co., Dept. M, Milwaukee, Wis.

CALIFORNIA Rosebuds selling like hot cakes. Agents coin money; new stuff. Big profits. Catalog free. Mission Factory PM, 519 No. Halsted, Chicago, Ill.

DUSTLESS Sponge Cloth. New Invention. (1) Rub—Dusts, Cleans and Polishes Automobiles, Furniture, Pianos. Retail \$59c—Costs 16c. "Sample Free." NuLife Sponge, Hartford, Conn.

BIG Profits with Exclusive Territory—\$50 to \$100 weekly easy. More has often been made in one day's work. A hot or cold running water bath equipment for any home at only \$7.50. No plumbing or water works required. Investigate. Send no money. Write today. Sanitary Supply Co., 753 Allen Building, Toledo, Ohio.

GO into business for yourself. Make your own products. Formulas, toilet articles, perfumes, extracts. 500% Profit. Big Catalog Free. National Scientific Laboratories, 1920W Broad, Richmond, Va.

AGENTS—N-R-G Laundry Tablets, the old reliable moneymaker for live agents. Millions sold—200% profit—sales waiting for you. Clothes washed spotlessly clean in 10 minutes without rubbing. Free samples. N-R-G Company, 230 W. Superior, Chicago.

GENUINE Gold Leaf Letters anyone can put on Store windows. Guaranteed to never tarnish. Large Profits. Enormous Demand. Free Samples. Write today. Metallic Letter Co., 438-A North Clark, Chicago.

AGENTS: Our gold-eyed Needle Cases are wonderful sellers; immense profits: \$50 to \$300 weekly; proof and particulars free; sample outfit 15c; factory prices. Paty Needle Co., 231 Davis Square, Somerville, Mass.

GO into business for yourself. Make your own products. Formulas, toilet articles, perfumes, extracts. 500% Profit. Big Catalog Free. National Scientific Laboratories, 1920W Broad, Richmond, Va.

MEN or Women Agents. Full or spare time, selling Stationery. Every Man and Woman a customer. Sample outfit Free. Scheffer Stationery Company, 1308 Ewing St., Fort Wayne, Ind.

AGENTS—Steady income. Large manufacturer of handkerchiefs and dress goods, etc., wishes representative in each locality. Factory to consumer. Big profits, honest goods. Credit given. Send for particulars. Freeport Mfg. Co., 59 Main St., Brooklyn, N. Y.

\$20 PROFIT daily selling self-threading needles, needlebooks; cost 3-5c each; sell 25c; three samples 25c. Catalog free. Needlebook Specialty Co., 661 Broadway, New York.

AGENTS: \$300—\$500 monthly easy taking orders for Morey Rim Tool. Autoists and trade buy on sight. M. Morey Rim Tool Company, Blissfield, Mich.

BIG Money—fast sales; everyone buys gold initials for their auto; sell \$1.50, profit \$1.44. Ten orders daily easy. Samples, information free. World Monogram, Dept. 16, Newark, N. J.

A BUSINESS of your own. Make and sell chipped glass name and house number plates, checkerboards, signs. Booklet Free. E. Palmer, Dept. 512, Wooster, Ohio.

EARN \$10 daily silvering mirrors, plating and refinishing metalware, autos, chandeliers, bedsteads, headlights. Outfits furnished. E. Decie Laboratories, 1133 Broadway, New York.

NOW that you have read all these offers, read Maceochee Company's (Cincinnati, Ohio) advertisement again.

HIGH GRADE SALESMEN WANTED

WANTED—Tailoring Salesmen, make \$60 to \$125 per week. Biggest merchants in many towns have started with our line. We are the largest made-to-measure tailoring house in the country, furnishing elaborate sample equipments, including 500 all-wool fabrics. You make your own profits from \$8.00 to \$15.00 on each order. Guaranteed absolute satisfaction, perfect fit, best workmanship, or no sale. Write for our line and all accessories to be sent free. Tell us all about yourself. Address N. O. Perry, Sales Manager, Box 483, Chicago, Ill.

EDMUND REH & CO., Inc. Wholesale tailors, are now making all wool cut and tailored to measure suits to sell at \$24.75. Entire line one price, worsteds, cashmeres, chevots, tropical weights, topcoatings, sport suits, choice of 30 style fashions at \$24.75. The outstanding value in popular price tailoring of this age, that will meet any legitimate competition. Liberal commissions, cash bonuses. We are interested only in men who make direct selling a business, part or full time. For further information write Edmund Reh & Co., Inc., Dept. B, 415 So. Wells, Chicago.

TAILORING Salesmen—Many men in your town pay \$15 to \$20 more than our wholesale prices for the same woolsens, workmanship and high-grade, perfect fitting, tailored-to-measure suits and topcoats—all these are live prospects. Complete selling outfit free. 200 choice patterns—all wool; five prices, \$18.50 to \$36.50. Absolute "no-pulling-out" hair cloth fronts. Positive 8-day service. Substantial commissions, bonuses and special prizes. Protected territory. Free advertising. Experience unnecessary. Our sales manual tells you "how." Tell us about yourself, giving two business references for quick action. Wholesale Direct Tailors, Dept. 1203, 83-89 Ellicott St., Buffalo, N. Y.

SALESMEN—Get this big sensational, order-getting shirt outfit free. Sell Stylemor Shirts all year round. It's Chicago's Wonder shirt line. Advanced fall showing of smartest, snappy patterns. Large double watches, low prices, quick service, makes shirt selling easy. Bellard of Texas made \$46.00 in two days. We deliver and collect. Write today for big free outfit. Stylemor, 81 W. Van Buren, Chicago, Ill., Dept. 1101.

BANCROFT-HUNTER Company, Inc., 411 So. Wells St., Chicago, makers of high grade men's all wool clothes selling direct to wearer at \$23.75, are opening sales agencies. Men are wanted who have sold tailoring or something similar. A liberal profit, bonus and co-operative advertising. To qualify must furnish references as to honesty. No investment required—we furnish everything. Write for booklet P entitled "Developing a Sales Agency," which tells everything about the proposition. Address above.

DISTRICT Agents—For Union Made pure wool suits and topcoats retailing at \$23.50, none higher. A remarkable line of 45 beautiful fabrics tailored by a large and well known old established firm, sold only thru our own stores and district agents. A real opportunity for any good man. Big money to start and chance for advancement. We furnish large sale outfit, 9x13 cloth samples. Men over 30 years of age with tailoring or clothing experience preferred. Can use ambitious spare time men in smaller towns. Interested only in serious men who seek a future. Write for free samples and full information. Address M. V. Harvey, Mgr., Box 80, Chicago.

THE Walton System will put you in a position to make money with a high-grade line, without any investment. Selling experience desirable, but not necessary. We make fine made-to-measure customized clothes, retailing for \$27.50, covered by the strongest money-back guarantee. The most attractive line you ever saw; 75 patterns all one price suits, \$27.50. Liberal commissions, bonuses and complete selling equipment. Write for booklet "An Independent Business without Capital," tells everything. Louis A. Walton Co., Inc., Desk A, 413 So. Wells, Chicago.

66 MILES on 1 Gallon. Wonderful Scientific Gas Saver. All autos, 1 free, demonstrator. Critchlow, V-124, Wheaton, Ill.

EASY Selling Specialty. Beautiful, Attractive, Appealing, Luminite Window Bulletin. Increase merchants' business 50% to 100%. Protected territory. \$8 commission on each \$20 sale. Thousands being sold; sells itself on demonstration. Display Products Co., Ltd., 106 Gibraltar Bldg., Kansas City, Mo.

TAKE Orders for department, hardware, and house furnishings stores for new 50c household necessity. Liberal discounts and commissions. Vest pocket sample. Manufacturers Consolidated Co., Dept. 109, Grand Rapids, Mich.

MAKE Money Selling Shirts. Our men find sales easy. Patented shirt turns inside out. Lasts twice as long. Sells on sight. Customers tell friends. Big money. Write Walton Duplex Co., Dept. B30, Brooks Bldg., Chicago.

SALESMEN—to earn \$300 to \$600 weekly. Whirlwind new dealer specialty. Liberal credit terms. \$40.00 weekly expenses guaranteed against commissions. Only producers wanted. Write reference as to ability. Salesmanager, Box 3820, Cedar Rapids, Iowa.

BEST Seller. Jem Rubber Repair for tires and tubes; superseded vulcanization at saving of over 800%; put it on cold, vulcanizes itself in two minutes, guaranteed to last life of tire or tube; sells to every auto owner and accessory dealer. Get particulars how to make big money and free sample. Amazon Rubber Co., Philadelphia, Pa. Dent. 510.

SALESMEN! Sideline, 1926 Advertising specialties; fans, pencils, forty other snappy sellers. Buyers in all cities and towns. Compact line, weight ten pounds. Write for information. Coshocton Novelty Company, Coshocton, Ohio.

GO into business for yourself without investing a penny. No rent to pay. No stock to carry. Yet you make bigger profits than regular storekeepers. Write for facts at once. Address Dept. 753, William C. Bartlett, Inc., 850 W. Adams Street, Chicago.

FREE Suit to Tailoring Agents. I furnish elegant Swatch Line Sample Outfit, give free suit and highest pay to introduce my tailoring. Just write a letter or postal card for my startling new special offer. F. R. Schau, Sales Manager, Dept. 142, Peoria and Adams Streets, Chicago.

TAKE orders for coffee, sugar, flour, meats, canned goods, staple groceries; also paints, radio sets, tires, auto and tractor oils. No capital or bond required. We deliver and collect. Permanent business. Big pay. Write at once. Hitchcock-Hill Co., Dept. 50, Chicago.

\$50.00 DAILY Selling Salesboards—Make up to \$33 on single sale selling largest, lowest priced line; no sample to carry; write for 3-color catalogue and full particulars. Lincoln Sales Co., Dept. E, 9 So. Clinton, Chicago.

TAILORING Salesmen: Our guaranteed \$23.50 and \$31.50 tailored to order suits are \$10 to \$20 cheaper than store prices; commission in advance; monthly bonus; protected territory; beautiful assortment 6x9 swatches free. Our national advertising campaign makes selling easy—big repeat business. DeLonge's record \$343 in one week. In one state alone 47 men average \$57.18 weekly. J. B. Simpson, Dept. 1174, 843 Adams, Chicago.

\$91.50 WEEKLY and up—Your Pay Daily—Introducing New 12 months Insured Hose for men, women, children. You write orders. We can deliver and collect (or goods on credit and you can deliver, suit yourself). No experience or capital needed. Samples furnished. All colors, grades, including silks, lises, woods, heathers. Write quick. Maccohee Textile Company, Card 3042, Cincinnati, Ohio.

A LIVE Proposition for Men Who Can Sell. We need a few more reliable men to sell our Advertising Thermometers. Made by largest manufacturers of thermometers in the world. Experience unnecessary but desirable. Liberal commissions. Give past employment and references. Taylor Brothers Co., Division of Taylor Instrument Companies, Rochester, N. Y.

DISTRICT Manager—Largest Eastern House. Suits, overcoats \$23.25, factory to wearer. Largest commissions. Possibilities \$5,000 up. Boston Wholesale Clothing, 47A Beach, Boston, Mass.

WONDERFUL newly invented Pricing System. All retail stores. Sells on sight. Tremendous market! Big repeats. Write quick for exclusive territory. Manufacturer, 25R Huntington, Boston, Mass.

TRAVELING Salesmen calling on retail stores wanted by large manufacturer to sell unique line of business-boosting articles. Year round, fast selling, main or side line. If not earning \$150 weekly, address Union Specialty Works, Inc., 222 Charles St., Beechville, N. Y.

SIDELINE Salesmen—35c article eliminates automobile accidents; fast seller; over 400% profits. Sample free. Klear-Vu, 625 Buder Bldg., St. Louis, Mo.

SALESMAN, write for particulars of an interesting and profitable business, selling and operating aluminum refillable salesboard. Square Hole Board Co., 120 Scheerer Ave., Newark, N. J.

COLLECTS Money from the Dead-Beats. Retails \$5.00—Cost \$1.00—Profit \$4.00. "New Method." Every Storekeeper, Doctor buys quickly. Wonderful Money Getter. Federal Association, Hartford, Conn.

DISTRICT Salesman: Must be reliable. Prefer married man, 30 years old or over and permanent resident in his community. Exceptional opportunity for good man. Address Sales Manager, 844 West Adams Street, Dept. 153, Chicago.

SALESMEN wanted in exclusive territories by an old established concern, to call on factories, hospitals, schools, department stores, institutions, cemeteries and public buildings. Wonderful advertising co-operation. Proposition will pay from four to ten thousand a year to right man. C. B. Dolge Company, Westport, Conn., Sales Department.

SALESMEN: \$100 week. No experience; genuine gold leaf sign letters and script. Consolidated Co., 636 S. Dearborn, Chicago.

NEWEST invention! Sells every office, home, store. Automatically coils telephone and iron cords. Abolishes snarls and kinks. Great time and temper saver. \$25 daily. Samples for test if desired. Neverknot, Dept. 2-1, McClurg Bldg., Chicago.

SALESMEN—Are you traveling by automobile? Sell Reliable fireproof safes along the way. Defray expenses and make more besides. Customers everywhere. Liberal advance. Write for money-making particulars. Reliable Safe & Lock Co., Dept. A, Covington, Ky.

CALENDAR and Specialty Salesmen will want to sell our new "Fireside Sunday School Calendar." Sells for less. Write O. L. Black Co., Indianapolis, Ind.

DELINQUENT account salesman solicitors; \$100.00 upward weekly, salary and commissions. No charge no collection basis. Give references, experience. American Credit Rating Company, Denver, Colo.

SALESMAN Wanted—To distribute nationally known medium-priced shoes direct to wearer; actual samples; permanent repeat business. Write today. Bloomer Shoe Co., Alton, Ill.

ARE you old at forty! See our advertisement on page 175 of this issue. The Electro Thermal Company, 2137 Main St., Steubenville, Ohio.

SALESMEN sell direct from factory miniature cedar chests all sizes, brass-trimmed and plain. This is your opportunity to handle a fast selling line. Charles W. Hall & Co., Inc., Valparaiso, Ind.

WANTED—Salespeople to sell The Daisy Desk an educational equipment direct for the home. The latest improved, with adjustable stand. Designed to work directly with school work. Protected territory. Charles W. Hall & Co., Inc., Valparaiso, Ind.

\$10,000 YEARLY, Easy, Sure. Selling latest, new, combination Life-Health-Accident Insurance Policy. Big Demand. Large Commissions. American, 1107-159 North State Street, Chicago.

DON'T sell for others. Employ agents yourself. Make your own products. Formulas, toilet articles, perfumes, extracts. 500% Profit. Big Catalog Free. National Scientific Laboratories, 1920W Broad, Richmond, Va.

SALESMEN and State distributors. Accessory dealers, filling stations, garages buy our product readily. Permanent repeater. No.-Dim Mfg. Co., Oklahoma City, Okla.

SIDELINE Salesmen, to sell an instant relief toothache drop to druggists and retailers. 40% clear profit. F. J. Liepold, Adrian, Minn.

YOUR trade uses salesboards. Make up to \$35 on single sale. Largest, lowest priced line. No samples to carry. Elaborate 3-color catalog free. Lincoln Sales Co., Dept. D, 9 So. Clinton, Chicago.

IF You Think in Terms of \$6,000 the First Year write Us Now. Strong line for retail stores. Nationally advertised. Established concern. Best season now starting. Liberal weekly advance to producer. The Continental Co., 1922 Euclid, Cleveland, Ohio, Dept. 200.

SELLS for \$9.75. Prints ad on wrapping paper, envelopes, etc. \$1.00 commission. Send 10c for sample work. Automatic Ad-Stamp, Joplin, Mo.

MEN Wanted—to sell dependable fruit trees, shrubbery, etc. Steady demand. Complete cooperation. Pay check weekly. Write Perry Nurseries, Dept. B, Rochester, N. Y.

HERE'S a big money maker! Masterlite Pocket Cigar Lighter; something new in specialty field; sells instantly upon demonstration to consumers and dealers. Send 50c stamps for sample and selling plans. M. Masterlite Mfg. Co., 110 East 23rd St., New York. (Manufacturers well-known Radio Gas Lighter.)

SALESMEN Can make \$5.00 a day selling our Calendars, Pencils, Signs, Advertising Novelties, Yardsticks, Whistles, etc. Liberal terms. Sells entire year. Fine side line. Local and traveling agents. Model Calendar Co., Dept. 236, South Bend, Ind.

FREE Suit to Tailoring Agents. I furnish elegant Swatch Line Sample Outfit, give free suit and highest pay to introduce my tailoring. Just write a letter or postal card for my startling new special offer. F. R. Schau, Sales Manager, Dept. 143, Peoria and Adams Streets, Chicago.

FOUR \$7.50 sales to merchants net you \$20.00 daily. Sayers Systems, 2803 Sheffield Ave., Chicago, Ill.

SALESMEN—Become Independent. Own Your business, experience unnecessary selling our \$7,500 Accidental Death; \$50 Accident; \$25 Sick Weekly Benefits—\$12.50 Yearly. Other Amounts proportionate. Guaranteed steady income from renewals. \$250,000 Deposited Insurance Department. Universal Policy, Dept. A, Newark, N. J.

ADVERTISING Salesmen wanted to take orders for Auto Key Purse; new invention; sells to advertisers by thousands; commission 20%; sample by mail 25c. Novelty Cutlery Company, 522 McGraw Ave., Canton, Ohio.

AUTOMOTIVE Specialty Salesmen. Steady Profits. Results Guaranteed. Adams-Barr, Columbus, Ohio.

MAKE \$100 Weekly in spare time. Sell what the public wants—long-distance radio receiving sets. Two sales weekly pay \$100 profit. No big investment, no canvassing. Sharpe of Colorado made \$955 in one month. Representatives wanted at once. This plan is sweeping the country—write today before your county is gone. Ozarka, Inc., 126-B Austin Ave., Chicago.

EASY to Sell Groceries, Paints, Lubricating Oils, from samples to consumers in towns and country. Prices meet all competition. No capital or experience necessary. Profitable, steady work. Commission advanced. Satisfaction guaranteed; 53 years in business. Write Loverin & Browne Co., Wholesale Grocers, 1775 So. State, Chicago, Ill.

\$60-\$200 A WEEK. Genuine Gold Letters for store windows. Easily applied. Free samples. Liberal offer to general agents. Metallic Letter Co., 438-B North Clark, Chicago.

CALIFORNIA Rosebuds selling like hot cakes. Agents coinng money. Absolutely new. Big profits. Catalog free. Mission Factory SP, 519 No. Halsted, Chicago, Ill.

HELP WANTED

\$91.50 WEEKLY and up—Your Pay Daily. Introducing New 12 months Insured Hose for men, women, children. You write orders. We deliver and collect (or goods on credit and you can deliver, suit yourself). No experience or capital needed. Samples furnished. All colors, grades, including silks, lisses, wools, heathers. Write quick. Macehee Textile Company, Card 2692, Cincinnati, Ohio.

YOU Are Wanted. Men—women, 18 up. U. S. Government Life Positions. Commence \$95.00 to \$158.00 month. Steady, sure work. No layoffs. Paid Summer vacation. Pleasant work. Short hours. Experience unnecessary. Common education sufficient. Candidates coached without leaving home. Full particulars Free. Write immediately. Franklin Institute, Dept. M-3, Rochester, N. Y.

MEN Wanted—prepare as firemen, brakemen, colored train or sleeping car porters, wire for application blank; experience unnecessary; first class roads, no strike. Name position wanted. Railway Institute, Dept. 35, Indianapolis, Ind.

QUALIFY for \$150—\$300 railroad jobs. Fireman, Brakeman, Baggage-man, Sleeping Car or Train Porter. 816 Railway Bureau, East St. Louis, Ill.

MR. BRUSH Salesmen: Old Established New York Brush Manufacturer requires the service of men in all territories to sell their extensive line of Sanitary Twisted in Wire Brushes. We pay larger commissions than any other Brush House in the country. Write immediately for proposition. Wire Grip Sanitary Brush Corp., 15 Mercer St., New York.

DON'T prepare for any Civil Service Examination without seeing our catalogue. Free. Columbian Correspondence College, Washington, D. C.

MAKE Money, silvering mirrors, refinishing auto headlights, tableware; metal plating, bedsteads, chandeliers. Outfits furnished. International Laboratories, Dept. TL, 309 Fifth Ave., New York.

BUILD splendid business making chipped number and name plates, signs, checkerboards. Write for particulars. Simplex Utility Co., 1133 Broadway, New York.

MAN Wanted (city or country), old established company will supply capital and start you in your own permanent business selling necessities people must buy every day. Experience unnecessary. Write McConnon & Co., Factory M-48, Winona, Minn.

YOU can get the job you want. Sample letters of application and instructions \$1.00. Allard, 1217 Mary Ann, Montreal, Can.

GO into business for yourself. Make your own products. Formulas, toilet articles, perfumes, extracts. 500% Profit. Big Catalog Free. National Scientific Laboratories, 1920W Broad, Richmond, Va.

YOU Are Wanted. U. S. Government Jobs. \$95—\$225 month. Steady. Sample coaching—Free. Write immediately. Franklin Institute, Dept. M-16, Rochester, N. Y.

MEN, 18 up, wanting U. S. Mail Service jobs, \$142 or \$225 monthly; steady; experience or correspondence course unnecessary; particulars free. Write P. Bradford, 112 N. 50th St., Philadelphia, Pa.

66 MILES on 1 Gallon. Wonderful Scientific Gas Saver. All autos, 1 free, demonstrator. Critchlow, W-124, Wheaton, Ill.

LOCOMOTIVE Firemen for railroads nearest their homes—everywhere; beginners \$150-\$250 monthly; promoted, locomotive engineer, \$3,000-\$4,000 yearly. Best paying positions on railroads. Railway Association, Desk M1, Brooklyn, N. Y.

RAILWAY Mail Clerks. \$158 month. Steady. Men 18—35. Particulars Free. Write immediately. Franklin Institute, Dept. M-16, Rochester, N. Y.

U. S. GOVERNMENT wants men. \$1,700—\$1,900 and up at start. Railway Mail clerk examination coming. Let our expert (former Government examiner) prepare you for this and also Rural Carrier, Post Office, Customs, Internal Revenue, and other branches. Write today for free booklet. Dept. S. Patterson Civil Service School, Rochester, N. Y.

MIRRORS Re-Silvered at Home. Costs Less 5 cents per square foot; you charge 75 cents. Immense profits, plating auto-parts, reflectors, tableware, stoves. Refinishing metalware, etc. Outfits furnished. Write for information. Sprinkle, Plater, 77, Marion, Ind.

GET a U. S. Government Job. Men 18—35. Railway Mail Clerks. Commence \$1,900 year. Steady. 25 coached free. Write immediately. Franklin Institute, Dept. M-16, Rochester, N. Y.

MEN wanting forest ranger positions. \$1,500—\$2,400 year. Write for free particulars of exams. Mokane, B-21, Denver, Colo.

\$25.00—\$75.00 WEEK. Auto Repairing. Hundreds Spring vacancies. Sample lessons free. Franklin Institute, Dept. M-400, Rochester, N. Y.

MEN wanting forest ranger, railway mail clerk and other govt. positions. Write for particulars. Mokane, B-23, Denver, Colo.

BECOME a Landscape Architect. Uncrowded profession of wonderful opportunity for money-making. Easily mastered by mail. Earn while you learn. Write for book. American Landscape School, 56-E, Newark, N. Y.

STEAMSHIP Positions—Europe, Orient. Good pay. Experience unnecessary. No compulsory service. Send stamped addressed envelope for list. Box 30-X, Mount Vernon, N. Y. or Box 336-A, Santa Monica, Calif.

\$115—\$100 MONTHLY paid—Ry. Station—office positions. Free passes; experience unnecessary. Write Baker, Supt., (ABT) Star Bldg., St. Louis, Mo.

SILVERING Mirrors, French plate. Easily learned; immense profits. Plans free. Address, Wear Mirror Works, Dept. 34, Excelsior Springs, Mo.

ALL men-women, 18-60, wanting to qualify for Government Positions, \$140-\$225 monthly, local or traveling, write Mr. Ozment, 101, St. Louis, Mo., immediately.

STORIES, poems, plays, etc., are wanted for publication. Good ideas bring big money. Submit manuscripts or write Literary Bureau, 522, Hannibal, Mo.

EARN \$10 daily silvering mirrors, plating and refinishing metalware, auto, chandeliers, bedsteads, headlights. Outfits furnished. E. Decie Laboratories, 1133 Broadway, New York.

FINGER Print Experts—Excellent paying positions; particulars free. Finger Print Headquarters, 188 East 79th, New York.

INVENTORS desiring to secure patents should write for our book "How to Get Your Patent," tells our terms and methods. Send sketch for our examination and instructions without charge. Randolph & Co., Dept. 418, Washington, D. C.

RAILWAY Mail Clerks. \$158 month. Men 18—35. Particulars Free. Franklin Institute, Dept. M-16, Rochester, N. Y.

MAKE money writing Photo-plays; details free to beginners. No correspondence course. Producer's League, 230 Wainwright, St. Louis.

GET posted—Good prices paid for butterflies, insects. See Sinclair display advertisement, page 18.

WANTED. Local representative for chain of Real Estate offices. Experience unnecessary. We teach you thoroughly by mail, furnish you large list of saleable properties, start you in business. Make \$300.00 to \$500.00 monthly. Free booklet. Dept. 303, Dawson Real Estate Co., Fort Smith, Ark.

DYKE'S Automobile and Gasoline Engine Encyclopedia. Latest edition contains information on repairing and adjusting every part of all motor cars now in use. Tells how to find out what is wrong and how to fix it. Mechanics everywhere depend upon this compendium to keep them up-to-date. Send No Money. Just write a post card. Pay postman the postage and 8¢. Popular Mechanics Press, Room 802, 200 E. Ontario St., Chicago, Ill.

INFORMATION

COMPLETE, accurate information on any subject \$2. National Information Bureau, 316A Shepard Building, Grand Rapids, Mich. Prompt service.

DETECTIVES: Practical Guidebook Solves Tangled Problems. \$1 postpaid. Dorey Publishing Company, 238th St., Riverdale Avenue, New York.

ADVICE on any subject \$1.00. Universal Bureau, 3810 Enright, St. Louis, Mo.

REPAIRS about home easily made with instructions in our new book. Tells exactly how to use tools, sharpen tools and cutlery, repair furniture and cabinets, upholster, work metal, solder, work glass, paint, stain, varnish, hang paper, repair plumbing, repair furnace, repair electrical equipment, repair shoes, repair harness, repair gloves, repair concrete work. Send No Money. Just write a postal and ask for "The Practical Book of Home Repairs." When postman hands you this book, pay him \$2.50 and the postal charges. Popular Mechanics Press, Room 802, 200 East Ontario St., Chicago, Ill.

BUSINESS SERVICE

MAKE 'Em Pay—My system will make them pay their bills. Write for the acid test. Literature free. Burleigh L. Horr, Horr Omelia Block, Rhineland, Wis.

CHARTERS—Delaware; best, cheapest; free forms. Colonial Charter Co., Wilmington, Del. (99)

DELAWARE Incorporator. Charters; Fees Small; forms. Chas. G. Guyer, 961 Orange St., Wilmington, Del.

TYPEWRITERS AND SUPPLIES

100 TYPEWRITERS Free. Overstocked. Rent rebuilt Underwood or Remington \$3.00 month. If you pay its value in rental, we give machine free. Particulars free. Pittsburgh Typewriter Exchange, 945 Hersch Bldg., Pittsburgh, Pa.

TYPEWRITERS. All Models, used and rebuilt, at lowest prices. Send for price list before buying elsewhere. We save you money. Big Money-Making Plans free with order. Keith's Supply House, Dept. A, Long Branch, N. J.

TYPEWRITERS, all standard makes, \$10 up. Fully guaranteed. Free trial. Write for complete illustrated lists. Northwestern Typewriter Exchange, 121 N. Francisco Ave., Chicago.

UNDERWOOD Typewriters—only \$3.00 down. Easy monthly payments. Low prices at less than manufacturers. 10 days' free trial. Rebuilt, all worn parts replaced. Just like a new machine. 5-year guarantee. Write for a big free catalogue C-151. Shiman-Ward Mfg. Co., 1512 Shipman Bldg., Chicago, Ill.

USED L. C. Smith \$5. 2 color ribbon—back spacer \$18.50. Used Oliver \$18. Ray, 296 5th Ave., New York.

TYPEWRITERS All Makes. Save One-half. Thoroughly rebuilt in our factory to the famous "Young Process." Fully guaranteed. Free trial. We handle all standard makes. Cash or sold on easy terms. Write for catalog. Young Typewriter Co., Dept. 5752, Chicago, Ill.

TYPEWRITERS—All Makes; Wonderful Values. Typewriter Bargain House, Ada, Okla.

TYPEWRITER Ribbons of Quality Priced Right. Write. Midwest, Box 47, Springfield, Ill.

STANDARD Typewriters: \$2—\$25.00. Rebuilt \$35.00. Rental \$1.00. Motorcycles \$15.00—\$65.00. Knights, 1512 Locust, St. Louis, Mo.

PRINTING, ENGRAVING AND MULTIGRAPHING

\$3.00 DELIVERED, 500 Watermarked Bond Letterheads, 8½x11, and 250 envelopes, money with order. Job Printing Specialty, National Printing Company, Goshen, Ind.

250 EACH Hammermill Bond Letterheads, Envelopes, \$3.00. Samples. Midland Press, 543 West Hickory, Kankakee, Ill.

EMBOSS your Stationery with Hand Embosser. Circular Free. Midwest, Box 47, Springfield, Ill.

GUMMED Labels, 500 name and address, 2 lines 35c, 3 lines 55c. Catalogue. Eastern Label Co., B Clintonville, Conn.

5,000 LOTS 5½x8½ Circulars, \$9.50; Ad. Slips, \$4.75; 3½x5 Four-page Folders, \$13.75. All Printing Lowest Prices. Elegant Samples Free. Good's Printery, Harrisonburg, Va.

1,000 LETTERHEADS; Envelopes, Cards or Statement \$2.95 Prepaid. Charles Champion, 4605 Wells Street, Milwaukee.

"NEARGRAVURE" Process—500 each Letterheads—Envelopes \$4.75 prepaid. Solidays, Knox, Ind.

UP-TO-DATE Business Stationary Printing. 1,000 letterheads or envelopes \$3.00. Samples. Moulton Printing Company, 1410 E. 8th, Kansas City, Mo.

250 LETTERHEADS and 250 Envelopes for \$2.50. Samples. Shephard Printing Co., Wheaton, Ill.

5,000 BOND Letterheads, \$11.75. Ewan, 49 Pearsall Ave., Jersey City, N. J.

5,000 BOND Letterheads \$15.00. Samples for stamp. Place, Harding, Mass.

TYPE, Rule, Border, Ornaments, Novelties, Leads, Slugs, Multigraph Type, Highest quality, lowest prices, immediate shipment. Send for catalogue. Trade Monotypers, 702 Pennsylvania Ave., Baltimore, Md.

500 BOND letterheads, printed, prepaid, \$1.60; 500 envelopes, \$1.60. Roe, Art Printer, Carleton, Mich.

MULTIGRAPH Type made from hardest metal, \$1.50 per 1,000 characters. Satisfaction guaranteed. Send for catalogue. Trade Monotypers, 702 Pennsylvania Ave., Baltimore, Md.

PRINTING? When it is a small order, write "Q" Shop, Roaring Spring, Penna. QUALITY Printing. Reasonable Prices. Samples free. Riley-Zaur Company, 1517 S. 48th Court, Cicero, Ill.

200 PRINTED Business Envelopes \$1.00. Commercial size. With name, business and address. Prompt service. List of 10 Big Dollar Specials Free. P. M. Kendall, Elmira, N. Y.

1,000 LETTERHEADS, Envelopes, Cards, \$3.00 postpaid; 500, \$2.25. Samples Free. Artservis Press, 68 Houghton, Worcester, Mass.

PRINTING. Lowest prices in America. Samples free. A. Pitz, Anama, Iowa.

225 BOND letterheads, envelopes, bill-headers, cards, \$1.25 each. Combination, \$4.00. Economic Press, Leonia, N. J.

WE print Stationery, Booklets, Catalogs, Circulars. Samples. Commercial Press, Batavia, Ohio.

250 LETTERHEADS, 250 white envelopes printed and mailed \$3.00. Samples printing free. Sunco, Mohawk, N. Y.

QUALITY Printing! Reasonable Prices! Send for Free Standardized samples and prices. Folders, Circulars, Catalogs our specialty. Ernest Fantus, 525 South Dearborn, Chicago.

PRINTING OUTFITS AND SUPPLIES

PRINTING Outfits, Presses, Type, Supplies. Stamp for information. Nicholas, M-110 High St., Boston.

COMPLETE printing outfits, presses, type, ink, paper supplies. Write for Catalog. Press Co., C-11, Meriden, Conn.

PRE-USED Printing Presses, Type supplies. List for 2c stamp. Popular Bargains, Richland, Pa.

PRINTING Outfits—Presses, type supplies, type novelties. Send stamp for catalogue. Model Press, York, Penna.

DUPLICATORS AND DEVICES

YOU can make 50 to 100 copies of a letter, notice, etc., at a cost of three cents on a Heyer Quality Duplicator. Write for free trial offer. The Heyer Duplicator Co., 14 S. Wells St., Chicago, Ill.

ADDING MACHINES

NEW \$3.50 Automatic Adding Machine. Adds, Subtracts, Multiplies. Absolutely accurate. Capacity \$999,999.99. Fully guaranteed. 75,000 pleased users. Makes adding easy, positive, quick. Eliminates Mistakes. Saves Time. Postpaid \$3.50. Bassett Co., 1438 R. Hollywood Ave., Chicago.

FREE Trial. Marvelous new Adding Machine. Adds, Subtracts, Multiplies, Divides, automatically. Work equals \$350.00 machine. Price only \$15.00. Speedy, durable, handsome. Five-year guarantee. Used by largest corporations. Write today for catalog and free trial offer. Lightning Calculator Co., Dept. E, Grand Rapids, Mich.

MAILING LISTS

500 CHICAGO, 500 Suburban Garages; \$3.00 Thousand; 500 \$1.50. P. Larson, 2410 North Ave., Chicago.

YOUR circulars mailed with ours. \$3.00 thousand. Shaw, Box 1373, Washington, D. C.

MAILING lists, any classification. Write Box 1373M, Washington, D. C.

NAMES—postcards—cuts. Ben Meyer, 35 West 31st, New York.

FOR SMOKERS

HOMESPUN Chewing and Smoking Tobacco—5 lbs. \$1.25; 10 lbs. \$2.50; 20 lbs. \$1.50. Hickory Ridge Farms, Mayfield, Ky.

FOR MEN

CARPENTERS: Popular Mechanics Carpenters' Handbook is filled with ideas for those who like to tinker with tools, and for professional carpenters. 40 articles on saws and sawing, 17 on benches and bench equipment, 22 on doors and door hanging, 18 on lumber, 13 on mitering, 74 on tools and their care, 22 on shop equipment, and many others—366 in all, and 229 illustrations. Send No Money. Just write a postal. Pay postman postage and \$1.50. Popular Mechanics Press, Room 802, 200 E. Ontario St., Chicago, Ill.

FOR BOYS

BOYS! Look! 250 Feet Fine Film—2,000 Theatre Tickets \$1.50 Postpaid Anywhere. Northern Theatre Supply, Duluth, Minn.

BOATS AND LAUNCHES

MAKE 16' Rowboat—Blueprint 30c. Weesha-Uco, 31st Office, Detroit.

BARKER Outfit converts Ford engines for boat use. Includes cooler, pressure oiler, thrust bearing, propeller, shaft and fittings. Barker Factory, Pine Island, Norwalk, Conn.

FORD propelled speedboat, easily built; blueprint and directions, sixty cents. Marine cooler booklet free to Ford boat owners. C. C. Hubbell, 4B East Ave., Norwalk, Conn.

BUILD your own boat. Do your own concrete work. Two new books tell how to make 21 kinds of boats and 173 articles from concrete. Each book filled with pictures. Send No Money. Just write a postal and say, "Send Popular Mechanics Boat Book and Concrete Handbook." Pay postman postage and \$1. Popular Mechanics Press, Room 802, 200 E. Ontario St., Chicago, Ill.

RAZORS AND BLADES

SAFETY blade stropper. It sharpens them all; \$1.50. F. Wallace Kutz, 132 Chamber St., Phillipsburg, N. J.

FOR THE HOME

MEN! Women! Make \$1 an Hour at Home. Weaving Colonial Rugs, genuine fluff rugs, fancy fabrics, from new and other materials. Home weavers always busy. You learn in 30 minutes. We guarantee it. Looms now as low as \$9.90. Liberal Pay-As-You-Weave terms. Solve your more-money problem by writing for Free Loom Book today. Union Loom Works, 480 Factory St., Boonville, N. Y.

GRANDFATHER'S Clock Works. \$5.00. Build your own case; Instructions free; make good profits selling your friends. Clock works with chimes for old or new cases. Write for full particulars. Clock Co., Ruffner St., Philadelphia.

FURNITURE: Make Furniture at Home. Popular Mechanics books tell how to make all pieces. "Mission Furniture and How to Make It, Book 1, Book 2, Book 3." Send No Money. Just write postal. Pay postman postage and \$3. Popular Mechanics Press, Room 802, 200 E. Ontario St., Chicago, Ill.

FOODS from Twenty Lands. Popular Mechanics new Cook Book made up of recipes sent by our readers from 20 countries. Many delightful foreign dishes, and many American ones, too. Only a few copies for sale. Send No Money. Just order on a postal. When postman hands you book, pay \$1.50 and postal charges. Popular Mechanics Press, Room 802, 200 East Ontario St., Chicago, Ill.

COMMERCIAL work. Directions for decorating with pressed leaves, antique painting, preserving plants, bouquets of colored grass, tree cone decoration, fungi decoration, decalcomania, diaphane, gas-light pictures, crystallized grasses, Grecian painting, copper impressions of leaves, skeleton leaves, leather work, modeling in clay, moss work, monochromatic drawing, paper flowers, pearl work, ornamenting with shells, etching shells, transparencies. All this and much more in "Youman's Household Guide." Send No Money. Just order on postal. When postman hands you book, pay \$2 and the postal charges. Popular Mechanics Press, Room 802, 200 East Ontario St., Chicago, Ill.

DIAMONDS, WATCHES AND JEWELRY

OUR New Jewelry and Novelty Catalogue is Just Out. Marko Bros., 3027 Logan, Chicago, Ill.

15 JEWEL Swiss watches, Cheap. Ralph B. Pile, Somerset, Penna.

ANTIQUES, WAR RELICS AND INDIAN GOODS

RELICS from Europe's battlefields. Weapons, medals, etc. Illustrated catalogue 25c (with sample War Photographs). Lieut. Welsh, 1889 Albany Ave., Brooklyn, N. Y.

SEND 5c for fine, new list Indian relics, antique firearms. F. E. Ellis, Webster Groves, Mo.

PHONOGRAPHS AND SUPPLIES

BUILD your own Phonograph. We furnish everything. Phonograph Parts and Radio catalog sent free. American Phonograph Co., 3752 Belmont, Chicago.

BUILD Your Phonograph. Spring Motors, Electric Motors, Tonearms, Amplifiers, Accessories. Latest Equipment also in Radio Mechanism and Cabinets. Catalog mailed for ten cents. Hoosier Mfg. & Supply Co., 313 Baldwin Block, Indianapolis, Ind.

MUSIC AND MUSICAL INSTRUMENTS

BAND and Orchestra Instruments—All makes of new and used instruments sold, exchanged and repaired. Standard and popular music sold. Write today for catalogue and Free subscription to "Musical Booster" magazine. "Deal with the Professional House." Crawford-Rutan Co., 1051 Grand Ave., Kansas City, Mo.

"MUSIC Composed" to words. Bauer Bros., (formerly of Sousa's Band), Oshkosh, Wis.

VIOLINS, Deep, Mellow, Soulful—on credit. Easy terms for wonderful instrument. Get details today. Gustav F. Henning, 2424 Gaylord St., Denver, Colo.

PIANO Jazz: Teaches Ear Playing, Negro Harmony, Player Piano Effects, Chimes, Blues, Chords, Sweet Harmony. Particulars Write "Piano Bill," Toronto 3, Canada.

SONG Poem Writers—Write Ray Hibbeler, DI, 2104 N. Keystone Ave., Chicago.

3,000 ILLUSTRATIONS all Musical Instruments and fittings you could want in our 100 page Catalogue Free for postal card with your name and address. Agents wanted. Willard Bryant Music House, 125 Broadway, Detroit, Mich. Established 1893.

WILL sell my Violin, \$17.25, for Conservatory outfit complete. Miller, 7323 Dorcas St., Foxchase, Pa.

CORNETISTS—Trombonists—Saxophonists—Clarinetists. Get "Free Pointers." Name Instrument. Virtuosi School, Concord, Mass.

SAXOPHONE quickly taught by time-saving charts. Nothing like them. Musical training unnecessary. Particulars free. California Music Studios, 950 Dale St., Pasadena, Calif.

I WANT Song Poems. Casper Nathan, 2544 N. Racine, Chicago.

WRITE Songs. Big money and reputation. Write for information. J. Gordon Pub. Co., 201 N. Hoyne Ave., Chicago.

VIOLINS—Handmade Masterpieces. Easy Terms. Illustrations Free. Kenneth Klugh, Ridgway, Penna.

PATENT ATTORNEYS

U. S. AND foreign patents, trademarks; moderate rates. 22 years' experience. George C. Heinicke, 32 Union Square, New York; registered in U. S. and Canada.

PATENTS and Trade-marks obtained. Prompt service. Write for our new book on patents. Established in 1889. D. Swift & Co., 309 7th St., Washington, D. C.

PERCY S. WEBSTER, 203 Saving and Loan Building, Stockton, California. Long established organization. Send for free book on Patents.

PATENTS: My fee in installments. Free personal advice. Frank T. Fuller, Washington, D. C.

ESTABLISHED 1864. Milo D. Stevens Company. Free Booklet, Patents, Trade-Marks, Copyrights. Offices, Monadnock Block, Chicago; Barrister Building, Washington, D. C.

PATENTS—Prompt Personal Service. Send for Record of Invention Form. Send sketch or model. References furnished. Write today. Jacobi & Jacobi, Patent Lawyers, 600 Ouray Building, Washington, D. C.

RICHARD E. BABCOCK, Patent Lawyer, Washington Loan & Trust Bldg., Washington, D. C. Established 1877. Booklet.

MILLIONS spent annually for ideas! Hundreds now wanted! Patent yours and profit! Write today for free book—tells how to protect yourself, how to invent, ideas wanted, how we help you sell, etc. American Industries, Inc., 500 Kresge Bldg., Washington, D. C.

INVENTIONS Patented; Trade-marks Registered; reasonable charges; prompt service; plain advice; request particulars. Jaynes & Jaynes, 700 Kellogg, Washington, D. C.

MONROE E. MILLER, Ouray Bldg., Washington, D. C., Patent Lawyer; Mechanical, Electrical Expert. Booklet and Priority Record blank gratis.

PATENTS, Trade-Marks, Designs. This firm has 27 years' experience and gives expert personal service at reasonable rates. We properly protect your invention. Write for free information and exact cost of procuring patent before proceeding. John B. Thomas & Co., 902 F St., N. W., Washington, D. C.

PATENTS. Time counts in applying for patents. Don't risk delay in protecting your ideas. Send sketch or model for instructions or write for Free Book "How to Obtain a Patent" and "Record of Invention" form. No charge for information on how to proceed. Communications strictly confidential. Prompt, careful, efficient service. Clarence A. O'Brien, Registered Patent Attorney, 58D Security Bank Building (directly across street from Patent Office), Washington, D. C. See pages 149 and 141.

PATENTS—Write for our Guide Books and "Record of Invention Blank" before disclosing inventions. Send model or sketch of your invention for Free Inspection and Instructions. Terms Reasonable. See advertisement on pages 142 and 143. Victor J. Evans & Co., 934 Ninth, Washington, D. C.

FRED H. HAYN, M. E., formerly First Assistant, Examiner U. S. Patent Office, 24 years' exp. I. W. Hellman Building, Los Angeles, Calif.

LACEY'S Patent Sense. Valuable book free. See ad page 145.

PROTECTIVE Patents at Fair Prices. Drawings, specification, claims, \$20. Send description with half fee. Prompt, efficient service. American Patents Corporation, Barrister Building, Washington, D. C.

PATENT Procured. Prompt Service. Personal, careful and efficient service. Highest references. Moderate fees. Send sketch or model for actual search and advice. George P. Kimmel, Master of Patent Law, 55D Legal Bldg., Washington, D. C.

PATENTS—Send for form "Evidence of Conception" to be signed and witnessed. Form, fee schedule, information free. Lancaster and Allwine, Registered Patent Attorneys in United States and Canada, 221 Ouray Bldg., Washington, D. C.

COMMERCIALIZE your inventions according to My Cooperation Plan before patenting. Write for booklet. Ralph Buren, Patent Lawyer, Jenifer Building, Washington, D. C.

PATENTS Procured; Trade Marks Registered—A comprehensive, experienced, prompt service for the protection and development of your ideas. Preliminary advice gladly furnished without charge. Booklet of information and form for disclosing idea free on request. Richard B. Owen, 30-Owen Bldg., Washington, D. C., or 41-R Park Row, New York.

UNPATENTED Ideas Can Be Sold. I tell you how and help you make the sale. Free particulars (Copyrighted). Write W. T. Greene, 807 Jenifer Building, Washington, D. C.

PATENTS. Booklet free. Highest references. Best results. Promptness assured. Send model or drawing for preliminary examination. Watson E. Coleman, Patent Lawyer, 644 G Street, Washington, D. C.

INVENTORS—Write for our Guide Book, "How to Get Your Patent" and Evidence of Invention Blank. Send model or sketch of your invention for our prompt examination and instructions free. Randolph & Co., Dent, 430, Washington, D. C.

INVENTORS: Send sketch or model for advice and exact cost of patent. Ask for our Free book: "How to Obtain a Patent." Tells what every inventor should know. Established twenty-eight years. Highest references. Prompt service. Reasonable charges. Chandler & Chandee, 474 Seventh, Washington, D. C.

MEXICAN Patent Attorney. Patents and Trade-Marks procured for Mexico. References. R. Alcala, Donceles 80, Mexico, D. F.

PATENTS, Trade-Marks, Copyrights. Very reasonable. Sanders, 7 Rand McNally Building, Chicago, Ill.

PATENT Book Free. Charles W. Lovett, Patent Attorney, Lynn, Mass.

"INVENTOR'S Advisor," the valuable Patent book with 139 mechanical movements and illustrations, sent free upon request. M. Labiner, Patent Attorney, 3 Parkrow, New York.

PATENTS—Our book "How to Obtain a Patent" sent free upon request. Contains full information about patents, trade-marks and designs. If you will send us a sketch of your invention we will promptly make search of the Patent Office records and advise you as to patentability, our charge for the service being \$5.00. Prompt, efficient service with moderate charge. Over twenty years' experience. Bank and commercial references. Talbert & Talbert, Registered Patent Lawyers, 597 McGill Bldg., Washington, D. C.

"INVENTORS' Guide" sent free on request; this book contains illustrations of patented inventions and gives valuable information and advice for all who have original ideas or improvements. Frank Ledermann, Registered Attorney and Engineer, Woolworth Bldg., 1712, New York.

FOR INVENTORS

PATENTS. If you have an invention which you wish to patent you can write fully and freely to Munn & Co., for advice in regard to the best way of obtaining protection. Please send sketches, or a model of your invention and a description of the device, explaining its operation. All communications are strictly confidential. Our Handbook on Patents is sent free on request. This explains our methods, terms, etc. in regard to Patents, Trade Marks, Foreign Patents, etc. "Scientific American" contains Patent Office Notes, Decisions of interest to inventors and particulars of recently patented inventions. Munn & Company, Solicitors of Patents, 623 Woolworth Building, New York; 521 Scientific American Bldg., Washington, D. C.; 1313 Tower Bldg., Chicago, Ill.; 866 Hobart Bldg., 582 Market St., San Francisco, Calif.; 521 Van Nuys Building, Los Angeles, Calif.

INVENTORS—Write for our Guide Books and "Record of Invention Blank" before disclosing inventions. Send model or sketch of your invention for our free inspection and instructions. Terms reasonable. See advertisement on pages 142 and 143. Victor J. Evans & Co., 157 Ninth, Washington, D. C.

LACEY'S Patent Sense. Valuable book free. See ad page 145.

IF you have ideas I will instruct you how to apply for patent yourself that protects and make inventions practical, 25 years' experience. Address Henry Fletcher, 53 Cannon St., Bridgeport, Conn.

PATENTS. Time counts in applying for patents. Don't risk delay in protecting your ideas. Send sketch or model for instructions or write for Free Book "How to Obtain a Patent" and "Record of Invention" form. No charge for information on how to proceed. Communications strictly confidential. Prompt, careful, efficient service. Clarence A. O'Brien, Registered Patent Attorney, 58D Security Bank Building (directly across street from Patent Office), Washington, D. C. See pages 149 and 141.

PATENTS: My fee in installments. Free personal advice. Frank T. Fuller, Washington, D. C.

INVENTORS Universal Educator—contains 999 mechanical movements; 50 perpetual motions. Tells how to obtain and sell patents. Suggests new ideas. Explains how to select your attorney and avoid patent sharks. Price (revised edition) \$2.00 postpaid. Albert E. Dieterich, 621-Ouray Bldg., Washington, D. C.

I SELL Patents. Established in 1900. The only man in America who has spent the past 25 years exclusively at this work. An experience highly valuable to you. If you have a good patent to sell. Charles A. Scott, 753PM Garson Avenue, Rochester, N. Y.

INVENTORS—Preliminary investigations only to determine if your inventions are patentable. Neither preparing nor prosecuting applications for patents. I am in a position to give you honest opinions. Communications secret. R. Emmitt Patterson, 635 F St., N. W., Washington, D. C.

CASHING In—If you have a practical, useful invention to sell, write promptly. American Patents Corporation, Barrister Building, Washington, D. C.

PERPETUAL Motion or any other mechanical models can be constructed with our Standard set of model parts. Our monthly reports keep you informed latest developments toward perpetual motion. Write for interesting information. Progressive Association, Westville, Conn.

RESPONSIBLE Company having wide distribution wants boiler room or steam specialty to add to present line. Highest references. 1301 Schaff Building, Philadelphia, Pa.

PATENTS wanted by manufacturers; send description and number. Box 126, Dowagiac, Mich.

HAVE You an invention? If so, write for our free book, "How to Get Your Patent," tells our terms and methods. Send model or sketch for our free examination and instructions. Randolph & Co., Dent, 144, Washington, D. C.

GET your own patents. Legal blanks, complete instructions \$1. Cutting Sons, Campbell, Calif.

PATENTS Procured; Trade Marks Registered—A comprehensive, experienced, prompt service for the protection and development of your ideas. Preliminary advice gladly furnished without charge. Booklet of information and form for disclosing idea free on request. Richard B. Owen, 30-Owen Bldg., Washington, D. C., or 41-R Park Row, New York.

UNPATENTED Ideas Can Be Sold. I tell you how and help you make the sale. Free particulars (Copyrighted). Write W. T. Greene, 807 Jenifer Building, Washington, D. C.

PATENTS FOR SALE

FOR Sale or Trade, Patent No. 1,311,365, on a Harrow. Address V. Foch, Eugene, Oreg.

INVENTIONS For Sale—Unusual opportunities. Manufacturers and investors write W. T. Greene, 819 Jenifer Bldg., Washington, D. C.

AMERICAN Rights For Sale. Twisting Machine, whereby the Bobbins or Spools are stationary and out of Cylinder; Patent No. 1,386,233, good for the Textile, Wire Rope and Rope Industries. D. Louis, 2332 Prince Edward St., Vancouver, B. C., Can.

U. S. PATENT 1,526,599, Canadian Patent 253,188, on Mothproof sheet-metal lined clothes cabinet, having rubber padding strins around doors making it airtight. Also removable sections on top. Mrs. Alice Hewett, Wakonda, S. D.

LATEST folding toothbrush invention assures users of a clean, sanitary toothbrush. Simple, inexpensive and durable. A. G. Ingle, Pomeroy, Wash.

PRESSED Tin Manufacturers: Improved methods of sealing lids for receptacles. U. S. Patent 150,200; Canadian 243,108. For sale or royalty. Big demand. Address S. B. Clifford, Chamber of Commerce, Winnipeg, Canada.

OUTRIGHT or Royalty—U. S. and Canadian patents on burglar proof device of exceptional merits. Attached in few seconds and manufactured at small cost. P. T. D'Almaforte, 257 San Gabriel Court, Sierra Madre, Calif.

INVENTOR of clever and useful precision instruments and tools desires financial backing. Address, Hoyer, c/o Richard B. Owen, Washington, D. C.

CIRCUIT Breaker, 1,539,451. First Movable fulcrum lever, causes extremity of lever travel as desired. Patent unrestricted. Walter Willis, Easton, Md.

PATENTED newspaper holder, Prevents wind from carrying paper away. Easy to manufacture. Make cash offer. Andrew R. Lezare, Crisfield, Md.

AUTOMATIC Safety Damper or Draft Regulator for furnace; cannot overheat. W. J. Pfeifer, 167 N. Taylor Ave., Oak Park, Ill.

FOR Sale—U. S. Canada Patents Combined; Shade and Curtain Rod Brackets. Cash or Royalty. Write Frank J. Fell, 1918 Dalzelle St., Detroit, Mich.

OUTRIGHT or royalty; recently patented, low speed pedal control, for Ford cars and trucks; patent No. 1,560,621. J. J. Swanson, Elgin, Nebr.

PATENT for Sale or on royalty. For breeding Skunks and like animals. Constructed so you can get the animals when the fur is prime. J. A. Smithline, Lockbridge, Iowa.

BOBBED Hair Rage, Patented Sanitary Self Cleaning Comb. Combination Comb Case and Cleaner. Absolutely cleans comb by withdrawing in Case. Write, Carl Duede, Stuart, Iowa.

PATENT No. 1,517,699, Brake tester; patent No. 1,501,196 gasoline saving device. \$100.00 each. W. J. Bliffert, 1359 7th St., Milwaukee, Wis.

FOR Sale—Patent on Self-propelling floor surfacing machine. G. C. Walter, 935 Broadway, Denver.

FOR Sale—Patent on Improved Door Lock. This is a very practical and valuable invention which should meet with ready market. Preferably sell outright but will consider royalty proposition. Address Wm. S. Callery, Dixon, Calif.

AUCTION sale cabinet. This clerking cabinet is so efficient over all of the clerking systems now on the market that there is no comparison. The inventor had a model made which he has used over six months. The sales are filed alphabetically and no matter how many and at what times the settlements can be made instantly. The change, checks, and notes can be made without delay. In fact, the clerk can have a complete settlement at the same time the auctioneer closes the sale. Charles C. Carek, Cashier State Bank of Touhy, Touhy, Nebr.

PANTOGRAPH—Absolutely New Invention. Different idea from any other. So simple child can operate it. Cheap to manufacture. Will be money maker if handled right. Sell patent or partner to manufacture. Have light machinery. Geo Mattila, 8216 South Vermont Ave., Los Angeles, Calif.

SHOP rights for sale, very cheap process for keeping bores of gears and pinions soft during carbonizing and hardening. L. E. Everist, 1938 Harvard Ave., Chicago, Ill.

AUTOMATIC Paper Feed for Sanitary Headrest for Barber Shops, Beauty Parlors, etc. Pat. No. 1,426,837. Aug. T. Pattimore, 5033 U St., Sacramento, Calif.

HAVE for Sale on Royalty—Portable Thawing Transformer with Combination Hookups for different size pipes from 1/2" to 4" and 10 feet to 300 feet long; operates on 110 volt A.C. current. Thaws through concrete or anywhere hard to get to in a few minutes. Patent pending No. 62,641. F. S. Whitmore, 1118 E. 5th Place, Tulsa, Okla.

FOR Sale, Outright—United States and Canadian Patent—United States Patent No. 1,506,459. Mechanical Device for lifting and lowering Seat and Cover of Toilet Bowl. William Street, 103 W. 127 St., New York City.

PATENT for Sale, or royalty basis. Combination kitchen table and ice box. Practical household article, especially adaptable to small apartment. A. M. Brown, 804 32d St., Milwaukee, Wis.

OUTRIGHT or Royalty; newly patented device for trapping gophers. Easily manufactured. Frank Ferris, Cummings, Kans.

PATENT for Sale. Kitchen article; cost 10c to manufacture. P. Bally, 5249 Oak View Ave., Eagle Rock City, Calif.

FOR Sale, Patent on Head-light with Automatic dimmers, better road lighting, no blinding glare. Cash or royalty. Carl Cooper, Route 4, Huntington, Ind.

FOR Sale, Fly Catcher. Patented April 21, 1925, No. 1,534,771. Outright or Commission. August Cvenegros, 607 Second National Bldg., Akron, Ohio.

"BLESSING-INESTIMABLE"—the cry, (ended dreadfulness of drudgeries). Wildfire any price. Get sample. Fredrick Packlind, Detroit, Minnesota.

YOU have a worth-while patent, haven't you? Why don't you tell our two million five hundred thousands readers about it? Most of them are specially interested in patents and new inventions. Ask me to tell you how other inventors successfully sold their patents. M. L. Rund, Manager Classified Advertising, Popular Mechanics Magazine, Chicago, Ill.

FOR Sale, Patent, Improved Flour Sifter, Outright or Royalty Basis. Harry Nakagawa, Tanana, Alaska.

OUTRIGHT—U. S. and Canadian—Newly patented improvements in non-skidding devices for automobiles. Simple in construction and attachable to any wheel. J. Urbaneck, 1308 W. 52nd St., Chicago, Ill.

FOR Sale outright—United States and Canadian patent on Improved Window catch device. Burglar proof and absolutely reliable; easy and cheap to make. Now, Manufacturers, here's your chance to make money. What offers? Sam R. Wallen, Chase, B. C., Canada.

PATENTS—Clevis; Musical Instrument; Tuck Gauge; Sheet Music Turner; Disk Plow Scraper. Talbert & Talbert, McGill Bldg., Washington, D. C.

SURVEYING INSTRUMENTS

LARGEST stock of new and used surveying instruments in the country direct from factory. Satisfaction guaranteed or money refunded. Wissler, 619 N. Broadway, St. Louis.

DRAWING INSTRUMENTS AND SUPPLIES

MECHANICAL Drawing, and Designing Work. Information on any technical subject \$1.50. Inventions perfected. Write for free particulars Tobler Mechanical Engineering Bureau, Box 295, Waterbury, Conn.

MODELS AND MODEL SUPPLIES

PATENTS. Time counts in applying for patents. Don't risk delay in protecting your ideas. Send sketch or model for instructions or write for Free book "How to Obtain a Patent" and "Record of Invention" form. No charge for information on how to proceed. Communications strictly confidential. Prompt, careful, efficient service. Clarence A. O'Brien, Registered Patent Attorney, 58D Security Bank Building (directly across street from Patent Office), Washington, D. C. See pages 140 and 141.

MODEL Steam plant for miniature power boats. Fired by Sterno heat. Absolutely safe and easy to handle. Steel boiler with 12 water tubes will keep 50 lbs. pressure with engine wide open. Send 4c stamp for circular S. Model Machine Shop, 417 East 71 St., New York City.

HULIT & Co., General Model Makers, 625 W. Jackson, Chicago, Ill. Specializing in high-grade model work on inventions of merit. Complete Equipment, Experienced Workmen.

DIES, Tools and General Manufacturing. Models and Manufacturing of new inventions or specialty. Logan Machine Co., 126 S. Clinton St., Chicago, Ill.

MODEL Steam Engines, Boilers and Model Pipe line fittings. Model Making Supplies. Send 20c for this year's illustrated catalogue and hand book. Bathe Mfg. Co., Dept. D., 5214 Woodland Ave., Philadelphia.

SPECIAL machine builders, tool and die makers, inventor's models, production work of all kinds. Dent, L. Quality Hardware & Machine Co., Ravenswood and Thorndale Avenues, Chicago, Ill.

WE make working models for inventors and do experimental work and carry a complete stock of brass gears and model supplies. Send for catalogue. The Pierce Model Works, Tinley Park, Ill.

THE Modelmaker, a magazine for all interested in making working models. Sample 10 cents. Modelmaker, 122 Liberty St., New York.

STANDARD Set of model parts make perpetual motion and other models. Save money. Write. Progressive Association, Westville, Conn.

MODEL Railway Cars to Order. John Woodlens, New Port Richey, Fla.

PLANS—Architectural, Commercial, Ten Dollars Up. Union Service, Liberty, Ind.

ACCURATE Working Drawings Made from Sketches. Rates on request. Ray Hanson, Thor, Iowa.

MANUFACTURING

METAL-CRAFT—Eventually—Metal-Craft. Competent Engineers, Designers and Producing Organization await your commands on dies, stampings, die-casting, deep pressing, screw-machine and wire products. Plating. Enameling. Burnishing. Assembling. Wrapping and Packing to your specifications. Large completely equipped plant which guarantees prompt, efficient service. It is not the quality of raw materials alone, nor the precision in manufacture, and not just the service rendered that has given Metal-Craft the good reputation they bear—but all of these, as a constant certainty. In Combination. Estimates promptly furnished. Metal-Craft Manufacturing Company, Chicago, Box 259-W.

MACHINE Work. A well-equipped machine shop, having small overhead expense, desires to take on an additional line of machinery to manufacture, or a line of articles such as can be made to advantage in a machine shop. In accordance with such a desire, correspondence with a reliable and established selling organization having its product manufactured by an outside firm, is solicited. References will be furnished and respectfully requested. L. H. Bradley, 270 Fifth St., Bridgeport, Conn.

LET us manufacture it for you. Can quote low prices and can furnish a product you would be proud of. Ideas worked out and simplified. Models made. Metal parts made to drawings or sample. Simplex Tool Co., Woonsocket, R. I.

MANUFACTURING concern wants another line. Present product insufficient. Flery-Deshler Mfg. Co., Bangor, Pa.

WE design and build special machinery, make models, dies, stamping tools, do general machine work and light manufacturing. Marshall Mfg. Co., Kansas City, Mo.

If you have work that could be done by machine for fraction of cost write me. I designed and build effective special machine. Henry Fletcher, 53 Cannon St., Bridgeport, Conn.

RUBBER articles developed and manufactured. Middle States Rubber Corporation, Independence, Mo.

WE design and build special machinery, tools, dies, jigs, and fixtures. Experimental work. Light stamping, quantity production. Reliable Machine Co., 400 West 23rd St., New York City.

WIRE goods made to order. Cooley Mfg. Co., 530 N. Western Ave., Chicago.

METAL Stampings, Dies and Special Machinery. Mail us your drawing or sample for estimate. Send for our free catalogue of Model Supplies. The Pierce Model Works, Tinley Park, Ill.

LIGHT stamping and manufacturing. Acme Tool Co., Mason City, Iowa.

OUR factory will make your models, manufacture your articles as well as build your tools, dies and fixtures. Standard Die & Specialty Co., 1932 Austin Ave., Chicago, Ill.

MANUFACTURING. Models. Dies, Stampings, Brass Work, one or thousands. Baum's Metal Specialties, Kansas City, Mo.

PATTERNS, wood and metal. Models, tools and dies. Brass, bronze, aluminum and iron castings. Screw machine work, production work of all kinds. Write Modern Machine & Pattern Co., Terre Haute, Ind.

FOR MECHANICS

66 MILES on 1 Gallon. Wonderful Scientific Gas Saver. All autos. 1 free demonstrator. Critchlow, X-124, Wheaton, Ill.

KINKS on metal Work. Popular Mechanics New Book, "Machinist's Kinks" contains 419 discoveries of extreme value to anyone who likes to work with metal. For the mechanic, machinist, or for the man who likes to tinker at home, 287 illustrations. Cloth bound. Send No Money. Just write a postal asking for "Machinist's Kinks." When the postman hands you the book, pay the few cents postage and the price of the book, \$1.50. Popular Mechanics Press, Room 802, 200 E. Ontario St., Chicago, Ill.

DYKE'S Automobile and Gasoline Engine Encyclopedia. The latest edition contains information on repairing and adjusting every part of every motor car now in use. Tells how to find out what is wrong and how to fix it. Mechanics everywhere depend upon this compendium to keep them up-to-date. Send No Money. Just ask for Dyke's Auto Encyclopedia on a post card. When the postman hands you the book, pay the few cents postage and \$6. Money back if not delighted. Popular Mechanics Press, Room 802, 200 E. Ontario St., Chicago, Ill.

ELECTRICAL

ELECTRICAL Dictionary—Cloth Binding—20c. 2,400 terms—67 Electrical Diagrams—Compiled by chief-engineer Cooke. Every Electrical man needs this handy vestpocket dictionary to carry with him on the job. It's a wonder! Electrical Terms fully explained in simple words. Wiring and radio diagrams included. Nearly 200 pages of valuable "dope." Get this little book today—send 20c—two dimes—for your copy. We pay postage. Money refunded if you want it. Chicago Engineering Works, Dent, D-512, 2154 Lawrence Ave., Chicago, Ill.

ELECTRICAL Kinks on all phases of practical electricity are to be found in Popular Mechanics new book, "Electrical Kinks." There are 47 ideas on wiring, 45 on making electrical devices, 19 on lighting, 5 on transformers, 5 on motors, 8 on generators, 11 on switches, 22 on testing, 12 on repairing, 11 on battery manufacture and repair, 5 on telephones, and 9 on electrician's tools. 214 articles, 162 pictures. Send no money. Just write a postal asking for "Electrical Kinks." When the postman hands you the book, pay the few cents postage, and \$1.50 for the book. Popular Mechanics Press, Room 802, 200 E. Ontario St., Chicago, Ill.

MACHINERY, TOOLS AND SUPPLIES

NO. 60 Hand Auto Cylinder grinder, \$750.00; No. 2 Cincinnati Milling machine, \$275.00; 21" Hendy Shaper, \$325.00; 16" X8" Bradford Engine lathe, \$300.00; Barnes 20" Drill Press, \$55.00; 24" Woodworker Planer, \$175.00; 26" Band Saw, \$65.00. Terms to suit on single machine or complete shop. Complete line of machinery and supplies. Cincinnati Machinery & Supply Co., 218 E. Pearl St., Cincinnati, Ohio.

SALE or trade—watchmakers lathe; Corona Typewriter; violin; 250-3000 Savase carbide; 5 KW-110V-DC Generator; American Shingle Mill; Oregon Broadleaf curly maple violin backs. Want machine lathe; motor; Saxophone; electric drill; small gas welder; jointer. 260 High St., Eugene, Oreg.

SPECIAL labor saving machinery designed and built. Punches and Dies and other special tools furnished for manufacturing work. Simplex Tool Company, Woonsocket, R. I.

\$21.50 FOR new concrete mixers. Send for catalogue. A. & C. Mfg. Co., Bedford, Ind.

BELT Dressing that Stays longer and Pulls more; one Quart \$2.00 or Formula \$5.00. Crowley Welding Plant, Crowley, La.

CONCRETE Building Block Machines and Molds. Catalogue free. Concrete Machine Co., 5 N. Main St., St. Louis, Mo.

ENGINES, MOTORS AND DYNAMOS

GENERATORS for radio transmitters \$8; microphones \$1; microphone transformers \$3. Transmitting supplies. R. Wood, 38 Way Ave. Corona, New York.

GUARANTEED new 1/2 H.P. single phase repulsion induction motors, heavy duty, \$30.50; other bargains. Arthur Wagner Company, 701 Washington Blvd., Chicago, Ill.

GUARANTEED 1/2 hp. 110 volt, 60 cycle, single phase, used motors with pulley at \$7.50, cash with order. We repair, rewind, electric motors and generators, etc. Bargains on electric fans. General Distributing Co., Security Storage Bldg., Duluth, Minn.

BRAND new 3/4 H.P. 110 V Direct Current motors \$4.65. Also bargains in larger motors. Queen City Electric Co., 1736 Grand Ave., Chicago, Ill.

THINKING of Electric Motors? Real Bargains. All sizes, all kinds, both new and rebuilt. Tell us your needs. Motors repaired and exchanged. Send for our price list. Hyre Electric Co., 615 RH South Dearborn Street, Chicago, Ill.

BRAND new 1 KW Westinghouse, 32 volt, 1,150 speed, light and power Generators at \$18.00 each. 25% cash, balance C.O.D. General Distributing Co., Security Storage Bldg., Duluth, Minn.

BENDING MACHINES

THE famous Hossfeld Wrenchless Universal Bender is the last word in bending machines; bends metal, cold or hot, into most any conceivable shape, including Eye-bolts and Automobile Spring Eyes. Bends up to 1" bars or 1 1/4" Pipe cold. Used by the largest corporations, yet so inexpensive that even a farm shop need not be without one. Send for circular. Hossfeld Mfg. Co., Box 344, Winona, Minn.

BLACKSMITHS

BLACKSMITH Notice: Young smith or handy man make more money doing hard jobs easy. In job shop or factory be a Master Machine and Plow Blacksmith and Expert Tool Dresser. With Colored Tempering Charts. All for One Dollar. Samples Free. W. M. Toy, Sidney, Ohio.

FOR SALE—MISCELLANEOUS

PURE Delicious Honey or Maple Syrup, quart 80c, gallon \$2.50. Comb chunk honey, 5-lb. pail \$1.15 f.o.b. Fay Barber, Lowville, N. Y.

KARSTADT'S Mammoth Pecans, genuine hand graded paper shells, pound \$1.50; ten pounds \$12.50. W. Karstaedt, Dayton, Ohio.

ADDRESSOGRAPHS. Letter Folders, Multigraphs, Envelope Sealers, Duplicators, less than half price. Guaranteed. Pruitt Co., 117 No. Market, Chicago.

LATEST Self-Propelling floor surfacing machine, 935 Broadway, Denver, Colo.

BUY—Exchange—Sell! Many of our readers have for sale or exchange the article you are looking for—and lots of them are looking for the very items you want to turn into cash. Get together! Let our two million five hundred thousand readers know your wishes—they'll help you! Send your ad today to M. L. Rund, Manager Classified Advertising, Popular Mechanics Magazine, Chicago.

WANTED—MISCELLANEOUS

MAIL us your discarded Jewelry, Gold, Crowns and Bridges, Watches, Diamonds, Silver, Platinum, and old False Teeth. Money promptly mailed. Goods returned if offer refused. United States Smelting Works, (The Old Reliable), Dent, 71, Chicago.

CASH sent immediately for gold, silver, platinum, diamonds, watches, bridge-work, crowns, and all valuables. Satisfaction guaranteed. Dept. 50, Busch Products, 2360 Eighth Ave., New York.

CASH Money for diamonds, old gold, platinum, silver, old watches, gold crowns, bridgework. Cash by return mail. Petersen, 2010 S. Division, Grand Rapids, Mich.

MAIL us your Platinum, magneto points, Discarded Jewelry, Diamonds, Old Gold, Silver, Gold Crowns, Bridgework. Cash promptly mailed. Your goods returned if offer refused. D. Davis, 1726 Roosevelt Rd., Chicago.

SWAP!—Buy!—Sell! Anything!—Anywhere! What have you to offer? Wm. Ortman Co., Post Office Box 673, Milwaukee, Wis.

REAL ESTATE, FARM AND ORCHARD LANDS

LESS than \$1 per Acre. 4 1/2 acres on Georgian Bay, \$10.50. 12 1/2 acres fur farm, \$13.20. 25 acres hunting campsite, \$60.30. 50 acres Muskoka Lake District, \$63.00. 100 acres Hunting and Trapping, \$91.80. 160 acres Farm, Canadian, West, \$315.00. Mining claim near mines that have paid millions, \$378.00. The very desirable properties listed above are being seized and sold for taxes, together with hundreds of other equally choice parcels of land at merely nominal prices. Many of them could not be bought in the ordinary way at ten times the price. Beautifully situated hunting and fishing camps for moose, deer, caribou, ducks, partridge, trout, whitefish, bass, etc. Summer homes, heavily wooded lands, for pleasure and investment. Easy monthly payments of \$5 upwards. Send for free illustrated list, with complete explanations. Send no money, but send for list to-day, so you will get first choice. Tax Sale Service, Room 617, 72 Queen Street W., Toronto 2, Ontario, Canada.

\$10.00 DOWN, \$3.00 monthly, buys 5 acre Cadillac, Michigan, Fruit or Poultry farm land, Camp Site or Summer Home. Near fine lakes and streams, \$200.00. Best hunting, fishing, bathing, swimming. Good auto roads. Get booklet and map. O. Hermann, 140 So. Dearborn St., Chicago.

60 ACRES Only \$1,800; Crops and 7 Cows, Pr. Horses, Calves, Bull, hog, poultry, equipment; 7-room cottage, level fields, woodlot, barn, poultry house; only few steps station and village conveniences. \$1,800 for all, part cash. Details pg. 8 Illus. Catalog. Free. Strout Farm Agency, 255-P, 4th Ave., New York City.

ATTENTION—"Get acquainted." Cash for your property. Farm, Hotel or Retail Store, no matter where located; confidential service. Hayes' Business Agency, Cincinnati, Ohio.

HERE'S your land! \$10 down and \$10 a month buys 20 acres of my best land in Cent. Mich. for \$400, or 10 acres for \$250. Write at once for free 48-page picture book. G. W. Swigart, P1259 1st Natl. Bank Bldg., Chicago.

TRUCK Land \$5 down \$5 monthly buys 40 acres Southern Mo. Price \$200. Send for list, Box 22-N, Kirkwood, Mo.

PECAN-Orange-Fig Groves "On the Gulf" Monthly payments. Guaranteed care. Big, quick returns. Suburban Orchards, Dept. M, Biloxi, Miss.

\$5.00 DOWN, \$5.00 monthly; 10 acres unimproved poultry, fruit, stock, woodland; \$100; Ozarks. Fishing, hunting, trapping. Alvin Zimmermann, 1800 N. Fifth, Kansas City, Kans.

SELL your property quickly for cash, no matter where located. Don't pay big commission. Particulars free. Real Estate Salesmen Co., Desk B, Lincoln, Nebr.

OREGON homesteads—recently opened—offer exceptional opportunities. Map and details \$1.00. Frank Thompson, Sheridan, Oreg.

FOR Sale—1,440 acres of cheap grazing land. W. E. Campbell, Bellevue, Texas.

SEEDS, PLANTS, TREES, ETC.

WANTED—Everyone interested in gardening to write for free copy of our beautiful Seed and Plant Guide. Our new specialties will interest you. H. W. Buckbee, Rockford Seed Farms, Dept. 901, Rockford, Ill.

FLOWER Lovers: Six packets choice Flower Seed 10c. Joemma, Longbranch, Wash.

DOGS AND PETS

SCOTCH Collies—Pedigreed show dogs or workers. Shipped anywhere. Welcome Arch Collie Kennels, Adams City, Colo.

RAT Terriers, Newfoundland, St. Bernards, Police Dogs. We send on approval. Descriptive circular 10c. Fairview Farm, Elmore, Minn.

BEAUTIFUL registered bull pups \$15. Bulldogs. 501 Rockwood, Dallas, Texas.

RAISE guinea pigs. Pay better than poultry or rabbits; easy to raise; little space required. We guarantee market. Particulars and booklet how to raise free. Cavies Distributing Co., 3102 Grand Ave., Kansas City, Mo.

A-1 SKUNK dog wanted. Trial asked. John Schwab, Collinsville, Ohio.

PEDIGREED German Police \$25. Collies \$18. Alredales \$15. Boston Terriers \$35. Chows, Red, \$40; All high class stock. Send in your order from this adv. C.O.D. anywhere. This is just half price. All pedigreed males. Maplewood Farm Kennels, Medway, Mass.

POLICE Dogs—Imported Studs at Service. Puppies for sale. Cherrycroft Kennels, Omaha, Nebr.

GERMAN police pups and grown dogs for sale. Veri-Best Police Dog Kennels, Portland, Ind.

SKUNK-CULTURE for Profit. That's the name of the book that tells how to make good money raising skunks for fur. Big prices for skins. Pleasant occupation. Can be raised on town lot. Little attention necessary. Skunks make pets as nice as cats. Catch mice, too. Send No Money. Just write a postal and ask for "Skunk Culture for Profit." When postman hands you this 142-page illustrated book, pay him \$1.50 and the postal charges. Popular Mechanics Press, Room 802, 200 East Ontario St., Chicago, Ill.

PERSONAL

UNUSUAL Horoscope Consisting of Extensive four page Special Horoscope, and Astro Analysis. Send 50c and birthdate. Money returned if dissatisfied. Prof. Bolles, Box 125, Cranford, N. J.

TOBACCO or Snuff Habit Cured or no pay. \$1.50 if cured. Remedy sent on trial. Superba Co., N3, Baltimore, Md.

SEND 25c and your date of birth for forecast of your vibrations for 1926. Arvel Synclare, Numerologist, Box 25, Patton, Calif.

MISCELLANEOUS

WEEDS—Cut them with cutter bar on Shaw Garden Tractor. Also plows, cultivators and runs belt machinery. Low prices. Immediate delivery. Shaw Manufacturing Company, Department C, Galesburg, Kans.

CUTS anybody can make. Simple, cheap process. \$1. Specimens, particulars, 2c stamp. M. Day, Windfall, Ind.

ARTIFICIAL Eyes. Booklet free. Denver Optic, 559 Barclay, Denver, Colo.

HOMEOPATHIC and Biochemic preparations sent postpaid to all parts of the world. Manual and booklets free. Halsey Bros. Co., 111 N. Wabash Ave., Chicago, Ill. Established 1855.

CAN You Draw? Make money at home. Something new. No canvassing. Sample and particulars 10c. "Straley," 1017 W. Mulberry, Springfield, Ohio.

MEXICAN made pistol holsters, cartridge belts, lariats, sombreros, horse-hair goods; list free. Ingersoll Leather Co., 307 Fannin, Houston, Tex.

FORMS to Cast Lead Soldiers, Indians, Marines, Trappers, Animals. 151 Kinds. Send 10c for Illustrated Catalogue. Henry Schiereke, 1034 72nd St., Brooklyn, N. Y.

GIFTS for all. Buy at wholesale price. Send for catalogue, free. I. Geiber Specialty Co., 32 Union Sq., New York, N. Y.

TRY Leroy Pens for Lettering. Pen and Socket 75c. Edgar Bourquin Manufacturer, 1253 Main Street, Waltham, Mass.

GET posted—good prices paid for butterflies, insects. See Sinclair display advertisement, page 18.

A PEN and Ink sketch of your face 10" by 13". Send photo and \$1.00. L. L. Knight, Box 235, Encinal, Texas.

OUR proposition will help you to get big money daily. Legitimate working plan and formula. \$1.00 bill. Henry Peter Bergman, 802 East 3rd St., Tulsa, Okla.

PLAY Piano by Ear! A Sound system. Write for free booklet. You'll be glad you did! Boucher's Harmony Studio, 127 Metcalfe St., Ottawa, Canada.

LOCKSMITHING, complete 500 tricks of the trade, new edition, many added features. \$1.50, money back if dissatisfied. H. Routson, 3406 Andover St., Oakland, Calif.

MIRRORS Re-Silvered at Home. Costs Less 5 cents per square foot; you charge 75 cents. Immense profits, plating autoparats, reflectors, tableware, stores. Refinishing metalware, etc. Outfits furnished. Write for information. Sprinkle, Plater, 288, Marion, Ind.

\$3.50 POCKET automatic adding machines. Absolutely accurate. Fully guaranteed. Bassett, 1458-S, Hollywood Ave., Chicago.

66 MILES on 1 Gallon. Wonderful Scientific Gas Saver. All autos. 1 free, demonstrator. Critchlow, Y-124, Wheaton, Ill.

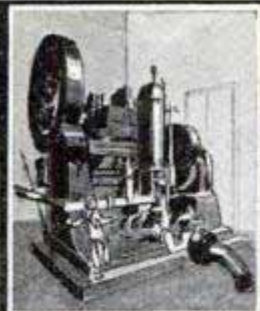

Be a Machine Draftsman—earn \$60 to \$150 a week



Be a Structural Draftsman—earn \$90 to \$200 a week



Be an Architectural Draftsman—earn \$60 to \$150 a week

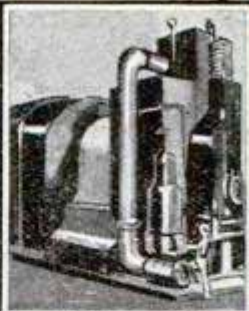

Be an Electrical Draftsman—earn \$60 to \$125 a week



Be an Auto Draftsman—earn \$60 to \$125 a week

3 Drafting Lessons **FREE!** Actually

to prove you can LEARN AT HOME, IN YOUR SPARE TIME!

We have invented a new, simplified way to teach Drafting—the first real improvement in Drafting home-instruction in history. We want you to see it, try it—without one penny of cost or obligation. We want to show you how we get away from the copying methods used in the past. See how we make you think, solve problems, do actual drafting room jobs from the first lesson!

Draftsmen Wanted \$60 to \$200 a week!

70,000 fine jobs advertised this year. Get ready to fill one. Get out of the rut. Make something of yourself. Plan your future in Drafting. Even if you have only common schooling, even if you know nothing of Drafting, we guarantee to make you a real Draftsman or to refund your money! Special surprise offer right now to the first 500 men who answer this ad—reduced price, easy terms. Coupon brings complete information.

A New, Rapid, Easier Training

Copying drafting lessons prepares you to be only a "tracer." This new "Job-Method" gives you actual drafting-room jobs in a new one-step-at-a-time way. With pictures which you can understand almost without reading the "lessons." And that is why American School-trained Draftsmen can qualify for a good job at big pay when they graduate.

Win Success Through Drafting

Drafting is easy, fascinating work. Short hours. Big pay. And the Draftsman is always in line for promotion for executive positions. This training is **Complete**. It includes high-school subjects (if you need them) and all the Engineering and Mathematics required of Drafting Experts.

Coupon Brings Three Lessons Free!

Get them. Test your own ability to learn Drafting and get ready for a fine job and big pay. Coupon also brings surprise offer, and complete information about your opportunities for success in Drafting.

Mail It Today!

FREE Job Service

Our employment department will help place you in a good job. Demand exceeds the supply. No charge for nation-wide employment service. Read want-ads for Draftsmen every day in Chicago Tribune or any big city paper—see the opportunities for yourself—and get ready for them.

MAIL COUPON TODAY!

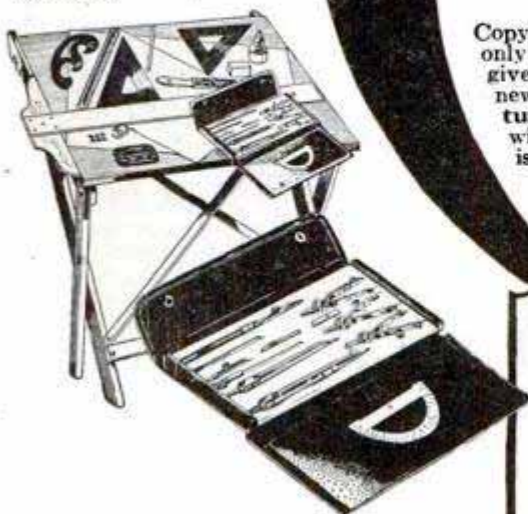

Complete Costly Drafting Outfit GIVEN!

You need a fine outfit like this to do precise, neat Drafting. Not one penny of extra charge for this complete, valuable, high grade outfit. Imported instruments. Table, board, mahogany-edge T square, triangles, ink, thumbtacks, etc., everything you will need. Retail value \$20. Coupon brings this Free Offer.

**CHIEF DRAFTING ENGINEER
AMERICAN SCHOOL**
Dept. D-274-A
Drexel Ave. & 58th St., CHICAGO

**CHIEF DRAFTING ENGINEER,
AMERICAN SCHOOL,**
Dept. D-274-A, Drexel Ave. & 58th St., Chicago

Rush 3 Free Drafting Lessons. Surprise offer, complete information, money-back guarantee, etc., to prove I can become a real draftsman at home in spare time.

Name.....
Street No.....
City..... State.....

Just Out!

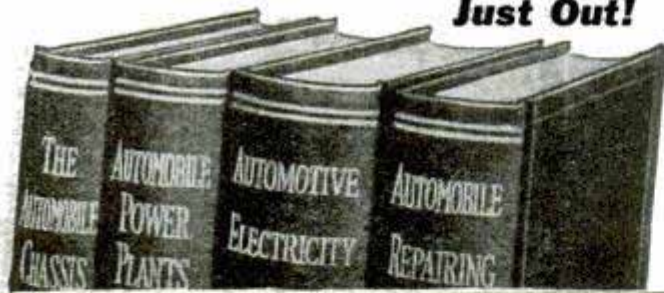

BE AN Automobile Mechanic!

There's big money in this field—Get in on it now while you have the chance. Trained auto men are wanted!

The demand for trained men in the automobile field is far greater than the supply.

More than 15,000,000 automobiles are in use in this country now, and every week the figures grow larger.

There are not enough trained automobile service and repair men to keep up with this steady growth.

If you are not satisfied with your present earnings, look into this proposition NOW.

Just Published

PRACTICAL AUTOMOBILE LIBRARY

Four Books—\$1.50 in 10 days and \$2 monthly for 6 months—only \$13.50 in all!

These four practical books, written by five well known teachers of automobile practice, will teach you, right in your own home during your leisure time, just what you need to know about automobile troubles and repair. They will teach you automobile construction, maintenance and repair as experts know them and will help you to earn an expert's pay.

Step up to a Big-Pay Auto Job

Hundreds of question-answering diagrams—hundreds of clearly-marked illustrations—make the books plain and readily understandable to any man with the mechanical instinct. All the explanations and descriptions are clear, simple, direct. Every chapter is packed with definite, step-by-step, how-to-do-it information.

Examine This New Library Free

No money down Small monthly payments

These books were written specially for self-instruction by men who have trained thousands of automobile operators and garage men. Examine the library for 10 days free. Just fill in and mail the attached coupon.

If you find the books what we say they are, send us \$1.50 in ten days and \$2 monthly for only six months. If you do not want the books, send them back at our expense. It costs you only a postage stamp to take a look at the books. Act now!

FREE EXAMINATION COUPON

McGraw-Hill Book Co., Inc., 370 Seventh Ave., New York

Send me for 10 days' free examination the New Practical Automobile Library. If satisfactory I will send you \$1.50 in 10 days and \$2.00 monthly until the special price of \$13.50 is paid. If not wanted, I will return the books at your expense.

Signed

Address

City and State

Position

Enclosure

P. M. 2-1-26

Catarrh, Etc.

Your blood, containing fruit acid, is the only substance that can dissolve any mucus or "paste" in your system.

Mucus-Making Foods

In its passage through the body mucus is secreted in various organs, causing disease. The effects or symptoms are then named variously according to location, but the source of the trouble is the same—fermentation, chiefly from butter, cheese, cream, fat, oil, salt, etc., when used beyond your capacity, or in wrong combinations.

100 Names for 1 Disease

Mucus causes catarrh of the eyes (conjunctivitis), of the nose (rhinitis), of the ears (otitis, deafness), of the bronchial tubes (bronchitis, asthma), of the lungs (tuberculosis), of the stomach (gastritis), of the appendix (appendicitis), of the bowels (colitis), etc.

Correct Eating Cures



Pure juice from grapefruits, without sugar, and pure tomato juice, berries, etc., when used as freely as water and combined with adequate quantities of brain-and-nerve nourishing foods with stimulative and laxative vegetables, can prepare your blood for dissolving mucus.

Fresh fruit acids clean a stomach that is suffering from mucus or acidity. Hyperacidity, acidosis, is produced by mucus from fermenting foods, just as vinegar is made from fermenting sugar, syrups and fruits. But fresh fruit acid when correctly combined is always beneficial.

Objectionable features of catarrh are expectoration, "hawking," "running nose." In a singer or speaker, a career, a life-work, is ruined by a little flocculent matter on the vocal cords producing hoarseness, forfeited engagements, missed opportunities, etc. Deafness hinders advancement in business. Noises in the head make the sufferer irritable, and irrational.

Tubercular Catarrh

A deposit of mucus in the lungs is often suppressed by medicine made from coal tar derivatives. The cough is sometimes quieted, but the mucus remains to form the seat of tuberculosis.

Why Envy the Live-Wire?

Mucus when present in large quantities prevents the nerves from assimilating their due nutriment. It is a cause of undue fatigue.

Stop using mucus-making foods and learn to take brain-and-nerve foods, etc. Build yourself into a go-getter, a live-wire, an untiring person, internally clean, who turns work into pleasure.

One pupil wrote: "No mucus, voice stronger, head clear as a bell, gained 20 pounds, and now earn four times as much."

BRINKLER SCHOOL OF EATING

Dept. 42, 131 West 72nd St., New York

LEARN WATCHMAKING AND ENGRAVING



BY OUR PROFIT-SHARING PLAN
OUR GRADUATES SUCCEED

One of our low students started in a very small way—now doing over \$30,000 a year. Another in Wisconsin, over \$10,000 the first year. Day or night classes. Call or write for FREE BOOK

Chicago School of Watchmaking, Prof. 1301, 4844 Lincoln Avenue, CHICAGO

TELEGRAPH—RADIO

\$18 to \$35 a week while training for Radio and Telegraph Operator jobs at \$150 to \$300 per month. Write for particulars.

CHICAGO TELEGRAPH INSTITUTE

Dept. 1601 1338 S. Michigan Avenue, CHICAGO

SUCCEED With Your Own Products

Make them yourself. Formulas, Processes, Trade-Secrets, Modern master methods.

CATALOG FREE

W. THAXLY CO.

Washington, D. C.



BE AN OFFICER in the U. S. Coast Guard \$1700 Up to \$7,500 Yearly

\$780 yearly at the U.S. Academy while training. You rank Ensign to Captain in service. Age requirements 18 to 24. Write Dept. F. for information.

COAST GUARD PREPARATORY SCHOOL
4000 Ga. Ave N. W. Washington, D. C.

**YOU CAN EARN
\$3000
TO
\$5000
A YEAR AND MORE
IN THE
AUTOMOBILE
BUSINESS**

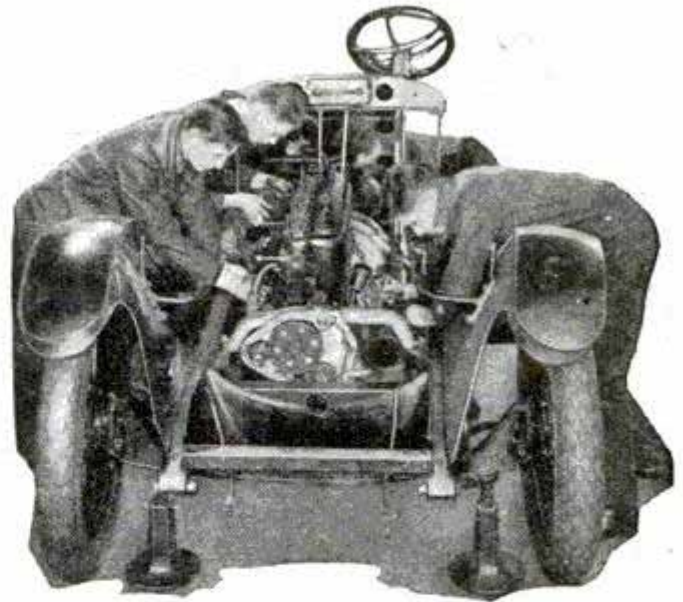

**BIG DEMAND FOR MEN TRAINED AT THE
STEWART AUTOMOBILE SCHOOL**

SUCCESS doesn't just happen. People are divided into two classes: Those who go ahead, "Take the bull by the horns" and do something, and those who sit and wonder why success doesn't come. The first are the successful men—the others are the failures.

GET OUT OF THE RUT

Now is the time and this is the opportunity for you to take a big step forward, to snap yourself out of the rut and to start on the road to success.

Remember that when proper training is backed up by determination nothing is impossible. Half of greatness is quick decision and action.

LEARN THE AUTO TRADE IN NEW YORK

In the big, splendidly equipped shops of the Stewart Automobile School you can master all kinds of repair work. Here you can lay the foundation for a successful career in the world's largest industry. You do the actual work yourself with tools on Passenger Cars, Trucks and Tractors.

There is no mystery—it is not difficult in any way—as you will see in our catalogue. You can do it easily. The Stewart Automobile School has thousands of successful graduates.

STEWART SYSTEM EASY

Stewart Instructors—all hand-picked men—have perfected the "personal instruction" policy of this school. Each

beginner is studied—his individual characteristics noted—then he receives his instruction in the way that will be most valuable to him and easiest to grasp.

The course of training is thorough—no one is rushed and every point is driven home. The complete catalogue (which you will receive as soon as you send in the attached coupon) contains a guarantee that you can remain until you are entirely satisfied.

DECIDE NOW

If you are not earning at least \$50 to \$75 or more a week—with a business of your own in sight—this message is intended for you. It is now possible for any average man, regardless of education or experience, to be trained at the Stewart Auto School for a big-pay job quickly. There is a crying demand for good men right now—but you must act quickly.

FREE BOOK—SEND FOR IT

You can open up the way to newer and better things by a mere scratch of the pen or pencil. You can take advantage of the great opportunities in the rapidly expanding automobile business, the largest and fastest growing industry in America. Investigate now. It costs you nothing and does not obligate you to buy anything. But find out—investigate—take a new lease on life. Send the coupon for our new big FREE book, which explains all details. Here is the coupon. Send it now!

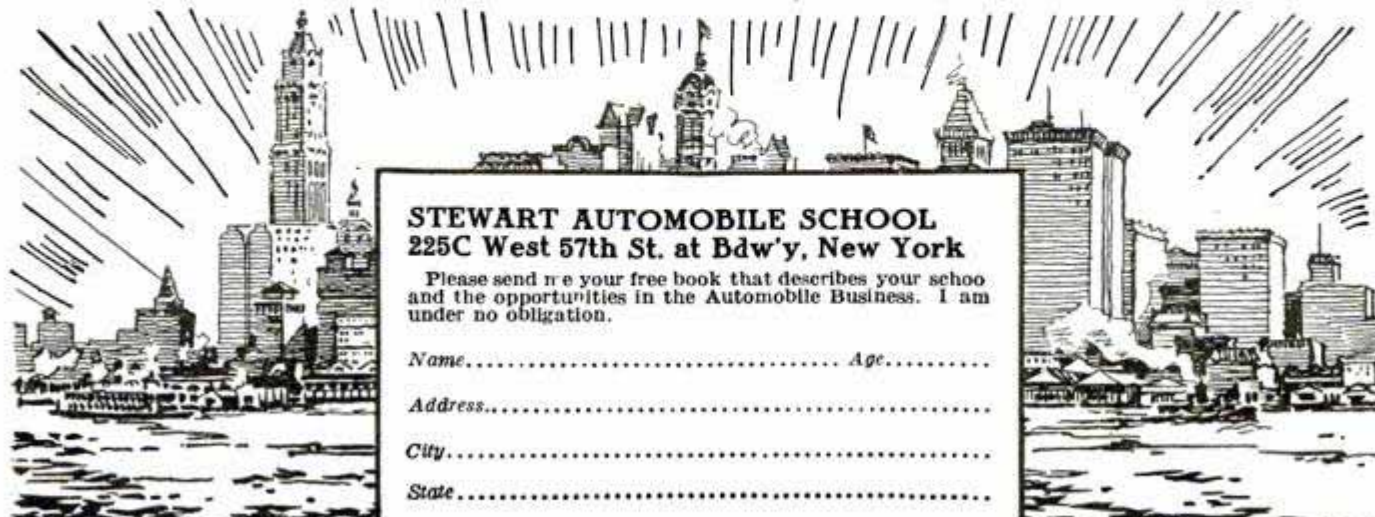

**STEWART AUTOMOBILE SCHOOL
225C West 57th St. at Bdwy, New York**

Please send me your free book that describes your school and the opportunities in the Automobile Business. I am under no obligation.

Name..... Age.....

Address.....

City.....

State.....



“How can I get a raise?”

I'M GLAD you asked that question, Tom, because at your age I know you ought to be earning more money. But frankly, you aren't worth any more than I am paying you now.

“You're just like a dozen other fellows in your department. Fair routine workers, but that's all. Honestly, I'd be afraid to trust you with a bigger job. I don't think you could handle it.

“What you need, Tom, is special training that will broaden your knowledge of this business. Why don't you take up an I. C. S. course as Bill Warren did? It's been the making of him and I know it will help you too.”

Isn't that good advice for you too?

Why don't you take up a home-study course with the International Correspondence Schools and get ready for a real job at a salary that will enable you to give your wife and children the comforts you would like them to have?

Right at home, in the odds and ends of spare time that now go to waste, you can prepare for the position you want in the work you like best. Yes, you can! Put it up to us to prove it by mailing this coupon that has meant so much to so many other men in just your circumstances.

Mail the Coupon for Free Booklet

INTERNATIONAL CORRESPONDENCE SCHOOLS
Box 5554-E, Scranton, Penna.

Without cost or obligation, please tell me how I can qualify for the position or in the subject before which I have marked an X:

BUSINESS TRAINING COURSES

- | | |
|--|---|
| <input type="checkbox"/> Business Management | <input type="checkbox"/> Salesmanship |
| <input type="checkbox"/> Industrial Management | <input type="checkbox"/> Advertising |
| <input type="checkbox"/> Personnel Organization | <input type="checkbox"/> Better Letters |
| <input type="checkbox"/> Traffic Management | <input type="checkbox"/> Show Card Lettering |
| <input type="checkbox"/> Business Law | <input type="checkbox"/> Stenography and Typing |
| <input type="checkbox"/> Banking and Banking Law | <input type="checkbox"/> Business English |
| <input type="checkbox"/> Accountancy (including C.P.A.) | <input type="checkbox"/> Civil Service |
| <input type="checkbox"/> Nicholson Cost Accounting | <input type="checkbox"/> Railway Mail Clerk |
| <input type="checkbox"/> Bookkeeping | <input type="checkbox"/> Common School Subjects |
| <input type="checkbox"/> Private Secretary | <input type="checkbox"/> High School Subjects |
| <input type="checkbox"/> Spanish <input type="checkbox"/> French | <input type="checkbox"/> Illustrating <input type="checkbox"/> Cartooning |

TECHNICAL AND INDUSTRIAL COURSES

- | | |
|---|--|
| <input type="checkbox"/> Electrical Engineering | <input type="checkbox"/> Architect |
| <input type="checkbox"/> Electric Lighting | <input type="checkbox"/> Architects' Blueprints |
| <input type="checkbox"/> Mechanical Engineer | <input type="checkbox"/> Contractor and Builder |
| <input type="checkbox"/> Mechanical Draftsman | <input type="checkbox"/> Architectural Draftsman |
| <input type="checkbox"/> Machine Shop Practice | <input type="checkbox"/> Concrete Builder |
| <input type="checkbox"/> Railroad Positions | <input type="checkbox"/> Structural Engineer |
| <input type="checkbox"/> Gas Engine Operating | <input type="checkbox"/> Chemistry <input type="checkbox"/> Pharmacy |
| <input type="checkbox"/> Civil Engineer | <input type="checkbox"/> Automobile Work |
| <input type="checkbox"/> Surveying and Mapping | <input type="checkbox"/> Airplane Engines |
| <input type="checkbox"/> Metallurgy | <input type="checkbox"/> Navigation |
| <input type="checkbox"/> Steam Engineering | <input type="checkbox"/> Agriculture and Poultry |
| <input type="checkbox"/> Radio | <input type="checkbox"/> Mathematics |

Name.....
Street.....
Address..... 3-6-24

City..... State.....

Occupation.....
Persons residing in Canada should send this coupon to the International Correspondence Schools Canadian, Limited, Montreal, Canada.

YOU Can Be a Dental Laboratory Expert

Make Up to \$150 A Week This Expert Is Stivison Trained



He Can Earn More in one day than the average Mechanic does in a week. He got it the same way you will get it if you select the

Stivison Way

Personal Instruction to Each Student In One Big School for Mechanical Dentists. Students are taught on Patients' work that is actually used. **Only Modern Methods Taught.** Thousands of dentists need Laboratory Experts.

Stivison Trained Graduates

Always in Demand Jobs Hunt You. Every Dentist does Laboratory Work that he would gladly have done by an expert and pay Big Prices.

Real Dentist's Tools are furnished and instructions given by Real Dentists on work that Dentists need. Our attractive Illustrated Catalog tells of many others who are earning big money and how easy you may be able to get into the Big Pay Class. If you live in Maine or California, it costs no more for you than it does for one living in Mo. or Kas. because WE PAY YOUR R. R. FARE TO KANSAS CITY. WE FURTHER ASSIST YOU in paying your TUITION by allowing You to Earn While You Learn. Bear in mind, the Catalog is Free and no man ever got in the Big Pay Class by wondering what he should do. Decide now and write for this "Short Cut to Success" today.

STIVISON DENTAL INSTITUTE

501 McMillen Bldg.

Kansas City, Mo.

Test Your Art Ability FREE



If you like to draw, test your natural sense of design, proportion, color, perspective, etc., with our Art Ability Questionnaire. Learn if your talent is worth developing, and how much training you will need. You will be frankly told what your score is.

Many Federal Students are making \$3,500, \$4,000, \$5,000 and \$6,000 yearly. The Federal course is recognized everywhere by art employers and buyers of commercial art. Learn at home in spare time, without previous training. *Personal, individual criticisms on your work.* Get this free test—send now for your Questionnaire.

Federal School of Commercial Designing
613 Federal Schools Bldg. Minneapolis, Minn.
Send me your free Questionnaire

Name.....
Address.....

Building Draftsmen WANTED



\$9,000 in Four Months

"I have made \$9000 in four months on nine buildings" writes Wm. J. Petrasek, Chicago, Ill.

\$210 Per Month

"I am making \$210 per month as Architectural Draftsman. Thanks to Chicago Tech." Geo. E. Shafner, Haley, Tenn.

\$6,000,000,000 in Building Train at Home for Big Money in This Fertile Field

Six Billion Dollars in one year! Think of it! Today Building is probably America's greatest and most profitable industry. Here is a field whose future is insured by the normal growth in population and the industrial expansion of our country. There is a big building shortage now and many competent observers predict that our largest cities will be practically rebuilt in the next ten years due to ever higher standards of living. Six Billion Dollars spent each year in building means fortunes for thousands who have the vision to grasp the opportunity open now to get in on the ground floor.

In Chicago Earn While You Learn



Chicago Tech. Building

Short Day or Evening Courses offered in Building Construction and Drafting in our Chicago School. Part time positions defray living expenses. 72-page "Blue Book" tells all. Ask for it if interested in coming to Chicago to attend the College.

Get Into Big Pay This Easy Way

Architectural or Building Draftsmen are needed everywhere. Get out of the low or moderate pay job. Step into a *real* job. You can do it with training in Architectural Drafting. Salaries are big because of the tremendous demand and the shortage of trained Building Draftsmen. Work is steady and you have a splendid chance to go into business for yourself. This is the opportunity offered to you by this old established school of Architecture and Building Construction. Step out of the \$40 a week class. Learn how to earn \$50 to \$100 a week—and later \$5,000 to \$10,000 a year as chief or superintendent.

Train at Home—Earn as You Learn

No need to quit your present job. Keep your present income and prepare for a bigger one. Our simple "Practice Plan Method" will qualify you quickly in your spare time. In-to it has gone over 25 years of experience and the best knowledge of our large staff of architects and builders. It is simple, complete, resultful. Practical, successful builders guide you. Lessons in plain English. A common schooling is all you need. Get the facts now—today.

FREE TRIAL LESSON AND BLUE PRINTS

Just to show you how easy it is to learn Architectural Drafting by our method, we will send you a Trial Lesson and Blue Prints Free. Test yourself and see how you like the work. Send no money—just the coupon. Get this Free Lesson now with our Big Book of Opportunity also free. Make your first step today—it costs you nothing.

This \$25.00 Drawing Outfit Sent without extra cost. Good for a lifetime. Mail the coupon and learn how to secure this valuable outfit.

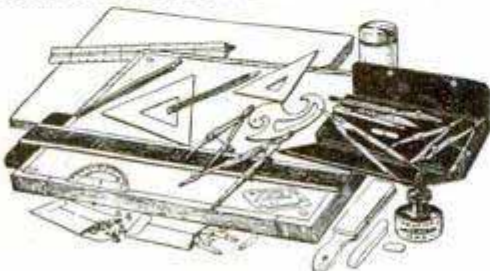

MAIL COUPON TODAY.

Chicago Tech. College, Dept. 230, Chicago Tech. Bldg., 118 East 26th St., Chicago, Ill.

Send me, without obligation, your Free Trial Lesson, Blue Prints and Book of Opportunity. I want to know how to become a Building Draftsman.

NAME.....

ADDRESS.....

CITY OR TOWN.....STATE.....

Architectural Drafting
 Machine Drafting

Electrical Drafting
 Structural Drafting

CHICAGO TECHNICAL COLLEGE

Dept. 230, Chicago Technical Building
118 East 26th Street CHICAGO, ILLINOIS

A Quick, Sure Way to a Big Income is to RAISE POULTRY



Easy to make \$1000 a Year Spare Time - \$5000 and up Full Time

Let the Other Fellow Pay YOU the Fancy Prices



When you go into a store and pay 75c to \$1.00 for a dozen eggs, did it ever occur to you that YOU might be getting the 75c to \$1.00 instead of the other fellow? Did it ever occur that a small back yard or vacant lot flock of poultry would pay enormous profits, if properly managed, and require very little of your time? In this country, where 85% of the people live in cities, and live right, want the best of everything—they will pay and pay well for fresh eggs and poultry meat. There will be a QUICK, sure demand for every egg or bird you produce. Poultry raising offers a golden opportunity. Is there any good reason why YOU shouldn't take advantage of it?

Start Small, Grow Fast, Sure Methods Bring Quick Success

Start small, if you like, just as hundreds thousands of others have started. Then, by following the sure, tried, proved, money-making methods which we will give you, you can grow as fast as you wish. Many of our students who began with the idea of having the BEST for their own tables and cutting living expenses, too, soon found in this fascinating, healthful, profitable business, the quick road to a large, steady, full-time income. You can get into a business of your own—one that will make you YOUR OWN BOSS with an income of \$5,000 a year and UP—or you can make \$1.00 to \$3.00 for EVERY hour of your spare time. Let me show you HOW!

Surprise Yourself—Let This FREE Book Open Your Eyes

Ask is a chance to PROVE that you can CASH-IN on my forty years experience as Commercial Poultryman and former Senior Poultryman in the U. S. Dept. of Agriculture. A chance to prove that the poultry business DOES have big opportunities for you—and that regardless of your location, whether in a city, a town or on the farm—I and the staff of experts associated with me—can show you the way to real SUCCESS and independence, just as we have already shown thousands of others. My new FREE book on "How to Raise Poultry for Profit," will be an eye-opener. Clip the coupon and send for it today. Do it now—this minute. You have everything to gain by—quick action!

READ! What Others Are Doing

"The results I am getting from your methods speak for themselves. In a flock of 65 fowls, I have gotten 888 eggs from the first of the month up to date (the 23rd). BNAAR CHANCE, Dewey, Okla.

"Your course on poultry raising is the most practical and complete in the country. You have opened up a pleasant and profitable way for me to gain an independent living." S. ANSONSON, Barrington, R.I.

"The information contained in your course has been of such great help to me that I would not take \$1,000 for what I have gained." L. M. WAGNER, Federalburg, Md.

"I consider my enrollment with the National Poultry Institute the best investment I ever made." MRS. J. W. CHAWLEY, Farnville, Va.



FREE BOOK TELLS HOW

NATIONAL POULTRY INSTITUTE, Dept. 400-F, Washington, D. C.

Gentlemen: I want to know more about the opportunities for me in the poultry business and about your plan for helping me make \$1,000 to \$5,000 a year and up. Send FREE book.

Name

Address

American Poultry Journal

OLDEST, LARGEST AND BEST

3 Months Free All ONE, TWO or FIVE year subscriptions received before Dec. 31st will be entered to commence with the January issue, and the Oct., Nov. and Dec. issues of this year will be mailed FREE. Order today and get them.

1 YEAR 75c. 2 YEARS \$1 5 YEARS \$2.00

Averages over 100 pages per issue. Tells how to feed, house and breed; how to secure high egg production; how to hatch and rear poultry successfully.

American Poultry Journal, 14-523 Plymouth Ct., Chicago

Per Chick Hatched "SUCCESSFUL" Is Cheapest To Buy

Mail a postal—Get our offer Poultry lessons free to every buyer. Eastern customers will be served quickly from our Eastern Warehouse. Catalog FREE. Make green, egg-making feed in "SUCCESSFUL" Grain Sprouters.

33 Years of Big Success

Des Moines Incubator Co., 639 Second St., Des Moines, Iowa

Poultry and Squabs for Profit

Foy's big book. CONTAINS MANY COLORED PLATES, encyclopedia of poultry information. Low prices on BABY CHICKS, fowls, eggs and incubators. Written by a man who knows. Mailed FREE.

FRANK FOY & SONS Box 18 CLINTON, IOWA

64 BREEDS Chickens, ducks, geese and turkeys. Pure-bred, high quality, hardy and most profitable. Fowls, eggs, incubators, brooders: lowest prices. America's great plant. At it 33 yrs. Fine new 100 page book and catalog free.

R.F. Neubert Co., Box 908, Mankato, Minn.

Poultry Miller's American Guide

Tells all about chickens—care, feeding and raising for profit. Also describes IDEAL INCUBATORS, Hot Water and Electric—IDEAL BROODERS—Coal and Oil Burning—Baby chicks FREE Eggs for Hatching. Special LOW PRICES

J. W. MILLER CO., Box 12, Rockford, Ill.

PLANS for Poultry Houses

All styles, 150 illustrations; secret of getting winter eggs, and copy of "The Full Egg Basket." Send 25 cents.

INLAND FOLTRY JOURNAL, Dept. 74 Indianapolis, Ind.

68 BREEDS Valuable New Poultry Book Free—100 Pages.

Fine Pure-bred Northern raised chickens, ducks, geese, turkeys, eggs, chicks also incubators at lowest prices. My 44th year.

W. A. Weber, Box 82 Mankato, Minn.

SQUAB BOOK FREE!

Pigeons Printed in Natural Colors

Make money breeding squabs. Sold by millions. Start small, grow big. Start now. Read how our customers sell squabs for \$12 a dozen. We have been established for 25 years. Better look into this. Let us send you, at no cost to you, our big, illustrated freebook telling how to make money breeding squabs. We sell Racing Homers also. Write

Plymouth Rock Squab Co. 634 H. St., Melrose Highlands, Mass.

RAISE BELGIAN HARES

NEW ZEALAND REDS—Chinchillas—Flemish Giants MAKE BIG MONEY—We supply stock and pay you following prices for all you raise: Belgian Hares \$2 each—New Zealand \$3 each—Chinchillas \$4 each—Flemish Giants \$5 each. 32-page illustrated book, catalog and contract, also copy of Fur Farming magazine, tells how to raise skunk, mink, fox, etc., for big profits, all for 10c. Address

OUTDOOR ENTERPRISE CO., Box 75, Holmes Park, Mo.

MONEY IN SQUABS

My big FREE Pigeon and Poultry Book, ILLUSTRATED IN NATURAL COLORS is a complete guide to the pigeon raiser. Gives description and prices on all best varieties. Write Today.

FRANK FOY & SONS, Box 28, Clinton, Iowa

Learn Watchwork, Jewelrywork and Engraving

A fine trade commanding a good salary, and your services always in demand. Address **Horological**, Dept. P, Bradley Institute, PEORIA, ILLINOIS, for our latest catalog.

WRIST WATCH FREE

JEWELED MOVMT. GUAR. 10 YRS.

Dainty watch—platinum effect, has ribbon bracelet and fancy case. Jeweled movement guar. 10 years—yours for introducing finest assortment liquid perfumes at 15c a bottle. Send for 30 bottles and select your gift as per offer in our catalog—no trust seen—just write to BELL PERFUMERY CO. Dep. D931, CHICAGO, ILL.



Men Wanted—

In BUILDING TRADES And AUTO INDUSTRY

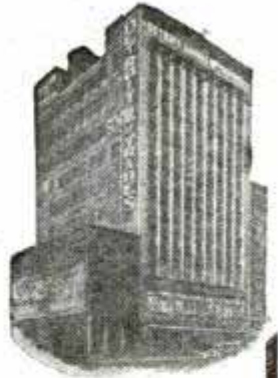

Come to Detroit, the Wonder City, and learn one of the high paying trades taught at the Big School, known as the Detroit School of Trades. Endorsed by Contractors, Builders and Manufacturers, operating under the Supervision of the State Board for Vocational Education.

Mr. Buick Says

D. D. Buick says: The Detroit School of Trades gives you a practical training on the actual work with tools, not books; under skilled instructors who are Master Mechanics. Each student receives individual training, not class instruction.

D. D. BUICK Do It Today

Mr. D. D. Buick, Director and Chief Engineer of this school and one of the founders of The Buick Motor Co., says: "Come to our School. Become a trained man and you will not have to work for low wages or be out of employment. A training in this School will mean your future Success in life."

Don't wait until tomorrow. Be a now man. Give yourself a chance. Make today a big day for yourself by sending in this coupon.

WE TEACH

- Bricklaying
- Plastering
- Plumbing
- Carpentry
- Estimating and Contracting
- Electricity
- Paper Hanging
- Painting and Decorating
- Sign Painting
- Show Card Writing
- Auto Striping
- Auto Mechanics
- Auto Trimming
- Metal Finishing
- Auto Painting
- Acetylene Welding
- Custom Shop Course

RETURN COUPON

DETROIT SCHOOL OF TRADES

217-221 Woodward Av., Dept. 226-A, Detroit, Mich.

I have checked above the trade I am interested in. Please send me without obligation on my part full information regarding your School of Trades.

Name

Address

City and State

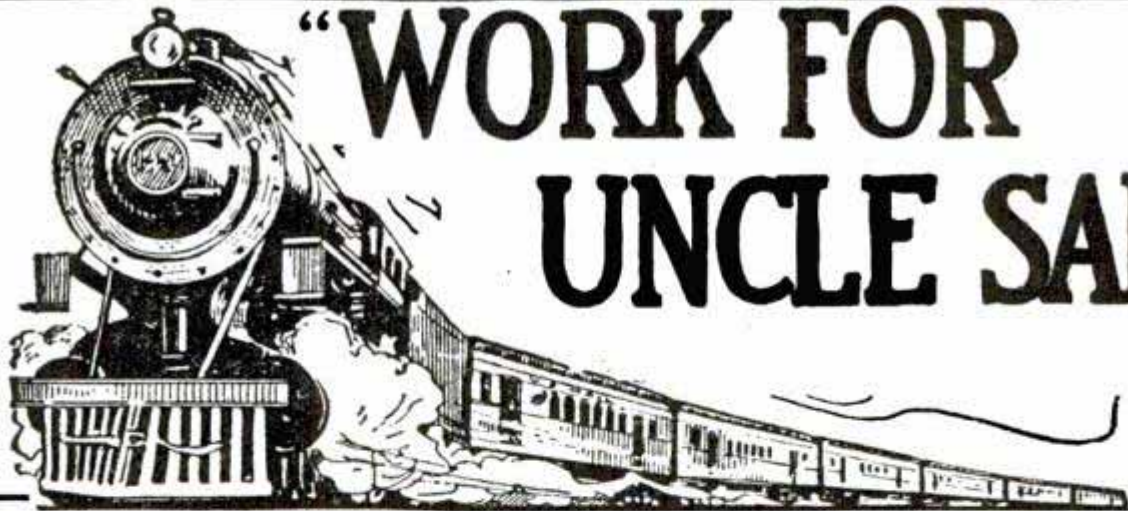

"WORK FOR UNCLE SAM"

TRAVEL ON GOVERNMENT PAY

RAILWAY MAIL CLERKS

\$1900 to \$2700 a Year

MANY OTHER GOVERNMENT POSITIONS
Short Hours Rapid Advancement Pleasant Work
Permanent Employment Long Vacation with Pay

MEN — BOYS, 18 UP

Fill out and mail the attached coupon now. Act at once

FRANKLIN INSTITUTE
Dept. M174, Rochester, N. Y.

Kindly send me entirely free of charge (1) A full description of the position checked below; (2) Free copy of book, "Government Positions and How to Get Them"; (3) A list of U. S. Government Jobs obtainable; (4) Tell me how to get the position checked.

- Railway Mail Clerk (\$1900-\$2700)
- Post Office Clerk (\$1700-\$2300)
- City Mail Carrier (\$1700-\$2100)
- Rural Mail Carrier (\$2100-\$3300)
- Clerk at Washington, D. C. (\$1140-\$1860)

NAME

ADDRESS

VALUABLE COUPON

California has these Big Pay Jobs waiting for you NOW!



AUTO JOBS

You can soon have a BIG-PAY auto job in California, where 1,386,417 cars are registered! Auto men are busy here. Many more jobs than trained men to fill them. Cars run every day in the year, due to balmy climate. If you really want to get into this fascinating industry and forge ahead fast we can speed you to success.

ELECTRICAL JOBS

Or, if you want to get into the wonderful fast growing electrical and radio industry, this is the place to get your training. Los Angeles is the center of tremendous hydro electrical development the greatest the world has ever seen. Trained men are needed on every hand.

National Tested Methods Proved by 21 Years Success

National has trained 16,000 graduates. Some are earning \$15,000 a year. Hundreds own their own business. They have forged ahead faster than other men because National's job way training is RIGHT. Business executives know National graduates can deliver the goods. National men are therefore chosen first for the big pay jobs.

We Guarantee to Help You Get These Jobs

The number of students at National is purposely limited so that we can give every man the best instruction and fullest assistance. We get you part-time jobs to help pay expenses while training. You have the benefit of working in shops that represent a \$1,000,000 investment. You have the benefit of our close connections with the leaders in the automotive and electrical industries. And we put you in touch with jobs when you have finished.

Send for Free Catalog of Opportunities

Check below the job you'd like to have and we will send you a big, 84-page, illustrated book telling you how you can get such a job and many others. Don't put this off. Mail the coupon today.

NATIONAL AUTO, ELECTRICAL AND RADIO SCHOOLS

Dept. 389, 4004 So. Figueroa St., Los Angeles, California

We Teach You At Home Amazing New Way!

You don't need to lose a day in preparation for the big pay opportunities in the auto business. If you can't come at once, you can begin studying at home. National's home training course conforms exactly to the wonderful instruction we give you here. Every lesson is complete with charts and diagrams which you can easily understand. No need to wait. If you can't come to us we will bring this great institution to you!

FREE To prove the merit of National Home Training,

we will send 4 FREE Auto Repair charts and Complete Lessons, and you can begin NOW, at no cost! You will actually learn to do 4 repair jobs and get pay from any auto owner.

Pick
the Job
you want
and we'll
help you
get it
Quick!

I am interested in the jobs checked below. Send me your free book describing them.

AUTOMOTIVE

- Master Mechanic \$3,000 to \$8,000
- Automotive Electrician \$300 and up Monthly
- Garage Manager \$3,000 up
- Battery Expert \$45 to \$60 weekly
- Expert Welder \$1.10 an hour

- Salesman \$3,000 up
- Tractor Engineer \$8 to \$18 Daily

ELECTRICAL & RADIO

- Electrical Draftsman \$2,500 to \$4,000 a year
- Construction Expert \$3,000 to \$4,500 a year
- Telephone Engineer \$3,000 to \$7,000 a year

- Ship Radio Expert \$2,500 to \$5,000 a year
- Illuminating Engineer \$3,000 to \$10,000 a year
- Armature Winder \$8 to \$12 a day
- Dynamo Expert \$8 to \$15 a day
- Power House Expert \$3,000 a year and up

If You Want to Learn Autos Now—At Home—Check here.

() I want to begin Auto Training at home. Send me your FREE Home Training Auto Repair Charts.

Name.....

Address.....

City..... State.....

Learn DRAFTING This Easy Professional Way!

You Can! From \$50 to Over \$200 A Week Now Being Paid to Expert Draftsmen. Join the Contented, Big-Paying Drafting Profession. Most Practical, All-Inclusive, Authoritative Course Ever Devised Prepares You In A Few Short Months—Right at Home. Paves Way For Quick and Amazing Salary Increases. Mail Coupon for FREE Descriptive Booklet.

INDUSTRY is booming! Right now every railroad, electrical concern, steel mill, machine shop, architect, constructor of bridges and radio stations, and contractors are in crying need of skilled draftsmen. Never before has the demand been so tremendous. In the last year alone there appeared over 100,000 ads in newspapers calling for the services of trained draftsmen.

Hundreds of our graduates are holding high-salary positions in this marvelous, rapidly growing profession. One of our most recent graduates—only 21 years old—three months after completing his training, "Started out as an expert draftsman at \$50 a week with unlimited chances for rapid advancement." "My salary has doubled since finishing the course," writes another Student, H. R. H. of Jackson Heights, New York. "\$275 for one drawing," is the price another graduate states he received for his work.

The Columbia School of Drafting has thousands of successful graduates holding down big-pay, drafting positions. This school specializes in teaching drafting by mail!

\$50 to \$200 a Week—and More

Our Columbia School Method—perfected after 15 years of teaching drafting exclusively—is a professional course, designed to prepare you for a practical, high-salary position as a Mechanical, Construction or Electrical Draftsman.

Earn While Learning

No matter if you know nothing about drafting or drawing now, you can quickly become a drafting expert by our marvelous method of practical home instruction—instruction which includes *Absolutely Free* all the latest, up-to-date material—everything you need to do a regular drafting job with. No special education or training needed. No wasted efforts—no long-winded theories. You start by doing actual jobs such as you will get later on in the drafting field. Many earn even while learning. Personal contact with all your work is

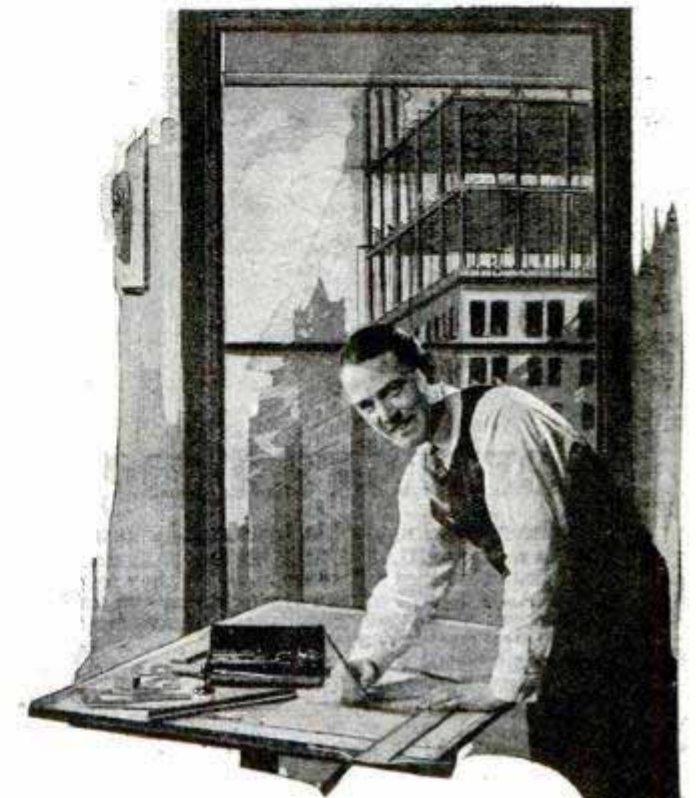

maintained by men who have achieved real success in the drafting profession. Make your start now. A Columbia School Training will qualify you for a bigger position in a field that is "brimful" of money-making opportunities.

Send for Free Book

We want to tell you more—more about the opportunities and rewards that the tremendous drafting profession holds for YOU—more about our successful graduates—more about our easy professional method of training. Our big illustrated booklet, "Drafting Your Success," unlocks a treasure-house of valuable, pay-boosting drafting secrets. Send for it at once—it's FREE. No obligation. Mail coupon now.

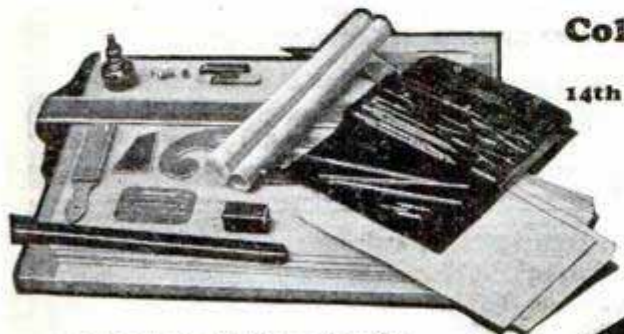

Here's your Free Outfit.
Exactly the same as used by
professional draftsmen.

Columbia School of Drafting

Dept. 12

14th and T Sts., N. W. Washington, D. C.

COLUMBIA SCHOOL OF DRAFTING, Dept. 12,
14th and T Sts., N. W., Washington, D. C.

Please send me your Free Book, "Drafting Your
Success."

Name.....

Address.....

City..... State.....

He thought he could throw me—



Dear Tom: You know how Ted Brown has always been saying he could throw me with one hand tied behind him, if he wanted to. Well, yesterday, he grabbed hold of me and we had it out. Gee, I wish you'd been there. You know how much bigger Ted is than I. He thought he had me licked dead easy—

but

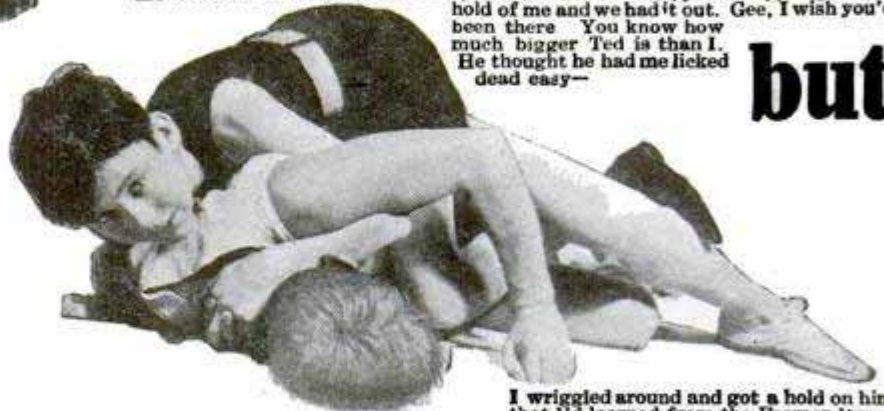

I wriggled around and got a hold on him that I'd learned from the Farmer Burns School of Wrestling. The next second—KERFLOP, and I had Mister Ted Brown on the ground, yelling for me to quit. It's a cinch to handle a fellow half as big again as you are if you know the secret holds. If I were you I'd write to Burns School for their free book about wrestling. So long—FRED.

Learn Wrestling Secrets from Worlds Champions Farmer Burns and Frank Gotch

Learn the marvelous holds, breaks, blocks and tricks that will enable you to handle big, strong men with ease. The renowned FARMER BURNS—"father of scientific wrestling"—and FRANK GOTCH the world's champion, have prepared a series of lessons in which they reveal the inside secrets of training that will make YOU, too, an expert wrestler. All the great secrets of *self-defense* and *jui-jitsu* illustrated by printed word and picture. The lessons teach you how to become a *great athlete*, and secret knowledge enabling you to throw boys and men larger and stronger than yourself.

Farmer Burns School
1772 Railway Exchange Bldg., Omaha, Neb.

Please send me at once without obligation your FREE illustrated booklet on Scientific Wrestling, Physical Culture, Self-Defense, and how to Win.

Name

Address

Age

Send for FREE Book



Our FREE ILLUSTRATED BOOK tells you all about the advantages in health, vigor and respect that being able to wrestle brings one. It tells you how to learn to become a skilled wrestler in your spare time. Brim full of interesting information about wrestling. Also lots of pictures. INVESTIGATE. Write today for this free book. No obligations. Tear out and mail coupon NOW!

Farmer Burns School 1772 Railway Exchange Bldg.
Omaha, Neb.

PATENTS

Booklet Free Highest References
Promptness Assured Best Results

Send drawing or model for preliminary examination of Patent Office records.

ALL BUSINESS GIVEN PROMPT AND PROPER ATTENTION

Listed Patent Lawyer in the latest editions of the Rand-McNally Directory of Bankers and Attorneys, of Chicago, Ill.; The Baggott & Ryall Directory of Attorneys, New York City; The Lawyers Guaranteed Directory, Detroit, Michigan; The Lawyers and Bankers Quarterly, published by the Legal Directory Publishing Company of St. Louis, Mo.; the American Lawyers Annual, Cleveland, Ohio.

WATSON E. COLEMAN,
REGISTERED PATENT LAWYER

644 G Street, N. W., Opp. U. S. Pat. Office
WASHINGTON, D. C.

Whatever Your Question;—be it the pronunciation of Fascista, the spelling of a puzzling word, the location of Esthonia the meaning of soviet, realtor, vitamin, etc., this Supreme Authority—

WEBSTER'S NEW INTERNATIONAL DICTIONARY

contains an accurate, final answer. 407,000 Words 2700 Pages, 6000 Illustrations.
Regular and India-Paper Editions
G. & C. MERRIAM CO., Springfield, Mass.

Write for specimen pages, prices, etc., and FREE Pocket Maps, per Popular Mechanics.



A practical resident school ~ NOT a correspondence course

WANTED~MEN for ELECTRICAL FIELD

Which of These Positions Do You Want?

Electrical Contractor.....	Up to \$25,000 per year
Electrical Estimator.....	Up to \$15,000 per year
Maintenance Engineer.....	\$3,000 to \$5,000 per year
House Wireman.....	\$1.00 to \$2.00 per hour
General Electrical Repairman.....	\$1.00 to \$1.75 per hour
Motor and Generator Expert.....	\$1.00 to \$1.50 per hour
Armature and Stator Winder.....	\$1.00 to \$1.50 per hour
Telephone Expert.....	\$40 to \$75 per week
Trouble Shooter.....	\$40 to \$60 per week
Radio Engineer.....	Unlimited
Power and Sub-Station Engineer.....	\$150 to \$250 per month
Power and Sub-Station Installer.....	\$150 to \$250 per month
Power and Sub-Station Operator.....	\$150 to \$200 per month
Boss of your own shop.....	Unlimited

Here's Your Chance For Big Electrical Job This Spring

This training course—formerly operated by the U. S. Veterans Bureau—will fit you for this interesting, well paid field in just 12 weeks. Remember this is **practical, shop training**—not a correspondence course.

You can finish in time to start a good job, right in the height of the big spring season. Don't wait. Get full information and our special offer by sending the coupon below now.

Now Is The Time To Start

You know already that electricity offers the fastest growing field in the world today. You know that the uses of electricity are increasing so fast that trained men are needed everywhere. Then why not get in ahead of the sleepy fellows, who can't see an opportunity till it is past? By the time they wake up you can be a **trained man**, bossing a job and getting big pay. Right now there are thousands of opportunities for you, and every chance to advance rapidly.

Large concerns are constantly in touch with our employment department—actually **hunting** for men who are properly trained to fill big jobs.

Learn The Practical Way

There is positively no way you can learn electricity except by first hand experience. That is what you get in the Greer Shops—**practical training on real working equipment**. Our job sheet plan has proved to be the simplest, easiest and best way to give this instruction. You actually work out electrical problems, under supervision of electrical experts. Every problem you work is a direct step into the **money-making end** of this business.

Complete Equipment

Our experiments and demonstrations are on **real apparatus**—not on toys. We have over thirty kinds of motors, so no type you ever meet can puzzle you. A real high line is in operation, carrying 2300 volts. Every electrical subject is covered, including radio. Step by step you learn about all this equipment by actually using it. You become a **valuable man** because you learn **how and why**. It would take you many years to get this knowledge any other way.

Free Employment Service

Our employment department will help you get a position as soon as you have finished your training. You can have a part time job while learning if desired. Don't wait. You can start your job **this spring** if you find out about my offer quickly. Send this coupon now. Address me personally, please.

ERWIN GREER, **GREER COLLEGE** Of Automotive and Electrical Trades
President.

ERWIN GREER, President, Greer College—Electrical Division,
Dept. 201-E, 2024 S. Wabash Ave., CHICAGO.

Please send me your **FREE BOOK** and offer for Electrical Course.
It is understood I am not obligated in any way.

Name

Address

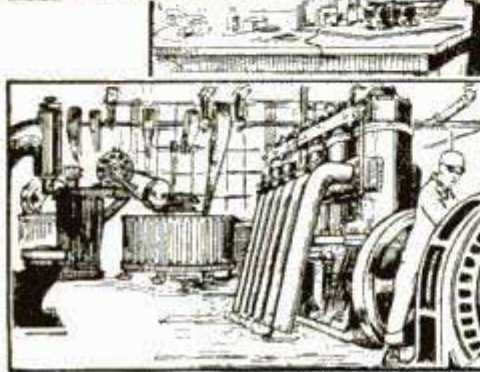
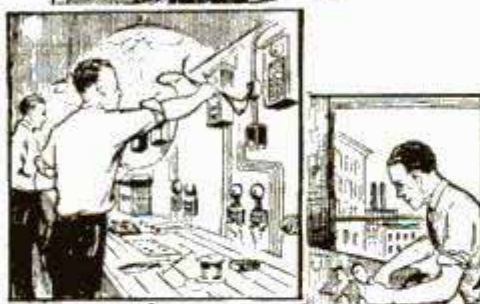
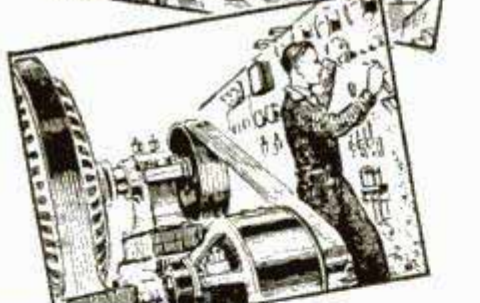
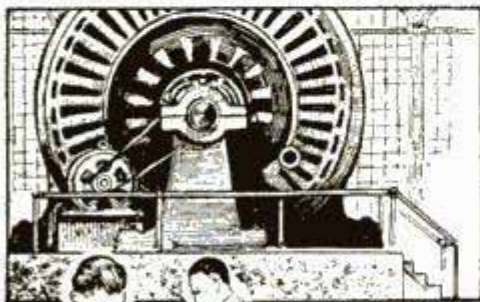

\$100 DEPOSIT DELIVERS Complete Outfit



Violet Ray

QUICK RESULTS No Medicine

Just \$1.00 brings you a complete outfit identical with the kind doctors have bought from us for years and used successfully in treating the ailments listed. Violet Rays give quick relief, permanent results. They scientifically and painlessly remove the cause of pain and sickness. Dr. L. H. Leight, Millerton, N. Y., writes: "I am having wonderful success in treating neuritis, and all stomach cases. I have given over 2,000 treatments with your outfit."

10 Day FREE Trial at your home

Send for Violet Ray Outfit without fail. Treat yourself and family with it. You'll be amazed at how Violet Rays enable you to conquer pain, disease, nervous troubles—how they give vigor, beauty, health. Owning an outfit saves doctor bills, delays, medicines—relieves pain. You should have this health machine in your home.

Send for FREE Book

Explains how Violet Rays (discovery of the world renowned scientist, Nikola Tesla) work and heal, what doctors and plain folks accomplish with them. Shows charts of human body explaining where pains start and how to banish them. Send for FREE copy today. Free for limited time only. Vi-Rex Company, 211 S. Peoria St., Chicago.

For special free advice, state your ailment

Mail Coupon—Send No Money

VI-REX COMPANY
211 S. Peoria St., Dept. 22, Chicago

Please send me without cost or obligation your free book describing your VI-REX Violet Ray outfits and details of your \$1.00 offer.

Name.....
Address.....
City..... State.....
Ailment.....

for
Health Vigor Beauty

Ailments successfully treated with Violet Rays

- Rheumatism
- Neuritis
- Paralysis
- Catarrh
- Nervousness
- Skin Diseases
- Hay Fever
- Headache
- Colds
- Constipation
- Sprains
- Asthma
- Deafness
- Eczema
- Eye Diseases
- Falling Hair
- Goitre
- Insomnia

\$60. to \$100. Weekly Selling 40 to 550 Meter Set

Spare Time Profits—No Capital

Public wants this Amazing New Set. Coast-to-coast reception. Receives all waves, 40 to 550 meters. Shot sub-panel makes assembly quick and easy. We need distributors everywhere. Demonstration sells. We carry stock. Set sells at half store prices. \$60 to \$100 weekly easily made.

FIVE TUBE DEMONSTRATOR WITH RADIO TRAINING



Our Special Plan trains you in Radio—gives you a Free Demonstrator Set and appoints you as distributor.

The entire cost is less than regular dealer's price for Set alone. Hundreds are making big money in spare time. Get started now while territory is still open. Write Today! Don't miss this opportunity to make a fortune in Radio. Get complete sales plan Free!

AMBU ENGINEERING INSTITUTE
2632 Prairie Avenue, Div. 23-B, Chicago, Illinois

Learn How to Write



If you write poor and with difficulty, I can show you how to steady your nerve and write with ease as plain-as-print. Send for samples and FREE BOOK. "How To Become An Expert Penman." Act Quick! Send Today! Your name written on a card if you enclose stamp

T. M. TEVIS, Box 25X, CHILLICOTHE, MO., U. S. A.

BUILD YOUR OWN AIRPLANE



Blueprints and Material now ready for Builders

America's smallest, practical Biplane, 100 miles per hr. with 30 H. P. motor.

Send 10c for illustrated catalog.

Lincoln Standard Aircraft Corp., Lincoln, Nebr.

Free Trial

In Your Own Home



FREE Instruction with Every Instrument

Deagan Xylorimba

Become a crack Xylorimba player right in your own home. Easiest instrument to play. Learn in a few hours with our 14 free complete lessons. Earn \$80.00 to \$200.00 a week. Deagan instruments are world-renowned—used extensively in leading dance, theatre and concert orchestras.

FREE LESSONS—A YEAR TO PAY!

Our free trial, easy payment plan makes it easy to learn at home. Send coupon below for illustrated literature and details of our special free trial offer.

Send Coupon Today!

J. C. DEAGAN, Inc., Dept. 1352, 1770 Berneau Ave., Chicago, Ill.

Dear Sirs: Without obligation, please send me literature and information regarding your free trial Deagan Xylorimba.

Name.....
Address.....
City..... State.....

LEARN *to* FLY

1000 Ambitious Young Men WANTED



Sweeney System

of Practical Airplane Mechanics opens up a world of opportunities for young men. *You Learn by Doing!*

Opportunities in Flying

Aviation Mechanics—\$50-\$125 Week
 Riggers—\$50-\$75 Week
 Flyers—\$125-\$225 Week
 Taxi Service—\$100-\$300 Week
 Aerial Photo Pilot—\$200-\$250 Week
 Special Messenger Service—\$125-\$200 Week
 Aerial Advertising—\$225-\$500 Week
 Crop Dusting—\$125-\$200 Week
 Crop Survey—\$125-\$225 Week

**You Fly
by Flying**

THIS photograph shows Instructors Wimer and Spencer working with students. The Sweeney System first prepares a student by intensive practical work on motors, building, recovering wings, rigging and all details of construction, repairing and handling. This is called ground school work. Instructor Spencer, an overseas flyer, tells you that it took about 4000 mechanics and assistants to keep several hundred flyers in the air at his field in France. To show you the quality of the men who teach you look at Spencer and Wimer for instance. Spencer was an army pilot and has been teaching and doing commercial flying since 1917. Wimer is a college man, went overseas, was with the 1st Air Park, was an observer, spent over 200 hours in the air and since the war has been with two big aircraft corporations.

Skilled Airplane Mechanics Wanted

Now after years of preparation, aided by the best flyers in the world, I have perfected the system of teaching whereby in a short time you become a skilled mechanic, and also if you wish, a skilled pilot. The mechanical and repair work end of aviation, as well as airplane construction, is thoroughly taught you!

All the resources, skill, experience and reputation of the great Million Dollar Sweeney School insure that the Sweeney aviation course is the simplest, most efficient, most practical system in the world.

LEARN TO FLY! Aviation is no longer a mystery—no longer a hazard; no, it is a business growing greater and more important; you can qualify as a mechanic, or an engineer, or repair man, or builder; five men on the ground are needed for one man in the air, but if you want to become a pilot you easily master the work and can go into postal, government, or commercial work. Flyers are in demand, earning big money at fairs taking up passengers, etc. \$5 for a 10 minute flight is pretty fine pay! The building of the new million dollar Fokker plant here means liberal high paid employment for hundreds of aviation mechanics.

SEND NAME TODAY for full details of this aviation mechanical course and photographs of planes and equipment actually used; also full information as to the commercial end of flying and opportunities for young men.

SWEENEY SCHOOL OF AVIATION

LEARN TO FLY BY FLYING
Sweeney
 SCHOOL OF AVIATION
 2206 SWEENEY BLDG, KANSAS CITY, MO.

THE SWEENEY SYSTEM

is divided into two parts. **FIRST:** You are thoroughly taught in the ground school. This fits you as an aviation mechanic. You can build your own plane and do anything required in aviation mechanics and construction and repairing when you have finished this work. You are thoroughly taught motors, etc., and work with thousands of dollars worth of new material, including all types of engines. Liberty 12s, Sturdevants, Gnomes, Hall Scott fours and sixes, etc.

SECONDLY: after completing this work if you want to be a pilot you take ten hours of flying. Now when you understand that two to seven hours is all the average man needs to learn expert flying you will appreciate what ten hours in the air under skilled men will do for you.

SEND THIS NOW

EMORY J. SWEENEY, President
 2206 Sweeney Bldg., KANSAS CITY, MO.

Please send me full information about your Aviation Course.

Name.....

P. O.

State..... Age.....



Salary increased 300% in few months

Chief draftsman of big company received big increase even before he had completed his course with the I. C. S.

"AT THE time I started my I. C. S. course I was working in a paper mill," writes A. J. Hutchins, Chief Draftsman for the American Strawboard Company.

"Before I had completed the course I was called upon to make drawings in one of the company's largest mills and was appointed Superintendent of Construction at an increase in salary of 300 per cent."

Every mail brings letters from students of the International Correspondence Schools telling of increases in salary due to spare-time study.

Why don't you study too and prepare for a real job at a real salary? You can do it if you really try.

Just mark and mail the coupon and we will send you complete information about the I. C. S. Drafting courses or any other course in which you are interested.

INTERNATIONAL CORRESPONDENCE SCHOOLS

Box 5555-E, Scranton, Penna.

Oldest and largest correspondence schools in the world

Without cost or obligation on my part, please tell me how I can qualify for the position or in the subject before which I have marked an X:

- | | |
|---|--|
| <input type="checkbox"/> Mechanical Drawing
Draftsmen's Course | <input type="checkbox"/> Structural Drafting
Ship Drafting |
| <input type="checkbox"/> Architectural Drawing | |
| <input type="checkbox"/> Electrical Engineering | <input type="checkbox"/> Architect |
| <input type="checkbox"/> Electric Lighting | <input type="checkbox"/> Architects' Blueprints |
| <input type="checkbox"/> Mechanical Engineer | <input type="checkbox"/> Contractor and Builder |
| <input type="checkbox"/> Machine Shop Practice | <input type="checkbox"/> Concrete Builder |
| <input type="checkbox"/> Railroad Positions | <input type="checkbox"/> Structural Engineer |
| <input type="checkbox"/> Gas Engine Operating | <input type="checkbox"/> Chemistry <input type="checkbox"/> Pharmacy |
| <input type="checkbox"/> Civil Engineer | <input type="checkbox"/> Automobile Work |
| <input type="checkbox"/> Surveying and Mapping | <input type="checkbox"/> Airplane Engines |
| <input type="checkbox"/> Metallurgy <input type="checkbox"/> Mining | <input type="checkbox"/> Agriculture and Poultry |
| <input type="checkbox"/> Steam Engineering <input type="checkbox"/> Radio | <input type="checkbox"/> Mathematics |

BUSINESS TRAINING COURSES

- | | |
|--|---|
| <input type="checkbox"/> Business Management | <input type="checkbox"/> Salesmanship |
| <input type="checkbox"/> Industrial Management | <input type="checkbox"/> Advertising |
| <input type="checkbox"/> Personnel Organization | <input type="checkbox"/> Better Letters |
| <input type="checkbox"/> Traffic Management | <input type="checkbox"/> Show Card Lettering |
| <input type="checkbox"/> Business Law | <input type="checkbox"/> Stenography and Typing |
| <input type="checkbox"/> Banking and Banking Law | <input type="checkbox"/> Business English |
| <input type="checkbox"/> Accountancy (including C.P.A.) | <input type="checkbox"/> Civil Service |
| <input type="checkbox"/> Nicholson Cost Accounting | <input type="checkbox"/> Railway Mail Clerk |
| <input type="checkbox"/> Bookkeeping | <input type="checkbox"/> Common School Subjects |
| <input type="checkbox"/> Private Secretary | <input type="checkbox"/> High School Subjects |
| <input type="checkbox"/> Spanish <input type="checkbox"/> French | <input type="checkbox"/> Illustrating |

Name.....
Street.....
Address.....

City..... State.....

Occupation.....

If you reside in Canada, send this coupon to the International Correspondence Schools Canadian, Limited, Montreal



YOUNG MAN! "Learn Radio!"

MAKE \$3,500 TO \$10,000 A YEAR your goal—I GUARANTEE to teach Radio to you quickly, at home in your spare time. As head of a large successful Radio Corporation I can sure give the real down-to-earth PRACTICAL training you need to earn big pay. No previous knowledge of radio required. A fascinating business—opportunities unlimited. Jobs galore for trained men. My FREE BOOK tells all. Write now! "Tune in" on SUCCESS! Learn radio right!

\$5 STARTS YOU. I FURNISH EVERYTHING including lessons, tools, testing apparatus, parts, sets to build and wire, etc. **PAY AS YOU LEARN AND EARN.** Personal instruction. Satisfaction or money back.

WRITE today for FREE BOOK and AMAZING SPECIAL OFFER.

A. G. HOFFMAN, President
MIDWEST RADIO CORPORATION

Pioneer Builders of Radio Apparatus
21-A Training Dept. Cincinnati, O.



LEARN WATCH REPAIRING



You can learn by our modern and original system of instruction every part of the **Watch Repairing Trade** at home as good or better than at a shop. You can earn money while learning and secure a well paying position or start in business after completing our course of instruction. Good watch repairers are always in demand and earn from \$50 to \$75 per week. For particulars apply to the **Wisconsin School of Watch Repairing**
166 Mason St., MILWAUKEE, WIS.

\$1500 - \$3000 Year For You

SALESMEN Men, 17 up. Several hundred wanted immediately. Travel—See your country at **WANTED** BIG PAY. Common education sufficient. Experience unnecessary.

FULL PARTICULARS—FREE

Write immediately for full particulars, free sample training in Selling and Free Book, "How To Be a Big Paid Salesman."

FRANKLIN INSTITUTE, Dept. M 702, ROCHESTER, N. Y.



New Way to Make Money at Home

Could you use \$5 to \$10 per day extra money? You can earn it in spare time, in a pleasant, fascinating, new way. No previous experience necessary. Complete outfit furnished free to members. Everything made so plain and clear a child can follow instructions. It sounds too good to be true but hundreds already know it is like a dream come true. Success guaranteed.

FREE Beautiful New Book on Home and Gift Decoration

Members are taught to decorate beautiful Art Novelties, lamps, shades, tables, chairs, bookracks, also etching on copper and brass, also pillow tops, batik, etc. Complete instructions for opening an Art Corner in your home, or Art Novelty Store, or selling to other stores. **FIND OUT** about this golden opportunity by writing **TODAY**. You'll say "It's just what I've wanted." Mail coupon or letter **NOW** enclosing 2c stamp.

FIRESIDE INDUSTRIES

Dept. 66-B
Adrian,
Michigan

Fire-side Industries
Dept. 66-B
Adrian, Mich.

Gentlemen: Without obligation on my part, please send me, **FREE**, the book of Fireside Industries, also particulars of your Guarantee and the special cooperative privileges and services. I enclose two-cent stamp.



Name.....

Address.....

City..... State.....



Samuel Glassberg



Tremendous Future for Every Man Who Enters Building Business Now. Leading Minneapolis Builder Tells How . . .

"Years ago, when one entered the building business, it was necessary to start at the bottom and work up step by step. My start was to carry the water bucket and be a general helper, at \$3.00 per week. I learned by experience, and it took me many years. Often I have wished I could have had the easy, quick, thorough training offered to boys and men today. The Chicago Tech. School for Builders can teach the fundamentals of building, give every man in 10 months' training what took me about 10 years to learn in the slow, hard school of experience. Today this modern method enables every boy and man to obtain his training during spare time. Opportunities now in the building business are the best ever, growing greater every year. There is an endless opportunity for trained men." So writes Samuel Glassberg, greatest home builder of the northwest, Pres. Glassberg Construction Co., Minneapolis. A self-made man who plans, finances, and builds an average of 75 homes annually, and knows every branch of the building business. He started as a boy. Today he has his own lumber mills, finance company, and employs more than 180 men.



Learn at Home in Spare Time to Earn \$3,000 to \$10,000 a Year

Get into the building business . . . no matter what your job is now. No overcrowding in this tremendous field—room for thousands of new men every day. For building is America's second largest industry. Why buck the competition of crowded industries where only a few men advance to big-pay jobs? Why stay at low wages? In spare time—at home—any man can get his start to become a building expert—and can earn \$65 to \$150 per week.

Clerk or carpenter—office man or bricklayer—salesman or superintendent—it makes no difference. Thousands of specialists—men who can read blue print plans and boss the others—are demanded for the \$6,000,000,000 of buildings that will be erected this year.

Men who are in the building game now know the high wages—\$10 to \$20 a day—paid to foremen, superintendents, and experts in various branches of building.

Building—Plan Reading—Estimating

Even men with ordinary training make real big money in the building field. But trained men win the top—salaries of \$3,000, \$5,000 and \$10,000. Fit yourself for this work. We'll show you the way. You can get into the building business quickly . . . easily. Or if you are in it now . . . and want to advance . . . you can get the training now that you must have for success.

FREE TRIAL LESSON—No Education Necessary

To show you how simple this Builder's Course is we send you a free trial lesson and actual blue print plans. Our book "How to Read Blue Prints" . . . written by a practical building expert, covers the first lesson. You will find this whole course as easy to read and understand as your daily newspaper with everything written in everyday language. You learn from actual blue print plans—from practical building experts. That's why Chicago Tech. School for Builders graduates get ahead so fast—why they are picked for the big jobs. And you don't need any other education.

Earning Less Than \$75 a Week? Then Act Now—Send the Coupon

Send the coupon. It places you under no obligation. Get the facts—today. Find out about this building course—what it has done for others—what it offers you. Builders in your own town or city are making big money. Here's your chance to get into the same big-pay field—or to have a building business of your own. Send the coupon. "How to Read Blue Prints," the Blue Print Plans and a book describing our whole course will be sent to you at once. See for yourself what building means in dollars and cents to you!

From Foreman to Contractor and \$450 a Month

"When I entered as a student I was in charge of a job as a foreman at \$8.00 a day. For the past four months I have been contracting and have averaged \$450.00 a month." Writes R. H. Edney, Asheville, N. C.

Salary Increased From \$1.50 a Day to \$210 a Month

"In 1920, I was a ditchman working for \$1.50 a day. And now my salary is \$210.00 a month. Chicago Tech. Training has taken me out of the ditch and landed me on the top of the building." So writes P. J. Marchand, New Orleans.

FREE Trial Lesson and Blue Print Plans



Qualify for a Good Paying and Permanent Position

- Plan Reading
- Estimating
- Foremanship
- Superintendence
- Building Construction
- Building Management
- Contracting
- Building Homes
- Real Estate and Insurance
- Public Estimating
- Building Inspecting
- Buying and Selling
- Building Material
- Quantity Surveying
- Promoting

Mail This Now!

Chicago Technical School for Builders, Dept. 277, Chicago Tech. Bldg., 118 East 26th St., Chicago, Ill.

Yes, I want to earn more. Send me, without obligation, details of the opportunities in the business of Building, details on how I can increase my earnings, and a copy of your book, "How to Read Blue Prints." (Write or print name plainly, please.)

Chicago Technical SCHOOL for BUILDERS

Dept. 277, Chicago Tech. Bldg., 118 E. 26th St., Chicago

Name

Address

City

State

Occupation

Heat Fountain Fits Any Stove!



PAT SCHAEFER

No longer do you have to depend on an uncertain supply of high priced coal. No longer do you have to contend with the soot, ashes, smoke and grime of dirty coal and wood. No more fires to kindle and tend. Pat Schaefer unconditionally guarantees to give you a new heating satisfaction without a change to your present furnace or stove—with a money back guarantee and a free trial privilege of his wonderful discovery.

Does Away with Coal and Wood For Any Stove or Furnace

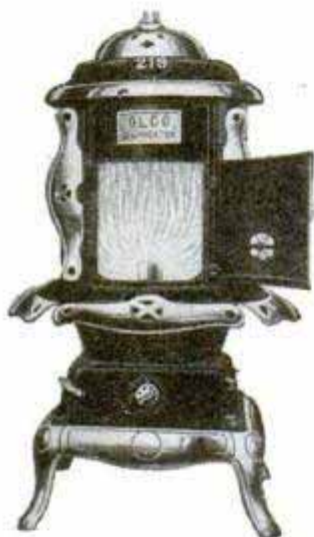

Mr. Schaefer's discovery has brought an already standard oil burner to a degree of perfection never before anticipated and as a result makes possible an offer never before made—actual trial of a wonderful heating invention in your own stove or furnace with the understanding that unless it gives you heating satisfaction it costs you nothing.

Fits Any Stove or Furnace

This new burner will be sent to any one for trial in their own home. It comes in sizes to fit any

heating stove, cooking range, or furnace. No holes to drill. No changes whatever. Easily installed in a few minutes. Burns ordinary kerosene in stoves and furnace oil in furnaces. Already tried in thousands of homes—with perfect satisfaction even where the temperature is 20 to 40 degrees below zero. Yet it can be regulated to any degree of heat wanted, for mild Fall and Spring days, by the simple turn of a valve.

Cheap—Clean—Simple

Mr. Schaefer's invention really makes it possible to burn gas in any stove—by combining air with ordinary kerosene or fuel oil. This gas burns with an intense, hot, clean flame. There are no ashes, smoke, or soot—no noisy motors. The cost of operation is very small. It is absolutely safe and will last a lifetime. Mr. S. K. Pedro of South Carolina writes: "Beats all other burners seen in this country. A sensation." Mr. Geo. Flynn of Michigan writes: "It is cleaner, cheaper, hotter and steadier than coal or wood."



Now, and for all time, do away with household drudgery and dirt. Eliminate the thousands of steps that coal and wood necessitate.

30 Days' Free Trial

Send immediately for special low introductory price and 30 days' trial offer. Interesting book included which tells of the different types of Mr. Schaefer's burners and how you can install one in your own stove or furnace. Act now. Fill out and mail the coupon immediately to



AGENTS AND SPARE TIME WORKERS \$250,000 Already Paid!

and only a start has been made. Spare time workers, full time workers, agents and salesmen, here is an unprecedented opportunity to cash in on a nation-wide slide of this wonderful invention. One agent made more than \$215 in one day. One made \$1000 in one month. The demand for oil heat for both heating stoves and furnaces is nation-wide. Heretofore, price alone has prevented millions from adopting it. Now, with the perfected Oliver—selling at a fraction of the cost of other oil burners—every home can afford the luxury of oil heat. Olivers also fit cooking ranges giving you all-year round sales. Spare time workers can realize tremendous profits right in their own neighborhoods. Write at once for free sample case and free territory plan, or check the coupon and mail it immediately to W. A. Schaefer, The Oliver Oil Burner Corporation, Dept. B-130, St. Louis, Mo.

OLIVER OIL BURNER CORPORATION

210 Chestnut St., Dept. B-130, St. Louis, Mo.

Oliver Oil Burner Corporation, Dept. B-130, 210 Chestnut St., St. Louis, Mo.

Send me your free book and special free trial offer. I am interested in your offer, without obligation to myself. I am interested in a burner for

() Heating Stove () Range () Furnace

Name.....

Address..... County.....

City..... State.....

() If interested in selling check in square here.

"An Iron Indian Could Make Money With Your Ideas"

That is the opinion of D. H. Garrett (address on request) who followed my ideas and made \$630 in one week. Says his success is due to my methods and that the profits are far beyond those of any other small town business.

WHAT is the biggest money you ever made—\$100 a week—\$200 a week—\$500 a week?

D. H. Garrett was up against it financially. I helped him get started as a Real Estate Specialist. Now he writes me that he made over \$600 in a single week.

Another man I helped—a man who had been working in a shop at hard labor—writes me that he is just putting through his first real estate deal and making \$420 in one lump.

Another user of my system, from Massachusetts, dropped in my office the other day and said he put through a deal the previous week that netted him \$1,500.

Isn't that the kind of a business you want to get into—a big-money business—where go-getters sometimes make as much in one deal as the average man earns in a whole year?

Write at once for my free book "How to Become a Real Estate Specialist." It tells how I started in my spare time—with less than \$5 capital—and earned more than \$100,000 net profit in less than five years.

It tells how other men and women—using my successful ideas—are making more money than they ever made before.

It tells how you can begin now—right at home—learn my successful system—become a Real Estate Specialist—build up an independent business of your own—make money my way.



What Others Say

"Your Course fitted me for position as Sales Manager of largest contractors and builders' real estate department in our city."—*Henry J. Duttard, Michigan.* "Your system is wonderful. Without giving up my job as stationary engineer I made \$900 the first three months in my spare time."—*F. E. Stokes, Pennsylvania.* "Have been helped a great deal by your system. I have now a new car, two new typewriters, a stenographer and a dandy office and money in the bank, all through my own efforts and without any capital to start with."—*Mrs. P. Moore, Connecticut.* "One lesson has been worth \$3,500 to me."—*C. J. Lewis, Virginia.* "I have made a little over \$1,200 since beginning your Course."—*S. M. Ford, Florida.* "Have sold one \$5,000 lot and three houses so far."—*Mrs. B. M. Morehouse, New York.*

Write for FREE BOOK at Once

Tear off the bottom margin of this page. Write on it your name and address. Drop it in the mail. You will then receive—without cost or obligation—a copy of my new, illustrated book which tells how you can do what others are doing—start in your spare time to learn my successful system and build up a money-making business of your own as a Real Estate Specialist. Get this important information now—at once—before it is too late. Find out how you can have a splendid business of your own and make more money than you ever thought possible.

AMERICAN BUSINESS BUILDERS, Inc.
Dept. 44-B, 18 East 18th St., NEW YORK

Be a Real Estate Specialist. Use my successful system. Start at home, in your spare time. Build a business of your own. No experience needed. No capital required. Write for full particulars and proof of amazing success.

If you want to get ahead—if you want to climb higher—if you want to have a good business of your own—if you want to make enough money to have a real "look in" on luxury—send for my free book. It will open your eyes to one of the biggest and best business opportunities that ever came your way.

Here are a few reasons why I think the business of a Real Estate Specialist has it "all over" any other business or profession:

(1) Real Estate is the biggest thing there is. More money is invested in it than in anything else. It is the basis of all wealth. We all live on the land; and we are clothed, fed and warmed by the products of the land.

(2) More money is made in it than in any other business I know of. Successful real estate men sometimes make \$2,000—\$5,000—\$10,000—on single deals—more than most men make in a whole year.

(3) It is easy to learn. It does not take years of study like medicine, dentistry, pharmacy, architecture, engineering, etc.

(4) You can start in your spare time, with little or no capital.

(5) Real Estate is a permanent, growing business almost unlimited in its scope. It is estimated that there are at least ten million properties on the market all the time.

(6) It is a pleasant business, requiring no hard, dirty, laborious work, and it brings you in touch with the best people.

(7) With the use of my proved-out system you can get started easily and quickly; and the co-operation of my company will help you every step of the way.

American Business Builders, Inc.,
Dept. 44-B, 18 East 18th St.,
New York

Send along your free book "How to Become a Real Estate Specialist."



Name.....

Address.....



**LEARN
TENOR
BANJO
from the
MASTER!**

I Can Teach You to Play!

The Tenor Banjo—typically American instrument, is sweeping the country like wildfire. Tenor Banjo music is flooding the country—orchestras, theatres, homes! Its possibilities are almost unlimited. Why envy the popularity of the people who play these instruments? I can teach you to play—quickly and easily.

Here's My Proposition

For the first time in the history of my long playing career—5 years with Isham Jones' Recording Orchestra—coupled with many years of vaudeville and teaching experience—I am now in a position to offer you my famous Home Study Tenor Banjo Course. I call it "The Key to Successful Banjo Playing." It is my course—compiled after years of study and experience with the tenor banjo—the instrument I helped to develop. Just to give you an idea of what people think of it, read these letters I received a few days ago from two of America's foremost banjo players.

READ WHAT THEY SAY

"I am going to recommend the McNeil Home Study Banjo Course to everyone who is interested in tenor banjo playing. It is wonderful and its 165 pages are chockful of intelligent instruction."
—JOE MUELLER.

(Mr. McNeil's successor and pupil-banjoist, with Isham Jones' Brunswick Recording Orchestra)

"In my estimation this is the best course I have ever seen as it can be used to great advantage either as a self-instructor or with teacher. It is a boon to professionals and amateurs alike."
—BILL HAIT.

Banjoist, Coon-Saunders' Night Hawks.

This Home Study Tenor Banjo Course of mine which I have named "The Key to Successful Banjo Playing," is the same course which I am using so successfully in my work as director of the Chicago Tenor Banjo Institute. Daily we are training professional banjo artists for bigger pay jobs with this marvelous course. This course can now be yours! It's so simple—as easy to learn as though I were actually sitting at your elbow teaching you the exact finger positions, chords, melody, harmony, progressions, "fill-ins," sight reading—other pointers galore!

Easy to Play the McNeil Way

A few happy hours—at home in your spare time will fit you to step into the expert banjoist class. I am not boasting when I say I am thoroughly qualified—probably more than any other tenor banjo artist—to teach you to play!

My Home Study Course for Tenor Banjo is suitable for beginners, advanced students, and professional artists.

It is a personalized, "A to Z" course. Includes everything you will ever want to know about tenor banjo playing. As an added feature to help you I will furnish you with a phonograph record—free when you enroll—played by myself, illustrating jazz strokes, breaks, etc., etc., just as I have played them many times for Brunswick records.

DON'T WAIT—BE THE FIRST!

Don't let another minute pass by without sending the coupon below! Along with my course you get my personal advice, and question-box service, without extra charge.

Easy to Pay—While Learning to Play

It's yours—all yours—for a small initial down payment and the balance at less than \$1.00 per week! Write today for my free booklet and full details on my course. **CHARLES MCNEIL, Director**

Chicago Tenor Banjo Institute
Dept. 1352, 1621 N. Lincoln St., Chicago, Ill.

Mr. Charles McNeil, Studio Director
CHICAGO TENOR BANJO INSTITUTE
Department 1352, 1621 N. Lincoln St., CHICAGO, ILL.

I would like to find out more about your new Home Study Tenor Banjo Course. Without obligation, please send me literature and full information.

Name.....

Address.....

City..... State.....

Beginner Advanced Student Professional Artist

**Easy To Earn
\$50 to \$100 a week**



Making Cards Like These

EVERY store in your neighborhood needs display cards like these! Learn to make clever show cards through easy home-study professional course. Earn \$50 to \$100 in full time—or \$25 to \$50 in spare time. Business of your own. Pleasant work. Write for big illustrated Free Book—also Free Offer.

Washington Show Card School
Room 302-D, Washington, D. C.



\$40.00 Suit for Only \$23.50!

Think of being able to offer a \$40.00 suit made of the finest quality of pure Virgin Wool; fit, fabric and fashion guaranteed, at the powerfully attractive price of \$23.50! Can you sell such values? You can, if the experience of 2,500 other salesmen means anything. And you don't have to know anything about selling clothing. We'll take you, train and equip you to go out and make a success of this work if you are honest, ambitious and willing to work. If you are, write us. You'll hear from us promptly with the full facts. Address Dept. 771.

William C. Bartlett, Inc., 850 Adams St., Chicago

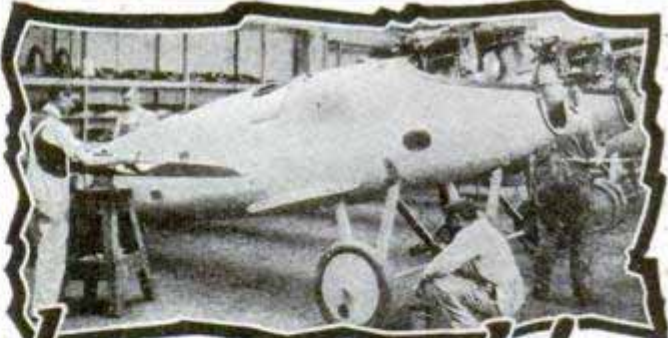

be an airplane expert!

Aviation is new! It is the field of wonderful opportunities today! It is not crowded. It offers every man of average ability a chance to become an Airplane Expert. I am looking for ambitious, daring, red-blooded fellows who want to make Big Pay in a clean, fascinating field. Airplane Experts can find steady employment—anywhere, any time.

PAYS BIG MONEY—QUICK!
It's a well-known fact that Aviation is one of the best paying lines of industry. I can cite you instance after instance where Airplane Experts are getting anywhere from \$2,000 to \$10,000 per year. A few happy hours—at home in your spare time—with my thorough aviation course will fit you to step into the big pay class!

OUTFIT FREE! A working outfit like the one pictured to the left is yours—free—the minute you enroll.

WRITE TODAY! My attractive and complete catalog is yours for the asking—absolutely free! Also—for a limited time I am including with each enrollment a special offer on free airplane parts. Don't hesitate. Write today.

Leslie Coombs, "The Chief," Chief Engineer
WESTERN AIRPLANE CORPORATION
Aeronautical Training Division Dept. M-2
Suite 402-3-4-5 Monadnock Block Chicago, Ill.

Leslie Coombs, Chief Engineer, WESTERN AIRPLANE CORPORATION, Dept. M-2, Monadnock Block, Chicago, Ill.

Dear "Chief"—I am an ambitious, red-blooded fellow and want to get into the new Big-Pay field—aviation! Please send me one of the free copies of your book on how to become an airplane expert. Also tell me about your special offer on free airplane parts.

Name.....

Address.....

City..... State.....

FREE 64 Page Auto Book



If you are mechanically inclined,

write today for your free copy of this dollar book. You want to make a success of life, to cash in on the amazing opportunities of the automotive business. The first step is to send for my big free book that gives all the facts and will open your eyes to how other fellows are making real money and are happy in the automobile business. Over 70,000 men date their prosperity from the day they got this wonderful book. It costs me over a dollar apiece to send this book but I will gladly send it to you free.

Yes—You can do as well as these—

Joe Wagner, Moulton, Texas. "Made \$3,300 clear last year. Own up to date garage."

John Anderson, Simpsonville, Ky. "Making twice as much money as I ever made in my life. Head mechanic in a modern garage."

Lynton Harmon, Harrison, Mo. "Wouldn't take \$5,000 for what I learned at your school."

H. O. Wending, Altamont, Ill. "In business with another old student, hired two more Sweeney men, have a complete modern garage, sailing fine."

Roy Parker, Jackson, Tenn. "Making \$100 a week clear."

Kenneth White, Princeton, Ind. "Used to think \$3.00 a day was fine before coming to your school. Now making \$1.50 to \$3.00 an hour."

Ernest Moore, Milton, West Va. "From head mechanic to sales manager with Overland Agency. Can always recommend your school."

Frank Roe, Keller, Texas. "Every ambitious fellow has an equal chance."

—and thousands of others.

JOBS PAY \$50 A WEEK AND UP COME RIGHT NOW.

If you are mechanically inclined, if you like to work with tools, you will learn under the "Sweeney System," by actually doing the work, everything about all kinds of automobiles, oxy-acetylene welding, vulcanizing, battery work, electrical work, aviation, building and repairing Radio sets. No experience or education needed. No books are used. You work on most complete gas engine and electrical equipment obtainable. Over \$200,000 invested. \$50,000 Radio Station WHB. You'll get dirty and greasy, but you'll learn by the "Sweeney System" that fits you for big pay jobs at \$50 a week and up waiting for Sweeney trained men

SWEENEY SYSTEM OF PRACTICAL INSTRUCTION

This trains men by actual experience, working with their hands instead of learning from books. This book is a photographic trip thru world's famous and popular trade school. Get the facts about how easy it is now to make big money doing work you like. Be independent. Travel. See the world. Own your own garage, tire shop, battery station. Most fellows start in with jobs \$50 a week up. Take the first step now by sending for this big free book.

E. J. SWEENEY, President

LEARN A TRADE—
Sweeney
 AUTOMOTIVE & ELECTRICAL SCHOOL
 2231 SWEENEY BLDG. KANSAS CITY, MO.



MEN WANTED FOR GOOD JOBS

let's go. If you want money, independence, a sure good pay job or business for yourself—travel—see the world—if you want to be somebody and have something—do the work you like, then clip this coupon or send postcard for this book today.

My FREE BOOK Tells You—

How to run a garage anywhere.
 How to learn several good trades.
 How to travel and see the world.
 How to fit yourself for prosperity.
 How to get a good mechanical job.
 How to learn to be a chauffeur or truck driver.

How to learn to repair any make of car. How to weld. How to learn batteries and auto tires.

Shows you hundreds of actual photographs of men at work in my big shops. Shows how 70,000 men got their start.

Shows how easy it is to learn; how much fun you have during recreation hours. Swimming pool, entertainment, band and orchestra, radio broadcasting. Answers every question.

AMAZING NEW OFFER!

The first step is to get my free 64-page book. I will gladly send it to you. And I will make you an amazing offer. I will make it easy for any man to learn the auto business. I will send you this valuable book free—no cost—no obligation. No colored students accepted. EMORY J. SWEENEY, Pres.

Send this NOW

EMORY J. SWEENEY, President
 2231 Sweeney Bldg., Kansas City, Mo.

Please send me your Free 64-page catalog and special offer.

Name.....

P. O.

State..... Age.....

The University of Minnesota
SKU-MAH



PRESENTING OUR EXCELLENT ANNUAL SKU-MAH INTER-CLASS



\$10.00
an hour for
DRAWING

Mr. Hutton says, "One of my first drawings is shown on the right. The other I made recently for a college publication. It took only five hours and brought me exactly fifty dollars. You can judge for yourself whether I have progressed under Federal School training."

Can you draw as well as Mr. Hutton did at first? Then with similar training you can become a successful artist like hundreds of other Federal students.

Many Earn \$200 to \$500 a Month

Advertisers and publishers buy millions of dollars worth of illustrations a year. If you like to draw, let your talent make your fortune. The Federal Course, containing exclusive lessons by such nationally known artists as Sid Smith, Neysa McMein, Fontaine Fox, Charles Livingston Bull tells you how. Write your name, age and address in the margin, mail it to us and we will mail a free copy of "A Road to Bigger Things," giving all details of how to become an illustrator or a cartoonist.

Federal School of Illustrating

2136 Federal School Bldg. Minneapolis, Minn.

LEARN Painting Paper Hanging and Decorating

Sign Painting—Auto Painting
\$12 to \$20 per Day—Sure Pay
Come NOW to this Big School and by Spring be a Top-Notcher in
THE BEST PAYING TRADES

Write Dept. 414 for Free Catalog.

CHICAGO PAINTING SCHOOL Dept. 414, 148 West Austin Ave., CHICAGO

WANT WORK AT HOME?

Earn \$18 to \$60 a week **RETOUCHING** photos. Men or women. No selling or canvassing. We teach you and furnish **WORKING OUTFIT** given with each enrollment. Limited offer. **Write today.** Artcraft Studios, Dept. 50, 3900 Sheridan Rd., Chicago



Big Entertainer 320 Jokes and Riddles, 153 Parlor Games and Magic, 15 Tricks with Cards, 73 Toasts, 7 Comic Recitations, 3 Monologues, 22 Funny Readings. Also Checkers, Chess, Dominoes, Fox and Geese, 9 Men Morris. All 15c postpaid.
J. C. DORN, 709 So. Dearborn Street, Dept. 15, Chicago, Ill.

Bodies of Rare Beauty for Fords

At Factory Prices!

\$22.75 and Up

Write for Circular A-2 showing this Model and others.
SPORT BODY WORKS
AURORA, ILL.

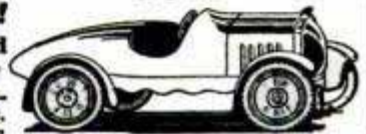

This model in grey prime, \$39.50



HERE'S
YOUR
CHANCE

BOYS!

to get FREE just what you've wanted for a long time
The latest model of \$1.00

EVERSHARP PENCIL

With polished red barrel, nickel trimmed, with pocket clip, large exposed eraser, new perfected tip, and twelve extra leads in magazine and a

\$2 EAGLE SELF-FILLING FOUNTAIN PEN

(14 Kt. Solid Gold, Iridium Pointed) Russet finish barrel with purple ends, long size, gold-filled lever and ball end pocket clip BOTH for only THREE yearly subscriptions to **POPULAR MECHANICS MAGAZINE**

Think of it! Fifteen minutes of your spare time and these

TWO WONDERFUL PRESENTS

are yours, without a penny's cost! The subscription rate of **POPULAR MECHANICS** in the U.S. and countries in the Postal Union, is \$2.50 a year, postpaid. All other countries, \$3, postpaid.

READ CAREFULLY. Send us THREE yearly subscriptions to **POPULAR MECHANICS**, with \$7.50 money order to cover, and we will mail you this Beautiful Pencil and Pen by return post. **START TODAY—RIGHT NOW.** To get your three yearly subscriptions and mail them to

POPULAR MECHANICS MAGAZINE
Room 408, 200 East Ontario Street Chicago, Illinois



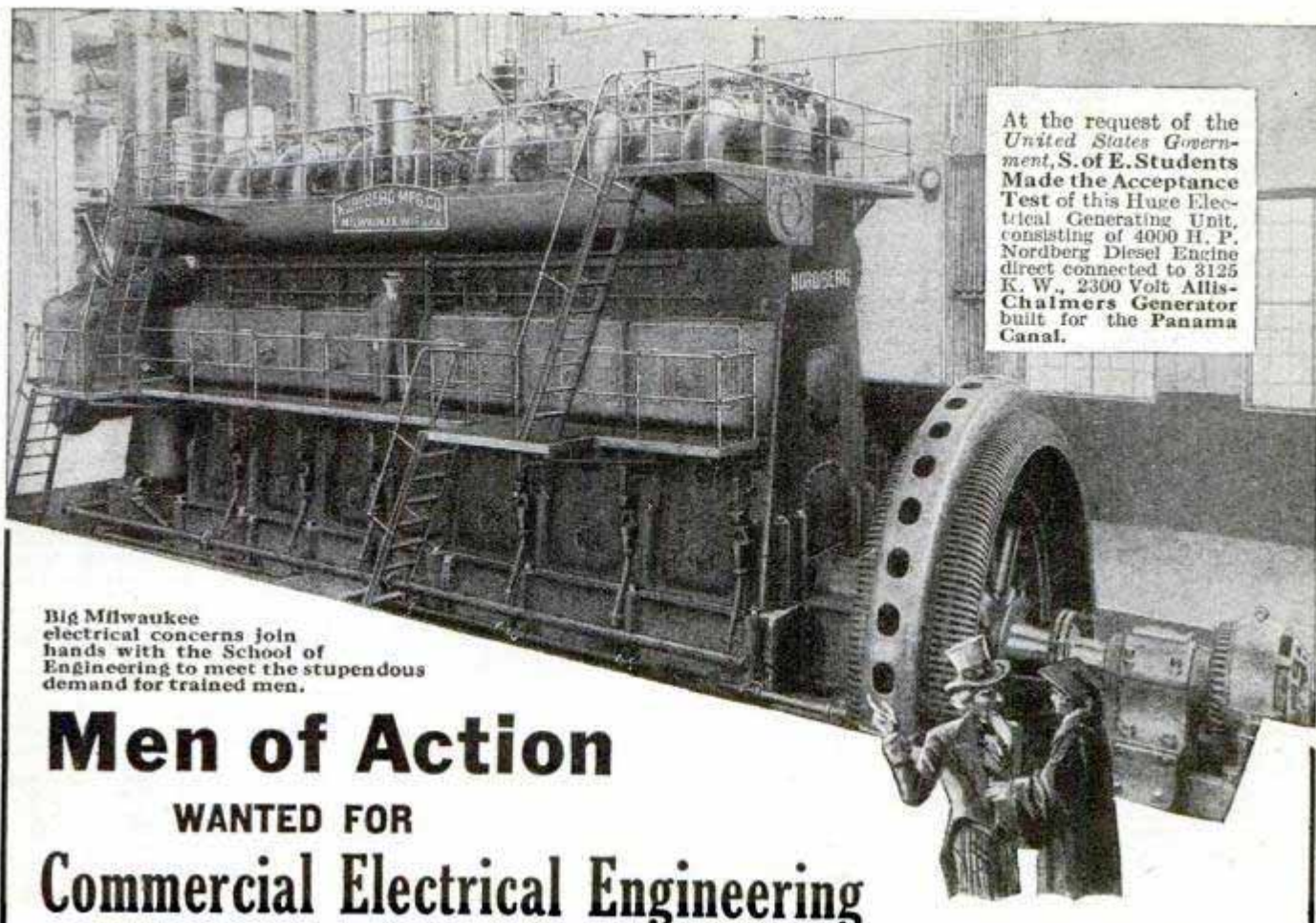

At the request of the United States Government, S. of E. Students Made the Acceptance Test of this Huge Electrical Generating Unit, consisting of 4000 H. P. Nordberg Diesel Engine direct connected to 3125 K. W., 2300 Volt Allis-Chalmers Generator built for the Panama Canal.

Big Milwaukee electrical concerns join hands with the School of Engineering to meet the stupendous demand for trained men.

Men of Action

WANTED FOR

Commercial Electrical Engineering

Takes you out of the class of the common laborer of which there is always an over plentiful supply at cheap rates of pay. Makes you a **Graduated Electrician, Electrotechnician, or Commercial Electrical Engineer** in 12 short months. Puts you in line for a job where big manufacturers are actually pleading for trained men and glad to pay **Big Salaries** ranging from \$2,000 to \$10,000 a year. Not a dream—**A DEAD SURE FACT!** For 20 years we have trained men for the electrical profession and **Our Graduates Have Succeeded in All Parts of the World.** Our 12 months' intensive training is the boiled down essence of what **We Know** fits men for big paying positions. It is work you'll love. **No Limit** to advancement. **Practical engineers teach you.** They know **What** to teach and **How** to teach it, so you can earn money with it. Hundreds of thousands of dollars worth of actual commercial machinery to work on in this school.

Uncle Sam Asks S. of E. OK!

Think of the opportunity to test plants such as this. The Nordberg Manufacturing Company is only one of many large concerns that is co-operating with School of Engineering students. This type of practical work, while in school, insures your future when you graduate. That's why our men are always in demand and always command big salaries. You can be one of these men if you **ACT!**

EARN WHILE YOU LEARN

By our special system you may earn part of your way while learning. Our Employment Department will help secure you a position to which you may devote a part of each day, spending the remainder at the school. This plan both solves the students' financial problems and provides splendid experience at the same time. Low tuition fee. Board and room reasonable. Daily Broadcasting WSOE. School Orchestra. Fraternities.

Write for FREE Catalog

Write today for our free, illustrated catalog. Read about this wonderful institution and the great opportunities that lie before you. Find out about our special method of training and the details of our "Earn While You Learn" plan.



ENTER AT ANY TIME



SCHOOL OF ENGINEERING OF MILWAUKEE
Dept. P. M. 226, 415-17 Marshall Street, Milwaukee, Wis.

Without obligating me in any way, please mail free 72-page illustrated book, "Electricity and the One Best Way to Learn It," and particulars regarding the course I have marked with an X.

- ... **Commercial Electrical Eng.**
- ... **Electrical Eng., B. S. Degree in 3 years.**
- ... **Electrotechnics.**
- ... **Junior Electrical Eng.**
- ... **Automotive Electricity.**
- ... **Radio Sales, Service and Broadcasting.**
- ... **Armature Winding.**
- ... **Light, Heat, Power Wiring and Testing.**
- ... **Practical Electricity.**
- ... **Home Laboratory Service.**
- ... **I am interested in your "Earn While You Learn" Plan.**

Name..... Age.....
Address.....
City..... State.....
Education.....

SCHOOL of ENGINEERING
of Milwaukee

Founded 1905 Dept. P. M. 226 415-17 Marshall St. Milwaukee, Wis.

THIS IS THE LIFE!

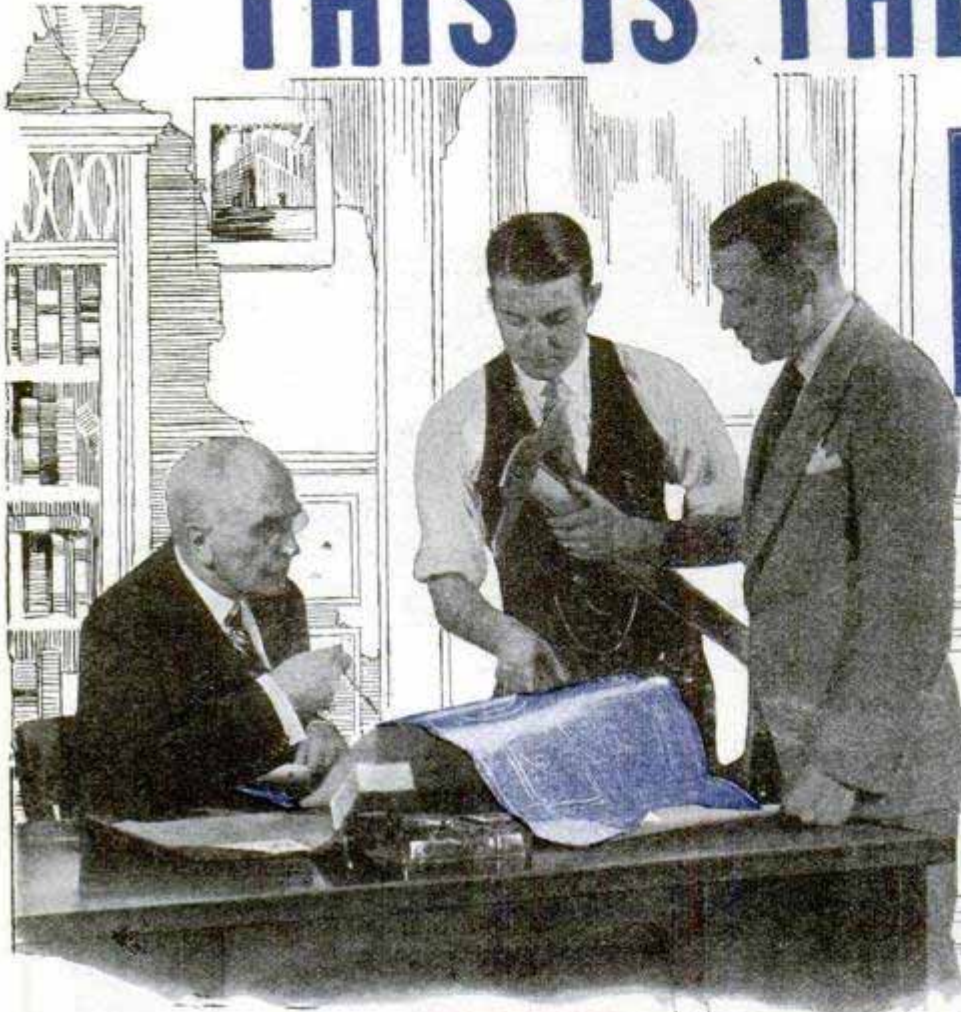

To the left is drawing of a valve, made by a student in only the sixth week of the Dobe drafting course.



The simple detail drawing above is reproduced from the work of a Dobe student while on his fourth lesson.



"Have completed \$100,000 worth of work this year, thanks to Dobe instruction." —D. E. SANDERS (S. Car.)

Follow the line of work you like, but *learn the right end*. No work is done—nor even begun—without the draftsman! He's an important member of the firm.

It's draftsmen all concerns are after. Read the papers! Count the ads for draftsmen wanted; notice the pay they mention; see the inducements they offer!

Every workman must understand drawings. It's as easy to learn to *make* them as to *read* them. And the man who can make drawings is the man who makes the money!

Do you realize what a big field drafting is? All building, engineering, or manufacturing starts on paper. Single jobs require thousands of drawings. The simplest things you use were drawn before they could be made; the tools you handle; even the pipe you smoke. *Everything you see around you was first a drawing.*

You can learn drafting. I can teach you.

At home. Easily. Nothing that pays well is any easier—or more interesting.

NO "TALENT" NEEDED! You can draft if you can hold a pen or pencil. The most "complicated" mechanical drawing, or architect's plan, is made a line at a time.

A few simple rules you carry in your head; and tools you can put in your pocket. That's all you need. Dobe trained men can handle any job—as any engineering or contracting firm will tell you! For I give you the same work you will later do for money. And I show you how to do it—the right way—the quick way—the workmanlike way.

\$100 A WEEK may sound big to some. It is *not* big pay for draftsmen. Nor does drafting stop there; every Chief Draftsman once worked at the board; it is from the boys in the drafting room that Construction Bosses and Plant Superintendents are chosen. Every architect, and most engineers *started at the drafting table.*

REMEMBER, it's *supply and demand* that regulates everyone's pay. What good is any trade in which there is a *waiting-list* instead of work? Or a head crammed with knowledge for which there is no actual, cash demand? But in drafting, you don't see signs "NO HELP WANTED!" Every industry is clamoring for draftsmen; read the want ads in any newspaper.

Blueprints are needed before a brick is laid, or a wheel can turn. The draftsman comes first. And what an enjoyable job he has! Drafting room hours are short, and time flies when you're drafting. Or, perhaps the whole day is spent in discussion of some work. Whatever it be, your pay goes merrily on.

Don't you think it might pay you, too, if you invested two minutes in filling out the coupon on opposite page?

Machine Shop or Mill—Railroading or Radio—Electric Companies—Building,

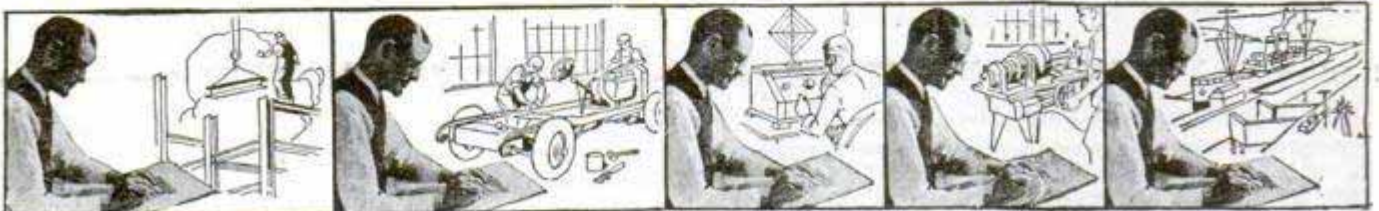

DRAFTING PAYS BEST!

**Beginners Earn \$50 and \$65 a Week or More!
Junior Draftsmen \$400 a Month; Chiefs, \$800**

There's *big* money in drafting. Make no mistake about that! My former students are getting all the way from \$250 a month as juniors, to \$833 a month as chiefs.

Here is your chance to take up drafting. Learn practical draftsmanship at home—but under the daily direction of Chief Draftsman Dobe—the man who has made finished draftsmen of thousands of men, young and old—men who had no previous training, or even the average amount of schooling. Give him your evenings for just a few months, and you'll be ready for almost any drafting job that offers. Begin in time to get all your tools without a dollar's extra outlay! Note offer:

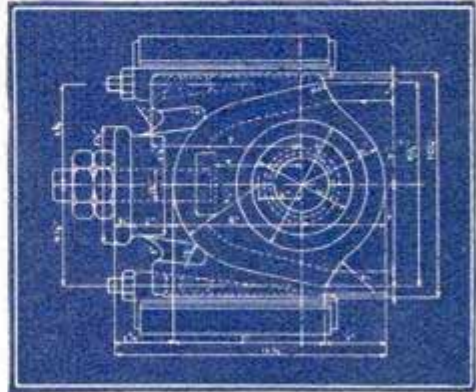

Above Drawing by a Two-Month Dobe Student

PAYING POSITIONS loom up almost as soon as you are enrolled in a Dobe class! We receive requests *daily* for junior men—for men only partly through our course. "We'll take a *beginner*," some concerns write us, "so long as he is a Dobe trained man and has begun *right!*" Furthermore, a lot of our students are willing to carry on special work for pay, right while their lessons go on.

But why try to tell you here, all the wonderful *facts* you'll find in my new, big book, *Successful Draftsmanship*? Full of actual information, fully illustrated, the biggest and most fascinating book ever published on the subject! Send for it in time to get your complete, lifetime drafting outfit *free of any extra cost whatever!* Coupon below.

Money-Making Tools



A Professional Drafting Set, and All Supplies Furnished!



"My new chief says, Dobe must teach right: I can handle everything so far. They pay me \$65 a week."—LEO NIECEBERGER (Pa.)



"Just been made chief and got a good boost in pay. Your course has the goods."—WM. G. HAZLETT (Col.)

Scores of engineering firms and manufacturers recruit their draftsmen from my classes. I haven't enough men now—and a busier season is coming. Therefore, I make this offer to get *action*: a beautiful set of imported drafting instruments, all rules and tools, and a *drafting table*, free of any extra expense to those who join up at once. You needn't decide now, but get your name in at once for this free offer! Clip coupon, and *mail it!* I want to caution you that this is a limited offer—it isn't one I can afford to keep on making!

WHY DRAFTING PAYS It's in the drafting room that the big ideas come—and the big money. Have you ever known a draftsman who didn't like his work? Or one who ever had to look for work? If a hundred dollars a week sounds big—yes, or \$150—you aren't in the right line of business! Get into a broader field—the broadest of all. That's drafting. Investigate the tremendous field of drafting before you decide on any line of work or career. Drafting fits in with almost any kind of work you can think of.

IN 1926 I predict a shortage in draftsmen. Last Spring, every sort of inducement was being offered men who could draft. Scores of our "boys" stepped right into fine jobs the week they had completed our course. This year will see still greater demand for draftsmen—with a big building boom and big production all over U. S. and abroad.

Engineering, or Mining—All Need Draftsmen!



Good for Tools

CHIEF DRAFTSMAN DOBE
1951 Lawrence Ave., Chicago, Dept 93-52

Please send **FREE** and **POSTPAID**, without obligation, your new, fully illustrated book, *Successful Draftsmanship*, complete information, terms, etc., *in time for free tool offer.*

Name..... Age.....

Address.....

.....

Magic

Learned Easily At Home



James Sherman
Master of Magic
who has performed his marvelous lesser-known in practically every civilized nation in the world.

Astonish Your Friends

gain that electric popularity that makes you the center of any crowd. Business and social success is assured the man who can perform mystifying tricks. You can earn big money either on the side or as a professional, as well as being the most popular person in your crowd. Why envy others' skill? You can learn Magic yourself, quick and easy. Even slight-of-hand, generally supposed to require long practice, is NOW made simple to learn. For James Sherman, one of the really Great Magicians, has finally opened up the secrets of his profession in a completely illustrated course offered at a merely nominal cost. Through the wonderful Sherman System you will be able to mystify and entertain your friends with simple tricks taught in your very first lesson. After that Mr. Sherman takes you through the entire maze of slight-of-hand, card tricks and elaborate stage diversions. The apparently superhuman doings of the accomplished magician become as simple as ABC when you just know how.

Earn \$250 to \$1000 a Month

There is a tremendous demand for magic entertainment. Clubs, Lodges, Charity and Social affairs—all will pay high fees to the man who knows Magic. Sherman really gets as high as \$250 for an half hours work right now. Opportunity everywhere to make money aside from your regular occupation. Salesmen find it a tremendous asset.

Mail Coupon for Special Offer

Find out all about this unprecedented opportunity to learn Magic. The coupon brings full details without any obligation. Mail it TODAY.

SHERMAN SYSTEM

Studio 13-52, 1926 Sunnyside Ave., CHICAGO

SHERMAN SYSTEM, Studio 13-52
1926 Sunnyside Ave., Chicago

Tell me all about James Sherman's new and simple system by which I can learn the secrets of MAGIC. No obligation on my part.

Name.....

Address.....

Age.....

BIG DEMAND—BIG PAY

Be a Plumber!

We Train You Quick Learn To Do Any Job —Step right into a Big

Pay Job or Start a Shop of Your Own. Work the year around—Earn more in one day than some folks do in a week. Why serve 4 years Apprenticeship? **LEARN in 8 to 12 WEEKS—REAL PLUMBERS TEACH YOU.** Learn All Branches including lead wiping, plan work, etc. Strictly tool using system. No books used. The Plumber Modernizes the Home and Turns Drudgery into Pleasure. Field growing daily. Don't envy a Plumber—Be One. Write for information—Special Tuition Fee and Amazing opportunities. Don't delay—Do it Today.

KANSAS CITY SCHOOL OF PLUMBING
2030 Troost Ave. KANSAS CITY, MO.

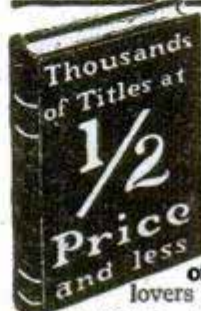
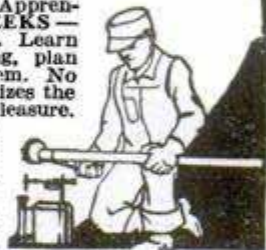

ANY BOOK IN PRINT

Delivered at your door. We pay the postage. Standard authors, fine editions, new books, all at biggest savings. Be sure to send postal for Clarkson's catalog. **FREE** log. This catalog is a short course in literature and is so used by some of America's leading universities; 300,000 book lovers buy from it. Free if you write now.

DAVID B. CLARKSON THE BOOK BROKER
221 CLARKSON BUILDING, CHICAGO, ILLINOIS

Practical Electrical Education

Learn by the thorough approved scientific methods which our twenty years of specializing enable us to give you.



Become a **Commercial Electrical Engineer in one year, or learn an Electrical Trade in from three to six months. Light, Heat, Power, A. C. and D. C. Armature Winding, Automotive Electricity, Radio included.** Course unexcelled. Illustrated catalog **FREE.** Be sure to mention age and education.

SCHOOL OF ENGINEERING OF MILWAUKEE
Dept. PM-2268 415 Marshall St., Milwaukee, Wis.

DRAW CARTONS

Turn Your Talent Into Money

Cartoonists earn from \$50 to \$300 per week—some even more. Remarkable new Circle System of Drawing teaches you in half the usual time. Send for **booklet** and sample **lesson plate** explaining full details of the Course.



THE NATIONAL SCHOOL OF CARTOONING
423 Park Building Cleveland, Ohio

LEARN RADIO FREE

STUDY IN SPARE TIME AT HOME
Earn a Diploma in Radio Engineering. Free Twin Superdon Set offer if you act now. Write
AMERICAN RADIO ENGINEERS
Dept. 325, Hearst Sq., Chicago, U. S. A.



Make storekeeper's profits without storekeeper's troubles. We'll show you how. In fact, we'll put you into business, furnish everything you need, train you, carry stock for you—without your investing a penny. We'll work with you until we've made you a success. We have done it for others. We'll do it for you—provided you are honest, ambitious and willing to work hard. If you are, write us. You'll hear from us at once with **FACTS.** Address Dept. 168.

GOODWEAR Chicago, Inc.
844 West Adams Street CHICAGO, ILL.

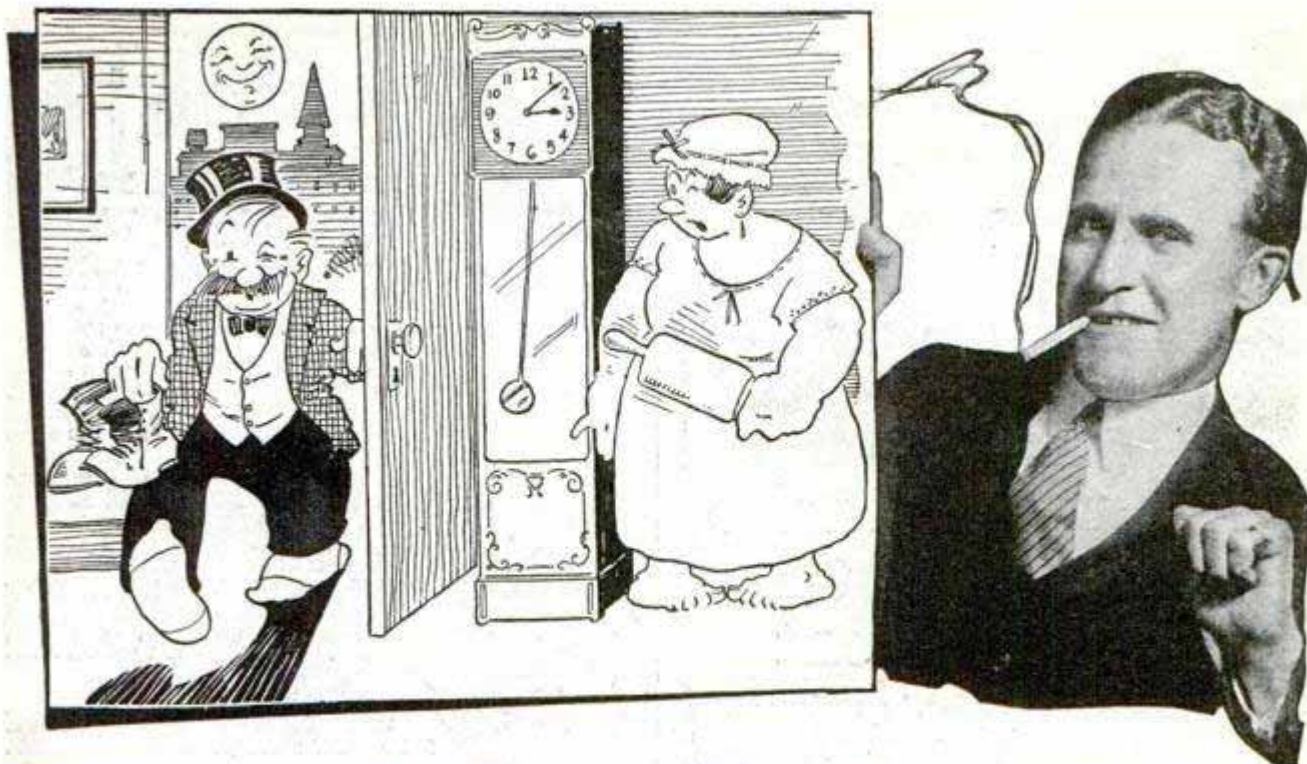

Earn \$50 to \$250 a Week in Cartooning

Like Graduate "R.P." of Washington School

Here's an actual experience of one who learned Cartooning by the Washington School method. "I want to tell you that I'm having wonderful success," writes former student R. P. "I have been with the Evening Times and Sunday Sun here. I am now working for myself and I find no trouble in cleaning up in the neighborhood of \$250 a week."

NEVER before have the opportunities in cartooning been so many or so varied. Millions of dollars were spent last year on comic strips, political and sport cartoons, animated cartoons, etc. And every day finds new use for cartoons in advertising, in the movies, and in countless other ways. *Now* is the time to begin your training—to look forward to a prosperous future—your own boss—freedom from routine—and the possibility of \$100 or more a week. Cash in on the amazing ever-increasing popularity of cartoons! Learn cartooning this easy way.

Simplified Method Makes Cartooning Easy for Anyone

No matter what your present position is—no matter how little you know about drawing—you can easily and quickly learn to make cartoons through this easy home method. You start with simple fundamentals. You learn the elementary principles and then progress by easy stages until you thoroughly understand the whole subject. Every step from beginning to end is clear and easy to understand. It is just as if your instructor stood right at your elbow. All your work receives his individual attention and correction—so you cannot help but progress rapidly. Thousands who never dreamed they could make cartoons, can now earn big money in this fascinating, profitable field. Many of our

students sell enough work during their training to pay for the course and are now holding down splendid positions.

Mail Coupon for Free Book

Learn more about the wonderful opportunities for making money in Cartooning and how our simplified method makes it easy for you to learn. Read about our students, how they make money while learning, and big salaries after they graduate. A handsomely illustrated booklet which is crammed full of interesting information on Cartooning and describes in detail this amazingly easy method will be sent to you without cost or obligation. Simply mail the coupon today. Washington School of Cartooning, Room 302-D, 1113 15th St. N. W., Washington, D. C.

Washington School of Cartooning,
Room 302-D, 1113 15th St. N. W., Washington, D. C.

Please send me, without obligation, your Free Booklet on Cartooning and full details of your new easy home study method of teaching Cartooning. (Please write plainly.)

Name.....
(State whether Mr., Miss or Mrs.)

Address.....

City..... State.....

(If under 16, please give age).....

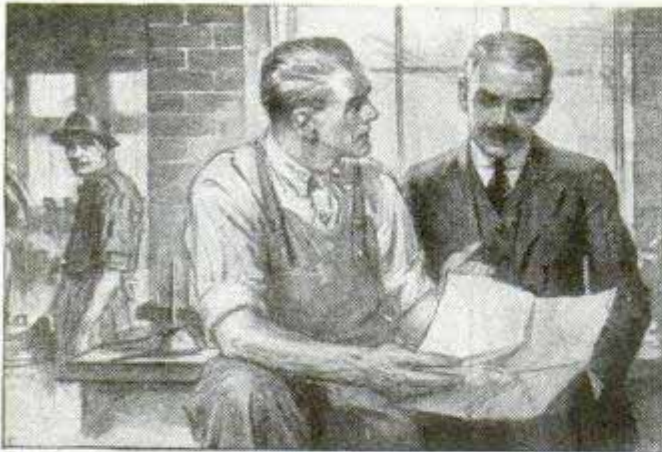

The only man who could talk to the Superintendent

"SOON after I began studying," a student wrote to us the other day, "we had a change in management at our plant. I certainly was glad then that I had decided to study in my spare time. For, thanks to my I. C. S. course, I was the only man in the organization who could talk to the Superintendent in his own language. As a result, I was promoted over men who had been here from ten to twenty years. My salary has been increased 90% in the last ten months."

THAT'S a true story of what just one I. C. S. student has done. There are thousands of others. Every mail brings letters from men and women telling of promotions and increases in salary due directly to spare-time study.

One hour a day, spent with the I. C. S. in the quiet of your own home, will prepare you for success in the work you like best. *Yes, it will!* Put it up to us to prove it.

Mail the Coupon for Free Booklet

INTERNATIONAL CORRESPONDENCE SCHOOLS
Box 5557-E, Scranton, Penna.

Without cost or obligation, please tell me how I can qualify for the position or in the subject before which I have marked an X:

BUSINESS TRAINING COURSES

- | | |
|--|---|
| <input type="checkbox"/> Business Management | <input type="checkbox"/> Salesmanship |
| <input type="checkbox"/> Industrial Management | <input type="checkbox"/> Advertising |
| <input type="checkbox"/> Personnel Organization | <input type="checkbox"/> Better Letters |
| <input type="checkbox"/> Traffic Management | <input type="checkbox"/> Show Card Lettering |
| <input type="checkbox"/> Business Law | <input type="checkbox"/> Stenography and Typing |
| <input type="checkbox"/> Banking and Banking Law | <input type="checkbox"/> Business English |
| <input type="checkbox"/> Accountancy (Including C.P.A.) | <input type="checkbox"/> Civil Service |
| <input type="checkbox"/> Nicholson Cost Accounting | <input type="checkbox"/> Railway Mail Clerk |
| <input type="checkbox"/> Bookkeeping | <input type="checkbox"/> Common School Subjects |
| <input type="checkbox"/> Private Secretary | <input type="checkbox"/> High School Subjects |
| <input type="checkbox"/> Spanish <input type="checkbox"/> French | <input type="checkbox"/> Illustrating <input type="checkbox"/> Cartooning |

TECHNICAL AND INDUSTRIAL COURSES

- | | |
|---|--|
| <input type="checkbox"/> Electrical Engineering | <input type="checkbox"/> Architect |
| <input type="checkbox"/> Electric Lighting | <input type="checkbox"/> Architects' Blue Prints |
| <input type="checkbox"/> Mechanical Engineer | <input type="checkbox"/> Contractor and Builder |
| <input type="checkbox"/> Mechanical Draftsman | <input type="checkbox"/> Architectural Draftsman |
| <input type="checkbox"/> Machine Shop Practice | <input type="checkbox"/> Concrete Builder |
| <input type="checkbox"/> Railroad Positions | <input type="checkbox"/> Structural Engineer |
| <input type="checkbox"/> Gas Engine Operating | <input type="checkbox"/> Chemistry <input type="checkbox"/> Pharmacy |
| <input type="checkbox"/> Civil Engineer | <input type="checkbox"/> Automobile Work |
| <input type="checkbox"/> Surveying and Mapping | <input type="checkbox"/> Airplane Engines |
| <input type="checkbox"/> Metallurgy | <input type="checkbox"/> Navigation |
| <input type="checkbox"/> Steam Engineering | <input type="checkbox"/> Agriculture and Poultry |
| <input type="checkbox"/> Radio | <input type="checkbox"/> Mathematics |

Name.....
Street..... 3-6-24
Address.....
City..... State.....

Occupation.....
Persons residing in Canada should send this coupon to the International Correspondence Schools-Canadian, Limited, Montreal, Canada.

ELECTRICITY

FREE BOOK
Send for it

LEARN in 12 WEEKS

Prepare for a good paying position in 12 weeks. Salaries from \$10 to \$25 a day not uncommon for Finlay trained men. Finlay Condensed Method, now in 23rd successful year, trains head and hand, combining practical shop work and intensive study. In 12 weeks we teach you HOW and WHY. Thousands of successful men have taken this short road to long pay. You have the same opportunity.

EARN \$10 to \$25 a DAY

Send for Finlay Catalog and full details on 12 weeks' course in Practical Electricity. Thousands of positions open. Enroll any time. Completely equipped shops and laboratories. Faculty of highly trained experts. Certificates awarded. Students assisted to positions. Success is calling you NOW. Write today and get the facts.



FINLAY ENGINEERING COLLEGE
104 FINLAY BLDG., KANSAS CITY, MO.

Rider Agents Wanted

Select from the 44 Styles, colors and sizes of Ranger Bicycles. Ride and exhibit sample Ranger and make money. Delivered free, express prepaid, on Approval. Factory-to-Rider bicycles \$21.50 up to \$5 a Month on any Ranger if desired. Boys and girls easily save the small monthly payments. Parents often advance first payment. best quality, at factory prices, express prepaid. Tires, Lamps, wheels and equipment, low prices. Send No Money, do business direct with makers.



Mead CYCLE COMPANY
DEPT. C-109 CHICAGO

Write today for free Ranger Catalog, factory prices and marvelous easy payment terms

BE A RAILWAY TRAFFIC INSPECTOR

Earn Up to \$250 Per Month Expenses Paid

MEN ARE WANTED to enter this fascinating profession. Splendid opportunities; travel or remain near home. Pleasant, outdoor work; meet big railway officials.

START AT \$110 PER MO.

Expenses paid, after 3 months' spare-time study at home. Any average man can qualify.

You Take No Risk!

For over seven years we have secured a position for practically every graduate, paying at least \$110 per month and expenses. Those few not securing positions had their money refunded. You can succeed—advance rapidly! Send coupon at once for full details. Positions waiting for graduates!

Standard Business Training Institute
Buffalo, N. Y.

Send me, entirely free, Booklet No. D-65, giving full particulars about course in Railway Traffic Inspection.



Name.....
Street.....
City.....

BE A BRICKLAYER

Thousands of *Big Pay Jobs* are waiting for men who can handle the trowel!

Make \$60 to \$90 a Week
I Train You At Home in Your Spare Time!



My Remarkable Job Analysis Method Fits You for Big Money

Now you can learn the highest paid trade of all—BRICKLAYING—right at home, in your spare time. By my remarkable Job Analysis Method, perfected by experts after years of study and effort, I teach you exactly how to do EVERYTHING that a regular, A-1, journeyman brick mason does on the wall. I show you how to construct four, eight, twelve and seventeen inch walls; how to build panels, pilasters, piers, arches, corners, angles, jambs, cornices and all other units of construction. I tell you all about the various kinds of bricks and their uses; how to mix mortar; how to handle the trowel; all about the various Bonds; everything—EVEN HOW TO READ BLUE PRINTS, ESTIMATE AND CONTRACT. I cover the trade from A to Z. In a few months' time you can fit yourself to step out and get a big pay job—\$50.00, \$60.00, \$70.00 a week and UP.

Not a Series of Dry Books—I Teach You the "Secrets" of This High Paid Trade JUST AS THOUGH I STOOD RIGHT BEHIND YOU!

With the Job Analysis Method you LEARN BY DOING. You actually handle the bricks, trowel, and mortar (in a garage, basement, attic or other handy place) and do each and every job that a bricklayer does on the wall. You get practical experience as you go along. Every job, every motion simply and clearly explained and fully illustrated with diagrams, photos, charts and blue prints. Better training in a few months than many apprentices get in four years. No time killed running errands for the boss or doing odd jobs for the men. No waste motion—every minute counts—careful, personal instruction from start to finish—real progress every day.



FREE Book Gives You Details of This Amazing Opportunity

MAIL COUPON Today!

Big Opportunity to Become Foreman, Contractor or Builder

Tremendous opportunities ahead. Make \$8.00, \$10.00, \$12.00 to \$15.00 a day right from the start and later make still more as foreman or "get-in" for yourself as contractor or builder. Thousands are making fortunes in the building business. You can start big and then go as much higher as you like. I know what I'm talking about because I myself have been a "brickie" and have also trained and hired other brick masons for years. I KNOW what the future holds for any ambitious man who learns this big pay trade.

ACT! Learn More About This Write for my FREE book, "The Quick Way to Big Pay Every Day."

The book tells all about my Job Analysis Method; about my experience as Bricklayer, Foreman, Contractor, Builder, and Real Estate Operator; how I train you at home in spare time; how to get a job; in fact, how I teach you to see, act, think and talk like a regular "brickie." ACT NOW—THIS VERY MINUTE. Clip the coupon while it is right before you. Let me send your FREE copy by return mail.

The National School of Bricklaying
Dept. O-10, Washington, D. C.

Send for Your **FREE COPY!**



The National School of Bricklaying, Dept. O-10, Ninth and G Streets, N. W., Washington, D. C.

Send me your FREE book on "The Quick Way to Big Pay Every Day," which tells all about how to become a bricklayer and how you train me at home in my spare time.

(Write or Print Name Clearly)

Name _____
Address _____
City _____

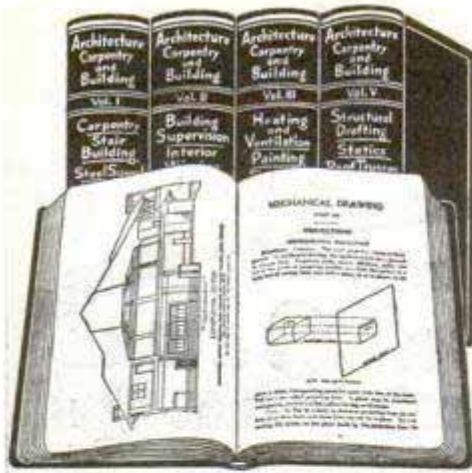

For
Architects,
Draftsmen,
Carpenters,
Contractors,
Builders
and all
who expect
to build

BRAIN TOOLS

Men who work with their hands know that head-work gets them more money.

Brain tools make the tools in your tool box at least twice as effective, and the best brain tools you can get are good books—not just any books, but books which tell you the things you want to know, and do it instantly.

Carpenters make themselves contractors by learning how to estimate correctly. Contractors are able to handle bigger and more profitable jobs by learning how the big fellows do it, and architects and those who want to enter this highly paid profession earn more money by having facts and figures at their finger tips.

This brand new set of five handsomely bound books covering all phases of architecture, carpentry and building, enable you to get authoritative, specialized information in a moment. No tedious long hours of reading—no hard grinding study but instant reference to the vital facts.

You don't waste a minute—the new jiffy index puts before your eyes, without wasteful time, the things you want to know.

The most complete work of its kind we have ever published; nothing has been overlooked. Use of tools—building construction, heating, lighting, plumbing, architectural drawing, blueprint reading; in short, the most comprehensive and easily understood work of its kind.

FREE Membership
Send now and we will include with these money making books a membership which entitles you to free consultation privileges with twenty highly paid experts. This alone is invaluable.

These Books Sent FREE

Yes, this is true. We ship them to you without a penny of down payment. When you get them, look them over carefully—note how easy it is to find what you want to know—test the index in any way you want to and then, if after 10 days you agree that you have at hand a veritable mine of invaluable information, send only \$2.00 and keep the books. After that send us only \$3.00 per month until the small total of only \$19.80 is paid. You'll thank the day you sent for your set.

Learning Means Earning

and here you have at hand information gathered from hundreds of experts, all for so small a sum you'll never miss the money. Use these books as others have done and you'll get many times their price in a few months. One job alone may repay you several fold. Send for your set today.

FREE EXAMINATION COUPON—
AMERICAN TECHNICAL SOCIETY, Dept. G-219, Chicago, Ill. You may send me, entirely without obligation, this handsome set of 5 volumes—Architecture, Carpentry and Building. I am to have full ten days in which to look them over and decide if I want to keep them. After which I will either send them back or send \$2.00 down and \$3.00 per month until the special price of only \$19.80 has been paid.

Name.....

City..... State.....

Reference.....



"BECOME A LIGHTNING TRICK CARTOONIST"

MAKE MONEY CHALK TALKING. SEND \$1.00 FOR SNAPPY PROGRAM OF TRICK DRAWINGS WITH INSTRUCTIONS BY A PROFESSIONAL CARTOONIST SATISFACTION GUARANTEED. CIRCULAR FREE. BALDA ART SERVICE, DL OSHKOSH, WIS.



Work for "Uncle Sam"

MEN 18 TO 45

City and Rural Mail Carriers

\$141.67 to \$275.00 Month

Many Other U. S. Gov't Jobs Now Obtainable

STEADY WORK. PAID VACATION. COMMON EDUCATION SUFFICIENT. PULL UNNECESSARY.

MAIL COUPON—TODAY SURE

Coupon
Franklin
Institute
Dept. M316
Rochester, N. Y.
Rush to, WITH-
OUT CHARGE, (1)
Your Copyrighted
Civil Service Book, (2)
Send pointers on how to
get a position as City or
Rural Mail Carrier at \$141.67
to \$275.00 a month.

Name.....
Address.....

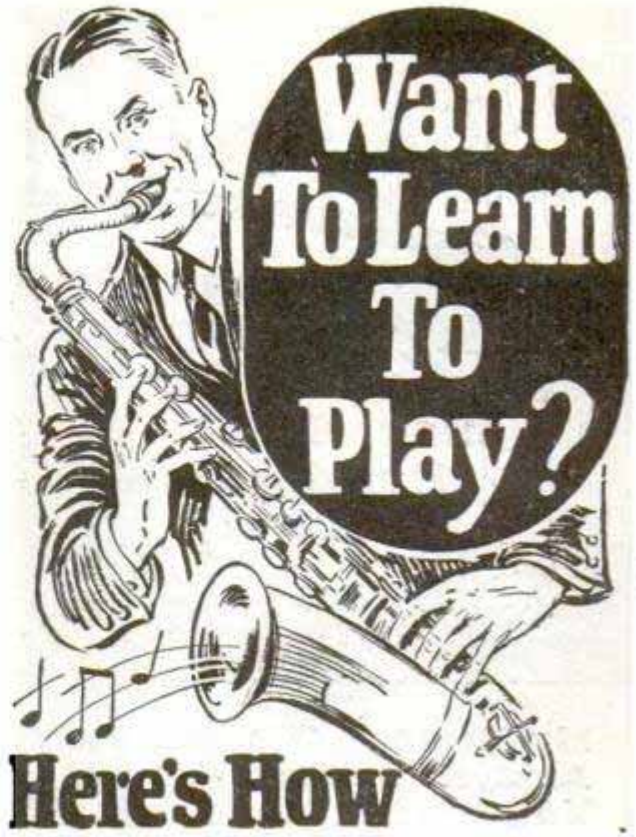

TAKE a tip from me! Six months ago I didn't know one note from another. Today I am a well-paid saxophonist! And I didn't have to part with a fortune to attain my present success, either—thanks to the marvelous course that the U. S. School of Music offered.

Easy Home-Study Method

That Method made good with me, all right. In a short time I was playing real tunes and melodies, not just scales. What's more, I played them well! So well that even while taking my course I was able to earn some extra money playing for entertainments.

Oh, yes, I made plenty of friends with my ability to "jazz" up parties. I actually became popular—I who a few short months before had wished I could play, if only to while away the time. Time! Every minute of my time is now in demand. And I am well paid for my pleasant work.

Send for Free Book

Say! If I could do it, you can do it! Send for the Free Book and Demonstration Lesson of the U. S. School of Music. They will show you the real road to popularity and success. Instruments supplied when needed, cash or credit. Write NOW. U. S. School of Music, 724 Brunswick Bldg., New York City

PICK YOUR COURSE!
Piano Drums and
Violin Traps
Banjo Mandolin
Flute Singing
Cornet Ukulele
Guitar Trombone
Saxophone
Voice and Speech
Culture, Automatic
Finger Control
and Many Others.

LEARN WATCHMAKING

and become independent. We help you secure a position. Easy to learn. Send for FREE CATALOG.

ST. LOUIS WATCHMAKING SCHOOL, Dept. 5, ST. LOUIS, MO.

FREE Send for our big booklet, "Health, Strength, and Development and How to Obtain Them." It is full of pictures and proofs of how bar-bells can make you strong, healthy, and well developed physically. Send NOW. Dept. P. M. 2-26
MILO BAR-BELL CO., 2749 N. Fairthrop Street, Philadelphia, Pa.



\$1000 REWARD For the Capture of This Man

CONVICT 6138, escaped from the State Penitentiary; Name, Charles Condray; Age, 37; Height, 5 ft. 8 in. Weight, 141 pounds; Hair, light brown; Eyes, gray. Easy enough to identify him from his photograph and this description, you may say—but, Condray took the name of "Brown", dyed his hair, darkened his skin, grew a mustache, put on weight and walked with a stoop. Yet, he was captured and identified so positively that he knew the game was up, and returned to the penitentiary without extradition.

How was it accomplished? Easy enough for the Finger Print Expert. They are the specialists, the leaders, the *cream* of detectives. Every day's paper tells their wonderful exploits in solving mysterious crimes and convicting dangerous criminals.

Why don't You be a Finger Print Expert?

More Trained Men Needed

The demand for trained men by governments, states, cities, detective agencies, corporations, and private bureaus is becoming greater every day. Here is a real opportunity for YOU. Can you imagine a more fascinating line of work than this? Often life and death depend upon finger print evidence—and big rewards go to the expert. Many experts earn regularly from \$3,000 to \$10,000 per year.

Learn at Home in Spare Time

And now you can learn the secrets of this science at home in your spare time. Any man with common school education and average ability can become a

Finger Print Detective in surprisingly short time.

Free Course in Secret Service

For a limited time we are making a special offer of a *Professional Finger Print Outfit, absolutely Free, and Free Course in Secret Service Intelligence.* Mastery of these two kindred professions will open a brilliant career for you.

Write quickly for fully illustrated free book on Finger Prints which explains this wonderful training in detail. Don't wait until this offer has expired—mail the coupon now. You may never see this announcement again! You assume no obligation —you have everything to

gain and nothing to lose. Write at once—address

University of Applied Science
Dept. 13-52 1920 Sunnyside Ave. Chicago, Illinois

UNIVERSITY OF APPLIED SCIENCE
Dept. 13-52, 1920 Sunnyside Avenue, Chicago, Illinois

Gentlemen:—Without any obligation whatever, send me your new, fully illustrated, FREE book on Finger Prints and your offer of a FREE course in Secret Service Intelligence and the Free Professional Finger Print Outfit.

Name.....

Address.....

Age.....



50%	100%	150%	200%
Promoted Over			
35 Candidates			
<i>Accountancy Brings 200% "Raise"</i>			
6 MONTHS	12 MONTHS	18 MONTHS	24 MONTHS

"When I enrolled for LaSalle training in Higher Accountancy," writes J. L. Trudell, a Michigan man, "I was doing the simplest kind of clerical work. I had had no previous bookkeeping experience. Before completing half the course—within a period of about eight months—three promotions brought me to be Assistant to the Chief Accountant. Within another year I was given entire charge of accounting, over about thirty-five assistants. The first of the year I was promoted to be Director of Advertising with present earnings nearly 200% more than when I first enrolled. I am very grateful for LaSalle training."

Send for Salary-Doubling Plan

Are you—like Trudell—following a well-organized plan to double—triple—quadruple your salary? Or are you relying for advancement upon day-to-day experience? LaSalle offers a sound and practical **salary-doubling plan** which has added millions and millions of dollars to the earning power of its members. If a successful career is worth a 2c stamp and two minutes of your time, check the field of advancement that appeals to you, fill in your name and address, and place the coupon in the mail TODAY.

LASALLE EXTENSION UNIVERSITY
The World's Largest Business Training Institution
Dept. 264-HR Chicago

I would welcome details of your salary-doubling plan, together with copy of "Accountancy, the Profession that Pays," also a copy of "Ten Years' Promotion in One," all without obligation.

Higher Accountancy

Training for positions as Auditor, Comptroller, Certified Public Accountant, Cost Accountant, etc.

Other LaSalle Opportunities

LaSalle opens the way to success in every important field of business. If more interested in one of the fields indicated below, check here:

- | | |
|---|--|
| <input type="checkbox"/> Business Management | <input type="checkbox"/> Modern Business Correspondence and Practice |
| <input type="checkbox"/> Modern Salesmanship | <input type="checkbox"/> Modern Foremanship and Production Methods |
| <input type="checkbox"/> Traffic Management | <input type="checkbox"/> Personnel and Employment Management |
| <input type="checkbox"/> Railway Station Management | <input type="checkbox"/> Expert Bookkeeping |
| <input type="checkbox"/> Law—Degree of LL.B. | <input type="checkbox"/> Business English |
| <input type="checkbox"/> Commercial Law | <input type="checkbox"/> Commercial Spanish |
| <input type="checkbox"/> Industrial Management | <input type="checkbox"/> Effective Speaking |
| <input type="checkbox"/> Efficiency | <input type="checkbox"/> C. P. A. Coaching |
| <input type="checkbox"/> Banking and Finance | |

Name

Present Position

Address



Your Choice
\$20.00
Musical Instruments
FREE TO OUR STUDENTS

Your choice of a Violin, Tenor Banjo, Hawaiian Guitar, Banjo, Cornet, Ukulele, Banjo Ukulele, Guitar, Mandolin or Banjo Mandolin. You will be proud to own any one of these instruments and you can have one absolutely free. A few cents a day for lessons is your only expense. Our system of teaching is so easy that you can play several pieces by note with the first four lessons. We guarantee success or no charge. Instrument and lessons sent on **one week's free trial**. Write for booklet today, no obligation.

CHICAGO CORRESPONDENCE SCHOOL OF MUSIC
Orchard and Willow Streets • Dept. 69 • Chicago, Illinois

RUPTURE
Try this to be rid of Rupture

Immediate and permanent relief and comfort is assured to rupture sufferers by the Schuiling Rupture Lock. It seals in the opening. No elastic bands, cruel springs or binding braces. Nothing to irritate or chafe. No harness to wear. A simple device. Relief, comfort and safety result from its use.

Write for free book and trial offer.
SCHUILING RUPTURE INSTITUTE
179 Murphy Bldg. Indianapolis, Ind.



Hotels Start You With Salaries up to \$3,500 a Year
— with your living

HOTELS, restaurants, clubs, apartments, everywhere need trained men and women—salaries to start up to \$3500 a year with your living. Over 70,000 high-class positions paying up to \$10,000 a year are open every year in the hotels of the United States. Today this is the 1st INDUSTRY IN AMERICA—with over \$992,394,968 in new hotels being built in 1925—exceeding by \$200,000,000 the next largest industry. These new hotels, restaurants, etc., will need over 60,000 trained men and women.

You can have one of these high-class big-pay positions, with luxurious meals and apartment and fascinating work. No previous experience necessary. The Lewis Schools guarantee to give you the valuable knowledge that it has taken some of the most successful hotel men years to obtain—men who are now making \$5,000 to \$50,000 a year. We train you by mail in your spare time at home with the Lewis Simplified Study Plan, and we put you in touch with big opportunities. Our students employed, our methods endorsed by leading hotel men everywhere. Send today for Free Book, "YOUR BIG OPPORTUNITY," showing how we can train you for one of these splendid positions in 20 weeks or less, and explaining our Money-Back Guarantee.

LEWIS HOTEL TRAINING SCHOOLS
Room U-388 Washington, D. C.

***** FREE BOOK COUPON *****
LEWIS HOTEL TRAINING SCHOOLS, Room U-388, WASHINGTON, D. C.
Send me without obligation the Free Book, "YOUR BIG OPPORTUNITY."

Name

Address

City

State

Electrical Experts are in Big Demand!
—L.L. Cooke!

I Will Train You at Home to fill a Big-Pay Job!



L. L. COOKE
Chief Engineer

It's a shame for you to earn \$15 or \$20 or \$30 a week, when in the same six days as an Electrical Expert you could make \$70 to \$200—and do it easier—not work half so hard. Why then remain in the small-pay game, in a line of work that offers no chance, no big promotion, no big income? Fit yourself for a real job in the great electrical industry. I'll show you how.

Be an Electrical Expert Earn \$3,500 to \$10,000 a Year

Look What These Cooke Trained Men are Earning



Makes \$700 in 24 Days in Radio

"Thanks to your interesting Course I made over \$700 in 24 days in Radio. Of course, this is a little above the average but I run from \$10 to \$40 clear profit every day; you can see what your training has done for me."

FRED G. McNABB,
848 Spring St., Atlanta, Ga.



\$70 to \$80 a Week for Jacquot

"Now I am specializing in auto electricity and battery work and make from \$70 to \$80 a week and am just getting started. I don't believe there is another school in the world like yours. Your lessons are a real joy to study."

ROBERT JACQUOT,
2005 W. Colorado Ave.,
Colorado Springs, Colo.



\$20 a Day for Schreck

"Use my name as a reference and depend on me as a booster. The biggest thing I ever did was answer your advertisement. I am averaging better than \$500 a month from my own business now. I used to make \$18 a week."

A. SCHRECK,
Phoenix, Ariz.



Plant Engineer — Pay Raised 150%

"I was a dumbbell in electricity until I got in touch with you Mr. Cooke, but now I have charge of a big plant including 600 motors and direct a force of 34 men—electricians, helpers, etc. My salary has gone up more than 150%."

GEORGE ILLINGWORTH,
63 Calumet Road,
Holyoke, Mass.

Today even the ordinary Electrician—the "screw driver" kind—is making money—big money. But it's the trained man—the man who knows the whys and wherefores of Electricity—the Electrical Expert—who is picked out to "boss" the ordinary Electricians—to boss the Big Jobs—the jobs that pay \$3,500 to \$10,000 a Year. Start by enrolling now for my easily learned, quickly grasped, right-up-to-the-minute, Spare-Time Home-Study Course in Practical Electricity.

Age or Lack of Experience No Drawback

You don't have to be a College Man; you don't have to be a High School Graduate. As Chief Engineer of the Chicago Engineering Works, I know exactly the kind of training you need and I will give you that training. My course in Electricity is simple, thorough and complete and offers every man, regardless of age, education or previous experience, the chance to become an "Electrical Expert," able to make from \$70 to \$200 a week.

No Extra Charge for Electrical Working Outfit

With me, you do practical work—at home. You start right in after your first few lessons to work at your profession in the regular way and make extra money in your spare time. For this you need tools, and I give them to you—5 big complete working outfits, with tools, measuring instruments and a real electric motor.

Your Satisfaction Guaranteed

So sure am I that you can learn Electricity—so sure am I that after studying with me, you, too, can get into the "big money" class in Electrical work, that I will guarantee under bond to return every single penny paid me in tuition, if, when you have finished my Course, you are not satisfied it was the best investment you ever made. And back of me in my guarantee, stands the Chicago Engineering Works, Inc., a two million dollar institution, thus assuring to every student enrolled, not only a wonderful training in Electricity, but an unsurpassed Student Service as well.

Get Started Now — Mail Coupon

I want to send you my Electrical Book and Proof Lessons, both Free. These cost you nothing and you'll enjoy them. Make the start today for a bright future in Electricity. Send in Coupon—NOW.

L.L. Cooke, Chief Engineer
Chicago Engineering Works

Dept. D 512
2150 Lawrence Av. Chicago

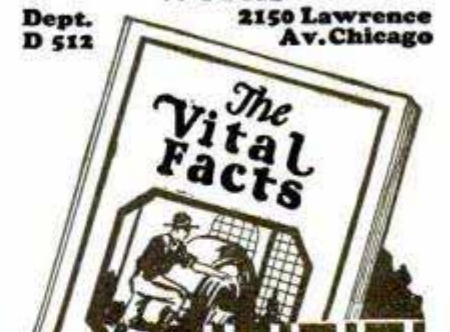

L. L. COOKE, The Man Who Makes "Big-Pay" Men
Dept. D 512,
2150 Lawrence Ave., Chicago

Send me at once without obligation your big illustrated book and complete details of your Home Study Course in Electricity, including your outfit and employment service offers.

5 big outfits given to you — no extra charge

MAIL COUPON FOR MY FREE BOOK

Name
Address.....
Occupation.....

The "Cooke" Trained Man is the "Big Pay" Man

Work for "Uncle Sam"

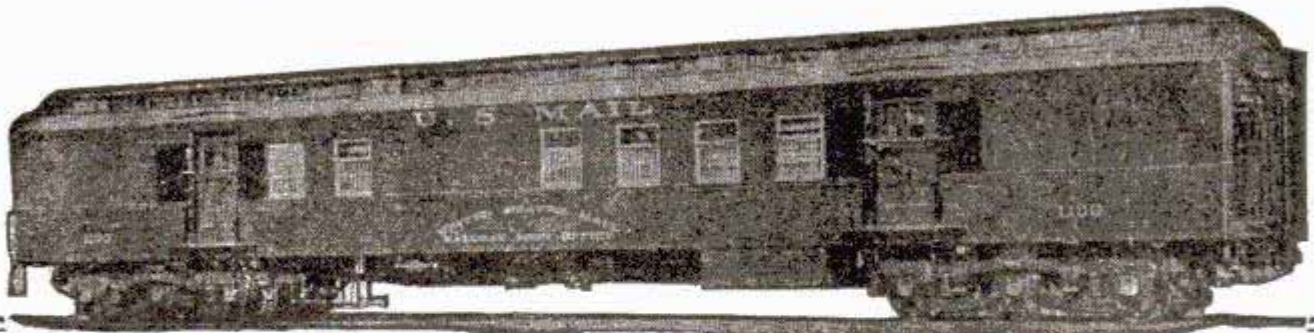

\$1140 to \$3000 Year

Many Positions: Railway Postal Clerks, City Mail Carriers, Income Tax Auditors, City Postal Clerks, Clerk at Washington, D. C.

MEN—BOYS 18 OR OVER

Short Hours Pleasant Work

Rapid Advancement
Permanent Employment
Long Vacation with Pay

Mail Coupon Now. Act at Once.

DO IT TODAY

You may forget tomorrow

FRANKLIN INSTITUTE
Dept. M176, Rochester, N. Y.

Kindly send me entirely free of charge: (1) A full description of the position checked below; (2) Free Specimen examination coaching; (3) Free copy of illustrated book, "Government Positions and How to Get Them"; (4) Full particulars telling how to get a U. S. Government job.

- Railway Postal Clerks (\$1900-\$2700)
- Post Office Clerk (\$1700-\$2300)
- City Mail Carrier (\$1700-\$2100)
- Clerk at Washington, D. C. (\$1140-\$1860)
- Income Tax Auditors (\$1860-\$3000)

CUT HERE

Name.....

Address.....

Use This Coupon Before You Mislay It—WRITE OR PRINT PLAINLY.

Electrical Dictionary 20¢

2400 Terms—67 Electrical Diagrams
Cloth Binding
Compiled by Chief Engineer Cooke

Every Electrical man needs this handy vestpocket dictionary to carry with him on the job. It's a wonder! Every Electrical Term fully explained in simple words. Wiring and radio diagrams included. Nearly 200 pages of valuable "dope." Compiled by Chief Engineer Cooke, the widely known authority on Electricity, out of his own years of practical experience. Get this little book today—send 20¢—two dimes—for your copy. We pay postage. Satisfaction guaranteed or money refunded.

Chicago Engineering Works
Dept. D-12, 2154 Lawrence Ave., Chicago, Ill.

Right
Up-to-Date

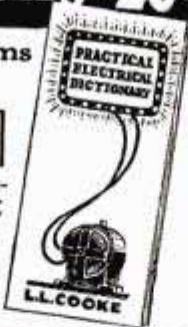

OH BOYS-GIRLS GREAT SPORT

THROW YOUR VOICE



into a Box, a Trunk, under the Table, back of a Door, any old place. Great Fun fooling Everybody with our Claxophone. FREE—a 32 page book teaching Ventriloquism, Mind Reading etc., also 12 Magic tricks, all for 10¢ (not stamps)—3 for 25¢—extra souvenir Free each 25¢ order.

MAXO TRICK CO., Box P. 218, New Haven, Conn.

Foot Pains go in 5 minutes if you wear FAIRYFOOT CUSHIONS. Must help or no pay. Write to FOOT REMEDY CO., 22nd St. & Millard Ave., Dept. 28, Chicago, Ill.

LEARN CARTOONING

Successful cartoonists earn big salaries. Many of the most popular cartoonists of today learned to draw in their spare time, at home, through the Landon Course of Cartooning and now earn \$75 to \$200 or more per week.



The Landon Picture Chart Method of teaching ORIGINAL drawing makes cartooning easy to learn. Hundreds of sketches like the above explain every step in creating ORIGINAL heads, figures, animals, etc. Send 6c in stamps today for sample Landon Picture Chart and full explanation of this wonderful course, also long list of successful Landon students and information showing possibilities for you. Please state your age.

The Landon School, 738 National Building, Cleveland, Ohio

Former Students Who Are Now Successful Comic Strip Artists

- BLOSSER**—Now drawing "Freckles and His Friends."
- BYRNES**—Now drawing "Reg'lar Fellers."
- BRANNER**—Now drawing "Winnie Winkle."
- LOCHER**—Now drawing "Cicero Sapp."
- TAYLOR**—Now drawing "Mom 'n Pop."
- EDWINA**—Now drawing "'Cap' Stubbs."
- CRANE**—Now drawing "Washington Tubbs II."
- ETHEL HAYS**—Now drawing "Flapper Fanny."
- PAUL FUNG**—Now drawing "Gus & Gussie."
- KNICKERBOCKER**—Now drawing "This and That."

Can you fix it

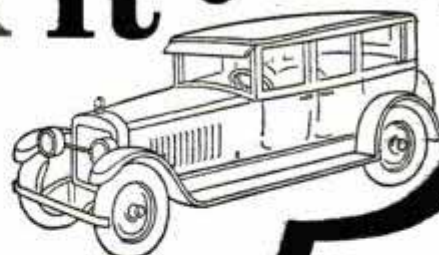

New books have "jiffy index," making all facts instantly available. You find anything you want to know in a moment, in this brand new 1926 edition.

These books tell how

HERE are the most interesting, the most practical books we have ever published on automobile construction, operation and repairs. Brimful of facts, photographs and explanations so easy to understand that anyone can learn how in almost no time.

Over 2000 pages, with diagrams, blueprints and everything else needed to make anyone an authority on automobiles.

Whether you want to qualify as garage owner, auto repair expert or merely wish to know how to keep your own car 100% efficient, you will welcome these books, especially on our

No Money Offer

This plan brings this valuable information within the reach of everyone. You don't send us a single penny. You don't have to pay us anything—just send your name and address and we'll send you the complete set of 5 volumes, specially bound in Flexo covers.

Read them carefully; keep them 10 days; find out anything you want to know, and then if you want to keep them, send only \$2.00 then and \$3.00 per month until the special low price of \$19.80 is paid. There is no further obligation.

American Technical Society Membership Free

This is a great organization for the publishing and spreading of specialized knowledge—we have over a million dollars of resources, enabling us to get the cooperation of the largest automobile manufacturers and dealers, who have furnished us plans and photographs. If you send NOW for this new edition of Automobile Engineering, we will include a Consultation Membership in this great organization.

Eighteen automobile experts will be ready to help you at all times. You can write or wire any time for special information. Answers will be sent to you promptly—without cost.

Don't Hesitate

There are no strings to this offer—it means just what it says. Send name and address on the coupon and ALL of the five books—the complete set—will be sent to you for examination.

Remember one fact only which you can find in these books may save you an expensive repair or help you to a better job.

Learn All About Autos

Get these five big books on this liberal offer and learn all the things you want to know about autos.

Carburetors, engines, springs and spring suspension, brakes, 4-wheel drives, lubrication systems—all are fully covered.

These complete and comprehensive auto books are yours if you want them on this easy plan. Send for a set NOW; there's nothing to pay.

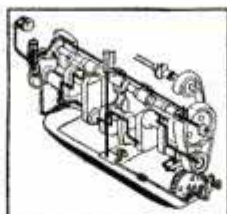

Modern Oiling System



You don't have to read the books through; the index enables you to put your finger on the information wanted in a jiffy.

For Free Offer, Use Coupon

American Technical Society,
Spec. Dept. A-219, Chicago, Ill.

I would like to look at the 5 Auto Books described above. Send them on your FREE offer. I will examine them carefully and return them in 10 days unless I like them; in which case I will send you \$2.00 then and \$3.00 per month until the total price of only \$19.80 is paid. You are to also send me Free Consulting Membership Certificate in the American Technical Society.

Name.....
Street.....
City..... State.....
Reference.....



Men Needed in Electricity

NO PROFESSION offers greater opportunity to-day than Electricity. Salaries of \$12 to \$30 a day are not uncommon and the opportunity for advancement is unlimited.

As Forrest Crissey said recently in *The Saturday Evening Post*—"The demand for electrical work is increasing immensely and electrical contractors assert that the supply of electrical workers cannot overtake the demand for several years."

Now is the time to prepare for a good position in this profitable, interesting profession. You can study right at home in spare time through the International Correspondence Schools—just as so many other men have done. The I. C. S. Electrical Courses have been endorsed by Thomas A. Edison and Charles P. Steinmetz—the late electrical wizard of the General Electric Co.

Just mark and mail the coupon printed below and full information about Electrical Engineering, Electric Lighting, Electric Wiring, Electric Railways, Radio or any other work of your choice will come to you by return mail.

Mail the Coupon for Free Booklet

TEAR OUT HERE
INTERNATIONAL CORRESPONDENCE SCHOOLS
 BOX 5556-E SCRANTON, PA.

Explain, without obligating me, how I can qualify for the position or in the subject, before which I mark X.

- | | |
|--|---|
| <input type="checkbox"/> ELECTRICAL ENGINEER | <input type="checkbox"/> CHEMICAL ENGINEER |
| <input type="checkbox"/> Electrician | <input type="checkbox"/> Pharmacy |
| <input type="checkbox"/> Electric Wiring | <input type="checkbox"/> SALESMANSHIP |
| <input type="checkbox"/> Electric Lighting | <input type="checkbox"/> Show Card and Sign Painting |
| <input type="checkbox"/> Electric Car Running | <input type="checkbox"/> RAILROAD POSITIONS |
| <input type="checkbox"/> Heavy Electric Traction | <input type="checkbox"/> ILLUSTRATOR |
| <input type="checkbox"/> Electrical Draftsman | <input type="checkbox"/> DESIGNER |
| <input type="checkbox"/> Electric Machine Designer | <input type="checkbox"/> BUSINESS MANAGEMENT |
| <input type="checkbox"/> Telegraph Expert | <input type="checkbox"/> Private Secretary |
| <input type="checkbox"/> Practical Telephony | <input type="checkbox"/> Business Correspondent |
| <input type="checkbox"/> MECHANICAL ENGINEER | <input type="checkbox"/> BOOKKEEPER |
| <input type="checkbox"/> Mechanical Draftsman | <input type="checkbox"/> Stenographer and Typist |
| <input type="checkbox"/> Toolmaker | <input type="checkbox"/> Cert. Public Accountant |
| <input type="checkbox"/> Machine Shop Practice | <input type="checkbox"/> Traffic Management |
| <input type="checkbox"/> Gas Engineer | <input type="checkbox"/> Commercial Law |
| <input type="checkbox"/> CIVIL ENGINEER | <input type="checkbox"/> GOOD ENGLISH |
| <input type="checkbox"/> Surveying and Mapping | <input type="checkbox"/> Common School Subjects |
| <input type="checkbox"/> Reading Architects' Blue Prints | <input type="checkbox"/> CIVIL SERVICE |
| <input type="checkbox"/> METALLURGY | <input type="checkbox"/> Railway Mail Clerk |
| <input type="checkbox"/> ARCHITECT | <input type="checkbox"/> STATIONARY ENGINEER |
| <input type="checkbox"/> Architectural Draftsman | <input type="checkbox"/> Textile Overseer or Supt. |
| <input type="checkbox"/> PLUMBING AND HEATING | <input type="checkbox"/> AGRICULTURE <input type="checkbox"/> Spanish |
| <input type="checkbox"/> Sheet Metal Worker | <input type="checkbox"/> Navigator <input type="checkbox"/> Math'm't's |
| <input type="checkbox"/> Automobiles | <input type="checkbox"/> Poultry Raising <input type="checkbox"/> RADIO |

Name _____ 3-6-24
 Present Business _____
 Occupation Address _____
 Street _____
 and No. _____
 City _____ State _____

Canadians may send this coupon to International Correspondence Schools Canadian, Limited, Montreal, Canada

RADIO EXPERTS

**EARN
BIG
MONEY**

**YOU CAN LEARN
AT HOME**

No other profession in the world offers the same big possibilities. Immense salaries await trained men in this fascinating, growing field. Fit yourself to be the radio expert of your own community. Thousands of men also needed in the great radio factories. I will quickly train you at home to be a radio expert. Write for all the facts today; learn how to get a wonderful 3-tube receiving set free. Remember, we guarantee satisfaction or refund tuition.

FREE!
3 Tube Set

WRITE TODAY
A. G. MOHAUPT, Radio Engineer
Radio Association of America
 Dept. A-2, 4513 Ravenswood Ave., Chicago

YOU CAN OIL PAINT

TALENT NOT REQUIRED—ANYONE CAN LEARN!

It's amazing how quickly our new method enables men and women to actually oil paint with ease and professional skill—even after the first lesson. Nothing difficult or tiresome to master. You begin to oil paint photos, portraits, landscapes or any art subject at once and earn real money. One student writes she earned the entire cost of the course in less than a week after completing the second lesson. You can do it, too. Our business methods show you how.

**EARN \$18.00 TO \$50.00 OR MORE
A WEEK AT HOME**

Demand for color art work is growing daily. Graduates everywhere tell us they are unable to keep up with orders. Learn more about this fascinating profession. Ask for our free illustrated booklet. It tells all about the course and free working outfit. Remember, no talent is required. You, too, can learn. So write today.

Pictorial Art Studios, 2731 N. Clark St., Dept. M. P., Chicago

YOU MUST ORDER NOW TO GET YOUR FREE BOOK

THIS OFFER WILL SOON BE WITHDRAWN

For a short time only we will give every subscriber to the New Library of Machine Shop Practice a copy of French's Engineering Drawing—the greatest book on mechanical drawing ever written. This book makes drawing as plain as day—tells you all about instruments, plans and methods—and prepares you to handle any drawing job you will ever have to do. It comes to you absolutely free with

Machine Shop Practice

9 volumes — 3065 pages — 3608 illustrations
(A combined home study course and reference library)

The New Machine Shop Library is written for practical men. It gives you the best methods for every kind of machine shop work. It explains machine tools and their operation, drawing and design, tool work, gears and grinding, jigs and fixtures, automatic screw machines and their tools and all of the mathematics you will ever have to use. It is plainly written, completely illustrated—the very best kind of help to the machine shop man who wants to advance himself.

**Sent
FREE**

**No money down—
only 7c
a day**

FREE EXAMINATION COUPON

McGraw-Hill Book Co., Inc., 370 Seventh Ave., New York

Send me for 10 days' free examination the New Library of Machine Shop Practice. If satisfactory I will send you \$1.50 in 10 days and \$2.00 monthly until the special price of \$19.50 is paid. If not wanted, I will return the books at your expense.

On receipt of my first payment of \$1.50 it is understood that I am to receive, free of charge, a copy of the second edition of French's Engineering Drawing.

Signed.....
 Address.....
 City and State.....
 Position.....
 Employer..... P. M. 2-1-26

WHAT I THINK OF PELMANISM - *By Judge Ben B. Lindsey*

PELMANISM is a big, vital, significant contribution to the mental life of America. I have the deep conviction that it is going to strike at the very roots of individual failure, for I see in it a new power, a great driving force.

I first heard of Pelmanism while in England on war work. Sooner or later almost every conversation touched on it, for the movement seemed to have the sweep of a religious conviction. Even in France I did not escape the word, for thousands of officers and men were *Pelmanizing* in order to fit themselves for return to civil life.

When I learned that Pelmanism had been brought to America by Americans for Americans, I was among the first to enroll. My reasons were two: first, because I have always felt that every mind needed regular, systematic, and scientific exercise, and, secondly, because I wanted to find out if Pelmanism was the thing that I could recommend to the hundreds who continually ask my advice in relation to their lives, problems, and ambitions.

In the twenty years that I have sat on the bench of the Juvenile Court of Denver, almost every variety of human failure has passed before me in melancholy procession. By *failure*, I do not mean the merely criminal mistakes of the individual, but the faults of training that keep a life from full development and complete expression.

Pelmanism the Answer

If I were asked to set down the principal cause of the average failure, I would have to put the blame at the door of our educational system. It is there that trouble begins—trouble that only the gifted and most fortunate are strong enough to overcome in later life.

What wonder that our boys and girls come forth into the world with something less than firm purpose, full confidence and leaping courage? What wonder that mind wandering and wool gathering are common, and that so many individuals are shackled by indecisions, doubts, and fears?

It is to these needs and these lacks that Pelmanism comes as an answer. The "twelve little gray books" are a remarkable achievement. Not only do they contain the discoveries that science knows about the mind and its working, but the treatment is so simple that the



JUDGE BEN B. LINDSEY

Judge Ben B. Lindsey is known throughout the whole modern world for his work in the Juvenile Court of Denver. Years ago his vision and courage lifted children out of the cruelties and stupidities of the criminal law, and forced society to recognize its duties and responsibilities in connection with the "citizens of tomorrow."

truths may be grasped by anyone of average education.

In plain words, what Pelmanism has done is to take psychology out of the college and put it into harness for the day's work. It lifts great, helpful truths out of the back water and plants them in the living stream.

As a matter of fact, Pelmanism ought to be the beginning of education instead of a remedy for its faults. First of all, it teaches the science of self-realization; it makes the student *discover* himself; it acquaints him with his sleeping powers and shows him how to develop them. The method is *exercise*, not of the haphazard sort, but a steady, increasing kind that brings each hidden power to full strength without strain or break.

Pelmanism's Large Returns

The human mind is *not* an automatic device. It will *not* "take care of itself." Will-power, originality, decision, resourcefulness, imagination, initiative, courage — these things are not gifts but results. Every one of these qualities can be developed by effort just as muscles can be developed by exercise. I do not mean by this that the individual can add to the brains that God gave him, but he can learn to make use of the brains that he has instead of letting them fall into flabbiness through disuse.

Other methods and systems that I have examined, while realizing the value of mental exercise, have made the mistake of limiting their efforts to the development of some single sense. What

Pelmanism does is to consider the mind as a whole and treat it as a whole. It goes in for mental team play, training the mind as a unity.

Its big value, however, is the instructional note. Each lesson is accompanied by a work sheet that is really a progress sheet. The student goes forward under a teacher in the sense that he is followed through from first to last, helped, guided, and encouraged at every turn by conscientious experts.

Pelmanism is no miracle. It calls for application. But I know of nothing that pays larger returns on an investment of one's spare time from day to day.

(Signed) Ben B. Lindsey.

Note: As Judge Lindsey has pointed out, Pelmanism is neither an experiment nor a theory. For almost a quarter of a century it has been showing men and women how to lead happy, successful, well-rounded lives. 550,000 Pelmanists in every country on the globe are the guarantee of what Pelman training can do for you.

No matter what your own particular difficulties are — poor memory, mind wandering, indecision, timidity, nervousness, or lack of personality — Pelmanism will show you the way to correct and overcome them. And on the positive side, it will uncover and develop qualities which you never dreamed existed in you. It will be of direct, tangible value to you in your business and social life. In the files at the Pelman Institute of America are hundreds of letters from successful Pelmanists telling how they doubled, trebled and even quadrupled their salaries, thanks to Pelman training.

How to Become a Pelmanist

"Scientific Mind Training" is the name of the absorbingly interesting booklet which tells about Pelmanism in detail. It is fascinating in itself with its wealth of original thought and clear observation. "Scientific Mind Training" makes an interesting addition to your library.

Your copy is waiting for you. It is absolutely free. Simply fill out the coupon and mail it to-day. It costs you nothing, it obligates you to nothing, but it is absolutely sure to show you the way to success and happiness. Don't put it off and then forget about it. Don't miss a big opportunity. MAIL THE COUPON NOW.

THE PELMAN INSTITUTE OF AMERICA

Approved as a correspondence school under the laws of the State of New York

Suite 62, 19 West 44th Street, N. Y. City.

THE PELMAN INSTITUTE OF AMERICA
Suite 62, 19 West 44th St., New York.

Please send me without obligation your free booklet, "Scientific Mind Training."

Name.....

Address.....

City..... State.....

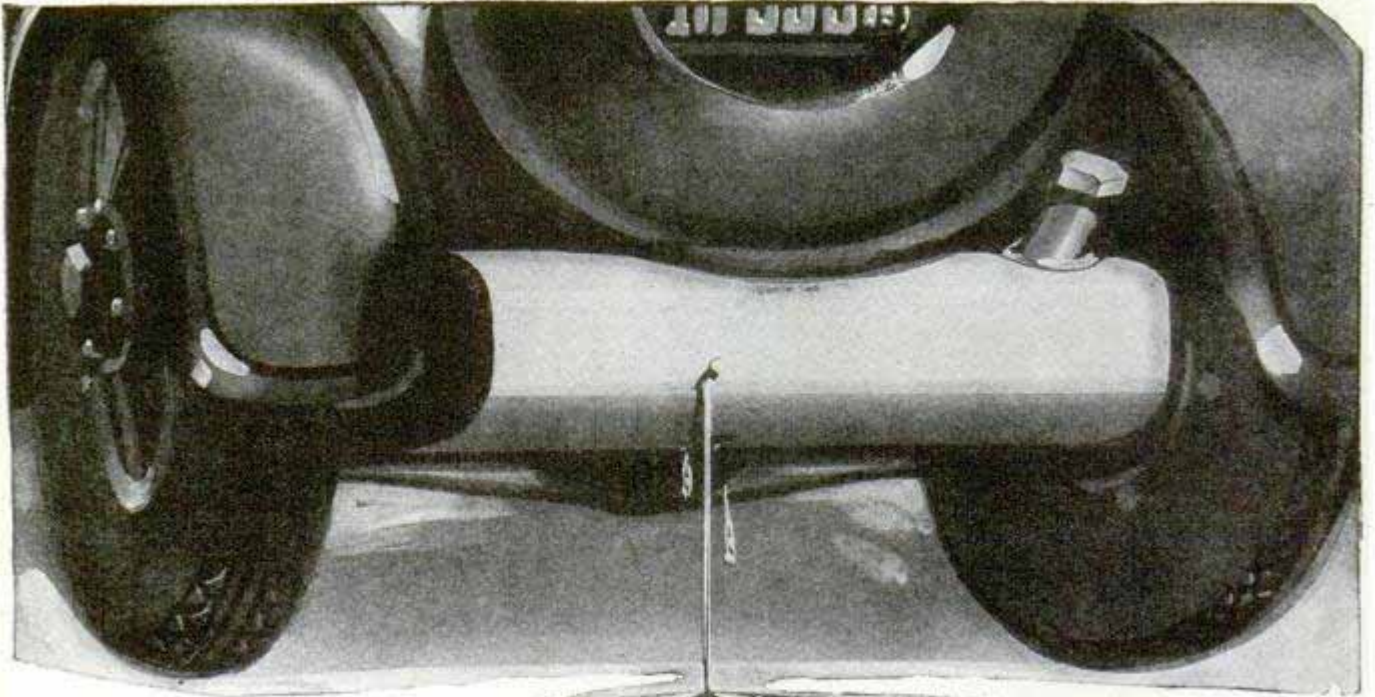

You're Losing Half Your Gasoline!

FOR every ten gallons you buy you are losing five! That's a startling statement, but true.

You are getting just half the power, half the mileage you should out of your gasoline! For now an amazing new invention — a ridiculously simple little device—makes practically any car give twice its regular mileage!

57 Miles on a Gallon

With this wonderful new invention auto drivers in all parts of the country have chalked up records of from 37 to 57 miles on a gallon of gasoline. Every day we hear of some new record—some difficult feat such as pulling a car through deep sand, or up a mountain, on half the usual gas.

Here's how this amazing new invention works. Your carburetor is adjusted to make starting easy — it gives a rich mixture to start a cold engine. But once your engine gets heated up, the mixture is far too rich, resulting in faulty explosion. Half the gasoline is drawn into the cylinders in a raw state and, instead of exploding, it burns. This causes a heavy deposit of carbon.

But with this startling little device in your car all this is changed. As soon as the engine warms up, this device automatically begins to admit a much larger volume of air, thoroughly vaporizing all the gasoline, giving it fully 50% more power — breaking it up so that it explodes instead of burning!

A Carbon Remover

Not only does this invention save you half your gasoline, but it also removes carbon, saving you

the expense and time of having your carbon scraped out—a job costing from \$5 to \$25.

The Stransky Vaporizer is absolutely automatic and self-regulating. It has no springs, shutters, diaphragms or delicate parts to get out of order. It requires no adjustment—you can attach it in three minutes. And it will lengthen the life of any car.

Introductory Sample Offer

To introduce this new invention in your community, Mr. J. A. Stransky, the inventor, will send a sample at his own risk. Write at once for his proposition. The price is so low that all your neighbors will want to order through you, giving you a generous profit.

Send the request blank for full details of our amazing offer.

J. A. Stransky Manufacturing Co.
B-10 Stransky Bldg.
Pukwana So. Dakota

AGENTS Earn \$120 a Day!

This is one of the greatest propositions of the century for agents — over twenty million people want this amazing little device! J. M. James made \$120.00 in one day. J. A. Williams made \$48.00 in three hours. Vernon Gaines made \$94.00 in one day. One demonstration brings from five to twenty orders. Ideal for spare time workers. Splendid opportunity for distributors and managers. Write at once for sample offer.



J. A. STRANSKY, Inventor,
at address below.



J. A. Stransky Mfg. Co.,
B-10 Stransky Bldg., Pukwana, So. Dakota

Please send me full details of your special introductory offer.

Name

Address

City.....State.....

As the Salesman—

would you
accept defeat?
... or

The prospect's emphatic tone and curt manner are unmistakable "I'm NOT Interested!"
As the salesman facing this situation, what would you do? Accept defeat? Or?

SUPPOSE a man you called on greeted you in this fashion. Would you know how to remain completely the master of the situation? Would you still feel reasonably sure of an opportunity to tell your story?

It is no disgrace to answer "No" to these questions—to admit that this and similar problems have blocked your progress.

But, it *is* an injustice to yourself, a rank injustice, to continue indefinitely on the same path, when the means are at your command to handle such situations easily and surely—to use *deliberately* the successful methods which others use only once in a while, by chance or accident.

For—*mark this well*—there is a fundamental rule of action that teaches exactly what to do to win the confidence of the man who has just said, "I'm not interested."

Why "trust to luck" when—

"Back of every successful action in business there are guiding principles, unchangeable laws."

Naturally you ask, "If this is true, how can I quickly acquire these principles?" The answer is, simply thru training that deals in *basic* principles—training that brings within your grasp not merely cold facts, not merely a fund of information, but the live, vital forces that mark the difference between success and mediocrity.

The LaSalle Problem Method of training for salesmen (and for men in every other branch of modern business) deals in such essentials, and *only* in essentials. Intensely practical, it combines the best that has been learned by thousands of salesmen in the "school of experience."

How Are Big Incomes Earned?

Isn't it true that the difference between, say, the \$50-a-week salesman and the \$200-a-week man lies chiefly in greater ability to meet just such situations as we pictured at the top of this page? Think that over a moment. Then consider that many of the men who take LaSalle training are successful before they enroll. Yet within a few months after starting they report their earning capacity doubled, tripled and often quadrupled, while those without previous sales experience become pace-setters for the "old timers."

The secret, if it may be called a secret, is the fact that they learn to recognize the *causes* underlying success instead of blindly following the methods by which others have achieved success.

Learn the principle and method that turns "I'm NOT interested!" into a receptive attitude.

Ask yourself this simple question: "Have I the necessary knowledge of the science and strategy of selling to make of myself the fullest success of which I am capable?"

For example, can you put down on paper the basic laws underlying every successful sale, the violation of any one of which unfaillingly reduces or destroys your chances to make the sale?

These four principles—together with *the plan* which has enabled thousands of men and women to double their incomes—are fully explained in the interesting booklet which will be sent *free* to any earnest man or woman interested in the science of selling.

Compressed into this booklet, which may be slipped into the pocket and read during odd moments, you will find the most inspiring and helpful matter you ever read on this great subject of salesmanship. An application of the fundamental laws which this booklet discloses will result in an immediate increase in your selling power.

This booklet is our contribution to the general cause of better salesmanship. Fill out and mail the coupon.

— — — — CLIP AND MAIL — — — —

LASALLE EXTENSION UNIVERSITY

The World's Largest Business Training Institution

Dept. 264-SR

Chicago

I should be glad to receive an outline of your *salary-doubling plan*, together with a copy of "Salesmanship in a Nutshell," also copy of "Ten Years' Promotion in One," all without obligation.

Modern Salesmanship—
Salesmanship in a Nutshell

Other LaSalle Opportunities

The LaSalle plan opens the way to success in every important field of business. Check below the opportunity that appeals to you.

- | | |
|--|--|
| <input type="checkbox"/> Business Management | <input type="checkbox"/> Banking and Finance |
| <input type="checkbox"/> Traffic Management | <input type="checkbox"/> Modern Foremanship and Production Methods |
| <input type="checkbox"/> Higher Accountancy | <input type="checkbox"/> Personnel and Employment Management |
| <input type="checkbox"/> Railway Station Management | <input type="checkbox"/> Expert Bookkeeping |
| <input type="checkbox"/> Law—Degree of LL. B. | <input type="checkbox"/> C. P. A. Coaching |
| <input type="checkbox"/> Commercial Law | <input type="checkbox"/> Business English |
| <input type="checkbox"/> Industrial Management | <input type="checkbox"/> Commercial Spanish |
| <input type="checkbox"/> Modern Business Correspondence and Practice | <input type="checkbox"/> Effective Speaking |

Name.....

Present Position.....

Address.....

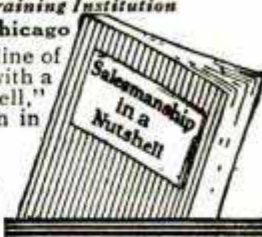



They Called Me a "Human Clam" But I Changed Almost Overnight

AS I passed the President's office I could not help hearing my name. Instinctively I paused to listen. "That human clam," he was saying, "can't represent us. He's a hard worker, but he seems to have no ability to express himself. I've given up hopes of making anything out of him."

So that was it! That was the reason why I had been passed over time and again when promotions were being made! That was why I was just a plodder—a truck horse. I was a failure unless I could do what seemed impossible—learn to use words forcefully, effectively and convincingly.

In 15 Minutes a Day

And then suddenly I discovered a new easy method which made me a powerful speaker almost overnight. I learned how to bend others to my will,

how to dominate one man or an audience of thousands. Soon I had won salary increases, promotion, popularity, power. Today I always have a ready flow of speech at my command. And I accomplished all this by simply spending 15 minutes a day in the privacy of my own home on this most fascinating subject.

* * *

There is no magic, no trick, no mystery about becoming a powerful and convincing talker. You, too, can conquer timidity, stage fright, self-consciousness and bash-

fulness, winning advancement in salary, popularity, social standing, and success. It is the power of forceful, convincing speech that causes one man to jump from obscurity to the presidency of a great corporation; a timid, retiring, self-conscious man to change almost overnight into a popular and much applauded after-dinner speaker. Thousands have accomplished just such amazing things through this simple, easy, yet effective training.

Send For This Amazing Book

This new method of training is fully described in a very interesting and informative booklet which is now being sent to everyone mailing the coupon below. This book is called, *How to Work Wonders With Words*. In it you are shown how to conquer stage fright, self-consciousness, timidity, bashfulness and fear. Not only men who have made millions but thousands have sent for this book—and are unstinting in their praise of it. You are told how to bring out and develop your priceless "hidden knack"—the natural gift within you—which will win for you advancement in position and salary, popularity, social standing, power and real success. You can obtain your copy absolutely free by sending the coupon.

NORTH AMERICAN INSTITUTE

3601 Michigan Avenue
Dept. 1352
Chicago, Illinois



What 15 Minutes a Day Will Show You

- How to address business meetings.
- How to propose and respond to toasts.
- How to make a political speech.
- How to tell entertaining stories.
- How to write better letters.
- How to enlarge your vocabulary.
- How to develop self-confidence.
- How to acquire a winning personality.
- How to strengthen your will-power.
- How to be the master of any situation.

North American Institute,
3601 Michigan Avenue., Dept. 1352
Chicago, Illinois.

Please send me FREE and without obligation my copy of your famous book, *How to Work Wonders With Words*.

Name.....

Address.....

City..... State.....



The Eveready Hour

LIKE the fabled ship in which Jason brought home the enchanted fleece of gold, the Eveready Hour brings a rich treasure of entertainment to charm the harbor-homes of its hearers.

Inaugurated two years ago, the Eveready Hour was an adventure in broadcasting—an hour of connected entertainment, uninterrupted by the frequent injection of the name of the broadcaster.

Many of these programs have become famous. Thousands of letters voice the appreciation of our audience and ask for repetition of favorites. We make no requests for these letters, but they mean much to our artists and to us, and are of great value in helping us in our efforts to arrange programs of a distinctive nature and pleasing to the vast audience.

Radio has already become a highly specialized art worthy of the most scrupulous code of ethics, and the Eveready Hour represents a sincere effort to pioneer in providing the most acceptable form of radio entertainment.

Eveready programs cover a wide range of entertainment and human interest, transporting us to periods of wholesome simplicity; to barren islands where marooned sailors meet adventure, starvation and death; to battle-

scarred France with singing doughboys; to emotional heights by telling with music the stories of the seasons; and to memories of yesteryear aroused by old ballad and musical comedy favorites.

Eveready Hour begins at 9 p. m. each Tuesday night, Eastern Standard Time.

NATIONAL CARBON COMPANY, INC.
New York San Francisco

Canadian National Carbon Co., Limited, Toronto, Ontario

Tuesday night means Eveready Hour—
9 p. m., Eastern Standard Time, through
the following stations:

WEAF—New York	WSAI—Cincinnati
WJAR—Providence	WWJ—Detroit
WEEL—Boston	WOC—Davenport
WTAG—Worcester	WEAR—Cleveland
WFI—Philadelphia	WCCO { Minneapolis
WGR—Buffalo	{ St. Paul
WCAE—Pittsburgh	WGN—Chicago
	KSD—St. Louis

EVEREADY
Radio Batteries
—they last longer

Artist's Conception of new
5,000,000-Cubic-foot Airship
Being Built for British
Government

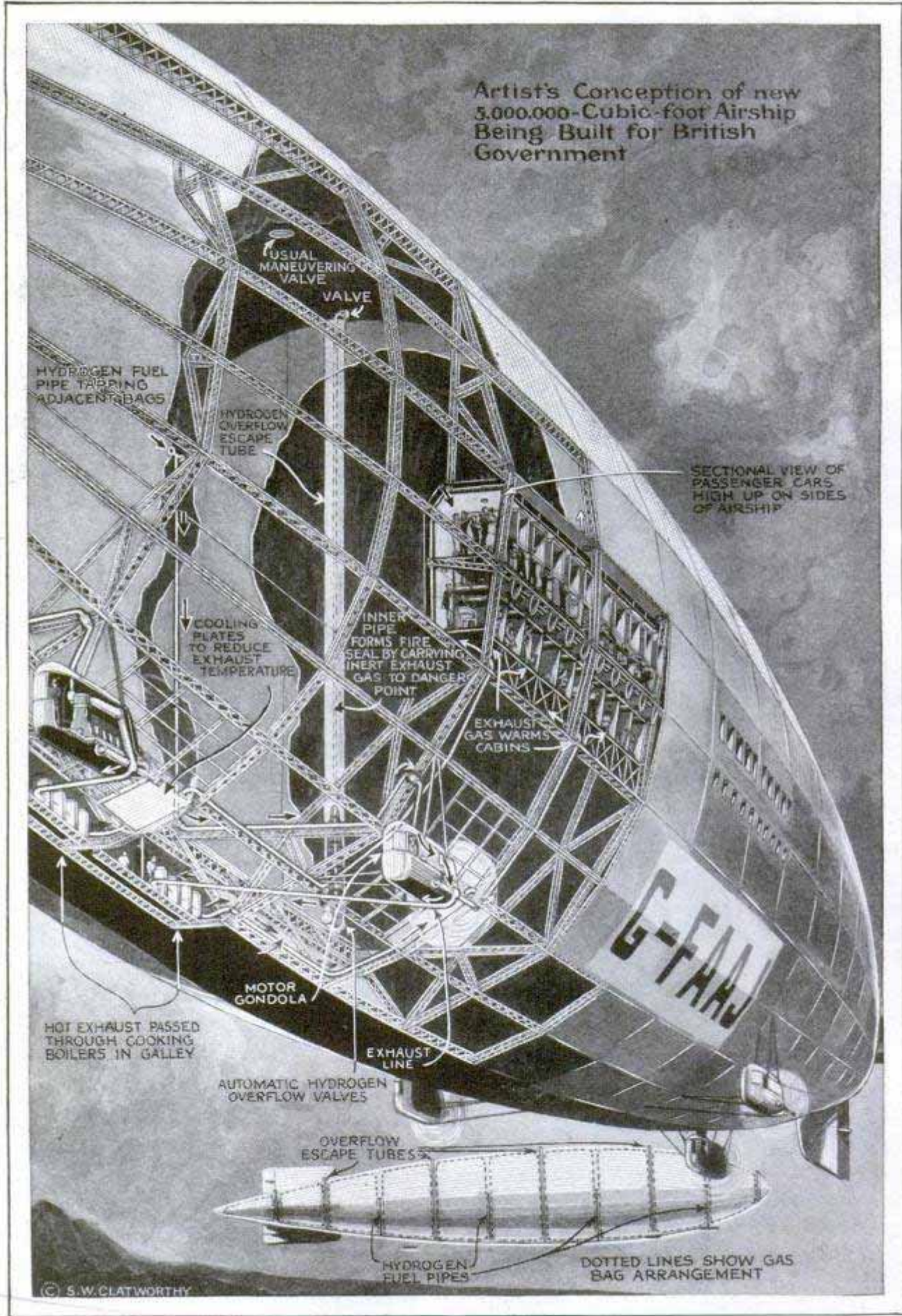

HYDROGEN FUEL
PIPE TAPPING
ADJACENT BAGS

USUAL
MANEUVERING
VALVE

HYDROGEN
OVERFLOW
ESCAPE
TUBE

SECTIONAL VIEW OF
PASSENGER CARS
HIGH UP ON SIDES
OF AIRSHIP

COOLING
PLATES TO
REDUCE
EXHAUST
TEMPERATURE

INNER
PIPE
FORMS FIRE
SEAL BY CARRYING
INERT EXHAUST
GAS TO DANGER
POINT

EXHAUST
GAS WARMS
CABINS

G-TAAU

MOTOR
GONDOLA

HOT EXHAUST PASSED
THROUGH COOKING
BOILERS IN GALLEY

EXHAUST
LINE

AUTOMATIC HYDROGEN
OVERFLOW VALVES

OVERFLOW
ESCAPE TUBES

HYDROGEN
FUEL PIPES

DOTTED LINES SHOW GAS
BAG ARRANGEMENT

© S. W. CLATWORTHY

England Is Seeking a Way to Make Hydrogen Gas Safe for Airships by Surrounding It with a Layer of Burnt-Out and Inert Exhaust Gases from the Motors of the Ship—See Page 204

849 Mr. W. H. Clacy, #639 Montgomery Ave. Bethesda Md.

Popular Mechanics Magazine

REGISTERED IN U. S. PATENT OFFICE

WRITTEN SO YOU CAN UNDERSTAND IT

Vol. 45

FEBRUARY, 1926

No. 2

Wind Tunnel Solves Skyscraper Problem

Government Scientists Revise Building Rules Following Study of Effect of Hundred-Mile-an-Hour Gale on Models

NEW rules governing the safeguarding of buildings against gales have been prepared by the bureau of standards as a result of wind-tunnel tests in which models were exposed to air streams moving at a velocity as high as seventy-six miles an hour, the equivalent of 100 miles an hour on weather bureau recorders. The tests disclosed that the arbitrary figure of thirty pounds' pressure per square foot, adopted many years ago, and to resist which all big buildings have since been built, was almost one-third greater than the actual pressure encountered in a seventy-six-mile gale.

The old figure was based on intricate calculations, but in recent years scientists had determined that the methods used involved several errors. The actual wind-tunnel tests showed that twenty-two pounds' pressure to the square foot was encountered in seventy-six-mile-an-hour winds, and that the thirty-pound pressure was not reached until the gale attained a speed of eighty-eight and one-half miles an hour, equal to 118 miles an hour as the weather bureau reckons velocity. Such extreme wind velocities are rarely

encountered, only a few momentary gusts recorded in New York and St. Paul, Minn., ever having attained such speeds.

The safety factor in building not only has an important bearing on the planning of tall buildings, but affects the design of bridges, wireless masts, tall factory chimneys and other engineering structures.

The character of the exposure of the building has an important bearing on the safety measures necessary, the government tests showed. A tall, slim building in the heart of a city, surrounded by other tall buildings, would not be in so much danger as a much smaller building on an exposed sea coast or lake shore. It is impractical, the investigators decided, to design a building to offer minimum wind resistance, since such construction not only would be costly, but quite fantastic. If one exposed face of the building was shaped to offer minimum resistance, the problem still would remain on the other sides.

Square, low buildings offered the minimum resistance, since the currents were deflected equally around the sides, and could rise and flow over the top. Condi-



Huge Wind Tunnel of the Bureau of Standards at Washington, Used to Test Building Models and Determine Exact Figures on Gale Pressures Their Walls Must Stand

849.

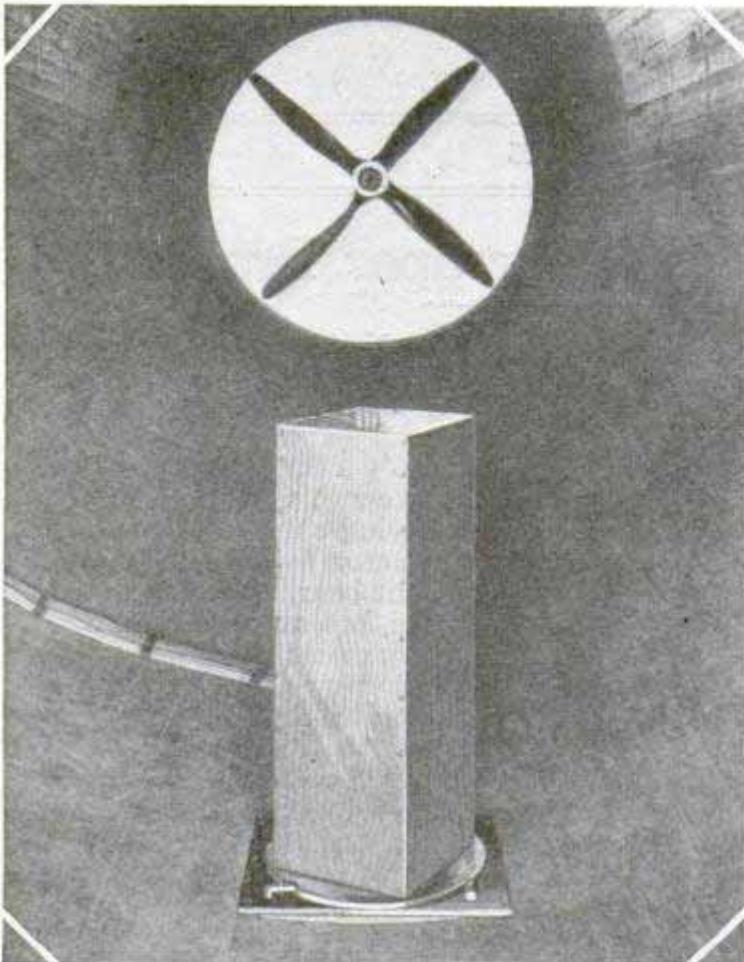

Rectangular Boxes Represent Building Forms, While Sets of Rubber Tubes Carry Inside Pressure to Recording Gauges

tions are reversed in a tall and narrow building. The air currents cannot rise easily to flow over the top, but instead are deflected upward and exert a lifting tendency which would carry off an insecurely anchored roof, the reason why so many buildings are unroofed in gales.

The rear face of the building is subjected to a terrific outward pull as the air flowing past draws into its high-velocity stream the still air behind the structure, leaving a partial vacuum there. In cyclonic disturbances, buildings frequently appear to explode, as the rear wall bursts outward from the air pressure within and the semivacuum without.

The models used in the wind-tunnel tests were simple boxes of various shapes, corresponding in proportions to certain types of buildings. Each wall was drilled with seventy small holes, and forty-nine more were bored through the top. Rubber tubes catching the air forced through these holes

on each of the five exposed faces led to recording instruments outside and gave an accurate measure of the air pressure on sides and roof. The models were mounted on revolving bases, so that they could be turned gradually to give thirteen different exposures, simulating the results of a shifting wind.

ENGLAND CURBS RAGMEN TO SAFEGUARD HEALTH.

902 To prevent the spread of disease, health authorities in England have forbidden ragmen to give children candy and toys in exchange for old clothing. The measure is a blow to thousands of youngsters who took keen delight in the chocolates, balloons and other trinkets they were given for rags and may affect big business, for large organizations profited from the materials collected by the ragmen.

new York Times 12/6/25

SIGNATURES IN SILVER ADORN CANE

877

As a remembrance of more than 200 famous persons he has met, a Russian actor carries their autographs inscribed in silver on a walking stick. The signatures were copied in metal script from actual autographs and inlaid in the cane. The cost of the engraving is said to be more than \$1,000 and the cane is valued at \$5,000.

Examining Silver Signatures on Cane; Names Are Inscribed in Inlaid Metal from Handwriting of More Than 200 Persons; the Cane Is Valued at Nearly \$5,000



Daniel Makarenko.

Washington, D.C.

Wanamahis

new York City 179

BIRDS' EYES BALKED BY BRIGHT COLORS

That the feathers of male birds serve as a protection from enemies rather than as a lure for mates, is the theory of Dr. Austin H. Clark of the national museum. Brilliant colors, he asserts, hide the wearers from other birds for the reason that the eye structure, radically different from that of human beings or other mammals, presents the landscape as a clear-cut patchwork of all colors and sizes. Therefore, objects which are most conspicuous to the human observer, would be difficult for a bird to see. In the bird's eye, Dr. Clark says, the lens is of a shorter focus so that the image projected by it, lies almost wholly in one plane. There is no blurred background in the vision of the bird, tending to make dull-colored objects less noticeable, as is the case in the mammal's sight. For that reason, birds of gaudy plumage are comparatively safe from detection by feathered enemies when they are on the tree tops or among the branches, while the dull-colored female bird, staying close to her nest, where her plumage blends with the surroundings, is hidden from the gaze of prowling mammal enemies.



Waving the Hand in Front of the Cylinder Casts a Shadow Which Is Made to Close a Circuit and Start the Washer

WASHER STARTED BY SHADOW CAST FROM HAND

Science has gone a step ahead of the day when mechanical servants can be put to work simply by pressing buttons for it is now possible to do it by merely waving the hand. This is accomplished in the apparatus a Russian inventor has devised, combining the principles of the photoelectric cell and the radio vacuum tube, for starting an electric washing machine. A wave of the hand casts a shadow in such a way that the sensitive light cell stimulates a shower of electrons from the tube, and closes a circuit which starts the motor running. Success of this experiment suggests that the same arrangement might be adapted to closing doors, starting furnace fires and other tasks.

LIGHTLESS AUTO STOP SIGNAL OPERATES BY REFLECTION

Operated by the brake rod or lever, an auto stop signal now on the market, is attached near the tail light so that reflection from it, or from the head lamps of cars in the rear, makes it plainly visible. It shows as soon as the brakes are applied and when they are released, the word "Stop" disappears. The sign requires no bulbs, glass or switches and is not likely to get out of order.



X-RAY STAIN SOUGHT TO BARE BODY'S HIDDEN DISEASES

To make the internal organs of the body opaque so that they can be photographed by X-rays, scientists are seeking a special kind of stain. It has already been discovered that injection of a special oil will make the lung cavities susceptible to registering on X-ray exposures and this, it is believed, will be of great aid in diagnosing tuberculosis.

Science 11/27/25

328/

Chicago agent

890

U. Stop Signal Co.

Meeting of Radiological Society of North

& ing...
 Cal...
 D. K.
 G...
 S...
 W...
 E...
 E...

8/105...
 West...
 11/27/25

Exhibited at Shipping and Engineering Exhibition

180

London England.
WIRELESS SET IS WATERPROOF FOR USE IN LIFEBOAT

878

Designed especially for emergency use in lifeboats, a small radio transmitter has all parts carefully inclosed so that they



Waterproof Wireless Transmitter for Lifeboats, and How Operator Employs Protecting Sleeve

cannot be damaged by water. The operator is provided with a sleeve which is attached to the set, and through which he inserts his arm for adjusting the sending apparatus.

BUILDING MATERIAL OF WASTE TO RESIST EARTHQUAKES

Synthetic lumber made of mill waste, or from growths which have been considered pests, promises conservation of the timber supply and is said to possess many of the qualities of brick and concrete besides having strength and elasticity which suit it to use in countries subject to earthquakes. The prickly pear, which abounds in Australia, rice husks in Japan, bean straw in Mexico and, recently, gorse and blackberry bushes that overrun parts of New Zealand are some of the materials that have been used for the manufacture of artificial lumber. The New Zealand product is said to be proof against insects, dust and damp, as

*879
 d. w. Henry George J. Cofilas
 Lager.
 New Zealand Times
 12/13/25*

cheap as wood and to last as long as concrete. Formed into a plaster, it protects timbers through the chemicals that it contains, is fireproof, as tests with torches have proved, and although holes can be made in it with hammers, it does not split or crack. For finer uses, it can be made to resemble marble, stone, tile or leather, and since it resists both cold and heat, it is suitable for refrigerator lining and other insulation. Damage to the material can be repaired by adding new plaster.

857
NEW INSTRUMENTS IN AIRPLANE INCREASE FLYING SAFETY

Practically every quiver of an airplane in flight is registered on an improved instrument board intended to make aviation safer. There are two rows of dials each of which is in plain view of the pilot and tells an important story. At the top, from left to right, are the oil-pressure gauge, air-speed indicator, a bank-and-turn indicator, a particular aid in fogs by which the flyer can determine whether he is going straight or turning, and a rate-of-climb indicator which shows how fast he is ascending. The lower row comprises the radiator thermometer, a gauge that tells the speed of the engine, fuel-level gauge, altimeter which gives the altitude of the plane, an electric clock, and a control switch. Together with direction charts and maps, this equipment leaves the pilot with very little to worry about when everything is running smoothly, and gives him an instant warning of the location of trouble.

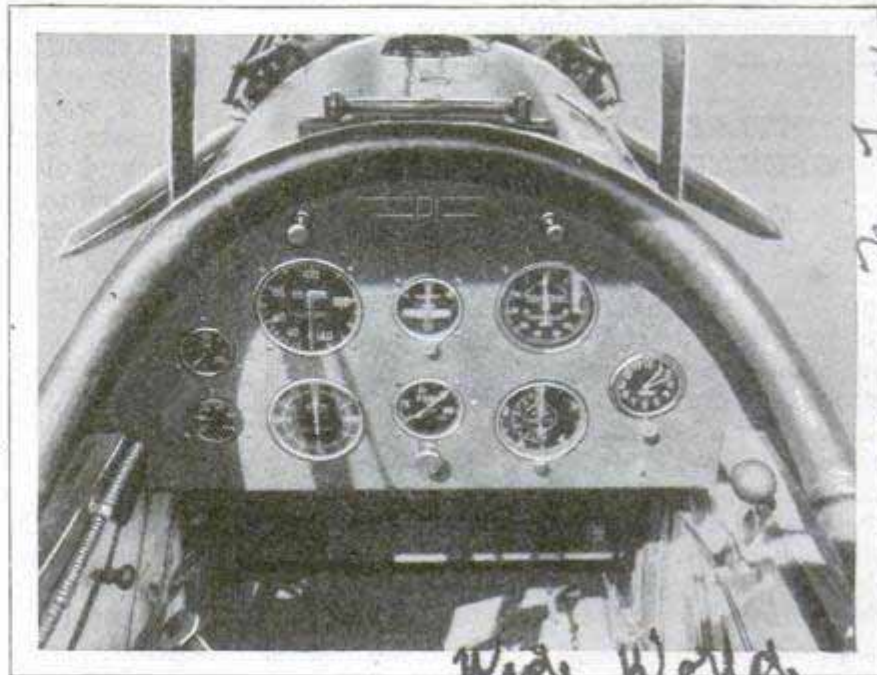

Instrument Board with Improved Aids for Flying Safety

Wide World

d. w. Morris M. Livingston

**SERUM MENDS BROKEN BONES
AND HELPS CURE DISEASE**

**BRAIN WORKINGS OF CHILDREN
STUDIED WITH CAMERA**

908

868

Prepared from a substance contained in small glands in the neck, a serum that already has proved beneficial in treating tetany, a child's disease, helps mend broken bones, according to reports from Japan. This is accomplished by the serum's effect in producing in the blood an increase of calcium phosphate, the substance of which bone is largely composed. Rats with broken legs were found to produce nearly twice as much new bone when fed with the serum as when not. It may be injected into the system or taken through the mouth. Results of experiments with the serum on human beings are awaited with interest, as it is believed that it may not only hasten the healing of fractures in young persons but render such action less difficult in old age. The discovery of the Japanese scientist was made in continuing investigations begun by a Canadian physiologist.

Why can some children multiply three times eight with less difficulty than four times seven? Why do others, bright in

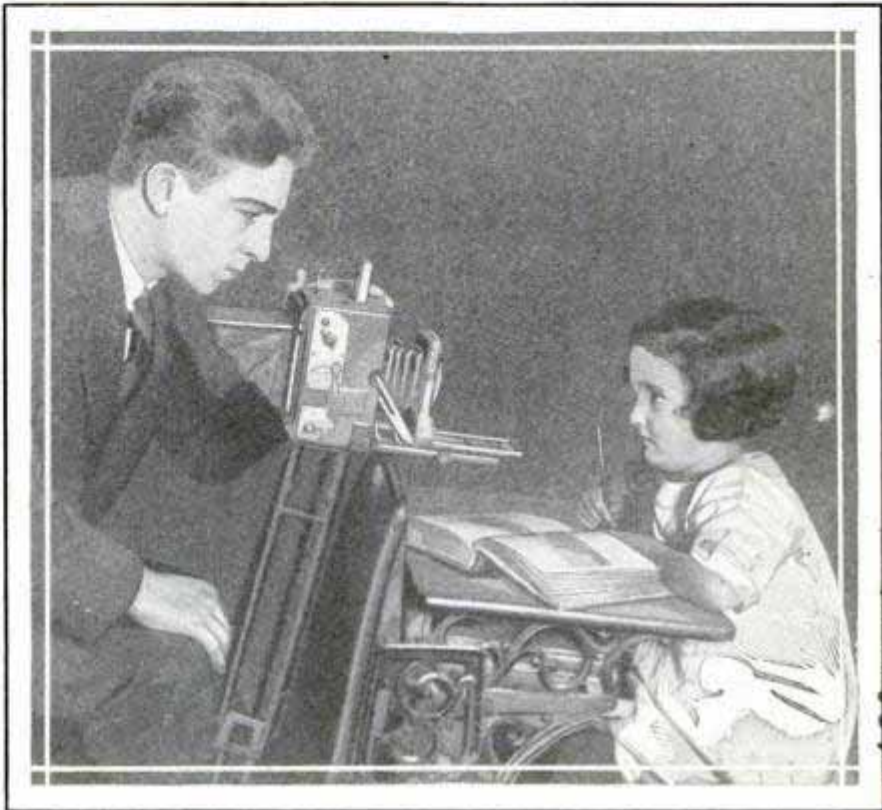

Using the Camera to Make Studying Easier; One of the Child Subjects Tested at the University of Chicago

Kansas City Star 2/6/25
Science Bulletin

Prof. Charles H. Judd, School of Education, University of Chicago

**SELF-CLEANING SPARK PLUG
IS COOLED BY AIR**

759

By using thin metal around the heavy part of the porcelain, a spark plug has been devised that is said to assure equal expansion and contraction, reducing breakage. It is cleaned simply by loosening the top half of the plug by one full turn. This permits gasoline and air to be ejected through openings in the plug while the motor is running, blowing out accumulations of oil. The plug is also adapted to priming.



no Chicago agent

arithmetic, find reading extremely difficult? Answers to these and many other questions concerning the school child's mentality are being sought by numerous tests with delicate instruments in laboratories of the school of education at the University of Chicago, with pupils as the subjects. In the reading tests, use of a special camera enables the teacher to do much to help pupils who hesitate and stammer. The instrument is a large one, and its lens is trained on the eyes of the pupil who is seated in a chair. From a point at the side, a pencil of light is trained on the eyeball and as the eyes move from side to side horizontally while reading, the camera records the position of the ray of light and plots a curve on a motion-picture film. Each child who sits in the chair leaves an impression of the movements of his eyes as he reads, thus exposing what words or groups of words are the "stickers." By revealing difficulty in following from the end of one line of type to the beginning of the next, and other obstacles in reading, the apparatus helps teachers correct the pupils and some are made into good readers in a few months.

BB + BB Int'l. Co.
Lindsborg, Kans.

SIDECAR WITH HINGED FRONT SIMPLIFIES ENTERING

86 ⁷ Getting in or out of a motorcycle sidecar taxi now in use in Berlin has been sim-

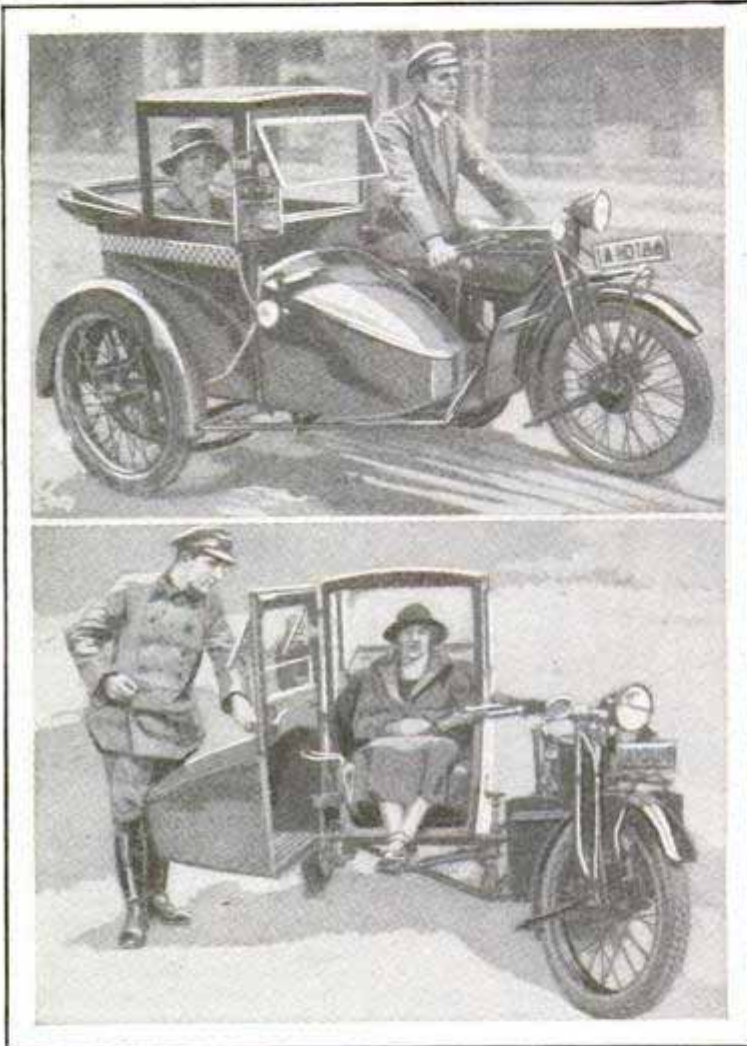

Motorcycle Sidecar Taxi Closed and Opened, Showing How Entire Front Swings Back for Easy Entering and Leaving

plified by having the entire front of the passenger compartment built as a door. It swings out on hinges, eliminating the trouble of climbing over the side or through a narrow opening. The meter is attached to this front, and, besides being protected by a windshield, the passenger may raise a folding top at the back of the cab in stormy weather.

TESTS FOR JEWEL FORGERIES TO GUARD BUYERS 880

Jewel forgers have become so clever that a special gem-testing institute has been established in Vienna, and similar studies are being carried on in this country, to detect imitations. Since glass ornaments were made in the early ages in Egypt and Phoenicia to look like real jewels, efforts to produce substitutes have

been persistent. Imitation diamonds are numerous and it is possible to make real ones in the laboratory, but the cost of the process is about \$200,000 a carat, while natural ones can be purchased at from \$100 to \$300 a carat. Rubies can be made by laboratory methods in about six hours, and some of them are so nearly like the real stones that other tests than with the eyes are necessary to distinguish them. While the synthetic emerald has brilliance and realistic color, it usually can be told from a genuine one with little difficulty. They are often built up in three parts, which are fastened by invisible cement. The top and bottom part may be glass crystals cut in many facets with a thin shaving of a real emerald between them to give the color. Others may have a slight cavity between the two crystals which is filled with a green liquid. Both imitations are easily detected by submerging the stone in a certain kind of oil and holding it up to the light. All synthetic stones are said to have telltale marks which can be found by special tests and with the use of special instruments, the development of which is of interest not only to dealers and buyers but also to insurance companies.

SPECIAL FOUNTAIN PEN FOR LETTERING 885

With but little practice, neat lettering in various styles is said to be accomplished with a special fountain pen which insures an even flow of ink and neater, more uniform results. The point operates on a rotary principle and is so arranged that the ink starts flowing the instant the user begins to write and stops at the end of the stroke. For slow work, the holder is but partly filled, and for fast lettering, a greater supply is needed, as gravity partly controls the operation of the instrument.



New York Times
12/6/25

E. E. Evans
1110 E. Wilson St

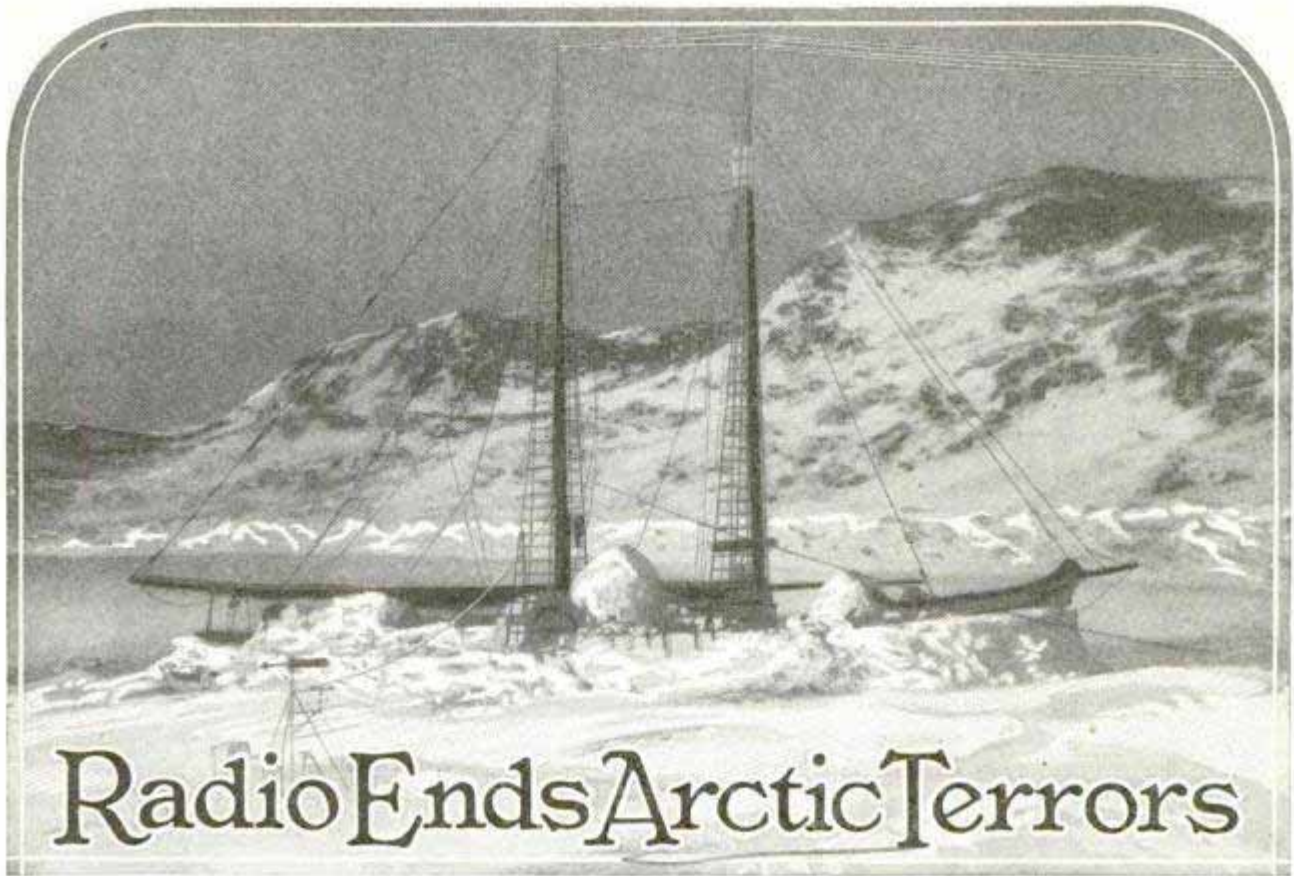

Radio Ends Arctic Terrors

RADIO has ended the terror of the long Arctic night, and the airplane has supplanted the dog sled and conquered vast unexplored distances, but with their advent much of the romance of the Far North has disappeared. That is the verdict of Commander Donald MacMillan and Lieut. Commander E. F. McDonald, who commanded the "Bowdoin" and "Peary," ships of the MacMillan expedition, last summer.

There was a time, McDonald explains, when Arctic explorers went into the north and were forgotten until they appeared again, and then the world hung breathless on their stories of a venture, while they were equally breathless as they listened to all the news of the outside world during their absence. Now the radio keeps the expedition informed from

hour to hour of all that is happening outside, and likewise tells the world of the accomplishments in the north, with the result that, when the expedition returns, neither side has much to relate.

When MacMillan came back from the north, in 1917, after four years' absence, he learned for the first time that a world war was raging. When he went north in the summer of 1913, the king of England was visiting the kaiser in Berlin, and when he came back in 1917 Europe had been

fighting for three years and America had just entered the war. On their latest trip, the explorers knew of the wreck of the "Shenandoah" two hours after it happened; learned of William Jennings Bryan's death thirty minutes after it occurred; followed the search for the Pacific flyers hour after hour



Eskimo Girls Try Their First "Tailor-Made" Cigaretts; Every One in Eskimoland Smokes, the Women Preferring Pipes

for nine days; got the baseball scores each day and tuned in on the play-by-play report of the world series. They held two-way conversations with a wireless operator at Box Hill, Victoria, Australia, and talked with other amateurs scattered all over the globe—all from the warm cabin of a ship only eleven degrees from the pole. And when there was a bit of exploring to do,

MacMillan stepped into the passenger seat of an amphibian plane and was whisked aloft and in three or four hours covered ground that it took him weeks of painful mushing behind a dog sled to get over only two years ago. On one flight he soared over territory where he and Eskimo companions toiled through waist-deep snow for days at a time, then turned the plane back home and arrived in time to sit down to dinner in his ship. On another aerial journey it took ten minutes to travel from Etah, Greenland, to the point on lonely Cape Sabine where last year he placed a bronze tablet in memory of the Greely expedition members, who died there while waiting for rescue. It took two years to place the tablet because the thirty-mile journey from Etah was impossible year before last.

Only ten minutes by airplane from the Etah settlement, yet in 1884 more than half of Greely's Lady Franklin Bay expedition starved to death there because the men were so weakened they could proceed no further. Lieut. Greely, a cavalry officer, had been sent north with twenty-five men to establish one of a chain of international stations for scientific study in the Far North. Several other governments sent similar expeditions to other localities. Owing to unusual ice conditions, relief ships were unable to reach the men for three years, and in the meantime their supplies gave out. They made their way overland to Cape Sabine, and there, in rude shelters, settled down to wait for help.

By early summer of 1884, only twelve of the original twenty-five were left, the others having starved on a diet consisting mainly of seal-skin boots and thongs, and a soup made from tiny sea bugs, so small that it took 1,500 or more to make a gill. To add to the horror of the wait, one of the privates in the party was caught stealing food. Because of his thefts he was



One of the Airplanes Used by the MacMillan Expedition as It Looked When Lifted to the Deck of the Steamer "Peary"

considerably stronger than any two of his mates, and Greely finally, after repeated warnings, ordered him shot. The execution was carried out on June 6, only a little more than two weeks before the relief ship finally arrived, in the night of June 22, 1884. In his diary Lieutenant, now Maj. Gen. Greely, retired, gives a vivid story of the sufferings which made

Arctic exploration in those days epochal. The only other survivor of the eleven rescued at Cape Sabine is a brigadier general who at that time was a sergeant, and one of the three sergeants appointed by Greely to execute the food pilferer, a man who had enlisted as C. B. Henry, although that was not his true name.

On June 4, 1884, Lieut. Greely entered in his diary:

"Our condition grows more horrible each day. No man knows when death is coming, and each has long since faced it unmoved. Each man who has died has passed into the preliminary stages of mental, but never violent, wandering, without suspicion that death had marked him."

Corporal Salor had just died of starvation, the thirteenth victim that winter, and the survivors lacked the strength to bury him. Corporal Ellison, one of the strongest men in the original party, lay in his sleeping bag with both hands and feet frozen off. Greely expected, and had expected for three months, to die any day.

Taking up his journal again, Greely wrote: "Henry stealing again from our shrimps" (the name given by the explor-

671

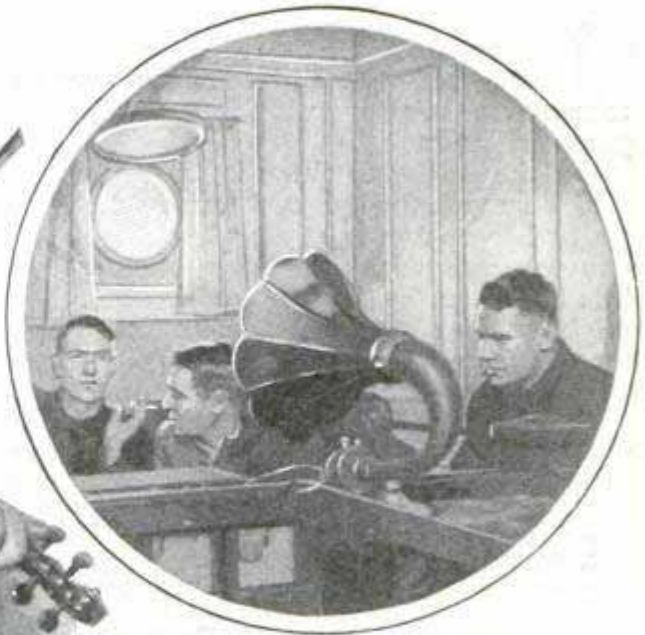
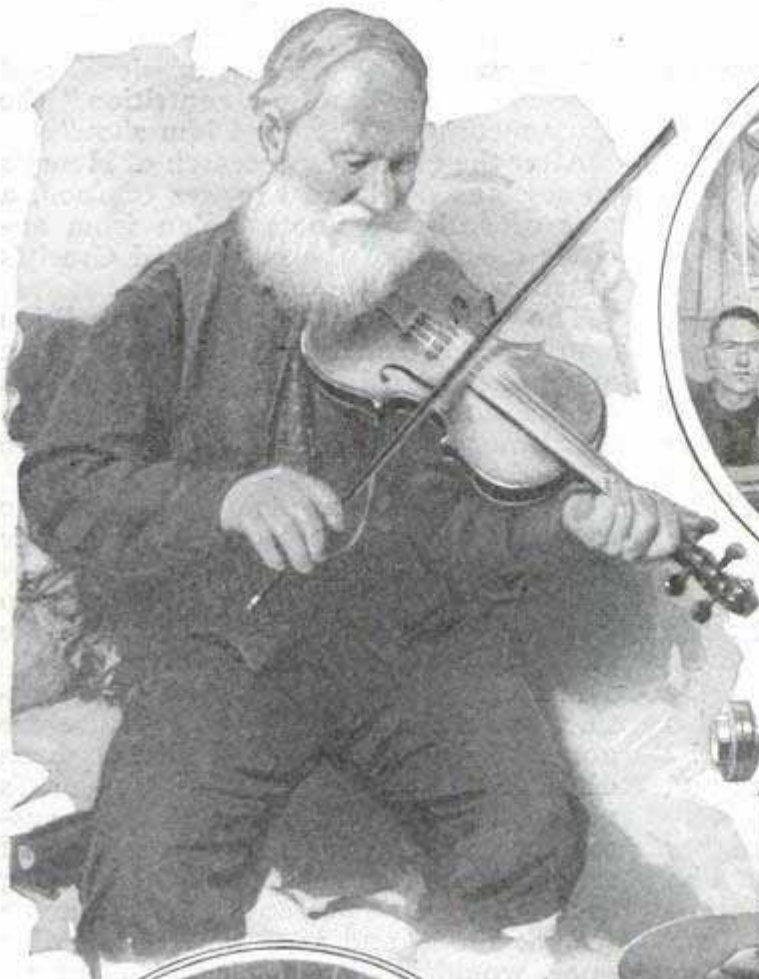

One of the Oldest Men in Labrador Broadcasts His Violin through the Microphone of WAP, the "Peary's" Radio Station, a Concert That Was Picked Up by Radio Amateurs in Many Lands; Above, the Crew of the "Peary" Listening to the Play-by-Play Broadcast of the World Series Games; Radio Has Lifted the Ancient Rule of Silence in the North

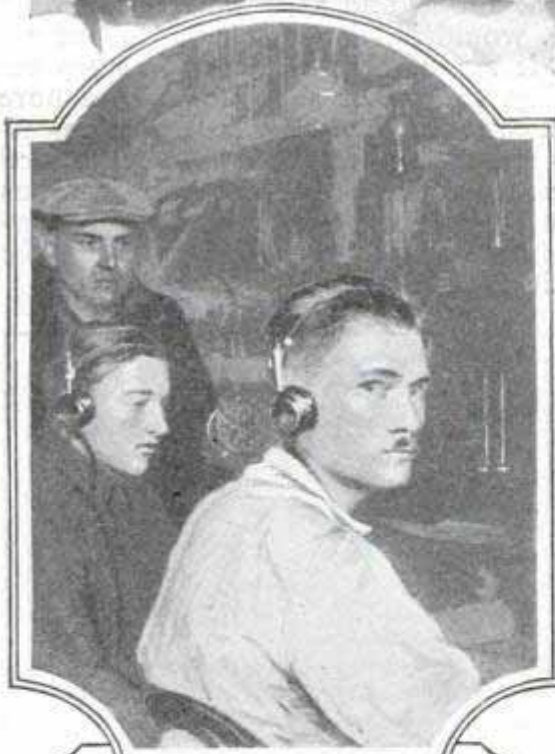

The Radio Operators Listening In on One of the Ships, and, at Right, an Eskimo Woman Showing Her Daughter How to Fire an Ancient Long-Barreled Colt, While the By-standers Cover Their Ears for Protection against the Expected Burst of Sound



ers, for politeness sake, to the sea bugs used in the soup). Schneider and Bender also suspected. It will be necessary to take some severe action, or the whole party will perish."

On the next day there is this entry:

"Henry acknowledged again to me that he had been stealing, and I had a long conversation with him, in which I told him that, as he had no conscience, he might at least have a little common sense; that it was evident that if any of the party survived, it must be through unity and fair dealing, otherwise everybody would perish. He promised to deal fairly in the future, and seemed impressed with my caution that he would come to grief if he did not."

Greely, however, doubted the man's sincerity and on the same day issued an order to Sergeants Brainard, Frederick and Long, directing that:

"Private Henry, having been repeatedly guilty of stealing the provisions of this party, which is now perishing slowly by starvation, has so far been condoned and pardoned. It is, however, imperatively ordered that if this man be detected either eating food of any kind not issued him regularly, or making caches or appropriating any article of provisions, you will at once shoot him and report the matter to me. Any other course would be a fatal leniency, the man being able to overpower any two of our present force."

Not a day later Henry was caught stealing shrimps out of the messpot while the cook's back was turned, and later was seen making a trip to the storehouse. When he returned, he admitted to Greely

that he had eaten several seal-skin shoe thongs out of the food supply.

"He was bold in his admissions, and showed neither fear nor contrition," the diary records. "I ordered him shot."

After the execution, a search of Henry's possessions disclosed supplies of food, a pair of seal-skin boots stolen from another member of the party, and Greely's watch, which had disappeared.

The Lady Franklin Bay expedition stands out in American polar-exploration annals as one of the most tragic events of the north, unlikely ever to have an equal, now that radio and airplanes have crossed the Arctic circle.

With radio to call help and guide the rescuers, there is no longer danger of slow starvation, while an airplane could ferry food to an icebound party, and, even if no landing spot were available, drop the packages.

Modern exploring is efficient and scientific, but the romance and adventure are gone. Even the law of silence has been discarded, since the air brings the world's news every day. In the past, it was customary to enjoin silence on the men of the expedition to keep them from boring each other. One person has just so much to talk about, and after he has told that once, would have nothing to do but repeat it again. If permitted to keep repeating, the talker soon becomes a bore and a cause for quarrels. But with a neatly typed digest of the day's news placed at each plate at breakfast, the radio has made possible sufficient new topics to permit interesting conversation during the Arctic nights.

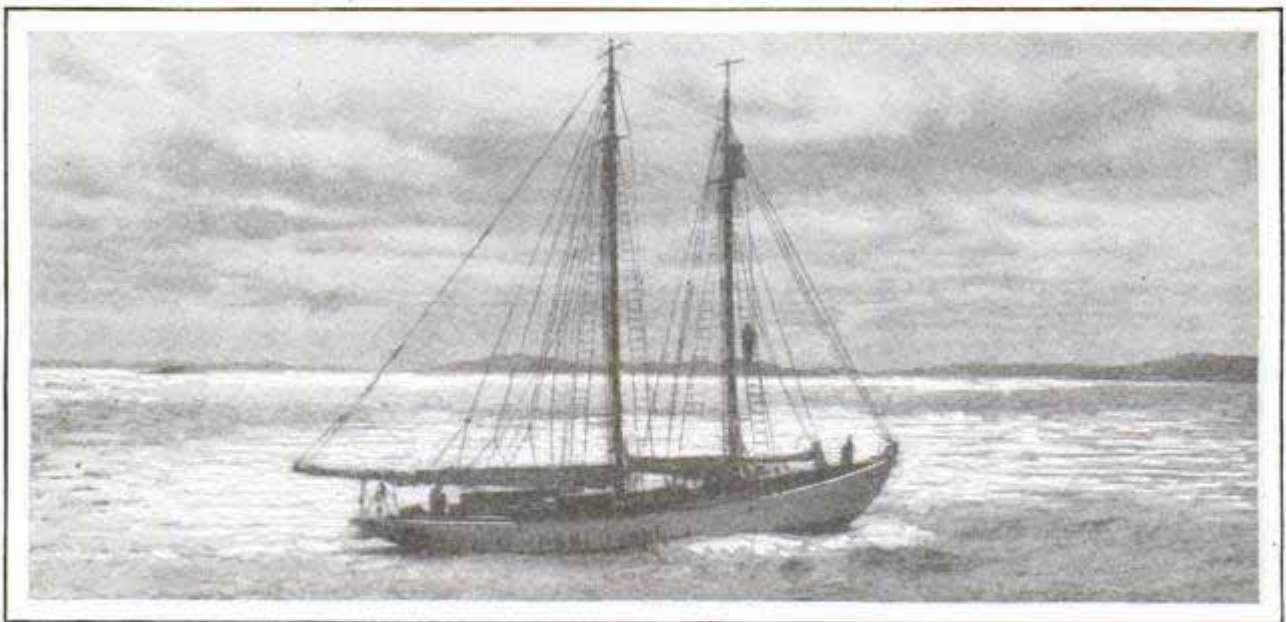

The Schooner "Bowdoin," MacMillan's Flagship, on Which His Party Wintered in 1923-24 at Etah, While Radio Kept Them Supplied with All the News, and Gave the World Their Story

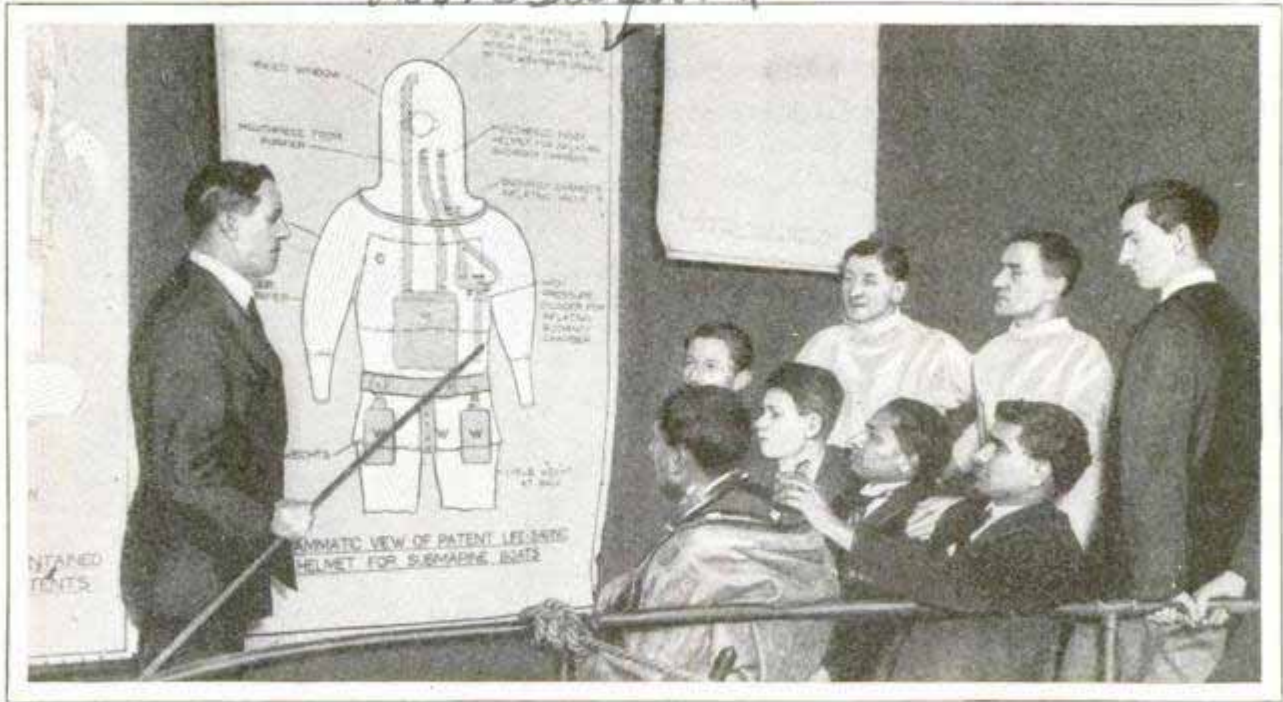

Diving-Suit Class at an Engineering School; the Instructor Is Pointing Out Different Parts of the Apparatus and Explaining Their Operation to Divers and Students

**SCHOOL FOR DEEP-SEA DIVERS
 TEACHES HOW TO WEAR SUIT**

Suits worn by divers have become so intricate that special instruction classes are held to teach candidates for the submarine profession how to wear them and manage the various units of the equipment. The lessons are given with the aid of charts, on which various modern suits are represented in diagrammatic form, giving the location of their important interior and exterior parts.

876

ELECTRICITY TO RIPEN ORANGES

When oranges are picked, they are usually fully developed in size and sugar content, but have not yet acquired the rich yellow color of complete maturity. This has been produced by the common method of placing the fruit in a sweating room with kerosene lamps. The warmth and the gases given off when the lights are extinguished, help give the desired shade. Lately, an improved way of obtaining the color has been devised through the use of electricity. Boxes of oranges are put in a closed room, and by an electric heater, the temperature is raised to about eighty degrees Fahrenheit. The heat and the moisture of the oranges cause them

to sweat. For each 10,000 parts of air in the room, one part of ethylene gas is released to assist the coloring process.

**TAXI BUILT LIKE HANSOM CAB
 AFFORDS CLEAR VIEW** 870

Besides being suited to congested traffic, a single-passenger taxicab introduced in Paris and built on the lines of the old-fashioned hansom cab, affords the chauffeur a good view of the street from his high seat at the rear, and the occupant of the cab can also enjoy an unobstructed outlook. The steering wheel, gear shifts and brakes are conveniently arranged for the driver.



Wide World.

In Motor Dress, the Hansom Cab Comes Back for Further Service; Sample of Compact Outfit Used in Paris

Utility Bulletin
 of New York Island Central

825

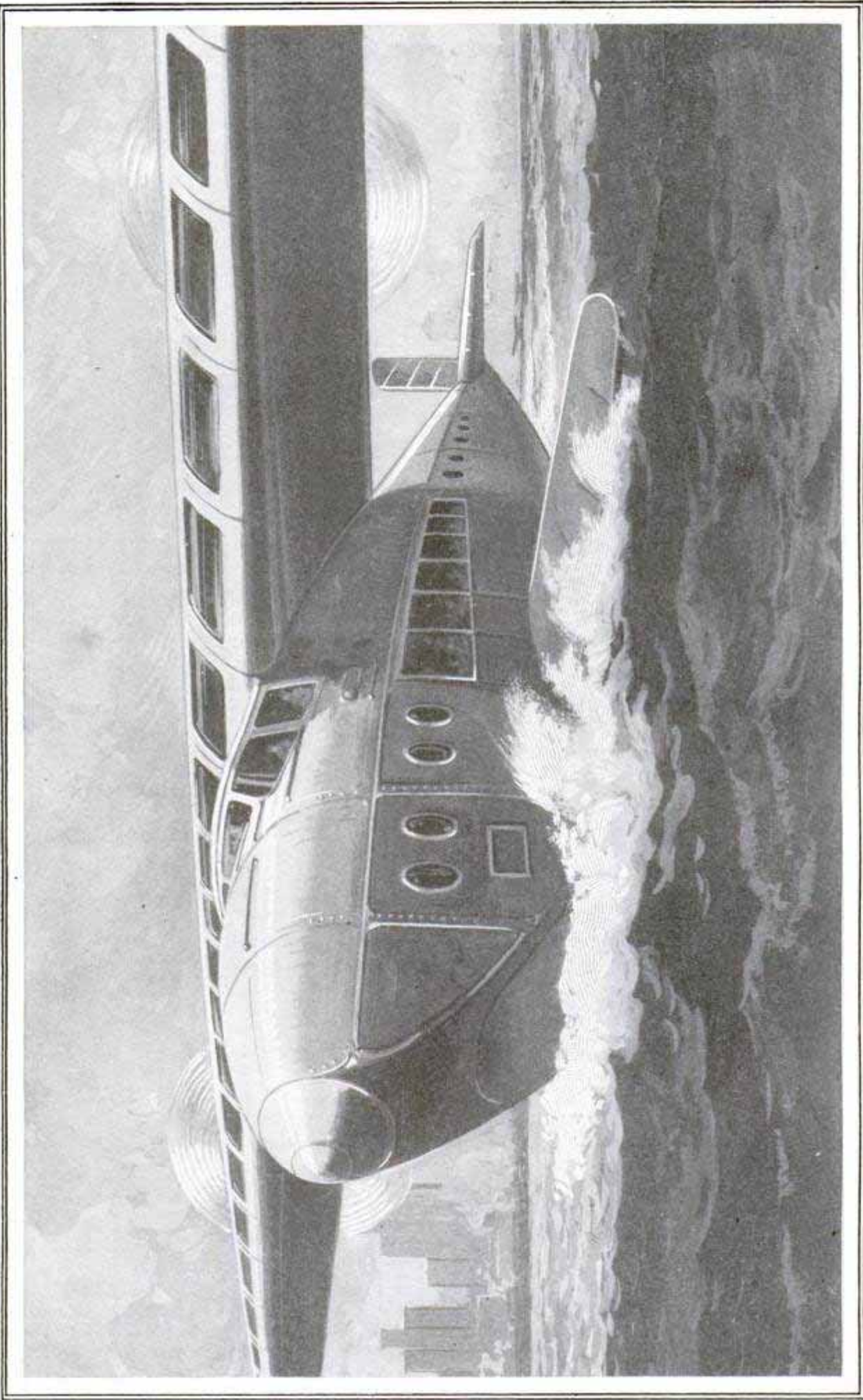

Sketch of Proposed Transatlantic Airplane, with Passengers' Cabins in the Metal Wings, as Well as in the Boatlike Hull, and Three Motors, One in Front and Two Pushing Behind, to Carry It at an Estimated Speed of 250 Miles an Hour through the Rarefied Air of the Upper Levels, Six Miles above the Earth

deusserte Technik für

CABINS IN AIRPLANE'S WINGS FOR TRANSATLANTIC FLIGHT

Estimating that a speed of 200 to 250 miles an hour would be necessary to make transatlantic airplane flights commercially attractive, Walter G. Brenner, a German inventor, has prepared plans for a giant ship which would utilize the decreased air resistance at very high altitudes to make such speed possible. The enormous resistance encountered at low altitudes at high speed would require engines out of all proportion to the plane to overcome it, he believes, but by ascending to between 26,000 and 33,000 feet, the density of the air would be so reduced that its resistance would be correspondingly lessened. At such heights the passengers, and the motors, too, would have to have air supplied at normal sea-level pressure, so the entire ship as designed is air-tight, the atmosphere being supplied by pumps. His plan calls for a light duraluminum body and wings, designed along the same lines as those of the all-metal Junkers plane, but greatly magnified. The passenger cabins would be located in the wings, now utilized in many metal ships for gasoline tanks. The leading edge of the wings would have glass windows. Control and crew quarters, freight space and additional passenger quarters would be located in the hull. The fuselage plan differs from the usual flying-boat type in that it is fitted with two wing-like metal pontoons, one on either side. Although the ship is designed as a monoplane, in the air the set of pontoons would give additional supporting surface.

Herr Brenner's design is based on the fact that a large part of the power developed by a flying machine's motors is used to overcome the air resistance. Without increasing the consumption of fuel, he believes he can double the speed of the ship at high altitudes, so that ordinary motors would be large enough to power it.

GAS MASKS GUARD WORKERS REPAIRING LEAKY MAINS

856

Gas masks of the type that protected soldiers during the world war were pressed into service by a crew of workers in Lon-

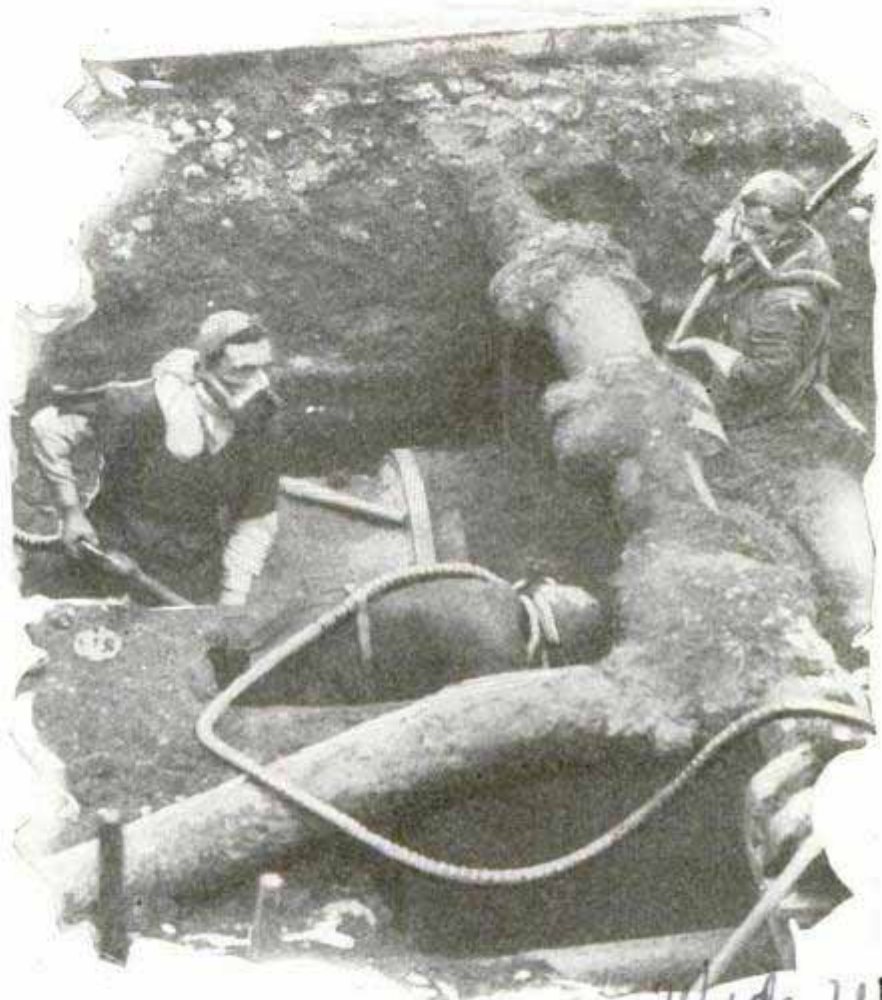

When Gas Masks Helped Peaceful Trench Diggers; Workmen in London Seeking Leaky Gas Mains, Protected by Mouth Shields

Wide World

don while hunting leaks in the city gas mains. The hazard of the job was increased by the necessity of working in deep trenches where vapors had insufficient chance to escape in case flows of considerable pressure were encountered. With the masks, the workers were able to make a thorough search.

RADIO GUIDES DRIVERLESS AUTO THROUGH CITY STREETS

*406
Auto J of rig 9/5/25*

Bowling along through Broadway traffic as easily as though a chauffeur were at the wheel, a driverless auto astonished New Yorkers not long ago. The apparent mystery was explained by a second car, following about fifteen feet behind. It contained wireless sending apparatus by which the forward car, equipped with receiving instruments, was operated.

Chandler.

PITCH OF PROPELLER MEASURED TO AVOID VIBRATIONS

846

As an aid to air and water transportation, a gauge devised by a western inventor permits accurate measurements of

Pitchometer

Inventor Measuring Ship's Propeller with Gauge, to Determine if Pitch Is Same in All Three Blades



International

the pitch of propellers so that they will run smoothly and avoid the damage that sometimes results from an improperly balanced unit. It can be used on propellers of all sizes and is said to have proved so successful that boat owners obtain final check with it before installing the propellers in their craft. The slightest difference in the curve of the blades can be detected with this instrument.

ENGINEERS RISK THEIR LIVES TO SPAN THE NARROWS

733

Battling against ocean tides, engineers risked their lives in erecting a span of electric-transmission cable across the Narrows, an arm of Puget sound, near Tacoma, Wash. The wires, six in all and

each to carry 110,000 volts, were suspended from two towers on each bank. The supports, 335 feet high, stand on bluffs 300 feet above the water, and the span is 6,241 feet long. The weight of the cables causes them to sag to within 245

feet above the sound, a height required by the government to prevent interference with vessels passing beneath. Lifting the strands to their lofty anchors necessitated the use of hoisting engines, tested to raise thirty-two tons each. The wires were first made fast to the insulators on one shore and then taken across, one at a time, on a barge pulled by a tug. A reel with a special brake payed the cable out as the boat proceeded. The water averaged about 150 feet in depth and the work was hindered by the strong tides which at times, ran over seven miles an hour. When the cable had been pulled to the opposite shore, it was made fast to tackle and hoisted to the tower where connection was completed. The line is intended to withstand a strain of many thousand pounds and to resist a seventy-mile wind even when it is coated with half an inch of ice. The wire in the

strands had to be severed by a special hydraulic cutter because of its hardness.

556

GLASSES ARE MADE FOG-PROOF WITH PIECE OF PARAFFIN



Glasses, mirrors and windshields are said to become proof against fogging or steaming by rubbing them with chemically treated paraffin. A little moisture is used with the substance, then the surface is lightly polished without removing the coating of wax.

Clear-Vu Specialty Co.,
625 Duane Bldg.

St. Louis, Mo.

*Isodrey Propeller Works
2425 W. 54 St.*

Cable Span Is More Than Mile Long

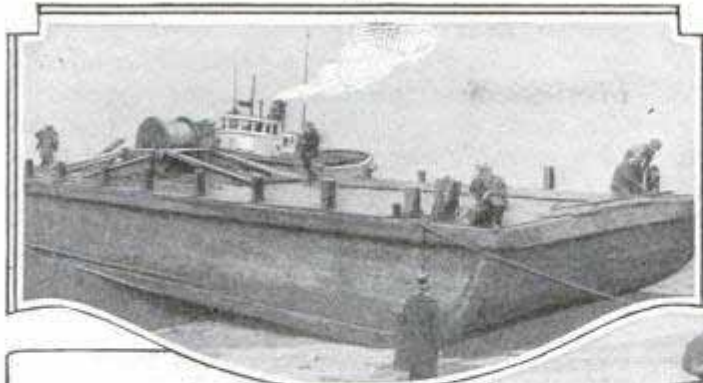

Barge Which Carried the Cable across Channel between Towers

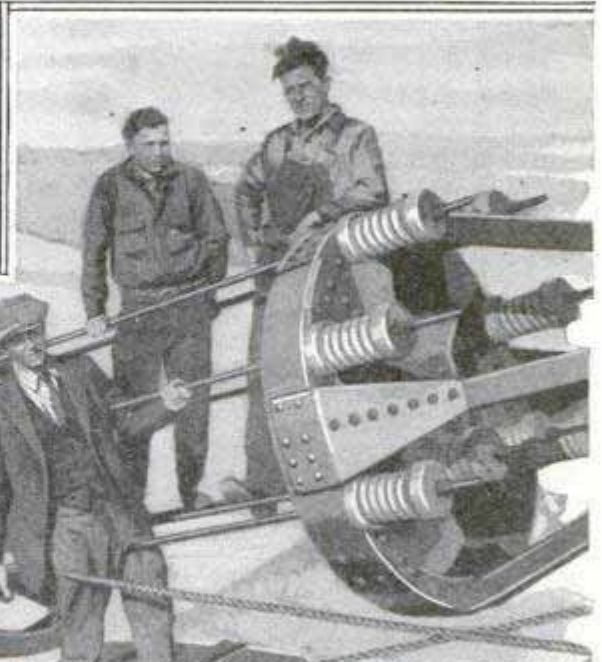

Workers on Platform at Top of One of the Masts, Showing Cage to Hold the Insulators; the Cable Is at Left

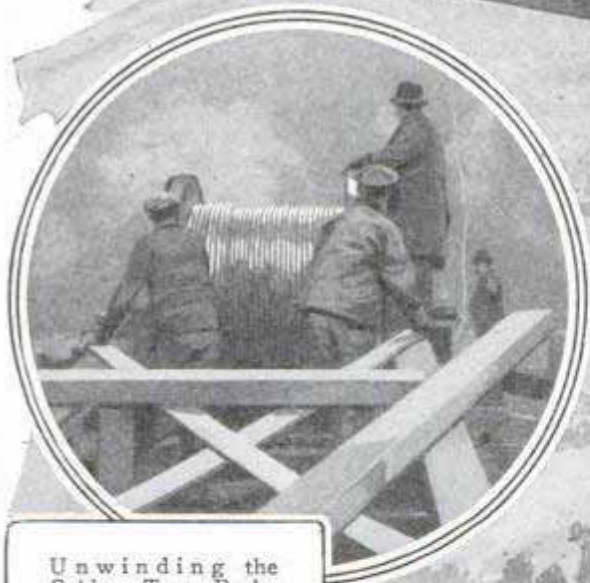

Unwinding the Cable; Two Brake Bands Controlled the Reel

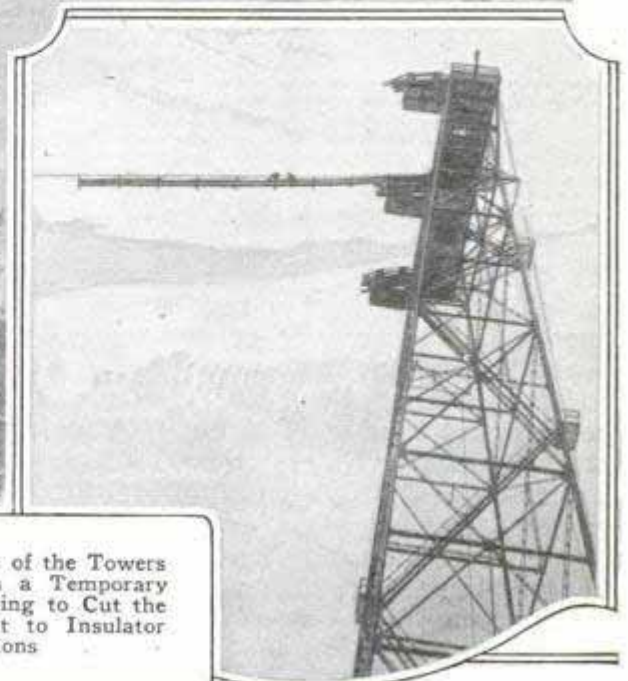

Looking Up at One of the Towers Where Workers on a Temporary Rigging Are Preparing to Cut the Cable and Draw It to Insulator Connections



*Ans. Peggy & May
Hollywood, Calif.*

*Harley-Clawson
Motor Co
Milwaukee, Wis.*

THEATER PATRONS ARE PAGED WITH LIGHTED BOX

Patrons of a Los Angeles theater are paged without annoyance to the rest of the audience by means of an illuminated box carried by an usher and displaying the



Silent Page to Summon Theater Patrons without Disturbing Audience; Glow from Flashlight in Handle Illuminates Stencil Letters in Slot at Top

name of the person wanted in stencils back of which the light shines. Thin brass letters are used to make up the names and can be adjusted quickly. An ordinary flashlight of the larger size furnishes the illumination and also serves as a handle.

NEW DEATH RAY KILLS GERMS IN TENTH OF SECOND

A ray which literally deals death and promises to be of practical use in combating insect pests has been developed in the laboratories of the General Electric company. It killed highly resistant bacteria spores in an exposure of one-tenth of a second and fruit flies, upon being rayed for an instant, showed almost complete collapse and died in a few hours. The rays are produced by an electrical discharge as powerful as 250,000 volts inside a glass vacuum tube at one end of which is a "window" of aluminum, through which rapidly moving electrons pass and have an effective range of eighteen inches. The air itself becomes luminous in front of the tube and castor oil was changed into a solid. Similar rays have been produced

within tubes before, but never in such quantity in the air, it is said. The effects of the emanations on higher forms of life were also striking. A small portion of a rabbit's ear was exposed to the rays for about fifty seconds. A scab developed on both sides of the ear and later, fell out, leaving a hole which became covered with a growth of snow-white hair.

SHIELD FOR MOTORCYCLE RIDER PROTECTS FACE AND LEGS

Fitting around the handlebars of the motorcycle, an apron arrangement with a transparent shield, protects the rider's face and legs and does not interfere with the controls. The shield itself is supported by a strong steel framework, permits unobstructed vision and can be quickly removed. Protection for the legs is afforded by coverings that fasten at the bottom and are held in place by springs.

OARS WITH REVERSIBLE LOCKS MAKE ROWING EASIER

Permitting the boatman to face forward when rowing or backward when trolling, reversible oars now on the market are intended to add to the safety and enjoyment of hunters, fishermen and pleasure seekers. To reverse, the oars are simply turned over thereby locking a gear arrangement which fits a standard oarlock, whether of the plate or countersunk type, and is held to the gunwale by thumb-screws. An additional advantage is that oars fitted with this attachment can be folded to three-fourths of their original length or entirely removed from the gears to simplify carrying in an automobile.



Reversible Oars Permit Boatman to Face Direction He Is Going, an Aid in Steering

\$10.00 per set

*Schenck & Co
N.Y.*

Ans. Dr. W. W. Coolidge

*Western Ave
Chicago
5/12/30*

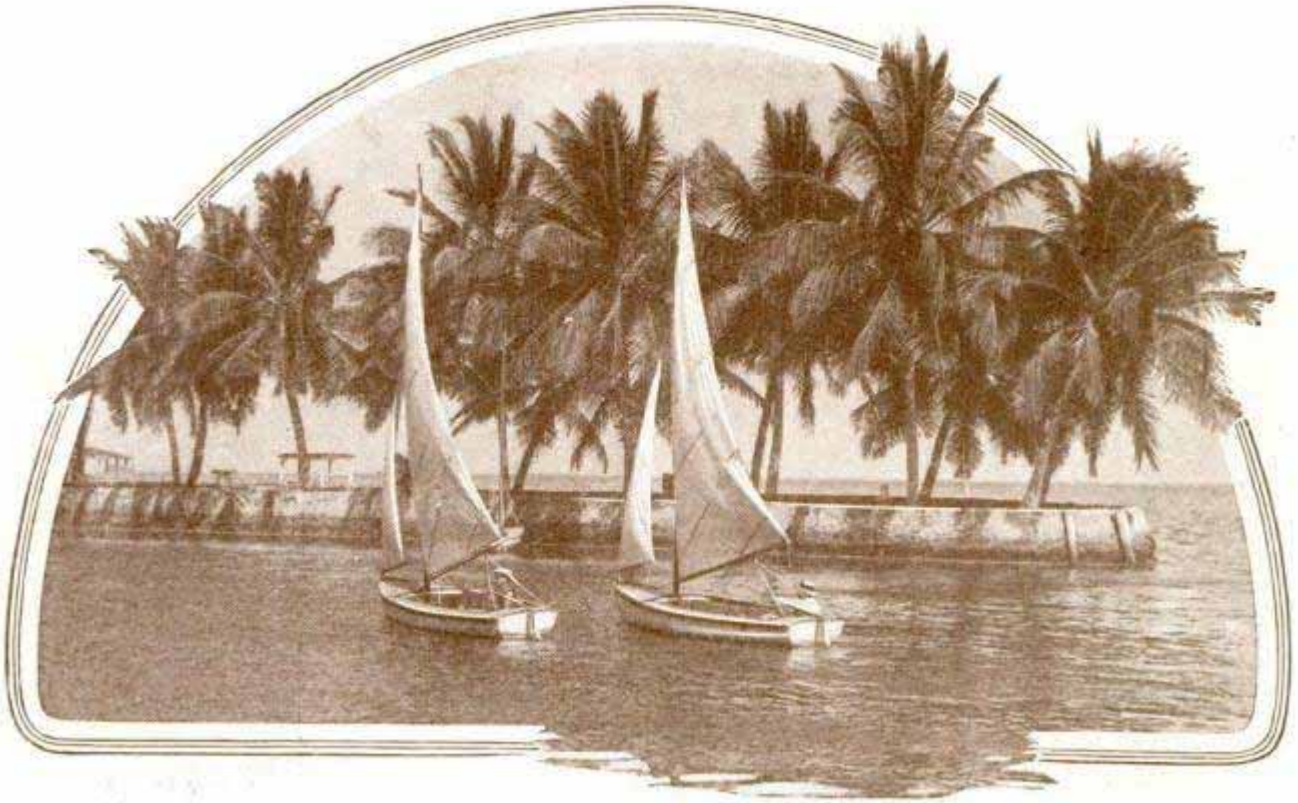

Florida Seas Are Reclaimed for Homes

High Prices of Beach-Front Lands Make Even Artificial Islands Pay, While Draining of the Everglades Provides Farm Sites

FLORIDA is mostly all ocean front, but there isn't enough to go around, and so the sea has been called on to produce new shore lands for homes. This artificial increase in available lots is being brought about by dredging sand from the bottom to create islands, separated from the mainland by deep channels, but connected by bridges. Marsh land and tidal overflows likewise are being built up higher than the sea and made available for the ever-spreading subdivisions.

There are more dredges at work in Florida, by a conservative estimate, than in any similar area on earth, and yet equipment cannot be erected fast enough to supply the demand for more floating land builders to suck up the sand from the sea and build it into home sites. In the interior, the reclaiming of waste land likewise is proceeding with the draining of vast sections of the Everglades swamp, to be converted into rich farm lands. Two and three crops of fruits and vegetables a year, ripening when winter has raised prices in the northern markets, enable Florida farmers to finance almost any kind of land-recovery project.

Since the state has become the mecca for all the automobile tourists of the east who seek warm climes for the winter months, the biggest boom in its history is under way. Railroads last fall were forced to order an embargo on all inbound freight not considered absolutely essential, the favored list being confined largely to food and clothing and the material needed to make boxes and barrels in which to ship the winter crops.

The railroad blockade became so bad that much freight had to be shipped in by water, and distributed by motor truck. One Chicago company, which had undertaken to equip several large hotels with crockery, china, silver and other articles, was forced to ship the material, equal to more than 100 freight-car loads, direct from the Lake Michigan port by boat. It went down the St. Lawrence to the sea and around to Tampa in eighteen days.

The "tin-can tourists" who drift south each winter and live in tent colonies present such a problem that one colony was forced to erect its own tent school and supply a teacher for the eighteen pupils, since the community in which they were settled had no space in its schools for additional students.

Florida has room for 40,000,000 people, but a permanent population of only 1,200,000.

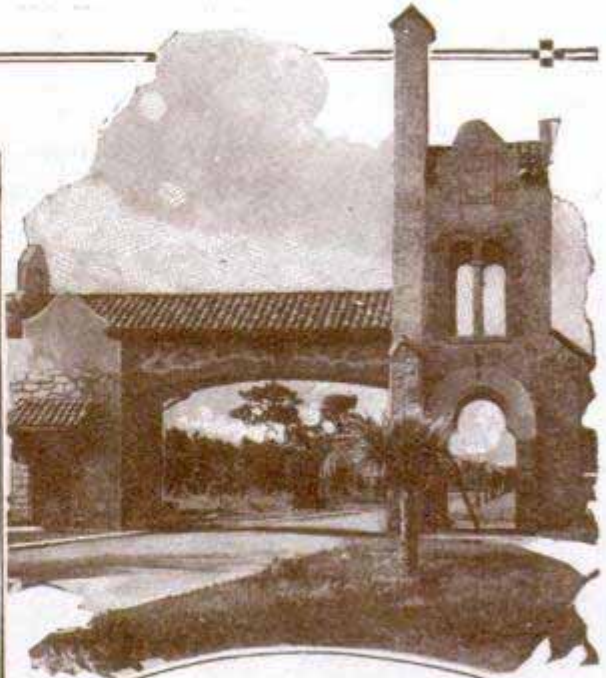

An Airplane View of Ormond Beach, One of Florida's Show Spots, with the Hotel and Its Recreation Pier in the Background, at Left; Above, an Ornate Entrance Gate to One of the Florida Subdivisions

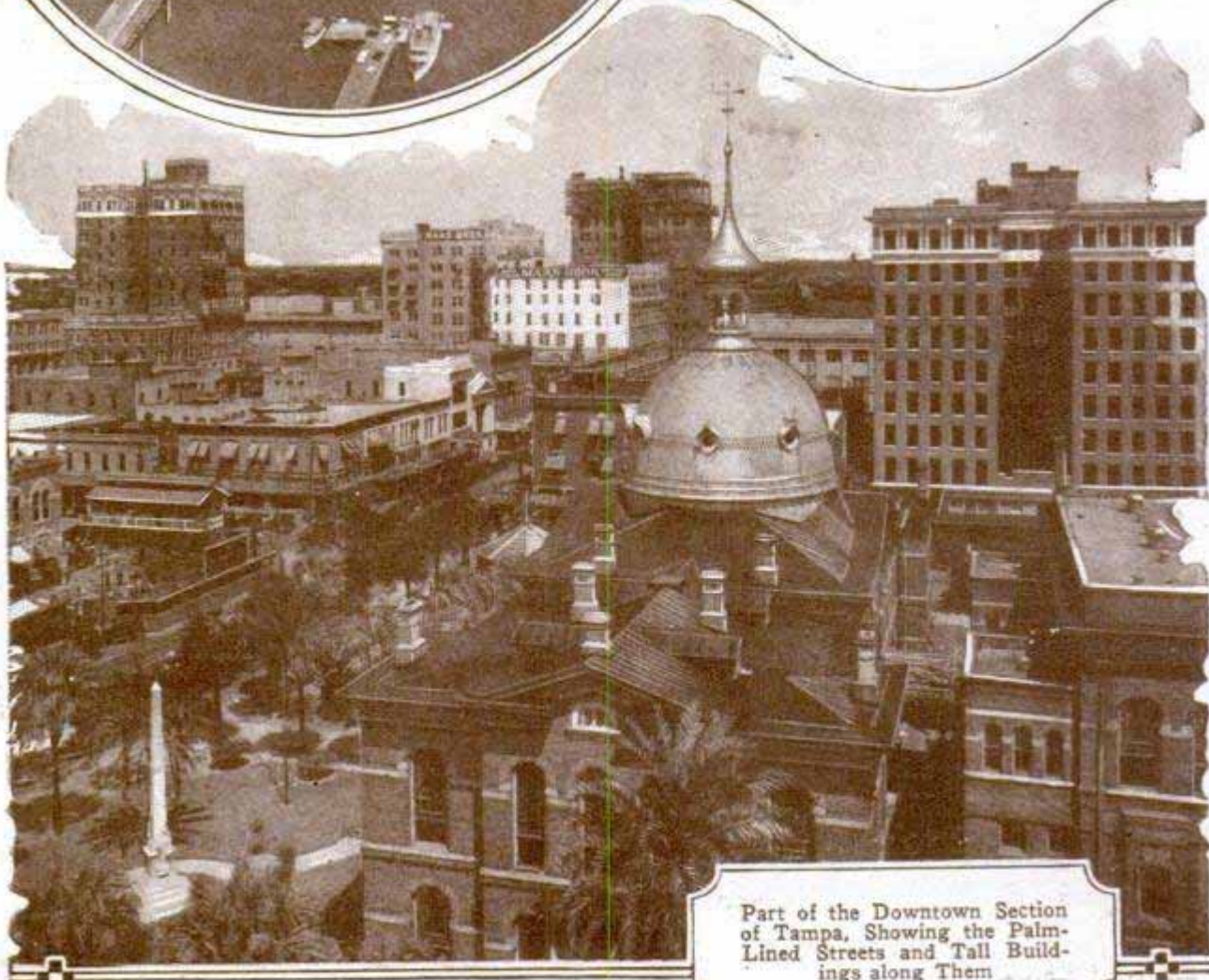

Part of the Downtown Section of Tampa, Showing the Palm-Lined Streets and Tall Buildings along Them



Bathers Frolicking in the Tropical Waves at Pablo Beach, Jacksonville, Above, and, at Right, a View from West Palm Beach across Lake Worth to the Famous Royal Poinciana Hotel, Noted as One of the Social Capitals of America during the Winter Season

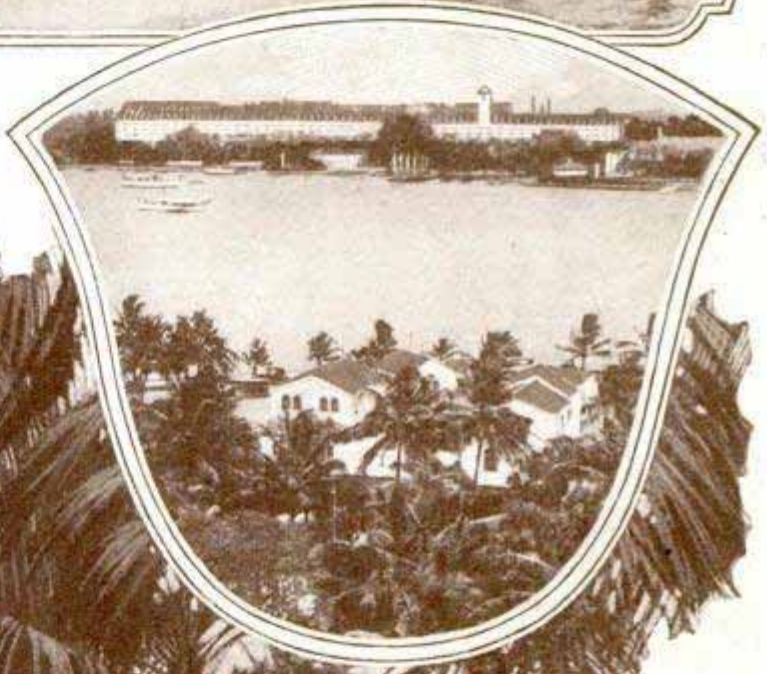

Seaplanes Ride at Anchor beside White-Painted Yachts, Ready to Ferry Passengers to the Coral Keys or Cuba



Above Is One of the Beautiful Winter Estates on the East Coast of Florida, with an Ornate Sunken Italian Garden in the Foreground, and the House, Showing the Predominating Spanish-Moorish Influence in Its White Stucco, Slender Columns and Tile Roof, in the Distance

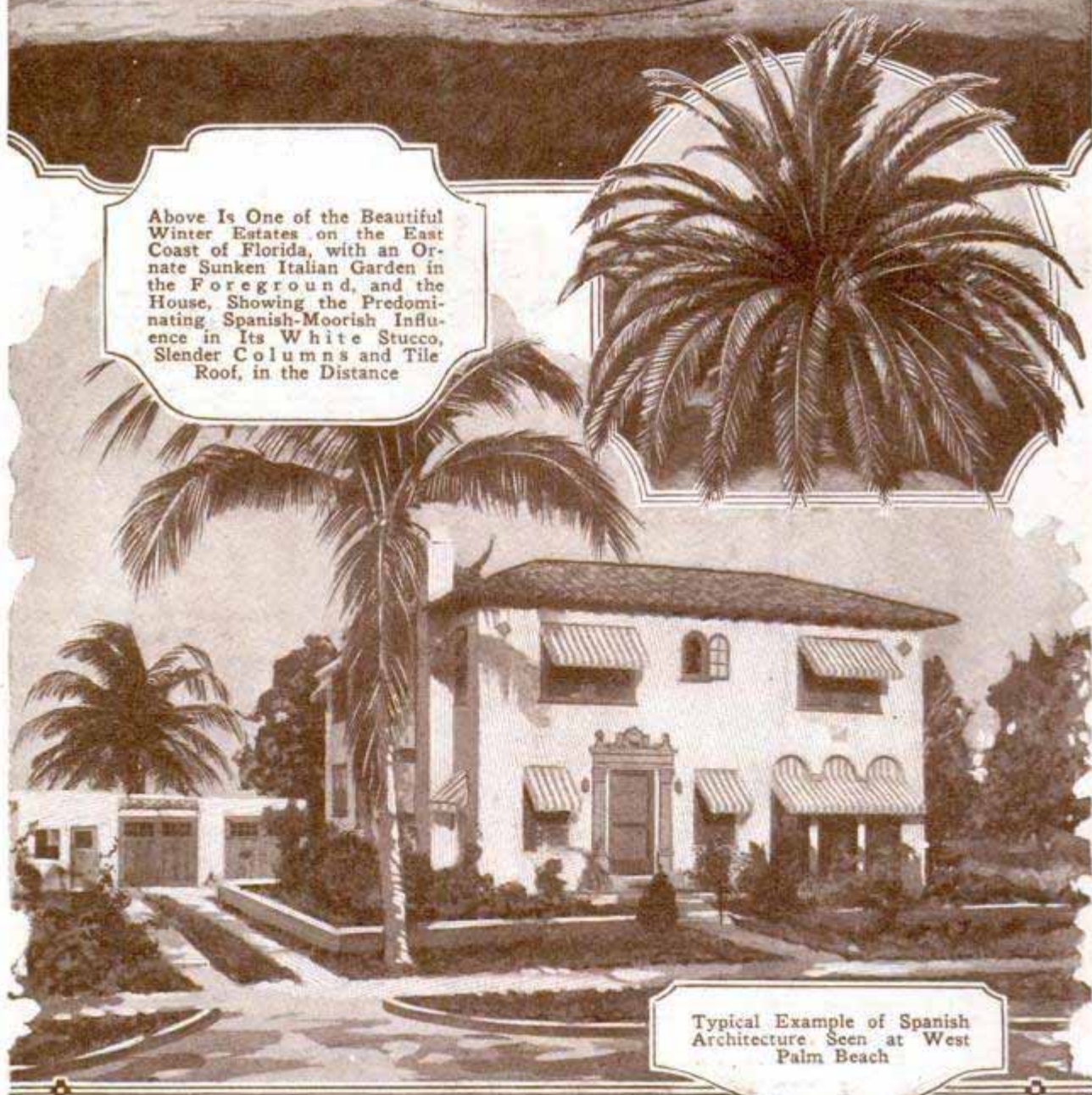

Typical Example of Spanish Architecture Seen at West Palm Beach

319



A Famous Resort Hotel at Sarasota, Built in the Prevailing Spanish Style; in Its Modern Boom Days Florida Has Revived the Influence of the Early Explorers

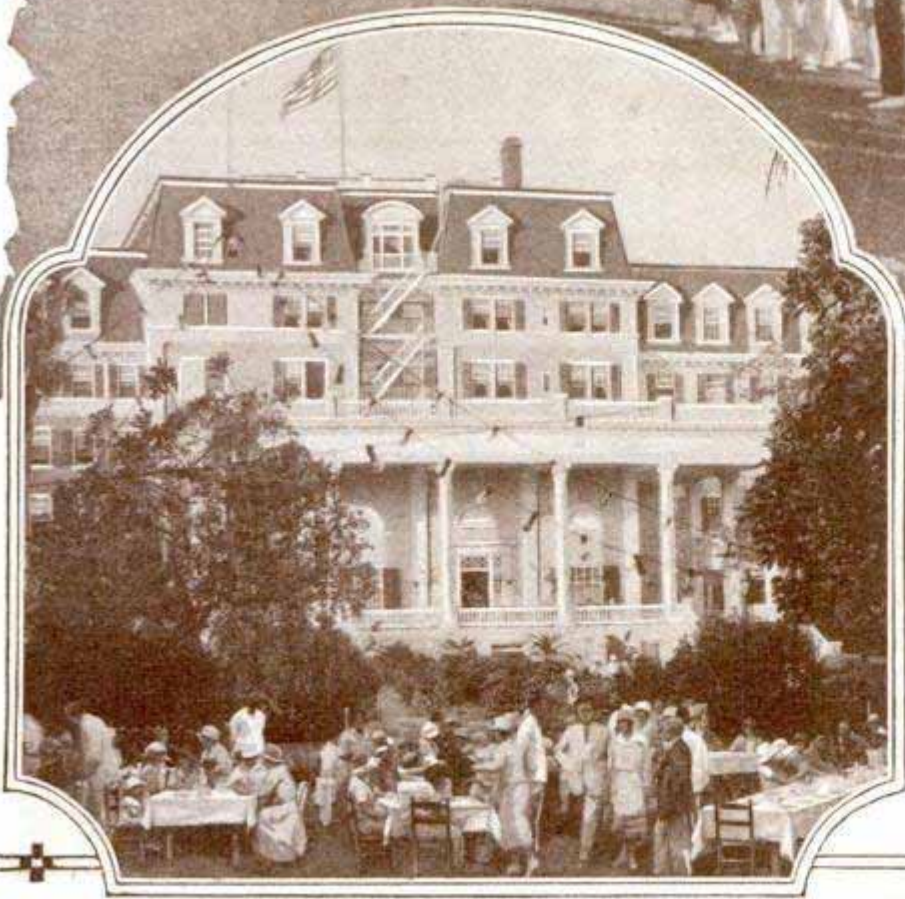
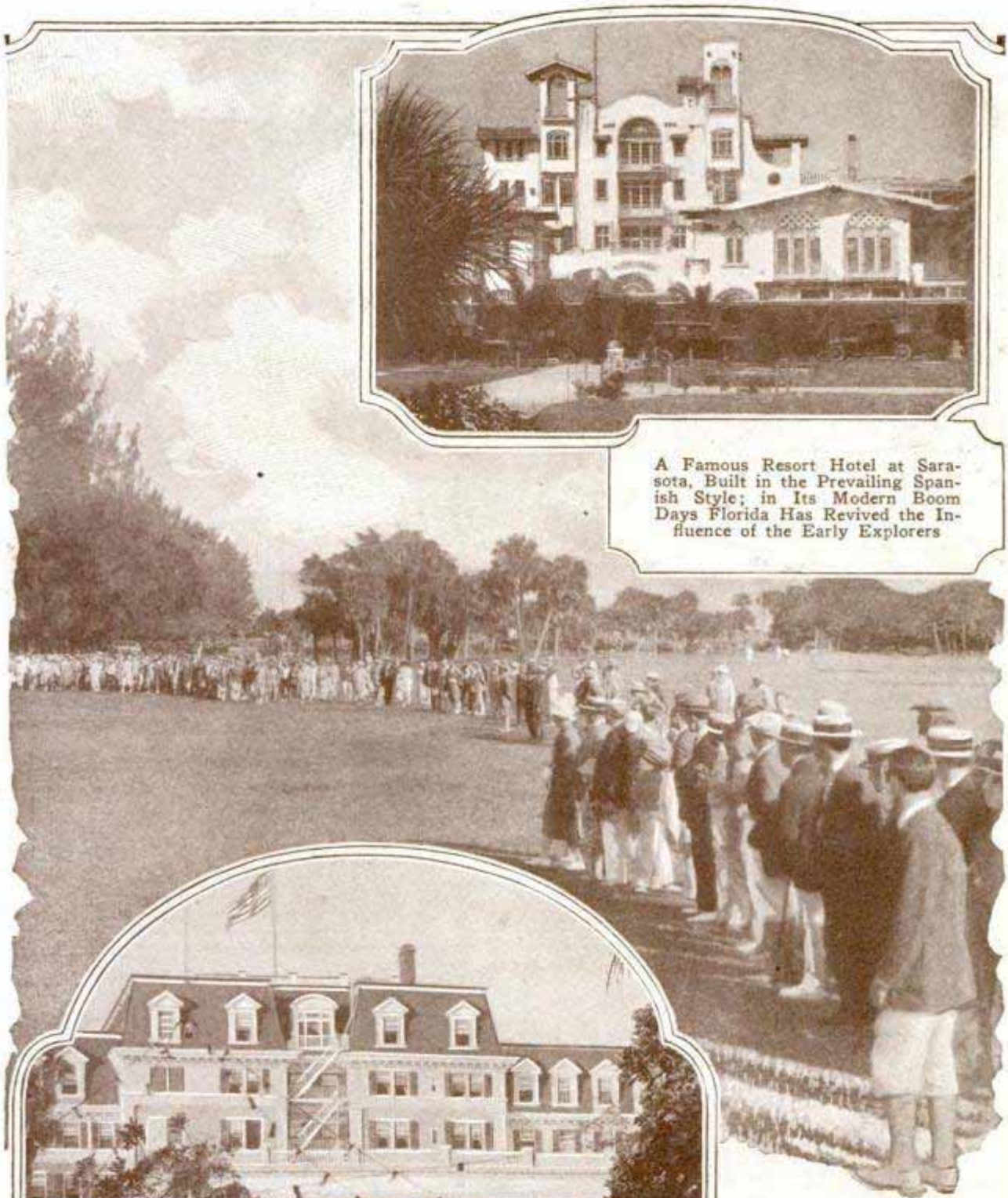

Gallery Following the Medal Play in a Tournament on the Private Links of One of the Big Hotels at Palm Beach; Year-Around Golf Makes the State a Paradise for Followers of the Game; at Left Is One of the Earlier Hotels, Erected before the Present Boom, When Old-Fashioned Resort Architecture Had Not Given Way to the Stucco and Moorish Decorations of the Present

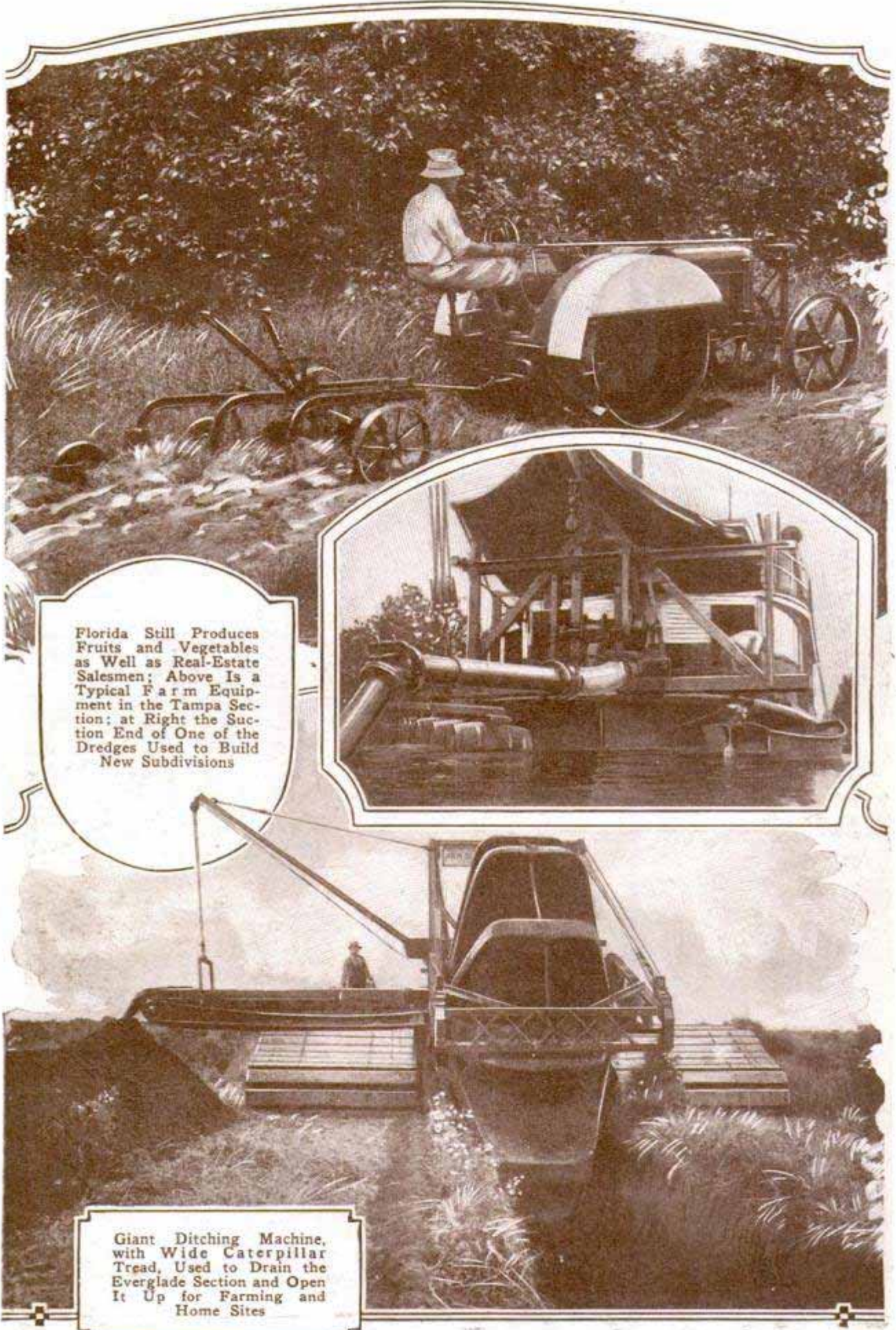

Florida Still Produces Fruits and Vegetables as Well as Real-Estate Salesmen; Above Is a Typical Farm Equipment in the Tampa Section; at Right the Suction End of One of the Dredges Used to Build New Subdivisions

Giant Ditching Machine, with Wide Caterpillar Tread, Used to Drain the Everglade Section and Open It Up for Farming and Home Sites



Portion of the Growing Skyline of Jacksonville, Where Tall Office Buildings Overshadow the Busy Wharves That Line the Waterfront; at Right, a Field of Pineapples, Growing in Long Rows between the Orange Trees on a Double-Duty Farm Lying in the Rich Agricultural Region Just Back of West Palm Beach

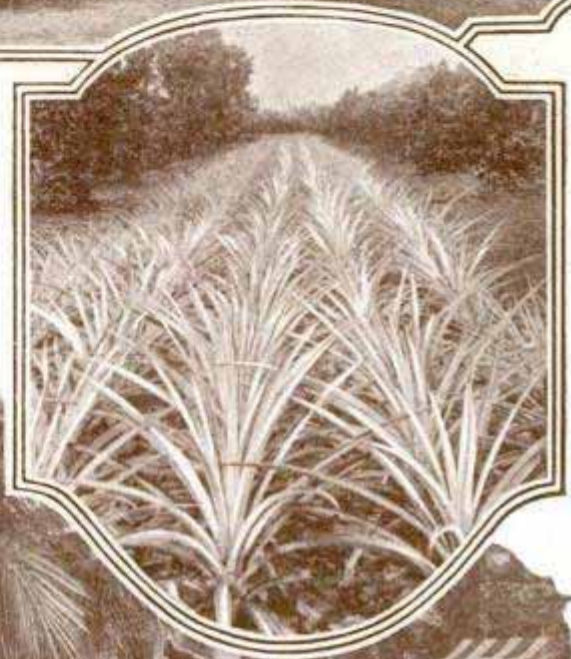

Afternoon Tea under the Palms at a Miami Beach Hotel; Summer Clothes, Gaily Striped Sunshades and the Ocean Breezes Offer an Attraction to Visitors Who Have Fled from Northern Snows

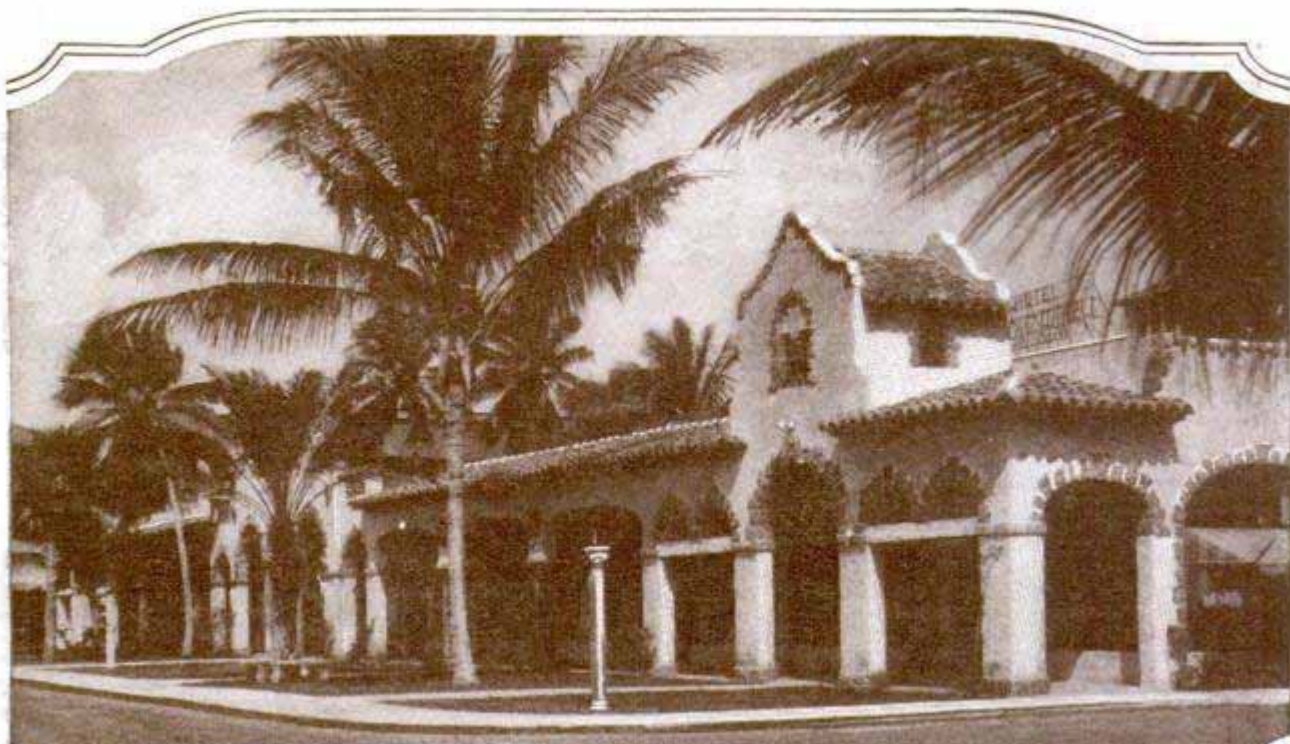

Shopping Section of Palm Beach, Where New York, London, Paris and Vienna Stores Have Branches Open Only Three Months Out of the Year, the Fashionable Season

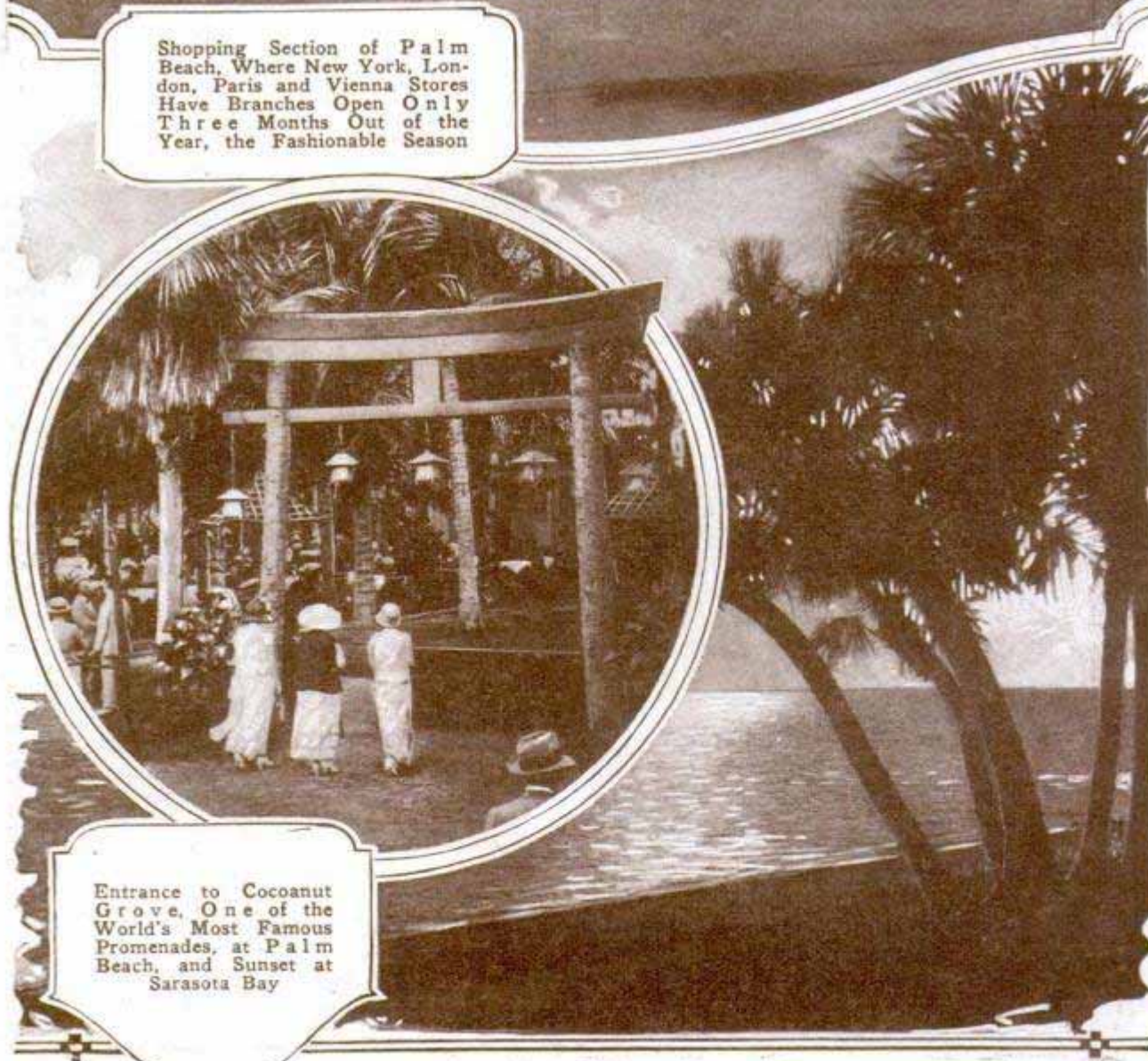

Entrance to Coconut Grove, One of the World's Most Famous Promenades, at Palm Beach, and Sunset at Sarasota Bay



Motorboat Racing, Showing a Fast Heat in an Amateur Race on Lake Worth, Which Lies between Palm Beach and West Palm Beach; at Right, a Section of the Railroad over the Sea, Linking Key West to the Mainland

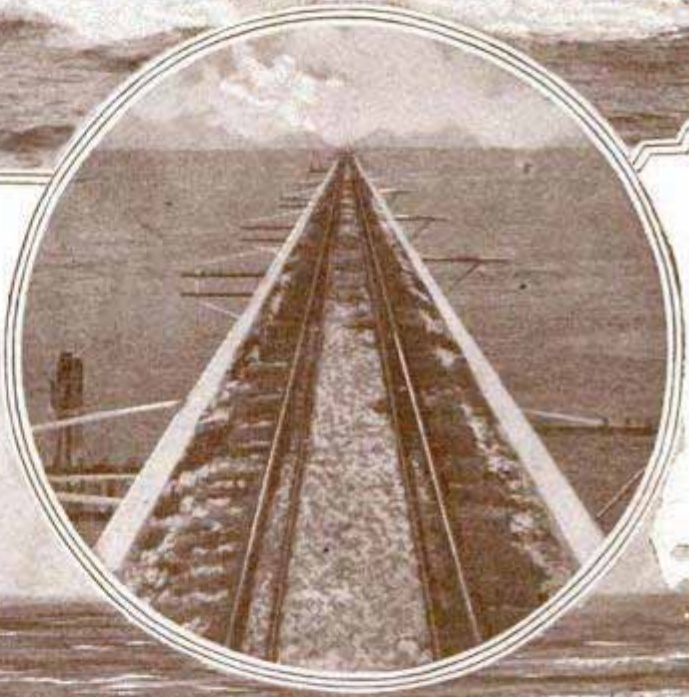

The Famous Beach at Daytona, Where Many Auto Speed Records Have Been Made



Above, Running Potatoes through a Sorter and Packing Them at the Edge of a Florida Field, and, Left, the Place Where Fresh Head Lettuce Comes From to Supply Northern Tables with Salad in the Heart of Winter; Florida's Output of Out-of-Season Delicacies Brought Fame Long Before the Real-Estate Agents Arrived.

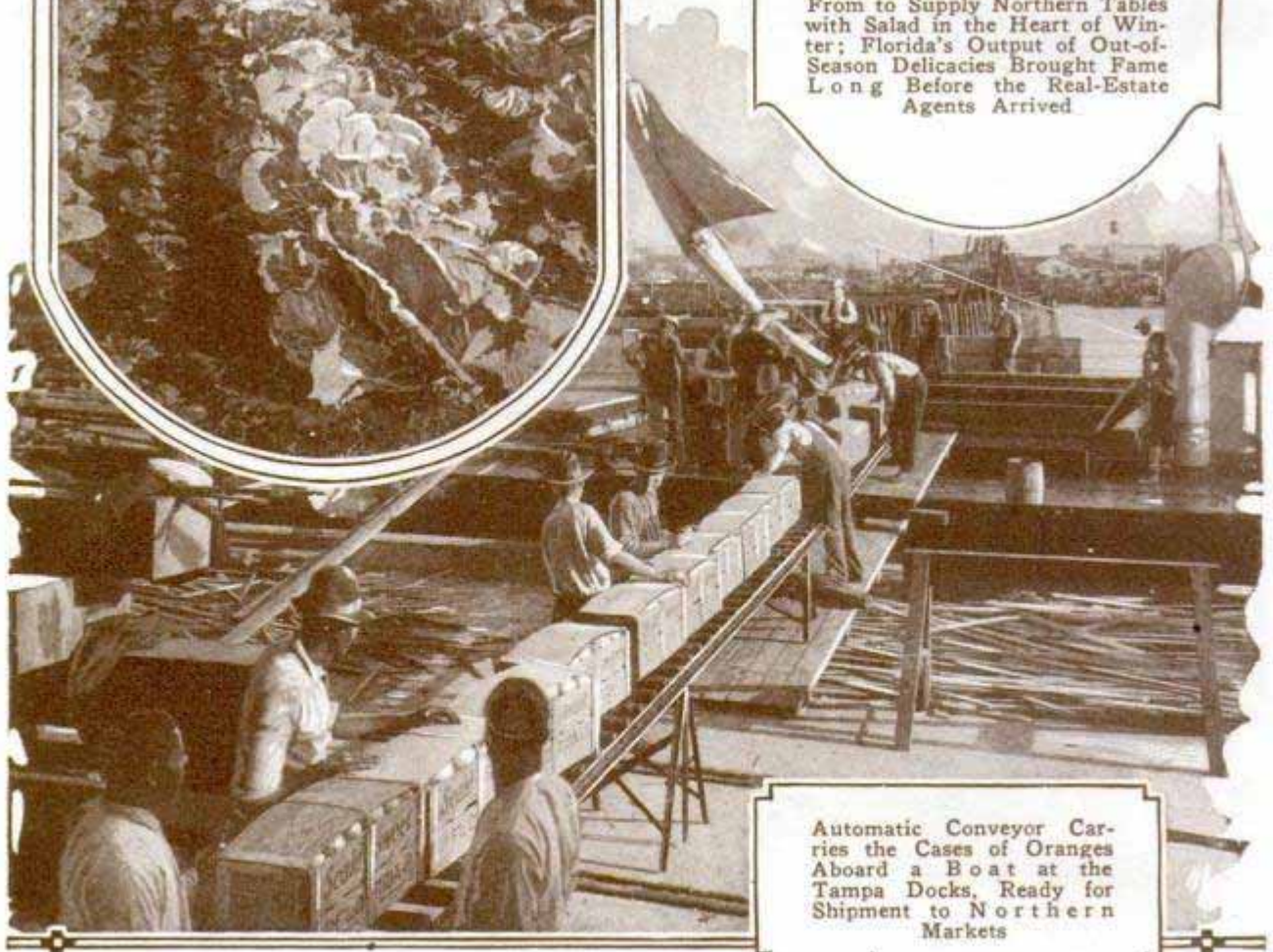

Automatic Conveyor Carries the Cases of Oranges Aboard a Boat at the Tampa Docks, Ready for Shipment to Northern Markets

VIBRATIONS ON EDGE OF DISK
IMPROVE RADIO TONE 836

Improved tone quality from the radio set, the phonograph and the telephone receiver is seen as a result of an invention by Dr. Lee DeForest. It is a method of sound reproduction in which no horn is used. Its chief difference lies in the way in which the vibrations are reproduced. While the present method is like beating a drum, the new way is to set up the vibrations in a curved diaphragm by applying an electromagnet unit to its edges. The entire surface of the diaphragm takes up the sound waves and sends them forth in all directions without distortion. In the opinion of a musical expert, the individual characteristics of various instruments are reproduced so successfully that even a highly trained ear can detect scarcely any difference from the original.

MOTORBOAT GARAGE IN HOME
HOLDS CARS IN WINTER 818

A bit of Venice has come to America in the form of motorboat garages built as



Motor Launch Entering Its Dock through Wide Back Door of Residence; Pumped Dry in Winter, the Space Holds Cars

BOX THAT HOLDS MANY GAMES
HELPS TRAIN CHILDREN 831

Development of the child's mind and body as well as his amusement are sought in a set of nearly 100 different games and a drawing scroll with twenty-three subjects, all packed in a small suitcase which the child can carry. A transparent slate fits over the scroll for easy copying in pencil or colors, and included in the list of games, is one that has been specially devised to test the young person's ingenuity and abilities and to encourage him to go to reference works, the Bible or his textbooks for answers. A "world" game fixes in the child's mind the principal cities of the world, their exports and other features, while other amusements include checkers, dominoes and outdoor games.



Using the Transparent Drawing Slate on Suitcase Which Is Full of Novel Games for Children

part of residences in Detroit, Mich. They are constructed at the rear of the dwellings and open directly into a lake so that the boats may be run into the shelters simply by opening the large doors that protect the openings. In winter, the water is pumped out, leaving a dry basement in which an automobile may be stored if there is room beside the boat.

813
AERIAL PHOTOS TAKEN AT NIGHT
WITH FIFTY-POUND FLASH

Darkness became daylight for the brief space of a fiftieth of a second over Rochester, N. Y., one night recently, and in that short time, camera men obtained pictures as clear and detailed as any they had taken by day. This was made possible by the carefully timed explosion of fifty pounds of flash-light powder dropped from a Martin bombing plane, flying at an altitude of 3,000 feet. The blast shook buildings and broke windows, but its glare enabled the cameras to record the scene.

Dr. Prof. Roy C. Osceery
Pleasant Hill, Ohio

Clifford L. Thorne
716 Van Slyke Ave
Detroit Mich.
Kodak Park Laboratories
Eastman Kodak Co. N.Y.

Info. - Parents Association
Pleasant Hill, Ohio

MUFFLER STOPS AUTO SMOKE AND ABSORBS POISON FUMES

One of the most serious perils of the automobile, carbon-monoxide gas, is reported to

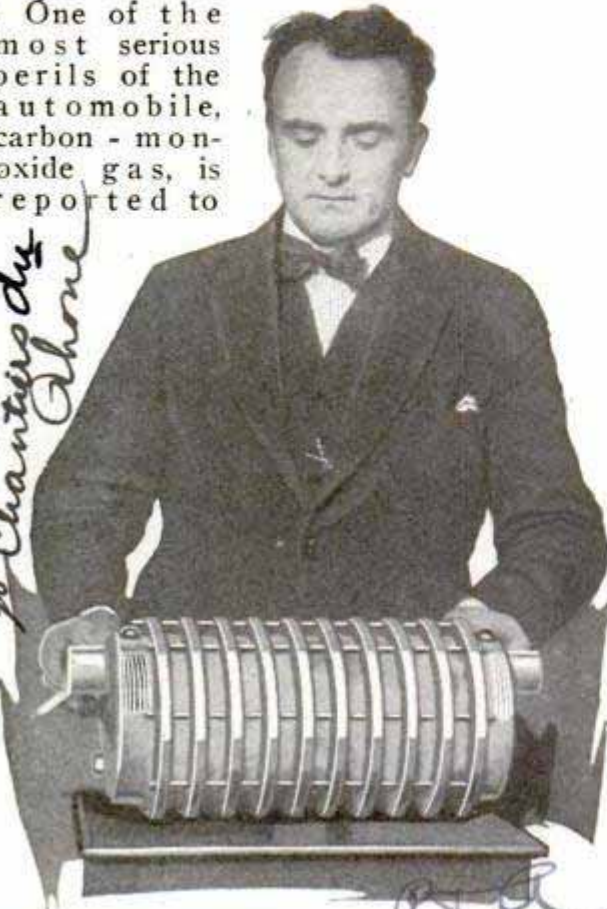

Muffler Which Eliminates Smoke from Auto Exhaust and Rids It of Poison Gas by Heat

have been eliminated in a special muffler devised by a Paris engineer. It not only does away with all traces of smoke but destroys the poisonous gas by transforming it into harmless carbon dioxide. This is done by a heating element in the muffler, which completes the combustion of the vapor.

AIRSHIP TO USE EXCESS GAS AS FUEL IN ENGINES

Using the excess hydrogen gas, which ordinarily is valved away as fuel is used and the airship grows lighter, by mixing it with heavy fuel oil in the propelling motors, and then utilizing the burnt exhaust gases from the engines to heat the passenger cabins, and later to protect the ship from fire, a new dirigible being built in England presents several novelties in construction. The airship is one of two 5,000,000-cubic-foot ships being built for the British government, embodying all the latest discoveries in Zeppelin construction. Lacking a cheap supply of helium, it is necessary to fill the gas bags with inflammable hydrogen. Provision is being

made, however, to take the exhaust and, after it has given up its heat to warm the cabins, turn it loose between the outer envelope of the ship and the gas bags, where it will form a protective covering against chance ignition of the dangerous hydrogen. The use of the valved excess hydrogen in the engines makes it possible to use cheap heavy fuel, from which there will be much less fire danger than from gasoline. Another novelty in the new ship is the placing of the passenger cabins not only within the hull, but high up on the sides, instead of in the lower keel.

HOW WOOD ROTTS

Aided by the presence of oxygen, small plantlike growths or fungi are responsible for the rotting of wood. These organisms feed upon the starch and other materials in the cells of the timber, finally reducing it to dry powder. The plants in turn throw off billions of tiny spores or cells which are carried about by insects, the winds and in many other ways. The air is often so loaded with them that wood is liable to decay almost anywhere, if exposed, as the plant cells become attached to it and develop. In most climates, it is practically impossible, experts say, to avoid the presence of these fungus spores and cells.

MOVING HEAD FOR DUCK DECOY HELPS LURE BIRDS

Wooden decoys are made more lifelike by the addition of moving heads in place of fixed ones. They turn with the action of the water against a rudder to which the head is connected. Ordinary decoys may be fitted with these attachments.

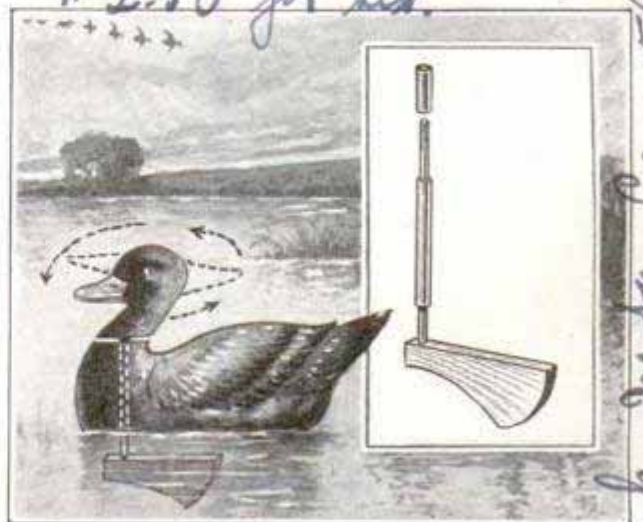

Decoy with Movable Head, and Diagram Showing Rudder Which Turns with Action of Water

Eugene Royer 48 Boulevard Hausman, Paris France
Commander H. S. Boothby
Capt. W. Chaturthy Esq. Shakespeare Road

Washington
W. W. Chicago
\$2.50 for air

765

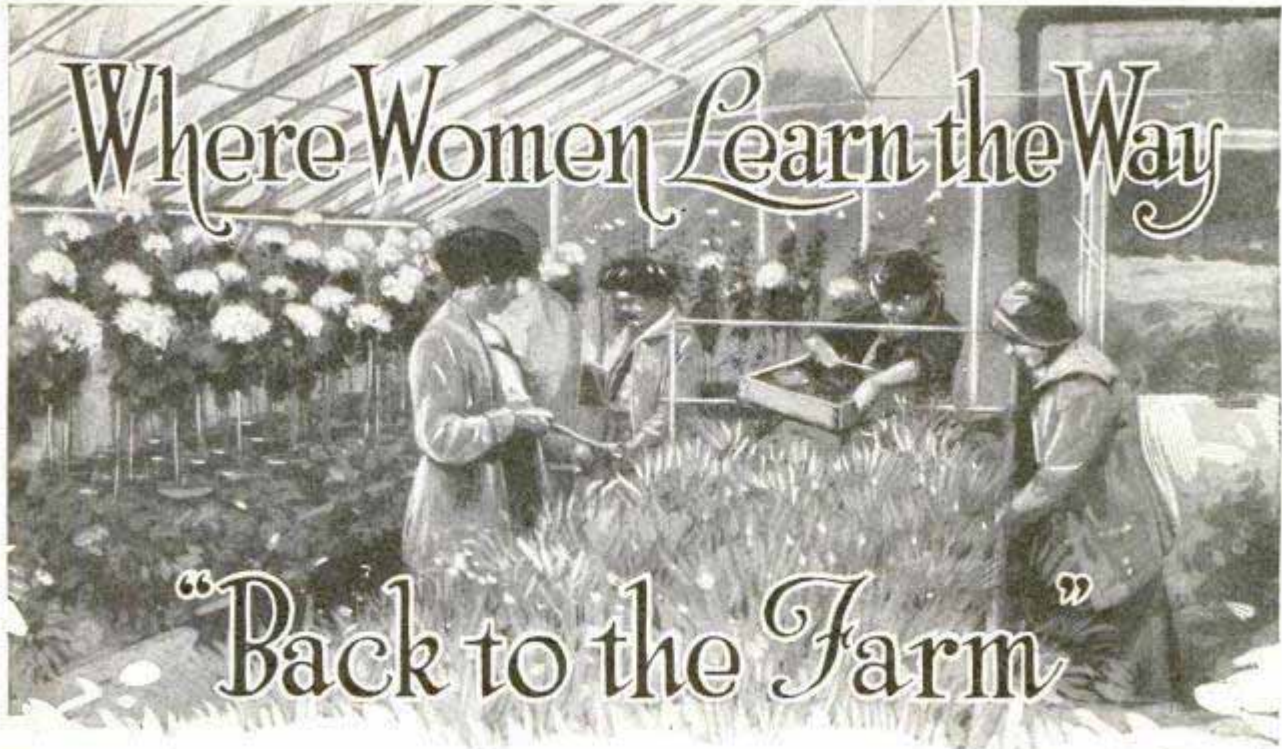

School Maintained by Club Women Trains City Girls for Positions as Estate Managers, Farmers and Horticultural Experts

By ROBERT H. MOULTON

IT was midsummer and the stifling heat of New York's downtown streets rose above the tops of her tallest skyscrapers. In an office on the uppermost floor of one of these buildings, a young woman left her desk and went to the window in search of a possible vagrant breeze. At her feet the hot, tired smoke-laden city lay scorching in the sun. But farther out were the cool, inviting waters of the river and the sound, and beyond these, stretching far away in panoramic fashion, the beautiful Long Island vista.

Then in her mind's eye she saw a tiny farm cottage, shaded by overhanging trees, a flower garden, a little three-acre plot of other growing things, some placidly grazing sheep, a stream that gurgled its way to the sea—such a scene as she had often pictured to herself. The next day she resigned her position and started out to make the picture of her dreams come true. That was four years ago. Today the same young woman is manager of one of the largest estates on Long Island, at a salary five times that which she received as a stenographer and her dream of the farm cottage is in a fair way soon to be realized.

The story of how this young woman, who, without any previous experience or knowledge of the subject, prepared her-

self in a few years for the responsible position of horticultural expert and manager of a country estate, including greenhouses, orchards and vegetable gardens, is an interesting one. In a degree, it is also the story of the success of numerous other young women who have turned their faces from the toil and grind of the city to the open country, and are earning a living from the soil.

She had heard of the school of horticulture for women at Ambler, Pa., an institution that is each year turning out young women qualified to run farms, to be florists, market gardeners, managers of fruit plantations, and specialists as teachers of home and school gardening in public and private schools. With the money she had saved, and some slight assistance from her family, she was enabled to take the two years' course offered by the college. Upon graduation, she was recommended to the owner of the estate who was seeking a manager. Her success in the new undertaking was immediate.

The school of horticulture for women was founded a few years ago by the club and college women of Philadelphia, and is under the direction of Miss Elizabeth Leighton Lee. In America this is the first school of its kind for women. Miss Lee believes that a woman may earn a good

Ambler
Pa.

Group of Girl Students at Work in the Garden at the Pennsylvania School of Horticulture for Women, Where City Girls Are Taught to Fill Positions as Estate Managers and Farm Experts

income from the smallest piece of ground, provided she specializes in some particular branch of horticulture. The field includes the raising of flowers, vegetable gardening, the growing of fruits, nuts and nursery stock, and in addition beet culture and chicken raising. While all of these branches do not require especially strenuous labor, the question naturally arises whether women are physically adapted to such work as plowing, spraying and the handling of heavy boxes and barrels of fruit. They are not always strong enough to do such work, but this is not necessary, so long as they know how such things should be done and can direct the efforts of laborers.

Women have an instinctive love for growing things and get a keener enjoyment from cultivating them than men.

The school property at Ambler consists of a farm of seventy-one acres. About twenty acres are used for the school in the various branches of horticulture and the remainder for farm crops. Much of that part used for horticulture is given to special plantations for practice and experimental work for the students. This includes an old apple orchard, a number of pear trees, young apple, peach, plum and cherry orchards, a vineyard of about 250 vines, a large variety of small fruits, flower and vegetable gardens, nurseries, greenhouse, hotbeds, cold frames, bee colonies and a poultry plant.

Recognizing that constant practice throughout each season is essential to success in horticultural

work, the school devotes a large part of the time to practice work in the growing of flowers, vegetables and fruits, each student planting and caring for a small plot of ground, under instruction, for which she is responsible. Theoretical instruction is given in botany, entomology, soils and horticultural chemistry. Training in the principles of simple carpentry is given, the students being taught to make cold frames, boxes, flats and various other articles incident to garden work.

The daily schedule at Ambler begins at 8:15, when the students go to the greenhouse for roll call and to receive charge for the day's work. They are simply dressed: in winter, in woolen skirts and blouses; in summer, khaki skirts and smocks. One squad takes charge of the greenhouse, looking after the watering, the temperature, the fire; cleaning of pots and beds, spraying for insects, etc. An-



Practical Lessons in Gardening Are Given, the Students Learning to Transplant Young Plants Started under Greenhouse Glass

other squad will transplant seedlings; perhaps a third will make cuttings for propagation and wash the sharp sand in the propagating bed before putting in their cuttings. This is done every three or four weeks, or generally after several plantings and cuttings.

From these propagating beds hundreds of plants are raised, and they are always kept full of cuttings through the winter. It takes twenty-six days as a rule for cuttings to make good roots, and from the propagating bench they go into two-inch pots. The heat, both bottom and top, the watering, sometimes three times a day, removal of weak and dead plants and the general watchfulness for pests, etc., make for strong vigorous plants as stock for filling the greenhouse.

Other students plant seeds in flats, and these flats are made in the carpentry class on Saturday afternoons. After the practical work in the greenhouse, lectures upon different subjects are given until luncheon; after luncheon, outdoor practical work if possible,

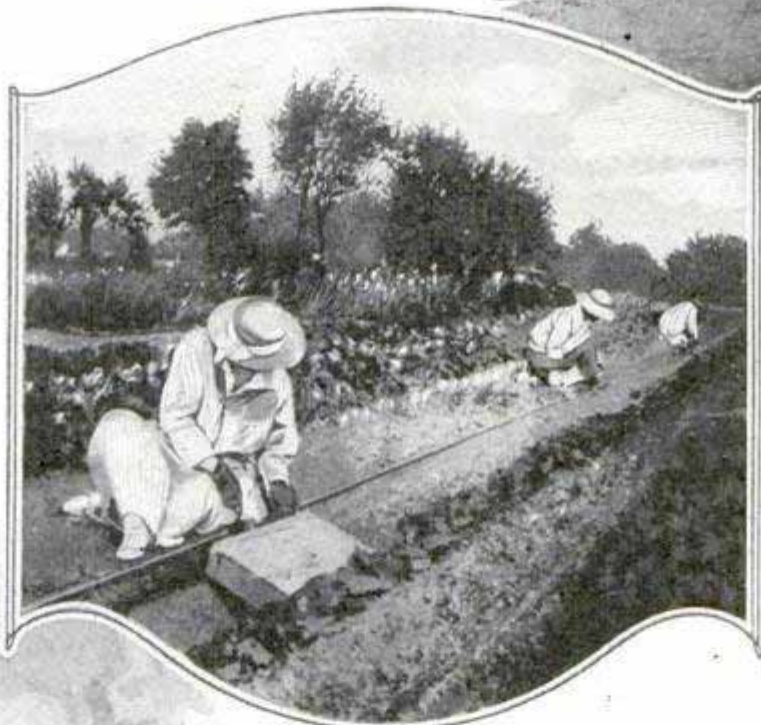

Lesson in Tree Trimming, Top, Practical Work in the Garden, Center, and a Teacher Giving a Spading Demonstration in the Field

weather permitting, either in the nursery, pruning, budding, grafting, or planting shrubs and small fruits, spraying the orchards, or laying out the grounds by the landscape-garden class; planning vegetable gardens or individual flower beds, or poultry yards. At 4:30 the day is

ended. In spring and summer the classes in botany and entomology go afield for specimens.

A recent feature of the school which is of keen interest is the jam kitchen. The products of the farm and orchards are thus conserved. In doing this, the preserving class use the latest recipes of the department of agriculture and the same equipment. The attractive little kitchen is a one-roomed building, with many windows completely screened. All the apparatus for quick work is placed conveniently, so that no steps are wasted.



Herbert C. Kearney
387 main st.

208

POPULAR MECHANICS

HEATER FOR AUTO ALSO SERVES
AS A TROUBLE LIGHT

775

To keep the automobile engine from freezing, a small, gasoline-burning heater, installed under the hood, produces a suffi-

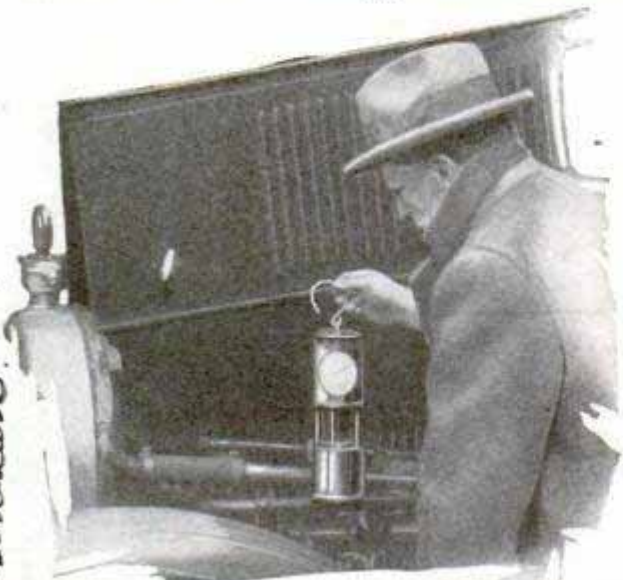

Adjusting Combination Heater and Lamp to Keep Auto Motor from Freezing

ciently brilliant flame for use as a trouble lamp. A single filling will last for forty to forty-eight hours and about half a cent's worth of fuel will last a whole day under continuous burning. The heater is said to raise the temperature from twenty to sixty degrees under the hood and may also be used to keep the inside of the car warm while driving, or as a stove while skating, hunting or at football games. It is so safe that gasoline poured over the heater will only extinguish the flame.

ALL OF DIAMONDS
IN WORLD WORTH
FIVE BILLION

According to a gem expert, the total value of all the diamonds in the world today is \$5,000,000,000, and a large share of them are in the United States, where about fifty per cent of the annual supply and of other precious stones is consumed. The world's gold supply is placed at less than \$8,000,000,000 and most of this is also in the United States at the present time. The emer-

is performed at
Royal Technical
High School,
Stockholm, Sweden

ald, the oldest of the precious gems, and the ruby often rival the diamond in value, although the latter has become a standard and favorite. Ruby mines in Burma have been worked for centuries, and their output during the last thirty-five years is placed at \$10,000,000.

IRON IS MADE WITHOUT "PIGS"
BY ELECTRIC PROCESS

726

Direct manufacture of malleable iron and steel without the intermediate formation of "pigs" is seen as a result of an electric process developed in Sweden. Iron ore and coal are mixed and fused under this method, producing iron holding only .02 per cent of carbon, according to reports, and steel that may be worked in the usual manner. The process is continuous and the fusing ceases only when the furnace is tapped. The absence of gases and slag results in a superior product.

TOTEM BIRD WITH BOARD WINGS
788 GUARDS VILLAGE

One of the most distinctive totem poles in a small village on Alert Bay, B. C., is surmounted by the large figure of a bird with outspread wings constructed of boards and vividly decorated. The emblem is believed to typify a real bird which may have been chosen as a sign of good fortune. Authorities are able to trace similarities between various races and peoples through their use of the totem.



Guardian of a Northern Village. Top of Totem Pole Showing Fantastic Bird with Outspread Wings of Painted Boards

Sole agent U. S.
Mexico and Canada.
Representative.

George H. King

New York Herald-Tribune
4/28/25

and at Tagfors

792

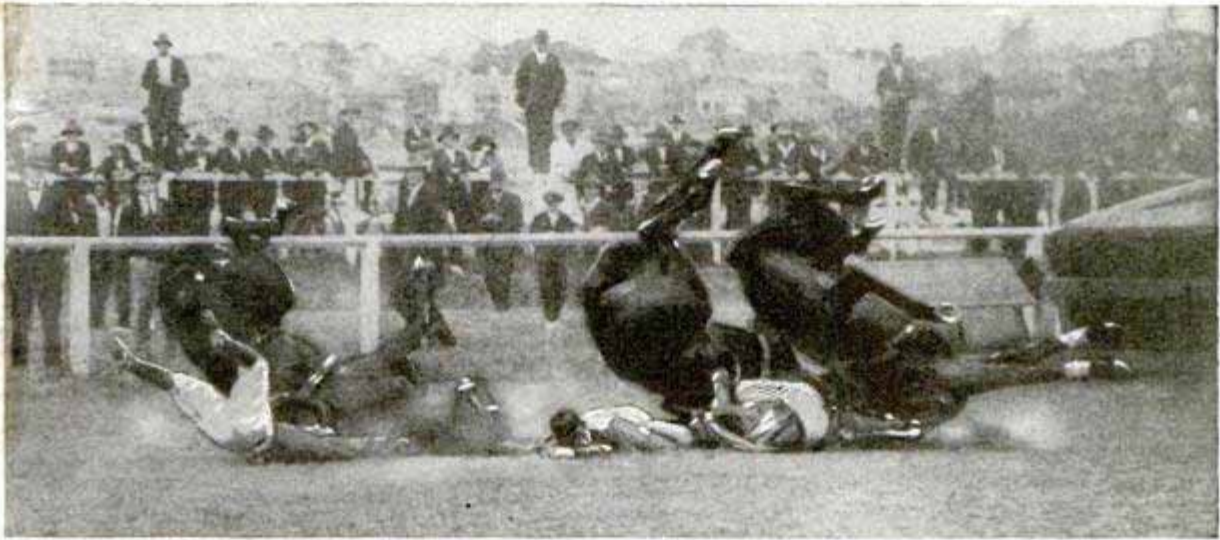
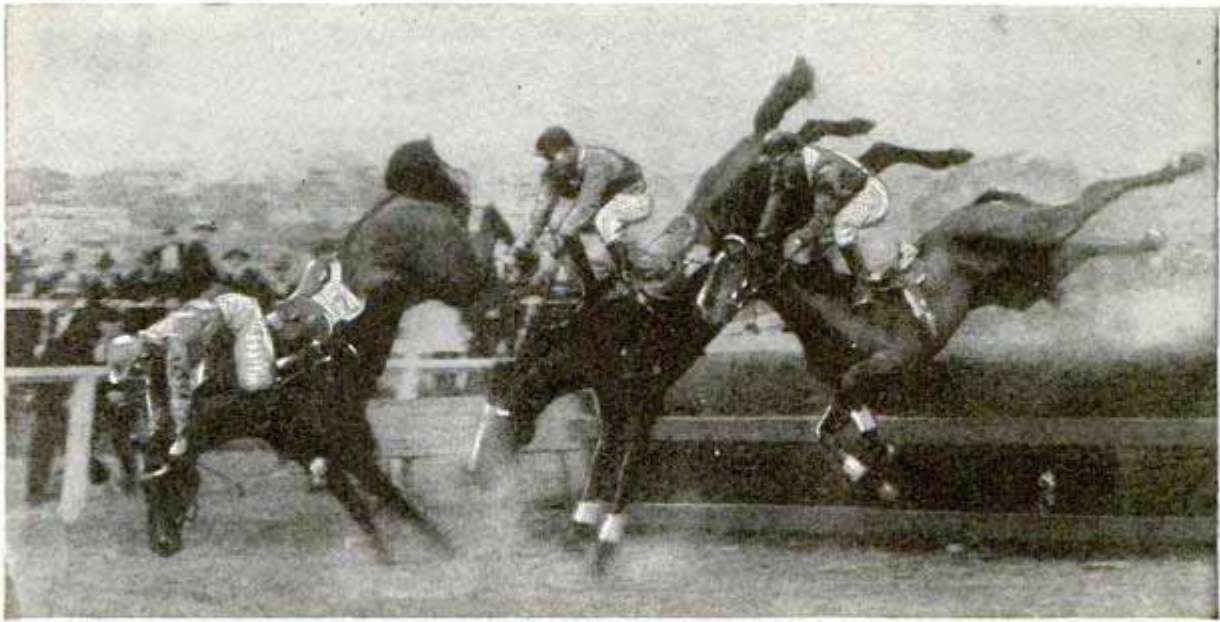

Copyright, Underwood & Underwood

The Camera's Report of a Disastrous Horse-Race Accident; Above, Just Preceding the Spill, Below, the Horses Rolling Over; All Taken Before the Spectators Realized What Was Happening

TRIPLE SPILL IN HORSE RACE TESTS CAMERA'S SPEED

One of the most unusual accidents that ever occurred in horse racing was recorded from start to finish by a rapid camera at an Australian race recently. Three horses, running neck and neck, fell together after jumping a hurdle. Two of them were killed. The rapidity of the action was further evidenced by the fact that spectators apparently did not realize what was happening at the actual moment of the fall, for the camera's record shows

them gazing at the horses without visible sign of excitement.

STAMPS HELD IN FOUNTAIN PEN PROTECTED FROM MOISTURE

Postage stamps are kept from damage and are readily available in a small receptacle at the end of a fountain pen. A twist of the barrel exposes a stamp from a small roll through a slot. Danger of loss and sticking to the pocket is eliminated by this plan. The holder is easily filled and stamps cannot drop out unless the barrel is turned.



Unrolling Stamp through Slot in Side of Pen-Holder Barrel by Twisting

Demonstrating invention of H. J. Ford Ltd. London, W. 1. England

Rangwick Race Course Sydney

774

696

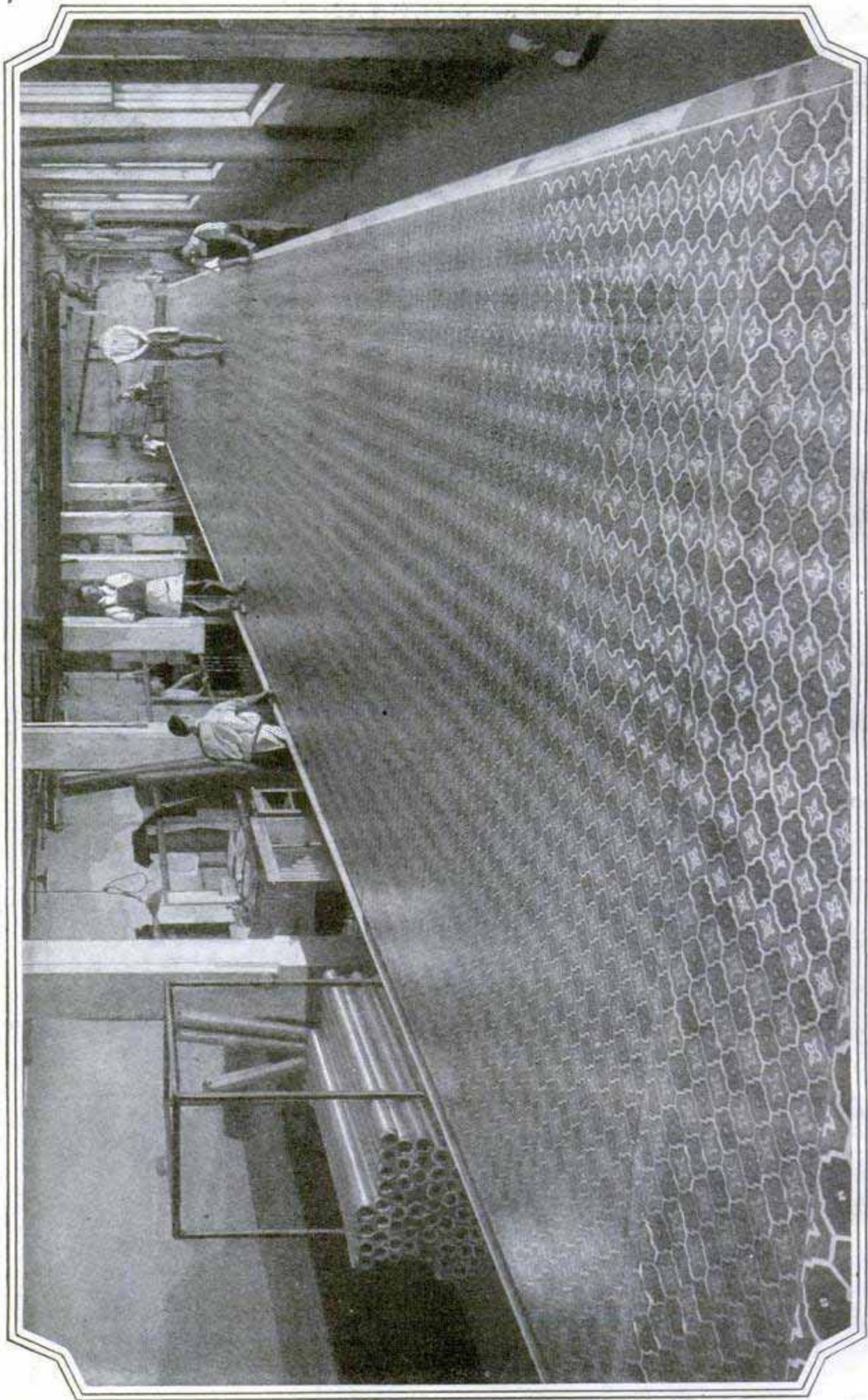

Inspecting Finished Linoleum before Shipment; Lengths Are Spread Flat on a Long Table, While Trained Experts Go Over Every Square Foot, Searching for Possible Flaws in the Pattern; These Sometimes Occur from Imperfect Inking of Printing Blocks or Running of Color

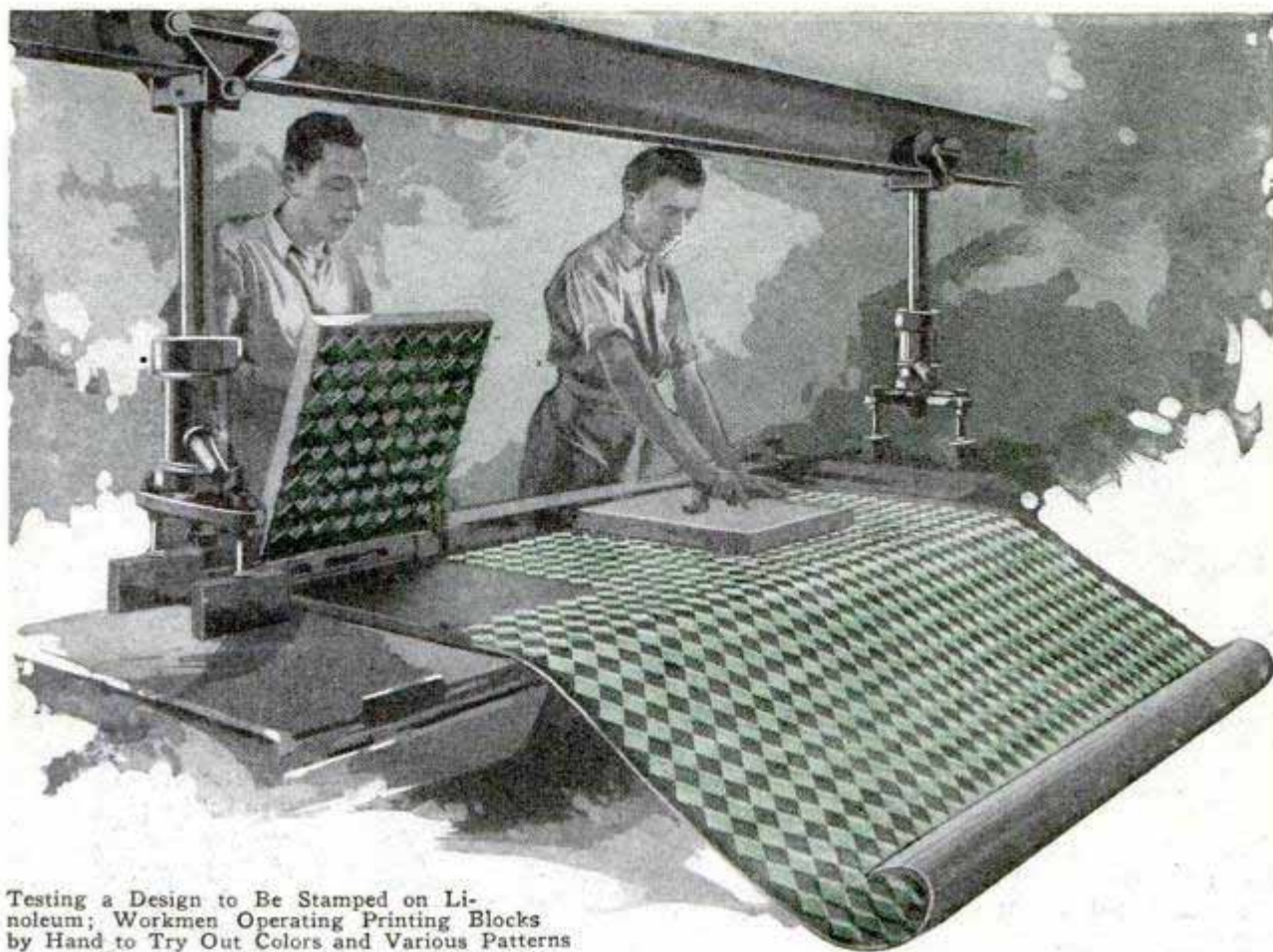

Testing a Design to Be Stamped on Linoleum; Workmen Operating Printing Blocks by Hand to Try Out Colors and Various Patterns

From Earthen Floors to Linoleum

How Products from Remote Parts of World Are Combined to Give Beauty and Utility in Floor Covering

IN the evolution of floors, from prehistoric days when hard-tamped earth was used to promote comfort, through periods during which rich rugs were laid or stone floors were covered with rushes to guard against dampness, the skill and imagination of man have ever been directed toward seeking better flooring.

New knowledge of chemical science now has helped produce a floor that is clean, a thing of beauty, durable and quiet. This is linoleum, a combination of flax and oil, the invention of Fred Walton, who sought to devise a material which would have the warmth of a carpet and the dust-and-water repelling qualities of oilcloth.

To make it, products are gathered from remote parts of the world. Linseed oil is brought from India, Russia, Siberia and Argentina, and cork from the Spanish peninsula and Africa. In marshy regions around Bengal, India, half-naked natives gather jute in swamps, and, to remove the outer fiber, they beat with flat wooden

paddles the tall stems. Only the inner fiber of jute is used in making burlap on which the cementlike linoleum "mix" is poured.

It is said that the idea of using linseed oil in making flooring came to the inventor when he noticed that the thin film which forms over a can of paint is exceedingly elastic and tough. Prior to this, another inventor had devised a method of making India rubber soft by use of steam heat, mixing it with granulated cork and then rolling the composition to desired thickness. Walton substituted linseed oil for costly rubber and thus was made the first linoleum.

Every step in the manufacture of this product, from hardening of the oil to final inspection of the finished product, requires the skill of experts and is carefully watched. After chemists have tested the oil for purity, it is boiled from three to ten hours and then is pumped into small conveyors which move under the roof of the oxidizing shed, from which are hung long



Pattern-Block Cutter at Work, Oxidized Linseed Oil, and Coating Burlap Backing

sheets of fabric. As the conveyors are moved from one end of the shed to the other, they distribute the oil to troughs. These are perforated to allow the oil to flow down the fabric sheets. This operation continues twice daily for six to ten weeks. In the heated air linseed oil slowly changes on the fabric to a tough elastic skin. When the sheets are taken down, they are about an inch in thickness and are passed through metal rollers which grind them to pulp. This is cast into huge heated kettles, holding about two tons each. The oil soon begins to fuse with the rosin and other gums that are mixed with it to give a better binding quality. When the mixture is ready, the kettles are tipped and the mass pours into huge cement basins to cool.

This process is called cement making, and the product has a consistency something between rubber and molasses candy. This cement is then chopped into blocks, about a foot square and between five and six inches in thickness, for convenience in handling. When it has aged three

weeks, it is mixed with "cork flour," and coloring matter is added to produce the shade desired. The product is next put through a big machine that looks like a meat grinder. Cement passes out in shreds and is dropped to the floor below. Here pulverized cork is added to make what is known as the mix—cement and cork. This material has the appearance of a dark brown, oily sawdust. It is warm and sticky, and ready for passing through the huge calendering machines. These ponderous mechanisms have great heated steel rollers through which the mix passes, covering burlap sheets that are fed from below. From here the material, still soft, is passed

into the "stoves," or drying rooms, where it is kept from two to eight weeks and then it is placed on long, broad tables on which keen-eyed inspectors walk, examining every square foot for possible flaws.

Printed linoleum, exactly as the name implies, is made of plain linoleum seasoned in the stoves and upon the surface of which a design or pattern is actually printed with oil paints. To

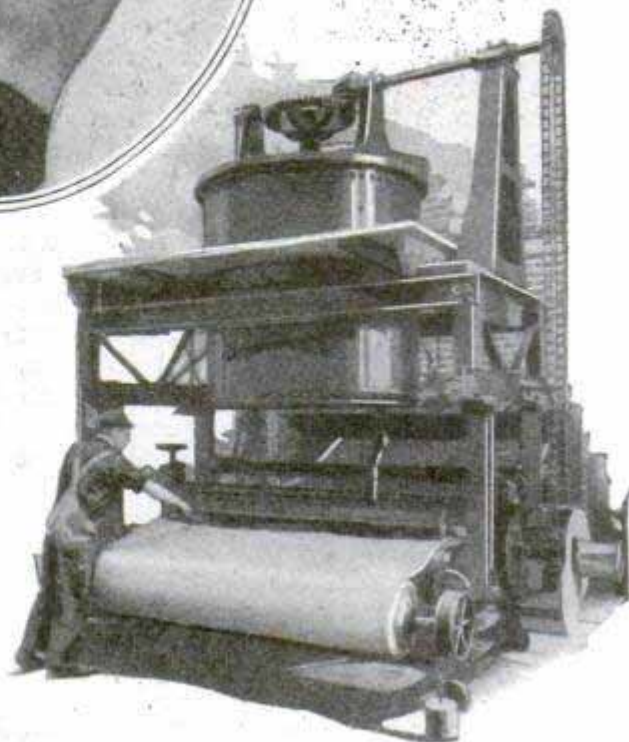
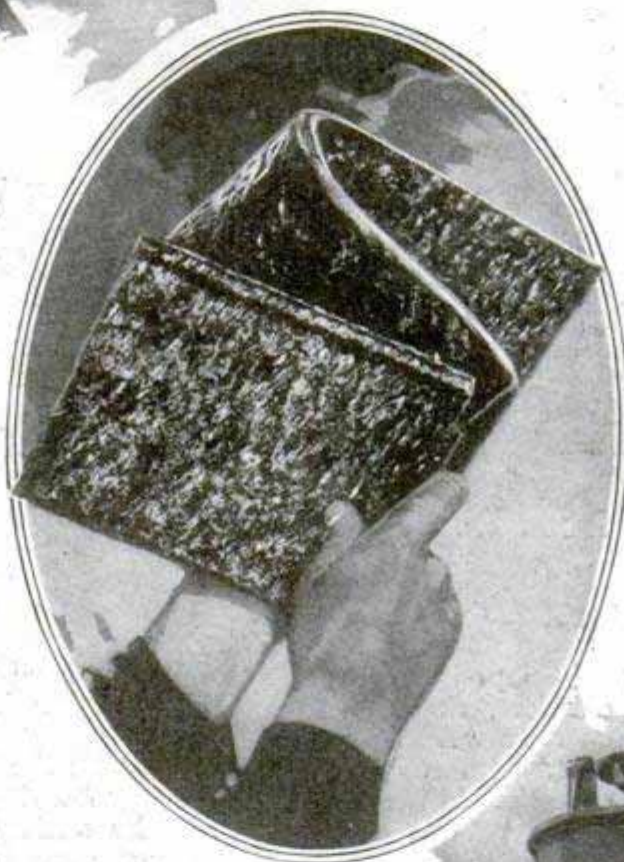

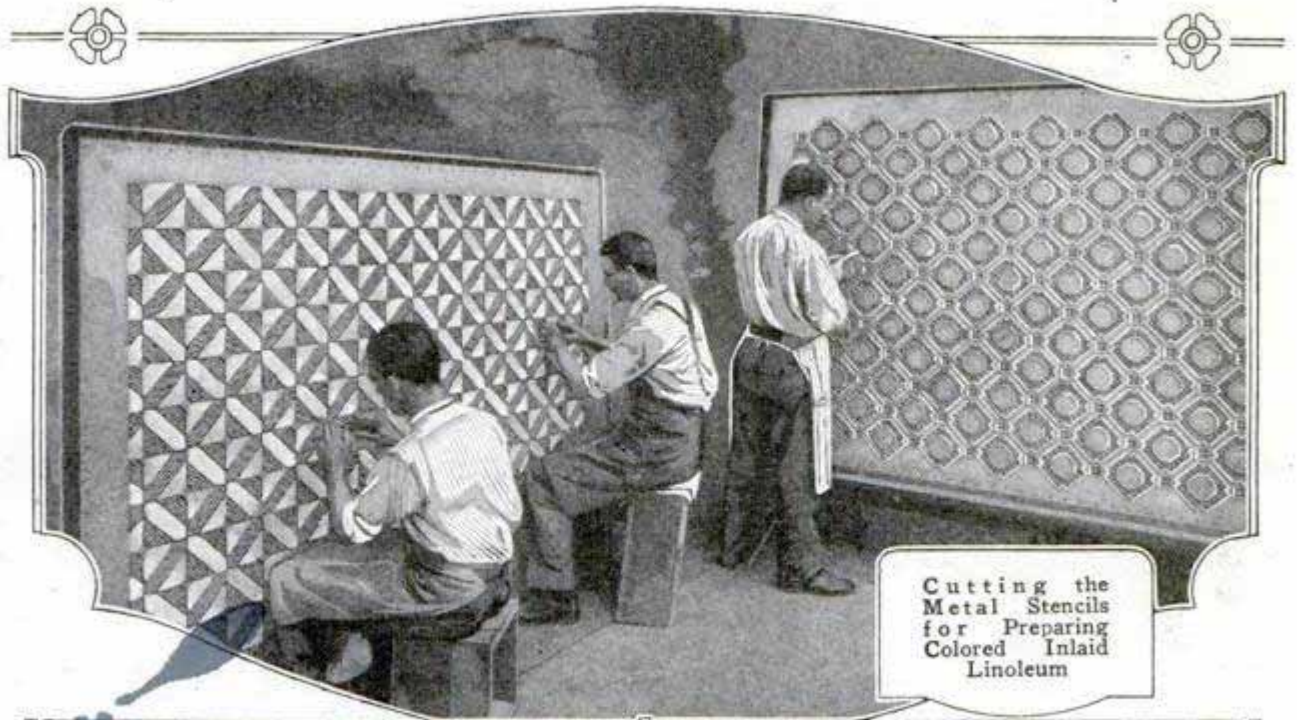

Cutting the Metal Stencils for Preparing Colored Inlaid Linoleum

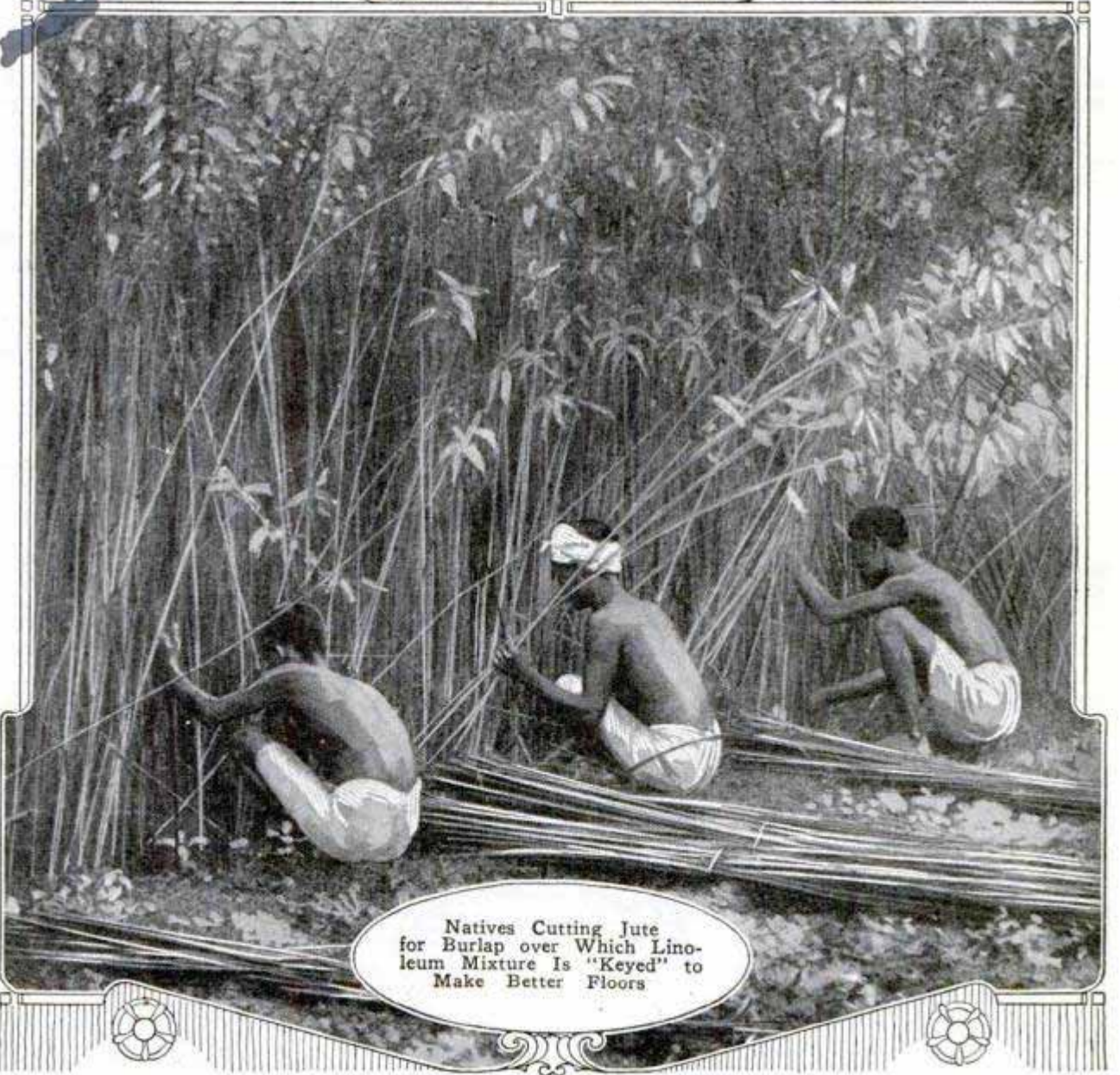

Natives Cutting Jute for Burlap over Which Linoleum Mixture Is "Keyed" to Make Better Floors

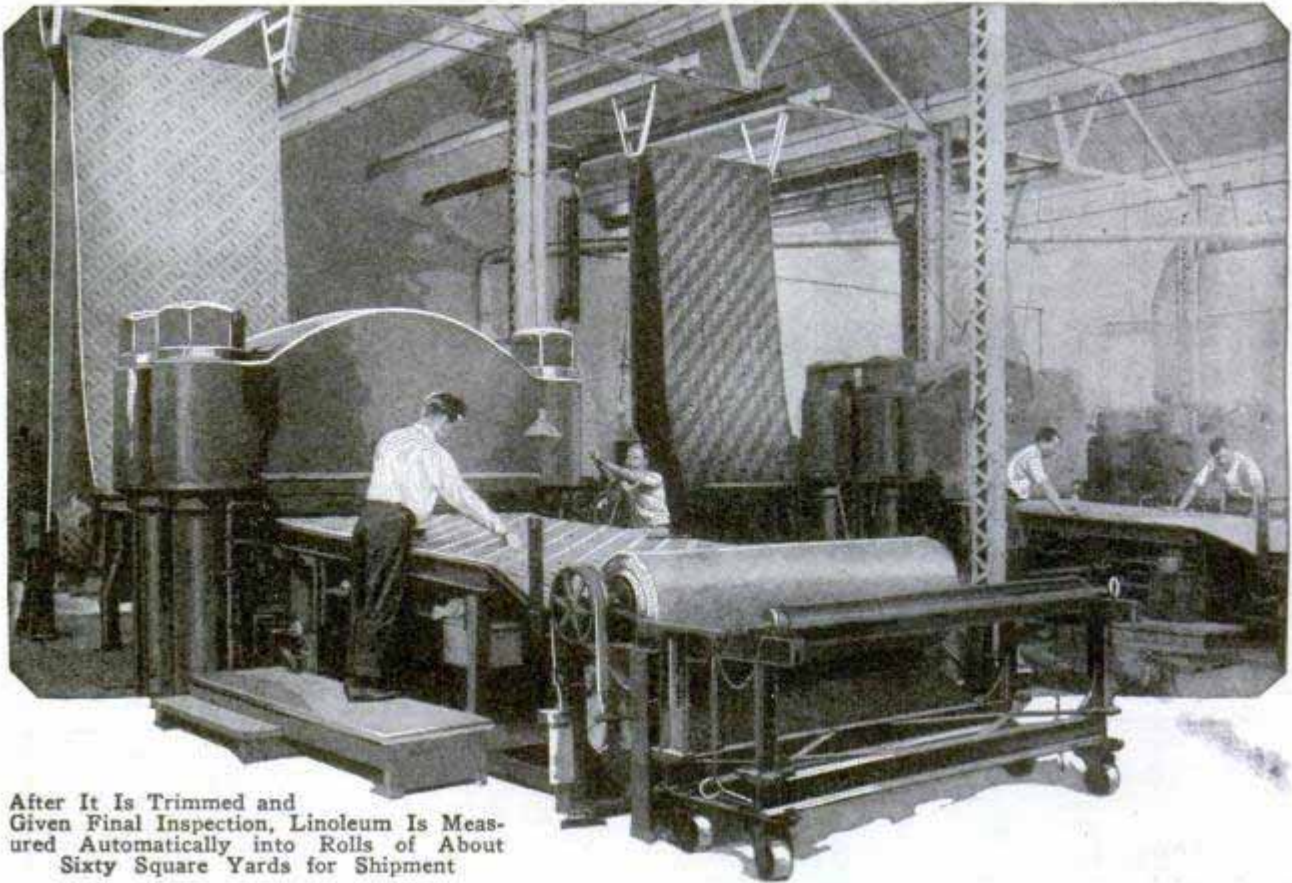

After It Is Trimmed and Given Final Inspection, Linoleum Is Measured Automatically into Rolls of About Sixty Square Yards for Shipment

fashion the patterns on wooden printing blocks requires great skill. For each color in the pattern a separate block must be made. Patterns are first sketched on paper and then transferred to the wooden forms.

There is still another kind of this flooring known as inlaid linoleum, straight-line and molded. When pulverized cork is added to the ground linoleum, cement pigments are put in to produce attractive blues, whites, reds, yellows and other colors, which are characteristic of the inlaid flooring. This material is passed through a calendaring machine which flattens it out in much the same fashion that pie dough is rolled. These sheets of mix are called "blankets." From the blankets little blocks of various-colored linoleum are cut out with steel dies. These are placed in their proper positions on bur-

lap, and then, by means of heavy hydraulic presses, forced together by heat and pressure. Thus, they are practically fused to each other and to the burlap backing.

Molded inlaid linoleum, or granulated, is made in quite another way. The mix, properly colored, is passed through stencils in granulated form onto the burlap. Heavy presses then key the colors permanently to the burlap. Both kinds of linoleum go back into the drying-rooms to be toughened, and as they pass into the ovens, the burlap back is coated with

heavy red paint to protect it from moisture possibly present in the surface on which the linoleum is to be laid. Thus, through the skill and invention of man, has been created a floor covering impervious to dampness, water and cold, and practically noiseless.

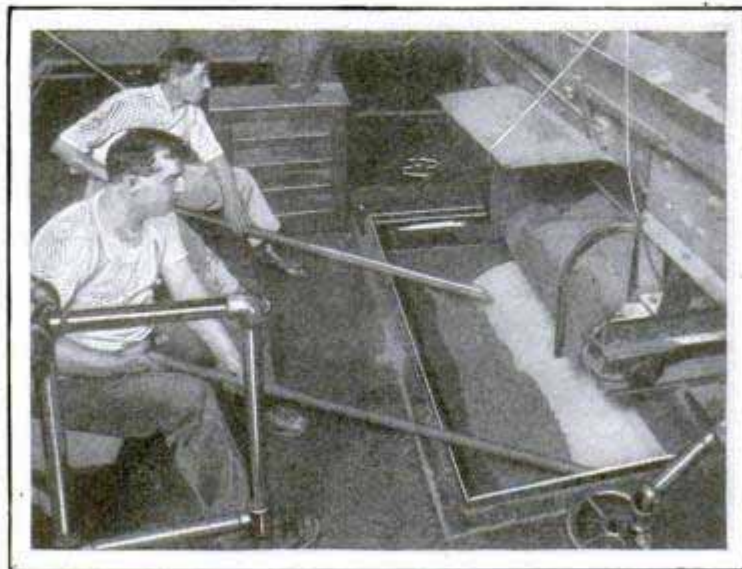

Linoleum "Mix" Passing through Calender to Press It into Flat Blankets for Covering Burlap

GROWTH OF PLANT IN SECOND MEASURED BY SOUND 8 2 2

By translating the growth of a plant into sound or light, two research students at the University of Pennsylvania, have been able to measure just how much the roots develop from second to second. The instrument used is a sensitive "ultramicrometer" and principles governing the operation of an ordinary radio set have been adapted to the task. Every fan knows that a change in the relation of the condenser plates will produce a corresponding alteration in the surge of current. This fact has been adapted to the measurement of the growth in a special "radio set" so arranged that the root of a plant is made to press down on the cross-bar supporting one of the condenser plates. The resulting changes are heard through an ordinary pair of headphones, a series of oscillations which can be counted with the aid of a stopwatch, provided they are within the range of the human ear. Metals are tested with this apparatus in much the same way, substituting the piece under observation for one of the condenser plates.

742

LIGHTHOUSE FOR AIRSHIP LINE HAS REFLECTING BASE

Beams are reflected from its lights and from the smooth curved base of a beacon erected at the Croydon aerodrome, England, to guide airships to safe landings. The lamps are of about 200,000 candlepower and can be seen for a distance of thirty miles.

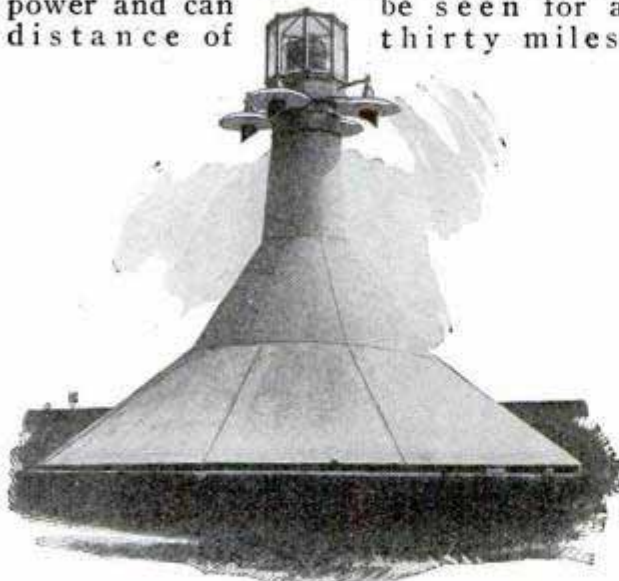

Curved Base of This Airplane Beacon Reflects Light for Guidance of Flyers

They are arranged so that they flash toward the sky three times and toward the base, twice.



Arrow Seems to Pierce the Arm, But Is Held by Slender Wire

DIAMOND DART PIERCING ARM LATEST FAD IN JEWELRY

Held in place by a hidden silver wire, a diamond-studded arrow, to be worn on the arm, apparently pierces the flesh. In reality, the ornament half encircles the arm on the inside, the point being separated from the end of the shaft. The wire is attached underneath and binds sufficiently to keep the clasp from slipping.

PURPLE LIGHTS ON FIRE BOXES TO REPLACE RED

Because the use of red lights for automobile stop signs, and other warnings, tends to detract from the effectiveness of the color when applied to locating fire-alarm boxes and stations, Detroit's city council has recommended that purple be adopted for fire purposes. Boxes are to be illuminated by a special type of lamp with a purple lens on each side. Experiments are said to have shown that this shade is visible under unfavorable conditions caused by smoke or fog. The words "Fire Alarm Box" are to be placed on the posts in letters discernible at a distance of 300 feet. It is proposed to forbid the use of the color for other purposes.

The Popular Mechanics' Bureau of Information offers its free service to all readers of our magazine. Names and addresses of manufacturers will be promptly furnished by addressing the Bureau.

Paris

795

Alarm 760

Received from J. O. Merrill
Rancho Co., 16 Wall St. Detroit, Mich

734

Tiny Beings Magnified a Million Times

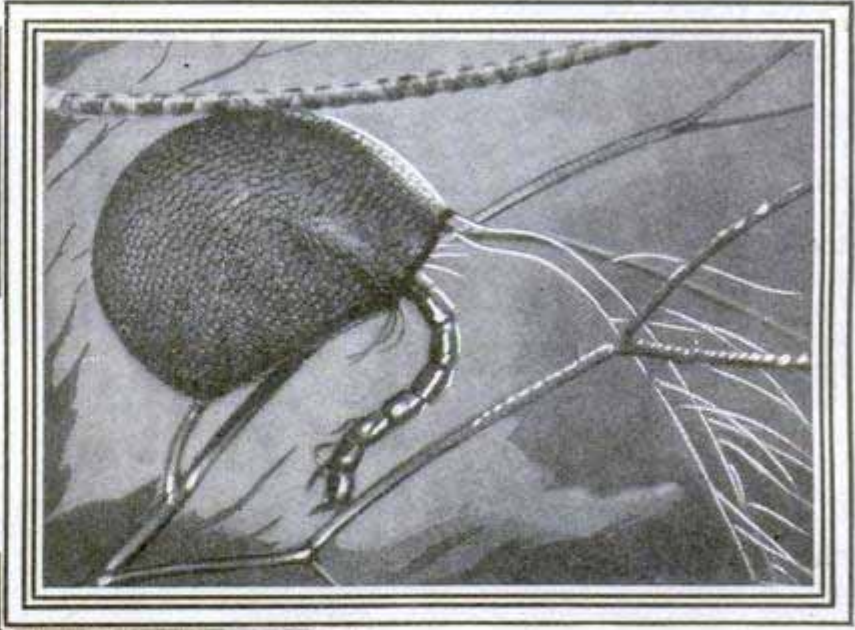

Secrets of a Lilliputian Wonderland Laid Bare by Science; Models of Rotifers and Pond Plants, Showing the Tiny Creatures Magnified 1,000,000 Diameters; Above, a Plant Capturing Larva of a Fly; Upper Left, Vegetarian Rotifer Extracting Its Food from a Spike of Moss; Center, Scene from Pond Life, and Below, a House-Building Rotifer in Its Home of Silt and Minute Particles of Sand

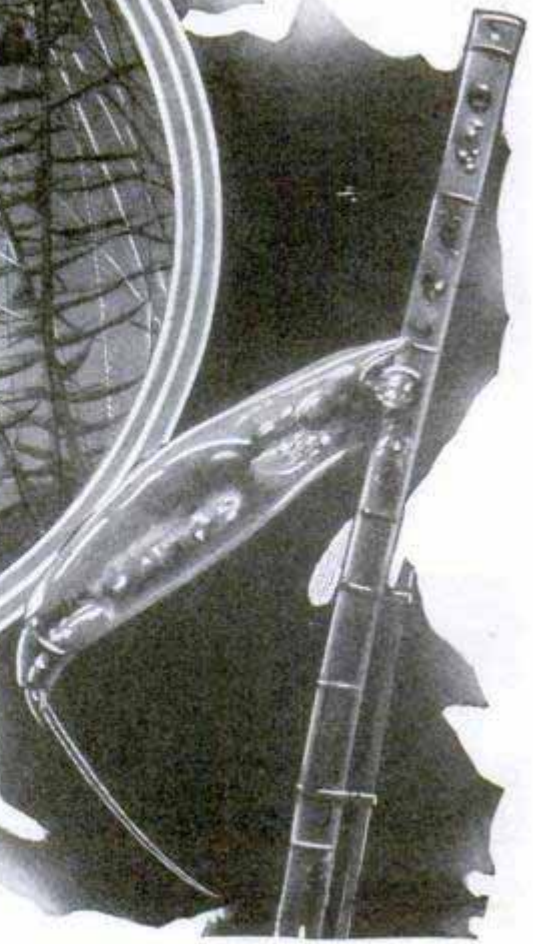
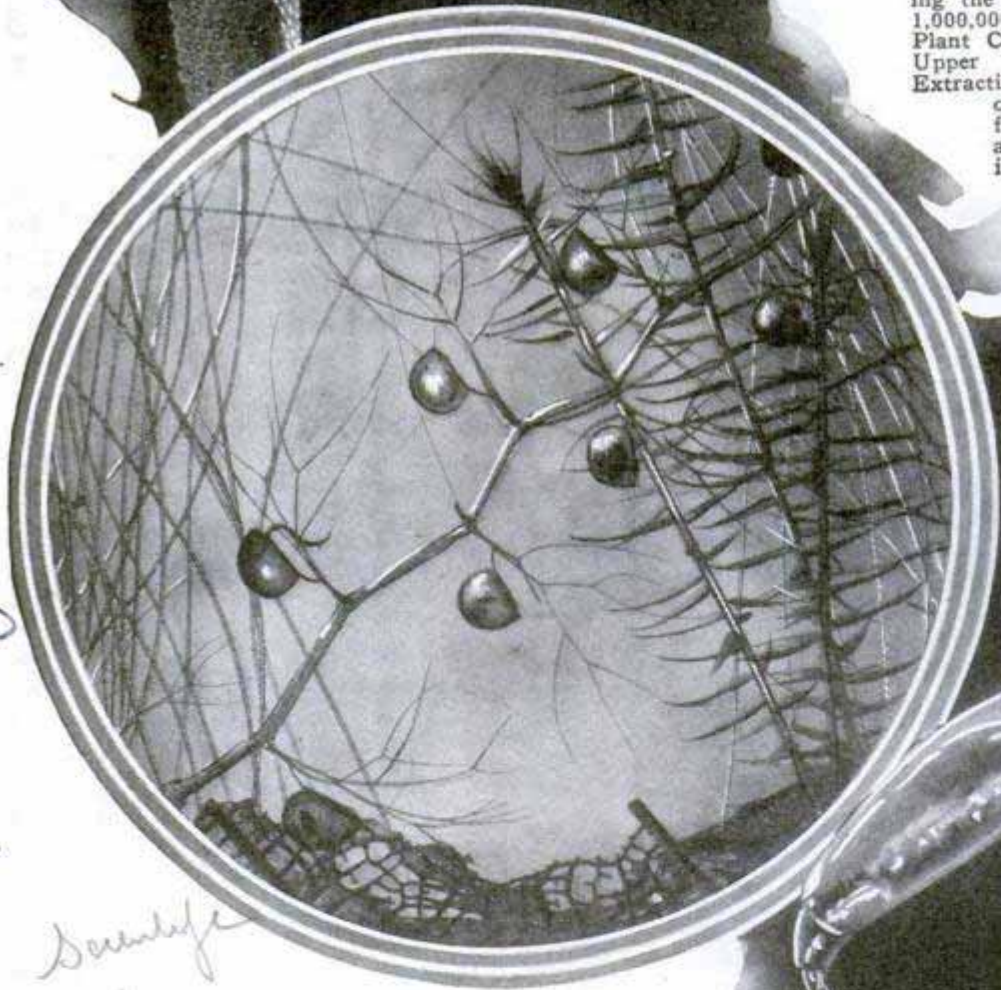

new York City

Science

These Models Have Been Arranged in Realistic Settings at the American Museum of Natural History Where Spectators May Study at Leisure What the Trained Eye of the Scientist Has Detected with the Aid of Powerful Microscopes; the Rotifer Group is Distinguished by Its Tiny Hairs Which Wave Rapidly and Have the Appearance of Rotating as the Small Creatures Use Them for Brushing Food into Their Mouths or for Swimming; They Have Nerves and Muscles, Digestive Organs and Minute Eye Spots

**ELECTRIC HEAT STORED NIGHTS
 TO WARM HOMES 8 20**

By storing up heat in water, engineers of a Milwaukee company hope to provide a way whereby electricity can be used without great expense for warming homes, and generators that normally remain idle at night can be run to advantage, thus eliminating the loss of unproductive equipment. Their plan is to heat the water by electricity in highly insulated tanks at night and keep the temperature at a useful height during the day by a small amount of current. The hot water would be made to circulate through the house in much the same way that it does in an ordinary furnace-heating system. The value of electricity as a heating agent is recognized, but in daytime, when current consumption is great and capacity is taxed at peak hours, sufficient electricity for heating purposes could not be delivered without the expense of erecting additional plants. It is hoped that by the water-storage plan, no extra generators will be needed, and the equipment used at night will be available for service during the day. The idea will be tested out in competition with an ordinary furnace.

**STRAW SHOES MADE OF HATS
 FOR SUMMER WEAR 804.**

A large overstock of Panama hats gave an eastern dealer the idea for an innovation in footwear—shoes made of straw. The uppers are practically all straw save narrow trimmings of black leather. Soles and heels are of the usual shoe material. Besides being comfortable and readily adapted to the shape of the foot, the straw shoes afford the contrast desired in some costumes and are easily cleaned.

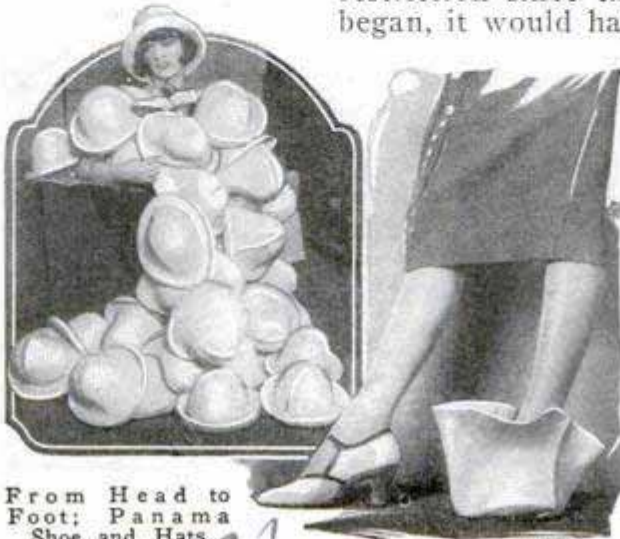

From Head to Foot; Panama Shoe and Hats

**MOVIE PROJECTOR FOR HOMES
 IS RUN BY PHONOGRAPH 8 00**

Attachable to the phonograph motor, a motion-picture projector, designed for



Movies from the Phonograph; Projector Attached to Motor in Cabinet Throws Pictures on Transparent Screen in Front

home use, is placed behind a transparent screen on an extension to the cabinet. The mechanism is so arranged that any scene desired may be stopped, without danger of burning the film, for looking at a "still" picture.

**HEART OF DEAD CHICKEN BEATS
 FOR THIRTEEN YEARS 810**

Kept alive by artificial methods, a bit of tissue from a chicken's heart has been growing in the laboratory of Dr. Alexis Carrel since 1913. It has to be pared every day, for its natural tendency is to double its bulk every twenty-four hours, and had it been allowed to grow without restriction since the day the experiment began, it would have covered an area as large as New York city, scientists say. Motion pictures of the growth of the tissue have been made. The film shows in a few minutes what occurs in twenty-four hours, an amazing display of the marvels of biology. So long as the tissue is properly cared for, it is believed it will not die.

Sold by Branchlyn. Semin Co
 414 74th Ave. New York.
 cont. Mr. Prager of Milwaukee, Wis.
 1153 49th St. Milwaukee, Wis.

and Maurice Schum.
 Mrs. D. Morrison.
 Mrs. Arthur Co. Green.
 Prof. Rockefeller of Rockefeller University.
 Avenue A 10-66th St. N.Y. City

Wolock & Co. Milwaukee, Wis.

761

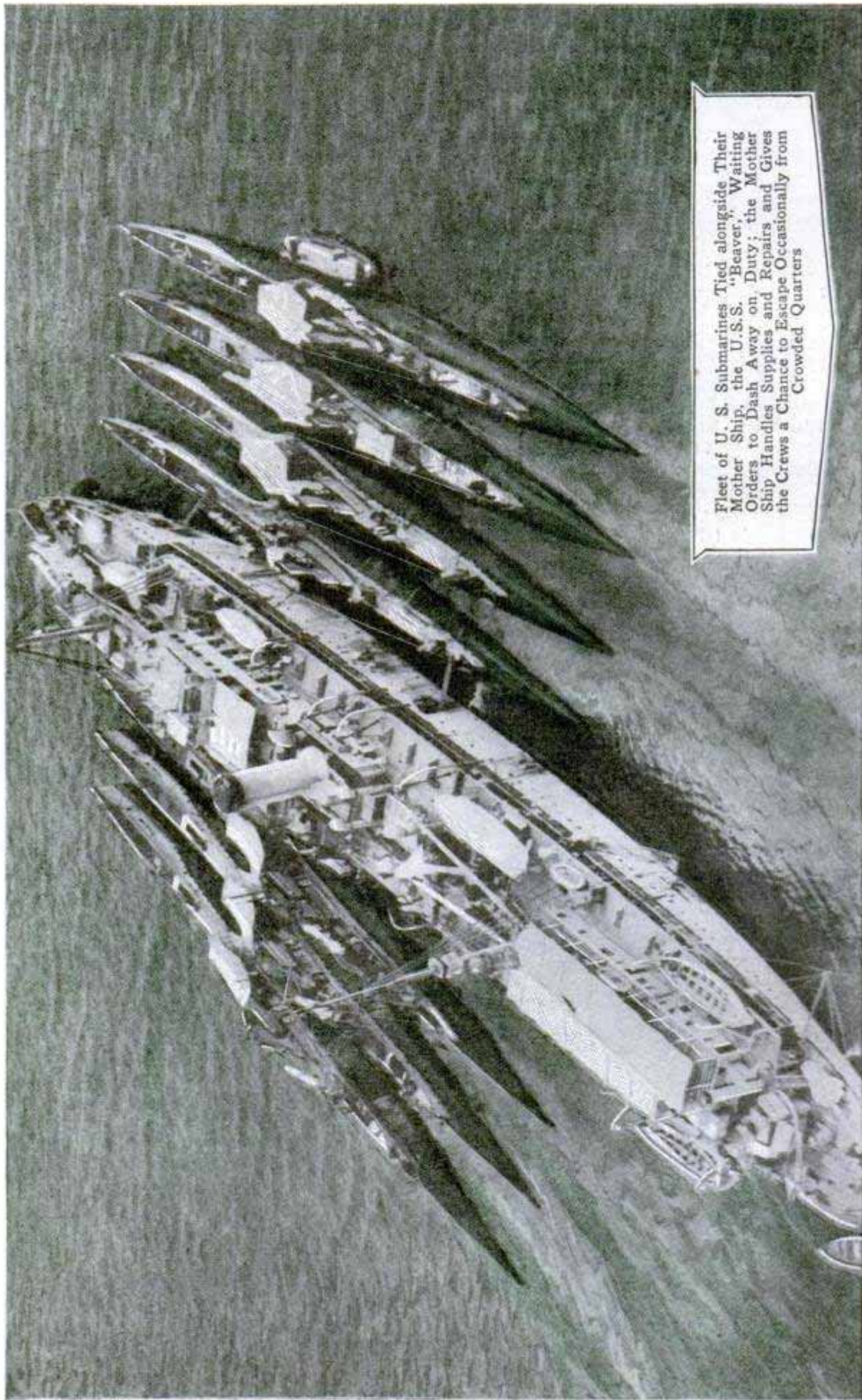

Fleet of U. S. Submarines Tied alongside Their Mother Ship, the U.S.S. "Beaver," Waiting Orders to Dash Away on Duty; the Mother Ship Handles Supplies and Repairs and Gives the Crews a Chance to Escape Occasionally from Crowded Quarters

Com. John W. Keary, navy 761
Department Bureau of
Navigation, Washington, D.C.

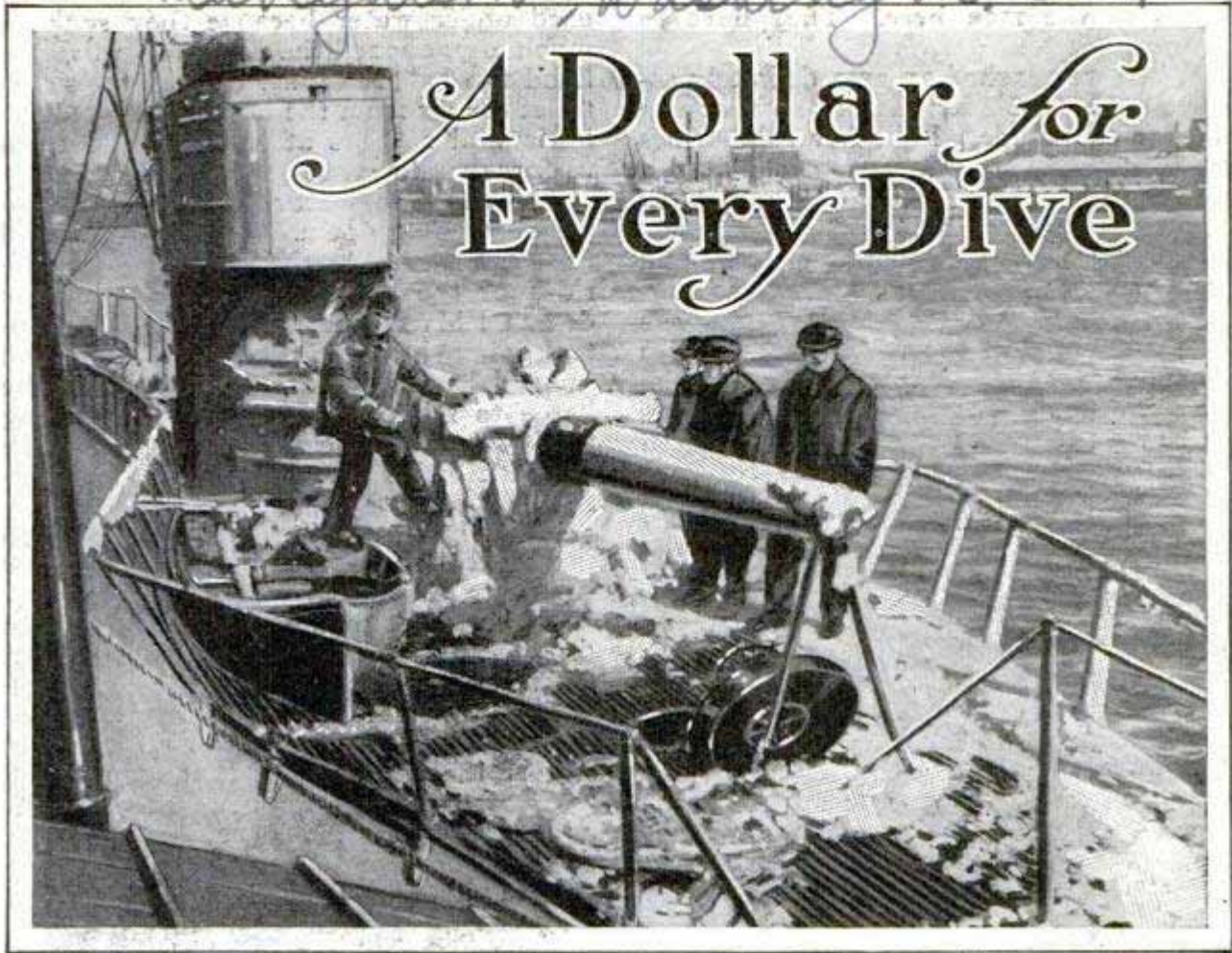

A Dollar for Every Dive

By FLOYD TAYLOR

REMEMBER, kid, Uncle Sam bets you a dollar to nothing that you'll never come back!"

That phrase is a commonplace at the United States navy's submarine base at New London, Conn. Every day some gob is heard shouting it to a companion on the deck of a submarine leaving its dock for a trial dive in Long Island sound.

The expression is explained by the navy's payment of a dollar a dive up to fifteen dives a month to the enlisted men in the submarine service. It's always used as a joke, as the submarine man's laugh at his ventures with the sea in a hard and dangerous service.

Recently Lieut. Charles B. Momsen, commander of the submarine "S-1," undertook to show two landsmen what life in the submarines was like.

J. W. Blank, chief gunner's mate, took us in hand when we arrived. We followed him to the bow and cautiously lowered ourselves through the cramped hatch to the torpedo room. We were just back of the tubes, between two rows of torpedoes with their great heads, painted red, filled with "TNT." We twisted through the entrance to the battery room, where the

men of the crew sleep in tiny bunks, as close together as peas in a pod. That room always has a bit of explosive hydrogen in the air, generated by the batteries. There can be no smoking in a submarine, if the crew wish to stay on this side of eternity.

The control room was explained to us and back we went through the engine room, jammed with Diesel engines, except for a narrow alleyway, to the motor room, in the stern. It holds the powerful electric motors and one torpedo tube. Finally Blank took us up to the tiny bridge, a sort of curved balcony perched on top the conning tower, which in turn rests on the control room, in the center of the boat.

"Most people," Momsen said as he guided the ship down the Thames river, "have the idea that submarines stay under water most of the time, but we don't. It's decidedly uncomfortable to stay down more than a few hours. They think that when a storm blows up, we can sink to avoid it. We can't do that. We have to stay on top and take it. Somebody has to stay up here on this bridge. Sometimes waves roll well over it, over the

heads of the men here. They have to hang on."

When we reached an area definitely assigned the "S-1" for diving, so that she would not collide with other submarines at practice, Lieut. Momsen spoke into a tube:

"Prepare for diving."

The horizontal rudders at bow and stern, which fold into the hull of the submarine, were rigged out. The flag was taken down. All the deck hatches were closed except the one in the center of the bridge, which opens into the conning tower. Two periscopes came sliding up until they rose far above us. The readings were checked in all the tanks.

Momsen took us below to the control room, leaving our quartermaster, Robert Blackwell, on the bridge. Blackwell has the most romantic job of all the crew—he bets his life on his quickness of limb every time the boat dives—but that comes a little later.

We were prepared for a "crash" dive used in emergencies in war. At the walls about us stood twelve men, each with one part of the bewildering gear to care for. There was a man to handle the horizontal rudders, men at the motor and engine controls, a man at the controls of the pumps and one to handle the vertical rudder. The whole boat is handled from the control room.

Momsen rang the diving bell twice. Sounds leaped to our eardrums from all about us. Simultaneously the men stopped the Diesel engines (they can't be

used under water because they suck so much air), opened the Kingston valves to flood the ballast tanks, opened the vents to let the air from the tanks and tilted the horizontal rudders at the bow and stern to force us down.

The depth indicator started to move—we were going down. Blackwell was still on the bridge. As the water rose up the sides of the submarine toward him, he deserted his steering apparatus, the control going to one of the men with us, and jumped backward, dropping through the hatch to the conning tower and jerking the hatch cover down over his head. With the jerk of his arm the boat was water-tight.

Blank had stood below the hatch into the control room, ready to jerk its cover if Blackwell failed to close it above.

"If he didn't make it, Blackwell would drown anyway," Blank explained, "but the rest of us would be saved."

As Blackwell leaped, another gob closed the main induction valve, which draws in air for the engines. If that man failed, the boat would be flooded in a few seconds under water.

The electric motors were started. One minute and eleven seconds after Momsen rang the diving bell we were completely under water. The men at the bow and stern planes reversed the planes' position to stop the descent.

The submarine was to "level off" at forty feet below the surface. Down we dropped. The indicator read thirty-seven feet, thirty-eight, forty, forty-one, forty-

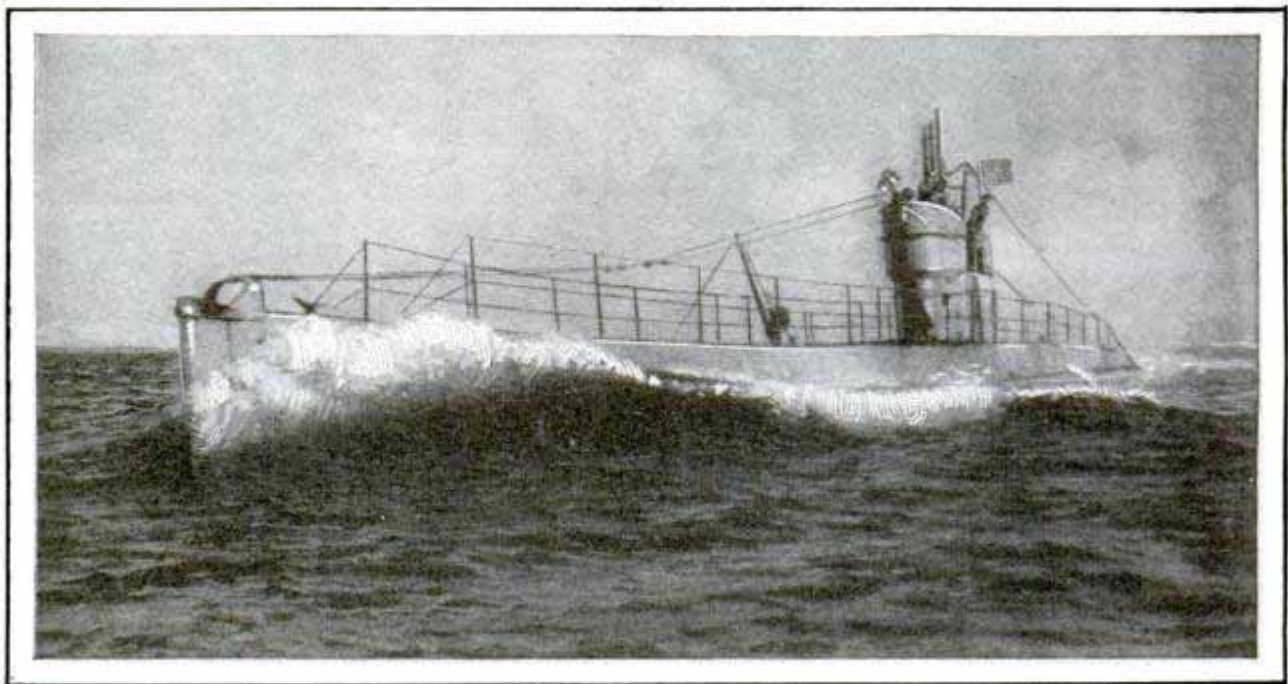

With Railings Rigged and Flag Flying, the "R-23" Starts Off on a Fifty-Two-Hour Trial Run on the Surface, One of the Preliminaries to Acceptance by the Navy Department

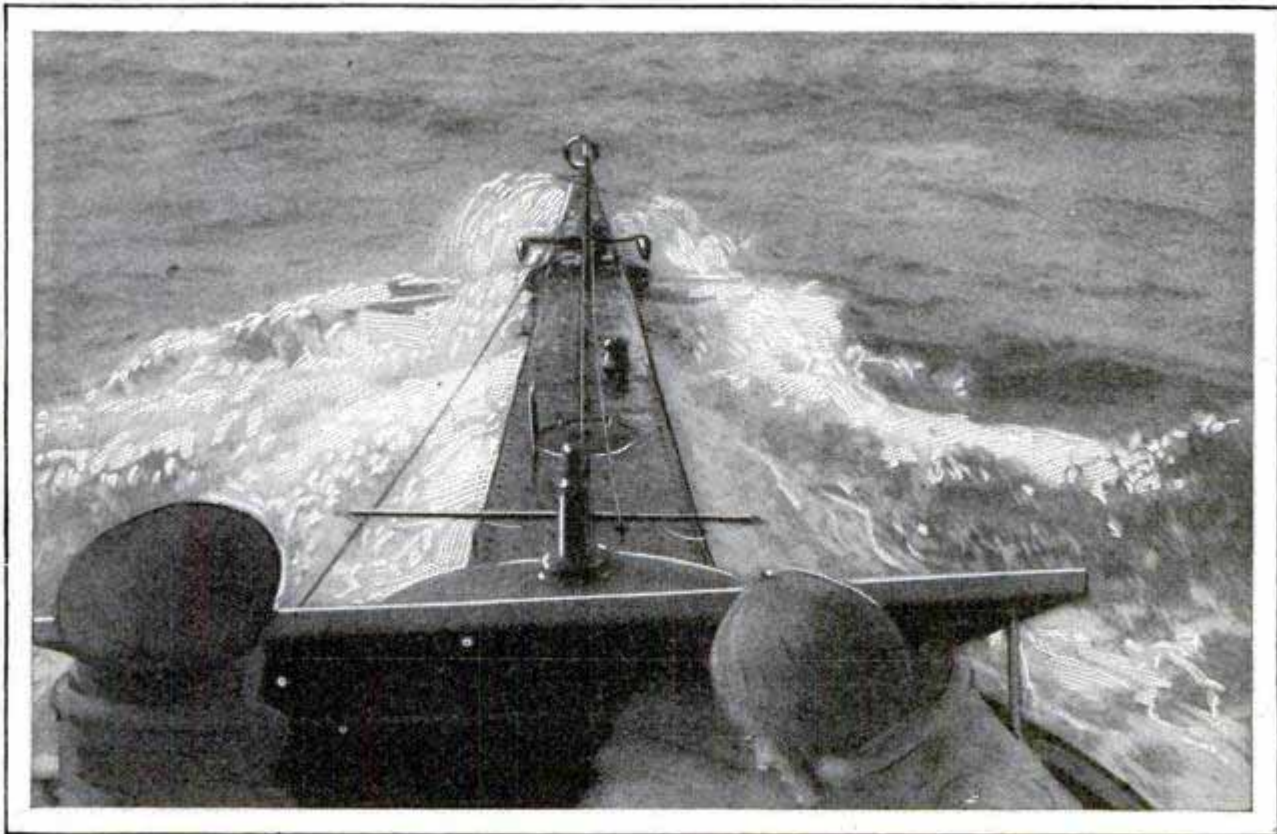

The Bow Wave of a Submarine Speeding along the Surface, as It Looks to the Officers behind the Shelter Protection of the Conning Tower, from Which They Navigate the Ship

two. Momsen stepped toward it. Down, every second farther down—we remembered we were in only seventy-five feet of water.

Forty-five, forty-six, forty-seven, forty-eight.

Momsen asked, in hardly more than a murmur:

"Can you stop her?"

"No."

Again, quietly, Momsen spoke:

"Blow the forward ballast tanks."

A gob shoved a lever releasing compressed air into the huge tanks running back from the bow, blowing the water from them. The depth indicator slackened its pace and we "leveled off" at fifty-five feet. We guests felt relieved. We glanced about cautiously and, finding that nobody else seemed greatly interested, endeavored to assume an air of perfect ease. A couple of gobs smiled at us.

Somebody, we learned later, had put 1,000 pounds of compressed air into the torpedo-room tanks and had not reported it. We had not been in the slightest danger—the boat could have been stopped at any level by "blowing" one or more of the ballast tanks. As we rose, Lieut. Momsen allowed us to use two of the periscopes. We swung them in the long arc between New London and Montauk Point. The view of the boats on the water and of the shore was so clear it seemed

we were on the bridge again. But we still were interested in that excellent record of fifty-five feet, when we had been invited for only forty. Somebody had made a little mistake—suppose, we asked, somebody made a big mistake. The lieutenant told us nobody made big mistakes.

"We have picked crews," he said, "and carefully trained ones. The most difficult problem in the submarine service is training crews; it must be done thoroughly. But we all make little mistakes."

Momsen sent us into the conning tower, where Quartermaster Blackwell was using a periscope. His hair was well sprinkled with gray; he had an air of health about him, a young face and a persistent smile. Blackwell has been in the navy sixteen years.

The conning tower has heavy glass portholes. We had risen until we were just under the surface. We looked forward through the misty green water, decorated with wandering bubbles, rising from the air caught in the structure of the boat.

Momsen called up to the conning tower that he was going to "porpoise." He had his men manipulate the gear so that the submarine rose until the conning tower was above the water then suddenly shot down again.

We asked Blackwell how he liked the submarine service.

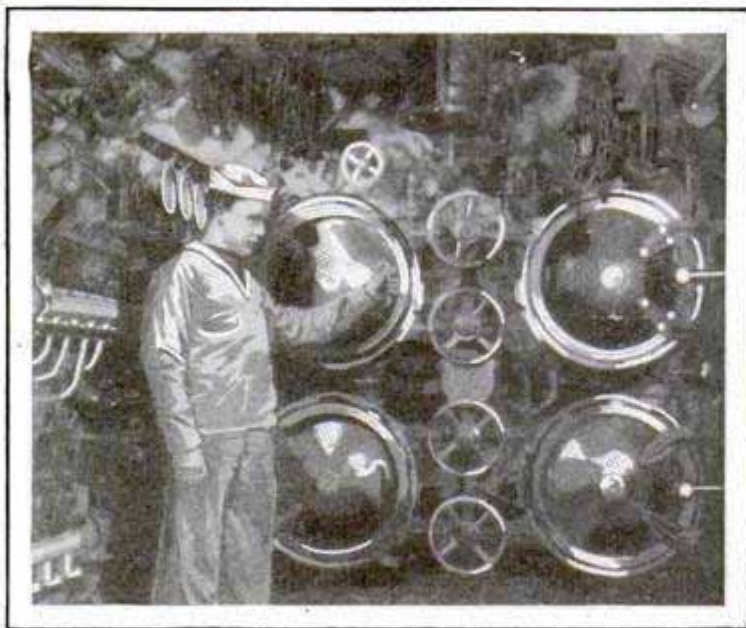

Torpedo Tubes of a German Submarine Being Inspected by a U. S. Sailor

"It's the best in the navy," he said.

We recalled that the enlisted men live in the submarines, in their cramped and oily compartments, none of them roomy enough for free movement of a man's body. The food is excellent, but the crews are living practically under war conditions.

They are made up of qualified men, men who have studied and practiced until they can operate any station in a submarine in the dark. The shortest time in which an enlisted man can qualify is six months, an officer must study and practice for a year.

Until the enlisted men qualify, they don't get the one dollar extra a dive. It irritates them a bit, too, that men in the air service are paid fifty per cent extra—they consider submarine assignments quite as hazardous. Their consoling thought is that their officers get nothing extra.

We wondered why Blackwell thought the submarine job "the best in the navy."

"You get fine officers in the submarines," he said, "and they treat you fine. It's crowded and they get their clothes dirty and can't get by just on their uniforms. An officer has to be a fine man to be a real submarine officer. We get a good chance to look him over."

We had been about the submarine base for ten days and had been impressed with the competence of both enlisted men and officers. We had found another

reason for men liking submarines—those who seemed to us the most competent, although, of course, we could hardly judge of competence, delighted in doing difficult jobs well. They were operating delicately built and expensive boats. They enjoyed making a good job of it.

Quartermaster Blackwell told us how to ride an air bubble. If a submarine went to the bottom through some accident and was not too far down, he said, a man could be put in the conning tower and sent up on an air bubble. The lower hatch of the tower would be closed. It would be partly filled with water and then compressed air admitted to it from the tanks of the boat until the pressure was the same as that outside. The man would jerk

open the upper hatch and the air in the tower would speed to the surface, carrying him with it. Every man in the boat could be sent up in this way, the last man could operate the air lines from valves in the conning tower. After each man had left, the tower would be pumped free of water for the next one. The danger is that men suddenly released from heavy air pressure get caisson disease, known as "the bends."

We glanced through the forward port holes of the conning tower and could just see the watertight breech cover of the four-inch gun on the forward deck, a

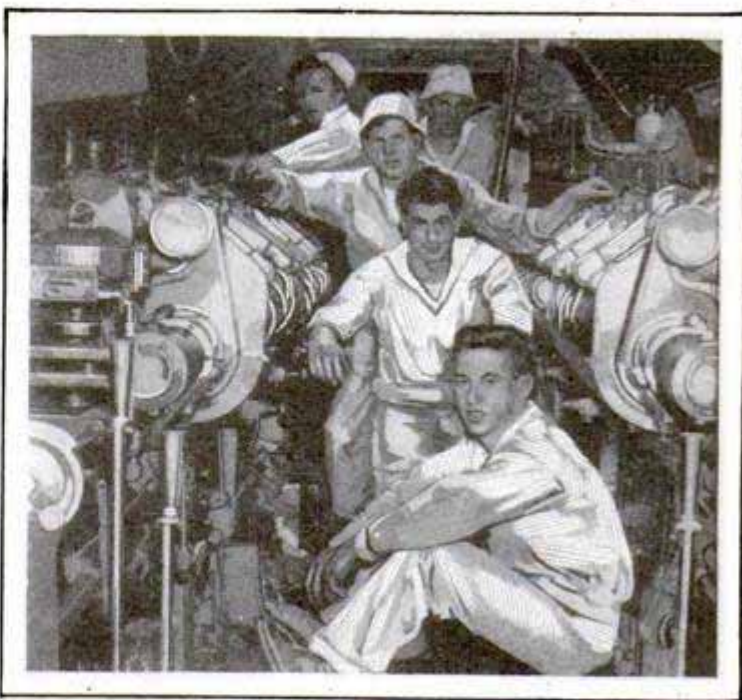

American Gobs in the Engine Room of a German U-Boat Looking Over the Machinery

wicked-looking gun with a range of nine miles. It is known as a "wet gun," carried on the deck above and below water. At the stern was a watertight tank, not high enough for a man to stand in, in which the "S-1" carries a little airplane, with wings which fold back. It has been difficult to develop a plane small enough with sufficient strength. The officers of the submarine base hope the navy finds enough money to experiment with the new all-metal planes on submarines, with a catapult, perhaps, to send them away.

We had been under water forty minutes when we finally came to the surface to stay. A considerable air pressure had been built up in the boat by air escaping from compressed-air lines. It was gradually released before the hatch was "cracked" and we went "top side."

761

As we came in toward the harbor, Momsen spun yarns of the deeds men had done in submarines. He told of the skipper of a United States navy sub in the Asiatic fleet who had come up from a deep dive directly under a destroyer, crushing his conning tower.

This skipper had dropped down again, found he was not seriously damaged and cruised away under water for fifteen minutes to get clear of a cluster of destroyers. Then, for fifteen minutes more, he went ahead to prove to his crew they could handle the boat under any conditions, with or without a conning tower. The destroyers were tearing around in circles, trying to find if he had gone to the bottom.

After that, Momsen said, the crew would have followed the skipper anywhere.

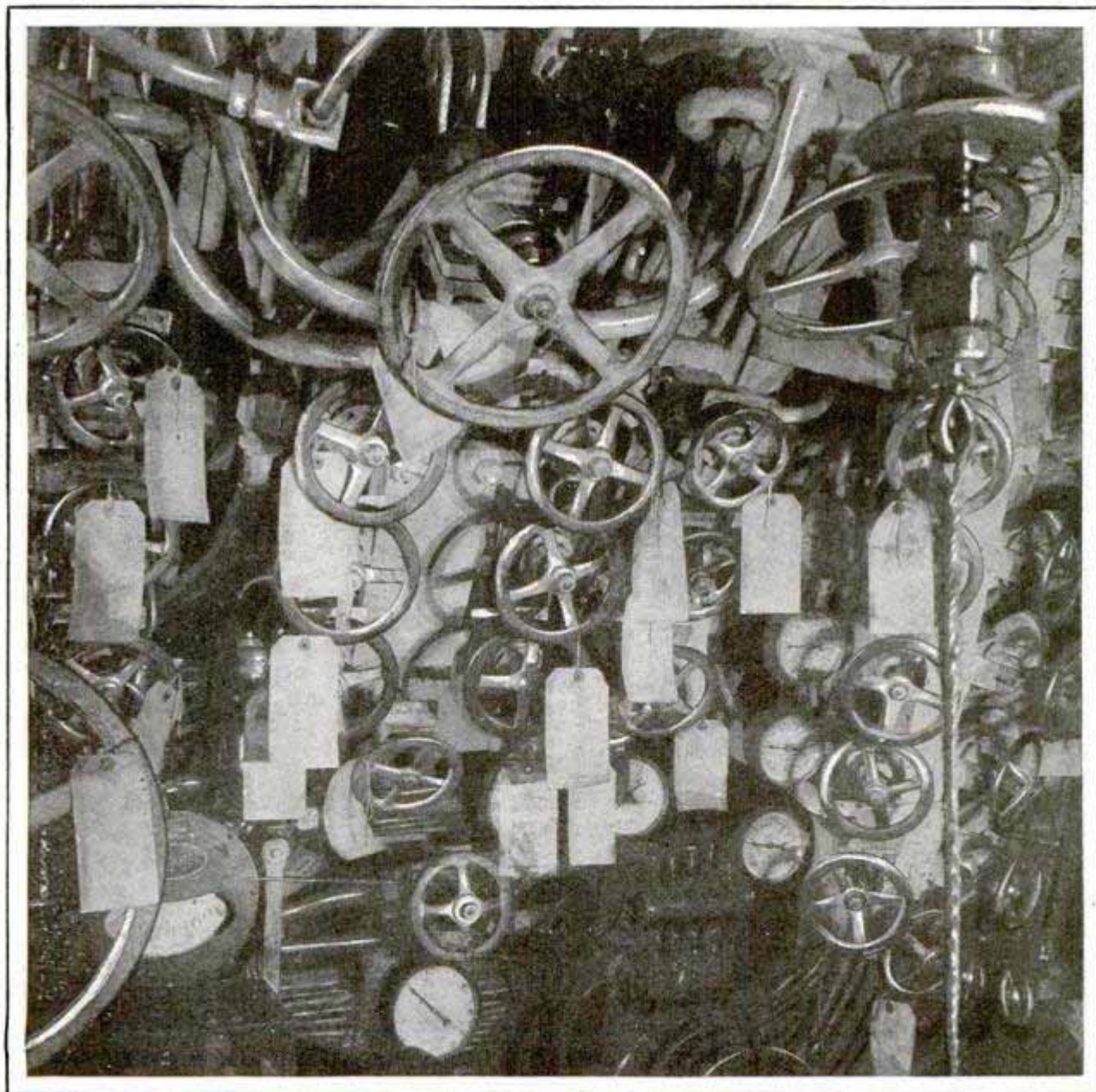

Pictures of the Control Apparatus of American Submarines Are Forbidden, but Here Are the Controls of a German U-Boat Surrendered to the U. S. after the Armistice

**AUTO WITH EXPANDING BODY
 SERVES AS SALES ROOM**

789

Automobiles, equipped with a commercial body that expands either by motor or hand power, are used by a western drug

1200 S. Hope St. Los Angeles Calif

*A. E. Robinson - maker -
 Robine Wholesale Manager,
 Rob. Car Co. of California,*



Auto Closed and Expanded, a nd View of Interior



company as sample-display rooms for their salesmen. The sides of the body move out and the top up, leaving a space about five by nine by seven feet in dimensions, which serves the salesman when he arrives at his customer's store. Drawers and lockers are provided to carry more than 7,000 separate articles, saving the expense of transporting trunks and other luggage and of hiring special hotel quarters. The top and sides are actuated by a set of gears. The doors at the rear remain closed to prevent interference from spectators. Light is provided from electric lamps at night and, by day, through hinged windows extending the full length of the body between the roof and top of half-body sections. Besides the stock, there is room for two chairs and a desk.

**MISTAKES IN PRINTING STAMPS
 BENEFIT COLLECTORS**

819

Errors in printing postage stamps often cost governments thousands of dollars, but they sometimes put small fortunes in

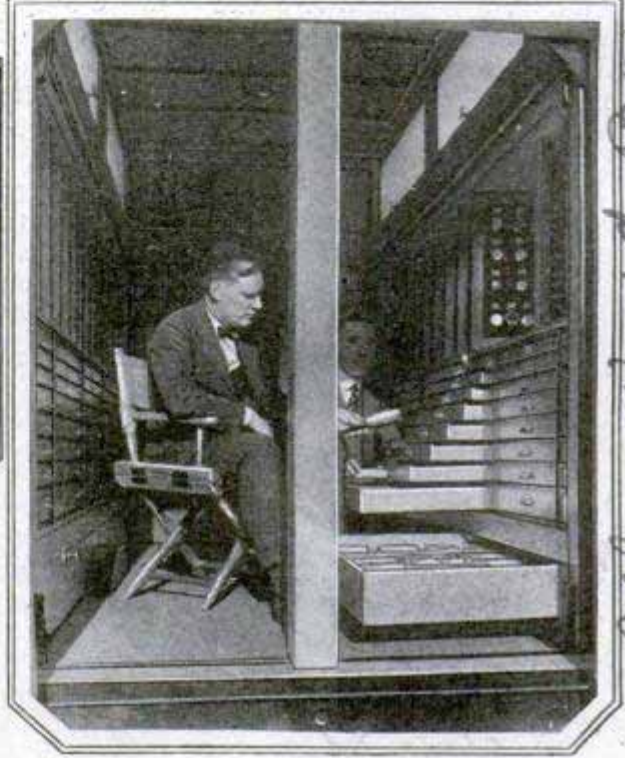

to the hands of the stamp collectors who value the misprinted tokens for their rarity. A few months ago, Great Britain issued a sheet of stamps which was so placed during the printing process that the glue was spread on the wrong side. An American dealer

obtained possession of a few of the stamps, the others were destroyed. The few that were saved now are commanding a high price. Another mistake that benefited the collectors occurred in connection with the changes in postal rates in this country. Dies were sent to the various post offices for restamping old one-cent envelopes to one and one-half cents, in accordance with the revised tariffs. By error, about 100 two-cent envelopes received the surcharge stamp. These are now being eagerly sought by collectors and are said to command a high figure at auctions.

☞ Within a minute after garlic is eaten by a cow, the flavor can be detected in the milk, an authority states.

*Wm. Allan Ward Postmaster
 Dallas, Texas*

NINE HUNDRED RADIO STATIONS BUILT IN FOUR YEARS 88

Evidence of the impressive growth of radio is seen in a recent census showing that there are 922 broadcasting stations throughout the world. Of the total, 566 are in the United States, the remaining 356 being scattered in different countries. Great Britain has twenty-one, of which the strongest is said to serve a population of 23,000,000 persons within the range of crystal sets alone; Germany has twenty stations; France has nineteen, Spain thirteen and Russia seven. Canadian stations number nearly 100. Australia is served by thirteen stations, India has only three, with two now under construction, South Africa has four, and there is one in the Canary islands. China's two stations are to be supplemented by four more. Although Japan has but three stations, thirty are to be erected by American contractors. Cuba has thirty-six broadcasting centers, most of them of low power; Mexico has sixteen, seven of which are in Mexico City, and South America twenty-seven.

Branch at Cincinnati, Ontario, Ont., Kansas City, Mo., San Francisco

VALVE GRINDER DRIVEN BY AIR MAKES WORK EASIER

Driven by compressed air, an automobile valve grinder has a speed control which permits a range of from ten to 1,000 oscillations per minute. This allows work that rivals that of the slower hand processes and completes the valve from start to finish so that no hand operations are necessary. The grinder weighs only four pounds and is also adapted to work on valve cages.

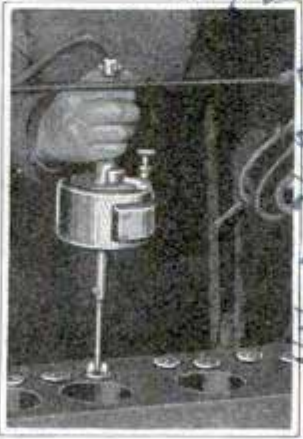

Brunner Mfg. Co. Utica N.Y.

ELECTRIC DUMMY SKATING RINK DRAWS CROWDS TO STORE 852

For exhibiting its winter stock of outing costumes and to reflect the holiday spirit, a large Berlin department store de-

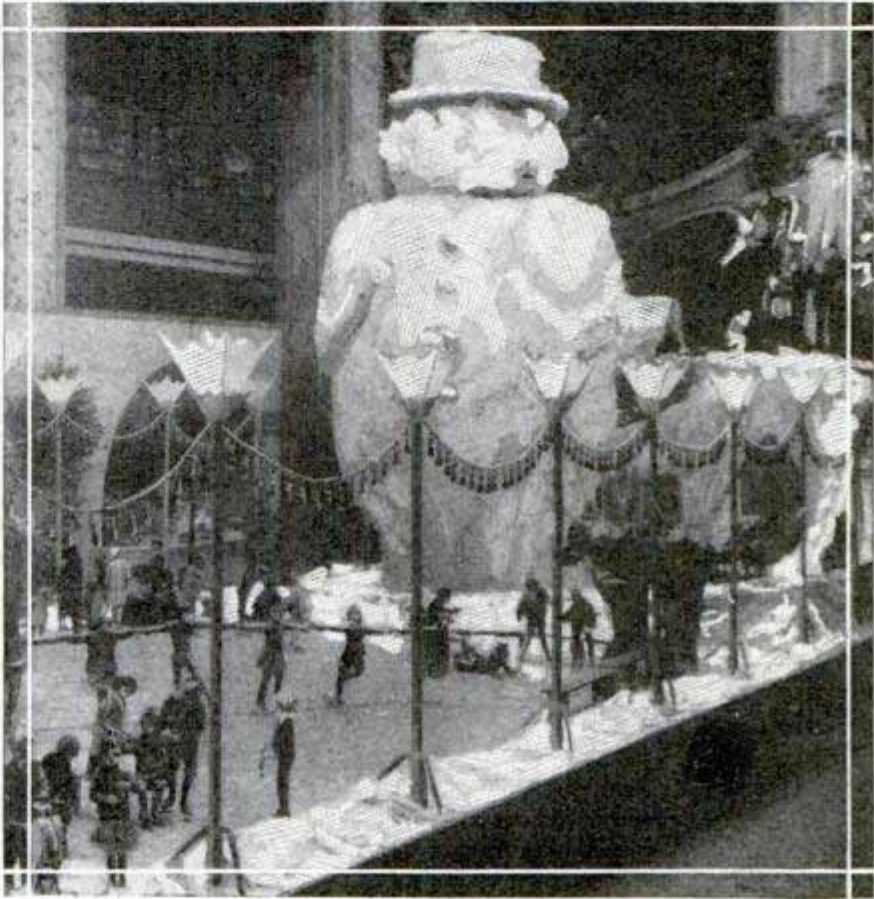

Copyright, P. & A. Winter Scene inside Store; Imitation Skating Rink with Electric Dummy Figures That Move and Mock Snow Man

vised a realistic skating rink, peopled with electric dummies, and featured by the mammoth figure of an imitation snow man guarding the scene. The lifelike models imitated the movements of real skaters and in the center, an electrically operated merry-go-round whirled a line of boy and girl figures to suggest the favorite skating game of "cracking the whip." Furs, sports costumes and shoes, as well as skates and other equipment, were effectively shown by this method.

THIRTY-PASSENGER AIRPLANE HAS RESTAURANT 393

With a carrying capacity of thirty passengers, a huge airplane added to the flying service between London and Paris is equipped with a restaurant. A steward is in attendance, and hot meals are served just as on a train. Another plane, under construction, is to be copied after a modern railway sleeping car.

Christmas Science Monitor 9/12/25

Dr. Willis Aircraft Co.,
126-130, O. St.
226

Sacramento Calif
PYGMY MOTOR FOR AIRPLANES
WEIGHS SIXTY-FOUR POUNDS

Westport Stockton
Coal Co., Ltd.
Ngakawa. N.Z.

practically immune. "There is almost no danger in the light-frame dwelling house," he says. "The most dangerous place is the outer edge of the sidewalk in the business district and the adjoining part of the street, where cornices and store fronts may come tumbling down. The safest places are in doorways and against walls."

835 Capable of developing twenty horsepower at 2,000 revolutions per minute, a motor for small airplanes weighs only six-

Meteor Motor Co. Factory
\$350.00 F.O.B.

2016.5 M.M.



Illustrating Light Weight of Motor for Small Airplanes; It Registers Sixty-Four Pounds

ty-four pounds complete with carburetor and magneto. It has been designed to meet the need for light, economical planes, which, some experts declare, are practical for passenger and swift transport service.

QUAKE SAFETY IN HEIGHT OF BUILDINGS 896

Steel-frame buildings, 200 feet high, are safer than similar structures only 100 feet tall, according to Dr. Bailey Willis, professor emeritus of geology at Stanford University, who has made a study of damage caused by earthquakes. The 100-foot building is just the right height, he says, to correspond with the earthquake's period of swing, and therefore receives the maximum amount of jerk when the tremor stops its movement in one direction and reverses. The mass of the building, acting as a pendulum swinging upside down, tries to continue its movement, with resulting damage. A 200-foot building, on the other hand, does not coincide with the earthquake swing, and hence is

851 COAL IS WASHED DOWN FLUME TO SAVE HAULING

In a mountainous district near Ngakawa, New Zealand, coal from the mines is mixed with water and floated down a winding flume more than five miles long, saving the expense and labor of electric trains and aerial carriers. The coal is given a rough sorting through screens as it passes from the storage bins into the trough, which is seventeen inches wide at the bottom, a foot high and lined with sheets of galvanized iron to give a smooth surface and prevent rust. The sheathing had to be bent by a special apparatus to fit the flume and is joined with galvanized bolts. Joints are separated by felt lining. At the delivery end, the contents of the flume are given an additional screening until only pieces of coal less than half an inch in diameter remain. These are extracted in a revolving screen which turns at the rate of 120 revolutions per minute. The water is then directed through a fine mesh which removes the dust. The flume, in places, turns in "hairpin bends" and passes through tunnels. Great engineering skill was required in constructing it to assure a steady flow. The direct distance between the mines and the delivery

(con
str
li

Stanford University
P.O. Calif

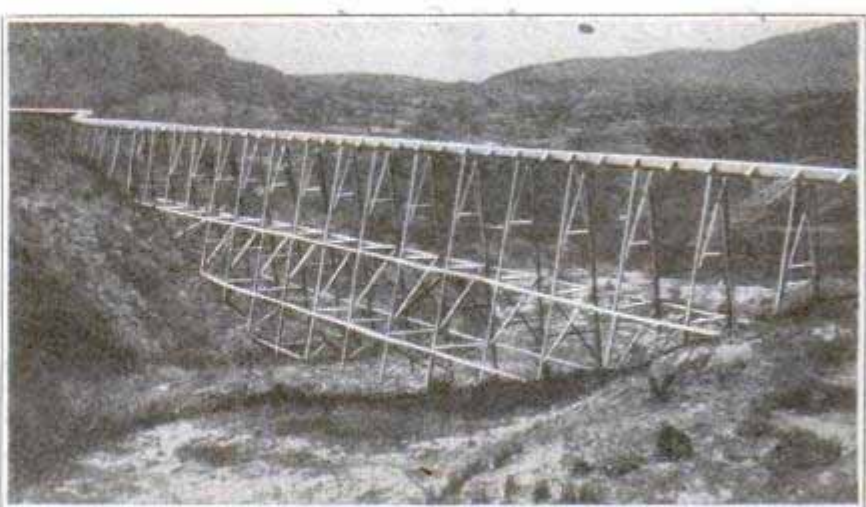

Winding Flume Constructed in New Zealand over Rough Country for Floating Coal from Mines to Shipping Point

point is only three and one-half miles, nearly two miles of flume being necessary to go around the hills.

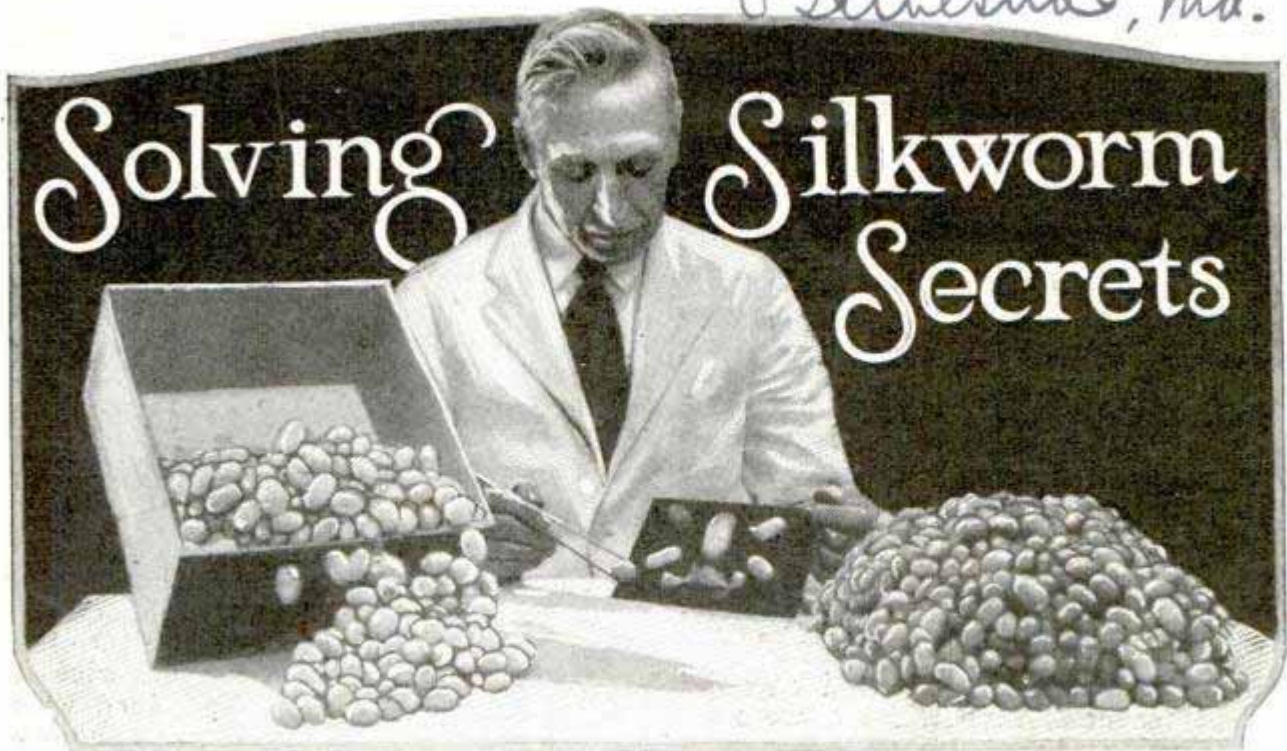

He Raises Silkworms as a Hobby and Provides Schools and Colleges with Experimental Material as Well as Educational Exhibits

DEAN of American silkworm experimenters is an appropriate title for Mr. T. A. Keleher, an amateur enthusiast of Washington, who during a period of twenty-six years has been devoting all his spare time to the study and culture of silkworms.

The silkworm—if you know anything about the career of this creature in the United States—is the silk factory of a million promises which never paid dividends. The obstacle of costly hand labor has prevented the development of this industry in the various sections of the country where silkworms will prosper and where mulberry trees will grow like weeds.

Silkworm culture was attempted by the early colonials of Virginia, South Carolina and Georgia. Some of the finest silk ever sold in London came from the hand reels of the Georgian colonists. Connecticut, Long Island, Pennsylvania and New Jersey tried to master the new business in later years—and failed. In 1833, farmers in Windham county, Connecticut, produced and marketed four tons of cocoons. It was during a period when congress was investigating the possibilities of commercialized silk production. Thousands and thousands of acres of mulberry trees were set out. People who never had seen silkworms attempted to raise them. The craze gripped the countryside. Hundreds of thousands of dollars were expended in fruitless efforts

to develop our domestic silk-producing industry.

Frost came and destroyed plantations. Inexperience of the growers collected wholesale tribute. Failures were as numerous as the enthusiasts. Popular sentiment with empty pockets jeered and ridiculed the enterprise which it had formerly fostered. Silkworm culture became a byword of folly.

Many attempts were made to revive the amateur and professional experimentation. A half century later, California, Utah, Louisiana, Alabama and Georgia delved into silkworm research. The Mormons even went so far as to teach silkworm culture in their schools. They built and equipped factories. They tried to perfect mechanical fingers to perform the work of hand laborers. And naught came of this effort to solve the secrets of silkworm raising and profitable silk production.

Experts of the department of agriculture devoted a decade to search and research. Silkworms were raised by the thousand in Washington. French women—expert hand reelers—were hired to come to America and teach our people how to recover the silken strands from the diminutive cocoons. Every effort was made to establish silk production as a household industry. Congress aided the campaign with liberal appropriations. And finally, the project was abandoned

715

as impractical. Mr. Keleher was a messenger in the employ of the federal bureau of entomology when the government silkworm investigations were in progress. To young Keleher was delegated the task of feeding and caring for the silkworms. The youth became so interested in the miniature silk factories that he devoted his spare time to studying the worms and their life cycle. When Uncle Sam abandoned silk-culture research, Keleher purchased the worms, eggs, moths, cocoons and hand reels, removed them to his home, and from that day to this has devoted his leisure to experimentation.

In the course of time, he developed a market for the products of his hobby. He appreciated the impossibility of commercializing his silk-culture knowledge. However, he found that there was a demand among schools and colleges for silkworms, their eggs, moths and cocoons. School teachers, in particular, were always anxious to secure silkworm eggs so that they could use them for demonstrational purposes. The pupils were able to study the life cycle of the silkworm at first hand by means of such exhibits. The eggs would hatch into hungry worms, which, in about ten days, would grow to be three inches long. Then the worms would spin their cocoons, containing from 750 to 1,200 yards of silk. The chrysalis at the center of the cocoon would ultimately emerge in the form of a moth. Subsequently, the mother moth would deposit 400 eggs, tiny as pinheads, and would disappear.

In addition to providing the schools and colleges where mulberry leaves were available with silkworms, Mr. Keleher has also made a specialty of producing educational exhibits mounted in glass cases which tell the life history of the industrious silkworm. These exhibit cases have been sold in all sections of the country. Mr. Keleher has raised more than half a million silkworms from eggs during his spare hours and has assisted in the education of many thousand school children.

During the winter, this amateur keeps his supply of silkworm eggs in cold storage. About the first of May, he removes the little box of eggs to his home. You can appreciate that the container is small when you understand that 30,000 of the eggs weigh only one ounce. In about a week, they begin to hatch. The worms, as they emerge, are only one-eighth of an inch long. They feed voraciously on the mulberry leaves and shortly develop into mature worms.

A certain proportion of the worms are killed by placing them in bottles containing poison. Their bodies are carefully cut away. The parchmentlike skin is preserved, dried in an oven and then inflated with a hand bulb to normal size. This inflated effigy of the silkworm is mounted in a glass-faced exhibition case on a cotton field.

Specimens of cocoons and mulberry leaves are also preserved and mounted. Cocoons which contain the silkworms in the resting or chrysalis stage are cut into equal parts, so that each presents a cross-sectional view of the chrysalis slumbering in its silk-lined cave. Moths are raised, poisoned and preserved. They are mounted with their wings fully extended to display their brilliant colors most attractively. The tiny silkworm eggs are also mounted and placed in the educational exhibits which are prized in primary and secondary schools

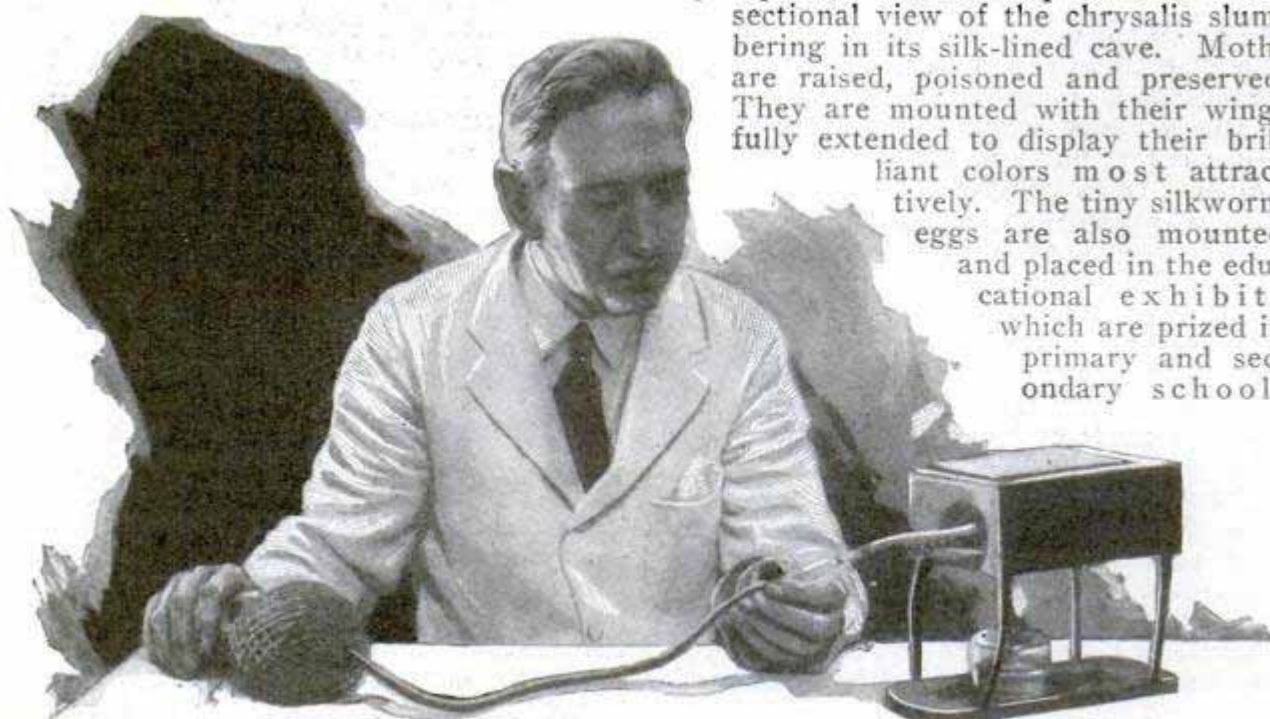

Using Special Alcohol-Burner Oven for Drying Silkworm Skins, to Be Mounted for Exhibition and Educational Purposes; the Bulb Helps Inflate the Skins to Normal Size

Mr. Keleher Dissecting Silkworm Bodies from Skins; Poison Bottles in Which Worms Are Killed on Table; on Hatching, Worms Are About One-Eighth of an Inch Long



Specimen Cocoons, Mulberry Leaves, Silkworms in Chrysalis Stage, and Moths Mounted and Placed in Show Boxes to Illustrate Life Cycle; Samples of Raw and Finished Silk Are Included

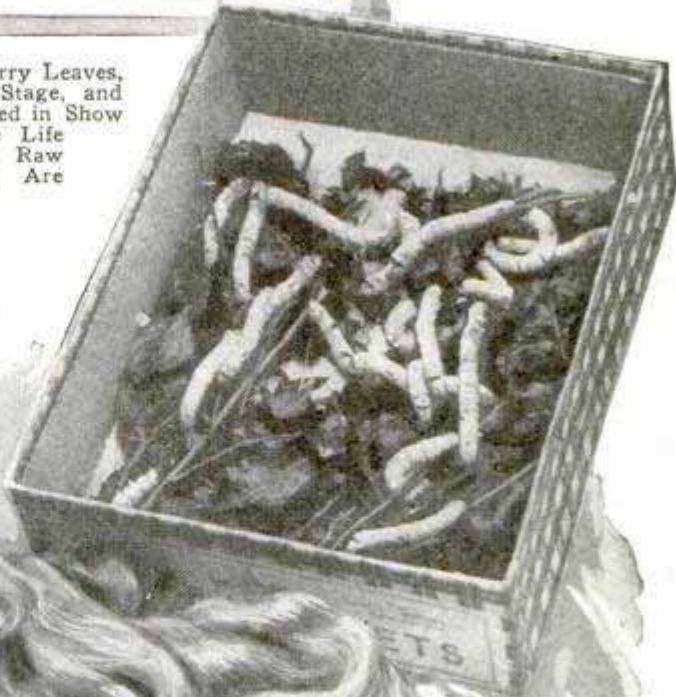
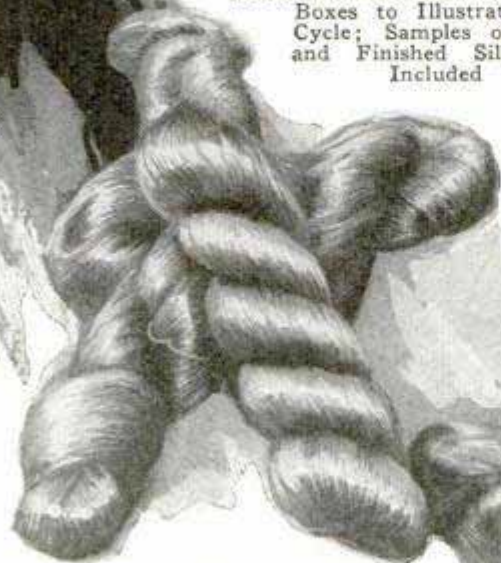

Worms Feeding on Mulberry Leaves and Samples of Commercial Silk; It Takes About Three and One-Fourth Pounds of Cocoons to Yield One Pound of Raw Silk, and One Pound of Raw Material Will Make Ten Yards of High-Quality Commercial Silk; Pierced Cocoons Are Not Suited to Reeling



a special oven where the temperature is 200 degrees or more. Exposure of cocoons for long periods to bright sunshine will also kill the chrysalis. Six hundred dried cocoons weigh one pound. However, it requires three and a fourth pounds of cocoons to yield one pound of raw silk. One pound of raw silk will make ten yards of high-quality commercial silk. Pierced cocoons from which the moths have emerged are unfit for reeling, but can be carded and made into thread.

So long as the industry is unprotected, silkworm culture cannot be commercialized successfully in this country. Mulberry leaves can be grown in profusion. Silkworms can be readily raised by the millions. But our wage scales and standards of life are too high to admit of an American working six days with a hand reel to produce four and a half pounds of silk—the average output of a skilled worker in China, Japan, France, Italy or Turkey. However, industrial sci-

Harvesting Leaves from Mulberry Trees to Feed the Worms, and Mounting Moths; This Is Done with Wings Distended to Display Brilliant Colors to Best Advantage in the Exhibition Life-Cycle Boxes

and colleges. Each exhibit is a true-size picture of the life cycle of the silkworm. It also features samples of raw and manufactured silk. Mr. Keleher raises rations for his silkworms on a dozen mulberry trees which he has grown to maturity in his backyard. He raises quantities of silkworms annually. He saves a certain amount of specimen material from each stage of the interesting worm's life cycle. The exercise of taxidermy skill converted these specimens into permanent educational relics from nature's matchless silk factory. In order to destroy the chrysalis within the cocoon, where the commercial extraction of the silk is contemplated, it is necessary to expose the cocoon for about two hours in



ence is now striving to solve the secret of how the silkworm converts mulberry leaves into silk. Artificial silk is made from spruce wood pulp and cotton linters.

This raw material is fed into a mechanical wizard and the artificial silk of commerce is delivered at the opposite end of the machine. Believing that an automatic silkworm can be invented which will convert mulberry leaves in similar manner into silk, scientists are now experimenting with that end in view.

**ELECTRICITY FOR FINDING ORES
SUPPLANTS MAGIC ROD**

Claims made for the forked twig and the witching stick as a means of finding precious metals have not been substantiated by careful tests, and the bureau of mines discredits their use, turning to electrical instruments as a more effective aid to prospecting. The work is still in the experimental stage but, in the opinion of mining men, will be valuable in the preliminary searching for metallic ores. In one system, instruments record the difference in potential of electrostatic or dynamic waves, either induced or pre-existing in ore bodies. After the differences have been observed at several points near the supposed ore area, an electrical field is plotted, at the center of which the deposit should be found. A portable apparatus is useful for prospectors or geologists in discovering new oil or gas fields. It is arranged to detect vapors as they reach the surface, determining whether they are of a natural-gas composition or hold heavier petroleum substance. In answer to many queries, the bureau of mines states that it is impossible to give advice as to instruments to aid in locating buried treasure.

*New York Times
12/6/25*

**BULLET-PROOF GASOLINE TANK
TO PROTECT AVIATORS**

Composed of two cylinders, one revolving inside of the other, a special gasoline tank for airplanes, tested at McCook field, did not leak after being struck by machine-gun bullets. It is said to be forty per cent lighter than other protected tanks of its kind, and is designed to be equipped with an automatic release so that it may be dropped from the plane in case of a crash, thus eliminating the danger of disastrous fires and explosions.

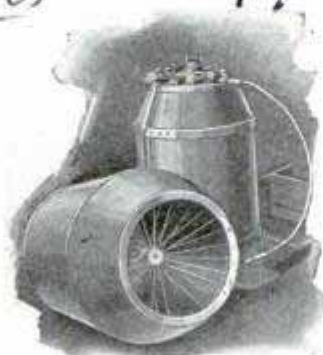

*A. W. - Mario Saragani
Pescara. Tested at*

**WRIST PAD FOR GOLF SCORE
WORN LIKE WATCH**

845

The task of keeping the golf score is simplified by a pad and pencil outfit worn like a wrist watch and neatly inclosed in a



Marking Up the Golf Score on Handy Pad Carried like Wrist Watch and Inclosed in Leather

leather case which is held in place with straps. Space is provided for the score of two players. It does not interfere with the stroke, can be made to match the rest of the golfing equipment and is always in position for reference.

**X-RAY IS USED TO DISCLOSE
FAULTS IN STEEL**

889

X-ray examinations of steel castings for big guns have disclosed hidden faults which might otherwise have escaped detection, with possibly fatal results when the piece was fired, it has just been revealed by the war department. In casting, metal bubbles sometimes form in the midst of the mass. Unless the cavities are reached in the turning and finishing processes they remain undiscovered. By applying X-ray examination, the government arsenal at Watertown has revealed hidden defects as large as two and a half inches in diameter. The special X-ray apparatus used in the work was perfected by the government, but is used for research and commercial work as well as in gun making. Steel equipment of a new high-pressure steam plant near Boston was tested at the arsenal to insure that no hidden defects would so weaken the metal as to cause it to burst when high-pressure steam was admitted.

*Report of Major Gen.
W. C. Williams,
Chief of Ordnance.*

Bureau of Mines

*Home Mfg Co
Ipswich, Mass*

571

Model Maker at His Bench; Constructing the Entire Miniature Requires Between 200 and 300 Hours and Special Tools



Left, Model Plane Mounted in Tunnel for Wind Test; the Air Is Drawn Past It at Varying Speeds, While Observers Check Its Balance, Lift and Resistance to the Air

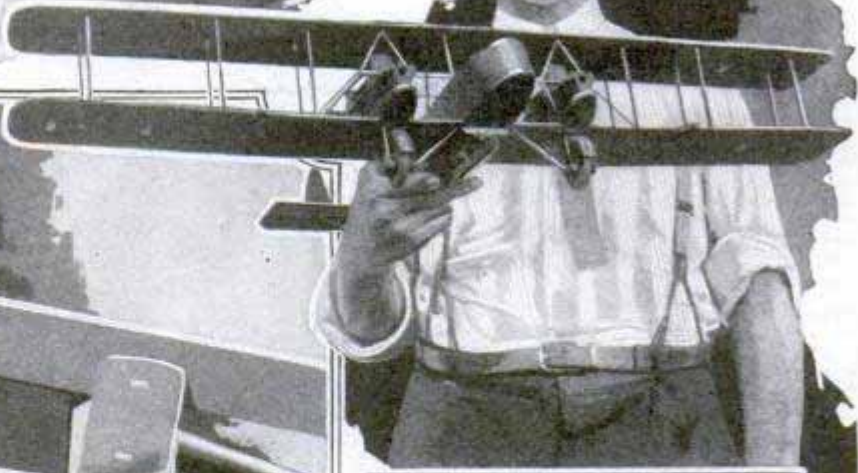
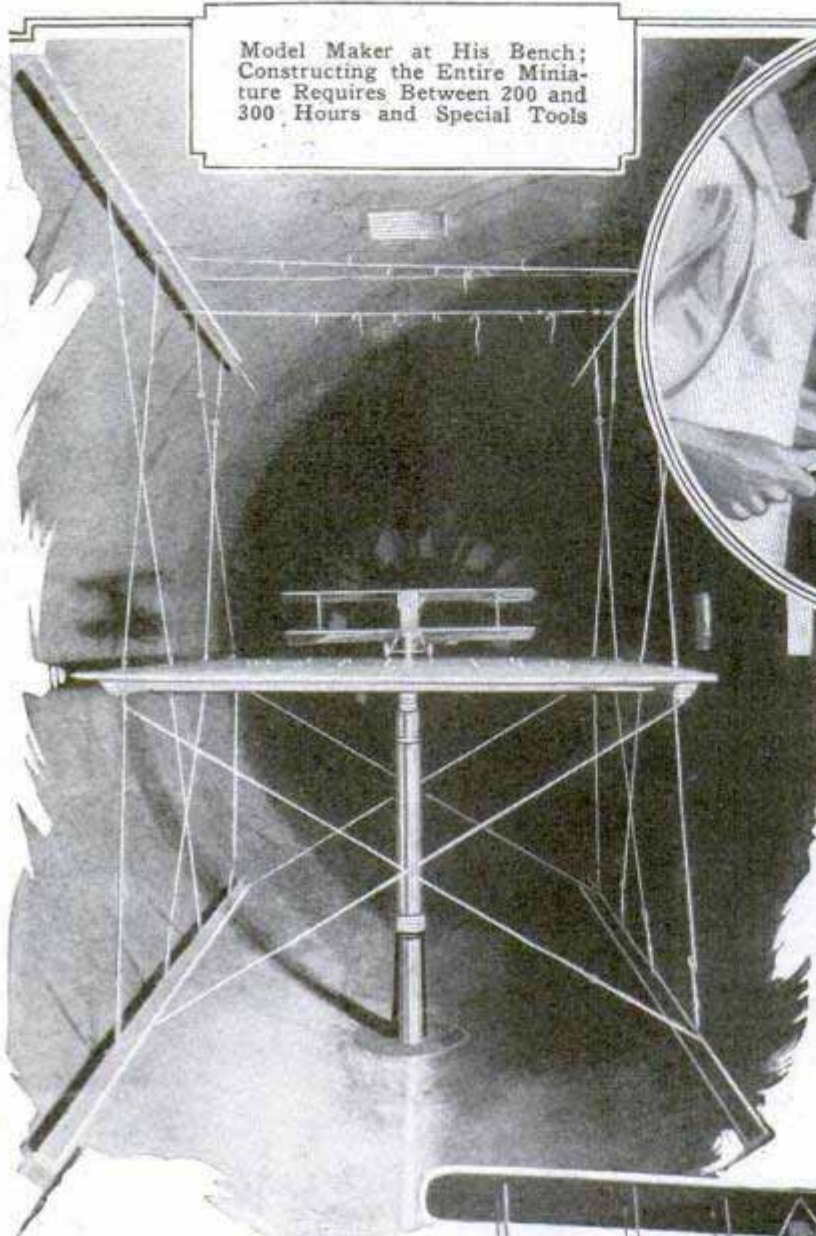

Scale Model of a Martin Bomber; Most of the Tiny Ships Are Built to One-Twenty-Fourth Full Size and Are Complete in Every Detail Except Motor; Left, Another View in the Workshop; Metal Templates Are Fashioned from Drawings and Parts for the Miniature Planes Exactly Copied

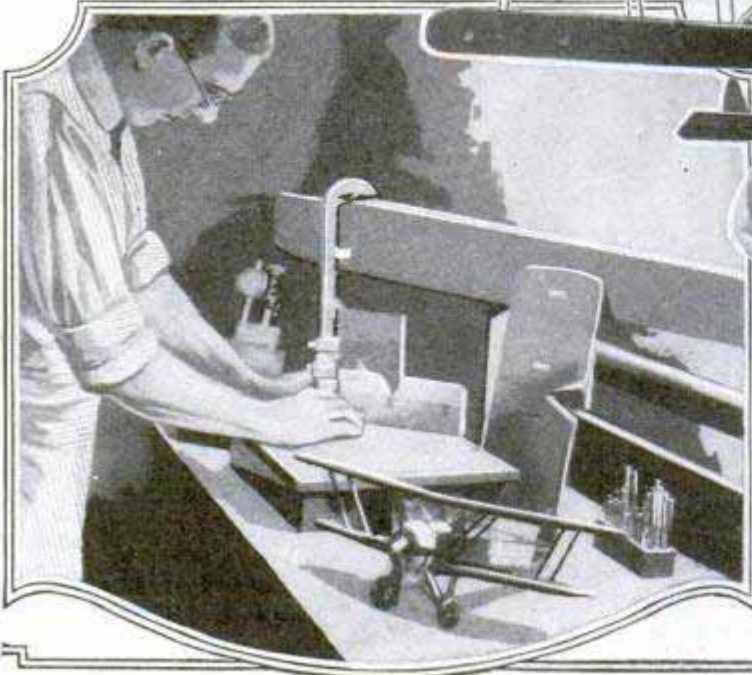



By TRUMAN B. MILLS, *Ed. 10#4
Dayton, Ohio.*

AIRPLANE-MODEL making has long been a fascinating pastime for persons mechanically inclined. It has, in fact, taken such a hold on popular fancy that many clubs have been formed throughout the country, the members of which make and fly their models for sport.

There is another kind of model, too, besides the one made for flying. That is the scale model made by the aeronautical engineer for wind-tunnel tests. These are built to be tested for the purpose of determining air resistance, the behavior of the plane in the air and for obtaining other similar data.

In days gone by, a man building an airplane first designed it on paper, then constructed a full-size model and tested it on a moving truck or in actual flight. Nowadays, the engineer simply makes a small-scale model of the plane, fastens it in a tunnel through which air is drawn simulating actual flying conditions, and puts the model through every test he could give it aloft. If any changes are to be made, they can be carried out in the model. When the model's performance in the wind tunnel has proved it satisfactory, the full-size plane is built. From these tests the engineer can forecast very accurately the behavior of the airplane itself, before it ever leaves the ground. Thus thousands of dollars are saved. The Wright brothers were the first to use the wind tunnel for practical purposes. They made many models and tested them out

before they actually attempted to launch their heavier-than-air machine.

At the engineering division of the United States army air service, McCook field, Dayton, Ohio, some of the best model makers in the world are daily at work preparing these miniature airplanes and parts for wind-tunnel tests. Experimental work at the field makes necessary the building and testing of hundreds of model machines and innumerable parts. These models are not made to fly. They are fashioned out of solid blocks of mahogany and metal, and in shape only do they resemble the full-size plane. In testing, they are held stationary in the tunnel while the air is drawn past them.

Visiting the model builder at his bench, a good idea may be gained as to how he goes about his interesting work. First, he gets an accurate drawing of the airplane with each part reduced, say to one-twenty-fourth of the full size. If the wing is twenty-four feet long, the drawing will show the model wing one foot in length. All other dimensions will be given accordingly, for building a one-twenty-fourth-scale model. From these drawings the model builder makes metal templates. Suppose he wants to make a wing. For this he uses a piece of aluminum alloy, cutting and filing it until it has a curvature on one edge that is an exact reproduction of the curve of the wing, or airfoil. The visitor will then see him plane a piece of mahogany down to the approx-

imate shape of the airfoil, and with scraper and file work the curvature of the

server to tell the lift and resistance down to one ten-thousandth of a pound of pres-

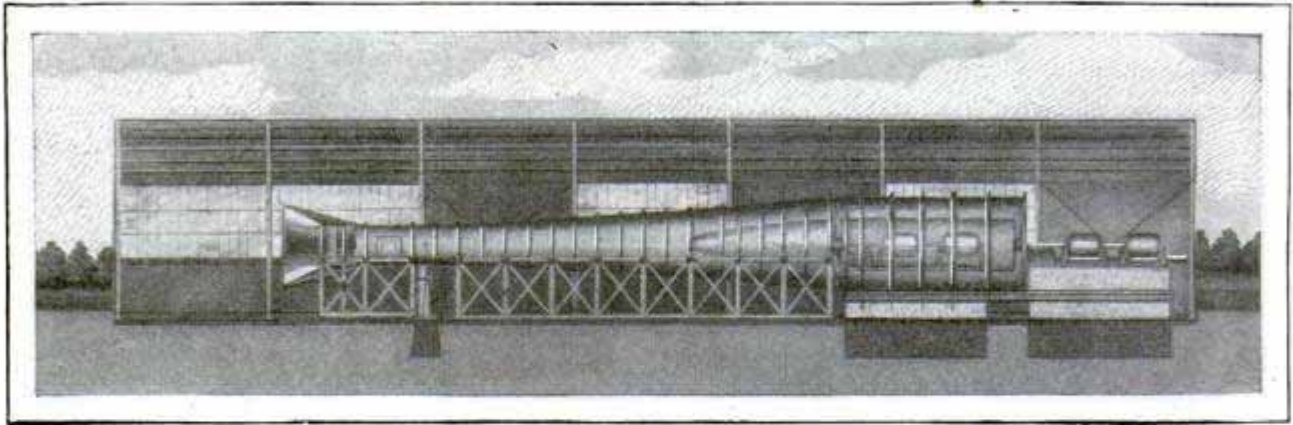

Cross Section of Wind Tunnel; at Right End, Motors That Drive Fans for Producing Artificial Breezes to Test Model Airplanes as Patterns for Real Ones

wood surface down to exact correspondence with the template's.

A special instrument, called the airfoil check gauge, has been devised for comparing the curvatures of the template and the airfoil with that given in the design. It checks the thickness of the wing to the thousandth of an inch. Together with the vernier height gauge and the micrometer, it enables the workman to do accurate model building. If the visitor pulls a hair out of his head, the model maker will measure its thickness. A hair is about two one-thousandths of an inch thick. By milling, scraping and filing, the model maker gets his piece of mahogany down to the exact size, allowing three to six-thousandths of an inch variation in wooden models. Metal models are checked to the thousandth of an inch.

Models built at McCook field have movable parts so that they may be adjusted in the wind tunnel to test their behavior in the air stream. Delicate balances in connection with the tunnel enable the ob-

sure. The McCook field wind tunnel is ninety-six feet long and has a testing throat eighteen feet in length and five feet in diameter. Here the models can be exposed to air streams of ten to 300 miles' velocity per hour.

MEMORIAL TO ROOSEVELT FEATURED BY FOUNTAIN

One of the designs submitted for the proposed memorial to Theodore Roosevelt in Washington, D. C., is distinguished by an electrically operated fountain which will project a shaft of water 200 feet high. From its base, symbolical ships point to the four points of the compass. The structure itself is of classical design, and is to be made of white granite. The proposed site is on the tidal basin on the line of Sixteenth street, projected southward from the White House. Two curving colonnades, each 670 feet long and sixty feet high, form a background to the fountain. They are intended to be set to east and

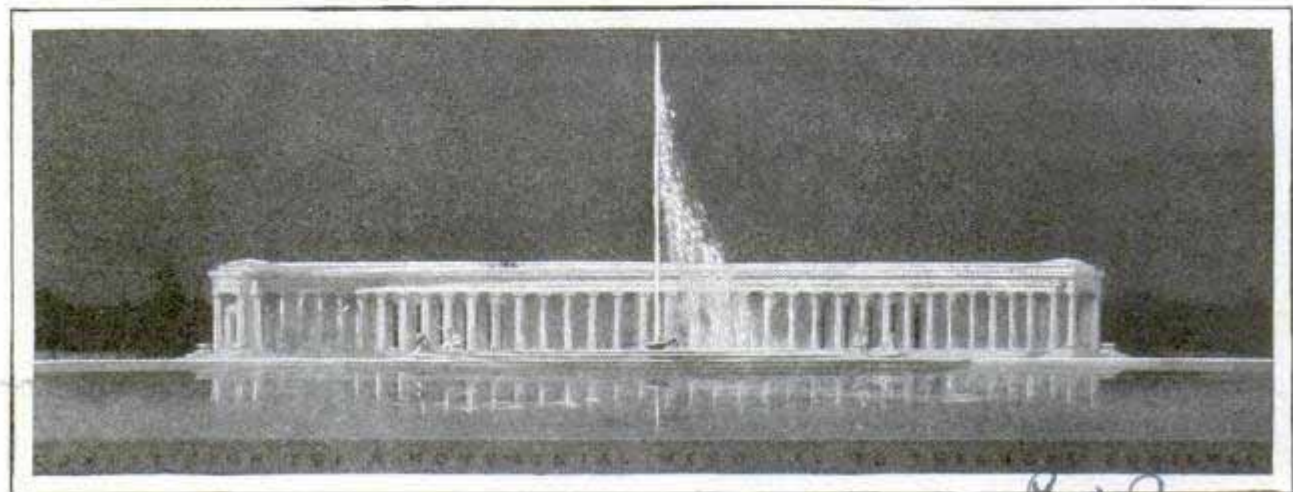

Drawing of Proposed Memorial to Roosevelt in Washington; the Central Fountain Will Throw Water 200 Feet High and Is Intended to Symbolize the Great American's Tireless Energy

west so that there will be no obstruction to the eye looking southward from the White House into Virginia. The style of architecture was chosen to harmonize with that of other structures in the capital. Water for the fountain will be taken from the Potomac river, which enters the basin, so that the supply will be independent of the city system.

VALUE OF HORSES MEASURED

BY PULL 896

Dynamometers, used for many years to measure the "horsepower" of gasoline, steam and electric engines, have been applied successfully to the measurement of the pulling power developed by live horses. As a result of the tests, new facts about the training and improvement of horses have been learned, according to officials of the Horse Association of America. Public pulling contests, in which the power of the horses was measured mechanically, have been held recently in five states. More than a quarter of a million farmers attended seventy-eight of the measuring contests. The idea that the horse has outlived its day is refuted by the association members, who insist that for some kinds of work the animal remains more economical than the motor truck. Congested traffic conditions, requiring frequent delays with motors running, and long waits at railroad sidings or piers, have run the cost of motor-truck operation up to the point where superior speed is more than offset by the excess expense. Well-built and strong-muscled horses, weighing from 1,550 to 1,700 pounds, are in demand for city cartage, and there is an actual shortage of them. One of the leaders in the association says that small farms must always be worked by horses or else abandoned.

*Meeting at Chicago
Dec. 2, 1925*

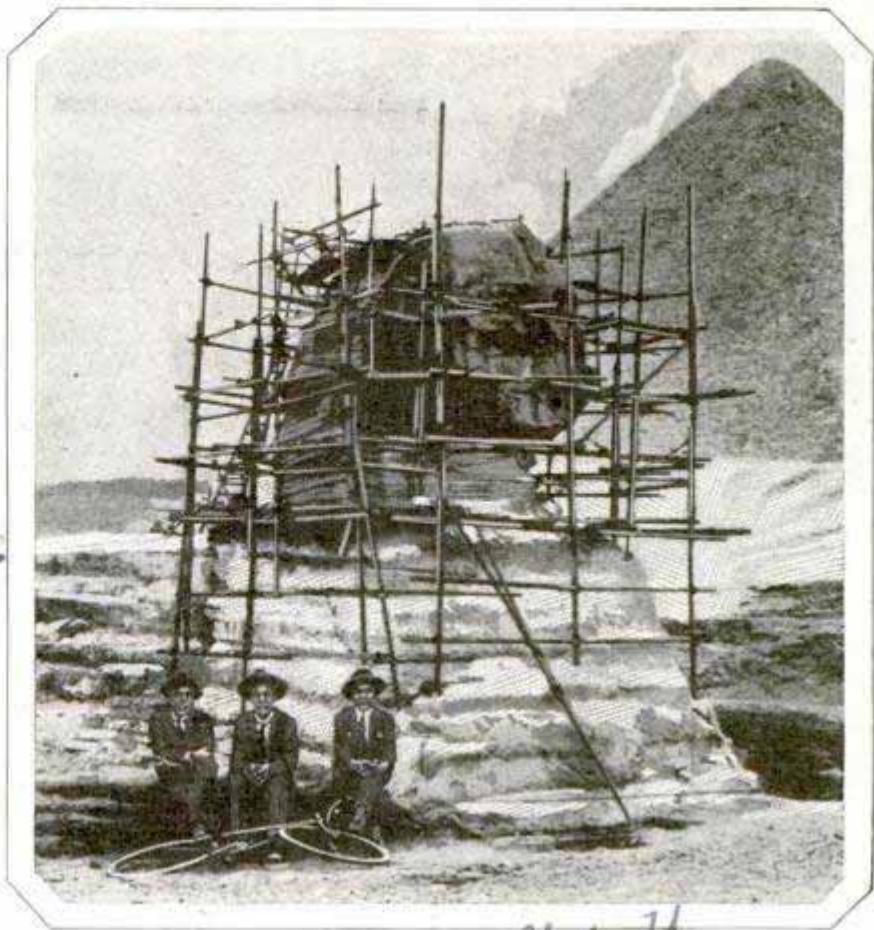

Modern Building Skill Enlisted to Preserve the Ancient Sphinx; Scaffolds Erected on Monument to Support Repair Men

BEAUTY DOCTORS TREAT SPHINX TO REPAIR TIME'S DAMAGE

To preserve the great Sphinx of Gizeh from further ravages of time, the Egyptian government has directed its department of antiquities to repair the monument. Scaffolding was erected and the huge stone face was carefully inspected and patched to prevent further wear.

BELT WITH CONCEALED SPRING INCREASES COMFORT 882

With a yielding spring hidden under the leather, a belt for men adjusts itself to motions of the body, prevents cramping and insures a better fit of the trousers. A sliding bar, to which the buckle is attached, is held against a spring that becomes compressed with extension of the bar and resumes its normal position when the tension ceases. The belt is specially suited to active pursuits such as bowling or tennis.



Leather of Belt Cut Away to Expose Spring Which Allows Buckle to Extend

*Woodward & Cochey
Mfr. Co., 76 W. Monroe, Chicago*

CLAMP FOR HOLDING BOARDS SERVES AS BENCH

830

Adjustable to many angles, a clamp to hold boards for planing, sawing or shaving, serves practically all the purposes of

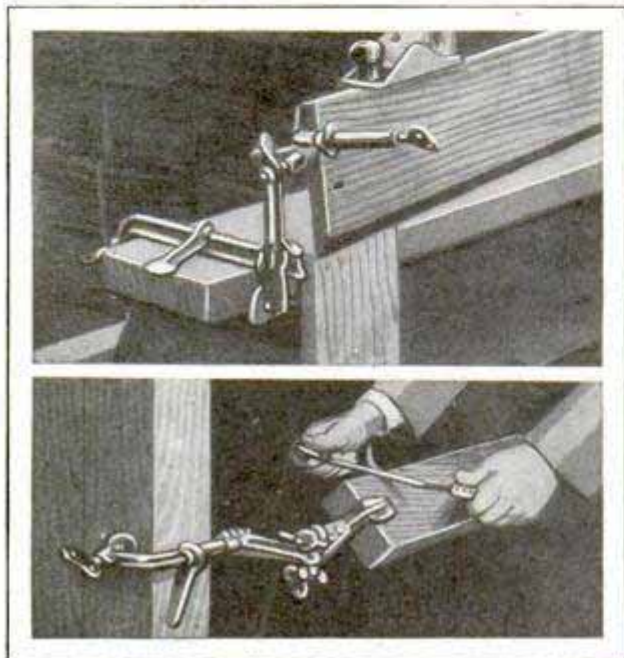

Illustrating How the Clamp Serves as Bench, and the Different Positions to Which It Is Adjusted

a carpenter's bench and permits full use of both hands. It can be attached almost anywhere and has an arm for bracing against a post or wall. The accessory is of special aid in making quick repairs on furniture or other articles.

BIRDS TAUGHT EVE TO SEW IS VIEW OF SURGEON

894

Adam and Eve learned the rudiments of the art of sewing from watching birds building their nests, in the opinion of Sir John Bland Sutton, British surgeon and scientist. According to Sir John, surgeons have been searching for many years for an ideal substance for stitching material to close wounds. Birds, plants, insects and other animals have been studied in the search for new ideas. In India, Brazil and Asia Minor ants have been used since remote antiquity to close wounds, he adds. The edges of the wound are

brought together and the ant, held, by forceps, applied. The ant opens its mandibles and grasps the edges, holding them tightly, and the body is then clipped off, leaving the mandibles in place.

THERMOMETER AIDS IN FISHING FOR COD AND HADDOCK

891

The whims of fisherman's luck have been reduced so far as cod and haddock are concerned by using the thermometer to test the temperature of the water and thus find places where the fish are most likely to be caught. By a thorough survey of the waters of the narrow channel which separates Labrador from Newfoundland, scientists found that the strait serves as a gigantic mixing machine for producing layers of tepid water. Here the codfish were discovered, for they are sensitive as to the temperatures, avoiding extremes in hot and cold. The observers patrolled more than 100 miles of the area, using specially constructed boats and taking frequent readings to chart the course of the currents. The cod were thickest in great pools of water at forty to fifty degrees at the two ends of the channel.

Science Service Bulletin

GROW STRAWBERRIES IN BOXES TO SAVE SPACE

848

Strawberry growers in Florida are able to produce large crops from small areas by raising the plants in boxes, one tier above the other. The leaves are exposed through holes in the sides of the beds. Each box has space for sixty vines and the task of picking the berries is simplified as they are within easy reach.

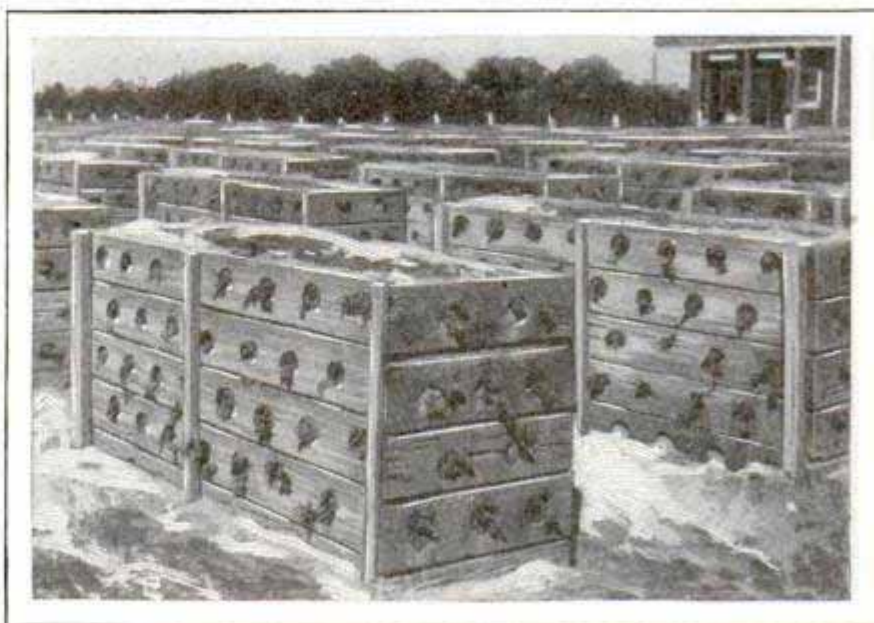

Growing Strawberry Vines in "Skyscraper" Garden in Florida; Each Box Has Room for Sixty Vines, Saving Much Ground Space

Chicago Daily News
12/8/25

National Gardens Florida

Photostatic Corp. 270 State St. Rochester, N.Y.

Camera Ends Drudgery in Keeping Records

Machine, Photographing Direct on Paper, Turns Out 640-Page Volume Every Three Hours at Immense Saving

DOING the work of thirty-five to forty stenographers and a dozen or more proofreaders, a wonder camera being installed in county offices throughout the country is saving the salaries of vast numbers of stenographers and "comparers" or proofreaders, expediting business by ending long delays in the writing of public records, and incidentally saving thousands of dollars for the taxpayers.

Capable of completing a 640-page record book every three hours, with photographs of documents on both sides of each page, the latest type of machine in one county completes five such books every two days, at a saving of several hundred dollars.

No films or plates are used in the photostat process, the pictures being taken direct on sensitized paper, and the resulting photograph is a negative with the black writing of the original document appearing in white, and the white paper black.

When an attorney or other person calls for a copy of a document from the record files, however, the book is placed under the camera lights and another picture taken, a negative of the book negative, or in other words a positive picture, just like the original, with black writing on a white background.

The advantage of the photostat process, aside from speed and saving of money, lies in the elimination of all chance for typographical errors or omissions in copying, and the preservation of facsimiles of all signatures.

The machine is a highly specialized apparatus developed for the one purpose, and a single unit, with its mercury-vapor lights and other equipment and an attached dark room for developing the prints, costs a couple of thousand dollars.

Special paper, coated with photographic emulsion on both sides of a high-grade linen bond, is used. The paper comes in rolls 350 feet long, which are placed on a giant spool just as films are put in a camera. The operator inserts a paper to be copied under the lights, presses a foot lever which opens and closes the lens, then removes the copied paper and substitute the next one, at the same time pressing another lever with the other foot. The second pressure revolves the spool and paper holder and brings the paper into position for exposing the reversed side, the movement taking place while the operator is placing the next sheet in the copyholder. Then the process is repeated, the copy made, and the paper holder revolved again, but this time the strip is automatically fed down from the holder, the exposed sheet cut off, and dropped through a chute into the dark room, where the developer completes the process. Cook county, Illinois, several years ago pioneered in adopting the photographic process for county records. Wayne county, Michigan, including the city of Detroit, Kenosha county, Wisconsin, and

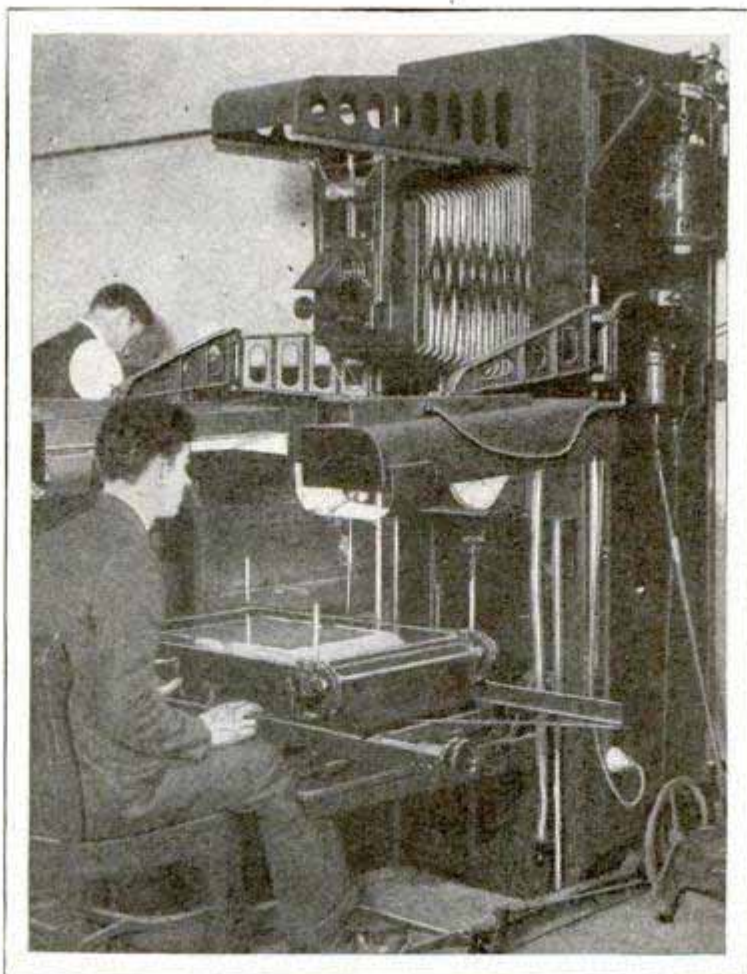

Copying from the Black Pages of a Photostatic Record Book, a Process Which Produces a Picture in Black on White

123 W. Madison St. Chicago.

From Ancient Books,
Laboriously Written
by Hand, through the
Book - Typewriter
Process, in the Center,
to the Latest
Model Photo-
static Records

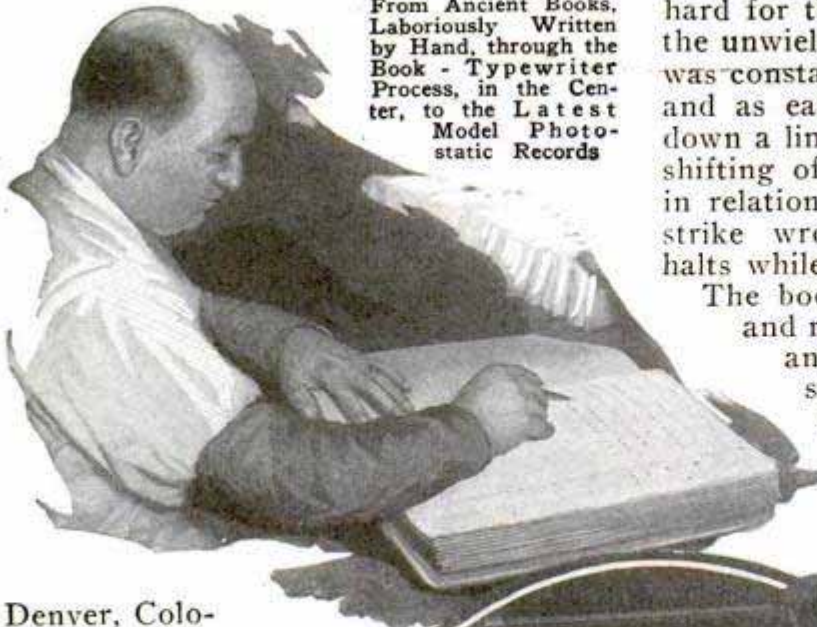

Denver, Colorado, have recently followed, and others are taking the same step. Cook-county records are now maintained with more than 400 less employes than the typewriting process required, and at the same time it has been made possible to get a copy of any document on record within a few days, instead of waiting as long as eight months after the order was placed. The system of recording has been more than ten years in developing, but it is only within the past two years that it has reached a fully perfected state.

The transition from all hand-written books to photostat records has been made in less than a century. Back in the nineties, when the first book-typing machine was invented, it was hailed as an enormous advance. The book typewriter reversed the usual typing process—instead of paper, carried in a roll feeding across the typewriter as each letter was depressed, the paper came ready bound in book form, the book was opened, and the typewriter, placed on top of it, moved across the page. It was rather

hard for the typist to work up speed on the unwieldy outfit, because the keyboard was constantly moving from left to right, and as each line was completed moved down a line nearer to her. The constant shifting of the position of the keyboard in relation to her body made it easy to strike wrong keys, requiring frequent halts while corrections were being made.

The book typewriter required a large and rigid metal table, long slide bars and feed screws to guide it, and several square feet of floor space. One of them took up almost as much room as a photostat machine, and the output of a single typist on legal-size records was not more than forty or fifty pages a day.

Compared to that, a trained operator after a bit of practice can turn out as high as 2,000 photostat pages in an eight-hour day, while 1,500 to 1,800 pages are common. The machine differs in many respects from any other camera. The work to be copied lies on a flat table, under a glass which keeps it pressed flat, and with mercury-vapor lights on either side focused on it.

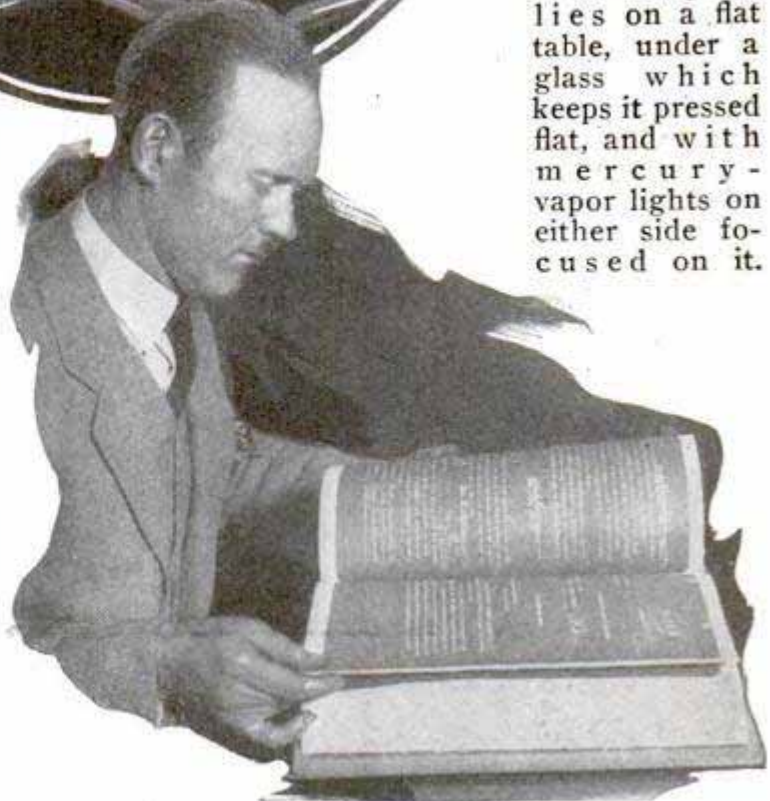

710

The camera lens is directly above, but as the camera is horizontal it is necessary for the light to turn a right angle to enter the lens, the turn being accomplished by a reflecting prism at an angle of forty-five degrees.

As a camera lens reverses the image it sees, turning it not only upside down but from left to right, a picture taken direct on sensitive paper, as in the photostat, could only be read by holding it in front of a mirror, unless something was done to correct the reversal of the light rays. A compound refraction is necessary to unscramble the mix-up of light rays after they pass through the lens, and this is accomplished by a specially designed prism.

After the picture is exposed, the paper wound down and automatically cut off, the strip drops through a door into the dark room and is developed, fixed

Operator Developing Double-Sided Pictures, Top; Placing Document to Be Copied beneath the Lens, Center; and Adjusting Roll of Photographic Paper in Machine

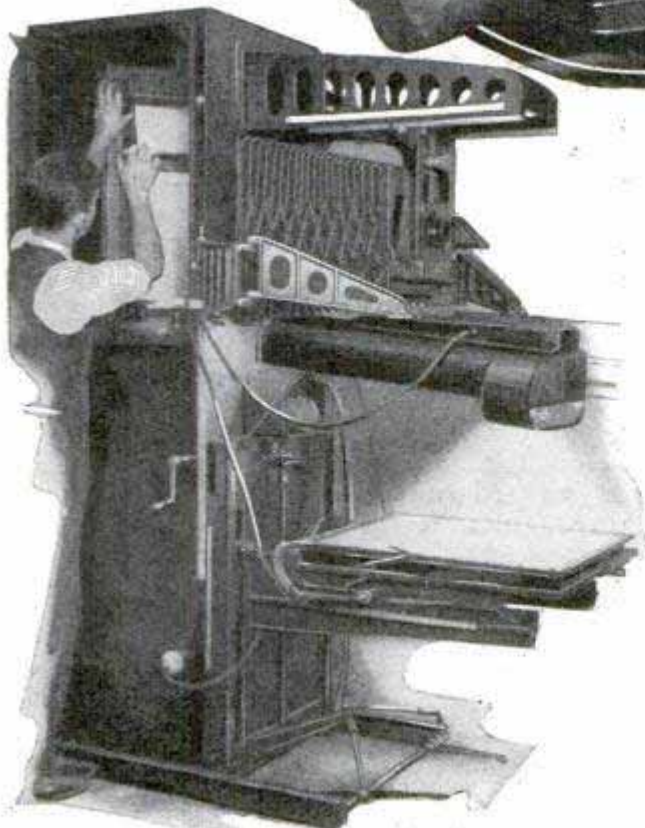
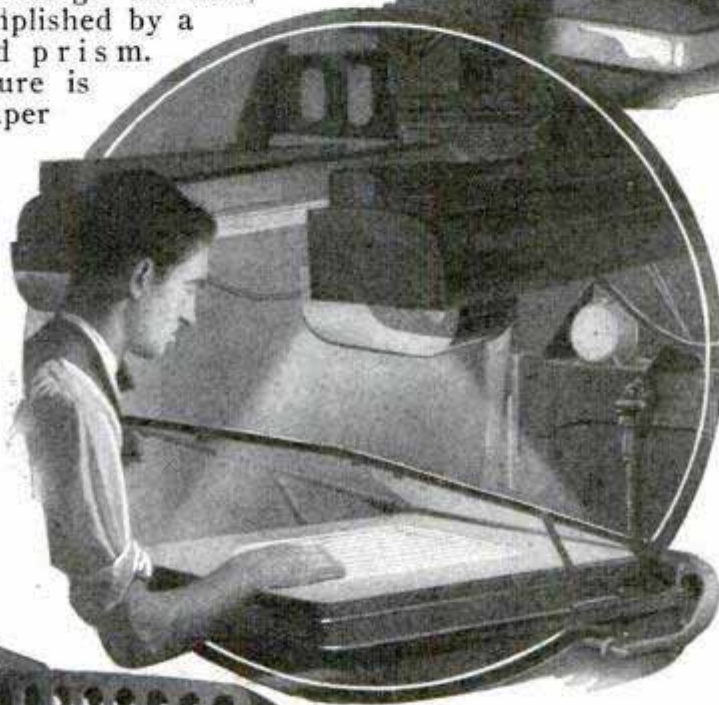

and washed in the usual way. If properly fixed like any other picture, it will not fade, forming a permanent record.

Where this system is used in public-record offices, papers are received, dated, stamped and indexed in the usual manner, but, while formerly they were turned over to the folio writers for copying, they are

sent to the photographic department instead. Here the original documents are stamped with book and page numbers. Thus copy and original always bear the same numbers and there can be no mistake. Furthermore, by the preservation of the individuality and identity of the original instrument, the register of deeds is relieved of the responsibility attendant upon copying of illegible handwriting, and only one or two series of books are needed.

COURSE OF ISRAEL'S EXODUS NOW SPANNED BY PHONES 879

Telephone wires now stretch across the Sinai desert over which Moses and Aaron led the Children of Israel. Long-distance service is available between Egypt and Palestine so that persons in the principal cities of the Holy Land, Jerusalem and Haifa, can talk to Cairo, Alexandria and Port Said in the land of the Pharaohs.

New York Herald
12/5/25

Made in Europe
no other data

Questions and
Answers.
POPULAR MECHANICS

ELECTRIC FINGER-NAIL BUFFER GIVES HIGH POLISH

847

Run by electricity from the lighting circuit, a rotary finger-nail buffer saves time



Acme

Electric Finger-Nail Buffer in Action; Pressure against Cloth Produces High Polish

in making the toilet and gives any degree of polish desired. Special pads fit on top of the revolving shaft and slight pressure of the nail against them is sufficient. The polisher requires but little current and occupies small space when not in use.

TUNNEL MILES THROUGH ROCK TO DIVERT RIVER

Engineers have started the task of drilling a tunnel, 19,400 feet long, through solid granite near Fresno, Calif., to lead King's river through a mountain and then let it out 2,470 feet above the level of the present stream bed. The drop, down a penstock 4,760 feet long, will turn water-wheel turbines in a large plant that will have a capacity of 160,000 horsepower. The completed tunnel will supply 720 cubic feet of water a second from a diversion dam sixty feet high and 220 feet long. The penstock is to be sixty inches in diameter at the inlet, gradually decreasing to forty-four inches at the outlet. Water will leave the opening at a velocity of 360 feet a second and will develop 20,000 horsepower in each wheel. The

New York Times
12/6/25

Kings River Canyon

penstock is to be held to the side of the mountain with huge concrete blocks, the largest weighing 1,650,000 pounds. Men and supplies are carried to the scene of the construction on an inclined electric railway. Future installations are planned which will increase the amount of electricity developed at the plant to 500,000 horsepower.

843

THE "WORLD'S BIGGEST"

While the Eiffel tower in Paris is the highest structure in the world, topping the cross on St. Paul's cathedral, London, by 580 feet, the distinction of being the world's tallest building still belongs to the Woolworth building, which is 792 feet above the pavement and 120 feet below it. In bulk, however, it is surpassed by the Equitable building in New York, which has 1,000 offices on its forty floors, providing accommodations for 15,000 persons. The Statue of Liberty is not the largest monument in the world as is often supposed, for the Sphinx in Egypt surpasses it, being 189 feet long with a face fourteen feet wide. The largest telescope in the world is at Mount Wilson observatory in California, and there are four and one-half tons of glass in the mirror. Ten years were required to grind and polish it.

PUSH COCK FOR AUTO RADIATOR SIMPLIFIES DRAINING

A push cock, to replace the petcock used to drain automobile radiators or crankcases, fits the standard threads on several makes of cars, yet will drain a radiator in one-fourth the time, due to a larger opening. The device consists of only two parts, a tube threaded at one end to screw in place of the petcock, and a sealing plug, tapered to seat tightly in the barrel. To open the cock, a small brass ring depending below the barrel is pushed upward, unseating the plug. Unlike petcocks, which frequently require pliers to twist them loose from accumulated rust and dirt, the plug is easily opened, and can be pushed up with a stick without the necessity of stooping or crawling under the car.



Loomis-Potts Co., Inc.
1012 B Baltimore Ave.

**PHONE REPLACES
TELEGRAPH KEY
ON RAILWAYS** 138

The tick of the telegraph is being supplanted by the telephone buzzer or bell in transmitting train orders, recent reports disclose, more than fifty-four per cent of the railroad mileage of the country being directed by voice over the wires instead of by key and sounder. Greater certainty and flexibility are claimed for the telephone since it has the advantage of person-to-person contact between headquarters and station operators and does not require special skill. On some lines, the telegraph is now used only for sending certain routine dispatches.

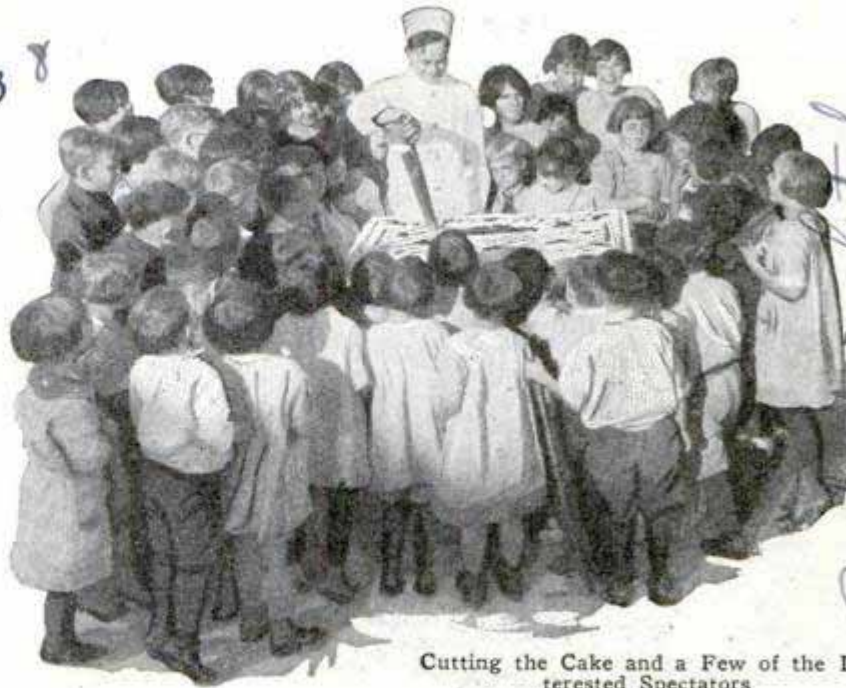

Cutting the Cake and a Few of the Interested Spectators

**THREE-HUNDRED-POUND CAKE
BAKED FOR CHILDREN** '770

Containing seven boxes of apples, 180 pounds of dough, fifty pounds of sugar and ten pounds of butter, a huge cake was baked for the children in a western nursery recently. It was forty-three inches long, two feet wide and eight inches thick. There was more than enough to go around.

**RADIO MEN RISK THEIR LIVES
TO BROADCAST CHIMES** 803

Radio fans, seated comfortably at their homes and listening to the mellow music of chimes broadcast from churches, perhaps do not realize that in some cases, nerve and skill are required in placing the microphones on lofty steeples where the sounds of the bells will be received most favorably. This is true of the Park Avenue Baptist church in New York City,

where melodies from the fifty-three-bell carillon are picked up on carefully adjusted microphones and broadcast by station WJZ. The radio men had to climb on narrow girders and over pinnacles of stone to set and connect the instruments to the station. One of the problems of the task is to find the place best suited to catching tones from the various bells without obscuring any of them or drowning out the smaller ones.

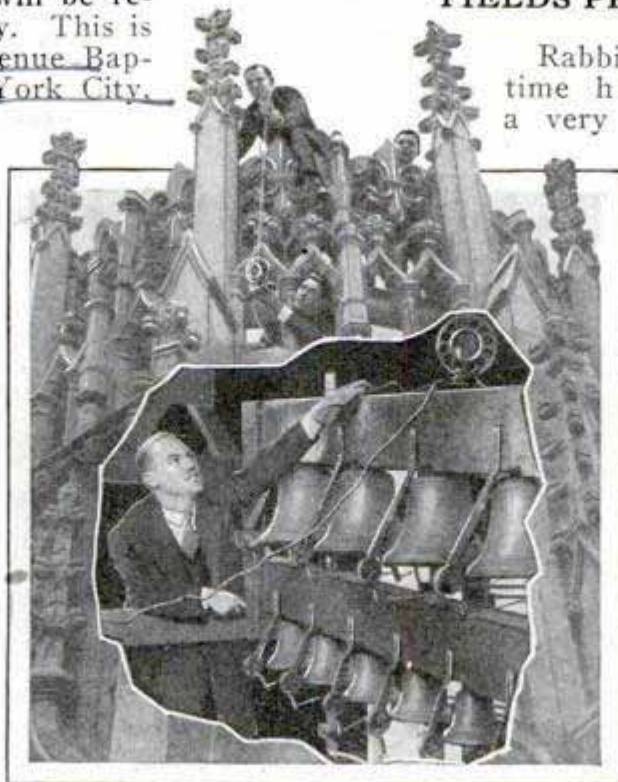

Climbing the Steeple, and Inset Showing Microphone Ready to Pick Up Carillon Music

**RABBIT PEST IN NEW ZEALAND
YIELDS PROFIT IN FUR** 670

Rabbits, which for a long time have been considered a very destructive pest in New Zealand because of their inroads on growing crops, have become a source of profit. Their fur, properly dyed, has proved to be a desirable substitute for the more expensive varieties. Last year, 18,500,000 rabbit skins valued at more than \$4,000,000, were exported from that country to the United States and to England. Trapping the animals has become a paying business. The opossum is also sought for its skin.

Baked in kitchen of Southern Pacific.
San Francisco Nursery for Homeless Children

New York Herald
10/30/25

James O. Ballantyne
Nelson, B. E.

**RADIO SET TUNES BY KEYBOARD
WITHOUT USE OF DIALS**

787

Pushing buttons on a small keyboard tunes a radio receiving set to various sta-



Demonstrating Remote-Control Radio Receiver Which Is Tuned by Pushing Buttons on Separate Panel

tions, no dials or knobs being employed. With this arrangement, the control could be placed in one room and the set in another or the user could manipulate the keyboard without leaving his chair.

**TROUBLE FINDER FOR AUTOS
LOCATES KNOCKS**

837

Without tearing down the motor, leaks in cylinders and knocks arising from worn wristpins, pistons or bearings can be located quickly by using a patented trouble finder now on the market. It consists mainly of a short length of hose with a pressure gauge in the center and a plug connection which is screwed into the cylinder in place of the spark plug. In making a test for compression, for instance, air is applied, after the piston has been locked on half stroke, up to fifty or sixty pounds' pressure. If the cylinder is leaky, the rapid falling of the needle in the air gauge will indicate it when the supply is cut off. The exact location of the leak can then be found by removing exhaust and intake manifolds and the cap from the oil-filling vent. Leaky valves will be indicated by an escape of air through the valve ports. If the trouble lies in defective pistons or rings, air will be driven into the crankcase, where it can be detected at the oil-filling vent. To locate knocks, a valve cap is placed on the upper open-

ing of the tester plug and a pump connected to the other opening. While operating the pump slowly and listening carefully, a loose wristpin, piston or connecting rod in the cylinder can be located.

**BEES SENT SOUTH FOR WINTER
FOR TWO CROPS OF HONEY**

To induce his bees to gather two crops of honey annually instead of one, a British Columbia man has sent several hives to New Zealand for the winter. Their arrival was timed to coincide with the beginning of summer in the southern hemisphere, and after their voyage almost the entire length of the Pacific ocean, the bees were expected to emerge from their hives for the blossoming fields of their new home. Thirty pounds of workers and ten queens were included in the shipment.

**ARMORED CAGE ON MAIL TRUCK
PROTECTS THE DRIVER**

Not content with merely protecting the mails, the postal authorities have designed an armored truck to guard the driver from bandit attacks. The chauffeur sits in a cabin with heavy doors on each side, a windshield of bullet-proof glass, and protection behind. The entire truck is armored throughout. Small openings in the doors permit the driver to give arm-

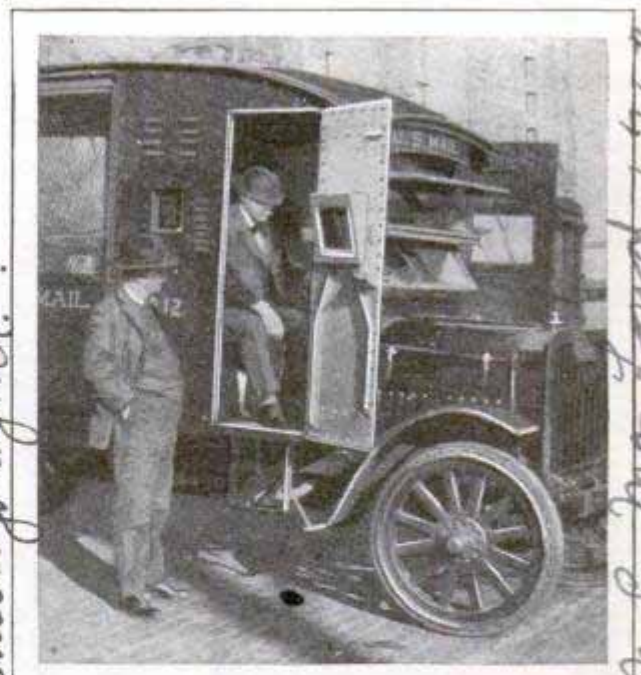

Door of Armored Mail Truck Open Showing Porthole; Windshields Are of Bullet-Proof Glass

signals. Vehicles of this type are to be placed in service in several large cities according to present plans.

The Borchardt Trouble Finder Co.,
Highmore, S. D.

Chicago agent

Paul D. St. Albans, Md.

The Voices of Ships



Raido

By BOYDEN SPARKES,

17 W. 42nd St. New York City.

HIGH adventure is the lot of the young men who go to sea as wireless operators. Only a small part of their compensation is tucked into their pay envelopes. Their best reward comes in the shape of thrills in a world they know to be as wild and unruly as when Kidd and Morgan sailed the Spanish Main.

In every rescue at sea, in every revolution on shore, in every mutiny, in every exploration about the icy poles, at least one of them is a participant, and those who are not are listening constantly to the electric whispers that tell of these exciting occurrences.

Consider the story of the "Ignazio Florio," an Italian freighter; the "Elven," a 6,500-ton freighter with a crew of thirty-two hardy Norsemen, and the "President Harding," one of the biggest American liners. October gales were sweeping over the steamer routes. Huge liners were limping into port a day or two days late, with lifeboats and superstructure smashed, passengers injured and veteran skippers proclaiming the gale the worst in their experience.

Out in mid-Atlantic, the "President Harding" was battling westward at reduced speed, shipping seas mountain-high. In the radio shack the operator was going through the usual routine, when out of the ether came a message filled with possible tragedy:

"SOS... SOS Lat 49:55N. Long 38:16 BROKEN STEERING ENGINE."

A messenger dashed to the bridge and handed the slip of paper to Capt. Paul C. Grening. "Rec'd 12:45," he automatically noted on the blank, and turned to his chart. In four minutes he had located the position of the disabled ship, spun the huge liner around on the new course and written a message to the injured freighter, which later proved to be the "Ignazio Florio." Within five minutes the air was full of messages. Ships for hundreds of miles around had picked up the SOS and were replying. The Norwegian tramp steamer "Elven," barely making two knots against the storm, sent back a cheery message that she was on her way. The "Lorain," "Portland Maru," "Ivergoil" and "Cadore," as well as the "President Harding" responded, but when the exchange of positions disclosed that the American liner and the little Norse freighter were nearest and could reach the scene first, the others decided to hold on to their original courses.

Through the afternoon and night the fight against the gale continued. At 10:00 p.m., the master of the fast sinking ship wirelessly the "Harding," which was making the fastest progress:

"We trust only in you, as we cannot remain a long time on ship. All lifeboats are broken. SOS. Master."

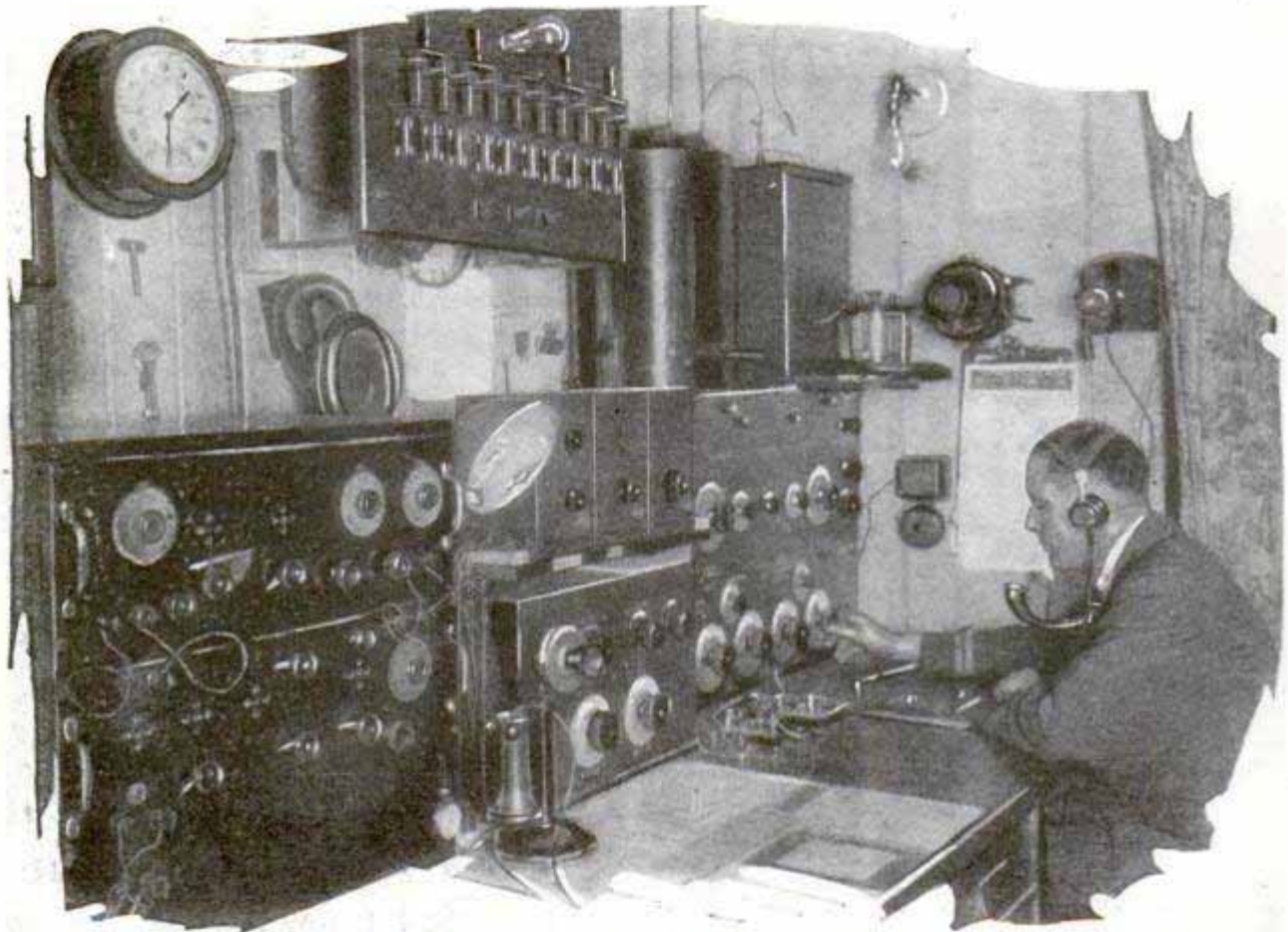

Wireless Room on the "America," One of the Liners on the New York-Bremen Run; the Operators Are Connected with the Bridge and Other Parts of the Ship by Telephone Service

As dawn broke through the murky clouds the "Harding's" men scanned the seas, but saw no trace of the "Florio." Capt. Grening wirelessly asked if there were any signal rockets aboard. Five minutes later "Sparks" in his radio shack picked up the reply: "We are firing rockets now. Do you see us?"

Then happened one of the strangest events in the history of the sea. Two minutes after that message, the "Florio" broke in again with, "A ship is passing us now. Is that you? He does not stop."

In that report is the whole incident. The "Florio" was so close she could see the passing ship, yet the stranger went on, unheeding the flaring rockets and disappeared in the mist. Probably no one will ever know what ship it was. The "Florio" and "Harding" both tried to raise the wireless operator of the stranger, but neither got an answer.

At 2:00 p.m., more than twenty-four hours after the first SOS, the liner sighted the ship—and then the radio went dead. The seas were getting higher, and for three hours both operators clicked vainly away without an answer, while the "Harding" maneuvered to get a lifeboat over the side and attempt to float the empty

craft down to the disabled ship, at the end of a line. The boat was smashed by a wave. Efforts to shoot lines aboard failed, and as the storm increased, the ships frequently became separated in the fast-growing darkness.

Just at five o'clock, radio communication was restored with a despairing cry from the "Florio": "Are you abandoning us? We are ready to come to you."

"We are standing by. Do not worry. Courage," flashed back through the air. Another lifeboat was launched and the Italian crew advised to stand ready to jump aboard as it drifted by, but the answer came back, "Boat is always too far away."

"Do not worry," the air carried back from Capt. Grening. "We will not leave you. Will you please put lights on your mast that we may be able to see you during the night. We will stay with you until the weather gets more moderate."

At dawn the wind dropped and the seas fell. The volunteer rescuers sprang into the lifeboat—so many that two had to be sent back because they were not needed. As they pulled away, the operator on the "Florio" wirelessly: "I am leaving my post for a few minutes to get my life

belt." He was gone seven minutes, then came his message, "Back on the job again." He had been at work continuously for more than seventy hours.

That is the story of the "Ignazio Florio" and the "President Harding," but the yarn of the "Elven" remains to be told. Despite the fact that the faster liner could get to the rescue first, the "Elven" continued doggedly on her way and arrived just as the "Harding" took the Italian crew aboard, then she turned about and resumed her course. Three days later, still battling the same gale, the Norsemen cried for the same aid they had been ready to give. Pounded for hours while bucking the head seas to go to the "Florio," the Norwegian boat had been weakened, until finally a sea, larger than the rest, ripped her apart be-



Lifeboat of the "President Harding" Taking Off the Crew of the "Ignazio Florio," Above, and the Doomed Italian Freighter as It Appeared from the "Harding's" Deck



yond repair. Capt. Jens Marcussen surveyed the damage and wrote out his own SOS, which was picked up by the "American Trader," 175 miles away, westbound for America. She turned in her course, started back and finally rescued the thirty-two men in the crew.

That is the life of a wireless man at sea when storms rage. Consider now the story from the diary of Marcel de Velez, born a Mexican, but an American at heart in the traditions of the American radio service.

Drunken "vivas," the bang, bang, bang of automatic forty-fives, rifle shots and the disquieting crash of broken glass could be heard along the waterfront. Some women screamed.

Then there came a thunder caused by the frantic lowering of bullet-proof shutters on the shop windows, as the sadly experienced merchants transformed their buildings into timid fortresses. Manzanillo was indulging in the enthusiasm of rebellion. It had come as quickly as one of the tropical rains.

Aboard the steamship "Coahuila" there was a tiny oasis of neutrality in the wireless shack. The apparatus there was American-owned. Its inhabitant, the only man in the ship's company who knew how to employ its magic, was de Velez.

The ship was tied up near the cavernous warehouses of the port. De Velez, standing in the doorway of the shack on the after part of the ship, observed the captain, Lopez Fuentes, striding along the deck toward the stern, where the red, green and white flag was fluttering in the sticky breeze.

Capt. Fuentes took hold of the halyards of that emblem, shook them free of the cleat and hauled down the flag. He had turned rebel and was "taking" his ship. Having lowered the flag, he promptly raised it. It was an act like that bold signature John Hancock sprawled across the Declaration of Independence.

The wireless operator adjusted his headphones and sent out a call to San Francisco for instructions. In a surprisingly short time he got them. They were curtly definite:

"Stand by your ship as long as possible."

Manzanillo was then entirely cut off from the rest of the world except for the skill in the hand and brain of that young American wireless operator. The captain ordered him not to accept any messages unless they were O.K.'d by him, but when the American consul who had important messages dealing with the safety of Americans in the interior, came aboard, de Velez remembered that he was first of all an American; and so, without consulting the captain, he sent some messages to the state department at Washington.

American refugees were beginning to pour into the town. The consul, through de Velez, sent out a call over the Pacific for ships to take these people out of the danger zone. They got three Pacific-mail passenger ships and one army transport. Later de Velez was informed by the operator of a mail steamer just leaving Mazatlan, far up the coast, that the federal gunboat "Progreso" was getting under way and had instructions to attack Manzanillo. De Velez hurried with this information to Capt. Fuentes, who took his ship to sea without even waiting to gather up half of his crew that was scattered about the town.

De Velez later received a message from the American consul for transmission to the American warship "Milwaukee." The Americans congregated in Manzanillo were fearful of coming events. Then the

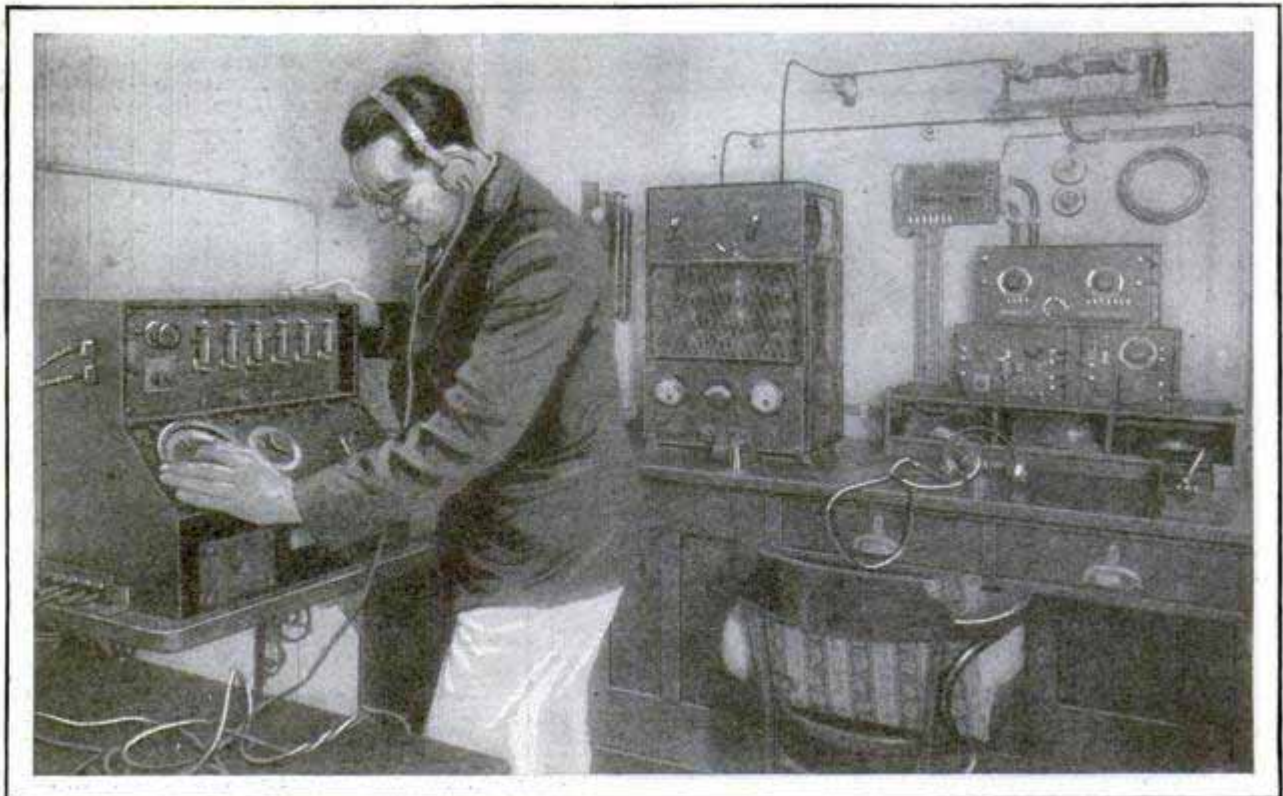

The Wireless "Shack" of an English Boat; the Sea-Going Operators Have Comfortable and Roomy Quarters and Their Apparatus Usually Is of the Best Make Obtainable

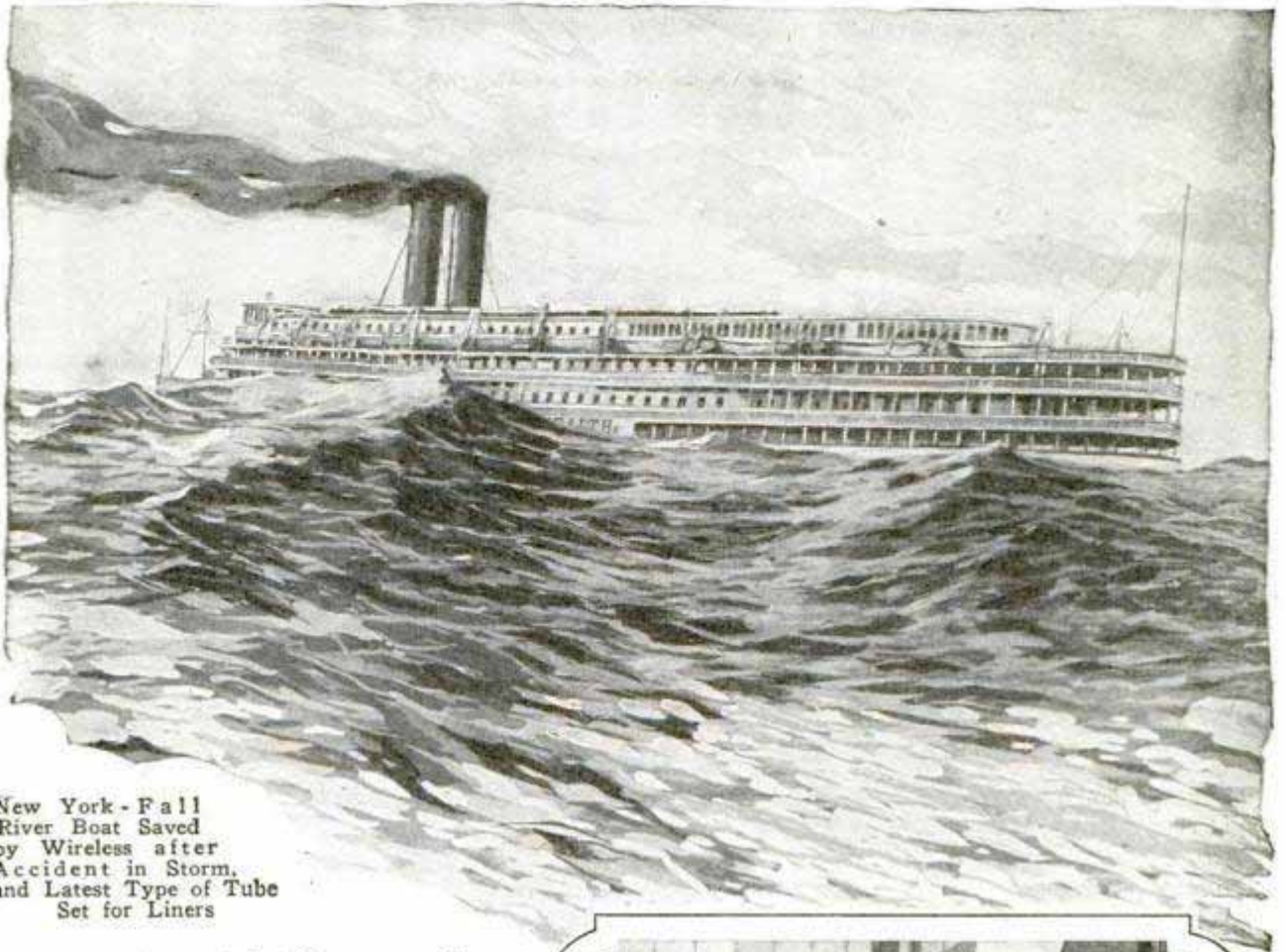

New York - Fall
River Boat Saved
by Wireless after
Accident in Storm,
and Latest Type of Tube
Set for Liners

operator aboard the "Progreso," which Fuentes had captured, ordered de Velez to stop sending. He kept on. A boat came alongside with another similar order. He continued to send. Then there came a peremptory message from Fuentes, who had been made an admiral. An officer came to the radio shack.

"Senor—"

De Velez sent three more words. He had finished. Then he turned around on his swivel seat.

"I shall send no more, Com-mandante." Even as he spoke, into his ear was pouring a mes-sage from the "Milwaukee." She was changing her course and was steaming for Manzanillo.

After that de Velez was made to dismantle his wireless and take it ashore. He went cheer-fully enough, for he had stood by the ship "as long as possible."

Three weeks later the rebels were driven out of Coahuila and "Admiral" Fuentes, de Velez' old commander, was placed against a wall and shot.

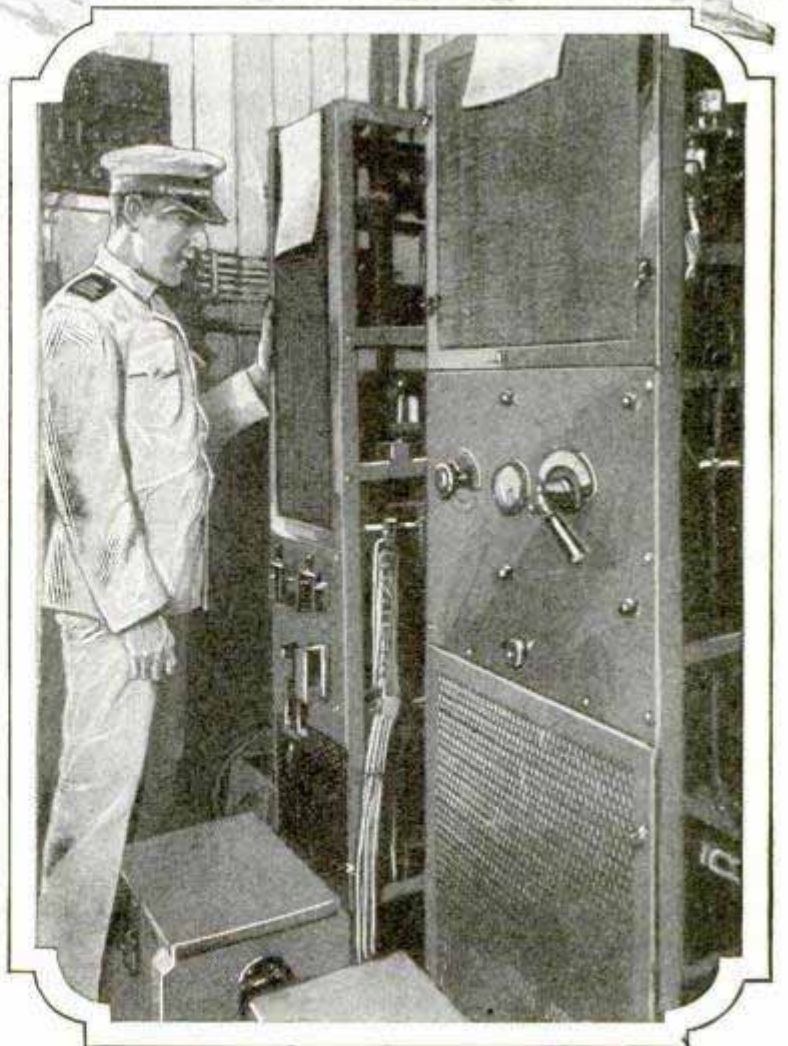

The variety of vital services performed every day by these wireless operators makes one marvel that maritime commerce ever was carried on without them. There is the matter of the weather.

The "Santa Luisa" is on a passenger run between New York and the west coast of South America. Last year, as she sailed from Cristobal, storm warnings were flying on shore. A West Indian hurricane was forming in the eastern Caribbean.

"The most critical time," wrote Capt. Dexter of the "Santa Luisa" afterward, "was at midnight of August 21. At that time we were off Watling Island, and the weather bureau and ships near the storm were sending out messages which our operators picked up, enabling us to steer clear of the dangerous storm center, at that hour dead ahead, 250 miles distant."

That letter, addressed to the Radio Corporation of America, closed with praise for the skillful work of the operators, John F. Thatcher and William Aseltine. But for them the "Santa Luisa" might have lost in her game of hide and seek with that ship-destroying wind storm.

Kaichiro Yonemura is no longer a sea-going operator but he clings fast to that tradition which rules that "Sparks," along with the captain, must "stand by the ship." When the earthquake was killing thousands and thousands of countrymen, including some of his own kinfolk and friends, Yonemura kept at his key at the Iwaki radio station at Tomioka. At that time he was the only link between Japan and the rest of the world, and every word that was printed in newspapers during the first few days after the disaster came through the brain of Yonemura; and at sea his fellow key pounders listened through the long watches of the night for the story of that cataclysm which was whispered over the Pacific.

When the navy airplane squadrons go winging out of sight of land some member of the clan of "Sparks" rides in the fuselage of each flying ship. You may be sure, too, that there is one aboard every submarine when it dives to the bottom of

the ocean. Moreover, when you read of a ship sinking, if there are two men who go to the bottom with her, certainly one of them is the wireless operator.

There is a monument to these heroes of the radio shacks on the Battery in New York. Three sides of the monument are filled with the names of operators who have perished at their posts of duty. Jack Phillips, who went down with the "Titanic," was one of these, but there are others who met death in the waters of the Great Lakes, in the Caribbean, in the Black Sea, the Atlantic, the Pacific.

Sometimes at night, when a blanket of silence sweeps from the air the musical programs, the speaking and other audible

entertainments of the radio, it is because from somewhere out at sea a wireless operator has flashed that tragic cry of a ship in distress — SOS.

A woman who called a New York station during one of these si-

lences recently demanded to know why the program had been stopped. The situation was explained to her.

"I certainly am sorry," she exclaimed with real contrition. "If I had known it was because a ship was in trouble, I'd never have complained, but if there is anything I can do to help—just let me know."

Adventure would be a saltless thing if it never was flavored with romance. Those who are assigned to the big passenger vessels, the transatlantic steamers such as the "Leviathan," have opportunities to meet and get acquainted with the finest people of two worlds, and when off watch they may pace the deck on moonlit nights with any lonesome beauties that happen to be aboard.

Their pay is not excessive. It ranges from \$90 to \$130 a month for most of them. A few aristocrats on the biggest boats get as much as \$250. They have no expenses for food or shelter. Many of those who go to sea in radio shacks have no other purpose than the saving of money for the satisfaction of some ambition ashore. All of them have abundant leisure for study. Some of the present-day skippers a few years ago were wireless operators.

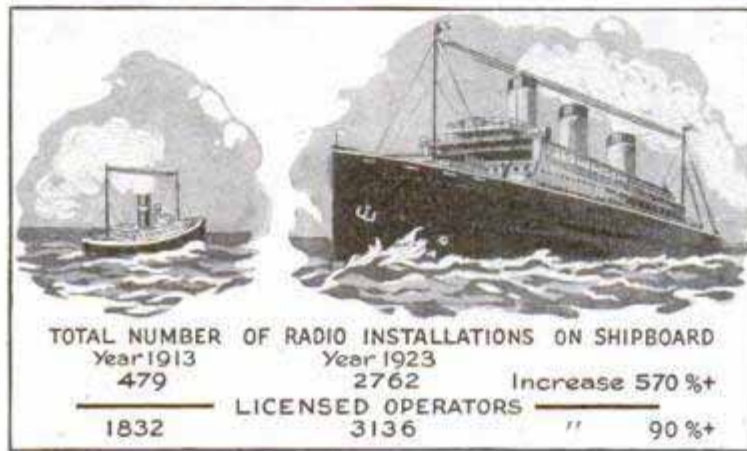



Where Stone and Steel Support the "Sky"; Interior of a Detroit Theater in Which the Ceiling Represents the Heavens and Settings Are Those of an Outdoor Garden

THEATER LIKE ITALIAN GARDEN HAS "SKY" INSIDE 8/7

Patrons of a Detroit, Mich., motion-picture theater can easily forget that they are inside a building for the decorations are modeled after those of an outdoor Italian garden, and the effect is increased by the ceiling. This is arranged to imitate the sky, across which realistic clouds drift at times, stars appear and twinkle and changing lights produce elusive color effects designed to harmonize with the theater's decorations.

PAINT IS DRY IN HALF HOUR 690

Wet-paint signs are not necessary after applying a finish for floors and almost any kind of woodwork, the manufacturers assert, for it is said to dry in less than half an hour. It produces a lustrous surface, resists alkalis and acids, withstands se-

vere scrubbing and is reported to be easily brushed on even by a novice at painting. The substance is also suited to coating concrete floors or stairways.

WALL'S MOTION WHEN PUSHED MEASURED BY LIGHT RAYS 8/5

Pushing a forty-inch brick wall with the hand to make it move sounds ridiculous,



Measuring How Much a Thick Brick Wall Moves When Pushed with the Hand

but a sensitive instrument used at the bureau of standards is able to record any motion that occurs and in many cases there is an appreciable bending of the wall. The gauge is in contact with the bricks and is so adjusted that the slightest movement will actuate light beams in such a way that the amount of bending can be told by their displacement. The instrument, an interferometer, is employed in making exacting tests on the solidity of structures and materials.

C. G. Peters, Bureau of Standards, Washington, D. C.

Chicago agents Heath and Mulligan

The Blidder Companies, 11001 Cleveland St

Madison

HAND TRUCK TO LIFT BUCKETS SAVES STRAIN ON BACK

Ash cans, garbage pails and similar containers are taken easily up or down stairs

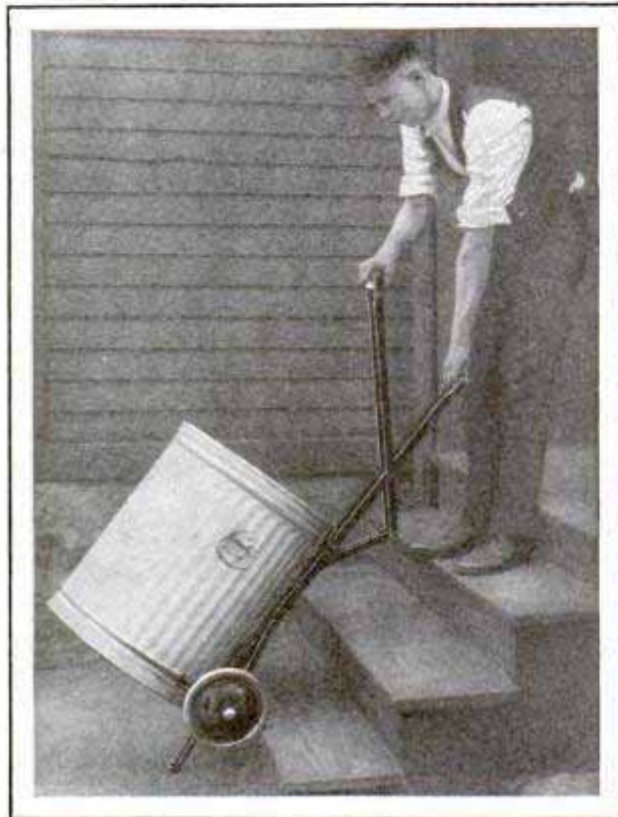

Lifting Truck in Operation. Clamp Holds the Bucket in Place and Handle Gives Leverage

in a small two-wheeled truck that holds the object firmly and raises it as desired by means of a hand lever. The wheels are rubber-covered to prevent damage to steps and floors when the truck is rolled. An extension leg at the bottom, helps in elevating the load.

TRACES OF NORSE COLONIES FOUND IN GREENLAND

Graveyards of old churches and many relics found by a Danish expedition in Greenland, afford traces of a Norse colony which is believed to have been settled about the year 1000 and which attained considerable size before the rigors of polar climate and lack of communication with Europe caused it to die out. The settlement was a republic, had

twelve churches and was sufficiently important to have a bishop. It was planted following the voyages and discoveries of Eric the Red. Twenty-five vessels set out with emigrants, but only fourteen of the fleet reached the destination. When Leif Ericsson brought Christianity to the settlement, plans were made for establishing other colonies on the coast of what is now New England, and one is believed to have dwelt for three years near Boston. The colony became "lost," when intercourse with Europe ceased about 1400 A.D. About 175 years later, when Greenland was again visited, no traces of white men were found. Scientists now believe that the climate and not the Eskimos was responsible for the disappearance of the settlers, who once counted 10,000 souls.

ELECTRIC COURSE FOR GIRLS TEACHES THEM REPAIRING

Knowledge likely to be useful to a housewife in repairing her own home and kitchen appliances is imparted to girls through an electrical course in the public schools of San Diego, Calif. They are taught how to fix the doorbell when it fails to ring, vacuum cleaners, electric irons and other implements. The causes of short circuits are explained and general information concerning the nature and uses of electricity given. Pupils in one of the classes are taught to make desk lamps. They fashion the pedestals on lathes, make the shades and learn how to wire the finished lamp. The instructor of the class says he has no trouble teaching the girls and that they have proved apt pupils.



Girls Receiving Training to Help Them Do Their Own Repairing When Electric Flatirons and Bells Will Not Work

824

New York Times
11/22/25

a junior high school

796
Sch...
Mrs. Betty...
326 Sprickels Bldg. San Diego, Calif.

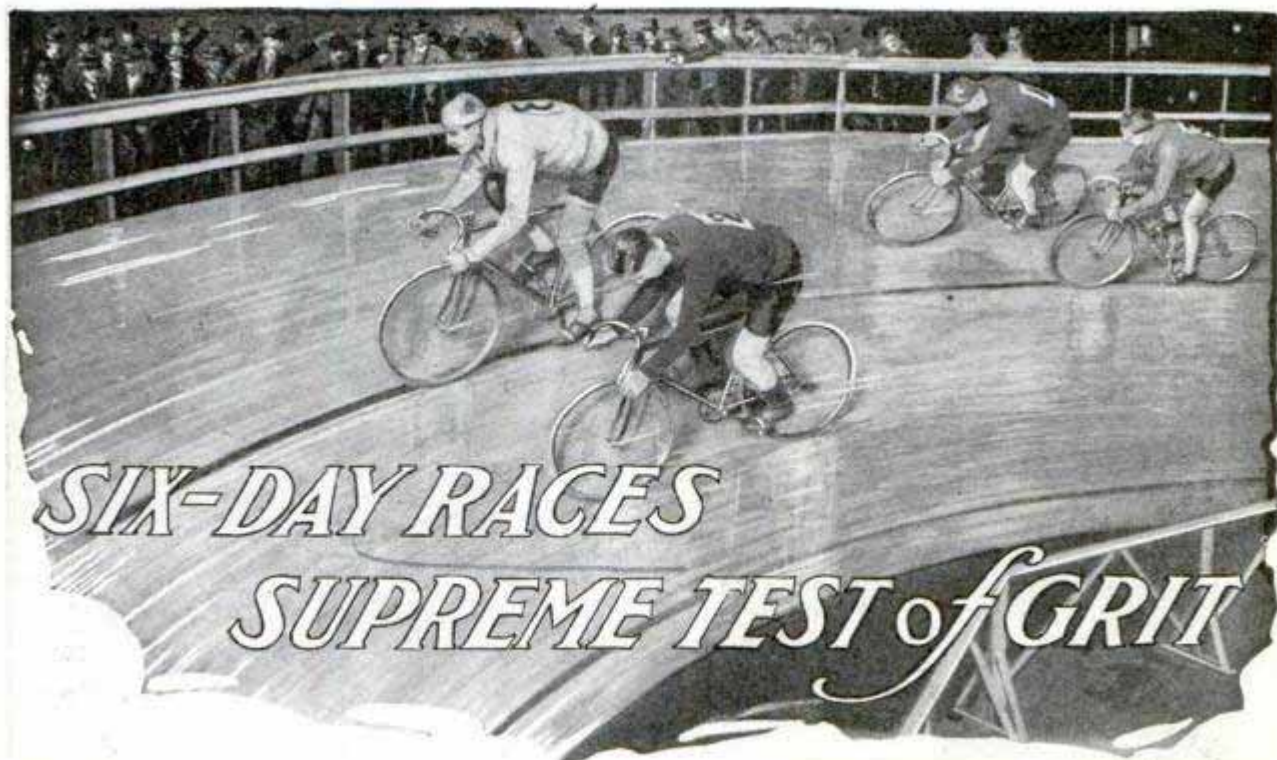

Breath-Taking Moments of Mad Sprints and Lap-Stealing Jams Hold Spectators through Days and Nights

A DOZEN cyclists are pedaling madly around a ten-lap-to-the-mile track in the closing lap of a two-mile sprint. As they dart out of the first steeply banked turn and level out in the straightaway down the back side, their dozen team mates, ready mounted, are given a shove by the dozen trainers and glide away at slow speed, waiting to "pick up" the first relay after it passes the finish line. Several thousand spectators are standing on their seats cheering the speeding racers. In a wild dash they come out of the second banked turn and flash down across the finish line.

Eleven slow up, expecting their team mates to pick up the race and carry on the next sprint. But the twelfth, stealing a march, darts out of the flock at racing speed, and before the other eleven wake up, is halfway around the end turn. Simultaneously his team mate, riding hard and high up on the bank, pulls out of the second relay group and prepares to relieve the first.

A jam has started, destined to steal a lap, and the wildest moment in a six-day bicycle race opens with all riders on the track, to stay there until the lap is gained, or the attempt abandoned.

The mad moments of a cycling jam have kept bicycle racing alive years after the majority of the people have given up the sport. They bring out thousands in

New York and Chicago every winter to sit through days and nights of the 144-hour races, watching hour after hour of listless pedaling to await the few brief moments of sprinting or lap stealing.

Three times in each twenty-four hours, at 3:00 p.m., 9:30 p.m. and again at two o'clock in the morning, the waiting fans are treated to an hour of sprints, ten two-mile speed dashes. Lap-stealing jams may start any time, though the favorite moment is at the close of a series of sprints, when the relief man is already on the track, and there is a chance to dart out and steal a quarter of the lap before opponents are aware of the attempt.

The hold that six-day racing has on the cycling fan is a mystery, until you have seen a dozen riders lazily rolling around the track suddenly settle down into racing speed and flash past in a dizzy sprint. The average newcomer who sees that once will come back again and again. He will arrive early in the evening to get a good seat for the 9:30 sprints, and still be sitting there at 2:00 a.m. waiting for the early morning dashes.

The six-day races at Madison Square Garden, New York, or the Coliseum, at Chicago, are the high spots of bicycle racing in the United States, but around Newark, N. J., and in some of the smaller cities near the Mississippi, notably in Iowa, the sport of cycling is kept alive by



In Their Trackside Bunks, Half the Riders Rest and Sleep While Their Team Mates Carry On; Each Rider Must Average Twelve Hours off and Twelve Hours on the Oval Each Day

the outdoor summer races. Newark is the cycling center of the country. There are more professional bicycle racers in it and the near-by Jersey towns than in all the rest of the country.

The open-air races, in the board-track velodromes, matched against other riders or pedaling behind motorcycle pacemakers, keep the riders in training for the 144-hour grinds in winter.

With the virtual disappearance of the non-professional pedal sport after the advent of the automobile, professional racing has become a highly organized amusement. Special lightweight cycles and small high-pressure tires form the equipment, and the riders are trained as religiously as a championship fighter.

The rider who enters a six-day race comes equipped with two complete bicycles and an extra pair of wheels, and his team mate has the same. The management furnishes the tires, and a race with a dozen riders will require an average of six repairs or replacements of tires each hour during ordinary riding, and from fifteen to twenty per hour during the sprints and jams. A completely equipped repair shop, with from two to six repairmen on

duty all the time, is required to keep the fleet of cycles going.

All the racing tires used in the United States are made by hand by one woman, Mrs. Ernest Pye, of Newark. Her husband invented them, and after his death, she has carried on the business under his patents. The tires are unlike any bicycle tire ever made for ordinary use. They carry 120 pounds' pressure, twice as much as the average old-time high-pressure automobile tire, yet there is no heavy casing of rubber and fabric.

Instead, a special cloth is woven by Mrs. Pye from selected thread, cut and sewed together to form a thin tube of single-thickness linen. An inner tube is cut from thin sheet rubber, cemented and inserted before the casing is closed. The tread comes in long strips of rubber, an inch and a quarter wide, and is cut off in sections equal to the circumference of a tire and cemented in place. Treads can be changed at will as they wear down, and the blow-outs, occurring frequently in such high-pressure tires, are easily patched.

The racing bicycles themselves are lightweight affairs of aluminum and steel, averaging about eighteen pounds com-

pletely equipped. The racers are permitted to use any gear ratio desired, but by common consent stick to 92 for the six-day races, because a rider can not pull a higher-g geared cycle through the endless hours of the long grind, when more than 2,500 miles are covered.

It is a far cry from the first six-day race, run in 1891 on the old-style high wheels, to the highly organized event of today. Until 1899, the riders were compelled to go it alone for 142 hours, resting, eating and sleeping as they desired. This manner of running the races prevailed for some time, but opposition to it developed, and lawmakers finally decided this form of amusement was too hard on the riders, ruling that no rider should stay on the track more than twelve hours of any twenty-four.

The idea of teaming the racers in pairs was then conceived, and has been followed ever since. The twelve-hour law still holds, so each rider is forced to carry his half of the burden, but they can divide the time to suit themselves.

The safety bicycle first appeared on the market in 1892, and in the following year Albert Shock rode one of the new inventions in a six-day race against a field mounted entirely

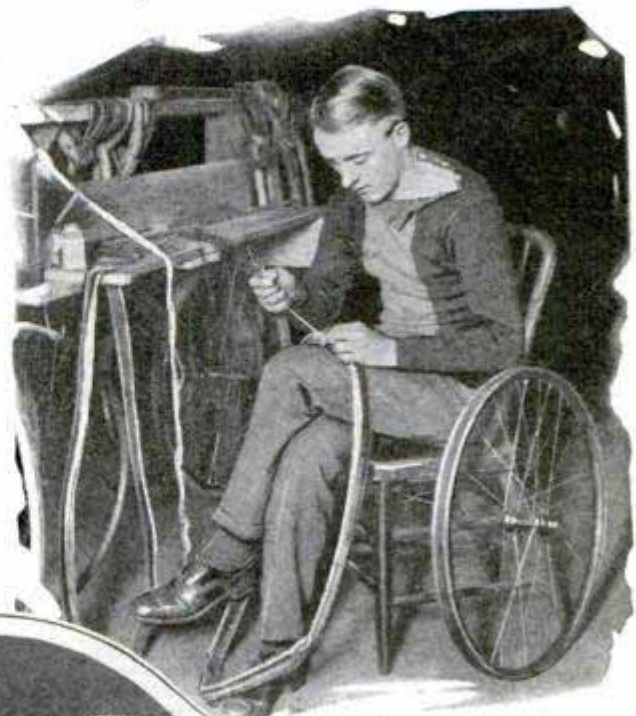

Trackside Repairs at All Six-Day Races in Recent Years Have Been in the Hands of "Pop" Brennan, Center, and His Crew of Assistants



on the old-style high wheels. He won handily, and the high wheel disappeared from racing thenceforth.

The six-day meets were captured steadily by Americans from 1899 through 1906, but in 1907 an international team composed of a German and a Hollander was organized and took first place. Honors have been about even since that time, but there is always a good field of foreign cyclists in this country, both from Europe and from far-off Australia. It was a Tasmanian, Alfred Grenda, who, teamed with Alfred Goulet, one of the greatest of the American six-day riders, set a new world's record in the 1914 race by covering 2,759 miles and two laps.

The racing spectator sees a row of little hut-covered cots stretched alongside the track, one for each team, and here the riders may sleep when off the track, but out of sight behind the scenes is an elaborate organization which keeps the cyclists fit. There are trainers galore, bath rubbers, trained chefs, diet specialists and others. The average rider, putting in his twelve



Feeding a Dozen Teams of Six-Day Riders Is a Mammoth Task, for Each Man Eats Enough for Four Ordinary People

hours a day on the track in a six-day meet, will eat approximately four times as much as an office worker. There is lots of meat in their diet, but the favorite is lamb, with steaks running second. For a recent six-day race in which twelve teams, or twenty-four riders, participated, the chef ordered 600 pounds of lamb chops, twelve sides of beef, producing 500 steaks; 400 chickens, ten boiled hams and fifty pounds of bacon.

Vegetables and fruit are consumed in correspondingly large quantities. The same racing squad consumed during the week three barrels of potatoes, four baskets of string beans, four barrels of spinach, ten dozen cans of asparagus, eight cases of peas, 100 bunches of celery, two bushels of onions, 200 heads of lettuce, ten quarts of tomatoes, twenty-five heads of cabbage, seventy pounds of prunes, two barrels of cooking apples for applesauce, six boxes of eating apples, 1,000 oranges, 300 grapefruit and twelve dozen lemons.

An apple or an orange can be eaten on the fly, and it is quite common to see riders pedaling around the course munching fruit or a sandwich as they go. Custard is one of their favorite dishes, and the same two dozen men consumed 300 dozen eggs, a large part of which went into this one dish. Among the other items of the chef's list for the six days were 700 quarts of milk, fifty pounds of butter, seventy-five pounds

of coffee, twenty pounds of tea, five pounds of cocoa, fifty pounds of rice, twenty pounds of oatmeal, six dozen boxes of corn flakes and 250 pounds of sugar.

Rub-down solution is purchased by the barrel, and enough liniments, gauze bandages, adhesive tape and similar remedies to stock a good-sized drug store. Accidents occur almost hourly, and the training quarters are kept busy making repairs ranging from a bit of adhesive over a skinned arm to fixing broken noses and reviving unconscious men.

In one recent race a member of the leading team, tangled up in a jam which wrecked four bicycles and threw as many riders, suffered a broken nose. He had it bound up in adhesive and was back on the track within a few minutes. Half an hour later he locked handlebars with another rider, both fell and part of the following field piled on them.

The rider with the broken nose was dragged out with a damaged skull. A few hours later he was on the track again, wearing a football headgear.

The bicycles which go through some of those wrecks are pulled out so badly bent and twisted as to appear hopelessly wrecked, but the spectators near the repair benches will see them taken apart, straightened and reassembled, with new wheels to replace the broken ones, and they will be ready for use again within an hour or two.

PURSE THAT STICKS TO POCKET TO PREVENT THEFT

With a strip of abrasivelike leather on its side, a pocketbook is intended to stick

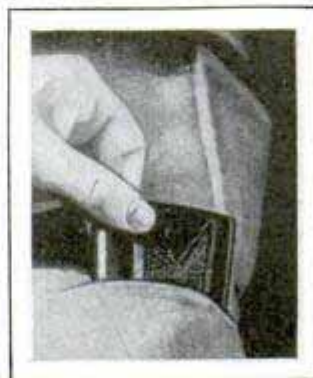

to the cloth so that a thief's attempt to remove it will attract the owner's attention. The adhesive property lies in the grain of the covering. It does not damage the pocket and the purse can be easily taken out by a person knowing

its construction simply by inserting the fingers between the strip and the pocket.

Wilson Mfg. Co., Inc.
119 North St.
Mass.

Chicago Evening News
11/24/25

SILKWORM'S SECRET APPLIED IN ARTIFICIAL PRODUCT 823 **SHOEING ROOSTERS FOR FIGHTS FORMER BLACKSMITH'S TRADE** 797

Manufactured by a process discovered from close study of the silkworm itself, artificial silk has assumed great importance in the commercial world as a substitute for the natural product in hosiery, garments, covering for telephone wires, artificial flowers, electromagnets and many other articles. Last year's output was approximately 185,000,000 pounds and, largely because of the competition of the artificial variety, the price of raw silk in 1920 dropped from \$18 to \$5 a pound. A basis of the manufactured silk is a vegetable fiber which resembles cotton more than it does silk. Credit for its invention is given to Count Hilaire de Chardonnet, who exhibited it at an exposition in Paris in 1889. The original fiber has been improved by adding cellulose, the material that constitutes the cell walls of plants. There are various processes for this, but in all, some kind of cellulose is made into a jellylike mass then pumped through little glass nozzles in which there are fine tubes, invisible to the unaided eye. The threads are treated chemically and then spun and handled like silk. Woven with cotton these shining strands give the material a silken sheen which has come into great demand.

Although cock fighting is now frowned upon in the United States, it is widely practiced in foreign countries, and in supplying steel spurs for the roosters, an Ohio man has built up a

Former Blacksmith, and Sample Styles of Steel Spurs Which Are Tempered by a Secret Process for Cock Fighting

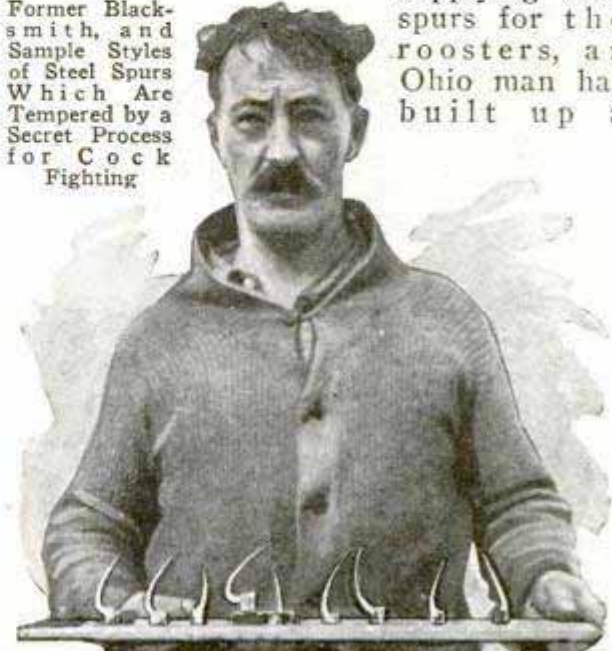

Wade Johnson, So. Orange, Ohio.

MEDICINE DROPPER AND CORK COMBINED IN ONE 799

Danger of breaking glass and the bother of handling two separate articles, are avoided in a combination bottle cork and dropper made of rubber. There is little likelihood of injuring the eye, for instance, when using the soft instrument to pour

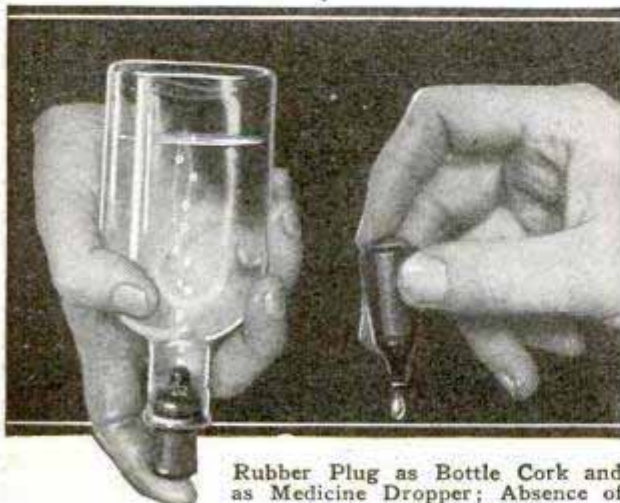

Rubber Plug as Bottle Cork and as Medicine Dropper; Absence of Glass Adds to Safety

medicine, and it can be easily kept sanitary by plunging it in boiling water.

Snyder Rubber Co. 160 N. Wells Chicago

profitable business with customers all over the world. The gaffs are made of a special steel, tempered by a secret process which the manufacturer discovered twenty-five years ago when he made spurs for one of his own roosters in the blacksmith shop he conducted. The barbs are made in various styles and some of them sell as high as \$40.

RED FIRE USED IN SKYROCKETS PRODUCED FROM METAL 790

Strontium, the metal base of red fire for railroad flares, skyrockets, and Roman candles, has been discovered in Nevada and if the deposits prove abundant, development of an industry new to the United States is anticipated as the supply heretofore has come from abroad. The metal usually is yellowish in color and in certain forms it is employed as a medicine, while a carbonate of strontium is used in Germany during sugar-refining processes.

Wade Johnson news. 11/5/25.

STUDENTS SEE SELVES TALKING IN WAVY LINES

739

Seeing His Speech; as Student Talks into Mouthpiece, Voice Vibrations Are Recorded in Lines on the Cylinder



Students at a London college literally see themselves speak, for their voices are recorded on a roll of special paper as they talk through a mouthpiece adjusted to a vibrating apparatus. The purpose of this instrument is to register the spoken word in such a way that defects in speech may be observed. The line produced varies according to the pronunciation and inflection given by the student. Comparing the results with a line of accurate speech, gives visible evidence of error.

PROGRESS OF CENTURY SHOWN AT ELECTRIC EXHIBIT 602

Refrigerators that cool by heat, a huge magnet to remove splinters of steel from the body and violet-ray instruments intended to produce a healthful circulation of the blood are among the marvels of the age displayed at an electrical show in New York City. One of the practical implements demonstrated was an electric marker that tattoos identification symbols on various articles, such as the letter "L" or "R" on right and left overshoes, or similar marks on match safes, tire gauges and other articles. Some 30,000 exhibits were displayed, including electric "hands" that wrapped chocolates.

REIMS CATHEDRAL IS RESTORED WITH CONCRETE GIRDERS

Modern building methods are being employed in restoring war-torn Reims cathedral to its former grandeur. In remodeling the inner and outer roofs, the architect has designed a special system of light, interlocking, reinforced-concrete girders and rafters. The units can be handled and put in place by two workmen. This form of construction will be used for the pent-roofs over the aisles as well as over the nave proper, and will be a trifle lighter than the ancient timber bracing besides leaving the roof passages practically unencumbered. Outwardly, the cathedral appears unchanged, though all the flying buttresses on the south and north sides and the apse have been rebuilt more or less. The south wall, facing the ancient palace of the archbishop, was relatively slightly damaged.

In the interior, the repairs of the nave are about finished as far as the choir. The roofing on this part of the cathedral is expected to be finished in 1926.

POCKET-SIZE FAN IS OPERATED BY FLASHLIGHT BATTERY

Operated by a small electric motor supplied with current from a flashlight battery, a tiny fan of German manufacture is intended to afford a cooling breeze at dances or the theater. It may be inserted in the flashlight case in place of the bulb and started or stopped by pressing the button. It takes up but little room in the pocket and is ready for use at all times. For running toy models a separate motor, about the size of a nickel, is inclosed in a metal shell slightly larger than that of a walnut. It can be operated by wires from the flashlight battery.



For running toy models a separate motor, about the size of a nickel, is inclosed in a metal shell slightly larger than that of a walnut. It can be operated by wires from the flashlight battery.

New York Edison Co., Electrical Show, Grand Central Palace, New York City

see letter several files
 Pennings 50
 March 50
 about 90

W. Sander Karlsruhe
 61, Chemnitz-Isablenz

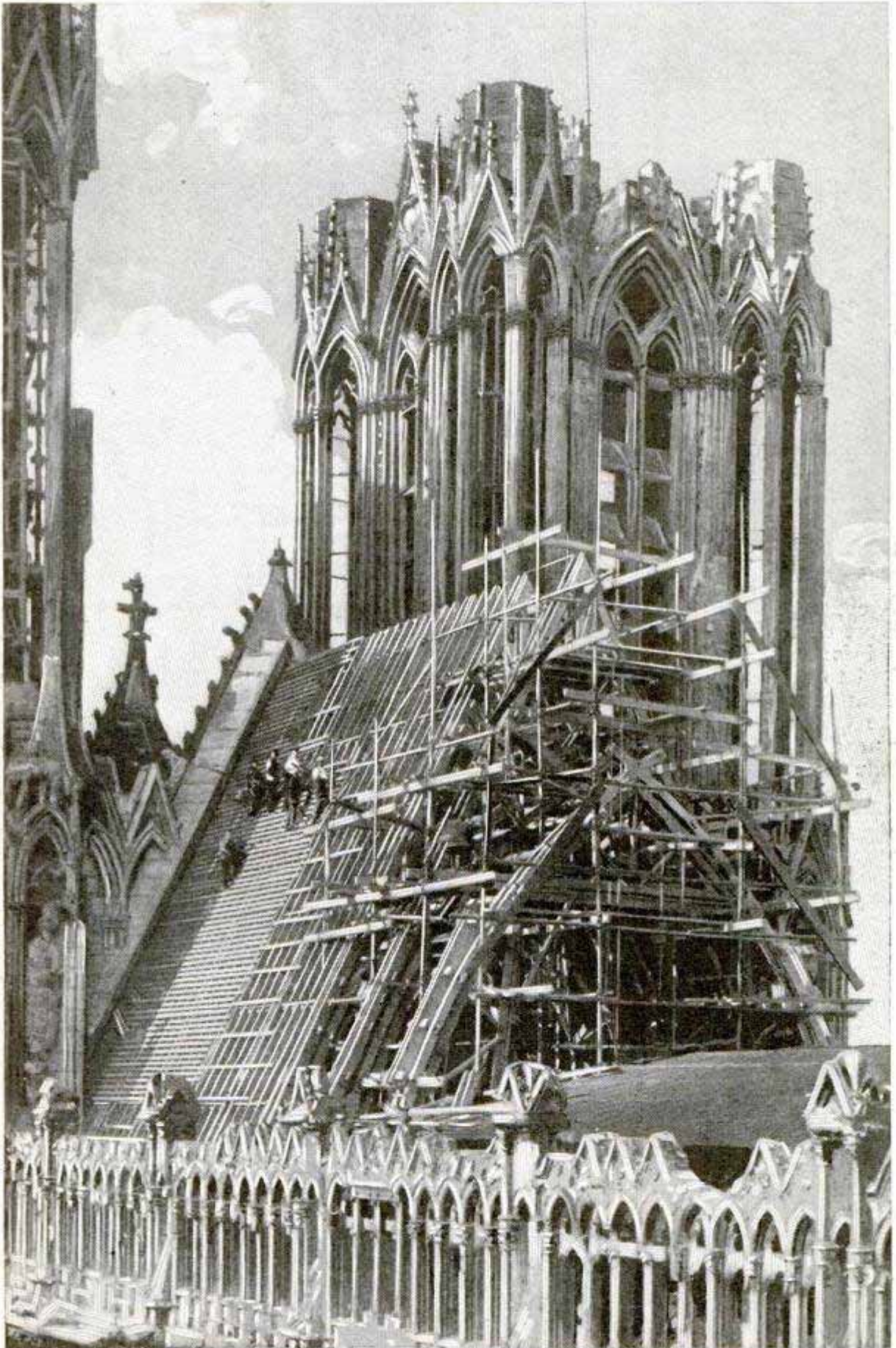

Courtesy L'Illustration

Restoring Reims Cathedral with Interlocking Concrete Rafters Lighter than Timbers Used in Original Structure; Outer Rafters and Battens to Support Lead Roofing Are Wood

W. S.
Kants

N E
W

D.
messer
und is
stellt d
zeug d
atorer
übliche

Der

D
man
derse
kann

Mode
Tran

N



"The Gossips," Sculpture in Soap on View at Recent Eastern Exhibition

SOAP FOR COMIC SCULPTURE RIVALS MARBLE

A contest in soap sculpture at an eastern art center revealed that the material, for informal subjects especially, is well suited to expression. One of the pieces that attracted considerable attention was "The Gossips," two women at a chance moment of conversation in a windy street. While it was not possible to reproduce many details as faithfully as could have been done in stone or marble, the soap lent itself to the purpose of expressing character as well as the proper attitude and pose.

TISSUELIKE STEEL IS TRANSPARENT

By the application of an electroplating process, sheets of steel so thin that they are as transparent as glass, have been prepared. In thickness, they will compare to tissue paper. To test their qualities, plates with ruled lines about one twenty-five-hundredth of an inch apart, were photographed through them and each of the lines was visible through a microscope.

WIRELESS PHONES FOR TRAINS TO REPLACE ARM SIGNALS

The practical benefits of radio will be carried to train control, eliminating the use of arm signals between flagman and engineer on long freights, if experiments conducted by the railroads meet with continued success. A special wireless-telephone set has been devised, by which the man in the cab and the brakemen or conductor at the other end of the train can interchange signals instantly. On curves and at night, the advantages of this system are apparent, and its use on passenger trains, it is believed, will improve service and decrease delays, although the air-valve method now in use has none of the disadvantages of arm signaling. A series of practical tests with this equipment has already been made on electrified sections of several lines, but further experiments are being conducted.

FIREBOAT WITH SIX BIG PUMPS EQUALS TWO DOZEN ENGINES

Equipped with six centrifugal pumps that can hurl twenty-nine streams of water, totaling 12,000 gallons of water a minute, a fireboat added to the Los Angeles department is regarded as the equivalent of twenty-four engines. A feature of the outfit is a high tower from which the hose lines can deliver water upon blazes in upper stories and upon roofs.

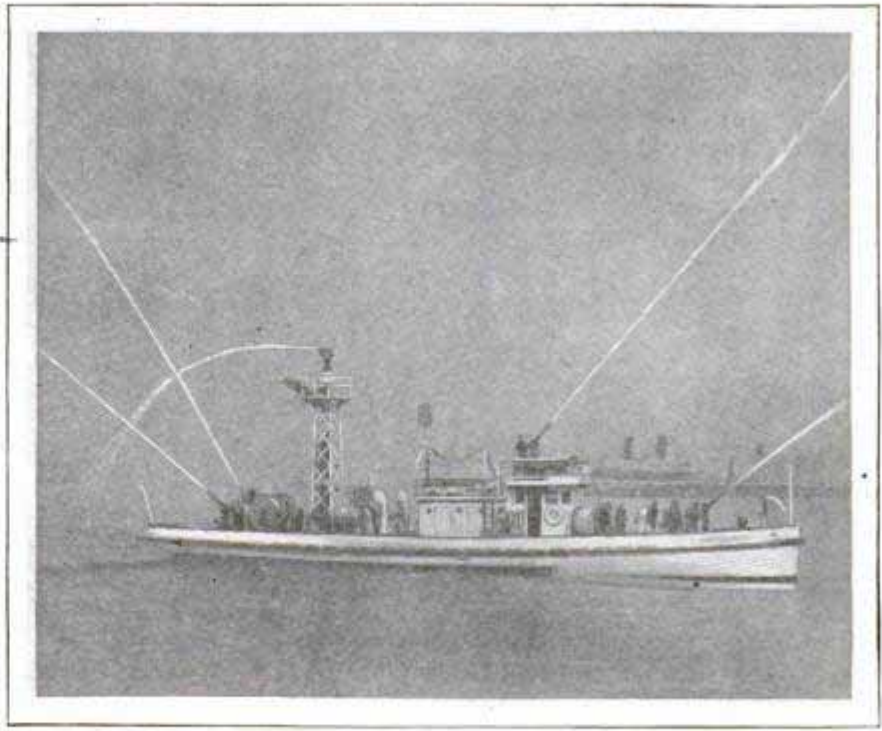

Fireboat with Six Pumps Can Throw Twenty-Nine Streams and Is Equivalent to Twenty-Four Engines

Public Service Bulletin 4/2/25
404 Soap & Electric Co. & Elmer

Chicago Evening Post 12/2/25

Experiments at
Carnegie Institute
You Karl Miller
Technical Institute

WITH UNCLE SAM'S PLANT HUNTERS

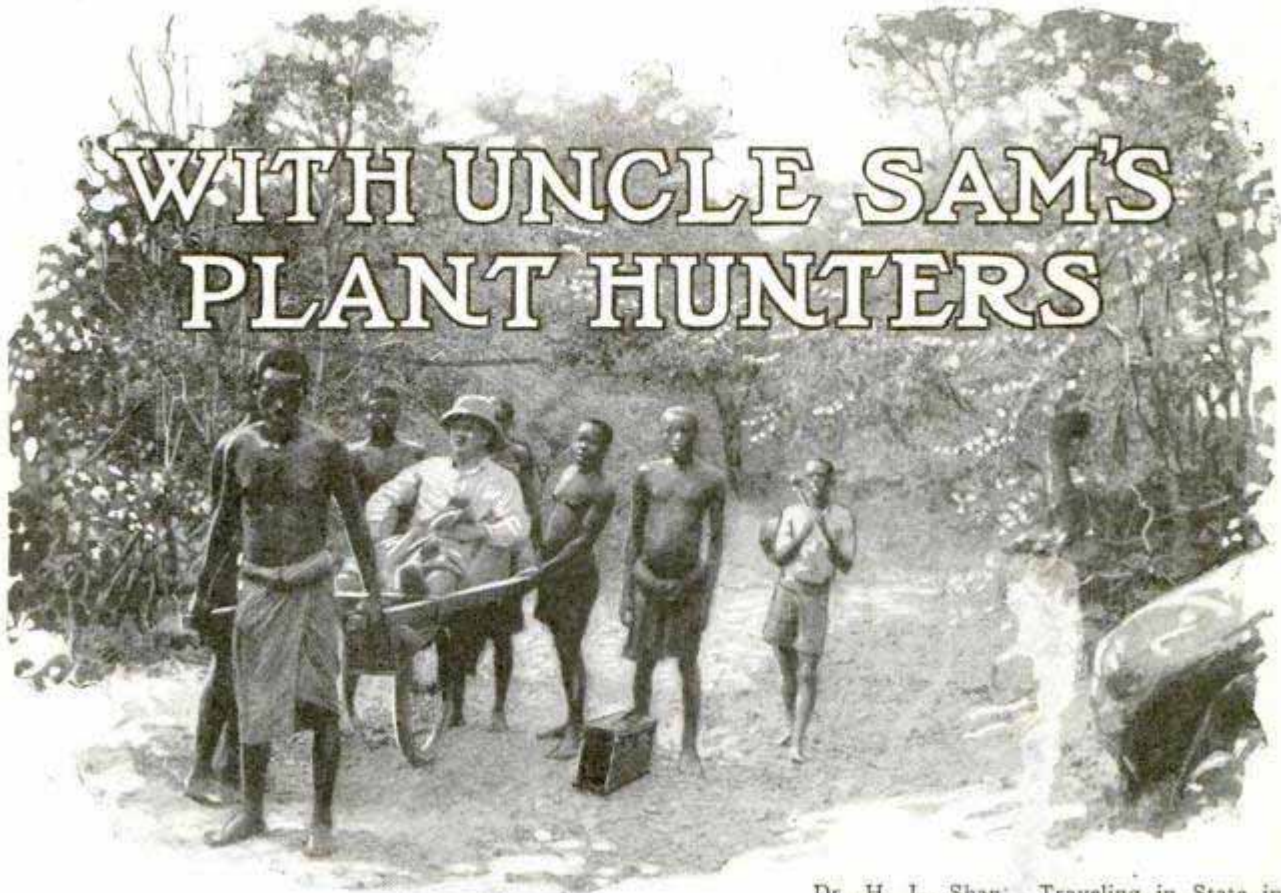

Dr. H. L. Shanley
Traveling in State in
a light cart

Bank Bldg Washington, D.C. List of National

By S. R. WINTERS

BEGINNING with the importation of a species of cabbage from Moscow, Russia, twenty-seven years ago, the department of agriculture has brought into America from foreign countries 65,054 varieties of fruits and vegetables. These seeds or plants, uprooted from the old-world soil, are imported for the purpose of determining their suitability to growth and fruitage in the United States.

Combing strange and remote places of the earth for new and possibly useful plant life, Uncle Sam details agricultural explorers afield. One of these alone has introduced thousands of plants from China, including the seedless persimmon, the jujube, Meyer's elm, and many other products that have enriched our farms and orchards. From Africa have come the long-staple Egyptian cotton and Sudan grass, Rhodes grass and many of the important kafir corns and sorghums. These crops reach a value of approximately \$50,000,000 annually in America.

It is one thing to hunt big game in Africa and quite another thing to go on plant explorations. And yet there is a similarity between the two, inasmuch as excitement and personal dangers are not entirely removed from the plant hunter's task. The late Frank N. Meyer, who for

thirteen years was a plant hunter with the department, upon returning late one night from a restaurant in Harbin, was waylaid by two Russians who sought to seize him and cover his head with a sack. A quick lunge with a pocket knife put one of his assailants on the ground and the other one fled. On another occasion, this eminent plant hunter wrote:

"At last I have arrived here in this provincial capital at Kar... and I feel like an old-time sailing ship that has come into port, loaded full with all sorts of things. But the ship has weathered some storms, and it is with the loss of her mainsail that she is berthed here now. For—and this is a bad thing, indeed—my interpreter and the coolie have deserted me cowardly in Siku for fear of being killed by Tibetans."

That was many years ago, but plant hunters of today are beset with certain dangers in the pursuit of their strange occupation. For instance, as this article is being written, P. H. Dorsett and his son, J. H. Dorsett, as agricultural explorers for Uncle Sam, are scouring the fields of northern China in search of flora that may prove valued accessions to American plant life. They maintained their office at Harbin with Maj. Morgan

Palmer, who was assassinated as a result of Chinese disturbances about two months ago. Fortunately, these agricultural missionaries were afield on a trip west of Harbin at the time of the murder. A year ago, the plant explorations of Mr. Dorsett were interrupted for a period of two weeks owing to disturbances in Peking, but these internal conflicts caused only a temporary cessation of his activities. Now, he is penetrating into the recesses of the mountains collecting specimens of

plants that may be able to withstand the rigors of our northern climate. F. A. McClure, who divides his labors between agricultural exploration for Uncle Sam and teaching of agriculture in the Canton Christian College, is combing sections of southern China for scions of fruits and vegetables that may enrich our orchards and gardens. This region, too, is

embroiled in minor disputes and disturbances that contribute to the dangers of our agricultural missionaries. The difficulties of such explorations in China are portrayed by a fellow explorer who writes:

"I have been in China and know there are practically no roads in the Chinese empire; I have seen the caravans of the coolies and have been carried in sedan chairs, and I find it difficult to imagine a man's exploring in China, at least for plants, unless he could travel unweariedly afoot." Then, we are told that at least one of these agricultural missionaries walked 1,800 miles during a two-year trip in northern China.

Dr. David Fairchild, in charge of the office of foreign seed and plant introduction, is at present away from the Washington office for a period of approximately two years. This extended expedition will take the pioneer plant hunter

through portions of Africa, Belgium, France, Spain, Italy, Switzerland, with the East Indies as his ultimate objective. For the last four months he has been invading the remote areas of northern Africa, a country which, it is to be remembered, has contributed a wealth of seeds and scions to enrich our variety of agricultural products. Dr. Fairchild, whose service as an agricultural explorer parallels the successful efforts of Barbour Lathrop of San Francisco, in establishing

a government plant - introduction section, speaking from a wealth of experience, declares:

"A country cannot transfer its mines or its industries or its climate, but it can sometimes share the wealth of its flora. In giving but a handful of seed, it may bestow a priceless source of food supply for millions of people."

A striking illustration is

the recorded fact that one packet of Sudan-grass seed picked up in Africa will pay many times the cost of maintaining a plant hunter in the field for years. This grass has an annual crop valuation of \$12,000,000 in this country.

The introduction of the jujube, the Chinese date, into America marks the establishment of a probably large and prosperous industry. If processed rightly, according to experts, this product is as inviting to the palate as a fresh date. It lends itself to consumption in a variety of ways—fresh, dried, stewed, preserved or pickled. When dried, it is used in making cakes and puddings or cooked with cereals. There is growing in the Sacramento valley of California an orchard of twelve acres of jujubes, the largest commercial orchard at this time. It is especially adapted to Texas and gives promise of becoming established in the south.

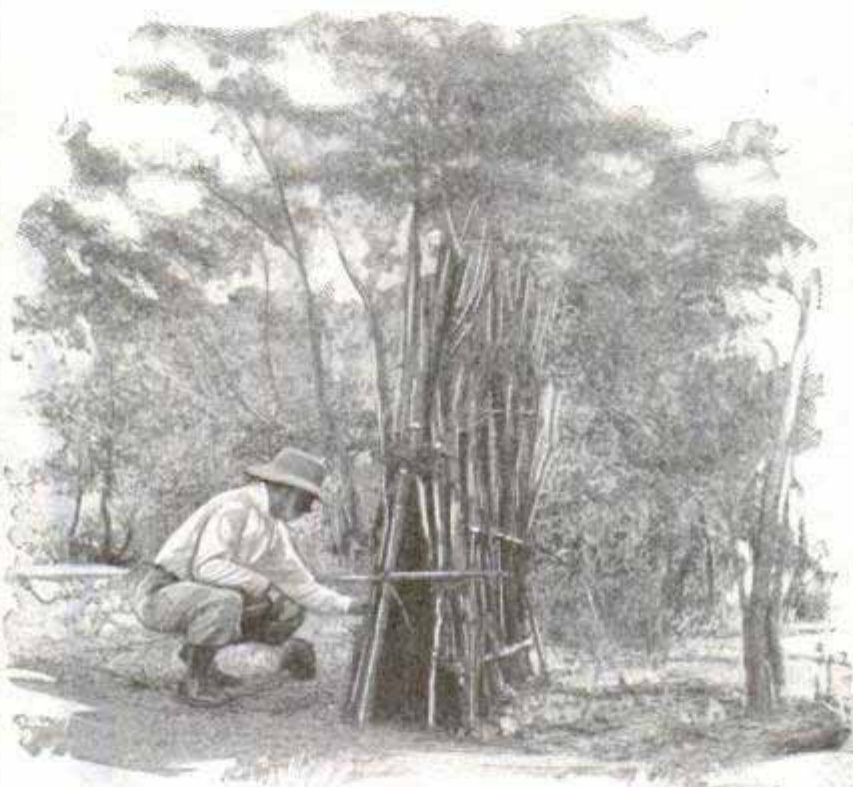

Government Plant Hunters Often Do a Bit of Animal Hunting on the Side; Here One Is Examining a Trap Set for Leopards

*James Mills Orchard Co.,
Hamilton City, Calif.*

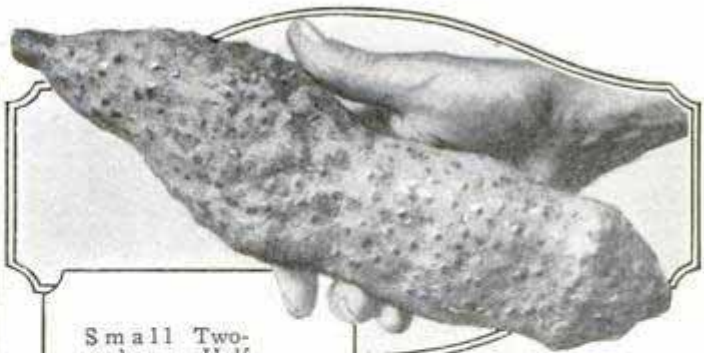
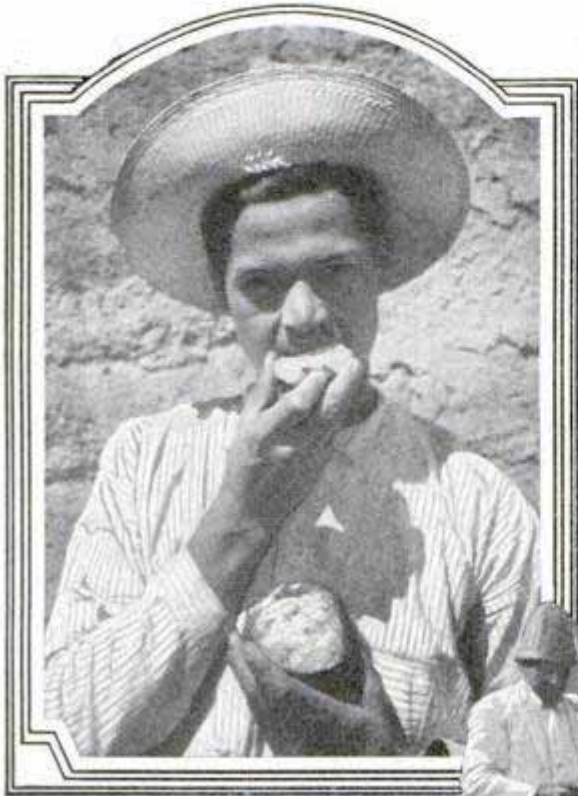

Small Two-and-a-Half Pound Tuber of a Yam Grown in Florida from Stock Brought by Plant Hunters from the West Indies

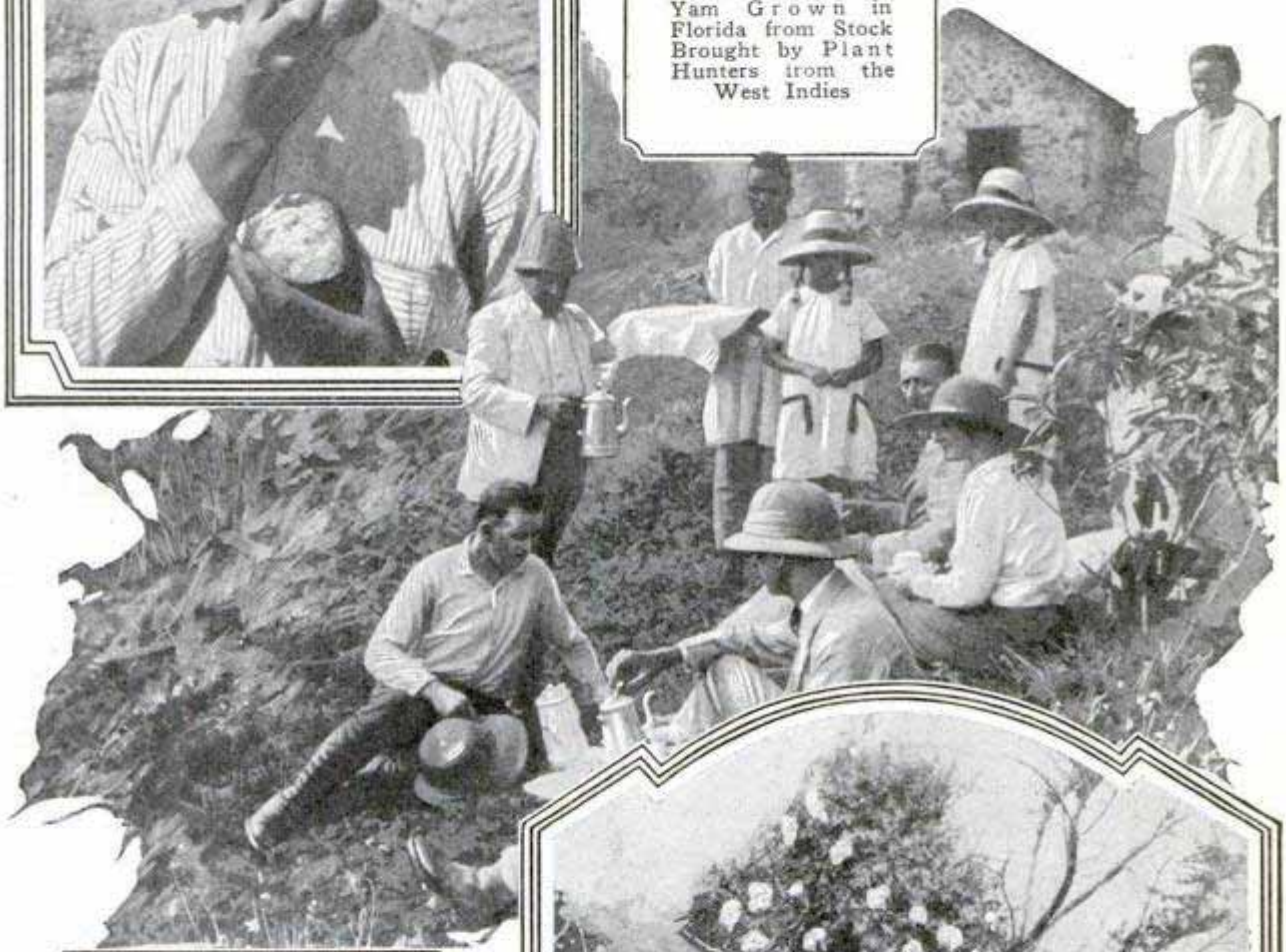

The Chayote, Top Left, Is a New Addition to the American Vegetable List, Brought by Government Hunters from Mexico and Central America; It Is Eaten like an Apple, without Salt or Other Seasoning; Center, Dr. Shantz Meets a Missionary and His Two Small Daughters and Pauses En Route for a Luncheon Spread on the Ground; at Right Is a Wild Cotton Plant, Growing under Natural Conditions in Africa; the Government Plant Experts Reach Every Far-Away Corner of the Globe in Their Search for New Varieties and Plants Which Are Proof against Various Forms of Blight Which Threaten the Established Species

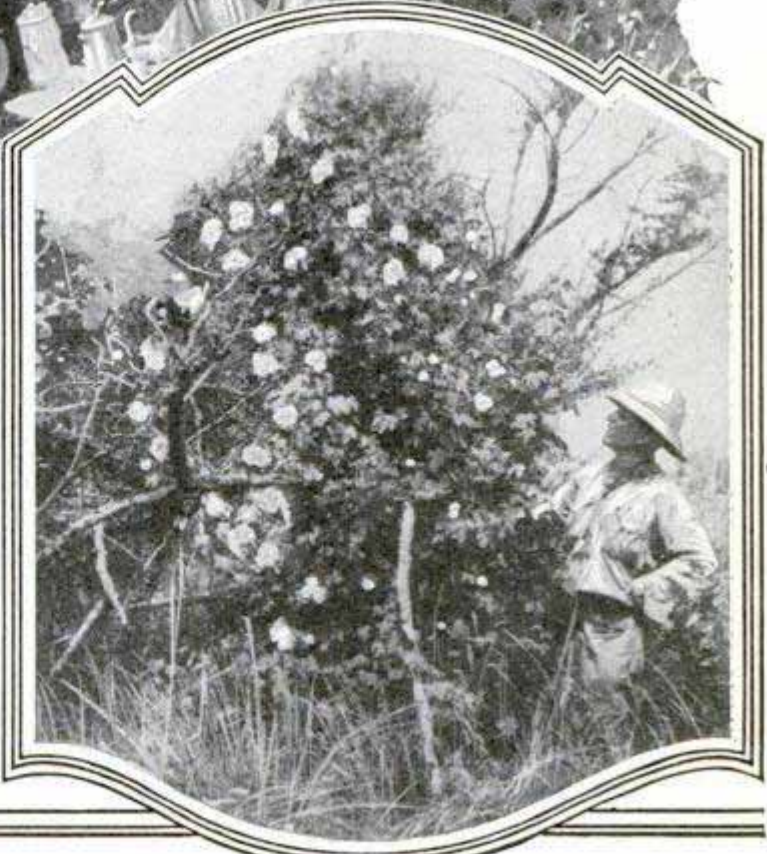



Two American Plant Hunters and a Native Chief Met in Their Ramblings through the Tropical Isles of the East Indies

The chayote, a comparatively recent addition to our vegetable kingdom, from Central America, takes the shape of a pear and flourishes on a perennial vine. It is related to the squash, but is said to possess a finer flavor and texture than the latter. A soil immune to freezing temperatures is necessary to insure its growth. It is now produced in Florida and in the Gulf-coast area. It may be served on the table in a variety of ways—fried, creamed, in stews, baked with meats or pickled. The chayote is trained upon a trellis like a grape vine and the ripe fruit is about four to six inches in length and three to four inches in diameter. Grown in the south, it comes to fruitage in November and is available in December and January, when other vegetables in some sections are not plentiful.

The Quetta nectarine, taking its name from the district in India where it is native, has been bestowed upon us by the plant hunters. This nectarine is a smooth-skinned peach and its good shipping quality is a virtue which recommends its commercialization. There is a twenty-acre orchard in California.

Thanks to agricultural missionaries, the pistachio nut, a strictly old-world product, has come to America from southern Europe. At present its growth is confined to the southwest, California and southern Texas, for instance. Both as a coloring and flavoring for candies its good

qualities are recognized. During 1923, we imported 79,000,000 pounds of oil for use in manufacturing paints and varnishes. Hence, there is justification in the small beginning of an industry in Florida, having as its purpose the production of tung oil for emergency needs. This oil is extracted from the seeds of the Chinese tung tree. Being unable to withstand cold, the oil-producing tree is restricted to growth in our southern climate.

The Barouni olive, which is adapted to soil and climatic conditions in this country, grows to an unusually large size. It is the largest variety yet introduced that can be used successfully as a ripe pickled olive. The cultivation of commercial orchards, approximating 150 acres, suggests concerted efforts to develop the Barouni olive industry.

Not very dissimilar to our haw berries, there comes from China apples the size of green peas. They are bright red in color and are eaten fresh or preserved. The productiveness of this tree is said to be so great as to put it in a class by itself. These apples in miniature can be grown in the northern states and are useful as ornamental plants

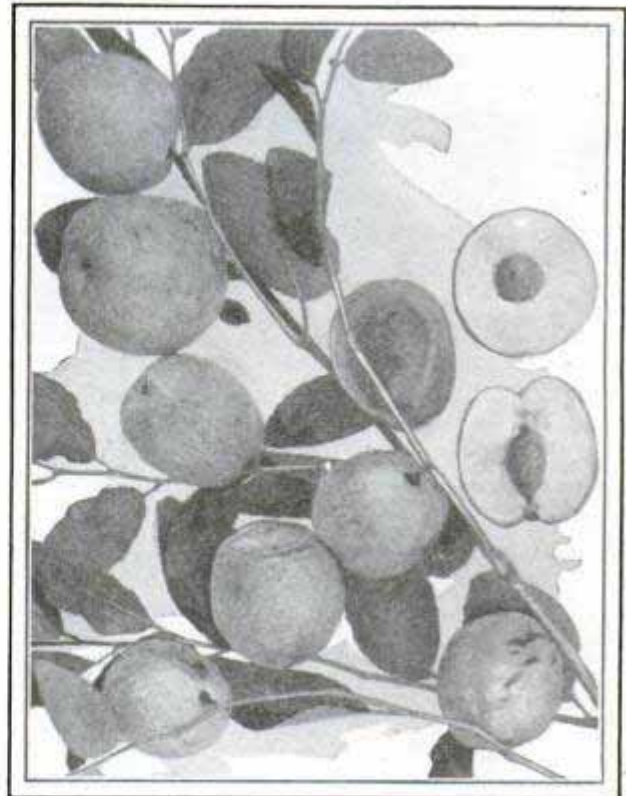

The Jujube, or Chinese Date, Introduced from China, Grows to a Diameter of Two Inches

Native Potato Market in Africa Visited by Dr. Shantz on One of His Trips

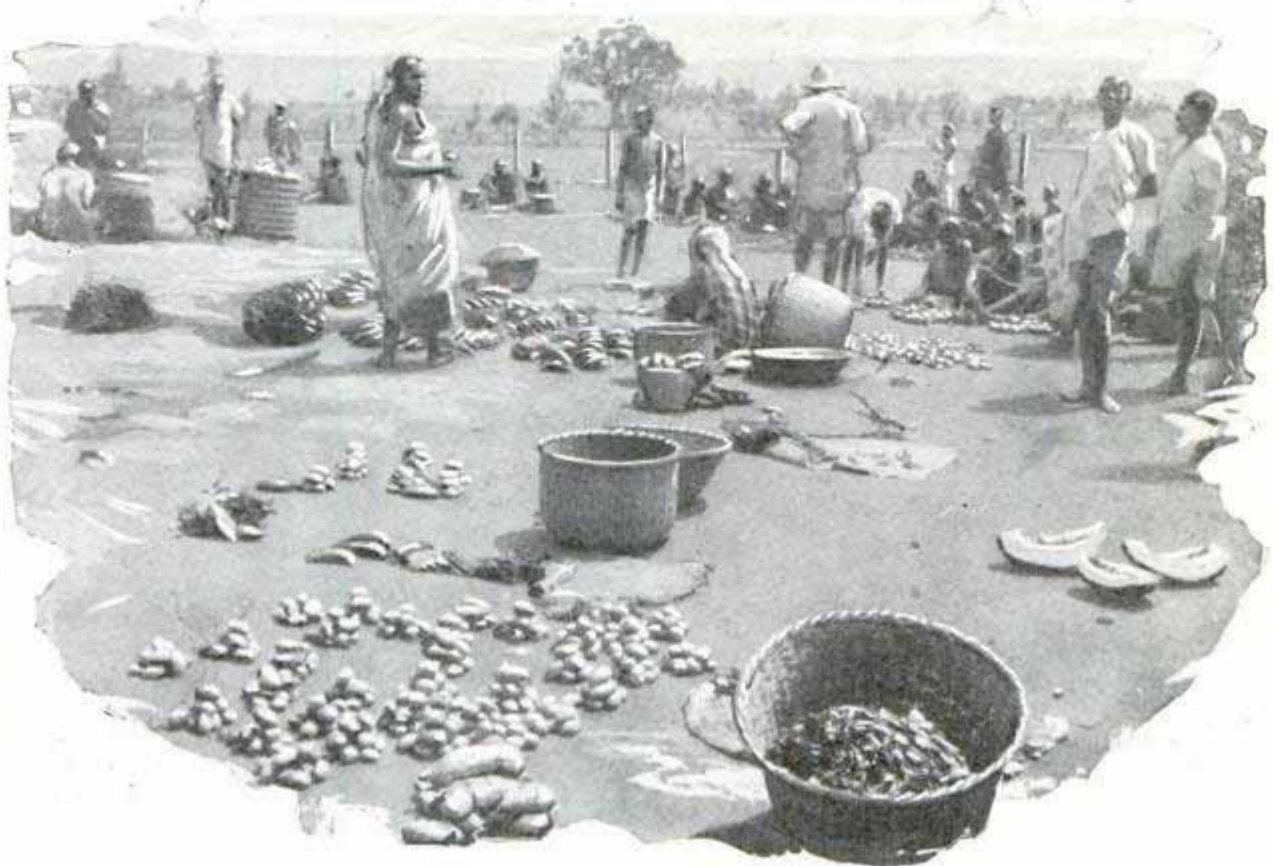

because of the numerous bright-red fruits which cluster on the tree.

A new tuberous vegetable has been introduced from the far east, and its tubers resemble closely strung beads. These tiny tubers may be fried or cooked in numerous ways, and they are said to be relished in salads or when pickled.

A plant susceptible to growth in extreme southern Florida and the so-called lemon area of California is the papaya. It is a relatively small tree that is productive of melons in gangs or bunches. The melons cluster around the trunk of the tree, suspended from abbreviated stalks.

The Smyrna-fig culture in California has not always been successful. Agricultural explorers overcame the handicap by importing from Syria an insect on which this variety of fig could rely for fertilization of its blossoms. Also, the wild variety of fig tree upon whose fruit this insect feeds was brought to California.

Japan, through the office of foreign seed and plant introduction, has contributed a large radish. It is more than two feet in length and as large in circumference as a fair-sized tree. The "udo," also a comparatively new vegetable, is a product of Japan. Its shoots are sliced and, after remaining in ice water for a while, are

served with mayonnaise dressing. These shoots have a "piney" flavor.

An agricultural explorer, traveling through Manchuria, observed a strange-looking cereal on the market. Seeds were obtained and from this mere beginning was developed the "grain sorghum," which is now grown extensively in America. The large ears, burdened with big grains, are ordinarily fed to cattle. However, this grain may be converted into breakfast food or griddlecakes.

The dasheen, a promising vegetable in Florida and areas of mild climate adjacent to the Gulf of Mexico, constitutes the chief article of food in certain tropics. It was brought to the United States by plant hunters, and when baked, it is as readily relished as potatoes. They are often cooked like the latter and dasheen chips find their way to hotel menus in northern cities.

"Poke around through the backyards of people who cannot understand what you are doing and are naturally suspicious of you," is the picturesque description employed by one plant hunter in describing the activities of these government missionaries. "You start out for some unexplored or forgotten part of the world," he continues. "You buy a couple of horses,

680

mules, or may be camels; one animal for yourself and the other for your baggage. Then you head for the back country and keep going until you reach a place where there are so few cooking vessels

“What a life! To wander with a definite, soul-absorbing object, on foot, from village to village, inquiring his way and learning as he went of some new plant variety

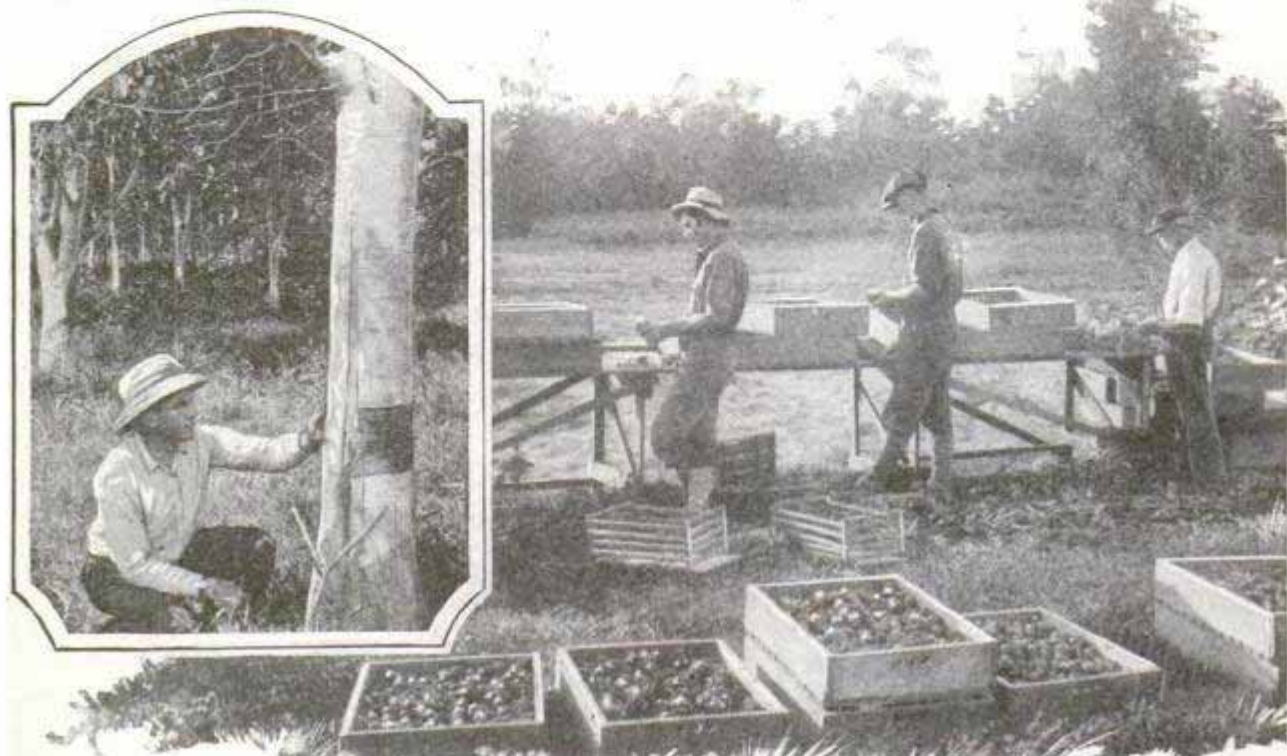

Dr. Shantz Examining Hevea Rubber Trees at Kampala, Uganda, Africa, in the Inset, and Plant Experts Grading and Preparing Plants for Shipment at a Bench in the Field

that an empty tomato can may pay for a night's lodging. You make yourself agreeable to the natives, jolly them. Then you go to the village market and watch like a hawk for everything that is brought in to be sold.

“When you find something that is worthwhile you get scions or seeds. If the latter, you pack them in charcoal; if the former you pack them in moss and inclose them in a pasteboard tube with waxed ends for shipment by whatever means may be most convenient.

“The scions or seeds, upon reaching Washington, are first subjected to an inspection service as a means of barring injurious insects. If the plant material is approved, it is placed for trial at state and federal experiment stations, or with individual plant experts or plantsmen interested in special groups of plants. If the specimens prove productive and economically desirable, they are placed in the hands of farmers who agree to devote a certain acreage to their growth. Hence, if these introductions establish their value their widespread distribution is insured.”

Such are the fruits of our plant hunters. A distinguished exponent of this tribe of globe-trotters, in a contemplative vein, writes of a fellow worker:

which, because of its perfume, the deliciousness of its fruit, the color of its flowers, the shade it cast, its alkali resistance or its hardiness in bleak northern regions, might be worthy of sending to this country for our farmers, horticulturists, or lovers of door-yard plants.”

781. **CLEANING AUTO BY SANDBLAST SAVES TIME IN PAINTING**

Sandblasting has been applied to cleaning automobiles, preparatory to painting,



and the time required is said to be reduced to two or four hours, depending upon the kind of car. Old paint, rust and dirt are thoroughly removed, saving the task of washing, spraying and scraping, and the difficult places in the

chassis or body are easily reached. The pressure can be regulated from about sixty pounds, for taking off grease and paint, to twelve or twenty pounds, when cleaning wood parts.

Hollingsworth Sand Blast Equipment Co., 1024 N. Myrtle St. Indianapolis, Ind.

Chicago agent - Dr. W. H. Hensley
4742 Kenmore Ave.

Dr. W. C. Ogden
Research Engineer
Es-Cell. Q. Tool - mfg. Co.

1467
Detroit
Mich

HIGH SPEEDS ARE MEASURED BY NOTES IN MUSICAL SCALE

Measuring the revolutions of high-speed machinery by comparing the musical note of a sound vibration with a similar note from a tuning fork, or other musical device, is accomplished by a new device. The idea is being applied particularly to small internal grinders, in which speeds of more than 50,000 revolutions per minute are necessary. The new device consists of a tiny alternating-current armature built onto the revolving grinder spindle and connected, through other necessary apparatus, to a headset worn by the operator. As each complete cycle of the alternating current will draw the headphone diaphragm in toward the magnets once and release it once—a complete vibration—it follows that the number of vibrations per minute will correspond to the revolutions made by the spindle carrying the armature. The musical note known as middle C, for instance, is produced by 261 vibrations per second, or 15,660 per minute, so that when the operator hears middle C he knows the spindle is turning 15,660 times a minute, and so on, when the tone heard corresponds to a note higher in the scale.

machinery 12/1925
BLIND MAN DEVICES PRINTER FOR BLIND TO OPERATE

Raised printing by which the blind can read with the aid of their fingers, is done on a special press which a blind man in California has invented. It is so arranged that the operator can correct his work



Demonstrating Printer for the Blind; Keyboard Operated by Left Hand, the Right Serving as Guide

while using the keyboard, as one hand is free to follow the impressions.

*Inventor, J. Robert
H. H. Hensley
Los Angeles, Calif.*



Closely Resembling the Natural Flowers, These Roses both Petals and Leaves, Are Made of Rubber

FLOWERS COPIED IN RUBBER FORM LASTING BOUQUET

Leaves and petals of roses and other flowers are copied in rubber directly from the blossom itself by a recently devised process. The rubber is in jelly form and is combined with a sheet of other material, then pressed into tissuelike thinness and stamped with the pattern of a real rose petal. Leaves are made in the same way and then attached to a rubber stem.

PICTURE PROJECTOR SHOWS "STILLS" AS SALES AID

A small picture projector, which takes a cartridge of tiny film and occupies but little space itself, has been placed on the market to supplant the bulky binders of photographs used by salesmen to illustrate their talks. The complete projector is considerably smaller than the average photograph book, yet will project distinct ten-by-one-inch pictures on the wall of a well-lighted room, and larger sizes in the dark. The pictures are sorted out in the order in which the salesman wishes to present them and then photographed, one by one, on an ordinary film cartridge of motion picture width. The cartridge is inserted in the projector in the same way as in a camera.

P. B. Corp & Co, Ltd. 46 & 47 Cheapside London, E. C. 2, England.
Rauch & Lomb Optical Rochester, N.Y.

Harry S. Newcomb
U. S. Bureau of Standards

266

POPULAR MECHANICS

Washington, D. C.

TEST ROOFING BY FLAME BLAST FOR FIRE PROTECTION

814

Fire-resisting ability of various roofing materials is tested at the bureau of standards by subjecting samples to intense heat,

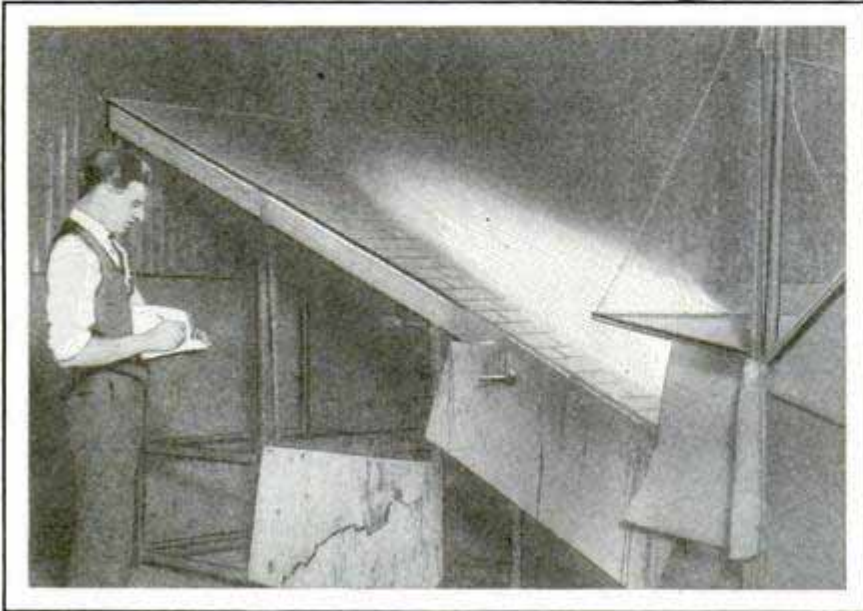

Exposing Roofing Material to Hot Blast at Bureau of Standards to Test Fire Resistance

after which an attempt is made to ignite them. The results are noted by an observer who checks the time the roofing is under test and how soon it shows signs of decomposition under the fire.

FLOOR SCRAPER AND SANDER SAVES TIME AND WORK

Operated wholly by hand-power, a combination floor scraper and sander is said to enable one man to do the work of six. It contains an automatic spring motor, so adjusted that the momentum of the idle stroke is absorbed and applied on the return cutting stroke. A wide blade, which can be sharpened without removing it from the holder, does most of the work and insures a smooth, even finish. A light sanding is done by a special attachment which is easily adjusted to the apparatus, or can be used separately with a stick handle.

*Triple "A" Machine Co.
4661 E. Raymond Ave.
06*



Combination Floor Scraper and Sander, Run by Spring Motor and Steered by User

MAN FASTING FORTY-ONE DAYS LOSES THIRTY POUNDS

866

So that scientists might observe the effects of prolonged fasting, a University of Chicago man recently went without

food for forty-one days. He lost between thirty and forty pounds, but his physical condition at the end of the ordeal was said to be good. His mental processes were retarded, but as in other cases, suddenly increased often above normal when he resumed eating. Since his seventeenth birthday, he started to go on diets of various kinds, and has fasted, in all, nearly 350 days. Before the longer fast, he had gone without food for thirty-three continuous days. Observations were made as to what happens to the digestive apparatus and the human system in

general when the body is deprived of nourishment for a given length of time.

GLOW OF PHOSPHORESCENT SEA BRIGHT ENOUGH FOR READING

On a recent voyage of the aircraft tender "Patoka," a strip of phosphorescent sea, so bright that newspapers could be read by its glow, was reported near Cuba. It was about six miles wide and extended as far as could be seen north and south. The light was so strong that shadows were cast upon the ship's awnings. In the wake of the vessel, where the water was disturbed by the propeller, marked red and green colors were noticeable beside the yellowish gleam of the band. The phenomenon, it is believed, was due to the action of ocean currents washing tremendous numbers of minute creatures that emit the phosphorescence into a close-packed area.

*Fire-drenched Haelgel.
11/23/25
new York Tribune*

3 12 H. C. Deane & Co.,
415 Madison Ave.

1349 Lexington Ave New York City

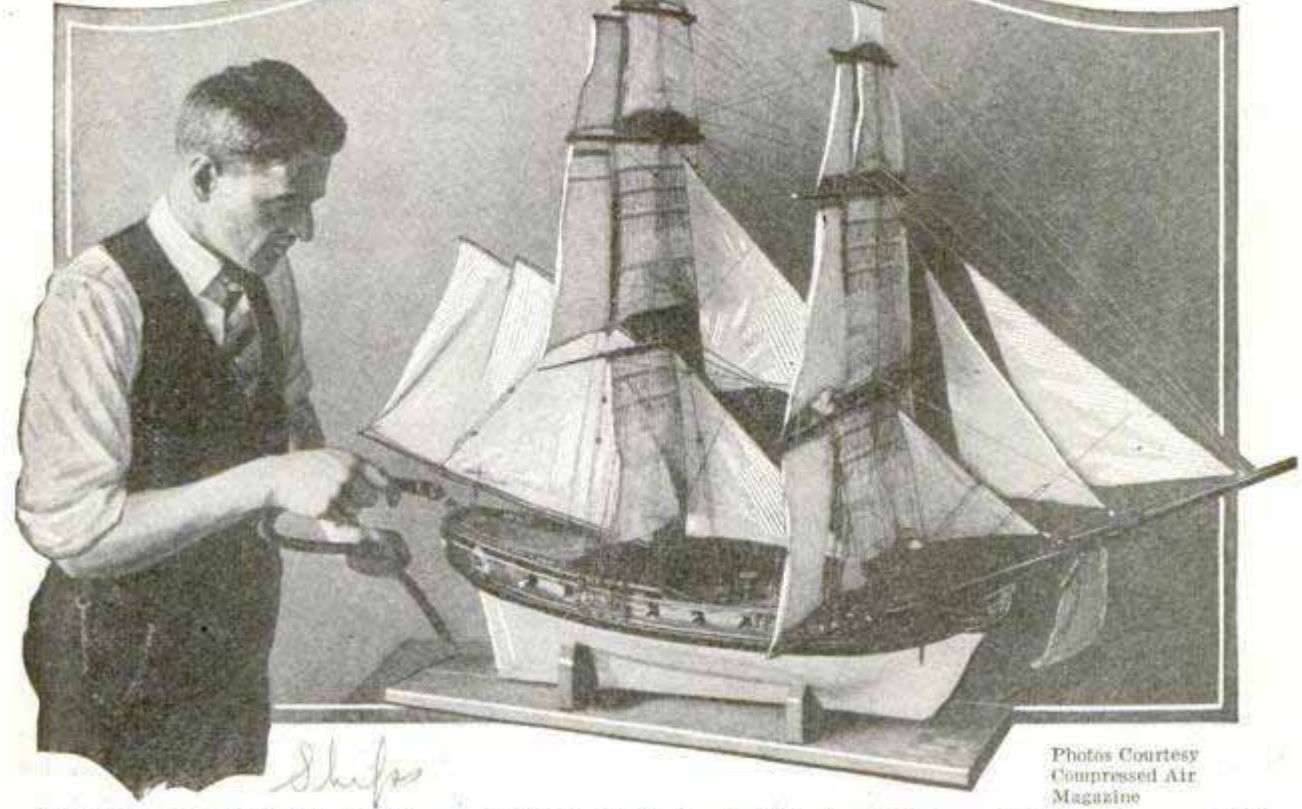

Photos Courtesy
Compressed Air
Magazine

Beautifully Carved Model of the Famous Old Brig "Fair America" Is Carefully Dusted Off by Compressed Air

A Shipyard High in a Skyscraper

Caravels, Frigates, Racing Schooners and Latest-Model Steamers
Launched from Tenth Floor, High above City Streets

LAUNCHING a steady stream of ships, ranging from replicas of Columbus' and pre-Columbian vessels down to the latest-model battleship or ocean liner, a New York shipyard occupies a unique location ten floors above a busy street on Manhattan island. The shipyard in a skyscraper is possible because the vessels that issue from its building ways, though complete in every detail, are only miniatures in size.

The unusual shipbuilder produces perfect models of warships for American and foreign governments; models of great ocean liners, perfect in detail and often ten to fifteen feet or more in length, for commercial ship owners; hull models and detail models used by real shipyards in testing the lines of proposed new vessels; historical models of every type of ship from Columbus' day down to the present, and trim little sail or power yachts for the model-yacht racing enthusiast. Not only are carved hulls produced, but the standing gear and the running gear and

all the ship's hardware of the sailing ships, complete to the tiniest model block; and powerful little steam and electric engines for power craft.

Starting twenty years ago with the making of exhibition models of ships for steamship companies and governments, the business has grown until the model racing yacht occupies a large part of its attention. Racing clubs have been established in nearly every large city and many towns, while the list of racing enthusiasts numbers such men as Franklin D. Roosevelt, former assistant secretary of the navy and once candidate for vice-president, who owns a whole fleet of model yachts, which he built himself.

The models bear no relation to toy-store sail or power boats. They are scientifically designed by noted yacht architects, so that they not only float, but actually sail, and at good speed. The National Model-Yacht Racing association governs the sport throughout the country, under rules as strict as those used in any big-

Howard Saniffath, Secretary.

27 Park Row
New York



yacht race. It takes a real ship, properly designed, to make the sport worth while, and some of these little fifty-inch craft sell for as much as \$200, while a forty-eight inch power boat, with a four-cylinder high-speed engine, turning over at better than 3,000 revolutions per minute, and a boiler with a working pressure of more than 100 pounds, will cost almost as much.

Model-boat building is almost as old as boats themselves. As early as Columbus' day, no government built a vessel without first seeing a small model which showed how the com-

pleted ship would look. The carpenters themselves worked from the model as much as from drawings. Some of these old models appear on the market from time to time and bring fabulous prices. Many of the old models appearing in the art stores were carved by sailors from fifty to one hundred years ago, and even these often sell for \$500 or more.

The modern exhibition models, instead of being carved hulls supported by framework, are often mounted on rippled glass, giving the semblance of water, and appear to be under way. One group, made for the engineer's corps of the army in the tenth-floor shipyard, illustrates the development of transatlantic ships from the clipper "Dreadnaught," built in 1835, down to the "Leviathan," with its three huge stacks and rakish lines. Another model shows the non-magnetic ship "Carnegie," heeled over under full sail on a sea of rippled glass. The famous race between the yachts "Aurora," "Winsome" and "Istalena" is commemorated in another group showing them under sail.

The models are constructed to exact scale, one mammoth piece turned out for the Argentine government showing the longitudinal

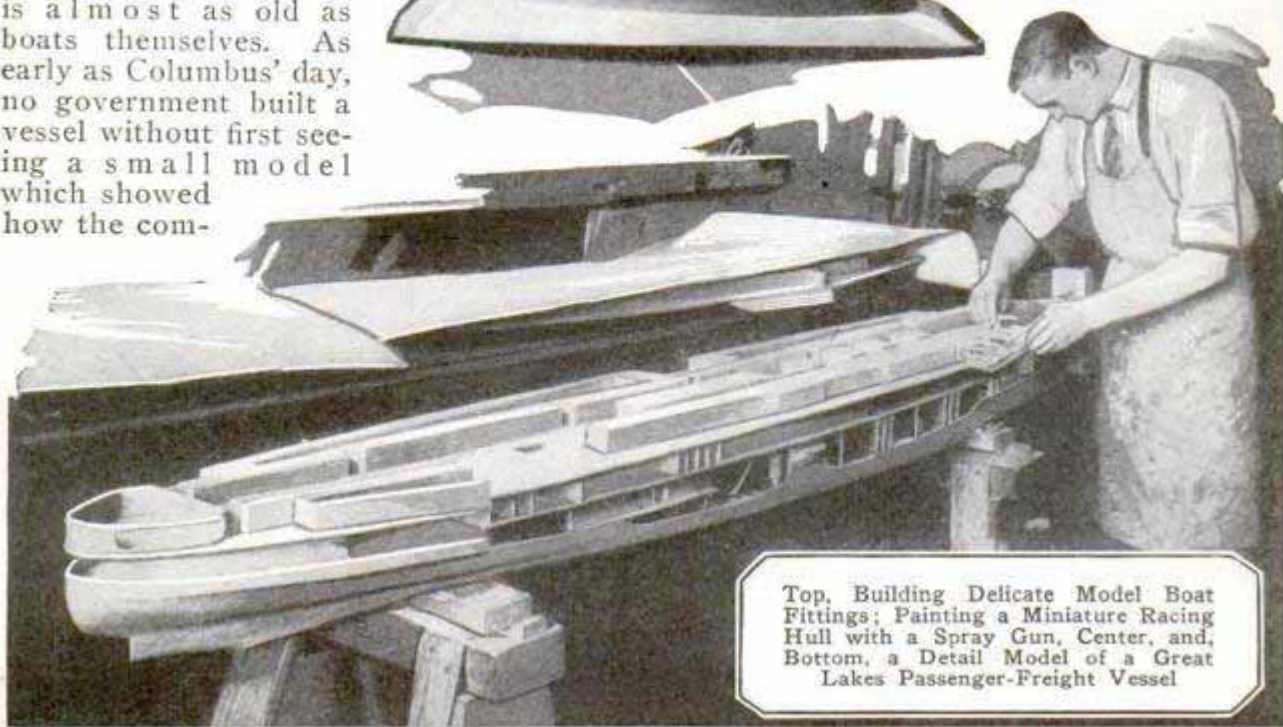

Top, Building Delicate Model Boat Fittings; Painting a Miniature Racing Hull with a Spray Gun, Center, and Bottom, a Detail Model of a Great Lakes Passenger-Freight Vessel

576

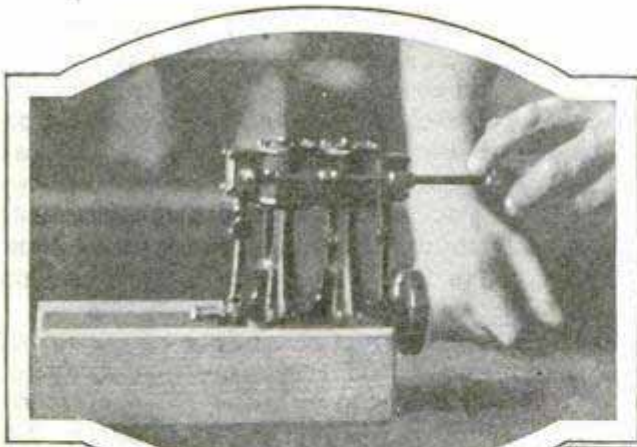

Testing High-Speed Steam Engine before Installing It

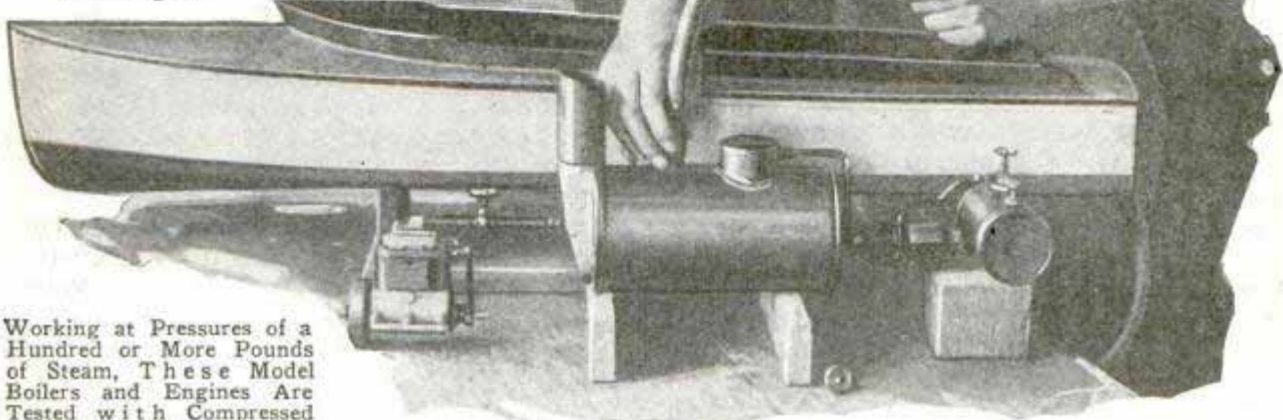

Working at Pressures of a Hundred or More Pounds of Steam, These Model Boilers and Engines Are Tested with Compressed Air before Installation

section of the battleship "Rivadavia" in a scale of one-fourth of an inch to the foot.

Horace E. Boucher, the founder of the aerial shipyard, was a model builder for the navy before he established his own plant. Many of the complicated warship models displayed under glass cases in the navy building at Washington were made by him. The bigger battleship models require months in the making, the services of ten to a dozen expert craftsmen, and cost anywhere from \$8,000 to \$10,000, or even more. Such minute parts as boat falls, winches and deck gear are movable and actually work, though often so small that the maker carved them under a magnifying glass.

The sectional models are even more intricate, showing every detail of the interior, with engines that actually work. Some of these models are used at Annapolis in teaching the midshipmen details of battleship operation. In the German navy, before the war, every ship was equipped with its working sectional model to be used in the training of new men.

It is in the making of racing models for the sailing and power-boat clubs, however, that the greatest ingenuity has been shown. Dozens of items of ship fittings

have been produced in exact scale. Boat davits, either common or patent types, ventilators, running lights, cleats, chocks, bits; blocks, single or double; anchors, turnbuckles, steering wheels, bells, stanchions, air ports, life rings, shackles, hawse pipe, binnacles, searchlights, deck winches, capstans; in fact, no end of tiny fittings are available.

Boats are designed and sold complete, but for the boy or man with a love for tools everything is supplied, from plans and parts, rough-carved hulls and parts, semi-finished hulls, to finished hulls and the parts needed for completion.

The list of models available is a naval history of five centuries. From the "Santa Maria," "Half Moon" and "Mayflower," it ranges through such famous early naval vessels as the "Constitution," "Wasp," "Bonhomme Richard" and "Lexington," down through early steam types and to the battleships, cruisers and submarines of the present. Then there are models of famous yachts, noted clipper ships, and typical steam merchant ships of the present.

The making of model power plants for these, and for the model motorboats raced by the amateur clubs, is a science in itself.

Every type of marine steam engine is produced in miniature—single and double-action oscillating engines, one and two-cylinder double-acting slide-valve types, high-speed twin or four-cylinder racing engines, the latest thing in compound types, with high and low-pressure cylinders, using the same steam twice, and many others.

Autoists who are accustomed to high-speed motor-car engines running at 1,800 to 2,200 revolutions per minute, are amazed at a tiny little steam plant, two and three-quarters by four and three-quarters inches and three and a half inches high, weighing only one pound ten ounces, yet developing a speed of 3,500 revolutions per minute. Every part, from the smallest wristpin to the three-quarter-inch piston, is as carefully machined as the corresponding part of an automobile engine.

The tiny boilers which generate the steam for these miniature power plants can be held in one hand, yet are equipped with superheaters and will develop eighty pounds of steam from cold water in three minutes. The engine fittings, from pressure gauges recording up to 120 pounds, through force pumps, whistles and valves, are all made with the same precision.

Power boats, ranging from thirty to forty-eight inches in length, and driven by these little steam plants will attain speeds up to twelve miles an hour. The racing rules, particularly for the sailing yachts, are quite elab-

orate. Each model owner follows his entry around in a rowboat, and trims sail as required to go on another tack. Unlike the large yachts, sailing before the wind is the most difficult point for a crewless model, so the rules have been changed to give the yacht in that position the right of way, which compels owners of boats on other tacks following their craft to keep them out of the way of a collision.

The little models can cover any kind of racing course, though the sport is at its best over a closed course, triangular or square in shape, where each boat is required to tack and round the corner buoys, bringing out the seamanship of the owner. The rules stipulate that the owner must row up to his craft gently, so as not to force it ahead on the advancing swell, and must be careful not to give his boat a shove on her way after changing the sails.

It takes a high degree of skill to sail one of the model yachts successfully. To meet changing conditions of wind, most of them have their masts so mounted that they can be shifted forward or aft, moving the entire sail layout and thereby changing the center of gravity to meet stronger or lighter winds. Many of the small yachts can be made to sail as closely into the wind as a big boat, provided the owner is an expert at adjusting his sails to the correct degree of slackness. All of these changes must be made from the accompanying rowboat as the yacht is turned on a new course. To make them successfully, without violating any of the rules against fouling a rival yacht or giving an extra

shove to one's own boat, is one of the chief thrills of the sport.

A Four-Foot Schooner-Rigged Yacht, Jockeying for Position before Crossing the Starting Line in a Model-Boat Race; Rules of a National Association Govern These Events as Strictly as Any Big Race



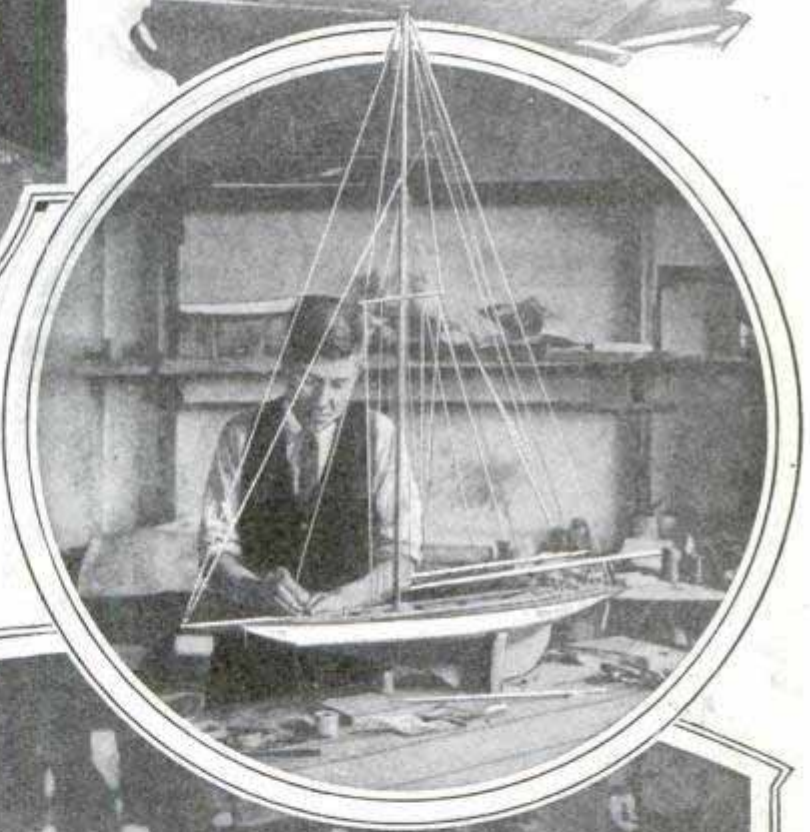
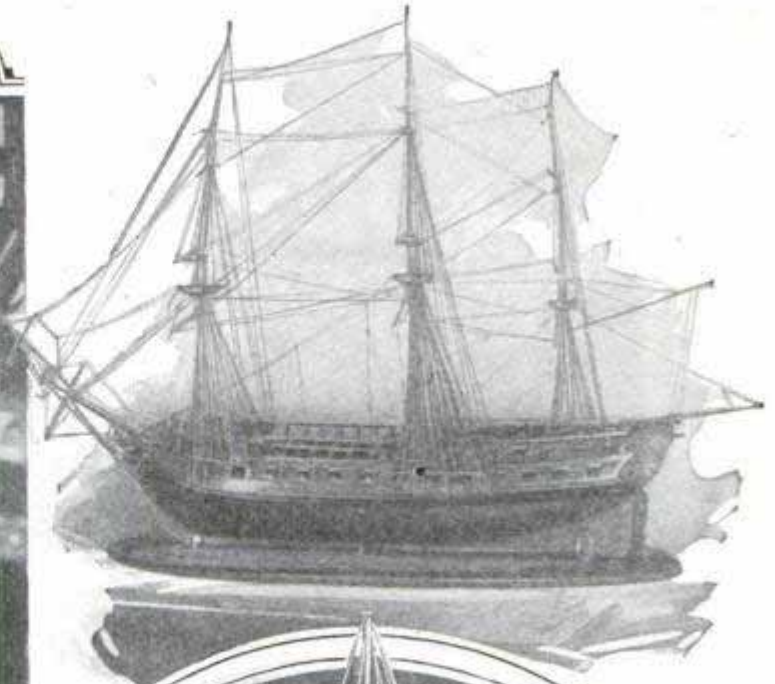

Workman, Above, Checking the Fair Lines as He Carves a Testing Model to Be Tried Before the Owner Orders His Full-Size Yacht Built; at Right Is a Model, Complete in Every Detail, of an Old-Time Frigate; Center, Rigging a Model of the Cup Defender "Resolute," Which Defeated the "Shamrock IV" for the America Cup in 1920; Many of These Boats Are Sold in Parts for the Owner to Build at Home

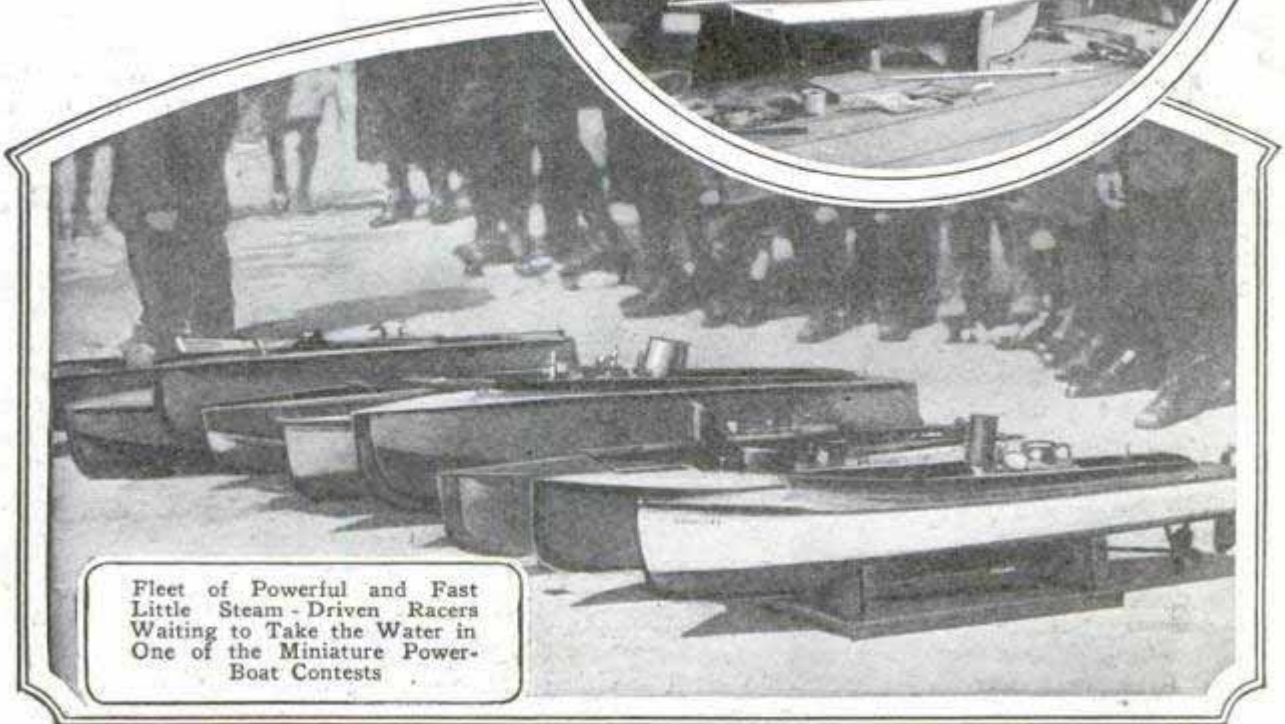

Fleet of Powerful and Fast Little Steam-Driven Racers Waiting to Take the Water in One of the Miniature Power-Boat Contests

Stephens-Adamsen Mfg. Co.
Aurora, Ill.

272
825

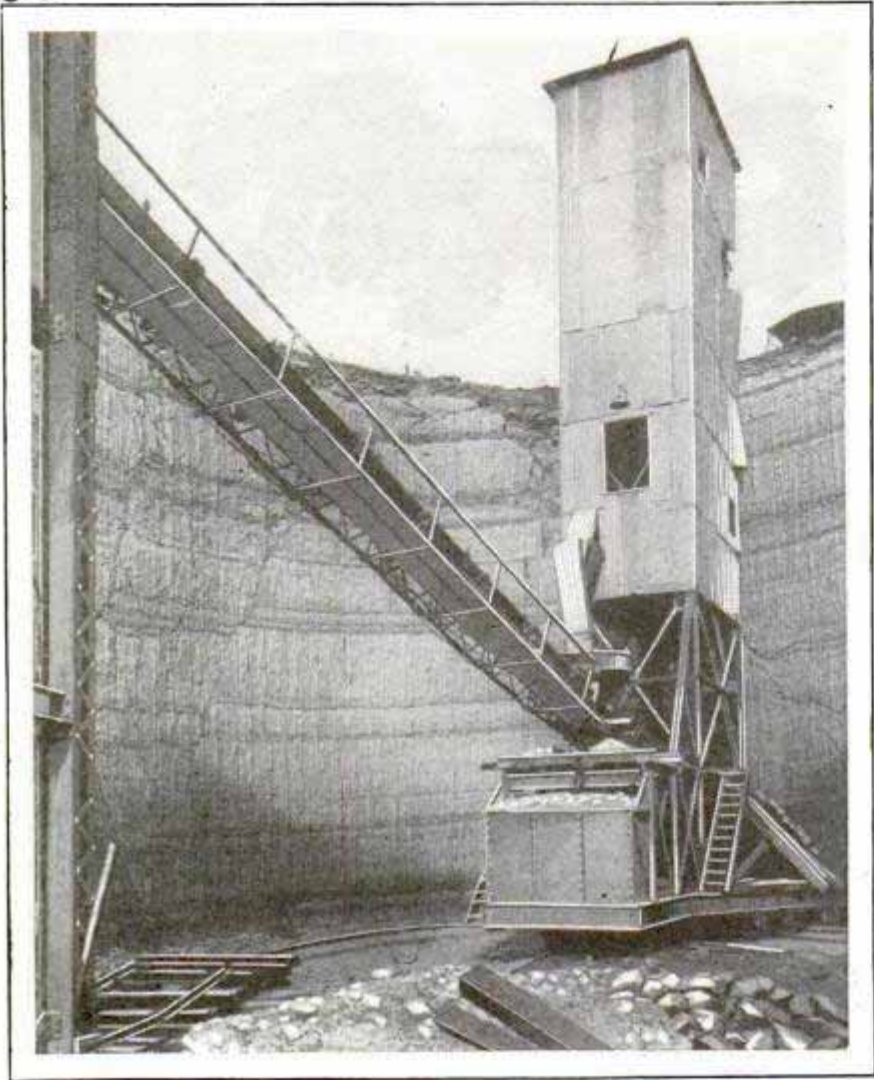

A Substitute for Boring and Blasting. Clay Cutter That Pares Dirt from Bank and Elevates It for Hauling

SHAVES CLAY FROM HILL AT FIFTY TONS AN HOUR

825 Replacing older methods of drilling holes and blasting, a bucket-elevator apparatus with cutting tools, shaves clay and similar materials from hillsides at the rate of fifty tons an hour, and delivers the product into a hopper for transportation. The elevator is arranged so that it scrapes against the bank, allowing the cutters to make a shallow upward stroke, dislodging the soil which falls into the buckets and is hoisted. The outfit rests on a movable pivot truck so that it may be swung about through an arc of almost 180 degrees and fifty-four feet across. Its maximum capacity is attained when a cut about fifty feet across is possible and when it operates continuously, according to the manufacturers.

SLEEP RESEMBLES INTOXICATION

838

Tests conducted by scientists at George Washington university on eight students, who were kept awake for sixty hours, have suggested the theory that sleep may be nothing more than a form of intoxication, and that by cultivating better habits, humanity may be able to reduce the number of hours required for slumber. Storing of poisons in the human system during the wakeful periods, it was indicated, induced the drowsiness and necessity for sleep. Microscopical examinations of the blood of the subjects showed that there were changes in it similar to those that occurred in the blood of a drunken man, and that a short period of sleep eradicated the effects. The lack of sleep seriously impaired the students' vision. Some reported seeing phantoms and others distortion of objects. A single night's

loss of sleep did not decrease their ability to drive an automobile, but on the second night, they had a tendency to fall asleep because of the rhythm of the motor. Their mental faculties and muscles remained up to standard.

SIX-SOCKET RATCHET WRENCH FITS AUTO SIDE POCKET

Intended especially for the motorist, a ratchet wrench that has six different-sized sockets in its handle, can be slipped into a side pocket of the car, saving search under cushions for the proper tool in making minor repairs. The ratchet may also be reversed, and besides the sockets, an extension, seven inches long, is provided for reaching difficult places. This, too, fits inside the handle of the wrench when not in use.



Wrench with Set of Different-Sized Sockets That Slip into the Handle

Price \$3.00

Husky Wrench Co.
928-16th Ave

Milwaukee, Wis

*Invention of Joseph
Mallagh, Engineer*

Dublin Post POPULAR MECHANICS

**FOGS REGISTER OWN WARNING
BY RINGING SIGNAL BELL** 782

By means of a beam of light and a sensitive cell which controls an electric current, fogs are made to register their own warning to protect ships at the port of Dublin. The beam is sent across the river in an oblique direction from a small lamp that shines through a lens. The rays are collected by a larger lens on the side of a lighthouse, and are thrown upon a sensitive photoelectric cell connected to a circuit controlling the alarm bell. So long as the light shines with sufficient intensity, the circuit is open and the bell cannot ring, but a fog dims the rays sufficiently to cause the cell to close the circuit, and the alarm sounds. The action is not instantaneous, about half a minute being required to operate the bell, so that passing ships cannot cause false alarms.

**AUTOMATIC NOZZLE FOR HOSE
REDUCES WATER WASTE** 716

Fitted with a spring button which automatically shuts off the water flow when pressure on it is removed, a hose nozzle now on the market prevents waste and damage to the lawn or garden in letting a stream rush into the soil when the hose is dropped to the ground. Special tips are provided with the nozzle for washing automobiles, filling pails or radiators, sprinkling, and other purposes, and a reel that is connected directly to the hydrant or water pipe, keeps the hose in good condition, helps avoid soiling of the hands or clothing, and occupies little space. When the automatic nozzle is used the hose may be kept full of water.

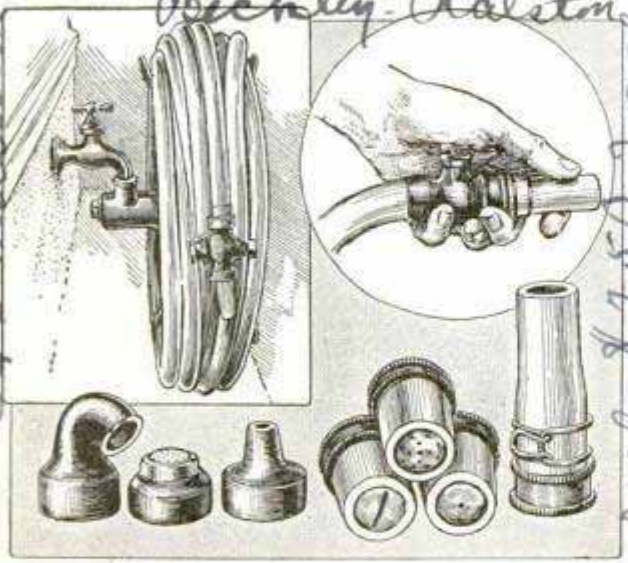

Hose on Reel, the Spring Nozzle Shut-Off, and Attachments for Special Uses

Rayford Mfg. Co.
Paterson, N.J.

**BANJO, HARP AND GUITAR IN ONE
IMITATE THE PIANO** 755

Five instruments, virtually a small string orchestra, are combined in a single piece constructed on the principles of a



Forty-Two-Stringed Combination Harp, Banjo and Guitar That Produces Orchestral Effects

banjo and adapted for concert or jazz-band playing. It is said to produce the tones of the harp, piano, guitar and mandolin besides those of the banjo. There are forty-two strings. Melodies are played with the left hand, while the right actuates the longer strings for bass tones. The frame of the instrument is made of hand-carved wood covered with gold leaf. In playing it, one end is supported on the lap and the other on a small stand.

**CEEDER PLASTER FOR CLOSETS
HELPS PREVENT MOTHS**

Aromatic red cedar has been mixed into a patented composition with plaster especially for clothes closets, to repel moths and other insects. The preparation may be applied over a surface already plastered and needs only mixing with clean water to make it ready for use. No stain or paint should be used over it as it will reduce the strength of the cedar odor. The plaster is said to produce a smooth finish, which, besides being as effective against moths as a cedar chest, is practically proof against dust.

Cedar Plaster
C. E. Wallman & Co. d. n. e.
New Orleans, La.

Sales agent: A. H. Trout Co., d. n. e. 342 Broadway, New York

and Prof. J. J. Leavelle, d. n. e. 1611 N. Lincoln St. Chicago

See me at 7150 Broadway

Planting a Forest Under a Skyscraper

Pile Drivers Force Acres of Pines through the Earth to Find Solid Foundation for Tons of Steel and Concrete

By J. EARLE MILLER

TRANSPLANTING vast forests of tall, straight pines from the Gulf states, turning them upside down and driving the trunks, top first, for scores of feet through surface loam, sand, muck and clay, the pile-driving crew is at work wherever tall buildings are to rise. Thousands of acres of fine timber, sixty, sev-

enty-five and eighty-foot shafts—a foot thick at the base and six inches at the top the minimum measure—disappear every year under the steady “tamp, tamp” of the steam-driven pile hammer.

The world's biggest building, in point of floor space—the American Furniture Mart, in Chicago—rests on more than 7,500 of these sixty-foot timbers, and that is not a record job at all. A vast ore dump recently completed for a steel mill at Indiana Harbor required 14,400 piles, all of them seventy-five and eighty-foot lengths. Their tops were bound together with the cement ore floor, several feet thick, at each cluster of timbers.

Even if a hundred suitable trees, long enough, straight enough and sound, could be found on a single acre, it would take a good-size forest to provide such a foundation. The pile driver itself is a product of the evolution in building. Originally a seagoing machine, designed to drive breakwaters and piers, it crawled onto dry land and acquired rollers when builders started after new records in skyscraper height. Wherever bedrock is too far down to be reached economically with foundation

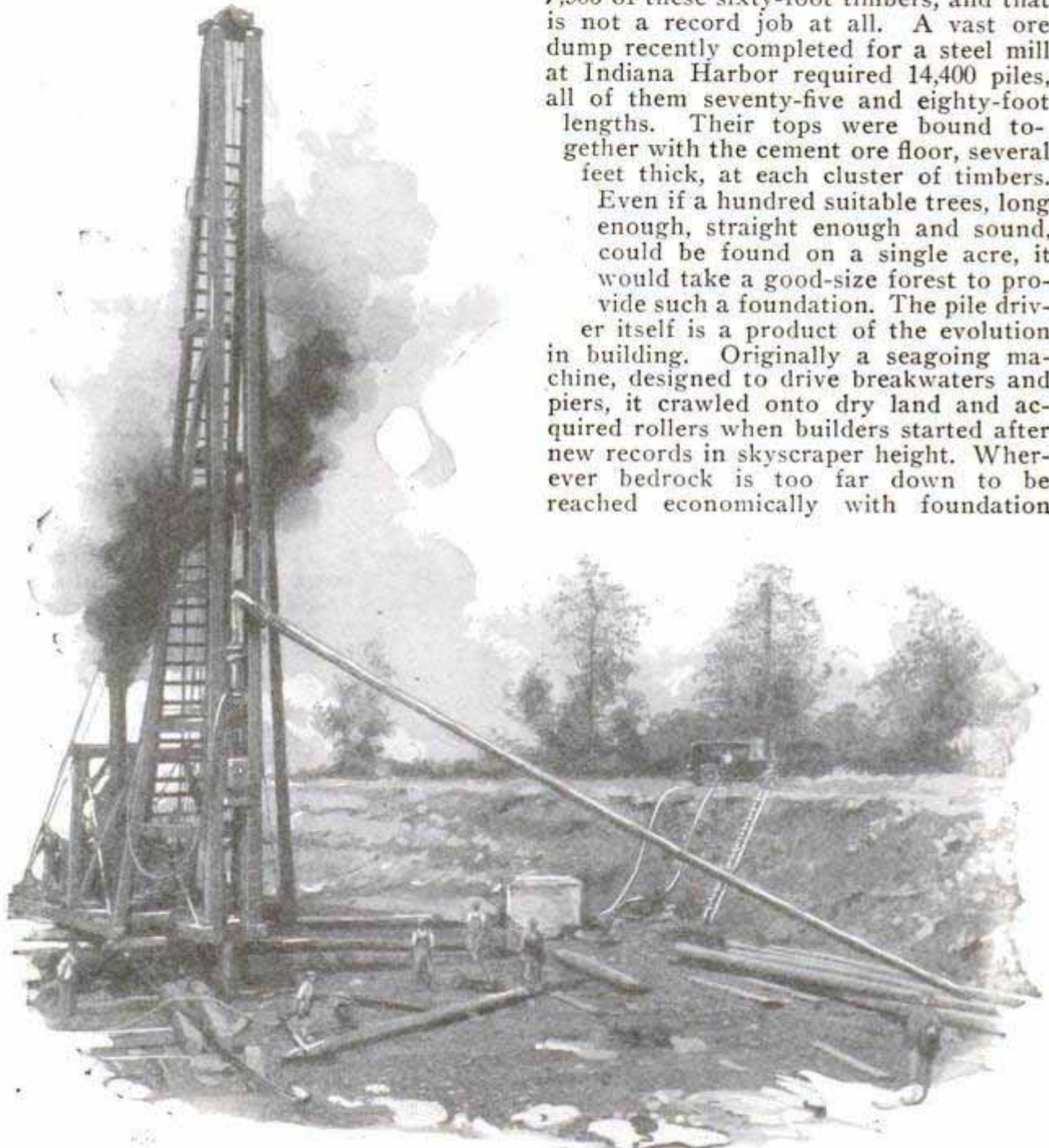

With a Hitch about the Twelve-Inch Butt, the Pile Driver Jerks a Sixty-Foot Tree Stem Upright, Ready to Be Rammed Home by Five-Ton Hammer Blows as Part of a Foundation

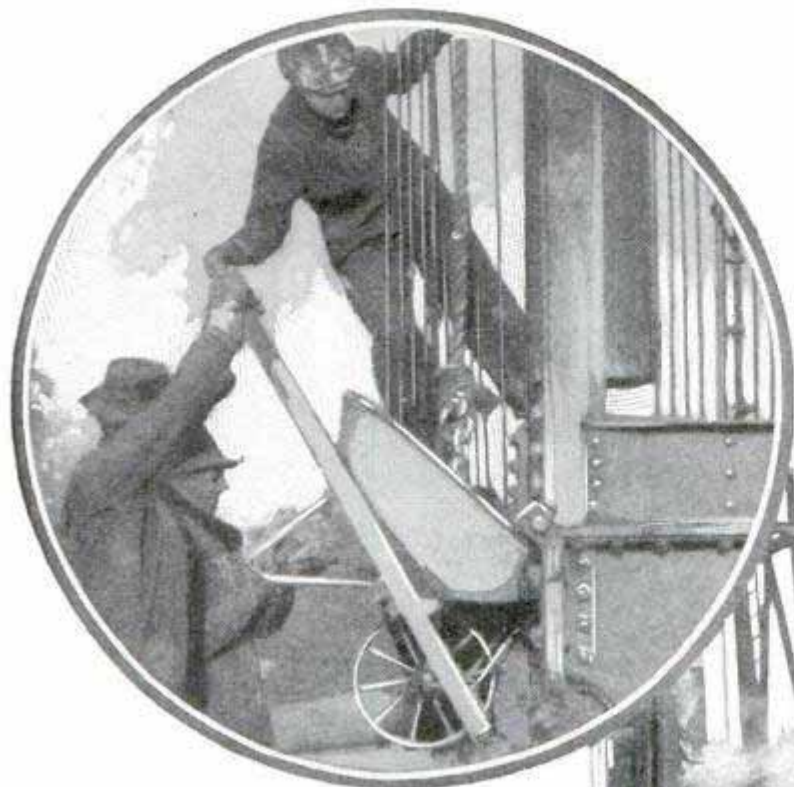

Concrete Is Poured on the Sunken Top of the Wooden Pile to Form a Watertight Joint for a Composite Pillar; Right, the Wooden Pile Being Rammed through Solid Earth by the Steam Hammer

caissons, the pile driver steps in. The Furniture Mart, erected on made land recovered from Lake Michigan, is more than 110 feet above the rock. But seventy feet or so below the surface lies a thick layer of hardpan, which was reached with sixty-foot piles, driven from the cellar level.

To drive one of those huge tree trunks through loam and clay, with an occasional boulder barring its progress, requires tremendous energy. The hammer of the average pile driver alone weighs five tons, and strikes a twenty-ton blow, at the rate of from fifty-five to sixty-five blows a minute.

By preparing the ground with a jet of water before the pile is started, the five-ton weight frequently will drive a sixty-foot pile for half its length by sheer weight, before the steam hammer strikes a single blow. The water jet is a long two-inch pipe, connected to the nearest fire hydrant, and expelling through its tapered nozzle a powerful stream. Pointed into the ground, it washes out the earth and by its own weight sinks for twenty feet or

more, leaving behind a deep hole into which the six-inch pile end drops. As the five-ton weight of the hammer drops onto the pile, it sinks many feet farther through the softened earth.

The hardpan formation far underground, on which most building piles rest, has all the inequalities, small hills and valleys of the average section of surface land. The boss of the pile-driving crew, watch-

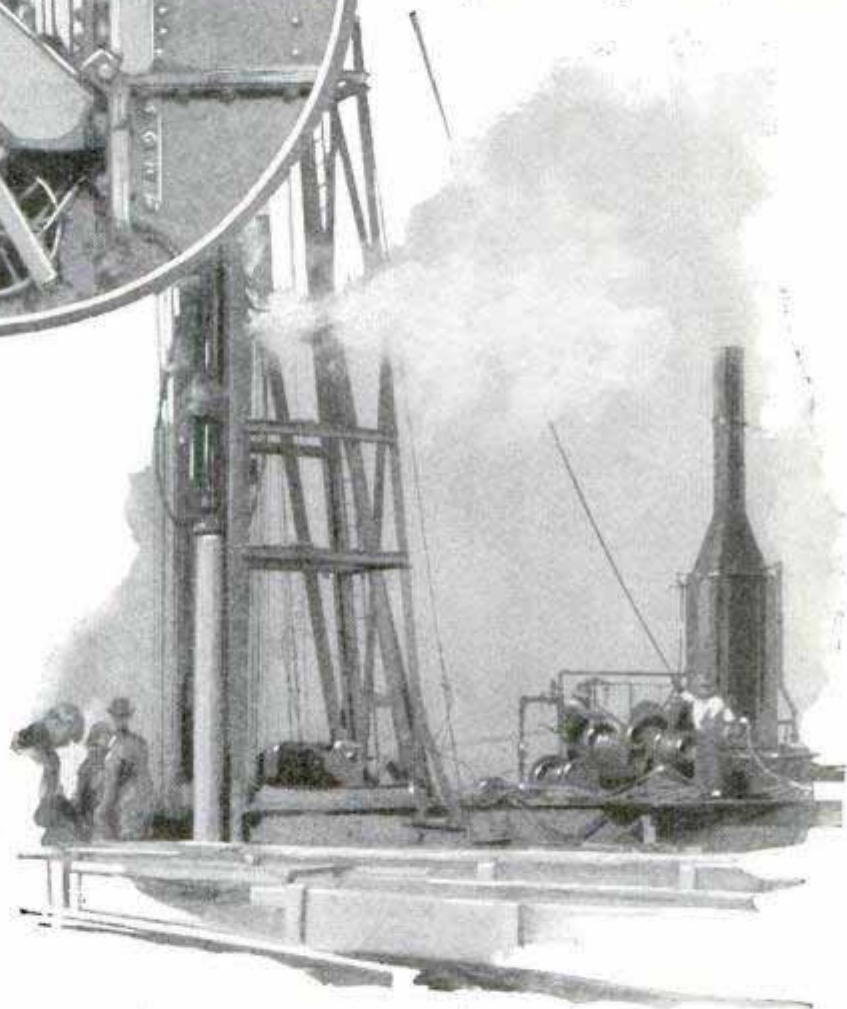

ing the hammer blows fall, can tell by the slowing up of the pile when it has reached its base, and the driving stops. Some piles will be left sticking several feet in the air, while only a short distance away, owing to a little valley in the hardpan, the pile will be driven all of its length, and still not reach a firm foundation. Then the "follower," a length of tree trunk, iron-bound at the top to save it from the hammer's blows and with an iron ferrule at the bottom to slip over the pile end, comes into play and, like the carpenter's nail set, drives the timber out of sight under the ground.

For the use of the pile driver and its crew of engineers, fireman, chopper, who prepares the tops to fit the pile hammer, laborers and others, the builder pays on the basis of lineal feet of piling driven. An average building job, where loam, sand and clay underlie the foundation, costs around thirty cents a foot, or \$18 for the driving of each sixty-foot length. Under those average conditions, a single crew will sink from twenty-five to thirty-one or two piles a day. The diamond drill which goes down before a big

soft sand or other easy going, the price per foot goes down as the daily quota of the pile driver goes up. One crew, placing foundations for a steel mill in the Gary district, set a record of 264 piles driven in a nine-hour day.

In that case, however, the soft sand of the northern Indiana dunes reached all the way down to hardpan.

The average building piling used in cities ranges somewhere between thirty and eighty feet, but marine piling often is much longer. Lengths of 225 feet, formed of several sections spliced together, are not uncommon in the west, particularly around Seattle, and around eastern ports. One big job in

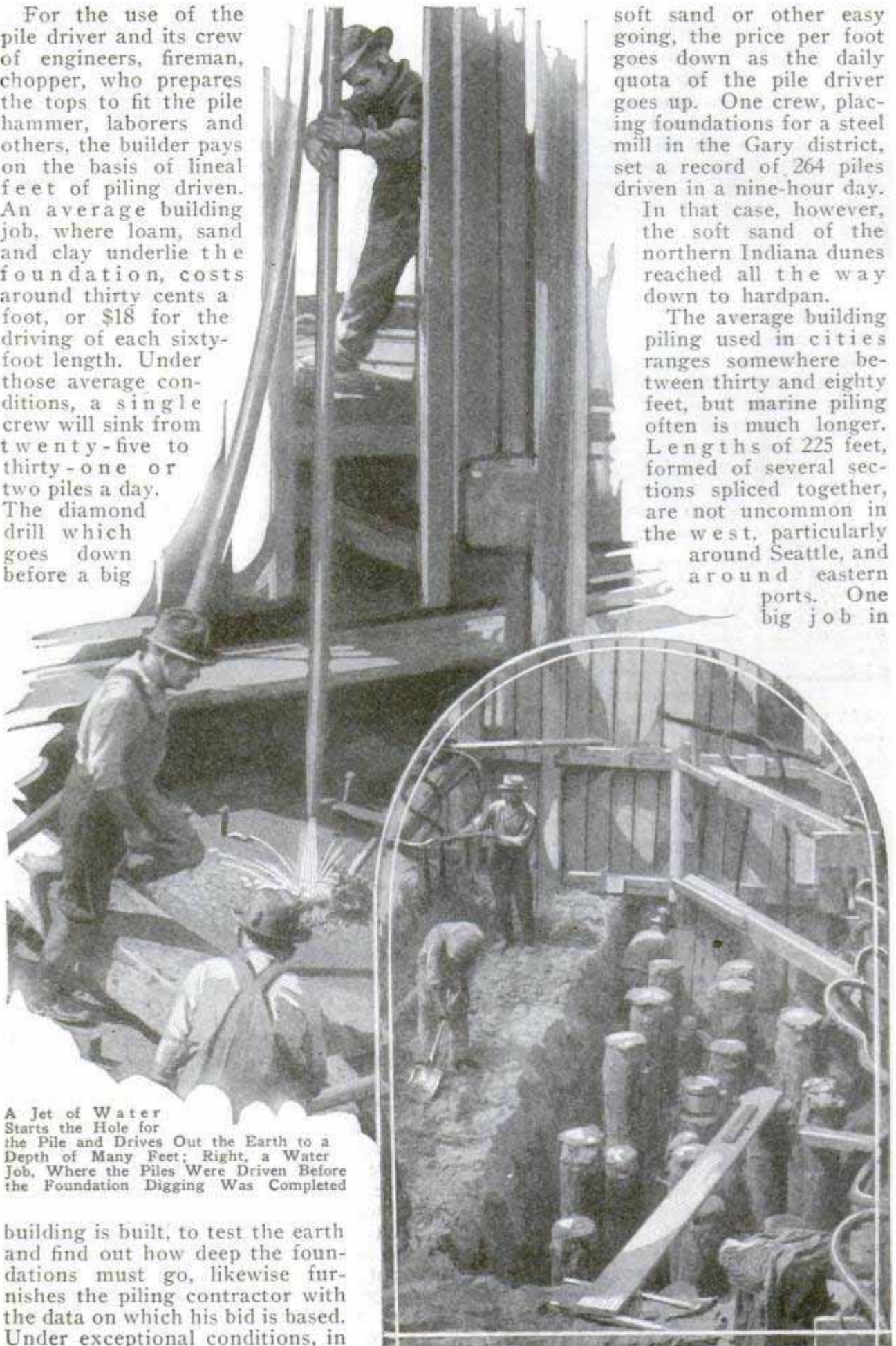

A Jet of Water Starts the Hole for the Pile and Drives Out the Earth to a Depth of Many Feet; Right, a Water Job, Where the Piles Were Driven Before the Foundation Digging Was Completed

building is built, to test the earth and find out how deep the foundations must go, likewise furnishes the piling contractor with the data on which his bid is based. Under exceptional conditions, in

the Hudson river at New York was given up and an entire construction project abandoned when pier piling 300 feet from shore failed to find bottom at a depth of 225 feet.

Not all piling used is of wood. Reinforced-concrete piles are often used for docks; combinations of wood and concrete for buildings, and there is a patent concrete pile which is poured into a hole driven by the pile driver. A core made in three sections is fitted in thin steel tubing, expanded to fill the form, and then locked. The pile driver forces tube and core into the earth, then the core is unlocked, when it collapses, and is drawn out, leaving the steel tube in which concrete is poured. When combination of wood and concrete is used, the

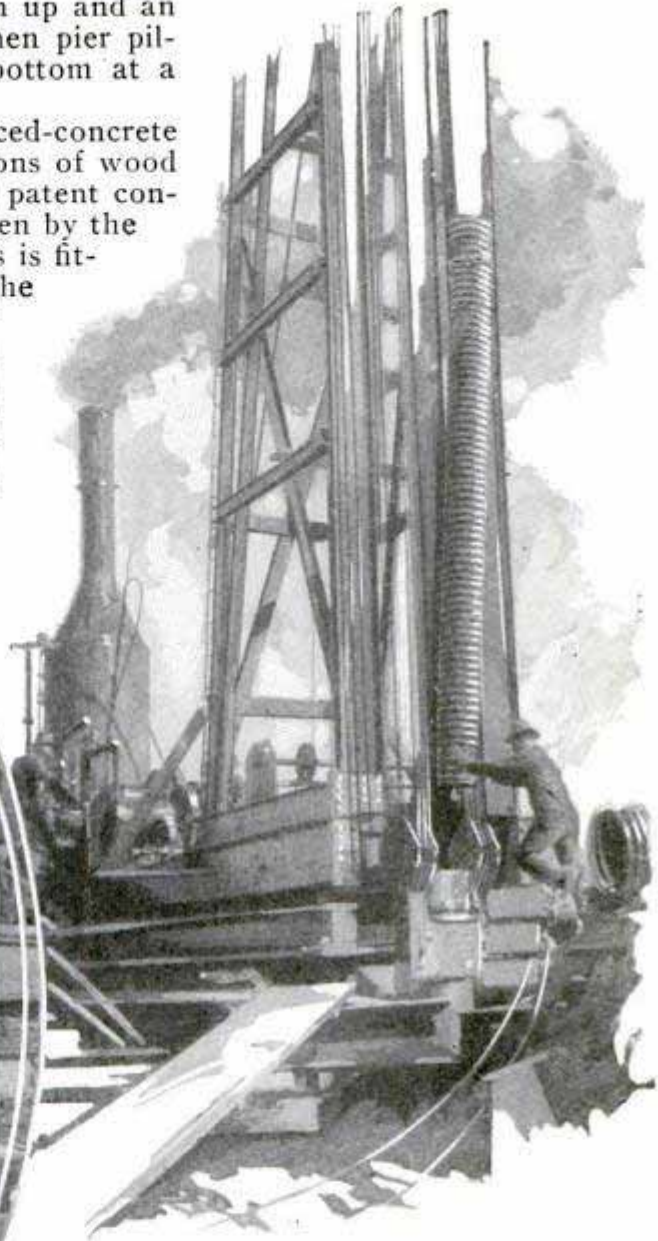
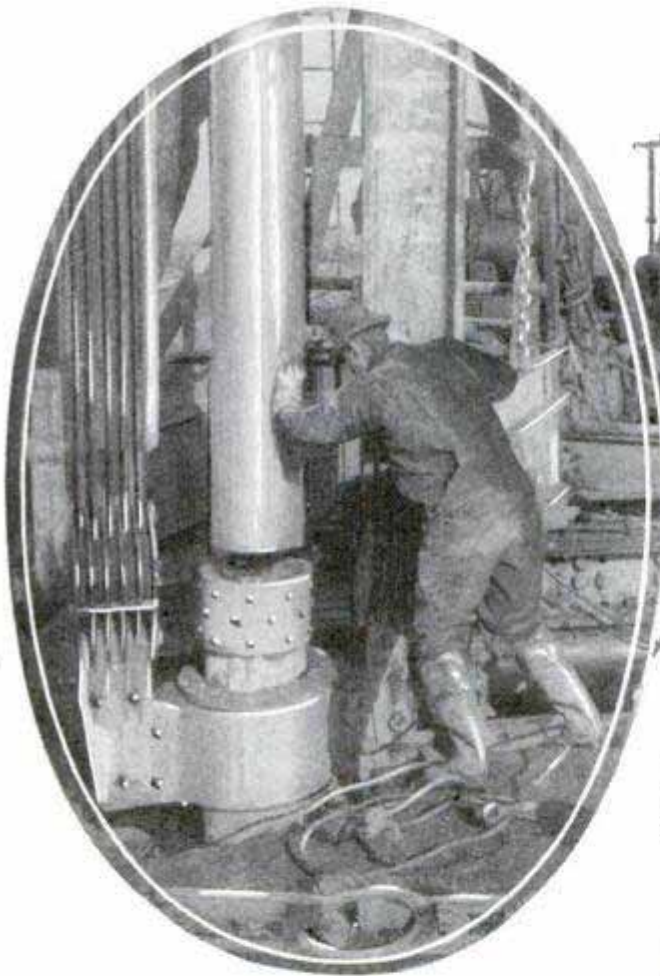

After the Wooden Pile Is Sunk below the Surface, the Corrugated Form for the Concrete Top of a Composite Pile Is Let Down; Left, the Cables and Sheaves of the Hundred-Ton Mechanism That "Pulls" the Pile Down

cost of the work is considerably higher than for straight wooden piling, but the top of the wood is driven below water level, and hence all chances of rotting are removed. The cost of wood piles plus the cost of driving under average conditions in the middle west totals about fifty-seven cents a foot, whereas a corresponding job of composite piling will cost around a dollar a foot. The big concrete piles used in dock work are molded in forms on the ground, seasoned for forty days or more and then sunk, like the wood, by the pile driver.

The latest model steel-tower pile drivers used for driving these concrete-and-wood piles save steam and time by pulling the piles down for a good part of their length, instead of driving them. Steel cables laced back and forth over five pulley sheaves give a tremendous pulling power, the lower end being held by the outer steel shell. Such an outfit can exert 100 tons' pull, though only a part of it can be used before the resistance of the wooden pile being forced down overcomes the resistance of the steel tube already in the ground, and starts to lift the latter out. The pulling drivers also have much heavier hammers, the steel core, cables and other extras adding more than four tons to the five-ton hammer.

Bob by Max Williams
New York City.

paper presented before
Optical Society by
Dr. W. W. Coblenz

**FIGUREHEAD OF CONSTITUTION
752 PRESERVED AS RELIC**

A wooden statue of Andrew Jackson, which was the figure-

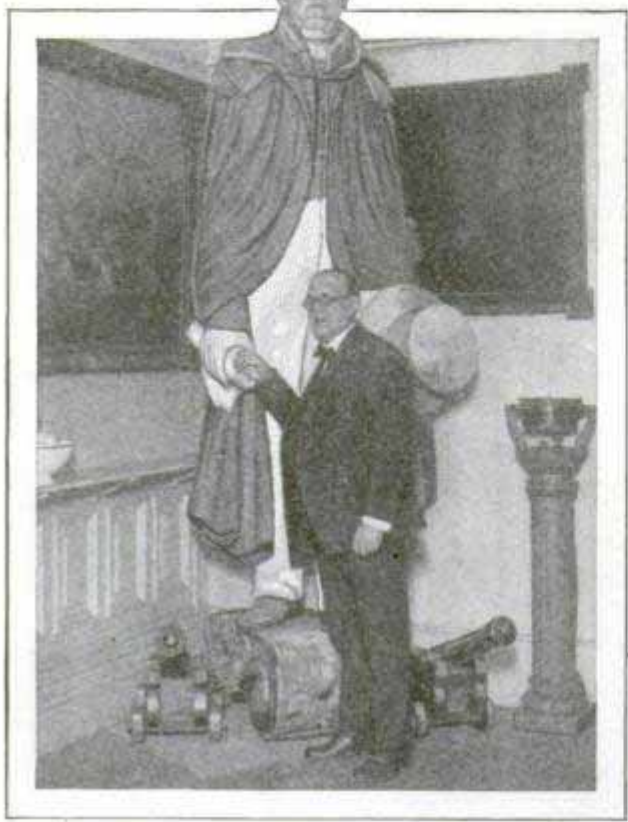

Wooden Statue of Andrew Jackson, the Figurehead of the Old "Constitution," Preserved in Relic Shop

head of the frigate "Constitution," has been secured and is being carefully preserved by a dealer in marine antiques. While the ornament was considered a splendid example of a ship's figurehead, it was regarded by some as inappropriate. A man is reported to have swum out to the frigate and cut off the head of the statue. The decoration was then removed and the head later recovered and replaced.

**RIVER DRAINED
786 TO UNCOVER GOLD**

Engineers in New Zealand are seeking to reclaim the gold deposited in the bed of the Kawarau river by shutting off the flow of the stream at its source, Lake Wakatipu. A dam and sluice gates, which can be closed at times to reduce the

waters so that miners can explore the river course, are to be constructed across the narrow opening that leads from the lake. Measurements indicate that the openings can be entirely closed for two to three months during the winter before the basin overflows, and thus there will be ample opportunity to search for gold along the bed of the stream.

**701 PLANT THAT GIVES COLD LIGHT
SHINES IN THE DARK**

Long sought by scientists, cold light is naturally produced by a variety of fungus that shines in the dark. The plant sometimes is found on decaying wood and its illumination is just within the limits to which the eye is sensitive. It does not contain any of the longer heat waves nor the shorter ultraviolet emanations, which are contained in sunlight although they cannot be seen by the unaided eye. Similar light is emitted by a species of shellfish, but this has less of the red than that from the fungus. The glow from the firefly likewise contains little blue or red, being mostly yellowish.

**769 ARCH MADE FROM ONE TREE
TO SHELTER TOURISTS**

A single redwood tree furnished all material for the construction of a rustic arch as a tourist shelter in Vancouver, B. C. The pillars are lengths of the trunk, and the bark has been left on in order to increase the natural effect. The only parts of the structure finished with tools are the capitals of the Doric pillars, the frieze and the pediment. The structure is modeled after a Grecian temple.



Rustic Arch of Grecian Pattern Constructed Wholly from a Single Redwood Tree as a Tourist Shelter

Stanley Park

emb. O. Johnson, Victoria St. Sabatia, New Zealand.

and E. W. Langley, U. S. Bureau of Standards

794



Floating Fire Department of the Spreewald Is Carried on Pontoons Lashed Together and Propelled by Poles; This Photo Was Taken during an Inspection by Fire Officials from Berlin

Wide World

FLOATING FIRE DEPARTMENT PROPELLED BY POLES

Fire-fighting apparatus is carried on scows and is floated to the scene of a blaze in the Spreewald, a river district near Berlin, Germany. The units have drills and undergo inspections similar to those given the regular departments. Long poles are used to help propel and steer the scows.

numerous to have any effect on the earth, and no use for them is known.

WAR VETERANS TOUR COUNTRY IN IMITATION TANK

By adding a tin superstructure in the form of an army tank to their automobile, three war veterans devised a novel vehicle for a tour of the country. Souvenirs and signs collected from various towns were placed on the sides of the car as evidence of their travels. Besides affording a spectacular conveyance, the tank sheltered the occupants from bad weather and protected their luggage.

736

STRANGE NEW RAY IS FOUND TEN MILES ABOVE EARTH

By sending instruments attached to balloons ten miles above the surface of the earth, Dr. R. A. Millikan, of the California institute of technology, has tested a new ray which is said to have 1,000 times the frequency of the X-ray, and to bombard the earth from all directions. The phenomenon is believed to be caused by atoms passing over to other atoms. The sun has no effect on the action, the scientist declares. Although the power of the rays is great, they are not sufficiently



Veterans and Their Souvenir-Covered "Tank" for Touring Country

*Los Angeles, Calif.
793
Dumro - Fred Lawley
Carl Partlow and
Ray Bergstresser*

at meeting of National Academy of Sciences, Madison Wis 11/9/25

624 Mr. Norman C. McLeod,
1717 St. Paul Ave

Strange Methods of Transportation

Baltimore, Md.

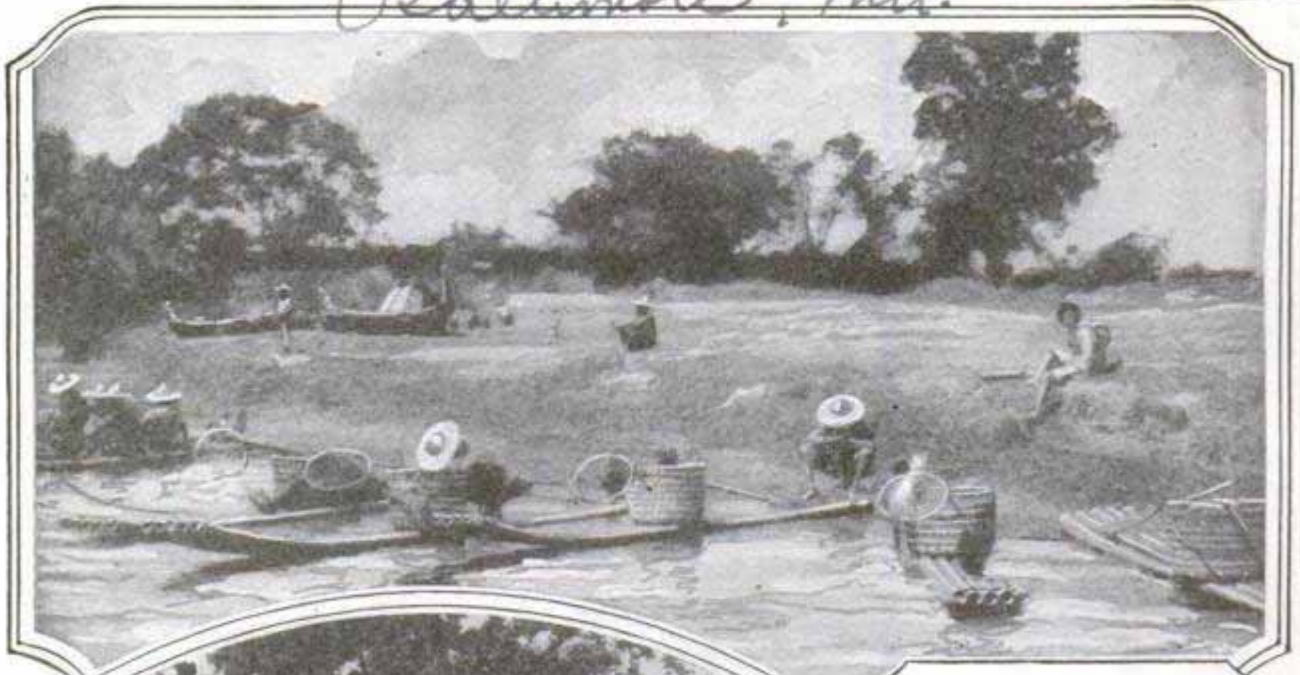

Bamboo, the Versatile Servant of the Orient, is of Particular Aid to the Chinese Fishermen, as a Few Poles of It, Lashed Together, Form a Light, Serviceable Boat for River Duty; in Madagascar, Tourists Travel in the "Filanzana," a Seat with Footrests, Slung between Supports Carried on the Shoulders of Sturdy Natives

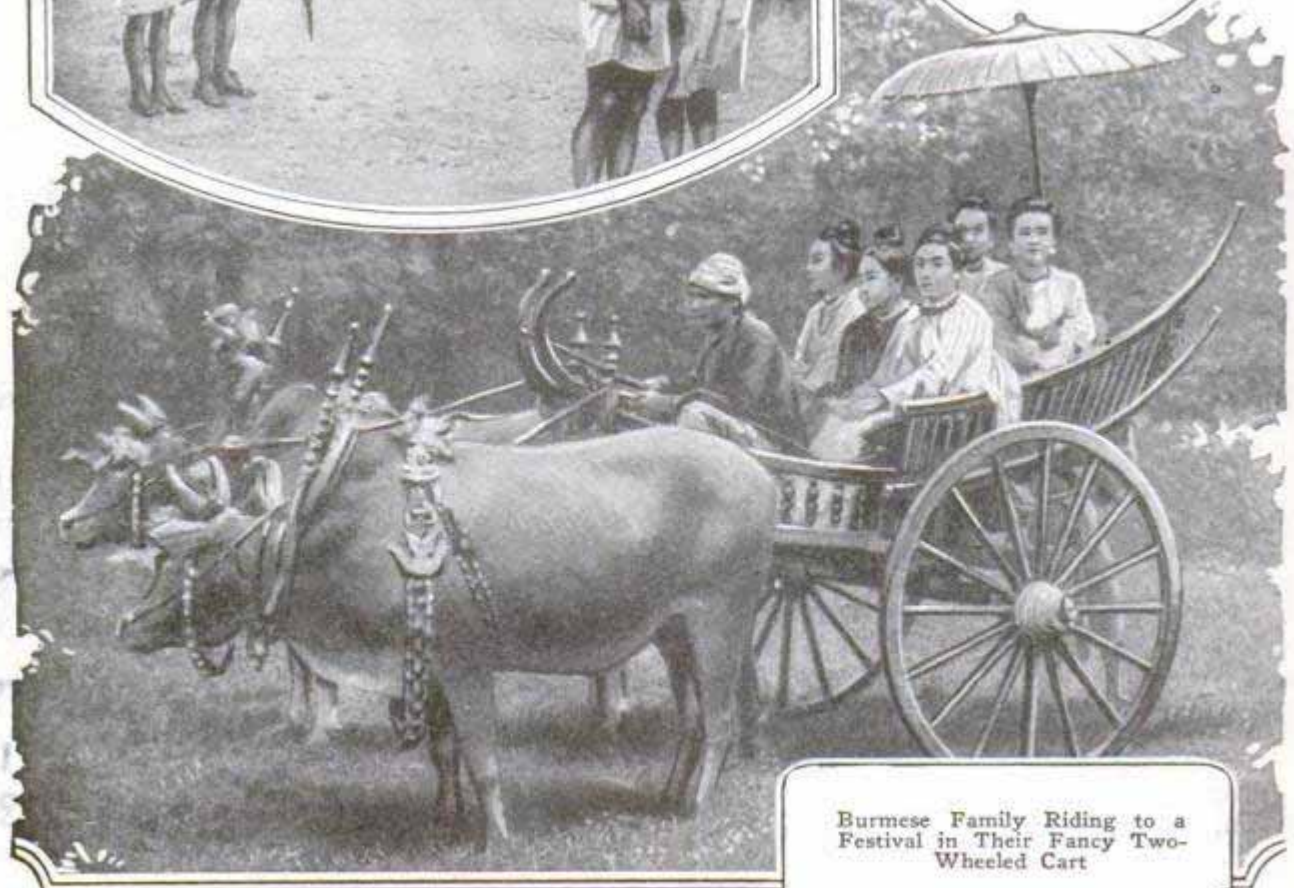

Burmese Family Riding to a Festival in Their Fancy Two-Wheeled Cart

Where Machines Are Still Unknown

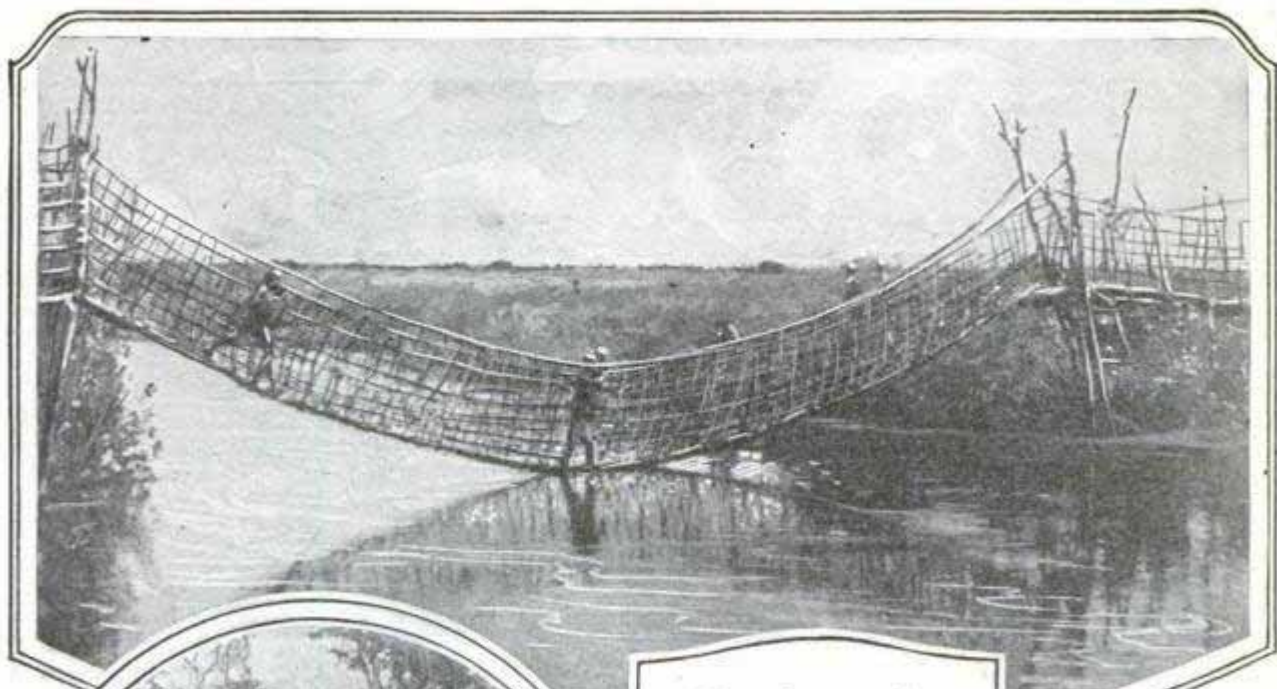

African Suspension Bridge Is Safe, but Sags under Weight

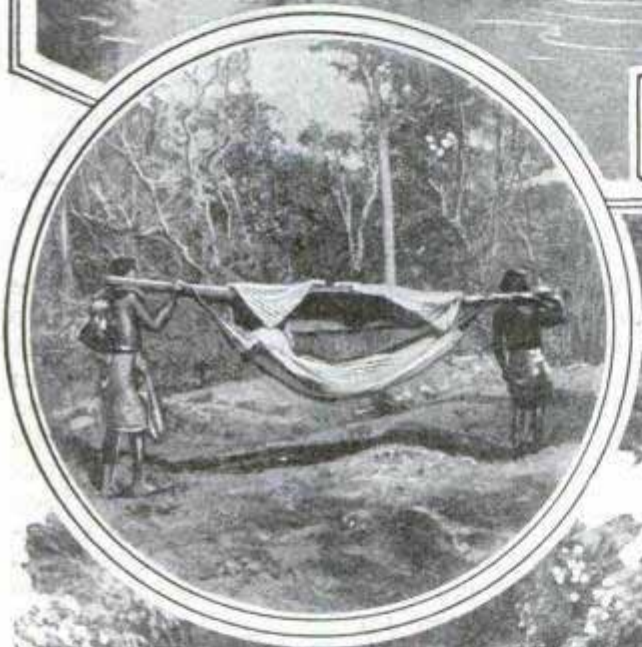

Inset, Primitive Shoulder Hammock for Travel in Rhodesia, South Africa; Above, Javanese Street Sprinkler in Action

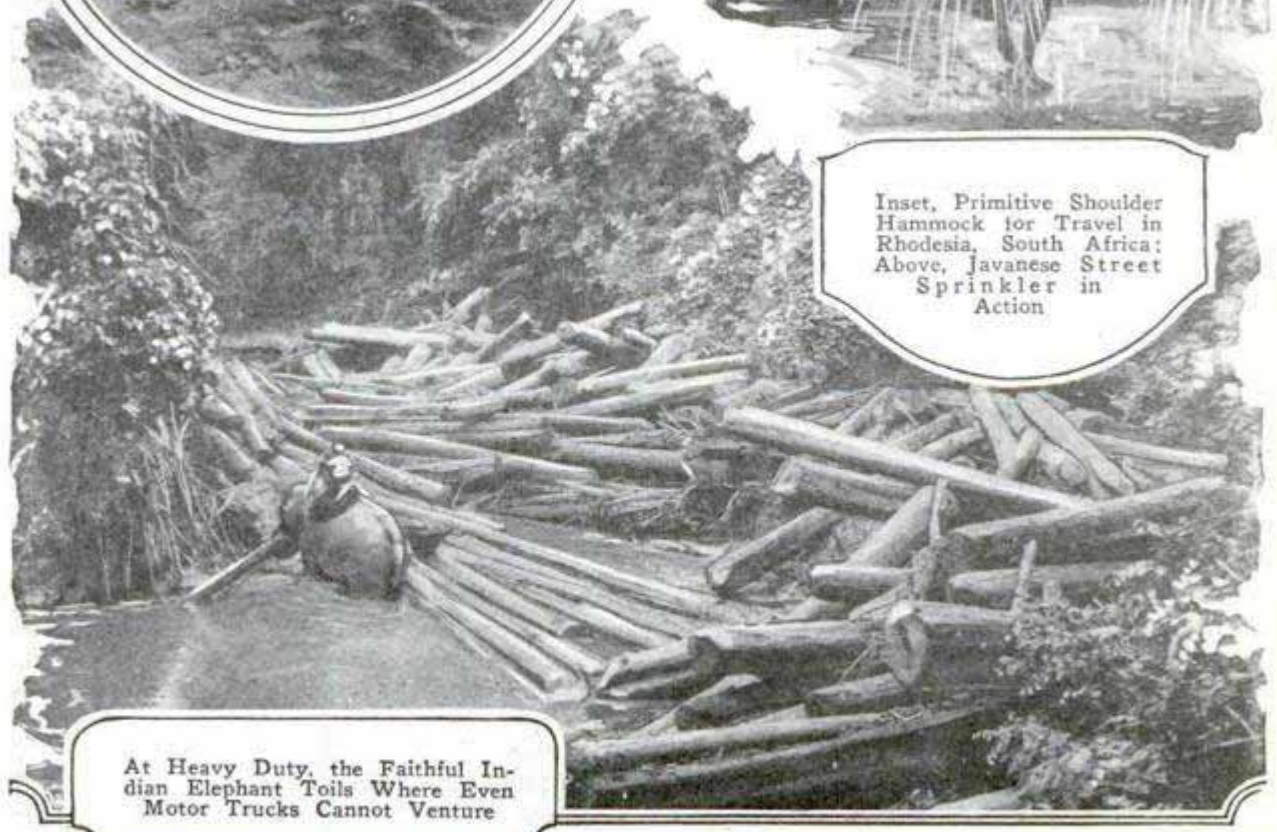

At Heavy Duty, the Faithful Indian Elephant Toils Where Even Motor Trucks Cannot Venture

ELEVATORS RUN IN STACKS ON STEAMLESS SHIP

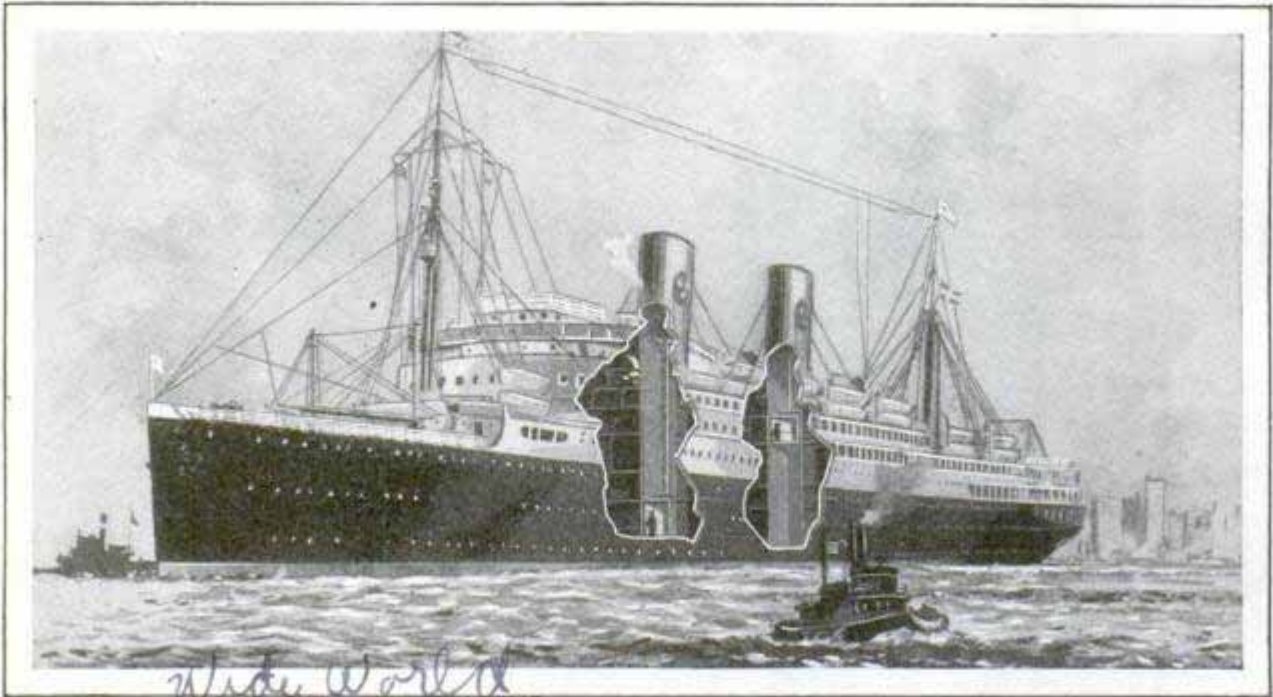

Cross-Sectional View of "Gripsholm's" Funnels Which Are Used as Elevator Shafts; Oil-Burning Motors, Replacing Steam Boilers, Eliminate the Need of Large Smoke Vents

Propelled by huge Diesel oil-burning motors, the Swedish-American liner "Gripsholm," has smokestacks like those of an ordinary steamer, but they are dummies and are used as elevator shafts. The ship has a displacement of 23,950 tons, is 578 feet long, and is one of the largest motorships in ocean service.

weather-observation stations. These are exposed glass containers arranged to catch the precipitation and the amount is read by means of a graduated scale on the side. A common type of gauge used in this country is what is known as the tipping bucket. It is adjusted to empty when only one one-hundredth of an inch of rain has fallen into an exposed cylinder, twelve inches in diameter, and automatically registers each emptying as the bucket comes up for more. The flow goes into another container and is again measured by a stick. At the smaller weather stations, the co-operative observatories, an eight-inch cylinder is used to catch the rain.

THIRTY-MILLION-TON RAINFALL MEASURED BY GLASS

London, home of dense fogs, recently experienced a heavy deluge when approximately 30,000,000 tons of rain fell in fifteen hours, more than twice as much as had fallen during the previous three weeks. This total was quickly computed by consulting the rain gauges in the

MOTOR REPLACING THE RICKSHA IN JAPANESE CITIES

Jinrikishas, the "man-pull carts" of the Orient, are being replaced by autos according to reports from Tokyo. Fleet-footed young men, whose speed rivaled that of horses, are said to be finding better opportunities to earn money in other ways than toiling between the shafts of these vehicles, and the manufacturers of the carts are devoting their plants to making baby buggies. The rickshas now are generally pulled by old men whose patronage is largely made up of leisurely tourists, or natives who desire the pleasure of talking to the cart man.

785

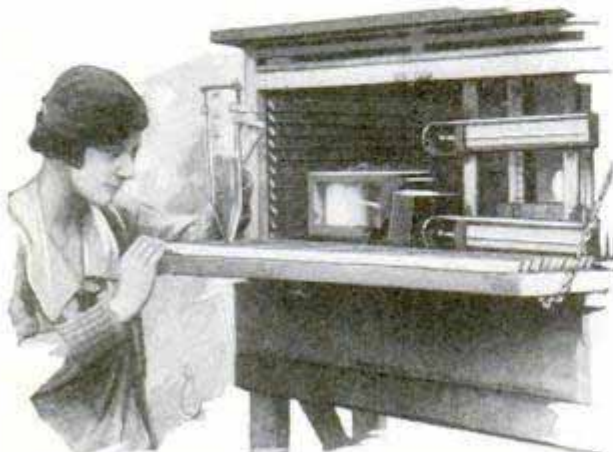

Measuring a Heavy London Rainfall in Graduated Glass Gauge; Thermometers in Background

meteorological station London, England

M. H. James 10/29/25 - from North China Herald.

RICH TONE OF ANCIENT VIOLINS BELIEVED DUE TO SALT 405

German manufacturers have advanced the theory that the exceptional resonance of some of the famous Amati violins is due to the lime salts with which the instruments are stained. The material is imbedded in the pores of the wood and is believed to affect its action under vibration in such a way as to produce the remarkable tone, the cause of which long has remained a secret.

DRY FIRE EXTINGUISHER USES POWDER TO KILL FLAMES 763

All kinds of fires, including burning oils, gasoline or ether, may be stopped in a few seconds with a hand outfit operated simply by opening a valve. This permits carbon-dioxide gas to rush from a small cylinder and mix with a chemical powder contained in a hopper. Flames are smothered and no damage from stains or other causes results to fabrics, rugs or polished surfaces from the chemicals and they develop no gases poisonous to the operator. Closing the valve shuts off the gas and powder, and the "gun" is ready for use without any attention unless the contents have been exhausted. New cylinders are installed with little trouble and the hopper is readily refilled with powder. The outfit weighs only about twenty pounds.



Modern Substitute for the Old-Fashioned Earring, Jeweled Frame with Pendant in Center

FRAME OF JEWELS FOR EARS LATEST WOMEN'S FAD 768

Now that fashion has decreed that women's ears may be exposed, a jeweled ornament has been devised, a clasp shaped to conform to the ear and supporting a pendant in the center. Piercing is not necessary for wearing the trinket, and as the frame holds the weight of the center jewel, there is little strain on the ear. The entire piece is set with gems.

SICK TREES CURED BY TRANSFUSION 79

Transfusion operations, like those performed upon human beings, have been successfully used on diseased trees in California. A solution of ferrous sulphate, placed in a bottle reservoir at the height of the tree top, flows into the trunk through a hose connected to a glass tube which is inserted in the tree in a hole bored nearly through it. The treatment promises to eliminate certain insect and blight diseases which affect trees, and some of them bore fruit heavily after the operation.

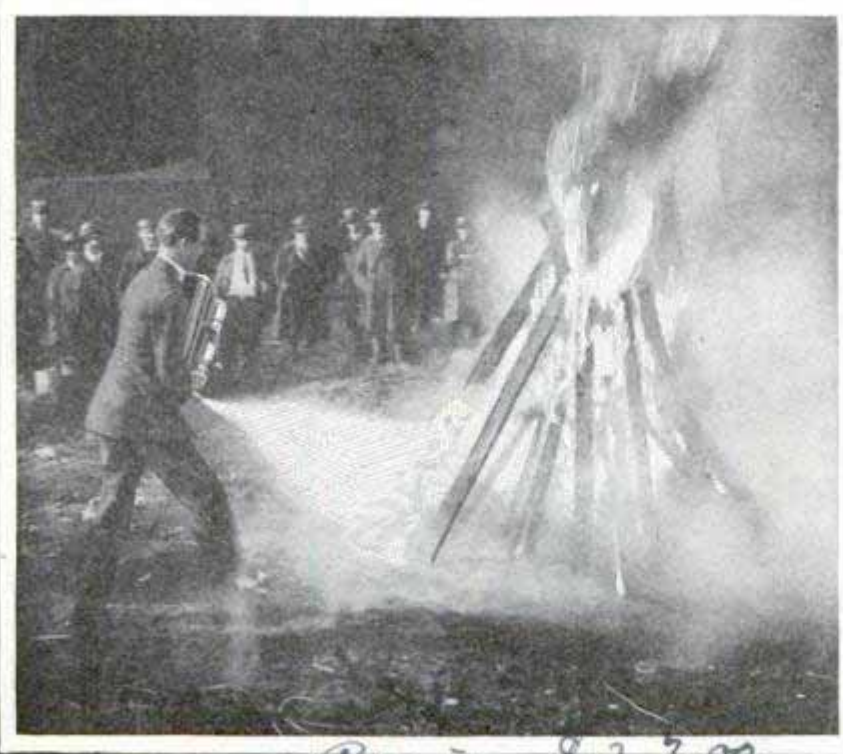

Blaze in Oil-Soaked Timbers Was Put Out in a Few Seconds with Gas and Powder Spray

Price \$27.00
Rastan. Blessing Co.
240 E. Ontario, Chicago

Berkeley
Prof. C. J. Lufeman
University of California
Berkeley

1530 Masonic Ave
San Francisco, Calif.

Ancient Weapons in Big-Game Hunting



A Single Arrow from the Bow of Arthur Young Kills the King of Beasts in Africa; Young's Equipment Was Modeled on Fourteenth-Century Patterns



Salmon Speared by an Accurate Arrow Shot through Four Feet of Water



Alaskan Brown Bears, Only Forty-Five Yards Distant, Furnish Excellent Targets for the Archer; Both Were Killed

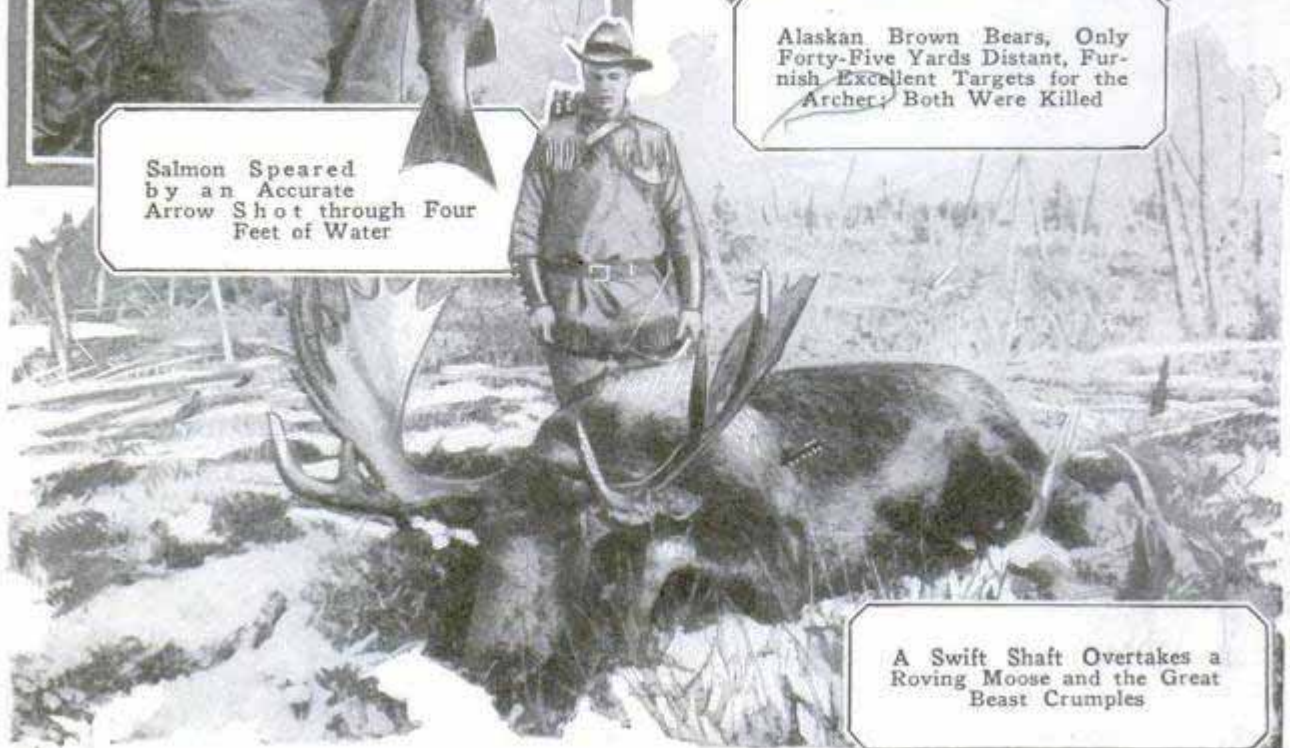

A Swift Shaft Overtakes a Roving Moose and the Great Beast Crumples

Belton Texas

*Ernest Woods
Ocean Beach*

San Francisco Calif

**SUN LOWERS BLOOD PRESSURE
IN TESTS WITH ANIMALS 749**

Application of sun baths may prove effective in treating high blood pressure, if results attained in a series of tests on animals by Prof. C. I. Reed of Baylor university, can be achieved in human beings. Powerful lights were directed into the eyes of animals under anæsthetics so that the beams would fall on the network of blood vessels lining them. The arterial blood pressure, it was found, was reduced as much as eighty per cent. Also, experiments were made by directing the rays upon the lining of the mouth and on the blood as it flowed through quartz tubes which had been inserted into the circulatory system of the animals. In these cases, too, an equally marked lowering of the blood pressure was found to take place.

**WAR SCENES MOLDED IN SAND
BY CRIPPLED SCULPTOR 762**

Sand is an effective medium under the fingers of a skilled western sculptor in producing realistic war scenes and other

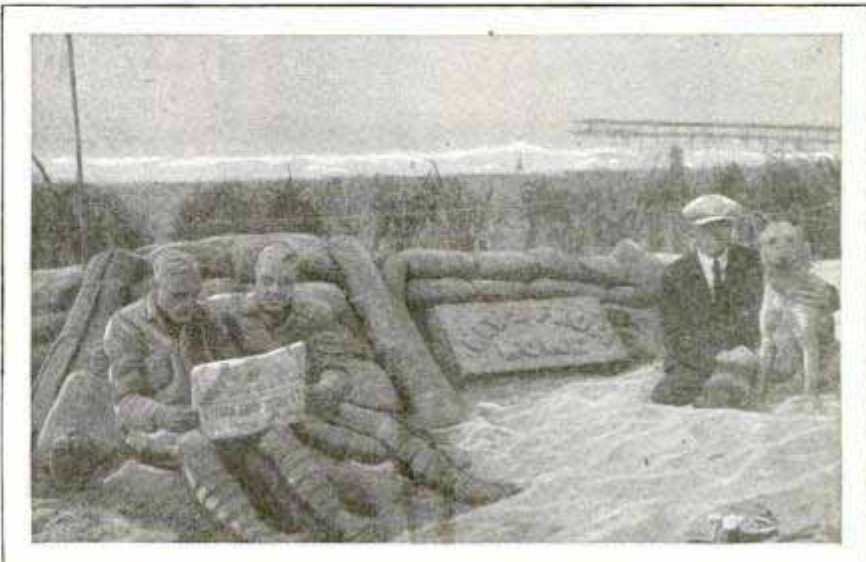

Sculptor and War Scene "News from Home," a Sketch of Army Trench Life Modeled in Sand on Ocean Beach

BAD EGGS USED IN TANNING

Eggs that are worthless so far as food value goes, are not wasted by the large dealers but are covered with kerosene after being broken, treated with boric acid and sold to tanneries for use in one of the first processes of making leather. The shells are removed by sieves and the egg mixture is placed in a revolving drum with the raw hides to make them pliant. Hundreds of tons of frozen eggs from Siberia and China are used in this country every year for baking purposes. In general there are five grades of eggs in the big markets, the strictly fresh, "fresh seconds," "cracks," broken in transit, "leakers" which have lost part of the contents, and the last grade, those which are sold to tanners.

studies. Although handicapped by the loss of both legs, he fashions elaborate sets on the beach, using only a few simple tools. Proper moistening and mixing give the sand the necessary consistency, and the figures last for some time in spite of winds and sun.

**GOLF BAG THAT STANDS ERECT
—PROTECTS THE CLUBS 757**

With a broad, cushioned base upon which it stands upright, a golf bag is intended to prevent spilling of the clubs upon wet grass, aids the player and serves as caddy. It is carried by a handle or shoulder strap, and there is space in the bottom sufficient to hold shoes, knickers and other equipment. The bag is waterproof, is said to weigh less than the average kind, and the material is such that it may be cleaned by sponging with soap and water.



Golf Bag That Remains Upright When Placed on Green Keeps Clubs from Wet Grass

*Robert W. Summers
Phila. Ledger 4/15/25*

*less mornis...
less mornis. Iowa*

449

Time and Money-Saving Tools

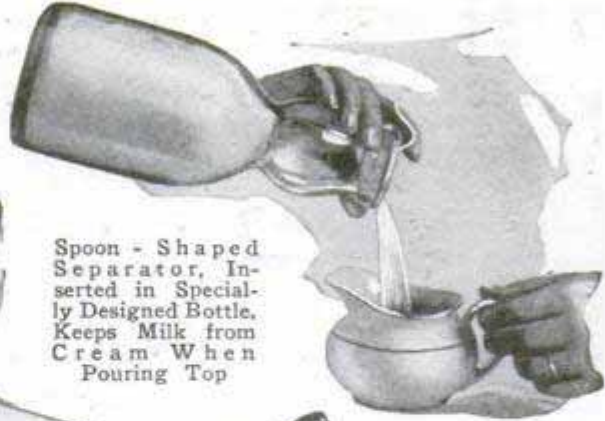

Spoon - Shaped Separator, Inserted in Specially Designed Bottle, Keeps Milk from Cream When Pouring Top



Food Press, for Home or Restaurant Kitchen, Squeezes Fruits or Meat for Loaf, and Stuffs Sausage



Ironing Board, Ladder and Other Articles Are Combined in Folding Unit



Metal Holder Supports the Newspaper for Reading at Table, Leaving Both Hands Free



Screen That Rolls Up like Shade Saves Work and Fits Casement Windows



Set of Pins Replaces Needle and Thread in Trussing Fowls and Other Meat



Sanitary Mop Wringer Has Metal Squeegee to Rub Excess Water from the Surface of the Rag

for Woman's Workshop in Home

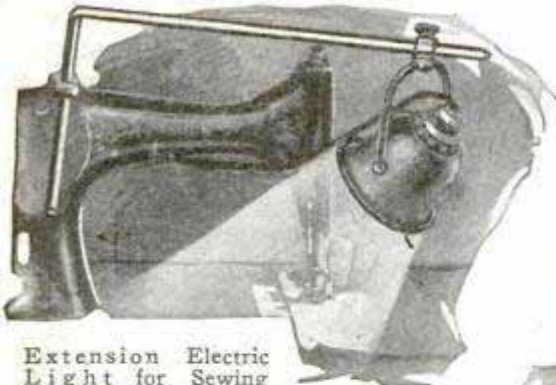

Extension Electric Light for Sewing Machine Saves Eyes and Focuses Rays on Work



Spots Are Kept from Tablecloth by Pitcher - Shaped Attachment for Sauce Bottle

Table and Chairs for Meals or Games Are All Folded Together in Small Unit When Not Used



Push Broom Connected to Handle by Swivel Is Used in Three Positions for Difficult Places



This Frying-Pan Handle Prevents Tipping Over and Serious Burns from Spattering Fat

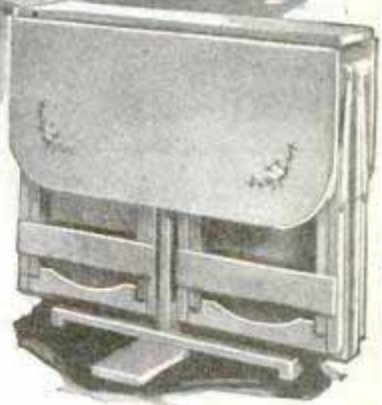

Rubber Massage Rollers for the Gums, Supplement the Brush

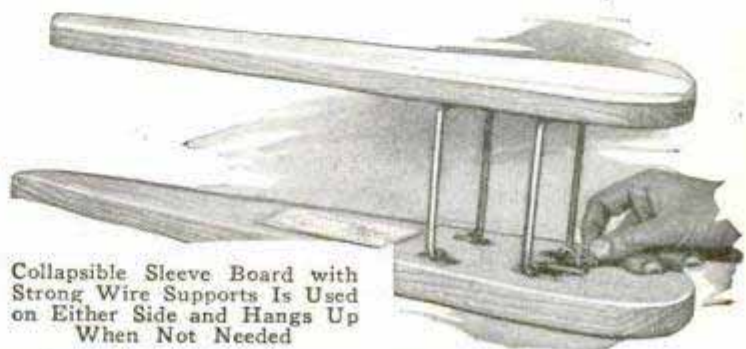

Collapsible Sleeve Board with Strong Wire Supports Is Used on Either Side and Hangs Up When Not Needed

obtain it by addressing Bureau of Information, Popular Mechanics Magazine, Chicago.

*Suggest American
Armour Corp.*

288 *33 W. 34th St. New York City*

*Christian Science
Monitor 11/7/25*

POPULAR MECHANICS

**BULLET-PROOF POLICE SHIELDS
AID ATTACKS ON BANDITS**

Shaped to cover all the body except the legs, a bullet-proof shield used by the Chicago police department, is strapped across



Shield Protects Policeman, and Peephole Permits Aiming

the shoulders and has a peephole of bullet-proof glass to aid in taking aim. The protector weighs but thirty pounds, is quickly adjusted and, in making raids on bandits, can be used as a portable "fort" behind which the policeman can crouch and be sheltered from bullet fire.

**OLD IDEAS ABOUT VENTILATION
DISPROVED BY TESTS**

Lack of air movement, and not the generally supposed "bad" products in the atmosphere of a closed room, is the chief menace of poor ventilation, according to tests recently completed by scientists. Their findings do not support the theory that the injury is done by poisonous respiratory substances and the so-called fatigue-producing toxins that were believed to be due to inhaling expired air. It was discovered that slight currents caused sensations of an agreeable kind, arising from a beneficial stimulus of the nerves of the skin. This effect was noticed from a breeze blowing on the cheek at the rate of less than six inches a second. The tests showed that the higher

the temperature, the greater must be the velocity of the air to produce the sensation. In crowded or too hot rooms, a system that delivers circulating air at a somewhat lower temperature than that of the room, and at or slightly above the velocity at which it can be felt on the cheek, for instance, is regarded as most likely to give the best results.

**PLANES AND WATERWAYS TAKE
PLACE OF ROADS IN SIAM**

Protected from intruders by French and British territory, the monarchy of Siam has had opportunity to develop independently in recent years and has kept abreast, if not in advance, of some other lands, particularly in the field of aviation. A recent visitor there saw pilots perform feats equal in daring to those practiced in other countries and the airplane is used almost exclusively in eastern Siam for transportation. In other sections of the country, the waterways have been developed extensively, canals and navigable streams bearing the brunt of traffic instead of roads, which are practically unknown in some parts of the region.

**CONDENSER FOR CAR RADIATOR
SAVES WATER AND SOLUTION**

Preventing loss of water or anti-freeze solutions, a condenser for the automobile circulating system, is said to afford positive protection against frozen radiators, cracked water jackets, and also to catch the alcohol fumes that otherwise are forced up into the car. It is attached to the lower end of the overflow pipe, where



it intercepts the liquids as they boil or flow over, holds them until the radiator or motor cools sufficiently, and then automatically returns them to the radiator by means of a sensitive spring. If the cap is on tight, there is said to be no loss of

water or alcohol, so that one filling of an anti-freeze solution will last an entire season. In hot weather also, the condenser is of aid, as it conserves the water supply reducing the danger of running dry.

*Hopkins Trust
Baltimore, Md.
Gubno
Dr. Anna
Hill London
Dr. Anna
Hill London*

*767
Chicago*

*The Bassich Mfg. Co.,
3152 N. Crawford Ave.*

*Evening News - Record
London Borough*

Montgomery Ward

London Borough Council

745

**FUEL FROM REFUSE
REDUCES COST
OF REMOVAL**

The 800,000 tons of refuse produced yearly by metropolitan London could be converted into fuel at a lower cost than is now expended for disposing of the material, an English engineer declares. His plan is to remove the tin cans, crush the refuse into powder and then press it into little bricks which will be treated with tar oil or coal to aid in ignition. On the basis of tests, it is estimated that the treatment plants could convert the rubbish into fuel at a cost of \$1.08 per ton, whereas the present disposal cost is \$1.75 per ton.

643

**AUTO HAULS SAW
AS A TRAILER
AND RUNS IT**

Power for a compact sawing unit, that does rip and crosscut work, mitering, grooving, planing and other operations, is furnished by the rear wheels of the auto, and when the "mill" is to be moved, it is pulled behind the car as a trailer. Power is conveyed from the car by a belt drive from small wheels which are placed in contact with those of the automobile by raising the rear axle and adjusting levers on the frame of the sawing unit. One man can connect or disconnect the saw and car in a few minutes.

Power

665

Vandervoort Power

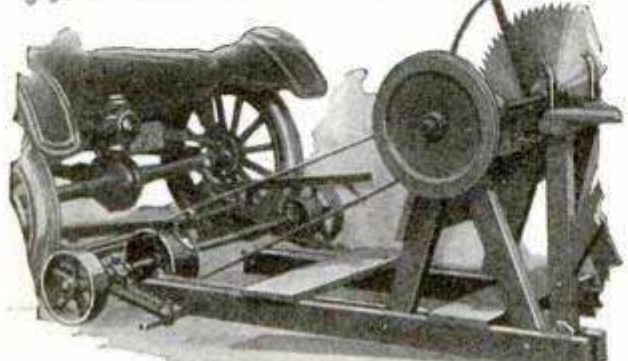

Saw Attached to Rear Auto Wheels for Power; When Not in Use It Is Hauled as a Trailer

*Van Dolsen Porter Mfg. Co. Inc.
Shelburne, Vt.*

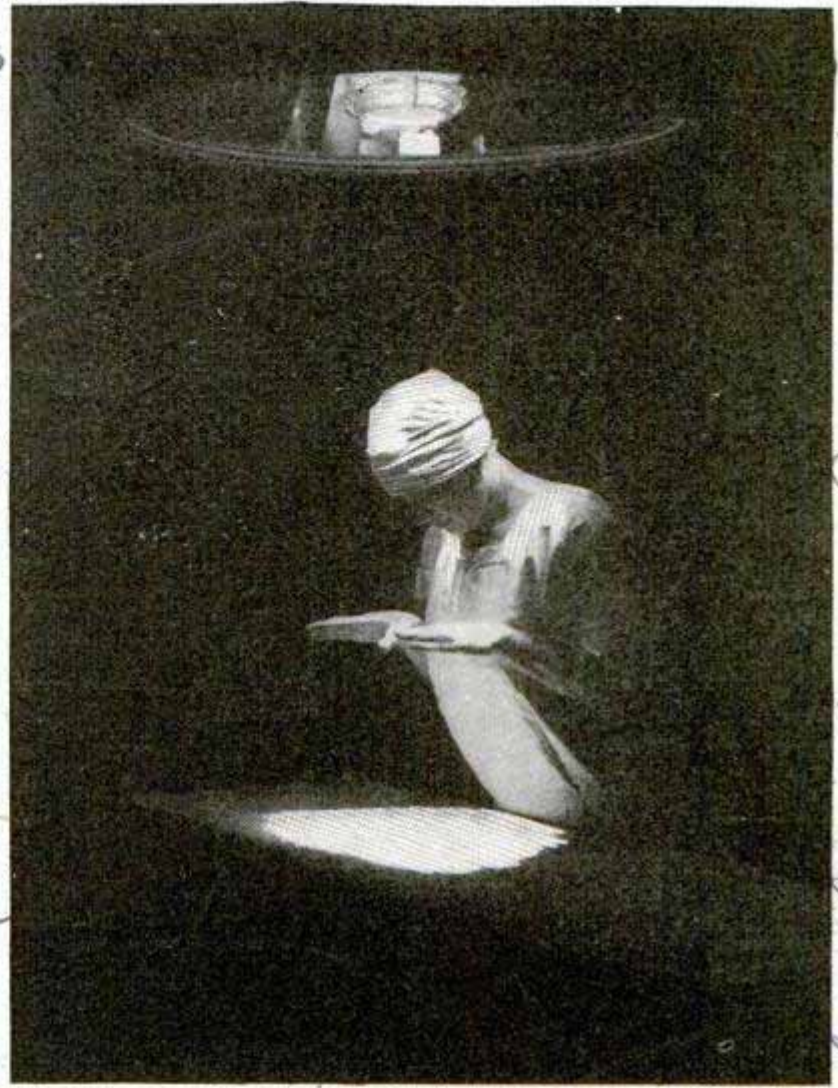

Special Reflectors in the Lamp above the Table Guide the Rays around the Hands So That They Cast No Shadow

**SCIALYTIC
LIGHT THAT CASTS NO SHADOW
AIDS IN OPERATIONS**

Surgeons performing operations, laboratory workers, engravers and others are aided by a shadowless light developed in France. The rays are reflected upon the surface to be illuminated in such a manner that the hands, or any other body held between the lamp and the working area, cannot obscure the surface by their shadows. This effect is secured by a cylindrical prismatic lens and a set of silvered reflectors adjusted around the inside of the lamp bowl which is of sheet metal. The light can be concentrated by focusing. A cover glass keeps the heat from persons below, and the shade is counterweighted so that the lamp may be tilted.

Popular Mechanics Magazine does not publish the name of maker or seller of devices described, but this will be furnished free by our Bureau of Information.

*La. Davidson
Gydney House
2nd Ely Place
London, E.C.1 - Eng*

*American agent - Atlantic Body
Phila
B. B. J. Corp.*

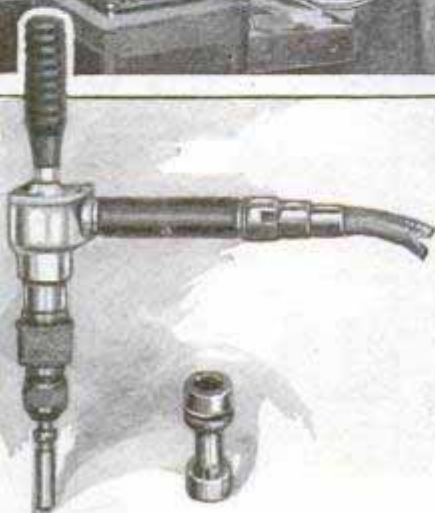
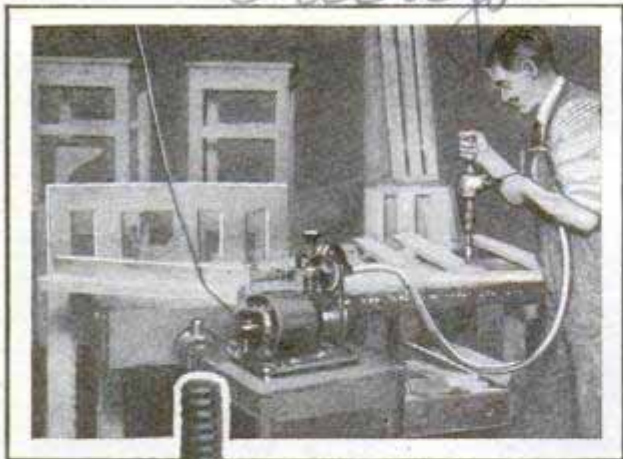

Motor-Driven Screwdriver in Operation; Head and Nut-Setting Attachment Below

SCREWDRIVER RUN BY MOTOR ALSO SETS NUTS

Run by a flexible shaft from an electric motor that is supplied with current from a lighting socket, a screwdriver with a nut-setting attachment saves time and labor. A reversing switch permits easy removal of the work, and a particular advantage is that the tool may be used from almost any angle.

EVERY AUTO BUYER GIVEN PAINT KIT

With every car sold, a Paris automobile dealer furnishes a pot of special paint and a sprayer, about the size of a fountain pen, so that scratches and mars can be touched up at once, to keep the body looking new. Pressure for applying the paint is obtained by blowing through a tube connected with the sprayer. While the preparation is specially adapted to covering metals, it also may be used on fabric and leather.

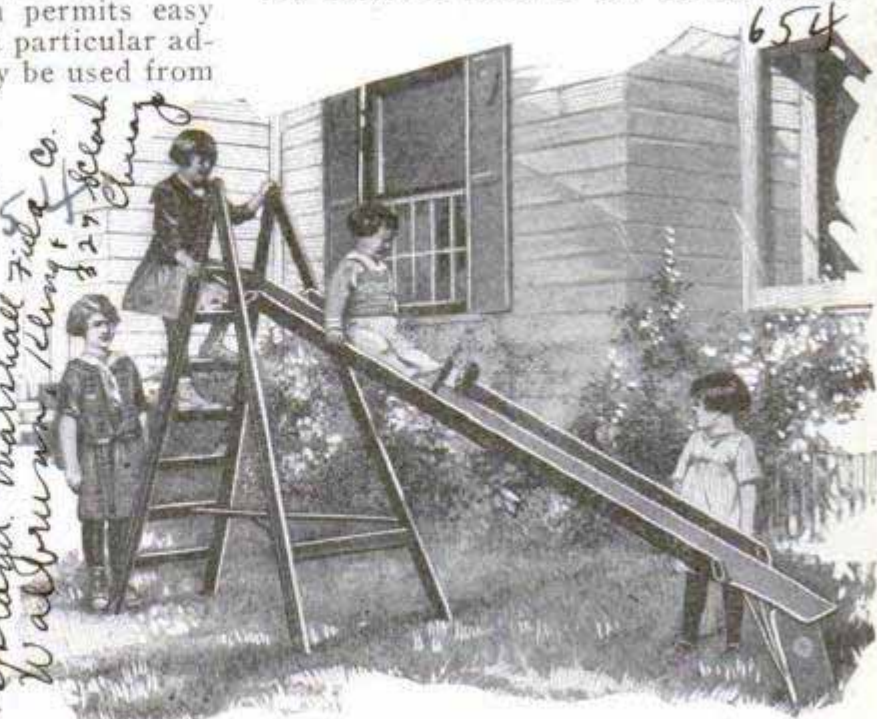

When Not Used as Slide, Trough Is Adjusted to Ladder as Teeter or on Pivot as Merry-Go-Round

TRENCHES OF LIGHT AID FLYERS TO LAND IN FOGS

Glass-covered parallel trenches, in which "neon" light tubes are installed, have been dug across the British landing field at Croydon to aid flyers to descend safely in fogs. The reddish glow of the lamps, it has been found, penetrates the mist more effectively than other kinds of light. Between the tubes is a "leader cable" which affects a sensitive instrument in an airplane flying above it. Having been guided to the field by radio, the pilot, after picking up the boundaries of the area by means of the cable, can circle around, gauging his altitude by means of the action of the cable on the instrument until the lights themselves are visible and the landing can be made with little or no risk of accident.

SLIDE AND TEETER COMBINED SERVES AS MERRY-GO-ROUND

Three of the favorite amusement makers of the children's playground, slide, teeter and merry-go-round, are combined in one simple unit that is easily adjusted and saves space. The chute, which becomes the teeter board or the arm of the merry-go-round, is supported by a strong ladder, six feet long and hinged in the center, as a base for the other devices. The outfit is finished in durable varnish and packed for shipment, weighs only fifty pounds. No tools are required to set up the different units of the combination.

Voisin Co, France.
Paris.
motor age
10/22/25

Small Sprayer, Marshall Field & Co.
Walworth, Chicago
10/27/25

The Merrimaker Corp
254 Cecil St.
Minneapolis, Minn.

684
10/23/25
Engineering

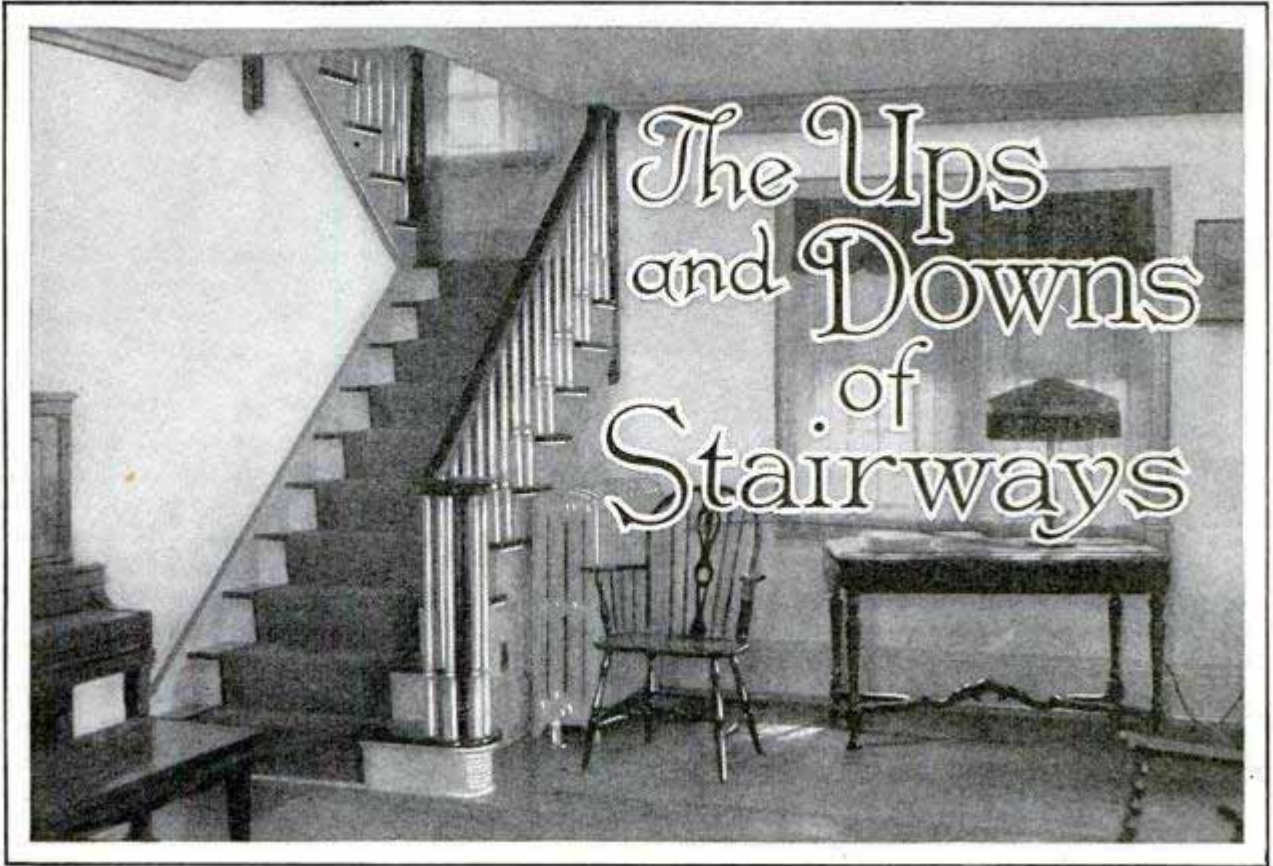

Why They Go Wrong and Squawk

By ROBERT TAYLOR JONES, A. I. A.

Technical Director of The Architects' Small House Service Bureau, Northwestern Division

1200 - 2nd Ave S, Minneapolis Minn

STAIRS go wrong on other matters than squeaks. When they become dangerous to life and limb, the mere fact that they sound as though they might decompose under your feet is of relative unimportance. The squeaks give proof of faulty building, but convenience and safety are matters of design.

Perhaps the most obvious thing about a stairway is how easily it may be climbed. You probably couple steepness with difficulty in climbing, but these two things do not necessarily go together. A steep stair properly designed may take less effort to mount than one that has a very low ascent. It is all a matter of proportion—the proportion of width of tread to height of riser. Make the tread twelve inches wide and the riser four inches high, and you will waste what energy you have left after climbing such a stair in curses on the designer who let you build it that way. That twelve-inch tread with an eight-inch riser may be a partial substitute for an osteopathic treatment, but if you do it enthusiastically fifty times a day with the baby in one arm, you may have to go to the hospital to recover, or else you may become too strong for

your little house. Proportion is the right thing. Architects have found a simple rule of thumb that applies very well to stairs in homes. It goes like this: "Take twice the height of the riser plus the width of the tread—from nosing to nosing—and the result must lie between twenty-four and twenty-five." Thus, for a seven-inch riser, we get fourteen as the first result and this, deducted from twenty-five leaves eleven as the preferred width of tread. If a ten-inch tread is wanted, then twenty-five minus ten equals fifteen and fifteen divided by two equals seven and one-half: a ten-inch tread and a seven and one-half-inch riser is a good combination.

For the attic stairway, it may be necessary to mount quickly using an eight-inch or nine-inch riser. Then the tread should be nine-inch or seven-inch respectively. Have the treads and the risers all of the same width and height throughout the flight. If there is the slightest difference, then take out an accident policy.

Accident policies are good for other things about a stair—"winders" are one of them. Winders in the main stairway of your home are an admission on the

part of the designer that he had not the skill or intelligence or sense of fair play to serve you faithfully. We have often



No city ordinance in the country will permit a stairway like this in a public building. Why is it not just as necessary to protect the limbs of your own family in your own home?

heard of sitting on the imagination and have wondered how it was done, but we know that you can't stand on it. See how the treads vanish into boarding-house pie points where they come together in a winding stairway. The risers are still there! Put your foot with too much confidence on the first of these and

you may pick it up somewhat disarticulated on the fourth one below.

One thing more about design. It has to do with the head room. Not every one has a two-gallon hat, but on the head of a six-foot man it makes a fine test of the clear space above him as he trips lightly from tread to tread. Even if he can get by bare-headed without dashing his brains

on the stair wall, that restricted place ought not to give him the sense of a low bridge. It is better to have a few feet less closet space or hallway in the second story than the feeling every time you come down the stairs that you must duck your head.

There are some other don'ts about stair design, but I have given you the main ones. Just remember that it takes space to work out a stairway properly.

And then as to this matter of squeaks—the construction of the stairs. Midway in the building of your home they will put in a temporary stairway so as not to tire the hod carrier. The way that stair is built of planks and treads nailed to the supporting "carriages" is exactly the way not to build the finished stairway.

Properly constructed, the stairs are part of the fittings of your home — like bookcases, china closets, and mantel pieces. That is, they are built as a unit and fitted into position after they have been assembled — like a great piece of furniture.



Section through the treads and risers showing how these are set into the wall stringer and how all is made tight by means of wedges set in glue

Good furniture is not nailed together. The pieces are fitted into each other and made secure with wedges, blocks and glue. That's the way to build a stair. The treads and risers should be housed together, and then they should be housed into the baseboard—called the stringer in this case—that runs along the wall at the side of the stairs. To make this last joint doubly sure, wedges are driven into the stringer and below each tread and riser. Not a nail is used—except perhaps as a temporary measure. Such a stair will not grow garrulous at the wrong moment.

What supports it? Well, it supports itself. To be sure, there are carriages below like floor joists set at an angle, but these are not connected to the treads or risers by nails. We want no nails here. If your stair goes up between walls, the carriages count only as a steadying influence. If it is open on one side, the car-

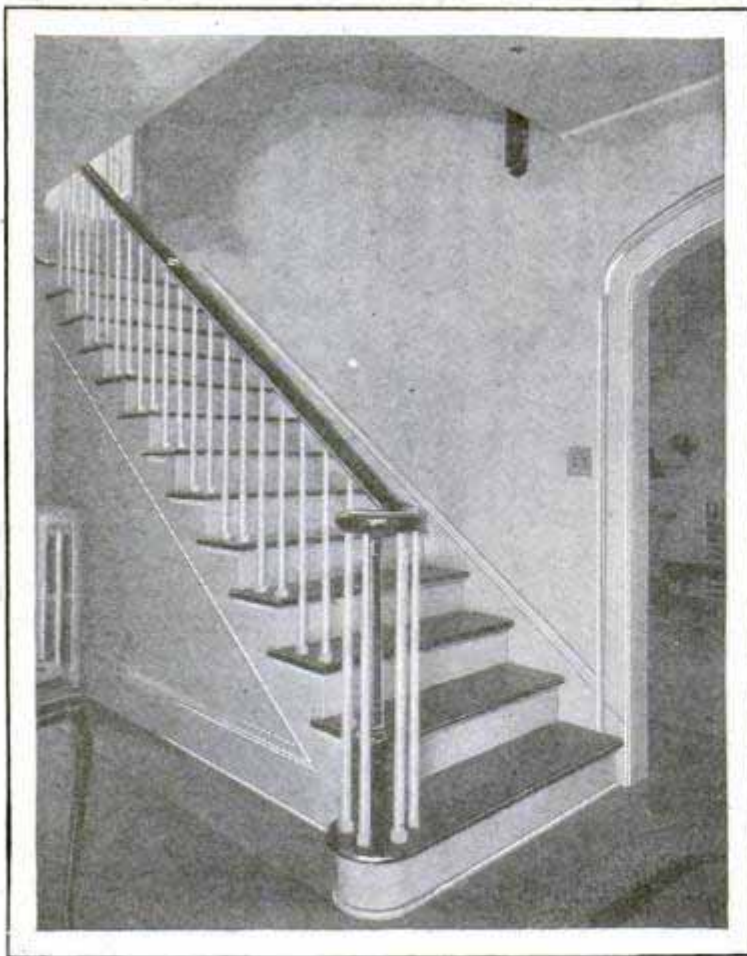

The Graceful Slim Spindles of This Colonial Stairway Add Beauty to a Home, but Construction Must Be Right to Be Safe

riages do heavy duty, for then there is no stringer to house the treads and risers into. It is evident that these carriages must be adequately supported. The proper way is to run them into headers at the first floor and at the landing above. It might interest you to know that the open stairway is much more expensive than the between-walls type—it is also much finer-appearing.

Like all pieces of furniture, the open rail and balustrade of an open stair may be cheap and flimsy or sound as the rock of Gibraltar. Have you sometimes in an unguarded and trusting moment taken confidential hold of a handrail mounted proudly on spindled balusters only to feel your heart in your mouth when the railing refused to accept the responsibility and the balusters rattled castanets to the accompaniment of your knees?

Perhaps after all you did not mind your knees, having at the time a hand full of splinters.

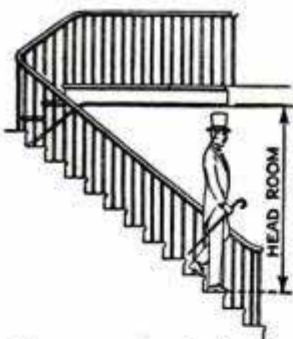

Of course you don't wear an opera hat in the house, but you should be able to wear it going up and down stairs even if you are a six-footer, as unconcernedly as the man in the sketch. Head room should not be less than seven feet, and seven feet six inches is better; for basement stairs it may be six feet six inches

slips into the tread never to come loose. It won't rattle and it won't violate your confidence if you should happen to lean upon it.

Balusters can be nailed on—that's the cheap way—or they can be doweled on, and sooner or later they will rattle and get wobbly; the one way is to dovetail them on. The nosing is doweled on over the baluster and it's there as long as the stairs last. In the old days there was a special kind of mechanic known as a

That's all a matter of workmanship.

If a fair price was paid for that particular stair, then someone was cheated, for the balustrade and handrail do not have to be double-jointed. There is just one sound way to connect a baluster to its tread—all other ways are compromises. The lower end of the spindle is dovetailed. It

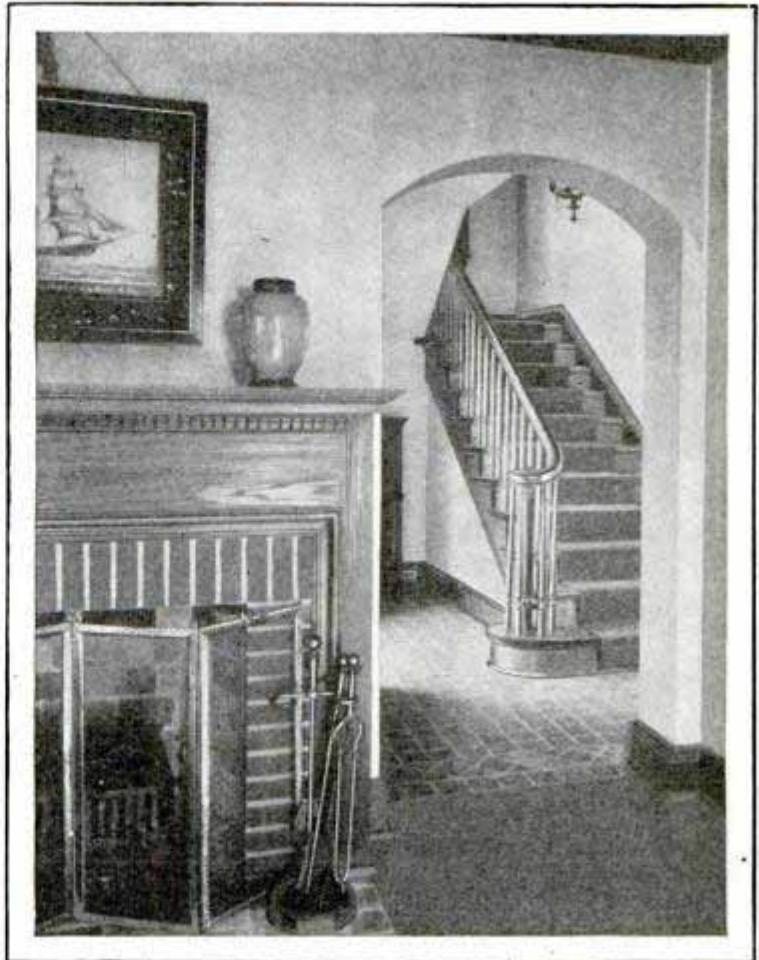

An Open Stairway Is More Costly Than One Inclosed between Two Walls, but Adds to the Attractiveness of the House

stair builder. He built stairs for keeps. He was an expert in woodworking and joinery, and he was employed on this particular bit of building because he knew how to do it best. Today much of our best stairwork is done by the woodworking mills. A least the most important parts are built up bodily at the mill and moved into the house to be set in place. Such work is often superior to the product of the old stair builder. If you mean

to have your stairway an ornament to your home, see that it is gracefully designed. And then, if you expect to have it remain long in fine condition, pay the price for good materials and workmanship. The stairway and the fireplace may be show spots of a house and well worth the extra expenditure involved.

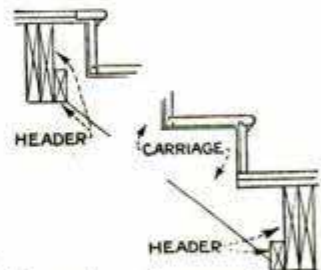

A section through the stairway, showing how stair beams are permanently secured to the floor beams. The small strip at base of the headers is often omitted. It should always be used

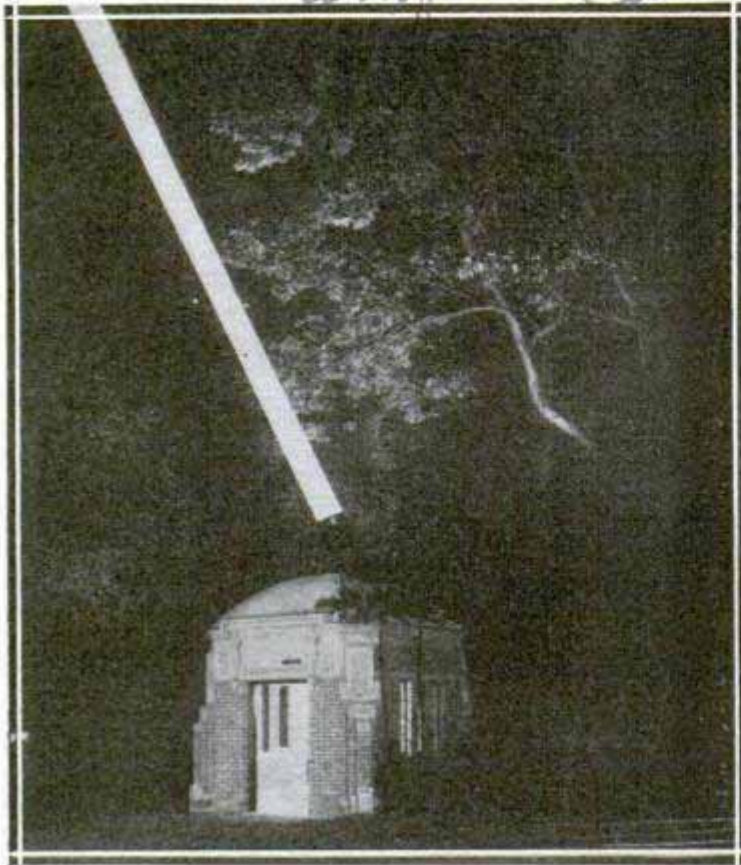

One of the Police "Pill Boxes" at Memphis, Tenn., with Its Searchlight to Summon Patrolmen at Night

Drive." Next he mounts his motorcycle and speeds to the scene of the crime, the other policemen following after reporting when they see the searchlight. If the burglar is operating during the daylight hours, the policeman in the pill box sets off the bomb-hurling device, and a series of aerial explosions will warn the men motoring over their territory to go in. Riot alarms, calls to big fires, the flashing of escaped prisoners and information in regard to major crimes may be broadcast from police headquarters either by radio or telephone. The only foot policemen retained in the new system are the traffic men at downtown intersections.

**BIRDS MADE HELPLESS
 BY OIL ON SEA**

Refuse oil discharged from ships has become such a menace to birds and fish that changes in the three-mile limit regulation and other rules have been recommended by protective associations. It has been found that the

film of oil on the surface of the water coats the birds' feathers and prevents them from flying and diving for their food. It suffocates newly hatched fish as it shuts off the oxygen supply and also kills their food. Even when vessels discharge waste oils at considerable distances from ports, the substance is sometimes blown in by the winds from 100 to 200 miles away. Some ships are equipped with apparatus which separates the oil from refuse before it is poured overboard.

Christian Science Monitor
 4/10/23

**PIPE WITH TRAP FOR NICOTINE
 GIVES COOL SMOKE**



Fitted with a tubular extension below the bowl, a tobacco pipe being used in London is said to afford a cool, sweet smoke, is easily cleaned and has no complicated parts to become clogged. The end of the trap is removable for quick cleansing, allowing the juices and accumulated ash to drop out.

764 **SIGNAL LIGHTS TO CONTROL
 POLICE IN MEMPHIS**

Farewell to the old-fashioned policeman. His passing is chronicled in plans adopted in Memphis, Tenn., for an electrified police department. Hail the fleet motor patrolman, the radio signal system, the powerful electric searchlight, the bomb hurlers and the automatic telephone. Two rows of electric police stations are under construction. They form an inner and an outer protective belt. Six stations are in each belt. They will be manned by six motorcycle policemen. These miniature stations are known as "pill boxes." Each is equipped with a radio-receiving set, electric searchlight on top, bomb-hurling signal device, automatic telephone and another phone of the ordinary kind. Five of the motorcycle policemen attached to each station patrol its territory. The sixth man stays at a desk in the structure. When a crime is reported, the policeman at the desk passes the alarm over the circuit. He then touches a button and the searchlight begins to revolve. That is a warning to the motorcycle patrolmen attached to his station to come in. He then makes a memorandum on a pad something like this: "Burglar in house at 41144 Riverside

LIGHT BEAMS PRODUCE MUSIC THROUGH WHIRLING DISKS

With a keyboard and an arrangement of rapidly revolving disks, H. Grindell

method, nitrogen is converted into a usable form by combining it with hydrogen to produce synthetic ammonia. A key agent for causing this transforma-

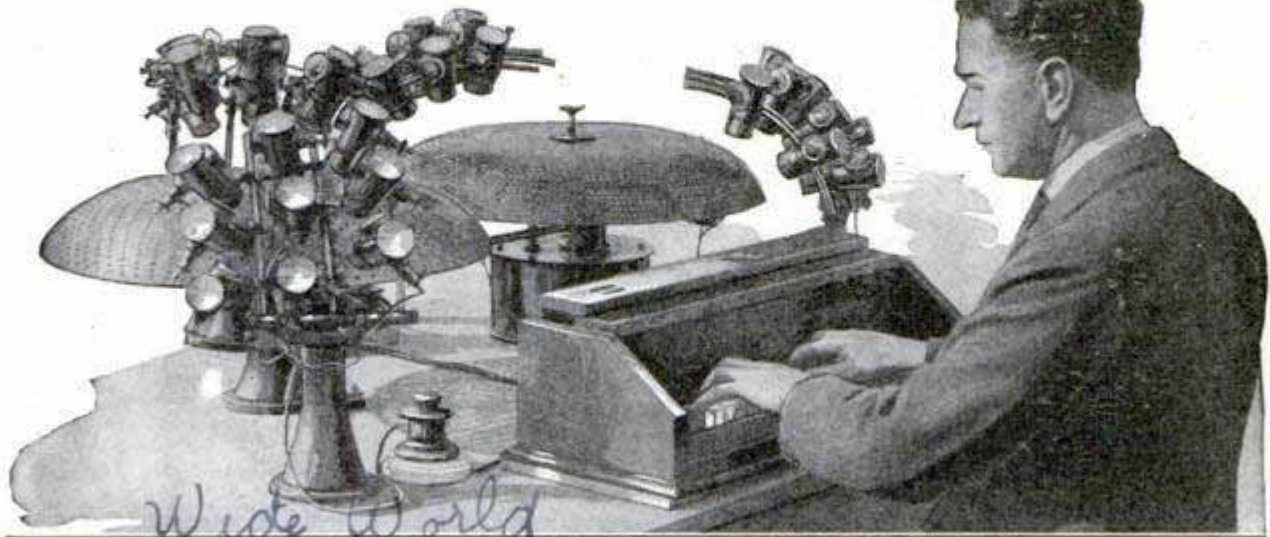

Mr. Matthews at the Keyboard of His Apparatus to Translate Light into Sound; Beams Pass through the Perforations in the Disks Which Revolve at 400 Revolutions a Minute

London England
Matthews, inventor of the so-called "death ray," has devised a method for translating light into music. Rays from special lamps pass through perforations in the disks and strike a light-sensitive element which produces electric waves as the illumination reaches it. These are converted into sounds that are amplified through a vacuum tube and loud speaker. The number and arrangement of the holes in the disks, which whirl at about 400 revolutions a minute, determine the pitch of the sounds produced.

tion was discovered in a mixture of oxide of iron, aluminum and potash.

FIRE PUT OUT BY VIBRATIONS TEST WITH FLAME SHOWS 730

Using a peculiar whistling note of a higher frequency than the human voice, an eastern scientist demonstrated that the vibrations could extinguish a sensitive gas flame inside a glass tube. The note vibrated 14,000 to 19,000 times per second.

KEY TO CHEAPER FERTILIZER FOUND BY CHEMISTS 792

As a result of the discoveries of Dr. Frederick G. Cottrell of the department of agriculture, nitrates may now be produced at little cost almost anywhere in the United States, and without the use of electricity. This means, experts declare, that the country will be independent of waterpower plants such as that established at Muscle Shoals, where more than \$80,000,000 was spent without producing any nitrates, and the fields of Chile no longer will be relied upon when the industry is fully developed here. It is predicted that, when production is reached on a large scale, nitrates for fertilizer may be had for six to eight cents a pound. The present prices, from nine to fourteen cents, are governed chiefly by import figures. Under Dr. Cottrell's process, which is a development of a German

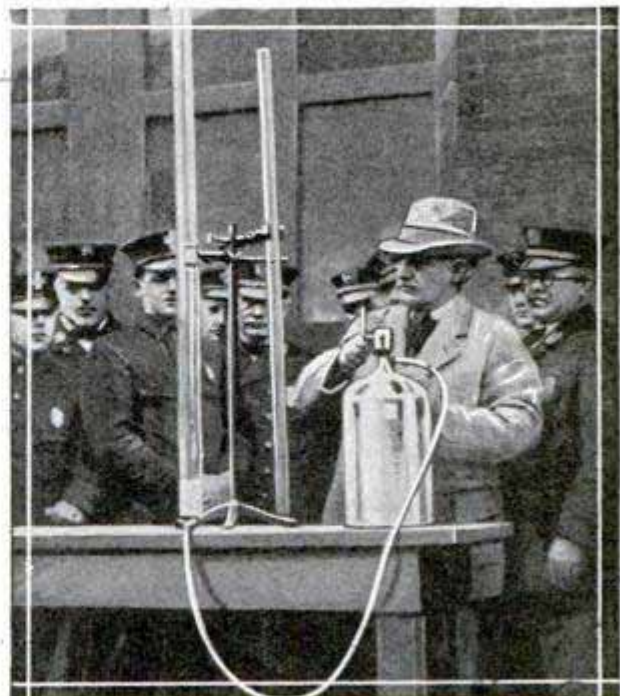

Demonstrating How Vibrations Control Fire: a Gas Flame in Tube Was Extinguished by a Shriill Note

Charles Kellogg Boston, Mass.

Fixed Nitrogen Research Laboratory - 12 - 2

see December 1926 - 0.929.

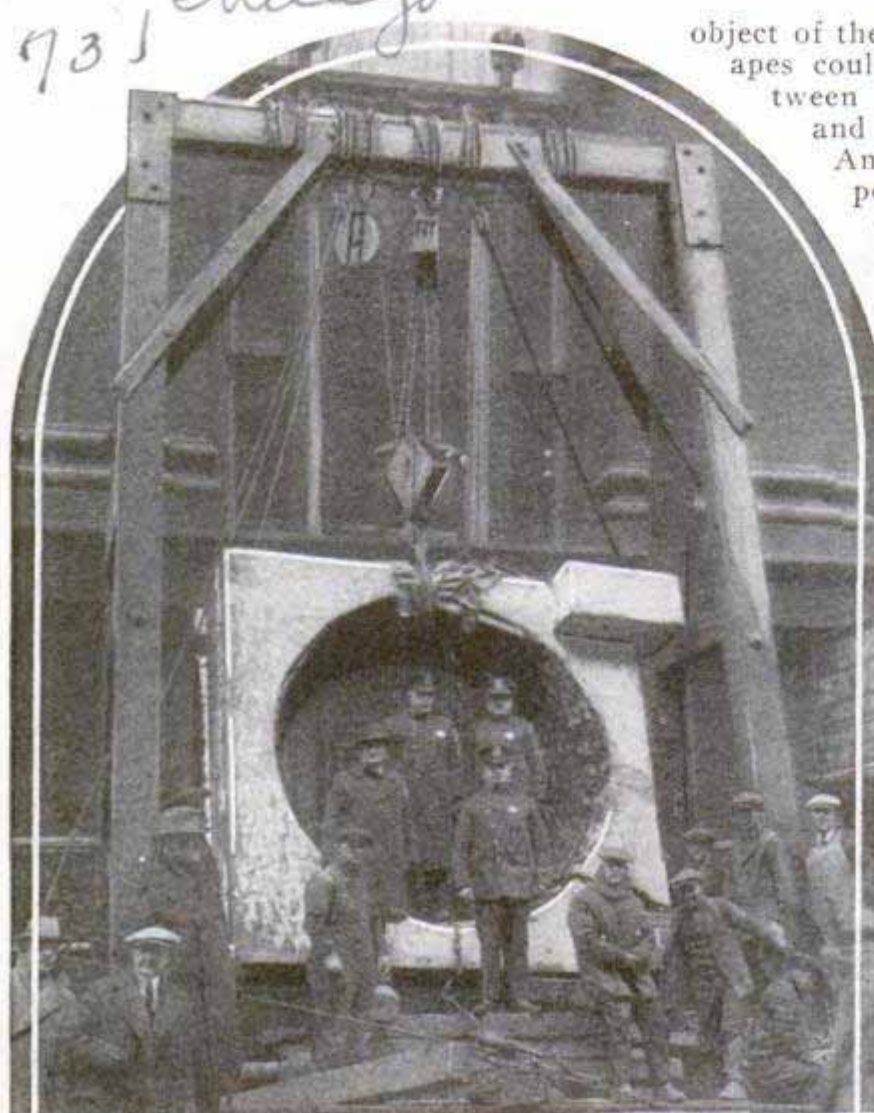

Part of 118-Ton Steel Vault on Tackle with Which It Was Installed in Banking Rooms

THREE HUNDRED MEN INSTALL HUNDRED-TON VAULT

Three big six-wheel trucks and 300 men were required to install a huge burglar-proof vault in a Chicago bank. Specially rigged tackle was employed in lowering the huge unit into place. The vault weighed 118 tons, and a single hinge more than 13,000 pounds. The cost of installation was placed at \$40,000.

APES USE REASON TO SOLVE DIFFICULT PROBLEMS 746

That the chimpanzee can solve problems hard for children of equal maturity has been shown by tests at Yale university. A long-necked bottle was fastened sideways to the floor and a piece of banana placed inside. In another part of the room, a length of hooked wire was provided within easy reach of the "subjects," two chimpanzees between two and four years old from western Africa. The

object of the test was to discover if the apes could solve the connection between the banana and the wire and use it to extract the fruit. Another test involved suspending a banana from the ceiling, where it could not be grasped except by piling boxes of different size one upon the other. The chimpanzees learned to construct a platform high enough to permit reaching the banana. Children of corresponding physical development failed to solve these and similar problems.

AUTO HUB LIGHT AIDS DRIVER

Attached to the hub of the left front wheel of the automobile, a four-candlepower electric light with a green lens at the side and alternate red and white glasses on the edge, produces a pin-wheel effect when the car is in motion to prevent side-swiping by an approaching auto. The signal is sufficiently distinctive to indicate the extreme outside of the car to an oncoming driver, even though he may be slightly blinded by brilliant headlights. In the daytime, the lamp adds to the appearance of the car, and the light is said to be visible at 200 yards after darkness.

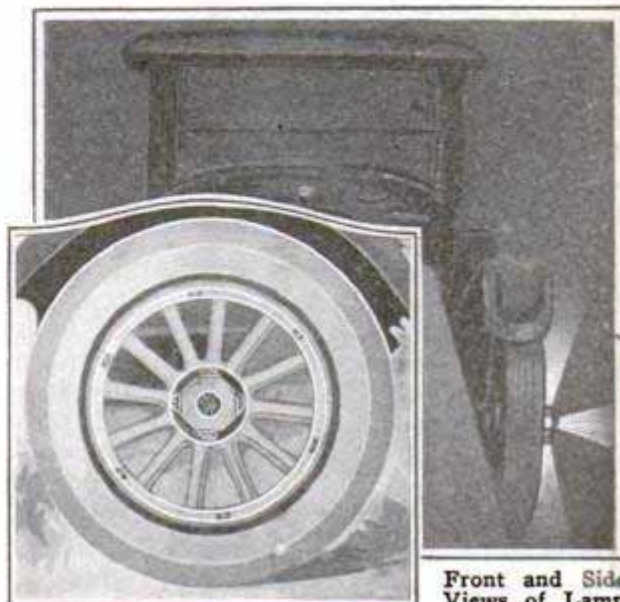

Front and Side Views of Lamp

Hurst National

Access

728
 Attached to the hub of the left front wheel of the automobile, a four-candlepower electric light with a green lens at the side and alternate red and white glasses on the edge, produces a pin-wheel effect when the car is in motion to prevent side-swiping by an approaching auto. The signal is sufficiently distinctive to indicate the extreme outside of the car to an oncoming driver, even though he may be slightly blinded by brilliant headlights. In the daytime, the lamp adds to the appearance of the car, and the light is said to be visible at 200 yards after darkness.
 Hurst Mfg. Co. 42 Spring St. Newark, N.J.
 No Chicago agent. Price - \$7.50 incl.

Robert M. Yerkes
 Institute of Psychology
 University of Chicago

Building-In the Radio Set

By EDWIN M. LOVE

LIKE all built-in furniture, the built-in radio cabinet illustrated saves floor room by utilizing waste space in a wall, and can be finished to match the trim of the room in which it is installed. The B and C-batteries, being slung below the cabinet behind the plaster, are properly hidden without making the case unduly large. The cabinet can be adapted to a set of almost any description, up to four or five tubes.

It consists of a simple three-sided box with a back, a pair of false side casings, and the casings mitered around the front, to which the grill door over the loud speaker and the radio-panel door, are hinged.

The two side jambs are of 1 by 4-in. stock, sized to 3 in. in width, with the edges beveled slightly toward the back, insuring close joints with adjacent members. Cut them 3 ft. long, and $\frac{3}{4}$ in. from one end, on the face side, work a dado, $\frac{3}{4}$ in. wide and $\frac{1}{4}$ in. deep. Nail to the other ends blocks $\frac{3}{8}$ in. thick and $1\frac{1}{2}$ in. wide, beveled on one edge to an angle of 45° , as shown in Fig. 1.

Fig. 2 shows the head jamb, which is $3\frac{3}{4}$ in. wide by 1 ft. $4\frac{1}{2}$ in. long, with each end notched to form $\frac{3}{4}$ by $\frac{3}{4}$ -in. projections, 2 in. long, that cross the side-jamb edges in the assembled cabinet. Cut a piece of three-ply $\frac{3}{8}$ -in. pine panel veneer 1 by 3 ft., carefully squaring and jointing the sides straight.

Make a lower sub-

rail of 1 by 2-in.

stock, $14\frac{1}{2}$ in.

long. As-

semble the side jambs with the head jamb by sliding the ends of the head into the side dados. If careful work has been done, the joint should be snug; however, if the dado is loose, drive a chisel into the groove, above the head jamb, and nail through the sides into the head-jamb ends before removing. The sides should be exactly 12 in. apart, inside. Now mark the subrail by the head jamb and nail in place across the lower ends of the sides, 2 ft. 9 in. below the head jamb. Carefully square the box and tack a diagonal strip from corner to corner to hold it until the back is nailed on.

In nailing on the back, use shingle nails driven every 4 in. at varying angles, starting at one end of the side jambs and working toward the other, so that, by moving the free ends this way or that, any crookedness can be straightened by alining with the true edges of the back. Make the subcasings of 1-in. stock, sized to 2 in.

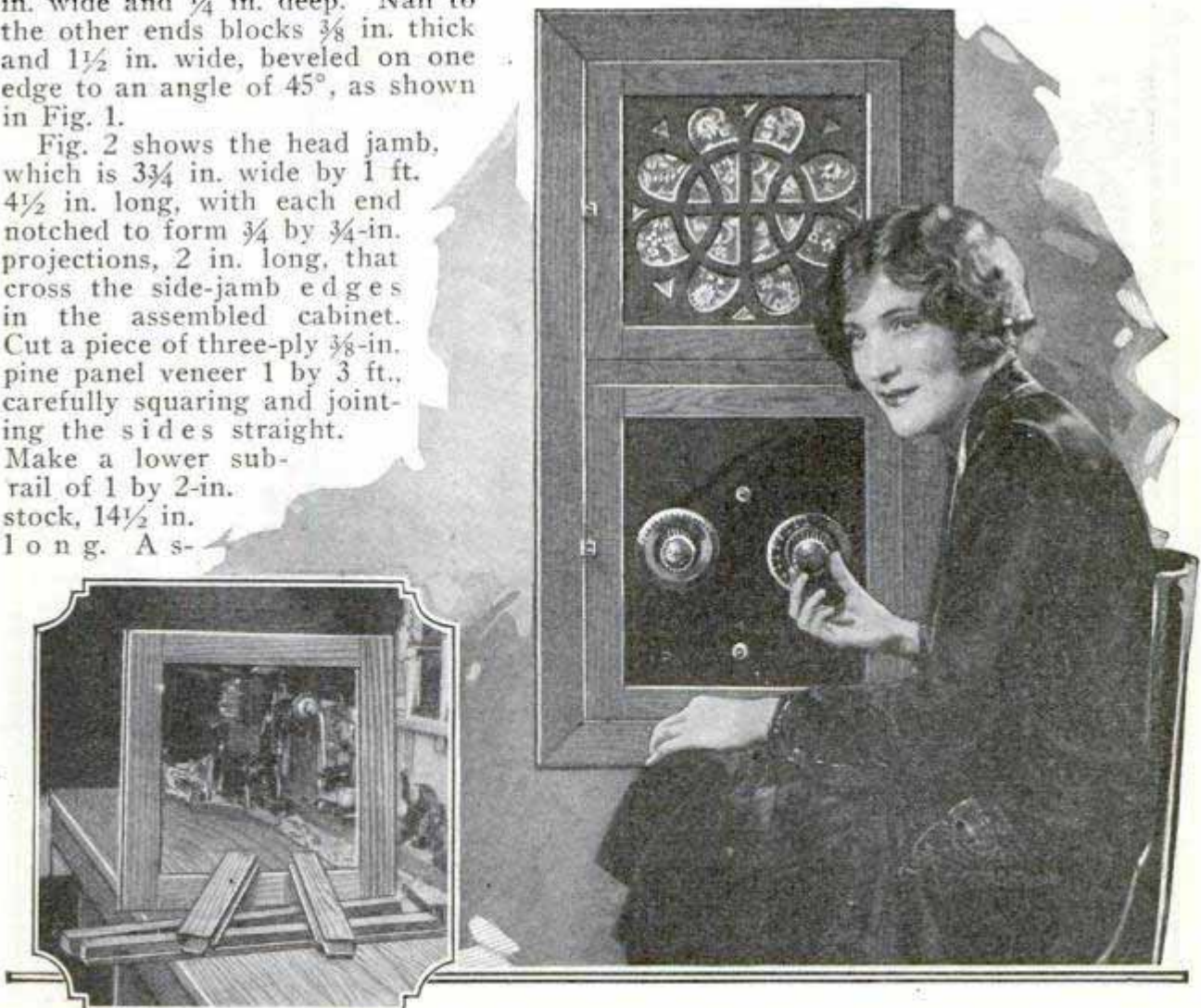

A Built-In Radio Set Not Only Saves Space in the Home, but May Also Be Made Very Attractive, as This Illustration Shows; Left, Door Frame, Stiles and Rails

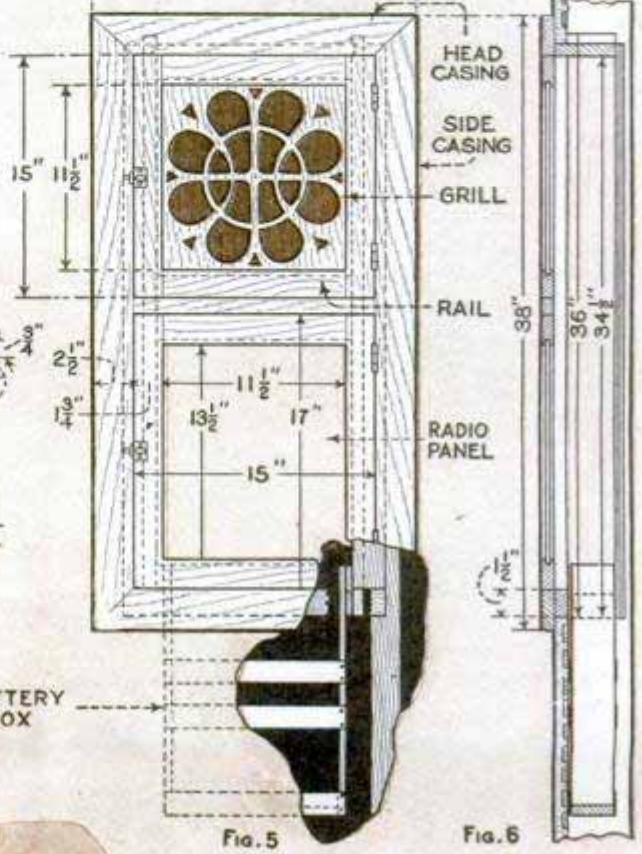
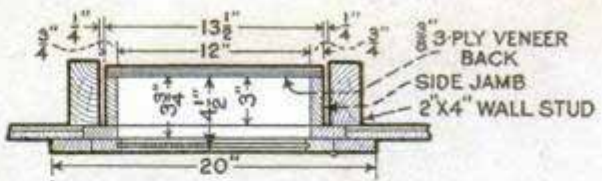
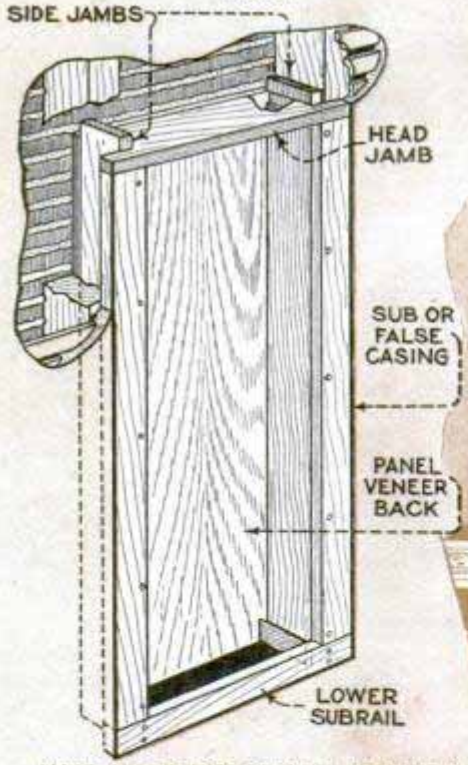
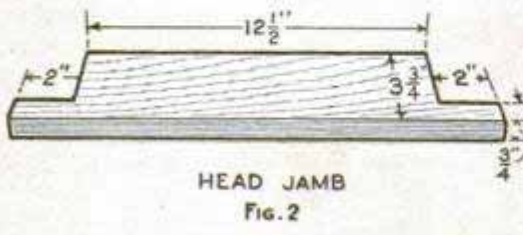
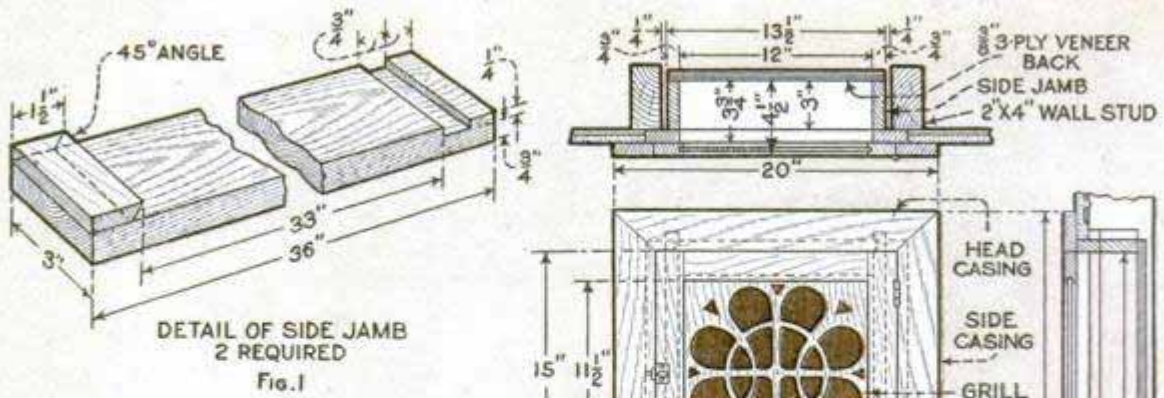

ELEVATION AND SECTIONS OF CABINET

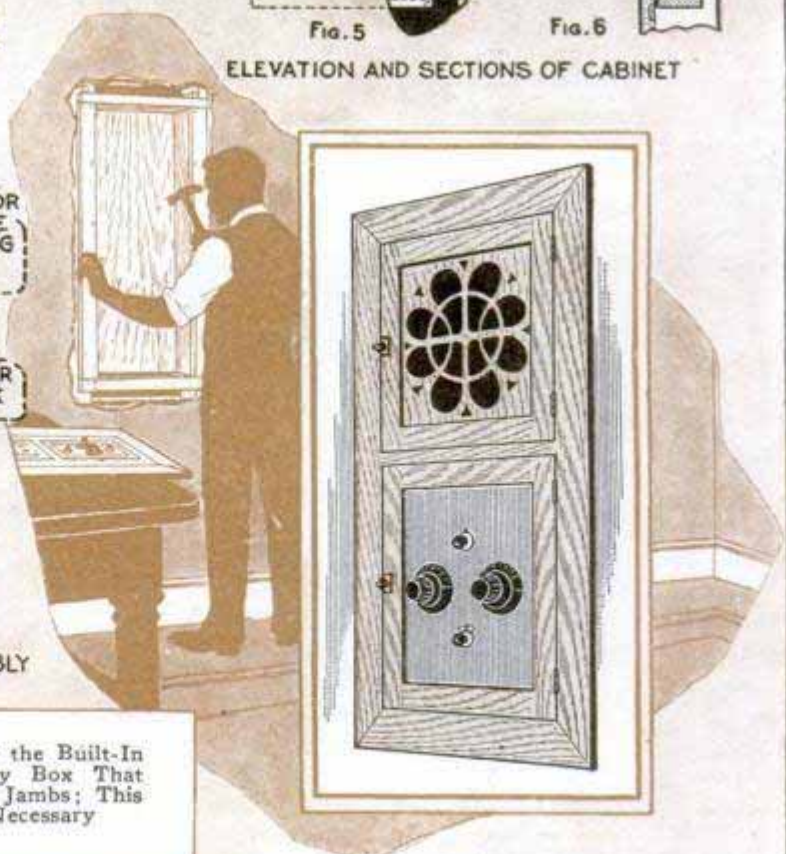

Various Details of Construction of the Built-In Radio Cabinet; Note the Battery Box That Hangs from the Ends of the Side Jambs; This Is Easily Removed When Necessary

in width, surfaced and jointed straight. Cut to length, to force tightly between the projecting horns of the head jamb and the lower subrail, and nail to the jambs flush with the inside faces. Nail into the ends from the head jamb and subrail, and surface down all projecting members until the joints are flush. (See Fig. 3.)

Make a casing muntin of 1-in. stock, 1 in. wide and $13\frac{1}{2}$ in. long, as in Fig. 4. Rabbet both ends, $\frac{3}{8}$ in. deep and $\frac{3}{4}$ in. long, on the face side, and nail it across the false casings, as in Fig. 5, 15 in. below the head jamb. Flush with the false-casing jambs, saw off the head jamb and subrail horns.

Gauge a line on each false jamb $1\frac{1}{2}$ in. from the inside edge, by which to guide the side casings. The head and lower casings are flush respectively with the head jamb and subrail. Make the casings of 1-in. stock, $2\frac{1}{2}$ in. wide, rounding one corner. (See Fig. 6.) The side casings are mortised to fit over the tenons of the muntin, and the corners are mitered. Tack

these in place to make sure of the fit of the joints, and then remove.

The rails and stiles of the two doors are all $\frac{3}{4}$ in. thick and $1\frac{3}{4}$ in. wide. Cut the stiles 1 in. longer than net measurements, and mortise the edges $\frac{3}{4}$ in. wide, 1 in. long and $1\frac{1}{4}$ in. deep, the distance between top and bottom mortises being 12 in. on the grill door and 14 in. on the panel door. Then rabbet the same edges $\frac{1}{2}$ in. wide and $\frac{1}{4}$ in. deep, as in Fig. 7.

Make the rails 14 in. long, with a tenon, $\frac{1}{4}$ in. thick and 1 in. wide, worked on each end after being rabbeted. Because the face side must fit between the shoulders on the stiles, it must be cut back $\frac{1}{4}$ in. on each end beyond the back. (See Fig. 8.) Rip the sides, rip to width, and then crosscut the sides and the edge. Fig. 9 illustrates the appearance of the assembly. Apply glue to both mortises and tenons,

and clamp firmly together, protecting the edges of the stiles with blocks under the clamp jaws.

While drying, make the loud-speaker grill. Cut a piece of panel veneer, 12 in. square, and trace on it a pattern prepared as follows: Lay out a 12-in. square with lines 1 in. apart as in the photo below Fig. 8, and locate the design intersections as they appear in the photograph. With an irregular curve draw outline through these points. Then blacken the back of the pattern and trace on the stock. Carefully made, a pattern of one-fourth of the design can be used for the entire tracing.

Pierce each space with a $\frac{1}{4}$ -in. hole, and cut out with a coping saw. Even the inside spaces can be reached with an ordinary frame, if it is slipped through the outer spaces. Smooth the edges by draw-filing, that is, by moving the wood rasp at right angles to its length. Lightly sandpaper any ragged corners. Plane the frame joints flush, giving a diagonal cut with the grain to avoid chip-

ping the surface, and smooth thoroughly. Tack the grill into the rabbet with $\frac{1}{2}$ -in. brads.

To set the cabinet in the wall, choose the place by sounding for studs with a hammer, lightly tapped on the plaster, and cut out full width between the studs and 3 ft. 1 in. long, having leveled for top and bottom. Chop away the plaster along lines plumbed 1 in. from the opening sides of the studs, and chisel out the laths. Preferably, the cabinet top, inside, should line with the tops of the doors and windows; but if this seems too high, drop the case lower. Slide it carefully in, and if projecting "keys" on the other side interfere, break them off. If the cabinet places well, lay aside and bore down through the wall plate for the lead-in; or, if an outside wall is used, simply install the cabinet and bring the lead in, and ground

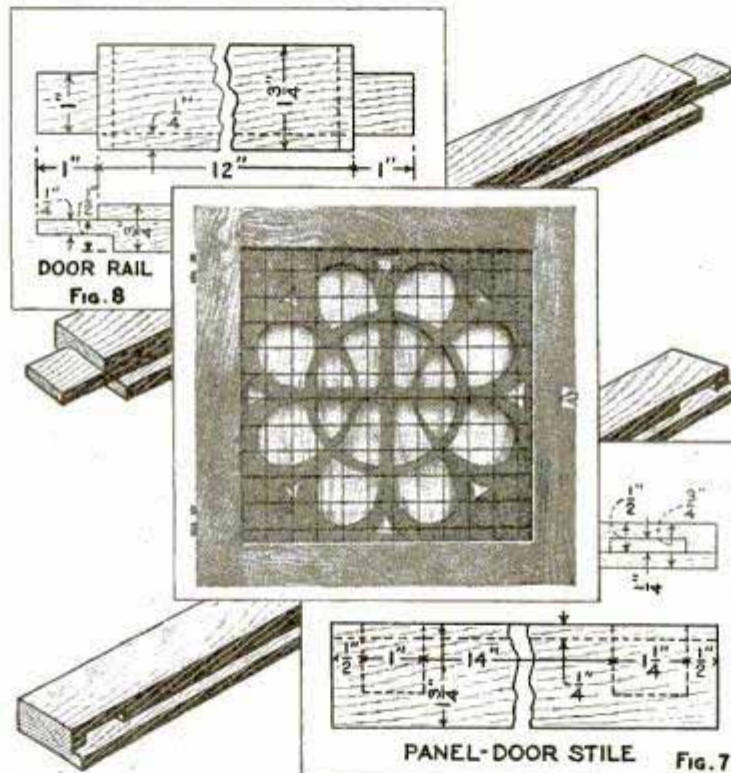

through the back. Nail up the cabinet through the false casings, and nail the casings into place, after which the doors are hung. Use 1 by $1\frac{1}{4}$ -in. loose-pin brass-plated hinges, placed 2 in. from the top and $2\frac{1}{2}$ in. above the bottom of each door, after having fitted the latter with less than $\frac{1}{16}$ -in. clearance all around. A simple way to locate the hinges is to block the door in place, measure the position of the top of the upper hinge and the bottom of the

lower hinge, and mark both stile and casing with the point of a pocketknife, in one thrust. Then lay the hinge halves in position and scribe around them with a knife. Mortise in the casement fasteners, but remove again before staining.

When the finishing is done, remove the grill door and cover the back with silk of the desired color, or with fine-mesh brass screen. Make a flat molding, $\frac{1}{8}$ by $\frac{3}{8}$ in., and miter it around the rabbet behind the grill. Lay the silk smoothly over the back and place one piece of mold by driving a $\frac{1}{2}$ -in. brad through the center. Then stretch the silk toward both ends, nailing the mold solidly. Repeat with the mold at

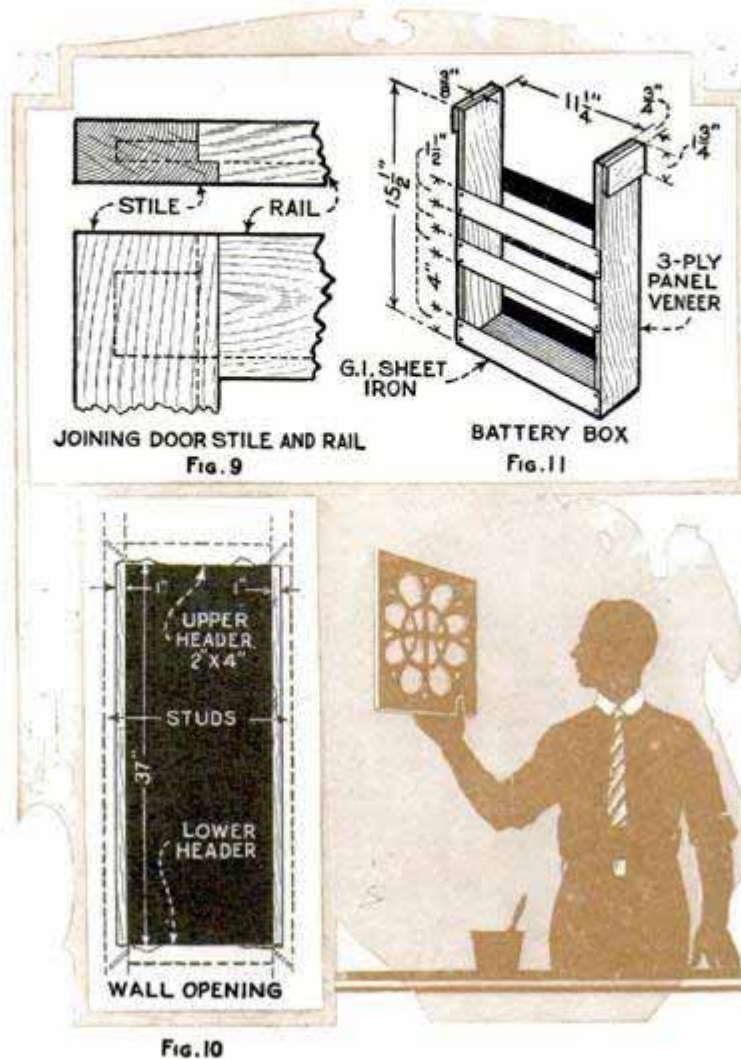

other two pieces, again stretching the cloth, and with the point of a knife against the slightly projecting edge of the mold, trim away the loose edges. Carefully done, this results in an extremely neat job. For the battery, build the crate detailed in Fig. 11, of $\frac{3}{8}$ -in. stock, with side straps of galvanized iron, $1\frac{1}{2}$ in. wide. Place two 45-volt batteries inside, one above the other, and blocked apart, bringing the lead wires up inside, and place the single C-battery. To install, open

the panel door and slide the crate inside, allowing it to drop until its cleats grip those on the side jambs. It may be necessary, for clearance, to break off the plaster keys below the cabinet by the use of a long chisel.

It is best to set the storage battery in the basement, bringing the A-battery leads through holes bored in the lower header. Mount the speaker on the upper jamb of the cabinet, by means of a small iron plate bolted to it and screwed to the jamb.

Use flexible leads from the battery, speaker, aerial and ground to the set, and cut them only as long as it is necessary

MATERIAL LIST

1 piece, 1 by 4 in. by 6 ft., pine, S4S, sanded.
 1 piece, 1 by 3 in. by 12 ft., pine, S4S, sanded.
 2 pieces, 1 by 2 in. by 6 ft., pine, S4S, sanded.
 2 pieces, $\frac{3}{4}$ by $1\frac{3}{4}$ in. net by 6 ft., pine, S4S, sanded.

1 piece, $\frac{3}{8}$ by 4 in. by 4 ft., pine, S4S, sanded.
 1 piece, $\frac{3}{8}$ by 16 in. by 4 ft., 3-ply panel veneer.
 1 pair 1 by $1\frac{1}{4}$ -in. loose-pin butts.
 2 small casement fasteners.
 1 piece galvanized iron, 9 by 12 in.

the opposite side, this time drawing the silk tight between the two pieces as well as stretching it lengthwise. Nail in the

in order to permit the door to open fully, as any excess of wire will naturally be in the way when the cabinet is to be closed.

Wire - The West Engineering Co. Ltd., 2 Ravenscourt Square, London, W.6, Eng.

Valve Spring Makes Good Catwhisker

The small spring at the end of a tire-valve stem makes a good catwhisker. This spring can be removed by pulling off the small cap at the end of the stem with a pair of pliers. It is a simple matter to mount it on the detector stand and solder it in place. This spring is stronger than the usual catwhisker, will keep its shape and, therefore, hold a good contact.—James Hare, Norman, Okla.

Paper Sleeves for Spiderweb Coil Forms

Paper sleeves around the spokes of the spiderweb coil forms make it easier to remove the finished coil. This popular type of self-supporting coil is wound on a wooden form of the type shown in the illustration, and when the pegs are pulled out to release the coil, they often stick, owing to the tightly wound wire, and the coil is damaged. This can be overcome

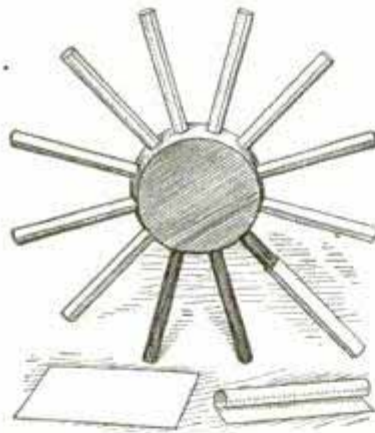

by cutting small pieces of light paper, 1 in. wide and the same length as the pegs, wrapping one around each peg and gluing the edge. When the coil is removed, the paper sleeves come with it and can easily

be pulled out.—Charles Latour, Jr., Plattsburg, N. Y.

Do Not Press Condenser Dials for Fine Tuning

Many radio fans have discovered that by simply pressing on the edge of the condenser dial one station can be tuned in and another out. This is extremely bad practice, and if persisted in will ultimately ruin the bearing of the condenser. The method is successful only where the two stations are close together in frequency and are crowded on the dial settings. A vernier, or slow motion, dial will have the same effect and will not injure the condenser. It is a tuning mechanism which will move the rotary plates of the condenser very slowly over the smallest possible distance, necessary to tune the receiver sharply and separate the stations.

Spring Connector Eliminates Soldering

A spiral-spring wire connector has lately made its appearance on the English market. The spring has two branches, bent to a right angle, the unconnected ends of which are somewhat larger in diameter than the inner ones. In use, the end A is screwed down over the bolt projecting below the panel, and because of the taper of the coil, it will fit tightly, in fact, can only be removed with a pair of pliers. The other branch, B, receives the connecting wire or busbar, as indicated. It, too, is inserted by a screwing motion. As the connecting wire is under great pressure when in position, a good electrical contact is assured. The connectors are made to fit standard busbar, wire and threads.

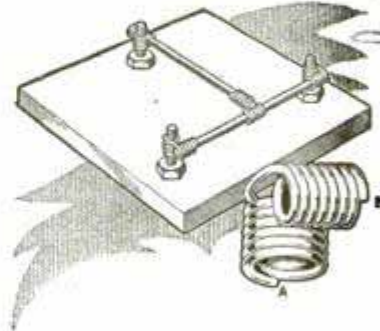

As the connecting wire is under great pressure when in position, a good electrical contact is assured. The connectors are made to fit standard busbar, wire and threads.

Bobber Battery Gauge Gives Voltage Reading

A bobber battery gauge that gives the true voltage reading of the A-battery when placed across the terminals, has lately made its appearance on the market. This method has its advantages over the hydrometer method in that there is no danger of spilling the acid solution on rugs and carpets. It is claimed that the voltage reading is preferable to specific-gravity reading owing to the fact that if the acid solution is too strong, the hydrometer will show a good charge, while in reality the voltage or pressure would not be up to the necessary point. To test the battery with the bobber gauge, turn on all the tubes in the set, and while taking the maximum load from the battery, the reading is taken across the A-battery terminals, showing the actual charge of the battery in voltage under operating conditions. The bobber gauge reads as low as $3\frac{3}{4}$ volts. When the battery is charged, the reading will be approximately $6\frac{1}{2}$ volts.



Connective system. Measure resistance & capacitance. 68 Ravenscourt Square, London, W.6, Eng.

Eagle Carburetor Co. 1150, 2 W. Madison Cleveland, Ohio

Simplified Wiring Diagram for the Counterphase Six; the Instruments Appear on the Diagram in Approximately the Position They Occupy on the Baseboard in the Set, So as to Make the Tracing of the Wires Easy. Properly Built, This Set is Very Selective

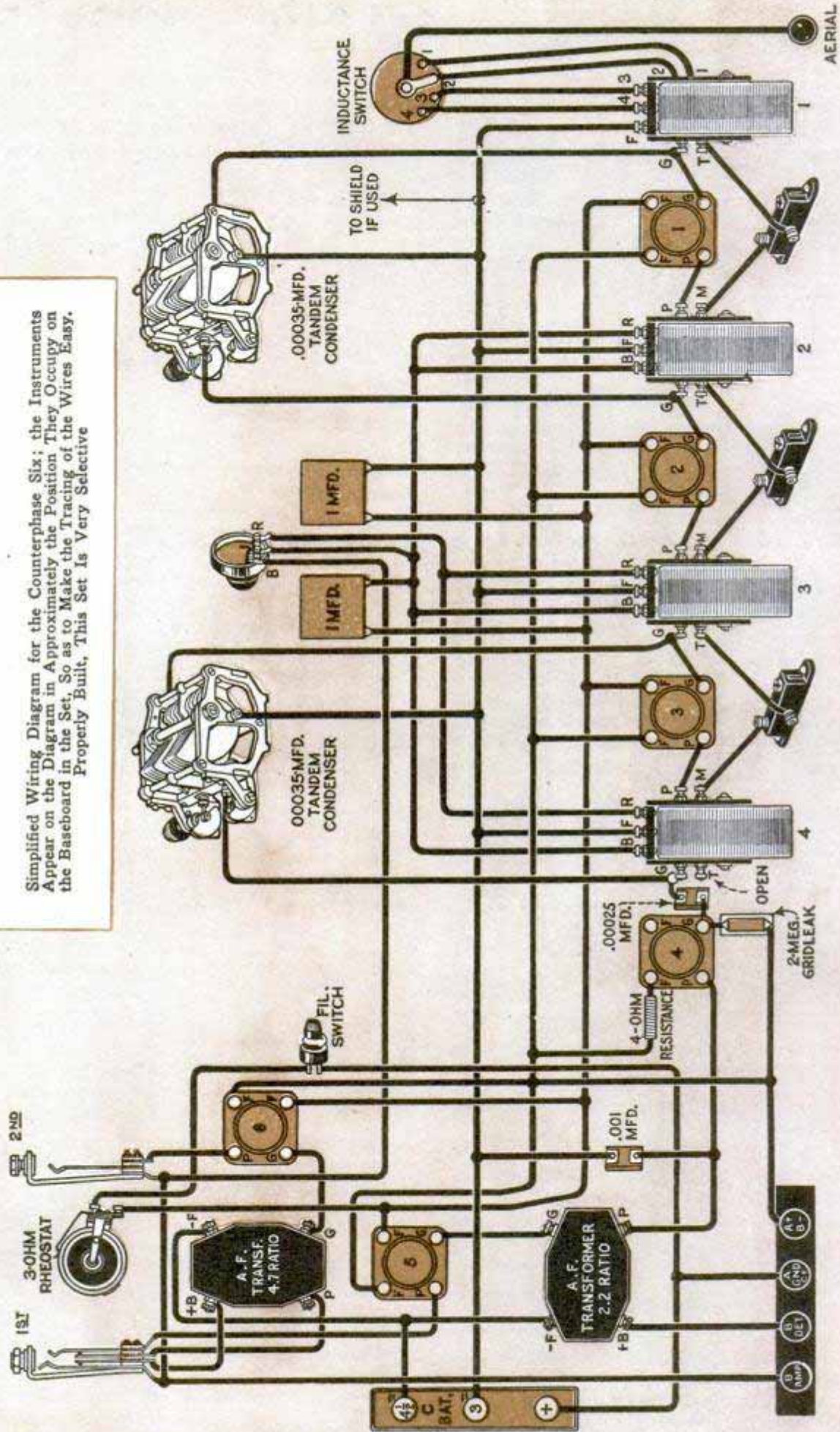

This Six-Tube Set Is Highly Selective

Counterphase Receiver Has Good Range and Volume Also, and Can Be Used on Fifteen-Foot Indoor Aerial

THIS circuit has been tested in Popular Mechanics radio laboratory along with several other circuits to find one that would meet the demand for selectivity without resorting to the superheterodyne method. During the tests we were able to bring in a number of outside stations through the Chicago ones, cutting out the locals at will, which can be said of very few circuits, other than the superheterodyne. The set is not difficult to build, and the cost low considering the results.

When the radio-amplification stages of a receiver are tuned to the same frequency, there is a tendency to oscillate.

In this set, this is prevented by a separate counterphase circuit in each stage, which is permanently regulated by means of a small adjustable condenser to suit the tube

used. In order to secure panel adjustment of the sensitivity, or tendency to oscillate, these circuits are controlled by a special double-resistance unit. Selectivity is governed by the degree of coupling between the aerial and the first coil. The inductance switch is used to regulate the number of turns through which the aerial current passes, from 2 to 25 turns as desired. The circuit is designed for the UV-201A or C-301A tubes throughout, including the detector tube. When this type of tube is used as a detector, it operates most efficiently at a low brilliancy; therefore a 4-ohm fixed resistance is placed in series with the positive de-

tor filament. Before drilling the front panel, note the two $\frac{3}{16}$ -in. holes indicated by the black dots; these holes are to be drilled only if the dials specified are used. Also note the distance of the $\frac{1}{2}$ -in. holes for the condensers from the bottom of the panel. This dimension is given as $4\frac{1}{4}$ or $3\frac{1}{2}$ in., the former figure applying if B-T dials are used, and the lesser distance if ordinary dials are to be employed. The other parts required can be of any good standard make.

It is a good plan to remove the coils from the baseboard while wiring the set at other points, mounting them last so as to eliminate the danger of injuring the

coils when working around them. All wires connected to G or P-posts, as well as those connected to the stationary plates of the condensers, are high-potential; and

should therefore be well spaced and kept away from the other apparatus.

As will be noted in the full-page wiring diagram, the rear trimmer condensers are fastened to the tandem condensers and can be permanently adjusted as follows: The rotor plates on the rear trimmer condenser attached to the right-hand tandem condenser, which is connected to the No. 1 coil, are turned halfway in, while those of the other are turned in fully. The dials on the front panel are then adjusted so that both read 100 when the rotor plates of the tandem condensers are all in and flush with the stationary plates. Connect the 6-volt A-battery to the set;

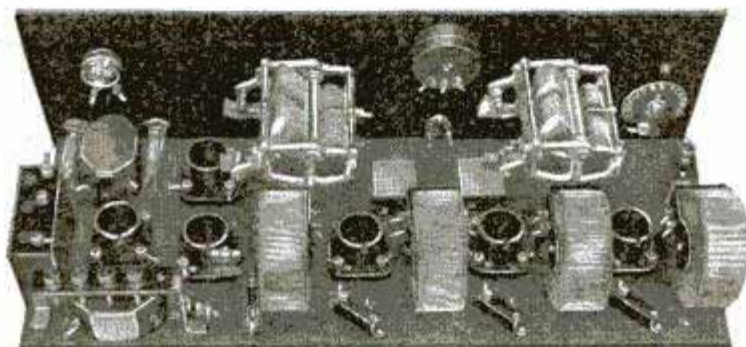

MATERIAL LIST

1 No. 6 counterphase kit (cost \$38), consisting of	2 dials	\$5.00
1 type-TA coil,	2 1-mfd. fixed condensers	2.50
3 type-TC coils,	1 .001-mfd. fixed condenser	.50
2 type-LD-17, B-T tandem condensers,	1 .00025-mfd. fixed condenser	.35
1 dual resistance (volume control),	1 2-meg. gridleak, with panel-mounting clip	.25
1 4-ohm fixed resistance,	6 standard sockets	4.50
1 set of colored leads.	1 double-circuit jack	1.00
Other parts (of any good standard make,	1 single-circuit jack	.70
total cost about \$34.26).	1 filament switch	.50
1 bakelite or formica panel 3-16 by 7 by 24 in.	1 3-ohm rheostat	1.00
1 wood baseboard $9\frac{3}{4}$ by $23\frac{1}{2}$ in.	1 inductance switch	1.90
1 a.f. transformer, ratio 2.2 to 1	5 binding posts and mounting strips	1.00
1 a.f. transformer, ratio 4.7 to 1	1 $4\frac{1}{2}$ -volt C-battery	.60

place tubes in the sockets; try the rheostat to see that it regulates the brilliancy of the tubes, and the on-and-off

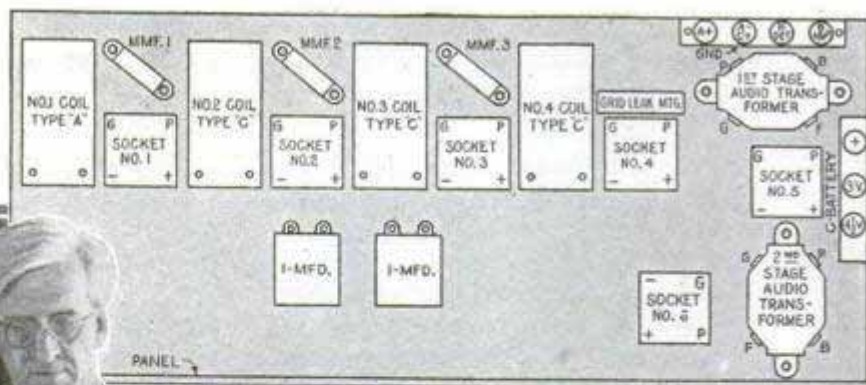
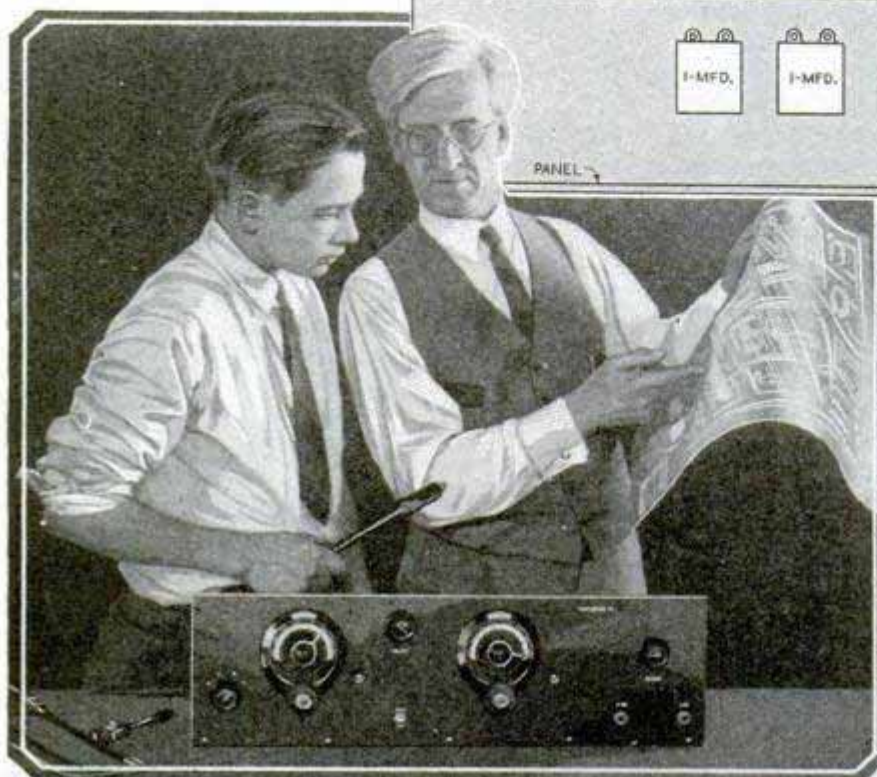

Above, Layout of Instruments on Subpanel; Left, Front of Assembled Set

ments, the control snaps into a neutral or zero position. Rotate the tandem-condenser dials slowly, maintaining about the same dial reading on both until a signal is tuned in. Adjust the three small counterphase condensers, shown between the coils, by means of the adjusting screw that will be found on each; a long, sharpened wooden rod should be used

switch also. To avoid an accident, remove the tubes and disconnect the A-battery. Connect the positive-A of this battery to both of the positive-B binding posts, and connect the A negative of the battery to the B-negative binding post. Insert the tubes; the filaments should not light. If any tube lights this indicates a wrong connection or contact at some part of the B-positive wire or apparatus connected to it. In making this test one tube can be moved from socket to socket.

To adjust the set, place the inductance switch on point 4 and the potentiometer volume control at zero; this is the position when the pointer is straight up or when, halfway between extreme adjust-

for turning this screw. Adjust each screw until the pointer at the end of each condenser is halfway down. Now tune in a comparatively weak signal. Reduce the brilliancy of the tubes to the point that gives the best results. Rotate the volume control (potentiometer) to the point giving the loudest clear signal. Plug the loud speaker into the second stage. The volume now should be greatly increased. Adjust the inductance switch to various points from 1 to 4, re-tuning for each adjustment. Volume should decrease toward 1, but the tuning should be correspondingly sharper, and the greatest volume should be obtained at point 3 or point 4.

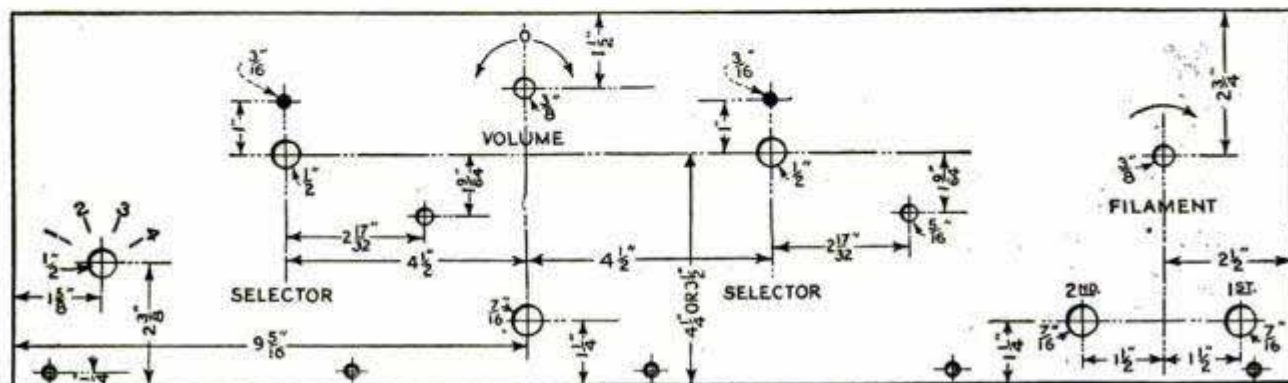

Layout of Template for Drilling Panel; Holes Marked by Black Dots Are for Dials Specified Only

The small counterphase condensers can now be adjusted permanently. Each must be carefully adjusted in turn, beginning with No. 3, which is next to the detector and directly back of tube No. 3. Tune in a strong signal near 40 on the dial. Remove tubes 1 and 2. Tune the signal carefully, using the trimming knobs on the front panel for maximum volume. Set the volume control at the midway or zero point. Rotate the tandem condenser at right back and forth "across the signal," and an oscillation beat or whistle will be heard as the signal is brought in and out of tune, or oscillation may be indicated by a click. When the counterphase condenser No. 3 is properly adjusted, oscillation will not occur, and no beat or whistle will be heard. The proper adjustment is halfway between the point where oscillation stops and the point where it is again heard. Adjust the condenser to this point and leave it permanently at this position. Replace tube No. 2 and adjust the condenser back of tube No. 2 in the same manner, except that the dial on the tandem condenser at the left is rotated across the signal to detect oscillation beat or click. Replace tube No. 1 and adjust the last counterphase condenser No. 1 in the same manner as No. 2. As the point of adjustment is quite sharp on No. 1 and No. 2, it will be necessary to proceed slowly, always making certain that the station is tuned to maximum volume, as the counterphase-condenser adjustment changes the tuning slightly.

When operating a receiving set near one or more powerful stations, it is desirable to shield the receiver in order to obtain maximum selectivity, because the wiring in the set, the battery leads and the tuning apparatus pick up and deliver directly to the detector sufficient energy to produce an audible signal regardless of tuning. This can largely be overcome by lining the inside of the cabinet with aluminum, copper or brass, of about 24-gauge thickness. All parts of the shield should be soldered together in a single unit. All holes should be as small as possible, but large enough to prevent contact with shafts or mounting bushings of any apparatus; also see that the shield does not come in contact with any metal apparatus on the subpanel, except where the apparatus is connected to the same wire or lead as the shield.

Blueprints for this set may be obtained from the Radio department, Popular Mechanics Magazine, 200 E. Ontario st., Chicago. Inclose fifteen cents to cover postage and packing. Specify blueprint 105.

**Moving Metal Shields
Tune Crystal Set**

544-

A crystal set that is tuned by moving metal plates through the magnetic field set up by the inductance coil, has proved to be an efficient and popular receiver in England. Neither capacity, moving coils nor tapped inductances are used in tuning this compact set. A fixed inductance coil of special design is tuned by letting two metal shields pass over the sides of the coil. When the set is working, the tuning coil creates a magnetic field which sets up eddy currents in the metal shields. The latter react and very sharp tuning over a wide wave band can be obtained. The metal shields are not in any way connected with the circuit used, but merely act by induction. For a wavelength outside the range of the coil in use, another coil has to be inserted; this can be done in a moment, as the coils are simply plugged in. The simple operation will appeal to persons who desire to receive broadcasting at close range.

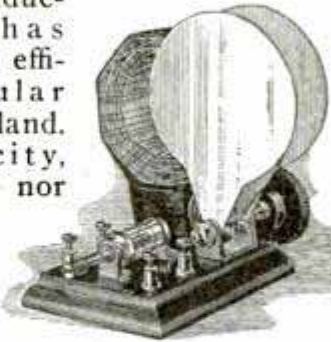

A simple ground clamp that can be fastened without screws is a novelty of interest to radio enthusiasts. As usual, the water pipe is first cleaned with a bit of sandpaper or filed bright at the point where the clamp is to be placed. The ground wire is then bent in the form of a "U," as shown in the illustration, and inserted under the clamp, the spring is placed in the proper notch, and the lever closed, making a quick, positive and direct contact. The importance of having a good ground cannot be over-emphasized. Many times the inefficient operation of the set is due to a faulty ground, and with the new clamp, which is easier to install in awkward places than the old type requiring a bolt and setscrew, an efficient ground is assured.

Ground Clamp Requires No Screws

A simple ground clamp that can be fastened without screws is a novelty of interest to radio enthusiasts. As usual, the water pipe is first cleaned with a bit of sandpaper or filed bright at the point

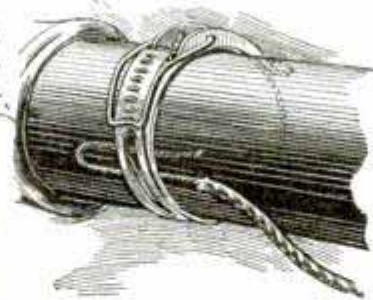

where the clamp is to be placed. The ground wire is then bent in the form of a "U," as shown in the illustration, and inserted under the clamp, the

spring is placed in the proper notch, and the lever closed, making a quick, positive and direct contact. The importance of having a good ground cannot be over-emphasized. Many times the inefficient operation of the set is due to a faulty ground, and with the new clamp, which is easier to install in awkward places than the old type requiring a bolt and setscrew, an efficient ground is assured.

Chicago 573-00
March 15, 1934
Chicago 573-00

Mr. Green, Ltd. Wacker Road, Goldmark, London W. 2, Eng

Snap. Life Clamps Co., 110 W. 14th St. New York City

Panel Permits Making Quick Battery Connections

Usually when one is most anxious to test a set, looking for wire and preparing it for the connections wastes time unnecessarily. The panel to be described does away with this and therefore should

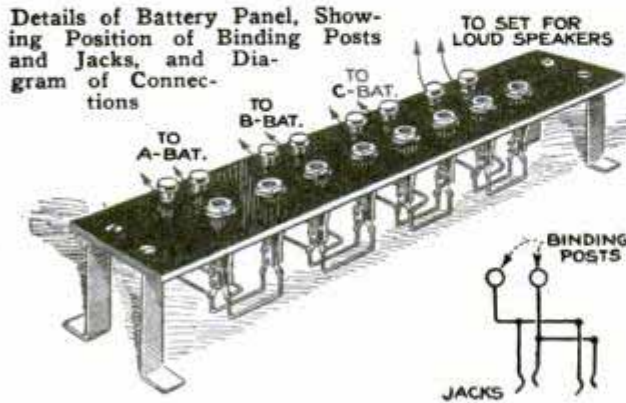

prove a welcome addition to the experimenter's equipment.

A strip of bakelite, $\frac{1}{8}$ by $2\frac{1}{2}$ by 12 in., is drilled for eight open-circuit jacks, as shown in the illustration. These holes are spaced 1 in., center to center, starting $2\frac{1}{2}$ in. from each end. About $\frac{1}{2}$ in. above these holes, directly over jacks Nos. 1, 3, 5 and 7, eight holes are drilled for the binding posts, in pairs. Each set of two jacks and one pair of binding posts are connected in parallel. In this way there will be three connections available for each battery and three separate ones for the horn, or for any other purpose.

By having two jacks for each battery circuit it is possible to take off two separate pairs of wires, while the binding posts make a permanent battery connection, and can be used for the set in regular use without disturbing that circuit while testing other sets. The panel takes the place of extra binding posts that so often clutter up the work table, and can be mounted under, or flush with the table, as desired, so that all wires will be under the table or workbench. The mounting brackets need not be used if the panel is to be mounted flush with the edge of the table, in which case a piece slightly smaller than the panel may be cut out of the table, and the panel then mounted by means of wood screws. Since there are eight jacks, an equal number of plugs should be provided; connect each plug to a standard 6-ft. telephone switchboard cord, or common lampcord, the free ends of which are connected to the set to be tested. The wire that is connected to the point on the plug should be positive in

all circuits; hence it is necessary that this point also make contact with the positive side of all jacks. The free ends of the wires should then be marked for polarity with tags, or painted red for positive and black for negative.—C. Reberger, Roselle Park, N. J.

Good Horn Extension Made from Old Appliance Cord

An ordinary appliance extension cord makes an excellent horn or phone extension for the radio set. The separable plug is pulled apart, and the screw plug is screwed into the socket at the other end of the cord. The free wires are then connected to the output terminals on the set. The phone or horn-cord tips are pushed into the two holes in the plug, where they are tightly held by the springs inside. With this extension, the phones or horn can be taken into an adjoining room without disturbing the set.

Handy Method of Soldering Leads to Switch Points

A handy method of soldering leads to switch points is shown in the illustration. In soldering these leads considerable difficulty is often experienced in securing a good joint

without smearing the threads with solder. This can be avoided and a firm connection neatly made by starting a nut on the end of the switch point, just far enough for the threads to catch. The wire is then



scraped free of insulation and a small loop is made on the end of the lead. A trace of soldering paste is touched on the surfaces to be joined, and a little solder is dropped in the cup formed by the nut and the end of the switch point. The looped end of the wire is forced into this cup and held in place, while the soldering iron is applied, until the joined surfaces are thoroughly heated. After the iron is removed, the lead is held in position until the solder has set.

Number of Plates in Variable Condensers Does Not Indicate Capacity

To classify condensers by the number of plates instead of the maximum capacity at which they are rated, is like marking batteries by their size instead of the voltage they are designed for. A 23-plate condenser may have any capacity from zero to infinity, depending on the size of the plates, the thickness of the dielectric, and other factors. This method of specifying condensers by the number of plates rather than the rated capacity originated in the early days of radio, and many manufacturers labeled their condensers in this manner. The public learned to call for a 23-plate condenser when they wanted one with a maximum capacity of .0005 mfd. This rule-of-thumb method will not answer in present-day delicately balanced receivers, and all manufacturers are now marking the rated capacity of their products without regard to the number of plates.

Stable Base for Home-Built Loop

A handy base for the home-built loop can be made of lead formed in the shape shown in the illustration. Making a base which is both good-looking and solid is often a problem, and is usually only partially solved by using a large, flat piece of wood. The objection to a base of this sort is that it is not sufficiently heavy to make the loop stable. The lead base looks good and holds the loop firmly. It is made in a plumbers' ladle by melting enough lead to fill it two-thirds, and after cooling, taking it out and filing all surfaces smooth. Glue a layer of soft felt on the flat side. Drill a hole in the middle of the top, a trifle smaller than the circular brass rod that is used as the connector between the base and the upright of the loop.

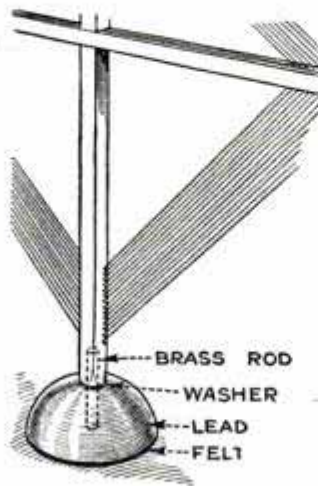

Drive the rod into the hole, leaving out the required length, which is usually about 3 in. Before setting the loop on the base, a nickelplated washer should be slipped over the rod. This base is naturally quite heavy, which is an advantage

rather than a fault. The lead base can be decorated as desired. Gold or silver radiator paint gives a pleasing finish, or ordinary black enamel can be used, which gives a glistening surface matching the radio panel.

Sockets and Adapters for Use with UX and CX-Tubes

The new UX and CX-tubes have longer prongs than those on earlier types and push directly into the socket without the cus-

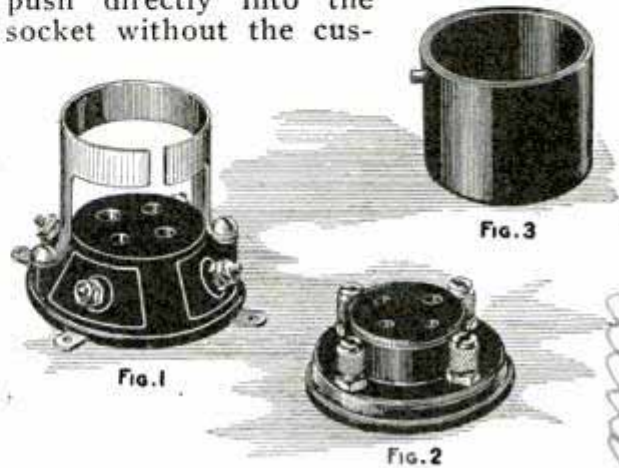

Sockets for the New UX and CX-Tubes and Adapter for Use in Standard A-Sockets

tomary turn as necessary with the bayonet sockets. Most of the new tubes, however, will fit in the old-type sockets with the exception of the new types replacing the UV-199 and C-299, the bases of these tubes having been changed so that the tubes are interchangeable in the new standard sockets. It will be remembered that the plate and grid of the UV-199 and C-299 tubes were placed at opposite corners of the old sockets. The new base arrangement of these tubes is now identical with that of the standard A-type bases. These tubes can be used with the old-type A-sockets, by means of the adapter shown in Fig. 2. This standardizing of bases and sockets makes changing from dry cell to storage battery tubes an easy matter. The socket shown in Fig. 1 is designed to take the old or standard tubes as well as the new types. Fig. 3 shows the new socket in simple form, being small and compact, it takes up very little room on the subpanel. There are several advantages in this type of socket; the tubes goes in easily without risk of breaking the glass tube loose from the base, as often happened when turning the tube in the bayonet-type socket. Good connection between the prongs on the tube to the socket contacts is assured, eliminating a common fault found in the old sockets having spring contacts.

*Socket 35¢
Connector 35¢
Cushion Mount 50¢*

*622-R
others }
American Standard
new York City
older types
of having
found
more &
more &
more &*

Double Loop Acts as Booster for Outside Aerial

A double loop of novel design has lately made its appearance on the market.



It is claimed that this loop greatly increases the range and selectivity of the set, and that it can be used either with or without an outside aerial on sets having two or more tubes. The feature of the device is the inside loop, which remains stationary while the outside loop revolves. The loop satisfactorily replaces the outside aerial on all types of sets for local stations, it is said, and when used as a booster with an outside aerial surprising volume on distant stations is obtained. The terminal strip, located near the base provides for a variety of connections for different circuits.

How to Change Sets to Suit Alternating-Current Tubes

In order to use the new a.c. tubes on any standard sets several changes are necessary in the wiring of the circuit. These changes consist in discarding the present filament circuit, and connecting all the negative filament terminals on the sockets to a common busbar. Both filament terminals can be connected to the busbar if desired; this adds strength to the assembly, and the dead post can be connected along with the negative line. This busbar then becomes the cathode lead, and is considered as the filament lead of an ordinary tube. A 4½-volt C-battery is necessary in the grid return of all the tubes, except the detector. The detector grid return is run direct to the cathode lead. The positive terminal of the C-battery is connected to the cathode lead. The negative terminal is connected

to the grid return of all the tubes except the detector. The negative B-lead is also connected to the cathode lead. The grid and plate leads are connected as for any ordinary tube. Plate voltages up to 150 volts can be used on the plates of the amplifiers, and from 45 to 90 volts on the plate of the detector. Never connect the 110-volt a.c. circuit to the tubes except through a step-down transformer. When using from one to three tubes the transformer should be connected for 4 volts; for four or five tubes, connect the transformer for 5 volts; over five tubes, connect for 6 volts. Never use higher voltage. The transformer should be not less than 75-watt, otherwise it will heat excessively and burn out. The connections from the transformer secondary to the heater terminals, should be made with not less than No. 14 wire, or flexible stranded wire of similar size. The cathode heaters are all connected in parallel. This is done by running two leads from the transformer secondary to busbars mounted on the upper rear of the front panel. These busbars can be mounted on the panel by means of bakelite blocks, or bakelite binding posts. Flexible leads are soldered to the busbar wires, and connected to the terminals on the tops of the tubes, by means of clips. Keep the a.c. supply transformer at least a foot away from the set, otherwise a hum may be heard through the set. Either one of the busbars, or heater leads, should be grounded on the end farthest from the transformer.

Adjustable Tool BORES Meter Holes

An adjustable tool for cutting large holes in panels for meters, tube sockets,

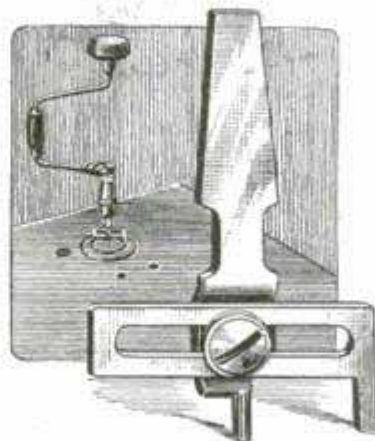

bezels, and other instruments, has lately made its appearance on the market. It is designed to cut mounting holes in either bakelite or hard-rubber panels. The adjustment provides for holes from 3/8 to 3 in. in diameter. On holes 3/8-in. or larger, the sizes commonly used for one-hole mounting instruments, the cutter is claimed to do neater work than a twist drill. The tool fits in an ordinary carpenter's brace.

Price - 65 cent

Price - 65 cent

*Harrison Parnely
3020 Spandan Road*

*Wm. Williams Elec. Prod. Co.
Santa Ana, Calif.*

*Wm. Williams
Santa Ana, Calif.*

Sales agent. Scott Sales Co. 443 S. San Pedro St.

625-12

**Success with New Hookups
Depends on Parts Used**

When trying out new circuits, follow the diagrams and specifications carefully. If this is not done, you will probably not get the best results from the set. Usually the designer has carefully selected the parts that work best in that particular hookup, and any deviation will give poor reception. Many parts, such as sockets, rheostats, jacks and fixed condensers, are now standardized so that any good make will do, but this does not apply to other components, such as coils, a.f. and r.f. transformers and specialized parts; these must conform to the needs of the individual circuit. Other parts may be similar in appearance and yet totally unsuited for that particular circuit. For example, in Popular Mechanics superheterodyne, condensers are specified in which the plates are not connected to the shaft. If another condenser is used, having the rotor plates fastened to the shaft, the rotor must be grounded to prevent howls. If this is neglected, as is very apt to occur, no grounding wire being shown in the circuit, the builder will have trouble, and may blame the set, when the fault is in using the wrong condensers.

**Handy Battery Connector Made of
Machine Screw and Wingnut**

A brass machine screw and wingnut mounted in the terminals of a 6-volt automobile storage battery, make an ideal connector for this type of battery, which usually comes with tapered cable connections that are un-

handy for radio purposes. Two methods are suggested for mounting the machine screw. The lower illustration shows a brass machine screw with a round head; a hole is drilled in the terminal, slightly larger than the head and of a depth to leave an end above the terminal for the wingnut. The hole around the screw is then filled with solder. The illustration above shows a brass machine screw stud mounted in a hole threaded to receive it. Either method is effective and makes a good permanent connector.

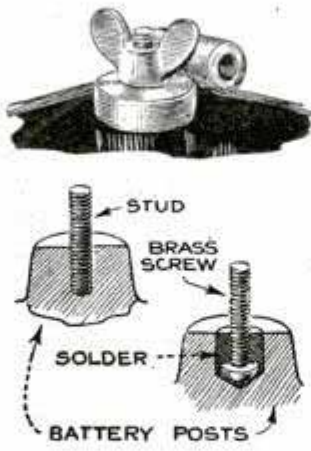

**Pilot Light on Panel Saves
Tubes and Batteries**

A pilot light on the panel is an ever-present reminder that the set is in operation, and that tubes and batteries are be-

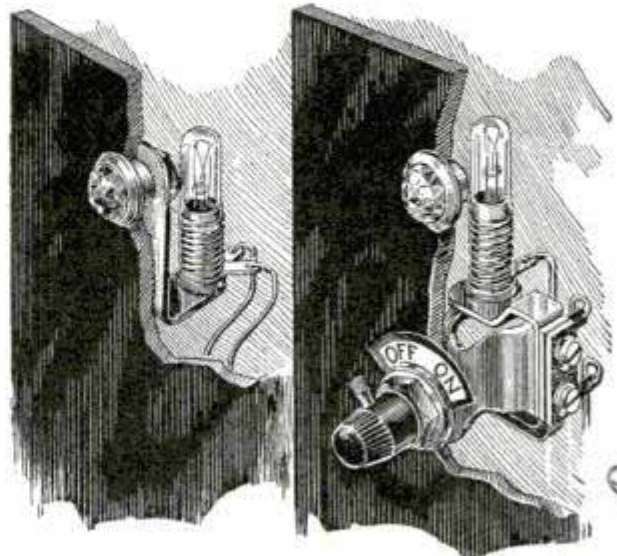

Two Ways of Mounting Pilot Light on Panel, Either with Lens and Lamp as a Unit or Separately

ing needlessly used, if there is no station on the air. Handy lights of this type, which can be operated on the A-battery line, have been marketed lately. They can be used with any type of switch. In the arrangement at the left in the illustration, one hole is drilled in the panel to take the jeweled lens and a locknut at the rear holds the lamp bracket in position. At the right the lamp bracket is shown in combination with an on-and-off switch, and the lens is mounted separately above the switch, which also makes a very neat-looking assembly.

Cleaning Crystals

Crystals that apparently have lost their sensitive spots can be cleaned and restored to their former effectiveness by placing them in a small bottle containing ether. Commercial ether will do for this purpose. Shake the bottle vigorously, and then remove the crystal with a pair of tweezers; do not touch it with the hands. It will quickly dry in the air, and when replaced in the set will often give as good results as when new.

On radio sets that are equipped with a potentiometer there is enough leakage across the potentiometer when the set is not in use to cause the A-battery to discharge much more rapidly than usual. Therefore, the A-battery should always be disconnected when the set is not operating.

*610-R
You buy with Co. Desplains, Chicago
2, 7 h.*

Semi-Automatic Coil Winder Simplifies Tapping

A coil winder that leaves the hands free for guiding the wire can be built from odds and ends around the workshop.

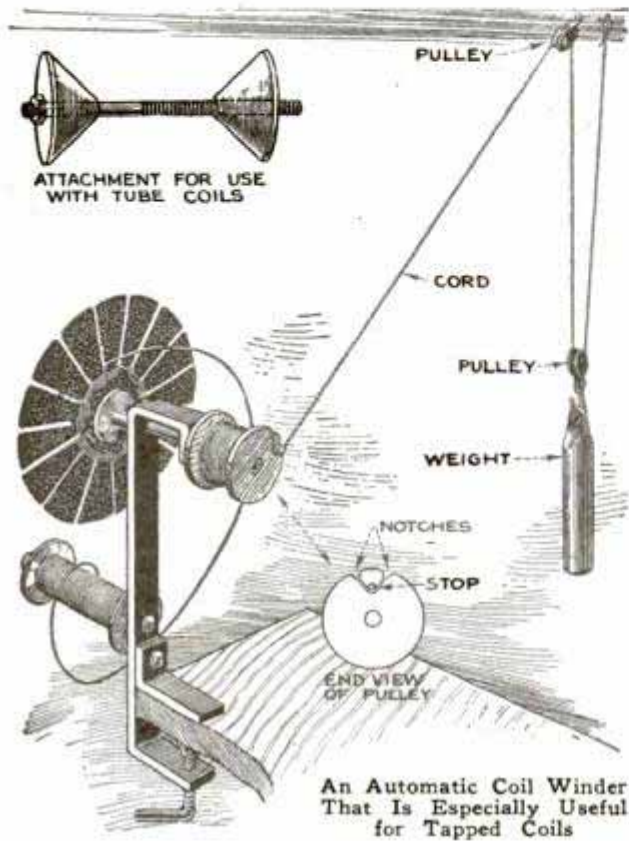

Tubular, spiderweb and diamond-weave coils can be wound on the device, and the number of turns automatically checked.

It is not necessary to make the clamp frame shown; the iron upright can simply be bent at the bottom and screwed to the table, and this will simplify it somewhat, although the clamp fixture is handy. The stock used for the frame should be about $\frac{1}{4}$ by 1-in. iron or steel. The shaft is made of $\frac{3}{8}$ -in. round steel, threaded at one end to screw part way into a wall flange and fastened with a pin or set-screw. The flange supports the small wooden blocks used to hold the coil forms; holes are drilled in the center of the blocks for a bolt that screws into the threads in the flange. For the tubular coils a separate attachment is used, made as shown in the detail. A pin to carry the wire spool is riveted near the bottom of the upright.

On the other end of the shaft is fastened a spool-shaped wooden pulley, $1\frac{1}{2}$ in. in diameter. The shaft is revolved by means of a heavy string or chalk line, wound around the spool and then rigged around two pulleys and fastened to the

ceiling, as shown. The lower pulley carries a sash weight, which, as it drops, supplies the power to operate the device. The length of the string, of course, depends on the number of turns desired on the coils. Into the outer side of the pulley, about $\frac{1}{2}$ in. below the edge, a pin is driven, and on either side of the pin a notch is cut in the edge of the spool.

Suppose we have to wind 60 turns of wire on a coil in the winder. The weight is down and there are some turns of line on the spool. Lead the line through one of the notches and loop it around the pin, then lead it back through the other notch and wind on 60 turns of the line. This, of course, draws up the weight. When the 60 turns have been wound on, the line may be hooked over the pin again to hold the winder stationary, and the wire started on the coil. Now, when the last loop of the line is thrown off the pin the winder will start to revolve and will keep on until the first loop around the pin is reached, when it will stop.

For tapping, the line is wound on the spool in the same manner, leading the line through the notches and looping it over the pin in the same way as before wherever a tap is to be taken off. It must be remembered, however, that as the string winds off from the outside of the spool and the wire is wound on the coil starting from the inside, the stops for the taps must be arranged in the reverse order when winding the cord on the pulley. For example, if a 60-turn coil is to have taps at the thirteenth and thirty-fifth turns, the first loop made on the pin, when winding on the line, will be the one for the thirty-fifth tap, and the loop will be made at the thirty-fifth turn of the line on the spool; the next loop, for the thirteenth tap, will be made at the forty-seventh turn of the line. The winder will then stop automatically as the loops are reached. When winding, let the wire slip through the fingers of one hand and press it in place on the form with the fingers of the other. The winder can be stopped and held at any point by slipping a wide rubber band over the line on the pulley.—James B. Hays, Boise, Idaho.

Glass Towel Rod Is Good Insulator

To use a glass towel-rack rod as an aerial insulator, notch the rod at each end with a three-cornered file for fastening the wire. As the rod has a highly polished surface, it makes an ideal insulator, and being usually of heavy glass, it will stand the strain.



A Homemade Refuse Burner

By A. J. R. CURTIS

IN thickly built-up residential districts and in localities where alleys are not available, refuse burners prove a great convenience in disposing of rubbish and trash. The design for the concrete burner shown in the accompanying illustration is one which may be depended on for the disposal also of a considerable amount of garbage, provided there is always an excess of paper and other odorless free-burning material. An excessive proportion of pure garbage will create unpleasant odors and therefore should be avoided.

The burner consists of a concrete box, 3 ft. 8 in. square and 4 ft. 1 in. high (above ground) in outside measurements. The walls are 6 in. thick, and extend 1 ft. below the ground. The roof slab is slightly arched, varying from 7 to 9

in. thick. Plain wooden box forms may be used inside and outside. In putting these forms together, the nails should be left protruding slightly to permit easy withdrawal in disassembling. The inside form, particularly, should be well oiled or soaked to prevent swelling caused by the absorption of moisture. The various rectangular openings are made by fastening small box forms between inner and outer main forms as the concrete is placed to the lower level of each opening. See Fig. 1. Similarly, the flue openings may be made circular, if preferred, by inserting short sections of stovepipe between forms. The openings through which the grate-shaker arms protrude are formed by inserting short sections of 1-in. iron pipe. Concrete made of 1 part cement to 2½ parts of sand and 3 parts of pebbles or crushed stone is recommended. The footing is placed in a shallow trench, and vertical reinforcing rods are then placed in position. The reinforcing is done entirely with ½-in. round rods, the verticals and horizontals both being located 12 in. apart, as shown.

doors - Pyrites Mtg. Co., Louisville, Ky.
 #1 - Attached door 10" x 12"

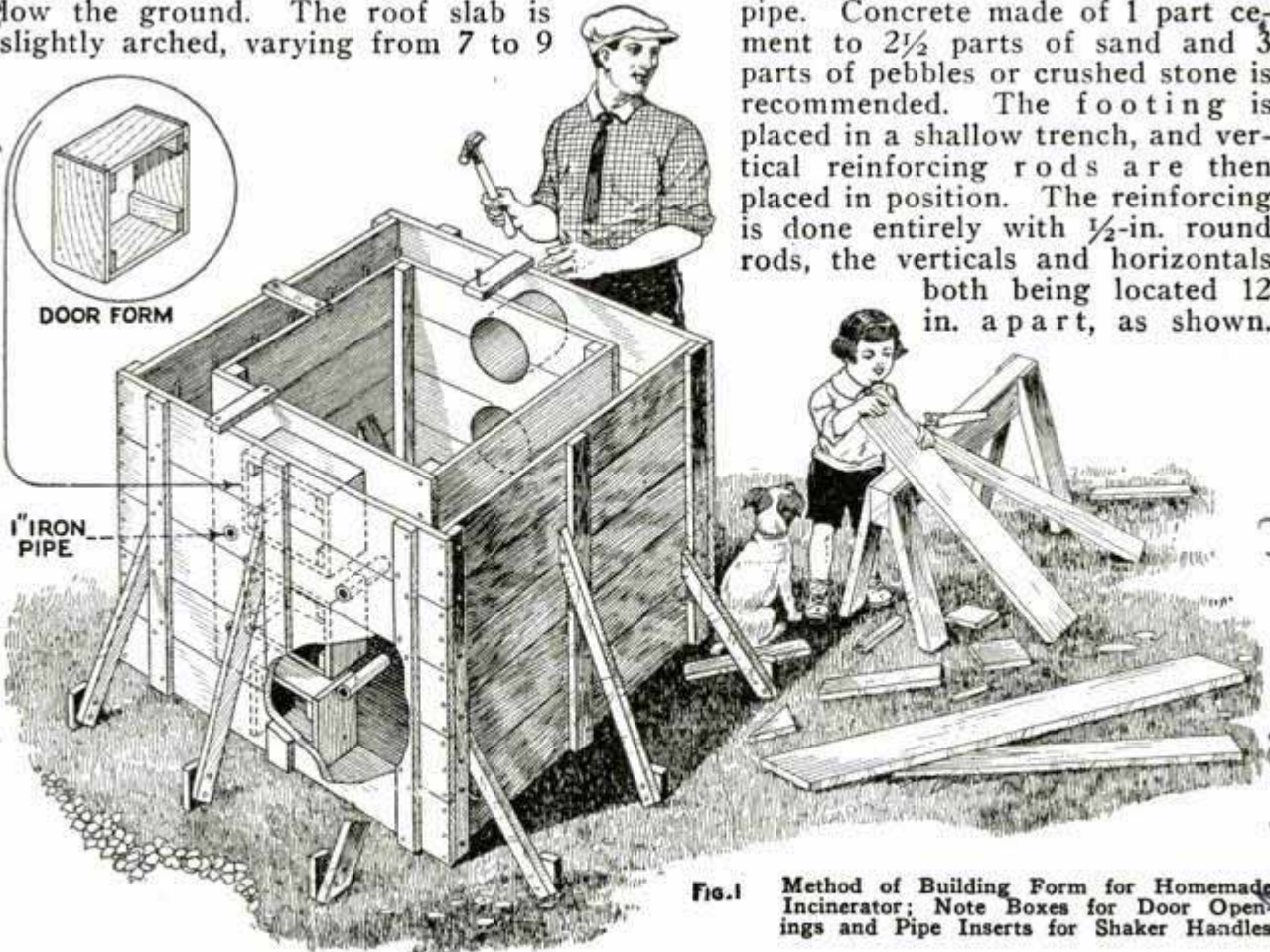
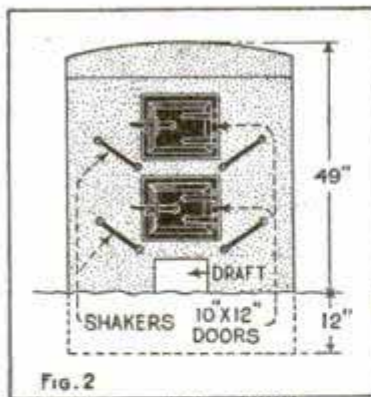

Fig. 1 Method of Building Form for Homemade Incinerator; Note Boxes for Door Openings and Pipe Inserts for Shaker Handles

Parabo - Krause & Manufacturers Co 2-176 E. 55th Cleveland, Ohio.
 Lemble grates for 2'-8" x 2'-1"



The roof reinforcing is also of $\frac{1}{2}$ -in. rods, spaced 6 in. apart in both

convenient, or a small chimney constructed especially for the burner. Concrete chimney blocks, resting on a solid concrete base, 12 in. deep and with other dimensions somewhat greater than the blocks, may be conveniently used. These

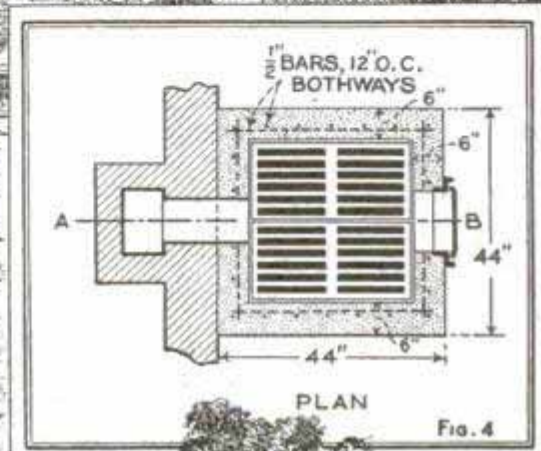
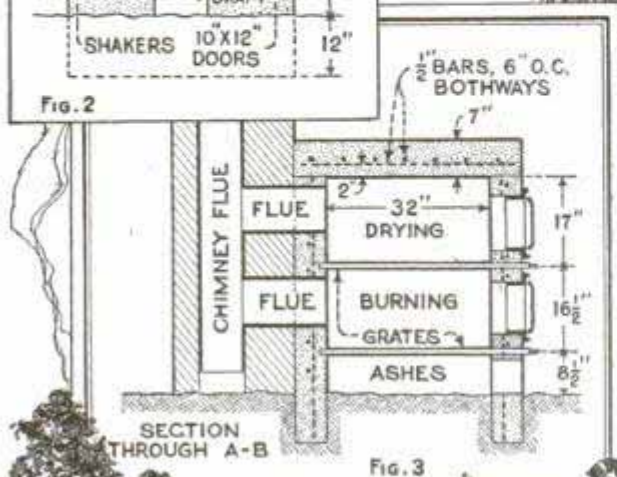

directions. After the vertical rods are in place, the horizontals may be wired in position as convenient.

The concrete should be just wet enough to flow nicely into all parts of the mold under light tamping. The forms are removed as soon as possible, any blemishes are immediately touched up with a similar mixture, and the entire surface scrubbed or painted with a creamy mixture of cement and water. The outer forms may generally be removed the day following the placing of the concrete, to permit surface finish. Inner forms may remain longer. Should any portion of the inner form become tightly wedged in, beware of straining the green concrete to remove it; it is far better to let it remain until burned out.

The doors and grates required for the refuse burner may be obtained by ordering (specifying dimensions) from any local hardware dealer. The flues may be attached to a house or other chimney if

blocks have tongue-and-grooved mortar joints, and are easily laid in cement.

If a monolithic (cast in place) chimney is preferred, it may be made of 1:2½:3 concrete and lined with chimney-flue lining or cull sewer-pipe sections, which are conveniently used as an inner form.

Replacing Watch Ribbons

In renewing wrist-watch ribbons, it is sometimes difficult to pass the ribbon, especially if heavy and readily frayed,

through the narrow slots in the hook and clasp. It can be done easily in the following way, however: Fold a narrow strip of pa-



per, about 2 in. long, and the width of the slot, in the middle. Tuck the ribbon end inside of the paper, and pass the folded end of the paper through the slot. The ribbon will readily follow the paper, if pushed slightly.—Richard C. Tarr, Gloucester, Mass.

Case for Tail-Light Lamp

A strong casing for a spare tail-light lamp can be made of an empty 10-gauge shotgun shell. The lamp is wrapped in a rag and is placed in the shell, bulb first, the ends of the rag hanging out at the open end. When it is desired to remove the lamp for use, it is pulled out by the ends of the rag. The shell is stiff enough to stand ordinary handling and the lamp, thus protected, can be carried in the tool box without much risk of breakage, unless, of course, a jack, or some other heavy tool, is placed above it.—E. T. Gunderson, Humboldt, Iowa.

Hand Grips Make Teeter Safe

In order that smaller children might enjoy a big seesaw as well as the older ones, the athletic director of a western school provided each board with the handgrips shown. Lengths of $\frac{1}{2}$ -in. iron rods were bent to the shape shown and the ends flattened and drilled for $\frac{1}{4}$ -in. bolts. With these grips, two children can safely sit on each end, facing each other. To

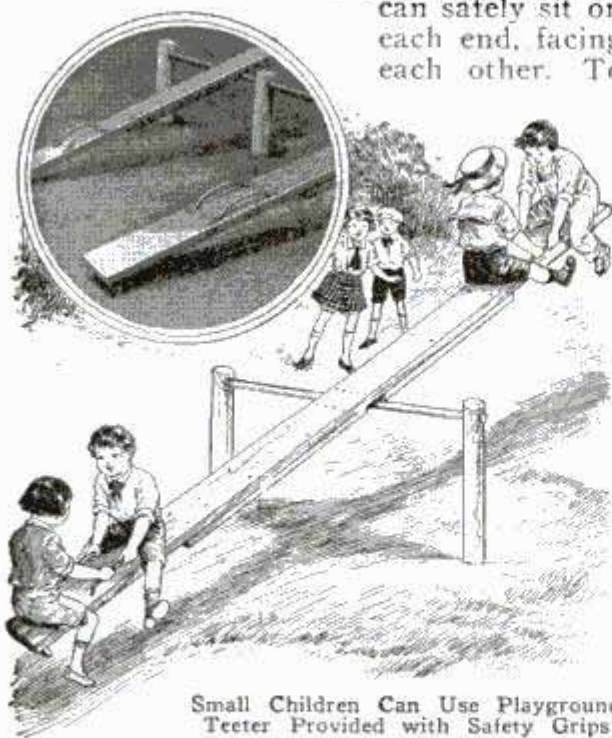

Small Children Can Use Playground Teeter Provided with Safety Grips

prevent rusting, the rods should be tinned or painted.—Dale R. Van Horn, Walton, Nebraska.

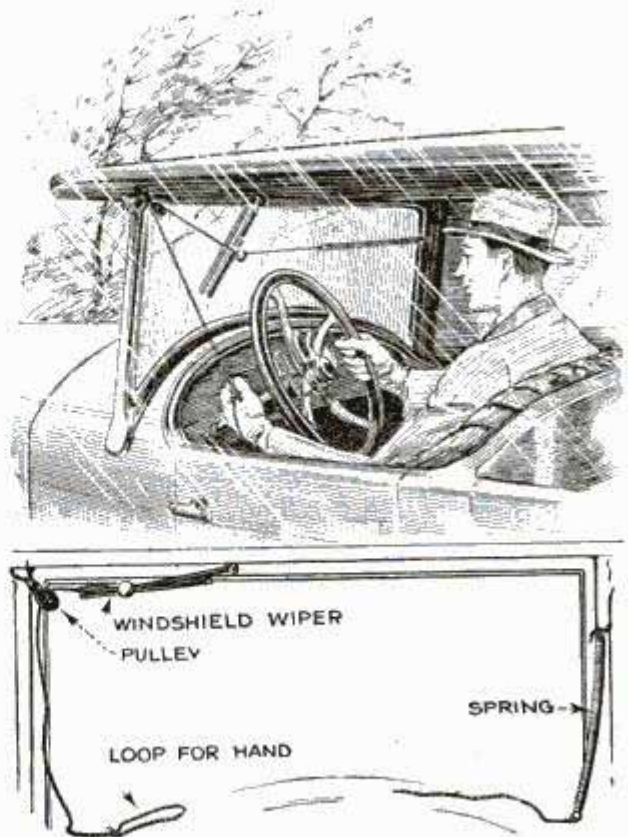

Semi-Automatic Windshield Wiper Which Does the Work Satisfactorily and Cost Only a Few Cents

Semi-Automatic Windshield Wiper

My Ford had only the ordinary windshield wiper operated by hand. This was rather inconvenient and tiresome, so I rigged up a semi-automatic attachment which proved entirely satisfactory. I took about 6 in. of spring from an old shade roller and fastened it to the right side of the windshield. Then I fastened the other end to the knob of the wiper, regulating the tension so that the wiper would be pulled over quickly. A pulley in the upper left-hand corner, through which is run a stout cord fastened to the knob, completes the device. When it rains, I loop one end of the string around my hand and when the windshield needs wiping, a downward sweep of my hand pulls the wiper over and when I let go the spring pulls it back again. The cost was only 10 cents for the pulley.—Dr. E. W. Henke, Newark, N. J.

Protecting Small Articles against Rust

Screws, nails and other small iron articles will resist moisture and consequently rust if they are tumbled about when new and dry, in a pan of powdered rosin. If slightly warmed before shaking, a fine coating of rosin dust will adhere to the surface of the metal.

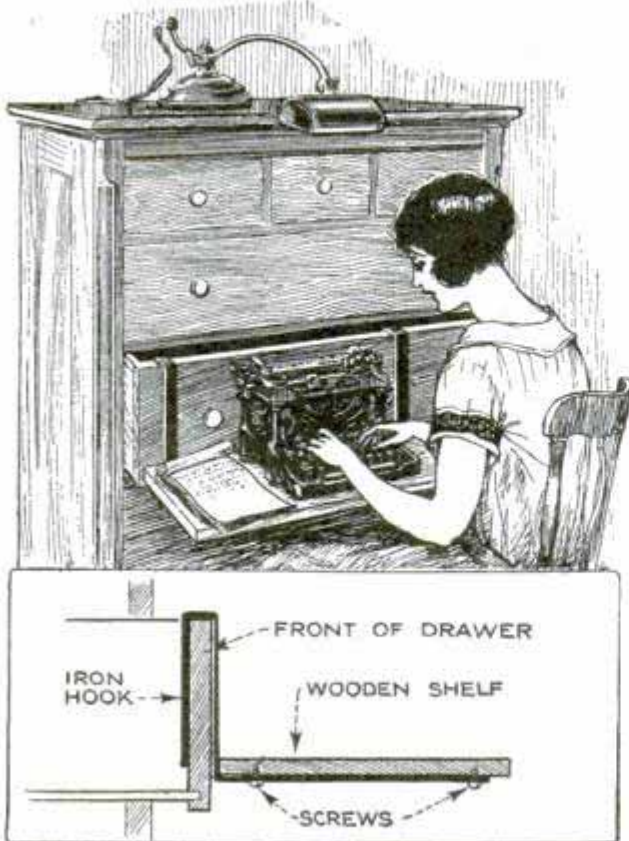

Handy Typewriter Shelf Which Hangs on Bureau Drawer Is Useful in the Home

Convenient Typewriter Shelf

A bureau drawer can be used to support a typewriter shelf by means of two flat-iron hangers, as shown in the illustration. The shelf is a 1-in. board, about 12 in. wide and of such length that it may be put in the drawer when not in use. A blacksmith or hardware dealer can bend the flat-iron hooks to the shape required. Two holes are drilled in them for woodscrews to hold the shelf. Strips of felt are glued on the underside of the hooks to prevent scratching or marring the front of the drawer. It is not advisable to put a heavy standard-size typewriter on such a shelf, but for portable machines up to 20 lb. in weight, it is entirely practical, and such a typewriter can also be put away in the drawer.—Mary E. Hopkins, New York City.

Blueprint-Toning Solutions

Some drafting rooms use hydrogen peroxide in water as a blueprint toner. When this is added to water, it makes a solution that brings out deep blues and clear whites on prints that have been overexposed. Another equally good toning solution can be made by dissolving two teaspoonfuls of potassium-bromide crystals in a gallon of water; after toning, wash the print in clear water.

How to Smoke Fish Properly

Usually, in smoking fish, the smudge or fire is built inside the smokehouse, which makes it necessary to open the door every time a fresh supply of fuel is added. A far better method is to locate the smokehouse so that it will be a little higher than the surface, on which a sheet-iron stove is placed, so that the pipe from the latter will enter through the bottom of the house.

The usual method of smoking fish is generally unsatisfactory, so much so that it should be condemned. By merely smoking the fish, as is usually the case, it is not cooked through, but is half raw. After two days of smoking, as directed, through the sheet-iron stove, next build a fire inside the smokehouse, the fuel being hardwood or ash that is thoroughly dry, so that the most heat and least smoke will be given off. The result of a day or two of this firing will be a thoroughly cooked product that is perfectly palatable. The fish should be arranged at least six feet above the fire.—Robert Page Lincoln, Minneapolis, Minn.

Reclaiming Oil in Small Quantities

Old crankcase oil contains a large percentage of gasoline and dirt. If the gas is evaporated from the oil, and the dirt and fine particles, which accumulate from the constant wearing of the parts of the engine, are removed,

the oil is as good as new. Oil companies are now saving the oil which they take out of automobile engines and reclaiming it in a wholesale manner. Although most automobile owners are not especially interested in reclaiming oil, there is a method of doing it in a small way which is simple and practical. The work should be done in a place protected from dust and dirt, such as a garage or basement. After removing the oil from the engine, pour it into a container and let it stand until the dirt has settled at the

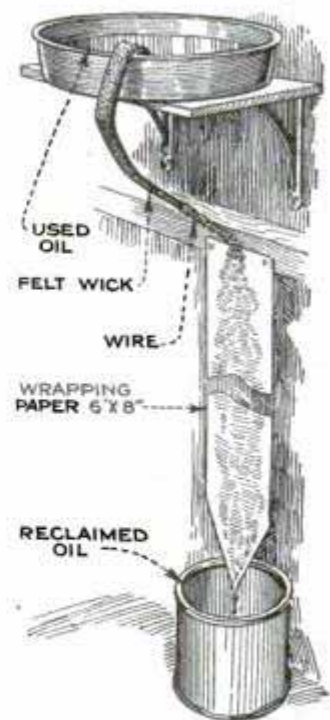

bottom. A flat vessel, 3 or 4 in. high and large in proportion to its height, should be used for this purpose, to give the greatest possible surface for evaporation of the gasoline that is mixed with the oil. Place a felt wick in the oil, clipping it to the edge of the pan so it cannot slip out; wind it with wire at the lower end, and hook a strip of ordinary wrapping paper, 5 or 6 ft. long and 7 or 8 in. wide, on the end, as shown in the drawing. Underneath the strip of paper place a jar to catch the oil as it seeps over the paper. From a pint to a quart of oil may flow over the paper in 24 hours. For rapid evaporation of the gasoline, a temperature of about 80° F. should be maintained.—Ruth Wilson, Manhattan, Kans.

Handy Cabinet for Toaster

A convenient compartment for the electric toaster, that is attached to the underside of the dining-table top, is shown in the illustration. A small wooden cabinet was made, and a piece of fairly heavy wood used to fasten it to the brace underneath the table top, and also to carry a flat-iron bracket from which the toaster support was suspended. A similar bracket was attached to the underside of a small board on which the toaster frame was fastened, and curved links, two on either side, were made of the necessary

shape and length to clear the table edge and elevate the toaster to the table level when it was used, as shown by the dotted lines. The top and sides of the cabinet were cut out to clear the table brace. A latch, not shown in the illustration, was used to lock the toaster support when up. The cabinet was provided with a door, which was closed when the toaster was lowered. This arrangement allows full use of the table top for regular service, and yet the toaster can be brought into play at any moment.

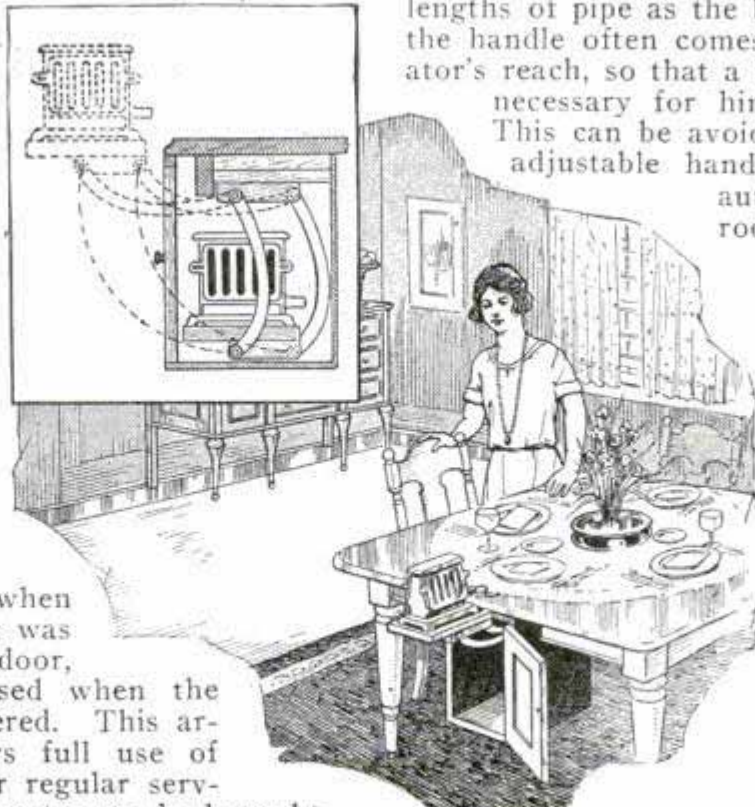

Novel and Convenient Arrangement for Toaster underneath Table Top

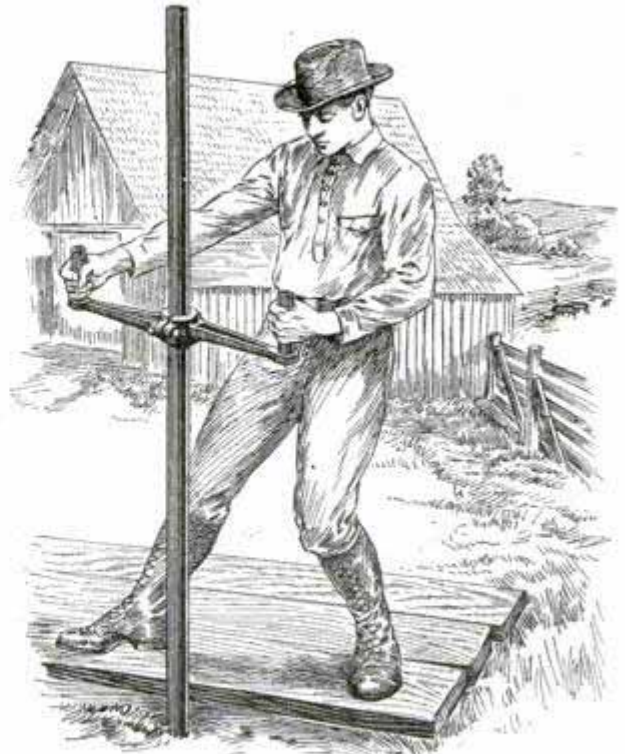

Adjustable Handle Facilitates Work of Boring Shallow Wells by Hand

Adjustable Well-Auger Handle

In farm wells whose depth does not exceed 30 to 50 ft., the pipe is usually set into a hole bored with a hand auger to the first gravel stratum. These augers are connected to the end of a $\frac{3}{4}$ -in. pipe and a handle is screwed onto the top end to turn the auger. When adding lengths of pipe as the boring progresses, the handle often comes above the operator's reach, so that a raised platform is necessary for him to stand on.

This can be avoided by making an adjustable handle from two old auto connecting

rods as shown. The

crank-bearing caps are removed and the two rods are bolted together so as to grip the pipe as indicated. Handholds can be made from pieces of an old hay-fork handle, bolted to the ends of the rods. As boring progresses, the handle is shifted to be within easy reach.



Removing Ink Stains

MOST ink stains on household materials and clothes can be removed in the home, but it should be clearly realized, at the start, that differences in the materials have a good deal to do with the fastness of the stains, and therefore with the ease with which they may be removed. For example, an ink stain on cotton cloth might be removed by using soap or a little soap and water, while a spot of the same ink on a light-colored wool could be removed only by the use of acids, with a great risk of permanent damage to the cloth itself. The different kinds of ink would also necessarily take different methods for the removal; thus an iron-tannin ink would be treated differently from a red ink, and both would be treated differently from an ink made from a soluble Prussian blue, such as is used in most safety and anti-fraud inks. The most that can be done, therefore, is to give a few general directions.

The first thing to do is to remove the stained fabric from the action of strong light. Sunlight, contrary to popular belief, will

not fade ordinary black writing inks, but will set the stain so as to make its removal very difficult. Stains made by red, violet and green inks, on the other hand, may be removed almost entirely by rinsing with water and exposing the fabric to the action of bright sunlight.

If the stained piece is large, or cannot be treated as a whole because of its size or because of the possibility of changing the color of surrounding parts, separate the stained part from the rest of the piece by clamping it in an embroidery frame. If this is not at hand, a satisfactory substitute may be made by clamping the stained part over the top of a mason jar by means of rubber bands or several turns of string.

First remove as much of the stain as possible by treating it with tepid water. Then pour warm or fairly hot water through the cloth. Next try the action of warm soap solution, working the fabric gently with the tips of the fingers or with a soft-bristle brush. In many cases stains can be removed by means of these simple methods. If the stain does not come



Fastening the Stained Portion of the Cloth over a Mason Jar

out there are a number of things that may be tried, those least likely to injure the fabric being named first.

For white goods, soak the stain in warm milk. Sour milk, or milk soured by the action of vinegar, will usually work better on most stains.

Treat the stain with lemon juice, preferably warm, by pouring the juice through the cloth held in the embroidery frame or over the mason jar, as previously described. Make a paste of lemon juice and salt and apply it to both sides of the fabric, allowing it to stand for some time. Remove



Above, Pouring Tepid Water through Stain; Left, Souring Milk for Obstinate Stains



Lemon Juice Alone, Preferably Warm, Will Often Remove Stubborn Stains and a Mixture of Salt and Lemon Juice Is Also Effective; Working Soap Solution with a Soft-Bristle Brush

the layer of salt and rinse the fabric. Sometimes, after this treatment, a faint stain may still be seen, which can be further reduced by the action of bleaching-powder solution.

Soak the spot in a cup of milk to which has been added several tablespoonfuls of kerosene. For articles that can be put through a regular washing process, this will be found one of the most effective methods. Goods that cannot be washed, or that will hold the kerosene and show a grease stain, should, preferably, be treated by one of the other methods, or, if the milk-and-kerosene treatment has been used, they should be given a washing in clean gasoline or benzine. The latter must be used with extreme care because of their inflammability. Professional

cleaners make use of various strong acids and other chemicals, such as oxalic acid and hydrochloric acid, and when these are applied by persons experienced in their use they do good work. They are poisonous, however, and should be handled with great care in the home, and they are very injurious to the fabric unless they are removed completely after the treatment. Goods treated with these acids should be rinsed in several changes of clean water and finally in water to which has been added a small amount of soda or

ammonia to neutralize the effect of the acid. For blue-black inks, use ammonia and oxalic acid alternately. For purple,



Ink Stains on Varnished Surfaces Are Removed by Rubbing with Fine Polishing Powder

blue, red, etc., use potassium permanganate and oxalic acid. For printing and India inks, sponge with a cloth dipped in carbon tetrachloride.

Stains on varnished woodwork can often be removed with very little damage to the finish by first moistening the spot with water and then rubbing the stain with a piece of cloth dipped in one of the fine-grained commercial polishing powders capable of polishing silverware and glass without scratching. The rubbing should be done with care, and the soapy layer containing the ink be removed with clean water before it has had time to dry. A second application may be found necessary, but the two will usually be enough. Fine pumice or rottenstone (powdered), which may be obtained from the local paint dealer, may also be used, and will not injure the finest surface

Choked Mufflers Cause Trouble

A rather unusual car trouble was found to be caused by a choked muffler. The engine seemed to run properly when the speed was slow, but if the speed was increased the engine would stop in

a short time. After the carburetor had been taken apart and cleaned, the valves ground and resealed and several gaskets replaced, without noting any improvement, the trouble was finally found to be in the muffler, which had only small openings for the exit of the exhaust gas. These were partly closed by an accumulation of carbon, which caused back pressure. At low speeds the gas had sufficient time to pass through these small openings, but at high speeds the gas was forced into the muffler from the engine quicker than it could get out. As soon as the muffler was cleaned, the trouble was over.—Mrs. F. G. Coleman, Kansas City, Mo.

Screen for Magic Lantern

Magic lanterns showing slides and projectors for opaque pictures are quite common. To get the best results from these they must be used with the proper screen. The best is made from large-size blotting paper; this is dead-white and makes a perfect projection surface; in fact, it is used as a standard in judging the quality of screens used in large theaters.—Guy E. McAllan, Millicent, Can.

Improved Cleaning Rod for Guns

As I do a lot of shooting I use a cleaning rod frequently. The one I have has a loose handle, that is, the rod turns freely in the handle. It is very annoying,

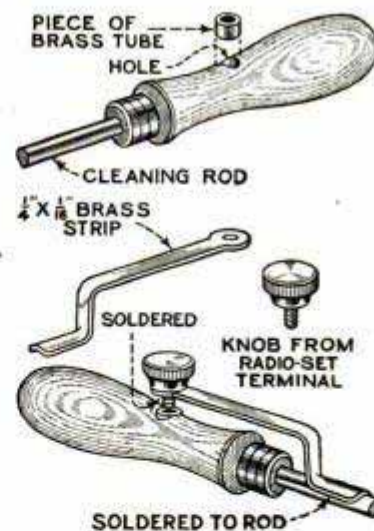

when the rod has to be turned with any degree of force, to have to grip the rod with the fingers, but the turning feature has its advantages also. To do away with the former and keep the latter, I designed the

following improvement. A piece of spring brass, about $\frac{1}{16}$ in. thick, was bent as shown. A hole was drilled in the handle of the rod and a small piece of brass tubing was fitted in it to keep the wood from being chewed up on the edges of the hole. A small knob and screw, or any little piece of brass rod to fit the hole in the brass tube, is soldered on the end of the spring-brass strip. The little knob

and screw can be obtained from radio-set scraps. The spring-brass strip is now soldered to the cleaning rod and the tool is complete. By pressing down on the knob, the handle and rod will turn together.—Joseph G. Heyck, Houston, Tex.

Automatic Gate for Closed Highways

Through many miles of range country in Arizona, New Mexico, and Texas, the highways cross huge ranches and gates are located in many places. Where cattle guards are not satisfactory, some other method is necessary. Gates are more or less objectionable as the driver has to get out to open and close them, but this is not necessary with the gate shown in the drawing. Two pipes, 4 in. in diameter and extending 16 ft. above the ground, are set at the ends of the opening in line with the fence. A third pipe, usually 6 in. in diameter, is also set vertically midway between them. These three pipes are connected by a length of 2 by 8-in. timber from which chains are attached with links, crossing at the center post, then down to each side of the gate, as shown. When the front bumper of the car strikes one side of the gate, it is swung open. The chains wrap about the center pipe, causing the gate to lift. But when the car has passed, the gate swings back into place. The gate is attached to the center post with U-bolts so that it will turn freely. The larger the center pipe is the harder the gate will be to open and the quicker it will close.

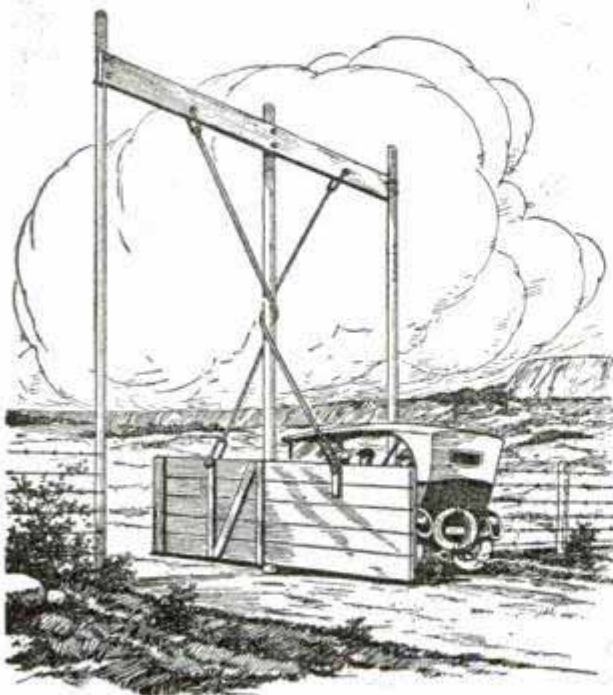

Novel Gates on Western Ranches Are Pushed Open by Passing Cars and Close by Gravity

Mooring the Motorboat

After trying several methods of mooring a motorboat in a boathouse that is exposed to rather heavy waves, the following

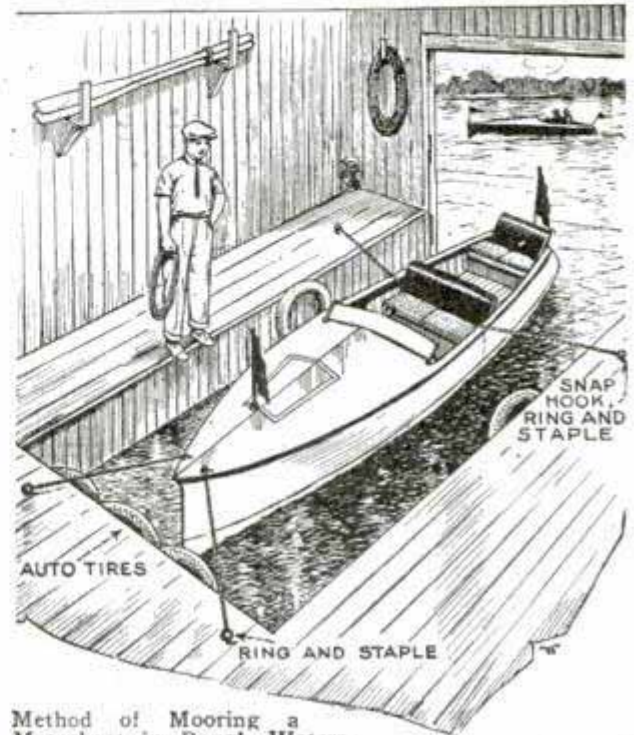

Method of Mooring a Motorboat in Rough Waters

method was adopted and found satisfactory. Two staples, with rings attached, were driven into the floor opposite the seat brackets and a rope with snap-hooks at both ends was used on each side, one snaphook being attached to the stapled ring and the other to the bracket and then snapped to the ring. This leaves the boat free to move laterally about 6 in. The front end of the boat is fastened by two lengths of chain to two stapled rings, as shown, and discarded auto tires are nailed to the dock sides to serve as bumpers. It takes only a few moments to make these arrangements, and when thus moored, the boat will be secure in the roughest seas and its sides and bow cannot be damaged.—Arthur G. Roach, Sudbury, Ont.

Picking Up Phonograph Needles

When playing the phonograph, the needles sometimes are dropped or spilled in the machine. If they are not recovered, they may get into the motor and cause serious trouble. I have found that a small horseshoe magnet picks up the needles much more quickly than the fingers, especially in the corners. The magnet can be left on the machine next to the needle box, where it will always be handy.—Henry B. O'Connell, New Haven, Connecticut.

Adjustable Arm Support Rests Driver on Long Trips

Most drivers of closed-model cars rest the left elbow on the sash sill to lessen

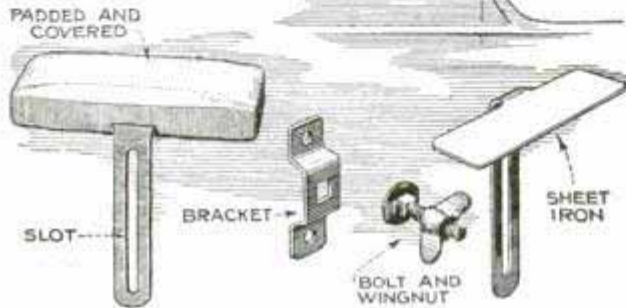
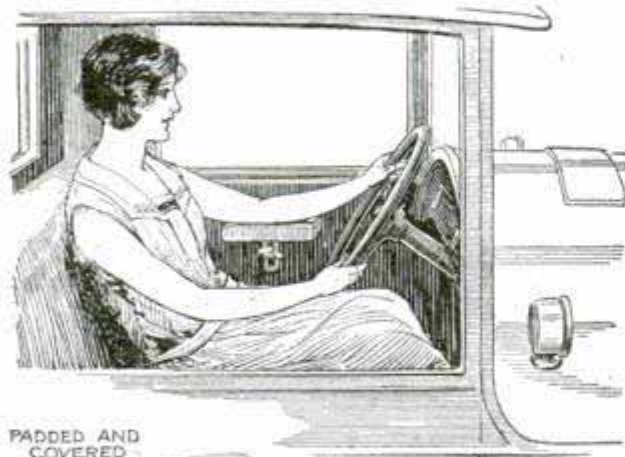

Adjustable Arm Rest for Driver Lessens Strain of Long-Distance Driving

the fatigue incidental to long-distance driving. However, the sill is usually located just a little too high, and is too hard for comfort, and the adjustable padded arm rest shown in the drawing will be found much better. It is made of a piece of sheet metal, bent as shown, with a pad on top and a slot in the support. A sheet-metal bracket attached to the side of the body holds a bolt, which keeps the arm rest in position by turning down the wingnut on the slotted part of the rest. This arrangement allows the rest to be raised or lowered to suit the driver.—G. A. Luers, Washington, D. C.

Durable Whiting Paint

Whiting paint, which is used to paint announcements and similar information on display windows, can be improved considerably so that it will not rub off so easily. To impart to whiting paint some of the permanent characteristics of ordinary paint, and yet have it retain its highly desirable quality of solubility, add a small amount of ordinary mucilage. The mucilage will help to make a better-flowing mixture of the whiting, and will cause it to harden after it has been applied to the glass surface, so that it cannot be rubbed

off. Such paint will even withstand a certain amount of wetting before it is dissolved.—J. S. Hagans, Chicago, Ill.

Knotting Thread When Sewing

To knot thread when sewing, first thread the needle, single or double, holding the needle and the end of the thread in the left hand between the thumb and forefinger. Then, take the thread with the right hand, wind it three or four times around the end of the needle and pull the winding down with the left hand to the end of the thread. A quick knot is made which shows neat on the work.

Casting Small Pillow Blocks

Recently I needed a number of small pillow blocks and shaft hangers for a $\frac{1}{4}$ -in. shaft. It struck me that I could make these of babbitt in a wooden form, so I made a pattern or mold as shown in the drawing, put a piece of heavy cardboard on either side, clamped the assembly in a vise and proceeded to cast the blocks. The only precaution observed was to keep the babbitt as cool as possible so as not to

char the wood. Some small pulleys that I needed later on were cast in the same manner, making the mold for the rim of the pulley from a piece of $\frac{1}{2}$ by 4-in. stuff, 4 in. long. A block of the same size was clamped on each side of the rim mold.

As the pulleys were to be attached on the ends of the shaft, I bored a $\frac{1}{4}$ -in. hole in one of the sidepieces, inserted the shaft through the hole into the mold, and cast the pulleys right on the shaft. This saved much time in drilling and tapping holes in the pulleys, and, as the work was light, served the purpose quite well. If it is desired to give the pulleys a more finished appearance the side blocks can be turned so as to give the sides of the pulleys the regular shape, hub and all.—A. L. Talsbury, Cherokee, Iowa.

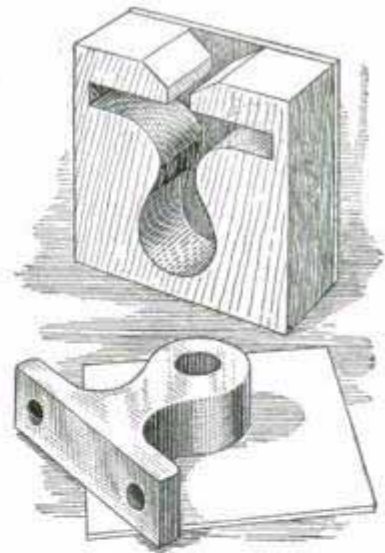

Heating Rooms with the Kitchen Range

In one residence the bathroom was located next to the kitchen and it seemed that some of the heat of the kitchen range might be used to heat it. This was done by removing a section of the wall directly behind the range, and replacing it with a square of sheet iron, which was fitted flush with the bathroom wall, as shown, and painted a suitable color. An inclosed box of galvanized iron connected the range with the wall. Despite the fact that the heat is transmitted only through the air and metal, it has not been necessary to use a stove in the bathroom except on very cold mornings, and so the original idea of filling the metal box with sand or some better conductor of heat was not carried out.

To heat the upstairs bathroom, which was directly over the lower one, a slightly different method was used. A drum oven, which fits on the stovepipe replacing one joint, was obtained and by cutting a circular hole in the back, it was possible to connect a few sections of new stovepipe to the oven, and run the pipe up to the bathroom, where it was attached to a floor register made from a discarded oil-stove lid. In this case the warm air from the kitchen enters the oven through the door and is further heated in the oven, from which it passes directly into the bathroom. When there are objectionable odors in the kitchen, the door of the oven is closed, preventing them from passing up to the bathroom. The total cost of materials, partly secondhand, was only \$5.85, and the work was done in leisure hours. The results have been highly satisfactory for more than two years. Such a method of heating is not, of course, limited to a bathroom; a sewing room or hall could be heated in the same way.

—Harold E. Benson, Boulder, Colo.

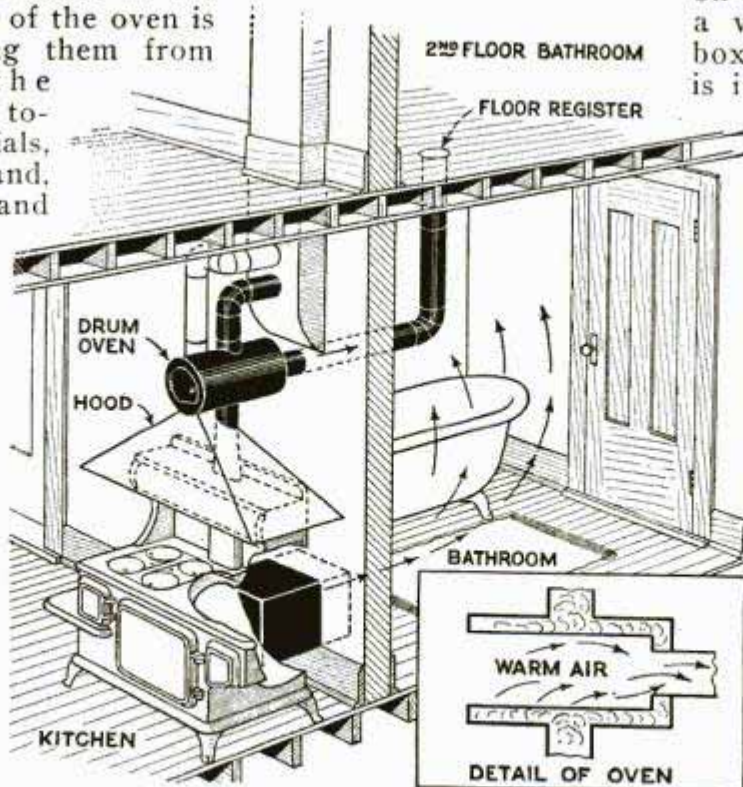

Novel Method of Using Surplus Heat from Kitchen Range to Warm Bathroom



Homemade Toy Gives the Boy an Enjoyable Imitation of a Boxing Bout

Novel Toy Pleases Children

Simple to make, the toy shown in the drawing is quite novel and will prove popular with the youngsters. When it is pushed along, the two figures pivoted on the handle perform a vigorous round at boxing. This motion is imparted by means

of a length of heavy wire, pivoted eccentrically to the wheel, and to the foot of the first figure, and a shorter length of wire connecting both figures, as shown. The figures are cut out of pieces of fairly heavy tin and are pivoted to the handle, the detail giving a clear idea of the construction.—E. W. Wehry, Cedar Rapids, Iowa.

Nail Puller for Shingles

In making repairs on a shingled roof, one of the difficulties encountered in

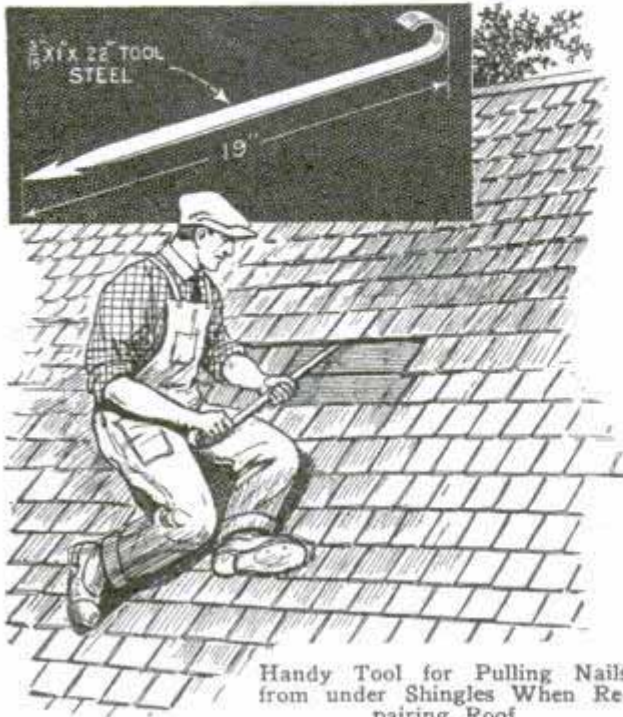

Handy Tool for Pulling Nails from under Shingles When Repairing Roof

patching in new shingles arises from the old nails, which are left in position under the rows above after the defective shingles have been pulled out. The usual method of getting these out is to push a thin bar up against the nail, and by hitting the other end of the bar with a hammer knock out or bend the nails. However, a better tool for the purpose is shown in the drawing. A piece of tool steel, $\frac{1}{16}$ by 1 by 22 in., is formed into a handle at one end and the other end is ground off to a point, which is then notched on each edge as shown. The notches are staggered a little so as not to weaken the cross section. Then the upper edges are beveled for easier working. In use, the point is pushed up under the shingles and, on drawing it back, a nail is caught by one or the other of the barbs. Then, a twist of the tool is usually sufficient to pull the nail out.—William Knowles, North Vancouver, Can.

A Hint to Home Dry Cleaners

Many housewives doing dry cleaning at home wash delicate garments in gasoline and are at a loss to know why they soil again so quickly and seem to catch dust and grime much more readily than before. In most instances this is due to the poor quality of gasoline employed. Low-test gasoline contains a high per-

centage of grease and oil, and when garments are cleaned in this, they naturally retain the impurities after the gas itself has evaporated. The remaining grease is not sufficient to be easily perceived, but it is present nevertheless, and dust or dirt falling upon the garment adheres so that it presents a soiled appearance in a very short time. To overcome this, one should use only the highest grade of gasoline obtainable. The garment will be more thoroughly cleaned and will remain clean longer. It will also air out quicker, so that the pressing can be done without leaving an objectionable odor in the fabric. Care should always be observed to keep all cleaning and drying operations away from flames of any kind.

Protecting Clothes on the Line

Some dogs have the habit of getting hold of and tearing clothes hanging on the clothesline to dry. To prevent this, a Kansas farmer elevated his revolving clothesline so that even the longest sheets would be above the dog's reach, and then provided a small concrete platform, as shown in the illustration, to permit one to hang up the clothes conveniently. Four lengths of old pipe were used to form the corner supports of the concrete slab, which is 4 in. thick, 2 ft. wide and 3 ft.



Preventing the Dog from Getting at the Clothes on the Line

long, and is elevated about 16 in. above the ground.

☛ A useful coat hanger may be made from a newspaper, rolled up and suspended by a cord around its center.

STARTING THE CAR IN COLD WEATHER

WHEN the weather commences to get very chilly it is time to consider methods of getting the auto engine started easily and quickly. The firing qualities of gasoline are partly destroyed by cold, which reduces the amount of highly volatile elements, the elements that give the gas its quick-starting "kick."

The driver, when the engine begins to be hard to start, usually tries to remedy this condition by enriching the mixture with the choke. He often keeps it drawn out too long, however, and thus defeats his own purpose. In starting, draw the choke button out all the way so as to close the choke valve completely, and use the starter for a few seconds only. If the engine then fails to start push in the choke slightly. Do not keep on pressing the starter button with the choke pulled out all the way for a long period, for this will draw raw gas into the cylinders in excessive amounts. If firing does not begin in a few minutes stop using the starter, and, since the trouble may be too much gasoline in the cylinders, allow the motor to stand for a few minutes until the excess gas has had a chance to evaporate, then press the starter switch again.

If the motor still will not start, the next move is to prime the cylinders directly, either through the priming cocks or through the spark-plug holes. Prime with a mixture of half gasoline and half ether, or with a teaspoonful of straight ether in each cylinder. An ordinary oil-can makes a good container for the priming mixture, and it can be prevented from evaporating quickly by means of a cork stuck tightly on the spout. In the absence of a suitable cork, a piece



of raw potato serves very well.

For ordinary temperatures above the freezing point, the dash primer makes short work of starting. Ordinarily, when a car is very hard to start, this indicates that compression is rather poor, and the car should be overhauled. Many mechanics regard the installation of a primer as treating the symptom rather than curing the disease; but the

fact remains that, where the owner feels that he cannot have the car overhauled, the primer does solve the problem of easy starting. There are two makes of mechanical vaporizing primers that are very effective, and there is also a slightly more expensive electric heating and vaporizing primer. Another attachment that is quite effective is a small electric heating element designed to be inserted between the carburetor and the intake manifold; it is sometimes connected to the starter switch so that, when the starter button is pressed, the heater warms the charge of fuel going to the cylinders and so makes starting easy. It may also be controlled by a switch on the instrument board.

After the engine has started let it run for at least three minutes before you drive away. This gives the oil a chance to get warm and is especially necessary where a high-pressure system of lubrication is employed. Push in the choke button all the way as soon as possible, for excessive use of the choke causes rapid carbonization and cuts the oil film on the cylinder walls; this means repair bills later on. Install a motometer or a dash engine-heat indicator on the car, and by all means fit a radiator cover or shutter. Keep the shutter closed until the engine comes up to summer temperature,



as indicated on the thermometer, or as high below this as it will rise. On a moderately cool day, the engine will reach the highest operating temperature more quickly if it is run at a moderate speed for ten or fifteen minutes after starting, for, even with the shutter closed, if the car is driven at 30 miles an hour, there is quite a volume of air driven over the engine and drawn past the radiator through the small openings left in the closed shutter or cover.

In short, the nearer the engine is kept to normal summer temperature the better condition it will be in at the close of the season, and the better it will operate throughout the winter.

If a lighter oil is specified for the engine in winter, do not fail to change as soon as the temperature drops and also make the transmission and differential lubricant lighter. This has quite an effect on the ease of starting. Another useful kink is to turn the engine over a few times with the hand crank before trying to set in motion with the starter. This breaks the cold film of oil on the cylinder walls and relieves the starter of a heavy duty. Also keep the battery well charged. The drain on the battery is very much heavier in the winter than in summer, and the battery is not quite so efficient in cold weather as in warm. Give it a chance, therefore, by boosting the generator output considerably.

Emergency Trolley for Forging Flood Streams

Although at times there is no water at all in the bed of some Texas streams, at other times they will overflow bridges and make crossing nearly impossible. Since many people are dependent upon contact with towns on the other side, emergency trolleys have been built at several points. These consist of a cable suspended across the stream from sturdy wooden towers, which are well braced as indicated. The small cars, which run on the cable with the passengers, are particularly interesting. They are 2 ft. wide and 4 ft. long. The bottom serves as a seat, while footrests are suspended un-

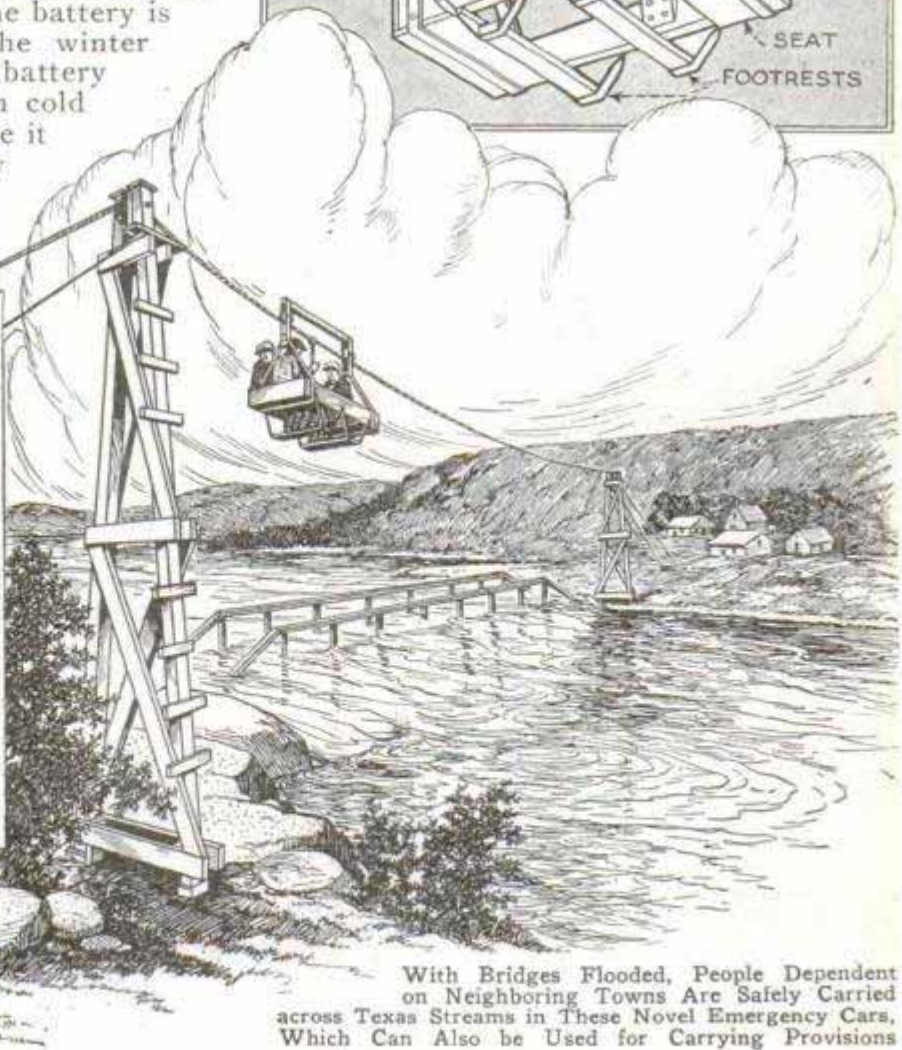
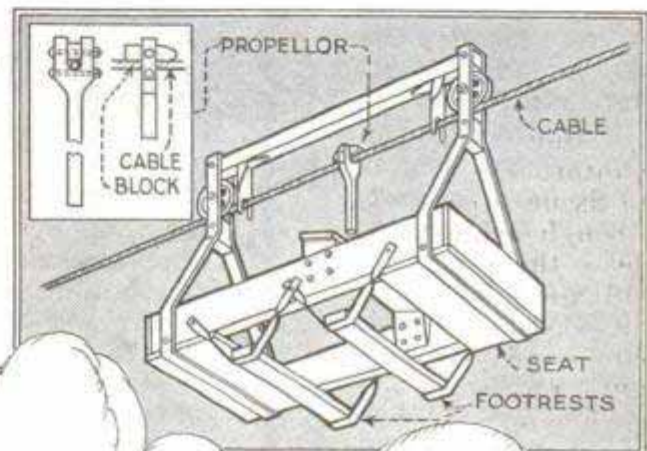

With Bridges Flooded, People Dependent on Neighboring Towns Are Safely Carried across Texas Streams in These Novel Emergency Cars, Which Can Also be Used for Carrying Provisions

derneath with flat-iron supports. Other lengths of flat iron are bolted to the sides, and are doubled at the top where pulleys are bolted in place to ride on the cable. The means of locomotion is also novel. While one end of the trolley is usually higher than the other, permitting coasting in one direction, it is necessary to propel the car in the other direction. This is done with a wooden lever, notched at the end, and having a block of wood pivoted on a bolt above the cable, as shown. By pulling in one direction, the lever engages the rope, preventing back-slipping, and the moment the pressure is released it is pushed forward for another grip on the cable, thus moving the car. From two to four persons can ride in such a car at one time, and, of course, it can also be used for provisions and mail.

Cleaning Small Paintbrushes

A quick and easy way to clean small paintbrushes is to wipe them thoroughly on tissue paper or rags immediately when through using them. This will not only clean them effectively, but the bristles will not get hard or become matted. I have used this method with all kinds of paint and varnish, including aeroplane dope, and prefer it to the regular method of cleaning in turpentine, as being cleaner, quicker and better.—J. G. Heyck, Houston, Tex.

Saw-Setting Vise on Sawbuck

To eliminate the necessity of carrying his saw to the workshop vise each time it required sharpening, a Wisconsin woodsman sawed two deep slots in the horns of the sawbuck as shown in the drawing. Into these the saw blade is inserted. By sliding the blade of the saw back or forth, each portion of the blade can be made to rest within one of them, preventing vibration.



Old Milk Cans for Tractor Oil and Fuel

Two old milk cans, which had begun to rust on the inside and were useless for

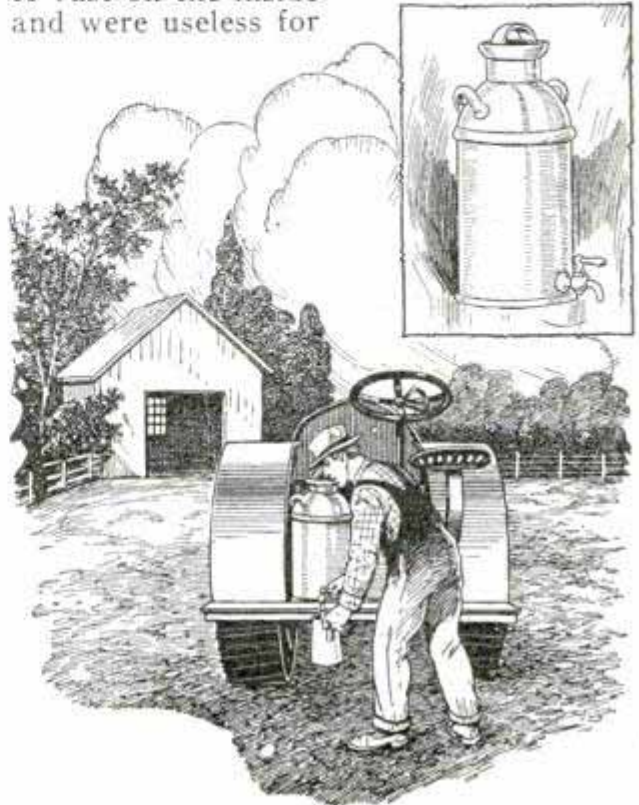

Using Old Milk Can on Farm Tractor for Holding Oil and Gas

their original purpose, still do service on a western farm for holding oil and gas for the tractor. A faucet is soldered in the side near the bottom of each can. The cans are taken along with the tractor; one contains lubricating oil and the other kerosene. With tight-fitting lids, there is no leakage, and the cost of the two faucets is considerably less than that of two steel drums.

Making Cold Patches Stick to Auto Inner Tubes

A garage man showed me how to make a cold patch stick to an inner tube so that it would last until the tube is worn out. It was done in the following way: After the tube had been thoroughly cleaned around the hole and the cement applied liberally, a lighted match was touched to the cement and allowed to burn until the cement seemed to disappear. Then the flame was blown out, the patch was clamped on and pressed firmly with the fingers. Thus the patch is cured by the heat into the tube, and the tube will tear before the patch will come off.—C. M. Baker, Wooster, Ohio.

Bamboo Bow and Arrow

Almost every boy, at some time or other, would like to try his skill with a bow and arrow, but it is rather difficult

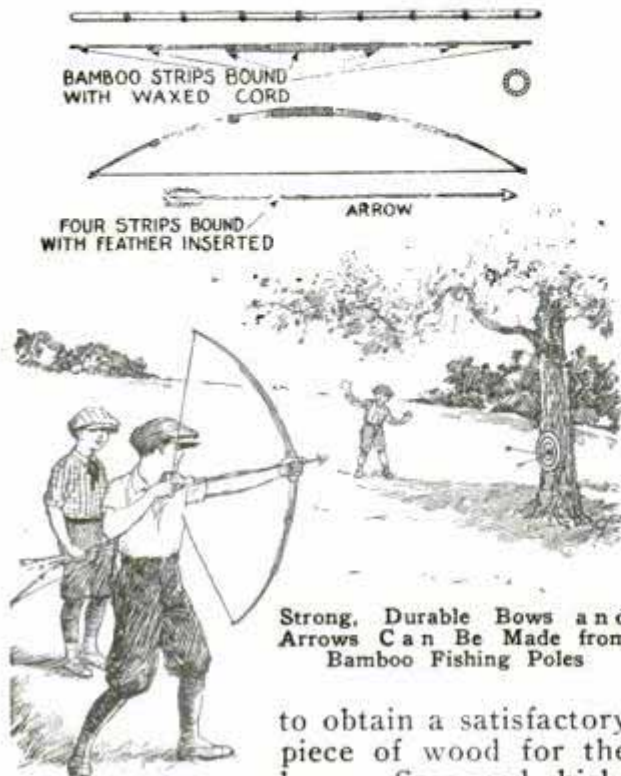

Strong, Durable Bows and Arrows Can Be Made from Bamboo Fishing Poles

to obtain a satisfactory piece of wood for the bow. Seasoned hickory is usually recommended, but an excellent substitute is the bamboo from a cheap fishpole. With reasonable care, a 5-ft. length of bamboo may be split into pieces of small dimensions; twelve or fifteen being obtained from a pole 1½ in. in diameter. After splitting it, the pieces of heart, or hardened pith, at the joints should be removed with a knife or plane so that the strips can be bound together in a compact bundle. The binding is a very particular part of the work, if the bow is to be made serviceable for any considerable length of time, and waxed cord should be used for this purpose. To begin, bind the middle section of the bundle to a distance of 6 in. on either side of the exact center. After fastening the string ends, cut away one-fourth of the number of sticks in the bundle just beyond the wrapping, and bind those remaining at points about 16 in. from the center of the bow. Cut away as many sticks as before and bind again, proceeding in this way until one-fourth of the sticks of the bundle remain. These are bound at the tip ends, and the bow is ready to receive the string. If the work has been done carefully, the result will be a well balanced bow that will last for years, especially if the bowstring is loosened after using it, so that the bamboo

may straighten again and retain its elasticity. Serviceable arrows may also be made of similar material by binding four of the narrow strips together and inserting balancing feathers.

Making Direct Photographic Positives

A little known process which can be used for making lantern slides and transparencies from ordinary plates or cut films, consists in subjecting the negative to the light when only partly developed. Exposing the plate to the light causes a reversal of the image, that is, the negative image is printed onto the remaining silver, which naturally assumes the form of a positive. A mere flashing on and off of a 50-watt lamp will often do the work. After printing, it is sometimes necessary to return the plate to the developer to produce a strong image. A thorough fixing and washing completes the process. —L. C. Ferguson, Ontario, Calif.

Paper Strip Indicates Bottom Margin

Typewritten letters appear neater if the margin at the bottom of the page is kept uniform. The spacing device on the typewriter takes care of the side margins, and the upper margin is in full view at all times, but one cannot see the lower edge of the sheet and therefore it is difficult to make a uniform margin. To inspect that width, the sheet must be turned out of the machine, and this often causes the paper to slip, resulting in irregular spacing, especially when carbon copies are used. The trouble can be eliminated and much time saved by feeding a strip of paper into the machine as shown in the illustration. The strip should lie about ½ in. over the right-hand edge of the sheet, and its top edge should coincide with the top of the sheet, the length of the strip being, of course, equal to that of the sheet. When the stop mark on the strip appears, a new sheet is inserted in the machine and in this way the bottom margin on all the sheets will be uniform.



Repairing Woven-Reed Furniture

One of the disadvantages of genuine woven-reed furniture is the brittleness of the reed after it has become thoroughly dried out. This brittleness often results in unsightly breaks.

The drawing shows a simple method of repairing such breaks without being deprived of the use of the article, as would be necessary if the article was sent to a shop. Break off the broken ends of the reed so that all ends are underneath and concealed by the crosspieces. Using the broken pieces as a sample, the necessary quantity of new reed can be obtained from almost any upholstering or furniture-repair shop. The new reed is soaked in water to make it pliable, and while in this condition, it is inserted under and over the crosspieces in such a manner that the ends will always be concealed underneath the crosspieces. If the work is carefully done, it will be almost impossible to detect where the repair was made. When the reed dries out, it will naturally retain its bent position, locking itself into the old weave, and will last as long as other parts of the body. When thoroughly dry, the patched spot is given a coat of varnish or stain, to correspond to the rest of the article.

In repairing the heavier crosspieces, the ends are beveled off with a sharp knife, and new pieces, of the proper length and with correspondingly beveled ends, are glued into position. The glued joints should be tied together with twine until the glue has hardened, before proceeding to complete the repair by the in-

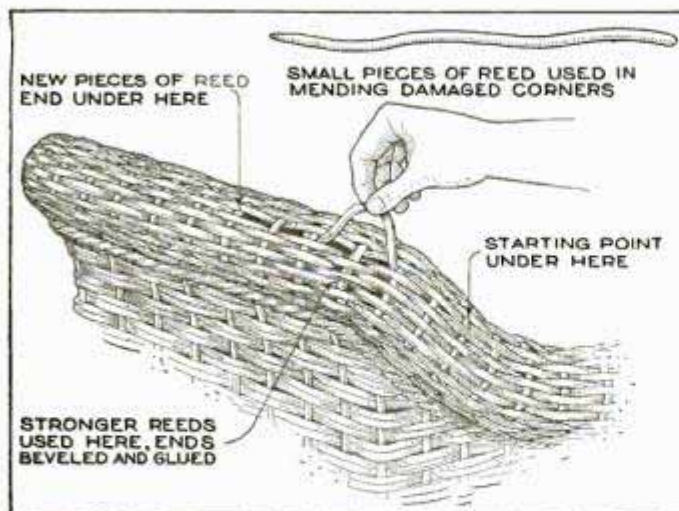

The Work of Repairing Reed Furniture Is So Simple That There Is No Excuse for Allowing the Damage to Spread

sertion of short lengths of reed as described above.—Frank E. Leitch, Brooklyn, N. Y.

Brush Holder Assists Home Painter

In painting the eaves of houses, and similar places that are rather difficult to get at, a brush holder of the kind shown

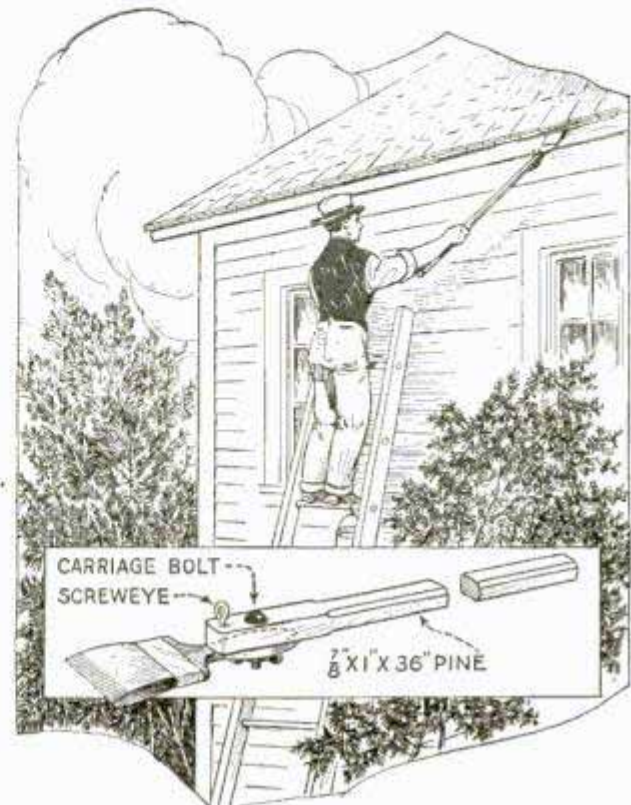

Holder for Paint Brush Assists Painter When Working on Eaves

in the illustration increases the painter's reach, eliminates frequent moving of the ladder and makes the work safer. A wooden stick, $\frac{7}{8}$ by 1 by 36 in. in dimensions, is drilled with a $\frac{1}{4}$ -in. hole through the center, about $2\frac{1}{2}$ in. from one end. A similar hole is drilled through the thickest part of the brush handle, and a $1\frac{3}{4}$ by $\frac{3}{16}$ -in. round-head carriage bolt with a thumbnut is used to fasten the brush to the stick, the other end of which can be rounded off and smoothed to form a handle. A screw-eye is then driven through the stick and brush handle to prevent wiggling if the thumbnut should come loose. The knack of handling the brush comes readily.

Drying Squeegee Prints Quickly

It takes several hours to dry squeegee prints in the usual way. The drying process can be hastened considerably by placing the ferrotype plates about 6 or 8 ft. from an electric fan. By doing this, the prints will dry quickly and one will be kept busy picking the dry prints from the floor.

Handy Stencil Disk Saves Time

Facilities for cutting individual stencils are seldom justified in a small concern, and therefore the disk stencil shown in



Convenient Disk Stencil for the Small Shop or Store the drawing will prove to be of exceptional merit. It is made from a thin brass disk through which letters are cut as indicated. A small round handle is fixed at the center, permitting the disk to turn, and a plate of the same stock as that of the disk is pivoted on the handle. This plate has a square opening cut to fit over the letters to facilitate stenciling. The parallel edges of the plate are also used as a guide for obtaining alinement. Such a stencil is a great convenience for the small shop or store and neat work can be turned out with it.

Glazed Tile as Good as Porous for Drainage Lines

An erroneous idea exists regarding the kind of tile that should be used for drainage. Some contend that drain tile should be porous enough to allow water to pass through the walls, and that glazed tile will not permit this action, and therefore should never be used. However, only $\frac{1}{25}$ gal. of water will pass through the wall of a very soft 4-in. clay tile in 24 hours. To put it another way, it would take 2,000,000 running feet of such tile to make a 4-in. tile line run full at the outlet, pro-

vided all the water were to pass through the wall of the tile and the slope of the tile were 5 in. per 100 ft. There is therefore no difference in the value of the tile made from clay, shale or concrete, as the drainage water enters the tile at the joints. For this purpose, a space of $\frac{1}{8}$ to $\frac{1}{4}$ in. should be left between the joints, the exact amount of space depending upon the nature of the soil. In the case of an extremely soft sand or quicksand, the joints should be covered with broken pieces of tile or a short piece of roofing paper.—C. M. Baker, Wooster, Ohio.

Cleaning Auto Shackle Pins

In a large auto-service station, specializing in lubrication and tightening up of cars, the head mechanic places considerable stress on the necessity of keeping spring shackle pins in good condition. Due to the clogged condition of the oil channels in these pins, they are frequently removed because of the impossibility of forcing grease through the clogged holes. Greasing is necessary to prevent the pins from squeaking and wearing, which results in a pronounced



clicking or rattling. Any shackle pin can readily be removed by the method shown in the illustration. The head or round part of the pin is held securely with a file, while the nut is removed from the other end. After the pin has been removed the grease hole is opened with a stiff wire and cleaned with a pipe cleaner. Due to the accumulation of solid dirt and grease, it is often impossible to clear the channel with a grease gun, though after it is once cleaned, continuous attention to lubrication will keep it clean.—G. A. Luers, Washington, D. C.

When fruit juice is spilled on table linen, sprinkle at once with salt to prevent a permanent stain.

Making an Egyptian Ash Tray

By HERBERT C. McKAY

ASIDE from its utility and novelty, the ash tray or smoking stand shown in the illustration is interesting and easy to make. The stand proper is a silhouette of an Egyptian dancing girl. The more difficult lines are painted instead of being sawed, and the ash container is in the form of a lotus flower.

The right-hand view, Fig. 1, gives the outlines of the figure. The scrollwork at the feet of the figure adds considerably to its strength. These scrolls should be enameled in contrasting colors; for example, if the base and scrolls are black, the flesh and gold of the feet and skirt border will stand out in good relief. The breast and skirt bands were enameled crimson in the original with ornaments in gold. The winged pheasant on the head was of gold relieved with black. The features were black outlines, as illustrated, upon a ground of flesh color. The base was an oval piece of wood, $\frac{1}{2}$ in. thick, 4 in. wide and 9 in. long.

The ash receiver is made from a piece of metal, which may be brass or copper, about $\frac{1}{32}$ in. in thickness and cut as shown in Fig. 2. This is laid upon a block of medium soft wood and the petals peened with a ball-peen hammer. (See Fig. 5.) They will curl up just as crepe

paper does when used for making artificial flowers. This piece is peened until the petals curl inward a little. Then a piece is cut as shown in Fig. 3. This is treated in the same manner, but the peening is stopped when the petals have turned straight upward. Then each petal is reversed and peened upon the back at the outer points. This recurves the points of the petals and makes them flare outward. Finally a piece is cut as shown in Fig. 4. Slits are cut from the junction of the petals toward the center to allow each leaf to curl. This is peened until each petal is concaved; then the petals are straightened until they project from the center in a plane. The center of each plate is drilled out large enough to admit the passage of a No. 14 gauge wire, and both sides of each plate are cleaned for soldering. The last plate is put in place first and soldered about $\frac{1}{2}$ in. below the top of the wire, then the six-pointed plate is soldered just above this and finally the

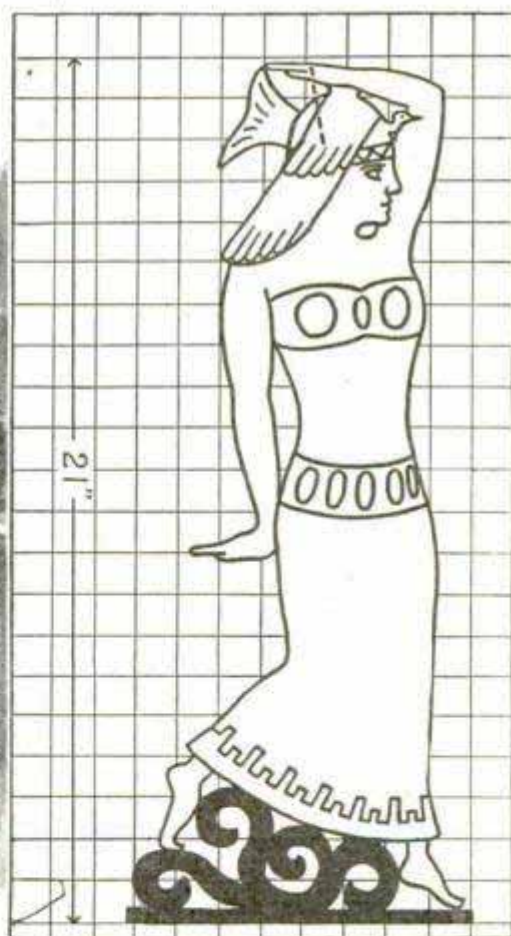
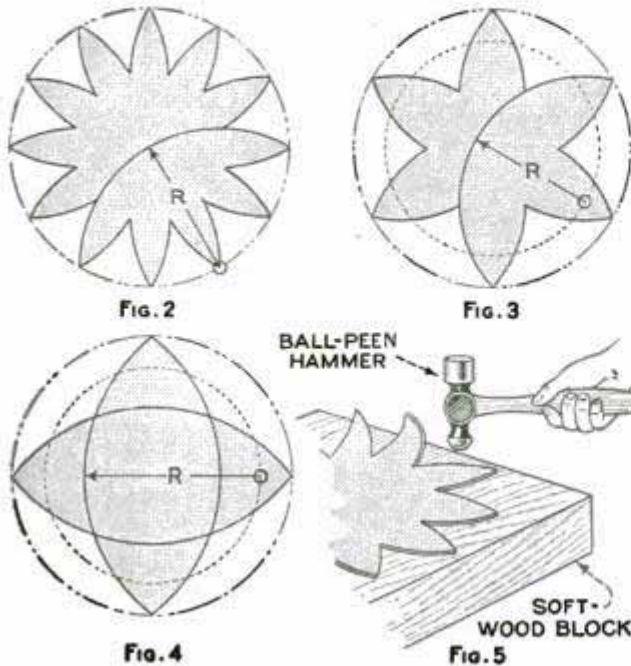

Fig. 1

A Lotus Ash Receiver Which Is Easy to Make with a Scrollsaw and Other Common Tools; It Resembles an Egyptian Dancer and Is Finished in Attractive Colors

twelve-petaled plate is soldered on top. The projecting wire is cut off with a pair of end-cutting pliers and solder smoothed above the projecting stump. The bottom of the four-petaled plate is enameled



Pattern and Method of Peening Thin Sheet-Copper Tray of Ash Receiver

green, while the rest of the petals are enameled ivory. When the enamel is dry, the inside of the cup is delicately veined in pale green and the tops of the four petals at the bottom are treated likewise. A hole is drilled through the upraised hand of the figure and down into the head. The wire stem of the lotus is inserted in this, and the stand is complete.

Burning Soft Coal, Coke or Small Anthracite Sizes

When burning soft coal, make a very careful deep bed of paper and wood to the height of the fire door. Light as usual and do not add coal until the wood becomes like charcoal embers. Add fuel gradually, opening the base door, feed-door draft and smoke-pipe dampers. Then let the coal slide off the shovel just inside of the door so that it forms a bank against the front of the heating section. Break up the crust which forms after the coal is ignited and spread it out evenly. Always bank fresh fuel on the front of the fire so that the live fire in the rear will burn the gases. When the fire is about 10 in. deep and thoroughly ignited, close the base door but leave the fire-door slide, the base-door flap and all smoke-pipe dampers open, to guard against possible explosions. These explosions are caused

by the sudden ignition of gases when the fire is smothered. For this reason live flame ought to be burning through the top of the fire or a red spot should be seen at all times. See that all fresh fuel ignites promptly. Break up the larger lumps or crust on top of the fire. Keep the feed door closed to prevent the escape of the gases, but leave the slide in that door open to complete combustion of gases. When the fire is burning briskly and the gases ignited, open the feed door slightly to increase combustion. The nature of this fuel requires more frequent firing, but it has high heat value.

Coke burns quickly and with an intense heat. It should fill the fire bed to the bottom of the feed-door opening, and can be banked higher in the rear of the firepot. It will require longer to ignite the first fuel and subsequent feedings should be ignited before the ashes are shaken or the drafts checked. The lower draft opening should be closed except for the first lighting. The smoke-pipe damper should be regulated according to the strength of the chimney so that the fire will not burn out too quickly. The draft in the feed door must be manipulated to assist in checking the fire.

Pea and buckwheat coal, or small-size anthracite, need little extra care or attention except that fresh fuel should be thoroughly ignited before the ashes are shaken out. The grates should also be shaken gently to avoid breaking down the fire bed. When a mixture of coke and buckwheat coal is burned, kindle with coke and add subsequent layers of buckwheat and coke. When the surface is covered with buckwheat, leave a small red spot for proper ignition of gases. Bank at night with buckwheat. Shake the grates gently also in this case.

Oil Filter from Old Felt Hat



the pail is large. The oil will seep through slowly and will be free from all dirt after it has been strained in this way.

Oil can be filtered satisfactorily by straining it through an old felt hat, as shown in the illustration. The hat is set in the top of a pail and the oil poured in. It may be necessary to provide additional support for the hat brim if

Luminous House Numbers

When calling for the first time on a new acquaintance, I always found it difficult to read the house numbers, and to find the right one, I was often obliged to light several matches. Thus, in most cases, I was late for my appointment. Considering the fact that new friends would have the same difficulty in locating my house, I finally hit upon the following idea and gave it a tryout to my satisfaction. I bought some luminous paint and painted my house numbers with it, causing them to shine at night and making them easily readable.—Henry B. O'Connell, New Haven, Conn.

Snow Clearance on Garage Doors

Swinging double doors used on such buildings as barns and garages are often difficult to open during winter because of the snow in front of them. A remedy is to attach a hinged board to the bottom of each door which can be raised and held up with hooks when desired. The doors are short enough to allow them to open over an ordinary fall of snow. The boards are attached to the bottom of the door with hinges and are held in place when down by large wooden turn buttons, fastened to the inside of the door at the bottom. Before opening the doors the

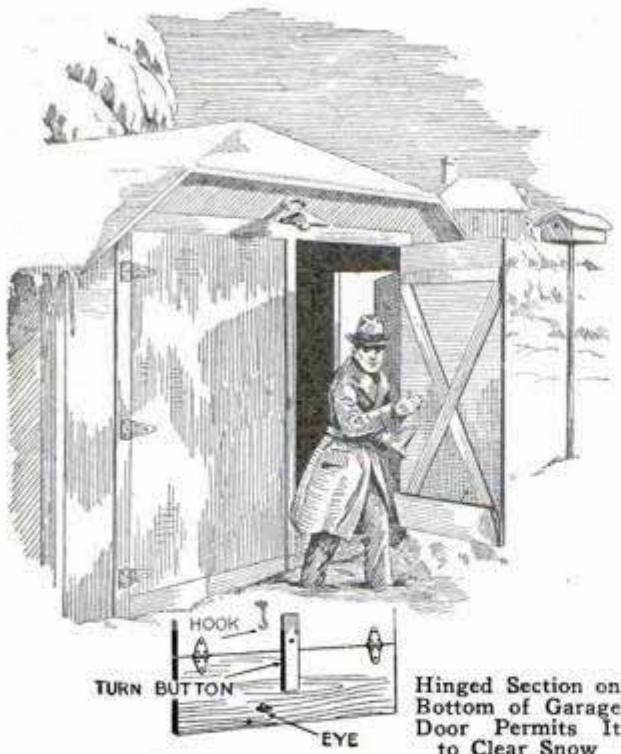

boards are lifted up and hooked as shown in the drawing.—E. T. Gunderson, Jr., Humboldt, Iowa.

Gable Ventilators for Homes

Many southern homes are now built with ventilators in one or both ends, just under the gables. This is an idea that can

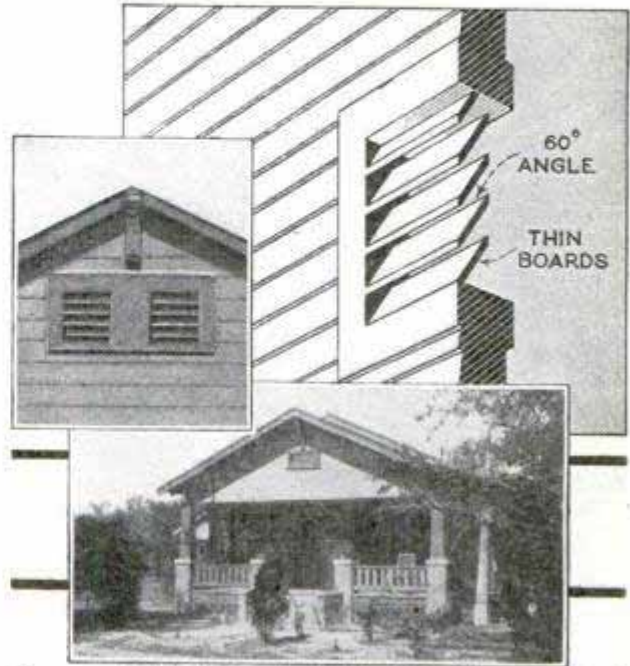

Ornamental Ventilators in Gables, Just below the Roof, Help Reduce Temperature in the House

be used to advantage during the summer months in other parts of the country, if ordinary precautions are used during the winter to keep out the cold. Practically all ventilators of this type are framed like a window. The thin boards in the ventilators are spaced $1\frac{1}{2}$ in. apart and set at a 60° angle, sloping outward, so that even driving rain cannot get in. Hot air, which otherwise is confined under the roof, escapes readily and the temperature inside of the house becomes much lower. In winter a pad of black building or roofing paper can be tacked over the opening on the inside, so that it will not be noticeable from the street. Where driving rains and snowstorms are more frequent, it may be better to make the blades of the ventilators from strips of sheet iron, the strips being curved or bent to form smaller openings and set closer together.

Remedy for Leaky Fountain Pens.

Many fountain pens soon begin to leak in the cap, and this is quite annoying. A good method of overcoming this trouble is to press a small piece of sponge into the end of the cap. All the ink which leaks out can then be removed by squeezing the sponge with a pencil or small piece of wood every few days.—R. Harry, New York, N. Y.

Oil Drum Makes Water-Tank Heater

Preventing the water in tanks and troughs from freezing is one of the farmer's winter problems. Water heaters are on the market but one can also be made without much trouble. An old oil drum

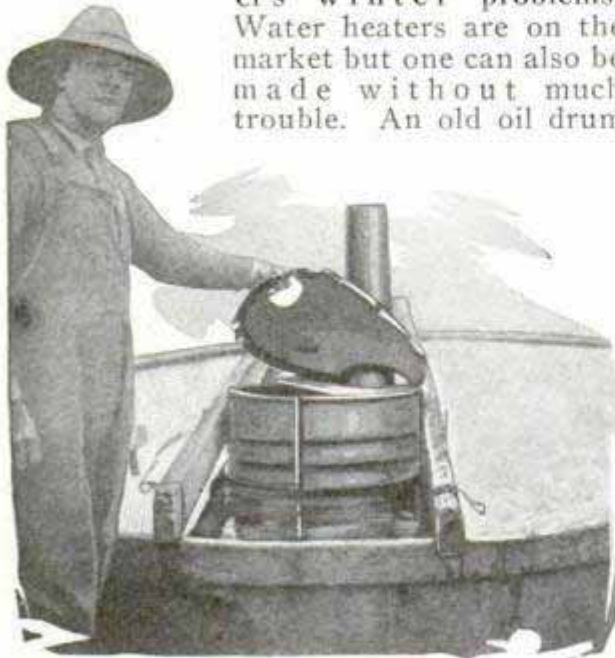

Old Oil Drum Makes Excellent Heater for the Farmer's Water Tank

is usually available. The top of this is cut out and a removable sheet-iron cover substituted, which has two holes cut in it for flues, one of which is the air intake, extending clear down to the bottom of the drum, and the other the smoke flue. A chunk of wood has been found to burn an entire day, and a coat of ice 2 in. thick over the whole tank was melted in about two hours. Cobs are used when a quick, hot fire is wanted, and wood chunks to keep a slow heat through the day and the following night. The tank is anchored securely by means of rocks, which are fastened to vertical rods hooked over the top of the drum.—Dale R. Van Horn, Walton, Nebr.

Do not apply furniture polish to soiled furniture, or it will never look bright; wring a cloth out of warm soapy water, and wipe the furniture carefully, then polish as usual, when quite dry.

Novel Photographic Collection

Those who are fond of collecting photographs, as well as the amateur photographer who likes to dabble in novelties, can obtain interesting photos in a simple way. The process involved is more or less well known, but the material used affords a pleasant departure from conventional methods. Go to your local movie theater and ask for a few pieces of waste film. These scraps will probably be portions of scenes from well-known photoplays, and it is with these pictures that you can start the collection. After looking over the films, pick out those scenes which appeal to you the most and clean the film thoroughly as it has collected a great deal of grease and dirt while being run through the projector. A few pieces of commercial cut film, and a printing frame are also needed. Open your printing frame and lay a strip of the film on the glass, emulsion side up. Now place a piece of the commercial film on top of that and close the frame. This film will be printed as a piece of prepared paper, but the exposure must be very short. A match burnt in front of the frame will prove sufficient.—L. C. Ferguson, Ontario, Calif.

Successful Mud Attachment for Cars

After years of experiment by newspapers throughout the country to find some means of transportation whereby afternoon-delivery service could be maintained the year around on muddy rural routes, a Springfield paper devised an attachment for an automobile wheel, which takes the



Effective Guard, Made of Two Extra Rims, Prevents Miring of Car on Muddy Roads

machine through the mud successfully. It is made by welding together two rims, to which, at intervals of 12 in., mud hooks are welded. This is bolted to the rim already on the wheel with long rim bolts. In order to solidify the entire wheel, an old brake drum is bolted, inside out, to the outside of the third rim. When these rods are drawn up, the wheel is capable of withstanding all jolts it will receive on its trips.

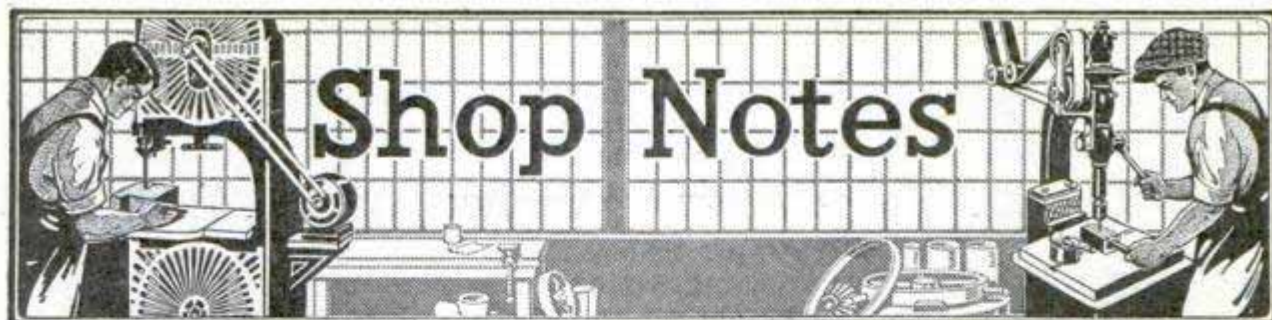

All Shop Notes published in 1925, in book form—Fifty Cents—from our Book Department

Hints on Driving Nails and Screws

NEARLY everyone knows that a nail or screw has greater holding power when driven into the side or edge of a board than when sunk in the end grain. It is commonly supposed that a nail driven with light blows requires a greater force to draw it than one driven with heavy blows; but opinions seem to conflict as to whether or not the usefulness of a screw is impaired by tapping it in for a distance with a hammer before sinking it home with the screwdriver.

Again, the amateur is told by the professional woodworker that a hammer held by the end of the handle is less likely to bend a nail being driven than if held near the head, only to find upon trial that, in his own case, the reverse is true. It appears to him that he can turn in a stubborn screw more easily with a long screwdriver than with a short; yet this seems as absurd as to suppose that, by merely lengthening the rear axle of an automobile, it could be operated with less power.

What are the facts in this case? All have a basis in the two elementary mechanical powers involved, that is, the lever and the inclined plane—in other words, the pry, as exemplified by a crowbar thrust under a rock to raise it, and a sloping runway to an elevated platform up which a barrel too heavy to be lifted can be rolled.

When a nail is driven, the little pointed iron cylinder, being forced between the fibers of the wood, cuts them and wedges them apart. Those at the sides are crushed into a compact mass, their cell

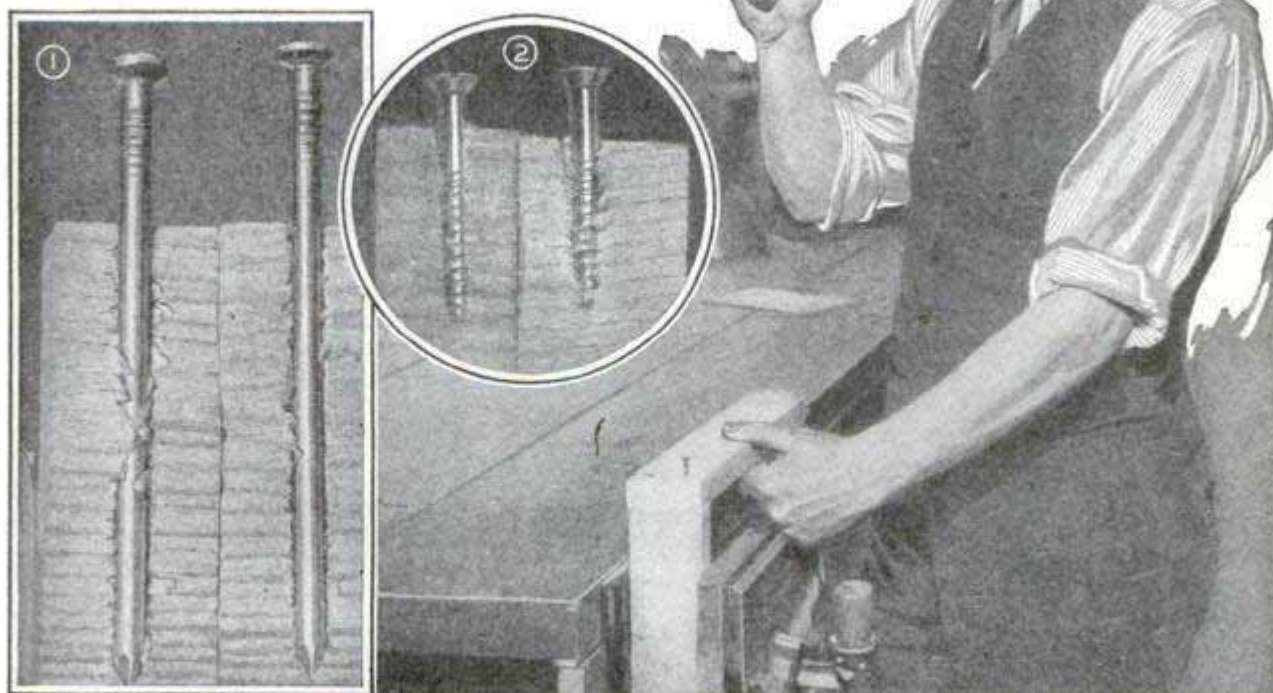

Fig. 1, Left, Nail Driven with Heavy Blows, and Right, with Light Ones; Fig. 2, Left, Screw Turned All the Way In; Right, Driven Halfway with Hammer

walls broken, their elasticity destroyed; while those forming the end grain are bent downward, some breaking off, but many remaining firm.

It is evident that the crushed side fibers contribute little friction, and are almost useless in holding the nail. The end fibers, therefore, must do most of the work in retaining it. When a force tending to draw the nail is applied, the downward bent fibers, already forced tightly against it, follow the nail upward. But the instant this occurs, they also tend

to occupy the space containing the nail, and the leverage so gained forces them still more tightly against it. If the force applied is sufficient, the pressure becomes so great that the tip-end fibers are crushed and broken, as a lever is broken when forced beyond its strength, and the nail can then, with little effort, be pulled out entirely.

In short, these downward-bent fibers form what is known as a toggle joint, as illustrated in Fig. 5. The lever ends, A, bear against the nail and move upward with it. They also tend to

move horizontally, until the levers themselves lie in a horizontal position; but since the horizontal distance, CB, through which they move, is much smaller than the vertical distance, the thrust against the nail is much greater than that applied to lift the nail, according to the law of levers. Moreover, as the levers approach a horizontal position, the horizontal motion approaches zero, while the vertical remains almost constant, so that the crushing effect exerted on the nail increases toward infinity, to the limit of strength of the material. It is no wonder, then, that a properly driven nail holds strongly.

Now, it is reasonable to assume that if the nail is driven with many light blows the fibers will be bent down slowly, and will have time to accommodate

themselves to the strain, reducing breakage to a minimum; while if heavy hammer blows are given, some fibers will break back at a considerable distance from the nail, and thereafter be valueless. That this is indeed the case is proved by Fig. 1, a photograph magnifying two split-out 16-penny box nails. That at the left was driven with heavy blows, that at the right, with light. However, an actual test proves that the difference in



Left, Effect of Screw Binding in One Member; Right, Screw Driven in End Wood

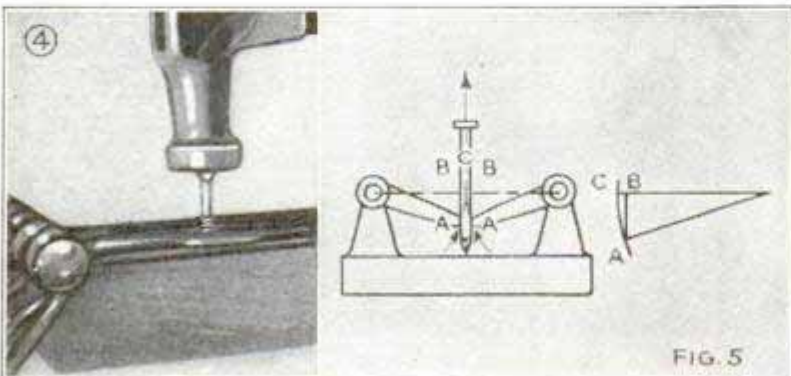

Left, Tapping Screw to Start It; Right, Toggle Effect of Downward-Bent Fibers

holding power is only around 12 per cent; which is not enough, in most construction work, to warrant the extra time required for light driving, since it is common experience that materials, and the mechanic's judgment, will vary more than this.

A screw has wound about it a thread, which is in effect an inclined plane. Here leverage is obtained through the greater rotary than lengthwise motion. This mechanical advantage acts in drawing the screw into the wood, and especially in clamping together the two pieces joined. It does not act to hold the screw in, although the threads naturally must strip out the fibers when the screw is drawn like a nail. Apparently, if the screw is driven for a distance before being turned in, the fibers are bent down, and in addition to the "baffle" effect of the threads, the toggle action is brought into play.

This additional force is not to be discredited. As a matter of fact, tests prove that a screw hammered halfway in holds about 25 per cent more in fir than one screwed all the way in. Probably driving one-quarter of the thread length is best. Fig. 2 shows split-out screws, the one at the left screwed in full distance, that at the right driven halfway with the hammer before being turned. Evidently the carpenter who taps the screws to start them when dapping in hinges, as in Fig. 4, acts on sound principle.

Fig. 3, at the right, illustrates a screw sunk in the end wood. Plainly, to draw it out, it is only necessary to strip the fibers parallel with the grain—in the case of this 1½-in. No. 10 screw, about 1 sq. in. of cross section. As the shearing resistance of fir or pine parallel with the grain is only about one-tenth of that perpendicular to the grain, small reliance can be placed on a screw entered in the end of a board.

Fig. 3, left, also illustrates a problem met in joining two members with screws, in which the upper member has not been bored sufficiently large to permit free movement of the screw. It is easily seen that the screw advances as fast in the upper as in the lower piece, keeping them the same distance apart until the head bears against the upper piece, when the threads that are cut in it must strip out before it will come down against the lower member. The force required may be sufficient to break the head.

Fig. 6 illustrates the drawing of a nail. The hammer,

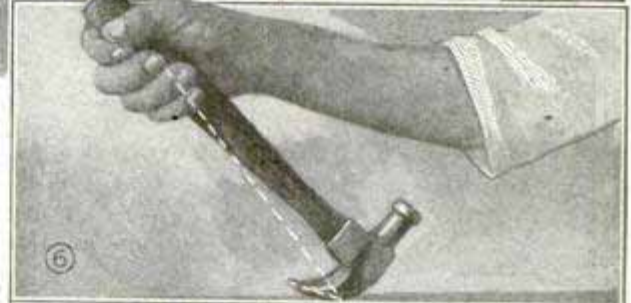
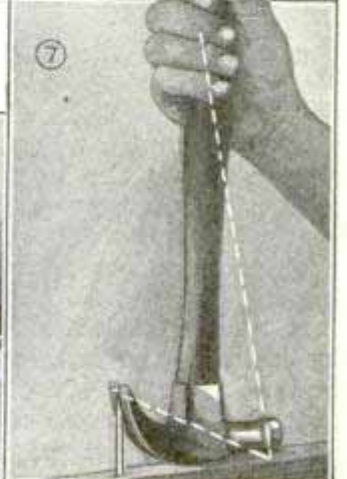
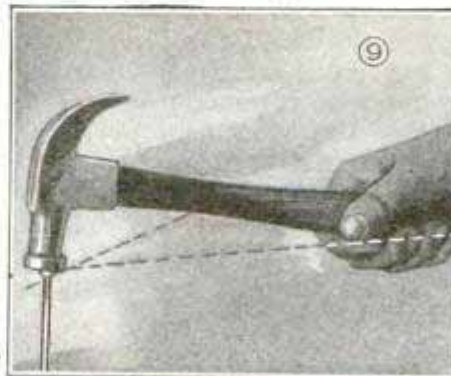

Fig. 6, Starting to Draw Nail; Fig. 8, Use of Block When Nail Is Partly Drawn



Left, Effect of Holding Hammer at End and at Neck; Right, Wrong Method of Drawing Nail

as the dotted lines indicate, forms a bell lever, with the handle arm nearly 16 times the length of the claw arm, so that 1 lb. pull on the handle applies an upward force of 16 lb. on the nail. When, as in Fig. 7, the nail is partly drawn, the hammer rocks backward, the weight arm is greatly increased in length, and the pull on the handle must be increased. Nearly all hammer-handle breaks are caused by trying to pull nails with the face edge as a fulcrum. The proper way is to place a block under the head, as in Fig. 8, thus restoring the short weight arm.

Hammers are so designed that a line drawn touching the width of the face intersects with

greater velocity to the head, and can consequently strike a harder blow.

The face of the hammer is slightly rounded, so that if it strikes a little out of true the face may still be at right angles to the nail. This convexity also makes it possible to drive home a nail without bruising the surrounding wood.

If a screwdriver were held truly in a line with the screw, the short driver would be just as effective as the long one, since only the direct torque, or twisting force, would act in each case. In practice, however, the driver is invariably held to one side or the other; and granting that the

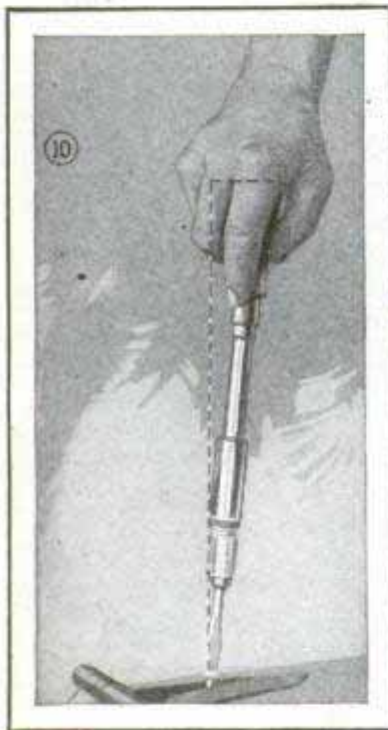

Fig. 10, Effect of Using Long Screwdriver; Note Lever Arm Indicated by Dotted Lines; Fig. 11, Short Lever Arm Formed by Short Screwdriver

the center of the handle end. When a blow is struck on a nail, the face meets the nail head squarely and forces it in along its length, whereas, if the handle is grasped near the head, the front of the face is thrown upward, and the inclined plane transmits a portion of the blow as a sidewise force against the nail, bending it. See Fig. 9.

A novice finds it difficult to drive nails by holding the hammer handle near the end because he handles it so inexpertly that the head wobbles from side to side, striking at angles in spite of him. Yet, if he practices a short time, he will find that the correct method is much the easier. Not only so, but he is able to give

angle of inclination is the same for the large or short tool, the power arm developed is longer in the longer driver, and a greater leverage is produced. Figures 10 and 11 illustrate this.

Fitting Piston Rings

The auto mechanic who has piston rings to fit will appreciate any new idea that will serve to cut down the time required for the job. Usually such a small amount of metal is to be taken off that the clamping and loosening of the vise take most of the time. Instead of setting each ring in the vise twice for filing, take one of the old rings that are to be

discarded and break off a piece equal to about one-fourth of its circumference. Choose a ring that has not been worn too much in width. Clamp this piece vertically in the vise, concave side outward, about $\frac{1}{16}$ in. from the left side, and extending about $\frac{1}{16}$ in. above the jaw of the vise. This leaves the vise open the width of the ring and a recess of $\frac{1}{16}$ in. into which the ring to be filed is placed. Just a slight pressure of the thumb and finger of the left hand will suffice to hold the ring while it is filed and a little practice will enable any mechanic to file the end squarely with a small flat file. The piece of old ring is not removed from the vise, but each succeeding ring is merely set into the vise and held as explained, while one side is filed, then slid out of the vise, inverted and replaced for the other side. This applies to step-cut rings. If diagonal-cut, file only on one side.

Bumper for Lumber-Yard Posts

Discarded truck tires of the solid type have been used effectively as bumpers for posts supporting the sheds in a southern lumber yard. The tires were mounted on stakes, notched as shown and pointed at the lower end to facilitate driving them into the ground. These tires are mounted on iron rims, which gives them enough strength to sustain a considerable impact. A bumper of this kind provided around each post prevents the latter from being broken off, which might cause the shed to collapse.—F. E. Walker, Atlanta, Ga.

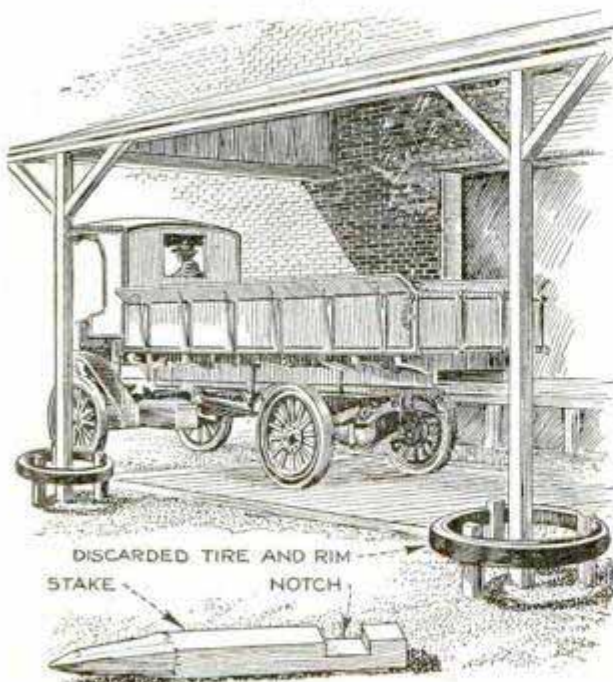

Solid Truck Tires on Rims Used as Bumpers around Posts in Lumber Yard

Gate for the Stock Corral

The photo shows a novel turnstile gate for a stock corral. One can enter or leave with both arms full, yet no cow or horse can go

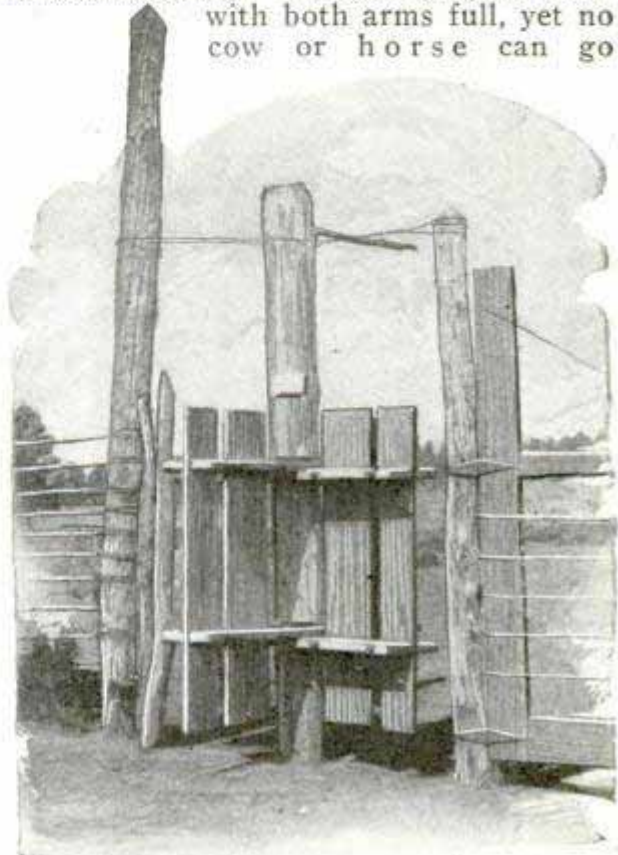

Novel Wooden Turnstile Gate Found Convenient in Western Stock Corral

through, no matter in what position the gate is left. Two pairs of crossarms are mounted upon a heavy post, which is hewn round and notched for the arms. The arms lie across each other at right angles. Planks are bolted to the crossarms vertically. By keeping the bearings lubricated with hard oil, the gate turns easily. The arms are made of 2 by 8-in. planks, about 6 ft. long. The gateway is $7\frac{1}{2}$ ft. across.—Dale R. Van Horn, Walton, Nebr.

Handling Celluloid Triangles

Most draftsmen appreciate the difficulty experienced in picking up celluloid triangles. This difficulty can be overcome by the addition of an ordinary glass push pin. Drill a small hole, slightly smaller in diameter than the pin, through the triangle. Countersink this hole slightly on one side and then insert the push pin. Clip off the pin so that only a small end projects. Rivet this portion over until it holds the push pin securely and then file away all the surplus metal so that the triangle will lie flat on the board.—Richard H. Robinson, Detroit, Mich.

Concrete Steps on High Curb

In towns built on hilly or rolling ground the curbing is often too high to mount easily. This makes steps of some

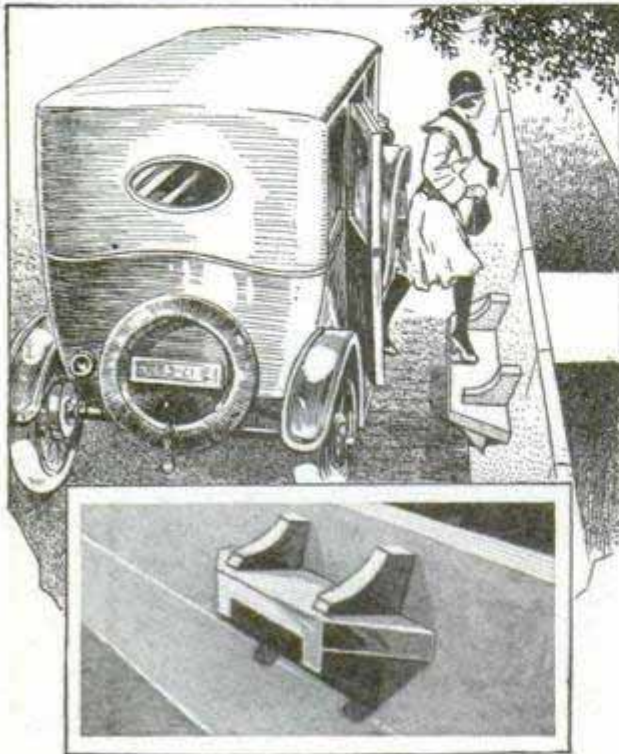

Concrete Steps on High Curbs Make It Easier for Automobilists to Reach the Sidewalk

sort necessary. The drawing shows how steps of concrete are built integral with the curb. They are braced as indicated, and are neat in appearance. The braces are not run clear to the pavement as this would check the flow of gutter water and stop refuse.

Wet Air in Compressed-Air Hammer

In a small shop I noticed that the air hammer in one of the worker's hands was spraying water out of the exhaust hole. He said that it always did this when it was started. One look at the compressor installation showed me the trouble. The air receiver was a small one, and the air from the compressor entered the tank at the top, while the outlet from the tank into the air hammer was about 4 in. from the bottom of the tank. This was what was wrong with the installation. Moisture is heavier than air and, of course, it settles in the bottom of the receiver and, as the receiver was small, it merely acted as a pipe for the air to flow through from the compressor, carrying the water along with it. In explaining the proper pipe layout to the boss afterward, I strongly urged him to supply a larger receiver so that the air

would have an opportunity to remain stationary long enough to cool and deposit part of the moisture. The larger tank would likewise provide ample storage against fluctuations in pressure, and give a steady volume of air to operate the air hammer.—August Jeffers, Bedford, Ind.

Removing Soldering Flux

Anyone who has worked with solder containing the flux, has no doubt experienced the difficulty of removing the hard crust which is formed around the solder. If this crust is left on, it not only shows poor workmanship, but the crust will later dissolve and run off in the form of acid, which is very injurious to other metal parts. The flux can be removed by dipping the soldered parts in cold water. If it is impossible to dip the parts in water, good results can be had by placing a wet cloth over the soldered parts for a few moments and then wiping them off. Either method will leave the metal bright and clean. It is best to apply the water to the soldered parts while they are still hot.—Ed Sundholm, Albert City, Iowa.

Holder for Signal Lantern

The warning lantern used to indicate the presence of excavations or obstructions in the road or for similar purposes



can be displayed conspicuously on the holder shown in the illustration. Two pieces of flat iron, one a few inches longer than the other, are notched in the end to fit the lantern frame as shown, the longer one being bent at right angles. A spacer, riveted to the uprights and holding them rigid, also serves as a shelf for the lantern. If desired, a suitable sign can be attached to the frame as indicated.

A wooden block or a concrete slab can be used as a base, the latter being preferred, as its greater weight lessens the possibility of the holder being overturned by the wind or otherwise.—A. C. Cole, Chicago, Ill.

Bleachers for Small Athletic Field

By ROY M. SINGER

HERE is a grandstand for a small athletic field that can easily be built, and that will prove a splendid project for the manual-training class of a boy's school. The woodwork is not at all difficult, but it will afford the boys a valuable study in practical problems, as well as form a monument for a particular class. The necessary concreting and painting can also be done by the class, thus making the project still more comprehensive.

All details of the stand are given in the drawings, so that little description is necessary. It consists of trusses supported by concrete piers; at the rear, lateral bracing is used to furnish stiffness. The piers are constructed as shown in the sketch, and should go down into the ground at least 3 ft. below grade, and always below the frost line.

The lower member of the truss consists of two 2 by 8's, the end post of three 2 by 10's, the intermediate post of two 2 by 20's, the diagonals of 2 by 10's, and the top chord of two 2 by 12's. A 2 by 4-in. rail is provided, as shown in the sketch.

The seats are built of two 2 by 8's and a total seating width of 20 in. is provided. The difference in elevation of the tiers is 16 in. The whole arrangement is designed for comfort and safety.

It may be well to add here a word of warning to anyone who contemplates building a seating arrangement of this kind. Remember that each member in the assembly must take a different load and that if one member does not take its full load, some other member must carry more than its load. Be careful, then, to see that all joints are tightly nailed and that all materials used are of good, sound

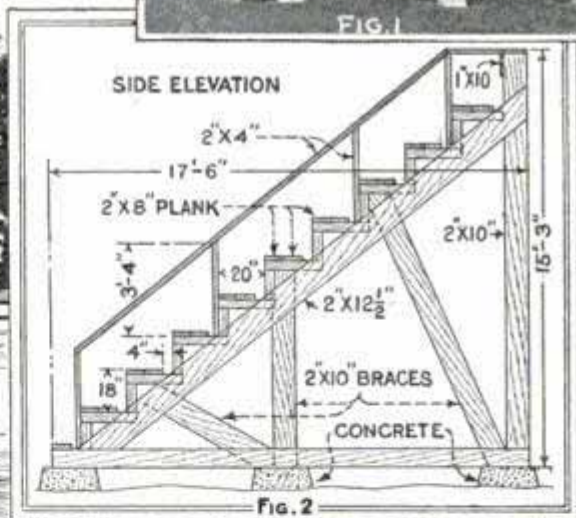
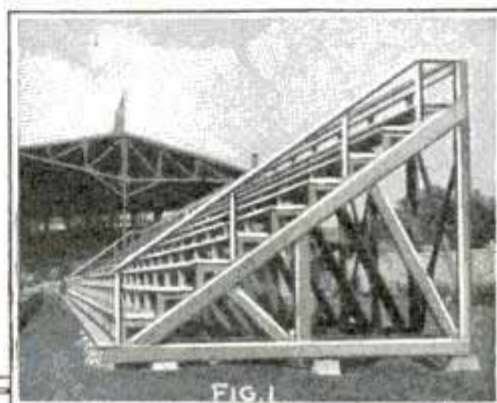
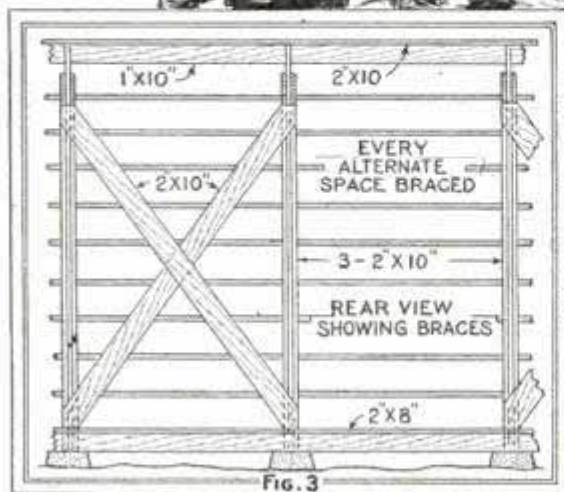
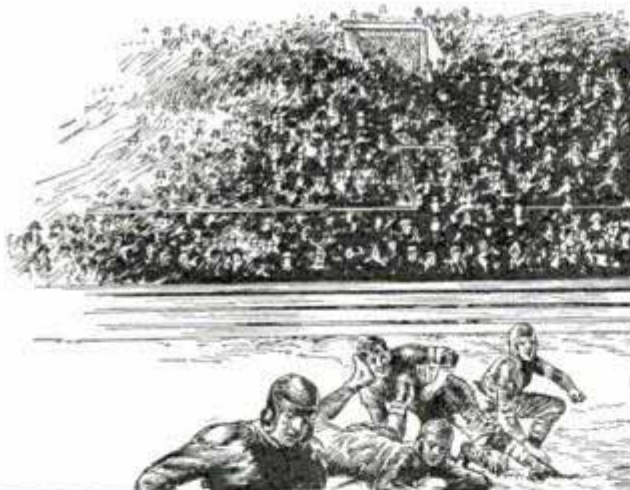

Fig. 1, Left End of Stand; Fig. 2 Detail Drawing of Left-End Assembly; Fig. 3, Details of Stand Showing the Bracing

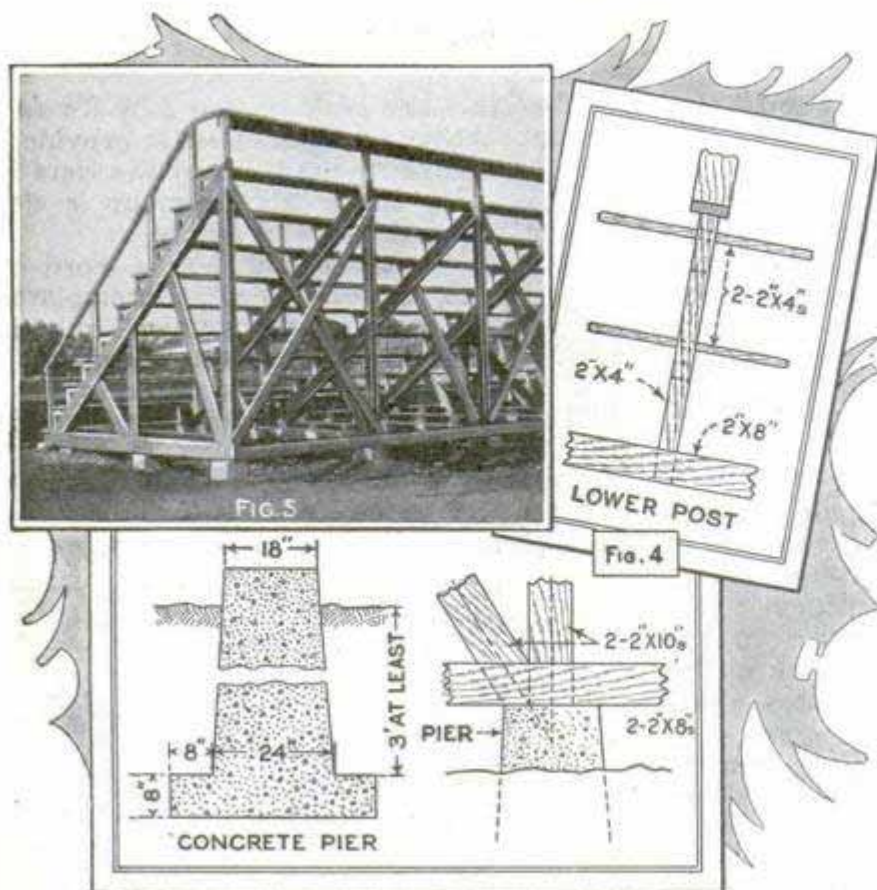

Fig. 5, Photo of Part of Rear of Stand; Fig. 4, Lower Post and, Below, Concrete-Pier Details

lumber. For an arrangement of this sort, the trusses should not be spaced farther apart than 10 feet.

Spillway for Bathing Pools

Bathing pools, fish ponds and lakes, fed from springs or small streams, must have some provision to prevent storm water from entering them, if the water is to be

kept clear and the pool saved from filling up with sediment. This is usually accomplished by building a small dam above the pool, the storm water being carried around through a spillway. A dam that operates automatically can be arranged by making the opening to the spillway wide enough so that the normal low-water flow will go over it in a thin sheet. The water at this point is made to run over a 2 by 8-in. plank, bolted edgewise to the concrete dam wall. In front of this, and at an angle to it, is placed another plank, the edge of which is beveled to provide an opening of uniform width, say $\frac{1}{4}$ to $\frac{1}{2}$ in. between it and the vertical plank, through which the low-water overflow runs into a separate pool as shown. A slight rise in the stream will cause the water to run with greater speed and in greater volume, so that it will skip the gap between the two boards and flow into the spillway around the pool. A baffle can be set up just behind the dam to hold back trash. This device is in use at the Georgia state college of agriculture, and a very small rise in the stream causes the water to switch to the spillway.

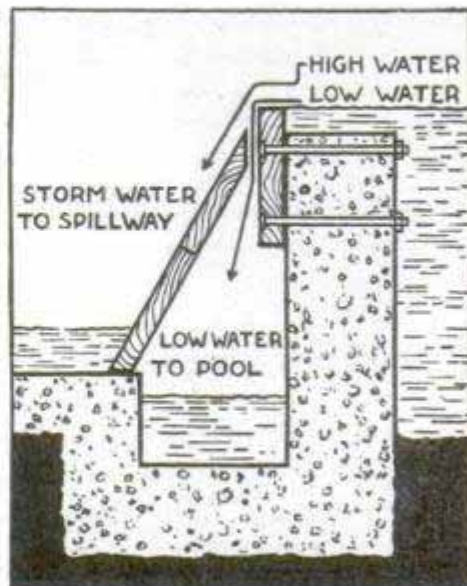
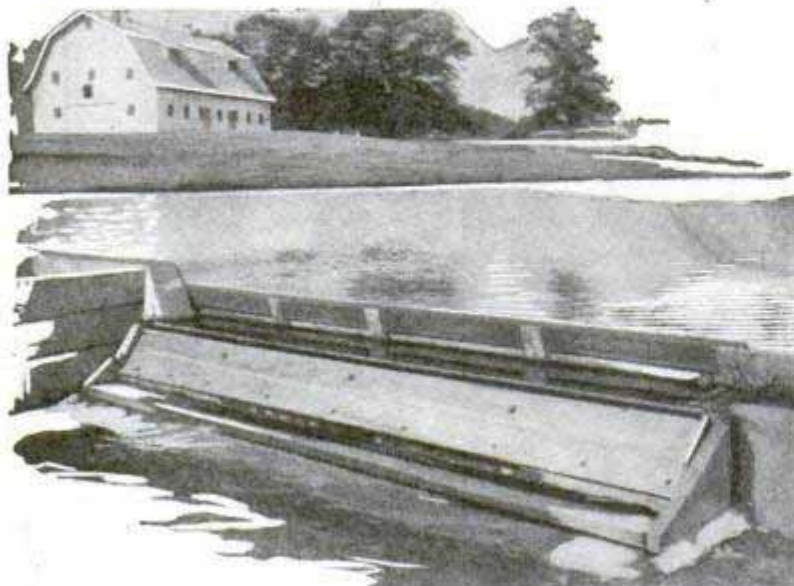

Automatic Dam Allows Water at Normal Level to Flow into a Pool, While a Small Rise in the Level Causes It to Run into the Spillway That Diverts It around the Pool

Battery Economy

To those who use dry cells in telephone or telegraph circuits, the following method of using them on closed circuits will prove valuable. This method permits the use of dry or any other open-circuit batteries on telegraph or telephone lines where the circuit is closed. The ordinary methods of doing this require sufficient battery power at each end of the line to operate the system. This doubles the necessary cost of batteries. The better method is to get just enough batteries to operate the system. Place half of them at one end of the line and the other half at the other, and connect the zincs at both ends of the same line, and the carbons to the other, or to the ground. The voltages of both sets will then be equal and, therefore, no current will flow on the line. When either party wishes to call the other, he simply reverses the connections of his set of batteries and uses the instruments. By this reversal the current of both batteries flows through the line. When through talking, he restores the connections to their original condition. The direction of the current through the line depends upon which party has called the other. The apparatus may be grouped in any way, and distributed anywhere on the line. The only condition to be observed is that the open-circuit voltages of the two sets of batteries should be equal, so that no current will flow until one set is reversed. Any batteries may be used together.

Safety Handle for Chisel or Punch

For holding chisels or punches while working in places where minor injuries may occur, pieces of air hose may be used to advantage. A slit is made in the hose about $1\frac{1}{2}$ in. from one end, through which the tool is inserted, and a piece of wood is driven into the hose from either end to hold it securely. In this way the tool can easily be shifted to work from any angle. The idea originated with G. L. Knotts, service supervisor at Du Pont, Washington.

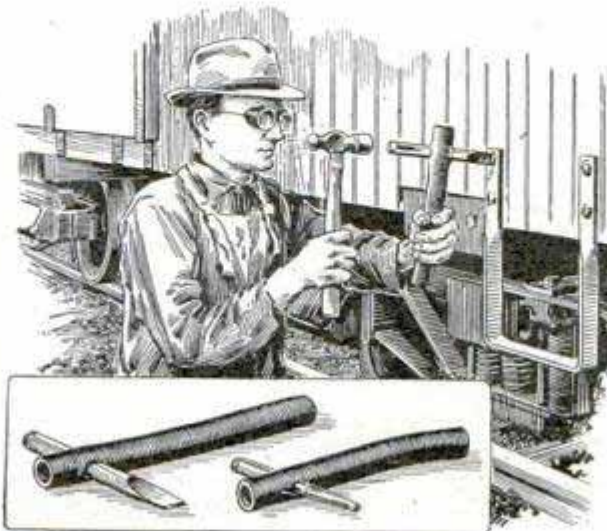

Pieces of Discarded Air Hose Make Safe and Convenient Handles for Chisels

Spring Holder for Metal Plates

When marking, lettering or cutting designs on brass plates it is important to have the work held so that it will not move, or else the worker may spoil the

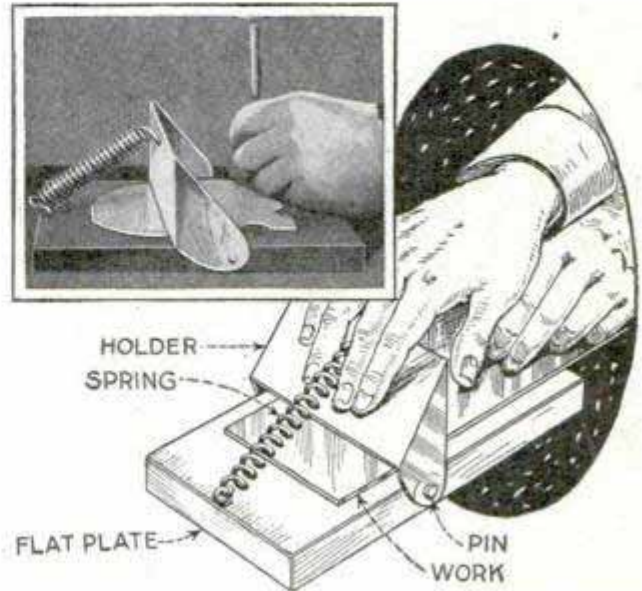

Device for Holding Metal Plates Securely While Working on Them

piece by marking it crooked. Such work is done best on a flat plate, and we have fitted a holding device to the plate that will grip a piece of the full width of the plate if necessary. The holder is made out of a piece of flat metal, formed as shown and attached to the plate by a pin on each side. When in use, one end of a coil spring is passed through a hole in the holder, and the other end is attached to a hook screwed into the plate. The operator lifts the holder by pulling it toward him, shoves the work underneath, and then releases it. This holds the work securely, and the continued tapping with a hammer when marking the work will not, with ordinary care, change its position. —Harry Moore, Montreal, Canada.

☐ A good paint for wire screen consists of dropblack, ground in oil, and about a third as much of asphaltum varnish, thinned with turpentine. Add some drier and strain the paint before using.

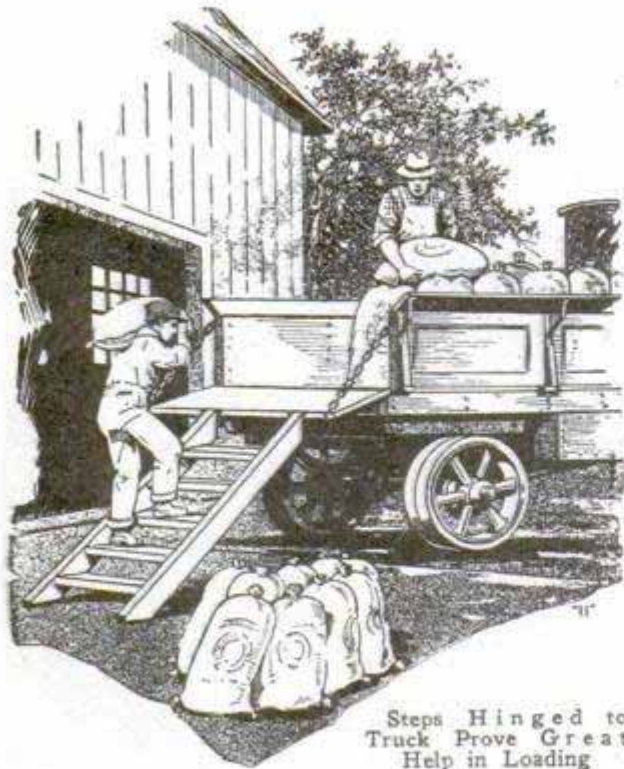

Steps Hinged to Truck Prove Great Help in Loading

Permanent Steps on Truck Aid Loading

The idea illustrated shows a set of steps for loading platform, which is used by a firm of private scavengers for conveniently dumping the contents of garbage cans into the truck and will find application in numerous other places where loads of material must be placed in the truck by hand. Both the loading platform and the steps attached to it are hinged, the former to the bed of the truck and the latter to the outer edge of the platform. When lowered, the platform is held securely by two lengths of chain and when raised, the steps hang down behind.

Stopping Leaky Steam Lines

Leaky joints on steam lines can often be permanently stopped by the use of a calking tool and a little lead wool. Occasions frequently arise when a small leak in either a water or steam line is causing inconvenience as well as loss of power. Repairs cannot be made while the line is in service, but a little lead wool worked tightly into the joint while the pressure on the line is reduced often eliminates the necessity of making an expensive repair.

Quadruple Tile Joint

In constructing a farm-drainage system it sometimes becomes necessary to join three or more tiles at one point; such joints are not regularly manufactured and it is rather difficult to build one that will not wash out, break down or resist burrowing animals.

A practically indestructible concrete joint, simple to make, is shown in the illustration. It accommodates a 14-in. outlet pipe and three branches of respectively 10, 6 and 4-in. diameter. The form is made of old 1-in. boards, is 20 in. long and at least 20 in. deep without top or bottom. These dimensions are required because there should be space below the pipes for a floor of 2 or 3-in. thickness, and above and on the sides for 4-in. walls around the largest tile. If a larger outlet pipe is used, the form should be dimensioned according to this rule. Openings are cut in the sides with a keyhole saw to fit the tiles. The lowest point of these holes should be the same distance from the bottom edge of the box as the thickness of the floor, that is, 2 to 3 in. The form is then nailed together and reinforced at the edges with lath.

Place the form on a level spot on the ground and build up some sand around the outside to keep it in place. Insert the tiles, pushing the 14-in. pipe far enough to project 4 in. inside of the box; the smaller ones are pushed in farther, or so that the distance between opposite open-

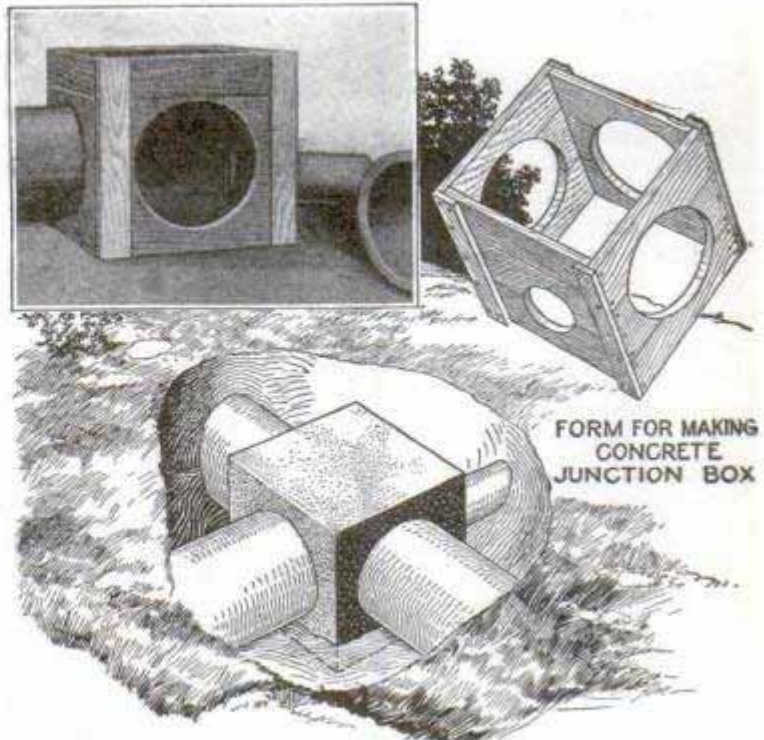

FORM FOR MAKING CONCRETE JUNCTION BOX

Practically Indestructible Four-Way Junction Box for Drain Tile Made of Cement

ings in no case is less than 14 in. Now pour in the cement—1 part cement to 3 of sand—until it reaches the lower edge of the tiles. After the floor has set, put in more cement around the tile in the lower corners of the box, troweling it down around the tile so as to bond with the cement of the bottom. Then, using wet sand, fill the openings in the ends of the tiles and build up a core in the central space until it is level with the top edge of the largest pipe. The remaining space in the upper part of the form is then filled with cement up to the top of the box. When the cement is set and nearly dry, the core can easily be removed by punching it loose with a piece of wood or iron. In regard to the relative sizes of outlet and branch tile, the rule is that the square of the diameter of the former should be at least equal to and preferably exceed the sum of the squared diameters of the branches.—J. R. Koontz, Bremen, Ind.

Copying Drawings and Photos

When copies of drawings, diagrams and photos in books or magazines are desired, it is too tedious and time-consuming a task to copy them by hand, if at all possible, and the accuracy of such work is also questionable. A good method of making photographic copies is shown in the illustration. Any good quality of photographic printing paper may be used, but those having a "hard" contrast are preferable.

The photo paper and the print are put face to face and a piece of glass is put over the photo paper. Exposure is then made with an electric lamp from above, the duration of exposure depending on the thickness

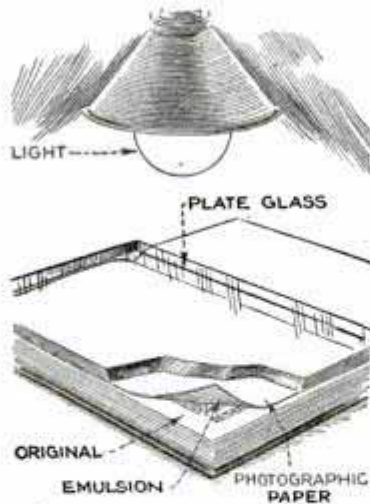

and quality of the photo paper, the intensity of illumination, the distance from the light to the print, and the reflective quality of the paper from which the print is to be made. The first photo is reversed and is used as a negative for making any number of prints. As the photo paper is kept so close to the original, the prints will be free from blurs.

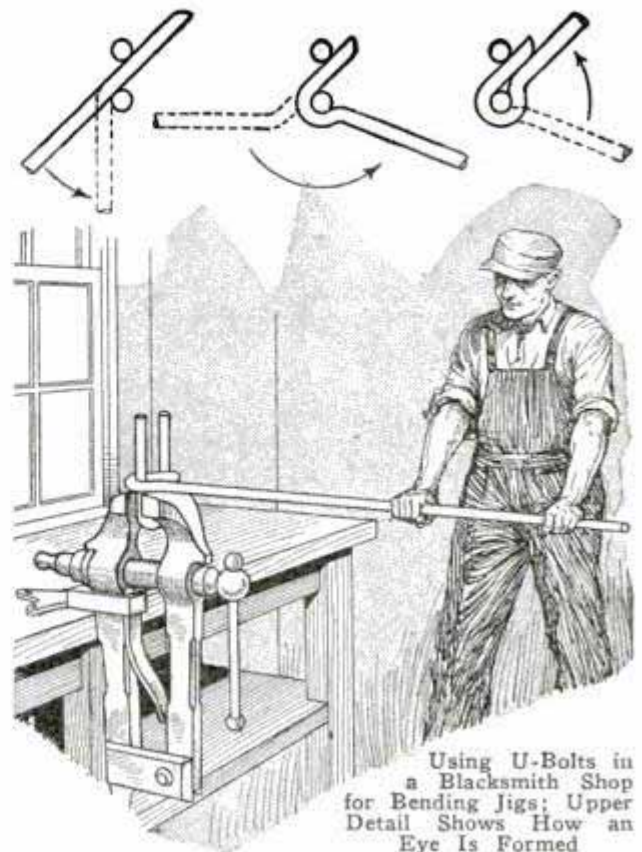

U-Bolt Makes Good Bending Jig

A set of U-bolts or forms of round steel stock, bent so that the parallel legs are separated a little more than the diameter, is used by a western blacksmith for bending round or flat stock. In use, the form is clamped in a vise, as illustrated, and the rod to be bent is slipped between the legs. The drawing shows the steps in bending an eye in hot stock, but simple bends are easily made in cold stock by using a pipe over the end to give leverage.

Preventing Rust on Dials

In wet, damp or steamy places, the rusting of gauges and dials can be prevented by first cleaning and polishing the surface thoroughly and then giving it two coats of collodion. The first coat must be thoroughly dry before the second is applied. The collodion prevents the air and moisture from getting in contact with the polished surface. Engine gauges will last from six months to a year without repolishing if properly treated in this way. Exposed copper and brass piping and other metals can also be protected by this method. When necessary, the collodion can be removed with alcohol.

☛ A T-handle tap wrench with part of the handle cut off can be chucked in a breast drill and used for holding small drills.

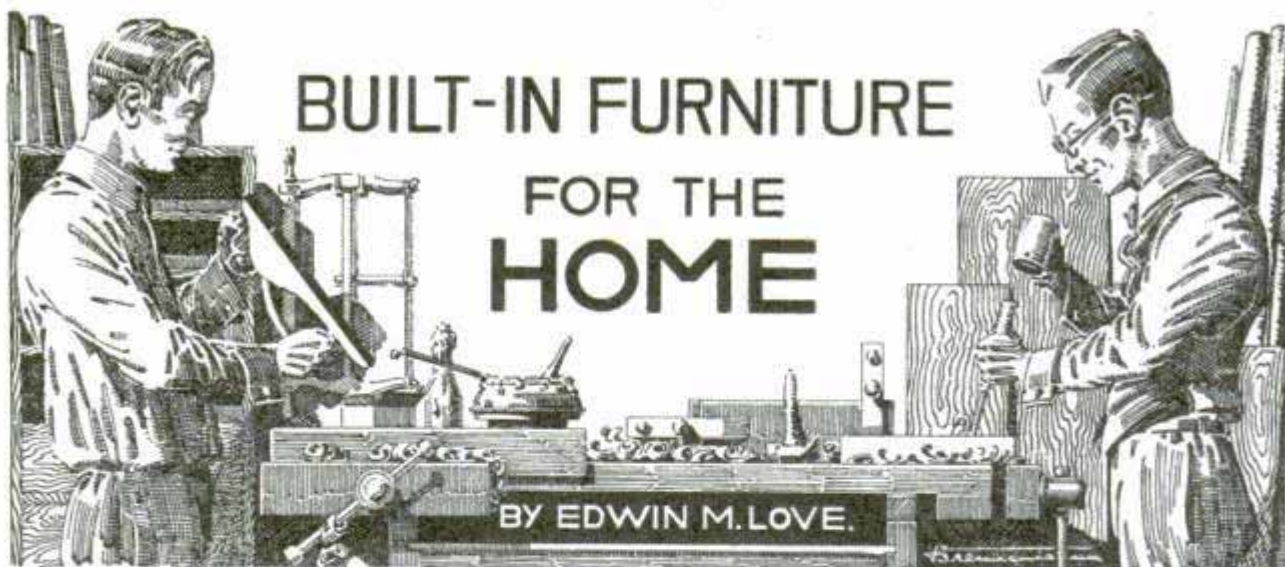

Part XV—Kitchen Cupboards That Meet in a Corner

THREE important considerations influence the design of kitchen cabinets. The sink should be placed in the best possible light; the drainboards should be large, with drawers, bins, and breadboard underneath; the cupboard should be as near as can be to the sink without isolating it too much from the dining room or breakfast nook.

Often the combination of the drainboard cabinet and main cupboard in a corner is the only practical way to utilize available space; and while the lower section of the cupboard in the corner can have no individual door, and is therefore a little remote, the design given here makes it quite accessible by putting two doors in the corner. Such a space can be used for storage of utensils infrequently used. Overbalancing this defect is the fact that the washed dishes can be

lifted directly from the drainboard into the cupboard.

If it is desirable to shorten the drainboard cabinet, take width from the drawer chest at the left of the sink, so as to keep the right drainboard as large as possible.

Under the window of the outside wall measure out from the plaster a distance of 1 ft. 10½ in., and draw a line on the floor, the full width of the room. Also draw a line 1 ft. 3¾ in. from the adjacent wall, and 6 ft. 8 in. from its end wall, square a line to the wall. Nail to the floor, ¾ in. inside of the end line, a cleat of 2 by 3-in. stock, sized to a width of 2 in. Nail down four other like cleats, one against the wall, one centered 1 ft. 6 in. from the end line, and the other two spaced evenly on the long section. Also nail down floor cleats for the drainboard cabinet, one for the partition at the left

MATERIAL LIST

- | | |
|--|---|
| 2 pieces, 1½ by 4 in. by 14 ft., pine or fir, S4S, sanded. | 1 piece, 1 by 12 in. by 14 ft., pine or fir, S4S, sanded. |
| 1 piece, 1½ by 4 in. by 10 ft., pine or fir, S4S, sanded. | 4 pieces, ¾ by 2 in. by 12 ft., pine or fir, S4S, sanded. |
| 1 piece, 1½ by 3 in. by 8 ft., pine or fir, S4S, sanded. | 2 pieces, 1 by 6 in. by 10 ft., pine or fir sheathing, S1S. |
| 1 piece, 1½ by 3 in. by 14 ft., pine or fir, S4S, sanded. | 1 piece, 3-in. crown mold, 8 ft. |
| 5 pieces, 1½ by 3 in. by 16 ft., pine or fir, S4S, sanded. | 1 piece, ¾ by ¾-in. baseshoe, 16 ft. |
| 1 piece, 1 by 2 in. by 10 ft., pine or fir, S4S, sanded. | 1 piece, 1 by 10 in. by 6 ft., pine or fir, drawer front, sanded. |
| 1 piece, 1 by 2 in. by 12 ft., pine or fir, S4S, sanded. | 1 piece, ¾ by 9 in. by 6 ft., pine or fir, drawer back, sanded. |
| 1 piece, 1 by 2 in. by 14 ft., pine or fir, S4S, sanded. | 1 piece, ¾ by 10 in. by 12 ft., pine or fir, drawer side, sanded. |
| 1 piece, 1 by 3 in. by 8 ft., pine or fir, S4S, sanded. | 3 pieces, ¾ by 6 in. by 12 ft., T & G pine drawer bottom, sanded. |
| 1 piece, 1 by 3 in. by 12 ft., pine or fir, S4S, sanded. | 1 piece, ¾ in. by 3 by 6 ft., three-ply panel veneer. |
| 1 piece, 1 by 4 in. by 14 ft., pine or fir, S4S, sanded. | 1 piece, ¾ in. by 3 by 4 ft., three-ply panel veneer. |
| 1 piece, 1 by 6 in. by 12 ft., pine or fir, S4S, sanded. | 2 sheets of tin, 12½ by 24 in. |
| 1 piece, 1 by 7 in. by 8 ft., pine or fir, S4S, sanded. | 12 pair 2½ by 2½ in. loose-pin butts. |
| 4 pieces, 1 by 12 in. by 12 ft., pine or fir, S4S, sanded. | 12 long catches. |
| 2 pieces, 2 by 3 in. by 10 ft., pine or fir, S1S1E. | 18 1½-in. glass drawer pulls (knobs). |
| | 2 lb. six-penny finish nails. |
| | 2 lb. eight-penny finish nails. |
| | 20 ½-in. corrugated fasteners. |
| | A few four-penny finish nails and 1-in. brads. |
| | Cost of materials, about \$32. |
| | Time to build, about 60 hours. |

of the sink, one for the other, and one on the bin-side of the third partition. These are all 2½ in. wide, serving as slides for the drawers. The dimensions are given in the drawings. Two other cleats, 2 in. wide, are put down for the shelf in the bottom of the door compartment.

Nail a cleat of 1 by 2-in. stock 2 ft. 11¼ in. from the floor for the back support of the drainboard. Plumb guide lines on the walls for the partitions, and on the end wall lay out the following distances for determining the height of the 1 by 1-in. wall drawer cleats: 12⅝ in. from the floor; 1 ft. 10¾ in. from the floor, and level around to the back wall. Nail up the two cleats, cutting them just long enough for the ends to form backing for the back edge of the partition. This procedure removes possible error due to a difference of level in the floor from front to back. Nail an end cleat for the drainboard to the end wall, and put in drawer cleats for the bins when the partitions are placed.

Now glue up stock for the two lower shelves of the cupboard, using 1 by 12-in. stock and 1 by 4-in. pine or fir. Use dowels or corrugated fasteners. Glue up 3-ft. lengths of 1 by 12-in. stock for the three

partitions, and two pieces, 1 ft. 2 in. long, for the bottom shelf in the pot cupboard under the right drainboard. Glue up the end and partition for the cooler, using a 1 by 12-in. by 8 ft. 4-in. board, and a 1 by 4-in. by 3 ft. piece.

Now cut a hole, 6 in. square, in the floor for the cooler vent. Scribe the lower shelf to the wall, joint the front edge with a slight bevel to insure a tight fit with the rail, and nail solidly to the cleats. Saw out a hole, 8 in. square, in the cooler space, and fit inside it a jamb, built of 1 by 2-in. stock as detailed. Cover this with screen wire and miter a thin strip over the edge to make a neat job.

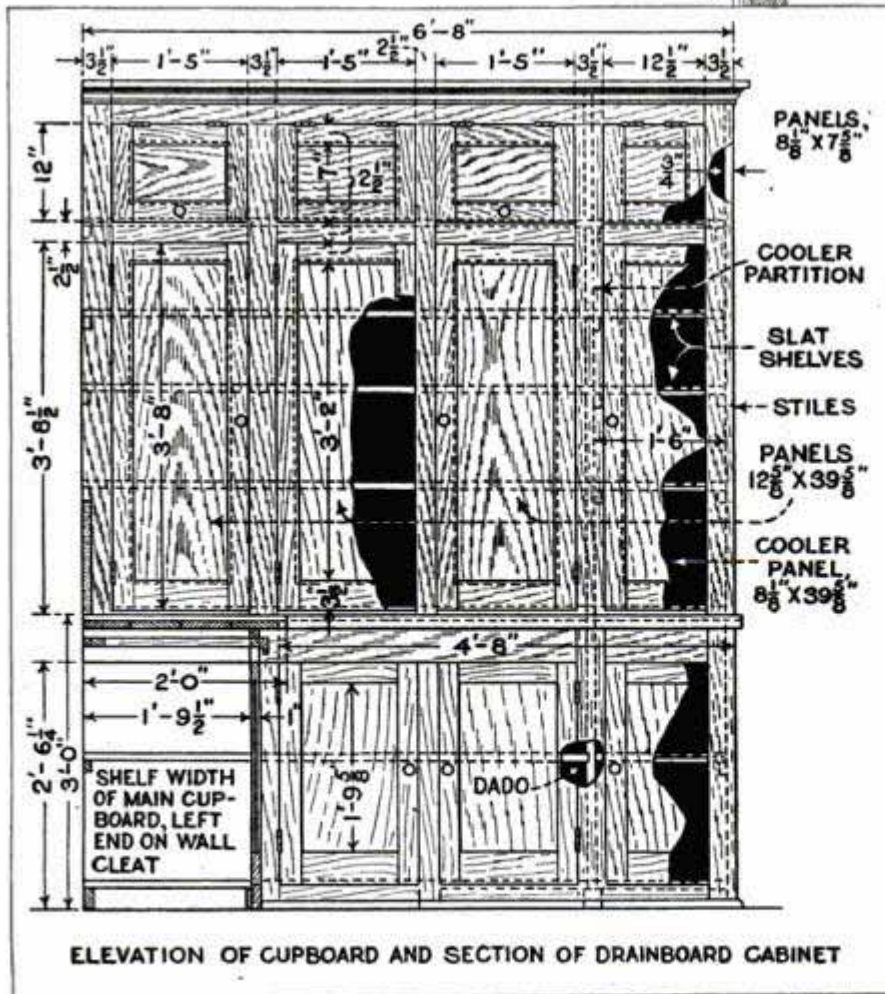

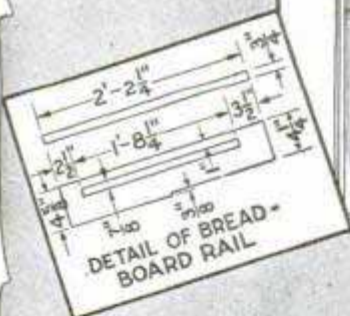
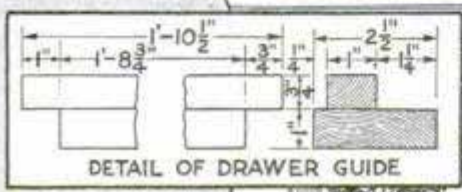
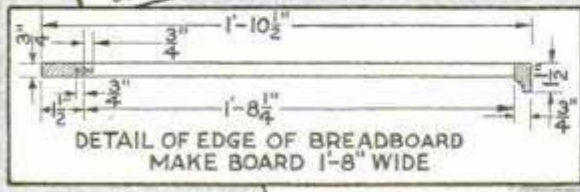
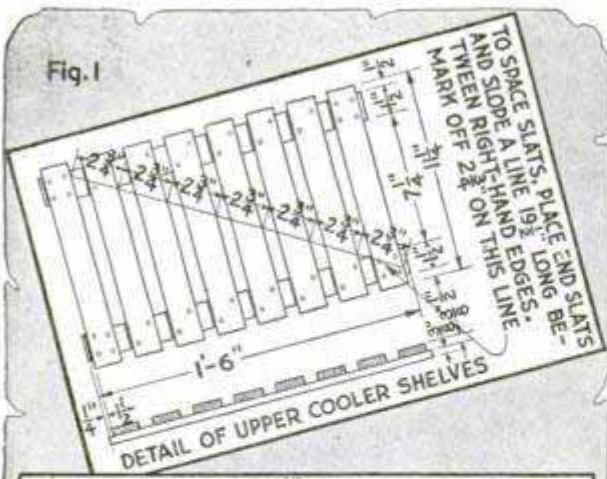

Lay out the ceiling by plumbing up from the bottom. If the ceiling joists run at right angles to the cupboard, nail a 1 by 2-in. cleat across them, 3/4 in. back from the point plumbed from the bottom, between the cooler section and the other; but if the joists run the other way, nail cleats running from front to rear of the cupboard, if it can be done. If necessary, go under the roof and nail in backing between the joists to nail the cleats to. Put a vent in the ceiling similar to that in the shelf.

Lay out the end board for shelves as dimensioned in the section, and after scribing it to the wall, nail on the cleats of 1 by 2-in. stock, chamfered on the inside corners. As the end of the countershelf rests on the offset at the drainboard level, the wide lower part must terminate 2 ft. 11 1/4 in. from the floor. Scribe the end board to the wall, carefully plumbing the front edge, and nail in position. Level lines from the tops of the cleats along the back wall to the end wall, and place similar cleats to carry the shelves. The cooler partition is fitted against the lower shelf, making the lower section 2 3/4 in. shorter than that of the end. Cleats are nailed to the cooler side of the partition, and dados, 1/4 in. deep, are cut for the cupboard - shelf

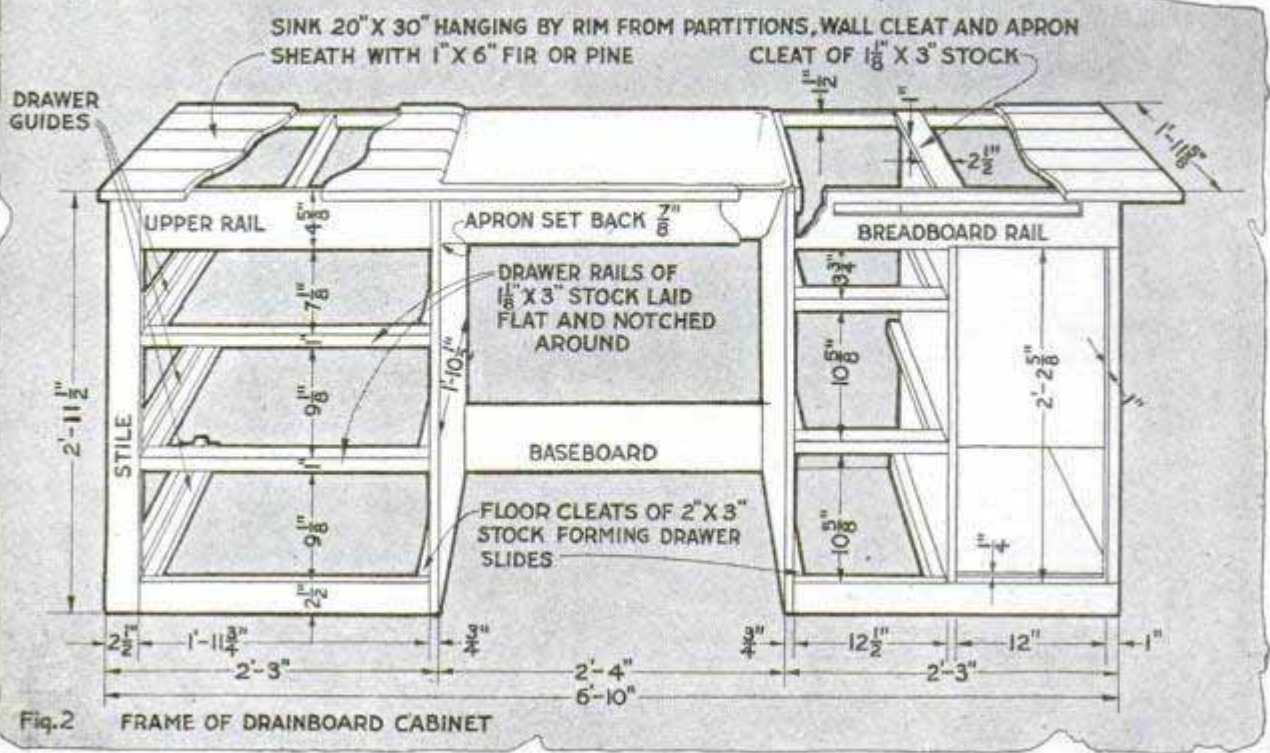

Fig. 2 FRAME OF DRAINBOARD CABINET

ends. Scribe the partition to the wall, and nail in place. Fit the shelves, using 1 by 12-in. stock for the upper section.

The cooler end stile is of $\frac{1}{8}$ by 3-in. stock, sized to a width of $2\frac{1}{2}$ in., and runs from top to bottom. The partition stile, of the same stock, is cut 7 ft. 11 in. Glue and nail the joints. Size a 6-ft. length of 1 by 5-in. stock to a width of $4\frac{1}{4}$ in., and cut it between the stiles and the wall and partition stile, keeping the upper edge 2 ft. $11\frac{1}{4}$ in. from the floor. Strengthen the backs of the joints by fitting blocks and gluing and nailing them on.

Make the countershelf of 1 by 7-in. by 4 ft. 8-in. stock, and notch it between the stiles so as to project under the shelves, where the back edge is nailed. The front edge is flush with the front of the rail, and the left end terminates against the rough work of the drainboard, which is built in later. Now fit the wall stile, cut in the ceiling rail, of 1 by 6-in. stock, shimming the partition to keep the rail flush with the stiles, and put in the lower rail, of $\frac{1}{8}$ by 3-in. stock, also sized to $2\frac{1}{2}$ in. in width. Cut in the other stiles as dimensioned in the elevation. Fit the short rail, of $\frac{1}{8}$ by $2\frac{1}{2}$ -in. net stock, between the stiles, the lower edge being 3 ft. $9\frac{1}{2}$ in. from the countershelf and the upper edge

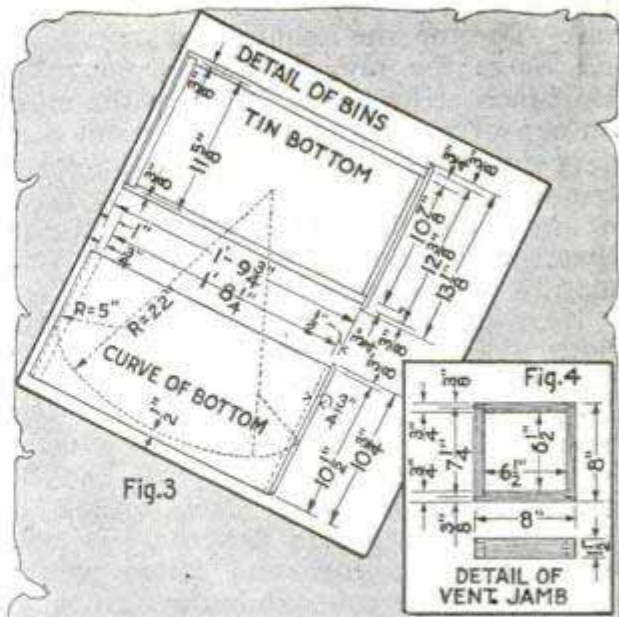
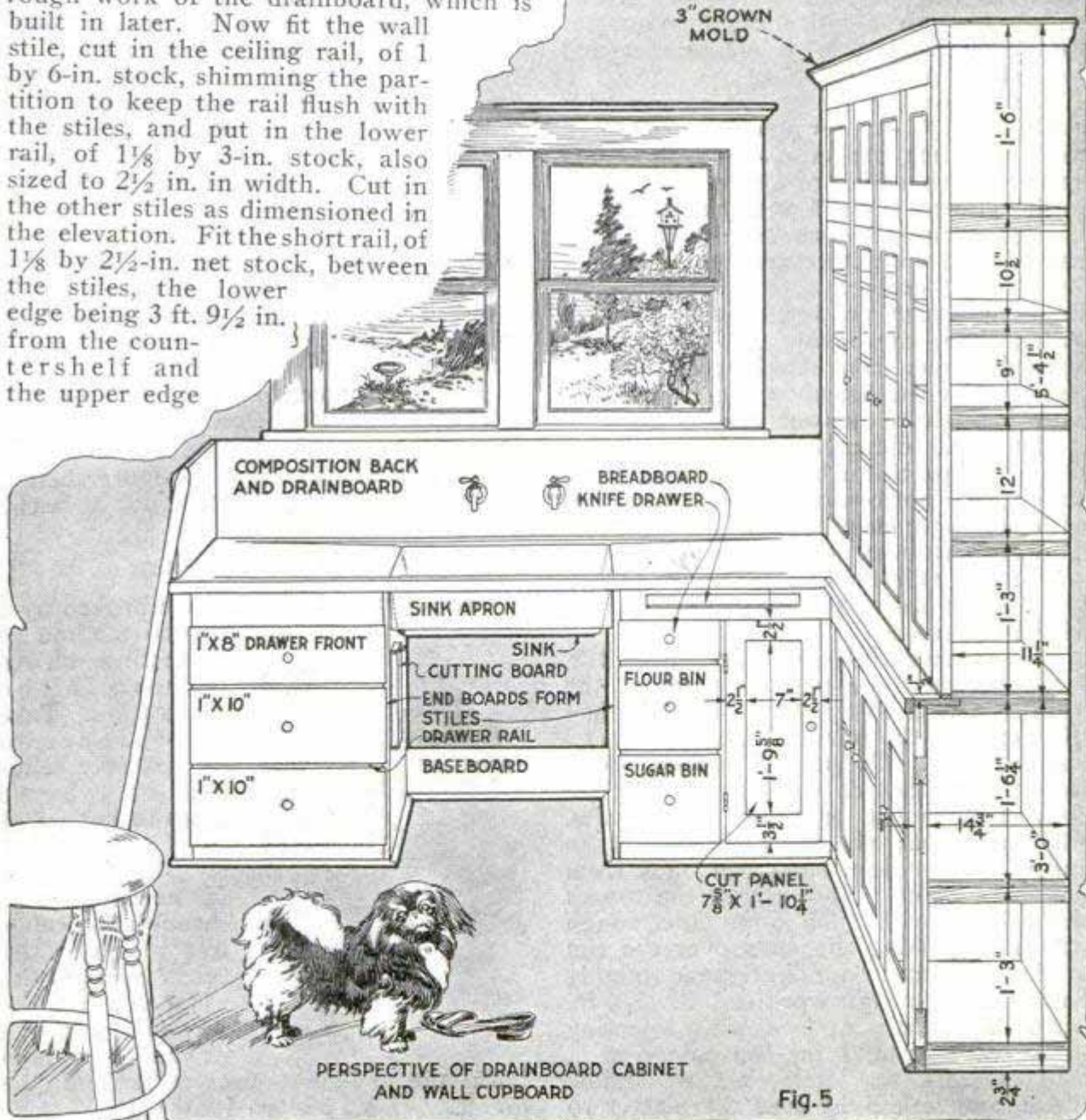

Fig. 3

Fig. 4

DETAIL OF VENT JAMB

3" CROWN MOLD



PERSPECTIVE OF DRAINBOARD CABINET AND WALL CUPBOARD

Fig. 5

Local Plumbing Shop

1 ft. from the lower edge of the ceiling rail. The top shelf shows a margin of $\frac{1}{4}$ in. above the rail, forming a doorstep. Half-inch strips, fitted between the stiles on top of the countershelf, prevent sagging doors from ever scraping the countershelf when opened, while leaving $\frac{1}{4}$ in. of the shelf edge for doorstops. Notice that the lower rail leaves a similar stop margin on the lower shelf.

Next fit the drainboard-cabinet partitions against the wall, locate and place the drawer-slide cleats, and nail them up. In doing this, be sure that the upper ends are level and line with the top of the wall cleat. Fit the end-wall stile, nail in place, and fit the rails. These are of $1\frac{1}{8}$ by 3-in. stock, put in flat, the left ends being notched, glued and nailed around the back of the stile, while the right ends are butted against the end partition and nailed through it with 4 eight-penny finish nails, which are, of course, set and puttied up before finishing.

The drawer guides at left consist of a guide of 1 by 1-in. net stock, long enough to fit between the stile and wall, glued and nailed to a slide of $1\frac{1}{8}$ by 3-in. stock, to fit between the rail and the wall cleat. The guide must be square with the front and parallel with the partition, as well as level, if the drawer is to work properly. For the upper drawer, cleats must be nailed above the opening, to prevent the opened drawer from sagging; or the center cleat for the drainboard may be made wide enough to answer the purpose.

The detail dimensions the breadboard rail. The partition behind it must come only to the bottom of the slot; together with the upper cleat, of $1\frac{1}{8}$ by 3-in. stock, it forms a runway for the breadboard.

The lock stile for the small door is 1 by 1 in., glued and nailed against the stile of the cupboard.

This construction gives a space of 2 ft. 4 in., between the two divisions of the cabinet, and a 20 by 30-in. sink will just slip between the partitions, the rim resting on them. To provide nailing space for the drainboard backing, nail a 1 by 2-in. cleat to the partitions at the rim. Also nail, under the front of the sink, an apron of 1 by 6-in. stock, set back from the front $\frac{7}{8}$ in. Now sheath the top of the cabinet with 1 by 6-in. pine, rough side up, notching the ends over the rim of the sink, and rounding them roughly on top. The rough work is 1 ft. $11\frac{5}{8}$ in. wide. Tack laths underneath, projecting $\frac{3}{8}$ in., as a ground for the composition man to work to. Remove the window apron, and lath tight over the plaster to

the bottom of the stool, returning the back around the end wall.

This provides for the use of woodstone, magnesite, asbesticite, or practically any other of the compositions now on the market from which one-piece drainboards and splash backs are molded. They are sanitary and wear much longer than wooden drainboards, and are comparatively cheap. They are subject to staining and are eaten by fruit acids, but a little care in their use will obviate this difficulty.

Build the bins of 1 by 12-in. stock. Lay out the sides to the curve shown, cut the curve, and tack the lower pieces on again. Assemble the drawer without a bottom, avoiding nailing through the lower pieces, which are immediately removed. In the front and back cut saw kerfs, $\frac{3}{8}$ in. deep, continuing the curve of the sides. Cut a strip of cardboard to measure the length of the curve and cut a piece of tin to fit. Slip the ends into the kerfs, tack down, and nail the bottom pieces solidly.

Build the other drawers of $\frac{3}{4}$ -in. stock, for the fronts, and $\frac{5}{8}$ -in. stock, for backs and sides, assembling the frames and slipping in the bottoms afterward. Make the eight large doors of $1\frac{1}{8}$ by $2\frac{1}{2}$ -in. net stock, for stiles and upper rails, and of $1\frac{1}{8}$ by $3\frac{1}{2}$ -in. net stock, for the lower rails. The four small upper doors are entirely of $2\frac{1}{2}$ -in. stock. The latter are hinged at the top.

Build the cooler shelves of $\frac{3}{8}$ by 2-in. strips, spaced as shown in the drawing. Run baseshoe around the cabinets, and nail on the front of the countershelf a piece of 1 by 2-in. material for a fascia.

Slide-Rule Protector

Slide-rule glasses are often broken by a slight knock or jar. A good method of protecting them is shown in the illustration. Take two pieces of fairly heavy celluloid and bend them in hot water to the semicircular shape shown. Holes are drilled through the celluloid to match the screw holes in the slide, and the screws are then driven in to hold

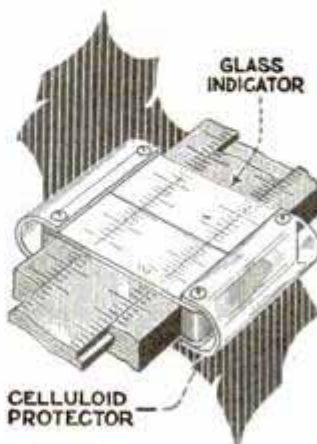

both the celluloid protectors and the glasses.—C. C. Fisher, Ithaca, N. Y.

Unloading Drain Tile

Unloading tile is a hard and tedious job, and it is nearly impossible to distribute them equally. A convenient method of laying them is shown in the drawing. The tiles are loaded on the grain wagon and a wooden trough, smoothed inside, is hooked to the rear end of the wagon and drags on the ground

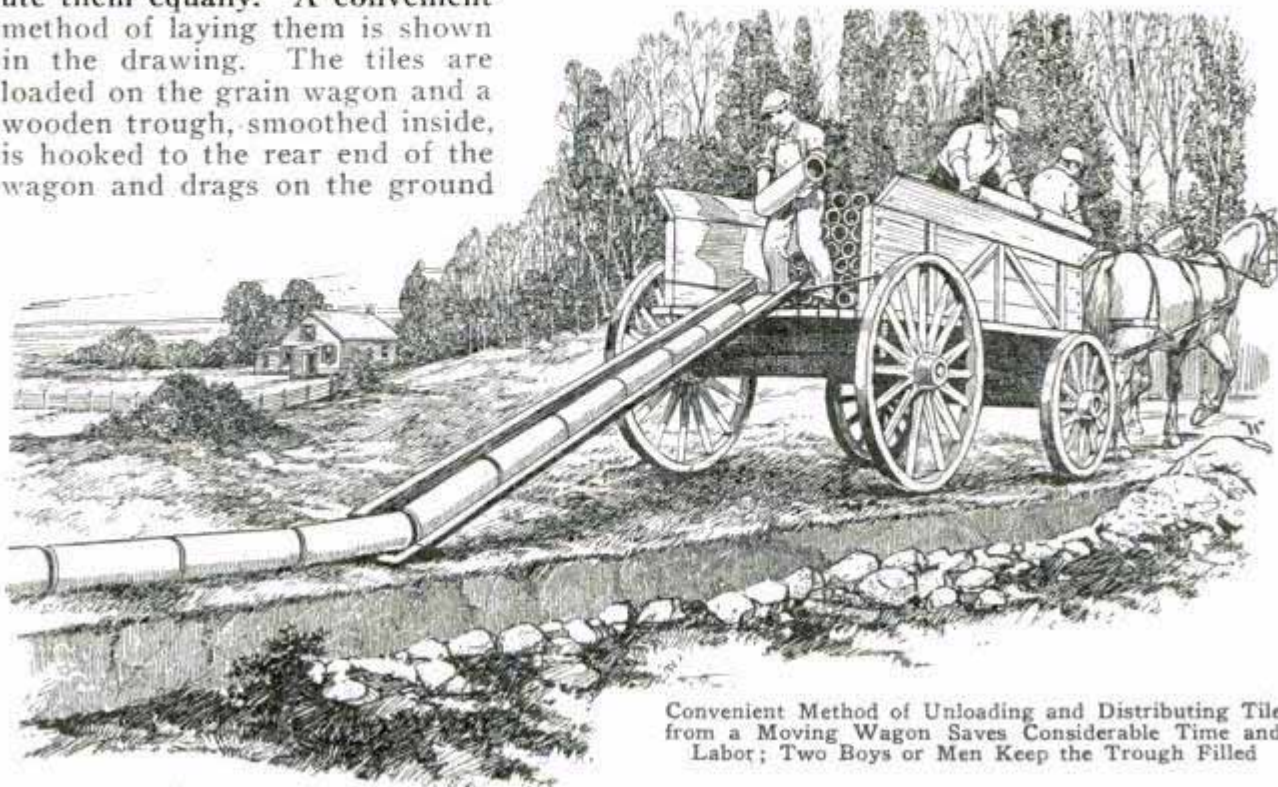

Convenient Method of Unloading and Distributing Tile from a Moving Wagon Saves Considerable Time and Labor; Two Boys or Men Keep the Trough Filled

while the wagon is pulled ahead. Two or three boys or men on the wagon, lay the tiles in the trough end to end and the tiles slide down on the ground as the wagon moves along. Of course, the slant of the trough must be such that the tiles will slide down readily. In this way it is possible to unload the tiles in a few minutes and have them equally distributed. —Simon M. Schwartz, Berne, Ind.

Repairing Cylinder Break

There are many methods of repairing cylinder breaks, the most common of which is welding. This is good practice, provided the parts are pre-heated, under which condition the weld can be relied on for service. Seaming the break with overlapping brass studs, tapped into holes drilled along the break, is also a good method if the break is in the center of the casting. Re-

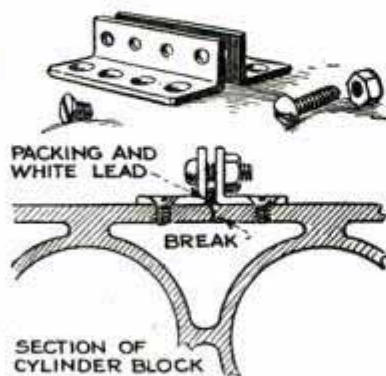

pair, which not only closes the gap but also draws the sides of the casting together, is shown in the illustration. Two angle plates are drilled as indicated and holes of corresponding size are drilled and tapped in the casting so that the plates can be screwed down with a little space between the adjacent sides. Packing, saturated in white lead, is tamped down between these sides directly over the crack, and small bolts and nuts are used to draw the sides together, which forces the packing down still more tightly. The plates, also, are bedded in white lead.—G. A. Luers, Washington, D. C.

Rethreading Tire Valves

When rethreading the inside of a tire valve, it should be held with the outer end downward and the small tap used should be dry and clean. This will cause the cuttings to fall out of the stem, preventing later trouble with a valve inside. If a battered outer end of a valve stem is to be refaced, the valve should be held with the outer end down or the work done with air in the tire. The center pin of the valve inside will strike the refacing tool and release some of the air, which will blow away the cuttings as fast as they are formed.—E. T. Gunderson, Jr., Humboldt, Iowa.

Operating Snips by Foot

Much more power can be applied to an ordinary pair of tin snips by means of the simple foot attachment shown in the illustra-



Cutting Heavy Work with Ordinary Tinnners' Snips by Foot Power

tion. This enables the worker to use the shears on much heavier work than can be cut by hand. A length of heavy wire is attached to one handle of the snips and reaches almost to the floor. At its lower end the wire is bent to form a loop for the worker's foot. The free handle of the snips is then held securely in a vise.—L. J. Trost, Kelly Field, Tex.

Planting Fence Posts Securely

Usually a post that is planted or driven into wet, swampy ground is hard to keep tight. It either becomes very loose or is lifted out of the ground entirely by hard freezing. Loose posts are certain to cause a loose, worthless fence. If this is your trouble, you can remedy it by digging the hole deep and wide. About 8 in. from the lower end of the post, saw a notch across it, a few inches deep. Get a piece of locust wood, about 18 in. long, mortise it into the notch in the post and nail it securely. When the post is planted and the hole is back-filled, the weight of the dirt will be on the crossbar and hold it down. The post will then stand solidly until it decays.—J. Marshall Porter, Cumberland, Md.

Chain-Block Sling for Tanks

Tanks can be handled easily with a chain block if there is a convenient hole in the tank. A shop doing this kind of work uses the special slinging device shown in the photo. It consists of a length of flat steel, 1 in. wide by $\frac{1}{4}$ in. thick and bent double, a crosspiece at right angles, $\frac{1}{2}$ in. thick, turning on a pin, and a sleeve fitting over the flat piece. This sleeve has a slot sawed out halfway around it to clear a screw turned into the doubled piece, and a slot on one side to clear the crosspiece. Before assembling, a chain ring is slipped into place in the bent piece for greater convenience in handling. One side of the crosspiece is heavier than the other; in other words it is off center. When inserting the device in the hole in the tank the heavy end is turned up inside the sleeve. When it has passed through the hole, the heavy end drops down to the horizontal position shown and is ready for lifting. To remove the sling from the tank, the sleeve is turned around till the other end of the horizontal slot stops against the screw. When the sling is pushed farther down into the tank the heavy end of the crosspiece falls down in line with the sleeve, enabling the sling to be pulled out. This device will be found useful also for lifting other pieces with holes in them when it is impossible to get inside of them with

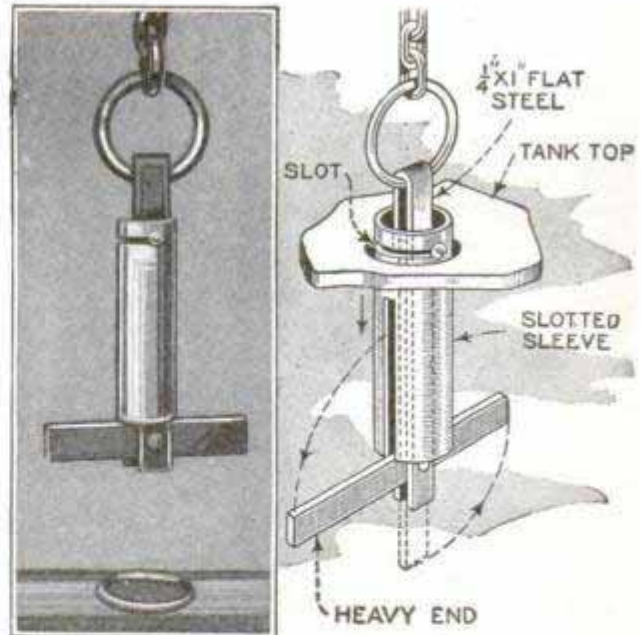

Convenient Chain-Block Sling Used for Hoisting Tanks Has Large Capacity and Is Simply Made

the hands. The lifter described, although of comparatively light material, has been used on tanks weighing up to 500 lb.—Harry Moore, Montreal, Can.

Story and One-Half Dutch Colonial

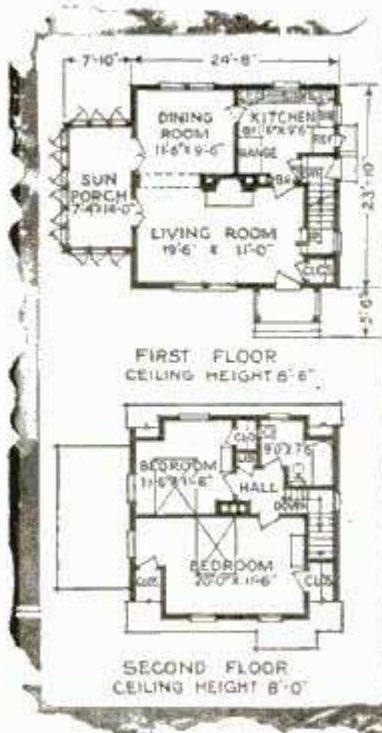

Copyright, Architects' Small House Service Bureau

Plan No. 5A29

QUESTIONS regarding home building addressed to this magazine will be answered by the Architects' Small House Service Bureau of the United States, Inc., controlled by the American Institute of Architects and indorsed by the department of commerce, United States government. Blueprints, specifications and material lists for the house shown above may be obtained at a nominal cost. Inclose self-addressed, stamped envelope for reply. If further information is desired send five cents and stamped envelope for a 24-page booklet explaining how the small home bureau functions and showing twelve sample plans.

HERE is a house without a trace of affectation and obviously one that will be in harmony with the life within and about it. Its style is borrowed from the Dutch colonists, but in this case an American dormer window has been added to complete the design.

It provides five main rooms, bathroom and five closets. It will require a lot from thirty-eight to forty-three feet in width. It is planned to be built of wood frame on masonry foundations, with a brick base course. The exterior is wood siding for the walls, and the roof shingled. You will find in this house every modern convenience and comfort within a small area, which has been so adjusted that in reality the interior appears exceedingly large for the size of the house. The sunporch assists greatly in producing the spacious effect on the first floor. It opens directly into the living and dining rooms.

One large open fireplace in the living room, with wide mantel shelf, takes care of the flues for the heater, kitchen range and fireplace itself. This, of course, is an economical arrangement. Each bedroom, on the second floor, has a closet, and light and air from two sides.

This house has much to commend it in plan and appearance, as well as construction costs.

Home Builders' Questions

Q. What type of gutter is the most lasting and inexpensive? **A.** The common hanging gutter is the most lasting and inexpensive that can be put on. If it is made of tin and it should happen to leak in time, it can easily be repaired or replaced. If it is made of copper, it may last a lifetime.

Q. How high above the porch roof ought the chimney stack to project? **A.** Run the stack three feet higher than the ridge.

Q. Does seasoning wood make it stronger? **A.** Many specimens of green wood tested in comparison with the same sections and kinds of seasoned wood show that, under a given load, the seasoned wood will deflect less, will not crush so soon, and will not break so readily as the green wood.

Q. My house was completed last June and the cesspool has already backed up a few times. Who should stand the expense of having this remedied, the contractor or myself? **A.** The contractor is not responsible for the backing up of your cesspool if it was built according to your directions or if you accepted it when he built it.

Q. What shall we do when the mortgage becomes due? Can it be renewed? If not, what shall we do then? **A.** If your property is a good risk you can almost certainly get a new mortgage written against it. If the person who loaned you money on the first mortgage will not renew, get somebody else to do so. It would be wise to get all the details in this regard well in advance of the date when the mortgage is due.

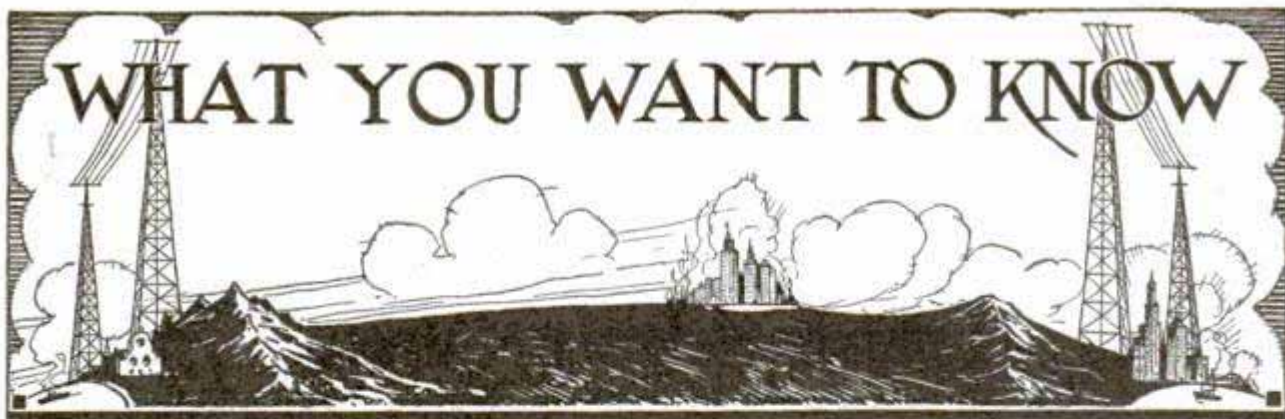

Q. I have a charger for recharging wet type B-batteries; how can I hook this up to a double-pole, double-throw switch so that I can charge both of the 48-volt units at once, in parallel, when the switch is thrown one way and the set connected when the switch is thrown in the opposite direction? **A.** This is very simple and the diagram (Fig. 1) shows how it is done. Two double-pole, double-throw switches are required, however; these switches may be of the common porcelain base

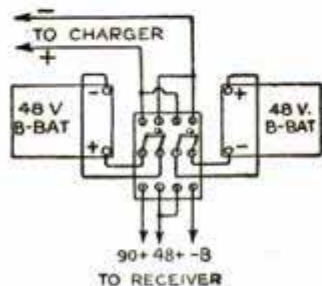

Fig. 1

type and should be mounted side by side in the manner shown.

Q. I am located in a dry, sandy country, where a good ground is hard to obtain. Can you offer any suggestions that would help me out? **A.** A counterpoise ground will solve your problem. This is obtained by stringing another wire under your present aerial and insulating it in the same manner; the lead from this wire goes to the ground post of the receiver. The diagram (Fig. 2) gives you the idea in detail; note that the aerial lead-in and the counterpoise lead are taken into the building at different points. It is also necessary, of course, that these leads be passed through porcelain insulators.

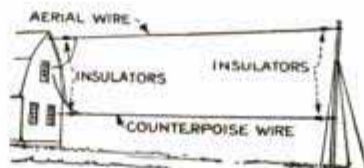

Fig. 2

Q. Can I use a wood panel for my radio set? If not, why? **A.** Wood makes a poor radio panel; it is never totally free from moisture and leaks are sure to occur. The minute energy employed in radio reception must be conserved, if good results are to be obtained. Bakelite, formica, and hard rubber all make good panel material, and provide good insulation as well as add to the appearance of the set.

Q. Have B-battery eliminators been improved to a point where they are practical, and all hum is eliminated? What is the total voltage that can be obtained without a detrimental drop when from five to eight tubes are used? **A.** There are several good B-battery eliminators now on the market that will meet these conditions. Some are designed for sets using up to five tubes and others can be used on eight and nine-tube sets if the highest B-voltage does not exceed 90 volts. Our tests show that some will deliver even higher voltage under an eight-tube load. Some of these eliminators give a slight hum, others are very quiet.

Q. I am using a B-battery eliminator with my eight-tube superheterodyne; this eliminator uses UV-201A tubes. When other electric apparatus is turned on in the house, the signals from the distant stations fade and the eliminator has to be readjusted to bring the

signals in at the former volume. What are the cause and remedy? **A.** The wiring from the mains to the house may not be large enough to carry the load of the other electrical apparatus in use, and when the house-light load is on, there will be a drop in voltage. This will also show in the B eliminator, and cause the signals to fade. The only remedy in this case is to get in touch with your power company and explain the situation to them; they can correct the trouble easily.

Q. What type of circuit is the worst offender for re-radiation? I live in a congested district and do not wish to annoy my neighbors. **A.** Single-circuit tuners and sets of the ultra-audion type are troublesome in this respect, and should not be used in crowded localities.

Q. Would the volume and range of a regenerative detector set be increased if two stages of r. f. amplification were added? **A.** The volume and range would be increased very little. You should add one or two stages of a.f. amplification instead.

Q. I have a Delco lighting plant, and when this plant is in operation it is impossible to use the radio set. What can I do to prevent this interference? **A.** Shorten the leads from the magneto or spark coil, and run them through a grounded shield. Metal-covered conduit or lead-covered cable can be used to good advantage. Ground the frame of the engine, magneto and metal shielding thoroughly.

Q. How can I repair my electric soldering iron? I have had it but a very short time and it is burned out. **A.** Remove the heating element; if the resistance wire is open close to the terminal, a new connection can be made by spreading the wire, and fastening it under the terminal. If the break is near the center, a temporary repair can be made by twisting the broken ends together.

Q. I wish to construct a three-circuit tuner employing only one tube; please show me the simplest circuit possible to do this. I have the tuner coil and a circuit for three tubes, but at present I wish to use the detector only.

A. We are giving you the circuit on this page (Fig. 3). It can be used with any type of three-circuit tuner. Use a .0005-mfd. variable condenser, and a 25-ohm rheostat. If the UV-199 tube is used, the A-battery should consist of three No. 6 dry cells connected in series, but if you are going to use a UV-201A or C-301A tube, it will be necessary for you to employ a 6-volt A-battery.

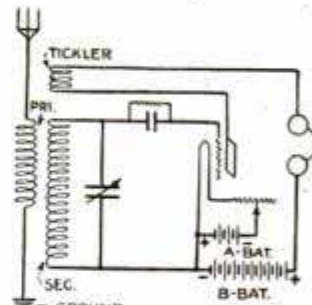

Fig. 3

IN accordance with the editorial policy of this magazine never to accept compensation in any form for what appears in our reading pages, and also to avoid the appearance of doing so, we are obliged to omit the name of the maker or the seller of any article described. This information, however, is kept on file and will be furnished free, by addressing Bureau of Information, Popular Mechanics Magazine, Chicago. [Editor.]



You buy a saw for cutting— so get the Saw that *cuts*

THERE need be no mystery in saw-buying. Not if you know a few basic facts about saws.

The saw is a cutting tool. Get the saw that cuts best and you have the best saw.

You can't very well try how a saw cuts in the hardware store, but you can ask for the saw that has grown great by its cutting.

Henry Disston made a saw that cut better than other saws. Then he developed his own saw steel to give an even keener and more lasting edge....

Eighty-five years of making saws that cut! Of balancing and taper-

ing Disston-Steel blades for speed and ease and perfect clearance. No wonder the Disston is "The Saw Most Carpenters Use"!

And today your own hardware dealer will sell you a Disston Saw that cuts better than ever.

Ask Disston

Tell us what work you are doing, in wood, metal, stone, ivory, rubber, leather, cloth, fibre or other materials. We will tell you how to saw it better and easier. Disston issues many free books to aid saw users.

HENRY DISSTON & SONS, INC.
Philadelphia, U. S. A.

DISSTON



The Future of the Telephone

IT WAS fifty years ago that Alexander Graham Bell invented the telephone, and yet this anniversary is but a milestone in the progress of telephone development. As the giant oak with its complicated structure grows from the acorn, so a nation-wide system has grown out of Bell's single telephone instrument.

The interconnection of millions of telephones throughout the land, regardless of distance, has not come about easily. It has resulted from a series of scientific discoveries and technical achievements embodied in a telephone

plant of vast extent and intricacy. Great economies have already been gained by such technical improvements and more are sure to follow for the benefit of telephone users everywhere.

There are still to come many other discoveries and achievements, not only in transmission of speech, but also in the material and construction details of every part of the network of plant.

The future of the telephone holds forth the promise of a service growing always greater and better, and of a progress—the end of which no one can foresee.

AMERICAN TELEPHONE AND TELEGRAPH COMPANY
AND ASSOCIATED COMPANIES

BELL  **SYSTEM**

IN ITS SEMI-CENTENNIAL YEAR THE BELL SYSTEM LOOKS FORWARD
TO CONTINUED PROGRESS IN TELEPHONE COMMUNICATION

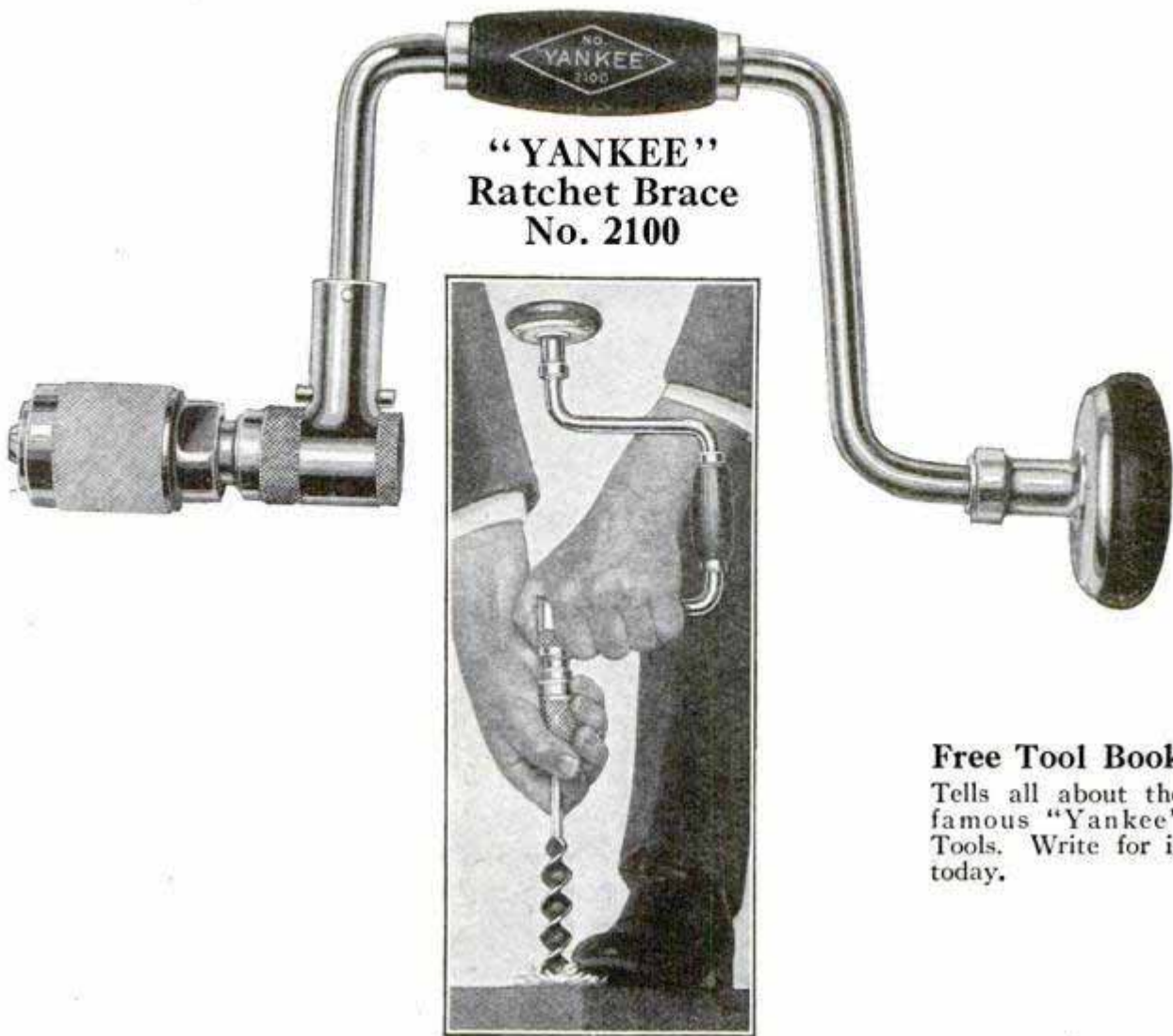

**"YANKEE"
Ratchet Brace
No. 2100**

Free Tool Book
Tells all about the famous "Yankee" Tools. Write for it today.

Try This Test—Yourself

Put auger bit in the chuck of "Yankee" Brace No. 2100. Bore deep into tough wood. Then pull upward with all your strength. Bit will not come out of chuck.

For this new "Yankee" Bit-brace Chuck is the most efficient ever made. Ball bearing, quick centering, and accurate.

You can slip into it any shape bit (round, square, any taper) and the bit is there to stay until you wish to release it.

This wonderful "Yankee" Brace is made especially for the man who appreciates a superior tool. For the man who wants accuracy and efficiency. For the man who knows that there is real economy in using

the finest tool of its kind because it saves time and labor.

And this new "Yankee" has the famous "Yankee" Ratchet. Smooth as stem-wind of a watch, yet unbreakable. Dust-proof and moisture-proof. The handles are hard rubber and indestructible.

"Yankee" nicked finish—the most durable known.

Some Other "Yankee" Tools

Ratchet Hand Drills Ratchet Screw-drivers
Automatic Feed Bench Drills Ratchet Tap Wrenches
Vises, with Removable Base

Dealers Everywhere Sell "Yankee" Tools
"Yankee" on the tool you buy means the utmost in quality, efficiency and durability

NORTH BROS. MFG. CO., Philadelphia, U. S. A.

"YANKEE" TOOLS

Make Better mechanics

"Something better"

"LET ME SEE something better" says the customer—very frequently indeed. That something better in an automobile may cost several hundred or perhaps even several thousand dollars more; but in a cigarette it costs just three cents more

F A T I M A

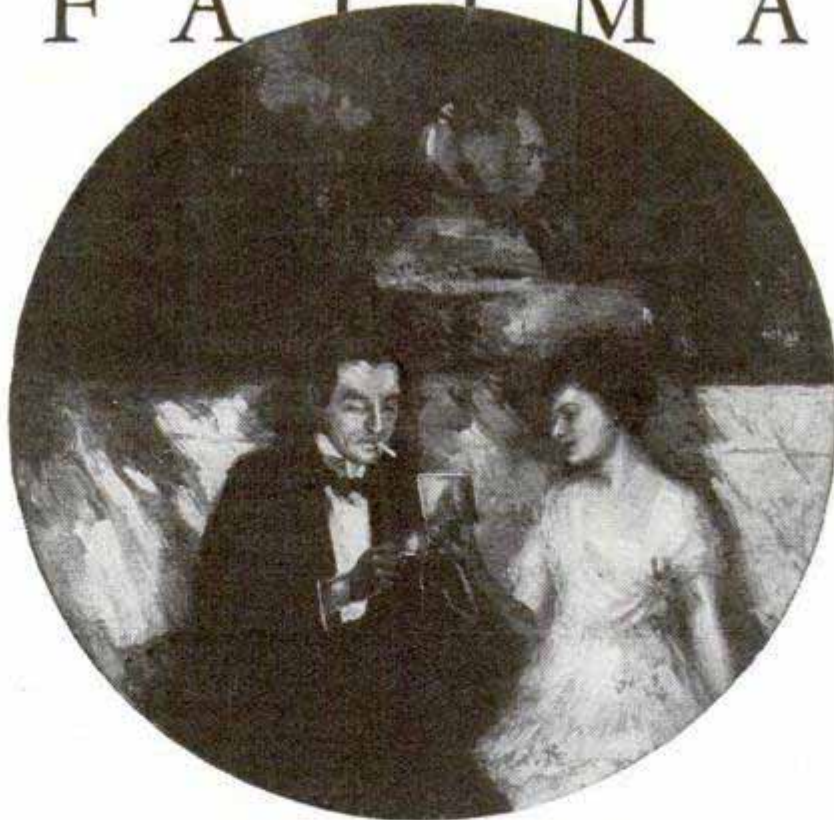

*"What a whale of a difference
just a few cents make"*

This husky hammer makes hard hitting easy



Look for
the
Red
Handle
with the
Black
Head

EXCLUSIVELY
PLUMB
(Trade Mark Reg.
U. S. Pat. Off.)

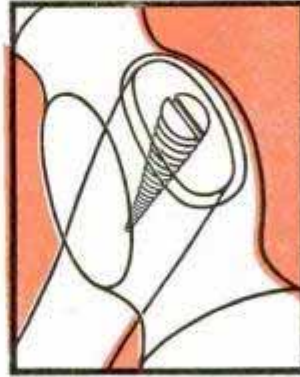

SOLID blows
without effort!

When you work on metal—drive a cold chisel or a punch—spread a rivet—cut a gasket—work around the car—

Do the hard hitting easily with a Plumb Ball Pein. See the weight of metal behind that tough face. See how the whole head is mounted off-center to add power.

See the sturdy mounting of the black head on the red handle—the oblong eye takes the handle full-size.

The pein is cone-shaped, not round. It spreads rivets instead of mashing them.

And there is the Take-Up Wedge (exclusive Plumb invention). If ever a hammer needed a tight head, this one does.

A tight head is assured on this, and any, Plumb Tool, with a turn of the wrist on the Take-Up Wedge.

To improve your work, to make hard hitting easy and safe, swing a Plumb Ball Pein Hammer.

FAYETTE R. PLUMB, Inc.
Philadelphia, U. S. A.

The Plumb Ball Pein Hammer. At good Hardware stores everywhere.

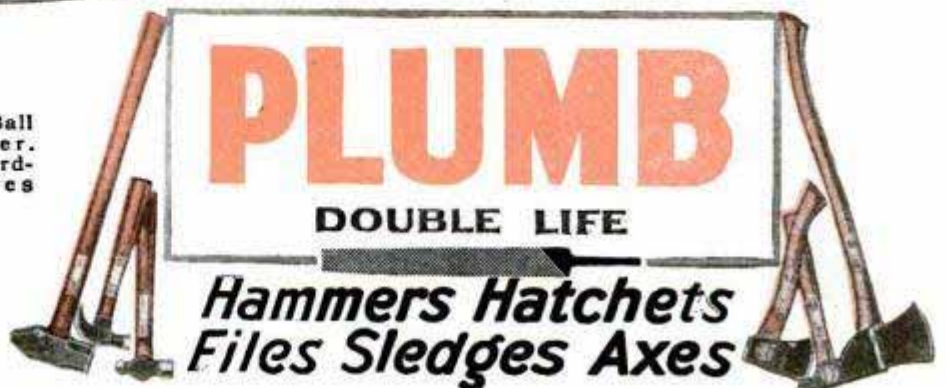



“Right?”
 “Sure it is—
 I used a Brown & Sharpe”

There's genuine satisfaction in doing work accurately. Whether you work in a tool room, on a production machine or in your own shop at home, you want your work to be *right*.

For accurate work you need good tools—the best tools that can be had. Brown & Sharpe Tools *are* good tools. Their high accuracy and fine design will always help you do work that is *right*.

Our Small Tool Catalog lists over 2,000 Brown & Sharpe Tools.
 Write for your copy today.

BROWN & SHARPE MFG. CO., PROVIDENCE, R. I., U.S.A.

BROWN & SHARPE TOOLS

“Standard of the Mechanical World”

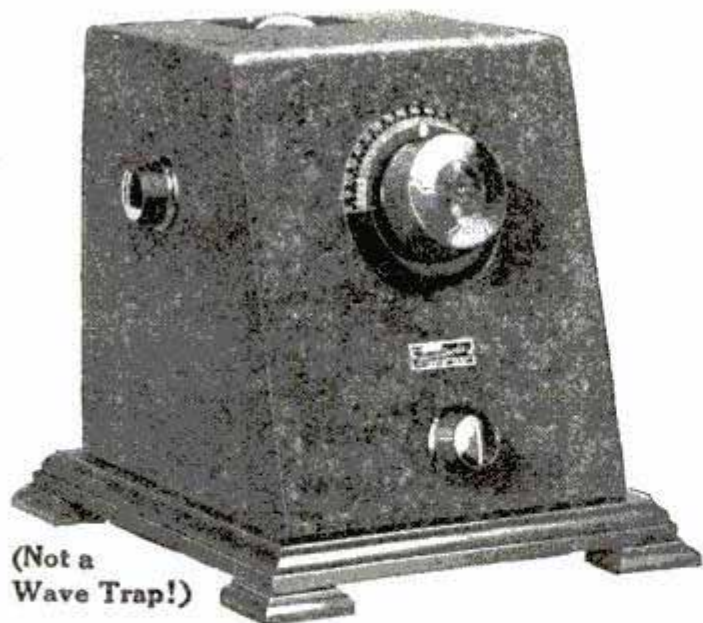

(Not a
Wave Trap!)

It *IS* true!

188 times the energy... and there is absolutely nothing else at all like

P E N E T R O L A

Without Penetrola the signal intensity of WOAI was 11, on the Audibility Meter—an impartial precision measuring device. With Penetrola the signal intensity of WOAI jumped above 2000—188 times the signal strength! Without Penetrola the scientifically measured signal intensity of WCAL was 35, scrambled with WCB at 29. With Penetrola WCAL went to 2000+ and WCB to zero—*selectivity with a vengeance!*

This is just exactly the sort of thing any Penetrola demonstration will show you on any set with any number or arrangement of stages. The wanted station is immensely intensified; interference is overwhelmed by Penetrola. There is so much volume available for the most distant signals that a shorter aerial may be used, curing excess static. Your set is stopped from radiating, and is stabilized. It is needless to operate near the oscillation point. And dial readings stay substantially the same.

Radio principles known to be of immense promise, but hitherto elusive, are now successfully applied by Walbert Penetrola. The widely heralded Isofarad Circuit, latest development of Walbert engineers, is the foundation of Penetrola performance. Here is one radio appliance literally unduplicated in any way by anybody, because there is no other Isofarad circuit. Nor is there any substitute for Penetrola action, which amplifies *ahead* of the detector entirely, strengthening signals which would otherwise never be detected! Remember, signals too weak to detect cannot be amplified by any means placed *beyond* the detector.

In a few moments any receiver, however costly, can be transformed with Penetrola. Or anyone can quickly assemble the Penetrola kit and obtain amazing Penetrola results most economically. The Penetrola price buys performance which cannot be obtained with any amount of investment in a receiver alone.

1st
Walbert
Made It
FIRST

For the sensation of the European tests note Penetrola Reception!

Penetrola in beautiful Black Crystallite, \$35
for Instant Attachment
Penetrola Kit with Complete, Simple \$15
Instructions

If your dealer is not stocked, remit purchase price direct to factory and you will be promptly supplied. State whether you wish Penetrola for outside aerial or for loop receiver.

W A L B E R T

Manufacturing Company, 933 Wrightwood Avenue, Chicago

Look *sent on* Approval

Adjusted to the Second
 Adjusted to Temperature
 Adjusted to Isochronism
 Adjusted to Positions
 21 Ruby and Sapphire Jewels
 25 Year Gold Strata Case
 Your choice of Dials
 (Including Montgomery R. R. Dial)
 New Ideas in Thin Cases

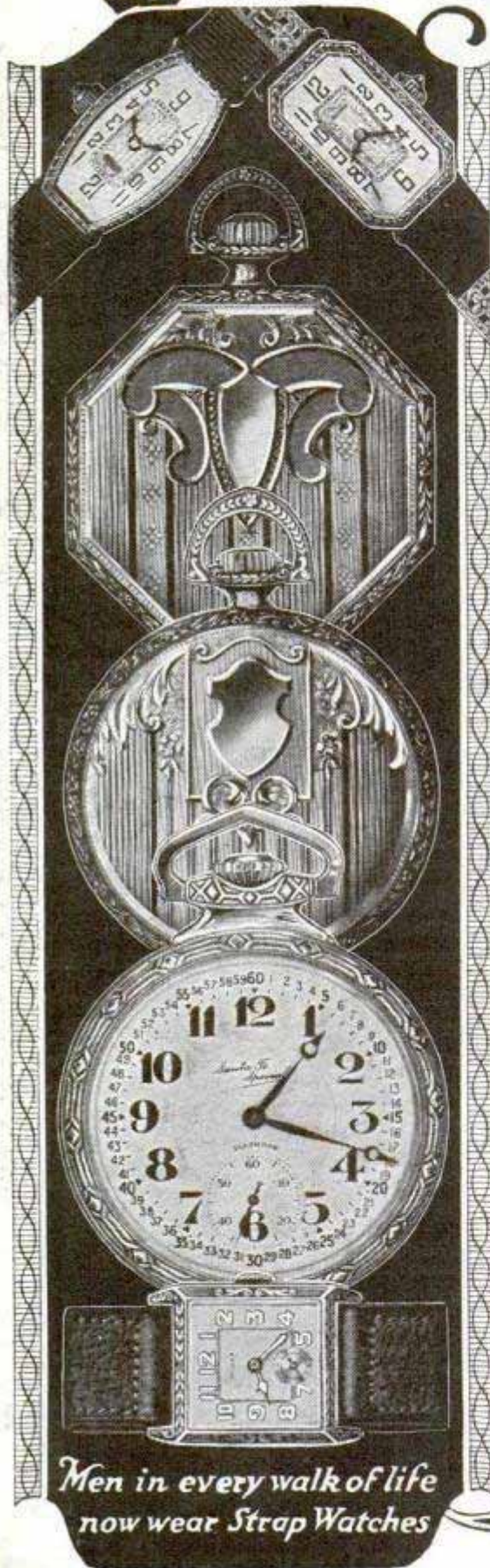

Men in every walk of life
 now wear Strap Watches

The 21 Jewel Santa Fe Special

We will send this famous watch, express prepaid, for you to examine, to inspect, to admire, to approve without one penny advance payment. Examine the watch and be convinced it's the best watch buy you ever saw. Just a small payment down, the balance in easy MONTHLY payments. You use the watch while paying for it.

Save $\frac{1}{3}$ to $\frac{1}{2}$ of Your Money

By purchasing this Famous Santa Fe Special Watch. Not only are you saving money from the present day prices of watches, but you can still secure the "Santa Fe Special" Watch, at the same low prices and terms that have made our watches famous.

Ladies' Wrist Watches

Artistic, dependable ladies' wrist watches—perfect timepieces, beautiful hand engraved cases in white or green gold. Send for New Watch Book and see the new shapes and designs. Sent on approval and sold on payments.

Write for "Santa Fe" Watch Book

Clip the coupon, fill out and receive the FREE WATCH BOOK just off the press. All the newest watch case designs in white or green gold, fancy shapes and thin models are shown. Read our easy payment offer. Wear the watch 30 days FREE. Watch sent for your examination and approval without a penny down. Nothing to risk. See the watch before you buy.

Write for New Book Today and Select Your Watch.
 Mail Coupon.

SANTA FE WATCH COMPANY

26 Thomas Building, Topeka, Kansas
 (Home of the Great Santa Fe Railway)

JUST OUT!

Send for our New Watch Book—Just off the press. It will post you about watch styles and values. Send for it today—It's FREE.

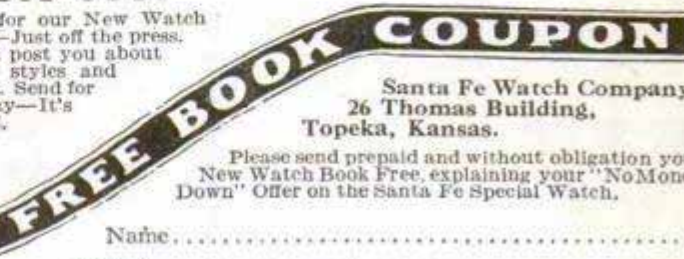

Santa Fe Watch Company,
 26 Thomas Building,
 Topeka, Kansas.

Please send prepaid and without obligation your New Watch Book Free, explaining your "No Money Down" Offer on the Santa Fe Special Watch.

Name

Address

State



LESS than carfare or busfare, far less than automobile cost—riding the new Harley-Davidson Single is the most economical means of comfortable travel.

Wholly a new type of machine. Travels 80 miles on every gallon of "gas"—ample power and speed for all road and traffic conditions—above all, a safe, sensible, comfortable mount for everyday use by everybody.

Easy to ride—practically self-balancing. You'll master it in the length of a city block.

Ride it to work and back—on errands—for pleasure on evenings and Sundays—and *save money every mile!*

Ask your Harley-Davidson Dealer for a demonstration. Mail coupon for illustrated literature.

HARLEY-DAVIDSON MOTOR COMPANY
Dept. P MILWAUKEE, WISCONSIN

The New
HARLEY-DAVIDSON
Single
[The New-Type]
[Motorcycle]

Safe—Comfortable

Perfect balance and a low center of gravity provide maximum safety at any speed. Luxurious springs in fork and seat post smooth out the roughest roads. Low saddle position adds to riding comfort and ease of handling. Balloon tires and broad footboards add the finishing touches to comfortable riding!

Park It Anywhere

Ride right up to your destination—and park there. Any 2x8 space will house your Single—in a hallway, on the porch, in a garage corner—anywhere. No parking troubles in even the most congested centers.

Easy to Buy

The Single is low in price. If you prefer to pay for it out of your income, your dealer has a convenient Pay-As-You-Ride Plan that he'll gladly explain to you.

Note: Rich sales opportunities now in the motorcycle business. Write for proposition.

*Mail
this
Coupon*

Harley-
Davidson
Motor Co.
Dept. P
Milwaukee, Wis.

- () Send free literature describing the "New Single"
() I'd like to sell the New Single. Particulars, please.

Name.....

Address.....

City.....

State.....

SARGENT

PLANES

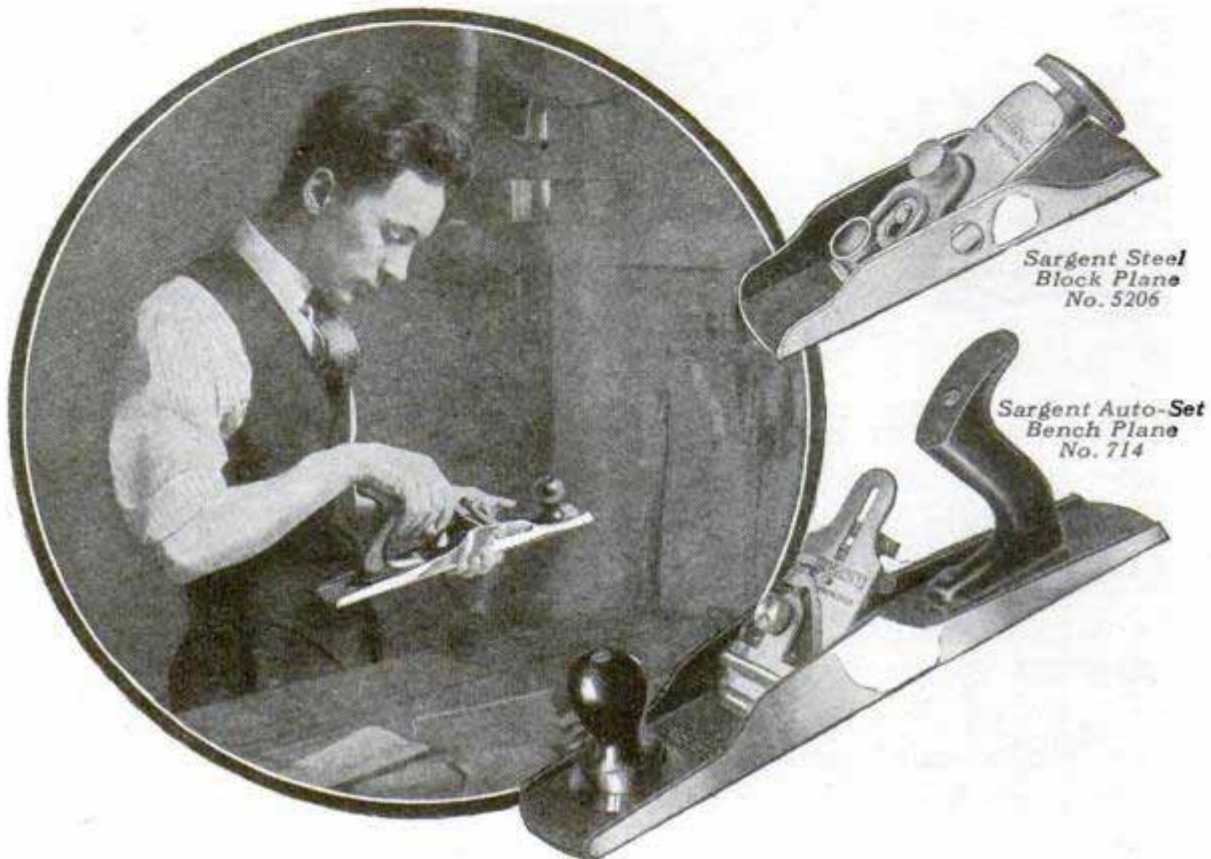

Sargent Steel
Block Plane
No. 5206

Sargent Auto-Set
Bench Plane
No. 714

Are the planes you use at home
or school as fine as these
Sargent favorites?

THESE Sargent Planes are popular tools with carpenters, manual training instructors and students, and chaps with home workshops. The reason is not hard to find. They are professional tools through and through—time-tested and proved most worthy. Carpenters find them superior for the most difficult jobs. Many school and home work benches can also testify to the quality of the work they do. They resist wear, seldom if ever needing repair or replacement.

The Sargent Auto-Set Bench Plane No. 714—the larger of the two illustrated—is particularly easy to adjust. The cutter of wear-resisting chromium steel can be removed, resharpened and replaced without changing original adjustments. How cleanly and quickly it cuts—across the grain, against the grain

and over rough or knotty surfaces, with never the slightest chatter. The Auto-Set is quite a time-saver—a tool of delightful "feel" and balance. It makes the big jobs easy.

The Sargent Steel Block Plane No. 5206 is a convenient plane for the smaller jobs. The low angle of cutter particularly fits it for end work. The cutter here, as in every Sargent Plane, is of chromium steel—selected because of its unusual edge-holding ability.

These two planes will take care of practically every job you'll ever have. They are versatile, dependable, lasting—and really most economical. You'll be proud to own both. See them at almost any good hardware store and write us now for free descriptive booklets.

SARGENT & COMPANY, Manufacturers, 49 Water St., New Haven, Conn.

Now only
Just a slight turn of the dials and \$59.50
 with all Chicago local stations
broadcasting I get everywhere outside. **GET SPECIAL OFFER**
 Retail



Built like—looks like—performs like a \$100 set. 27 in. long.

Get Amazing Offer who will demonstrate our set to friends.



Notice!

Enormous demand for the celebrated Miraco Ultra-5 resulting from its many enthusiastic users so highly recommending it to their friends, has enabled us to add hosts of costly new features, latest refinements and up-to-the-minute improvements such as you might expect to find only on the newest sets selling at much higher prices. So the Improved Ultra-5 for 1922 is even a better set—finer, more beautiful set—a more selective, more powerful set—finitely credible as this may sound—for less money than ever before.

Coast to Coast Reception Verified By Users
 Reports from users of the Powerful New Miraco Ultra-5 everywhere leave little for us to add. These are only a few of the thousands in our files and which we receive daily:

CALIFORNIA THE FIRST NIGHT
 Received KFI Los Angeles, Cal. and Mexico City the first night, besides about twenty more on my Ultra-5. Ray K. . . . Eaton, Ohio.

CANADA TO THE GULF AND COAST TO COAST
 I sure do like the Miraco Ultra-5. I got from CKY, Winnipeg, Canada, W. G. M., New Orleans, and from W. G. L., New York, and California, last night. Chas. M. D. . . . Savannah, Ill.

CUTS THROUGH THE LOCALS
 My set certainly cuts through the locals. For a good well made set and good workmanship it can't be beat. I know there is anything on this side, my Miraco Ultra-5 will beat it. J. H. A. . . . Pittsburg, Pa.

PRAISES ITS CLEAR TONE
 Received the Ultra-5. It is working fine and in fact is the clearest tone outfit I ever heard. I have gotten 40 or more stations including KFI, Los Angeles, Calif. W. A. G. . . . Fortwin, Kansas.

CINCINNATI HEARS CINCINNATI THE FIRST EVENING
 I wish to thank you for your promptness in shipping, and the perfect condition in which the Ultra-5 arrived. I have proven your remarks to be absolutely truthful. The tone, volume, and distance are excellent. The first evening I enjoyed a concert from Cincinnati. E. E. S. . . . San Francisco, Cal.

NEW YORK GETS 'EM COAST TO COAST
 I have one of your Miraco Ultra-5 radios and it's working fine. I get all stations from coast to coast and would like to be one of your agents. Kendrick, B. E. . . . Cooperstown, N. Y.

OUTPERFORMS ALL OTHER SETS IN HIS LOCALITY
 There is not a radio in this neighborhood that can compare with the Miraco Ultra-5. J. B. . . . Alden, Iowa.

COAST TO COAST THE FIRST NIGHT
 The first night I had the Miraco Ultra-5 I got Santa Catalina Island on the Pacific Coast, also New York and last night Chicago. W. O. K. Lester. L. W. . . . Hot Springs, S. D.

TENNESSEE HEARS CALIFORNIA
 Received my Ultra-5 O. K. Never saw a set packed so well. As to performance, it is just simply wonderful. No trouble for me to get Los Angeles, California, and without any interference. Wonderful tone and easily operated. W. F. T. . . . Adamsville, Tenn.

AS GOOD AS IT LOOKS
 I received the Ultra-5 in fine shape. It is a beautiful piece of furniture and works just as good as it looks. Arthur S. A. . . . Greenock, Pa.

YOU'LL WANT IT, TOO!
 The Miraco Ultra-5 you want me is so magnificent I would like the agency for it. Wm. E. C. . . . Winton.

HAS EXCEPTIONALLY FINE TONE
 My Ultra-5 works fine. My friend liked it very much and said it certainly is a good set and has an exceptionally fine tone. I would like to sell your sets in my spare time. H. M. S. . . . Stuttgart, Ark.

TUNES OUT POWERFUL NEARBY STATION AND GETS DISTANCE
 We are surely having fine luck with the set. We get everywhere with all Chicago stations broadcasting. We now live about one mile from the Waldorf Hotel. It has a wavelength of 370 meters and all other sets around here they are not able to get out or get any other station without also hearing WGN. But with our Miraco 5 we don't have any trouble. Just a slight turn of the dials and it isn't there. We can get outside any night better than our neighbors. Here are some outside stations we have heard in four nights on the loudspeaker: W. G. M., W. G. L., W. G. P., W. G. R., W. G. S., W. G. T., W. G. U., W. G. V., W. G. W., W. G. X, W. G. Y, W. G. Z, W. G. AA, W. G. AB, W. G. AC, W. G. AD, W. G. AE, W. G. AF, W. G. AG, W. G. AH, W. G. AI, W. G. AJ, W. G. AK, W. G. AL, W. G. AM, W. G. AN, W. G. AO, W. G. AP, W. G. AQ, W. G. AR, W. G. AS, W. G. AT, W. G. AU, W. G. AV, W. G. AW, W. G. AX, W. G. AY, W. G. AZ, W. G. BA, W. G. BB, W. G. BC, W. G. BD, W. G. BE, W. G. BF, W. G. BG, W. G. BH, W. G. BI, W. G. BJ, W. G. BK, W. G. BL, W. G. BM, W. G. BN, W. G. BO, W. G. BP, W. G. BQ, W. G. BR, W. G. BS, W. G. BT, W. G. BU, W. G. BV, W. G. BW, W. G. BX, W. G. BY, W. G. BZ, W. G. CA, W. G. CB, W. G. CC, W. G. CD, W. G. CE, W. G. CF, W. G. CG, W. G. CH, W. G. CI, W. G. CJ, W. G. CK, W. G. CL, W. G. CM, W. G. CN, W. G. CO, W. G. CP, W. G. CQ, W. G. CR, W. G. CS, W. G. CT, W. G. CU, W. G. CV, W. G. CW, W. G. CX, W. G. CY, W. G. CZ, W. G. DA, W. G. DB, W. G. DC, W. G. DD, W. G. DE, W. G. DF, W. G. DG, W. G. DH, W. G. DI, W. G. DJ, W. G. DK, W. G. DL, W. G. DM, W. G. DN, W. G. DO, W. G. DP, W. G. DQ, W. G. DR, W. G. DS, W. G. DT, W. G. DU, W. G. DV, W. G. DW, W. G. DX, W. G. DY, W. G. DZ, W. G. EA, W. G. EB, W. G. EC, W. G. ED, W. G. EE, W. G. EF, W. G. EG, W. G. EH, W. G. EI, W. G. EJ, W. G. EK, W. G. EL, W. G. EM, W. G. EN, W. G. EO, W. G. EP, W. G. EQ, W. G. ER, W. G. ES, W. G. ET, W. G. EU, W. G. EV, W. G. EW, W. G. EX, W. G. EY, W. G. EZ, W. G. FA, W. G. FB, W. G. FC, W. G. FD, W. G. FE, W. G. FF, W. G. FG, W. G. FH, W. G. FI, W. G. FJ, W. G. FK, W. G. FL, W. G. FM, W. G. FN, W. G. FO, W. G. FP, W. G. FQ, W. G. FR, W. G. FS, W. G. FT, W. G. FU, W. G. FV, W. G. FW, W. G. FX, W. G. FY, W. G. FZ, W. G. GA, W. G. GB, W. G. GC, W. G. GD, W. G. GE, W. G. GF, W. G. GH, W. G. GI, W. G. GJ, W. G. GK, W. G. GL, W. G. GM, W. G. GN, W. G. GO, W. G. GP, W. G. GQ, W. G. GR, W. G. GS, W. G. GT, W. G. GU, W. G. GV, W. G. GW, W. G. GX, W. G. GY, W. G. GZ, W. G. HA, W. G. HB, W. G. HC, W. G. HD, W. G. HE, W. G. HF, W. G. HG, W. G. HH, W. G. HI, W. G. HJ, W. G. HK, W. G. HL, W. G. HM, W. G. HN, W. G. HO, W. G. HP, W. G. HQ, W. G. HR, W. G. HS, W. G. HT, W. G. HU, W. G. HV, W. G. HW, W. G. HX, W. G. HY, W. G. HZ, W. G. IA, W. G. IB, W. G. IC, W. G. ID, W. G. IE, W. G. IF, W. G. IG, W. G. IH, W. G. II, W. G. IJ, W. G. IK, W. G. IL, W. G. IM, W. G. IN, W. G. IO, W. G. IP, W. G. IQ, W. G. IR, W. G. IS, W. G. IT, W. G. IU, W. G. IV, W. G. IW, W. G. IX, W. G. IY, W. G. IZ, W. G. JA, W. G. JB, W. G. JC, W. G. JD, W. G. JE, W. G. JF, W. G. JG, W. G. JH, W. G. JI, W. G. JJ, W. G. JK, W. G. JL, W. G. JM, W. G. JN, W. G. JO, W. G. JP, W. G. JQ, W. G. JR, W. G. JS, W. G. JT, W. G. JU, W. G. JV, W. G. JW, W. G. JX, W. G. JY, W. G. JZ, W. G. KA, W. G. KB, W. G. KC, W. G. KD, W. G. KE, W. G. KF, W. G. KG, W. G. KH, W. G. KI, W. G. KJ, W. G. KK, W. G. KL, W. G. KM, W. G. KN, W. G. KO, W. G. KP, W. G. KQ, W. G. KR, W. G. KS, W. G. KT, W. G. KU, W. G. KV, W. G. KW, W. G. KX, W. G. KY, W. G. KZ, W. G. LA, W. G. LB, W. G. LC, W. G. LD, W. G. LE, W. G. LF, W. G. LG, W. G. LH, W. G. LI, W. G. LJ, W. G. LK, W. G. LL, W. G. LM, W. G. LN, W. G. LO, W. G. LP, W. G. LQ, W. G. LR, W. G. LS, W. G. LT, W. G. LU, W. G. LV, W. G. LW, W. G. LX, W. G. LY, W. G. LZ, W. G. MA, W. G. MB, W. G. MC, W. G. MD, W. G. ME, W. G. MF, W. G. MG, W. G. MH, W. G. MI, W. G. MJ, W. G. MK, W. G. ML, W. G. MM, W. G. MN, W. G. MO, W. G. MP, W. G. MQ, W. G. MR, W. G. MS, W. G. MT, W. G. MU, W. G. MV, W. G. MW, W. G. MX, W. G. MY, W. G. MZ, W. G. NA, W. G. NB, W. G. NC, W. G. ND, W. G. NE, W. G. NF, W. G. NG, W. G. NH, W. G. NI, W. G. NJ, W. G. NK, W. G. NL, W. G. NM, W. G. NO, W. G. NP, W. G. NQ, W. G. NR, W. G. NS, W. G. NT, W. G. NU, W. G. NV, W. G. NW, W. G. NX, W. G. NY, W. G. NZ, W. G. OA, W. G. OB, W. G. OC, W. G. OD, W. G. OE, W. G. OF, W. G. OG, W. G. OH, W. G. OI, W. G. OJ, W. G. OK, W. G. OL, W. G. OM, W. G. ON, W. G. OO, W. G. OP, W. G. OQ, W. G. OR, W. G. OS, W. G. OT, W. G. OU, W. G. OV, W. G. OW, W. G. OX, W. G. OY, W. G. OZ, W. G. PA, W. G. PB, W. G. PC, W. G. PD, W. G. PE, W. G. PF, W. G. PG, W. G. PH, W. G. PI, W. G. PJ, W. G. PK, W. G. PL, W. G. PM, W. G. PN, W. G. PO, W. G. PP, W. G. PQ, W. G. PR, W. G. PS, W. G. PT, W. G. PU, W. G. PV, W. G. PW, W. G. PX, W. G. PY, W. G. PZ, W. G. QA, W. G. QB, W. G. QC, W. G. QD, W. G. QE, W. G. QF, W. G. QG, W. G. QH, W. G. QI, W. G. QJ, W. G. QK, W. G. QL, W. G. QM, W. G. QN, W. G. QO, W. G. QP, W. G. QQ, W. G. QR, W. G. QS, W. G. QT, W. G. QU, W. G. QV, W. G. QW, W. G. QX, W. G. QY, W. G. QZ, W. G. RA, W. G. RB, W. G. RC, W. G. RD, W. G. RE, W. G. RF, W. G. RG, W. G. RH, W. G. RI, W. G. RJ, W. G. RK, W. G. RL, W. G. RM, W. G. RN, W. G. RO, W. G. RP, W. G. RQ, W. G. RR, W. G. RS, W. G. RT, W. G. RU, W. G. RV, W. G. RW, W. G. RX, W. G. RY, W. G. RZ, W. G. SA, W. G. SB, W. G. SC, W. G. SD, W. G. SE, W. G. SF, W. G. SG, W. G. SH, W. G. SI, W. G. SJ, W. G. SK, W. G. SL, W. G. SM, W. G. SN, W. G. SO, W. G. SP, W. G. SQ, W. G. SR, W. G. SS, W. G. ST, W. G. SU, W. G. SV, W. G. SW, W. G. SX, W. G. SY, W. G. SZ, W. G. TA, W. G. TB, W. G. TC, W. G. TD, W. G. TE, W. G. TF, W. G. TG, W. G. TH, W. G. TI, W. G. TJ, W. G. TK, W. G. TL, W. G. TM, W. G. TN, W. G. TO, W. G. TP, W. G. TQ, W. G. TR, W. G. TS, W. G. TT, W. G. TU, W. G. TV, W. G. TW, W. G. TX, W. G. TY, W. G. TZ, W. G. UA, W. G. UB, W. G. UC, W. G. UD, W. G. UE, W. G. UF, W. G. UG, W. G. UH, W. G. UI, W. G. UJ, W. G. UK, W. G. UL, W. G. UM, W. G. UN, W. G. UO, W. G. UP, W. G. UQ, W. G. UR, W. G. US, W. G. UT, W. G. UY, W. G. UZ, W. G. VA, W. G. VB, W. G. VC, W. G. VD, W. G. VE, W. G. VF, W. G. VG, W. G. VH, W. G. VI, W. G. VJ, W. G. VK, W. G. VL, W. G. VM, W. G. VN, W. G. VO, W. G. VP, W. G. VQ, W. G. VR, W. G. VS, W. G. VT, W. G. VU, W. G. VV, W. G. VW, W. G. VX, W. G. VY, W. G. VZ, W. G. WA, W. G. WB, W. G. WC, W. G. WD, W. G. WE, W. G. WF, W. G. WG, W. G. WH, W. G. WI, W. G. WJ, W. G. WK, W. G. WL, W. G. WM, W. G. WN, W. G. WO, W. G. WP, W. G. WQ, W. G. WR, W. G. WS, W. G. WT, W. G. WU, W. G. WV, W. G. WW, W. G. WX, W. G. WY, W. G. WZ, W. G. XA, W. G. XB, W. G. XC, W. G. XD, W. G. XE, W. G. XF, W. G. XG, W. G. XH, W. G. XI, W. G. XJ, W. G. XK, W. G. XL, W. G. XM, W. G. XN, W. G. XO, W. G. XP, W. G. XQ, W. G. XR, W. G. XS, W. G. XT, W. G. XU, W. G. XV, W. G. XW, W. G. XX, W. G. XY, W. G. XZ, W. G. YA, W. G. YB, W. G. YC, W. G. YD, W. G. YE, W. G. YF, W. G. YG, W. G. YH, W. G. YI, W. G. YJ, W. G. YK, W. G. YL, W. G. YM, W. G. YN, W. G. YO, W. G. YP, W. G. YQ, W. G. YR, W. G. YS, W. G. YT, W. G. YU, W. G. YV, W. G. YW, W. G. YX, W. G. YY, W. G. YZ, W. G. ZA, W. G. ZB, W. G. ZC, W. G. ZD, W. G. ZE, W. G. ZF, W. G. ZG, W. G. ZH, W. G. ZI, W. G. ZJ, W. G. ZK, W. G. ZL, W. G. ZM, W. G. ZN, W. G. ZO, W. G. ZP, W. G. ZQ, W. G. ZR, W. G. ZS, W. G. ZT, W. G. ZU, W. G. ZV, W. G. ZW, W. G. ZX, W. G. ZY, W. G. ZZ.

CALIFORNIA TO CUBA
 Your Ultra-5 works splendidly from Los Angeles to Cuba, everything came in fine. Roy H. . . . Rochester, Pa.

BOLE IT THE DAY RECEIVED
 I received my Miraco Ultra-5 a few days and it is the very best I have. The buyer is very much pleased. It sure works fine. Jacob K. . . . Bush, N. Dak.

BY STATIONS IN FIRST FEW DAYS
 Our Ultra-5 arrived in fine shape. Had no trouble at all hooking it up. Set it up about 11:00 A. M. and heard several stations, including tonight we have gotten 97 stations without just trying to get new stations for us to listen to the different programs as we get them. Claude L. B. . . . Willow Lakes, S. D.

IOWA HEARS MEXICO CITY
 We have given the Ultra-5 quite a thorough tryout and are very well pleased with its performance. Alongside of an expensive receiver its performance on tone, volume and distance are more than we expected. We pulled in KFI, Los Angeles, Cal., with many others the first evening and last night Mexico City came in clearly on the loudspeaker. Lewis W. H. . . . Greenville, Iowa.

PRAISES ITS CLEARNESS
 I received my Ultra-5 in fine condition and am very pleased with it. I really think that it is the best radio I have heard. Everything comes in so clear and plain. Sydney C. M. . . . Ft. Harrison, Mo.

The Powerful New
MIRACO Ultra-5
 [ULTRA SELECTIVE FIVE TUBE SET IN MAHOGANY CABINET]

Guaranteed by One of the Oldest Radio Builders

Tested and Approved by Radio's Highest Authorities

You can either save or make a lot of money by sending coupon today for our Amazing Special Offer. It will astonish you. Just say you'll let your friends listen to the powerful new Miraco Ultra-5 in your home and we ship it to you ON APPROVAL at the wholesale price—satisfaction unconditionally guaranteed. The wonderful selectivity, long distance range, clarity of tone, power and volume of this famous set—plus its beauty of appearance and splendid construction—will sell it to your friends. Big profits easy for you—accepting their orders. No salesmanship required—no agreement to sign. You can also buy accessories at wholesale from us. Even at its retail price this latest improved big beautiful 1926 model Miraco Ultra-5 is an astonishing bargain, in the opinion of radio authorities. Remember, too, that each Miraco comes completely built, thoroughly tested and fully guaranteed by the great Midwest Radio Corporation—one of America's oldest, reliable and most successful makers of quality sets. Send coupon now.

Compare its construction with highest priced sets

Note the neat, sturdy, high-class construction. All wiring concealed under genuine Formica base panel (A). Wiring is flexible to prevent broken or noisy connections. Genuine Formica panel (B)—handsomely gold-etched on front. Oscillations are easily controlled on all wave-lengths and "B" battery consumption is minimized while selectivity, distance range, clarity and volume are amazingly increased by the patented Counter-Balancer (C) and "Duoformer" ultra low loss inductance coils (D, E and F). Adjustment for different length aerials (G). Shielded transformers, of celebrated make, amplify without distortion (H and I). Lowest dielectric loss type sockets—riveted into base panel. Low loss plate condensers—and other latest features of costliest sets. Literature describes fully—send for it!

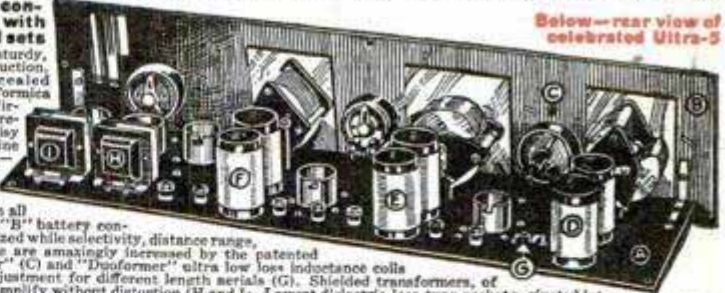

Below—rear view of celebrated Ultra-5

AGENTS! DEALERS!
 Write for the new Miraco proposition. Nation-wide use and popularity of Miraco sets. Comparatively low prices make them wanted everywhere.



Other Miraco Long Distance Sets \$13⁵⁰ up
 Got Special Offer!

Remember you are dealing with a big, responsible corporation—one of the oldest and most successful in the industry, a concern which has grown to immense size through the recommendations of satisfied customers—when you buy a Miraco. Absolutely no risk on your part. All Miraco sets work on storage or dry batteries, are easily connected, operated, and logged. Approved by Radio's Highest Authorities. Unmatched values! Let testimony of users convince you. Send coupon for complete literature and AMAZING SPECIAL OFFER!



All the Proof you want is waiting for You!

Reports from hosts of users in every state prove Miraco sets—at rock-bottom factory prices—outperform sets costing up to three times as much. Send for latest literature, SPECIAL OFFER and plenty of additional testimony leaving no doubt that "Miraco Radio Gets 'em Coast to Coast."

MIDWEST RADIO CORPORATION
 Pioneer Builders of Sets Cincinnati, Ohio
 407-T East Eighth Street
 Send free literature, AMAZING SPECIAL OFFER and all particulars regarding your big money-saving proposition on Guaranteed Miraco Sets and all radio supplies.
 Agent User Dealer
 NAME _____
 ADDRESS _____

Send coupon for Amazing Special Offer.



TRADE MARK REG.
WURLITZER
 SUPREMACY IN MUSICAL INSTRUMENTS



Learn to Play

You are always popular and sure of a good time if you can play some musical instrument. By yourself, with your friends around the piano, in orchestras or bands,—there is no end to the pleasure music will give you. And there is no easier way to earn money in your spare time. Choose your instrument now and let Wurlitzer help you buy it and learn to play it.

Try Any Instrument in Your Own Home At Our Expense

You may now have any known musical instrument for a week's free trial in your own home. There is no obligation to buy—no expense for the trial. You may return the instrument at the end of a week if you decide not to keep it.

Monthly Payments

The Wurlitzer plan makes it easy for you to own the instrument you want. Payments are conveniently arranged in small monthly sums—a few cents a day will pay.

Wurlitzer instruments are known everywhere for their unusual tone quality and excellence of workmanship. They are used by the greatest

professional musicians, bands and orchestras. Harry L. Jacobs of Sousa's Band, Brooke's Marine Band, and Chicago Grand Opera says: "I am proud to be the owner of one of your new cornets. It is positively superior to anything I have had in all my years of cornet playing."

Easy to Buy

Thousands of amateur musicians are playing on Wurlitzer instruments. Many of them could not have bought except through the Wurlitzer selling plan. Wurlitzer is the world's greatest music house, with stores and dealers in all parts of the country. But no matter where you live you will receive the same service by mail as though you lived next door to the factory. Send the coupon today.

Send for Free Catalog

The greatest musical catalog ever published. Over 3,000 articles—every known instrument described and illustrated—many of them shown in full color. Gives you all details of the Wurlitzer plan. Send coupon now.

The Rudolph Wurlitzer Co., Dept. 1772
 117 E. 4th St., Cincinnati 329 S. Wabash Ave., Chicago
 120 W. 42nd St., N. Y. 134 Golden Gate Ave., San Francisco

Send me absolutely free, your new illustrated catalog of musical instruments. Also tell me how I may try any instrument in my own home at your expense and how the Wurlitzer plan makes it easy for me to buy. No obligation.

Name _____
 Address _____
 City _____ State _____
 Instrument _____
 (State instrument in which you are interested.)

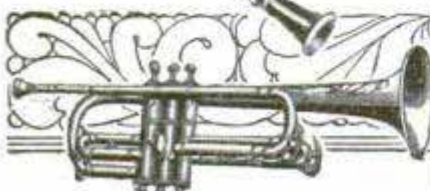

**The World's Only
Ball Bearing Typewriter**



**Yours
for
10 Days
FREE**

If you decide to keep it
only **\$3.00**
DOWN
BALANCE
EASY
TERMS

NEVER has there been such a TYPEWRITER

BARGAIN on as EASY TERMS! a genuine SILENT Ball Bearing L. C. Smith—GUARANTEED 5 YEARS—at a 40% SAVING!

Money Cannot Buy a better typewriter. Because of its ball bearings and other exclusive features, the L. C. Smith has been recognized for over 20 years as the world's finest, easiest running, longest wearing typewriter. U. S. Government has bought 50,000. The choice of railroads, big corporations like the Standard Oil Co., etc.

SEND NO MONEY Just mail the coupon. No red tape; no obligation. We will promptly ship you the typewriter to use for 10 days in your home or office. See how wonderfully speedy and easy it operates, the perfect work it turns out. We depend entirely on the typewriter selling itself; no one will urge you to buy. If you don't think it the finest, easiest running machine ever used, we want you to return it at our expense. You'll want to keep it and you can, by paying \$3.00 down—and \$5 monthly until our Special Price of \$66.20 has been paid.

Now is the time to buy. Take advantage of this LOW PRICE, EASY TERMS OFFER. We may never be able to offer it again.

Send the coupon now—before this offer is withdrawn

\$40 SAVED by Using this Coupon
SMITH TYPEWRITER SALES CORP.
112-360 E. Grand Avenue, CHICAGO, ILL.

Ship me the L. C. Smith Typewriter F. O. B. Chicago. I will deposit \$3 with the express agent on arrival subject to 10 days' trial. If I keep it I will send you \$1 a week until the \$63.20 balance of the special \$66.20 price is paid. The title to remain in you until then. It is understood that I have 10 days in which to examine and try the typewriter. If I choose not to keep it, I will repack and return it to the express agent, who is instructed to return my \$3. You are to give your standard 5-year guarantee

NAME.....
ADDRESS.....
OCCUPATION.....
EMPLOYED BY.....

**Only
the L. C. Smith
Has All These
Features:**

- Ball Bearings at all points of wear and friction (636 of them)
- All of the writing always in sight
- Non-Shift Carriage
- Silent in Operation
- Two Color Ribbon
- Back Spacer
- Tabulator
- All the latest operating conveniences
- Beautiful—re-n~~ew~~ed

**GUARANTEED
FIVE
YEARS**

**Send
No MONEY
Just this
Coupon**

**FREE
TO YOU NOW**

Complete Course of Lessons in Touch Typewriting; Tools; and Waterproof Cover; Complete Operating Instructions given with this machine. This is the easiest typewriter to operate and learn. You can learn to use it in a day with our instructions.



New! LA TWIN MOTOR FOR ROWBOATS

The sensation of the year. Offering new advanced features in Power, Speed, Control, Weight and Performance. For example—

NEW—Super-Power Twin Motor
—At normal speed develops 3.85 H. P. (Brake Test). In racing trim develops 4.65 H. P.

- NEW—Under-water Stream-Line Design
—Cuts the water like a knife
- NEW—Giant Drive Propeller
—Gives flashing speed
- NEW—"Safety Propeller"
—Protects Boat, Boaters and Motor
- NEW—Super-charged Water Pump
—Insures a cool motor always at all speeds and reverse
- NEW—Combination Propeller and Rudder
—Steers WITHOUT A RUDDER!
- NEW—Unit Control Carburetor
—One easy adjustment for all speeds and weathers
- NEW—"Top-Spin" Easy Starter with big Eiseman Magneto
—Gets you away in a flash
- NEW—Combination Racing and Trolling Control
—One throttle lever for all speeds
- NEW—Lifetime Guarantee
—Against all defects in material and workmanship
- NEW—Five Days' Trial Offer
—Gives you a chance to match with any other Motor

[WRITE FOR FREE CATALOG FOLDER TODAY] (1)

LOCKWOOD-ASH
— MOTOR — COMPANY —
616 Jackson St. Jackson, Mich.

Build and Fly Your Own 3 ft. Model Aeroplane!

Every Boy's Airplane
The simplest-to-make Model Airplane; all parts ready to put together without nails, wire or glue. Anyone can do it in 2 hours. Beautiful Monoplane Model; 3 1/2 ft. wing spread; guaranteed to fly. Complete outfit, postpaid, \$6.

Send 5c now for complete 48 page catalog



IDEAL Scale Drawings and Building—Flying Instructions show you how to build and fly accurate duplicates of any of the following famous 'planes. Complete plans for any one sent postpaid for 25 cents!
Curtiss J N4 D-2 Training Plane; De Havilland "Round-the-World Flyer"; N-C-4 Naval Seaplane; Bleriot, Nieuport or Taube Monoplane; or Cecil Peoli Racer.
(Set of 7 Plans, \$1.25 postpaid)

Ideal Aeroplane & Supply Co.
408 West Broadway, New York
Ask your Dealer for Ideal Model Aeroplanes

SOFT SNAP FOR AGENTS
GLAROFF Kills Headlight Glare.
Our representatives making from \$12 a day up to \$8000 yearly. Simple new device protects driver from glare of headlights and sun. Write for Special Free Offer.
GLAROFF MFG. CO., 805B Read St., Sioux Falls, S. D.

EDWARDS WILL SAVE YOU MONEY ON METAL ROOFS

We own our own steel mills, roll our own sheets, make them into high-grade REO METAL SHINGLES, Sidings, Ceilings and Roofings of every type and style for every kind of building. We control every operation from the raw material to the finished roof and we sell direct from our factories to the user. Not a dollar to divide with anybody but the customer! You get better value for less money.

OUTLAST THREE ORDINARY ROOFS

EDWARDS METAL ROOFS are weather-proof, lightning-proof, fire-proof! The galvanizing bends with the metal. No tools required.



LOW-COST ALL-METAL GARAGES

Any size. Any style. Portable. Ready to erect. Complete with frames, doors, sash and hardware. Ornamental,

durable, economical. Blue-prints and complete instructions FREE. Write today. Get our low prices and Free Samples. Ask for Roofing Book No. 150 or for Garage Book No.

THE EDWARDS MFG. CO.
200-250 Butler St. Cincinnati, O.



FELTMAN & CURME WANT

Partner-Representatives

The greatest retail shoe store organization in the world, selling wonderful shoes at \$5 and \$6 to 25 million people through stores, want Partner-Representatives to sell to the other 75 millions direct.

Fast Sales, Known Values and National Reputation make this an outstanding opportunity for a limited number of men who can make good to share in our success. Wonderful opportunity, big pay and fullest co-operation. Effective selling portfolio and sample case. Write at once for Partner-Representative proposition.

FELTMAN & CURME
Dept. 805-B. 118 So. State Street, Chicago, Ill.



Real MOVIES

—Make them yourself with
**VICAM Standard
MOVIE CAMERA**

Camera, Tripod, Projector and 2 Magazines Complete outfit for taking and showing standard size pictures. Equal to biggest cameras. Loads in daylight. Projects on wall or sheet.

\$37

Send 10c in Stamps for illustrated BOOKLET
VICAM PHOTO APPLIANCE CORPORATION
1224 Belmont Avenue, PHILADELPHIA

Just Out GREEN, RED, SELLS FOR \$1.25. SAMPLE 67c

**Unbreakable
Trio Self-Filling
Fountain Pens**



Guaranteed for 2 years. "It makes Carbon Copies"

Money refunded if you don't think it's the best pen you ever wrote with. Finished in beautiful green or red. Send for wholesale quantity price list and distributing plans. **F. SPORS & CO., 351 Main St., Lesueur Center, Minnesota**

Send for this
**RADIO
BOOK
FREE**



1926 Catalog of
**RADIO
BARGAINS**
Save $\frac{1}{3}$ to $\frac{1}{2}$

**AMERICAN
RADYNOLA
5 TUBE SET**

64 illustrated pages containing thousands of bargains in radio sets, semi-finished sets and radio kits of all styles, sizes and approved circuits. 5-tube sets as low as \$29.58. Beautiful models of the very latest designs and types. Elaborate console models with loud speakers built right in cabinets of genuine mahogany and walnut. All sets guaranteed. Coast to coast receiving range. Also contains everything in radio supplies, including batteries, chargers, loud speakers, transformers, condensers, rheostats and any other parts you may want for improving your set or building a new one. Guaranteed saving to you of $\frac{1}{3}$ to $\frac{1}{2}$.

The Biggest 5-Tube Value on the Market

Positively the world's greatest 5-tube radio bargain. Regular \$75.00 value. Our large quantity production enables us to sell this set for only \$29.50, fully built and wired in beautiful mahogany cabinet of latest design with sloping Bakelite panel of Satin finish, handsomely etched and engraved as illustrated. Constructed of the finest low-loss condensers, coils and sockets. Bakelite baseboard panel and dials. Price for set only ... **\$29⁵⁰**
Transportation charges extra. Ship. wt. 25 lbs.

This set with all accessories, including the famous American Bell loud speaker with adjustable unit, 2-45 volt "B" batteries, one guaranteed 100 Ampere Hour storage "A" battery, cable for battery connection, 5-201 A tubes, aerial and ground equipment and everything complete ready to set up and operate. Nothing else to buy. Price ... **\$59⁷⁵**
Transportation charges extra. Ship. wt. 100 lbs.



Columbia Grand 5-Tube Console Set



\$57⁹⁵

Beautiful Walnut Cabinet in two-toned effect. Two door panels inlaid with highest grade burl walnut. Cabinet is 39 inches high. Top measures 18x37 inches. Equipped with high-grade built-in loud speaker with adjustable unit. Large roomy interior for holding all batteries, books, etc. 5-tube tuned radio frequency receiver. Coast to coast. Very selective. Has latest type, low-loss condensers, coils and sockets. Bakelite baseboard, sockets and dial knobs. Dials beautifully etched in gold on walnut finish bakelite panel. Price for set only, fully built and wired - \$57.95.
Transportation charges extra. Shipped by freight or express.

This set with all accessories, which includes 2-45 volt "B" batteries, one guaranteed 100 ampere hour storage "A" battery, 5-201A tubes, multicolored cable for easy battery connection, aerial and ground equipment, instructions for setting up and operating—everything complete, nothing else to buy—**\$84.95**
Transportation charges extra. Shipped by freight or express.

Semi-Finished 5-Tube Radio Frequency Set

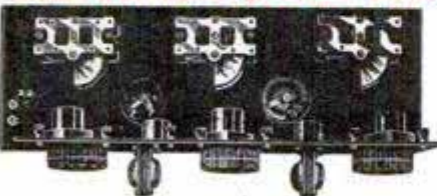

\$18⁷⁵

This special offer is astounding in the radio world. Coast to coast reception on loud speaker. Low loss condensers and sockets. Highest quality transformers. Bakelite rheostats. All wiring concealed under Bakelite baseboard. 7x18 panel—fits into any standard 7x18 cabinet. Complete instructions for operating. Guaranteed saving to you of \$50.00. Price of set all mounted, \$18.75. Cabinet of same model as American Radynola pictured above \$5.65 extra.

Order From This Page—Save About One-Half

Semi-Finished 8-Tube Super-Heterodyne

\$43⁷⁵



World's Famous 8-tube Super-Heterodyne. Fully mounted on panel and baseboard. Comes completely assembled ready to wire and operate. We have testimonials from thousands of builders of this set. Some have received foreign stations on loop aerial. Unsurpassed in volume and tone quality. Low-loss straight line frequency condensers, vernier dials, finest quality rheostats. Matched Columbia long wave transformers. Requires only three screws for attaching panel and baseboard and set is ready to operate. 7x30 panel. Price of set **\$43.75**
Requires following accessories to complete this set: 7x30 cabinet, 8-201 A tubes for storage battery operation or No. 199 tubes for dry cell operation, 100 Ampere hour storage battery, 2-45V "B" batteries, loud speaker, center tapped loop aerial. All these items are listed in our catalog at a tremendous saving.

Complete Parts for Best 45 Kilocycle Super-Heterodyne Genuine Remler Parts

\$49⁵⁰

Complete Parts for Genuine Popular Mechanics 8-Tube Super-Heterodyne

\$89⁵⁰

Our semi-finished sets come with all parts mounted on panel and baseboard ready for wiring. Do not fail to send for our catalog. Remember—we are the largest exclusive radio mail order dealers in the world and carry the best of everything in radio. We save you $\frac{1}{2}$ to $\frac{1}{3}$ on the following kits. Detailed descriptions appear in our catalog.

Catalog includes list of broadcasting stations, general radio information and facts about our free service division. Write for it today.

NEUTRODYNE
Genuine licensed Neutrodyne kit of parts, come fully assembled on the panel and baseboard with complete instructions, ready to wire. Price, **\$29.75**

COCKADAY
3-tube Cockaday kit of parts, fully assembled on panel and baseboard, ready to wire. Price, **\$15.85**

**FOUR TUBE BROWNING-
DRAKE** and also **PRESS-
LEY** and **REMLER SUPER-
HETERODYNE**
At Bargain Prices.

HARKNESS
2-tube reflex kit of parts, fully assembled on panel and baseboard, ready to wire. Complete instructions. Price, **\$16.95**

RANDOLPH RADIO CORPORATION
159 N. Union Ave. Dept. 246 Chicago, Illinois

Your Choice \$100 DOWN

SELECT NOW!
Prompt Delivery—No Red Tape!

Send No Money—just send your name and address. We'll open a charge account, and your choice of these special bargains will come Prepaid for your approval and 15 Day Trial. You pay the Postman \$1. upon arrival. If satisfied, pay the balance in 10 equal monthly payments. Otherwise return and your deposit will be refunded.

We Trust You
 Your credit is good with us. Our Charge Account System is simple, easy and convenient. **TRANSACTIONS CONFIDENTIAL. ORDER NOW.**

Free—Complete booklet with 3,000 bargains in Diamonds, Watches and Jewelry. 10 months to pay on everything.

A75—Ladies 18K White Gold Ring; 3 AAA Quality blue-white Diamonds. Regular \$50. value. Price \$42.50

A76—Ladies 18K White Gold. AAA blue-white diamond and regular-cut diamond on each side of shank \$52.

A77—Gents heavy 18K White Gold ring. 2 blue-white Diamonds; 1 Blue Sapphire. \$57.50

A78—14K White Gold Wrist Watch: 4 Regular cut Blue-white Diamonds; 4 Blue Sapphires. 15 Jewel Guaranteed movement. \$42.50.

A79—The same Wrist Watch without diamond or Sapphires—\$24.95

A80—Remarkable value in Gents' Strap Watch, high grade Gold Filled Case. Guaranteed to wear for 10 Years; dependable 15 Jewel Movement, Radium Hands and Dial, Genuine Leather Strap—price \$22.50

A81—The best watch value ever offered. 12 size, 21 Jewel, Illinois Watch, Adjusted; 14K Gold Filled Case; will wear for 20 Years. Price \$45. Knife and Chain Free

AUTHORIZED CAPITAL \$1,000,000.

L.W. SWEET INC.

66W/1650 - 1660 BROADWAY, NEW YORK

500 QUARTS OF FIRE GAS FROM 1 QUART OF LIQUID

At last the ideal way to put out fires quick has been discovered. This is a new fire gun that shoots a chemical more than 25 feet without pumping. And this chemical coming in contact with fire creates a gas of more than 500 times the original volume. This gas smothers out fires instantly by shutting off the air. It puts out celluloid, gasoline, kerosene fires that water only makes worse. Absolutely stainless to clothes, harmless to people. Inexpensive. Always ready. Absolutely necessary for cars and homes, farms, garages, factories, schools, etc. Write at once for low price introductory offer to the Weldon Manufacturing Company, Dept. B-7, Grand Rapids, Michigan. Agents or spare-time workers interested in making up to \$25 a day should write immediately for sales plan.—Adv.

NEW VEST POCKET ADDING MACHINE

Adds as rapidly and accurately as a \$300 machine, yet fits the vest pocket. Mechanically perfect. Easy to operate. Everyone who uses figures should own one.

\$2.95

COUNTS UP TO 999,999,999

Total visible at all times. A pull of the finger clears it. Don't carry a pocket full of pencil stubs and scrap paper to do your figuring. Carry a Ve-Po-Ad.

10 DAYS TRIAL SEND NO MONEY. Just name and address and we will send machine postpaid. Pay postman on delivery \$2.95. Use it for 10 days to prove it does all we claim. If not perfectly satisfied we will refund your money. Limited supply. Order today.

RELIABLE ADDING MACHINE CORP., Dept. 42
 184 West Washington Street, CHICAGO, ILL.

AGENTS

Here's a money maker for you. Everybody wants one. Splendid profit. Write for special offer. **DO IT NOW.**

Agents
Earn
\$112.50
a week

This New Invention Amazes Ford Owners Everywhere!

Flock To Buy New Steering Device That Makes Driving Safer and Easier!

SHOCKS and Bumps and Shimmy of Fords now entirely eliminated! The amazing Steady-Boy gives Fords same comfort as \$2,000 or \$3,000 car. Makes holding Ford on road marvelously easy. One Finger Pressure! Even the ruttiest, bumpiest roads hold no terror now for Ford Drivers.

Guaranteed To Outlast The Ford

Steady-Boy is unconditionally guaranteed. Sold direct on 2 weeks' trial. Garage men, mechanics, agents earn enormous profits. Steady-Boy sells for only \$7.50—much less than owner pays for replacement of standard parts in a year. Steady-Boy saves the parts, preserves car. Albert Schoen in a garage in St. Louis sold six in a jiffy. And his profit was \$22.50. Never has there been so fast a selling Ford accessory. And there are thousands of Ford owners—every one a live prospect—within your reach. Big money selling to fleet owners.

Free Sample Offer

Write for our generous Free Sample Offer. Learn of our wonderful sales plan. It places you under no obligation whatever. Just send name and address. I'll show you enormous earnings, either spare or full time. Write today.

Moon Bros. Manufacturing Co., Dept. B-20, 4900 McKissock Ave., St. Louis, Mo.

**500
PUNCTURES
Yet Leaks
No Air**

**We
Want
Agents**



**Over
1,000,000
Sold**

OVER 18,000,000 car owners are waiting for my amazing, long-life, no-trouble, air-filled, Milburn Puncture-Proof Inner Tube—the only tube to successfully withstand the 500-nail-hole-test without loss of air. Costs no more than the ordinary tube and is sold under a positive, money-back guarantee.

**Makes Motoring a Pleasure
Doubles Tire Mileage**

Users of Milburn Puncture-Proof Tubes everywhere are enjoying the easy riding performance of the air-filled tube without the annoyance of punctures and slow leaks. And a tire mileage increase from 12,000 to 15,000 miles. Many users report 30,000 miles (double mileage) without removing a tire from the wheel.

Test the Milburn at My Risk

You'll be delighted. And you'll realize how easily orders are secured. Sales experience is not necessary to coin money selling the Milburn. *Positively the biggest tube value obtainable.* Absolutely non-competitive. I control all basic patents. Car owners buy on demonstration. It makes no difference what tires they use or what car they drive.

\$5,000 to \$10,000

That's what the Milburn Agency will net you per year—and more. Stop working for others. Get into business for yourself selling Milburn Puncture-Proof Tubes. My *No-Capital-Direct-From-Factory-Sales-Plan* makes it easily possible. Line up your territory rights on this whirlwind seller—NOW—full or part time.

FREE TUBE OFFER

To every car owner answering this ad. Act quick. Clip and mail your FREE TUBE COUPON—NOW. References: Industrial State Bank, Chicago—National Bank of the Republic, Chicago — Baker State Bank, Chicago.

**C. M. MILBURN, President
Milburn Puncture-Proof Tube
Company, Inc.
4650 Shields Avenue
CHICAGO, ILLINOIS**

**Money-Back
Guarantee**

We hereby agree to refund to any purchaser the full amount paid for any Milburn Puncture-Proof Tube that leaks air when punctured by anything not larger than a twenty-penny spike. We also guarantee that casings will last much longer and give much greater mileage where Milburn Puncture-Proof Tubes are used.

PROOF

J. D. Cooper—"I have made 80,000 miles with my Milburn Puncture-Proof Tubes and have not as yet removed a rim or casing and my casings are in excellent condition."

S. C. Winfrey—"I have driven 600 nats in one of my Milburn Puncture-Proof Tubes without loss of air."

J. S. MacElroy—"Received the shipment of 200 Milburn Puncture-Proof Tubes and find them as represented. Hope to send you another 200 tube order soon."

J. T. Berdahl—"Have been using Milburn Tubes since 1922, driving every day. Have pulled out any number of nats without loss of air."

FREE TUBE COUPON — MAIL NOW
C. M. MILBURN, President
MILBURN PUNCTURE-PROOF TUBE CO., INC.,
4650 Shields Ave., Chicago, Ill.
If the money-making opportunity is as big as you claim, I am interested in receiving the facts so that I can enjoy a share of the profits selling MILBURN PUNCTURE-PROOF TUBES.
Without obligation, send me information about commission and FREE TUBE OFFER to car owners.
Name.....
Address.....
City.....
State.....



America's Fastest Team Plays in KEDS!

THE Original Celtics have a reputation as one of the fastest teams in American basketball. Last year they were National Professional Basketball Champions.

And this star team wears Keds!

"We have found this basketball shoe to be the ideal for players of our type. Our club is very much pleased with your shoes after using them on all sorts of floors."

That's what Manager James A. Furey has to say about Keds. Here's why—

Keds soles are full of life—built to absorb jolts—remarkably tough. The uppers are of durable canvas—strong enough to protect against twists—yet light and comfortable. A special Feltex innersole absorbs perspiration—keeps the feet cool.

Remember—Keds are made only by the United States Rubber Company—look for the name!

Our Keds Hand-book of Sports is full of interesting information on games, sports, and dozens of other subjects. Sent free if you address Dept. 1070, 1790 Broadway, New York City.

United States Rubber Company

They are not Keds unless
the name Keds is on
the shoe!

Keds

Trademark Reg. U.S. Pat. Off.



"COMET"
the special
Keds basketball
shoe. It gives a
sure grip on the
smoothest floor.

Different from all others—the NEW BENJAMIN



AIR RIFLE

Made on a different principle from all other Air-Rifles.

The Benjamin is really a strong air-pump used to compress the air in the air chamber to any degree of power desired. From one to six strokes of the pump give all the force necessary. Each additional stroke gives increased power. The Benjamin works on the same principle as all air-drills and air-hammers—with this difference:

You control the shooting force as you desire. Look at this block of hardwood. It shows how Benjamin power is regulated as you wish.

You can't have accidents with a Benjamin. It's safe, always, because you control the power. The Benjamin never loses shooting force, and has no springs to get out of order or shake your aim. Write us for an interesting folder about this wonderful air-gun.

If your dealer does not handle same, send direct to factory.

(PRICE \$5)
(POSTPAID)

BENJAMIN AIR-RIFLE & MFG.
CO., 615 N. Broadway, St. Louis, Mo.

Ask your
dealer for
demon-
stration.

Pacific-Coast
Representatives
THAYER &
BOWER
Los Angeles
Calif., and
San Francisco
Calif.



AGENTS 500% PROFIT GENUINE GOLD LEAF LETTERS

S guaranteed to never tarnish. Anyone can put them on stores and office windows. Enormous demand, large profits. Paul Clark says: Smallest day \$28.70. H. L. Reel made \$920 in two months. Write today for free sample and liberal offer to general agents.
METALLIC LETTER CO., 433-B N. Clark St., CHICAGO

Beautiful HOUSES \$900 and BUNGALOWS

CAN BE BUILT FOR AND UP

This and many others in my new book, Building Plans for Modern Homes, will save you hundreds of dollars. One of the most complete and comprehensive books of plans ever published by any architect. New edition just off the press. Nearly 600 floor plans and photographs of Colonial houses, bungalows, etc., costing from \$200 up; gives sizes and cost to build. Sent postpaid for \$3.00.



FREDERICK H. GOWING
ARCHITECT
101 Tremont St., BOSTON, MASS.

Taxidermy Book FREE.

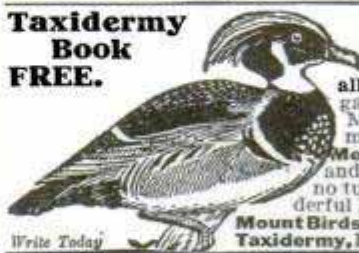

Write Today

Stuff Beautiful Birds.

Learn by mail to stuff and mount all kinds of birds, animals, fish and game heads, make rugs, tan skins. Mount your own specimens and make money preserving for others. Men, Women and boys learn easily and quickly. Success guaranteed or no tuition. Write today for our wonderful FREE book "How to Learn to Mount Birds and Animals." N.W. School of Taxidermy, 1772 Elwood Bldg., Omaha, Neb.

FREE 1000 Illustrations ELECTRIC FIXTURE CATALOG!



Write today for your copy. Save 50% direct from Manufacturer. No Middleman's Profit. OUR SPECIAL: 8 Room Electric Set, ready to hang, \$24.50—Other bargains.

UNITED LIGHTING FIXTURE CO.
83 Flatbush Ave. Dept. P, Brooklyn, N. Y.



*Any good
mechanic
will tell you*



Use Starrett Tools

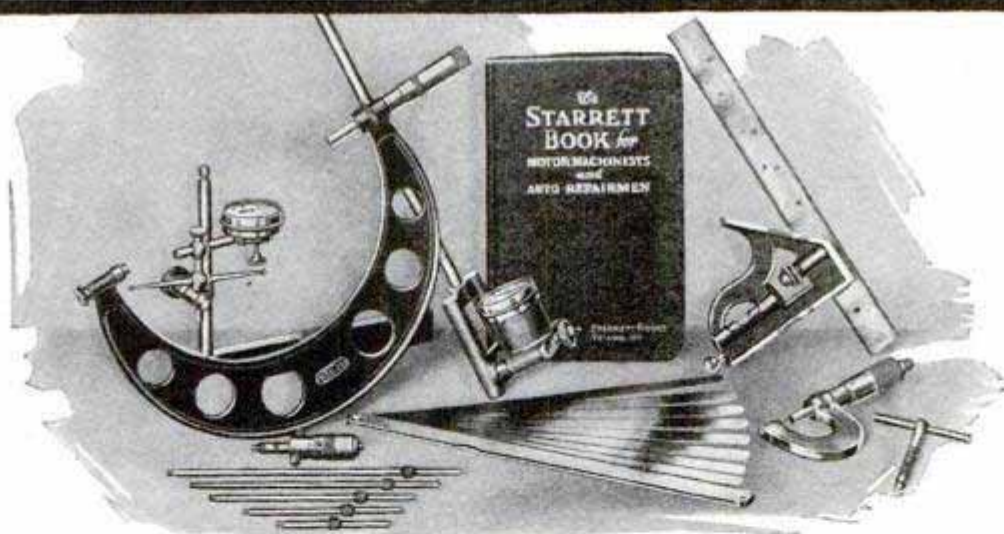

For a fussy bit of work—a job where extreme accuracy is essential and tool convenience means speed—there's nothing like a full kit of Starrett Tools.

Ask your automotive supply or hardware dealer to show you the No. 224 Mike (2 to 6 in.); the No. 452 Cylinder Gage; No. 124A Inside Mike (2 to 8 in.); No. 172E Thickness Gage with leaves 12 inches long; the old reliable No. 3 one inch Mike; a copy of the Starrett Data Book for Machinists—or any of the more than 2000 Starrett Tools.

Send for free copy of the New Supplement and Catalog No. 23. 'AP'

THE L. S. STARRETT CO.

*World's Greatest Toolmakers
Manufacturers of Hacksaws Unexcelled
Steel Tapes—Standard for Accuracy
ATHOL, MASS.*



When a radiator won't get HOT

TRY THIS



AIRID Air Valves make cold radiators hot. Attach easily to any steam radiator without tools—need no adjusting—never leak—make no noise. Sold at heating and plumbing stores. Only \$1.60.

AIRID
AIR VALVES
make cold radiators HOT

AMERICAN RADIATOR COMPANY

1812 Elmwood Ave., Buffalo, N. Y.

Send me a trial Airid (one only). Guaranteed 5 years. (This will be mailed C. O. D., or enclose check or money order for \$1.60.)

Name

Address

WHITE FLAME
BURNERS make your old kerosene lamps and lanterns give a brilliant white light better than electricity or gas. Doubles your light. Saves oil. **NO MANTLE TO BREAK.** Guaranteed Safe and Reliable. Delights every user. Send now for complete sample postpaid 50 cents, stamps or coin. 3 for \$1.25. Money Back If Not Satisfactory. Live Representatives Wanted. Exclusive Territory. **WHITE FLAME LIGHT CO., 68 Clark Bldg., Grand Rapids, Mich.**

Hand Forged Razor Steel Blades, No. 57

A GENUINE \$2 KNIFE FOR \$1.18 POSTPAID



\$1000.
A MONTH
is his average
PROFIT

Yes, \$1,000 a month profit!—that's what Richardson Baker, the Washington, D. C. **CROWN FUEL SAVER** distributor averages. His orders keep four installers busy. **YOU CAN DO WHAT BAKER IS DOING**—establish yourself in the **paying, substantial, permanent** business of distributing the

CROWN FUEL SAVER
and **Smoke Abater**

The same features Baker finds so desirable will help you. The **CROWN** represents a fundamental advance in the science of heating and the field is not competitive. **WE GUARANTEE A FUEL SAVING OF 20%!**

Write Today. Line up for the quick, easy cold-weather sales which can be made now. Become the **CROWN** heating specialist in your vicinity. Write Now! Don't delay! Territory protection assured.

C. F. S. Co., 42 N. 10th St., Richmond, Ind.
Sole Canadian Distributor
33 St. Vincent St., Montreal, Can.



THIS CLEAR, POWERFUL 6 POWER VEST POCKET TELESCOPE
with glove leather case \$2

Only 3 3/4 in. long! Easily slips in vest pocket, yet powerful, precise, adjustable to either eye, six full magnifications, and brings distant objects close without objectionable "trembling" of higher power glasses. Nothing cheap in appearance or action. Guaranteed satisfactory by us and by maker, or money back at once. Handsome black baked-in enamel finish. Fine flint glass lenses by Wollensak. Check, money order or C.O.D. \$2.00 prepaid, including fine limp leather case.

BOSTON SPORTING GOODS CO. Dept. P. 80 Boylston St. BOSTON, MASS.

Delivered to You Free

for 30 days trial on approval. You can have your choice of 44 Styles, colors and sizes of the famous **RANGER** Bicycles. Express prepaid. **Factory-to-Rider** Prices save you \$10 to \$20 on your bicycle.

\$5 a Month if desired. Many boys and girls easily save the small monthly payments. Parents often advance first payment.

Tires best quality, at factory prices, express prepaid. Lamps, wheels and equipment, low prices. Send **No Money**, do business direct with makers.

Mead CYCLE COMPANY
DEPT. C-109 CHICAGO

Write today for free Ranger Catalog, factory prices and marvelous easy payment terms



CLASS 25¢ PINS

BUY DIRECT FROM THE MAKER
CATALOG FREE

Either pin shows made with any 3 letters and 2 figures 1 or 2 colors enamel, Silver plate 25¢ ea. \$2.50 doz. Sterling silver, 40¢ ea. \$4.00 doz.

BASTIAN BROS. CO.
3490 630 Bastian Bldg., Rochester, N. Y.



TOSTWICH
THE GREATEST
PROFIT-MAKER

The Tostwich brings amazingly big profits and sales wherever installed—a patented process—makes sandwiches taste 100% better than ever before. Full information without obligation to you—write today. **THE TOSTWICH CORPORATION**
Dept. 1772, 646 No. Michigan Ave., Chicago.

Direct at Factory Prices

This \$2 KNIFE \$1.18 Postpaid
Hand Forged Razor Steel Blades
Handy shaped Blade makes this knife best for mechanics, sportsmen and farmers; light but strong; re-sharpened easily. Stag handle. German silver finish; blades file tested, hand forged from razor steel and warranted.

Sample \$1.18 3 for \$3.00 Postpaid.

Send for our 100-page List and **FREE**
"HOW TO USE A RAZOR"

MAHER & GROSH CO., 106 A St., Toledo, Ohio

The
THRIFT
BOOK
OF
A
NATION



We are style headquarters. From the designing rooms of New York and Paris come the new modes shown in our catalog. You pay nothing extra for style—but you get it, and quality besides, when your selection is made from the World's Largest Store. We guarantee a saving.



Spring is cleaning time. New rugs; a davenport for the living room; a new vacuum cleaner; a bedroom to be kalsomined. Everything you need to make your home attractive is priced in the Thrift Book to save you money. And we give Real 24-Hour Service.



Men order from the World's Largest Store because they find it convenient and economical. Style apparel and sturdy work clothing are displayed at attractive prices in our new catalog. Nine million families buy from the book of 35,000 bargains. You should have it, too!

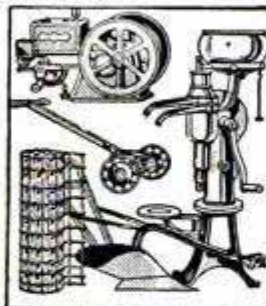

Farming demands good tools. We have them. Most everything used on the farm is quoted in the Thrift Book and at a price way below that asked elsewhere. Our line of hardware, implements, gas engines, harness and cream separators is most complete. Be sure you have our catalog.

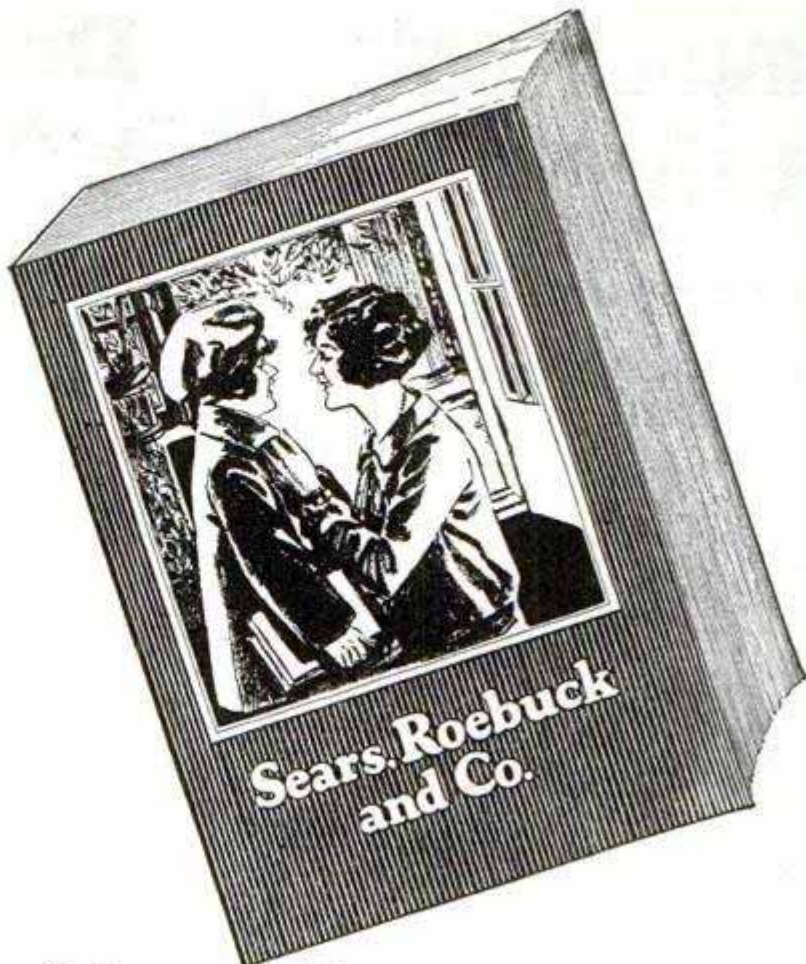

35,000 Bargains in this New Spring Book

With this new catalog—"The Thrift Book of a Nation"—you have access to 35,000 bargains, the greatest store in the world!

So complete is this book that practically every need for the family, the home, the farm, and the shop can be supplied from its pages—at prices that insure big savings.

Millions buy from the World's Largest Store because they have found here the quality they prefer; have learned that 99 out of every 100 orders are actually shipped within 24 hours after they are received; have proven to their own satisfaction that they make real savings.

Our new catalog is ready. Your copy is waiting for you. Just fill in and mail the coupon.

Sears, Roebuck and Co.

Chicago • Philadelphia • Kansas City • Dallas • Seattle

We give
real 24 hour
service

Mail the coupon TODAY to the store nearest you
SEARS, ROEBUCK AND CO., 80P21
Chicago - Philadelphia - Kansas City - Dallas - Seattle
Send me free your big Spring and Summer Catalog

Name

Postoffice

Rural Route..... Box No.....

State

Street and No.....

WORLD'S LARGEST STORE

WE OWN AND OPERATE SUPER-POWER RADIO
BROADCASTING STATION W-L-S—TUNE IN ON 345 METERS

"Saws 25 Cords In 5 Hours"

Any hustler can make big money with the one-profit WITTE Saw RIG—Ed. Davis sawed 25 cords in 5 hours—another user sawed 40 loads of pole wood in 3 hours. Hundreds of owners make \$3,000 to \$5,000 a year. Sold on Easy Payments.

**5 H-P.
3-in-1
Saw
Rig**

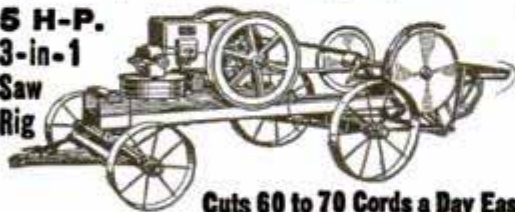

Cuts 60 to 70 Cords a Day Easy

A real all purpose outfit for farmers and men who make wood sawing a regular business. When not sawing you can fill silos, grind feed, shell corn, thrash and do other work. Easy to start at 40 below zero. Completely equipped with WICO Magneto, speed and power regulator, throttling governor and 2 fly wheels.

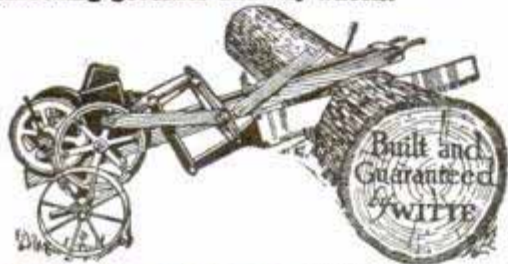

WITTE LOG & TREE Saw

Cuts down trees and saws them up FAST—one man cuts 10 to 15 cords a day—makes ties. The WITTE is easy to run and trouble-proof. Thousands in use. Powerful engine runs other farm machinery. Uses all low priced fuels.

EASY Pay only a few dollars down and take a year for the balance of low price. **PAYMENTS—MAKE YOUR OWN TERMS.**

FREE Write today for full description and low price—no obligation. Or if interested, ask for our Engine or Pump catalogs.

WITTE ENGINE WORKS

Kansas City, Mo. Pittsburgh, Pa.
6746 Witte Bldg. 6746 Empire Bldg.
6746 Witte Bldg., San Francisco, Calif.

Don't Pay for 4 Months

We will send you the Famous Metal-to-Metal

Old Tan Harness



and you don't send us a cent for four months. Free trial. Write at once for our special offer and free book about the improved harness with metal-to-metal wherever there is wear and strain. No old-fashioned buckles. Amazing strength and durability. Act quick! **WRITE TODAY.**

BABSON BROS., 19th St. & California Ave. Chicago Dept. 13-52



The New Sypher

More for the money than ever built before. Length over all, 30 in. Between centers, 14 in. Swing over bed, 7 1/2 in. Includes counter shaft. Bronze taper bearings. Weight 80 pounds. Absolutely accurate. Time payments if desired. Write today for circular.

\$60

The Sypher Mfg. Co. Dept. D Toledo, Ohio

Agents \$12.00 a day

NEW Self-Heating IRON

New invention now makes ironing easy in every home. Ends hot stove drudgery. Cuts ironing time in half. Saves steps. Costs one cent for 3 hours use. No attachments. No cords. No tubes. Gives quick regulated heat. Guaranteed. Sells fast. Mrs. Wagner, Ohio, sold 24 in few hours spare time. Moyer, Pennsylvania, made \$164 in one week. You can do as well. Work all or spare time. No experience needed. No capital. New plan. Simply take orders. We deliver and collect. Commissions paid same day you take orders. Send for exclusive territory and FREE OUTFIT OFFER. Write today. **THE AKRON LAMP CO., 32 Iron St., AKRON, OHIO**



\$25000 A WEEK!

Made with the new and improved "Krispy" Potato Chip Outfit.

Potato Chips the lunch of the hour. Everybody is eating them. One stand in small building sells \$100 worth in a week. Think of it! Grocers, druggists, pool rooms, cigar stands, tourists' counters, parks—all sell thousands of packages. Supply them. Get the big profits. Chips easily, quickly made at home. No experience necessary. Write today. Get in a big profit fast growing business now. **SERVICE & EQUIPMENT CO., 905 Hoag St., Toledo, Ohio**



REDDING & COMPANY

(Est. 1859) 9 West 23 St., N. Y. C.

Masonic Books, Monitors, Bibles, Jewelry, and Lodge Supplies

Send for catalogue 3 of Books and Jewelry; catalogue 4 of Lodge Supplies. No obligations. Mail orders promptly filled.



"If I hadn't been all through it myself, I wouldn't have the assurance to say to you 'cheer up.'"

ERICKSON.

Those who wear them say: ERICKSON LEGS are Wonderful because they do not chafe, overheat or draw end of stump.



If you have had a recent amputation send for new booklet on TEST LEGS for beginners.

E. H. ERICKSON CO.
38-A Washington Av. N.
MINNEAPOLIS - MINN.

INSTALL YOUR OWN
FREE PLANS
HOT WATER HEATING PLANT
CUT-TO-FIT GUARANTEED

Complete Hot Water Plants ready for shipment. Outfits as low as \$200.

PLUMBING and HEATING

→ **SAVE HALF** ←

By our New Easy Method and Lowest Wholesale Prices.

Mail the coupon for our FREE Bargain

Catalog. Gives illustrations, complete descriptions, sizes and wholesale prices on Heating Outfits of all kinds, Water Supply Systems, Complete Bathroom Outfits and Plumbing Supplies, Fittings, Pipes, etc. All at wholesale. Send today for your copy.



50 Years and Million Dollar Plants

behind our bonded guarantee. Every Hardin-Lavin System is figured to eliminate long runs of piping, to save valuable time and unnecessary materials and expensive labor. We furnish Heating Plants or Plumbing Outfits cut-to-fit at the factory for the exact job and we thread and mark all the larger pipes. Any Handy Man with our simplified plan and new easy method can do the installing.

MAIL COUPON TODAY

We have saved economical buyers hundreds of thousands of dollars. Everything you get from us is guaranteed highest quality, Grade A merchandise with new, exclusive features.

HARDIN-LAVIN CO.

ESTABLISHED 1876

When in Chicago Visit Our New Plant at
 107-17 West Pershing Rd., CHICAGO



HARDIN-LAVIN COMPANY.

107-17 West Pershing Rd., Chicago, Ill.

Gentlemen: Please send me your FREE BARGAIN CATALOG with special wholesale prices. I am interested in:

- Water Supply System Stm. Htg. Plant Warm Air Furnace
 H. W. Htg. Plant Pipeless Furnace Bathroom Outfit

NAME.....

ADDRESS.....

P. O.....STATE.....

MOVIES IN YOUR HOME

Practical Movie Machines in many wonderful models, some as low as \$3.75 and use same size film as big theatres. Fine films at lowest prices with a film exchange service. Many biblical films. Write for free illustrated catalog.

PARAMOUNT MFG. CO.
 Dept. MB, 120 High Street, Boston, Mass.

NEW MARVELOUS ONE-MINUTE CAMERA

Takes and finishes pictures inside the camera in one minute. Agents wanted. Exclusive Territory. Make money selling these wonderful cameras or taking photos or both. Six different models. Photos 4x6, 3 1/2 x 5 1/2, 3x4 1/2, 2 1/2 x 3 1/2, 2x3 and 1 1/2 x 2 1/4 inches. No experience necessary. Any one can operate these cameras. Write today for special offer.

CROWN MINUTE CAMERA COMPANY. Dept. 940, NORWALK, CONN.

Do Your PRINTING

Cards, stationery, circulars, labels, paper. Complete Outfits \$8.85 up, Rotary Jobber, \$150, Card Cutters \$3 Save Money. Print for others, big profit. Easy with rules sent. Write for catalog presses, type, paper, cards ink, etc. **THE PRESS CO., L-37, MERIDEN, CONN.**

AMAZING BARGAINS

In Silks, Woolens and Wash Fabrics

Save money on your dress goods and make extra money taking orders from your friends and neighbors. Hundreds of women doing it. We show you how. No experience or capital needed. Mail postal today.

AGENTS \$7 to \$12 a Day

Every woman is eager to buy our beautiful imported and domestic fabrics. Liberal commissions. Write for big sample book and complete selling instructions. Address

THE NATIONAL IMPORTING COMPANY
 Dept. B-6 573 Broadway, New York City

WRITE FOR 1000 LOVELY PATTERNS

Going to Build Remodel or Repair?

DON'T think of building a new home or repairing an old one without a copy of our free woodwork catalog.

To those who contemplate building or remodeling, this book is a valuable work of reference. In it are found the latest ideas and most advanced styles for everything in millwork. It illustrates and describes windows and sash of all kinds, including porch and storm sash, doors, frames, mouldings, screens, porchwork, stairwork, hardwood flooring, interior finish, cabinet work—in fact, practically everything in manufactured millwork. Every article in the book shows a low money-saving price direct to you.

FREE ESTIMATES

Send us your lumber and millwork bills for a free estimate. Let us quote prices on your material and tell you the exact amount of freight. Then compare our prices with others. This service costs you nothing and places you under no obligation whatever.



CHICAGO MILLWORK SUPPLY CO., 1444 W. 37th St., Chicago, Ill.
 PLEASE SEND ME YOUR FREE BOOK

Name _____ St. No. _____
 Town _____
 State _____
 Occupation _____

Book is Free

Earn \$100 a Week Profits in Advance

I pay men \$100.00 a week and up by my plan which I want to send you at once. Be your own boss, work where and when you like. You can do fine even without previous experience. **Biggest values—positively sell on sight.**

Profits in Advance

My plan pays biggest profits and commission in this line, all paid in advance, we attend to

Sell fine TAILORING

delivering orders and collections. Astonishing values get orders easy when you show samples of our tailored to order, all wool, suits and overcoats—one price \$31.50. Our advertising helps you take orders quick.

ALL PURE WOOL
\$31.50
ALL ONE PRICE



FREE!

This big, fine sample outfit furnished free, contains 100 big all wool samples, all one price, \$31.50, fine colored fashions, stationery, supplies, tape, etc. All in classy, fine carrying case. Also complete sales manual, we place you in **Big Money Class.**

W. Z. Gibson, Inc., Chicago

Dept. P-516, 161 West Harrison Street

Without obligating me in any way, please send me complete information regarding your new plan to earn \$100 weekly.

Name.....

Address.....

City..... State.....

Can You Sell \$3.50 Ford Size Tires at

If so, write for our new plan on INSYDE TYRES. Written guarantee. Big money every day! American Auto Accessories Co., Dept. 78 Cincinnati, Ohio

Amaze Your Friends With Chemical Tricks

The Boy's Hand Book of Chemistry
Price 15 Cents

Write secret letters with invisible ink; pour blue, brown and black liquid from a glass of water; make a magic pitcher of bluing; make your own magic writing paper, your own ink and dyes. It's all easy if you have Chemcraft Junior—the pocket Chemical outfit. Get yours now. Order right away and get a FREE Copy of The Boy's Handbook of Chemistry; 100 pages of experiments, formulae, interesting chemical information, money-making suggestions and catalog of supplies.



Porter Chemical Co.
113 Washington St.
Hagerstown, Md.

BOTH
25¢
POSTPAID

I made \$93 my first week



"Since then I've been earning over \$100 every week selling the Stay-Prest Trousers Presser"—says S. L. Patterson of Iowa. Jack Ames made \$24.00 in four hours. Randle sold twenty-five the first day. Mary Roberts cleared \$10.00 in one evening. You too can make big money by selling this

Wonderful New INVENTION Stay-Prest Trousers Presser

Keeps pants always pressed. Puts in knife edge crease, removes baggy knees and smooths out entire surface. Easy to use—takes only a few seconds. No steam or heat. Saves nap of cloth. Lengthens life of trousers. Durably made of hardwood—lasts years. Finished in black leatherette. All metal parts heavily nicked. Looks rich. Fits any size trousers. Folds to 15 inch package to fit small handbag. Over 250,000 in use. **BIG CASH PROFITS IN ADVANCE** Your profits in advance. Simply write orders. We ship and collect. Stay-Prest sells quickly—average sale made in 8 minutes. 40% profit. Newest thing out. Big repeater.

FREE—To Men and Women Special offer enables you to obtain Selling Outfit absolutely free—everything you need to take orders. We guarantee you will make sales. Write for plan and exclusive territory. The Getgey-Jung Co. B-122 C. & J. Bldg., Cincinnati, Ohio

Self-Filler DE LUXE Stylo Pen

"INDEPENDENT"

All the best features of a Fountain Pen. Lasts longer. Writes smoother. Improves handwriting. Eliminates fatigue. GUARANTEED

- 14 Kt. White Gold Point.
- Chased Rubber Holder.
- Lever Filler. Pocket Clip.

\$2.00
By Mail

Your Name in Gold Inlay, 25c.

Write for Pen Catalog. Agents Wanted.
J. C. Ulrich & Co., 161 Washington St., New York
Known the World Over for 40 Years.



CLASS RINGS & PINS

Largest Catalog Issued—FREE
Samples loaned class officers. Prices \$.20 to \$8.00 each. No order for class, society, club emblems too large or too small. Special designs made on request.



METAL ARTS CO., Inc. 7705 South Ave., Rochester, N. Y.

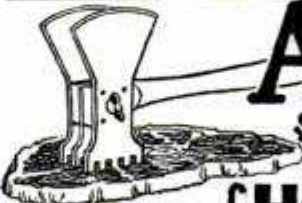

Agents! \$20 a day

- Meat Tenderer
- Mince Knife
- Cleaver
- Ice Tool
- Food Chopper
- Fish Scaler
- Nut Crumbler

HANDIEST TOOL IN THE KITCHEN. Housewives all say "Just what I want." The *Ideal Fiber Cutter* is a real household aid. Tested and Approved by Good Housekeeping. Two minute demonstration sells it—**100 PER CENT PROFIT.** Boorem, Pennsylvania says, "Have bought my home and car with Cutter profits." Bassett, Washington, new agent, writes, "Made \$7.50 in 2 hours today." You can do as well. No experience needed. Work spare or full time. Write for details.

THE TYLER COMPANY, M-5 Muncie, Indiana

Eliminate Poisons WITH THE VIT-O-NET Magnetic Blanket



This new discovery will add 10 to 20 years to your life. Decayed waste kills life forces and causes untold human misery. The Vit-O-Net Electro-Magnetic Blanket eliminates more poisonous waste than any other method. The greatest discovery in recent years. Gives you new life—new power. Magnetic warmth soothes and strengthens. Relieves pain. Dissolves congestions responsible for scores of ailments.

VIT-O-NET MAGNETIC BLANKET

USED by GREATEST HOSPITALS and PHYSICIANS for treatment of Rheumatism, Neuritis, Nervousness, Catarrh, Eczema, Blood Pressure, Kidney Trouble, etc. Frequently successful after all other methods fail. Helps to restore health. Pays for itself over and over again.

Read These "I can attribute my good health to the help of Vit-O-Net." "Received greater benefit from Vit-O-Net than from treatments costing \$1600.00." "No words can express my love for my blanket." "Would not take \$500.00 for it or do without it for nerves." "I am an entirely new man."

Get FREE Health Document Tells why 90% of diseases are caused by improper elimination. Reveals valuable health secrets you ought to know. Write for your copy today.

Representatives Wanted

VIT-O-NET MFG. CO. 4105 Ravenswood Avenue Desk 526 Chicago, Ill.

New Free BOOK



This New FREE Book Quotes you the lowest factory prices on Quality heating stoves, furnaces, porcelain enamel combination ranges, coal and wood ranges and gas stoves. 200 styles and sizes. Cash or easy terms—as low as \$3.00 monthly. 90 days FREE trial; 360 days approval test. 24 hour shipments, 500,000 pleased Kalamazoo customers. Make a \$25 to \$75 saving by sending postal for FREE book today.

KALAMAZOO STOVE CO., Mrs. 391 Rochester Ave. Kalamazoo, Mich.

"A Kalamazoo, Trade Mark Registered Direct to You"



Direct From Factory

\$39 buys this RACEABOUT

torpedo body in gray prime for your Ford. Special hood and bullet nose shell.

Write for Catalog

AMERICAN TOP & BODY CO., Erie Ave., Delphi, Ind.

GO INTO BUSINESS for Yourself

Establish and operate a "New System Specialty Candy Factory" in your community. We furnish everything. Money-making opportunity unlimited. Either men or women. Big Candy Booklet Free. Write for it today. Don't put it off! W. HILLYER RAGSDALE, DRAWER 321, EAST ORANGE, N. J.

MOTORCYCLES

LESS THAN HALF COST

Ace, Indian, Cleveland, Harley-Davidson, Henderson Motorcycles and Sidecars, new, used and rebuilt. **Rider Agents Wanted.** Write for FREE trial offer, agent's free outfit and big bargain bulletin. **New American Bicycles** in different styles and colors. Write for illustrated catalog giving our money saving prices.

AMERICAN MOTOR CYCLE CO.

2047 W. Chicago Ave., Dept. 229, Chicago



Great New Invention for seekers of Health Power Beauty



Elco Health Generators at last are ready for you! If you want more health—greater power to enjoy the pleasures and delights about you, or if more beauty is your desire—write! Ask for the book on these inventions which has just been prepared. It will be sent to you without cost. It tells you how Elco Health Generators aid you in leaving the lethargy and hopelessness of bad health and weakness behind forever. Re-vitalize yourself. Bring back energy. Be wholly alive. Write today!

10 Days Free Trial—Write for FREE BOOK



These great new inventions generate High Frequency Violet Ray, Mechanical Vibration, Medical Electricity and Ozone. Combined or separate.

They operate on the electric light in your home or on their own motive power at less than 60 cents per year. Elco Health Generators are positively the only instruments which can give you in one outfit Electricity, Violet Ray—Vibration and Ozone—the four greatest curative agents. Send coupon below. Get the Free Book NOW!



For All These:

- Rheumatism
- Gout
- Lumbago
- Neuralgia
- Sciatica
- Headache
- Neuritis
- Nervousness
- Circulation
- Weakness
- Paralysis
- Eye Trouble
- Asthma
- Hay Fever
- Sore Throat
- Catarrh
- Deafness
- Insomnia
- Pain
- Development
- Skin Disease
- Pimples
- Scalp Disorders
- Obesity

MAIL the COUPON for FREE Book!

Do not put this paper down without sending the coupon. Don't go on as you are with pains and with almost no life and energy. You owe it to yourself to be a better man or woman. You were put here to enjoy life—not just to drag through it. So do not rest another day until you have put your name on the coupon here. That will bring the whole story of these great new inventions. Do it today—now.



Lindstrom & Company

30 West Lake Street. Dept. 13-52, Chicago, Ill.

Please send me your free book, "Health—Power—Beauty" and full information on your 10-day Free Trial Offer.

Name

Address

4-Room ALADDIN

\$375

NOT PORTABLE

WE PAY THE FREIGHT

You can buy all

the materials for a complete home direct from the manufacturer and save four profits, on lumber, millwork, hardware, labor.



5-Room ALADDIN

\$478



Nine different floor plan arrangements of this house are shown in Catalog. 2 and 3 bedroom designs—grade and inside cellar entrances

6-Room ALADDIN

\$618

Living room, dining room, kitchen, 3 bedrooms, bathroom. 3 other plans in catalog. All material readi-cut, saving 18% on cost.



Story and Half ALADDIN

\$789



Story and a half semi-bungalow, with second floor available for 2 bedrooms. 2 floor plan arrangements. Any handy man can erect these houses.

7-Room ALADDIN

\$956

Large living room with circle-tread open stairway, dining room, kitchen. 3 bedrooms, each with clothes closet. Bathroom on second floor.



Price includes all lumber cut to fit; highest grade interior woodwork, siding, flooring, windows, doors, glass, paint, hardware, nails, lath, roofing, with complete instructions and drawings. Freight paid to your station. Permanent Homes—NOT PORTABLE. Many styles of year 'round dwellings, summer cottages and garages to choose from. Write nearest mill today for FREE Money-Saving Catalog No. 1543

THE ALADDIN CO., BAY CITY, MICHIGAN

Wilmington, North Carolina; Portland, Oregon; Toronto, Ontario

Big Money!

AGENTS ~ Salesmen-Distributors

Wanted to use and introduce this famous automatic attachment for Fords. No experience needed. Sell to Ford Owners, Fleet Owners, Dealers, etc. 250,000 already in use. Get Plan that starts you without capital in a business of your own; and make from \$250 to \$2000 a month profit. Thousands of others making big, permanent money with us. Makes Fords run on 94% air—start easy in coldest weather—increases mileage per gal. of gas 50% to 100%—prevents carbon and crank case oil dilution. Installed in 5 minutes without tools.

CADILLAC NOW USES AS STANDARD EQUIPMENT thermostatic carburetor control under Blancke license. This convincing proof, together with money-saving features, National Advertising, etc., enables you to sell Blancke Controls on sight. Write today—NOW, for big profit plan. **A. C. Blancke & Co., 602 W. Lake St., Dept. 805-B, Chicago, Ill.**

Blancke Thermostatic Carburetor Control For Ford Cars and Trucks

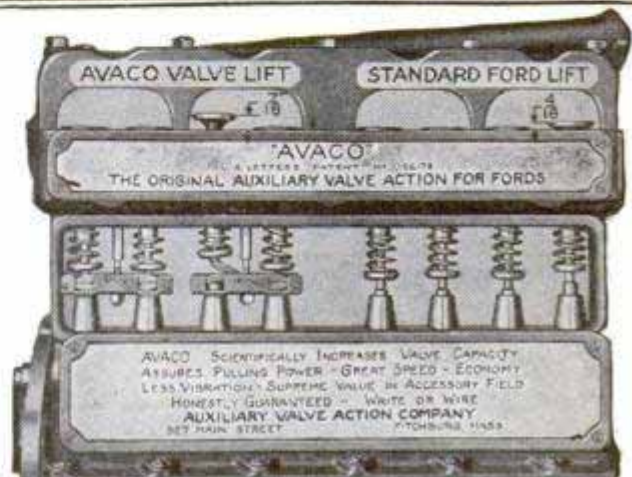

Does Your Boat Leak?



Send for our Booklets, "How to Make Your Boat Leakproof" and "Marine Glue—What to Use—How to Use it."

Jeffery's Marine Glues

in all the various grades

L. W. FERDINAND & CO., 152 Kneeland St., Boston, Mass.

SHAW MOTOR ATTACHMENT

MAKES YOUR BIKE A MOTORCYCLE!

A high grade 2½ H. P. motor attachment quickly clamped on any bike frame. Speed 4 to 40 miles an hour. 90 to 125 miles per gallon of gas.

Special Low Price Now! Write today for Complete Description and Special Low Prices on SHAW Motor Attachments and the SHAW Complete Motorcycle. **SHAW MANUFACTURING COMPANY** Dept. 37 Galesburg, Kansas



STOP FORD CRANKSHAFT END-PLAY!

C-A ADJUSTABLE BEARING corrects and prevents end-play without removing motor. Eliminates many troubles. Easy to install—simply drop pan. Only \$3.75. Ask your dealer or sent prepaid by **ADJUSTABLE BEARING CO.** Dept. P **BRAZIL, MD.**

You-and This New Machine Can Earn \$500 a Month



Operate a Tire Repair Shop

70,000,000 Tires in use. America's greatest opportunity for men with small capital. We furnish everything—\$100 and up. Easy payments. We train you FREE right at home. Start making money at once. Write today for Free Book of Opportunity.

Haywood Tire Equipment Co., 1344 S. Oakley, Chicago

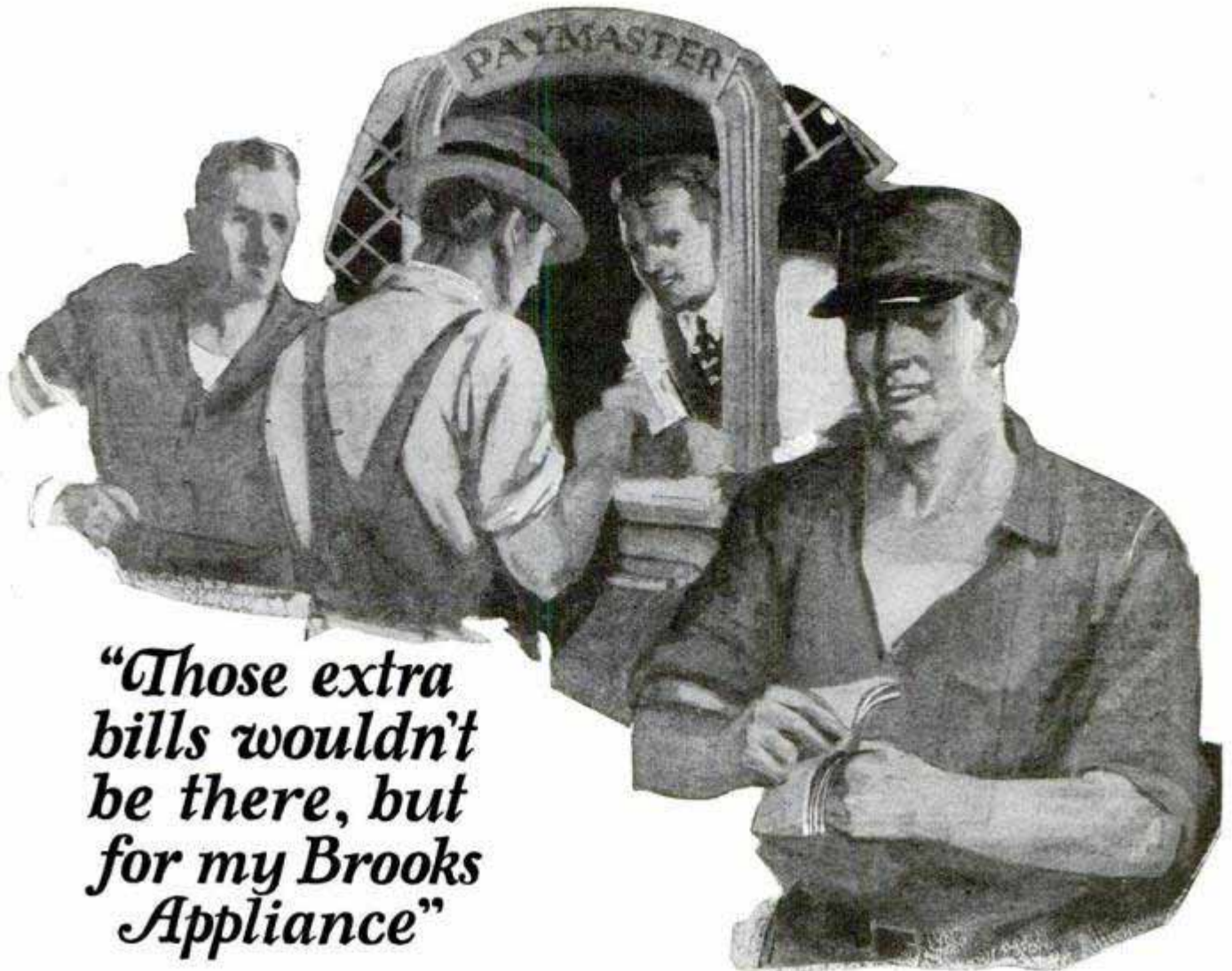

"Those extra bills wouldn't be there, but for my Brooks Appliance"

Does RUPTURE Cut YOUR Pay?

YOU can't be at your best—mentally or physically—under the handicap of rupture unless the condition is relieved by the gentle, soothing and healing restraint of a Brooks Appliance.

Throw away that old truss; free yourself of the irritation and annoyance of having to wear a steel or leather harness. Your Brooks Appliance weighs only a few ounces; elastic webbing holds a soft rubber air cushion in place, exerting an even and constant pressure, just as if it were the palm of your hand. That gives Nature a chance to repair the damage and eventually to effect a cure.

PROOF that the Brooks Appliance does heal rupture is found in the unsolicited testimony of hundreds of thousands of people in all walks of life whose letters, coming to us during the past thirty-five years, form our most cherished possession.

Send in the coupon today and you will re-

ceive valuable information on the treatment and healing of rupture in men, women and children, together with the names of many people who were cured after vainly trying other methods.

Sent on Trial to Prove It

Remember we send our Appliance on trial to prove what we say is true. You are to be sole judge. Now fill out and mail the coupon.



FREE INFORMATION COUPON

BROOKS APPLIANCE CO.,
215-C State St., Marshall, Mich.

Please mail in plain sealed envelope your illustrated book and full information about your appliance for Rupture, price and a number of testimonials from those who have been cured.

Name

City..... R. F. D.....

State.....



PA INVENTORS.

JUST
ACROSS
STREET
FROM
U. S. PAT.
OFFICE.

At the right is a view of my drafting and specification offices where a large staff of experienced experts are in my constant employ. All drawings and specifications are prepared under my personal supervision.



PROTECT YOUR IDEAS Take the First Step Today

If you have a useful, practical, novel idea for any new article or for an improvement on an old one, you should communicate with a competent Registered Patent Attorney AT ONCE. Every year thousands of applications for patents are filed in the U. S. Patent Office. Frequently two or more applications are made for the same or substantially the same idea (even though the inventors may live in different sections of the country and be entirely unknown to one another). In such a case, the burden of proof rests upon the last application filed. Delays of even a few days in filing the application sometimes mean the loss of a patent. So lose no time. Get in touch with me at once by mailing the coupon on the opposite page.

Prompt, Careful, Efficient Service

This large, experienced organization devotes its entire time and attention to patent and trademark cases. Our offices are directly across the street from the U. S. Patent Office. We understand the technicalities of patent law. We know the rules and requirements of the Patent Office. We can proceed in the quickest, safest and best ways in preparing an application for a patent covering your idea. Our success has been built on the strength of careful, efficient, satisfactory service to inventors and trademark owners located in every state in the Union.

Clip this Coupon and Mail

TENTS

Write for these **FREE BOOKS**!

NO CHARGE
for Information
On How to
Proceed!

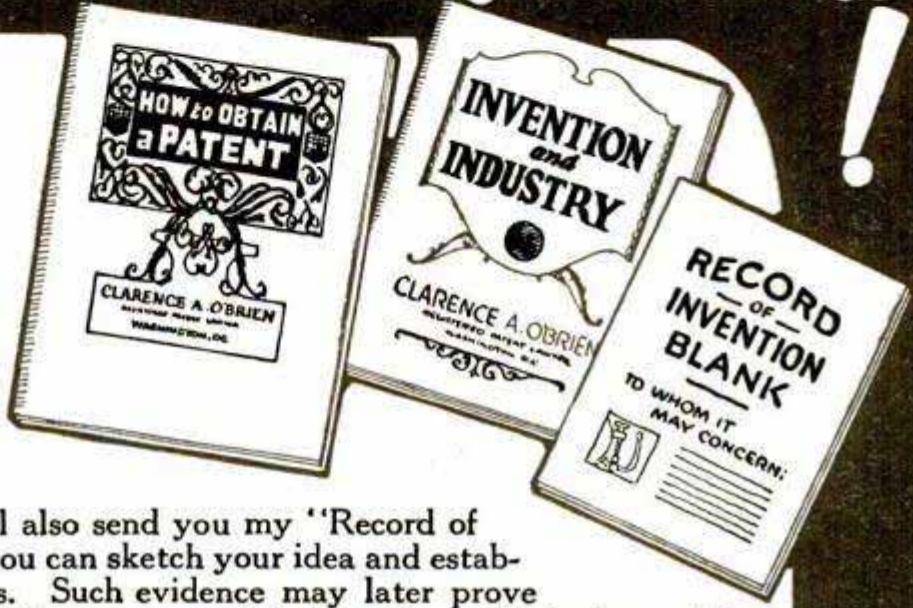

The books shown here contain valuable information relating to patent procedure that every inventor should have. And with them I will also send you my "Record of Invention" form, on which you can sketch your idea and establish its date before a witness. Such evidence may later prove valuable to you. Simply mail the coupon and I will send you the books, and the "Record of Invention" form, together with detailed information on how to proceed and the costs involved. Do this NOW. No need to lose a minute's time. The coupon will bring you complete information entirely without charge or obligation.

STRICT SECRECY PRESERVED

All communications, sketches, drawings, etc., are held in strictest confidence in strong, steel, fireproof files, which are accessible only to authorized members of my staff. Feel free to write me fully and frankly. Your case will have my personal attention. It is probable that I can help you. Highest references. But **FIRST**—clip the coupon and get my free books. Do **THAT** right now.

FREE COUPON
CLARENCE A. O'BRIEN

Registered Patent Attorney

70-D Security Savings and Commercial Bank Bldg., Washington, D. C.

Clarence A. O'Brien

Registered Patent Attorney

Member of Bar of: Supreme Court of the United States; Court of Appeals, District of Columbia; Supreme Court, District of Columbia; United States Court of Claims.

Practice confined exclusively to Patents, Trademarks and Copyrights

Please send me your free books, "How to Obtain a Patent," and "Invention and Industry," together with your "Record of Invention" form without any cost or obligation on my part.

Name

Address

(Important: Write or Print name clearly)

It Now!

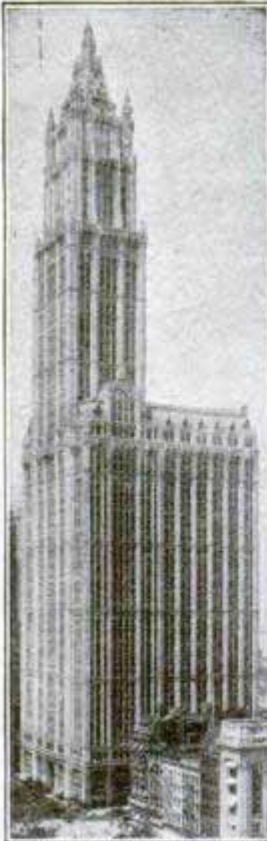

Our New York Office
Suite 1007 Woolworth Bldg.



Our Philadelphia Office
Suite 714-15 Liberty Bldg.



Our Washington Office
Victor Building

PATENTS TRADE-MARKS AND COPYRIGHTS

Have You An Idea?

Our Offer: FOR THE PROTECTION OF YOUR INVENTION YOUR FIRST STEP

Before disclosing an invention the inventor should write for our blank form

“RECORD OF INVENTION”

This should be signed and witnessed and returned to us together with model or sketch and description of the invention for INSPECTION and INSTRUCTIONS

No Charge for the Above Information

Our Four Books Mailed Free to Inventors

Our Illustrated Guide BOOK

HowtoObtainPatent

Contains full instructions regarding U. S. Patents. Our Methods, Terms, and 100 Mechanical Movements illustrated and described.

Our Trade Mark Book

Shows value and necessity of Trade Mark Protection. Information regarding *Trade Marks and unfair competition in trade.*

Our Foreign Book

We have Direct Agencies in Foreign Countries, and secure Foreign Patents in shortest time and lowest cost.

Progress of Invention

Description of World's Most Pressing Problems by Leading Scientists and Inventors.

We Regard a Satisfied Client as our best advertisement, and furnish anyone, upon request, lists of clients in any state for whom we have secured patents.

*Highest References—Prompt Attention
—Reasonable Terms*

VICTOR J. EVANS & CO.

PATENT ATTORNEYS

Main Offices: 956 9th St., N. W., Washington, D. C.

Opposite U. S. Patent Office

PATENTS TRADE-MARKS AND COPYRIGHTS

IMPORTANT

TO HAVE YOUR CASE MADE SPECIAL AND AVOID DELAY YOU SHOULD HAVE YOUR CASE MADE SPECIAL IN OUR OFFICE to secure protection, save correspondence and secure early filing date in Patent Office. To secure special preparation of your case send \$25.00 on account with model or sketch and description of invention.

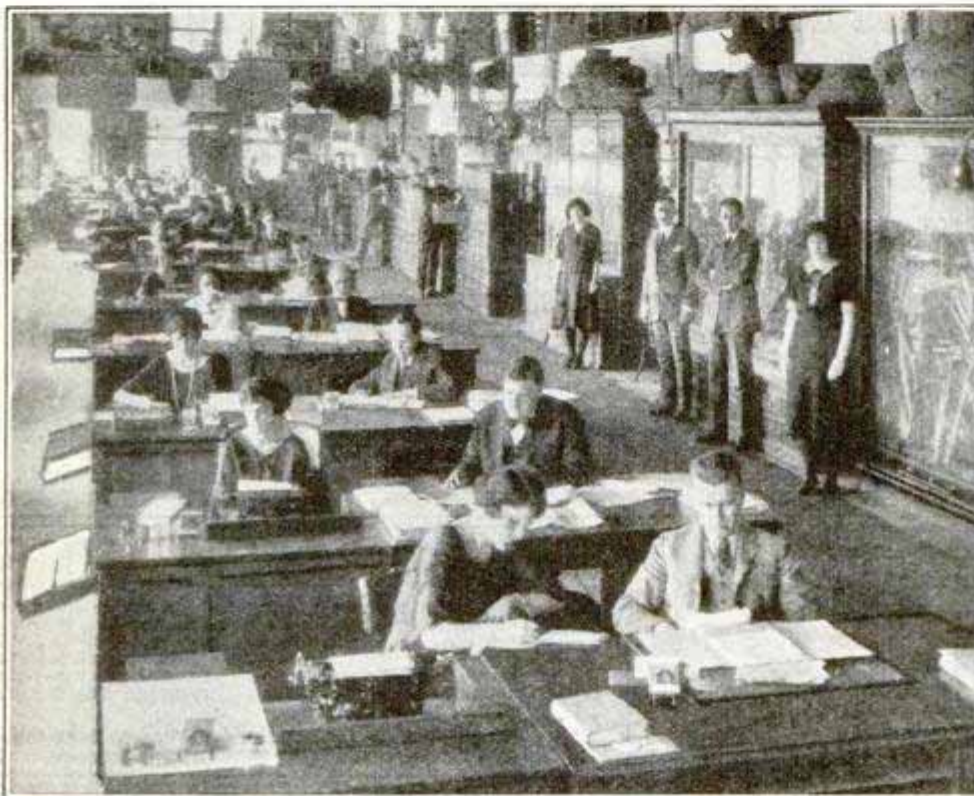

MAIN OFFICE, VICTOR J. EVANS & CO.—VICTOR BUILDING, WASHINGTON, D. C.

Our Lawyers Practice in all U. S. Courts and defend Clients in Suits involving Patents, Trademarks and Copyrights

All Communications and Data Strictly Confidential. Interference and Infringement Suits Prosecuted

OUR ORGANIZATION OFFERS PERSONAL SERVICE By Experienced Patent Lawyers, Solicitors and Draftsmen

**FREE
COUPON**

**VICTOR J. EVANS & CO.
PATENT ATTORNEYS**

NEW YORK OFFICES
1007 Woolworth Bldg.

CHICAGO OFFICES
1114 Tacoma Bldg.

PHILADELPHIA OFFICES
714-715 Liberty Bldg.

PITTSBURGH OFFICES
514 Empire Bldg.

SAN FRANCISCO OFFICES
Hobart Bldg.

MAIN OFFICES: 956 9th Street, N. W., WASHINGTON, D. C.

Gentlemen: Please send me *Free of Charge* your books as described on preceding page.

Name

Address



Our Chicago Office
Suite 1114 Tacoma Building



Our Pittsburgh Office
Suite 514 Empire Building



Our San Francisco Office
Suite 1010 Hobart Building

PATENTS

TRADE MARKS · DESIGNS · FOREIGN PATENTS

MUNN & CO. PATENT ATTORNEYS

Associated since 1846 with the Scientific American

672 WOOLWORTH BUILDING
New York City

523 SCIENTIFIC AMERICAN BLDG.
Washington, D. C.

1312 TOWER BUILDING
Chicago, Ill.

665 HOBART BUILDING
San Francisco, Cal.

520 VAN NUYS BUILDING
Los Angeles, Cal.

Books and Information on Patents and Trade Marks by Request. Associates in All Foreign Countries.

PATENTS

To the Man with an Idea

I offer a comprehensive, experienced, efficient service for his prompt, legal protection and the development of his proposition.

Send sketch, or model and description, for advice as to cost, search through prior United States patents, etc. Preliminary advice gladly furnished without charge.

My experience and familiarity with various arts frequently enable me to accurately advise clients as to probable patentability before they go to any expense.

Booklet of valuable information and form for properly disclosing your idea free on request. Write today.

Richard B. Owen, Patent Lawyer
9-303 Owen Bldg., Washington, D.C.
41-E Park Row, New York City

TRADE-MARKS
REGISTERED



PATENTS

Send us sketch or model for advice and exact cost of patent. Our book "How to Obtain a Patent" sent free. It tells how to apply for Patents, Trade Marks, Foreign Patents, Copyrights, etc.; gives information on Patent Procedure; tells what every inventor should know. Thousands of inventors, who are our clients, are our reference.

CHANDLEE & CHANDLEE, 25 Years' Experience
473 7th St. Washington, D. C.

Have You An Invention?

If so the WORLD PROGRESS will send you upon request sample copy Free containing SUGGESTIONS TO INVENTORS as to Inventions Needed. We invite manufacturers to address us regarding inventions they want.

Subscription for one year 60 cents

WORLD PROGRESS PUB. CO., Inc.
Room 203 Victor Bldg. WASHINGTON, D. C.

PATENTS C. L. PARKER

Formerly Member Examining
Corps, U. S. Patent Office
PATENT LAWYER
MCGILL BLDG.
WASHINGTON, D. C.

Patents, Trade Marks, Copyrights, Patent Litigation
Pamphlet of instructions sent upon request

★ PATENTS ★
SERVIC YOU WITH AN IDEA!
We Give Genuine Personal Service. Write **FREELY**, sending DATA of your invention, for full advice.
E. E. VROOMAN & CO., 525 9th St., N. W., Washington, D. C.
27 YEARS' EXPERIENCE

U.S. PATENTS



SEND FOR THIS FORM

DON'T LOSE YOUR RIGHTS TO PATENT PROTECTION

Before disclosing your invention to anyone send for blank form "EVIDENCE OF CONCEPTION" to be signed and witnessed. A sample form together with printed instructions will show you just how to work up your evidence and establish the same before filing application for patent. As registered patent attorneys we represent hundreds of inventors all over the United States and Canada in the advancement of inventions. Our schedule of fees will be found reasonable. The form "Evidence of Conception," sample, instructions relating to obtaining of patents and schedule of fees sent upon request. Ask for them—a post card will do.

PATENTS AND TRADE MARKS



Registered Patent Attorneys in U. S. and Canada.

480 Ouray Bldg., WASHINGTON, D. C.

Originators of forms "Evidence of Conception."

ESTABLISHED 1877
LAW OFFICES OF

RICHARD E. BABCOCK

PATENTS AND TRADE-MARKS

WASHINGTON LOAN & TRUST BUILDING

WASHINGTON, D. C.

BOOKLET ON REQUEST

PATENTS

Trade Marks, Copyrights, Patent Litigation Handbook with illustrations, 100 mechanical movements. Sent free on request.

ALBERT E. DIETERICH
formerly member examining corps U. S. Patent Office
PATENT LAWYER and SOLICITOR

621-A, Ouray Bldg.

27 Years' Experience Washington, D. C.

PATENTS

As one of the oldest patent firms in America we give inventors at lowest consistent charge, a service noted for results, evidenced by many well known Patents of extraordinary value. Book, Patent-Sense, free. Lacey & Lacey, 446 F St., Wash., D.C. Estab. 1869.

BLUE BOOK ON PATENTS

AND PRIORITY RECORD BLANK GRATIS.

MONROE E. MILLER, PATENT LAWYER
411-2 Ouray Building, WASHINGTON, D. C.
ELECTRICAL AND MECHANICAL EXPERT

PATENTS Personal Prompt Service

Send for Record of Invention Form.

JACOBI & JACOBI, Patent Lawyers, 601 Ouray Building WASHINGTON, D. C.

Fibre-Lite Limbs

BRACES AND TRUSSES



DO NATURE'S WORK. GREAT INVENTION. EASY TERMS. AGENTS WANTED
WRITE FOR FREE FIBRE SAMPLE. **WORMAN CO.** 252-P HENNEPIN AVE. MINNEAPOLIS, MINN.

Great Inventors Now Teach You How to Invent

How to develop, patent and market your ideas; amazing new course teaches science of invention by mail. Every man, woman, and child is born with *creative imagination*. Some develop this faculty to a greater degree than others, and those who develop it to the *greatest extent* are successful inventors. Invention is an orderly process of the mind, which combines two or more known facts to produce a new fact. Anyone who develops the right mental process can become an inventor. Every successful inventor has this type of mind developed by constant experience over a period of perhaps



Raymond Francis Yates

who with fourteen other famous inventors now makes it easy for you to learn how to invent in your spare time at home.

many years. Heretofore those who succeeded in the field of invention had to discover all the principles themselves. But, now, just as any student of medicine, law, or engineering can take full advantage of all the recorded experience in these fields of study, so can YOU take the same kind of short cut to the habits of thought, and the methods of work required of successful inventors.

Little Inventions Win Fortunes

Fortunes have been made by men who have thought of a "little" idea in a flash. The man who invented the bottle top, the man who invented the crimped hairpin, the man who invented the thin lead automatic pencil, the man who invented the snap fastener—all these men, perhaps, got their ideas in a flash, and founded their fortunes as a result of a single idea. But in every case their minds operated in accordance with the scientific laws of successful invention.

Edison says: "Invention should be taught as a profession." Every inventor realizes the hopelessness of groping in the dark for the habits of thought and methods of work required for successful invention. Trying to invent without knowing the fundamental requirements of invention is like trying to build a bridge without knowing engineering.

Don't Waste Ideas! Every man at some time or other has an idea for something he would like to invent, but his mind doesn't know how to work. He doesn't know what to do about it—doesn't know how to think along inventive lines—and soon someone whose mind is trained along inventive lines invents just the thing you may have thought of.

WRITE FOR FREE BOOK

A wonderful book explaining this wonderful new course in detail has been written and will be sent free to those genuinely interested. This book explains the course in detail, and proves that anyone can become an inventor who trains his mind—may be the beginning of a fortune for you. If you have ever had an idea for an invention, or if you would like to become a spare-time or professional inventor and if you would like to know what to do about it, send in your name at once on the coupon **NOW!** Only a limited number of these books are available for free distribution.

Bureau of Inventive Science, 32 Wisner Bldg., Rochester, N. Y.

BUREAU OF INVENTIVE SCIENCE

Dept. 32, Wisner Bldg., Rochester, N. Y.

Please send me your free book "The Science of Invention."

Name.....

Address.....

City.....

State.....

PATENTS

**Booklet Free Highest References
Promptness Assured Best Results**

Send drawing or model for preliminary examination of Patent Office records.

ALL BUSINESS GIVEN PROMPT AND PROPER ATTENTION

Listed Patent Lawyer in the latest editions of the Rand-McNally Directory of Bankers and Attorneys, of Chicago, Ill.; The Baggott & Ryall Directory of Attorneys, New York City; The Lawyers Guaranteed Directory, Detroit, Michigan; The Lawyers and Bankers Quarterly, published by the Legal Directory Publishing Company of St. Louis, Mo.; the American Lawyers Annual, Cleveland, Ohio.

WATSON E. COLEMAN,
REGISTERED PATENT LAWYER

644 G Street, N. W., Opp. U. S. Pat. Office
WASHINGTON, D. C.



*"Been on a
vacation
Bill?"*

"No, Jim — I've stopped smoking. Gained six pounds in a week. You know how I used to smoke—a package of cigarettes and a cigar or two a day—it sure had some hold on me. But I'm cured—

took a scientific home tobacco treatment—fixed me up in two weeks.

"Wasn't hard on me at all—noticed improvement the first day—I feel like a new man. It didn't interfere with my work—didn't leave any druggish after-effects—the money I saved in the last two weeks has paid for the treatment alone.

"Why don't you take it! It has cured men like you and me for over forty years—it is a doctor's individual prescription that sure fixes you up. Just send the coupon for full information NOW. No obligation. All correspondence is strictly confidential."



*"A Doctor's
Prescription"*

The Keeley Institute, Dwight, Ill.

Please send me, without any obligation on my part, your free booklet which will tell me how to rid myself of the tobacco habit.

Name

Town

Street..... State..... PM-2



GEARS ALL KINDS SMALL

The most accurate made and prices reasonable. We carry a complete line of gears in stock for immediate shipment. Can also quote on special gears of all kinds. Send us your inquiries.

WRITE FOR CATALOGUE.

CHICAGO STOCK GEAR WORKS
105-109 S. Jefferson St., CHICAGO



BOW LEGS?

OUR GARTER (Pat'd)

Makes Trousers Hang Straight

If Legs Bend In or Out. Self Adjustable.
Free Booklet — Plain Sealed Envelope

THE T. GARTER CO. Dept. 2, New London, New Hampshire



LUCK

All around you there is abundant Success, Wealth and Happiness. Get Your Share. The "LUCKY SEVEN" Secret Rules are free to all who wear this Rare and beautiful Talisman Ring. On each side of this Odd and Charming Ring is moulded the figure of Fortuna—The "Goddess of Luck". Ancient belief, that her emblem brings luck and success to wearer in Love, Games, Business, Health and everything. Genuine 14-K Antique Gold S. Ring, mounted with one carat Blazing Blue White Mexican 1m. Diamond. Guaranteed 20 years. Send strip paper to show finger size and we will send you this wonderful ring. When it arrives pay the postman only \$3.95. Nothing more to pay. Yours to keep, wear and enjoy forever. Wear 7 days—follow the 7 rules that we send you. If not satisfied your money quickly returned. Address Radio-FlashDiamond Importing Co., St. Paul Minn. Dept. 44L

INVENTORS PROTECT YOUR IDEAS

Send for our Guide Book, **HOW TO GET A PATENT**, and Evidence of Invention Blank, sent Free on request. Tells our terms, methods, etc. Send model or sketch and description of your invention for **INSPECTION** and **INSTRUCTIONS FREE. TERMS REASONABLE. BEST REFERENCES.**

RANDOLPH & CO.
300 Victor Bldg., WASHINGTON, D. C.

NAME

STREET

CITY..... STATE.....

Home No. 616
5 Rooms
Materials \$1511.00



Buy Your Home Direct From Mill!

You can buy at wholesale prices just the home you want, and save \$200 to \$2,000. Materials shipped direct from mill to your station.

Ready-Cut Enables You to Do Own Building

Studs, joists, rafters and sheathing cut and fitted at mill. Plans so easy to follow and material so accurately cut, many buyers put up own houses. Save in both labor and lumber.

Send For Book of 200 Plans!

Through the Gordon-Van Tine system we furnish complete plans, architectural service, lumber and building material shipped direct to you from our forest mills. Many built-in

conveniences to save steps and lighten housework. Homes planned for utmost comfort and beauty. Over 200,000 customers. Many write we save them up to \$2000.

Shows photos, floor plans, prices of town and country homes. 144 pages.

Write!

Send Us Your Bills to Figure We carry largest stocks of lumber, mill-work and building material in the country. Send us your bills and we will figure them free at wholesale prices.

Garages \$89 Up

Build it yourself. Material Ready-Cut.

Four Mills We ship from one nearest you. Safe arrival guaranteed.

Gordon-Van Tine Co.

ESTABLISHED 1865

Satisfaction Guaranteed or Money Back
669 Case Street DAVENPORT, IOWA



WHAT EVERY MASON WANTS

We have Masonic books and lodge supplies for Blue Lodge, Chapter, Commandery, Scottish Rite, and Shrine.

Our Rituals Are Used the World Over
Send for free catalog of books and rituals for Masons, Odd Fellows, Knights of Pythias, Knights of Columbus, Elks, etc.

EZRA A. COOK, Publisher, Inc.
1350 N. Clark St., Dept. M. Chicago, Ill.

PATENT NO. 1,418,950

MYERS ELECTRIC IRON CORD HOLDER

A wonderful invention. Keeps cord out of way while ironing. Grips the ironing board. Tested and approved by Good Housekeeping Institute.

AGENTS WANTED
Sample 50 cents postpaid.

C. A. MYERS CO.
6339 Woodlawn Ave., Chicago, Ill., U. S. A.

Men Earn \$90 A WEEK!

WEARING THESE HUTCHINS PANTS

Sensational prices and wonderful quality make Hutchins made-to-measure trousers sure fire sellers. You merely take orders, we deliver. Guaranteed finest quality, beautiful materials. Men eager to buy at amazing low prices—\$5.95, two pairs for \$11. Your big profit in advance.

NO EXPERIENCE REQUIRED

Even inexperienced men earn \$90, \$100 and more every week taking orders. Get your tailored pants FREE and cash in big on this opportunity.

SEND NO MONEY—Just name and address. Beautiful samples sent you FREE. But act at once. Do not delay. Start right out making big money. Address

HUTCHINS PANTS CO., B-19 East Fifth St., Cincinnati, Ohio



"The Finest Saxophone I've Ever Played"—

THIS opinion, expressed by thousands of owners of King Saxophones, Trumpets, Trombones and other band instruments, is a tribute to the exacting standards to which "Kings" are built. Every instrument is true in pitch and scale,—is easy to play and has a beautiful tone quality.

FREE TRIAL—Easy Payments—You can have 10 days free trial to prove to your own satisfaction that a "King" is the finest instrument you can obtain. Convenient payments are extended in purchasing. Other band instruments accepted as part payment.

Send for a Catalog—If you play any instrument or are thinking of getting one, send for the "King" catalog. This catalog will tell you how "Kings" are built, explain the various exclusive features which make "Kings" the finest instruments you can obtain.

THE H. N. WHITE CO., 5211-72 Superior Ave., Cleveland, O.

MAIL THE COUPON

THE H. N. WHITE CO., 5211-72 Superior Ave., Cleveland, Ohio
Kindly send me free without obligation your latest catalog on _____ (instrument)

Name _____
Address _____
City _____ State _____

\$5 DOWN Buys Any Latest Model WITTE Engine

Now, more than ever, the need for economical, dependable power is felt by the producer who is faced with ever-increasing labor costs. **WITTE Throttling Governor ENGINES** answer this important question perfectly—now an economical, dependable power plant is within the reach of everyone.

Up to 10 H-P.

Today the **WITTE ENGINE** sells at the lowest price in history. Into this **WITTE** has gone the ripe experience of more than 42 years of engine building—over 100,000 users all over the world have placed upon it their stamp of approval. You, too, can put a **WITTE** on your place, secure in the knowledge that represents the

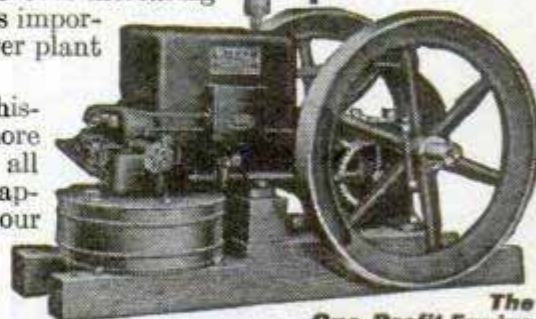

Standard of Power

The WITTE Throttling Governor

the original and leader of the throttling-governor type. An even steady speed with a big surplus of power for the heavy loads. The minimum in fuel consumption—the **WITTE ENGINE** burns kerosene, gasoline, gas-oil, distillate or gas at a fuel cost of less than 2c an hour per H-P. Simple, trouble-proof and guaranteed for a lifetime of hard work. Completely equipped with **WICO** Magneto, speed and power regulator and throttling governor.



The WICO Magneto

—the most perfect system of high tension ignition known. Makes starting easy, even at 40 below zero—sure performance in any climate or temperature. Not affected by rain, hail, snow or sleet. The perfect replacement for old-style battery-equipped engine.

Makes all Jobs Easy and Cheap—No need to do the hard, back-breaking work—no need to pay high prices for poor labor—you can show \$1,000.00 more profit every year you have a **WITTE** working on your place. Investigate now!

All Sizes, 2 to 25 H-P. Easy Terms. Scrap the Old One—Pay a Little Down on the New Witte!

Ask for Our Big **FREE ENGINE BOOK** or if interested, ask for our Log and Tree Saw, 3-in-1 Saw Rig or Pump catalog.—ED. H. WITTE.



WITTE ENGINE WORKS

1744 WITTE BLDG., KANSAS CITY, MO.
1744 EMPIRE BLDG., PITTSBURGH, PA.
1744 WITTE BLDG., SAN FRANCISCO, CALIF.



I Made \$21.00 In Five Hours

—Writes Peter Werner, III, Sell Madison "Better-Made" Shirts for Large Manufacturer Direct to wearer. No capital or experience needed. Many earn \$100.00 weekly and bonus.

Write for Free Samples

MADISON SHIRT MILLS, 562 Broadway, New York

AUTO BODIES—RADIO SETS

SEND FOR THE INTERNATIONAL CATALOG, our net price list. Full line of **RADIO SETS**; and auto bodies for Fords at Wholesale Prices. Save big money by buying Direct from Factory. INTERNATIONAL BODY WORKS, 914 W. Ohio St., Dept. 7, CHICAGO, ILL.

MAKE YOUR Ford INTO THIS Sport Car—Save \$50 to \$150

Famous sure-fit **RED-I-KUT** life-size patterns and picture instructions show how you can easily convert your Ford into this **Fast, Saucy, Sport Car** as thousands have done, with easily obtained materials. No need to lay up the car. Rear seat folds making 4-passenger car. **Look at Wilfred Eno's.** Eno says: "It took me 2 Sundays to build it and I was am proud to hear them say, 'He built that snappy sport car.' I never cut any steel or did any wood-work before but one can't go wrong with Kuempel patterns. St. Louis, Mo."



The **Lark** life-size patterns for each part of the body so you can't go wrong, picture instructions and **CONICAL DISK WHEEL PATTERNS**. Only \$5.00 delivered. \$4 extra brings patterns for **Jiffy Top** and **Geum** windshield. 22 size **RKO Steel** for **Lark** \$10 complete. Extreme West \$13. Order now while we can make good delivery, and realize on any these wonderful days in your Lark. Keen, Classy, Up-to-the-minute. You can build it. Over 11,000 in use. Don't hesitate. "Swing Lo" Underligning Irons, no frame cutting kind, \$6.59. Only \$4.99 when ordered with Lark patterns. Send 5c coin for new manual of other distinctive sport body patterns from \$5.00 up—"**RKO**" Steel "Swing-Lo" Irons, Taps and Windshields. **ORDER RIGHT NOW.** KUEMPEL CO., 69 Kuempel Bldg., Guttenberg, Iowa

30 Days' Free Trial

Select from 44 Styles, colors and sizes, famous **Ranger** bicycles. Delivered free on approval, express prepaid, at **Factory Prices**. You can easily save \$10 to \$25 on your bicycle. Prices \$21.50 and up. \$5 a Month often advance first deposit. Boys and girls can easily earn small monthly payments. Pay as you ride. Best quality, at factory prices, express prepaid. Tires, lamps, wheels and equipment, low prices. Send No Money, do business direct with makers.



Mead CYCLE COMPANY DEPT. C-109 CHICAGO

Write today for free Ranger Catalog, factory prices and marvelous easy payment terms

AGENTS!!! 300 to 500% PROFIT

Goods have Fine Appearance, Good Quality. Sells easy, and agents make big money. Write today for **FREE CATALOGUE AND SAMPLES.**

National Soap Company 512 W. Huron St., Dept. D-6, Chicago



The "Lark" Class—Snap



38-inch Easy Riding Seat

A new Parks!

Cabinet Shop
Special No. 7

\$250

as illustrated
with motor



The Most Popular Machine Parks Ever Built!

A winner from the start. A real machine, yet convenient size for the small shop. Does everything in woodworking. Has circular rip and cut-off saw, 6-inch jointer, 16-inch bandsaw. Lathe and shaper attached if desired at small cost. Operates from any light socket. Just plug in and go to work! Write for interesting circular.

The Parks Ball Bearing Machine Co.
1500-1540 Knowlton Street, Cincinnati, Ohio
Canadian Factory: 200 Notre Dame East, Montreal, Can.

PARKS

WOODWORKING MACHINES

KINKADE GARDEN TRACTOR AND POWER LAWNMOWER

A Practical, Proven Power Cultivator for
Gardeners, Suburbanites, Truckers, Florists,
Nurserymen, Fruit Growers.

AMERICAN FARM MACHINE CO.
1058-33rd Av. S. E., Minneapolis, Minn.



Catalog
Free

CUT WINTER FUEL THE EASY WAY



The farmers best helper for 40 years. Thousands save money
and backaches every year. YOU CAN TOO. Send for free
catalog showing low prices. Address Dept. 115.

FOLDING SAWING MACHINE CO., 2633 S. State St., CHICAGO, ILL.



The Famous KON-VER-TER SLIDE RULE

Instantly adds, subtracts, divides, multiplies,
converts fractions or decimals of an inch. Gives
sines, co-sines, versed sines, co-versed sines,
tangents, co-tangents, secants, co-secants of
angles directly. Gives square roots, squares,
cube roots, cubes and fifth roots and powers of
all numbers. Logarithms, co-logarithms,
anti-logarithms. Instructions with rule. De-
Luxe Model \$5. Cash or C. O. D.

NEW ENGLAND NOVELTY CO.
Dept. A. WAKEFIELD, MASS.

PILLIOD Tool Cases Excel

Machinists, Tool Makers and Car-
penters find them most satisfactory
in construction, appearance, service
and price. Immediate shipment.

Booklet describing 20 styles on request.

THE PILLIOD LUMBER CO.
Dept. 1 Swanton, Ohio

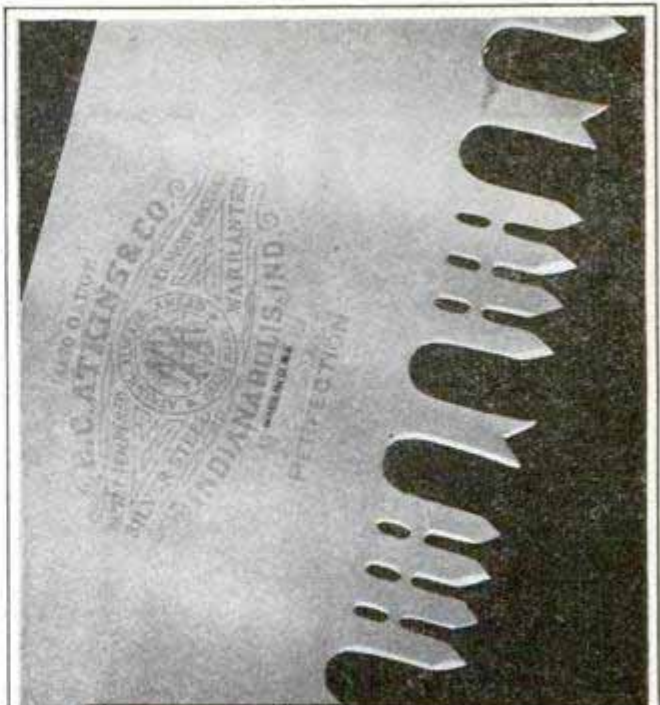

ATKINS Announces a NEW Cross Cut Saw

WHEN we say this new ATKINS
"Silver Steel," "Segment Ground"
Cross Cut Saw is the best saw of this
type that ever bore the ATKINS name—

It means this saw MUST cut easier
and faster—

MUST hold its edge longer and return
more actual sawing service and greater
value than any saw ever offered.

Not only have we improved the world-famed
ATKINS Cross Cut Saw, but with it we an-
nounce another innovation—every new ATKINS
"Silver Steel" Cross Cut is packed with the
BLUE STICK—a wooden sheath protecting
the original set and sharpening of every tooth.
Only "Silver Steel" Saws are packed with the
BLUE STICK.

The ATKINS name on any saw for cutting
wood, stone or metal means so much in extra
value that you should remember—"Look for
the ATKINS name on the blade."

Your hardware dealer can show you ATKINS
Saws—or we will gladly send you our booklets
on ATKINS Saws for any purpose.

E. C. ATKINS & CO. Est. 1857
Dept. P. INDIANAPOLIS, IND., U.S.A.

Leading Manufacturers of Saws for Every Use, Saw Tools,
Saw Specialties and Machine Knives.

ATKINS SILVER SAWS STEEL SAWS

WHITING-ADAMS TWIN

Identical in those Qualities which make Brushes Good



Whiting's
Celebrated
Brushes



Adams
Superior
Brushes

Each parallels the goodness of the other. Alike in length and strength, in suppleness and permanence of bristles—alike in all save name—these fine brushes have led all others for upwards of one hundred years. Buy by either name—or both combined. You are certain of equal—and unequal—brush service and satisfaction.

WHITING-ADAMS BOSTON

Brush Manufacturers for 117 years and the largest in the World

Why Car owners like Crescent Tools

THE eight-inch Crescent Wrench alone fits more than 400 nuts and bolts on one of America's most popular cars—a typical case. This is more than the owner is ever likely to touch. It is a time-saver in keeping body bolts, etc., properly tightened.

Crescent Tool Co.
210 Harrison Street
Jamestown, N. Y.
Originators of the Crescent Wrench.

FOR RADIO, TOO

Crescent Long Nose Pliers are not only handy to have in the motor kit, but they are great for radio work as well.



KEY KASE RENCH KIT

The famous midget set of five wrenches and handy screw-driver now sold in a handsome leather pocket key case. Great for radio, ignition systems and many other little jobs and adjustments.

NIAGARA METAL STAMPING CORPORATION
Dept. 200
Niagara Falls, N. Y.



25¢

Sent Parcel Post Prepaid
If not at your Dealers

PREMAX

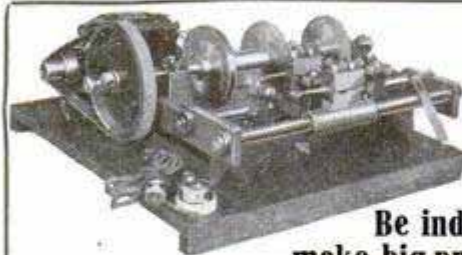

Don't Be a Slave

Be independent and make big profits with the

BEISSER KEY MACHINE

You can start a business of your own, no experience necessary. Only machine that will make first keys without taking lock apart. Makes a dozen duplicate keys per minute.

Write Today for Full Particulars

BEISSER KEY MACHINE CO.

407 Fort Street, East

Detroit, Michigan

NOW ONLY
\$4.00
DOWN



Put This MARVELOUS NEW ENGINE with Easy Starting Device To Work For You.

Increase Your Profits \$1000.00

Get my new FREE Book and ridiculously low prices—any size, 1½ H.P. up—Stationary, Saw Rip. Guaranteed to satisfy or your money returned. Built to stand hardest use. 30 days FREE trial. Send postcard for my new Free Book before you choose any engine. Write today. **Harry Overman, Pres.**

OTTAWA MFG. CO. 531-E King St. Ottawa, Kansas.
531-E Magee Bldg. Pittsburgh, Pa.



CALCULATIONS

in Office, School, Store and Shop can be instantly made with the Midget Slide Rule. I give the answer to any problem involving fractions, mixed numbers, decimals, whole numbers, roots, powers, Logs, and Trig. Functions. Thousands of these rules are used by Accountants, Engineers, Clerks, Students, etc. It is the most versatile calculator ever invented. If you have any figuring to do, order a Midget Slide Rule on trial. Made of aluminum with figures on white celluloid. Size 4". Price with Instruction Book, \$1.50. Leather Case, 50c extra. Catalogue Free. Sent C. O. D. if desired. Your money back if you are not satisfied.

GILSON SLIDE RULE CO., Niles, Mich.



Toolmakers and Machinists
FIND
GERSTNER Tool Cases

valuable because of the time they save. No tools mislaid—every tool has its place. Use one and you will wonder how you got along without it. Catalog free.

H. Gerstner & Sons

426 Columbia St., Dayton, Ohio

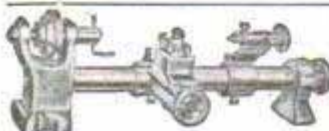

WADE BENCH LATHE

AMATEUR MECHANICS, REPAIR SHOPS, INVENTORS, STUDENTS

A real machine tool for the home work bench—capacity 4" dia., x 12" length. For Metal—Wood—Composition Materials—Turning—Facing—Boring—Drilling—Winding—Thread Cutting—Accurate—Strong—Quiet—Compact. Slide-rest has travel entire length of bed. Leadscrew inside bed. No. 1 Lathe, plain headstock, \$28.00. No. 2 Lathe, back-gear headstock, \$38.00. Complete line of accessories at equally low prices. Write for free catalog—just out

THE GEROLD CO., Dept. P-19, 120 Liberty St., New York

SIMONDS

CRESCENT-GROUND
CROSS-CUT SAWS



THE STANDARD SAW OF THE BIG WOODS

From the North Woods of Maine to the Redwood Forests of California, Simonds Crescent-Ground Cross-Cut Saws are universally preferred by men who count upon cutting tools most. Years of experience have taught them that Simonds Saws are uniformly flawless—assurance

of longer life and superior cutting qualities. Simonds quality is the result of careful, scientific tempering of the steel in Simonds own plants and near a century's experience in producing cutting tools. Next time, ask your dealer for a Simonds.

Simonds Special Cross-Cut Saw files have the same superior cutting qualities that distinguish Simonds Saws.

SIMONDS SAW AND STEEL CO., FITCHBURG, MASS.

"The Saw Makers"

Branch Stores and Service Shops in Principal Cities

Established 1852

SIMONDS

Pronounced SI-MONDS

SAWS FILES KNIVES STEEL

\$6
CASH WITH ORDER



17" Over all, 4" Swing, 11" Centers. Shipping weight 13 lbs. Bed is machined and lathe well built. Also made in larger sizes.

SYPHER MFG. CO., Dept. L, Toledo, O.

The De Luxe The Machine That Cheats the Printer

Price \$12.50 Big Profits

Here it is, boys! Look it over. The selling Wonder of the Century. Handle a live one and climb the ladder of success. The machine pays for itself over and over each year. It prints the merchant's "ad" automatically on roll wrapping paper in one or two colors as you pull the paper. Guaranteed for five years. \$25.00 per day easy. Write for proof today. Woodworkers Mfg. Co., Racine Ave. & Cortland St., Chicago



BURN YOUR NAME ON TOOLS

WITH THE ARKOGRAF

PROTECT YOUR TOOLS FROM THEFT
Write with electricity any name or design on the hardest and finest tools and instruments, or any metal, like writing on paper with pen or pencil. Complete Outfit \$3.50—Prepaid Anywhere. Interesting illustrated circular free. Write today. Agents wanted. ARKOGRAF PEN CO., 1171 E. Stark St., Portland, Oregon



TURN WASTED TIME INTO PROFITS!

Every Purchaser Finds Numerous Uses for the TORIT Acetylene Torch No. 23

An Improvement Over the Torit No. 13

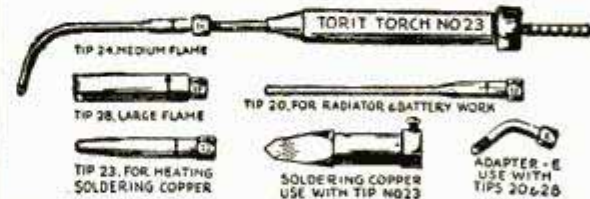

Uses Acetylene Only. No oxygen or air pressure required. Tips suck in air. Simply connect to Presto auto tank, light gas, and the outfit is put to work. Gives Heat Instantly! Beats anything you ever tried for soldering, radiator repairing, melting, lead burning, tempering, heating, light brazing, etc. Consists of torch, 4 tips for different kinds of work, soldering copper, 5 feet rubber tubing, tank connection, and full instructions. All ready to use. Quickly Pays for Itself. PRICE (Complete, as shown) \$7.50

ST. PAUL WELDING & MFG. CO.
177 West Third Street Saint Paul, Minnesota

UTAH LOUDSPEAKER

Ours is the strongest guarantee! Use it 10 days. If not the finest you ever heard, return it and get your money. Dealers Everywhere.

Utah Radio Products Co. Dept. 50, 1427 S. Michigan Ave. CHICAGO, ILLINOIS

Save Time and Money

Get a SHAW GARDEN TRACTOR

Now you can get a better power Garden Tractor at less cost. Amazingly Low Price on the SHAW. Just the thing for Truck Gardeners, Small Farms, Estates, etc.; Low Cost; Simple to operate.

SPECIAL OFFER
Write at once for Special Offer. Address Dept. P. 2.

SHAW MFG. CO.
GALESBURG, KANSAS

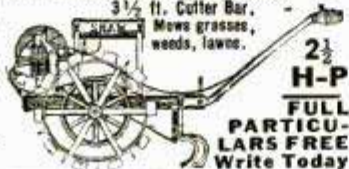

2 1/2 H-P FULL PARTICULARS FREE Write Today



Learn to Play a Harmonica via Radio

To stimulate interest in good music by teaching people to play instead of merely listen, a series of harmonica programs and lessons, known as the "Hohner Harmony Hour," are being broadcast through Stations WEF, New York; WJAR, Providence; WEEL, Boston; WOO, Philadelphia; WCAP, Washington; WGR, Buffalo; and WWJ, Detroit.

In addition to the musical numbers, ranging from the "bluest" of jazz selections to classical and operatic compositions, a series of harmonica lessons are broadcast by a well-known instructor.

If you want to enjoy one of the most popular features "on the air" and learn to play a harmonica for pleasure or profit, procure a copy of the Free Instruction Book and "tune in" for the "Hohner Harmony Hour." If your dealer cannot supply you Address M. Hohner, Inc., Dept. 181, 114 East 16th St., New York.



Always carry, in your kit or your car, the famous

IVER JOHNSON \$1.00 STEEL FISHING ROD



Takes down handily into three short joints for easy stowing away or carrying, in neat cloth case. 8 ft. of lively, resilient, strong steel—a joy to handle—weighs only 7 1/2 ozs. Brass ferrule butts—can't rust. Non-slip corrugated grip of hard wood, waterproof, varnished, banded to take any reel. It's a big dollar's worth, for still fishing, bait fishing, trolling, "worming," or for emergencies when your expensive fly or casting rod is out of commission. Send \$1 today for this handiest of rods, postpaid. Satisfaction or money back. Sporting Goods Catalog free.

IVER-JOHNSON SPORTING GOODS CO.
10 Cornhill, Boston, Mass.

Save On This Home \$803



Just think! Through our amazing new plan you can get this \$2400 bungalow for only \$1606—a clear cut saving to you of \$803 or actually a third! We furnish you with the finest materials cut to fit direct from our mill—saving you big money on your lumber, mill work and labor. Satisfaction guaranteed or your money back.

Buy Direct from Mill—Save 4 Profits

You positively save four big profits by buying direct from our mill. We give you everything complete—all lumber cut-to-fit, windows, doors, flooring, shingles, lath, glass, paints, varnish, putty, hardware, nails, molding, cupboards—all plainly marked and easily assembled according to drawings and directions we furnish. We pay the freight. Write now for our beautiful book of homes which shows you a large number of lovely homes, priced from \$478 up. Send for it at once—no obligation.

INTERNATIONAL MILL & TIMBER CO.
B-2 South Wenona Ave. BAY CITY, MICHIGAN

Makes Old Ford a Tractor

We furnish everything for converting Ford Auto Chassis with Engine into a handy Farm Tractor. Just right for truck growers, small farms, nurseries, etc. Pulls 16" Plow, Discs, Seeds, Cultivates; Runs Belt Machinery. We also build Garden Tractors and Cutter Bar Mower Attachments.



Write for Free Particulars.
SHAW MFG. CO., Dept. F, Galesburg, Kan.

PLUMBING-HEATING

YOU SAVE HALF

Send for **FREE BOOK** of Guaranteed Plumbing and Heating. Everything cut-to-fit. 50 yrs. in business. Thousands of customers. "You saved me \$400.00," says Mr. Edw. Borkosky of N. J. Write today.

HARDIN-LAVIN CO., 107-170 W. Pershing Rd., CHICAGO

New Pants Save Buying a New Suit

You need not discard your good coat and vest because the pants are worn. Save them by mailing us your vest or sample. Upon receipt we send best matching sample for approval. If satisfactory, we make pants to your measure and guarantee satisfaction.

FREE BELT

SPECIAL OFFER

We also give you Free with each order for new pants, one Genuine Cowhide Leather Belt and Initialed buckle. Send vest or sample today and get in on this bargain offer.

American Match Pants Co.
Dept. P.M., 6 W. Randolph Street, Chicago, Ill.

If you want to make \$50-\$75-\$100-Per week



SELL Harrison clothes full time or part time. Be your own boss—with unlimited income. Harrison clothes are the finest clothes \$24.75 can buy! They are smartest New York styles, splendidly tailored, guaranteed to fit; easiest to sell. You make most money selling them because we pay highest commissions (\$4.00 or more cash on every suit). You make good money right from the first day. Prompt deliveries, enormous repeat business because every suit satisfies. You collect cash commission when you make sale; we ship direct and collect direct. Handsome selling kit Free. Write today. Be on job in a week. S. Harrison Bros., Dept. 206, 133 W. 21st St., New York City

Examine Free! Startling Offers Unusual Cash Diamond Buys



As Low as \$60 PER CARAT

60% OF MARKET PRICE

Write for our latest lists and see the hundreds of startling offers in unset diamonds, beautiful mountings, and others already mounted. You can now get the mounting you like best and the diamond of your choice—both at a price so low, you'll be amazed. Shows how and why: this 75-year-old, \$1,000,000.00, largest and oldest diamond banking institution in the world having just completed big cash deals direct with European diamond cutters, and having other diamonds on which money was loaned, but not repaid, can make these startling legitimate offers passing on the advantages to friends and customers alike. You make further savings here through our cash policy of no charge accounts—no installments, but extra value for cash.

List of Rare Diamond Buys—Unbeatable Values
Sheet No. 1.

Price	Exact Wt.	Description
\$82	1/2-3/32 ct.	Flawless Gem Fine Steel white color. Ac Try to match at \$135.00.
\$116	3/4 less 3/16ct.	Weesellton Showy Brilliancy. Spread Try to match at \$235.00.
\$237	7/8-1/32 ct.	Flawless Gem Perfection and Proporti Try to match at \$385.00.
\$345	1-3/32 ct.	Jaegerfont Rare color grade and Try to match at \$550.00.

ATKINSON AUTOMATIC TIMER

\$75 to \$100 Weekly



Every Ford Needs One

New Invention that will make starting easy. Smoother running at all speeds. Short Proof—Kick Proof. Agents or Salesmen can earn big money. Sells for \$3.00. Write for free folder and confidential prices. Start quick before your territory is taken.

ATKINSON AUTOMATIC TIMER CO., CYNTHIANA, KY.

Tire AGENTS WANTED

Use and Introduce **MELLINGER CORD TIRES**

15,000 MILES GUARANTEED Lowest Wholesale Prices in America. Shipped prepaid on approval. Make big money all or part time. No capital or experience. Sample sections furnished.

YOUR TIRES FREE! Simply send name today for valuable **FREE BOOK**: tells how thousands have gone into big business. **SPECIAL AGENTS' OFFER**. Wholesale Prices and **FREE SAMPLE KIT**. Write nearest address.

MELLINGER TIRE & RUBBER CO.
PHILADELPHIA, PA. Dept. 1915 KANSAS CITY, MO.



Why Pay Full Prices

Costs Nothing to See

At our risk we send you any bargain you wish for absolutely free examination. No red tape. Try to match at full 60% more if you can or don't keep it. Diamonds of desirable quality at \$125 per carat. Yes, some even lower priced—also finest gems obtainable at higher per carat—but proportionately low bargain prices. Our bargains have guaranteed loan values, also unlimited exchange privilege at full price paid.

Latest List Diamond Bargains

Send at once for latest list. Every gem described in full detail with exact weight, color, quality, etc. Get details of Free Examination Offer. No obligation to buy. List is free.

Mail Coupon NOW!

JOS. DeROY & SONS, 1941 DeRoy Bldg., Pittsburgh, Pa. Only opposite Post Office

Without obligation to buy, send me free, your Latest Bargain List of Diamonds, Watches and other Jewelry.

Name.....
Address.....
City..... State.....

BETTER HEAT

EASIER COOKING CHEAPER THAN COAL OR WOOD



If you're interested in cheap fuel and more efficient heat, write for free folder on the **HOME ECONOMY OIL-GAS BURNER**

Turns low cost kerosene or furnace oil into gas. Simple new principle burner that cannot clog with carbon. A control valve makes it the most efficient on the market. Can be installed by anyone. Fits any stove or furnace. Simple in operation. Objectionable noises eliminated. Entirely different from others. Gravity outfits for stoves or ranges, \$20. Pressure outfits for furnaces, \$35.

Wonderful opportunity for agents and distributors.

HOME ECONOMY BURNERS, Inc.,
600-604 Keith Theatre Bldg., SYRACUSE, N. Y.

Knowing tomorrow's weather today is possible with a ~



Tycos Stormoguide

If your Dealer cannot supply you, write

Taylor Instrument Companies
ROCHESTER N.Y.
Canadian Plant, Tycos Bldg Toronto

There's a Tycos or Taylor Thermometer for Every Purpose

Puncture Proof ^{any} TIRE with new wonder GALACITE

THE COST per tire is Very Low

in 1 minute

The greatest and most outstanding automotive invention of the past few years—banishes tire trouble forever. This wonderful new scientific discovery repairs a puncture instantly without taking the tire off wheel or rim. Actually makes any tire puncture-proof for life. Guaranteed not to injure tube, valve or tire. On the contrary, it preserves and lengthens the life of both tube and tire, often—

Increasing Tire Mileage from 10,000 to 12,000 Miles.

MAKE THIS TEST Take a hammer and drive as many nails into a tire as you wish, 10-20-100, it makes no difference. GALACITE seals the punctures instantly as soon as they are made. Stops all slow leaks and porous places. Used in all kinds of tires including low pressure Balloon. GALACITE is warranted for one year, but will last indefinitely.

GUARANTEED TO DO ALL WE CLAIM

Don't confuse Galacite with anything else ever intended for the same purpose; it is new and different—a revolutionary invention, the result of years of research and experiment. GALACITE is backed by a Money Back Guarantee. It must make good—or we will. You take no risk.

AGENTS—\$5,000 to \$10,000 a Year

TREMENDOUS PROFITS. Agents and Distributors everywhere to demonstrate and sell to car owners, garages, filling stations. Work all or spare time in your own home town or traveling. GALACITE sells itself. Every customer becomes so enthusiastic that he helps you sell his friends. A revolutionary invention that will make you independent. You can also manufacture and sell Galacite puncture proof inner tubes.

ACT QUICK SEND NO MONEY. Just your name and address will bring complete particulars by return mail. Get this information right now. Test it out. Get started while the territory you want is still open.

C.F. JOHNSON & CO. 19 W. Jackson Blvd., Dept. 962 CHICAGO

"GALACITE" Trade Mark Registered
Licensed under Folmir-Hewitt Process



You save 20 cents!

Special offer: Send dealer's name and 20 cents in stamps for one 40c sample can of Valspar, the famous waterproof, weatherproof accident-proof varnish. State whether you want clear Valspar Varnish or give color desired. Valentine & Company, 458 Fourth Avenue, New York, N. Y.

\$4.50 LIST PRICE

WALLACE COMBINATION JACK and RIM TOOL

Just the tool for all motorists, garage owners. All-in-one. Ball Bearing. Fits all split rims. Will fit any style and size. If your dealer cannot supply you send your order direct to us. Representatives wanted everywhere.

WALLACE RIM TOOL & MFG. CO.
Dept. P. M., 24 S. Clinton St., Chicago



REMINGTON PORTABLE TYPEWRITER

Dealers and Branches Everywhere

SHOW IT—and IT'S SOLD

The Handy Knife Sharpener is the fastest selling home necessity ever offered. Everyone a prospect. Sells for \$1.00, your profit 65c. Free deliveries. Guaranteed.

Morgan Mfg. Co., Dept. G, 443 S. Dearborn, Chicago



\$35 Complete Outfit as illustrated

Delivery Paid East of the Mississippi

\$38 Delivery Paid West of Miss.



MECHANICS BENCH SAW

With this saw you can make your own repairs in shop, home, farm or garage. Makes a clean edge on the toughest wood—no planing necessary. Rips, cross-cuts, bevels, miters, mortises, tenons, or grooves. Attach to any lamp socket. Weight only 61 lbs. Will cut up to 1 1/4". All metal. Saw size 6 in. Table 10x13, base 7x11, height 7 in. Table tilts for beveling 5 degrees left 10 degrees right.

WRITE FOR OUR NET PRICE BUILDERS' HARDWARE CATALOG

Saw Table Can be purchased with 6-inch saw for **\$22.50**

Delivery paid East of Mississippi. **\$24.50** Delivery paid West of Mississippi.

Motor This heavy duty motor can be furnished separately for **\$12.90** delivery paid East of Mississippi. **\$13.90** Delivery paid West of Mississippi. Complete with Cord, Plug and flat or grooved Pulley. Guaranteed 50% Overload. Special Prices on Quantities of 10 or Over.

PAUL J. DEVITT, 1101-1107 So. 2nd St., Phila., Pa.

LUMINOUS PAINT

Make Your Watches, Clocks, Etc., Visible by Night The very latest discovery in the scientific world. Hitherto, practically unobtainable except at an exorbitant price, we have at last succeeded in producing this remarkable LUMINOUS PAINT, which, applied to the surface of any article, emits rays of white light, rendering it perfectly visible in the dark. THE DARKER THE NIGHT, THE MORE BRILLIANT IT SHINES. Quite simple to use. Anyone—you can do it. A little applied to the dial of your watch or clock will enable you to tell the time by night. You can coat the push buttons or switch plates of your electric lights, match boxes, and innumerable other articles; make your own Luminous Crucifixes, Luminous Rosaries, etc. Small bottle, price 25c. Larger sizes, 50c and \$1 postpaid. **JOHNSON SMITH & CO., Dept. 490, RACINE, WIS.**

Serpent's Eggs
Box contains 12 eggs. When lit with a match, each one gradually hatches itself into a snake several feet long, which curls and twists about in a most life-like manner. Price per box, 10c postpaid, 3 for 25c.



CIGARETTE MAKER
Roll your own and save money. Makes them better and quicker besides saving more than half. Use your favorite brand of tobacco. Neat, useful and handy. Pocket size, weighs 1/2 oz. Made entirely of metal, nickel-plated. Price 25c postpaid.



MIDGET BIBLE
GREAT CURIOSITY Smallest Bible in the World. Size of a postage stamp. 200 Pages. Said to bring good luck to the owner. A genuine work of art. Must be seen to be appreciated. Make good money selling them to friends, church acquaintances, etc. PRICE 15c each, 3 for 40c, 12 for \$1.35, 100 for \$7.50. Also obtainable in Leather Binding, with gold edges. Price 50c each, 3 for \$1.25, \$4.50 per doz. Magnifying Glass for use with Midget Bible, 15c.



STAGE MONEY
With a bunch of these bills, it is easy for each person of limited means to appear prosperous by flashing a roll of these bills at the proper time and peeling off a genuine bill or two from the outside of the roll, the effect created will be found to be all that can be desired. Prices, postpaid: 40 Bills 20c, 125 for 50c, or \$3.50 thousand postpaid.



Wonderful X-Ray Tube
A wonderful little instrument producing optical illusions both surprising and startling. With it you can see what is apparently the bones of your fingers, the leg in a lead pencil, the interior opening in a pipe stem, and many other similar illusions. A mystery that no one has been able to satisfactorily explain. Price 10c, 3 for 25c, 1 dozen 75c. **Johnson Smith & Co.**



Good Luck Ring
Quaint and Novel Design
A VERY striking and uncommon ring. Silver finish, skull and crossbone design, with two brilliant, flashing gems sparkling out of the eyes. Said by many to bring Good Luck to the wearer, hence its name, Good Luck Ring. Very unique ring that you will take a pride in wearing. **ONLY 25 CENTS.**



Exploding Cigarettes
JUST LIKE ORDINARY CIGARETTES, BUT SUCH REAL STARTLERS! The box contains ten genuine cigarettes of excellent quality. They appear so real, but when each cigarette is about one-third smoked, the victim gets a very great surprise as it goes off with a loud BANG! A great mirth provoker yet entirely harmless! Price 25c per box.



Popular Watch Charms
ONLY 15c
3 for 40c; \$1.35 doz.



Very pretty little curiosities and decidedly novel. Fitted with Magnifying Lenses that enlarge the pictures to a very surprising degree; in fact, it seems almost incredible that a clear picture could be possible in such a small compass, and how sharp and distinct they show up when you look through. Come in assorted views—Actresses, views of Panama Canal, Lord's Prayer in type, etc.

Mystic Skeleton
A jointed figure of a skeleton 14 in. in height, will dance to music and perform various gyrations and movements while the operator may be some distance from it. 10c & pd.



NEW BOOK ON ROPE SPLICING
Useful Knots, Hitches, Splices, etc.
A most practical handbook giving complete and simple directions for making all the most useful knots, hitches, rigging, splices, etc. Over 100 illustrations. All about wire rope attachments, lashing, blocks, tackles, etc. 37 Heraldic Knots illustrated. Of great value to mechanics, riggers, campers, boatmen. Price 20c postpaid.

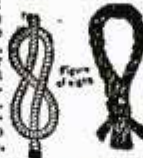

MAGIC FLUTE
Wonderfully Sweet Toned and Musical
The Magic Flute, or Human-tone, is a unique and novel musical instrument that is played with nose and mouth combined. There is just a little knack in playing it which, when once acquired after a little practice will enable you to produce very sweet music that somewhat resembles a flute. There is no fingering, and once you have mastered it you can play all kinds of music with facility and ease. When played as an accompaniment to a piano or any other musical instrument, the effect is as charming as it is surprising.



BLANK CARTRIDGE PISTOL

Protection against Burglars, Tramps & Dogs
Prices 50c \$1.00 Post-paid
Well made and effective; modelled on latest type of Revolver; appearance alone is enough to scare a burglar. When loaded it may be as effective as a real revolver without danger to life. It takes standard .22 Cal. Blank Cartridges obtainable everywhere. Price 50c, superior quality, \$1.00 post-paid. Blank Cartridges, by express, 50c per 100. Holster (Cowboy type) for Blank Cartridge Pistol, 50c. **Johnson Smith & Co., Dept. 490, Racine, Wis.**



BOYS! BOYS! BOYS! THROW YOUR VOICE

Into a trunk, under the bed or anywhere. Lots of fun fooling the teacher, policeman or friends.
THE VENTRILO
a little instrument, fits in the mouth out of sight, used with above for Bird Calls, etc. Anyone can use it.
Never Fails. A 32 page book on ventriloquism, the Ventrilo, ALL FOR 10 CENTS



K.K.K.

Everything about the Ku Klux Klan told in a clear, fearless manner. Book tells all—How it started and was oppressed in 1871—The New Ku Klux Klan—How Organized—How Members are Enrolled—Oath of the Klan—Questions for Candidates—Creed—Objects of the Order—Obedience—Fidelity—Pledge of Loyalty—Ku Klux Klan and the Masons—The Jews—The Masons—Real K. of C. Oath—The Negro Ku Klux Klan, etc., etc. Latest and most complete book on the Klan published. Price 35c, Postpaid. Stamps or Coin.



LOOK 35c LOOK

Wonderful instrument. Greatest thing yet. Nine separate articles in one. Everybody delighted with it. Odd, curious and interesting. Lots of pleasure as well as very useful. It is a double Microscope for examining the wonders of nature. It is also an Opera Glass, a Stereoscope, a Burning Lens, a Reading Glass, a Telescope, a Compass, a Pocket Mirror, and a Laryngoscope—for examining eye, ear, nose and throat. It is worth all the cost to locate even one painful cinder in the eye. Folds flat and fits the pocket. Something great—you need one. Don't miss it. Sent by mail, postpaid. **Only 35c or 3 for \$1.00**



25 CENTS BABY TANK

Goos backward or forward by its own power. Nothing to wind. What makes it go is a mystery. It crawls along, overcoming obstacles just like the larger Tanks. Performances of most amazing "stunts." Runs ten times longer than most mechanical toys. Hand-somely finished and colorfully decorated. 25c postpaid.



Female SEX Indicator 25c Male Sex Indicator

Hold the MAGIC INDICATOR over a man's hand—instantly it moves in a straight line, backward and forward. Hold it over a woman's hand and it describes a complete and continuous circle. The same action can be obtained over a letter written by a man or woman, etc. It is fascinating, baffling. We have never been able to figure out how it's done, but we've never seen it fail. Many novel and entertaining feats may be performed with the Sex Indicator. For example, similar results can be obtained with animals, cats, dogs, rabbits, over birds, chickens, canaries, etc. Also used to predetermine the sex of chickens and birds, etc., in fact it is sold as a patented sex tester in Europe. Price 25c, or 3 for 85c, postpaid. **JOHNSON SMITH & CO., Dept. 490, RACINE, WIS.**



Address orders for all goods on this and opposite pages to **JOHNSON SMITH & CO.**

Dept. 490 RACINE, WIS.
A Deluxe Edition of our new 1925 CATALOG mailed on receipt of 25c. Handsome cloth binding. Only book of its kind. 420 pages of all the latest tricks in magic, the newest novelties, puzzles, games, sporting goods, interesting books, curiosities in seeds and plants, etc., unobtainable elsewhere. Remit by Money Order, Check, Coin, Stamps, etc. Stamps of foreign countries also accepted.

SALESMEN!

\$600⁺ month

New Invention
No Competition

ANY MAN CAN SELL IT



Act Quick

Be First in the Field with this New Extinguisher

APPROVED BY UNDERWRITERS

This Is Your Opportunity to Double Your Income!

Write for Free Outfit Offer!

FYR-FYTER

1007 Fyr-Fyter Bldg. DAYTON, OHIO

LOFTIS

BROS. & CO. F8&8

DIAMONDS WATCHES

CASH or CREDIT

Genuine Diamonds **GUARANTEED**
We import Diamonds direct from Europe and sell direct by mail.

Send For Free Catalog
Over 2,000 illustrations of Diamond-set jewelry, Watches, Wrist Watches, Pearls, Mesh Bags, Silverware, etc. Sent prepaid for your **FREE EXAMINATION**

TERMS: Goods delivered on first payment of one-tenth of purchase price; balance in equal amounts, payable weekly, semi-monthly, or monthly, as convenient. **Money back if not satisfied**



No. 27
Blue White, perfect-cut Diamond. The ring is Solid 18-k White Gold. Price \$100. Terms: \$10 down, then **\$2.50 A Week**



No. 28
Blue White perfect-cut Diamond. The ring is Solid 18-k White Gold, \$37.50. Pay \$3.75 down, then **\$1.00 A Week**

WEDDING RINGS
All Platinum, \$25 up. With Diamonds: Three Diamonds, \$65; five Diamonds, \$80; seven Diamonds, \$95; nine Diamonds, \$110; surrounded by Diamonds, \$225. Solid White or Green Gold, \$5.00 up.

No. 16—Wrist Watch, Solid 18-k White Gold. 17 Jewels, **\$27.50**. 14-k, 16 Jewels, **\$22.50**.

Railroad Watches—Guaranteed to Pass Inspection
HAMILTON No. 992. 21 Jewels, Adjusted to 5 positions. Gold \$55 filled 25-Year Case
ELGIN'S LATEST RAYMOND. 31 Jewels; 8 Adjustments. Runs 40 hours one winding. Gold filled 20-Year Case **\$55**

LOFTIS THE OLD RELIABLE ORIGINAL
BROS. & CO. F8&8 CREDIT JEWELERS
Dept. K 894 108 N. State Street, Chicago, Illinois
Stores in Leading Cities

Radio Fans Listen in on WHT every Tuesday night from 7 to 7:30; every Friday night from 10 to 10:30, central standard time. Loftis Bros. & Co.'s hour of music.

Lighting Fixtures

READY TO HANG
(Direct from the Manufacturer)

Completely wired, including glassware. Send for New Catalogue No. 27. Just reduced prices. *Special proposition to DEALERS.*

ERIE FIXTURE SUPPLY CO.
STA. A ERIE, PA.

Your Coat and Vest can be Matched with new Trousers

Save the price of a new suit. We match hundreds of coats and vests satisfactorily every day. Every pair tailored to your measure. 60,000 patterns. We submit sample of cloth for your approval. *Just mail your vest or a sample of the suit to*

MATCH PANTS COMPANY
Dept. 2-A, 36 W. Randolph Street, Chicago
Enclose return postage if vest is sent.

SPORT BODIES for FORD and CHEV. 490 at \$34.50 UP

Life-size paper patterns—You can build your own body at small cost. We are manufacturers and our quantity production enables us to quote exceptional low prices. Our unique shipping methods save you 73% in **FREIGHT CHARGES**. Send at once for free particulars on Central Bodies. Our Book: "HOW TO BUILD A FORD RACER" sent anywhere on receipt of 25c in cash or stamps. **WRITE TODAY!**

Central Auto Supply Co. Dept. 120, Louisville, Ky.

A NEW TOOL

A SAW IN CUTTING A FILE IN EFFECT

DOUBLE EDGED TOOL FOR KEEN ACCURATE CUTTING

FOR LOCKSMITHS, TOOLMAKERS, MACHINISTS, ELECTRICIANS, DIE-SINKERS, MECHANICS, ADAPTED TO RECEIVE SLOTTING OR HACK. *SAWS OF DIFFERENT THICKNESSES AND HOLD THEM RIGIDLY FROM SIDE DEFLECTION*

POST PAID U. S. \$2.00 HENRY NOYES, 504 18th Street, Oakland, California

40 Years OF BIG VALUE Lathes

15" Lathe as low as **\$250.00**

Write for Catalog

SEBASTIAN LATHE CO.
107 Culvert Street CINCINNATI, O., U. S. A.

Gold Seal SEBASTIAN LATHES GUARANTEED CORRECT



All the stations—evenly spaced around a 360° dial—with



ALL-AMERICAN
TRADE MARK

STRAIGHT-LINE-FREQUENCY
TUNING

A free-running Condenser with perfect mechanical balance—modern, highly efficient Toroid Coils.



LATEST WHOLESALE RADIO CATALOG Simply Send Name
FREE TODAY for big 64-page book explaining liberal proposition paying agents \$60 to \$100 a week and how to get latest radio goods at Wholesale. Live dealers and agents wanted.
STANDARD RADIO CO., 1402 Walnut St., Kansas City, Mo.

COAST TO COAST RADIO—Low Price
IMPERIAL 5 Tube Set
Latest, most advanced type 5 tube tuned radio frequency receiver. Greater range, power, selectivity and perfect tone. Why pay more when you can't get more than the new IMPERIAL gives you? Write at once for full particulars of this new, better radio receiver and low prices.
SIMPLEX CO., 2035 S. Michigan, Dept. 23, Chicago



FARAWAY RADIO
\$22.50
Gets stations Far and near Loud and Clear

FARAWAY RADIO AGAIN to the FRONT
AMAZING new set, Model 55.—5 tube set, at an exceptional price. Most advanced set on the market today—designed exclusively for the new tubes. Users get stations from New York to Frisco—loud and clear. Operates with either dry cell or storage battery. SATISFACTION GUARANTEED. Don't pay \$100 to \$150. Write for our money-saving plan and literature.
2 Tube Set - \$22.50 5 Tube Set - \$63.50
Dealers-Agents: Biggest possibilities you ever heard of. Write for plan and territory quickly.
The Faraway Radio Co., Dept. T-3, 125-27 E. 3rd St., Cincinnati, O.

Save Time and Trouble use Belden Products

BEFORE you build your next set, send for the new Belden booklet entitled "Helpful Hints for Radio Fans." It describes every Belden Radio Product. It contains a lot of helpful hints of value to the man who contemplates building a new receiver.



Belden Radio Products cover everything from magnet wire to aerial wire. The largest set manufacturers use Belden Products.



Use Belden Magnet Wire if you wind your own coils.

Belden

Send for Free Illustrated Booklet
Belden Manufacturing Company, 2306-J So. Western Ave. Chicago.
Please send me your latest illustrated booklet, free, describing Belden Radio Products and their use in radio work.

Name

Address

BURGESS FLASHLIGHTS & BATTERIES



SOMETHING to remember is that any good flashlight case practically never wears out. Filled with a Burgess Flashlight Battery, you have done about all that you can to insure yourself against the inconvenience and danger always present in darkness.

Burgess Flashlight Uni-Cels will fit any case you may have. Try them—no better batteries are made.

A Laboratory Product

BURGESS BATTERY COMPANY
GENERAL SALES OFFICE: CHICAGO

*Canadian Factories and Offices:
Niagara Falls and Winnipeg*



FREE 64 Page Catalog of Radio Bargains



The World's Largest Exclusive Radio Mail Order House Will Send You This Wonderful Book FREE

Contains thousands of bargains in radio sets, semi-finished sets and radio kits of all styles, sizes and approved circuits. Beautiful models of latest designs and types. Elaborate console models with loud speakers built right in cabinets of genuine mahogany and walnut. **All sets guaranteed.** Coast to coast receiving range. Also contains everything in radio supplies including batteries, chargers, loud speakers, transformers, condensers, rheostats and any other parts you may want for improving your set or building a new one. **Guaranteed saving to you of 1/4 to 1/2.**



American Radynola

AMERICAN RADYNOLA 5 TUBE SET \$29.50

World's Best 5 Tube Set
Fully built and wired. Beautiful mahogany cabinet. Sloping panel design. Finest low-loss condensers, coils and sockets. Bakelite baseboard, panels and dials. Regular \$75.00 value. Price \$29.50. Transportation charges extra. Shipping weight 25 lbs.

Set with all accessories including tubes, loud speaker, storage battery, "B" batteries, aerial and ground equipment—\$59.75. Shipping weight 100 lbs. Complete instructions with set.

Satisfaction Guaranteed. Send for Catalogue Today!

RANDOLPH RADIO CORP.
159 N. UNION AV. Dept. 247 CHICAGO, ILL.

RADIO DEALERS WANTED!

If you are the type of dealer who hustles after business, who isn't content to wait for trade to come in but who takes sets out to demonstrate, can talk and sell quality merchandise, and knows Radio values, we have a big proposition for you. Are you that dealer?

50% DISCOUNT TO DEALERS



We manufacture a complete line of high grade receivers and sell to dealers at 50% discount. We are distributors for more than 225 Nationally advertised lines.

Write today for amazing offers, new 112-page catalog and regular monthly catalogs quoting below-the-market prices on latest merchandise—all free. Everything in Radio for less.

AMERICAN RADIO MFG. CO.
1416-18 McGee St. Dept. O, Kansas City, Mo.

RADIO ^{long distance} COMPLETE

THESE are the finest long distance sets at the lowest prices in history. Wonderful new circuits that bring amazing results. **SATISFACTION GUARANTEED.** Everything furnished with complete sets. There's a set for every pocket-book.

- 5 TUBE SET**—100 Amp. Storage "A" Battery, rubber covered "A" Battery Cable; "B" Battery, 90 V. 5 Tubes, Loud Speaker, Loud Speaker Plug, Antenna..... **\$95.95**
- 3 TUBE SET**—3 Dry Cells; "B" Battery, 90 V.; 3 Tubes, Loud Speaker, Head Phones, Antenna..... **\$49.95**
- 2 Tube Set**—2 Dry Cells; "B" Battery, 45 V.; 2 Tubes, Head Phones, Antenna..... **\$29.95**
- 1 Tube Set**—1 Dry Cell; "B" Battery, 22 1/2 V.; 1 Tube, Head Phones, Antenna..... **\$18.95**

Sets also sold without accessories. Full line radio accessories and partly assembled kits. Console models and units for installing radios in phonographs. Write for free catalog. Don't buy until you see us.

THE MELLODYNE RADIO COMPANY
Department M-2 CINCINNATI, OHIO

Write for free catalog today

The KODEL MICROPHONE Loud Speaker



Two Models

\$15

\$20

THE loud speaker that has the whole country talking. An exact replica of the microphone used in broadcasting. Tremendous volume - - rich clear tone - - Handsomely finished in Roman Gold. At any radio dealer.

Write for descriptive literature

THE KODEL RADIO CORP.

517 E. Pearl St. Cincinnati, O.

Owners of Broadcasting Station W K R G

Como Duplex Transformers

"The World's Standard for Push Pull Amplification"

Use them in your set and you will realize why they are continually specified by leading Radio Engineers. The fact that they are widely copied is proof of their superiority. "Take no chances—use Como."

\$12.50 per matched pair at leading dealers. Send for literature.

Como Apparatus Corp., Manchester, New Hampshire

MOTORCYCLES



RELIABLE STANDARD MAKES that you can **DEPEND** on. Enjoy the glorious experience of going wherever you like—when ever you like. The price is within your means—25% to 50% less than others. These machines are slightly used, thoroughly overhauled or rebuilt. Send for catalogs. **MYEROW BROS.,** 15 Berkeley St. Boston, Mass.

Save 20 to 50% FREE RADIO CATALOG

**LATEST
IN
HOOK-UPS
AND
RADIO**

Get the lowest rock-bottom prices on radio parts, sets, kits. New free Radio Catalog and Guide brimful of standard, reliable, guaranteed goods. Over 100 latest hook-ups and illustrations. Be sure to get this thrifty book before you buy. It puts money in your pocket. Saves you as much as half on a set. Also please include name of radio fan. Send letter or postal NOW.

THE BARAWIK COMPANY

103-168 S. Canal St., Chicago, U. S. A.



Resistance Coupled Amplification for All

The Daven Super-Amplifier is for set owners who want more volume or for set builders or manufacturers who want resistance coupled amplification without the labor of assembly. All the plate resistors, grid leaks and fixed condensers of the proper value, as well as all necessary binding posts, are supplied. There is nothing to do but connect with the tuner and the batteries.

Thousands have changed over their amplifiers to the resistance coupled system and testify to the wonderful improvement in richness and sweetness of tone and hearty, generous volume. The Daven Super-Amplifier makes even the best set a little better.

A One-Purpose Tube

The new Daven Tube MU-20, 6 volt, ¼ ampere, increases the amplification of The Daven Super-Amplifier fifty per cent without distortion. The tone remains sweet and true. Daven Power Tube Type MU-6 is recommended for the last or output stage of any set. Any Daven dealer will show you how to hook up the Daven Super-Amplifier.

Daven products are sold only by good dealers

The Sine of Merit

DAVEN RADIO CORPORATION

Resistor Specialists

NEWARK Reg. U. S. Pat. Off. NEW JERSEY

CLIP THIS COUPON

DAVEN RADIO CORPORATION,
165 Summit St., Newark, N. J.

Please send me the following on Resistance Coupled Amplification:

- Resistor Manual, 30c is enclosed.
 Complete Catalog (free).



**RESISTOR
MANUAL**

The Handbook of Resistance Coupled Amplification. At Best Radio Dealers 25c. Direct by mail 30c.

Name

Address

For Dealers: Send your letterhead and we will have our nearest distributor communicate with you.

THE BIG LITTLE THINGS OF RADIO

EFFICIENCY

That Meets the Requirements of Eminent Radio Engineers

Apex Vernier Dials are more than mere "knobs." In reality they are instruments endowed with an ultra degree of efficiency. Their rich elegance of finish lends a touch of striking attractiveness to any set. Precision of production and of operation makes a good set a better set—providing a greater range of selectivity—positiveness of control—and utmost simplicity of tuning in most difficult stations. Ratio 12 to 1. Clockwise or counter clockwise. No back lash. Royal Brass Finish 4-inch \$1.50—3 1/4-inch \$1.25. Satin Silver Finish 4-inch \$1.75—3 1/4-inch \$1.50. DeLuxe Gold (24K) Finish 4-inch \$2.50—3 1/4-inch \$1.85. Your dealer has them. If not, order direct.

APEX Rheostat Dials are as essential to successful operation and pleasing appearance as are Apex Vernier Dials. Royal Brass Finish—60c. Satin Silver Finish—70c. DeLuxe Gold (24K)—80c.

APEX ELECTRIC MFG. CO.
Dept. 201

1410 W. 59th St. CHICAGO



ALUMINUM SOLDER

SOLDERS ALUMINUM of any description. NO ACIDS OR FLUX NECESSARY. For home, shop and garage use. Your tool kit is not complete without HAMILTON LEAD CO. ALUMINUM SOLDER. (Name on every bar.) Send 25c for 2 six inch bars, or \$1.00 for 9 bars; postpaid.

HAMILTON LEAD CO., HAMILTON, OHIO



12-Cell—24-Volt Storage 'B' Battery

Positively given free with each purchase of a WORLD "A" Storage Battery. You must send this ad with your order.

Send Your Order in Today

FREE!

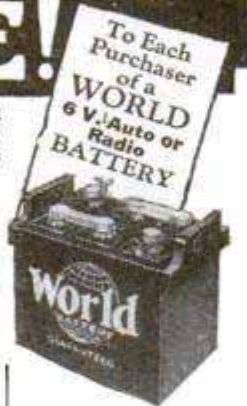

WORLD Batteries are famous for their guaranteed quality and service. Backed by years of successful manufacture and thousands of satisfied users. Equipped with Solid Rubber Case an insurance against acid and leakage. You save 50 per cent and get a 2-Year Guarantee Bond in Writing. WORLD Battery owners "tell their friends." That's our best proof of performance. Send your order in today.

Solid Rubber Case Radio Batteries
6-Volt, 100-Ampere.....\$11.25
6-Volt, 120-Ampere..... 13.25
6-Volt, 140-Ampere..... 14.00

Solid Rubber Case Auto Batteries
6-Volt, 11-Plate.....\$11.25
6-Volt, 13-Plate..... 13.25
12-Volt, 7-Plate..... 16.00

Send No Money Just state battery wanted and we will ship day order is received, by Express C. O. D., subject to your examination on arrival. **FREE "B" Battery** included. **Extra Offer:** 5 per cent discount for cash in full with order. Buy now and get a guaranteed battery at 50 per cent saving to you.

WORLD BATTERY COMPANY
1219 S. Wabash Ave., Dept. 6, Chicago, Ill.

World For **AUTO and RADIO** STORAGE BATTERIES

Approved and Listed as Standard by Leading Authorities including Radio News Laboratories, Popular Science Institute of Standards, Popular Radio Laboratories, Radio Broadcast Laboratories, Radio in the home, and Lefa., Inc.

THE B-T COUNTERPHASE

THE ONLY NEW CIRCUIT OF THE YEAR AND THE GREATEST OF ALL TIME



B-T TOROSTYLE TRANSFORMER

Both Torostyle Transformers and the Counterphase circuit are covered by B-T Patents.

B-T Counterphase 5-tube Kits contain: 3 Torostyle Coils, 1 Tandem and 1 single .00035 Condenser, 3 M. M. F. Condensers, 1 dual and 1 4-ohm Resistance, wires cut to length in colors and 9-color wiring diagrams. **Price \$28.50**

6-tube Kit Contains: additional parts required for 6 tubes **Price \$38.00**

Better Tuning, 9th edition has a fund of useful information, Hook-ups, etc. Postpaid 10c. [Circulars free.]

Bremer-Tully Mfg. Company
532 S. Canal St., Chicago

THIS WONDERFUL INVENTION



converts any ordinary cook stove into a gas stove. OXO-GAS is made from kerosene and air. Cheaper, cleaner and more efficient than coal. Responsible distributors wanted.

GLORIA LIGHT CO.
111-2 N. May St. Chicago, Ill.

Radio Blueprints at Cost!

Blueprints for the most popular sets described in Popular Mechanics Magazine can be obtained for a charge just sufficient to cover the cost of production and mailing. The sets for which blueprints are available are:

- One Tube Ultra-Audion..... April 1924 — 10c
- One Tube Triple-Coil Receiver..... May 1924 — 10c
- One Tube Pocket Receiver..... April 1925 — 10c
- Two Tube Loud Speaker Set..... May 1925 — 10c
- Three Tube Portable Reflex Receiver..... June 1925 — 10c
- Three Tube Cockaday Receiver..... April 1925 — 10c
- Three Tube Ultra-Audion Receiver..... Sept. 1925 — 10c
- Three Tube Low-Loss Short Wave Receiver..... Oct. 1925 — 10c
- Four Tube Loop Set..... Aug. 1925 — 10c
- Five Tube Neutrodyne Receiver..... Feb. Mar. 1924 — 10c
- Five Tube No-Battery Set..... July 1925 — 10c
- Six Tube Perfect-tone Receiver..... Nov. 1925 — 10c
- Six Tube Self-contained Receiver..... July 1925 — 10c
- Eight Tube Superheterodyne Receiver (Four prints in set)..... Feb. Mar. 1925 — \$1.00
- Nine Tube Portable Superheterodyne Receiver (Three prints in set)..... Sept. 1925 — 75c
- New 1926 Model Popular Mechanics Superheterodyne..... Jan. 1926.....
- Set of blueprints including full size drilling templates..... 75c

Address the **RADIO DEPT. Popular Mechanics Magazine**
200 E. Ontario St., CHICAGO

Back numbers of the magazines describing the construction of the sets can be obtained from our Circulation Department, price 25 cents each.

Imagine a Radio Receiver of THIS Quality for Only **\$32⁴⁸** Del'd

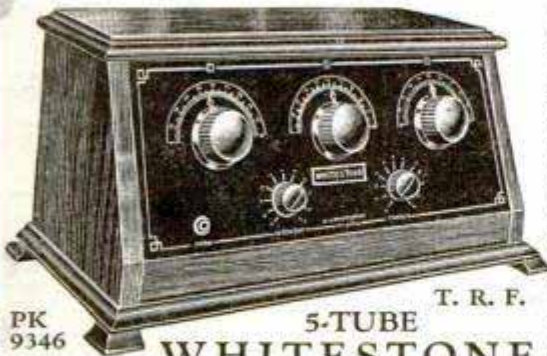

PK 9346

T. R. F.

5-TUBE
WHITESTONE

ASSEMBLED READY FOR USE

Made by Boissonnault, specialist for many years in the manufacture of delicate sound-detecting instruments.

band—quickly tuned—easily understood—even a 4-year-old child can operate it—can be used in any home anywhere, no electrical house wiring needed, uses either dry cells or storage battery, unequalled either for remote country or city use, no aerial or ground connection required for nearby stations—tremendous volume—clear, sweet tone—no distortion—no howling—no squealing—handsome appearance—you will be delighted with it.

SPECIFICATIONS: Panel, sub-panel, latest rheostats, Kurz-Kasch knobs and panels, sockets condensers—low loss coils—specially matched Boissonnault-design transformers—latest wiring, only 11 soldered connections—rigid brackets—filament control jack, no switch—battery leads, no binding posts, positive contacts—beautiful mahogany finish piano polish cabinet. **Wonderful value!**

No Money in Advance—if you wish to examine at your express office before acceptance notify us when ordering—If after acceptance you are not more than pleased we will refund your money—We pay transportation.

(Necessary for foreign customers to remit in advance for set and transportation expense.)

RADIO SPECIALTY CO., Div. 1632, 245 Greenwich St., NEW YORK

23,000 sets sold! Only one in 200 returned—think of that for satisfaction!

Read the experience of an electric company of Kalamazoo, Mich., radio experts (name given on request): "During the past three years **WE HAVE SOLD MANY HUNDREDS OF RADIO RECEIVERS**, of all makes, such as the (naming the highest priced, most advertised sets.) We do testing for two wholesale firms and **IN THE PAST YEAR WE HAVE TRIED OUT OVER 300 SETS.** We put the Whitestone on trial in our own home, **GIVING IT A VERY CRITICAL TEST.** On the first night **WE RECEIVED ON THE LOUD SPEAKER STATIONS IN 67 CITIES**, among them **KGO OF LOS ANGELES**, a station of only 500 watts. We believe this receiver is **EQUAL TO ANY** on the market, and **VASTLY SUPERIOR TO 90%** of the sets on sale **AT TWICE OR EVEN FOUR TIMES THE PRICE. THE VOLUME IS GIGANTIC. THE QUALITY IS EXCEPTIONALLY SHARP AND SWEET.** The set is **AS SELECTIVE AS ANY AND ALTOGETHER IT SURPASSES ANYTHING WE HAVE EVER SEEN OR HEARD."**

JUST THE RECEIVER FOR YOU

1926-model—**assembled ready for use** a few minutes after you open the box—receives 1,000 to 3,000 miles, 180 to 600 meters, the full broadcasting band

SEND FOR
FREE CATALOG
containing 68 pages of kits, sets, parts and accessories.

SOLDERALL
METAL IN PASTE FORM

The only convenient metal solder

Every Electrical Connection needs Solderall for perfect reception

25¢

The **SOLDERALL CO., NEWARK, N.J.**

AGENTS—\$100 to \$200⁰⁰

Selling Super Built \$13.50 Suits. Rendell made 31 sales in five days. Profit \$111.00. It's easy. We show you how.

YOU GET YOUR PAY EVERY DAY

If you have an ounce of ambition and want to make money write for free samples.

CHICAGO SUPER BUILT GARMENT CO., Inc.
Desk 9, 416 So. Dearborn St. Chicago, Illinois

\$1.50 For Your Old Radio Tubes

regardless make or condition, toward purchase of each new standard \$2.50 tube. Positively guaranteed. We do not sell re-built or bootleg tubes. *Agents Wanted.*

SUPER-SERVICE LABORATORIES.
Dept. 29, Room 58, 39 West Adams, Chicago, Ill.

Sell Stylemor and make more

Pick a live wire. Don't waste any more time. Sell Stylemor shirts and make your hours count! 150 snappy, popular styles. Low prices. Smart selling outfit **FREE.** You only take orders. We deliver and collect. Highest commissions in advance and your own shirts free for a little work on your part. Unusual proposition. Write us today

Stylemor, Inc., 81 W. Van Buren St., Dept. 805B, Chicago

The Aalco Loop

REGISTERED U.S. PATENTS OFFICE

INFRINGEMENTS VIGOROUSLY PROSECUTED

The Famous Aalco Folding Loop

Specified by Mr. Brittin for
POPULAR MECHANICS 1926 SUPER-HET.

Illustrated and described on Pages 128 to 133 of Jan. Popular Mechanics. A clean cut product combining highest efficiency, durable construction and extreme beauty. Folds instantly without loose wires.

SOLD BY ALL RELIABLE DEALERS AND JOBBERS Price \$15⁰⁰

If your dealer cannot supply you send order direct

Aalco Radio Laboratories, Inc., 1912 Wabash Ave., Chicago, U. S. A.

Double Keen Double Joy



Gem Blades Banish Bad Shaves!

DDOUBLE the shaves and double the satisfaction! That's what you'll find in that wonderful edge of the Gem Double-Life Blade.

It's double-keen—the keenest shaving edge ever ground on steel. The steel we use is double-heavy and double-hard. Twice as many edges couldn't give you half as good a shave. We guarantee it to out-shave and outlast any other blade.

Switch to Gem—the single-edge, Double-Life — double-perfect razor blade!

Each blade double-protected and double-sealed. Sold everywhere.

P.S.—Your money does double duty when it buys the Gem de luxe Razor

GEM SAFETY RAZOR CORPORATION
Brooklyn, N. Y.

GEM

Double Life
BLADES

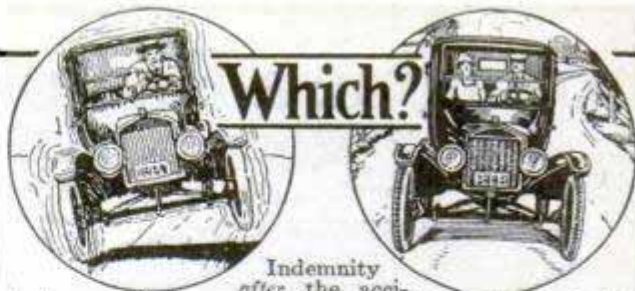
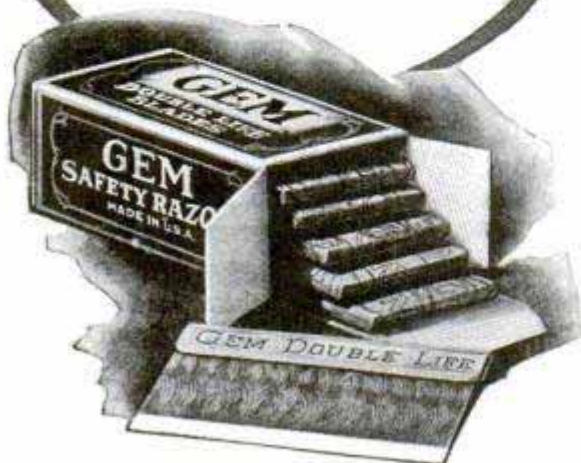

Which?

Indemnity after the accident or accident prevention? Less mileage or more? No comfort or all? Hard driving or easy? Only advantages are known to the driver whose Ford is equipped with stabilizing Hawley Safety Rods!

If you own a Ford

If You Own a Ford—

You will be interested in knowing that 15,000 Ford owners have installed Hawley Safety Rods; that this easily attached device is the one sure way to avoid wheel buckling and locked steering gear; that it affords big car comfort and ease of handling; that it increases mileage through certain road-traction; that its safety factor is less costly than any insurance!

Hawley Safety Rods replace the "wishbone", that one flaw in a Ford. They are really an auxiliary frame promoting absolute chassis rigidity. Twenty minutes to install—only a hammer and wrench required.

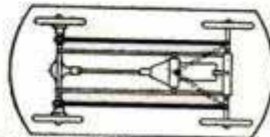
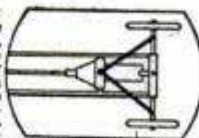

FREE 7-DAY TRIAL— We will gladly send, on approval a set of Hawley Safety Rods to any Ford owner. Merely give motor and license numbers and we will ship prepaid. If you like them \$10 pays entire cost; if not all we claim, return at our expense. AGENTS WRITE.

HAWLEY SAFETY RODS

Hawley Machine Co., Inc., 1211 Marbridge Bldg., New York City

21 Jewel ~ Extra thin STUDEBAKER

The Insured Watch

A Lifetime Time-piece

Sold direct from the factory at a saving of 50%.

SENT FOR
\$1.00
DOWN!



Only \$1.00! The balance in easy monthly payments. You get the famous Studebaker 21 Jewel Watch—insured for a lifetime; 8 adjustments, including heat, cold, isochronism and 5 positions—choice of 60 new Art Beauty Cases in green gold, white gold or yellow gold effects. Latest thin models.

Chain Free! For a limited time we are offering a beautiful Chain FREE!

Write For FREE Book Send today for wonderful Studebaker Book of Advance Watch Styles and our \$1.00 Down Offer—FREE!

STUDEBAKER WATCH CO.
Dept. H22 South Bend, Indiana
Canadian Address: Windsor, Ontario

For Expert or Handy Man The Turner No. 45 Is Best

\$8²⁵
Postpaid

It permits you to do your best work because all the hazards and troubles common to ordinary blotorches have been eliminated by Turner patented features. Over 50 years' experience have enabled us to perfect a blotorch that is safe, fast, convenient and durable.

TURNER BLOTORCH

"Safe as a Candle"

There are eleven patented improvements. The Super-heating Burner Baffle and heater plug that perfectly gasifies present day kerosene or gasoline; the separate Adjusting and Cleaning Needle that gives freedom from orifice trouble; the Automatic

Safety Valve that prevents explosions; the seamless, solderless, leakproof, polished brass tank with but one opening and that above fuel line; the Pistol Grip that fits any hand perfectly, and other features. **FEARLESSLY GUARANTEED.**

If your dealer can't supply you, write us direct.

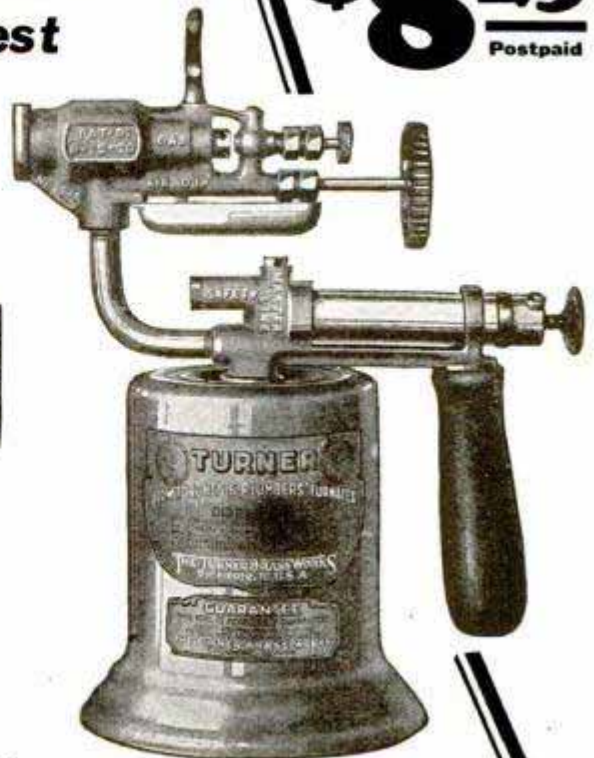

THE TURNER BRASS WORKS
Industry Ave., Sycamore, Ill.

The World's Largest Exclusive Manufacturers of Blotorches, Firepots & Brazers.

Interlox

MASTER SLIDE RULE

Takes accurate inside or outside measurements

MASTER RULE MFG. CO., 841-43 E. 136th St., New York

Works fast. Slides in and out quickly. Durable made of brass trimmed boxwood. Any length 2 to 8 feet. 20 cents per lineal foot. If not at dealer's, sent postpaid.

Dealers and Agents: request attractive proposition



66 Miles on 1 Gallon

Wonderful Vapor Humidifier
For All Make Autos. Spare or full time Ancients Wanted Everywhere
1 FREE TO INTRODUCE
BIG PROFITS to any MAN WITH CAR
CRITCHLOW, Inventor, E-111, WHEATON, ILLINOIS



BEFORE USING TROUSERS FRIEND

Returns its Cost OVER AND OVER

The "Trousers Friend"

This scientific device made of everlasting steel, nickel plated, positively removes baggy knees and automatically preserves the creases without

pressing, without dampening and so easily that anyone can adjust it in a moment. Hang your trousers on a "Trousers Friend" in the evening and put them on speck and span in the morning. Takes very little room in grip. Works equally well at home, in Hotel or Pullman.

Order One Today; Send No Money

Pay the Postman \$1.75 and postage. Use it thirty days; if not satisfactory your money returned. If you remit with order we pay postage.

NELSON MANUFACTURING COMPANY

53 New Montgomery St., San Francisco

Secure an agency The "Trousers Friend" is filling a World need. We want you to present it to millions waiting for it. Write today.



AFTER USING TROUSERS FRIEND



THIS BOOK tells you

free!

—Just what you want to know about reducing speeds with the compact, efficient IXL Speed Reduction unit. IXL Speed Reducers may be built into machines, or installed in plants in place of belts, chains and open gearing.

They are compact, efficient and safe, transmit power with least possible loss. Made in many types and sizes—up to fifty-thousand-to-one reduction.

Send for free booklet.



IXL Spur Gear Speed Reducer

FOOTE BROS. GEAR & MACHINE CO.

230-240 N. Curtis St., Chicago, Ill.

Sales offices in all principal cities in U. S. and Canada

We make cut gears of all kinds, Micarta Pinions, Micarta Timing Gears, Flexible Couplings, Speed Reducers, Special Machinery.

FOOTE BROS. GEAR & MACHINE CO.

230-240 N. Curtis St. CHICAGO, ILL.

Please send without obligation a copy of the Foote IXL Speed Reducer Book.

Signed

Address

Make \$25⁰⁰ to \$40⁰⁰ a day Winter and Summer.

**No Dull Seasons
No Lay-Offs
Your Own Boss**

The American Universal Electrically Driven Floor Surfacing Machine offers you an opportunity of a lifetime to get into something for yourself, be your own boss, build up a real business, and make big money for you the year 'round—Winter and Summer. Do like thousands of others have done. Accept this wonderful opportunity to get behind an electrically driven American Universal Floor Surfacing Machine and build up a big, profitable business of your own.

An American Universal Floor Surfacing Contractor

Makes \$25 to \$40 a Day

every working day in the year—Winter and Summer, month in and month out, and has no strikes, lay-offs, or idle periods to worry him.

Every New Floor Must Be Surfaced — Every Old Floor Needs Resurfacing

There is surfacing work to be done in every new and old business or residence in your vicinity. If you are willing to don a pair of overalls you can make from \$25 to \$40 a day every working day in the year. Men from all lines of business have accepted this opportunity and are now making real money. All started with one machine, but many are now operating six or more machines and have become floor surfacing contractors on a large scale.

No Experience Necessary

Any intelligent man can learn to operate the electrically driven American Universal Floor Surfacing Machine in a very short time. It actually does in a day the work of six men scraping by hand and does much better work than can be done by hand. **Write now for particulars.** Let us tell you how you can become an American Floor Surfacing contractor. You can secure this information absolutely free without any obligation on your part.

The American Floor Surfacing Machine Company

Originators of Floor Sanding Machines

523 South St. Clair Street, Toledo, Ohio

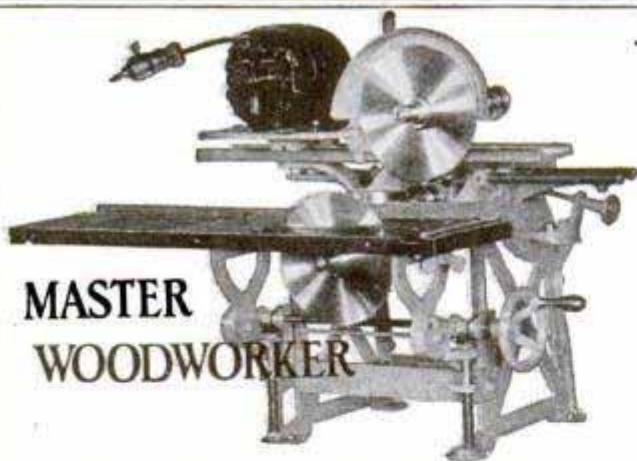

**MASTER
WOODWORKER**

A New Joy in Making Things

There is a world of pleasure in store for the man who delights in making things and who installs a Master Woodworker.

Then he can spend all of his time on the enjoyable part of planning and fitting, and eliminate the tedious hours of hand planing, sawing and so forth, which spoils half the fun.

The "Master" is 12 machines in one. It does cross cutting, ripping, jointing, boring, sanding, dadoing, planing, plowing, mitering, rabbeting, molding, band sawing, mortising, tenoning, grinding, matching and stair routing.

Wonderfully speedy and accurate—sturdy and reliable. Lasts a life time—runs from a lamp socket.

Model No. 10, illustrated, rips 1" stock, cross cuts 2" stock. Three larger models for heavier work.

Costs little—sold on easy payments.

MASTER WOODWORKER MFG. CO.
612 BRUSH ST., DETROIT, MICH.

Send for big descriptive book

P. M. 2



A CONVENIENT OUTFIT OF
CRESCENT Wood Working
Machines

consists of No. 12 Saw Table with Tilted Top, 4" Bench Jointer, 20" Band Saw, each with individual motors.

Prices Very Low, Quality Very High

Send today for circulars of Band Saws, Saw Tables, Shapers, Jointers, Variety Wood Worker, Planers, Planers and Matchers, Disk Grinders, Cut Off Table, Swing Saws, Borers, Hollow Chisel Mortiser, Tenoner, Universal Wood Workers.

The Crescent Machine Co. 93 Columbia Street
LEETONIA, OHIO

VERY LATEST WINDBREAKER

Sale to Make New Customers

**CHECKED
FLANNEL
OVERBLOUSE**

\$1.98
2 for \$3.89



YOUR ORDER SHIPPED SAME DAY RECEIVED

FREE—BARGAIN CATALOG with EVERY ORDER

All the rage in NEW YORK and CHICAGO. You see them everywhere, but no where else at our LOW Price

Made of warm and durable domet flannel. Has popular knitted sweater bottom. Finished with attached collar and two pockets, with button through flaps. FULL SIZES for men, 14 to 17 neck. Assorted checked patterns.

SEND NO MONEY Just send letter NOW—when delivered pay mailman only \$1.98 and a few cents delivery charges. If not satisfied we will return your money. Isn't that fair?

NORMAN ROBERTS CO., Dept. 31-B-221, CHICAGO

The Biggest Little Tools Made!

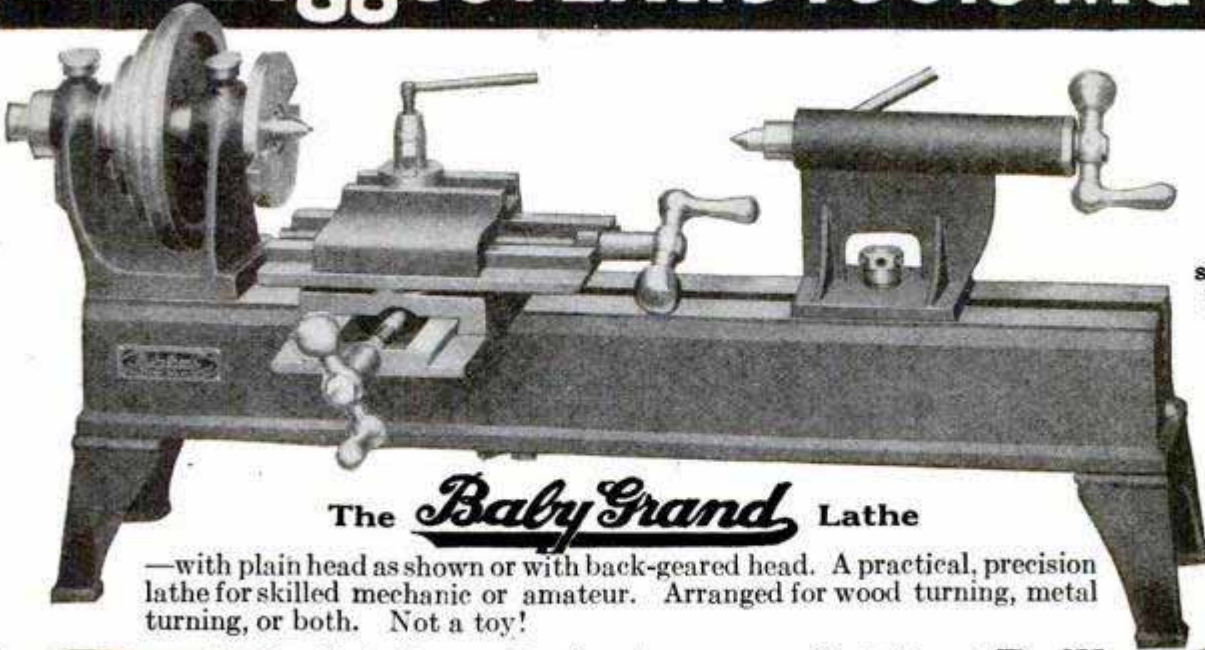

12" or 18"
between
centers;
6" swing;
speed range
180 to 1750
R. P. M.

The *Baby Grand* Lathe

—with plain head as shown or with back-gear head. A practical, precision lathe for skilled mechanic or amateur. Arranged for wood turning, metal turning, or both. Not a toy!



Baby Grand Grinder

6" high; wheels 4" dia.; 1/4" face. Will keep those edge tools in perfect cutting condition. Unusual value and serviceability combined with low price make this the biggest little grinder made.

Practical
Tools for Prac-
tical Men

Baby Grand Drill

Capacity 0" to 3/4" drills. Wide speed range, versatility, handiness, plus a maximum of drilling efficiency make the Baby Grand supreme in its class. Comes complete with chuck as shown.



Write today for prices and complete information on the full line of Baby Grand Tools
The Watson Mfg. Co., 102 Watson Building Toledo, Ohio

RIM CUT TIRES

WITH our metal clamps you can easily repair your RIM CUT TIRES. State size, balloon, straight side or clincher tire. Measure length of cut and add two inches. Cost you only \$.10 per inch. Order now, don't wait for descriptive circular, your money back if not satisfied. C. O. D. \$.10 extra.

RIM CUT CLAMP MFG. CO.
P. O. Box 12, Station A. Elizabeth, N. J.

FORD OWNERS ATTENTION!

Automatic Spotlight Bracket for Fords, moves Spotlight automatically with steering wheel. Use any spotlight. See page 940 Dec. Popular Mechanics. Price: 2.00. Write for circular. Agents Wanted. Write for discounts. Easy to install.

IDEAL BRACKET COMPANY 1401 Weller Avenue LaPorte, Indiana

Nestler Rubber Fusing Stations

An opportunity is offered one man in each community to secure the sole and exclusive right to operate the famous Nestler Rubber Fusing Process of servicing pneumatic tires. Unlike any other method on earth. The Nestler method is the perfected and only known way of successfully retreading pneumatic auto or truck tires, including all sizes of balloon tires. Every car owner needs Nestler Service. Nestlerized repairs outlast the tire. No previous experience necessary. We teach you the business in two weeks or less. Moderate capital required. Big profit on each tire you do. Here is your opportunity to have a permanent and highly profitable business in your own name. Remember only one man can secure this profitable franchise in each community. Act now if you want to be that man. Write today for two interesting books describing the Nestler Rubber Fusing Process and the methods that are being employed by Nestler licensees everywhere to build up prosperous businesses.

NESTLER RUBBER FUSING CO., Inc.
Dept. G, 245 West 55th Street, New York City

PRICES REDUCED

Only
\$3
Down



A
Year
to
Pay

Yes, lowest prices on **UNDERWOOD, REMINGTON, L. C. SMITH, ROYAL**, and all standard makes on easiest terms ever offered. Re-manufactured like new by the famous "Young Process" to give a lifetime of service.

10 Days Trial Our liberal "direct from factory plan" saves half. You actually use the typewriter 10 days without obligation to buy. Let us prove we have the greatest typewriter bargains ever offered. You actually save from \$40 to \$50.

Big Illustrated Catalog FREE This interesting valuable book explains fully how "Young Process of Re-Manufacturing" guarantees you highest quality, perfect service and satisfaction. **Rush coupon today to**
YOUNG TYPEWRITER CO., (Est. 1911)

SEND COUPON NOW

Young Typewriter Co., Dept. 1102, 654 W. Randolph St., Chicago

Send me Free book and Special Reduced Prices. This does not obligate me in any way.

Name.....

Address.....

City..... State.....

Earn as Much as \$40.00 a Day

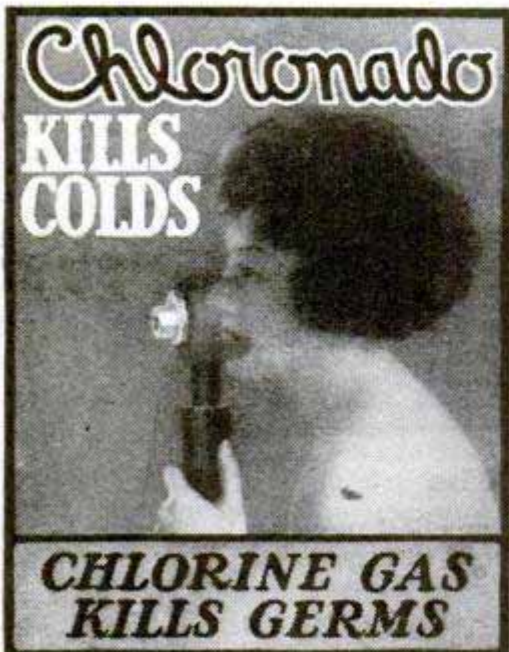

With Chloronado

Here's the opportunity of a lifetime to build a highly profitable business.

Chlorine Gas—the treatment developed by U. S. Army Physicians—for colds, catarrh, hay fever, bronchitis, influenza and many other respiratory diseases can now be had by everyone in their own homes.

The same gas treatment used by President Coolidge and thousands of prominent people with remarkable results.

A Money-Making Offer to Men and Women

Chloronado salesmen can easily earn \$5,000 or better—distributors \$10,000 to \$15,000. Everyone is interested in preventing disease—everyone is a prospect for Chloronado.

There is still some choice territory open to wide-awake salesmen and distributors. Enter your application in NOW—

Get the cream of the business in your locality by being the first to offer this amazing device. Live leads furnished to salesmen—National advertising and circularizing campaigns—every possible help and co-operation to aid you in building a permanent, profitable business. Write or wire for full details.

Chloronado Needed Everywhere

Chloronado is the first scientific Chlorine Gas Generator for the home. Thousands now in use. Millions need this aid to the prevention of colds and other chronic respiratory ailments.

A Very Interesting Proposition to State Distributors

CHLORONADO LABORATORIES CO. 439 E. Fort St. Detroit, Mich.

INFANTILE PARALYSIS

Sixteen years of deformity. Then 5½ months' treatment at McLain Sanitarium. Photos and parents' letter complete the story:

"Ura's foot is just fine and improving every day. People who knew how his foot was before he went to McLain's say it doesn't seem possible that it could have been straightened."

MR. AND MRS. B. E. HILLIARD, Rosebud, Texas.

McLain Sanitarium is a private institution devoted to the treatment of crippled children and young adults. No surgical operation requiring chloroform or general anaesthetics. Plaster paris not used. Patients received without delay. Parents retain full charge of children if desired.

Write for Free Books

"Deformities and Paralysis" and "References", which show and tell of McLain Sanitarium's facilities for treating Club Feet, Infantile Paralysis, Spinal Diseases and Deformities, Hip and Knee Disease, Wry Neck, etc.

McLAIN

Orthopedic Sanitarium
902 Aubert Ave.
St. Louis, Mo., U. S. A. JR655



SALESMEN!

Unlimited earning possibilities. X-Cel-All Master-Lite scientific lighting a necessity wherever artificial light is used. Churches, schools, factories, etc., etc. Completely assembled HOME OUTFIT ready to attach to light socket, sells \$3.95. You collect and keep \$1.00. We ship to customer C. O. D. for balance. Try this and be convinced, then become permanent member of fast growing organization. Write or wire at once.

X-Cel-All Company, Ltd., Dept. 211 Factory and General Offices, Monaca, Penna.

Every Household Needs a Bartlett Compound Lever Snip

A special snip for repair work about the house or shop. Cuts screen, stove pipe, picture wire, paper, wallboard, tin, cloth, and sheet metals.

Sold by dealers or direct.

- 7-inch stamped, \$2.70;
- 8-inch, forged, \$4.00;
- 10-inch, \$6.00; 12-in., \$8.00; 14-inch, \$9.50.

Postpaid.



Every tool guaranteed.

Bartlett Mfg. Co., 420 E. Lafayette Ave., Detroit, Mich.

AGENTS \$10 to \$25 DAILY!

Men or Women



Here is your lifetime opportunity! \$10.00 to \$25.00 every day selling America's Finest Shirts direct from our own big, honorable factory. Easy work, lowest factory prices, individual patterns and remarkable values. Big steady demand in every locality.

No experience or money necessary. We show you how and furnish everything you need. Your success is assured, with a steady income every month. Every customer satisfied. Big Repeat Business. Be our factory agent and supply big demand for Packard Tailored

Shirts in your locality. Failure impossible. Essex Coach free for selling Shirts.

Write Now for Free Samples

Just send your name and address now for Free Samples. Be first before some one beats you to it. WRITE TODAY.

PACKARD MANUFACTURING CO.
Dept. 217, 629 Orleans St., CHICAGO, ILL.



\$351.00
Cleared
in one day
(Aug. 1925)
by W.H. Adams
Dayton, Ohio

V. A. Marini, Santa Cruz, Cal. (Nov. 1924) reports \$11,275 sales in 3 months. J. Gordon of New Jersey says \$4000 profit in two months. Alexander of Penn. \$3000 profit in four months. Ira Shook, Flint \$365 in one day. Bram, bought one outfit then 10 more within a year. Patillo, Ocala, writes: "Crispettes all you claim and then some." John W Culp, South Carolina, writes, "Everything going lovely. Wrappers lying all over. It's a good old world after all." Ferrin, \$380 in 1 day. Mrs. Lane, Pittsburgh,

one day. J. R. Bert, Ala. "only thing I ever bought that equaled advertisement."



WE'LL START YOU IN BUSINESS

Furnish secret formulas, raw material, and equipment. Very little capital required; no experience needed.

Build Paying Business of Your Own

No limit to the sale of Crispettes. Everybody likes them. It's a delicious food confection made with or without sugar. Write me for facts about a business that will make you independent. Start now, in your own town.

Profits \$1,000 a Month Easily Possible

Send postal for illustrated book of facts. In contains enthusiastic letters from others—shows their places of business, tells how and when to start, and all information needed. Free. Write now!

LONG-EAKINS COMPANY

228 High Street

Springfield, Ohio

\$1 DOWN

21 Jewels

Nothing less than 21 Ruby and Sapphire jewels is good enough for the Burlington masterpiece.

Quality and Style

Adjusted to the second—temperature—synchronism—positions. 25 year Gold Strata Case, in 100 exquisite designs. Only \$1 down. Balance in small monthly payments. Send for free book.

Burlington Watch Company
 19th Street and Marshall Boulevard
 Dept. 13-52 Chicago, Illinois

FREE TO FORD OWNERS

Sioux Falls, S. D.—Jim May, former lieutenant of the A. E. F., now Captain May, has perfected an amazing invention for Fords, called the Wesco Gas Saver and Carbon Remover. Under actual tests the Wesco has enabled Ford owners to get as high as 60 miles on a single gallon of gasoline. To quickly introduce it, Captain May is offering a Wesco free to one person in each locality who will show and recommend it to their friends. Just send name and address to Captain J. A. May, 316 West Ninth Street, Sioux Falls, S. D. Also ask him to tell you how local and State distributors can make \$500.00 to \$1500.00 a month supplying the enormous demand for Wescos.—Adv.

Big 3 ft. Telescope

Has unusually powerful lenses—magnifying over 8 times. Makes people and objects miles away seem close. Brings new pleasures to home, farm, camp, travel sport. See moon and stars as never before. New Ferry "Wonder" telescope has 5 sections—opens out over 3 ft. long, measures 12 inches closed. Big, strong and powerful yet light, compact, easy to carry. Body and draws fully brass bound with knurled edges. Body covered with black leatherette, draws made of special, smooth finish fibre, easy to slide in and out. Brass safety caps at each end to keep out dust. Powerful lenses are special clear achromatic European optical glass.

3 ft. long open—12 in. long closed—FIVE SECTIONS—8-power Lenses

Free

YES ABSOLUTELY FREE! Handsome leatherette covered Carrying Case light, strong, complete with strap. Case is 12 in. long, 2 1/2 in. in diameter. Protects from dust and damage. Handy for farmers, auto tourists and bikers.

Read These Letters Thousands of Delighted Users

"I am delighted with the 'Wonder' telescope. Today I have been watching submarines 3 miles off the coast." —Philip Brush
 "I can see across the Mississippi 3 miles and see people bathing." —M. L. Thorn.
 "I am nearly 80 years old and if I could not get another would not take \$10.00 for it." —A. R. Walker
 "I can tell time on the church clock 5 miles away." —Edward Foster
 "Could tell color of aeroplane 4 miles away." —Mrs. L. M. Yarbrough
 "I saw a Light House 18 miles away." —Clyde Scribner.
 "Can see men working 7 miles away." —S. M. Gearhart.
 "I could see windmill more than 4 miles away." —Raymond Cosanova.

Send No Money

Sign and mail coupon below and Ferry Wonder 3 ft. Telescope with free Carrying Case will come by return mail. Pay postman special bargain price of \$1.85 plus few cents postage. Satisfaction guaranteed or your money back. Send coupon today!

FERRY & CO., Chicago, Ill.

Ferry & Co., Dept. 1772
 3224 N. Halsted St.,
 Chicago, Ill.

Send me 3 ft. Ferry Wonder Telescope and Free Carrying Case. I will pay postman \$1.85 plus postage on arrival. If I am not satisfied you will refund my money.

Name _____
 Address _____
 City _____ State _____
Catalog of Things You Want Sent Free





Let Your Face Be Your Guide

Why go on wondering about what Barbasol is like? Send 10c and get yourself the trial tube. Use Barbasol 3 times according to directions—and let your own face be the judge. We know your happy countenance will say, "Thank you for using Barbasol!"

— COUPON —

The Barbasol Co., Indianapolis, Ind.

I enclose 10c. Please send trial tube and I'll give it a fair trial.

Name.....

Address.....

P. M. 2-26

Barbasol

For Modern Shaving

You can make \$100 a week

Yes, you can make \$100 a week. You can do as well as H. T. Pearl who made \$750 in one month. You can begin like R. L. Marshall who made \$80 in five hours. You don't have to invest any money. Experience is unnecessary—yet you can start right in to make big money. In a short while you can enjoy an income of \$5000 a year for the easiest, most pleasant and fascinating work you ever did.



HUDSON Coach

Hudson Coach GIVEN!

We want men and women to represent us everywhere. Wonderful plan. 350 Household Necessities direct from factory to home. Spare time or full time returns amazing profits for easy work. We furnish everything you need to start. In addition to big earnings we offer you a brand-new Hudson Super-Six Coach. Write at once for details of this money-mak'ng proposition. We'll send FREE PROOF that you can make \$100 a week in this pleasant, dignified, permanent business.

Write quick for details

The American Products Co. Dept. 5034 Cincinnati, Ohio.

EASY WORK!—BIG PROFITS! FREE Reducing Belt Starts You

Get into the big money class! Make \$15 a day, full time or spare time. No experience or capital needed. Free sample belt. Amazing profits. Exclusive territory. District Managers wanted. Write today for wonderful proposition.

THE VITO CO., Dept. 62, New Haven, Conn.

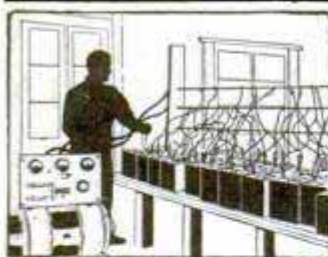

HB ONE DAY BATTERY CHARGING PAYS \$150 to \$300 MONTHLY PROFITS

Get in the moneymaking One Day Battery Charging business now. Big demand for One Day Charging Service for auto and radio batteries. Over 12000 shops now making big monthly profits with One Day Charging. Only \$35 cash puts moneymaking HB One Day Charging outfit in your shop. Easy terms on balance—let your big monthly profits pay for outfit. No experience needed. Complete operating instructions free with each outfit. 30 days' free trial in your shop on moneyback guarantee. Ask for money saving prices on HB Automatic Air Compressors, Motors, Tire Buffers, Grinders, etc. Write for free bulletin 26.

HOBART BROS. CO. Box M25 TROY, OHIO

NOW ONLY \$35 PUTS THIS MONEY MAKING SERVICE IN YOUR SHOP

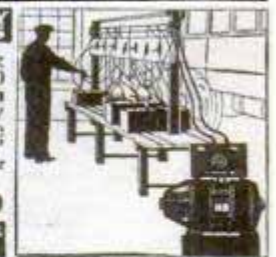

An Easy Way to Make Money

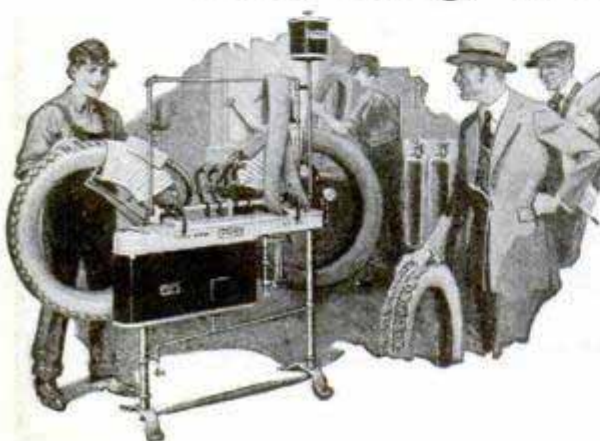

Go into the tire repair business NOW and make \$75 or more a week. One man made \$45 the first day he received his outfit. Millions of new autos every year and high price of tires creating enormous demand for tire repair work. No big investment necessary. We teach you. Easy to learn. Big profits and independence if you act now.

SHALER New Tire Repair Outfit

Makes it Easy for You

to become expert in a few hours and make big money right away. This wonderful outfit costs but little, yet does everything expensive complicated outfits do. A boy can operate it and make perfect repairs because EXCLUSIVE AUTOMATIC HEAT CONTROL prevents overcuring and undercuring

WRITE QUICK for new Shaler book on Balloon Tire Repairing, and full information... **FREE**

C. A. SHALER CO., 2702 Fourth St., Waupun, Wis., U. S. A.
World's Headquarters for Tire Repair equipment

WINDOW SIGNS



AGENTS

500% Profit

Selling Genuine Gold Leaf Letters
Guaranteed to Never Tarnish

For Store Fronts, Office Windows, Bank Windows, Office Doors, Panels, Board Signs, Trucks, Automobiles and Glass Signs of all kinds. No experience necessary. Anyone can put them on and make money right from the start without previous experience. All you have to do is to show your samples, the letters are very attractive and easy to sell. Letters costing 4c sell for 25c. One agent says: "Your letters are the best thing I have seen in years. I have made \$125.00 the first week and still going strong." Paul Clark says: "Smallest day \$28.70." H. Gilder made \$835.00 in six weeks.

\$60 to \$200 a Week—Now Is the Time

General Agents It is easy to appoint sub agents for this line. We pay you 20% cash commission on all orders we receive from local agents appointed by you anywhere. We allow you 50% discount on your own orders. You can sell to nearby trade or travel all over the country as you please. Large demand for window lettering everywhere. WRITE TODAY for free sample, full particulars and liberal offer to general agents.

Our Agents Are Coining Money

READ WHAT THEY SAY

Makes \$38.75 in Two Days

Gentlemen: Enclosed please find order and M. O. of \$4.00. Send balance C. O. D. I expect the next order will be a larger one, as I have plenty of sign work on hand. I will send you a picture of the job I have done here. I made \$38.75 in two days, and have about \$150.00 worth of orders already taken, besides many promises.

Yours truly, A. E. WEINTRAUB, Helena, Ark.

\$25 00 in Three Hours

Gentlemen: Please find enclosed \$7.75 for order enclosed. Times are not good here, and this is a small town. However, I sold over \$25.00 worth in three hours. When I leave here and strike a live town, look out for my smoke. I am more than pleased with results. Believe I can make \$25.00 per day in a good town. Will send for a supply when these are up. Please send these by mail. I enclose extra stamps.

Yours for business,
 J. B. TOWER, Portales, N. M.

Takes in \$62.80 in Two Days

Gentlemen: I received the order here today all O. K. and am wiring you tonight an order to be sent to East Radford, Va. I put up \$27.70 worth of jobs here today. I got \$35.10 out of Marion, Va. You may send me 500 more letters C. O. D. to Bristol, Tenn., on receipt of this letter.

Yours truly,
 F. E. DURAWAY, Bristol, Tenn.

MAIL COUPON AT ONCE

METALLIC LETTER CO., 430 N. Clark St., CHICAGO, ILL.

Be a Traveling Sign Man

For a quick, easy money-making proposition for agents, salesmen and sign painters, there is nothing to equal the selling and putting on of our gold and silver metallic letters for office windows, store fronts, bank windows, and glass signs. No experience is necessary. Anyone can put them on and succeed right from the start. You can sell to local and near-by trade, or travel all over the country as you please.

Metallic Letter Co., 430 N. Clark St., Chicago

Please send free sample, full particulars and liberal offer to general agents.

Name.....

Address.....

City..... State.....

Geneva Binoculars



free!

World's Most Complete Binocular Catalog, showing 58 Styles

Prices \$9.50 to \$106. Powers (magnification) from 4 to 24. Illustrates and describes every style clearly. Explains how to select a

glass for touring, hunting, night use, sports, ranching, etc. Tells of Geneva patents, which increase field of vision over old styles.

Everybody is Buying a Binocular

1924 was a wonderful Binocular year. 1925 still bigger. 1926 will be biggest of all. Select glass you

prefer and have us send it on 10 days' free trial. No obligation. Write for free catalog. Postal will do.

Geneva Optical Co. 41 Linden Street
GENEVA, N. Y.

BLUE WHITE DIAMONDS 12 Months To Pay



No. 938—Price \$38.00
\$2 Down and \$3 a Month

This blazing, blue-white diamond, sparkling with the colors of the rainbow, has every appearance of costing at least \$60. It is set in an attractive, engraved 18 KT. SOLID WHITE GOLD mounting. Two blue sapphires are set in the shanks. Guaranteed to stand any test.

No
Red
Tape

Easy
Terms

SEND NO MONEY Pay only \$2.00 to postman after you get this ring. If you keep it, pay only \$3.00 a month for 12 months. If you return it within 10 days we will return your money—every cent.

PRICE CUT TO \$38: WORTH \$60

You now can buy this gorgeous ring at the wholesale price. Compare it with similar rings at \$60.00. We guarantee it to stand any test or comparison. It is the greatest bargain ever offered by any Diamond Importer. We will give you 8% more than you paid for it when you exchange for a larger diamond ring.

FREE Every customer who answers this advertisement will get a \$7.50 value premium as a gift from us. Thousands of bargains shown in this very interesting book. **Write for Catalog**

STERLING DIAMOND & WATCH CO.

(Diamond Importers—\$1,000,000 Stock—Established 1879)
1540 Broadway Dept. 2106 New York, N. Y.

Florida is Calling You

Do you want to get away
From the *grind* of every day—
From the drudgery of things you have to do?
Do you want to settle down
Near a lively, busy town,
Where the joy of living will appeal to you?

Do you want to scent the breeze
Coming through the orange trees?
Do you want to hear the birds call—loud and clear?
Are you seeking perfect health
That's combined with certain wealth
And an income from an orange grove each year?

Do you want a piece of land
That will grow to beat the band
All the different garden crops that you enjoy?
Do you want to make a "Nest,"
And a permanent bequest
For the future welfare of each girl and boy?

Do you want a sunny clime
Where there's fishing all the time?
Where there's ducks and deer and quail and other
game?

Where the summer climate's cool,
And within each lake and pool,
You can swim in January—just the same?

Do you want to buy this land
On an easy-payment plan,
With about your monthly outlay for cigars?
Do you want to read a book
That will make you want to look
On the finest land that lays beneath the stars?

Send a letter right away;
Put it in the mail today,
We will send this Booklet absolutely FREE.
After you have read it through,
If a *thought* occurs to you—
Just address another letter here to me.

We will answer, straight and true,
Questions that occur to you.
We have nothing to evade or to conceal.
On an Orange County Farm
Life will take on added charm,
And you'll never lack a dollar—nor a meal.

Send for our Big FREE Illustrated Book—
"TWENTY ACRES AND PLENTY." It tells of
almost unbelievable profits made from trucking and
fruit-growing in our part of FLORIDA. Also about
sick-and-out-of-work Clauses, and other protective
features of our contract. Address **Sylvester E.
Wilson, Dept. U-1, Orlando, Flor'da.**

MOTORCYCLES



Price \$10 and up purchased
through our Co-Operative
Plan for as low as \$1.00
down and \$1.00 per week
**Indiana Harley-Davidsons Ace
Henderson and Cleverlands**

Motorcycles shipped to all parts of the world

WALKER-INDIAN CO., 186 Mass. Ave., BOSTON

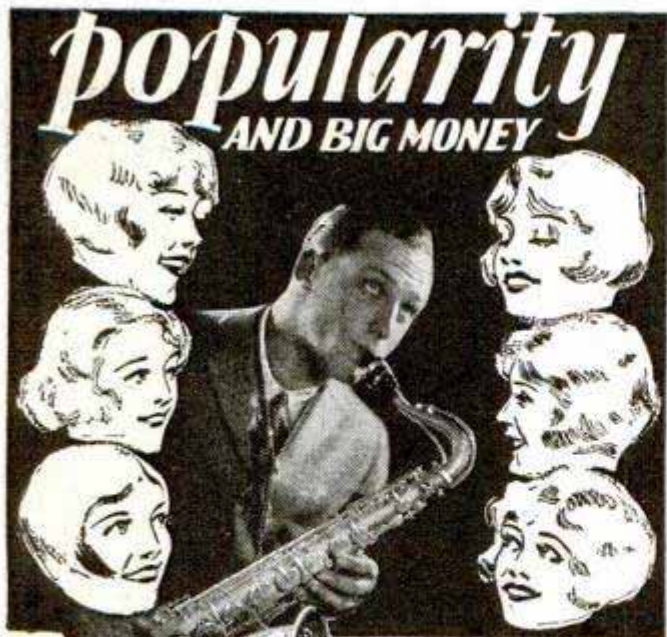

popularity AND BIG MONEY

YOU know Sax players are popular everywhere. Also they earn \$50 to \$60 a week spare time, two or three times that in full time. The YORK Sax is the easiest of all to play. Marvelously easy to blow. Easy fingering. Many play popular music in just a few days. You may have this wonderful Sax right in your home for 6 Days' FREE trial. If you aren't delighted send it back and it costs you nothing.

Nearly a Year to Pay
Send immediately for our beautiful literature and Free Trial Easy Payment Plan.

THE HOUSE OF YORK

J. W. York & Sons, Dept. B-126, Grand Rapids, Michigan

AGENTS NEW SPARK PLUG Visible Flash



Just Out—Amazing Invention—**Beacon Lite Spark Plugs.** You see the flash of each explosion in the cylinders. Tells which are firing right. Greatest improvement in spark plugs since gas engines were invented. Wonderful gas savers. Agents coinng money.

\$90 A WEEK

Easy to make with new sure-fire plans. Sells on sight to every auto owner. Phillips, Ont., writes "Sold 2 dozen today, 3 dozen yesterday. Rush 10 dozen." Write for special **Free Demonstrator Offer** and **FREE** deal to introduce these wonder spark plugs in your territory. Write quick—today.

CENTRAL PETROLEUM COMPANY
1022 Century Building Cleveland, Ohio

For Your Boat



Elto

Ole Evinrude's New Quick Detachable ROWBOAT MOTOR

Easily carried. Quickly attached to any boat (without tools). Drives boat any speed, 2 to 10 miles per hour. No rowing, no work, no bother.

**Fast—Light—Powerful
Easy to Carry**

Has 12 exclusive features, all described in our new Free Catalog. Write for it today.

Elto Outboard Motor Co.
Manufacturer's Home Bldg.
Dept. AA

Milwaukee, Wis.

Elto—The Motor that Starts with a Touch

A Business of Your Own Pays Best!

\$15 to \$20 Daily
as an Expert
FOLEY SAW FILER
and **Foley Salesman**

Why be content to work for someone else for \$25 to \$35 a week—you can make that much in two days with a **Foley Saw Filer and Setter** and be independent.

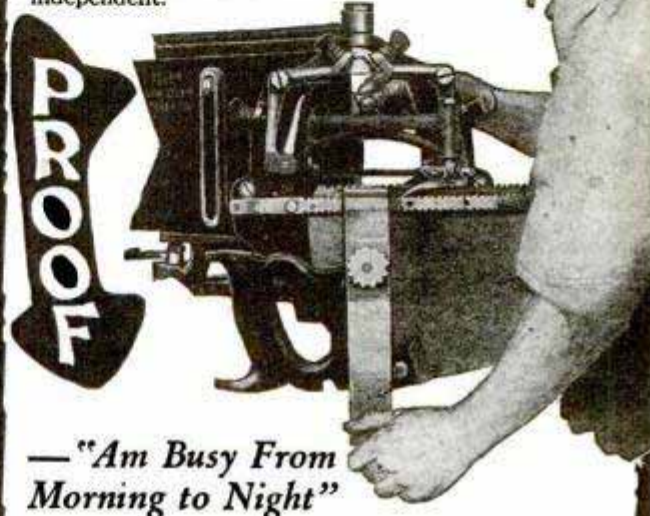

—“Am Busy From Morning to Night”

writes L. C. Miller, Jamaica, L. I. He has already filed 1600 saws—often 8 or 10 after supper. J. E. Battey, Jacksonville, Fla., demonstrated before a crowd of men and got 25 orders. Chas. Fuller, Lima, Ohio, gets business from 300 miles away. Hundreds make \$75 to \$150 weekly operating and selling **Foley Saw Tools**.

Files a Saw in 5 Minutes— Sets a Saw in 1 Minute

That's all it takes to give a perfect cutting edge to a saw with a **Foley Saw Filer and Setter**. Nothing like them on the market. 5 times faster than hand filing—much more efficient—makes every man an expert. Contractors, carpenters, hardware dealers, schools, butchers, and woodworking plants are all prospects. You can make big money supplying this demand.

Take a New Lease on Life

This coupon shows you the way to a profitable, dignified permanent business. No experience necessary—no large investment. Write for our special introductory offer, and complete proof.

FOLEY SAW TOOL COMPANY
914 E. Lake St., Minneapolis, Minn.

FOLEY SAW TOOL COMPANY,
914 E. Lake St., Minneapolis, Minn.

You know what I want—send me the proof.

Name.....
Address.....
City..... State.....

Play a Tune



On Your
Favorite
Stringed
Instrument



in 10 Minutes!

No Knowledge of Music Necessary
No Tiresome Practice

Now you can pick up your favorite stringed instrument and play a tune almost instantly, even if you don't know one note of music. These wonderful "Instant Playing" Instruments take all the work out of learning to play. No expensive lessons. No complicated musical signs and symbols. Play by numbers instead of notes (or by notes if you wish). Just press the numbered keys and you are playing tunes. Hundreds are playing "Instant Playing" Instruments who could never learn the old way.

Amazing New Invention

This is not merely a system of instruction—it is a new device invented by a musician, Prof. James F. Reed, that revolutionizes stringed instrument playing. "Instant Playing" Instruments give clearer, truer tones, are easier to finger and anybody can play. Famous Vaudeville Star, Trixie Friganza, writes: "I learned to play a tune in 3 minutes and had never touched a stringed instrument before." John Matise wrote: "Played tunes on the Guitar the same day and am delighted. Anyone can play." Leonard Cleary: "In only a few days I have had my money's worth in fun. It certainly is one fine instrument." Constance Sedler: "I was playing in four minutes."

SEND FOR
FREE BOOK

Tells all about new "Instant Playing" Instruments and how you can play in 10 minutes. Also Free Catalog of special bargains in musical instruments. No obligation. Send for this Free Book now! Your friends will be astonished at your learning to play so quickly. You will be popular and always sure of a good time. Send coupon today.



Choose
Your
Instrument

What is your favorite stringed instrument? Send for this Free Book, and choose the one you would like to play. You can play it in 10 minutes! Send coupon now!

FERRY & CO. Dept. 9772, 3224 N. Halsted St., Chicago, Ill.

Send me Free Book on "Instant Playing" Instruments and tell me how I can play tunes in 10 minutes. No obligation.

Name

Address

City..... State.....



BUILD SHIP MODELS!

Easy to build and sell. Plans and instructions: Pirate Ship, 52c—Viking Galley, 42c—Magellan's "Victoria", 77c—Hudson's "Half Moon," 92c—Chinese Junk, 47c—or all for \$2.90.

RICHTER & STROESSER, 405A Eleventh Avenue, Milwaukee, Wis.

Information on any book free. Write Popular Mechanics Press, Chicago, Ill.

Save Money on New or Used Auto Parts!

15 years of progress has made our stock of new and used accessories and replacement parts the largest in the world. We can furnish you with anything from a Cotter-Pin to a complete Power Plant.

FREE! CATALOG
of Parts Both

NEW AND USED

The most complete catalog ever issued. Chock full of bargains. Save 30% to 80% on your purchases. Buy from Warshawsky. Every item guaranteed to be just as represented.

WRITE TODAY SURE!

Big Illustrated
Radio Catalog
FREE

A FEW SPECIAL BARGAINS IN NEW REPLACEMENT PARTS
Prices quoted are F. O. B. Chicago

- Ford Cylinder Heads, New \$3.75
- Ford Cylinder Blocks, New, Complete with rings, wrist pins, pistons, bushings \$20.00
- Ford Counter Balance Crank Shafts, A \$19.00 value \$12.50
- Ford Triple Seal Pistons, New, Up to .005 oversize, Complete with wrist pins and bushings, Per set \$5.00
- Ford Gas Savers, New, 2-in. manifold, \$3.50 value \$1.00
- Ford Water Pump, New \$2.50
- Genuine Chevrolet Pistons, New, Up to .005 oversize \$1.00
- Nu-Life Ring Expanders, 5c
- Miles Piston Rings, New, 40c
- All sizes. A \$1.25 value

WARSHAWSKY & CO.

"World's Largest Car Wreckers and Replacement Parts House."

No Branches 1915 So. State St., Dept. P. M. 2 Chicago, Ill.

CEMENT THEM ON AT HOME - FIT FAST RUBBER SOLES For Men, Women and Children (over 10 yrs.)

Regular 75c a pair. Price to introduce with large tube of Stick Fast Cement, cement spreader, shoe rasp, and For Either Old Worn Soles or New Ones. Applied in 10 minutes at home on old worn soles or new ones. They stay on. Our marvelous waterproof stick fast cement does the work perfectly. Neat, good looking, wear like iron. Fit Fast rubber soles keep feet dry, make walking easy. Do not heat or draw feet, will not slip on automobile pedals. Are light, outwear leather, made of toughest rubber combination known to industry. Fit any size, width or shape of shoe except children under 10 years. Do your own half soiling. Complete instructions with every outfit.

4 SOLES for \$1 Postpaid
How To Order. Place shoe on a piece of white paper, draw line around it. Also be sure to give size of shoe. Complete Outfit \$1 Postpaid. Outfit includes 7 pieces, 4 soles (2 pair) 1 large tube of stick fast cement, 1 cement spreader, 1 shoe rasp. Complete outfit is shipped post paid to any address in the United States for \$1. Save 50% by mailing your dollar now. Every pair sold on positive money back guarantee.
DURABLE RUBBER CORPORATION, Dept. C, 601 Insurance Exchange Bldg., Detroit, Mich.



Build a Boat Popular Mechanics Boat Book tells how to make 21 kinds of boats and canoes.

Fully illustrated. You can build a boat any time of the year. Many do the building in winter. Price 50 cents. POPULAR MECHANICS PRESS, Popular Mechanics Bldg., Rm. 702, Chicago, Ill.



YOU CAN CLEAR \$150 to \$300 PROFIT EVERY MONTH WITH ONE DAY BATTERY CHARGING

Own a big money-making business charging auto and radio batteries in one day. New improved method with **HB One Day Battery Charger**. No experience needed. **One Day Charging endorsed by leading battery manufacturers.** Thousands of HB's in use. **Just \$35 cash puts an HB One Day Battery Charging outfit in your shop,** complete, ready to operate. 30 days' free trial on money-back guarantee. **Long, easy terms on balance** more than paid by your big monthly battery charging profits. **HB users everywhere making big money.** You can, too. Get HB new low prices on air compressors, tire buffers, motorgrinders and other shop equipment. **Write today for free bulletin 2.**

HOBART BROS. CO. Box M-2 TROY, OHIO

MORE HB ONE DAY BATTERY CHARGERS ARE IN USE THAN ANY OTHER MAKE



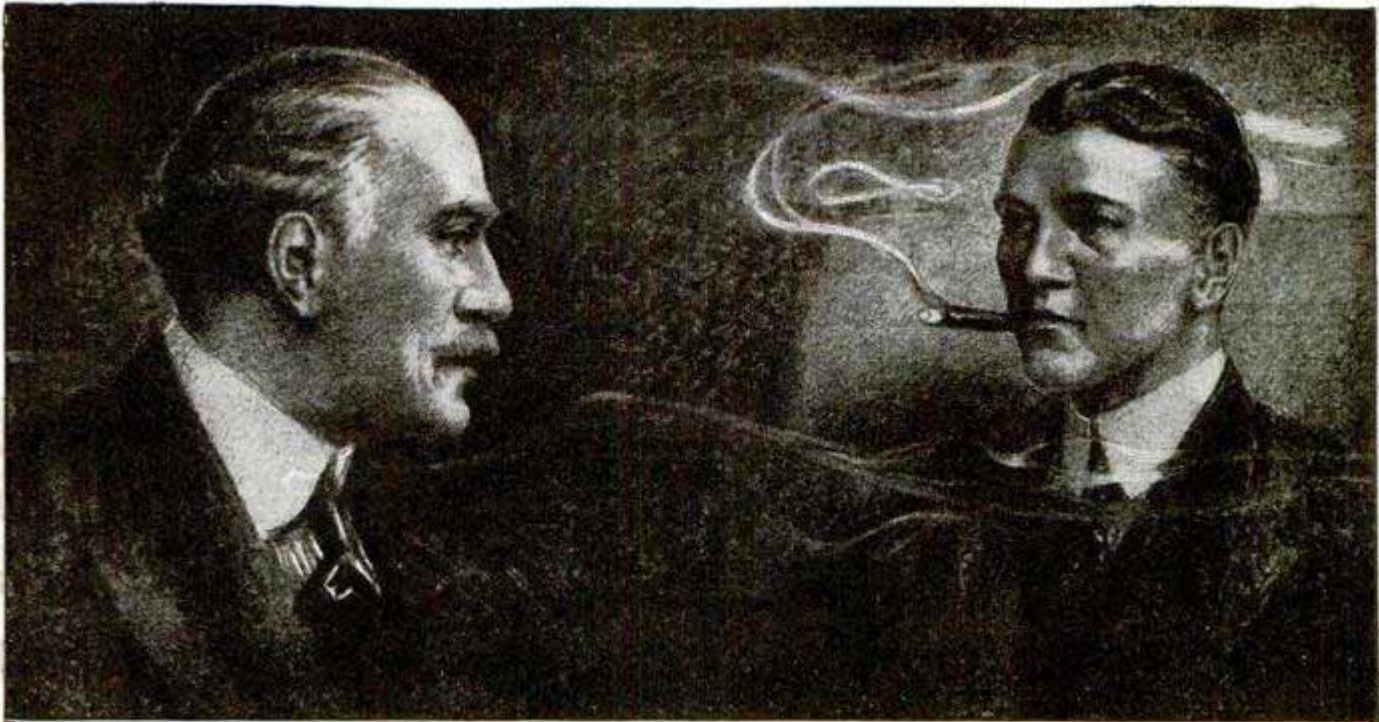

Tobacco Is Hurting You

Look at the facts square in the face, Mr. Tobacco User. You may think tobacco is not hurting you.

That is because you haven't as yet, perhaps, felt the effects of the nicotine poison in YOUR system. For you know that nicotine, as absorbed into the system through smoking and chewing tobacco, is a slow working poison. Slow, yes—but sure.

Tobacco is lowering your efficiency. It slows a man down. Makes it harder for you to concentrate your mind on your work. You haven't near the amount of "pep" and energy you would have if you stopped using it. There's many a man twice as old as you in years who's twice as young in energy, simply because he lets tobacco alone.

Some day you will realize to what an alarming extent tobacco has undermined your system.

When your hands begin to tremble—
and your appetite begins to fail—
and your heart seems to "skip a beat" now and then—
and slight exertion makes you short of breath—
then you have a right to suspect that
TOBACCO is getting the upper hand.

Any well-informed doctor will tell you that these are only a few of many symptoms of tobacco poisoning.

And YOU know that the use of tobacco in any form is an expensive, utterly useless habit. You know you ought to quit.

Tobacco Habit Banished Let Us Help You

It doesn't make a particle of difference whether you've been a user of tobacco for a single month or 50 years, or how much you use, or in what form you use it—whether you smoke cigars, cigarettes, pipe, chew plug or fine cut or use snuff—**Tobacco Redeemer** will positively remove all craving for tobacco in any form in a very few days. Not the slightest shock to the nervous system. Your tobacco craving will usually begin to decrease after the very first dose—there's no long waiting for results.

Tobacco Redeemer contains no habit-forming drugs of any kind and is marvelously quick, scientific and thoroughly reliable.

It is in no sense a substitute for tobacco. After finishing the treatment you have absolutely no desire to use tobacco again or to continue the use of the remedy. It helps to quiet the nerves and make you feel better in every way.

Results Guaranteed A single trial will convince you. Our legal-binding, money-back guarantee goes with each full treatment. We will refund every cent you pay for the treatment if after taking it according to the easy-to-follow directions, it should fail to banish the tobacco habit completely.

SEND Coupon for Free Proof Let us send you our free booklet on the deadly effects of tobacco, together with testimonial letters from men all over the country telling how they have been absolutely freed from the tobacco habit by this simple home treatment. You could not ask for stronger proof that **Tobacco Redeemer** will free you from the habit than the evidence we will gladly send on request. Just mail the coupon—or a postal will do.

NEWELL PHARMACAL CO.
Dept. 300 Clayton Station St. Louis, Mo.



Free Book Coupon

NEWELL PHARMACAL CO.

Dept. 300 Clayton Station St. Louis, Mo.

Please send, without obligating me in any way, your free booklet regarding the tobacco habit and proof that **Tobacco Redeemer** will positively free me from the tobacco habit or my money will be refunded.

Name

Street and No.

Town..... State.....

Wonder Set of Radio!



Only \$10.95

500 Miles Without Tubes or Batteries!

First combination tube and crystal set ever made. The efficiency of this wonderful set is such that hundreds of people have actually removed the tube and batteries and with the crystal ALONE got stations 500 miles and more away. Think of it! With tube and batteries, records up to 1500 miles have been made under good weather conditions. The simple turn of a knob and either crystal or tube is thrown into operation without the change of a connection. Truly, this is the Wonder Set of Radio.

Loudspeaker on Locals

With crystal alone in the close vicinity of powerful city broadcasting stations beautiful loudspeaker reception is thoroughly practical. Using the tube, stations as far as 12 to 15 miles have been brought in nicely on the speaker.

Construction

Combination King, the Wonder Set, is a beautiful instrument. Mounted on a handsome hardwood base 9" x 11" with parts of bakelite, gold catwhisker, and handsomely nicked fittings together with flexible colored cables for battery connections, it is an ornament to any home.

**Buy Direct at Factory
Price of Only \$10.95**

To introduce this wonderful radio our factory is making this special price of only \$10.95 and the instrument will be shipped POSTPAID to any part of the U. S. To get quick delivery at this price order TODAY!

**Agents Wanted—
Big Money Quick!
WRITE TODAY**

**Aerial Electric Co.
128-36 W. Kinzie, Chicago**

- (1) Rush my set prepaid. I will pay postman \$10.95. ()
- (2) Send money making Agent's Proposition at once. ()

Name _____
Address _____

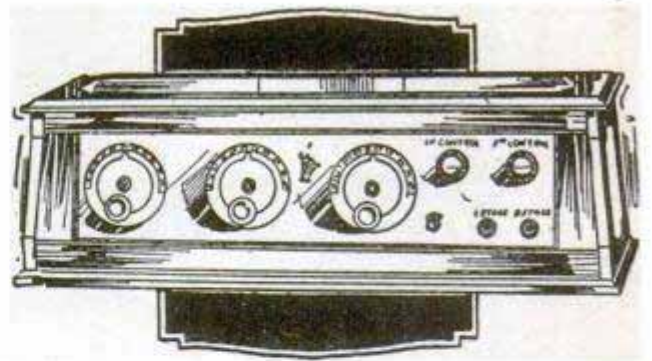

\$20 for Your Old Set

Greatest Offer! \$20 allowed on even Your Crystal Set by buying this wonderful **5 Tube Tuned Radio Frequency Valleytone NOW!** Cuts thru local stations. Solid Walnut cabinet, Apex dials, B-T Condensers, Etc. Fully guaranteed. Set complete with loud speaker, A Battery, 2 B Batteries, 5 Tubes, Aerial and equipment ready to install. Reg. Value \$160. Our price \$98.00—less \$20 Old Set allowance. Net.... **\$78.00**

Head Phones

Guaranteed in every way. Regular \$5.00 value—our price only..... **\$1.89**



GENUINE WONDER TUBES

Guaranteed. Will replace free for any defects if tube still lights. U. V.-119 or B 201 A type. **Each..... 90c**

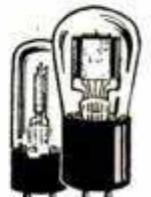

ORDER DIRECT from This Adv.

Save 50%—Our guarantee covers every item and protects you. Money refunded if not satisfied. Write order plainly. Send money order or bank draft for 1/4 of total order, pay balance on delivery plus shipping charge. References—Foreman National Bank—Or Any Com'l Agency—

Warshawsky & Company, Inc.
1915-31 S. State St. Dept. P.M. 02 Chicago

Saxophonists!

FREE Cord or Reed Cutter!



Yes, we mean just that! For a limited time we are offering to every saxophonist who mentions this ad our latest F. & U. Book of Sax Music and Accessories, and a choice of either a Master Built Reed Trimmer or a FitsU DeLuxe Saxophone Cord (Non-slip)! Frankly, we will lose money on this offer. We admit it! But—we want every saxophonist to get a copy of our biggest, latest, and best—

F. & U. BOOK of Saxophone Music—Accessories—Rebuilding

This handsome book is chockful of tricks of the trade, with plenty of sample parts for you to play! Contains everything you need to know about saxophone music, more than you need to know about Sax playing and lists completely all of our famous F & U saxophone accessories. You need this book. Send for it today. Don't delay—your copy is waiting to hurry to you along with your choice of a cord or reed trimmer—either are free.

FINDER & URBANEK, INC.
Dept. 1301 1322 W. Congress St., Chicago



KORACH LOOP AERIALS

Suitable for
Popular Mechanics Super-Circuit
Best Results Guaranteed

Selected by Cockaday and others for
Trans-Atlantic Tests

SPECIAL PRICES

Large size	Junior Size
\$12.50	\$10.00
(formerly \$16.50) 9-taps	(formerly \$12.50) 5-taps

Directional—Collapsible—Can be Logged
(Dept. 5) **KORACH RADIO CO.** 20 E. Jackson Boul., Chicago
Literature on request—Dealers Write



Let European Surgeons Show Results Equal to This Simple Home Treatment

You will be amazed, as I was amazed, when you find out the facts disclosed in the article below. The world has been electrified by the newspaper reports of the work of famous European Gland Surgeons, BUT they themselves admit the limitations of medicine and surgery. Now, a well known American Scientist has developed a simple treatment that any man can use in the privacy of his own home—and it has been used already by 20,000 men with quick, positive results—in many instances almost miraculous.

By BYRAM C. KELLY, A.M., LL.D.

Because I am just past 40 myself is probably the main reason why I made the investigation which disclosed to me a number of startling new facts about old age.

I had begun to wonder if I would soon start to "break"—to lose my old time pep and aggressiveness, my resistance to disease, when through a mutual friend I made the acquaintance of the scientist who has recently brought to light most interesting facts about the peculiar condition of men past middle age.

Why Many Men Are Old at 40

I have learned that nearly two-thirds (65%) of all men past a certain middle age have a disorder of a little gland called the Prostate. And Prostate Disorder is not only the direct cause of much distress, but it displays itself in many parts of the body, mental as well as physical.

Common Symptoms

Many of the ailments heretofore simply taken for granted as old age symptoms—sciatica, aches in back, legs and feet, nervousness and irritability, frequent dizzy spells indicating high blood pressure—frequent nightly risings—are well known symptoms of Prostate trouble.

20,000 Men Find Relief

But here is the most amazing of all the things I learned: **Right here in this country more than 20,000 men have used a new treatment in their own home with astonishing results.** The treatment has been quietly and scientifically tried out. And now it has been definitely proved that the results are beyond question and that the treatment can be effectively used by—and has been used by—men in every walk of life, statesmen, bankers, lawyers, doctors, etc.—men of all ages up to ninety.

INDISPUTABLE EVIDENCE

Below are printed three testimonials selected by the writer of this article from thousands of such letters received by the Electro Thermal Company.



"It has wonderfully relieved my prostatic decline and bladder trouble, and simply routed constipation and piles. It also imparts an exhilaration and buoyancy that is indeed very gratifying."—H. M. Miller, Reedley, Calif.

"Had trouble with my Prostate Gland for five years. Sent for Electro Thermal Treatment and about the third treatment felt much better. Can recommend your treatment to anyone afflicted as I was."—D. W. Cornelius, Pittsburgh, Pa.



"Had to be up ten to fifteen times at night. Spent hundreds of dollars trying to get relief then began using your treatment. I feel that the trouble is entirely relieved."—Dr. J. Frank McMichael, Union City, Tenn.



All Explained in Free Book

The discoverer of this treatment has written a wonderfully interesting book, which tells every man approaching middle age or older the full facts about Prostate trouble and its far reaching effects. It will be sent to you absolutely free if you will simply mail the coupon below. It describes the splendid treatment and shows how you may regain your youthful vigor and be free from certain disorders. No obligation. But mail the coupon at once.

The ELECTRO THERMAL COMPANY

2154 Main St., Steubenville, Ohio

THE ELECTRO THERMAL COMPANY,
2154 Main Street, Steubenville, Ohio.

Western Office, Dept. 21-W, 711 Van Nuys Bldg.,
Los Angeles, Calif.

Please send me free and without obligation, copy of your interesting book, "Why Many Men Are Old at 40."

Name

Address

City.....State.....

Fastest Cutting

Saws Fifteen Cords a Day!



Men—
Let Me Send You My
Greatest LOG SAW Offer!

ONLY
\$39

Puts the OTTAWA Working for YOU!



It's easier now than ever before to own this fastest-cutting, easiest-moved, most powerful Log Saw. Now, you can make big money sawing firewood, stave-bolts, ice, shingle timber, etc. Write today for full details of this most wonderful offer. Know how easy it is to make big money sawing fifteen cords of wood a day with no hard work.

350 Saw Cuts a Minute—

Make BIG MONEY—

nearly six each second. Just think of it—now you have a log—in a few seconds it's all sawed up into lengths you can use—without any hard work! The OTTAWA has balanced crank shaft, power force feed, friction clutch.

Wood selling at \$3 a cord brings owner \$45 a day. Saw your own wood—go into the wood business. Don't let the lack of ready money stop you. Remember, we sell on very easy terms. More in use than all others combined.

"I average \$20 profit a day with my OTTAWA."—J. Schill, New York. "My OTTAWA has earned \$700 for me."—S. Graham, Wisconsin. "I can make more money with the OTTAWA than by farming."—D. Goff, Missouri.

OTTAWA 4.H.P. LOG SAW



30 Days to Try—one whole month or use the OTTAWA a your own sawing. Shipped on trial only—backed by 10-year guarantee. Prove to yourself how easy you can saw 15 cords or more a day—at a cost of 1 1/2¢ a cord.

To Save You Freight—and get your machine to you a few days after you order, I ship from: Ottawa, Kan.; Pittsburgh, Pa.; St. Paul, Minn.; Albany, N. Y.; Memphis, Tenn.; Indianapolis, Ind.; Pueblo, Colo.; Ft. Worth, Texas; Portland, Ore.; San Francisco, Cal.

FREE Send me your name and address on post card today, so I can send you my wonderful new edition of the "Wood Sawing Encyclopedia." Educational, instructive. Be sure to investigate—will help you to make big money.

HARRY OVERMAN, Pres. OTTAWA MFG. CO.
1742-P Wood St., Ottawa, Kans. Room 1742-P, Magee Bldg., Pittsburgh, Pa.



Looks Like a Real

Protect yourself from toughs and hold-up men. Most amazing automatic. 4 1/2 in. long; gun-metal finish. Can't tell from real automatic until you pull the trigger, and presto! you have Opera Glass, Reading Glass, Magnifying Glass, Telescope, Mirror, Sun Dial, Compass, etc. L-a-s of fun; useful, instructive; a real protector.



AUTOMATIC \$1.48

Send No Money!

Just send name. On arrival of "Automatic" deposit with Postman \$1.48 plus a few pennies postage. Satisfaction guaranteed or deposit refunded. Supply limited. Order now. Big Bargain Catalog sent FREE. ORDER TODAY!

FERRY & CO., 3224 N. Halsted St., Dept. 8772, Chicago, Ill.

KARAS HARMONIK TRANSFORMERS ORTHOMETRIC CONDENSERS

The highest quality parts possible to produce.

KARAS ELECTRIC CO., 4046 N. Rockwell Street, CHICAGO

PLUMBING-HEATING

YOU SAVE HALF
Send for BIG FREE BOOK of Guaranteed Plumbing and Heating. Everything cut-to-fit. 50 yrs. in business. Thousands of customers. "You saved me \$400.00," says Mr. Edw. Rorksky of N. J. Write today.
HARDIN-LAVIN CO., 107-170, W. Pershing Rd., CHICAGO

THE WOTEN GASOLINE ENGINE

Air-cooled—Water-cooled. One-half H. P. in 15 pounds. Handiest little engine ever made. Ideal wherever power is needed. Also the Metalmen Model Airplane Engine, one-half H. P. in 3 1/2 pounds. The market demands them in thousands. Generous agency propositions on request. Complete line of small gasoline and steam engines, battery chargers, etc. Catalogue Free.

DYNAMIC MANUFACTURING CO.
First Nat'l Bank Bldg., Dept. 7, CHICAGO

Handy Tools for Handy Men!

Men everywhere are finding it easy to build things in wood with Boice-Crane Machines. New 64-page illustrated booklet explaining how to perform many wood-working operations sent postpaid on receipt of 10c. Also shows the complete line of Boice-Crane Circular Saws, Jig Saws, Band Saws, Mortisers, Jointers, Lathes, Drills and explains our E-Z Pay Plan and Money-Back Guarantee.

14" Band Saw
Table 12"x14" tilts 45 degrees. Saws 7" stock. Uses blades 3/16" to 1/2" wide. Bronze bearings.



Handisaw Model 2
Does ripping, mitering, grooving, sanding, grinding and drilling with ease and accuracy. Table 10"x13". Saw 7" dia. Cuts 2 1/2" stock. Dadoses 3/4"x 3/8". Cuts moulding.



8" Bench Lathe
Does turning, drilling, sawing, sanding, grinding and jig sawing in wood or soft metal. Swings 8". Capacity between centers 19". Metal-working model fitted with compound slide rest. All Boice machines driven by 1/4 to 1/2 h.p. motor attached to light socket. Machines sold with or without motor.

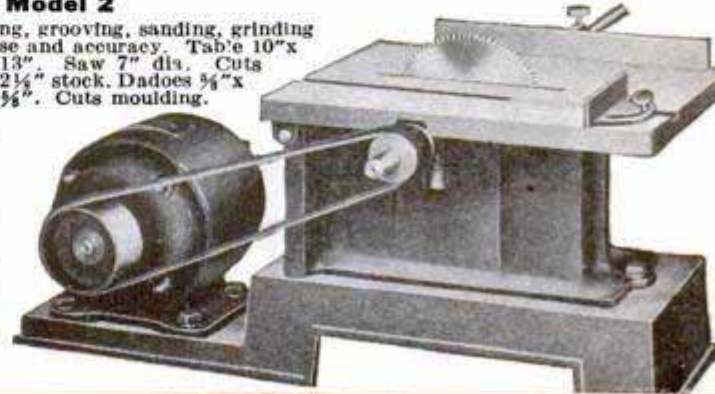

W. B. & J. E. Boice
Dept. P. M. 2-B, Toledo, Ohio

Guaranteed for FIVE Years! A guarantee you'll never use; the average Underwood lasts for LIFE! © 1925, S-W Co.

Thousands use a typewriter at home—to their pleasure and profit. The typewritten letter wins. Stories that are typed sell. There's always a wealth of work for a typist. Learn and earn on an Underwood—fast, spirited touch, and beautiful writer. See our offer!



**Write Us a Check for
THREE DOLLARS
and Own an Underwood**

Don't go another week without a typewriter. And don't pay another month's rental on some relic. A genuine Underwood is a joy to use—and easy to own. Act in time to receive one from this new lot!

If you've been "saving" for a typewriter, the time has come to spend. The cash involved? *Three dollars.* That's all that stands between you and actual use of your Underwood complete!

The Shipman-Ward price on a factory rebuilt Underwood makes it folly to buy a second-rate machine. And our plan of payment makes it equally foolish to wait.

Don't send any money now. But do let us have your name and address at once—for the big typewriter book that's free.

The biggest concern in the country buy Underwoods from us. You can make the same big saving, on one machine. So why pay the top price? This is a regular Underwood, the most popular model, with standard 4-bank keyboard, and every improvement; full size and complete equipment; tools and cover.

No other company makes such a wide-open offer; nor could we, on any other make of writing machine. See below.

Why Be Old Fashioned?

Modern Letters — Business or Social — Are TYPED! Four hundred Underwood typewriters, fresh from our finishing room, ready for shipment. They will soon find homes! For the home use of typewriters is increasing by leaps and bounds. A man needs one constantly. A boy in school shouldn't be denied one. Girls who work get ahead much faster at the office if they have their own typewriters at home.

You'll be amazed at the uses everyone in your household will find for an Underwood typewriter. Don't try to do with a less perfect machine, though; it doesn't pay. It isn't necessary. Since Shipman-Ward started rebuilding Underwoods, a fine typewriter is not a luxury in any sense. Few things around your

house cost so little as will now buy your Underwood. Nothing you ever bought was purchased on such liberal terms. These machines are in sparkling condition, rebuilt from the platen down. Not a single worn part; not a fault nor a flaw; nothing but what is just as perfect as its gleaming nickel or enamel finish.

Send No Money! All we want is your name and address, and a chance to present the facts about the wonderful Shipman-Ward plan; a plan that has built one of the world's largest typewriter businesses; the plan that was made for the benefit of all consumers. You run no risk buying this way! We let the machine do all the selling. Our big book of typewriters in actual colors is the thing to think of now! Coupon brings it free.

Free Book Coupon

SHIPMAN-WARD MFG. CO.
2122 Shipman Bldg., Chicago

Please send FREE, full offer, catalog, typing manual, and outline your free course in Touch Typewriting without obligation!

Name.....

St. or R. F. D.....

P. O..... State.....

EVERY MAN WHO USES TOOLS Needs a Set of BITS

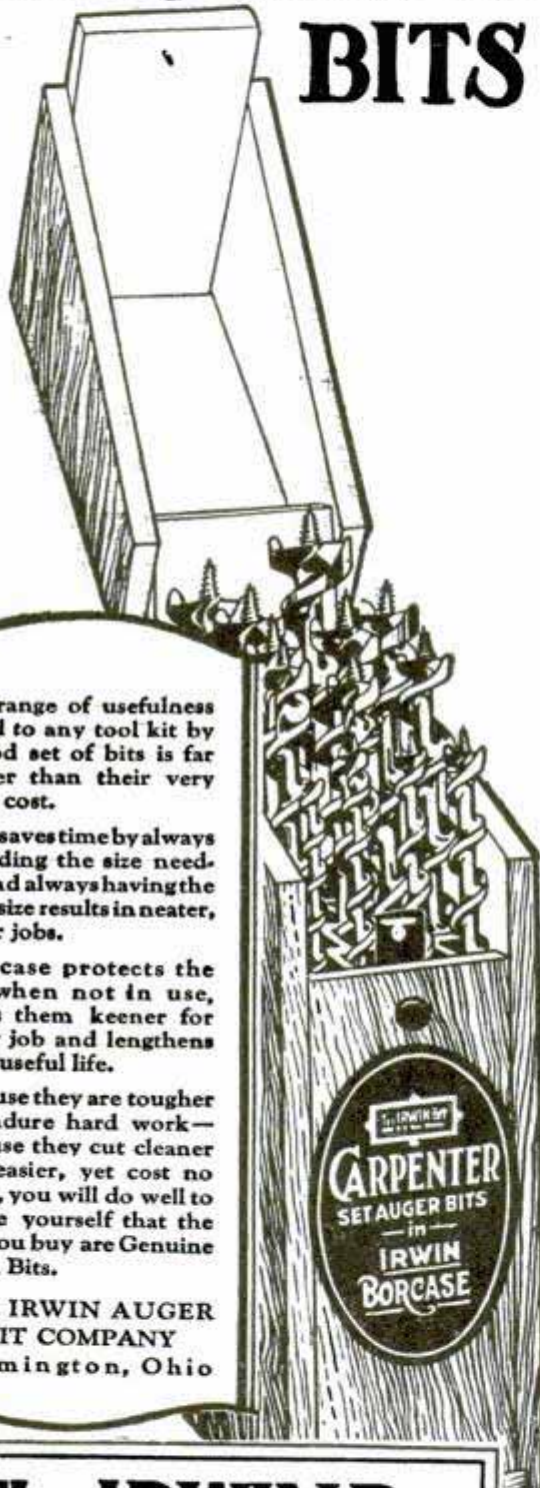

The range of usefulness added to any tool kit by a good set of bits is far greater than their very small cost.

A set saves time by always providing the size needed, and always having the right size results in neater, better jobs.

The case protects the bits when not in use, keeps them keener for every job and lengthens their useful life.

Because they are tougher to endure hard work—because they cut cleaner and easier, yet cost no more, you will do well to assure yourself that the bits you buy are Genuine Irwin Bits.

THE IRWIN AUGER BIT COMPANY
Wilmington, Ohio

The IRWIN Bit

REG. U.S. PAT. OFF.

Red Devil Tools Better Made



No. 444 "Red Devil" Giant Grip Tool

Fifteen jobs with this tool and a screwdriver! That is what a garage man did with the "Red Devil" Giant Grip Tool. A husky plier and wrench—replaces a multitude of tools—grips like a vise and can't slip.

The power is built into the No. 444. Will grip or turn any round or irregular shape up to 3/4 inches. Will not damage brass or copper nuts, unions or bushings. Ask your dealer for "Red Devil" Giant Grip No. 444—7 1/2 inch. Price \$1.

SMITH & HEMENWAY CO., Inc.
Mfrs. of "Red Devil" Tools
Irvington, N. J.
Branches: New York, Chicago, San Francisco, London, Eng.

BIG RADIO OFFER—Send No Money

The most amazing Radio offer made! Everything you need to complete a set. 1 Pair long distance, super-sensitive ear phones head set (Guaranteed 2,000 ohms); 100 Feet heavy ribbon antenna complete to install with 2 loss-proof insulators; 1 sure-contact ground clamp; 25 Ft. high grade lead-in wire. Big \$5.00 value! Send no money. Just pay postman only \$2.65, plus a few cents postage upon arrival. Mail us your name and address at once!

APEX STAMPING COMPANY RIVERDALE, ILL.

New Invention!

Does away with phonograph needles Guaranteed to play 27,000 records!

This wonderful invention selling for \$2 saves \$25 in needles. Thousands now use it all over the United States and Canada. Fits in holder just like ordinary needles. Millions who are now using old fashioned needles will go wild over Everplay when they see and try it. Get one for your phonograph. Plays perfectly on all phonographs and all records. Take orders from friends; make big money spare or full time.



The blunt needle garbles—the sharp needle ruins the record. Everplay fits groove perfectly. Gives perfect reproduction—saves the records—saves \$25 worth of needles. Complete sales outfit, including regular \$2 Everplay, circulars and sales plan at special price of \$1. No room to tell our story here. Write us today!



New Improved model sells for \$2 Saves \$25 in Needles

Greatly enlarged to show remarkable construction.

Sample on Approval if requested. Just send us your name and address. THE EVERPLAY CO., Desk 2-3, 218 S. Wabash Avenue, CHICAGO

FANSTEEL
Balkite
Radio Power Units

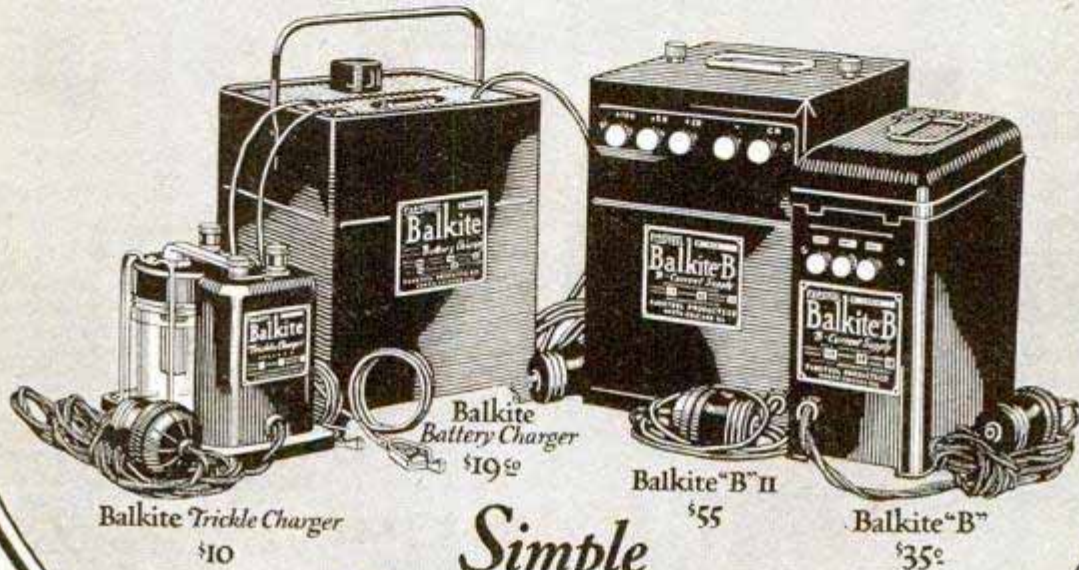

*Simple
 Entirely Noiseless
 Permanent*

Manufactured by FANSTEEL PRODUCTS COMPANY, Inc., North Chicago, Illinois

**Convert your present receiver into
 A LIGHT SOCKET SET
 with
 Balkite Radio Power Units**

Ask your Radio Dealer

Manufactured by FANSTEEL PRODUCTS COMPANY, Inc., North Chicago, Illinois

Sole Licensees in the United Kingdom:
 Messrs Radio Accessories Ltd., 9-13 Hythe Rd., Wellesden, London, N.W. 10

FANSTEEL



Just Sign Here

We'll send you a 10-day tube of this unique shaving cream, postpaid

GENTLEMEN:—

Palmolive Shaving Cream embodies the four great essentials 1000 men told us they wanted in a shaving cream, plus a fifth which we added.

Its success is a sensation. Men are flocking to it by the thousands.

We believe it will give you shaving comforts unknown to you before. That it will surpass your present method of shaving in five important ways.

In your interest and in ours, let us send you a 10-day tube to try. We know we can win you in this way. 80% of its present users thus were won from other preparations.

Five Advantages

1. Multiplies itself in lather 250 times.
2. Softens the beard in one minute.
3. Maintains its creamy fullness for 10 minutes on the face.
4. Strong bubbles hold the hairs erect for cutting.
5. Fine after effects due to palm and olive oil content.

We're the makers of Palmolive Soap, as you know. Thus 60 years of soap study stands back of this creation. We made up and discarded 130 formulas before venturing it on the market.

Just Send Coupon

Your present method may suit you well. But still there may be a better one. This test may mean much to you in comfort. Send the coupon before you forget.

THE PALMOLIVE COMPANY (Del. Corp.)
Chicago, Illinois

To add the final touch to shaving luxury, we have created Palmolive After Shaving Talc—especially for men. Doesn't show. Leaves the skin smooth and fresh, and gives that well-groomed look. Try the sample we are sending free with the tube of shaving cream. There are new delights here for every man who shaves. Please let us prove them to you. Clip coupon now.

COUPON

10 SHAVES FREE
and a can of Palmolive After Shaving Talc

Simply insert your name and address and mail to Dept. B-1119 The Palmolive Company (Del. Corp.), 3702 Iron Street, Chicago, Ill.

Residents of Wisconsin should address The Palmolive Company (Wis. Corp.), Milwaukee, Wis.

3058



Get Ready for a Thrilling Springtime

YOU'VE got to hand it to spring for real thrills! And it's not so far away at that!

Get out in the cool, crisp springtime air. Hop on a powerful, waiting Indian. Spin over the road to the friendly purr of a ready engine. No crowds! No traffic! No nerve-straining roar of the city! And no matter where you go—fishing, hunting, touring, camping—trust to an Indian. It's a "sure-fire" joy producer!



Be Our Guest Indian Day February 22nd

And just think! Your nearest Indian Dealer is giving a wonderful celebration for you—at his store. Note the date. Come along. Bring her too. See the latest 1926 Indian models. Join in the fun of this great annual pow-wow. Music! Excitement! Surprises galore! And valuable souvenirs that will always hold pleasant memories for you!

Don't miss this glorious entertainment. Remember the date. It's a big day for you!

ENROLL NOW Under Indian Club Plan

Under our Indian Club Plan you pick your favorite model and deposit only a small sum. Pay a few easily saved dollars regularly during the winter months—and your Indian will be ready to give you a springtime of thrills!

Visit your nearest Indian dealer on Indian Day and join in the fun. Write us for free descriptive literature, covering our complete line and how you can join the Indian Club.

Indian Motorcycle Co.

Dept. P-2, Springfield, Mass.

New "Easy Pay" Plan

Puts Any
LATHE
in Your
Shop

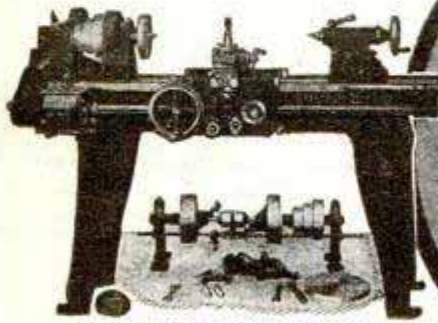

11 inch Swing over Bed,
3 1/2 ft. Bed, Quick Change
Gear, Net Fac-
tory Price..... **\$304**
Easy Payments If Desired

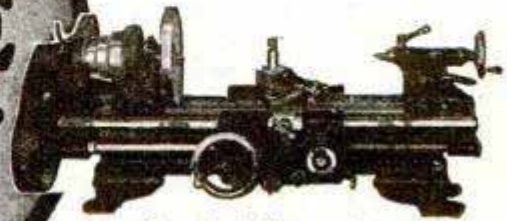

Standard Change Bench
Lathe, 9 inch Swing over
Bed, 2 1/2 ft. Bed, Net
Factory Price..... **\$212**
Easy Payments If Desired

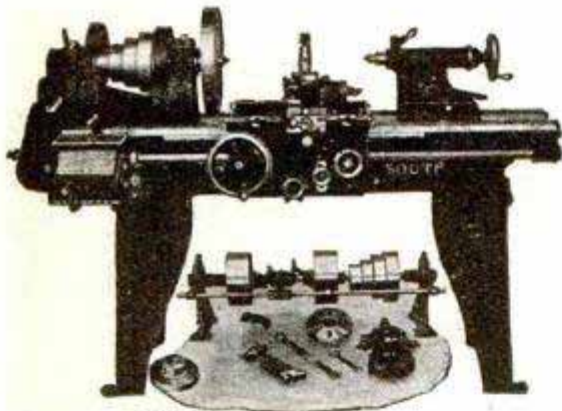

15 inch Swing over Bed,
6 ft. Bed, Quick Change
Gear, Net Fac-
tory Price..... **\$468**
Easy Payments If Desired



16 inch Swing over
Bed, 8 ft. Bed, Quick
Change Gear, Silent
Chain Motor Driven
Lathe, Net
Factory Price **\$719**
Easy Payments If Desired

NOW you can easily obtain a Lathe that will do all your work on terms so easy you won't feel the cost at all. You select the Lathe you need from our big Free Catalog, and make one small payment down. We ship the Lathe at once, and allow you to pay the balance of our low net factory price in convenient monthly payments. In this way Lathe

—Earns Own Cost

and more by what it saves and makes for you. You can have work done just as you want it, and when you want it, right in your own shop. You can do job work for others.

South Bend Lathes

are preferred by operators. 33,000 in use in the U. S. and 64 Foreign Countries. They are used by 5 Largest Railroads, 8 Largest Auto Factories, 2 Largest Steel Plants, Largest Radio Company, etc.

Write for Free Catalog!

Shows 96 styles and sizes from smallest Bench Lathe to largest Factory Production Lathe. Send coupon today.

South Bend Lathe Works 805 East Madison Street
South Bend :: Indiana

**SOUTH BEND LATHE WORKS,
805 E. Madison St., South Bend, Ind.**

Gentlemen:—I would like your net factory prices and terms on a

Screw Cutting Lathe, size.....

Kind of work..... Please send Free Catalog.

Name.....

Address.....

City..... State.....

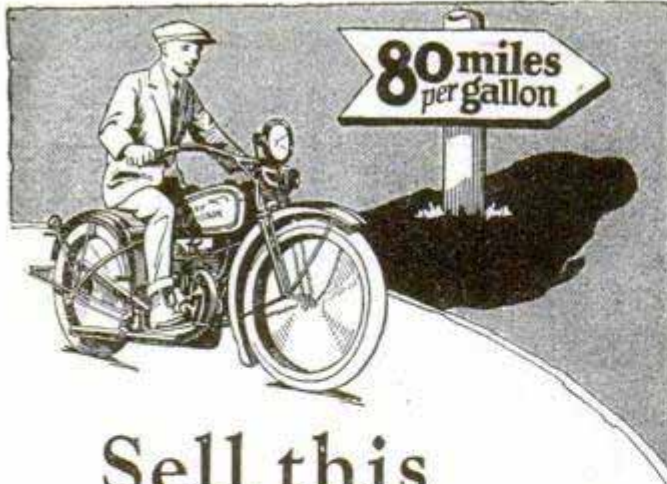

Sell this New-Type Motorcycle!

EVERY man between the ages of 15 and 50 can be interested in the new Harley-Davidson Single. Four times as economical as the cheapest car—80 miles to a gallon of gasoline! Cheaper than carfare or busfare!

We need a few more live, aggressive dealers to sell the New Single. Many exclusive features and Harley-Davidson national advertising make sales easy—and profitable! With the help of our finance corporation you can sell on the "Pay-As-You-Ride" plan.

Let us start you in this pleasant, paying business. Write us today for our special proposition.

HARLEY-DAVIDSON MOTOR CO.
Dept. P. N. Milwaukee, Wisconsin

The New [This New-Type] Motorcycle HARLEY-DAVIDSON Single

See our other Ad on page 121

Genuine DIAMOND



WRIST WATCH

Simply send \$2.00 and this 14 Karat Solid White Gold Rectangular Wrist Watch set with four perfect cut, Genuine Diamonds comes to you all charges paid. Highest grade 15 ruby and Sapphire Jeweled Movement. Life time guarantee. Price, only \$42.50.

10 DAYS' FREE TRIAL

If not satisfactory or if you can duplicate this watch for \$70.00, your deposit will be refunded.

\$4.05 PER MONTH

After trial pay balance \$4.05 a month for ten months.

FREE ROYAL CATALOG

Illustrates and describes thousands of special values in diamonds, watches and jewelry—send for your copy at once. Address Dept.

ROYAL DIAMOND & WATCH CO.
Dept. 1530 170 BROADWAY, NEW YORK

Leaky Roofs

Made
Water-tight
at
Small Cost



an amazingly simple way to make your leaky roofs watertight and last you 10 years longer at one-fifth the cost of a new roof. 20 years use on industrial buildings all over the world proves what it will do for you.

You pour it on right over the old roof and spread it out with a roofer's brush. You do it yourself in a few hours—no labor cost—you end your roof worries for 10 years to come. Remember, Seal-Tite is not a paint.

Don't Pay for 4 Months!

We ask no pay till 4 months of sun and rain have proved all our claims. **SEAL-TITE** must do what we say it will or it costs you nothing. Could you make a fairer offer if you wrote it yourself?

WRITE NOW!

Our big, illustrated circular tells all about how you can turn an old, leaky roof into a new, watertight roof, at a small fraction of the cost of a new roof. What a wonderful chance to save! Don't wait for the next rain to remind you that your roofs leak. Look into this thing right now. Seal-Tite carries a positive 10-year guarantee. Send today for full details of our amazing offer. Write TODAY!

Established 1908

Monarch Paint Co., Dept. 13-52 Cleveland, Ohio

DOUBLES TIRE MILEAGE

and
Makes Pumping Up
Tires Unnecessary



Line up with big money. The Hughes "Airlox" Valve Cap is a proven success. Air-tight. Eliminates all troubles due to under-inflation; lasts life of tire. Positive necessity to auto owners. Doubles tire mileage. Tested and approved by leading auto manufacturers. \$100 a week for hustlers. Unlimited demand. No competition.

FREE SAMPLES TO AGENTS

to use and introduce in exclusive territories. Immense uncrowded field. Don't hesitate. Write today for facts and FREE SAMPLES.

AIRLOX RUBBER CO.
2512-14 W. Monroe St., Dept. 805, Chicago, Ill.

Concrete Articles easily made with instructions and pictures to follow. Our Concrete Handbook and 1925 Shop Notes tell how to use concrete. Hundreds of Ideas. Send No Money. Pay postman 98c. Popular Mechanics Press, Room 702, Chicago, Ill.

\$1 a Week

for Your Choice of
Any Standard Make

TYPEWRITER



Never before a typewriter offer like this! ONLY \$1.00 WEEKLY and you can own an Underwood, Royal, L. C. Smith, Remington or any standard typewriter at lowest prices in years. We will ship typewriter to you on **TEN DAYS' TRIAL**. Every machine completely re-manufactured by the famous "Young Process" giving longest, satisfactory service and appearance like new—backed up by our **FIVE YEAR WRITTEN GUARANTEE**.

FREE CATALOG fully illustrated and with complete information about typewriters sent on request—no obligation whatever. **WRITE TODAY.**

Ask for Agency Offer—Agents Wanted Everywhere.

YOUNG TYPEWRITER COMPANY
654 W. RANDOLPH ST., Dept. 5102, CHICAGO, ILL.

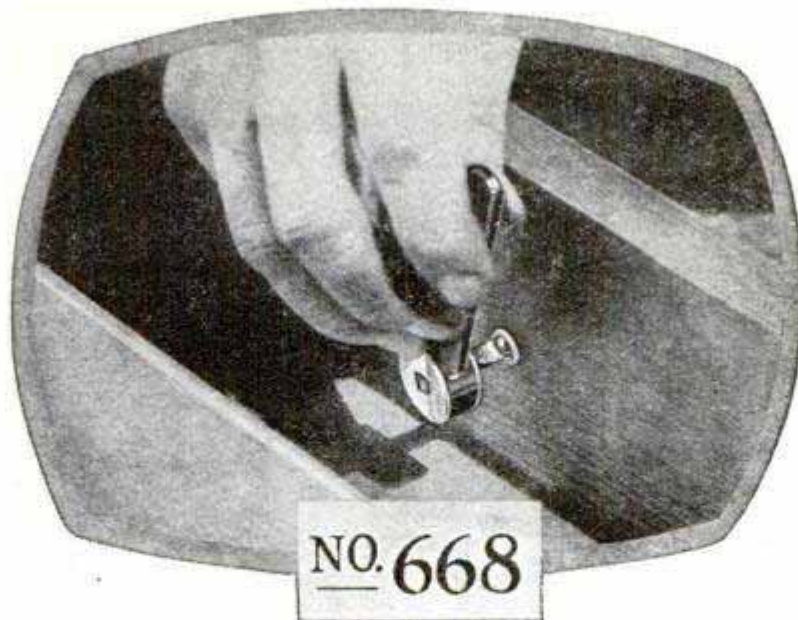

A new right-angle ratchet screw-driver

and a 450-page book of Goodell-Pratt Tools

Yours for only \$1.00

Take advantage of this special offer today.
Screw-driver and pocket catalog sent post-
paid to any part of the United States.

HOUSE owner, car owner, radio fan, car-
penter, mechanic—if you are any of
these you will want this new right-angle
ratchet screw-driver and the pocket-size
catalog packed full of pictures and descrip-
tions of Goodell-Pratt Good Tools.

The right-angle ratchet screw driver is the
newest tool made by the Goodell-Pratt Com-
pany, toolsmiths of national repute for
many years. It is for use on the screws

you can't get at with a straight screw-
driver. It is all metal—4 inches long, with
a 3-inch handle, giving remarkable leverage.
The blade is hardened tool steel held in
place by a spring retainer. Ratchet teeth
are broached into the driver head. Hard-
ened tool steel dog is actuated by spring
engaged teeth. To reverse the action,
change the blade to the other side of the
driver head.

*Fits your pocket. Shows
many tools you would
like to own.*

GOODELL-PRATT COMPANY, Greenfield, Mass., U. S. A.

Toolsmiths

Tear out this coupon, fill it out and mail today



GOODELL-PRATT COMPANY

Greenfield, Mass., U. S. A.

I enclose check money order for \$1.00 for 450-page pocket-size
Goodell-Pratt catalog and a right-angle ratchet screw-driver
No. 668.

Name.....

Address.....

City..... State.....



Swinging, Swaying Tantalizing' Tunes

The lure of jazz is yours with a Buescher True-Tone Saxophone. Young folks are enamored by these tantalizing tunes. They love that syncopation.

If you want to be popular—if you want to be admired—favored, get this wonderful instrument. At home, at parties, everywhere, the Saxophone player is the center of attraction.

BUESCHER

TRUE-TONE Saxophone
Easy to Play
Easy to Pay

You don't have to "study" the Saxophone as you do other instruments. There is no practice drudgery. You don't have to be "talented." Three lessons sent free with the instrument start you. In a week you can play popular airs. No teacher needed.

It's all fun, and even though you're only out for pleasure now, you can, in 90 days' time, if you wish, join a band or orchestra.

First class Saxophonists make big money. Try it out free for six days in your own home.

Free Saxophone Book

Send the coupon! Or a postal for full particulars and copy of Saxophone Book! Mention any other instrument in which you may be interested. No obligation. Do this today. (112)

BUESCHER BAND INSTRUMENT CO.
Everything in Band and Orchestra Instruments
1386 Buescher Block Elkhart, Ind.

Buescher Band Instrument Co.,
1386 Buescher Block, Elkhart, Ind.

Gentlemen: I am interested in the instrument checked below:

Saxophone.....Cornet.....Trombone.....Trumpet.....
(Mention any other instrument interested in)

Name.....

St. Address.....

Town.....State.....

New Speed Way Shop

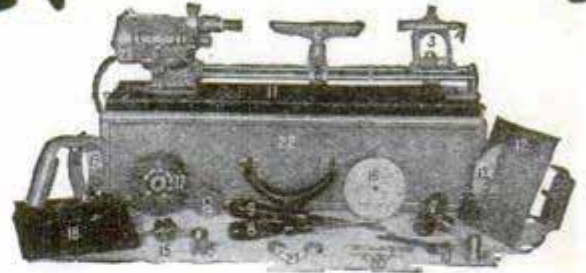

Six Complete Motor Driven Tools

A compact metal and woodworking outfit for mechanics, householders and "handy" men. Driven by famous Speed Way motor which is easily detached, giving you a Portable Electric Drill. Tools quickly interchangeable.

Saw, Lathe, Grinder, Buffer, Cleaner, Drill
Attaches to any lamp socket. All packed under pressed steel case (No. 22 above) with lathe bolted to platform 25 in. x 6 in.

Check the Numbers on the Photograph

- | | | |
|-----------------|-------------------------|------------------------------------|
| 1. Lathe Bed | 9. Gouge Chisel | 17. 4-in. Wire Brush |
| 2. Tool Rest | 10. Universal Wrench | 18. Tool Case |
| 3. Tail Stock | 11. Base 25 in. x 6 in. | 19. Drill Handle |
| 4. Centers | 12. Saw Table | 20. Drill Bits |
| 5. Chuck | 13. 5-in. Circular Saw | 21. Nut and Washer |
| 6. Spur Center | 14. 2-in. Wheel | 22. Steel Cover |
| 7. Face Plate | 15. Arbor and Flanges | 23. The Well Known Speed Way Motor |
| 8. Parting Tool | 16. Cloth Buffer | |

Only \$10 Down—Easy Payments

Five minutes after receipt you can have the chips flying. Pay as you enjoy it. Use the Speed Way Shop for pleasure or profit.

Write Today For Full Information

Every tool in the "Shop" is high grade, for regular work. A money maker for the small job man. Get full particulars. Write today.

ELECTRO-MAGNETIC TOOL COMPANY
DEPARTMENT 22
1630 South 52nd Ave., Cicero, Illinois (Adjoining Chicago)

FREE —

Our Latest 100 Page RADIO CATALOG

Just off the press—waiting for you. All the latest sets with special kits to build them. Parts and accessories by well-known manufacturers. Every fan needs this latest guide-book to the best in radio.

Write for your FREE copy.

Chicago Salvage Stock Store

509 S. State St.,
Chicago, U. S. A.
Dept. P. M.-6



No other
portable typewriter
has all these
modern features

THE KEYBOARD has four rows of keys—the same as office typewriters. You don't have to shift for figures.

Instead of a six-yard ribbon, Corona's automatically reversing two-color ribbon is twelve yards long.

The large self-spacing carriage return lever is right up where you want it for quick action. It is the only portable with a *real* variable line spacer. There is also a convenient stenciling device.

Corona has a shift key on each side. Back spacer and margin release are conveniently located *on the keyboard*.

You can see what you are writing without moving your head an inch. The visibility is perfect—and at right angles to vision.

The type bar action operates on exactly the same principle as that employed on all the best full-size machines—the type comes *up* to strike the paper.

The full width carriage takes a No. 10 envelope—just like any office machine.

Over 700,000 Coronas, more than all other makes of portables combined, prove Corona's durability.

MODELS and PRICES

The price of this standard keyboard Corona is \$60 with case. Other models at \$50. Special keyboards available for all foreign languages and technical writing. Dealers will accept used typewriters as part payment.

Corona—the only portable with all these big machine features—

HAVE you ever used a regular office typewriter? If you have, the column on the left will tell you why you should choose Corona as your own "private" typewriter. No other portable has so many big-machine features. You'll be at home on it in five minutes.

If you have never used a typewriter, you will find a dozen good reasons for making Corona your first and last choice. While you are getting a personal typewriter you may as well have the one that is most like a big office machine—except for weight and bulk. Take Corona with you, typewrite anywhere—it will travel easily in its own handy case.

There's a Corona dealer near you who will be glad to bring Corona to you for examination. Look for Corona in your phone book, or mail the coupon.



MAIL THIS TODAY

CORONA TYPEWRITER CO., Inc.
108 Main Street, Groton, N. Y.

Please send me latest information about
Corona—without obligation on my part.

Name.....

Address.....

CORONA

The Standard Portable



MAN TO MAN A Message to Canadians

How would *you* feel toward the man who gave his spare time to fitting himself to work better for *you*?

Wouldn't you want to reward his efforts? Wouldn't you want to put your hand on his shoulder and tell him, man to man, that you appreciated it—that you admired his efforts? You would!

Your employer is a man who lives, thinks, loves and is loved as you are. In his home he is very like you are in yours.

That hand on the shoulder, those friendly words and promotion can be yours.

It does not matter where you live, nor what your present education. Tens of thousands of Canadians have succeeded in life—some have risen to very high positions—solely through the vocational training and unremitting special personal service received at home from the I. C. S.

If you will mark this coupon and mail it to us today, we will send you **FREE OF ALL CHARGE**, an illustrated booklet descriptive of the I. C. S. methods and of the course of instruction that can benefit you most.

INTERNATIONAL CORRESPONDENCE SCHOOLS
Box 1892, Scranton, Penna.

Without cost or obligation, please tell me how I can qualify for the position or in the subject before which I have marked an **X**:

BUSINESS TRAINING COURSES

- | | |
|--|---|
| <input type="checkbox"/> Business Management | <input type="checkbox"/> Salesmanship |
| <input type="checkbox"/> Industrial Management | <input type="checkbox"/> Advertising |
| <input type="checkbox"/> Personnel Organization | <input type="checkbox"/> Better Letters |
| <input type="checkbox"/> Traffic Management | <input type="checkbox"/> Show Card Lettering |
| <input type="checkbox"/> Business Law | <input type="checkbox"/> Stenography and Typing |
| <input type="checkbox"/> Banking and Banking Law | <input type="checkbox"/> Business English |
| <input type="checkbox"/> Accountancy (Including C.P.A.) | <input type="checkbox"/> Civil Service |
| <input type="checkbox"/> Nicholson Cost Accounting | <input type="checkbox"/> Railway Mail Clerk |
| <input type="checkbox"/> Bookkeeping | <input type="checkbox"/> Common School Subjects |
| <input type="checkbox"/> Private Secretary | <input type="checkbox"/> High School Subjects |
| <input type="checkbox"/> Spanish <input type="checkbox"/> French | <input type="checkbox"/> Illustrating <input type="checkbox"/> Cartooning |

TECHNICAL AND INDUSTRIAL COURSES

- | | |
|---|--|
| <input type="checkbox"/> Electrical Engineering | <input type="checkbox"/> Architect |
| <input type="checkbox"/> Electric Lighting | <input type="checkbox"/> Architects' Blue Prints |
| <input type="checkbox"/> Mechanical Engineer | <input type="checkbox"/> Contractor and Builder |
| <input type="checkbox"/> Mechanical Draftsman | <input type="checkbox"/> Architectural Draftsman |
| <input type="checkbox"/> Machine Shop Practice | <input type="checkbox"/> Concrete Builder |
| <input type="checkbox"/> Railroad Positions | <input type="checkbox"/> Structural Engineer |
| <input type="checkbox"/> Gas Engine Operating | <input type="checkbox"/> Chemistry <input type="checkbox"/> Pharmacy |
| <input type="checkbox"/> Civil Engineer | <input type="checkbox"/> Automobile Work |
| <input type="checkbox"/> Surveying and Mapping | <input type="checkbox"/> Airplane Engines |
| <input type="checkbox"/> Metallurgy | <input type="checkbox"/> Navigation |
| <input type="checkbox"/> Steam Engineering | <input type="checkbox"/> Agriculture and Poultry |
| <input type="checkbox"/> Radio | <input type="checkbox"/> Mathematics |

Name.....
 Street.....
 Address..... 3-6-24
 City..... State.....

Occupation.....
Persons residing in Canada should send this coupon to the International Correspondence Schools Canadian, Limited, Montreal, Canada.



Patrick Conway
famous band-
master uses and
endorses Conn.

Use Your Talent, Now

That longing to play some instrument, to express yourself in music, can be quickly and easily gratified. Choose any Conn instrument, you'll win pleasure and profit in the shortest time. Remember Conn is the only maker of every instrument for the band.

Endorsed by foremost artists for beauty of tone, perfect scale, reliable action.

Free Trial; Easy Payments. Write for free book "Success in Music" and details of trial offer. Mention instrument.

C. G. CONN, Ltd.
231 Conn Bldg., Elkhart, Ind.



CONN

BAND INSTRUMENTS
WORLD'S LARGEST MANUFACTURING



Wear this Shirt and Earn \$75 to \$100 A Week

With or without experience, you can easily earn \$75 to \$100 a week taking orders for the famous FASHION WEAR shirts. Wear one of them and show to your friends. Every man a customer. Finest quality at low direct-to-wearer prices. Sales quick and easy. Some are earning as high as \$175 a week.

Mail Coupon For FREE Samples

We send you Free complete sample outfit with wonderful swatches. You take the order. We deliver. **START NOW** and build a permanent, profitable and fascinating business of your own. Collect your profit in advance and always have money. These remarkable shirts are selling amazingly fast, and sales are good all year round. We help you sell and give you a fair share on every shirt sold. If you really want the best money-making work anywhere send immediately for free sample outfit. Act before someone else grabs the rich territory that you can have. Simply mail coupon.

CHARLES HOPE,

THE FASHION WEAR CO.
1200-20 Jackson St., Dept. B-351, Cincinnati, Ohio

Fashion Wear Shirt Co.
1200 Jackson St., Dept. B-351, Cincinnati, Ohio.
Send your sample outfit FREE by return mail.

Name.....
 Address.....
 City..... State.....

Real Pen Satisfaction



Only
\$2⁵⁰!

No Other
Fountain Pen
Like It!

*Absolutely
Guaranteed
or Your
Money
Back*

You Can See
Right Through
This Pen

THE man who invented this amazing pen consented to let us sell it only under one condition—that we work out a plan whereby the price would be within the reach of everyone, instead of selling it at \$7.00 or \$8.75, the price of other pens of equal quality.

Of course, it was impossible to sell this remarkable pen through the stores. Their profit alone on a \$7.00 or \$8.75 pen is more than what you actually pay for the **POSTAL RESERVOIR PEN**. And so we decided to let Uncle Sam do the selling for us—through the United States mails.

The Pen That Says "Fill Me Up!" When Empty

The **POSTAL RESERVOIR PEN** (named **POSTAL** because it is sold by mail only) is distinctive in design and contains features which are not found in any other pen. It is transparent, so you can always see when it needs filling. It is self-filling—employs an entirely new method, the easiest ever devised. Holds 3 to 4 times more ink than any other self-filling pen. Manufactured from same materials as used in highest priced pens. Never before have so many improvements and refinements been combined in a single, handsome, smooth-writing, never-clogging pen that you will be proud to own and delighted to use.

Five Days' FREE TRIAL!

Send for your **POSTAL** pen NOW. State whether you want men's or women's model. Use it five days and if you are not delighted with it, return it and your money will be promptly refunded. You are to be the sole judge. Compare it with any pen at any price. Remember the price is low only because our sales policy of manufacturer-to-user eliminates all in-between profits, commissions and handling. Send the coupon NOW and learn what real fountain pen satisfaction is.

Read These Remarkable **POSTAL** Features:

- It Is Transparent**—You can always see exactly how much ink you've got. Can't run unexpectedly dry.
- It is Unbreakable**—You can even step on it without injuring it. A wonderful pen for life time service.
- It's the Smoothest Writing Pen You Ever Saw**—Big, Solid 14 Karat gold point, tipped with the finest iridium.
- It is Self-filling**—the easiest of all pens to fill.
- It Holds 3 to 4 Times More Ink Than Any Other Self-filling Pen**—Fill it once a month,—and get real "writing mileage."
- And Remember**—the materials and workmanship are guaranteed to be equal or superior to those found in any other pen, whether sold at \$7.00, \$8.75 or more.

How to Get the Postal Pen SEND NO MONEY

Simply fill in and mail the coupon. Do not send a penny! When you get your Postal Pen, you will also receive 5 post cards, each worth 50c on the purchase price of another pen.

Every Postal Pen owner finds that his friends admire his remarkable pen and ask where they can get others like it. You can easily sell your premium post cards for 50c each and earn back the full price of your pen.

You do not have to sell the cards—dispose of them any way you wish—whatever you make on them is yours to keep.

Postal Pen Co., Inc.,
Dept. PM-1,
25 West 43rd Street,
New York City

Please send me one Postal Reservoir Pen, and five special Premium Postcards which I may give away or dispose of at 50c each. I will pay postman \$2.50 upon receipt of the pen. If after 5 days' use I desire to return the Postal Pen you agree to refund purchase price. Check which you want..... Men's size

Actual Size of **MEN'S MODEL**

Postal

RESERVOIR PEN

Write or
Send
Coupon
Today

Name.....

Address.....

City..... State.....

Postal Pen Co., Inc., 25 West 43rd St., New York City

Every Handy Man needs SMOOTH-ON NO. 1



SMOOTH-ON No. 1 hardens like iron and expands in doing so to make cracked, open or loose parts everlastingly tight.

Don't pay any professional fixer a big price to make such repairs. With Smooth-On No. 1, you yourself can do a perfect job for a few cents and usually in a few minutes.

Get the Smooth-On habit and you will quickly find that it keeps many dollars in your own pocket. Try it on the following and see for yourself:

In the Home

Stopping leaks in steam, water, gas, oil or stove pipes, mending cracks, breaks or leaks in furnaces and boilers, radiators, tanks, sinks, pots and pails, making loose handles tight on umbrellas, knives, hammers, brushes, drawers, etc., tightening loose screws, hooks, locks, door knobs, etc.

How to make HOME-AUTOMOBILE REPAIRS

Do it with SMOOTH-ON

Write for **FREE BOOK**



Do it with SMOOTH-ON

SMOOTH-ON MFG. CO., Dept. 37,
574 Communipaw Ave., Jersey City, N. J.
Please send the free Smooth-On Repair Book.

Name

Address

P. M.

On the Automobile

Making bursted water jackets and pumps good as new, stopping leaks in radiator, hose connections, gas tank and gas, oil and exhaust lines, making a fume-proof joint between exhaust pipe and tonneau heater, tightening loose headlight posts, keeping grease cups, hub caps and nuts from loosening and falling off, etc.

To get perfect results, write to us for and use the Smooth-On Repair Book. Free if you return the coupon.

Get Smooth-On No. 1 in 7-oz., 1-lb. or 5-lb. tins at any hardware store or if necessary direct from us.

SMOOTH-ON MFG. CO.
Dept. 37, 574 Communipaw Ave.
JERSEY CITY, N. J.

"The enchantment of distance,
the joy of clearness, with
FROST-FONES"

New! Better!

Two useful new items of
FROST-RADIO now ready

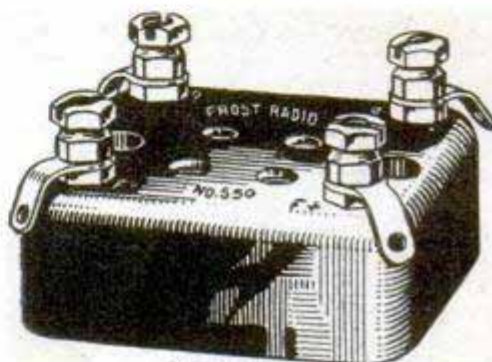

FROST-RADIO

FROST-RADIO
No. 530 SOCKET . . 40c

This new socket takes ALL tubes with the new type bases. Has perfect spring construction which grips each tube prong full length with self-cleaning, sliding contact. Genuine black Bakelite in high lustre finish. Order from your dealer today.

No. 540
FROST-RADIO
Adapter
25c

With this handy, inexpensive adapter you can instantly fit the new CX299 or UX199, and the CX220 or UX120, into your present standard base sockets.

No need to rebuild your set to take the new tubes. Genuine black Bakelite—high lustre finish. Ask your dealer to supply you.

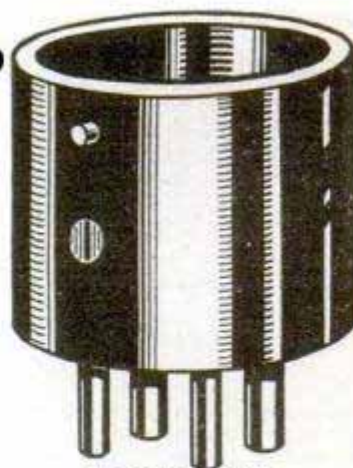

FROST-RADIO

HERBERT H. FROST, Inc.
314 West Superior Street, Chicago
New York Cleveland Kansas City Los Angeles
Export Office: 314 West Superior Street, Chicago



**Mystery
Razor
FREE!**

*If You'll Use This
New Invention*

I'll Guarantee

To Keep You in Razor Blades for Life!

KRISS-KROSS marks such a radical advance in new shaving comfort and economy that it deserves to be classed as much more than a stropper. It's a **super-stropper**—a blade **rejuvenator**! Almost literally it makes a new blade out of an old one every day—makes hundreds of keen, quick shaves blossom where only one grew before.

KRISS-KROSS strops your blade on the diagonal just like a master barber. Pressure decreases automatically. Nickel jig flies up to notify you when your blade is ready with the **keenest cutting-edge steel can take!**

No wonder that this super-stropper prolongs the life of any make blade, single or double edge, for weeks, months and years! No more bother about remembering to buy new blades! No more "raking" with dull ones! KRISS-KROSS solves your blade problem for all time.

Sensational Offer

And now for my smashing offer! To introduce KRISS-KROSS stropper during the next 30 days I am giving with it, **free**, a new kind of razor. This unique razor, with 5 special process blades, completes the outfit with which I guarantee to keep you in razor blades for life!

**Rhodes' KRISS KROSS
STROPPER**

Rhodes Mfg. Co., Inc., 1418 Pendleton Ave., Dept. B-370, St. Louis, Mo.



Most astonishing razor you ever saw. Really 3 razors in one. Adjustable to any shaving position. Flip of finger makes it straight or T-shape in a jiffy. Nothing like it ever on the market before. I'll send you one FREE to introduce KRISS-KROSS super-stropper. Limited offer. Find out about it today!

Use the blades and keep re-newing them with KRISS-KROSS super-stropper. If one of them goes back on you I'll recondition or replace them with new ones free. No strings. No red tape. I give my amazing guarantee in **writing**. It is an ironclad agreement to **KEEP YOU IN RAZOR BLADES FOR LIFE!**

Send for Full Details

This astonishing offer is limited. Send for information on amazing KRISS-KROSS inventions today. They are never sold in stores—and are even more remarkable than I can tell you here. Clip the coupon to-day! No obligation!

AGENTS: \$30 — \$66 A Day!

Make big money with KRISS-KROSS! Free razor boosts sales amazingly. H. King made \$66 one day. C. E. Conklin made \$22 in 2 hours. Others average \$175-\$400 a month. Every man buys on sight. Unique surprise bonus plan brings big extra profits. Most wonderful sales plan ever originated. Get details at once.
Sold only through Authorized Representatives.

Rhodes Mfg. Co., Inc.,
1418 Pendleton Ave., Dept. B-370
St. Louis, Mo.

Without obligation please send me full details of your special introductory offer to keep me in Razor Blades for LIFE. Also send me full description of KRISS-KROSS stropper and FREE adjustable razor.

Name

Address

City State

() Check this space if you are interested in becoming an authorized KRISS-KROSS representative.

Successful American Farmers in Canada invite you to come

This Farmer's Experience Can Be Yours



Above—Home of Otto Zimmerman

Below—Big Modern Barn on the Zimmerman Farm

"I came from Wisconsin in 1908 and settled on my present farm of 320 acres, for which I paid \$7.00 per acre in 1903.

"I had about \$150.00 in cash and horses and equipment to farm with. I now have a 10-room modern house, electric lighted, sewer, good barns, elevator and granaries. My buildings are worth \$20,000.00.

"We have good markets, lower freight rate than in the States and the taxes are much lower. We do not feel the cold here as we did in Wisconsin although the mercury might run lower sometimes, but it is very dry.

"I can heartily recommend any man looking for a home to come to Western Canada. Land is cheaper than in the States and you can secure a start on less money. I raised on an average this year of 40 bushels of wheat and 60 bushels of oats.

"I do not go in for dairy cattle although this is a good country for cattle and hogs. Corn for ensilage is raised in the district, but I feed green sheaves. There is surely room here for good industrious farmers from the States."

(Signed) OTTO ZIMMERMAN

Saskatchewan, Canada, Nov. 16th, 1925

THESE FACTS BRING SUCCESS:

Low Taxes; Low Priced Lands; Good Soil;
Good Schools; Low Freight Rates; Big Yields per Acre;
Good Laws; Good Markets; Favorable Climate.



J. N. K. MACALISTER, Supt. of Colonization

Dept. 502, Canadian Pacific Railway Depot
Winnipeg, Manitoba, Canada

NEW FORD TIMER

GUARANTEED for 3 YEARS

Entirely New Principle

Study the illustration and you will note the rotating member is the brush principle traveling on the outside surface of the commutator—this assures you of a steady, even and powerful spark at exactly the proper time—The natural centrifugal action of the rotor keeps the commutator clean as it should be—provision is made for the elimination of any oil, grit or grime, therefore it cannot accumulate in the WEEKS SUPER TIMER. This principle is entirely new and unique.

Sensational Invention

Millions of Ford Owners have been waiting for this "SUPER TIMER"—does away with common TIMER troubles. Entirely new principle. DYNAMO TYPE, no heavy pressure contact, no rollers to wear flat and cause endless trouble; smooth, easy, positive contact. The faster you run the hotter the spark, positive contact at all times, short circuits impossible, no oiling necessary, perfect firing, gives more power, saves wear and tear, adding many extra miles to the gallon, instant starting in the coldest weather, the motor promptly responds to the hot spark, the pick-up is marvelous. No parts to wear out, and the fact that the SUPER TIMER OUTLASTS 6 ORDINARY TIMERS enables us to guarantee this TIMER for 3 years.

Ford Owners Wild Over It

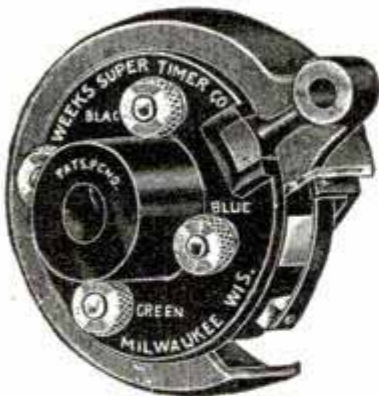

Beyond a question of a doubt the most needed article on a Ford today is a GOOD TIMER, one that would accomplish a real purpose and serve the owner—without continual care and attention, annoyance and trouble. The "SUPER" TIMER is the latest achievement of Mr. Weeks whose zealous interest is to make each and every Ford Owner the proud possessor of a better running Ford. Already the "SUPER" TIMER has met with instant approval. Ford Owners everywhere generously acknowledge it to be the BEST TIMER on the market. It is indeed a real TIMER for Fords.

Fortunes Now Being Made

Every Ford Owner knows the value of a good reliable TIMER on a Ford. He has been accustomed to continual trouble—THE ORDINARY TYPE OF TIMER means nothing but trouble—THE PRINCIPLE OF CONSTRUCTION HAS BEEN WRONG—The SUPER is built on the DYNAMO TYPE—which in itself means uniformity, regularity and long life—When you consider the Big Fortunes now being made in the Ford Field you will realize the big opportunity this proposition offers you—an all-year-round seller—with tremendous profits.

Be The First in Your Locality—

Its low cost makes it easy to sell and as our advertising campaign will bring in many requests for territory it is greatly to your advantage to act now—will send sample for trial.

Weeks Super Timer Co.

426-700 Eleventh St.

MILWAUKEE, WISCONSIN

MAIL TODAY
WEEKS SUPER TIMER COMPANY, WISC.
 426-700 Eleventh St., MILWAUKEE, WISC.

Gentlemen: Kindly mail me full free information about your wonderful invention.

Name
 St. or R. F. D.
 Town
 County
 State

Be Your Own Boss

Why keep on punching the time clock? Aren't you tired of taking orders from someone else? There's nothing like being in business for yourself!

Here's your big opportunity. Grasp it. Realize your ambition. Have a profitable business of your own. Be the Johnson Floor Expert in your community. Spring, the big business season, is just ahead. Now is the time to get started. We'll help you build your business.



Earn
\$15 to \$25
a Day

Be independent! Have a home of your own—a bank account. Enjoy the comforts and luxuries of life.

As the Johnson Floor Expert you can make big money right from the start. There's a bigger demand for this service every day. Homes, clubs, hotels, stores, offices, schools and public buildings all want it.

You can go into any home, wax-polish all the floors in just a short time and not upset the rooms at all. It's the kind of service people appreciate—and it pays big profits.

Mail Coupon today for full information on the Johnson Floor Service Plan.

JOHNSON'S WAX *Electric floor Polisher*

This ingenious Electric Floor Polisher means success, independence, a profitable business of your own. It's extremely efficient. Wax-polishes any floor ten times faster and better than is possible any other way. Polishes right under

davenport, beds, buffets and desks. Johnson's Electric Floor Polisher is simple, sturdy, light, easy to handle. Runs itself from any lamp socket. Costs less than 2 cents an hour to operate. Cuts floor and linoleum maintenance costs in half.

Investment Less Than \$50

Have you ever seen such an opportunity? Think of it! A profitable business of your own for less than \$50! No more lay-offs. No dull seasons. Start giving orders instead of taking them. Have a business that will be as big as you want to make it. Get started now. Don't delay. Return coupon today.

--- MAIL ME BACK TO ---

S. C. JOHNSON & SON
Dept. P. A. 2, RACINE, WIS.

"The Floor Finishing Authorities"

Please tell me how I can earn \$15 to \$25 a day giving Johnson Floor Service.

NAME

ADDRESS

CITY & STATE

How you can make quick success in the auto business !!

Read how Clarence Jones made his start

Follow the example of this man and hundreds of others who are making good. This is your *short, sure way* to the **BIG PAY END** of the auto business. Send the coupon below *now* and get our big free Auto book. It tells you all about the Greer plan of training—how you can get just what you need in 8 to 12 weeks.

Don't Wait. You Can Start a Good Auto Job This Spring

Many men in various branches of the auto business are earning from \$50 to \$125 per week. Many who start up for themselves on a small scale are earning much more than that. Take for instance this case of Mr. Jones.

Biggest Auto Year Ahead

Most of the big auto factories are running at full speed all winter. What does that mean? It means 1926 will be by far the greatest automobile year in history. There will be millions of new cars to be kept in shape, in addition to over 20 million now in use. The shortage of trained men will be greater than ever before. The man who really **knows what he's about** is going to find 1926 a very profitable year for him. All you need is the training that will start you into the big pay end of this business.

This book tells you how the Greer Shops provide that training in 8 to 12 weeks. Think of it! A good pay job—with a big future—before spring is half gone.

What Leading Manufacturers Say

This book tells you what leading Auto Manufacturers say about Greer training. It contains letters from many men who got their start here, telling of their great success and how thankful they are to the Greer Shops. It contains so many interesting facts about the industry in general that it is a very worthwhile look for anyone interested in autos, trucks or tractors. It is illustrated with hundreds of interesting photographs.

Actual Practice on Real Cars

You get **REAL** experience in the Greer Shops—served up in the way that has **proved** to be the right way. By our system you learn easily, quickly, thoroughly. You need know nothing about automobiles to start with.

I have been helping men get started into the big money jobs of the auto business almost as long as that business has been in existence—24 years, to be exact. In those years, I have learned **what auto men need**, and have learned **how to supply it**. Our training fits you to start into any branch of the Auto, truck or tractor business.

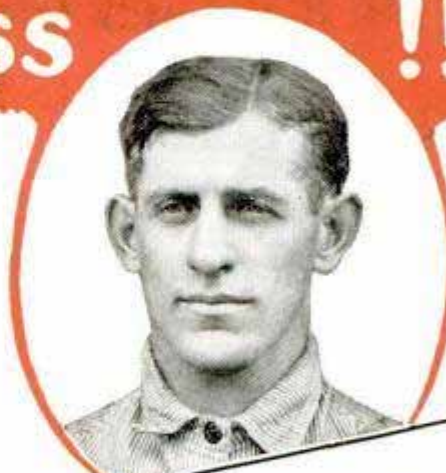

Dear Mr. Greer—
I took this opportunity of expressing my appreciation for what Greer College has done for me. I graduated from your college about a year ago and I am now in business for myself and feel that I am quite successful.
The training which I have received in the Greer shops has given me the foundation on which to build a future far surpassing my most sanguine expectations.
Considering the fact that I have been in business for only a year, I feel that the success that I have attained in the last nine months for my own work, which amounted to about \$250.00 is very gratifying. If the business comes this way for me, regularly, it won't be long before I can branch out and have a small amount of stock of my own, dealing in new and used tires, radiators, etc., and greasing.
Just as soon as we get a few more orders, I will be able to get on three more men and I prefer Greer graduates.
Yours sincerely,
Clarence Jones
8700 Sherhart Ave.,
Chicago, Ill.

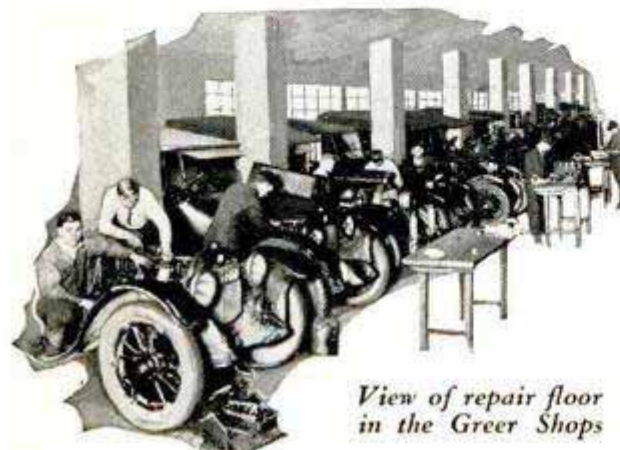

View of repair floor in the Greer Shops

Start Right — land one of these jobs

- Automobile Repairmen —\$125 to \$250 per month
- Head Automotive Mechanic —\$150 to \$500 per month
- Automobile Salesmen —Up to \$20,000 per year
- Garage Owners —\$300 to \$5,000 per month
- Garage Managers —\$150 to \$350 per month
- Storage Battery Men —\$150 to \$300 per month
- Electrical Experts —\$175 to \$350 per month
- Truck and Tractor Men —\$6.00 to \$10.00 per day
- Tire Experts —\$150 to \$250 per month



The 7 story home of the Greer Shops

Repairs —\$125 to \$250 per month

Free Employment Service

Our employment department is in touch with the best jobs available at all times. We help you get started in the right place when you are ready. Part time jobs while learning if desired.

Send the coupon **now** so you will get full information quickly. You want to land that good job this spring and this book is going to show you how. Address me personally, please

ERWIN GREER, President

ERWIN GREER, President
Greer College Automotive and Electrical Trades
2024 South Wabash Ave., Dept. 201, Chicago
Please send me your **FREE BOOK** and offer. It is understood that I am not obligated in any way.

Name.....
Address.....

Solid walnut cabinet. Compartments for all batteries—no unsightly wires. Built in imported loud speaker.

Five tube, tuned radio frequency. Cabinet 50 inches long, 26 inches deep and 42 inches high. Retail price including all accessories

19750

Built to equal the best in radio and yet sell at a price within the reach of all.

OZARKA



Handy portable radio, built-in loud speaker. Compact, light in weight, uses dry cells. An ideal instrument for home use as well as outdoors. Weight complete 25 lbs. Retail price including all accessories.....

\$7500



Five tube tuned radio frequency, built-in loud speaker and space for "B" batteries. Cabinet 25" long and 16 1/2" deep. Bronze panel, longest distance possible, selective and a tone which will please. Retail price complete with all accessories.....

\$10000



Extra long distance radio, loud, clear reception coast to coast. Large cabinet, space for "B" batteries. Furnished complete with imported English Hi-Power loud speaker built to more than meet any competition for distance, tone, volume or selectivity retails complete with loud speaker and accessories for.....

\$12500



Make More Money Sell Radio in Spare Time-Evenings

IN four years we have taught 3700 men how to make \$50 to \$100 a week selling Ozarka radio instruments, evenings.

These men were not experienced salesmen—our (12) FREE Sales Lessons taught them just what they needed. They did not understand radio—our (10) FREE Radio Service Lessons gave them the technical knowledge they needed. Today many of these men have been so successful they have been able to give up their jobs, put all their time on Ozarka. Many have other men working for them.

What these men have done, others can do, who are willing to try.

Ozarkas are sold in competition with all other instruments—results speak for themselves—distance, volume, tone, selectivity and appearance. Your selling price is away under any instrument of similar high quality—the commissions are large, from \$30.00 to \$60.00 a sale—two sales weekly is a low average.

We not only furnish sales and service lessons and leads from our national advertising but attractive literature, booklets, letterheads, envelopes, business cards, window signs,

movie slides and movie reels all with your name printed on them. Your selling is made just as easy as possible—the results of these 3700 men prove this. The necessary investment is small—the possible profits are large. In territory, not now covered, we need exclusive Ozarka representatives.

Send for Our 84-Page Book —The Ozarka Plan

You'll find this book very different to any you ever read—it's a true story of life, why some men struggle to get ahead while others make money rapidly. You'll find it a thoroughly tried out and proven plan of making money in your spare time—an entirely different and easier plan of selling radio—the on article in big demand today.

While this book has been expensive to publish it is FREE to any man who is anxious to get ahead. It has meant a turning point in many a man's life—it may mean the same to you. Costs nothing to get it, and yet may mean so much. If you really want to make more money, you'll send for it today! Simply use the coupon below!

Use This Coupon!

OZARKA, INC.,
120 Austin Avenue P,
Chicago, Ill.

I am greatly interested in the FREE Book, Ozarka Plan No. 100, telling how I can establish myself in the radio business and increase my present income.

Name.....

Address..... City.....

OZARKA INCORPORATED

120 Austin Avenue P : Chicago, Illinois

Иллюстрация: эдвардский дизайнерский проект